

aiwa

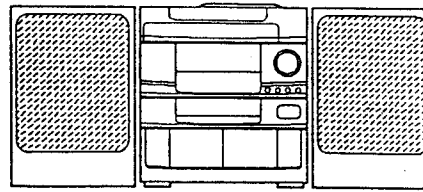

Z-M2900

COMPACT DISC STEREO
CASSETTE RECEIVER

SYSTEM	CD-CASSEIVER	SPEAKER
Z-M2900	CX-ZM2900	SX-Z290

- BASIC TAPE MECHANISM : ZM-3MK2 PR6N
- BASIC CD MECHANISM : 6ZG-1 DFNM
- TYPE : V

C VR C.B SCHEMATIC DIAGRAM - 4 (VR)

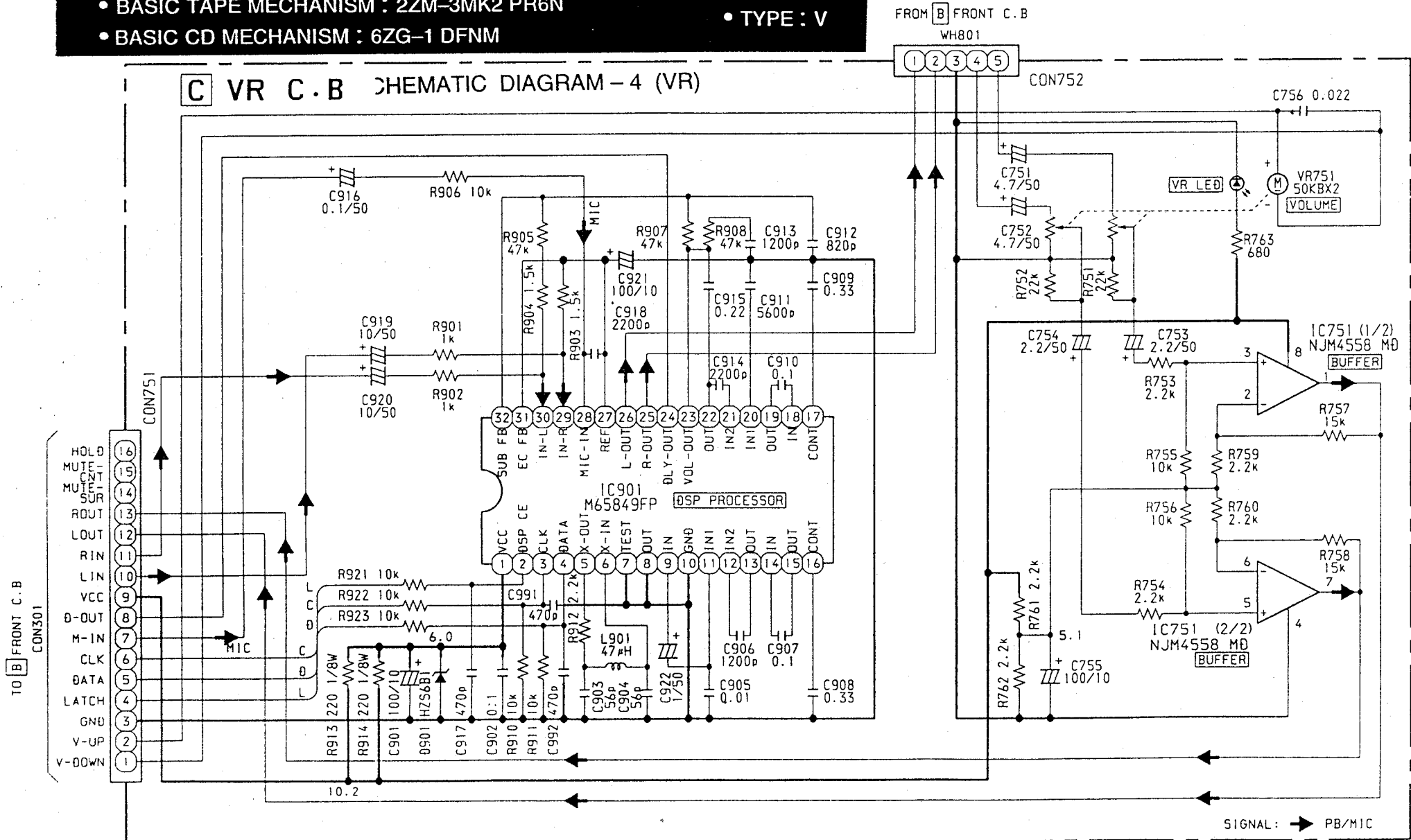

BLOCK DIAGRAM - 2 (MAIN / FRONT)

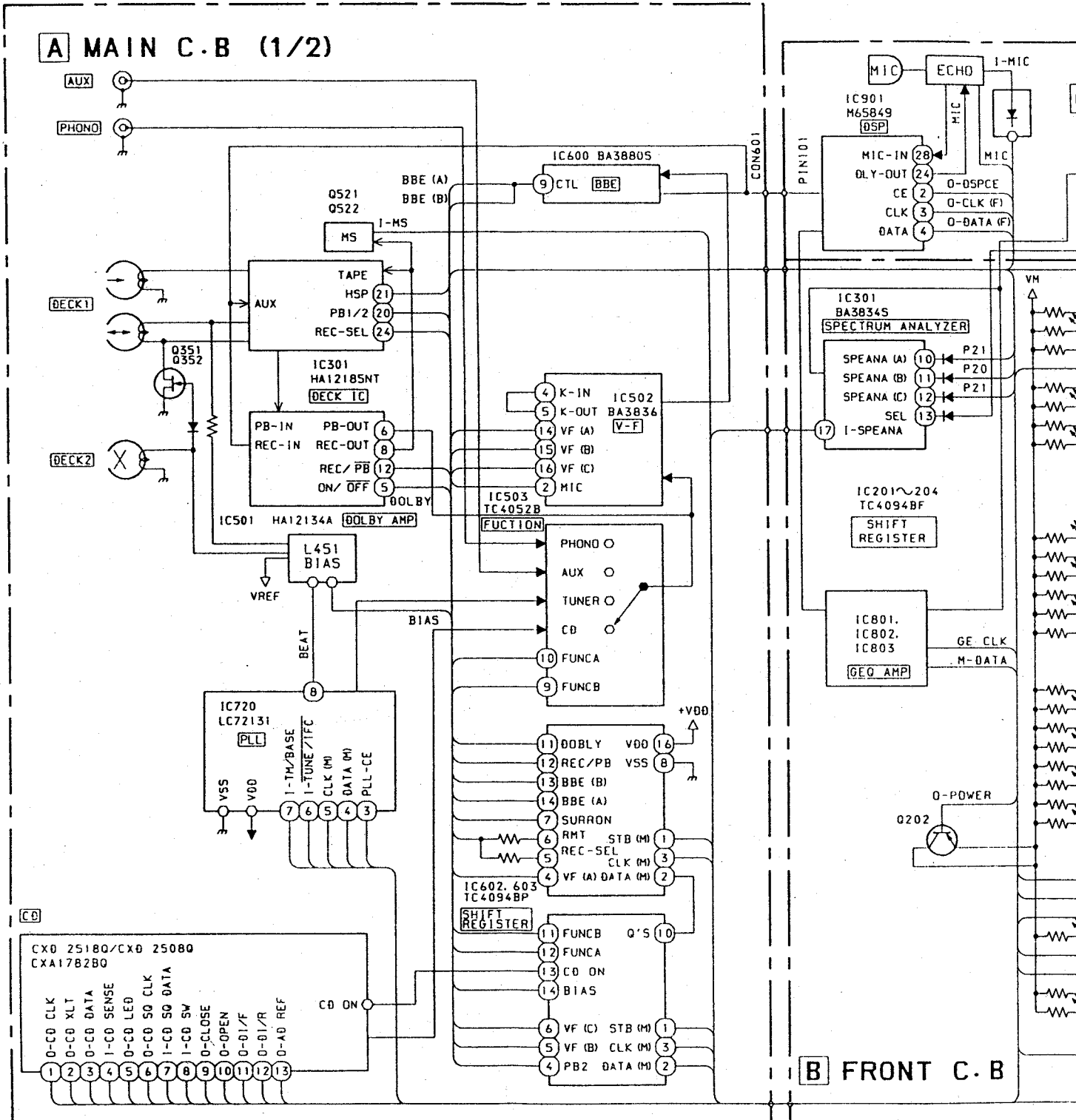

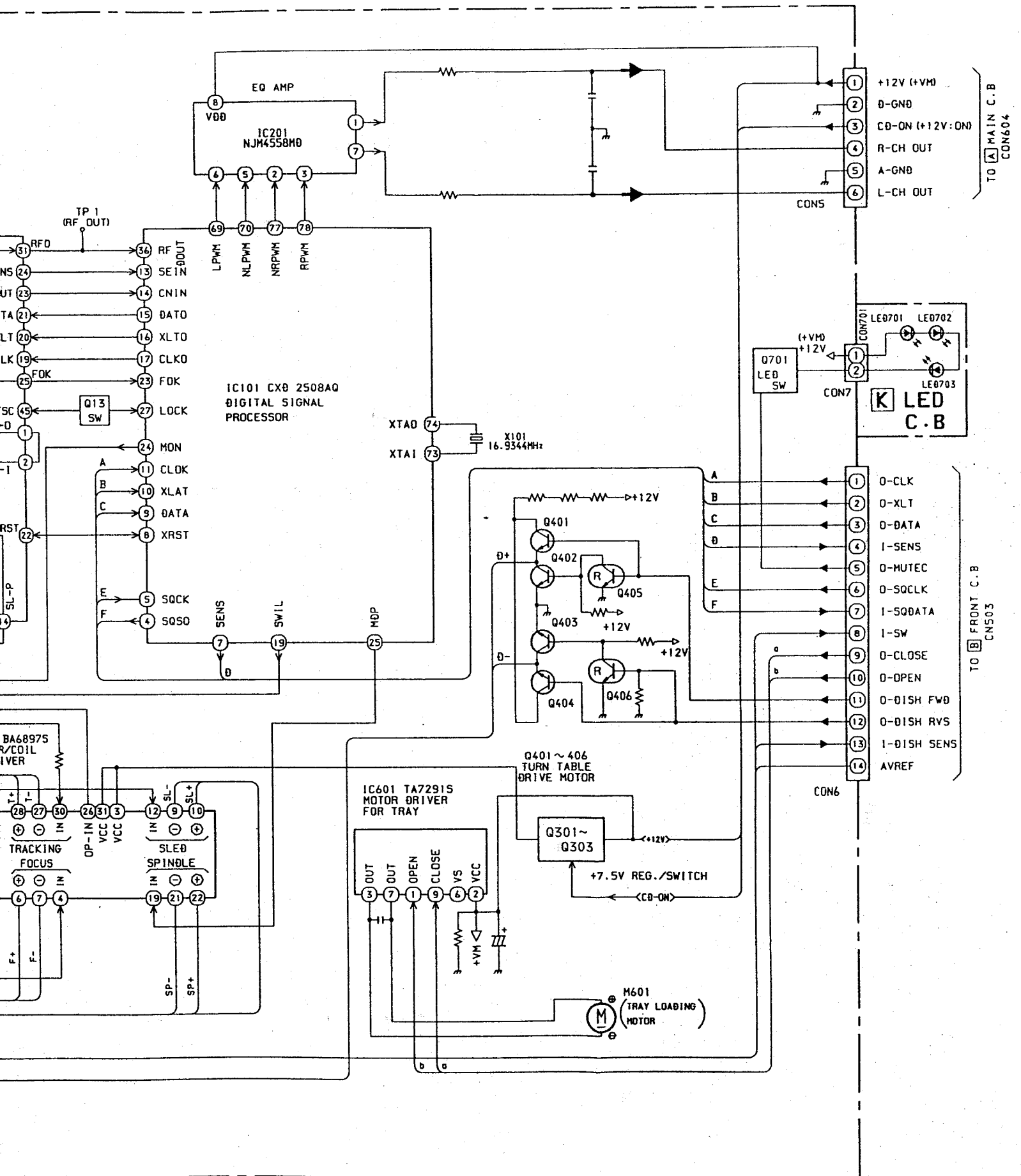
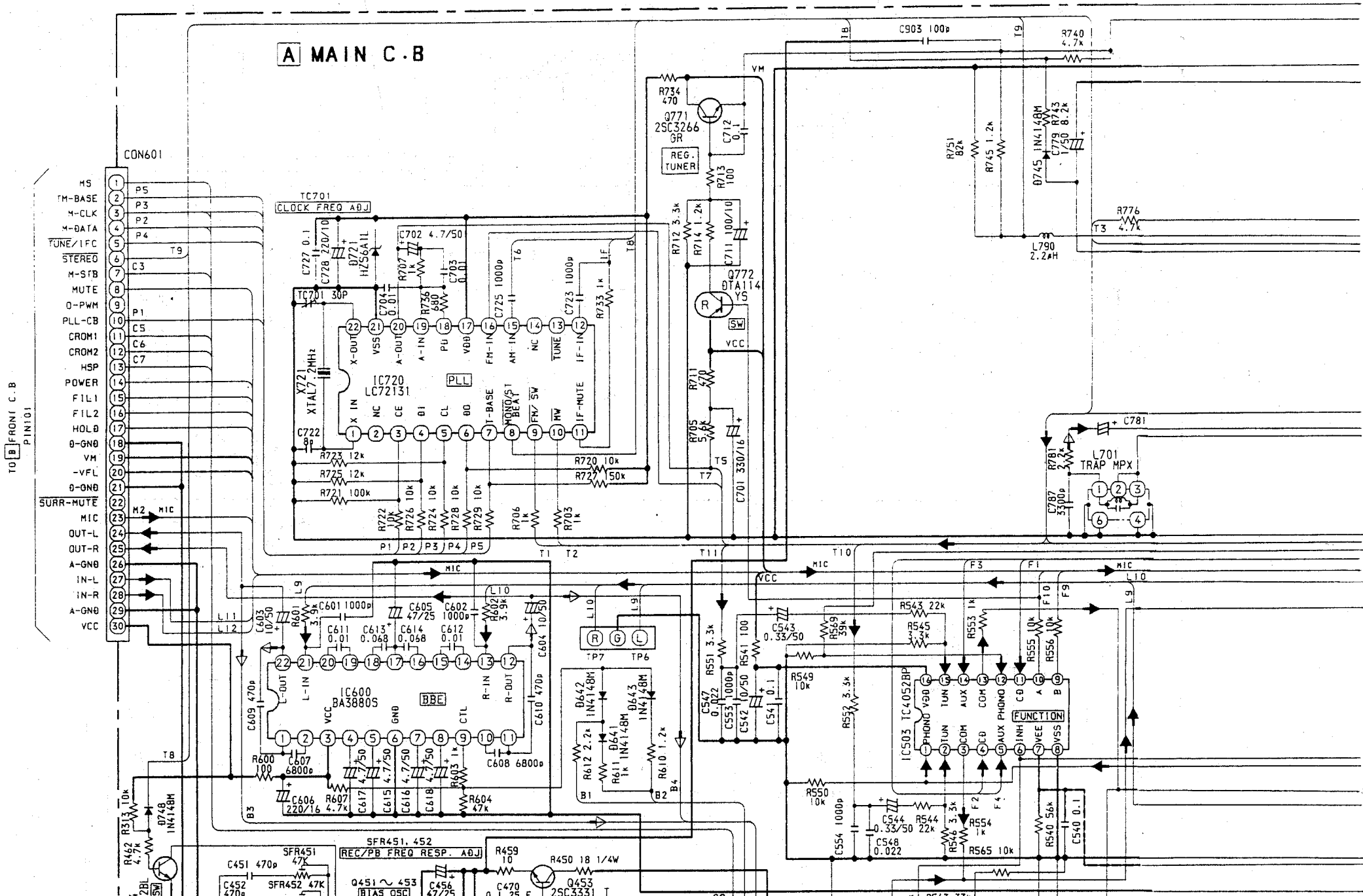
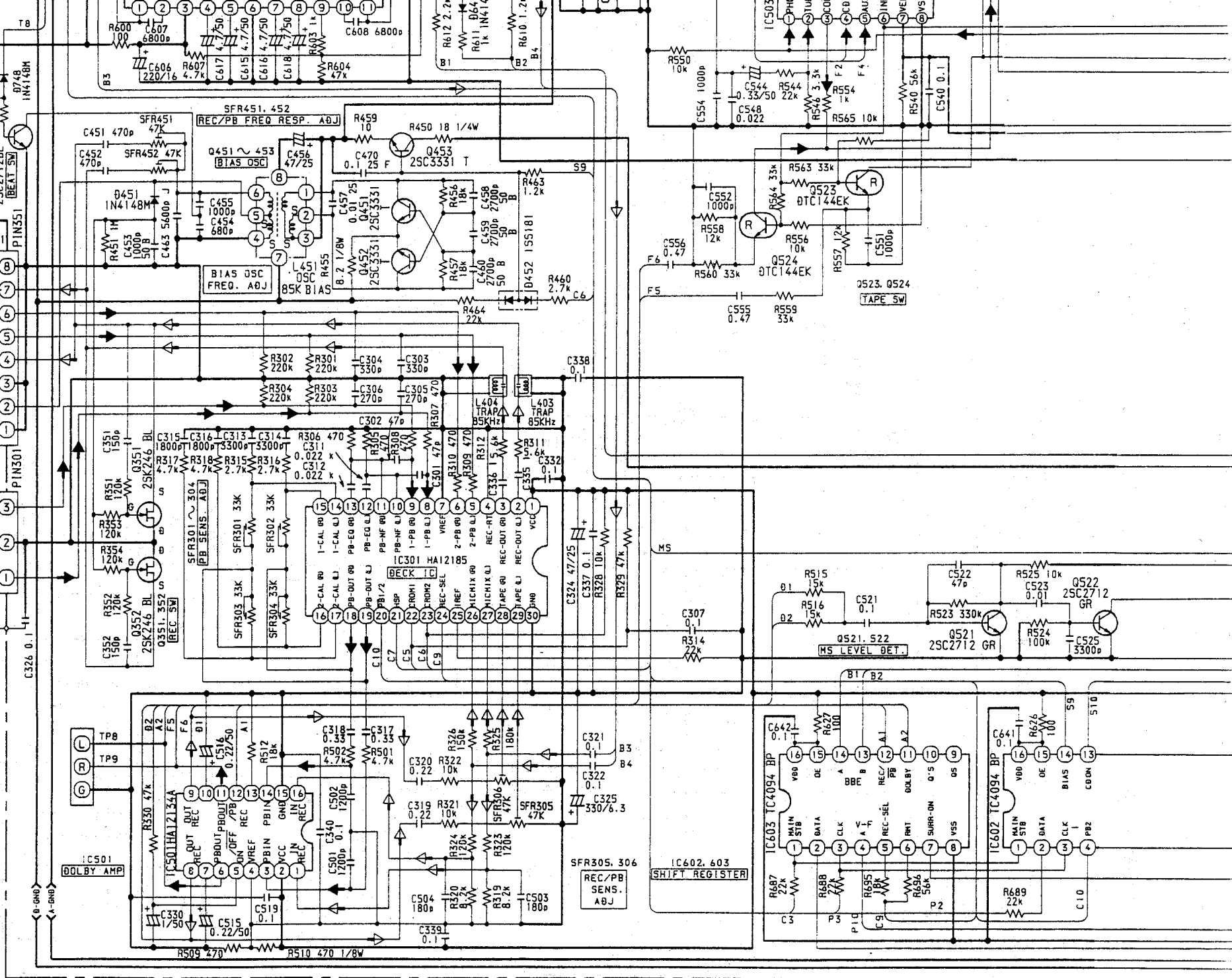
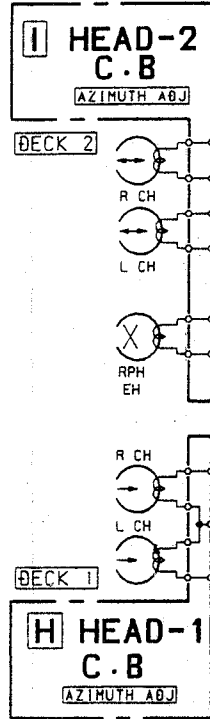
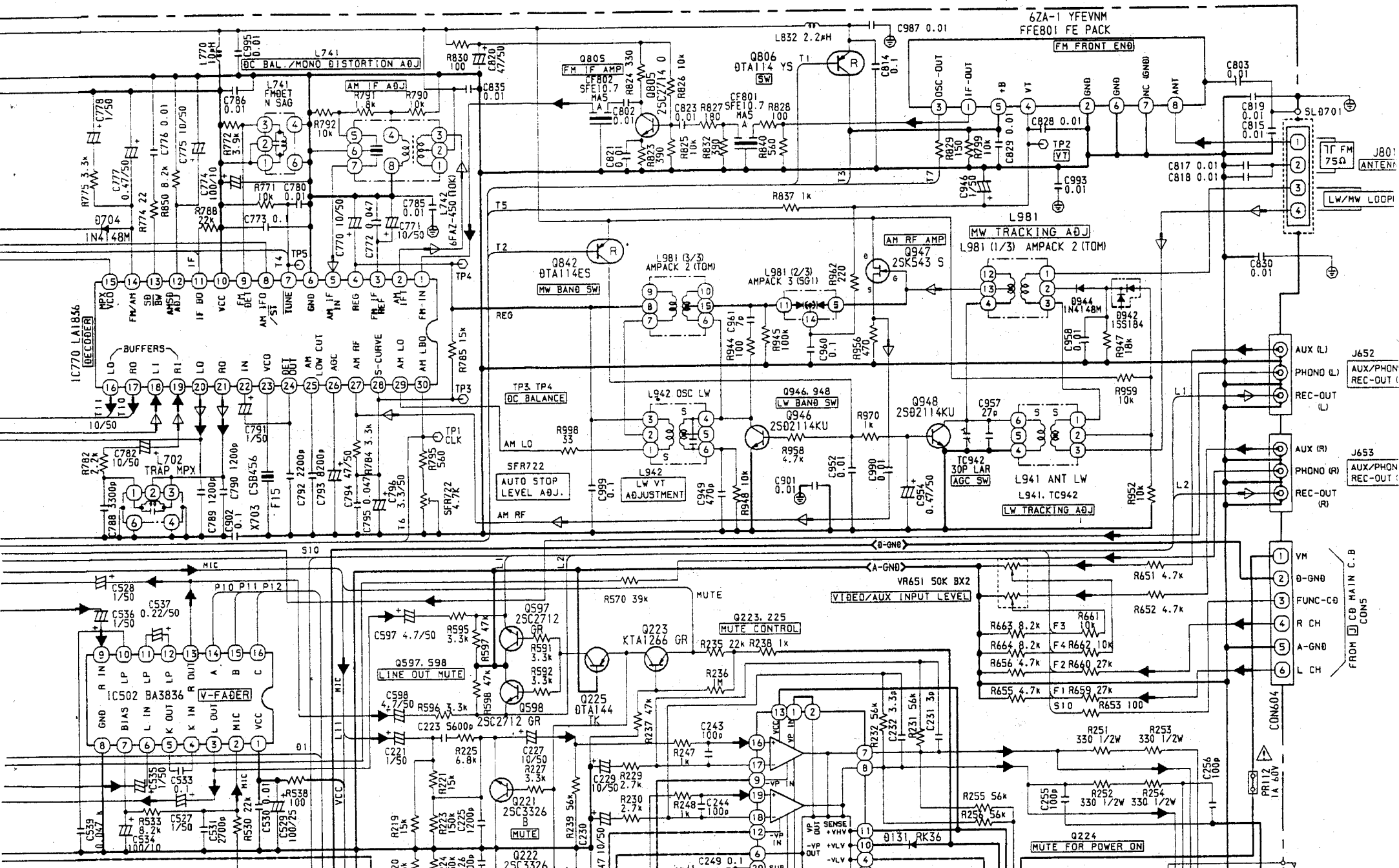
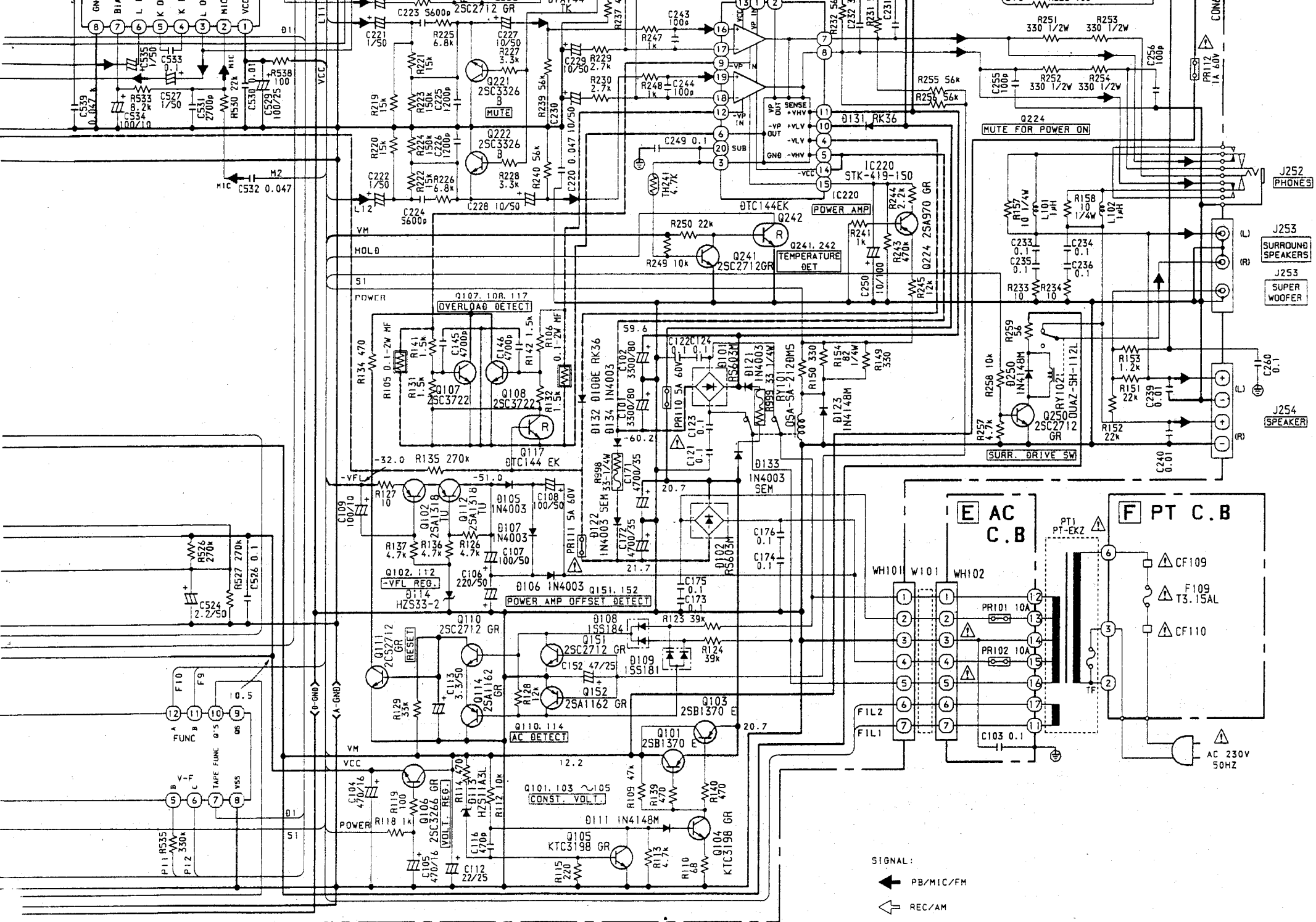

DIAGRAM - 1 (MAIN)









SCHEMATIC DIAGRAM - 2 (FRONT)

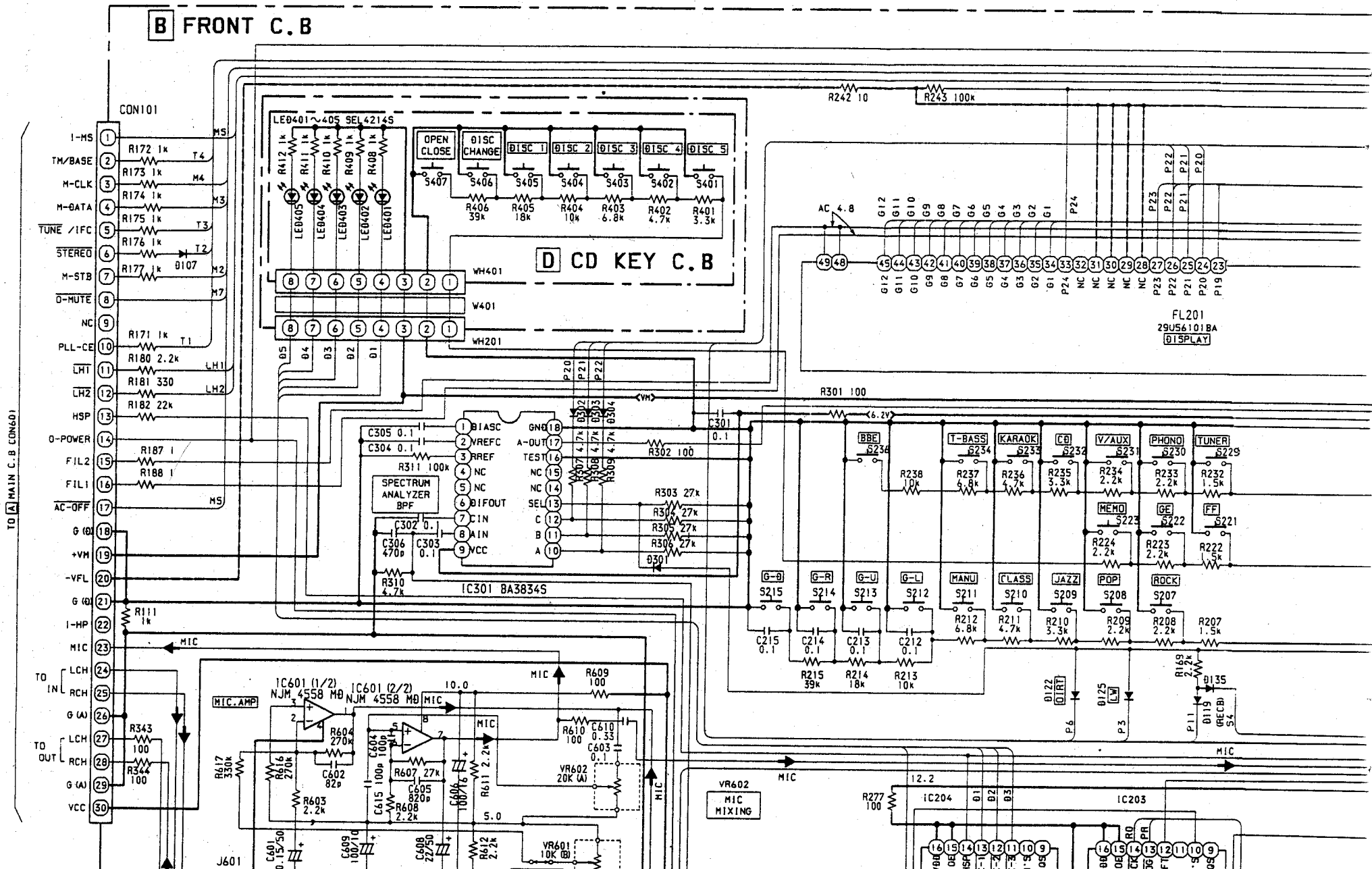

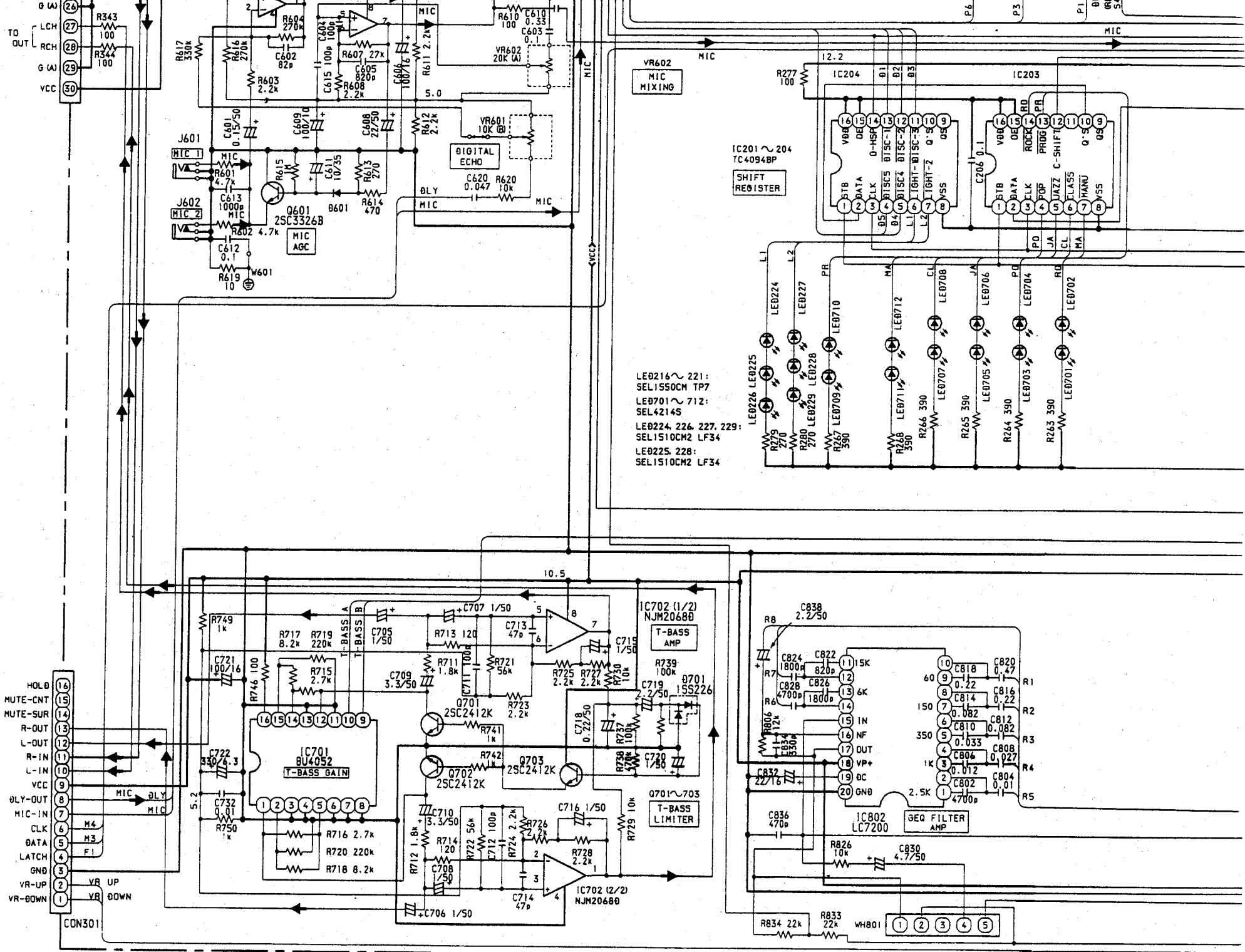

- LE0216 ~ 221: SEL1550CM TP7
- LE0701 ~ 712: SEL4214S
- LE0224, 226, 227, 229: SEL1510CM2 LF34
- LE0225, 228: SEL1510CM2 LF34

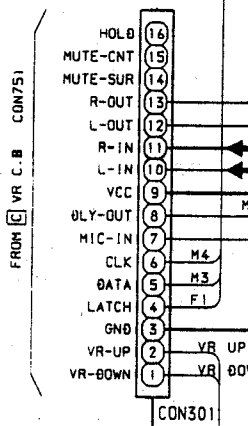

TO VR C.B CON752

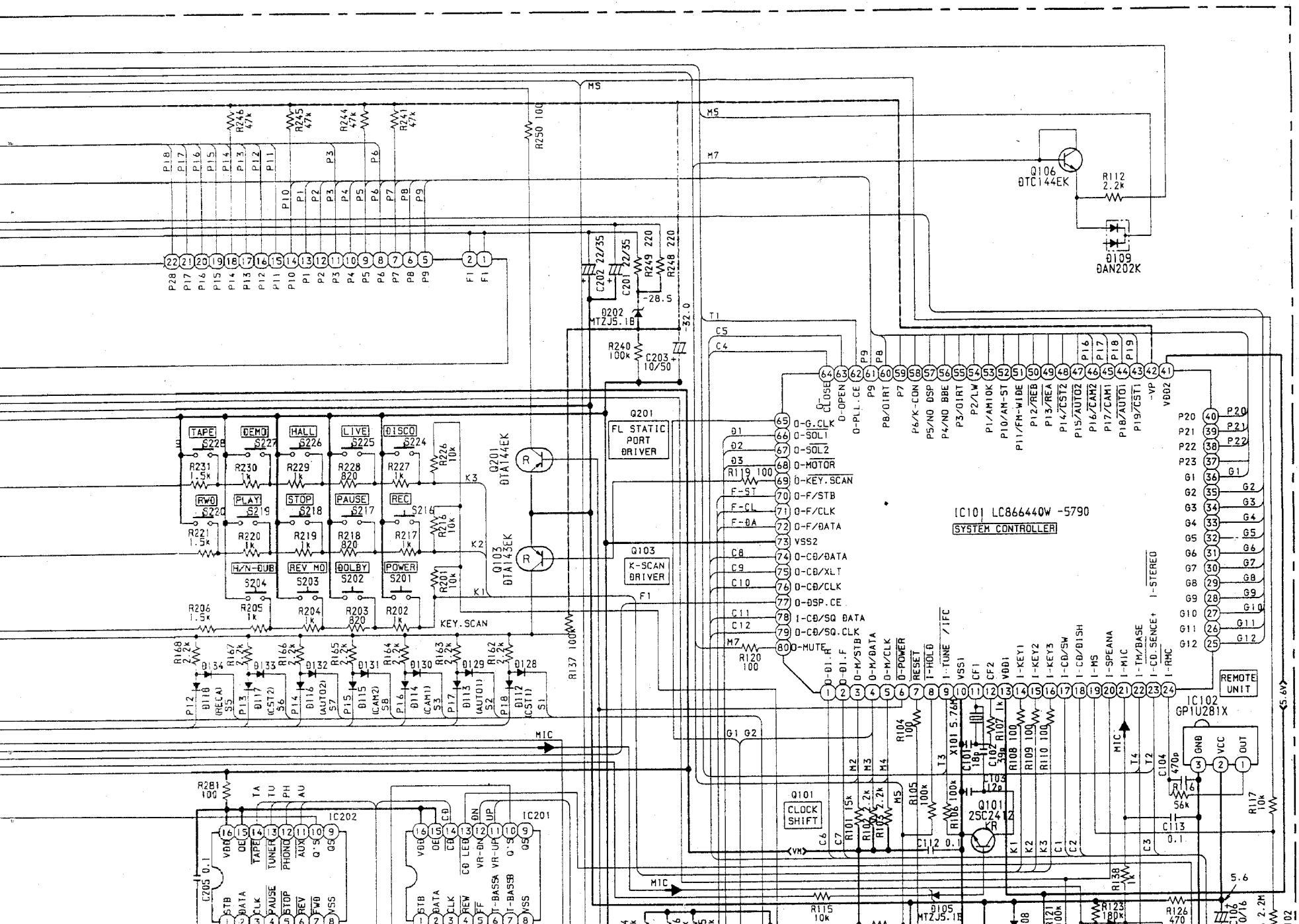

IC101 LC866440W-5790
SYSTEM CONTROLLER

IC102 GP1U2B1X

Q101
CLOCK
SHIFT

Q201
FL STATIC
PORT
DRIVER

Q103
K-SCAN
DRIVER

Q106
DTC144EK

Q109
DAN202K

REMOTE
UNIT

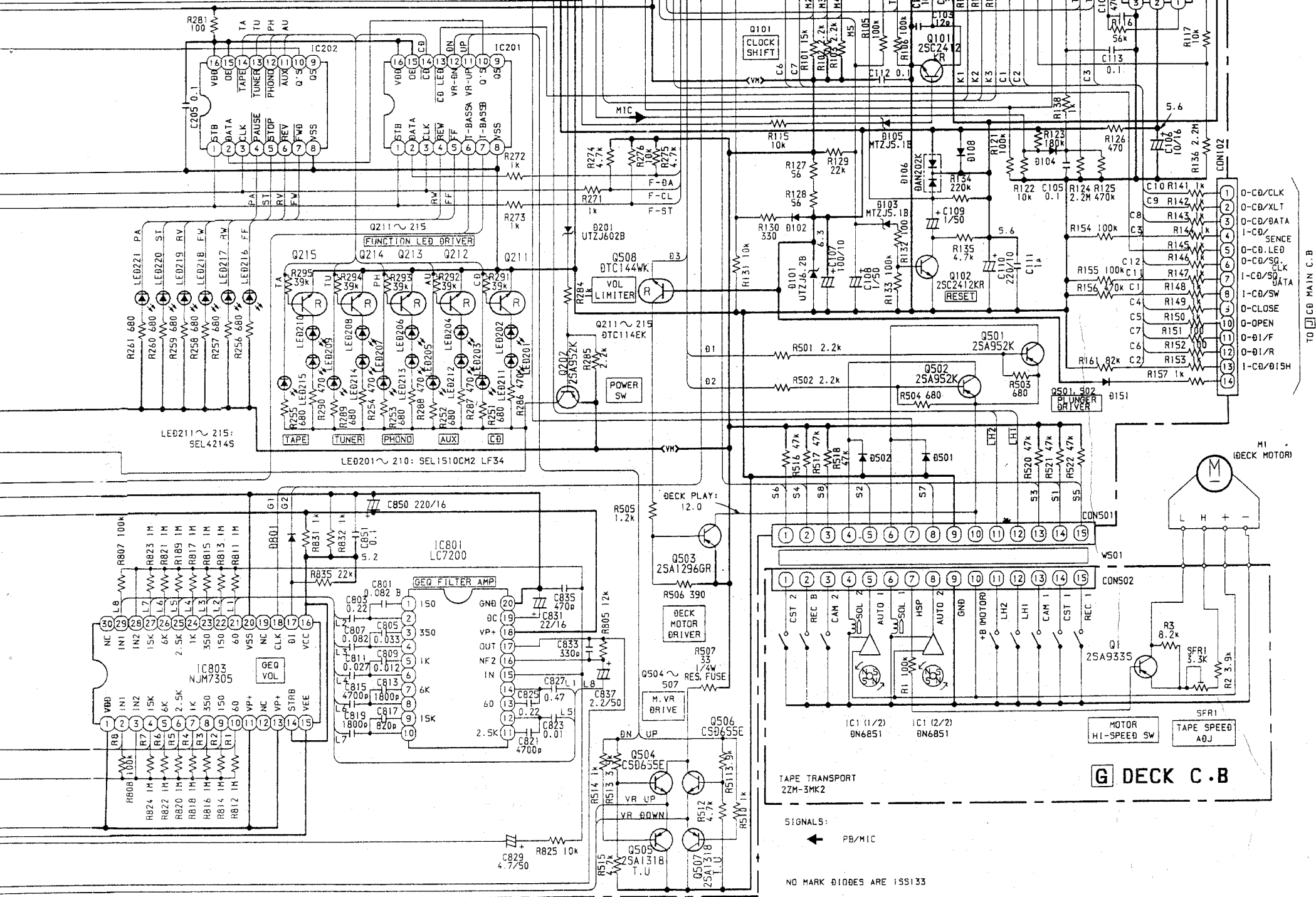

J CD MAIN C.B

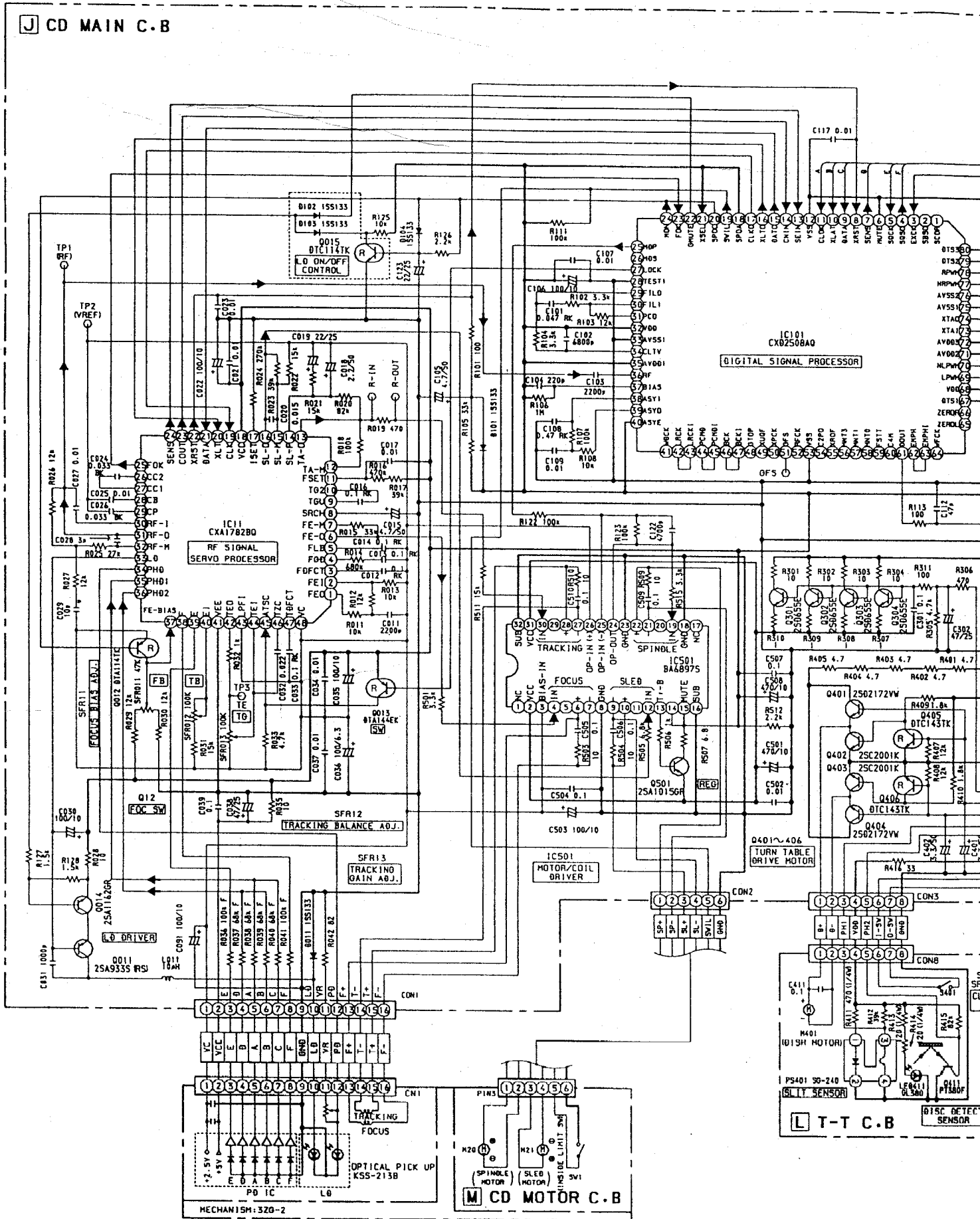

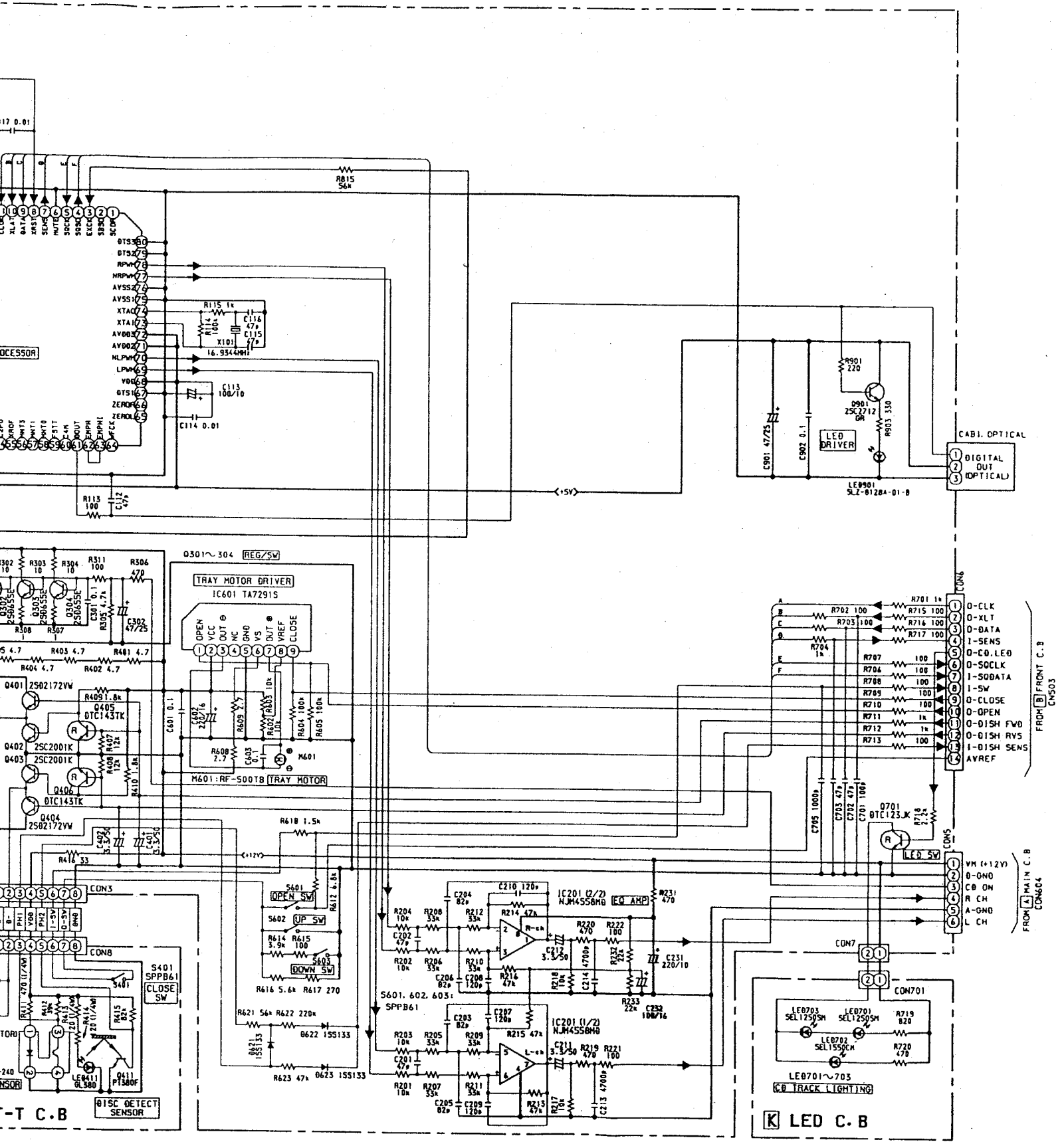

SIGNAL:

- ➔ ANALOG
- CONTROL

CABINET OPTICAL

- 1 DIGITAL
- 2 OUT
- 3 OPTICAL

FROM FRONT C.B.
CON503

FROM MAIN C.B.
CON604

LE0701~705
CB TRACK LIGHTING

K LED C.B.

CON6

- 1 0-CLK
- 2 0-XLT
- 3 0-DATA
- 4 I-SENS
- 5 0-CO.LEO
- 6 0-SOCLK
- 7 1-SODATA
- 8 1-SW
- 9 0-CLOSE
- 10 0-OPEN
- 11 0-DISH FWD
- 12 0-DISH RVS
- 13 1-DISH SENS
- 14 AVREF

CON7

- 1 VM (+12V)
- 2 0-GND
- 3 CB ON
- 4 R CH
- 5 A-GND
- 6 L CH