

Video Cassette Recorder

Operating Instructions



Hi-Fi

SLV-SE610G
SLV-SE710G
SLV-SE710I
SLV-SE810G

VIDEOplus®
VIDEOplus®
VIDEOplus®

WARNING



To prevent fire or shock hazard, do not expose the unit to rain or moisture.

To avoid electrical shock, do not open the cabinet. Refer servicing to qualified personnel only.

Mains lead must only be changed at a qualified service shop.

Notice for customers in the United Kingdom and Republic of Ireland

A moulded plug complying with BS1363 is fitted to this equipment for your safety and convenience. If the 13A fitted plug does not match the outlet socket in your home, please refer to your Appointed Sony Dealer for advice.

Should the fuse in the plug supplied need to be replaced, a 5 AMP fuse approved by ASTA or BSI to BS1362, (i.e., marked with  or  mark) must be used.

If the plug supplied with this equipment has a detachable fuse cover, be sure to attach the fuse cover after you change the fuse. Never use the plug without the fuse cover. If you should lose the fuse cover, please contact your nearest Sony service station.

Precautions

Safety

- This unit operates on 220 – 240 V AC, 50 Hz. Check that the unit's operating voltage is identical with your local power supply.
- If anything falls into the cabinet, unplug the unit and have it checked by qualified personnel before operating it any further.
- The unit is not disconnected from the mains as long as it is connected to the mains, even if the unit itself has been turned off.
- Unplug the unit from the wall outlet if you do not intend to use it for an extended period of time. To disconnect the cord, pull it out by the plug, never by the cord.

Installing

- Allow adequate air circulation to prevent internal heat buildup.
- Do not place the unit on surfaces (rugs, blankets, etc.) or near materials (curtains, draperies) that may block the ventilation slots.
- Do not install the unit near heat sources such as radiators or air ducts, or in a place subject to direct sunlight, excessive dust, mechanical vibration or shock.
- Do not install the unit in an inclined position. It is designed to be operated in a horizontal position only.
- Keep the unit and cassettes away from equipment with strong magnets, such as microwave ovens or large loudspeakers.
- Do not place heavy objects on the unit.
- If the unit is brought directly from a cold to a warm location, moisture may condense inside the VCR and cause damage to the video head and tape. When you first install the unit, or when you move it from a cold to a warm location, wait for about three hours before operating the unit.

Caution

Television programmes, films, video tapes and other materials may be copyrighted. Unauthorized recording of such material may be contrary to the provisions of the copyright laws. Also, use of this recorder with cable television transmission may require authorization from the cable television transmitter and/or programme owner.

Compatible colour systems

This VCR is designed to record and play back using the PAL colour system. Recording of video sources based on other colour systems cannot be guaranteed.

VIDEO Plus+ and PlusCode are registered trademarks of Gemstar Development Corporation. The VIDEO Plus+ system is manufactured under license from Gemstar Development Corporation.

Table of contents

Getting Started

- 4 Index to parts and controls
- 10 Step 1 : Unpacking
- 11 Step 2 : Setting up the remote commander
- 15 Step 3 : Connecting the VCR
- 19 Step 4 : Setting up the VCR with the Auto Set Up function
- 21 Step 5 : Tuning your TV to the VCR
- 23 Selecting a language
- 24 Presetting channels
- 27 Changing/disabling programme positions
- 32 Setting the clock
- 36 Setting your personal code

Basic Operations

- 38 Playing a tape
- 40 Recording TV programmes
- 43 Recording TV programmes using the Dial Timer (SLV-SE810G only)
- 48 Recording TV programmes using the VIDEO Plus+ system (not available on SLV-SE610G)
- 52 Recording TV programmes using the timer

Additional Operations

- 56 Playing/searching at various speeds
- 58 Setting the recording duration time
- 59 Synchronized Recording (not available on SLV-SE610G)
- 61 Checking/changing/cancelling timer settings
- 63 Recording stereo and bilingual programmes
- 65 Searching using the Smart Search function
- 67 Storing, searching and deleting programme information (Smart Search Plus)
- 72 Searching using the index function
- 73 Adjusting the picture
- 75 Reducing the VCR's power consumption
- 76 Changing menu options

Editing

- 79 Connecting to a VCR or stereo system
- 81 Basic editing
- 82 Audio dubbing (SLV-SE810G only)

Additional Information

- 83 Troubleshooting
- 87 Specifications
- 88 Index

Back Cover

Quick Start Guide

Index to parts and controls

Refer to the pages indicated in parentheses () for details.

Front panel

SLV-SE810G

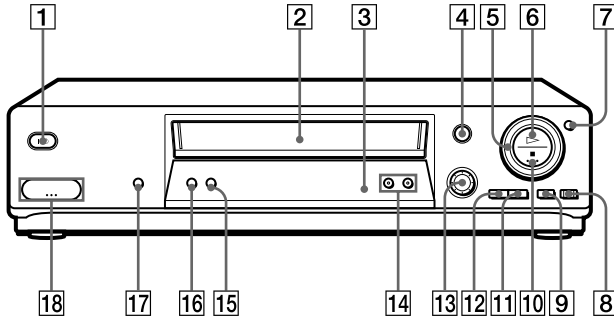

- | | |
|--|--|
| <p>1 I/⏻ (on/standby) switch (36)</p> <p>2 Tape compartment</p> <p>3 Remote sensor (11)</p> <p>4 ≡ (eject) button (38)</p> <p>5 Shuttle ring (56)</p> <p>6 ▷ (play) button (38) (56)</p> <p>7 JOG button (57)</p> <p>8 ● REC (record) button (40) (58) (81)</p> <p>9 (pause) button (38) (81)</p> <p>10 ■ (stop) button (38) (81)</p> <p>11 ►► (fast-forward) button (38) (56)</p> <p>12 ◀◀ (rewind) button (38) (56)</p> | <p>13 ⊕ DIAL TIMER (43)</p> <p>14 PROGRAM +/- buttons (22) (57) (73)</p> <p>15 AUDIO DUB button (82)</p> <p>16 AUTO SET UP/R F (Radio Frequency) CHANNEL button (19) (21)</p> <p>17 SYNCHRO REC (Synchronized Recording) button (59)</p> <p>18 ↻ LINE-2 L (left) ↻ R (right) jacks (covered) (79) (80)</p> <p>How to open the jack cover</p> <p>1 Press the bottom of the cover.</p> <p>2 Hook your finger on the top edge of the cover and pull it open.</p> |
|--|--|

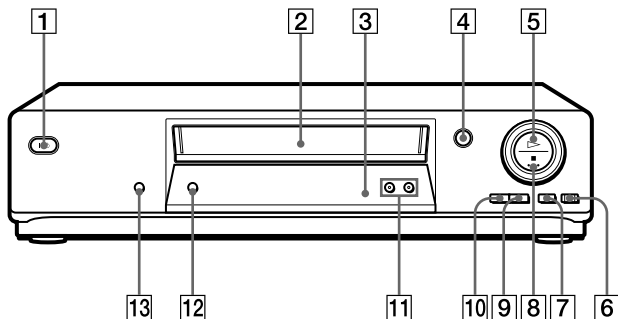

- | | |
|---|--|
| <p>1 I/O (on/standby) switch (36)</p> <p>2 Tape compartment</p> <p>3 Remote sensor (11)</p> <p>4 ≡ (eject) button (38)</p> <p>5 ▷ (play) button (38) (56)</p> <p>6 ● REC (record) button (40) (58) (81)</p> <p>7 (pause) button (38) (81)</p> <p>8 ■ (stop) button (38) (81)</p> | <p>9 ►► (fast-forward) button (38) (56)</p> <p>10 ◀◀ (rewind) button (38) (56)</p> <p>11 PROGRAM +/- buttons (22) (57) (73)</p> <p>12 AUTO SET UP/RF (Radio Frequency) CHANNEL button (19) (21)</p> <p>13 SYNCHRO REC (Synchronized Recording) button* (59)</p> |
|---|--|

* not available on SLV-SE610G

Display window

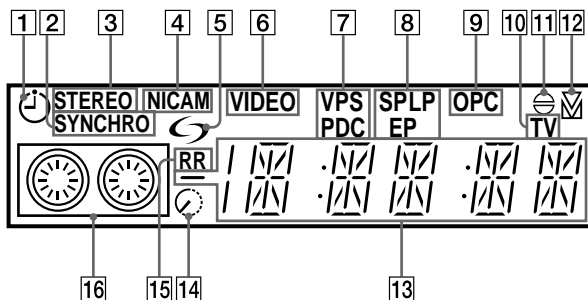

1 Timer indicator (45) (50) (53)

2 SYNCHRO indicator*¹ (60)

3 STEREO indicator (63)

4 NICAM indicator (63)

5 ↻ (smartlink) indicator*¹ (17)

6 VIDEO indicator (16) (41)

7 VPS (Video Programme System)/
PDC (Programme Delivery Control)
indicator*¹ (50)

8 Tape speed indicators (40)

9 OPC (Optimum Picture Control)
indicator (74)

*¹not available on SLV-SE610G

*²SLV-SE810G only

10 TV indicator*¹ (42)

11 Audio dubbing indicator*² (82)

12 Tracking indicator (73)

13 Time counter/clock/line/programme
position indicator (38) (40) (81)

14 Remaining time indicator (40)

15 RR (Reality Regenerator) indicator
(73)

16 Tape/recording indicator (40)

Rear panel

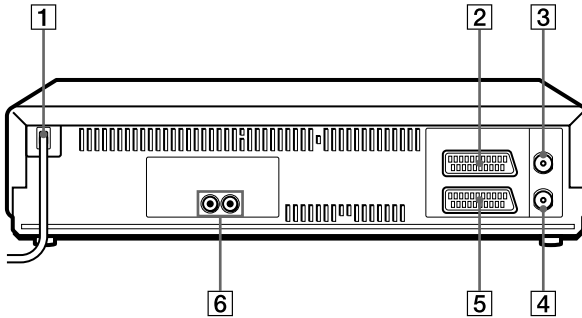

1 Mains lead (15) (16)

2 ↷ LINE-2 IN
 ↷ ENTREE LIGNE-2 connector*¹
 (18) (59) (80)

↷ LINE-3 IN
 ↷ ENTREE LIGNE-3 connector*²
 (18) (59) (80)

3 AERIAL IN
 ANTENNE ENTREE connector (15)
 (16)

4 AERIAL OUT
 ANTENNE SORTIE connector (15)
 (16)

5 ↷ LINE-1 (TV)
 ↷ LIGNE-1 (TV) connector (16)
 (79)

6 ↷ (audio out) R/D (right) L/G (left)
 jacks*³ (18)

*¹SLV-SE710G, and SE710I only

*²SLV-SE810G only

*³not available on SLV-SE610G

continued

Remote commander

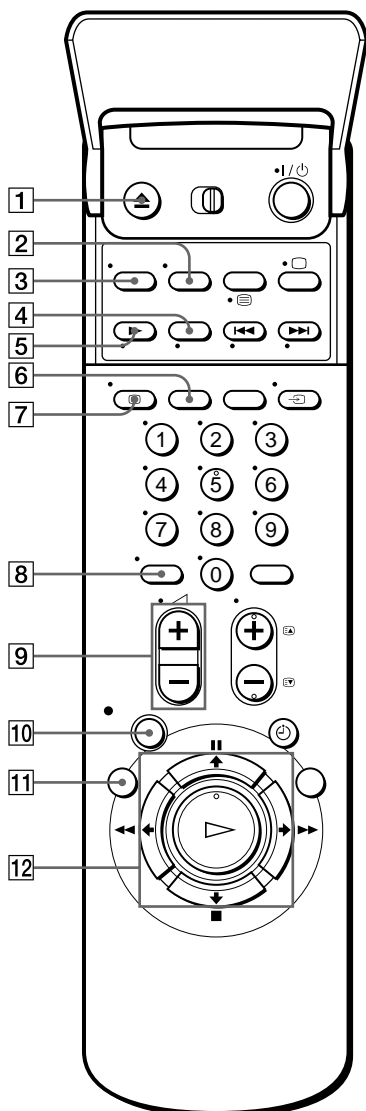

- 1 ▲ EJECT button (38)
- 2 WIDE button (*for TV*) (13)
- 3 AUDIO MONITOR button (63)
- 4 ×2 button*¹ (56)
- 5 ► SLOW button*¹ (56)
- 6 SP (Standard Play)/LP (Long Play) button (40)
- 7 DISPLAY button (40)
- 8 -/- (ten's digit) button (12) (41)
- 9 (volume) +/- buttons (*for TV*) (13)
- 10 ● REC (record) button (40) (58)
- 11 MENU button (32) (61)
- 12 PAUSE/▲ button (32) (38)
 STOP/▼ button (32) (38)
 ◀◀ REW (rewind)/◀ button (38) (56)
 ▶▶ FF (fast-forward)/▶ button (38) (56)
 ▷ PLAY/OK button (32) (38)

*¹FASTEXT buttons (*for TV*) (not available on SLV-SE610G, SE710G, SE710I)

*²not available on SLV-SE610G, SE710G, SE710I

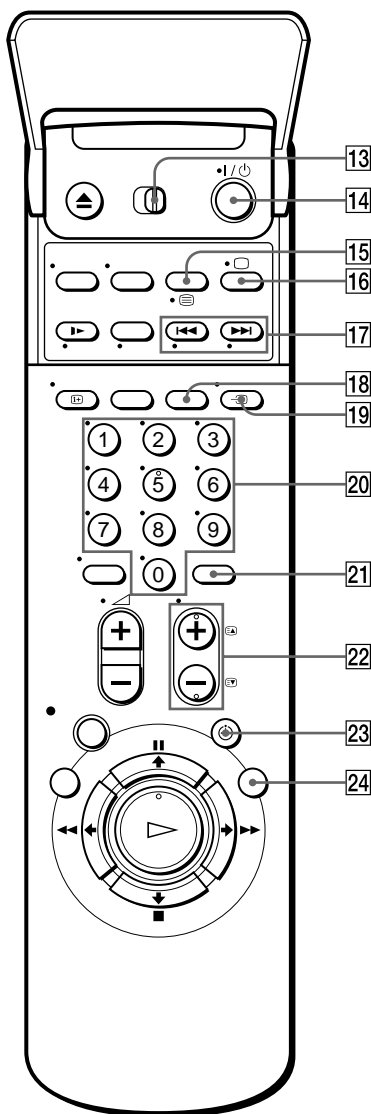

13 TV / VIDEO remote control switch (11)

14 I/⏻ (on/standby) switch (12) (50)

15 COUNTER/REMAIN button (40)

☰ (Teletext) button*² (for TV) (13)

16 □ TV power on/TV mode select button*² (for TV) (12)

17 ◀◀▶▶ INDEX SEARCH buttons*¹ (72)

18 CLEAR button (38) (49) (61)

19 ↻ TV/VIDEO button (12) (16) (41)

20 Programme number buttons (12) (41)

21 INPUT SELECT button (41) (53) (81)

22 PROG (programme) +/- buttons (12) (25) (40)

⬆️/⬇️ Teletext page access buttons*² (for TV) (13)

23 ⏰ TIMER button (48) (52)

24 SMART SEARCH button (65)

*¹ FASTTEXT buttons (for TV) (not available on SLV-SE610G, SE710G, SE710I)

*² not available on SLV-SE610G, SE710G, SE710I

Step 1 : Unpacking

Check that you have received the following items with the VCR:

- Remote commander
- Aerial cable

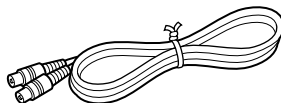
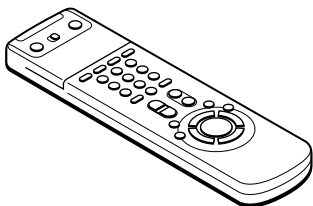

- R6 (size AA) batteries

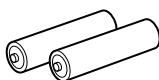

Check your model name

The instructions in this manual are for the 4 models: SLV-SE610G, SE710G, SE710I, and SE810G. Check your model number by looking at the rear panel of your VCR.

SLV-SE810G is the model used for illustration purposes. Any difference in operation is clearly indicated in the text, for example, "SLV-SE610G only."

Step 2 : Setting up the remote commander

Inserting the batteries

Insert two R6 (size AA) batteries by matching the + and – on the batteries to the diagram inside the battery compartment.

Insert the negative (–) end first, then push in and down until the positive (+) end clicks into position.

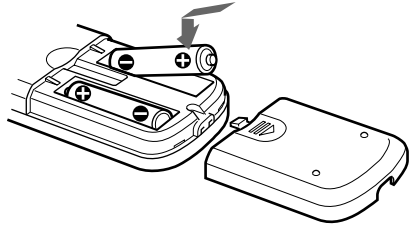

Using the remote commander

You can use this remote commander to operate this VCR and a Sony TV. Buttons on the remote commander marked with a dot (•) can be used to operate your Sony TV. If the TV does not have the  symbol near the remote sensor, this remote commander will not operate the TV.

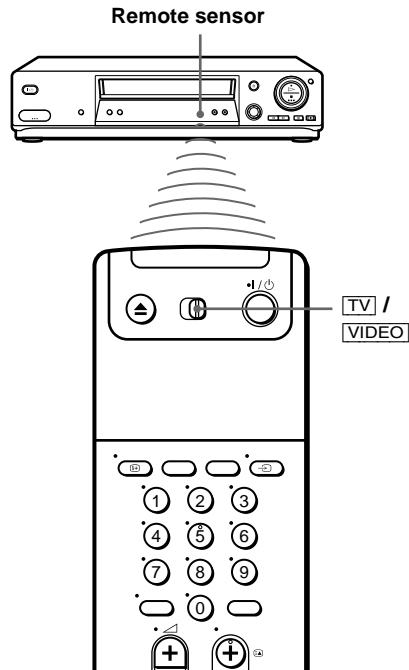

To operate	Set TV / VIDEO to
the VCR	VIDEO and point at the remote sensor at the VCR
a Sony TV	TV and point at the remote sensor at the TV

continued

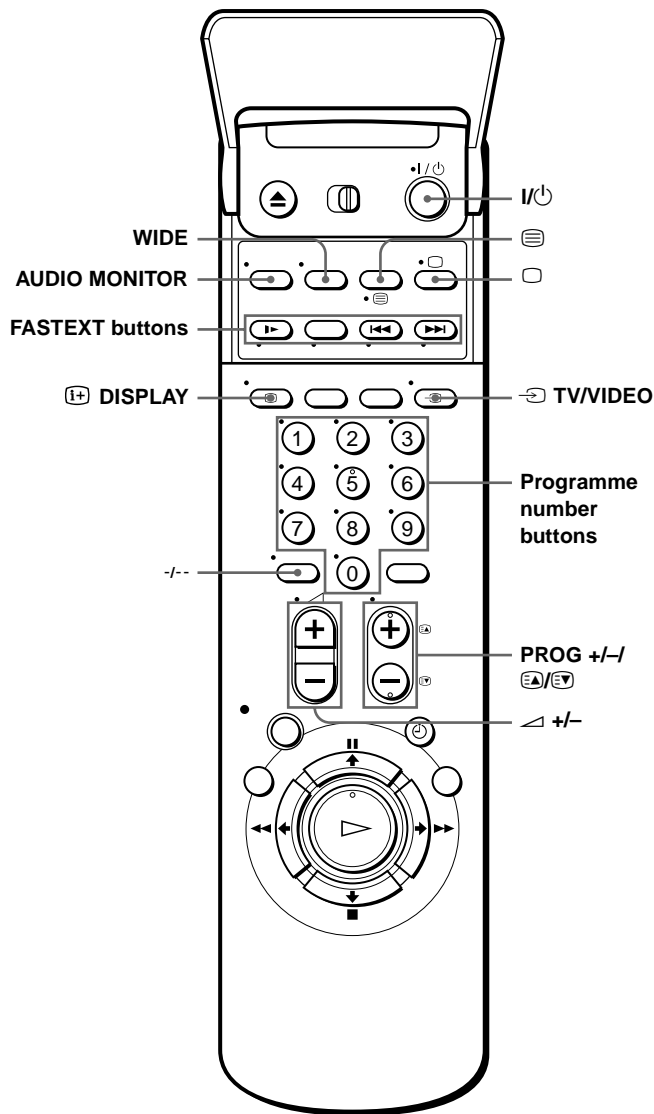

TV control buttons

To	Press
Set the TV to standby mode	I/Power
Select an input source: aerial in or line in	TV/VIDEO
Select the TV's programme position	Programme number buttons, -/--, PROG +/-

To	Press
Adjust the volume of the TV	+/-
Switch to TV (Teletext off)*	(TV)
Switch to Teletext*	(Teletext)
Select the sound	AUDIO MONITOR
Use FASTEXT*	FASTEXT buttons
Call up the on-screen display	DISPLAY
Change the Teletext page*	
Switch to/from wide mode of a Sony wide TV (For other manufactures' wide TVs, see "Controlling other TVs with the remote commander (SLV-SE810G only)" below.)	WIDE

Notes

- With normal use, the batteries should last about three to six months.
- If you do not use the remote commander for an extended period of time, remove the batteries to avoid possible damage from battery leakage.
- Do not use a new battery together with an old one.
- Do not use different types of batteries together.
- Some buttons may not work with certain Sony TVs.

* not available on SLV-SE610G, SE710G, and SE710I

Controlling other TVs with the remote commander (SLV-SE810G only)

The remote commander is preprogrammed to control non-Sony TVs. If your TV is listed in the following table, set the appropriate manufacturer's code number.

- 1 Set / at the top of the remote commander to .
- 2 Hold down , and enter your TV's code number using the programme number buttons. Then release .

Now you can use the following TV control buttons to control your TV:

, , programme number buttons, , PROG +/-, +/-, , , FASTEXT buttons, WIDE*, MENU*, *, and OK*.

* These buttons may not work with all TVs.

continued

Code numbers of controllable TVs

If more than one code number is listed, try entering them one at a time until you find the one that works with your TV.

To switch to wide mode, see the footnotes below this table for the applicable code numbers.

Manufacturer	Code number
Sony	01* ¹ , 02
Akai	68
Ferguson	52
Grundig	10* ¹ , 11* ¹
Hitachi	24
JVC	33
Loewe	45
Mivar	09, 70
NEC	66

Manufacturer	Code number
Nokia	15, 16, 69* ³
Panasonic	17* ¹ , 49
Philips	06* ¹ , 07* ¹ , 08* ¹
Saba	12, 13
Samsung	22, 23
Sanyo	25
Sharp	29
Telefunken	36
Thomson	43* ²
Toshiba	38

*¹ Press WIDE to switch the wide picture mode on or off.

*² Press WIDE, then press \triangleleft +/- to select the wide picture mode you want.

*³ Press WIDE. The menu appears on the TV screen. Then, press $\uparrow/\downarrow/\leftarrow/\rightarrow$ to select the wide picture you want and press OK.

Tip

- When you set your TV's code number correctly while the TV is turned on, the TV turns off automatically.

Notes

- If you enter a new code number, the code number previously entered will be erased.
- If the TV uses a different remote control system from the one programmed to work with the VCR, you cannot control your TV with the remote commander.
- When you replace the batteries of the remote commander, the code number may change. Set the appropriate code number every time you replace the batteries.

Step 3 : Connecting the VCR

If your TV has a Scart (EURO-AV) connector, see page 16.

If your TV does not have a Scart (EURO-AV) connector

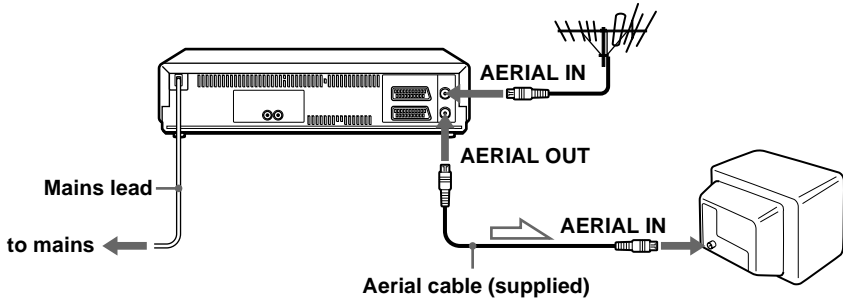

 : Signal flow

1

Disconnect the aerial cable from your TV and connect it to AERIAL IN on the rear panel of the VCR.

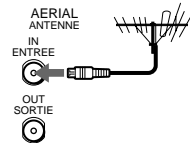

2

Connect AERIAL OUT of the VCR and the aerial input of your TV using the supplied aerial cable.

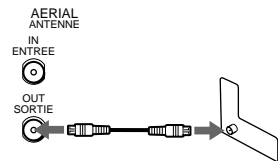

3

Connect the mains lead to the mains.

Note

- When you connect the VCR and your TV only with an aerial cable, you have to tune your TV to the VCR (see page 21).

If your TV has a Scart (EURO-AV) connector

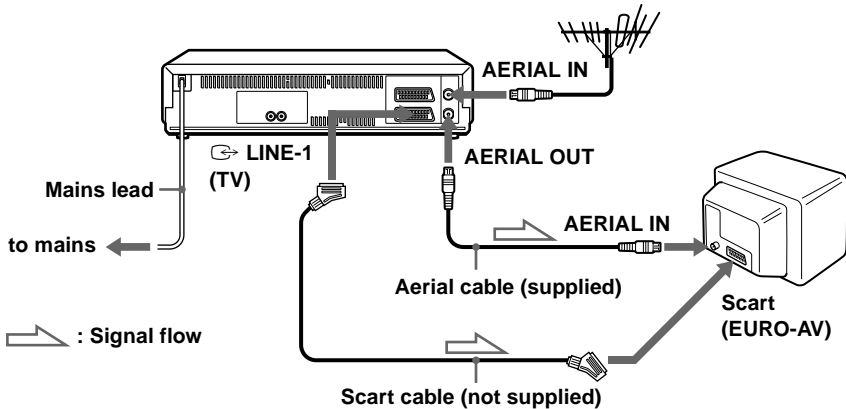

- 1 Disconnect the aerial cable from your TV and connect it to AERIAL IN on the rear panel of the VCR.

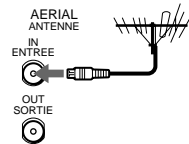

- 2 Connect AERIAL OUT of the VCR and the aerial input of your TV using the supplied aerial cable.

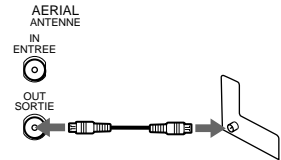

- 3 Connect LINE-1 (TV) on the VCR and the Scart (EURO-AV) connector on the TV with the optional Scart cable.

This connection improves picture and sound quality. Whenever you want to watch the VCR picture, press  TV/VIDEO to display the VIDEO indicator in the display window.

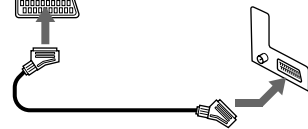

- 4 Connect the mains lead to the mains.

Note

- If the TV is connected to the LINE-1 (TV) connector, setting the RF channel to OFF is recommended. In the OFF position, only the signal from the aerial is output through the AERIAL OUT connector (see page 22).

About the SMARTLINK features (not available on SLV-SE610G)

If the connected TV complies with SMARTLINK, MEGALOGIC*¹, EASYLINK*², Q-Link*³, EURO VIEW LINK*⁴, or T-V LINK*⁵, this

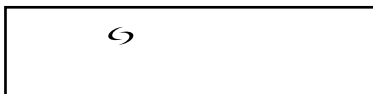

VCR automatically runs the SMARTLINK function after you complete the steps on the previous page (the  indicator appears in the VCR's display window when you turn on the TV). You can enjoy the following SMARTLINK features.

- **Preset Download**
You can download your TV tuner preset data to this VCR and tune the VCR according to that data in Auto Set Up. This greatly simplifies the Auto Set Up procedure. Be careful not to disconnect the cables or exit the Auto Set Up function during the procedure. See "Setting up the VCR with the Auto Set Up function" on page 19.
- **TV Direct Rec**
You can easily record what you are watching on the TV. For details, see "Recording what you are watching on the TV (TV Direct Rec) (not available on SLV-SE610G)" on page 42.
- **One Touch Play**
With One Touch Play, you can start playback automatically without turning on the TV. For details, see "Starting playback automatically with one button (One Touch Play) (not available on SLV-SE610G)" on page 39.
- **One Touch Menu**
You can turn on the VCR and TV, set the TV to the video channel, and display the VCR's on-screen display automatically by pressing MENU on the remote commander.
- **One Touch Timer**
You can turn on the VCR and TV, set the TV to the video channel, and display the timer recording menu (the TIMER METHOD menu, the TIMER menu, or the VIDEO Plus+ menu) automatically by pressing  TIMER on the remote commander.
You can set which timer recording menu is displayed using TIMER OPTIONS in the OPTIONS-2 menu (see page 77).
- **Automatic Power Off**
You can have the VCR turn off automatically, if the VCR is not used after you turn off the TV.

*¹ "MEGALOGIC" is a registered trademark of Grundig Corporation.

*² "EASYLINK" is a trademark of Philips Corporation.

*³ "Q-Link" is a trademark of Panasonic Corporation.

*⁴ "EURO VIEW LINK" is a trademark of Toshiba Corporation.

*⁵ "T-V LINK" is a trademark of JVC Corporation.

Note

- Not all TVs respond to the functions above.

Additional connections

To a stereo system (not available on SLV-SE610G)

You can improve sound quality by connecting a stereo system to the ↻ R/D L/G jacks as shown on the right.

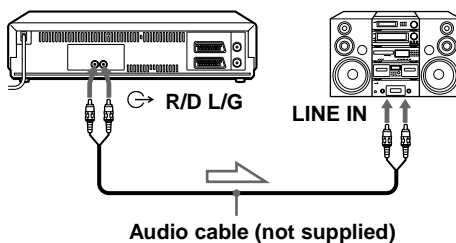

↻ : Signal flow

To a set top box with Line Through (not available on SLV-SE610G)

Using the Line Through function, you can watch programmes from a set top box connected to this VCR on the TV even when the VCR is turned off. When you turn on the set top box, this VCR automatically sends the signal from the set top box to the TV without turning itself on.

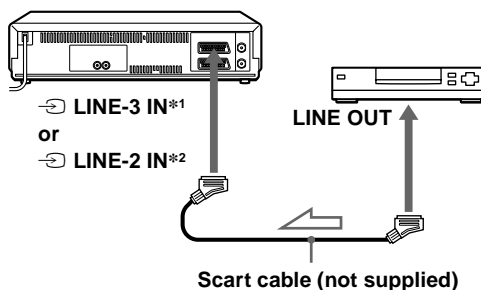

↻ : Signal flow

- 1 Connect the set top box to the LINE-3 IN*1 (or LINE-2 IN*2) connector as shown above.
- 2 Set POWER SAVE to OFF or PARTIAL*1 in the OPTIONS-2 menu.
- 3 Turn off the VCR.
To watch a programme, turn on the set top box and the TV.

Note

- You cannot watch programmes on the TV while recording unless you are recording a programme from your set top box.

*1 SLV-SE810G only

*2 SLV-SE710G and SE710I only

Step 4 : Setting up the VCR with the Auto Set Up function

Before using the VCR for the first time, set up the VCR using the Auto Set Up function. With this function, you can set the TV channels, guide channels for the VIDEO Plus+ system*, RF channel, and VCR clock* automatically.

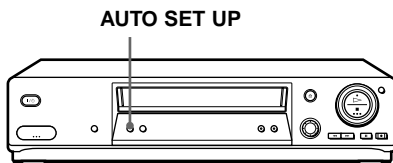

Hold down AUTO SET UP on the VCR for more than three seconds.

The VCR automatically turns on, and starts searching for all of the receivable channels and presets them in the appropriate order for your local area*.

If you want to change the order of the channels or disable unwanted programme positions, see “Changing/disabling programme positions” on page 27.



If you use the SMARTLINK connection (not available on SLV-SE610G), the Preset Download function starts and the  indicator flashes in the display window during download.

After the search or download is complete, the current time appears in the display window for any stations that transmit a time signal (not available on SLV-SE610G). If the time does not appear, set the clock manually (see page 32).

To cancel the Auto Set Up function

Press AUTO SET UP.

continued

Notes

- If you stop the Auto Set Up function during step 3, you must repeat set up from step 1.
- Whenever you operate the Auto Set Up function, some of the settings (VIDEO Plus+*, timer, etc.) will be reset. If this happens, you have to set them again.

* not available on SLV-SE610G

Step 5 : Tuning your TV to the VCR

If your TV has a Scart (EURO-AV) connector, see page 22.

If your TV does not have a Scart (EURO-AV) connector

Follow the steps below so that your TV will properly receive the video signals from your VCR.

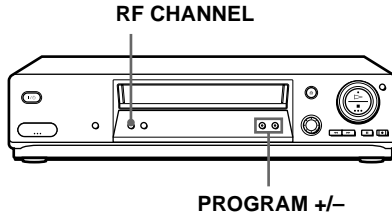

1



Press RF CHANNEL on the VCR lightly.

The factory-preset RF channel appears in the display window.

The VCR signal is output through this channel to the TV.

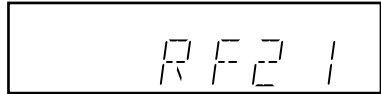

2

Turn on your TV and select a programme position for the VCR picture.

This programme position will now be referred to as the video channel.

3

Tune the TV to the same channel shown in the VCR display window so that the picture on the right appears clearly on the TV screen.

Refer to your TV manual for TV tuning instructions.

If the picture does not appear clearly, see “To obtain a clear picture from the VCR” below.



continued

4

Press RF CHANNEL.

You have now tuned your TV to the VCR. Whenever you want to play a tape, set the TV to the video channel.

To check to see if the TV tuning is correct

Set the TV to the video channel and press PROGRAM +/- on the VCR. If the TV screen changes to a different programme each time you press PROGRAM +/-, the TV tuning is correct.

To obtain a clear picture from the VCR

If the screen does not appear clearly in step 3 above, press PROGRAM +/- so that another RF channel appears. Then tune the TV to the new RF channel so that a clear picture appears.

If your TV has a Scart (EURO-AV) connector

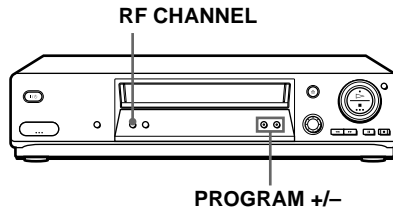

1

Press RF CHANNEL on the VCR lightly.

The factory-preset RF channel appears in the display window.

The VCR signal is output through this channel to the TV.

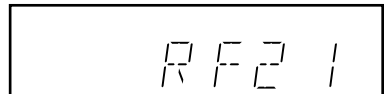

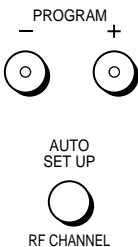
2

Press PROGRAM +/- to set the RF channel to OFF, and press RF CHANNEL again.



RF channel set up is complete.

Selecting a language

If you prefer an on-screen language other than English, use the on-screen display to select another language.

Before you start...

- Turn on the VCR and the TV.
- Set the TV to the video channel.
- Refer to “Index to parts and controls” for button locations.

1

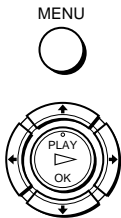

Press MENU, then press \uparrow/\downarrow to highlight SETTINGS and press OK.

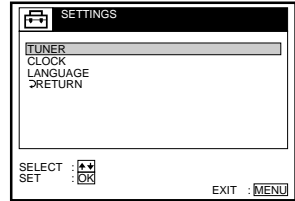

2



Press \uparrow/\downarrow to highlight LANGUAGE, then press OK.

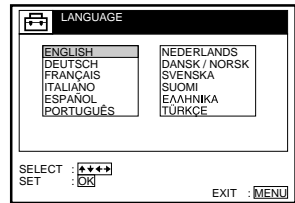

3



Press $\uparrow/\downarrow/\leftarrow/\rightarrow$ to highlight the desired language, then press OK.

4

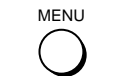

Press MENU to exit the menu.

Tip

- If you want to return to the previous menu, highlight RETURN and press OK.

Note

- The menu disappears automatically if you don't proceed for more than a few minutes.

Presetting channels

If some channels could not be preset using the Auto Set Up function, you can preset them manually.

Before you start...

- Turn on the VCR and the TV.
- Set the TV to the video channel.
- Refer to “Index to parts and controls” for button locations.

1

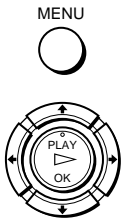

Press MENU, then press **↑/↓** to highlight SETTINGS and press OK.

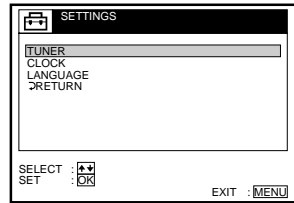

2



Press **↑/↓** to highlight TUNER, then press OK.

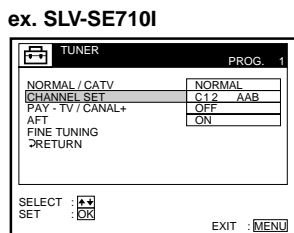

3



SLV-SE710I only:
Press **↑/↓** to highlight NORMAL/
CATV, then press OK.

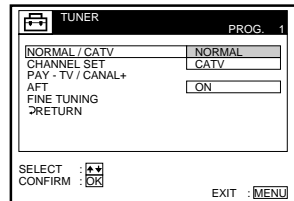

4



SLV-SE710I only:
Press **↑/↓** to highlight NORMAL,
then press OK.
To preset CATV (Cable Television)
channels, select CATV.

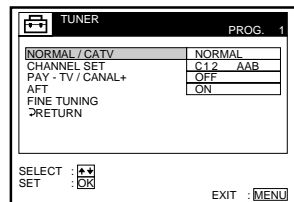

5

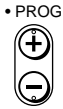

Press PROG +/- to select the programme position.

Selected programme position

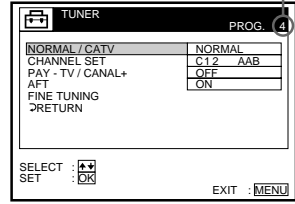

6



Press / to highlight CHANNEL SET, then press OK.

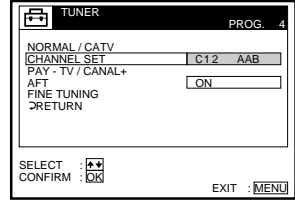

7



Press / repeatedly until the channel you want is displayed.

The channels appear in the following order:

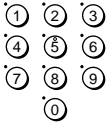

- VHF IA-IJ, SA10-SA13 (SLV-SE710I only)
- UHF B21 - B69
- CATV S1 - S20 (SLV-SE710I only)
- HYPER S21 - S41 (SLV-SE710I only)
- CATV S01 - S05 (SLV-SE710I only)

If you know the number of the channel you want, press the programme number buttons. For example, for channel 5, first press "0" and then press "5."

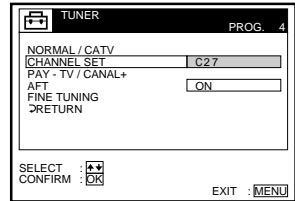

8

To preset another programme position, repeat steps 5 through 7.

9



Press MENU to exit the menu.

If the picture is not clear

Normally, the Auto Fine Tuning (AFT) function automatically tunes in channels clearly. However, if the picture is not clear, you may also use the manual tuning function.

- 1 Press **PROG +/-** or the programme number buttons to select the programme position for which you cannot obtain a clear picture.
- 2 Press **MENU**, then select **SETTINGS** and press **OK**.
- 3 Select **TUNER**, then press **OK**.
- 4 Select **FINE TUNING**, then press **OK**.

The fine tuning meter appears.

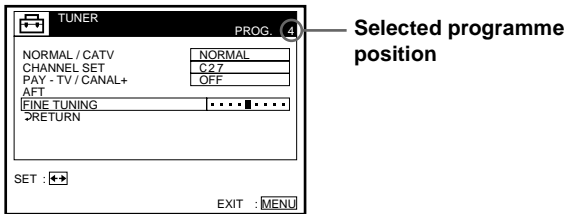

- 5 Press **\leftarrow/\rightarrow** to get a clearer picture, then press **MENU** to exit the menu.
Note that the AFT (Auto Fine Tuning) setting switches to **OFF**.

Tip

- If you want to return to the previous menu, highlight **RETURN** and press **OK**.

Notes

- The menu disappears automatically if you don't proceed for more than a few minutes.
- When adjusting **FINE TUNING**, the menu may become difficult to read due to interference from the picture being received.

Changing/disabling programme positions

After setting the channels, you can change the programme positions as you like. If any programme positions are unused or contain unwanted channels, you can disable them.

You can also change the station names (not available on SLV-SE610G). If the station names are not displayed, you can enter them manually.

Changing programme positions

Before you start...

- Turn on the VCR and the TV.
- Set the TV to the video channel.
- Refer to “Index to parts and controls” for button locations.

1 Press MENU, then press \uparrow/\downarrow to highlight **LISTS** and press OK.

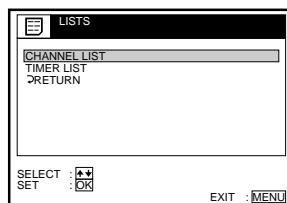
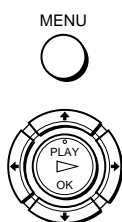

2 Press \uparrow/\downarrow to highlight **CHANNEL LIST**, then press OK.

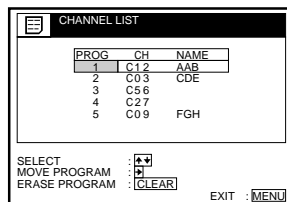

3 Press \uparrow/\downarrow to highlight the row which you want to change the programme position, then press \rightarrow .
To display other pages for programme positions 6 to 60, press \uparrow/\downarrow repeatedly.

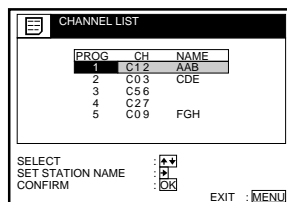

continued

4



Press **↑/↓** until the selected channel row moves to the desired programme position.

The selected channel is inserted at the new programme position and the intermediate channels are displaced to fill the gap.

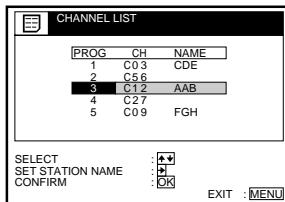

5



Press **OK** to confirm the setting.

6

To change the programme position of another station, repeat steps 3 through 5.

7



Press **MENU** to exit the menu.

Tip

- If you want to return to the previous menu, highlight **RETURN** and press **OK**.

Note

- The menu disappears automatically if you don't proceed for more than a few minutes.

Disabling unwanted programme positions

After presetting channels, you can disable unused programme positions. The disabled positions will be skipped later when you press the **PROG +/-** buttons.

Before you start...

- Turn on the VCR and the TV.
- Set the TV to the video channel.
- Refer to "Index to parts and controls" for button locations.

1



Press **MENU**, then press **↑/↓** to highlight **LISTS**, and press **OK**.

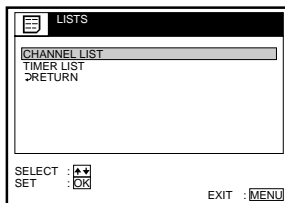

2



Press **↑/↓** to highlight CHANNEL LIST, then press OK.

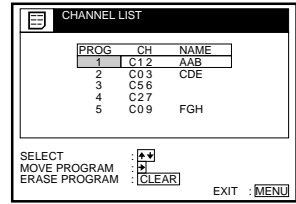

3



Press **↑/↓** to highlight the row which you want to disable.

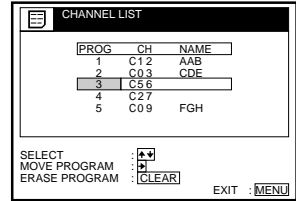

4



Press CLEAR.

The selected row will be cleared as shown on the right.

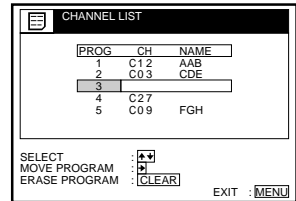

5

Repeat steps 3 and 4 for any other programme positions you want to disable.

6



Press MENU to exit the menu.

Tip

- If you want to return to the previous menu, highlight RETURN and press OK.

Notes

- The menu disappears automatically if you don't proceed for more than a few minutes.
- Be sure to select the programme position you want to disable correctly. If you disable a programme position by mistake, you need to reset that channel manually.

continued

Changing the station names (not available on SLV-SE610G)

You can change or enter the station names (up to 5 characters). The VCR must receive channel information (for instance, SMARTLINK information) for station names to appear automatically.

Before you start...

- Turn on the VCR and the TV.
- Set the TV to the video channel.
- Refer to “Index to parts and controls” for button locations.

1 Press MENU, then press **↑/↓** to highlight LISTS and press OK.

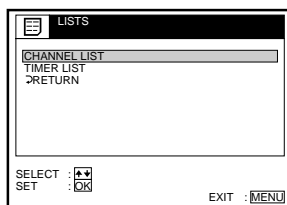
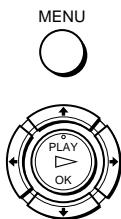

2 Press **↑/↓** to highlight CHANNEL LIST, then press OK.

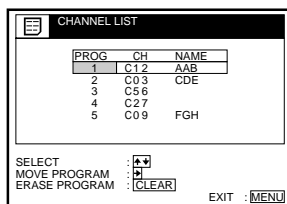

3 Press **↑/↓** to highlight the row which you want to change or enter the station name, then press **→**.



To display other pages for programme positions 6 to 60, press **↑/↓** repeatedly.

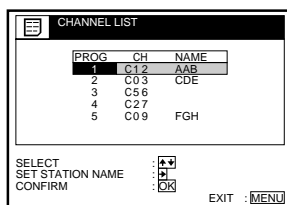

4 Press **→**.

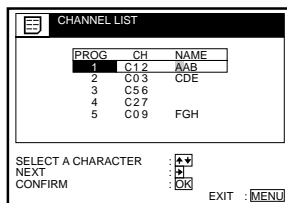

5



Enter the station name.

- 1 Press **↑/↓** to select a character.
Each time you press **↑**, the character changes as shown below.
A → B → ... → Z → a → b → ...
→ z → 0 → 1 → ... → 9 →
(symbols) → (blank space) → A

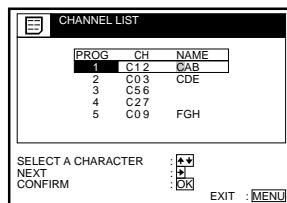

- 2 Press **→** to set the next character.
The next space is highlighted.
To correct a character, press **←/→** until the character you want to correct is highlighted, then reset it.
You can set up to 5 characters for the station name.

6



Press OK to confirm the new name.

7



Press MENU to exit the menu.

Tip

- If you want to return to the previous menu, highlight RETURN and press OK.

Notes

- The menu disappears automatically if you don't proceed for more than a few minutes.
- If you enter a symbol in step 5, it will appear as a blank space in the display window.

Setting the clock

You must set the time and date on the VCR to use the timer features properly. If the VCR clock was not set in the Auto Set Up procedure, you need to set it manually.

The Auto Clock Set function (not available on SLV-SE610G) works only if a station in your area is broadcasting a time signal. If the Auto Set Up function did not set the clock correctly for your local area, try another station for the Auto Clock Set function.

Setting the clock manually

Before you start...

- Turn on the VCR and the TV.
- Set the TV to the video channel.
- Refer to “Index to parts and controls” for button locations.

1

MENU

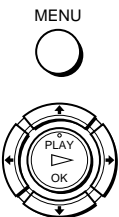

Press MENU, then press **↑/↓** to highlight SETTINGS and press OK.

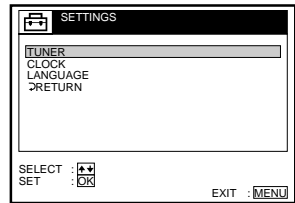

2



Press **↑/↓** to highlight CLOCK, then press OK.

For SLV-SE610G, only the clock setting menu appears. Skip the next step and go to step 4.

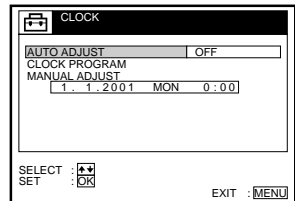

3



Press **↑/↓** to highlight MANUAL ADJUST, then press OK.

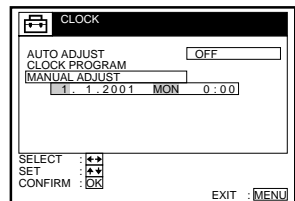

4



Press **↑/↓** to set the day.

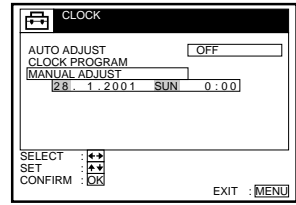

5



Press **→** to highlight the month and set the month pressing **↑/↓**.

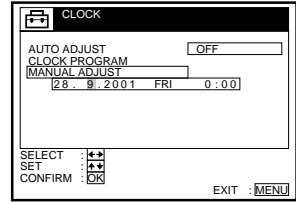

6



Set the year, hour, and minutes in sequence, pressing **→** to highlight the item to be set, and press **↑/↓** to select the digits.

The day of the week is set automatically.

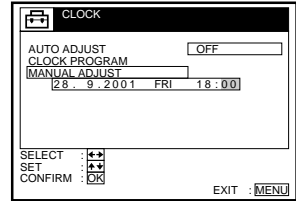

7



Press **OK** to start the clock.

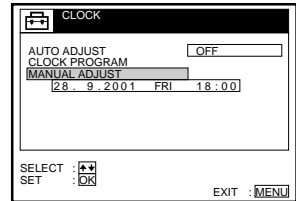

8



Press **MENU** to exit the menu.

Tips

- To change the digits while setting, press **←** to return to the item to be changed, and select the digits by pressing **↑/↓**.
- If you want to return to the previous menu, highlight **RETURN** and press **OK**.

Note

- The menu disappears automatically if you don't proceed for more than a few minutes.

Changing the station for the Auto Clock Set function (not available on SLV-SE610G)

Before you start...

- Turn on the VCR and the TV.
- Set the TV to the video channel.
- Refer to “Index to parts and controls” for button locations.

1

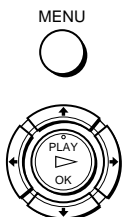

Press MENU, then press **↑/↓** to highlight SETTINGS and press OK.

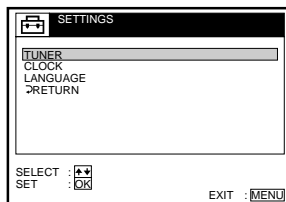

2



Press **↑/↓** to highlight CLOCK, then press OK.

AUTO ADJUST is highlighted.

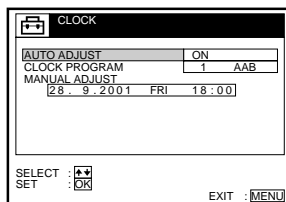

3



Press OK.

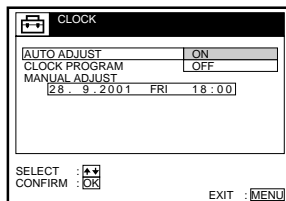

4



Press **↑/↓** to highlight ON, then press OK.

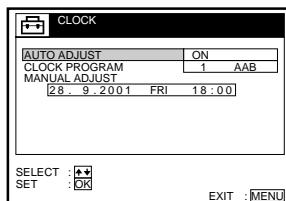

5



Press **↓** to highlight **CLOCK PROGRAM**, then press **OK**.

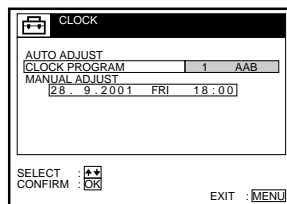

6



Press **↑/↓** repeatedly until the programme position of the station that carries a time signal appears.

If the VCR does not receive a time signal from any station, **AUTO ADJUST** returns to **OFF** automatically.

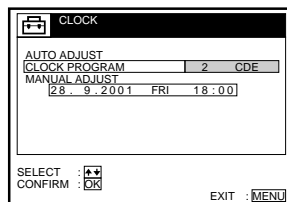

7

MENU



Press **MENU** to exit the menu.

Tips

- If you set **AUTO ADJUST** to **ON**, the Auto Clock Set function is activated whenever the VCR is turned off. The time is adjusted automatically by making reference to the time signal from the station whose programme position is displayed in the “**CLOCK PROGRAM**” row. If you do not need the Auto Clock Set, select **OFF**.
- If you want to return to the previous menu, highlight **RETURN** and press **OK**.

Note

- The menu disappears automatically if you don't proceed for more than a few minutes.

Setting your personal code

For identification, you can enter a personal code into the VCR. Once you enter your personal code, you can confirm it any time but can never change it. Please make a note of the code to quote to the police if your VCR is stolen.

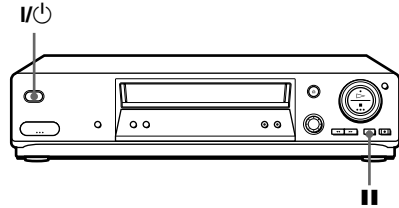

Before you start...

- Turn on your TV and set it to the video channel.
- If there is a tape in the VCR, remove it.
- Turn off the VCR.

1



Hold down **⏸** (pause) and **I/⏻** (on/standby) on the VCR simultaneously for more than three seconds.

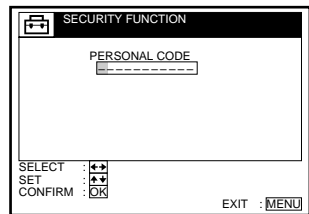

2



Enter your personal code.

- 1 Press **⬆**/**⬇** to select a character. Each time you press **⬆**, the character changes as shown below.
A → **B** → ... → **Z** → **0** → **1** → ...
 → **9** → **(blank space)** → **-**
(hyphen) → **A**

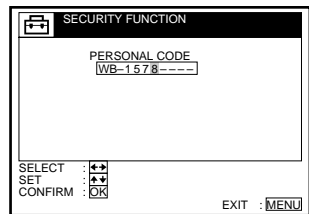

- 2 Press **➡** to set the next character. The next space is highlighted. To correct a character, press **⬅**/**➡** until the character you want to correct is highlighted, then reset it. You can set up to 11 characters for your personal code.

3



Press **OK**.

A confirmation screen appears.

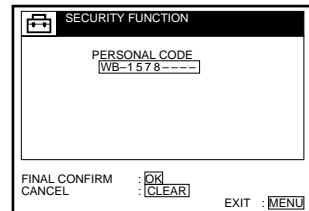

4

If the displayed personal code is correct, press OK.

If the displayed personal code is wrong, press CLEAR and continue from step 2.

CLEAR



To confirm your personal code

While the VCR is turned off and there is no tape in the VCR, hold down **II** (pause) and **I/⏻** (on/standby) on the VCR simultaneously for more than three seconds. The entered personal code appears on the TV screen. Press any button to enter normal viewing mode.

Note

- The menu disappears automatically if you don't proceed for more than a few minutes.

Playing a tape

Before you start...

- Refer to “Index to parts and controls” for button locations.

1 Turn on your TV and set it to the video channel.

2 Insert a tape.
The VCR turns on and starts playing automatically if you insert a tape with its safety tab removed.

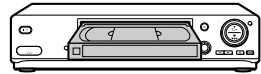

3 Press ▷ PLAY.
When the tape reaches the end, it will rewind automatically.



Additional tasks

To	Press
Stop play	■ STOP
Pause play	PAUSE
Resume play after pause	PAUSE or ▷ PLAY
Fast-forward the tape	▶▶ FF during stop
Rewind the tape	◀◀ REW during stop
Eject the tape	▲ EJECT

To use the time counter

Press CLEAR at the point on the tape that you want to find later. The counter in the display window resets to “0:00:00.” Search for the point afterwards by referring to the counter.



To display the counter on the TV screen, press ⊕ DISPLAY.

Notes

- The counter resets to “0:00:00” whenever a tape is reinserted.
- The counter stops counting when it comes to a portion with no recording.
- The time counter does not appear on the TV screen when using an NTSC-recorded tape.
- Depending on your TV, the following may occur while playing an NTSC-recorded tape:
 - The picture becomes black and white.
 - The picture shakes.
 - No picture appears on the TV screen.
 - Black streaks appear horizontally on the TV screen.
 - The colour density increases or decreases.
- If you play back a tape in LP or EP mode with the NTSC system, the sound becomes monaural.
- While setting the menu on the TV screen, buttons for playback on the remote commander do not function.

Starting playback automatically with one button (One Touch Play) (not available on SLV-SE610G)

If you use the SMARTLINK connection, you can turn on the VCR and the TV, set the TV to the video channel, and start playback automatically with one button.

1 Insert a tape.

The VCR automatically turns on.

If you insert a tape with its safety tab removed, the TV turns on and switches to the video channel. Playback starts automatically.

2 Press PLAY.

The TV turns on and switches to the video channel automatically. Playback starts.

Tip

- When there already is a tape in the VCR, the VCR and the TV turn on, the TV is set to the video channel, and playback starts automatically in one sequence when you press  PLAY.

Note

- When you use the One Touch Play function, leave the TV on or in the standby mode.

Recording TV programmes

Before you start...

- Refer to “Index to parts and controls” for button locations.

1 Turn on your TV and set it to the video channel.

2 Insert a tape with its safety tab in place.

3 Press PROG +/- to select the programme position or station name* you want to record.



4 Press SP/LP to select the tape speed, SP or LP.



LP (Long Play) provides recording time twice as long as SP. However, SP (Standard Play) produces better picture and audio quality.

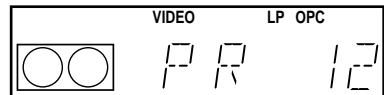

5 Press ● REC to start recording.



The recording indicator lights up red in the display window.

Recording indicator



To stop recording

Press ■ STOP.

To check the remaining time

Press (+) DISPLAY. With the display on, press COUNTER/REMAIN to check the remaining time. Each time you press COUNTER/REMAIN, the

time counter and the remaining time appear alternately. The  indicator indicates the remaining time.

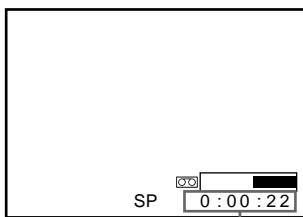

Time counter

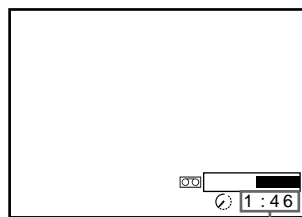

Remaining time

In order to get an accurate remaining time indication, be sure TAPE LENGTH in the OPTIONS-1 menu is set according to the tape type you use (see page 77).

To watch another TV programme while recording

- 1 Press  TV/VIDEO to turn off the VIDEO indicator in the display window.
- 2 Select another programme position on the TV.

To save a recording

To prevent accidental erasure, break off the safety tab as illustrated. To record on the same tape again, cover the tab hole with adhesive tape.

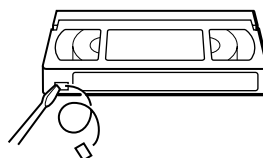



Safety tab

Tips

- To select a programme position, you can use the programme number buttons on the remote commander. For two-digit numbers, press the **-/-** (ten's digit) button followed by the programme number buttons.
- If you connect additional equipment to a LINE connector or jack, you can select the input signal using the INPUT SELECT or PROG +/- buttons.
- The  DISPLAY information appears on the TV screen indicating information about the tape, but the information won't be recorded on the tape.
- If you don't want to watch TV while recording, you can turn off the TV.

Notes

- The  DISPLAY information does not appear during still (pause) mode or slow-motion playback.
- The  DISPLAY information will not appear while playing an NTSC-recorded tape.

- If a tape has portions recorded in both PAL and NTSC systems, the time counter reading will not be correct. This discrepancy is due to the difference between the counting cycles of the two video systems.
- When you insert a non-standard commercially available tape, the remaining time may not be correct.
- The remaining time is intended for rough measurement only.
- About 30 seconds after the tape begins playback, the tape remaining time will be displayed.
- The station name* may not appear if the VCR does not receive station name information signals.

* not available on SLV-SE610G

Recording what you are watching on the TV (TV Direct Rec) (not available on SLV-SE610G)

If you use the SMARTLINK connection, you can easily record what you are watching on the TV (other than tapes being played on the VCR).

1 Insert a tape with its safety tab in place.

2 Press ● REC while you are watching a TV programme or external source.

The VCR automatically turns on, then the TV indicator lights up and the VCR starts recording what you are watching on the TV.

Tips

- The TV indicator appears in the display window after you press ● REC in some situations such as:
 - when you are watching a source connected to the TV's line input, or
 - when the TV tuner preset data for the programme position is different from the data in the VCR tuner preset.
- If there is a tape with its safety tab in place in the VCR, the VCR automatically turns on and starts recording what you are watching on the TV when you press ● REC.
- You can turn the TV Direct Rec function ON and OFF in the OPTIONS-2 menu (see page 77).

Notes

- You cannot record what you are watching using this method when the VCR is in the following modes; pause, timer standby, tuner preset, Auto Set Up, and recording.
- When the TV indicator is lit in the display window, do not turn off the TV nor change the TV programme position. When the TV indicator is not lit, the VCR continues recording the programme even if you change the TV programme position on the TV.

Recording TV programmes using the Dial Timer (SLV-SE810G only)

The Dial Timer function allows you to make timer recordings of programmes without turning on your TV. Set the recording timer to record up to eight programmes, including settings made with other timer methods, that will be broadcast within the next month. The recording start time and recording stop time can be set at one minute intervals.

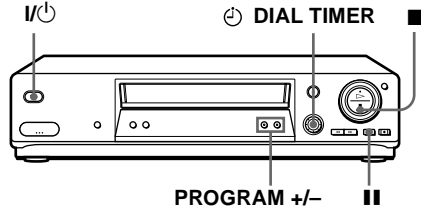

Before you start...

- Insert a tape with its safety tab in place. Make sure the tape is longer than the total recording time.
- Refer to “Index to parts and controls” for button locations.

1 Press DIAL TIMER.



“DATE” and “TODAY” appear alternately in the display window.

If the date and time are not set, “DAY” will appear. See step 2 in the following section, “To set the clock” to set the date and time.

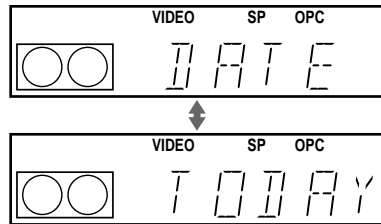

2 Turn DIAL TIMER to set the recording date.



continued

3

DIAL TIMER



Press DIAL TIMER.

“START” and the current time appear alternately in the display window.

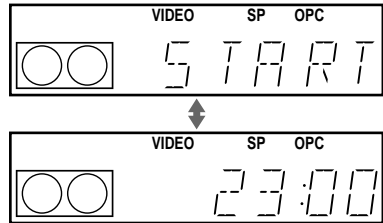
**4**

DIAL TIMER

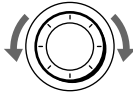

Turn DIAL TIMER to set the recording start time.

You can set the recording start time in 15 minute intervals or adjust the time in one minute intervals by pressing the PROGRAM +/- buttons.

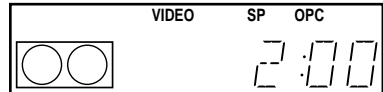
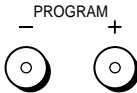
**5**

DIAL TIMER



Press DIAL TIMER.

“STOP” and the recording stop time appear alternately in the display window.

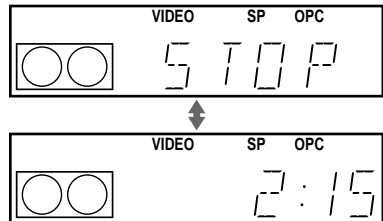
**6**

DIAL TIMER

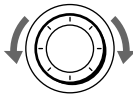

Turn DIAL TIMER to set the recording stop time.

You can set the recording stop time in 15 minute intervals or adjust the time in one minute intervals by pressing the PROGRAM +/- buttons.

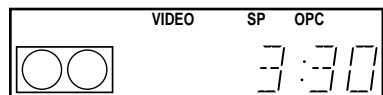
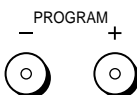

7

DIAL TIMER



Press DIAL TIMER.

The programme position or station name appears in the display window.

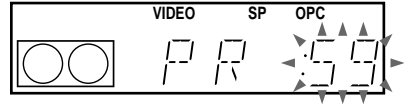

8

DIAL TIMER

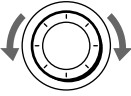

Turn DIAL TIMER to set the programme position.

To record from another source connected to one or more of the LINE inputs, turn DIAL TIMER or press INPUT SELECT to display the connected line in the display window.

INPUT SELECT



9

DIAL TIMER



Press DIAL TIMER to complete the setting.

“OK” appears in the display window for about five seconds.

The indicator appears in the display window and the VCR stands by for recording.

To record from another source, leave the connected equipment switched on.

To return to the previous step

To return to the previous step, press the PROGRAM + and – buttons on the VCR at the same time during any of the Dial Timer settings.

To stop recording

To stop the VCR while recording, press STOP.

To use the VCR after setting the timer

To use the VCR before a recording begins, just press . The indicator turns off and the VCR switches on. Remember to press to reset the VCR to recording standby after using the VCR.

You can also do the following tasks while the VCR is recording:

- Reset the counter (page 38).
- Display tape information on the TV screen (page 40).
- Check the timer settings (page 61).
- Watch another TV programme (page 41).

continued

To set the clock

- 1** Turn \ominus DIAL TIMER so that “CLOCK” appears in the display window.
- 2** Press \ominus DIAL TIMER.
“DAY” appears in the display window.
- 3** Turn \ominus DIAL TIMER to set the day.
- 4** Press \ominus DIAL TIMER.
“MONTH” appears in the display window.
- 5** Turn and press \ominus DIAL TIMER to set the month, and then the year.
After you set the year, “CLOCK” appears in the display window again.
- 6** Turn and press \ominus DIAL TIMER to set the hour and minute.
- 7** When you have finished setting the time, press \ominus DIAL TIMER to start the clock.

Tips

- To cancel a Dial Timer setting, press \blacksquare (stop) on the VCR while you are making the setting.
- The programme is recorded in the current tape speed mode. To change the tape speed, press SP/LP before you complete the setting in step 9.
- When you are recording a programme in the SP mode and the remaining tape becomes shorter than the recording time, the tape speed is automatically changed to the LP mode. Note that some interference will appear on the picture at the point the tape speed is changed. If you want to keep the same tape speed, set AUTO LONG PLAY to OFF in the OPTIONS-1 menu (page 77).
- To check, change, or cancel the programme setting, see “Checking/changing/cancelling timer settings” (page 61).

Notes

- If eight programmes have already been set using the VIDEO Plus+ system or the TIMER menu, “FULL” appears in the display window for about five seconds.
- The \ominus indicator flashes in the display window when you complete the setting in step 9 with no tape inserted.
- If you set the clock using the Auto Clock Set function and AUTO ADJUST is set to ON, the clock will adjust itself to the incoming time signal regardless of adjustments made with the Dial Timer. Be sure you have set the Auto Clock Set correctly.
- The station name may not appear if the VCR does not receive station name information signals.

About the Demonstration Mode

The Dial Timer function has a Demonstration Mode that allows the user, such as a salesperson, to enter more than eight examples of timer settings when demonstrating the use of the Dial Timer. It cancels the FULL notice which appears if eight programmes have already been set. Do not use the Demonstration Mode for making timer recordings. Doing so may cause the settings to be inaccurate.

To activate the Demonstration Mode

Press **||** (pause) on the VCR while turning the **⏻** DIAL TIMER. “DEMO” appears in the display window for a few seconds.

To cancel the Demonstration Mode

Turn the power off and unplug the mains lead. Although the Demonstration Mode is cancelled, the timer settings entered while using the Demonstration Mode will remain. Be sure to manually cancel the timer settings before you use the Dial Timer or any other timer method after reconnecting the mains lead (see page 61).

Recording TV programmes using the VIDEO Plus+ system (not available on SLV-SE610G)

The VIDEO Plus+ system is the feature that simplifies programming the VCR to make timer recordings. Just enter the PlusCode number listed in the TV programme guide. The date, times, and programme position of that programme are set automatically. You can preset a total of eight programmes, including settings made with other timer methods.



Before you start...

- Check that the VCR clock is set to the correct time and date.
- Insert a tape with its safety tab in place. Make sure the tape is longer than the total recording time.
- Turn on your TV and set it to the video channel.
- Set TIMER OPTIONS to VIDEO Plus+ or VARIABLE in the OPTIONS-2 menu (see page 77).
- Refer to “Index to parts and controls” for button locations.

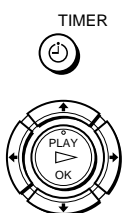
1



TIMER Press  TIMER.

- When you set TIMER OPTIONS to VARIABLE:
The TIMER METHOD menu appears on the TV screen. Press / to select VIDEO Plus+, then press OK.

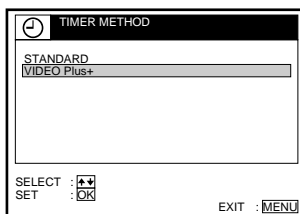

- When you set TIMER OPTIONS to VIDEO Plus+:
The VIDEO Plus+ menu appears on the TV screen.

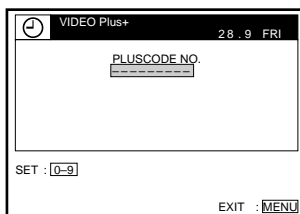

2

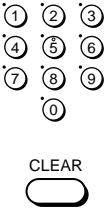

Press the programme number buttons to enter the PlusCode number.

If you make a mistake, press CLEAR and re-enter the correct number.

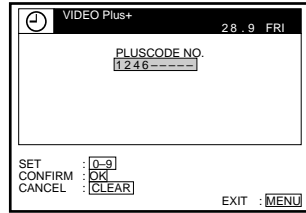

3

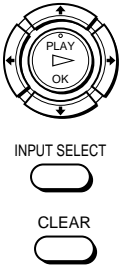

Press OK.

The date, start and stop times, programme position or station name, tape speed, and VPS/PDC setting appear on the TV screen.

- If “- -” appears in the “PROG.” (programme) column (this may happen for local broadcasts), you have to set the appropriate programme position manually. Press **↑/↓** to select the desired programme position.

To record from another source connected to one or more of the LINE inputs, press INPUT SELECT to display the connected line in the “PROG.” position.

You will only have to do this operation once for the referred channel. The VCR will then store your setting.

If the information is incorrect, press CLEAR to cancel the setting.

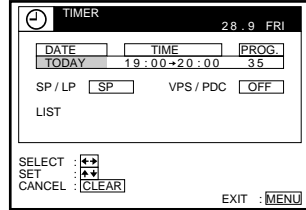

4



If you want to change the date, tape speed, and the VPS/PDC setting:

1 Press **←/→** to highlight the item you want to change.

2 Press **↑/↓** to reset it.

- To record the same programme every day or the same day every week, see “Daily/weekly recording” on page 50.
- To use the VPS/PDC function, set VPS/PDC to ON.

For details about the VPS/PDC function, see “Timer recording with VPS/PDC signals” on page 50.

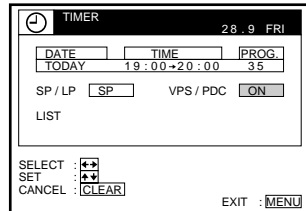

5



Press MENU to exit the menu.

continued

6



Press **I/⏻** to turn off the VCR.

The **⏻** indicator appears in the display window and the VCR stands by for recording.

To record from another source, leave the connected equipment switched on.

To stop recording

To stop the VCR while recording, press **■ STOP**.

Daily/weekly recording

In step 4 above, press **↓** to select the recording pattern. Each time you press **↓**, the indication changes as shown below. Press **↑** to change the indication in reverse order.

TODAY → SUN-SAT (Sunday to Saturday) → MON-SAT (Monday to Saturday) → MON-FRI (Monday to Friday) → SAT (every Saturday) → MON (every Monday) → SUN (every Sunday) → 1 month later → (dates count down) → TOMORROW → TODAY

Timer recording with VPS/PDC signals

Some broadcast systems transmit VPS (Video Programme System) or PDC (Programme Delivery Control) signals with their TV programmes. These signals ensure that your timer recordings are made regardless of broadcast delays, early starts, or broadcast interruptions (when the VPS or PDC indicator in the display window is lit).

To use the VPS/PDC function, set VPS/PDC to ON in step 4 above. You can also use the VPS/PDC function for a source connected to one or more of the LINE inputs.

To record a programme from your set top box

If you connect a set top box and the VCR, you can record a programme from your set top box.

- 1** Turn on the set top box.
- 2** On the set top box, select the programme for which you want to make a timer setting.
- 3** Follow steps 1 through 6 above.
- 4** Keep the set top box turned on until the VCR finishes recording the programme for which you have made a timer setting.

To use the VCR after setting the timer

To use the VCR before a recording begins, just press **I/⏻**. The **⏻** indicator turns off and the VCR switches on. Remember to press **I/⏻** to reset the VCR to recording standby after using the VCR.

You can also do the following tasks while the VCR is recording:

- Reset the counter (page 38).
- Display tape information on the TV screen (page 40).
- Check the timer settings (page 61).
- Watch another TV programme (page 41).

Tips

- To set the programme position, you can also use the PROG +/- or programme number buttons.
- To set the programme position with a two digit number, press -/-- (ten's digit) button followed by the programme number buttons.
- To set the line input video source, you can also use the PROG +/- buttons.
- To set the tape speed, you can also use the SP/LP button.
- When you are recording a programme in the SP mode and the remaining tape becomes shorter than the recording time, the tape speed is automatically changed to the LP mode. Note that some interference will appear on the picture at the point the tape speed is changed. If you want to keep the same tape speed, set AUTO LONG PLAY to OFF in the OPTIONS-1 menu (page 77).
- To check, change, or cancel the programme setting, press ◀/▶ to choose LIST, then press OK in step 4. For details, see step 3 in "Checking/changing/cancelling timer settings" (page 61).

Notes

- If the VPS/PDC signal is too weak or the broadcasting station failed to transmit VPS/PDC signals, the VCR will start recording at the set time without using the VPS/PDC function.
- The ⊕ indicator flashes in the display window when you press I/⊕ with no tape inserted.
- When you set TIMER OPTIONS to STANDARD in the OPTIONS-2 menu, the VIDEO Plus+ menu does not appear on the TV screen. Select VIDEO Plus+ or VARIABLE.
- The VPS/PDC function is automatically set to OFF for the timer recording of a programme from your set top box.
- The station name may not appear if the VCR does not receive station name information signals.

Recording TV programmes using the timer

You can preset a total of eight programmes, including settings made with other timer methods.

Before you start...

- Check that the VCR clock is set to the correct time and date.
- Insert a tape with its safety tab in place. Make sure the tape is longer than the total recording time.
- Turn on your TV and set it to the video channel.
- Set **TIMER OPTIONS** to **STANDARD** or **VARIABLE** in the **OPTIONS-2** menu (see page 77).*
- Refer to “Index to parts and controls” for button locations.

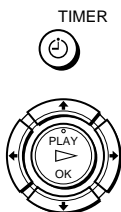

1



Press  **TIMER**.

For SLV-SE610G:
The **TIMER** menu appears on the TV screen.

For SLV-SE710G, SE710I, and SE810G:

- When you set **TIMER OPTIONS** to **VARIABLE**:
The **TIMER METHOD** menu appears on the TV screen. Press / to select **STANDARD**, then press **OK**.

- When you set **TIMER OPTIONS** to **STANDARD**:
The **TIMER** menu appears on the TV screen.

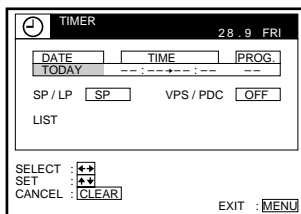
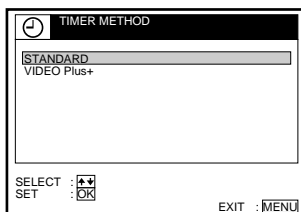
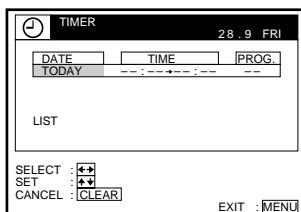

2



Set the date, start and stop times, programme position or station name*, tape speed, and VPS/PDC function*:

1 Press **→** to highlight each item in turn.

2 Press **↑/↓** to set each item. To correct a setting, press **←** to return to that setting and reset.

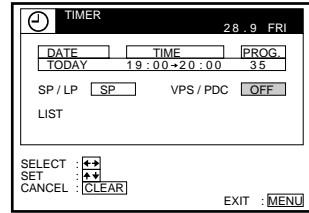

- To record the same programme every day or the same day every week, see “Daily/weekly recording” on page 53.
- To use the VPS/PDC function*, set VPS/PDC to ON. For details about the VPS/PDC function, see “Timer recording with VPS/PDC signals” on page 50.
- To record from another source connected to one or more of the LINE inputs, press INPUT SELECT to display the connected line in the “PROG.” position.

3



Press MENU to exit the menu.

4



Press **I/O** to turn off the VCR.

The **Ⓢ** indicator appears in the display window and the VCR stands by for recording.

To record from another source, leave the connected equipment switched on.

To stop recording

To stop the VCR while recording, press **■ STOP**.

Daily/weekly recording

In step 2 above, press **↓** to select the recording pattern. Each time you press **↓**, the indication changes as shown below. Press **↑** to change the indication in reverse order.

TODAY → **SUN-SAT (Sunday to Saturday)** → **MON-SAT (Monday to Saturday)** → **MON-FRI (Monday to Friday)** → **SAT (every Saturday)**
 → **MON (every Monday)** → **SUN (every Sunday)** → **1 month later** →
(dates count down) → **TOMORROW** → **TODAY**

continued

To record a programme from your set top box

If you connect a set top box and the VCR, you can record a programme from your set top box.

- 1** Turn on the set top box.
- 2** On the set top box, select the programme for which you want to make a timer setting.
- 3** Follow steps 1 through 4 above.
- 4** Keep the set top box turned on until the VCR finishes recording the programme for which you have made a timer setting.

To use the VCR after setting the timer

To use the VCR before a recording begins, just press I/⏻. The ⏻ indicator turns off and the VCR switches on. Remember to press I/⏻ to reset the VCR to recording standby after using the VCR.

You can also do the following tasks while the VCR is recording:

- Reset the counter (page 38).
- Display tape information on the TV screen (page 40).
- Check the timer settings (page 61).
- Watch another TV programme (page 41).

Tips

- To set the programme position, you can also use the PROG +/- or programme number buttons.
- To set the programme position with a two digit number, press -/-- (ten's digit) button followed by the programme number buttons.
- To set the line input video source, you can also use the PROG +/- buttons.
- To set the tape speed, you can also use the SP/LP button.
- When you are recording a programme in the SP mode and the remaining tape becomes shorter than the recording time, the tape speed is automatically changed to the LP mode. Note that some interference will appear on the picture at the point the tape speed is changed. If you want to keep the same tape speed, set AUTO LONG PLAY to OFF in the OPTIONS-1 menu (page 77).
- Even if you set TIMER OPTIONS* to VIDEO Plus+ in the OPTIONS-2 menu, you can set the timer manually. Press MENU to select TIMER, then go to step 2.
- To check, change, or cancel the programme setting, press ◀/▶ to choose LIST, then press OK in step 2. For details, see step 3 in "Checking/changing/cancelling timer settings" (page 61).

Notes

- When setting the timer with VPS/PDC* signals, enter the start and stop times exactly as indicated in the TV programme guide. Otherwise, the VPS/PDC function won't work.
- If the VPS/PDC* signal is too weak or the broadcasting station failed to transmit VPS/PDC signals, the VCR will start recording at the set time without using the VPS/PDC function.
- The ☹ indicator flashes in the display window when you press I/⏻ with no tape inserted.
- The VPS/PDC function* is automatically set to OFF for the timer recording of a programme from your set top box.
- The station name* may not appear if the VCR does not receive station name information signals.

* not available on SLV-SE610G

Playing/searching at various speeds

Before you start...

- Refer to “Index to parts and controls” for button locations.

Playback options	Operation
View the picture during fast-forward or rewind	During fast-forward, hold down ►► FF/►►. During rewind, hold down ◀◀ REW/◀◀.
Play at high speed	<ul style="list-style-type: none"> • During playback, press ►► FF or ◀◀ REW <u>on the remote commander.</u> • During playback, hold down ►► FF/►► or ◀◀ REW/◀◀. When you release the button, normal playback resumes.
Play at twice the normal speed	During playback, press ×2.
Play in slow motion	During playback, press ►► SLOW.
Play frame by frame	During pause, press ►► FF or ◀◀ REW <u>on the remote commander.</u> Hold down ►► FF or ◀◀ REW to play one frame each second.
Rewind and start play	During stop, press ▷ (play) <u>on the VCR</u> while holding down ◀◀ <u>on the VCR.</u>

To resume normal playback

Press ▷ PLAY.

Using the shuttle ring (SLV-SE810G only)

With the shuttle ring, you can operate a variety of playback options. There are two ways for using the shuttle ring, normal mode and jog mode.

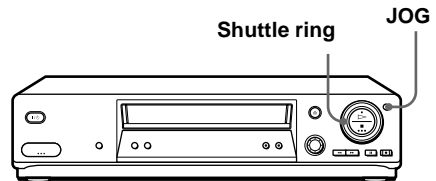

To use the shuttle ring in normal mode

During playback or pause, turn the shuttle ring clockwise or anticlockwise. Each change in the shuttle ring position changes the playback mode in the following way.

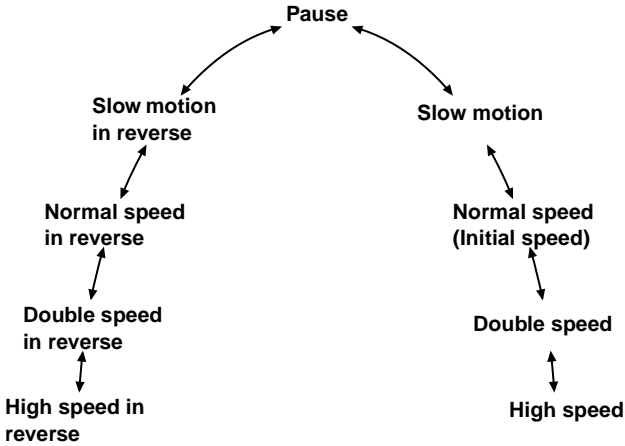

To use the shuttle ring in jog mode

Use this mode for frame-by-frame playback.

Press JOG to enter the jog mode. The JOG button lights up. If you change to the jog mode during any playback mode, playback pauses so you can see a still picture. Each change in the shuttle ring position shifts the picture one frame. To shift frames in reverse, turn the shuttle ring anticlockwise. The frame shift speed depends on the speed you turn the shuttle ring.

To resume normal mode, press JOG again. The JOG button turns off.

Tip

- Adjust the picture using the PROGRAM +/- buttons on the VCR if:
 - Streaks appear while playing in slow motion.
 - Bands appear at the top or bottom while pausing.
 - The picture shakes while pausing.

To set tracking to the centre position, press both buttons (+/-) at the same time.

Notes

- The sound is muted during these operations.
- In the LP mode, noise may appear or there may be no colour.
- If the playback mode mark doesn't appear on the TV screen, press **[+]** DISPLAY.

Setting the recording duration time

After you have started recording in the normal way, you can have the VCR stop recording automatically after a specified duration.

Before you start...

- Refer to “Index to parts and controls” for button locations.

1 While recording, press ● REC.

The ☹ indicator appears in the display window.

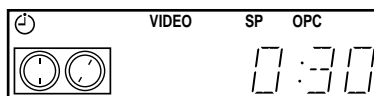

2 Press ● REC repeatedly to set the duration time.

Each press advances the time in increments of 30 minutes.

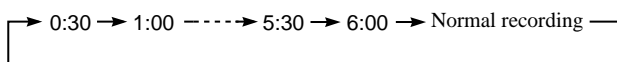

The tape counter decreases minute by minute to 0:00, then the VCR stops recording and turns off automatically.

To extend the duration

Press ● REC repeatedly to set a new duration time.

To cancel the duration

Press ● REC repeatedly until the ☹ indicator disappears and the VCR returns to the normal recording mode.

To stop recording

To stop the VCR while recording, press ■ STOP.

Note

- You cannot display the current tape time in the display window when setting the recording duration time.

Synchronized Recording (not available on SLV-SE610G)

You can set the VCR to automatically record programmes from equipment such as a set top box by connecting the equipment to the LINE-3 IN*¹ (or LINE-2 IN*²) connector. The connected equipment must have a timer function for this feature to work.

When the connected equipment turns on, the VCR also automatically turns on and starts recording a programme from LINE-3 IN*¹ (or LINE-2 IN*²).

How to connect for Synchronized Recording

Connect the LINE-3 IN*¹ (or LINE-2 IN*²) connector of the VCR to the TV Scart connector of the set top box. Then connect the LINE-1 (TV) connector to the TV.

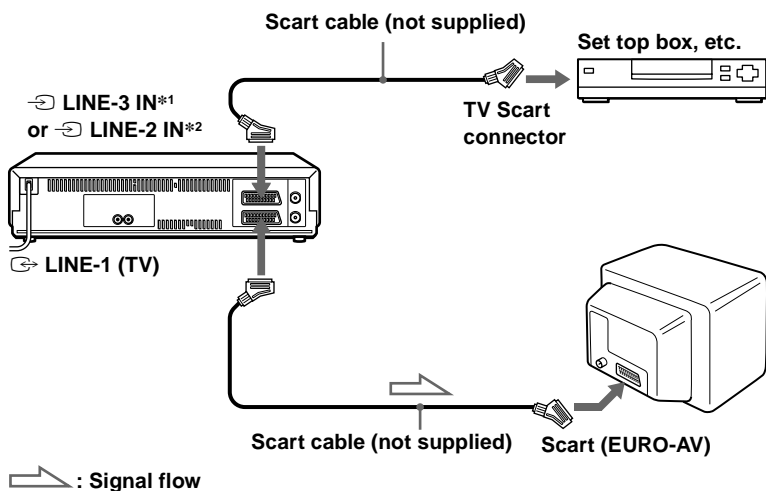

Recording programmes using the Synchronized Recording function

Before you start...

- Insert a tape with its safety tab in place. Make sure the tape is longer than the total recording time.
- Refer to “Index to parts and controls” for button locations.

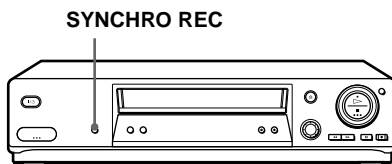

- 1** Press INPUT SELECT or PROG +/- to display “L3*¹ (or L2*²)” in the display window.
- 2** Set the timer on the connected equipment to the time of the programme you want to record, then turn it off.
- 3** Press SP/LP to select the tape speed.
- 4** Hold down SYNCHRO REC for more than two seconds.

The SYNCHRO indicator appears in the display window and the VCR stands by for recording.

The VCR automatically turns on and starts recording when it receives an input signal from the connected equipment.

The VCR automatically stops recording when the tape reaches the end or when the connected equipment stops transmitting an input signal.

To cancel the Synchronized Recording function

Press SYNCHRO REC. The SYNCHRO indicator disappears.

To stop recording

Press ■ STOP while recording.

Notes

- This function may not work with some types of set top boxes.
- Some TVs or other equipment with timer functions will automatically turn off if no operation is performed within a certain amount of time. In this case, the Synchronized Recording also stops automatically.
- When the connected equipment turns on while the SYNCHRO indicator is appeared, recording starts automatically.
- If the settings for timer recording and Synchronized Recording overlap, the programme that starts first has priority and the second programme starts recording only after the first programme has finished.
- The Auto Clock Set function does not work while the VCR stands by for Synchronized Recording.

*¹SLV-SE810G only

*²SLV-SE710G and SE710I only

Checking/changing/cancelling timer settings

Before you start...

- Turn on your TV and set it to the video channel.
- Refer to “Index to parts and controls” for button locations.

- 1 Press **I/⏻** to turn on the VCR.
- 2 Press **MENU**, then press **↑/↓** to highlight **LISTS** and press **OK**.

- 3 Press **↑/↓** to highlight **TIMER LIST**, then press **OK**:

- If you want to change or cancel a setting, go on to the next step.
- If you do not need to change or cancel the settings, press **MENU**, then turn off the VCR to return to recording standby.

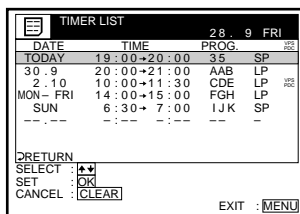

- 4 Press **↑/↓** to select the setting you want to change or cancel, then press **OK**.

The selected setting appears in the **TIMER** menu.

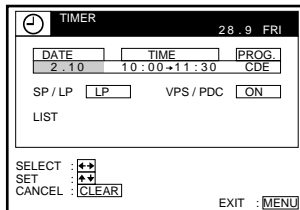

- 5 • To change the setting, press **←/→** to highlight the item you want to change, then press **↑/↓** to reset it.
- To cancel the setting, press **CLEAR**.

- 6 Press **MENU** to exit the menu.

If any settings remain, turn off the VCR to return to recording standby.

When the timer settings overlap

The programme that starts first has priority and the second programme starts recording only after the first programme has finished. If the programmes start at the same time, the programme listed first in the menu has priority.

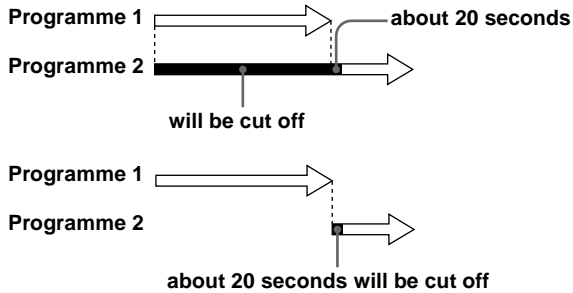

Tip

- In step 6 above, you can check the **TIMER LIST** by selecting **LIST** and pressing **OK**. Press **MENU** to exit the **TIMER LIST**.

Recording stereo and bilingual programmes

In NICAM system

This VCR receives and records stereo and bilingual programmes based on the NICAM system (The NICAM indicator appears). When a stereo or bilingual programme is received, the STEREO indicator appears in the display window.

To record a NICAM programme, HIFI AUDIO in the OPTIONS-1 menu should be set to NICAM (initial setting). To check the menu setting, see page 77 for details.

To select the sound while recording

Press AUDIO MONITOR to select the sound you want.

Stereo programmes

To listen to	On-screen display	Display window
Stereo	STEREO	STEREO
Standard sound*	No indicator	No indicator

* Usually the mixed sound of left and right channels (monaural)

Bilingual programmes

To listen to	On-screen display	Display window
Main	MAIN	STEREO
Sub	SUB	STEREO
Main and sub	MAIN/SUB	STEREO
Standard sound*	No indicator	No indicator

* Usually the main sound (monaural)

continued

Selecting the sound during playback

Press AUDIO MONITOR to select the sound you want.

To listen to	On-screen display	Display window
Stereo/main and sub (left and right channels)	STEREO	STEREO
Left channel/main	LCH	STEREO
Right channel/sub	RCH	STEREO
Standard sound	No indicator	No indicator

How sound is recorded on a video tape

The VCR records sound onto two separate tracks. Hi-fi audio is recorded onto the main track along with the picture. Monaural sound is recorded onto the normal audio track along the edge of the tape.

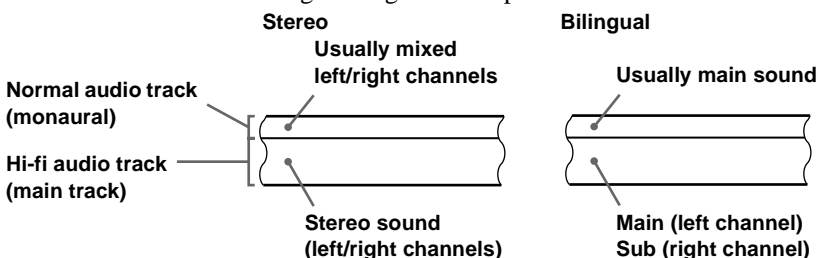

Notes

- To listen to playback sounds in stereo, you must use the Scart or AUDIO OUT connections.
- When you play a tape recorded in monaural, the sound is heard in monaural regardless of the AUDIO MONITOR setting.
- If the AUDIO MONITOR button does not function, check that AUDIO MIX in the OPTIONS-1 menu is set to OFF (see page 76).

Searching using the Smart Search function

If you record multiple programmes on a tape, you can use the Smart Search function to see what has been recorded on your tape. You can see information such as date, time, and programme position of the programmes recorded. You can also start playback directly from the selected programme using the SMART SEARCH screen.

All programmes are listed on the screen, regardless of how the programme was recorded.

To store programme information, see “Storing the programme information” on page 67. If you eject the tape before storing the information, the information will be cleared.

Before you start...

- Turn on your TV and set it to the video channel.
- Refer to “Index to parts and controls” for button locations.

- 1 After recording, press I/⏻ to turn on the VCR.
- 2 Press SMART SEARCH.
- 3 Press ↑/↓/←/→ to select the programme you want to start viewing.

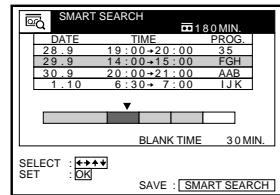

- 4 Press OK.
The VCR starts searching, and playback starts automatically from the beginning of the selected programme.

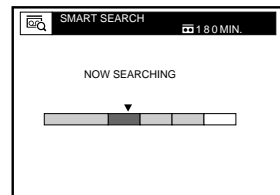

To stop searching

Press ■ STOP.

To exit the SMART SEARCH screen

Press MENU.

continued

To record in a blank space

Blank space on the tape will appear as a blank row in the SMART SEARCH screen. Select the last blank row in step 3, then press OK. The VCR rewinds/fast-forwards the tape to the beginning of the blank space, then stops. Start recording. Note that “BLANK TIME” and the remaining time indication only refers to the length of the last blank space.

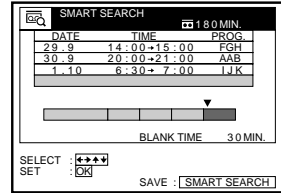

Tips

- You can store information for up to 24 programmes on a single list.
- While recording, you can display the SMART SEARCH screen using the SMART SEARCH button. If you decide to stop recording, press MENU to make the SMART SEARCH screen disappear first. Then press ■ STOP.
- You can have the player recall the data of the last cassette used to record programmes even after you eject the tape (page 70).

Notes

- You cannot use this function unless the clock is set.
- Depending on the tape, the total or remaining time may not appear correctly.
- If many short programmes are recorded on a tape, multiple programmes may be included in a single block. In this case, only the latest programme information will appear in the SMART SEARCH screen.
- Blank time is measured from the end of the last recorded programme to the end of the tape. However, if you eject the tape and then make a new recording on the same tape, the original recorded programme(s) is displayed as a blank space.
- The station name* may not appear if the VCR does not receive station name information signals.
- If you start recording a programme “D” from the middle of a previously recorded programme “A” and into another previously recorded programme “B,” the Smart Search information for the second programme “B,” which is recorded over, is deleted.

Originally recorded programmes

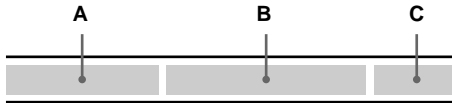

Recording the programme “D” over the programme “A” and “B”



* not available on SLV-SE610G

Storing, searching and deleting programme information (Smart Search Plus)

You can store programme information, such as the recording date and time, and programme position, for a maximum of four tapes. You can select a programme and start playback, by recalling the information directly from the Smart Search Plus screen.

Storing the programme information

You can store programme information for a maximum of four tapes. Before recording a programme, select a memory bank number from the list on the SMART SEARCH screen.

The unit will not memorize the memory bank number for each cassette. Note the number you assigned to each cassette.

Before you start...

- Turn on your TV and set it to the video channel.
- Refer to “Index to parts and controls” for button locations.

- 1 Insert a cassette for recording.
The VCR automatically turns on.
- 2 Press SMART SEARCH.
The SMART SEARCH -RECALL- screen appears.
RECALL is highlighted and the data for the last cassette used to record programmes appears.

SMART SEARCH -RECALL-

RECALL 1 2 3 4

DATE	TIME	PROG.
29 .9	14 :00-15 :00	FGH
30 .9	20 :00+21 :00	AAB
1 .10	6 :30+ 7 :00	IJK

SELECT SET :

EXIT :

- 3 Press ←/→ to select a memory bank number.
Note the memory bank number on the cassette.
To cancel the process, press SMART SEARCH.

SMART SEARCH -RECALL-

RECALL 1 2 3 4

DATE	TIME	PROG.
NO DATA		

SELECT SET :

EXIT :

- 4 Press OK.
- 5 Start recording.
The information about the recorded programme will be stored on the selected memory number.

continued

To assign a memory number after recording

After recording a programme, you can store the programme information as a new memory before ejecting the cassette. However, you can not add the memory on the existed memory bank number. To store the memory as additional, select the memory bank number before.

1 Press I/⏻ to turn on the VCR.

2 Press SMART SEARCH.

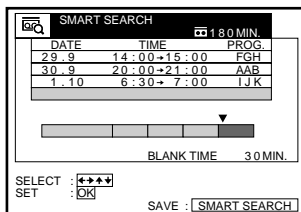

3 Press SMART SEARCH again.

The SMART SEARCH -SAVE- screen appears.

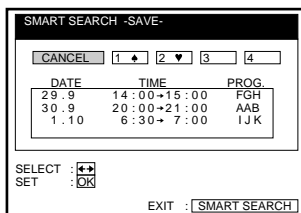

4 Press ←/→ to select a memory bank number.

Select the memory bank number with no information or the memory bank number to be deleted.

To cancel the process, select CANCEL.

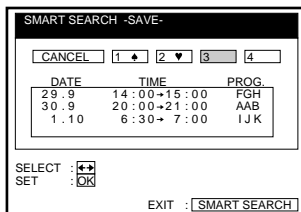

5 Press OK.

To exit the SMART SEARCH screen

Press SMART SEARCH.

Note

- If you select a number that is already contains programmes, the old programme information is cleared and the new programme information is stored.

Searching for programme information stored on the memory bank number

You can start playback of the recorded programme after calling the programme information from the four memory bank numbers.

Before you start...

- Turn on your TV and set it to the video channel.

- 1** Insert the cassette for which you want to use the memory bank number.
The VCR automatically turns on.
- 2** Press SMART SEARCH.
The SMART SEARCH -RECALL- screen appears.

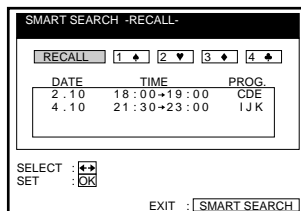

- 3** Press ←/→ to select the memory bank number for the inserted cassette.

The programme information contained in the selected memory bank number appears.

When you selected wrong memory bank number, eject the cassette and repeat steps from step 1.

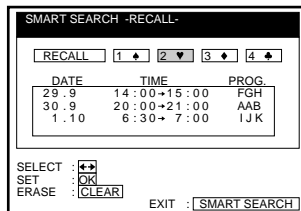

- 4** Press OK.

The selected memory bank number appears on the SMART SEARCH screen.

memory bank number

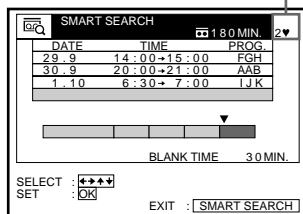

- 5** Press ↑/↓/←/→ to select the programme you want to start viewing.

- 6** Press OK.

The VCR starts searching, and playback starts automatically from the beginning of the selected programme.

To stop searching

Press ■ STOP.

To exit the SMART SEARCH screen

Press SMART SEARCH.

Recalling the most recent programme information

Programme information that is not saved in one of the memory bank numbers is erased when the cassette is ejected. The RECALL memory bank will temporarily memorize the programme information of the last tape used for recording in case that it is accidentally ejected.

If you re-insert the cassette in Step 1 that you accidentally ejected and then select RECALL in Step 3, the data for the last tape used to record programmes appears. Press OK and the latest information will appear on the SMART SEARCH screen. You can then add new information to this programme list. For an explanation about viewing programme information without using one of the memory banks, see page 65.

If you want to erase the latest information in the RECALL memory bank, press the SMART SEARCH button instead of the OK button in Step 3 and then close the SMART SEARCH screen. The new information will replace all of the current information in the RECALL memory bank.

Note

- When you insert the cassette whose information does not exist on the memory bank number, you can not search the recorded programme.

Deleting the programme information

You can delete the programme information stored in a memory number.

Before you start...

- Turn on your TV and the VCR.
- Set the TV to the video channel.

1 Press SMART SEARCH.

The SMART SEARCH -RECALL- screen appears.

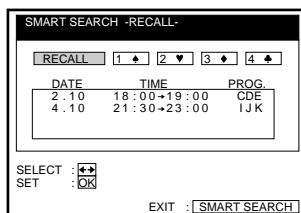

2 Press ←/→ to select the memory bank number to delete.

The programme information on the selected memory bank number appears. Check the information that you want to delete.

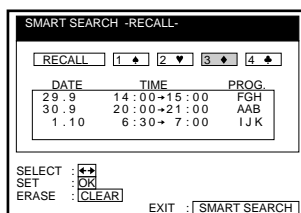

- 3** Press CLEAR.
The programme information is deleted.

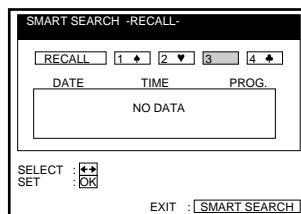

- 4** Press SMART SEARCH.
The SMART SEARCH screen disappears.

Note

- You can not use or return the deleted information.

About the Demonstration Mode

The Smart Search Plus function has a Demonstration Mode that allows the user, such as a salesperson, to automatically display the Smart Search Plus screens.

To activate the Demonstration Mode

While the VCR is turned on, press and hold the both ■ (stop) and ≡ (eject) buttons on the VCR for a few seconds. The demonstration will start and the four kinds of Smart Search Plus screens will be displayed repeatedly. If you operate the VCR, the Demonstration Mode temporarily stops. After about five minutes, the demonstration will restart.

To cancel the Demonstration Mode

While the VCR is turned off, press and hold the both ■ (stop) and ≡ (eject) buttons on the VCR for a few seconds. You can also cancel the Demonstration Mode if you turn the power off and unplug the mains lead.

Searching using the index function

The VCR automatically marks the tape with an index signal at the point where each recording begins. Use these signals as references to find a specific recording.

1 Insert an indexed tape into the VCR.

2 Press **⏮/⏭** INDEX SEARCH.

- To search ahead, press **⏭** INDEX SEARCH.
- To search backwards, press **⏮** INDEX SEARCH.

The VCR starts searching, and playback starts automatically from that point.

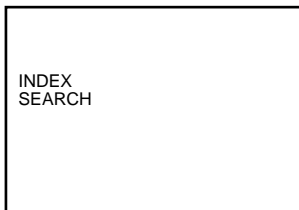

To stop searching

Press **■** STOP.

Notes

- No index signal will be added when recording starts from recording pause. However, an index signal will be marked if you change the programme position during recording pause.
- When you press **⏮** INDEX SEARCH, if there is nothing recorded before the selected index signal, playback may not start exactly at the index signal.

Adjusting the picture

Adjusting the tracking

Although the VCR automatically adjusts the tracking when playing a tape (the  indicator flashes in the display window, then turns off), distortion may occur if the recording is in poor condition. In this case, manually adjust the tracking.

During playback, press PROGRAM +/- on the VCR to display the tracking meter. The distortion should disappear as you press one of the two buttons (the  indicator lights up).

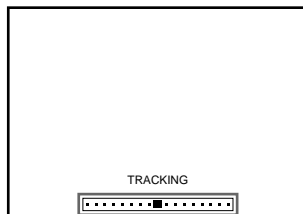

To resume automatic tracking adjustments, eject the tape and re-insert it.





About the Reality Regenerator (RR) function

The Reality Regenerator (RR) function automatically restores the picture to its original quality during playback.

To use the Reality Regenerator (RR) function

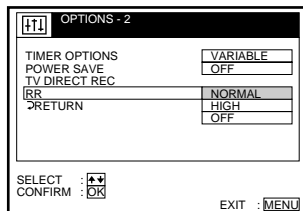
- 1 Press MENU, then select OPTIONS and press OK.
- 2 Press  to highlight OPTIONS-2 then press OK.
- 3 Press  to highlight RR, then press OK.



- 4 Press  to set RR to NORMAL or HIGH, then press OK.
The RR indicator lights up in the display window.
- 5 Press MENU to return to the original screen.

To turn it off, select OFF in step 3. The RR indicator turns off in the display window.

About the Optimum Picture Control (OPC) function

The Optimum Picture Control (OPC) function automatically improves recording and playback quality by adjusting the VCR to the condition of the video heads and tape. To maintain better picture quality, we recommend that you set OPC to ON in the OPTIONS-1 menu (the OPC indicator lights up in the display window). For details, see page 76.

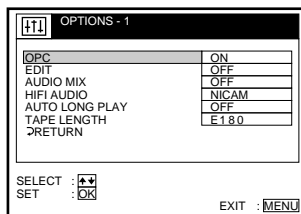

OPC playback

The OPC function automatically works on all types of tapes, including rental tapes and tapes that were not recorded with OPC.

OPC recording

Whenever you insert a tape and start recording for the first time, the VCR adjusts to the tape using the OPC function (the OPC indicator flashes rapidly). This adjustment is retained until the tape is ejected.

To deactivate the OPC function

Set OPC to OFF in the OPTIONS-1 menu. The OPC indicator in the display window turns off.

Tip

- To set tracking to the centre position, press the PROGRAM + and – buttons on the VCR at the same time.

Notes

- You can adjust the tracking for an NTSC-recorded tape but the tracking meter won't be displayed.
- With the Auto Long Play function on, the OPC function will work only in SP mode. If the tape speed automatically switches from SP to LP, the OPC function turns off. If, however, the entire programme is recorded in LP mode, the OPC function will work.
- There is a delay of about ten seconds before the VCR actually starts recording while the VCR analyses the tape. To avoid the delay, first set the VCR to recording pause (the OPC indicator flashes slowly) and press ● REC to have the VCR analyse the tape (the OPC indicator flashes rapidly) and return to recording pause. After the OPC indicator stops flashing, press ■ PAUSE to start recording immediately.

If you want to start recording quickly without using the OPC function, first set the VCR to recording pause (the OPC indicator flashes slowly) and press ■ PAUSE again to start recording.

Reducing the VCR's power consumption

You can turn off the indicators in the display window when the VCR is off (standby mode) to reduce the VCR's power consumption.

- 1 Press MENU, then select OPTIONS and press OK.
- 2 Press **↑/↓** to highlight OPTIONS-2, then press OK.
- 3 Press **↑/↓** to select POWER SAVE, then press OK.

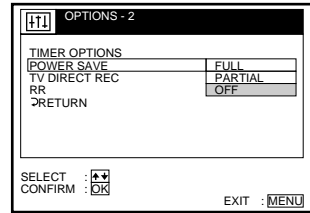

- 4 Press **↑/↓** to highlight the option, then press OK.
For SLV-SE710G, SE710I, and SE810G
 - FULL to reduce the power consumption to a minimum
 - PARTIAL to reduce the power consumptionFor SLV-SE610G
 - ON to reduce the power consumption to a minimum

- 5 Press MENU to return to the original screen.

To turn on the indicators in the display window

Set POWER SAVE to OFF in step 4.

Notes

- When the VCR stands by for recording, the indicators in the display window remain lit even when POWER SAVE is set to FULL, PARTIAL, or ON.
- If POWER SAVE is set to FULL*, you cannot watch or record programmes from your set top box during standby mode (page 77).

* not available on SLV-SE610G

Changing menu options

- 1 Press MENU, then select OPTIONS and press OK.

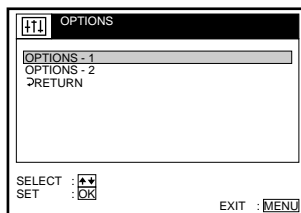

- 2 Press \uparrow/\downarrow to highlight OPTIONS-1 or OPTIONS-2, then press OK.

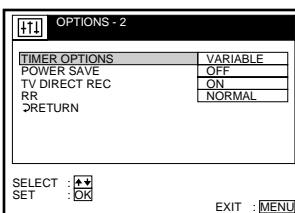
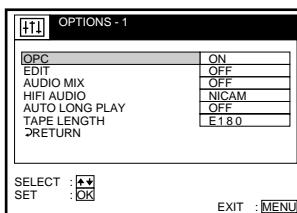

- 3 Press \uparrow/\downarrow to select the option, then press OK.

- 4 Press \uparrow/\downarrow to change the setting, then press OK.

- 5 Press MENU to return to the original screen.

Menu choices

Initial settings are indicated in bold print.

OPTIONS-1

Menu option	Set this option to
OPC	<ul style="list-style-type: none"> • ON to switch on the OPC (Optimum Picture Control) function and improve picture quality. • OFF to switch off OPC.
EDIT	<ul style="list-style-type: none"> • ON to minimize picture deterioration when editing. • OFF to turn off EDIT.
AUDIO MIX	<ul style="list-style-type: none"> • ON to listen to the hi-fi and normal audio tracks at the same time. The AUDIO MONITOR button will not function. • OFF to listen to the hi-fi and normal audio tracks separately. Select the sound using the AUDIO MONITOR button. <p>If you press \blacktriangle EJECT, AUDIO MIX will be reset to OFF. For details, see page 64.</p>

Menu option	Set this option to
HIFI AUDIO	<ul style="list-style-type: none"> • NICAM to record NICAM broadcasts on the hi-fi audio track. • STANDARD to record standard sound on the hi-fi audio track. For details, see page 63.
AUTO LONG PLAY	<ul style="list-style-type: none"> • ON to change the timer recording tape speed automatically to the LP mode when the remaining tape length becomes shorter than the recording time. Note that for AUTO LONG PLAY to work correctly, the TAPE LENGTH setting must be accurate. • OFF to keep the set tape speed.
TAPE LENGTH	<ul style="list-style-type: none"> • E180 to use an E-180 or shorter type tape. • E195 to use an E-195 type tape. • E240 to use an E-240 type tape. • E300 to use an E-300 type tape.

OPTIONS-2

Menu option	Set this option to
TIMER OPTIONS*1	<ul style="list-style-type: none"> • VARIABLE to display the TIMER METHOD menu for selecting STANDARD or VIDEO Plus+ when pressing the ⊖ TIMER button. • STANDARD to display the TIMER menu when pressing the ⊖ TIMER button. • VIDEO Plus+ to display the VIDEO Plus+ menu when pressing the ⊖ TIMER button. For details, see page 48 and 52.
POWER SAVE*2	<ul style="list-style-type: none"> • FULL to turn off the indicators in the display window during standby mode to reduce the VCR's power consumption to a minimum. For using the Line Through function (page 18), select PARTIAL or OFF. • PARTIAL to turn off the indicators in the display window to conserve the VCR's power. • OFF to turn on the indicators in the display window while the VCR is standing by.
POWER SAVE*3	<ul style="list-style-type: none"> • ON to turn off the indicators in the display window during standby mode to reduce the VCR's power consumption to a minimum. • OFF to turn on the indicators in the display window while the VCR is standing by.
TV DIRECT REC*1	<ul style="list-style-type: none"> • ON to activate the TV Direct Rec function. • OFF to deactivate it.

continued

Menu option	Set this option to
RR	<ul style="list-style-type: none"> • NORMAL for normal everyday use. • HIGH for well-used video tapes such as rented tapes. Select this option when NORMAL does not improve the picture quality. • OFF to switch off the RR function.

Notes

- When the VCR stands by for recording, the indicators in the display window remain lit even when **POWER SAVE** is set to **FULL**, **PARTIAL**, or **ON**.
- With the **EDIT** option **ON**, the **OPC** function does not work.

*¹ not available on SLV-SE610G

*² SLV-SE710G, SE710I, and SE810G only

*³ SLV-SE610G only

Connecting to a VCR or stereo system

How to connect to record on this VCR

Connect the line outputs of the other VCR to the LINE IN connector or jacks of this VCR. Refer to the examples A through C and choose the connection that best suits your VCR.

Example A

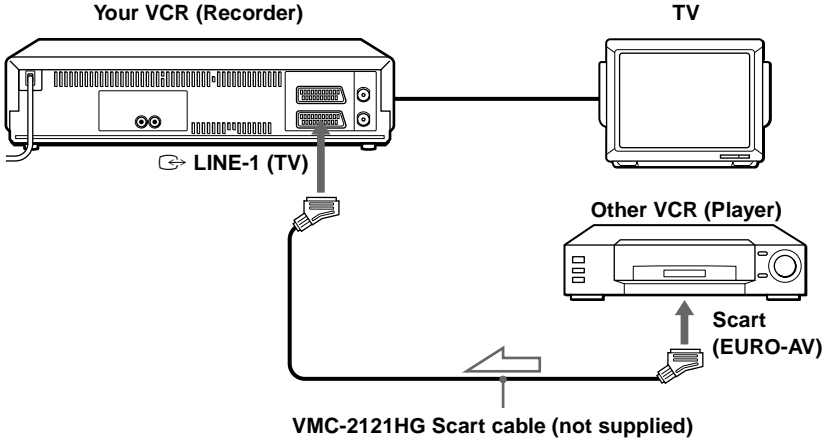

 : Signal flow

Example B

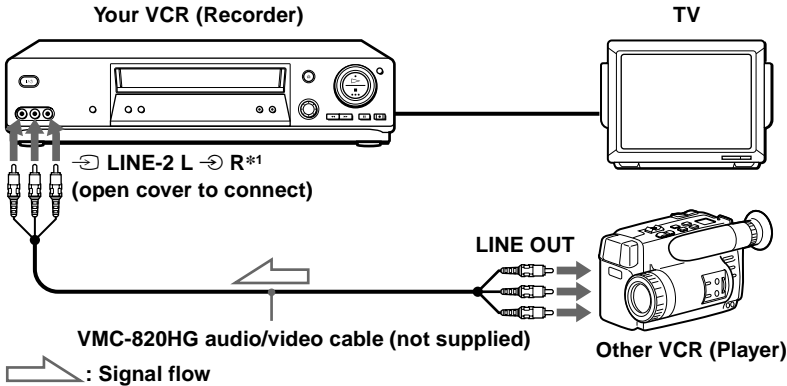

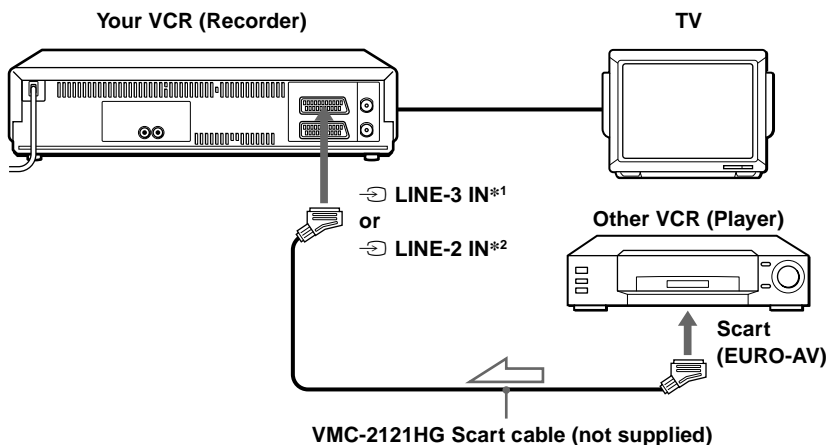

 : Signal flow

Example C



 : Signal flow

How to connect to a stereo system (SLV-SE810G only)

Connect the  LINE-2 L  R jacks on this VCR to the audio output jacks on the stereo system, using the RK-C510HG audio cable (not supplied).

Notes

- Make sure you connect the plugs to jacks of the same colour.*¹
- If the other VCR is a monaural type, leave the red plugs unconnected.
- If you connect this VCR to both the LINE IN and LINE OUT jacks of the other VCR, select the input correctly to prevent a humming noise.
- If the other VCR does not have a Scart (EURO-AV) connector, use the VMC-2106HG cable instead and connect the cable to the line out jacks of the other VCR.

*¹ SLV-SE810G only

*² SLV-SE710G and 710I only

Basic editing

when recording on this VCR

Before you start editing

- Turn on your TV and set it to the video channel.
- Press INPUT SELECT to display the connected line in the display window.
- Press SP/LP to select the tape speed, SP or LP.
- On this VCR, set EDIT to ON in the OPTIONS-1 menu. If the other VCR has a similar function, turn it on as well.

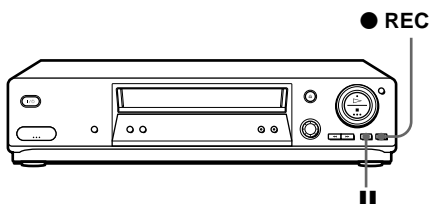

- 1** Insert a source tape with its safety tab removed into the other (playback) VCR. Search for the point to start playback and set it to playback pause.
- 2** Insert a tape with its safety tab in place into this (recording) VCR. Search for the point to start recording and press **||** (pause).
- 3** Press **● REC** on this VCR to set it to recording pause.
- 4** To start editing, press the **||** (pause) buttons on both VCRs at the same time.

To stop editing

Press the **■** (stop) buttons on both VCRs.

Tip

- To cut out unwanted scenes while editing, press **||** (pause) on this VCR when an unwanted scene begins. When it ends, press **||** (pause) again to resume recording.

Note

- If you start editing following the procedure above, the VCR won't start recording with the OPC function. To record a tape with the OPC function, press **● REC** again during recording pause in step 3 so the VCR analyses the tape. Then, press **||** (pause) after the OPC indicator stops flashing to start recording. If you press **||** (pause) before the OPC indicator stops flashing, the OPC function is cancelled.

Audio dubbing (SLV-SE810G only)

This feature lets you record over the normal audio track. The monaural sound previously recorded is replaced while the original hi-fi sound remains unchanged. Use this feature to add commentary to a tape that you have recorded with a camcorder.

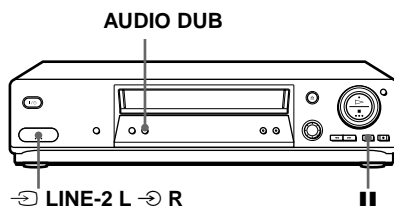

Before you start...

- Open the ⊖ LINE-2 L ⊖ R jacks cover on the front panel and connect a playback source.
- Turn on the TV and set it to the video channel.

- 1** Insert a source tape into your stereo system (or the playback VCR). Search for the point to start playback and set it to playback pause.
- 2** Insert a prerecorded tape with its safety tab in place into this (recording) VCR. Search for the start of the section to be replaced and press **||** (pause).
The VCR enters pause mode.
- 3** Press **AUDIO DUB**.
The programme position changes to “L2,” and the ⊖ indicator appears in the display window.
- 4** To start editing, press the **||** (pause) buttons on this VCR and the stereo system (or other VCR) at the same time.
After you use this feature, the audio in playback mode is automatically set to monaural.

To stop editing

Press **■** (stop) on this VCR and the stereo system (or other VCR).

To listen to both the hi-fi and normal audio

Set **AUDIO MIX** to **ON** in the **OPTIONS-1** menu (page 76). Use this feature to listen to dubbed audio over the original hi-fi audio. When **AUDIO MIX** is set to **ON**, the **AUDIO MONITOR** button does not function.

Remember to reset **AUDIO MIX** to **OFF** after playing the tape.

Note

- If you eject the tape or turn the VCR off, **AUDIO MIX** is automatically set to **OFF**.

Troubleshooting

If you have any questions or problems not covered below, please consult your nearest Sony service facility.

	Symptom	Remedy
Power	The I/⏻ (on/standby) switch does not function.	<ul style="list-style-type: none"> Connect the mains lead to the mains securely.
	The power is turned on but the VCR does not operate.	<ul style="list-style-type: none"> Moisture condensation has occurred. Turn the power off, unplug the mains lead and leave the VCR to dry for over three hours.
	The VCR is plugged in but the display window remains dark.	<ul style="list-style-type: none"> Set POWER SAVE in the OPTIONS-2 menu to OFF (see page 75).
Clock	The clock has stopped and “-:-” appears in the display window.	<ul style="list-style-type: none"> The clock stops if the VCR is disconnected from the mains for more than one hour. Reset the clock (and timer).
Playback	The playback picture does not appear on the TV screen.	<ul style="list-style-type: none"> Make sure the TV is set to the video channel. If you are using a monitor, set it to video input. If the VCR is connected to the TV with the Scart cable, make sure the VIDEO indicator is lit in the display window. Use the  TV/VIDEO button on the remote commander to light up the VIDEO indicator.
	The picture is not clear.	<ul style="list-style-type: none"> If your TV is connected to the VCR with both Scart and aerial cables, make sure the RF channel is set to OFF (see page 22). Existing broadcasts may interfere with the VCR. Reset the RF channel output of your VCR. Adjust the tracking with the PROGRAM +/- buttons <u>on the VCR</u>. The video heads are dirty (see the last page of Troubleshooting). Clean the video heads using the Sony T-25CLD, E-25CLDR, or T-25CLW video head cleaning cassette. If these cleaning cassettes are not available in your area, have the heads cleaned at your nearest Sony service facility (a standard service charge will be required). Do not use a commercially available liquid type cleaning cassette other than Sony’s, as it may damage the video heads. The video heads may have to be replaced. Consult your local Sony service facility for more information.
	The picture rolls vertically during picture search.	<ul style="list-style-type: none"> Adjust the vertical hold control on the TV or monitor.



	Symptom	Remedy
Playback	The picture has no sound.	<ul style="list-style-type: none"> The tape is defective. If you made A/V connections, check the audio cable connection.
	The sound is unstable or has an echo.	<ul style="list-style-type: none"> When you play a tape with the same sound recorded on both the hi-fi and normal audio tracks, make sure AUDIO MIX in the OPTIONS-1 menu is set to OFF.
	The sound from a tape recorded with the VCR is not in stereo or the STEREO indicator in the display window is flashing.	<ul style="list-style-type: none"> Adjust the tracking. The video heads are dirty. Clean the video heads using the Sony T-25CLD, E-25CLDR, or T-25CLW video head cleaning cassette as explained above.
Recording	No TV programme appears on the TV screen.	<ul style="list-style-type: none"> Make sure the TV is set to the video channel. If you are using a monitor, set it to video input. If your TV is connected to the VCR with both Scart and aerial cables, make sure the RF channel is set to OFF (see page 22). Existing broadcasts may interfere with the VCR. Reset the RF channel output of your VCR. Select the correct source with the INPUT SELECT button. Select a programme position when recording TV programmes; select a line input when recording from other equipment.
	TV reception is poor.	<ul style="list-style-type: none"> Make sure the aerial cable is connected securely. Adjust the TV aerial.
	The tape starts playing as soon as it is inserted.	<ul style="list-style-type: none"> The safety tab has been removed. To record on this tape, cover the tab hole (see page 41).
	The tape is ejected when you press ● REC.	<ul style="list-style-type: none"> The safety tab has been removed. To record on this tape, cover the tab hole (see page 41).
	Nothing happens when you press ● REC.	<ul style="list-style-type: none"> Make sure the tape is not at its end.
Timer recording	The timer does not operate.	<ul style="list-style-type: none"> Check that the clock is set. Make sure a tape has been inserted. Check that the safety tab has not been removed. Make sure the tape is not at its end. Make sure a programme has been set for timer recording. Make sure your timer settings are past the current time. Check that the set top box is turned on. The clock stops if the VCR is disconnected from the mains for more than one hour. Reset the clock and timer. Turn the power off and unplug the mains lead.

	Symptom	Remedy
Timer recording	The VIDEO Plus+ menu or the TIMER menu does not appear.	<ul style="list-style-type: none"> Check that TIMER OPTIONS in the OPTIONS-2 menu is set correctly (see page 77).
	The VPS/PDC function does not operate properly.	<ul style="list-style-type: none"> Check that the clock and the date are set correctly. Check that the VPS/PDC time you set is the correct one (there might be a mistake in the TV programme guide). If the broadcast you wanted to record did not send the good VPS/PDC information, the VCR will not start recording. If the reception is poor, the VPS/PDC signal might be altered and the VCR might not start recording.
Synchronized Recording	The SYNCHRO REC button turns off while recording or does not go back to recording standby mode.	<ul style="list-style-type: none"> The tape has reached its end. Insert a new tape and press SYNCHRO REC again.
	The Synchronized Recording function does not work.	<ul style="list-style-type: none"> The connected equipment was not turned off. Turn off the connected equipment and press SYNCHRO REC again. There was a power failure. Press SYNCHRO REC again.
	The programme recorded with the Synchronized Recording function is incomplete.	<ul style="list-style-type: none"> If the settings for timer recordings and Synchronized Recording overlap, the programme that starts first has priority and the second programme starts recording only after the first programme has finished. There was a power failure. Press SYNCHRO REC again.
Others	A tape cannot be inserted.	<ul style="list-style-type: none"> Check that a tape isn't already in the tape compartment.
	The remote commander does not function.	<ul style="list-style-type: none"> Make sure you are pointing the remote commander at the remote sensor on the VCR. Replace all the batteries in the remote commander with new ones if they are weak. Make sure the [TV] / [VIDEO] remote control switch is set correctly.
	The SMARTLINK function does not work.	<ul style="list-style-type: none"> Check that your TV complies with SMARTLINK, MEGALOGIC, EASYLINK, Q-Link, EURO VIEW LINK, or T-V LINK. Make sure you use the Scart cable to connect the VCR and your TV. Make sure the Scart cable is connected securely.
	The tracking meter does not appear on the TV screen.	<ul style="list-style-type: none"> The recording condition of the tape is very poor and tracking cannot be adjusted. The tracking meter does not appear when playing back an NTSC-recorded tape.

continued

	Symptom	Remedy
Others	You cannot control other TVs.	<ul style="list-style-type: none"> Set your TV's code number. The code number may change when you replace the batteries of the remote commander.
	The display window becomes dim.	<ul style="list-style-type: none"> The display window automatically becomes dim when the VCR is in standby or timer recording mode.
	The VCR needs to be cleaned.	<ul style="list-style-type: none"> Clean the cabinet, panel and controls with a dry, soft cloth, or a soft cloth slightly moistened with a mild detergent solution. Do not use any type of solvent, such as alcohol or benzine.

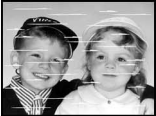
Symptoms caused by contaminated video heads

<ul style="list-style-type: none"> Normal picture 	<ul style="list-style-type: none"> Rough picture 	<ul style="list-style-type: none"> Unclear picture 	<ul style="list-style-type: none"> No picture (or black & white screen appears)
			
<p>initial contamination →</p>			<p>terminal</p>

Specifications

System

Channel coverage

- PAL (I)
- VHF IA to IJ, SA10 to SA13 (SLV-SE710I only)
- UHF B21 to B69
- CATV S01 to S05, S1 to S20 (SLV-SE710I only)
- HYPERS S21 to S41 (SLV-SE710I only)

RF output signal

- UHF channels 21 to 69

Aerial out

- 75-ohm asymmetrical aerial socket

Tape speed

- SP: PAL 23.39 mm/s (recording/playback)
- NTSC 33.35 mm/s (playback only)
- LP: PAL 11.70 mm/s (recording/playback)
- NTSC 16.67 mm/s (playback only)
- EP: NTSC 11.12 mm/s (playback only)

Maximum recording/playback time

- 10 hrs. in LP mode (with E300 tape)

Fast-forward and rewind time

- Approx. 1 min. (with E180 tape)

Inputs and outputs

↻ LINE-1 (TV)

- 21-pin
- Video input: pin 20
- Audio input: pins 2 and 6
- Video output: pin 19
- Audio output: pins 1 and 3

↻ LINE-2 IN (SLV-SE710G, SE710I)

- 21-pin
- Video input: pin 20
- Audio input: pins 2 and 6

↻ LINE-3 IN (SLV-SE810G)

- 21-pin
- Video input: pin 20
- Audio input: pins 2 and 6

↻ LINE-2 IN L ↔ R (SLV-SE810G)

- VIDEO IN, phono jack (1)
- Input signal: 1 Vp-p, 75 ohms, unbalanced, sync negative
- AUDIO IN, phono jack (2)
- Input level: 327 mVrms
- Input impedance: more than 47 kilohms

↻ R/D L/G (SLV-SE710G, SE710I, SE810G)

- Phono jack (2)
- Rated output level: 327 mVrms
- Load impedance: 47 kilohms
- Output impedance: less than 10 kilohms

General

Power requirements

- 220 – 240 V AC, 50 Hz

Power consumption

- 20 W
- 1.2 W (POWER SAVE is set to ON, minimum)

Operating temperature

- 5°C to 40°C

Storage temperature

- 20°C to 60°C

Dimensions including projecting parts and controls

- Approx. 430 × 98 × 283 mm (w/h/d) (SLV-SE610G, SE710G, SE710I)
- Approx. 430 × 98 × 289 mm (w/h/d) (SLV-SE810G)

Mass

- Approx. 4.1 kg

Supplied accessories

- Remote commander (1)
- R6 (size AA) batteries (2)
- Aerial cable (1)

Design and specifications are subject to change without notice.

Index

A

- Adjusting
 - picture 26, 73
 - tracking 73
- Aerial hookup 15
- AFT (Auto Fine Tuning) 26
- Audio dubbing 82
- Audio track 64
- Auto Clock Set 34
- Auto Long Play 77
- Auto Set Up 19

C

- Changing the programme position 27
- Changing the station name 30
- Cleaning the video heads 83
- Clock setting 32
- Colour system 2
- compatible colour systems 2
- Connecting
 - the VCR and your TV 15, 16
 - to a set top box 18
 - to a stereo system 18
 - to a TV with a Scart (EURO-AV) connector 16
- Counter 38

D

- Demonstration 47, 71
- Dial Timer 43
- Disabling the programme positions 28
- Dubbing. *see* Editing

E

- Editing 79
- EP mode 39

H

- Hi-fi audio track 64

I

- Index search 72

L

- Language selecting 23
- LP mode 40

M

- Monaural 63
- Monitoring
 - during playback 64
 - during recording 63

N

- NICAM broadcasts 63
- Normal audio track 64

O

- OPC (Optimum Picture Control) 74
- Optional setting 76

P

- PDC (Programme Delivery Control) 50
- Picture adjustment. *See* Adjusting
- Playback 38
 - at various speeds 56
 - frame-by-frame 56
 - selecting the sound 64
 - slow motion 56
- Power save 75
- Presetting channels 24

R

- Reality Regenerator 73
- Recording 40
 - bilingual programmes 63
 - duration time 58
 - saving 41
 - stereo programmes 63
 - timer setting 52
 - using the Dial Timer 43
 - VIDEO Plus+ 48
 - what you are watching on the TV 42
 - while watching another programme 41
- RF channel 21, 22

S

- Safety tab 41
- Scart connection 16
- Searching
 - at various speeds 56
 - using the index function 72
 - using the Smart Search function 65
- Security function 36
- Smart Search 65
- SMARTLINK
 - Automatic Power Off 17
 - One Touch Menu 17
 - One Touch Play 17, 39
 - One Touch Timer 17
 - Preset Download 17
 - TV Direct Rec 17, 42
- SP mode 40
- Stereo 63
- Synchronized Recording 59

T

- Timer setting 52
 - cancelling 61
 - changing 61
 - checking 61
 - daily/weekly recording 50, 53
 - using the Dial Timer 43
 - using the VIDEO Plus+ system 48
- Tracking adjustment. *See* Adjusting

V

- VIDEO Plus+ system 48
- VPS (Video Programme System) 50

Quick Start Guide

1 Connecting the VCR

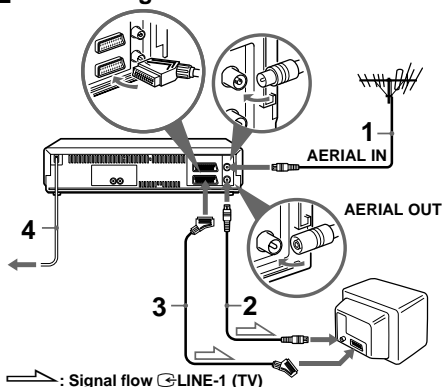

- 1 ... Connect the aerial to AERIAL IN of the VCR.
- 2 ... Connect AERIAL OUT the aerial input of your TV using the supplied aerial cable.
- 3 ... For better picture and sound, connect LINE-1 (TV) to your TV using a Scart cable if your TV has a Scart (EURO-AV) connector.
- 4 ... Connect the mains lead to the mains.

2 Using the Auto Set Up function

AUTO SET UP



You can preset channels.

Hold AUTO SET UP on the VCR for more than three seconds.

When all the receivable channels are preset, "SET UP" disappears from the display window. You can rearrange the programme position to your favourite order (see "Changing/disabling programme positions").

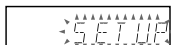

3 Tuning your TV to the VCR

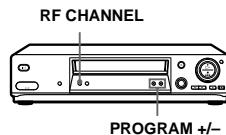

A If your TV does not have a Scart (EURO-AV) connector

- 1 ... Press RF CHANNEL on the VCR lightly.



- 2 ... Turn on your TV and select a programme position for the VCR picture.
- 3 ... Tune the TV to the same channel shown in the VCR display window so that SONY VIDEO CASSETTE RECORDER appears clearly on the TV screen. Refer to your TV's instruction manual for tuning instructions.
- 4 ... Press RF CHANNEL.

B If your TV has a Scart (EURO-AV) connector

- 1 ... Press RF CHANNEL on the VCR lightly.
- 2 ... Press PROGRAM +/- to set the RF channel to OFF.

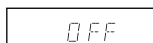

- 3 ... Press RF CHANNEL.

Now you can operate your VCR.

Setting your personal code

For security, you can enter a personal code (up to eleven characters), such as your post code. If your VCR is stolen and then recovered, you can identify your VCR using your personal code. Once you enter the code, you can never change it. Please make a note of the code to quote to the police if your VCR is stolen.