

# SLV-SE230/SE430/SE630/SE730/SE737/ SE830/SX730/SX737

## RMT-V405/V405A/V406/V406A/V406B/V407A/V407B/V407C

# SERVICE MANUAL

*AEP Model*

SLV-SE230B/SE230D/SE430K/SE630B/SE630D/SE630E/SE630N/  
SE730B/SE730D/SE730E/SE730N/SE737E/SE830B/SE830D/  
SE830E/SE830N/SX730D/SX730E/SX730N/SX737D

*UK Model*

SLV-SE230G/SE230I/SE730G/SE730I/SE830G



**VHS**

**Hi-Fi**

**SHOWVIEW®**

Photo: SLV-SE830N  
RMT-V407A

**TS-10 MECHANISM**

Refer to the **SERVICE MANUAL** of **VHS MECHANICAL ADJUSTMENT MANUAL VII** for **MECHANICAL ADJUSTMENTS**. (9-921-790-11)

## SPECIFICATIONS

### System

#### Colour system

SE230B/SE630B/SE730B/SE830B:

SECAM (L)

VHF F2 to F10

UHF F21 to F69

CATV B to Q

HYPER S21 to S41

PAL (B/G)

VHF E2 to E12

VHF italian channels A to H

UHF E21 to E69

CATV S01 to S05, S1 to S20

HYPER S21 to S41

SE230D/SE630D/SE630E/SE730D/SE730E/  
SE737E/SE830D/SE830E/SX730D/SX730E/  
SX737D:

PAL (B/G)

VHF E2 to E12

VHF italian channels A to H

UHF E21 to E69

CATV S01 to S05, S1 to S20

HYPER S21 to S41

SE230G/SE730G/SE830G:

PAL (I)

UHF B21 to B69

SE230I/SE730I:

PAL (I)

VHF IA to IJ, SA10 to SA13

UHF B21 to B69

CATV S01 to S05, S1 to S20

HYPER S21 to S41

SE430K/SE630N/SE730N/SE830N/SX730N:

PAL (B/G, D/K)

VHF E2 to E12, R1 to R12

UHF E21 to E69, R21 to R69

CATV S1 to S41, S01 to S05

RF output signal

SE230D/SE230G/SE230I/SE430K/SE630D/  
SE630E/SE630N/SE730D/SE730E/SE730G/  
SE730I/SE730N/SE737E/SE830D/SE830E/  
SE830G/SE830N/SX730D/SX730E/SX730N/  
SX737D:

UHF channels 21 to 69

Aerial out

75-ohm asymmetrical aerial socket

Tape speed

SE230B:

SP: PAL 23.39 mm/s (recording/playback)

NTSC 33.35 mm/s (playback only)

SECAM

23.39 mm/s (recording/playback)

MESECAM

23.39 mm/s (playback only)

LP: NTSC 16.67 mm/s (playback only)

SECAM

11.70 mm/s (recording/playback)

MESECAM

11.70 mm/s (playback only)

SE230D:

SP: PAL 23.39 mm/s (recording/playback)

NTSC 33.35 mm/s (playback only)

LP: NTSC 16.67 mm/s (playback only)

SE230G/SE230I/SE630D/SE630E/SE730D/  
SE730E/SE730G/SE730I/SE737E/SE830D/  
SE830E/SE830G/SX730D/SX730E/SX737D:

SP: PAL 23.39 mm/s (recording/playback)

NTSC 33.35 mm/s (playback only)

LP: PAL 11.70 mm/s (recording/playback)

NTSC 16.67 mm/s (playback only)

EP: NTSC 11.12 mm/s (playback only)

— Continued on next page —

## VIDEO CASSETTE RECORDER

# SONY®

SE430K/SE630N/SE730N/SE830N/SX730N:  
SP: PAL/MESECAM

23.39 mm/s (recording/playback)

NTSC 33.35 mm/s (playback only)

LP: PAL/MESECAM

11.70 mm/s (recording/playback)

NTSC 16.67 mm/s (playback only)

EP: NTSC 11.12 mm/s (playback only)

SE630B/SE730B/SE830B:

SP: PAL 23.39 mm/s (recording/playback)

NTSC 33.35 mm/s (playback only)

SECAM

23.39 mm/s (recording/playback)

MESECAM

23.39 mm/s (playback only)

LP: PAL 11.70 mm/s (recording/playback)

NTSC 16.67 mm/s (playback only)

SECAM

11.70 mm/s (recording/playback)

MESECAM

11.70 mm/s (playback only)

EP: NTSC 11.12 mm/s (playback only)

Maximum recording/playback time

10 hrs. in LP mode (with E300 tape)

Rewind time

Approx. 1 min. (with E180 tape)

## Inputs and outputs

LINE-1 (EURO AV)

21-pin

Video input: pin 20

Audio input: pins 2 and 6

Video output: pin 19

Audio output: pins 1 and 3

LINE-2 (DEC/EXT)/LINE-3 (DEC/EXT)

21-pin

Video input: pin 20

Audio input: pins 2 and 6

SE830B/SE830D/SE830E/SE830G/SE830N:

↺ LINE-2 L ↺ R

VIDEO IN, phono jack (1)

Input signal: 1 Vp-p, 75 ohms,

unbalanced, sync negative

AUDIO IN, phono jack (2)

Input level: 327 mVrms

Input impedance: more than 47 kilohms

SE730B/SE730D/SE730E/SE730G/SE730I/

SE730N/SE737E/SE830B/SE830D/SE830E/

SE830G/SE830N/SX730D/SX730E/SX730N/

SX737D:

AUDIO (OUT/SORTIE) R/D L/G

Phono jack (2)

Rated output level: 327 mVrms

Load impedance: 47 kilohms

Output impedance: less than 10 kilohms

## General

Power requirements

220 – 240 V AC, 50 Hz

Power consumption

SE230B/SE230D/SE230G/SE230I/SE430K:

15 W

1.2 W (POWER SAVE is set to ECO2, minimum)

SE630B/SE630D/SE630E/SE630N:

17 W

1.2 W (POWER SAVE is set to ECO2, minimum)

SE730B/SE730D/SE730E/SE730G/SE730I/

SE730N/SE737E/SE830B/SE830D/SE830E/

SE830G/SE830N/SX730D/SX730E/SX730N/

SX737D:

17 W

1.3 W (POWER SAVE is set to ECO2, minimum)

Operating temperature

5 °C to 40 °C

Storage temperature

–20 °C to 60 °C

Dimensions including projecting parts and controls (w/h/d)

SE230B/SE230D/SE230G/SE230I/SE430K:

Approx. 360 × 95 × 245 mm

SE630B/SE630D/SE630E/SE630N/SE730B/

SE730D/SE730E/SE730G/SE730I/SE730N/

SE737E/SX730D/SX730E/SX730N/SX737D:

Approx. 430 × 96 × 245 mm

SE830B/SE830D/SE830E/SE830G/SE830N:

Approx. 430 × 96 × 253 mm

Mass

SE230B/SE230D/SE230G/SE230I/SE430K:

Approx. 2.8 kg

SE630B/SE630D/SE630E/SE630N/SE730B/

SE730D/SE730E/SE730G/SE730I/SE730N/

SE737E/SE830B/SE830D/SE830E/SE830G/

SE830N/SX730D/SX730E/SX730N/SX737D:

Approx. 3.1 kg

## Supplied accessories

Remote commander (1)

R6 (size AA) batteries (2)

Aerial cable (1)

SE230B/SE630B/SE730B/SE830B:

PERITEL cable (1)

Design and specifications are subject to change without notice.

## SAFETY CHECK-OUT

After correcting the original service problem, perform the following safety checks before releasing the set to the customer:

1. Check the area of your repair for unsoldered or poorly-soldered connections. Check the entire board surface for solder splashes and bridges.
2. Check the interboard wiring to ensure that no wires are “pinched” or contact high-wattage resistors.
3. Look for unauthorized replacement parts, particularly transistors, that were installed during a previous repair. Point them out to the customer and recommend their replacement.
4. Look for parts which, though functioning, show obvious signs of deterioration. Point them out to the customer and recommend their replacement.
5. Check the B+ voltage to see it is at the values specified.

### SAFETY-RELATED COMPONENT WARNING!!

COMPONENTS IDENTIFIED BY MARK  $\triangle$  OR DOTTED LINE WITH MARK  $\triangle$  ON THE SCHEMATIC DIAGRAMS AND IN THE PARTS LIST ARE CRITICAL TO SAFE OPERATION. REPLACE THESE COMPONENTS WITH SONY PARTS WHOSE PART NUMBERS APPEAR AS SHOWN IN THIS MANUAL OR IN SUPPLEMENTS PUBLISHED BY SONY.

## TABLE OF CONTENTS

### Important Service Guide

- ◆ Mode Switch (Program Switch) Assembly Point ..... 4
- ◆ How to eject the cassette tape  
(If the unit does not operate on condition that tape is inserted  
into housing ass'y) ..... 4

### 1. General

Getting Started	
Index to parts and controls .....	1-1
Step 1 : Unpacking .....	1-2
Step 2 : Setting up the remote commander .....	1-3
Step 3 : Connecting the VCR .....	1-4
Step 4 : Setting up the VCR with the Auto Set Up function .....	1-5
Step 5 : Selecting the TV system .....	1-5
Setting the clock .....	1-6
Downloading the TV tuner's preset data .....	1-6
Selecting a language .....	1-6
Presetting channels .....	1-7
Changing/disabling programme positions .....	1-7
Setting the Canal Plus decoder .....	1-9
Basic Operations	
Playing a tape .....	1-9
Recording TV programmes .....	1-10
Recording TV programmes using the Dial Timer .....	1-11
Recording TV programmes using the Show View® system .....	1-12
Recording TV programmes using the timer .....	1-13
Additional Operations	
Playing/searching at various speeds .....	1-14
Setting the recording duration time .....	1-15
Checking/changing/cancelling timer settings .....	1-15
Recording stereo and bilingual programmes .....	1-15
Searching using the index function .....	1-16
Adjusting the picture .....	1-17
Reducing the VCR's power consumption .....	1-17
Changing menu options .....	1-17
Editing	
Connecting to a VCR or stereo system .....	1-18
Basic editing .....	1-18
Audio dubbing .....	1-18
Additional Information	
Troubleshooting .....	1-19
Index .....	1-20
Quick Start Guide .....	1-20

### 2. Disassembly

2-1 Mono Models	
2-1-1 Cabinet Top .....	2-1
2-1-2 Cover Bottom .....	2-1
2-1-3 Ass'y-Panel Front .....	2-2
2-1-4 Ass'y Main PCB, Deck .....	2-3
2-2 Hi-Fi Models	
2-2-1 Cabinet Top .....	2-4
2-2-2 Cover Bottom .....	2-4
2-2-3 Ass'y-Panel Front .....	2-5
2-2-4 Ass'y Jack PCB .....	2-5
2-2-5 Ass'y Main PCB, Deck .....	2-6

- Main A model: SE230/SE430/SE630
- Main B model: SE730/SE737/SE830/SX730/SX737
- Hi-Fi model: SE630/SE730/SE737/SE830/SX730/SX737
- Mono model: SE230/SE430

### 3. P.C.Boards

3-1 Main PCB (Main A model) .....	3-3
3-2 Main PCB (Main B model) .....	3-7
3-3 Function PCB (Hi-Fi model) .....	3-11
3-4 Dial Timer PCB (SE830) .....	3-11

### 4. Schematic Diagrams

◆ Block Identification of Main PCB .....	4-3
4-1 S.M.P.S. (Main A model) .....	4-5
4-2 S.M.P.S. (Main B model) .....	4-7
4-3 Power (Main A model) .....	4-9
4-4 Power (Main B model) .....	4-11
4-5 System Control/Servo (Main A model) .....	4-13
4-6 System Control/Servo (Main B model) .....	4-15
4-7 Audio/Video .....	4-17
4-8 Hi-Fi (Hi-Fi model) .....	4-19
4-9 TM-Block .....	4-21
4-10 OSD/VPS/PDC .....	4-23
4-11 SECAM (SE230B/SE630B/SE730B/SE830B) .....	4-25
4-12 A2/NICAM (Hi-Fi model) .....	4-27
4-13 Input-Output (2 Scart Jack) (Main A model) .....	4-29
4-14 Input-Output (2 Scart Jack) (Main B model) .....	4-31
4-15 Function (SE630) .....	4-33
4-16 Function (Main B model) .....	4-35

### 5. Alignment and Adjustment

5-1 Reference .....	5-1
5-1-1 Location of adjustment button of remote control .....	5-1
5-1-2 Test point location for adjustment mode setting (Mono model) .....	5-2
5-1-3 SW7T01 (TEST) location for adjustment mode setting (Hi-Fi model) .....	5-3
5-2 Mechanical Adjustment .....	5-4
5-2-1 The number and position of test point .....	5-4
5-2-2 ACE Head Position (X-Point) Adjustment .....	5-4
5-3 Head Switching Point Adjustment .....	5-5
5-4 NVRAM Option Setting .....	5-5

### 6. Repair Parts List

6-1 Exploded Views .....	6-2
6-1-1 Instrument Assembly (Mono Models) .....	6-2
6-1-2 Instrument Assembly (Hi-Fi Models) .....	6-3
6-1-3 Mechanical Parts (Top Side) .....	6-4
6-1-4 Mechanical Parts (Bottom Side) .....	6-5
6-2 Electrical Parts List .....	6-6

# IMPORTANT SERVICE GUIDE

## ◆ MODE SWITCH (PROGRAM SWITCH) ASSEMBLY POINT

1) When installing the ass'y deck on the Main PCB, be sure to align the assembly point of mode switch.

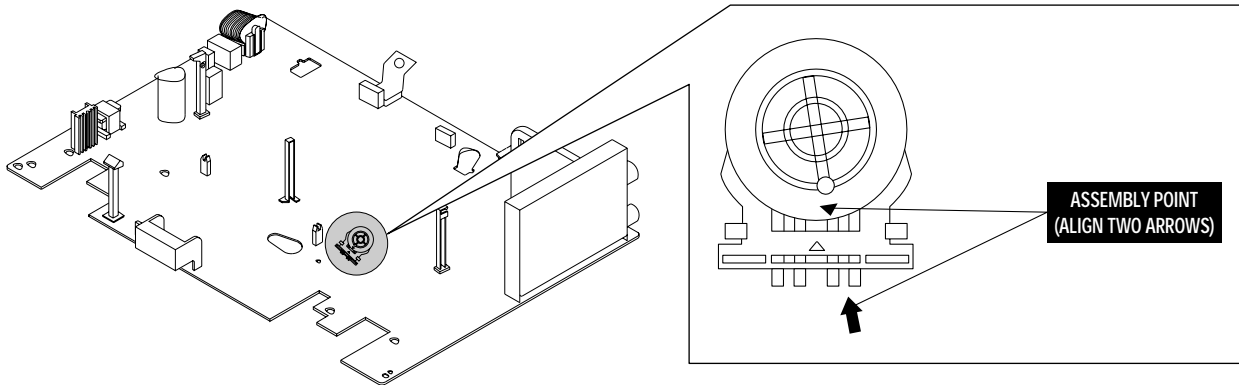

Fig. 1

## ◆ HOW TO EJECT THE CASSETTE TAPE

(If the unit does not operate on condition that tape is inserted into housing ass'y)

- 1) Turn the Gear Worm ❶ clockwise in the direction of arrow with screw driver. (See Fig. 2)  
(Other method ; Remove the screw of Motor Load Ass'y, Separate the Motor Load Ass'y)
- 2) When Slider S, T are approached in the position of unloading, rotate holder Clutch counterclockwise after inserting screw driver in the hole of frame's bottom in order to wind the unwianded tape. (Refer to Fig. 3)  
(If you rotate Gear Worm ❶ continuously when tape is in state of unwinding, you may cause a tape contamination by grease and tape damage. Be sure to wind the unwianded tape in the state of set horizontally.)
- 3) Rotate Gear Worm ❶ clockwise using screw driver again up to the state of eject mode and then pick out the tape. (Refer to Fig. 2)

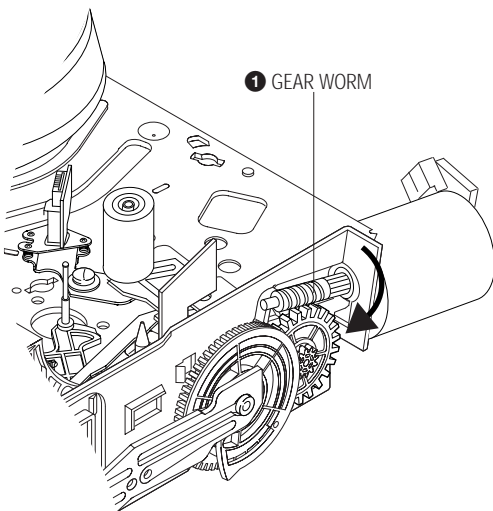

Fig. 2

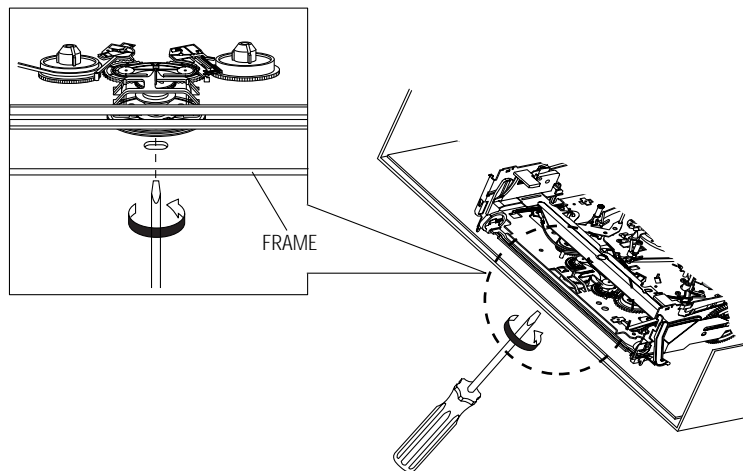

Fig. 3

# 1. GENERAL

This section is extracted from SLV-SE430K/SE630N/SE730N/SE830N/SX730N instruction manual. (3-081-623-11)

## Getting Started

### Index to parts and controls

Refer to the pages indicated in parentheses ( ) for details.

#### Front panel

For SLV-SE830N

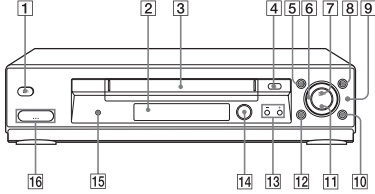

- |   |  |
|---|--|
| 1 I/⏻ (on/standby) switch               | 12 ■ (pause) button (39) (50) (74) (75)                          |
| 2 Remote sensor (12)                    | 13 PROGRAM +/- buttons* (47) (59) (68)                           |
| 3 Tape compartment                      | 14 ⊙ DIAL TIMER (46)   |
| 4 ⏏ (eject) button (39)                 | 15 AUDIO DUB button (75)   |
| 5 ◀◀ (rewind) button (39) (58)          | 16 ⏮ LINE-2 L (left) ⏭ R (right) jacks (covered)* (72) (73) (75) |
| 6 Shuttle ring (58)                     |  |
| 7 ▷ (play) button* (39) (58)            |  |
| 8 ▶▶ (fast-forward) button (39) (58)    |  |
| 9 JOG button (58)                       |  |
| 10 REC ● (record) button (43) (60) (74) |  |
| 11 ■ (stop) button* (22) (39) (74) (75) |  |
- How to open the jack cover**  
 1 Press the bottom of the cover.  
 2 Hook your finger on the top edge of the cover and pull it open.
- \* The ▷ (play), ■ (stop) and PROGRAM + buttons and jack cover have a tactile dot.

For SLV-SE730N, SX730N and SE630N

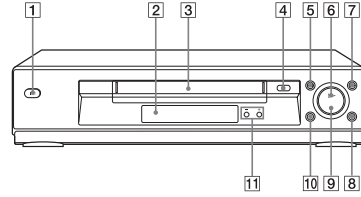

- |                                |  |
|--------------------------------|--|
| 1 I/⏻ (on/standby) switch      | 7 ▶▶ (fast-forward) button (39) (58)   |
| 2 Remote sensor (12)           | 8 REC ● (record) button (43) (60) (74) |
| 3 Tape compartment             | 9 ■ (stop) button* (22) (39) (74) (75) |
| 4 ⏏ (eject) button (39)        | 10 ■ (pause) button (39) (74) (75)     |
| 5 ◀◀ (rewind) button (39) (58) | 11 PROGRAM +/- buttons* (59) (68)      |
| 6 ▷ (play) button* (39) (58)   |  |
- \* The ▷ (play), ■ (stop) and PROGRAM + buttons have a tactile dot.

4 | Index to parts and controls

For SLV-SE430K

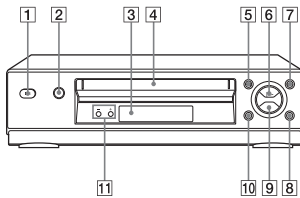

- |                                |  |
|--------------------------------|--|
| 1 I/⏻ (on/standby) switch      | 7 ▶▶ (fast-forward) button (39) (58)   |
| 2 ⏏ (eject) button (39)        | 8 REC ● (record) button (43) (60) (74) |
| 3 Remote sensor (12)           | 9 ■ (stop) button* (22) (39) (74) (75) |
| 4 Tape compartment             | 10 ■ (pause) button (39) (74) (75)     |
| 5 ◀◀ (rewind) button (39) (58) | 11 PROGRAM +/- buttons* (59) (68)      |
| 6 ▷ (play) button* (39) (58)   |  |
- \* The ▷ (play), ■ (stop) and PROGRAM + buttons have a tactile dot.

continued

Index to parts and controls | 5

#### Display window

For SLV-SE830N, SE730N and SX730N

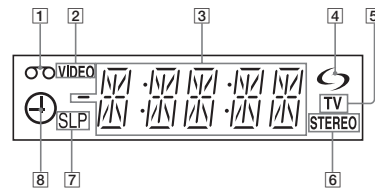

- |   |   |
|---|---|
| 1 Tape indicator  | 5 TV indicator (45)                             |
| 2 VIDEO indicator (17) (43)   | 6 STEREO indicator (63)                         |
| 3 Time counter/clock/line/programme position indicator (40) (42) (74) | 7 Tape speed indicators (42)                    |
| 4 ↻ (smartlink) indicator (18)  | 8 Timer/recording indicator (43) (48) (53) (56) |

For SLV-SE630N and SE430K

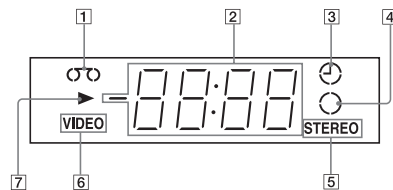

- |   |                             |
|---|-----------------------------|
| 1 Tape indicator  | 5 STEREO indicator* (63)    |
| 2 Time counter/clock/line/programme position indicator (40) (42) (74) | 6 VIDEO indicator (17) (43) |
| 3 Timer indicator (48) (53) (56)                                      | 7 Playback indicator        |
| 4 Recording indicator (43)  |                             |
- \* not available on SLV-SE430K

6 | Index to parts and controls

continued

Index to parts and controls | 7

## Rear panel

For SLV-SE830N, SE730N, SX730N and SE630N

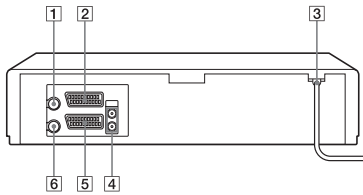

For SLV-SE430K

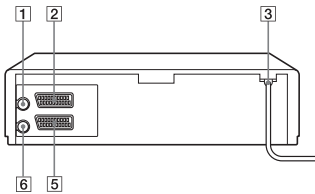

1  $\pi$  (in from antenna) connector (16) (17)

2 LINE-3 (DEC/EXT) connector\*<sup>1</sup>  
LINE-2 (DEC/EXT) connector\*<sup>2</sup>  
(19) (36) (73)

3 Mains lead (16) (17)

4 AUDIO (OUT/SORTIE) R/D (right)  
L/G (left) jacks\*<sup>3</sup> (19)

5 LINE-1 (EURO AV) connector (17)  
(36) (72)

6  $\square$  (out to tv) connector (16) (17)

\*<sup>1</sup> SLV-SE830N

\*<sup>2</sup> SLV-SE730N, SX730N, SE630N and  
SE430K

\*<sup>3</sup> not available on SLV-SE630N

## Remote commander

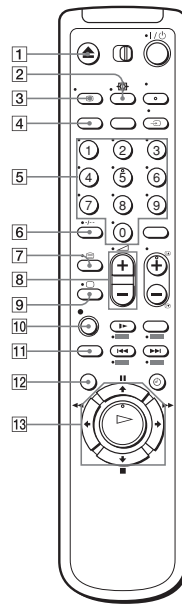

1  $\uparrow$  (eject) button (39)

2  $\square$  (wide) button (for TV) (14) (15)

3  $\square$  DISPLAY button (14) (40) (43)

4 COUNTER/REMAIN button (43)  
5 Programme number buttons\*<sup>1</sup> (13)  
(44)

6 -.- (ten's digit) button (13) (44)

7  $\square$  (Teletext) button (for TV)\*<sup>2</sup> (14)

8  $\triangleleft$  (volume) +/- buttons (for TV)  
(13)

9  $\square$  TV power on/TV mode select  
button (for TV)\*<sup>2</sup> (13)

10  $\bullet$  REC (record) button (43) (60)

11 SP (Standard Play)/LP (Long Play)  
button (42)

12 MENU button (24) (61)

13  $\parallel$  (pause)/ $\uparrow$  button (24) (39)

$\blacksquare$  (stop)/ $\downarrow$  button (24) (39)

$\ll$  (rewind)/ $\leftarrow$  button (24) (39)

$\gg$  (fast-forward)/ $\rightarrow$  button (24)

(39) (58)

$\triangleright$  (play)/OK button\*<sup>1</sup> (24) (39)

(58)

\*<sup>1</sup> The  $\triangleright$  (play), AUDIO MONITOR,  
number 5 and PROG + buttons have a  
tactile dot.

\*<sup>2</sup> SLV-SE830N only

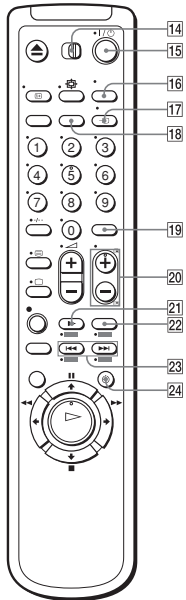

14  $\square$  /  $\square$  remote control switch  
(12)

15  $\text{I/O}$  (on/standby) switch (13) (14)  
(53)

16 AUDIO MONITOR button\*<sup>1</sup>\*<sup>3</sup> (14)  
(64)

17  $\square$  TV/VIDEO button (13) (17) (43)

18 CLEAR button (40) (52) (61)

19 INPUT SELECT button (42) (56)  
(74)

20 PROG (programme) +/- buttons\*<sup>1</sup>  
(13) (42)

$\square$  /  $\square$  Teletext page access buttons  
(for TV)\*<sup>2</sup> (14)

21  $\blacktriangleright$  SLOW button\*<sup>4</sup> (58)

22 x2 button\*<sup>4</sup> (58)

23  $\ll$  /  $\gg$  (index search)  
buttons\*<sup>3</sup>\*<sup>4</sup> (66)

24  $\square$  TIMER button (51) (55)

\*<sup>1</sup> The  $\triangleright$  (play), AUDIO MONITOR,  
number 5 and PROG + buttons have a  
tactile dot.

\*<sup>2</sup> SLV-SE830N only

\*<sup>3</sup> not available on SLV-SE430K

\*<sup>4</sup> FASTTEXT buttons (for TV)  
(SLV-SE830N only)

## Step 1 : Unpacking

Check that you have received the following items with the VCR:

• Remote commander

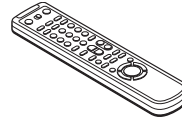

• R6 (size AA) batteries



• Aerial cable



### Check your model name

The instructions in this manual are for the 5 models: SLV-SE830N, SE730N, SX730N, SE630N and SE430K. Check your model name by looking at the rear panel of your VCR. SLV-SE830N is the model used for illustration purposes. Any difference in operation is clearly indicated in the text, for example, "SLV-SE830N only."

## Step 2 : Setting up the remote commander

### Inserting the batteries

Insert two R6 (size AA) batteries by matching the + and - on the batteries to the diagram inside the battery compartment.

Insert the negative (-) end first, then push in and down until the positive (+) end clicks into position.

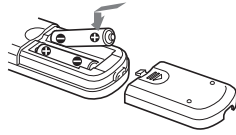

### Using the remote commander

You can use this remote commander to operate this VCR and a Sony TV. Buttons on the remote commander marked with a dot (•) can be used to operate your Sony TV. If the TV does not have the  symbol near the remote sensor, this remote commander will not operate the TV.

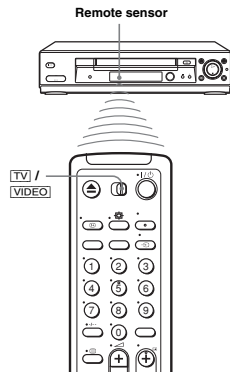

To operate	Set [TV] / [VIDEO] to
the VCR	[VIDEO] and point at the remote sensor at the VCR
a Sony TV	[TV] and point at the remote sensor at the TV

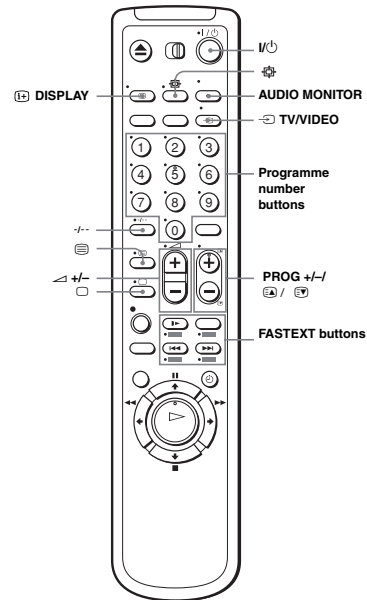

### TV control buttons

To	Press
Set the TV to standby mode	I/O
Select an input source: aerial in or line in	TV/VIDEO
Select the TV's programme position	Programme number buttons, +/-, PROG +/-
Adjust the volume of the TV	∠ +/-
Switch to TV (Teletext off)* <sup>1</sup>	□ (TV)

continued

Setting up the remote commander 13

12 Setting up the remote commander

To	Press
Switch to Teletext* <sup>1</sup>	⊞ (Teletext)
Select the sound* <sup>2</sup>	AUDIO MONITOR
Use FASTEXT* <sup>1</sup>	FASTEXT buttons
Call up the on-screen display	⊞ DISPLAY
Change the Teletext page* <sup>1</sup>	⊞ / ⊞
Switch to/from wide mode of a Sony wide TV (For other manufactures' wide TVs, see "Controlling other TVs with the remote commander (SLV-SE830N only)" below.)	⊞ (wide)

#### Notes

- With normal use, the batteries should last about three to six months.
- If you do not use the remote commander for an extended period of time, remove the batteries to avoid possible damage from battery leakage.
- Do not use a new battery together with an old one.
- Do not use different types of batteries together.
- Some buttons may not work with certain Sony TVs.

\*<sup>1</sup> SLV-SE830N only\*<sup>2</sup> not available on SLV-SE430K

### Controlling other TVs with the remote commander (SLV-SE830N only)

The remote commander is preprogrammed to control non-Sony TVs. If your TV is listed in the following table, set the appropriate manufacturer's code number.

**1** Set [TV] / [VIDEO] at the top of the remote commander to [TV].

**2** Hold down I/O, and enter your TV's code number using the programme number buttons. Then release I/O.

Now you can use the following TV control buttons to control your TV:

I/O, TV/VIDEO, programme number buttons, +/- (ten's digit), PROG +/-, ∠ +/-, □ (TV), ⊞ (Teletext), FASTEXT buttons, ⊞ (wide)\*, MENU\*, ↑/↓/←/→\*, and OK\*.

\* These buttons may not work with all TVs.

### Code numbers of controllable TVs

If more than one code number is listed, try entering them one at a time until you find the one that works with your TV.

To switch to wide mode, see the footnotes below this table for the applicable code numbers.

Manufacturer	Code number
Sony	01* <sup>1</sup> , 02
Akai	68
Ferguson	52
Grundig	10* <sup>1</sup> , 11* <sup>1</sup>
Hitachi	24
JVC	33
Loewe	45
Mivar	09, 70
NEC	66
Nokia	15, 16, 69* <sup>3</sup>

Manufacturer	Code number
Panasonic	17* <sup>1</sup> , 49
Philips	06* <sup>1</sup> , 07* <sup>1</sup> , 08* <sup>1</sup>
Saba	12, 13
Samsung	22, 23
Sanyo	25
Sharp	29
Telefunken	36
Thomson	43* <sup>2</sup>
Toshiba	38

\*<sup>1</sup> Press ⊞ (wide) to switch the wide picture mode on or off.\*<sup>2</sup> Press ⊞ (wide), then press ∠ +/- to select the wide picture mode you want.\*<sup>3</sup> Press ⊞ (wide). The menu appears on the TV screen. Then, press ↑/↓/←/→ to select the wide picture you want and press OK.

#### Tip

• When you set your TV's code number correctly while the TV is turned on, the TV turns off automatically.

#### Notes

- If you enter a new code number, the code number previously entered will be erased.
- If the TV uses a different remote control system from the one programmed to work with the VCR, you cannot control your TV with the remote commander.
- When you replace the batteries of the remote commander, the code number may change. Set the appropriate code number every time you replace the batteries.

14 Setting up the remote commander

Setting up the remote commander 15

### Step 3 : Connecting the VCR

If your TV has a Scart (EURO-AV) connector, see page 17.

If your TV does not have a Scart (EURO-AV) connector

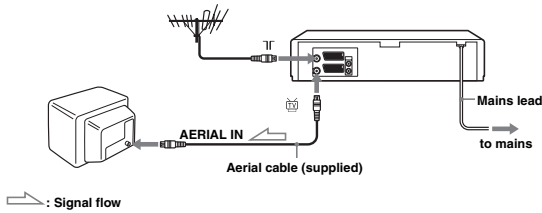

- 1 Disconnect the aerial cable from your TV and connect it to on the rear panel of the VCR.
- 2 Connect of the VCR and the aerial input of your TV using the supplied aerial cable.
- 3 Connect the mains lead to the mains.

**Note**

- When you connect the VCR and your TV only with an aerial cable, you have to tune your TV to the VCR (see page 20).

### If your TV has a Scart (EURO-AV) connector

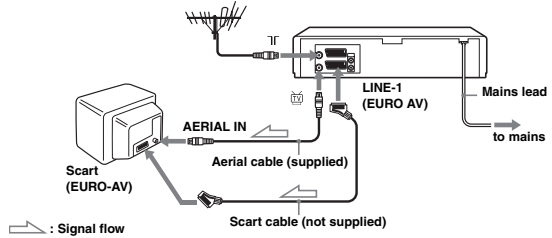

- 1 Disconnect the aerial cable from your TV and connect it to on the rear panel of the VCR.
- 2 Connect of the VCR and the aerial input of your TV using the supplied aerial cable.
- 3 Connect LINE-1 (EURO AV) on the VCR and the Scart (EURO-AV) connector on the TV with the optional Scart cable.  
This connection improves picture and sound quality. Whenever you want to watch the VCR picture, press TV/VIDEO to display the VIDEO indicator in the display window.
- 4 Connect the mains lead to the mains.

Getting Started

### About the SMARTLINK features (not available on SLV-SE630N and SE430K)

If the connected TV complies with SMARTLINK, MEGALOGIC<sup>#1</sup>, EASYLINK<sup>#2</sup>, Q-Link<sup>#3</sup>, EURO VIEW LINK<sup>#4</sup>, or T-V LINK<sup>#5</sup>, this VCR automatically runs the SMARTLINK function after you complete the steps on the previous page (the indicator appears in the VCR's display window when you turn on the TV). You can enjoy the following SMARTLINK features.

- TV Direct Rec  
You can easily record what you are watching on the TV when the VCR is turned on. For details, see "Recording what you are watching on the TV (TV Direct Rec) (not available on SLV-SE630N and SE430K)" on page 45.
- One Touch Play  
With One Touch Play, you can start playback automatically without turning on the TV. For details, see "Starting playback automatically with one button (One Touch Play) (not available on SLV-SE630N and SE430K)" on page 41.
- One Touch Menu  
When the VCR is turned on, you can turn on the TV, set the TV to the video channel, and display the VCR's on-screen display automatically by pressing MENU on the remote commander.
- One Touch Timer  
When the VCR is turned on, you can turn on the TV, set the TV to the video channel, and display the timer recording menu (the TIMER PROGRAMMING menu or the SHOWVIEW menu) automatically by pressing TIMER on the remote commander. You can set which timer recording menu is displayed using TIMER METHOD in the EASY OPERATION menu (see page 71).
- NextView Download  
You can easily set the timer by using the NextView Download function on your TV. Please refer to your TV's instruction manual.

<sup>#1</sup>"MEGALOGIC" is a registered trademark of Grundig Corporation.  
<sup>#2</sup>"EASYLINK" is a trademark of Philips Corporation.  
<sup>#3</sup>"Q-Link" is a trademark of Panasonic Corporation.  
<sup>#4</sup>"EURO VIEW LINK" is a trademark of Toshiba Corporation.  
<sup>#5</sup>"T-V LINK" is a trademark of JVC Corporation.

**Note**

- Not all TVs respond to the functions above.

### Additional connections

#### To a stereo system (not available on SLV-SE630N and SE430K)

You can improve sound quality by connecting a stereo system to the AUDIO R/D L/G jacks as shown on the right.

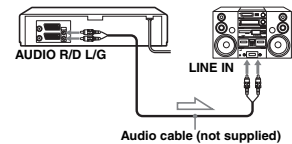

#### To a satellite or digital tuner with Line Through

Using the Line Through function, you can watch programmes from a satellite or digital tuner connected to this VCR on the TV even when the VCR is turned off. When you turn on the satellite or digital tuner, this VCR automatically sends the signal from the satellite or digital tuner to the TV without turning itself on.

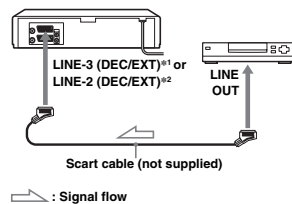

- 1 Connect the satellite or digital tuner to the LINE-3 (DEC/EXT)<sup>\*1</sup> or LINE-2 (DEC/EXT)<sup>\*2</sup> connector as shown above.
- 2 Turn off the VCR.  
To watch a programme, turn on the satellite or digital tuner and the TV.

**Notes**

- The Line Through function will not operate properly if POWER SAVE in the USER SET menu is set to ECO2. Set POWER SAVE to OFF or ECO1 to ensure proper operation (see page 69).
- You cannot watch programmes on the TV while recording unless you are recording a satellite or digital programme.
- This function may not work with some types of satellite or digital tuners.
- When the VCR is turned off, set the TV to the video channel.

<sup>\*1</sup>SLV-SE830N  
<sup>\*2</sup>SLV-SE730N, SX730N, SE630N and SE430K

Getting Started



## Step 4 : Setting up the VCR with the Auto Set Up function

Before using the VCR for the first time, set up the VCR using the Auto Set Up function. With this function, you can set the language for the on-screen display, TV channels, guide channels for the ShowView system\*, and VCR clock\* automatically.

- 1 Turn on your TV and set it to the video channel.  
If your TV does not have a Scart (EURO-AV) connector, tune the TV to channel 32 (the initial RF channel for this VCR). Refer to your TV manual for TV tuning instructions. If the picture does not appear clearly, see "To change the RF channel" on page 22.

- 2 Connect the mains lead to the mains.  
The VCR automatically turns on, and the language abbreviations appear on the TV screen.

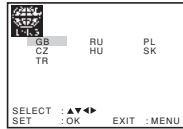

The abbreviations of the languages are as follows:

Abbreviation	Country	Language
CZ	Czech	Czech
HU	Hungary	Hungarian
PL	Poland	Polish
SK	Slovakia	Slovak
TR	Turkey	Turkish
RU	Russia	Russian

- 3 Press  $\uparrow/\downarrow/\leftarrow/\rightarrow$  to select the language abbreviation from the table in step 2, then press OK.  
The message for the Auto Set Up function appears.



- 4 Press OK.  
The COUNTRY SELECTION menu\* appears.

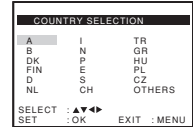

The abbreviations of the countries are as follows:

Abbreviation	Country
A	Austria
B	Belgium
DK	Denmark
FIN	Finland
D	Germany
NL	Netherlands
I	Italy
N	Norway
P	Portugal

Abbreviation	Country
E	Spain
S	Sweden
CH	Switzerland
TR	Turkey
GR	Greece
HU	Hungary
PL	Poland
CZ	Czech
OTHERS	other countries

- 5 For SLV-SE830N, SE730N and SX730N  
Press  $\uparrow/\downarrow/\leftarrow/\rightarrow$  to select the abbreviation of your country from the table in step 4, then press OK.  
If your country does not appear, select OTHERS.



The VCR starts searching for all of the receivable channels and presets them (in the appropriate order for your local area).

If you want to change the order of the channels or disable unwanted programme positions, see "Changing/disabling programme positions" on page 31.

After the search or download is complete, the current time appears for any stations that transmit a time signal. If the time does not appear, set the clock manually. See "Setting the clock" on page 24.

For SLV-SE630N and SE430K  
The clock setting menu appears. See "Setting the clock" on page 24.

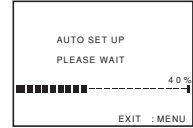

### To cancel the Auto Set Up function

Press MENU.

### To change the RF channel

If the picture does not appear clearly on the TV, change the RF channel on the VCR and TV. Select INSTALLATION from the menu, then press  $\uparrow/\downarrow$  to highlight VCR OUTPUT CH and press  $\rightarrow$ . Select the RF channel by pressing the  $\uparrow/\downarrow$  buttons. Then, tune the TV to the new RF channel so that a clear picture appears.

### Tip

- If you want to change the language for the on-screen display from the one preset in the Auto Set Up function, see page 27.

### Notes

- Whenever you operate the Auto Set Up function, some of the settings (ShowView\*, timer, etc.) will be reset. If this happens, you have to set them again.
- Auto preset starts automatically only when you plug in the mains lead for the first time after you purchase the VCR.
- After using the Auto Set Up function, the language abbreviations do not appear automatically when you connect the mains lead again. If you want to use the Auto Set Up function again, press MENU, then press  $\uparrow/\downarrow/\leftarrow/\rightarrow$  to highlight INSTALLATION and press OK. Press  $\uparrow/\downarrow$  to highlight AUTO SET UP, then repeat all procedures from step 4.
- Auto preset can be performed by pressing  $\blacksquare$  (stop) on the VCR continuously for 5 seconds or more with no tape inserted.

\* not available on SLV-SE630N and SE430K

## Step 5 : Selecting the TV system

You must select the appropriate TV system for your area.

### Before you start...

- Turn on the VCR and the TV.
- Set the TV to the video channel.
- Refer to "Index to parts and controls" for button locations.

- 1 Press MENU, then press  $\uparrow/\downarrow/\leftarrow/\rightarrow$  to highlight INSTALLATION and press OK.

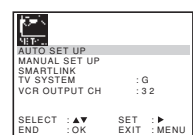

- 2 Press  $\uparrow/\downarrow$  to highlight TV SYSTEM, then press  $\rightarrow$ .

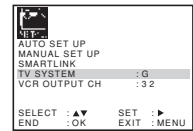

- 3 Press  $\rightarrow$  to select the appropriate TV system. Select "G" for the B/G TV system, or "K" for the D/K TV system.



- 4 Press MENU to exit the menu.





## Setting the clock

You must set the time and date on the VCR to use the timer features properly. The Auto Clock Set function\* works only if a station in your area is broadcasting a time signal.

### Before you start...

- Turn on the VCR and the TV.
- Set the TV to the video channel.
- Refer to "Index to parts and controls" for button locations.

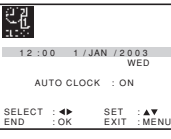

- 1 Press MENU, then press to highlight CLOCK SET and press OK.

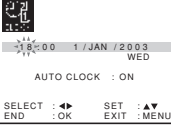

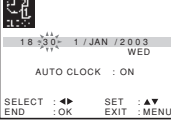
- 2 Press to set the hour.



- 3 Press to select the minutes and set the minutes by pressing .





- 4 Set the day, month, and year in sequence by pressing to select the item to be set, and press to select the digits, then press . The day of the week is set automatically.

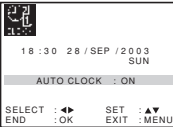

- 5 Press to select ON for the setting of the Auto Clock Set function\*.

The VCR automatically sets the clock according to the time signal broadcast between the channels PR 1 to PR 5.

If you do not need the Auto Clock Set function, select OFF.



- 6 Press MENU to exit the menu.



### Tips

- If you set AUTO CLOCK\* to ON, the Auto Clock Set function is activated whenever the VCR is turned off. The time is adjusted automatically by making reference to the time signal from the station.
- To change the digits while setting, press to return to the item to be changed, and select the digits by pressing .

\* not available on SLV-SE630N and SE430K



## Downloading the TV tuner's preset data (SLV-SE830N, SE730N and SX730N only)

You can download your TV tuner's preset data to the VCR and tune the VCR according to that data using the SMARTLINK connection.

### Before you start...

- Turn on the VCR and the TV.
- Set the TV to the video channel.
- Refer to "Index to parts and controls" for button locations.

- 1 Press MENU, then press to highlight INSTALLATION and press OK.

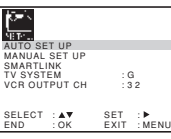

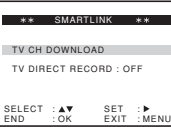
- 2 Press to highlight SMARTLINK, then press .

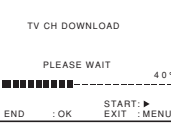

- 3 Press to highlight TV CH DOWNLOAD, then press . The Preset Download function starts and the <img alt="circular arrow icon"/> indicator flashes in the display window during download.



## Selecting a language

You can change the on-screen display language from the one you selected with the Auto Set Up function.

### Before you start...

- Turn on the VCR and the TV.
- Set the TV to the video channel.
- Refer to "Index to parts and controls" for button locations.

- 1 Press MENU, then press to highlight LANGUAGE SET and press OK.



- 2 Press to highlight the abbreviation of the desired language from the table on page 20, then press OK.





## Presetting channels



If some channels could not be preset using the Auto Set Up function, you can preset them manually.

### Before you start...



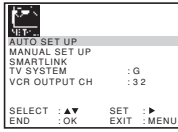

- Turn on the VCR and the TV.
- Set the TV to the video channel.
- Refer to "Index to parts and controls" for button locations.

**1**  Press MENU, then press  to highlight INSTALLATION and press OK.

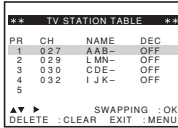



**2**  Press  to highlight MANUAL SET UP, then press .



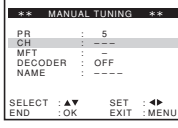

**3**  Press  to highlight the row which you want to preset, then press . To display other pages for programme positions 6 to 80, press  repeatedly.



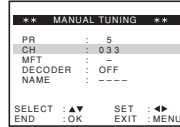

**4**  Press  repeatedly until the channel you want is displayed.



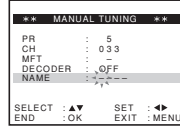

**5**  Press  to highlight NAME, then press .





**6** Enter the station name.

**1** Press  to select a character. Each time you press , the character changes as shown below.

A → B → ... → Z → 0 → 1 → ... → 9 → A

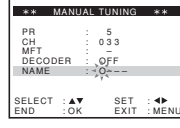

**2** Press  to set the next character. The next space is flashed. To correct a character, press  until the character you want to correct is flashed, then set it. You can set up to 4 characters for the station name.



**7**  Press OK to confirm the station name.

**8**  Press MENU to exit the menu.

### If the picture is not clear

If the picture is not clear, you may use the Manual Fine Tuning (MFT) function. After step 4, press  to select MFT. Press  to get a clear picture, then press MENU to exit the menu.

### Tips

- To set the programme position for the decoder, see "Setting the Canal Plus decoder" on page 36.
- The VCR must receive channel information for station names to appear automatically.

### Notes

- If the TV sound is distorted or noisy, select the appropriate TV system ("G" or "K") for your area (see page 23).
- When adjusting MFT, the menu may become difficult to read due to interference from the picture being received.

## Changing/disabling programme positions



After setting the channels, you can change the programme positions as you like. If any programme positions are unused or contain unwanted channels, you can disable them.

You can also change the station names. If the station names are not displayed, you can enter them manually.



### Changing programme positions

#### Before you start...

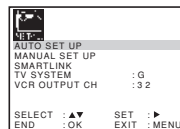

- Turn on the VCR and the TV.
- Set the TV to the video channel.
- Refer to "Index to parts and controls" for button locations.

**1**  Press MENU, then press  to highlight INSTALLATION and press OK.

**2**  Press  to highlight MANUAL SET UP, then press .

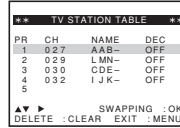

**3**  Press  to highlight the row containing the programme position you want to change. To display other pages for programme positions 6 to 80, press  repeatedly.

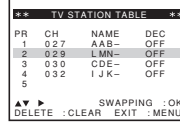

- 4 Press OK, then press **↑/↓** to move to the desired programme position.



PR	CH	NAME	DEC
1	027	AAB-	OFF
2	029	LMN-	OFF
3	030	CDE-	OFF
4	032	IJK-	OFF
5	033	----	OFF

- 5 Press OK to confirm the setting.



- 6 To change the programme position of another station, repeat steps 3 through 5.

- 7 Press MENU to exit the menu.



### Disabling unwanted programme positions

After presetting channels, you can disable unused programme positions. The disabled positions will be skipped later when you press the PROG +/- buttons.

#### Before you start...

- Turn on the VCR and the TV.
- Set the TV to the video channel.
- Refer to "Index to parts and controls" for button locations.

- 1 Press MENU, then press **↑/↓/←/→** to highlight INSTALLATION, and press OK.



SELECT	SET
END	EXIT

- 2 Press **↑/↓** to highlight MANUAL SET UP, then press **→**.



PR	CH	NAME	DEC
1	027	AAB-	OFF
2	029	LMN-	OFF
3	030	CDE-	OFF
4	032	IJK-	OFF
5	033	----	OFF

- 3 Press **↑/↓** to highlight the row which you want to disable.



To display other pages for programme positions 6 to 80, press **↑/↓** repeatedly.

PR	CH	NAME	DEC
1	027	AAB-	OFF
2	029	LMN-	OFF
3	030	CDE-	OFF
4	032	IJK-	OFF
5	033	----	OFF

- 4 Press CLEAR. The selected row will be cleared as shown on the right.



PR	CH	NAME	DEC
1	027	AAB-	OFF
2	029	LMN-	OFF
3	030	CDE-	OFF
4	032	IJK-	OFF
5	033	----	OFF

- 5 Repeat steps 3 and 4 for any other programme positions you want to disable.

- 6 Press MENU to exit the menu.



#### Note

- Be sure to select the programme position you want to disable correctly. If you disable a programme position by mistake, you need to reset that channel manually.

Getting Started

Getting Started

### Changing the station names

You can change or enter the station names (up to 4 characters). The VCR must receive channel information for station names to appear automatically\*.

\* not available on SLV-SE630N and SE430K

#### Before you start...

- Turn on the VCR and the TV.
- Set the TV to the video channel.
- Refer to "Index to parts and controls" for button locations.

- 1 Press MENU, then press **↑/↓/←/→** to highlight INSTALLATION and press OK.



SELECT	SET
END	EXIT

- 2 Press **↑/↓** to highlight MANUAL SET UP, then press **→**.



PR	CH	NAME	DEC
1	027	AAB-	OFF
2	029	LMN-	OFF
3	030	CDE-	OFF
4	032	IJK-	OFF
5	033	----	OFF

- 3 Press **↑/↓** to highlight the row which you want to change or enter the station name, then press **→**. To display other pages for programme positions 6 to 80, press **↑/↓** repeatedly.



PR	CH	NAME	DEC
1	027	AAB-	OFF
2	029	LMN-	OFF
3	030	CDE-	OFF
4	032	IJK-	OFF
5	033	----	OFF

- 4 Press **↑/↓** to highlight NAME, then press **→**.



PR	CH	NAME	DEC
1	027	AAB-	OFF
2	029	LMN-	OFF
3	030	CDE-	OFF
4	032	IJK-	OFF
5	033	----	OFF

- 5 Enter the station name.



- 1 Press **↑/↓** to select a character. Each time you press **↑**, the character changes as shown below.

A → B → ... → Z → 0 → 1 → ... → 9 → A

PR	CH	NAME	DEC
1	027	AAB-	OFF
2	029	LMN-	OFF
3	030	CDE-	OFF
4	032	IJK-	OFF
5	033	----	OFF

- 2 Press **→** to set the next character.

The next space flashes.

To correct a character, press **←/→** until the character you want to correct flashes, then reset it.

You can set up to 4 characters for the station name.

- 6 Press OK to confirm the new name.



- 7 Press MENU to exit the menu.



## Setting the Canal Plus decoder

You can watch or record Canal Plus programmes if you connect a decoder (not supplied) to the VCR.

### Connecting a decoder

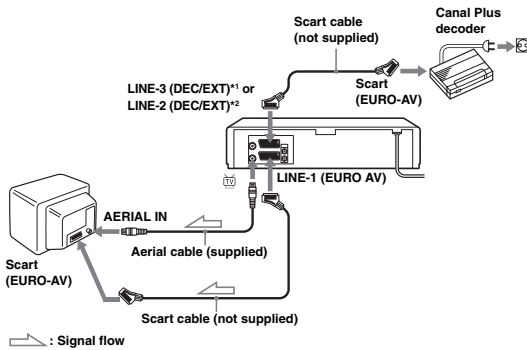

### Setting Canal Plus channels

To watch or record Canal Plus programmes, set your VCR to receive the channels using the on-screen display.

In order to set the channels correctly, be sure to follow all of the steps below.

#### Before you start...

- Turn on the VCR, the TV, and the decoder.
- Set the TV to the video channel.
- Refer to "Index to parts and controls" for button locations.

## 6 Press MENU to exit the menu.



#### Notes

- To superimpose subtitles while watching Canal Plus programmes, make both decoder-VCR and VCR-TV connections using 21-pin Scart cables that are compatible with the RGB signals. You cannot record subtitles on the VCR.
- When you watch Canal Plus programmes through the RFU input of the TV, press  $\square$  TV/VIDEO so that the VIDEO indicator appears in the display window.

\*1 SLV-SE830N

\*2 SLV-SE730N, SX730N, SE630N and SE430K

## 1 Press MENU, then press $\uparrow/\downarrow/\leftarrow/\rightarrow$ to highlight INSTALLATION and press OK.

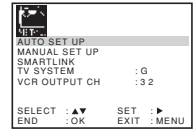

## 2 Press $\uparrow/\downarrow$ to highlight MANUAL SET UP, then press $\rightarrow$ .

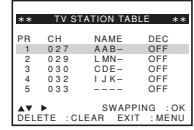

## 3 Press $\uparrow/\downarrow$ to highlight the row which you want to set for the decoder, then press $\rightarrow$ . To display positions 6 to 80, press $\uparrow/\downarrow$ repeatedly.

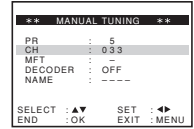

## 4 Press $\uparrow/\downarrow$ to highlight DECODER.

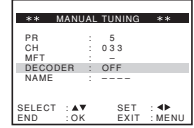

## 5 Press $\rightarrow$ to set DECODER to ON, then press OK.

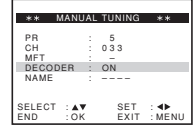

continued

## Basic Operations

### Playing a tape

#### Before you start...

- Refer to "Index to parts and controls" for button locations.

## 1 Turn on your TV and set it to the video channel.

## 2 Insert a tape.

The VCR turns on and starts playing automatically if you insert a tape with its safety tab removed.

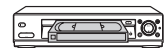

## 3 Press $\triangleright$ (play).

When the tape reaches the end, it will rewind automatically.



#### Additional tasks

To	Press
Stop play	■ (stop)
Pause play	⏸ (pause)
Resume play after pause	⏸ (pause) or $\triangleright$ (play)
Fast-forward the tape	⏩ (fast-forward) during stop
Rewind the tape	⏪ (rewind) during stop
Eject the tape	⏏ (eject)

continued

### To set the colour system

If the playback picture has no colour, or streaks appear during playback, set COLOUR SYSTEM in the USER SET menu to conform to the system that the tape was recorded in (see page 70). (Normally set the option to AUTO.)

### To use the time counter

Press CLEAR at the point on the tape that you want to find later. The counter in the display window resets to "0:00:00" or "00:00." Search for the point afterwards by referring to the counter.

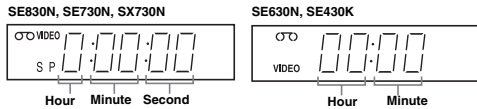

To display the counter on the TV screen, press **[DISP]** DISPLAY.

#### Notes

- The counter resets to "0:00:00" or "00:00" whenever a tape is reinserted.
- The counter stops counting when it comes to a portion with no recording.
- Depending on your TV, the following may occur while playing an NTSC-recorded tape:
  - The picture becomes black and white.
  - The picture shakes.
  - No picture appears on the TV screen.
  - Black streaks appear horizontally on the TV screen.
  - The colour density increases or decreases.
- While setting the menu on the TV screen, buttons for playback on the remote commander do not function.

### Starting playback automatically with one button (One Touch Play) (not available on SLV-SE630N and SE430K)

If you use the SMARTLINK connection, you can turn on the TV, set the TV to the video channel, and start playback automatically with one button.

- Insert a tape.  
The VCR automatically turns on.  
If you insert a tape with its safety tab removed, the TV turns on and switches to the video channel. Playback starts automatically.
- Press **[▶]** (play).  
The TV turns on and switches to the video channel automatically. Playback starts.

#### Tip

- When there already is a tape in the VCR, press **[VCR]** to turn on the VCR first. When you press **[▶]** (play), the TV turns on, the TV is set to the video channel, and playback starts automatically in one sequence.

#### Note

- When you use the One Touch Play function, leave the TV on or in the standby mode.

## Recording TV programmes

### Before you start...

- Refer to "Index to parts and controls" for button locations.

- Turn on your TV and set it to the video channel.  
To record from a decoder, turn it on.
- Insert a tape with its safety tab in place.
- To record a normal channel, press **[PROG +/-]** until the programme position number you want appears in the display window.
  - To record from a decoder or other source connected to one or more of the LINE inputs, press **[INPUT SELECT]** until the connected line appears in the display window.
- Press **[SP/LP]** to select the tape speed, SP or LP.
  - LP (Long Play) provides recording time twice as long as SP. However, SP (Standard Play) produces better picture and audio quality.

- Press **[REC]** to start recording.
  - The recording indicator lights up red in the display window.

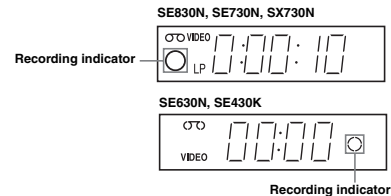

### To stop recording

Press **[STOP]** (stop).

### To check the remaining time

Press **[DISP]** DISPLAY twice. With the display on, press **[COUNTER/REMAIN]** to check the remaining time. Each time you press **[COUNTER/REMAIN]**, the time counter and the remaining time appear alternately.

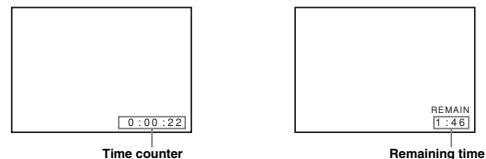

In order to get an accurate remaining time indication, be sure TAPE SELECT in the USER SET menu is set according to the tape type you use (see page 70).

### To watch another TV programme while recording

- Press **[TV/VIDEO]** to turn off the VIDEO indicator in the display window.
- Select another programme position on the TV.

### To save a recording

To prevent accidental erasure, break off the safety tab as illustrated. To record on the same tape again, cover the tab hole with adhesive tape.



Safety tab

### Tips

- To select a programme position, you can use the programme number buttons on the remote commander. For two-digit numbers, for example, press 2 and 3 to select "PR 23."
- If you connect additional equipment to a LINE connector or jack, you can select the input signal using the INPUT SELECT or PROG +/- buttons.
- The [DISP] DISPLAY information appears on the TV screen indicating information about the tape, but the information will not be recorded on the tape.
- If you do not want to watch TV while recording, you can turn off the TV. When using a decoder, make sure to leave it on.

### Notes

- The [DISP] DISPLAY information does not appear during still (pause) mode or slow-motion playback.
- If a tape has portions recorded in both PAL (MESECAM) and NTSC systems, the time counter reading will not be correct. This discrepancy is due to the difference between the counting cycles of the two video systems.
- You cannot watch a Canal Plus programme while recording another Canal Plus programme.
- When you insert a non-standard commercially available tape, the remaining time may not be correct.
- The remaining time is intended for rough measurement only.
- About 30 seconds after the tape begins playback, the tape remaining time will be displayed.

### Recording what you are watching on the TV (TV Direct Rec) (not available on SLV-SE630N and SE430K)

If you use the SMARTLINK connection, you can easily record what you are watching on the TV (other than tapes being played on the VCR).

- Press I/⏻ to turn on the VCR.
- Insert a tape with its safety tab in place.
- Press ● REC while you are watching a TV programme or external source.  
The TV indicator lights up and the VCR starts recording what you are watching on the TV.

### Tip

- The TV indicator appears in the display window after you press ● REC in some situations such as:
  - when you are watching a source connected to the TV's line input, or
  - when the TV tuner preset data for the programme position is different from the data in the VCR tuner preset.

### Notes

- You cannot record what you are watching using this method when the VCR is in the following modes; pause, timer standby, tuner preset, Auto Set Up, and recording.
- When the TV indicator is lit in the display window, do not turn off the TV nor change the TV programme position. When the TV indicator is not lit, the VCR continues recording the programme even if you change the TV programme position on the TV.
- To use the TV Direct Rec function, select SMARTLINK in the INSTALLATION menu, then set TV DIRECT RECORD to ON.

## Recording TV programmes using the Dial Timer (SLV-SE830N only)

The Dial Timer function allows you to make timer recordings of programmes without turning on your TV. Set the recording timer to record up to eight programmes, including settings made with other timer methods, that will be broadcast within the next month. The recording start time and recording stop time can be set at one minute intervals.

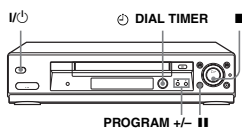

### Before you start...

- Insert a tape with its safety tab in place. Make sure the tape is longer than the total recording time.
- To record from a decoder, turn it on.
- Refer to "Index to parts and controls" for button locations.

- Press DIAL TIMER. "DATE" and "TODAY" appear alternately in the display window. If the date and time are not set, "DAY" will appear. See step 2 in the following section, "To set the clock" to set the date and time.

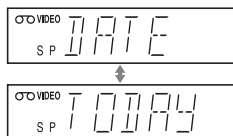

- Turn DIAL TIMER to set the recording date.



- Press DIAL TIMER. "START" and the current time appear alternately in the display window.

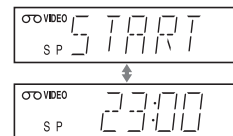

- Turn DIAL TIMER to set the recording start time. You can set the recording start time in 15 minute intervals or adjust the time in one minute intervals by pressing the PROGRAM +/- buttons.





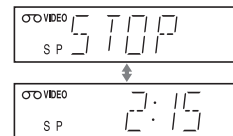







- Press DIAL TIMER. "STOP" and the recording stop time alternately appear in the display window.



- Turn DIAL TIMER to set the recording stop time. You can set the recording stop time in 15 minute intervals or adjust the time in one minute intervals by pressing the PROGRAM +/- buttons.



- 7**  Press  DIAL TIMER.  
The programme position or LINE input appears in the display window.
- 
- 8**  Turn  DIAL TIMER to set the programme position.
- 
-  To record from a decoder or other source connected to one or more of the LINE inputs, turn  DIAL TIMER or press INPUT SELECT to display the connected line in the display window.
- 9**  Press  DIAL TIMER to complete the setting.  
"OK" appears in the display window for about five seconds.  
The  indicator appears in the display window and the VCR stands by for recording.  
To record from a decoder or other source, leave the connected equipment switched on.



#### To return to the previous step

To return to the previous step, press the PROGRAM + and – buttons on the VCR at the same time during any of the Dial Timer settings.

#### To stop recording

To stop the VCR while recording, press  (stop).







#### To use the VCR after setting the timer

To use the VCR before a recording begins, just press . The  indicator turns off and the VCR switches on. Remember to press  to reset the VCR to recording standby after using the VCR.

You can also do the following tasks while the VCR is recording:

- Reset the counter (page 40).
- Display tape information on the TV screen (page 43).
- Check the timer settings (page 61).
- Watch another TV programme (page 43).

#### To set the clock

- 1 Hold down  DIAL TIMER so that "DAY" appears in the display window. However, if the clock has already been set, the current setting appears.
- 2 Turn  DIAL TIMER to set the day.
- 3 Press  DIAL TIMER.  
"MONTH" appears in the display window.
- 4 Turn and press  DIAL TIMER to set the month, and then the year.  
After you set the year, "CLOCK" appears in the display window again.
- 5 Turn and press  DIAL TIMER to set the hour and minute.
- 6 When you have finished setting the time, press  DIAL TIMER to start the clock.

#### Tips

- To cancel a Dial Timer setting, press  (stop) on the VCR while you are making the setting.
- The programme is recorded in the current tape speed mode. To change the tape speed, press SP/LP before you complete the setting in step 9.
- To check, change, or cancel the programme setting, see "Checking/changing/cancelling timer settings" on page 61.

#### Notes



- If eight programmes have already been set using the ShowView system or the TIMER PROGRAMMING menu, "FULL" appears in the display window for about five seconds.
- The  indicator flashes in the display window when you complete the setting in step 9 with no tape inserted.
- If you set the clock using the Auto Clock Set function and AUTO CLOCK is set to ON, the clock will adjust itself to the incoming time signal regardless of adjustments made with the Dial Timer. Be sure you have set the Auto Clock Set correctly.
- When the time is set incorrectly, "ERROR" appears in the display window in step 9. Set the timer again from step 1.
- You cannot set the tape speed to AUTO using the Dial Timer. To select AUTO, set the tape speed in the TIMER PROGRAMMING menu (see page 61).

continued

### About the Demonstration Mode

The Dial Timer function has a Demonstration Mode that allows the user, such as a salesperson, to enter more than eight examples of timer settings when demonstrating the use of the Dial Timer. It cancels the "FULL" notice which appears if eight programmes have already been set. Do not use the Demonstration Mode for making timer recordings. Doing so may cause the settings to be inaccurate.

#### To activate the Demonstration Mode

Press  (pause) on the VCR while turning the  DIAL TIMER. "DEMO" appears in the display window for a few seconds.

#### To cancel the Demonstration Mode



Turn the power off and unplug the mains lead. Although the Demonstration Mode is cancelled, the timer settings entered while using the Demonstration Mode will remain. Be sure to manually cancel the timer settings before you use the Dial Timer or any other timer method after reconnecting the mains lead (see page 61).

## Recording TV programmes using the ShowView® system (SLV-SE830N, SE730N and SX730N only)

The ShowView system is the feature that simplifies programming the VCR to make timer recordings. Just enter the ShowView number listed in the TV programme guide. The date, times, and programme position of that programme are set automatically. You can preset a total of eight programmes, including settings made with other timer methods.

#### Before you start...

- Check that the VCR clock is set to the correct time and date.
- Insert a tape with its safety tab in place. Make sure the tape is longer than the total recording time.
- To record from a decoder, turn it on.
- Turn on your TV and set it to the video channel.
- Set TIMER METHOD to SHOWVIEW or VARIABLE in the EASY OPERATION menu (see page 71).
- Refer to "Index to parts and controls" for button locations.

- 1  Press  TIMER.
  - When you set TIMER METHOD to VARIABLE:  
The TIMER METHOD menu appears on the TV screen. Press  to select SHOWVIEW, then press OK.
  - When you set TIMER METHOD to SHOWVIEW:  
The SHOWVIEW menu appears on the TV screen.

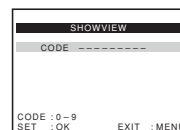
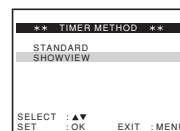

continued



**2**  Press the programme number buttons to enter the ShowView number.  
If you make a mistake, press CLEAR and re-enter the correct number.

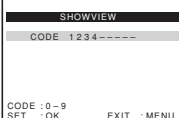

**3**  Press OK.  
The date, start and stop times, programme position, tape speed and VPS/PDC setting appear on the TV screen.

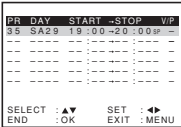

- If “-” appears in the “PR” (programme) column (this may happen for local broadcasts), you have to set the appropriate programme position manually. Press  $\uparrow/\downarrow$  to select the desired programme position.
- To record from a decoder or other source connected to one or more of the LINE inputs, press INPUT SELECT to display the connected line in the “PR” position. You will only have to do this operation once for the referred channel. The VCR will then store your setting.

If the information is incorrect, press CLEAR to cancel the setting.

**4**  If you want to change the date, tape speed and the VPS/PDC setting:

- Press  $\leftarrow/\rightarrow$  to select the item you want to change.
- Press  $\uparrow/\downarrow$  to reset it.

- To record the same programme every day or the same day every week, see “Daily/weekly recording” on page 53.
- To use the VPS/PDC function, set V/P to ON. For details about the VPS/PDC function, see “Timer recording with VPS/PDC signals” on page 53.

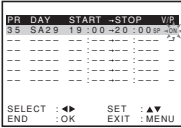

**5**  Press MENU to exit the menu.

**6**  Press I/O to turn off the VCR.  
The  $\odot$  indicator appears in the display window and the VCR stands by for recording.  
To record from a decoder or other source, leave the connected equipment switched on.

**To stop recording**

To stop the VCR while recording, press  $\blacksquare$  (stop).

**Daily/weekly recording**

In step 4 above, press  $\downarrow$  to select the recording pattern. Each time you press  $\downarrow$ , the indication changes as shown below. Press  $\uparrow$  to change the indication in reverse order.

today  $\rightarrow$  DLY (Monday to Sunday)  $\rightarrow$  W-SA (every Saturday) .....  $\rightarrow$  W-SU (every Sunday)  $\rightarrow$  1 month later  $\rightarrow$  (dates count down)  $\rightarrow$  today

**Timer recording with VPS/PDC signals**

Some broadcast systems transmit VPS (Video Programme System) or PDC (Programme Delivery Control) signals with their TV programmes. These signals ensure that your timer recordings are made regardless of broadcast delays, early starts, or broadcast interruptions.

To use the VPS/PDC function, set V/P to ON in step 4 above. You can also use the VPS/PDC function for a source connected to one or more of the LINE inputs.

**To use the VCR after setting the timer**

To use the VCR before a recording begins, just press I/O. The  $\odot$  indicator turns off and the VCR switches on. Remember to press I/O to reset the VCR to recording standby after using the VCR.

You can also do the following tasks while the VCR is recording:

- Reset the counter (page 40).
- Display tape information on the TV screen (page 43).
- Check the timer settings (page 61).
- Watch another TV programme (page 43).

52 Recording TV programmes using the ShowView® system (SLV-SE830N, SE730N and SX730N only)

Recording TV programmes using the ShowView® system (SLV-SE830N, SE730N and SX730N only) 53

**To use the Auto Tape Speed function**

In step 4 above, press  $\downarrow$  to select AUTO. When you are recording a programme in the SP mode and the remaining tape length becomes shorter than the recording time, the recording tape speed is automatically changed to the LP mode. Note that some noise will appear on the picture when the tape speed is changed. To operate this function correctly, the “TAPE SELECT” setting in the USER SET menu must be accurate (see page 70).

**Tips**

- To set the line input video source, you can also use the INPUT SELECT button.
- You can set the extended time for the ShowView setting by 10, 20, 30, 40, 50, or 60 minutes. Set SHOWVIEW EXTEND in the EASY OPERATION menu to the desired extended time on page 71.
- To check, change, or cancel the programme setting, see “Checking/changing/cancelling timer settings” on page 61.

**Notes**

- If the VPS/PDC signal is too weak or the broadcasting station failed to transmit VPS/PDC signals, the VCR will start recording at the set time without using the VPS/PDC function.
- The  $\odot$  and  $\circ$  indicators flash in the display window when you press I/O with no tape inserted.
- When you set TIMER METHOD to STANDARD in the EASY OPERATION menu, the SHOWVIEW menu does not appear on the TV screen. Select SHOWVIEW or VARIABLE.

**Recording TV programmes using the timer**

You can preset a total of eight programmes, including settings made with other timer methods.

**Before you start...**

- Check that the VCR clock is set to the correct time and date.
- Insert a tape with its safety tab in place. Make sure the tape is longer than the total recording time.
- To record from a decoder, turn it on.
- Turn on your TV and set it to the video channel.
- Set TIMER METHOD\* to STANDARD or VARIABLE in the EASY OPERATION menu (see page 71).
- Refer to “Index to parts and controls” for button locations.

**1**  Press  $\odot$  TIMER.  
For SLV-SE630N and SE430K  
The TIMER PROGRAMMING menu appears on the TV screen.

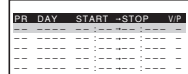

**For SLV-SE830N, SE730N and SX730N**

- When you set TIMER METHOD to VARIABLE:  
The TIMER METHOD menu appears on the TV screen. Press  $\uparrow/\downarrow$  to select STANDARD, then press OK.

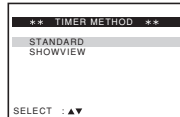

- When you set TIMER METHOD to STANDARD:  
The TIMER PROGRAMMING menu appears on the TV screen.

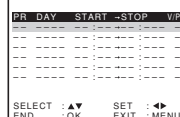

54 Recording TV programmes using the ShowView® system (SLV-SE830N, SE730N and SX730N only)

Recording TV programmes using the timer 55

- 2** Set the date, start and stop times, programme position, tape speed and VPS/PDC function\*:
- 1 Press **→** to select each item in turn.
  - 2 Press **↑/↓** to set each item. To correct a setting, press **←** to return to that setting and reset.
- To record the same programme every day or the same day every week, see "Daily/weekly recording" on page 56.
  - To use the VPS/PDC function\*, set V/P to ON. For details about the VPS/PDC function, see "Timer recording with VPS/PDC signals" on page 53.
  - To record from a decoder or other source connected to one or more of the LINE inputs, press INPUT SELECT to display the connected line in the "PR" position.

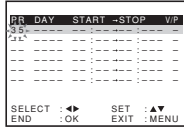

- 3** Press MENU to exit the menu.
- 4** Press I/O to turn off the VCR. The ⊖ indicator appears in the display window and the VCR stands by for recording. To record from a decoder or other source, leave the connected equipment switched on.

**To stop recording**

To stop the VCR while recording, press ■ (stop).

**Daily/weekly recording**

In step 2 above, press ↓ to select the recording pattern. Each time you press ↓, the indication changes as shown below. Press ↑ to change the indication in reverse order.

today → DLY (Monday to Sunday) → W-SA (every Saturday) ..... → W-SU (every Sunday) → 1 month later → (dates count down) → today

**To use the VCR after setting the timer**

To use the VCR before a recording begins, just press I/O. The ⊖ indicator turns off and the VCR switches on. Remember to press I/O to reset the VCR to recording standby after using the VCR.

You can also do the following tasks while the VCR is recording:

- Reset the counter (page 40).
- Display tape information on the TV screen (page 43).
- Check the timer settings (page 61).
- Watch another TV programme (page 43).

**To use the Auto Tape Speed function**

In step 2 above, press ↓ to select AUTO. When you are recording a programme in the SP mode and the remaining tape length becomes shorter than the recording time, the recording tape speed is automatically changed to the LP mode. Note that some noise will appear on the picture when the tape speed is changed. To operate this function correctly, the "TAPE SELECT" setting in the USER SET menu must be accurate (see page 70).

**Tips**

- To set the line input video source, you can also use the INPUT SELECT button.
- Even if you set TIMER METHOD\* to SHOWVIEW in the EASY OPERATION menu, you can set the timer manually. Press MENU to select TIMER PROGRAMMING, then go to step 2.
- To check, change, or cancel the programme setting, see "Checking/changing/cancelling timer settings" on page 61.

**Notes**

- When setting the timer with VPS/PDC\* signals, enter the start and stop times exactly as indicated in the TV programme guide. Otherwise, the VPS/PDC function will not work.
- If the VPS/PDC\* signal is too weak or the broadcasting station failed to transmit VPS/PDC signals, the VCR will start recording at the set time without using the VPS/PDC function.
- The ⊖ and ⊕ indicators flash in the display window when you press I/O with no tape inserted.
- The VPS/PDC function\* is automatically set to off for the timer recording of a satellite programme.

\* not available on SLV-SE630N and SE430K

**Additional Operations**

**Playing/searching at various speeds**

**Before you start...**

- Refer to "Index to parts and controls" for button locations.

Playback options	Operation
View the picture during fast-forward or rewind	During fast-forward, hold down ►► (fast-forward). During rewind, hold down ◀◀ (rewind).
Play at high speed	• During playback, press ►► (fast-forward) or ◀◀ (rewind) on the remote commander. • During playback, hold down ►► (fast-forward) or ◀◀ (rewind). When you release the button, normal playback resumes.
Play at twice the normal speed	During playback, press ×2.
Play in slow motion	During playback, press ► SLOW.
Play frame by frame	During pause, press ►► (fast-forward) or ◀◀ (rewind)* on the remote commander.

\* SLV-SE830N only

**To resume normal playback**

Press ▷ (play).

**Using the shuttle ring (SLV-SE830N only)**

With the shuttle ring, you can operate a variety of playback options. There are two ways for using the shuttle ring, normal mode and jog mode.

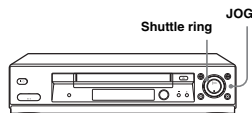

**To use the shuttle ring in normal mode**

During playback or pause, turn the shuttle ring clockwise or anticlockwise. Each change in the shuttle ring position changes the playback mode in the following way.

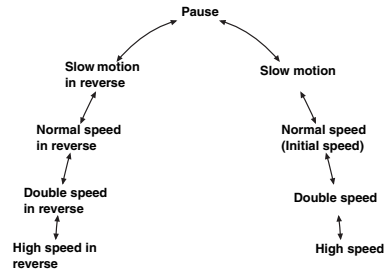

**To use the shuttle ring in jog mode**

Use this mode for frame-by-frame playback.

Press JOG to enter the jog mode. The JOG button lights up. If you change to the jog mode during any playback mode, playback pauses so you can see a still picture. Each change in the shuttle ring position shifts the picture one frame. To shift frames in reverse, turn the shuttle ring anticlockwise. The frame shift speed depends on the speed you turn the shuttle ring. To resume normal mode, press JOG again. The JOG button turns off.

**Tip**

- Adjust the picture using the PROGRAM +/- buttons on the VCR if:
  - Streaks appear while playing in slow motion.
  - Bands appear at the top or bottom while pausing.
  - The picture shakes while pausing.
 To set tracking to the centre position, press both buttons (+/-) at the same time.

**Notes**

- The sound is muted during these operations.
- In the LP mode, noise may appear or there may be no colour.
- If the playback mode mark does not appear on the TV screen, press [DISPLAY].
- The picture may show noise when playing at high speed in reverse.
- The picture returns to normal playback from slow motion in reverse in 30 seconds.

## Setting the recording duration time

After you have started recording in the normal way, you can have the VCR stop recording automatically after a specified duration.

### Before you start...

- Refer to "Index to parts and controls" for button locations.

#### 1 While recording, press ● REC.

The ⊖ indicator appears in the display window.



#### 2 Press ● REC repeatedly to set the duration time.

In SP mode

Each press advances the time in increments of 30 minutes.

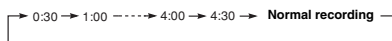

In LP mode

Each press advances the time as shown below.

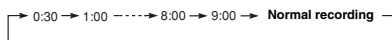

The tape counter decreases minute by minute to 0:00, then the VCR stops recording and turns off automatically.

#### To extend the duration

Press ● REC repeatedly to set a new duration time.

#### To cancel the duration

Press ● REC repeatedly until the ⊖ indicator disappears and the VCR returns to the normal recording mode.

#### To stop recording

To stop the VCR while recording, press ■ (stop).

#### Note

- You cannot display the current tape time in the display window when setting the recording duration time.

## Checking/changing/cancelling timer settings

### Before you start...

- Turn on your TV and set it to the video channel.
- Refer to "Index to parts and controls" for button locations.

#### 1 Press I/⏻ to turn on the VCR.

#### 2 Press MENU, then press ↑/↓ to highlight TIMER PROGRAMMING and press OK.

- If you want to change or cancel a setting, go on to the next step.
- If you do not need to change or cancel the settings, press MENU, then turn off the VCR to return to recording standby.

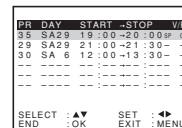

#### 3 Press ↑/↓ to select the setting you want to change or cancel, then press →.

The PR number on the selected row flashes.

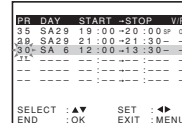

#### 4 To change the setting, press ←/→ to select the item you want to change, then press ↑/↓ to reset it.

- To cancel the setting, press CLEAR.

#### 5 Press MENU to exit the menu.

If any settings remain, turn off the VCR to return to recording standby.

continued

### When the timer settings overlap

The programme that starts first has priority and the second programme starts recording only after the first programme has finished. If the programmes start at the same time, the programme listed first in the menu has priority.

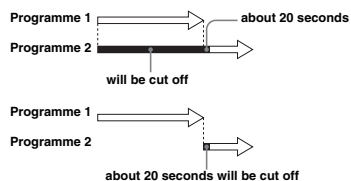

## Recording stereo and bilingual programmes (not available on SLV-SE430K)

### In the ZWEITON (German stereo) system

This VCR automatically receives and records stereo and bilingual programmes based on the ZWEITON system. When a stereo or bilingual programme is received, the STEREO indicator appears in the display window.

#### To select bilingual sound while recording

Press AUDIO MONITOR to select the sound you want.

To listen to	On-screen display	Display window
Main	MAIN	STEREO
Sub	SUB	STEREO
Main and sub	MAIN/SUB	STEREO
Standard sound*	MONO	STEREO

\* Usually the main channel heard from both the left and right in bilingual programmes

#### To select stereo programme while recording

To listen to	On-screen display	Display window
Stereo	STEREO	STEREO
Left channel	LCH	STEREO
Right channel	RCH	STEREO
Standard sound	LCH + RCH	STEREO

\* Usually the mixed sound of left and right channels in stereo programmes

continued

### In the NICAM system

This VCR receives and records stereo and bilingual programmes based on the NICAM system (NICAM appears on the TV screen). When a stereo or bilingual programme is received, the STEREO indicator appears in the display window.

To record a NICAM programme, NICAM in the USER SET menu should be set to ON (initial setting). To check the menu setting, see page 71 for details.

### To select the sound while recording

Press AUDIO MONITOR to select the sound you want.

#### Stereo programmes

To listen to	On-screen display	Display window
Stereo	NICAM, STEREO	STEREO
Left channel	NICAM, LCH	STEREO
Right channel	NICAM, RCH	STEREO
Left and right channels*	NICAM, LCH + RCH	STEREO

\* Usually the mixed sound of left and right channels

#### Bilingual programmes

To listen to	On-screen display	Display window
Main	NICAM, MAIN	STEREO
Sub	NICAM, SUB	STEREO
Main and sub	NICAM, MAIN/SUB	STEREO
Standard sound*	NICAM, MONO	STEREO

\* Usually the main sound (monaural)

### Selecting the sound during Hi-fi playback

Press AUDIO MONITOR to select the sound you want.

To listen to	On-screen display	Display window
Stereo	STEREO	STEREO
Left channel	LCH	STEREO
Right channel	RCH	STEREO
Mix sound*	MIX	STEREO
Mono sound	MONO	No indicator

\* The mixed sound of left and right channels, and the normal mono audio track

### How sound is recorded on a video tape

The VCR records sound onto two separate tracks. Hi-fi audio is recorded onto the main track along with the picture. Monaural sound is recorded onto the normal audio track along the edge of the tape.

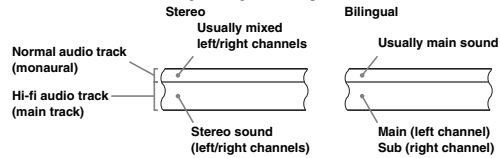

#### Notes

- To listen to playback sounds in stereo, you must use the Scart or AUDIO OUT connections.
- When you play a tape recorded in monaural, the sound is heard in monaural regardless of the AUDIO MONITOR setting.

## Searching using the index function (not available on SLV-SE430K)

The VCR automatically marks the tape with an index signal at the point where each recording begins. Use these signals as references to find a specific recording.

### To find a specific recording by scanning (Index scan)

- 1 Insert an indexed tape into the VCR.
- 2 Press ◀▶/▶▶ (index search). The VCR starts scanning each recording for five seconds in the corresponding direction.

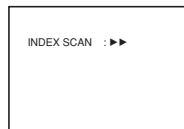

- 3 Press ▷ (play) to start playback when you find the desired point.

### To search a specific recording (Index search)

- 1 Insert an indexed tape into the VCR.
- 2 Press ◀▶/▶▶ (index search) twice.
  - To search ahead, press ▶▶ (index search) twice.
  - To search backwards, press ◀▶ (index search) twice.

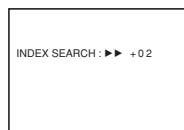

- 3 Press ◀▶/▶▶ (index search) depending on the direction where your desired programme is located. Each time you press the button, the number increases or decreases up to ±20, respectively.
- 4 The VCR starts searching, and playback starts automatically from that point.

### To stop searching

Press ■ (stop).

#### Notes

- No index signal will be added when recording starts from recording pause. However, an index signal will be marked if you change the programme position during recording pause.
- When you press ◀▶ (index search), if there is nothing recorded before the selected index signal, playback may not start exactly at the index signal.

## Adjusting the picture

### Adjusting the tracking

Although the VCR automatically adjusts the tracking when playing a tape, distortion may occur if the recording is in poor condition. In this case, manually adjust the tracking.

During playback, press PROGRAM +/- on the VCR to display the tracking meter. The distortion should disappear as you press one of the two buttons. To resume automatic tracking adjustments, eject the tape and re-insert it.

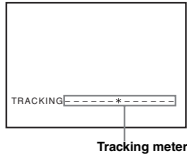

### Adjusting the picture sharpness (Smart trilogic)

You can automatically adjust the sharpness of the picture.

1 During playback, press MENU, then press ↑/↓/←/→ to highlight USER SET and press OK.

2 Press ↑/↓ to highlight SMART TRILOGIC, then press →.

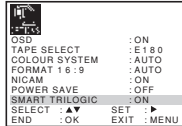

3 Press ↑/↓ to set SMART TRILOGIC to ON or OFF.

- ON: Picture sharpness is automatically adjusted.
- OFF: Adjust the picture sharpness manually.

To soften the picture, press ←.

To sharpen the picture, press →.

4 Press MENU to return to the original screen.

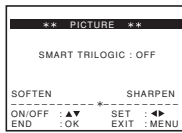

## Reducing the VCR's power consumption

You can turn off the indicators in the display window when the VCR is off (standby mode) to reduce the VCR's power consumption.

1 Press MENU, then press ↑/↓/←/→ to highlight USER SET and press OK.

2 Press ↑/↓ to highlight POWER SAVE.

3 Press → to set to ECO1 or ECO2, then press OK.

- ECO1: To reduce the power consumption.
- ECO2: To reduce the power consumption to a minimum.

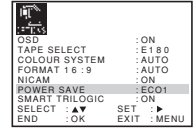

### To turn on the indicators in the display window

Set POWER SAVE to OFF in step 3.

#### Notes

- When the VCR stands by for recording, the ⊙ indicator in the display window remain lit even when POWER SAVE is set to ECO1 or ECO2.
- The Line Through function will not operate properly if POWER SAVE is set to ECO2. Set POWER SAVE to OFF or ECO1 to ensure proper operation.

## Changing menu options

1 Press MENU, then select USER SET or EASY OPERATION and press OK.

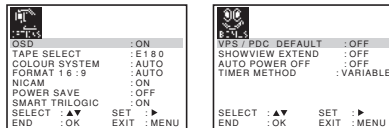

2 Press ↑/↓ to select the option.

3 Press → to change the setting, then press OK.

### Menu choices

Initial settings are indicated in bold print.

#### USER SET

Menu option	Set this option to
OSD	<ul style="list-style-type: none"> <li>• <b>ON</b> to display the menu on the TV screen.</li> <li>• OFF to disappear the menu from the TV screen.</li> </ul>
TAPE SELECT	<ul style="list-style-type: none"> <li>• <b>E180</b> to use an E-180 or shorter type tape.</li> <li>• E240 to use an E-240 type tape.</li> <li>• E260 to use an E-260 type tape.</li> <li>• E300 to use an E-300 type tape.</li> </ul>
COLOUR SYSTEM	<ul style="list-style-type: none"> <li>• <b>AUTO</b> to set the colour system automatically.</li> <li>• PAL to play back a tape recorded in the PAL colour system.</li> <li>• MESECAM to play back a tape recorded in the MESECAM colour system.</li> </ul> <p>If you press ▲ (eject) or turn the VCR off, COLOUR SYSTEM will be reset to AUTO.</p>
FORMAT 16:9	<ul style="list-style-type: none"> <li>• <b>AUTO</b> when you use a wide screen TV. The VCR automatically detects if programmes being played back or recorded are in normal or wide screen format.</li> <li>• ON if the VCR cannot detect wide screen TV programmes with AUTO. The VCR always plays back and records in wide screen format.</li> <li>• OFF if you are not using a wide screen TV.</li> </ul>

Menu option	Set this option to
NICAM <sup>*1</sup>	<ul style="list-style-type: none"> <li>• <b>ON</b> to record NICAM broadcasts on the hi-fi audio track.</li> <li>• OFF to record standard sound on the hi-fi audio track. For details, see page 63.</li> </ul>
POWER SAVE	<ul style="list-style-type: none"> <li>• ECO1 to turn off the indicators in the display window to conserve the VCR's power.</li> <li>• ECO2 to turn off the indicators in the display window during standby mode to reduce the VCR's power consumption to a minimum. For using the Line Through function and Canal plus function, select ECO1 or OFF.</li> <li>• <b>OFF</b> to turn on the indicators in the display window while the VCR is standing by.</li> </ul>
SMART TRILOGIC	<ul style="list-style-type: none"> <li>• <b>ON</b> to automatically adjust the sharpness of the picture.</li> <li>• OFF to manually adjust the sharpness of the picture.</li> </ul>

#### EASY OPERATION

Menu option	Set this option to
VPS/PDC DEFAULT <sup>*2</sup>	<ul style="list-style-type: none"> <li>• <b>OFF</b> to deactivate the VPS/PDC function.</li> <li>• ON to activate it.</li> </ul>
SHOWVIEW EXTEND <sup>*2</sup>	<ul style="list-style-type: none"> <li>• <b>OFF</b> to deactivate the ShowView Extend function.</li> <li>• 10/20/30.../60 (minutes) to extend the time of the ShowView setting by the selected amount of time.</li> </ul>
AUTO POWER OFF	<ul style="list-style-type: none"> <li>• <b>OFF</b> to deactivate the Auto Power Off function.</li> <li>• 2HOUR/3HOUR to turn the VCR off automatically if no signal is received and you do not press any of the buttons during this time.</li> </ul>
TIMER METHOD <sup>*2</sup>	<ul style="list-style-type: none"> <li>• <b>VARIABLE</b> to display the TIMER METHOD menu for selecting STANDARD or SHOWVIEW when pressing the ⊙ TIMER button.</li> <li>• STANDARD to display the TIMER PROGRAMMING menu when pressing the ⊙ TIMER button.</li> <li>• SHOWVIEW to display the SHOWVIEW menu when pressing the ⊙ TIMER button.</li> </ul> <p>For details, see pages 51 and 55.</p>

<sup>\*1</sup>not available on SLV-SE430K

<sup>\*2</sup>not available on SLV-SE630N and SE430K

## Connecting to a VCR or stereo system

### How to connect to record on this VCR

Connect the line outputs of the other VCR to the input connector of this VCR. Refer to the examples A through C and choose the connection that best suits your VCR.

Example A

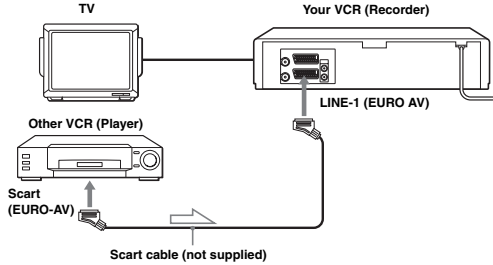

Signal flow

Example B (SLV-SE830N only)

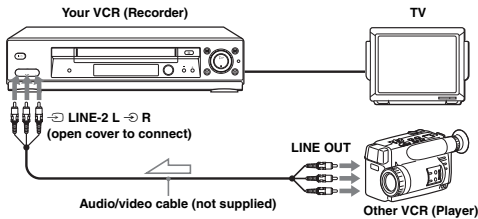

Signal flow

Example C

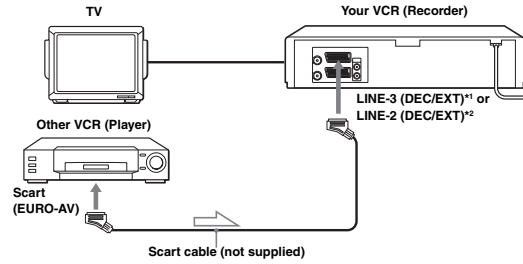

Signal flow

### How to connect to a stereo system (SLV-SE830N only)

Connect the LINE-2 L-R jacks on this VCR to the audio output jacks on the stereo system, using an audio cable (not supplied).

#### Notes

- Make sure you connect the plugs to jacks of the same colour.
- If the other VCR is a monaural type, leave the red plugs unconnected.
- If you connect this VCR to both the LINE IN and LINE OUT jacks of the other VCR, select the input correctly to prevent a humming noise.
- If the other VCR does not have a Scart (EURO-AV) connector, use an adequate cable instead and connect the cable to the line out jacks of the other VCR.
- When you connect another VCR to the LINE-3 (DEC/EXT)\*1 or LINE-2 (DEC/EXT)\*2 connector, press INPUT SELECT to display "L3"\*1 or "L2"\*2 in the display window.

\*1 SLV-SE830N

\*2 SLV-SE730N, SX730N, SE630N and SE430K

## Basic editing

### When recording on this VCR

#### Before you start editing

- Turn on your TV and set it to the video channel.
- Press INPUT SELECT to display the connected line in the display window.
- Press SP/LP to select the tape speed, SP or LP.

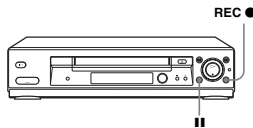

- 1 Insert a source tape with its safety tab removed into the other (playback) VCR. Search for the point to start playback and set it to playback pause.
- 2 Insert a tape with its safety tab in place into this (recording) VCR. Search for the point to start recording and press **II** (pause) to set it to playback pause.
- 3 Press **REC** on this VCR to set it to recording pause.
- 4 To start editing, press the **II** (pause) buttons on both VCRs at the same time.

#### To stop editing

Press the **■** (stop) buttons on both VCRs.

#### Tip

- To cut out unwanted scenes while editing, press **II** (pause) on this VCR when an unwanted scene begins. When it ends, press **II** (pause) again to resume recording.

## Audio dubbing (SLV-SE830N only)

This feature lets you record over the normal audio track. The monaural sound previously recorded is replaced while the original hi-fi sound remains unchanged. Use this feature to add commentary to a tape that you have recorded with a camcorder.

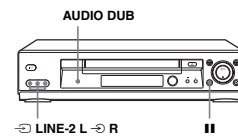

#### Before you start...

- Open the LINE-2 L-R jacks cover on the front panel and connect a playback source.
- Turn on the TV and set it to the video channel.

- 1 Insert a source tape into your stereo system (or the playback VCR). Search for the point to start playback and set it to playback pause.
- 2 Insert a prerecorded tape with its safety tab in place into this (recording) VCR. Search for the start of the section to be replaced and press **II** (pause). The VCR enters pause mode.
- 3 Press **AUDIO DUB**. "A\_DUB" and the **○** indicator appears in the display window.
- 4 To start editing, press the **II** (pause) buttons on this VCR and the stereo system (or other VCR) at the same time. After you use this feature, the audio in playback mode is automatically set to monaural.

#### To stop editing

Press **■** (stop) on this VCR and the stereo system (or other VCR).

## Troubleshooting

If you have any questions or problems not covered below, please consult your nearest Sony service facility.

	Symptom	Remedy
Power	The I/O (on/standby) switch does not function.	• Connect the mains lead to the mains securely.
	The power is turned on but the VCR does not operate.	• Moisture condensation has occurred. Turn the power off, unplug the mains lead and leave the VCR to dry for over three hours.
	The VCR is plugged in but the display window remains dark.	• Set POWER SAVE in the USER SET menu to OFF (see page 69).
Clock	The clock has stopped and "--:--" appears in the display window.	• The clock stops if the VCR is disconnected from the mains. Reset the clock (and timer).
	The playback picture does not appear on the TV screen.	• Make sure the TV is set to the video channel. If you are using a monitor, set it to video input. • If the VCR is connected to the TV with the Scart cable, make sure the VIDEO indicator is lit in the display window. Use the TV/VIDEO button on the remote commander to light up the VIDEO indicator.
Playback	The picture is not clear.	• Existing broadcasts may interfere with the VCR. Reset the RF channel output of your VCR (see page 22). • Adjust the tracking with the PROGRAM +/- buttons on the VCR. • The video heads are dirty (see the last page of Troubleshooting). Clean the video heads using a Sony video head cleaning cassette. If a Sony cleaning cassette is not available in your area, have the heads cleaned at your nearest Sony service facility (a standard service charge will be required). Do not use a commercially available liquid type cleaning cassette other than Sony's, as it may damage the video heads. • The video heads may have to be replaced. Consult your local Sony service facility for more information.
	The picture has no colour.	• The COLOUR SYSTEM option in the USER SET menu is set to the wrong position. Set the option to conform to the system that the tape was recorded in.
	The picture rolls vertically during picture search.	• Adjust the vertical hold control on the TV or monitor.

	Symptom	Remedy
Playback	The picture has no sound.	• The tape is defective. • If you made A/V connections, check the audio cable connection.
	The sound from a tape recorded with the VCR is not in stereo or the STEREO indicator in the display window is flashing.	• Adjust the tracking. • The video heads are dirty. Clean the video heads using a Sony video head cleaning cassette as explained above.
	No TV programme appears on the TV screen.	• Make sure the TV is set to the video channel. If you are using a monitor, set it to video input. • Existing broadcasts may interfere with the VCR. Reset the RF channel output of your VCR (see page 22). • Select the correct source with the INPUT SELECT button. Select a programme position when recording TV programmes; select a line input when recording from other equipment.
Recording	TV reception is poor.	• Make sure the aerial cable is connected securely. • Adjust the TV aerial. • Make sure the TV system is correctly set for your TV. • Make sure TV SYSTEM (B/G or D/K) in the INSTALLATION menu is set to the same system in your local area.
	The tape starts playing as soon as it is inserted.	• The safety tab has been removed. To record on this tape, cover the tab hole (see page 44).
	The tape is ejected when you press ● REC.	• The safety tab has been removed. To record on this tape, cover the tab hole (see page 44).
Timer recording	Nothing happens when you press ● REC.	• Make sure the tape is not at its end.
	The timer does not operate.	• Check that the clock is set. • Make sure a tape has been inserted. • Check that the safety tab has not been removed. • Make sure the tape is not at its end. • Make sure a programme has been set for timer recording. • Make sure your timer settings are past the current time. • Check that the decoder is turned on. • Check that the satellite tuner is turned on. • The clock stops if the VCR is disconnected from the mains. Reset the clock and timer. • Turn the power off and unplug the mains lead.

	Symptom	Remedy
Timer recording	The SHOWVIEW menu or the TIMER PROGRAMMING menu does not appear.	• Check that TIMER METHOD in the EASY OPERATION menu is set correctly (see page 71).
	The VPS/PDC function does not operate properly.	• Check that the clock and the date are set correctly. • Check that the VPS/PDC time you set is the correct one (there might be a mistake in the TV programme guide). If the broadcast you wanted to record did not send the good VPS/PDC information, the VCR will not start recording. • If the reception is poor, the VPS/PDC signal might be altered and the VCR might not start recording.
Canal Plus	You cannot watch Canal Plus programmes when the VCR is in standby mode.	• Check that DEC is set to ON for this channel in the TV STATION TABLE menu. • Make sure the Canal Plus Scart cable is plugged securely.
	A Canal Plus programme is always recorded scrambled.	• Make sure the Canal Plus Scart cable is plugged securely. • Check that DEC is set to ON for this channel in the TV STATION TABLE menu.
Others	A tape cannot be inserted.	• Check that a tape is not already in the tape compartment.
	The remote commander does not function.	• Make sure you are pointing the remote commander at the remote sensor on the VCR. • Replace all the batteries in the remote commander with new ones if they are weak. • Make sure the [TV] / [VIDEO] remote control switch is set correctly.
	The selected input line connector number does not appear in the display window.	• Press INPUT SELECT to display the connected line.
	The tracking meter does not appear on the TV screen.	• The recording condition of the tape is very poor and tracking cannot be adjusted.
	You cannot control other TVs.	• Set your TV's code number. The code number may change when you replace the batteries of the remote commander.
	The display window becomes dim.	• The display window automatically becomes dim when the VCR is in standby or timer recording mode.
	The VCR needs to be cleaned.	• Clean the cabinet, panel and controls with a dry, soft cloth, or a soft cloth slightly moistened with a mild detergent solution. Do not use any type of solvent, such as alcohol or benzene.

	Symptom	Remedy
Others	The Line Through function does not operate.	• Set POWER SAVE in the USER SET menu to OFF (see page 69).

### Symptoms caused by contaminated video heads

• Normal picture      • Rough picture      • Unclear picture      • No picture (or black & white screen appears)

The diagram shows four stages of video head contamination. From left to right: 1. 'Normal picture' showing a clear image of a couple. 2. 'Rough picture' showing a slightly grainy image. 3. 'Unclear picture' showing a very blurry image. 4. 'No picture (or black & white screen appears)' showing a completely black and white screen. An arrow labeled 'initial contamination' points from the first image to the second, and another arrow labeled 'terminal' points from the third image to the fourth.

## Index

### A

Adjusting  
  picture 68  
  tracking 68  
Aerial hookup 16  
Audio dubbing 75  
Audio track 65  
Auto Clock Set 21  
Auto Set Up 20

### C

Canal Plus 36  
Changing the programme position 31  
Changing the station name 34  
Cleaning the video heads 76  
Clock setting 24  
Colour system  
  compatible colour systems 2  
  setting 40  
Connecting  
  the VCR and your TV 16, 17  
  to a satellite tuner 19  
  to a stereo system 19, 72  
  to a TV with a Scart (EURO-AV) connector 17  
Counter 40  
Country selection 21

### D

Demonstration 50  
Dial Timer 46  
Disabling the programme positions 32  
Dubbing. *see* Editing

### E

Editing 72

### H

Hi-fi audio track 65

### I

Index scan 66  
Index search 66

### L

Language selection 20, 27  
LP mode 42

### M

Manual fine tuning 30  
Monaural 64  
Monitoring  
  during playback 64  
  during recording 64

### N

NICAM broadcasts 64  
Normal audio track 65

### O

Optional setting 70

### P

PDC (Programme Delivery Control) 53  
Playback 39  
  at various speeds 58  
  frame-by-frame 58  
  selecting the sound 64  
  slow motion 58  
Power save 69  
Preset download 26  
Presetting channels 28

### R

Recording 42  
  bilingual programmes 63  
  duration time 60  
  saving 44  
  stereo programmes 63  
  timer setting 55  
  using the Dial Timer 46  
  using the ShowView system 51  
  what you are watching on the TV 45  
  while watching another programme 43  
RF channel 20, 22

### S

Safety tab 44  
Scart connection 17  
Searching  
  at various speeds 58  
  using the index function 66  
ShowView  
  recording 51  
Smart trilogy 68  
SMARTLINK  
  NextView Download 18  
  One Touch Menu 18  
  One Touch Play 18, 41  
  One Touch Timer 18  
  TV Direct Rec 18, 45  
SP mode 42  
Stereo 63  
T  
  Timer setting 55  
    cancelling 61  
    changing 61  
    checking 61  
    daily/weekly recording 53, 56  
    using the Dial Timer 46  
    using the ShowView system 51

### V

VPS (Video Programme System) 53

### W

Wide screen format 70

### Z

ZWEITON broadcasts 63

## Quick Start Guide

### 1 Connecting the VCR

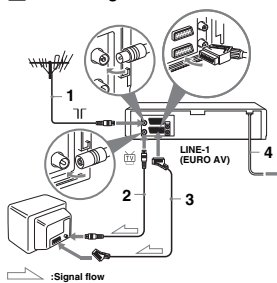

- 1 ... Connect the aerial to of the VCR.  
2 ... Connect and the aerial input of your TV using the supplied aerial cable.  
3 ... For better picture and sound, connect LINE-1 (EURO AV) to your TV using a Scart cable if your TV has a Scart (EURO-AV) connector.  
4 ... Connect the mains lead to the mains.

### 2 Using the Auto Set Up function

- 1 ... Turn on your TV and set it to the video channel.  
If your TV does not have a Scart (EURO-AV) connector, tune the TV to channel 32 (the initial RF channel of this VCR). Refer to your TV's manual for TV tuning instructions. If the picture does not appear clearly, see "To change the RF channel."  
2 ... Connect the mains lead to the mains.

- 3 ... Press to select a language, then press OK.  
4 ... When the COUNTRY SELECTION menu appears, press to select a country, then press OK.  
When all of the receivable channels are preset, the menu disappears from the TV screen. You can rearrange the programme position in any order (see "Changing/disabling programme positions").

### 3 Setting the clock

- 1 ... Press MENU, then press to highlight CLOCK SET and press OK.  
2 ... Press to set the hour, then press .  
3 ... Press to set the minutes. Set the day, month, and year in sequence by pressing to select the item to be set, and press to select the digits, then press OK.  
4 ... Press MENU.

Now you can operate your VCR.



## 2. DISASSEMBLY

### 2-1 MONO MODELS

#### 2-1-1 Cabinet Top

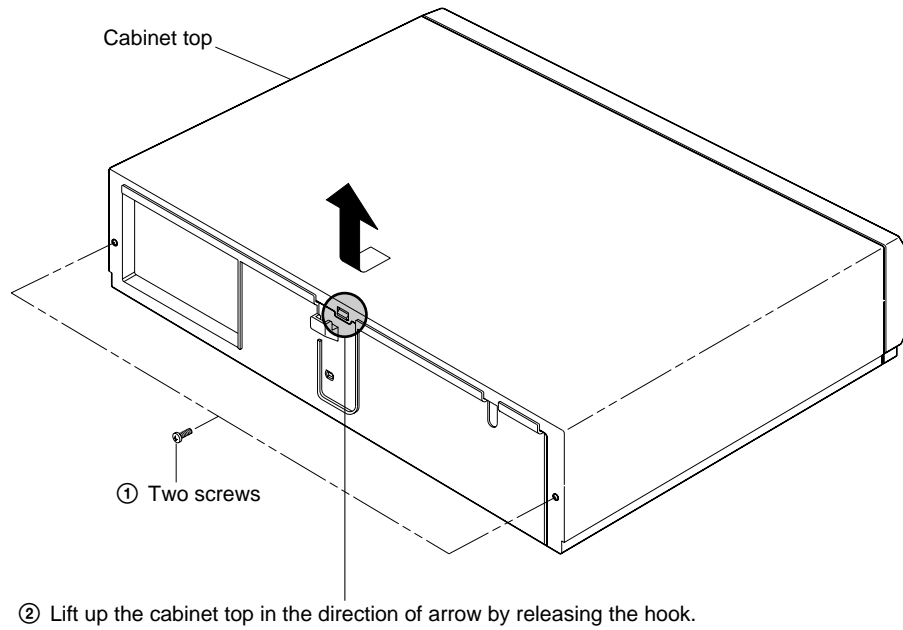

Fig. 2-1 Cabinet Top

#### 2-1-2 Cover Bottom

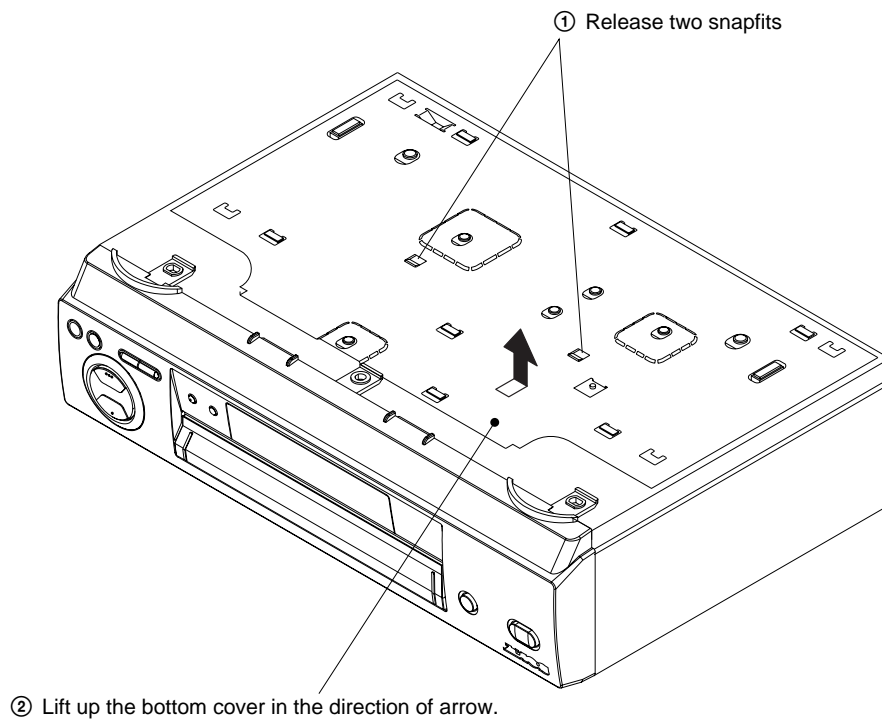

Fig. 2-2 Cover Bottom

### 2-1-3 Ass'y-Panel Front

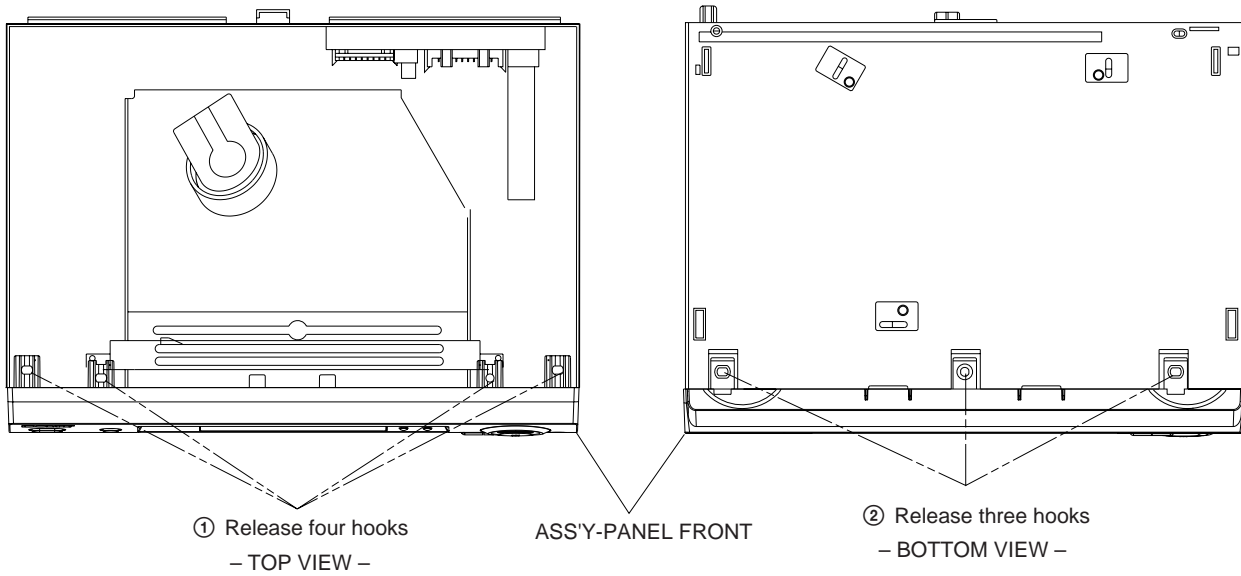

Fig. 2-3 Ass'y-Panel Front

## 2-1-4 ASS'Y Main PCB, Deck

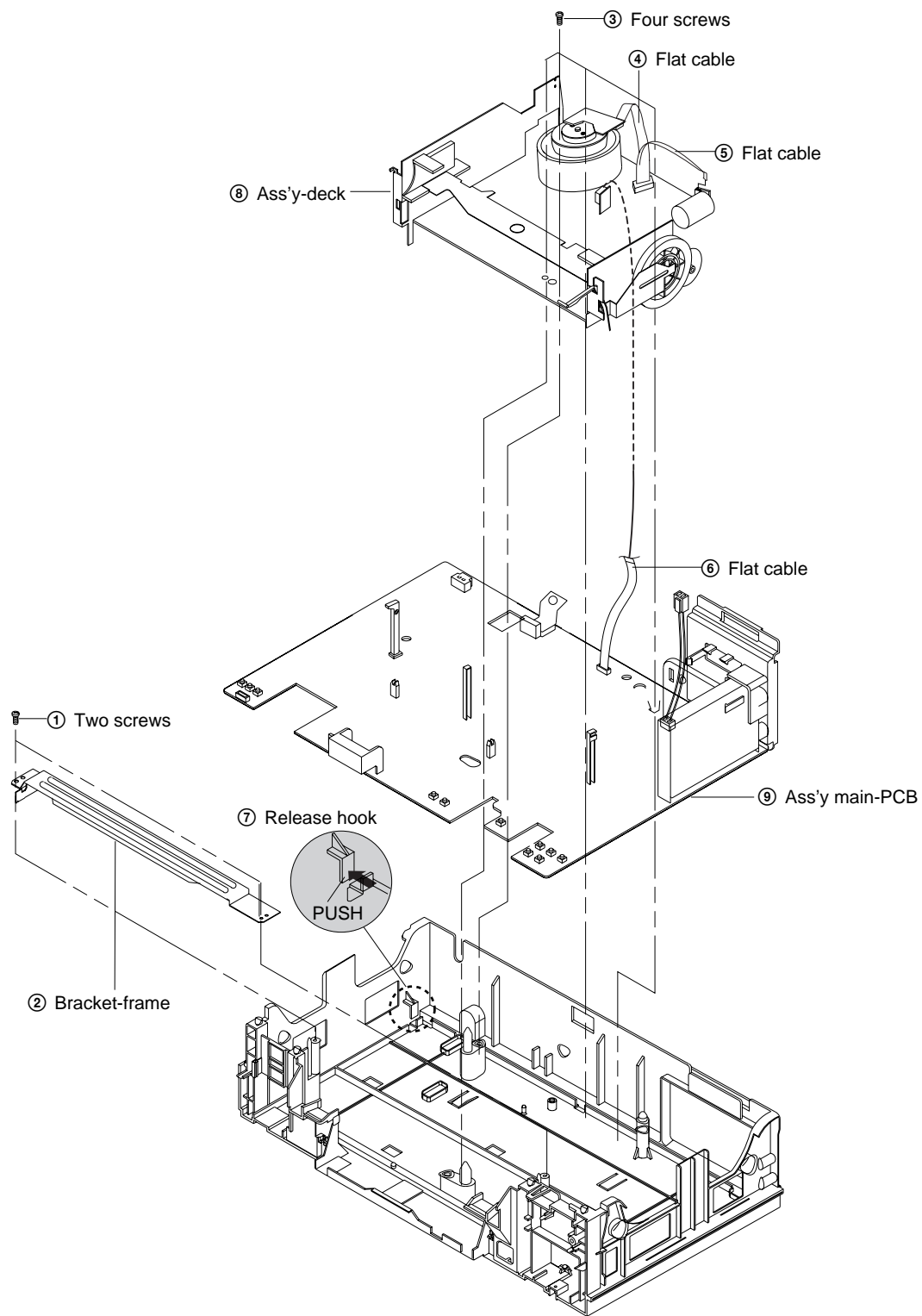

Fig. 2-4 Ass'y Main-PCB, Deck

## 2-2 Hi-Fi MODELS

### 2-2-1 Cabinet Top

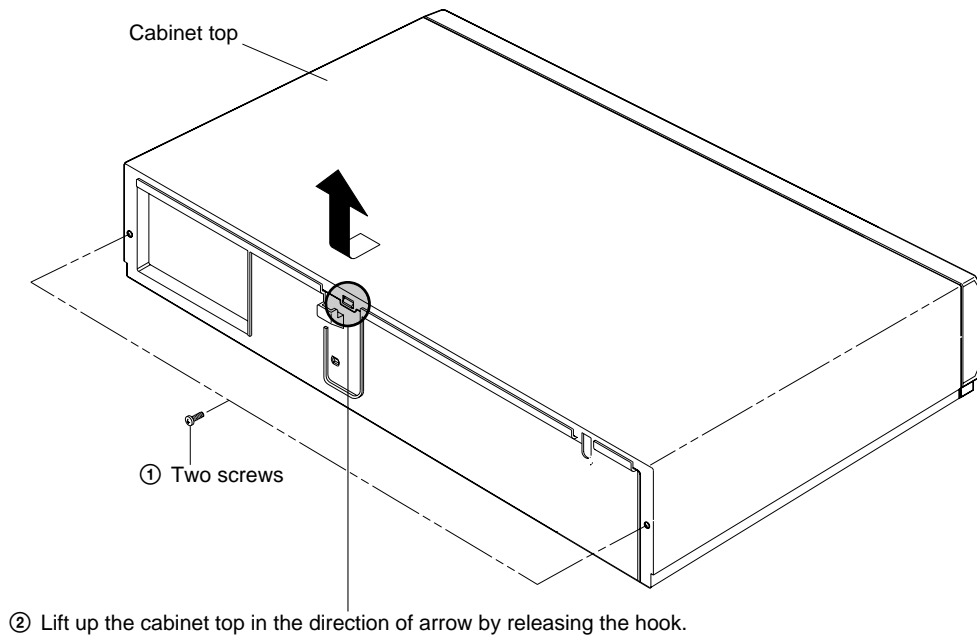

Fig. 2-5 Cabinet Top

### 2-2-2 Cover Bottom

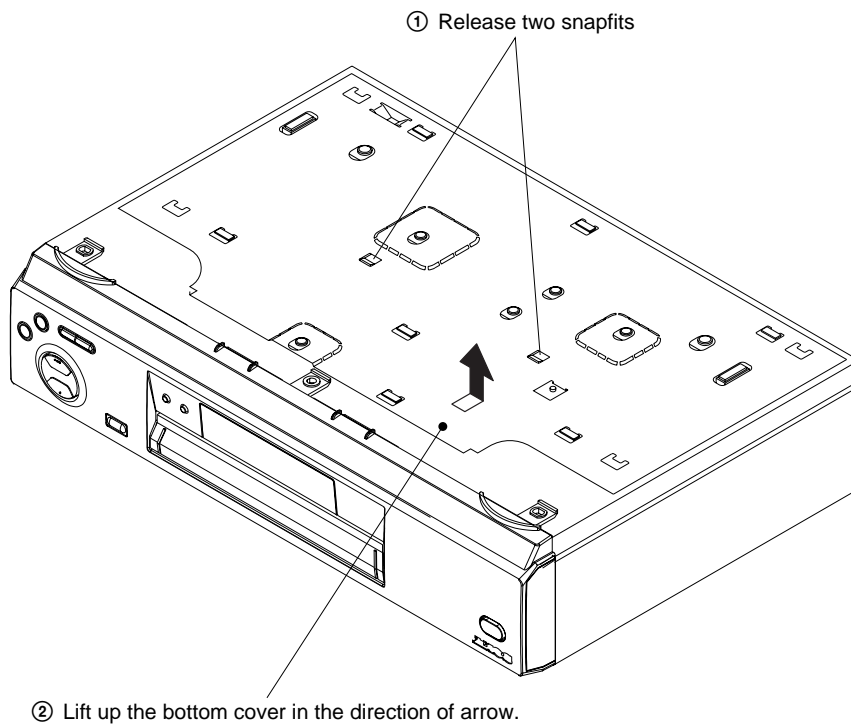

Fig. 2-6 Cover Bottom

### 2-2-3 Ass'y-Panel Front

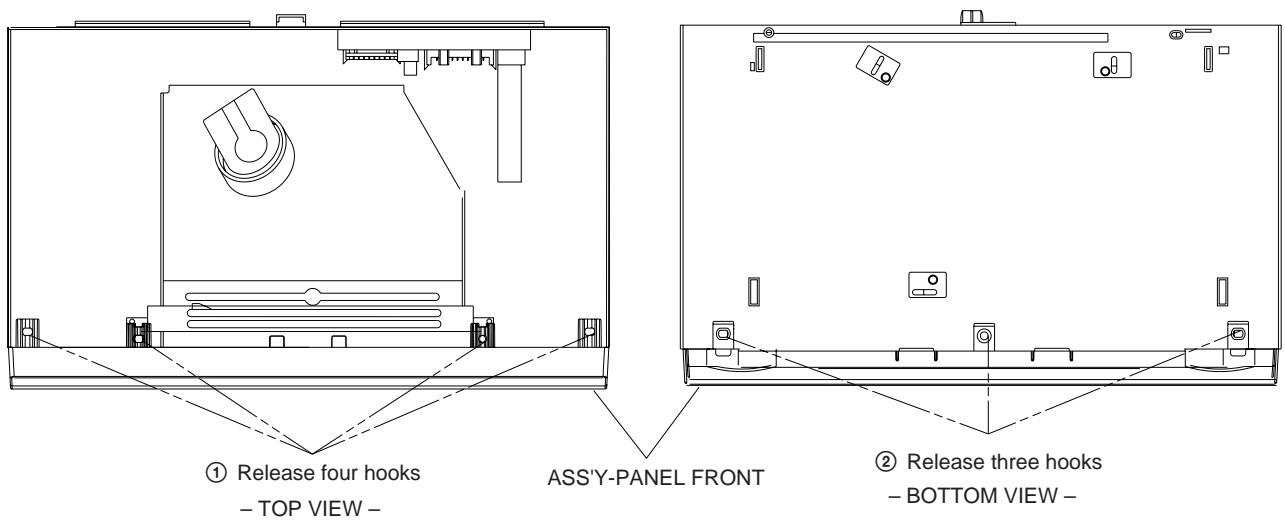

Fig. 2-7 Ass'y-Panel Front

### 2-2-4 Ass'y Jack PCB

Disconnect the CN7T04 from the ass'y main-PCB and then lift the ass'y jack-PCB up.

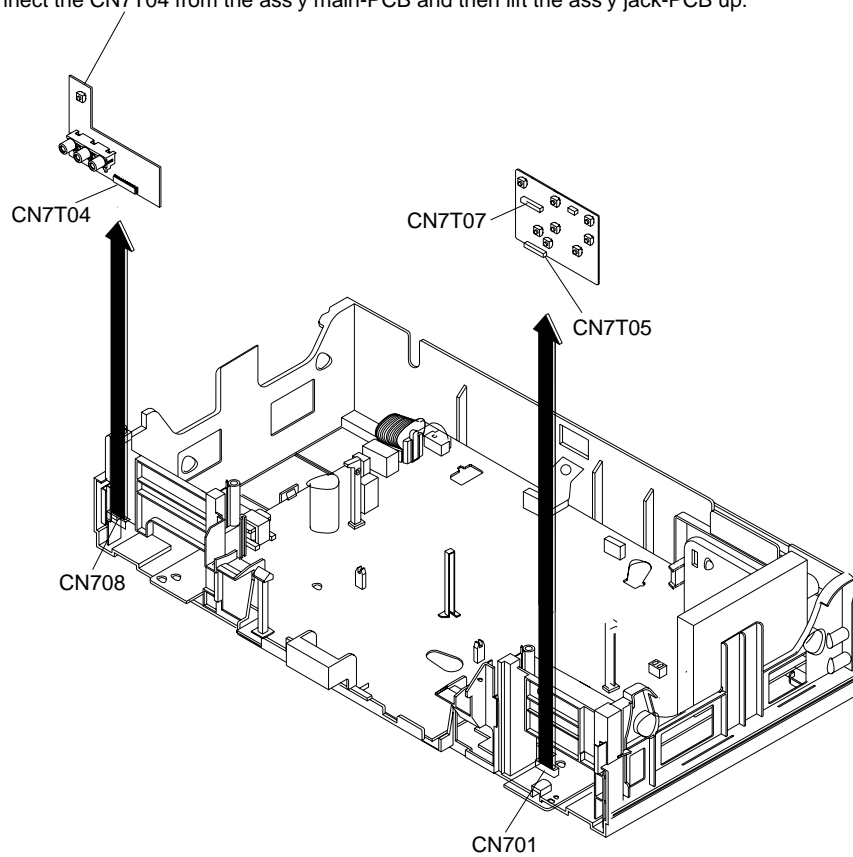

Fig. 2-8 Ass'y Jack-PCB

## 2-2-5 Ass'y, Main-PCB, Deck

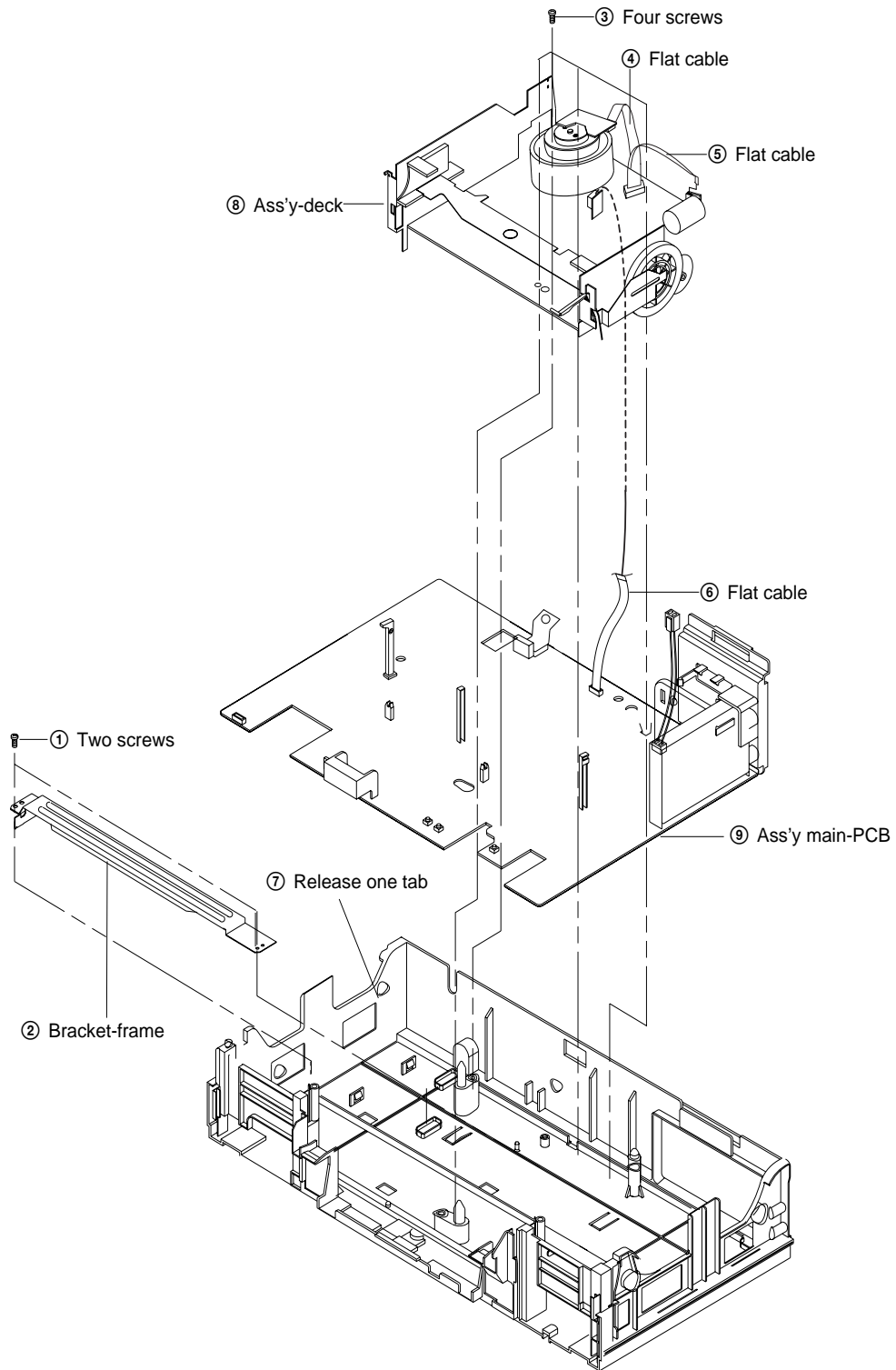

Fig. 2-9 Ass'y Main-PCB, Deck

---

## 3. P.C. BOARDS

---

<b>3-1 Main PCB (Main A model)</b> - - - - -	<b>3-3</b>
<b>3-2 Main PCB (Main B model)</b> - - - - -	<b>3-7</b>
<b>3-3 Function PCB (Hi-Fi model)</b> - - - - -	<b>3-11</b>
<b>3-4 Dial Timer PCB (SE830)</b> - - - - -	<b>3-11</b>

- Main A model: SE230/SE430/SE630  
Main B model: SE730/SE737/SE830/SX730/SX737  
Hi-Fi model: SE630/SE730/SE737/SE830/SX730/SX737  
Mono model: SE230/SE430

# 3-1 MAIN PCB (Main A model)

## COMPONENT SIDE

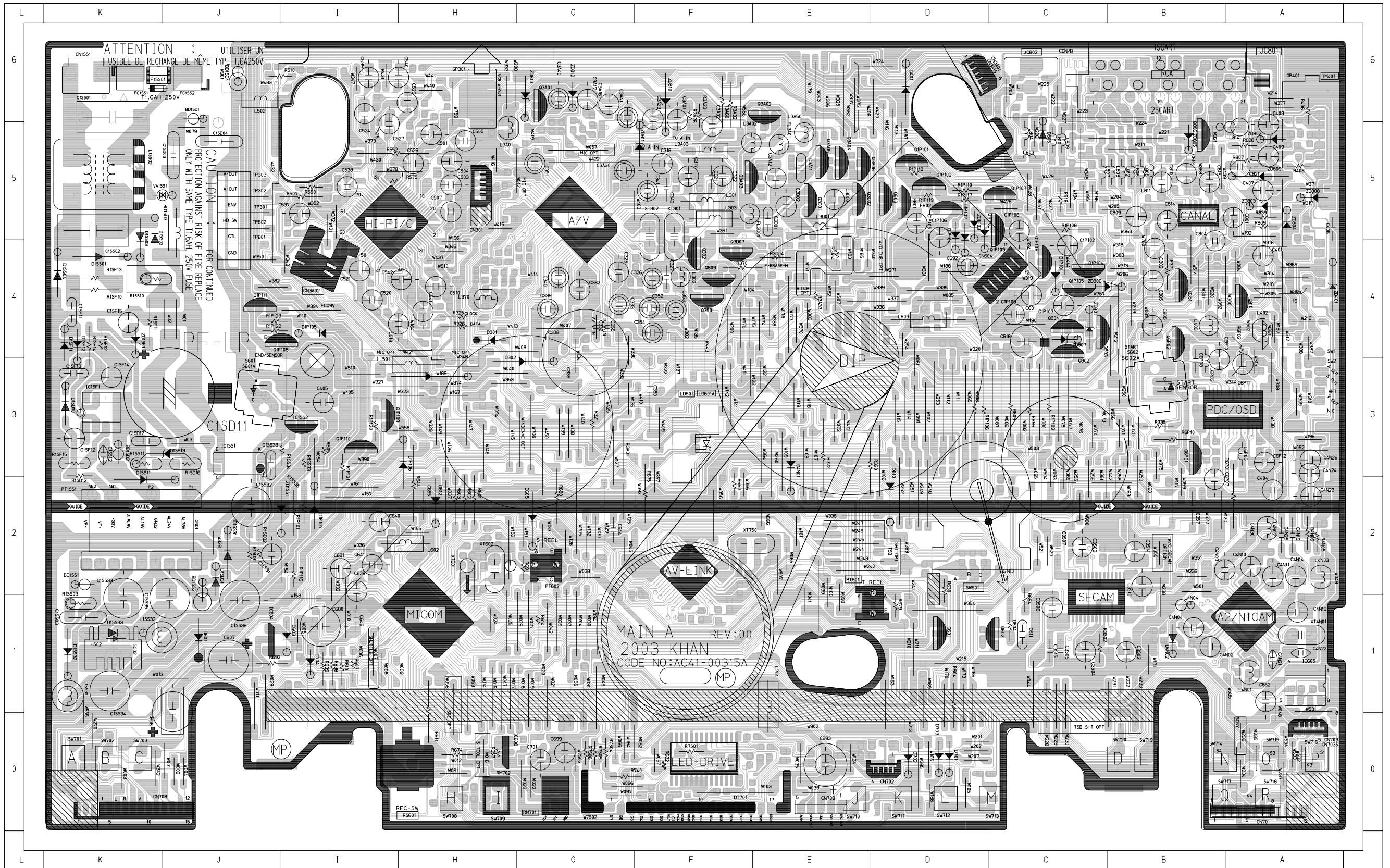



**CONDUCTOR SIDE**

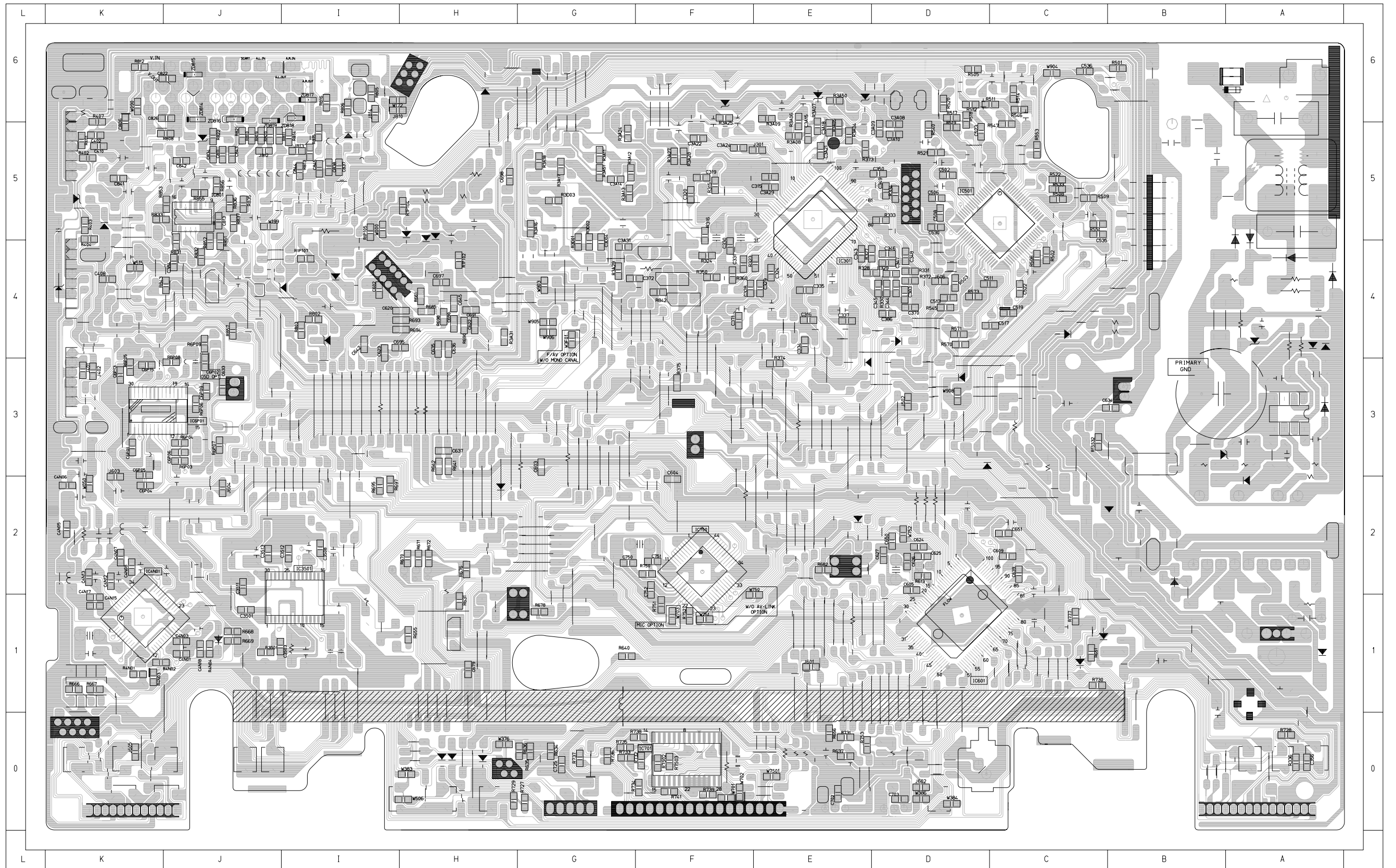

3-2 MAIN PCB (Main B model)

COMPONENT SIDE

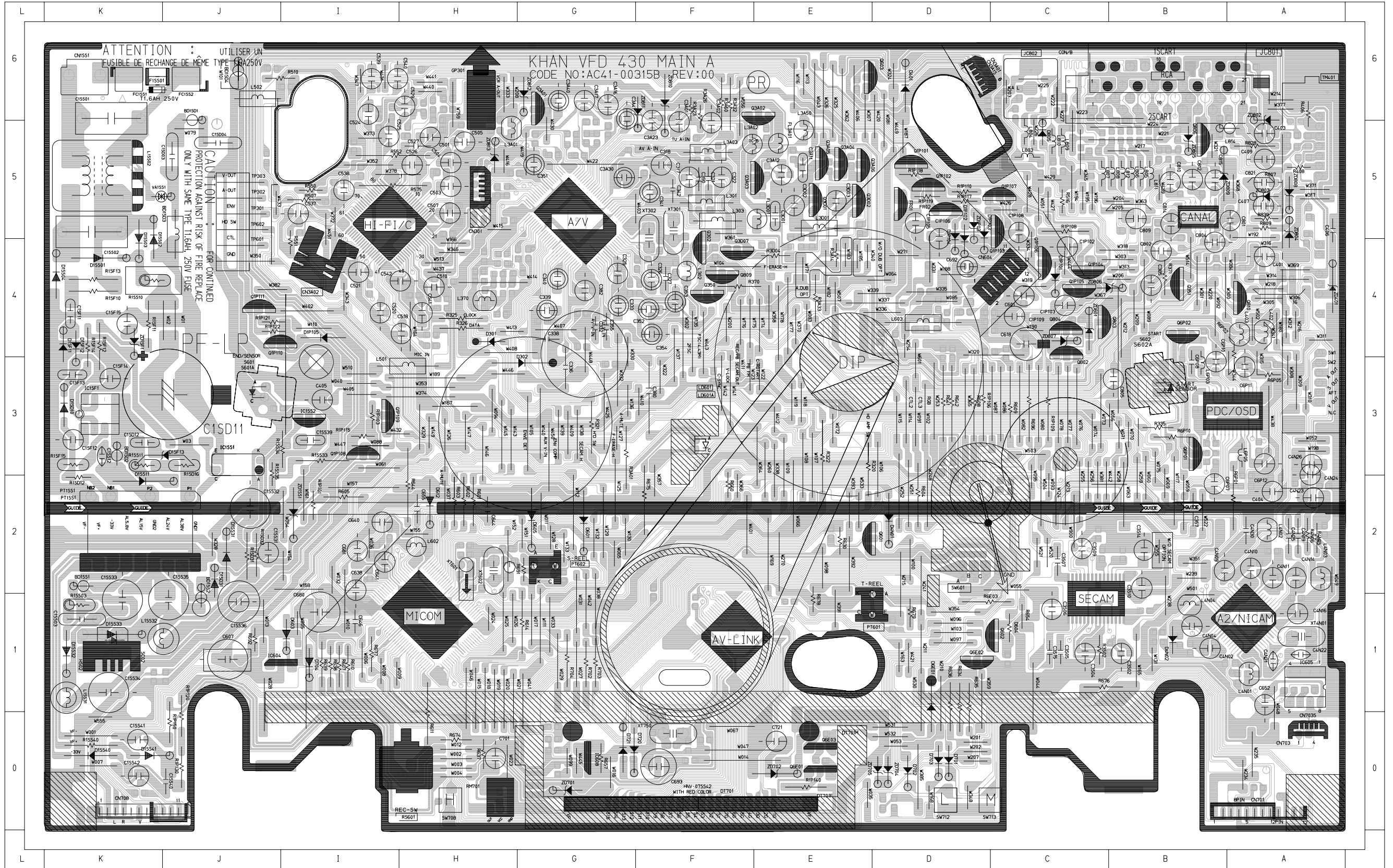

CONDUCTOR SIDE

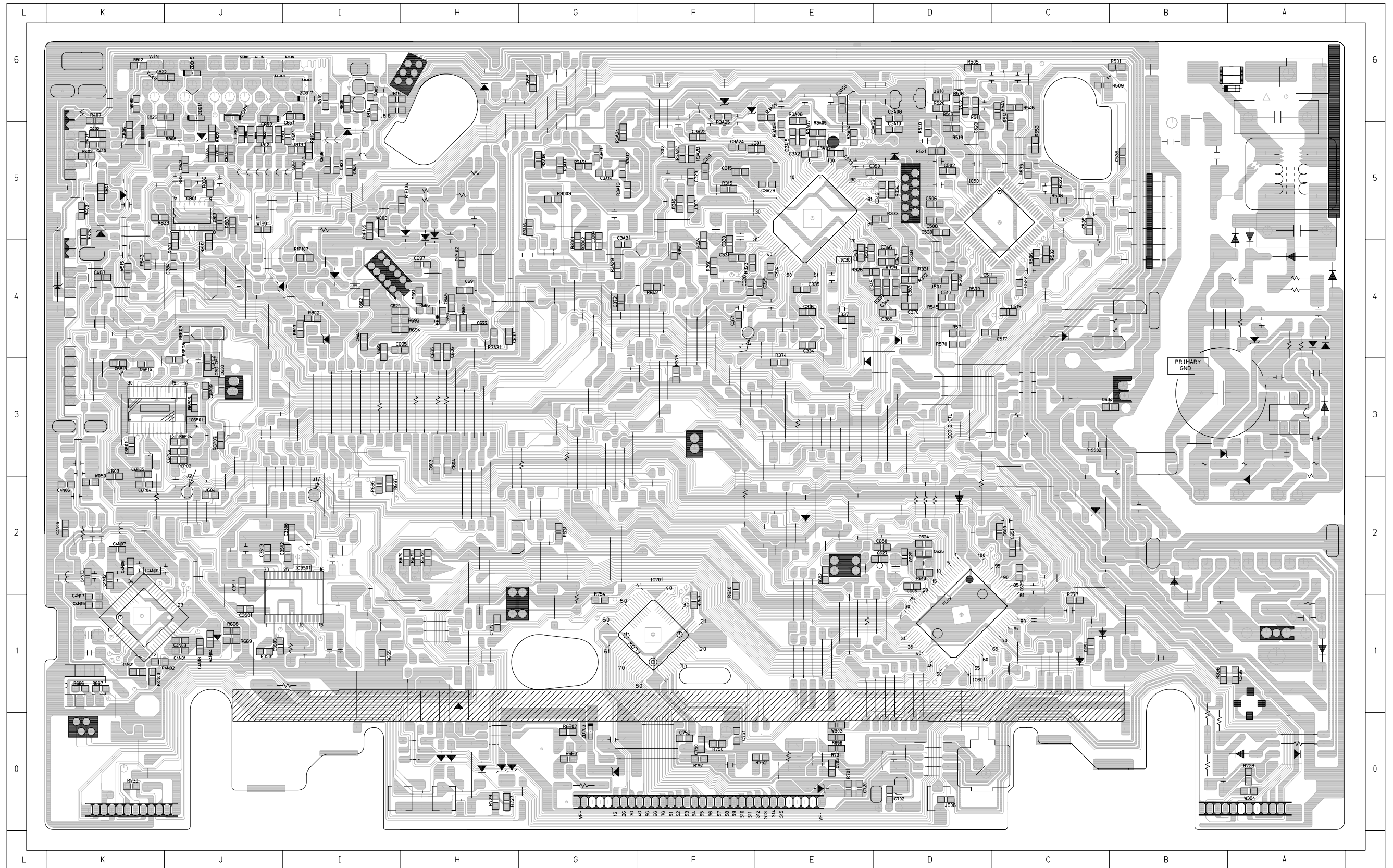

### 3-3 FUNCTION PCB (Hi-Fi model)

#### COMPONENT SIDE

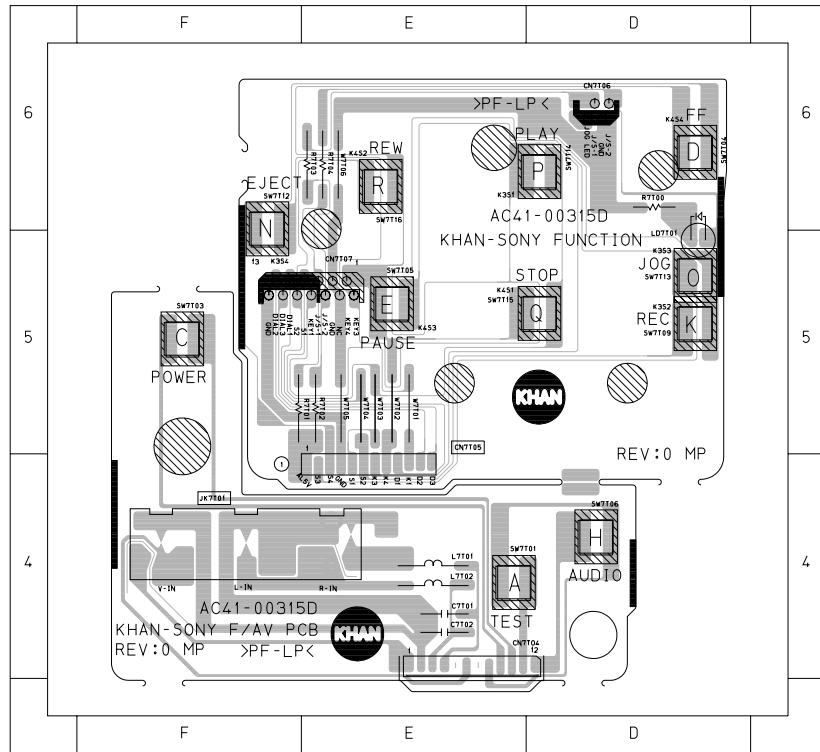

#### CONDUCTOR SIDE

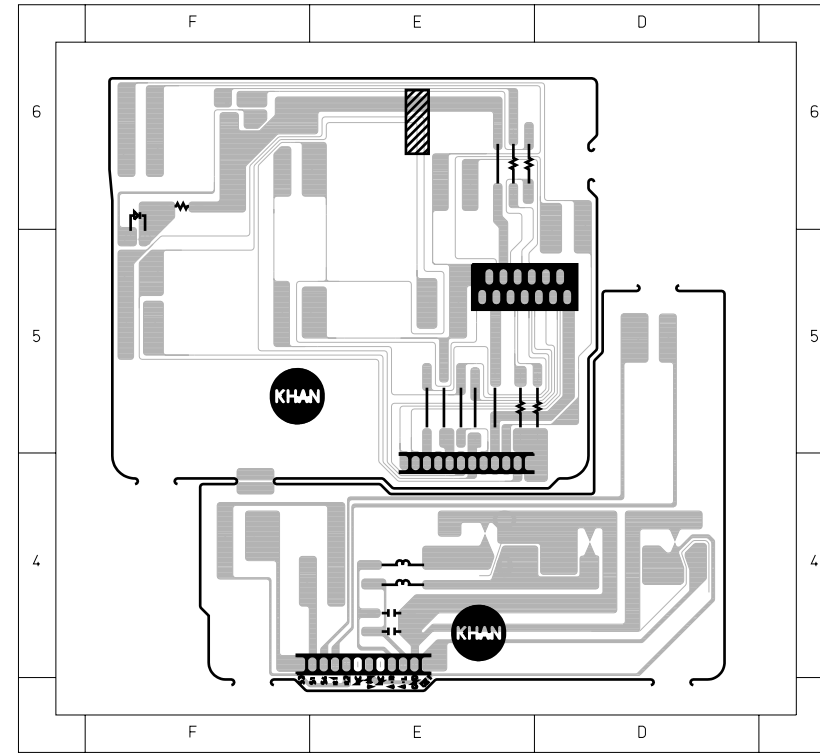

### 3-4 DIAL TIMER PCB (SE830)

#### COMPONENT SIDE

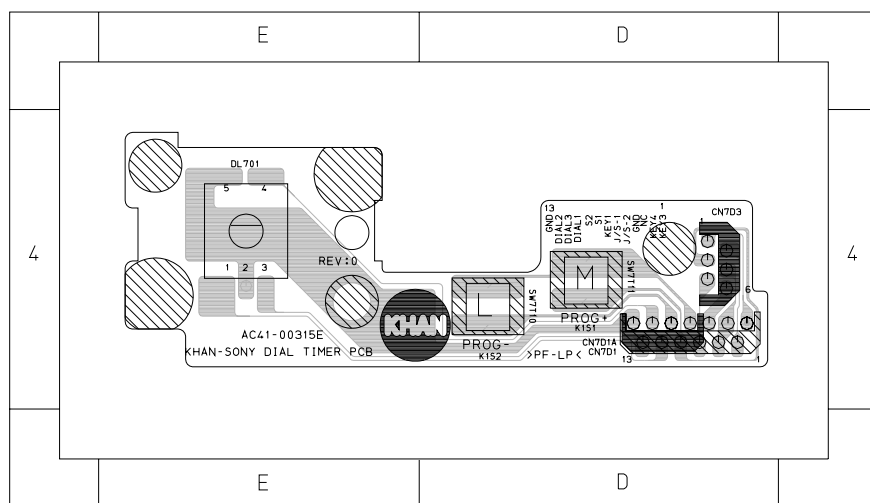

#### CONDUCTOR SIDE

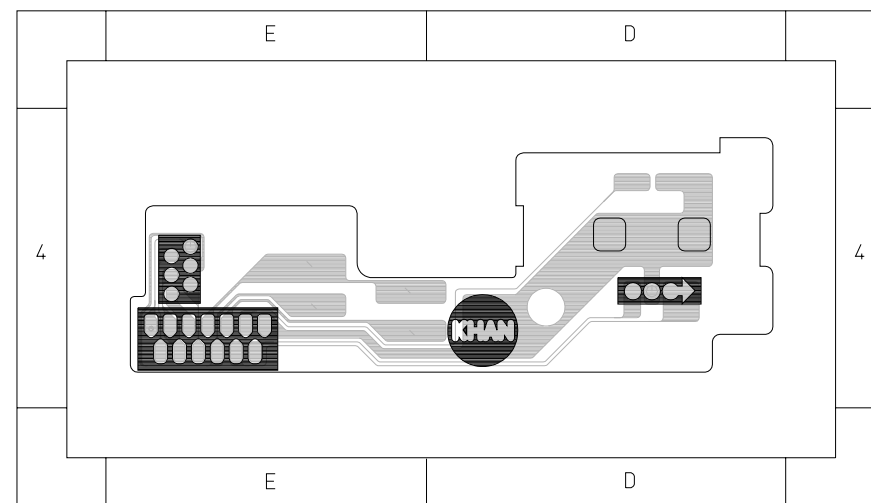

## 4. SCHEMATIC DIAGRAMS

◆ Block Identification of Main PCB	4-3
4-1 S.M.P.S. (Main A model)	4-5
4-2 S.M.P.S. (Main B model)	4-7
4-3 Power (Main A model)	4-9
4-4 Power (Main B model)	4-11
4-5 System Control/Servo (Main A model)	4-13
4-6 System Control/Servo (Main B model)	4-15
4-7 Audio/Video	4-17
4-8 Hi-Fi (Hi-Fi model)	4-19
4-9 TM-Block	4-21
4-10 OSD/VPS/PDC	4-23
4-11 SECAM (SE230B/SE630B/SE730B/SE830B)	4-25
4-12 A2/NICAM (Hi-Fi model)	4-27
4-13 Input-Output (2 Scart Jack) (Main A model)	4-29
4-14 Input-Output (2 Scart Jack) (Main B model)	4-31
4-15 Function (SE630)	4-33
4-16 Function (Main B model)	4-35

- Main A model: SE230/SE430/SE630  
Main B model: SE730/SE737/SE830/SX730/SX737  
Hi-Fi model: SE630/SE730/SE737/SE830/SX730/SX737  
Mono model: SE230/SE430

◆ BLOCK IDENTIFICATION OF MAIN PCB

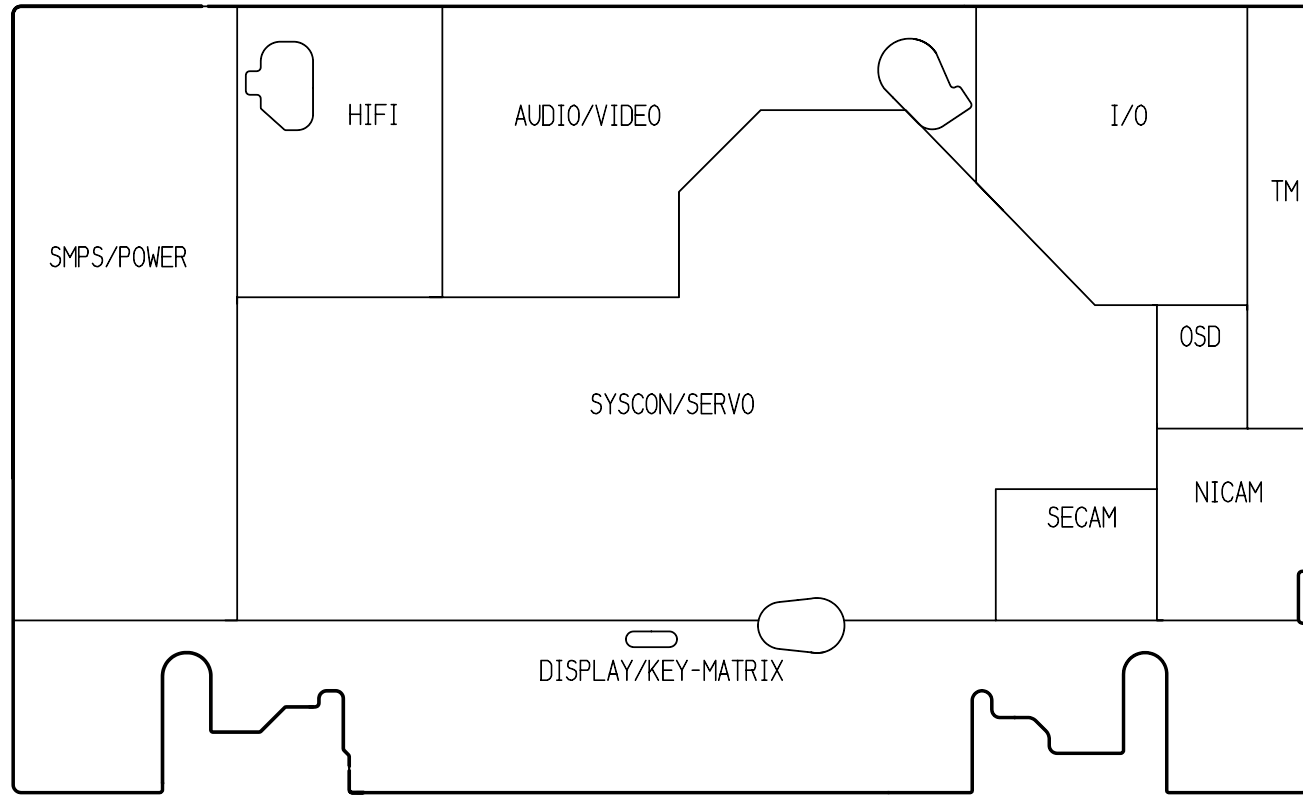

Component Side

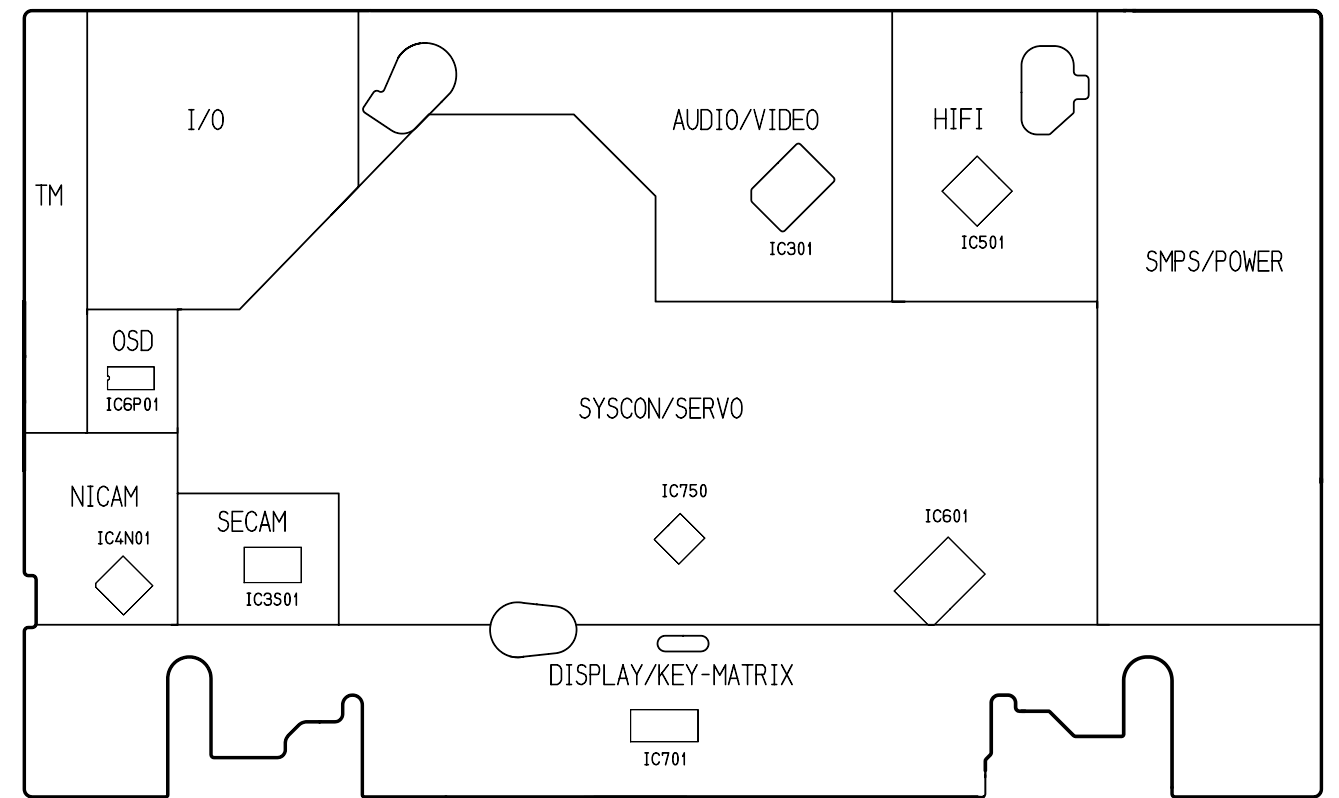

Conductor Side

4-1 S.M.P.S. (Main A model)

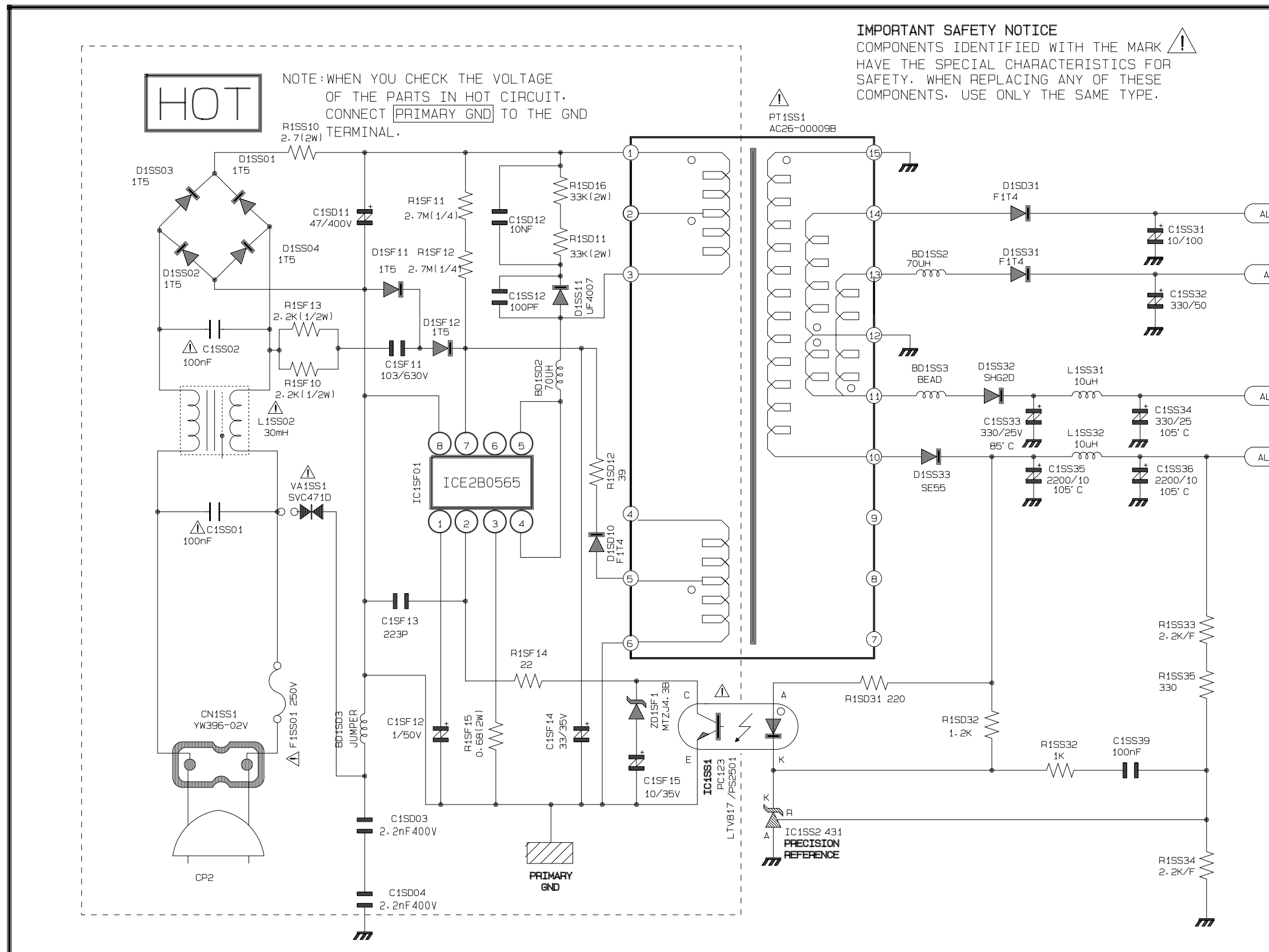

4-2 S.M.P.S. (Main B model)

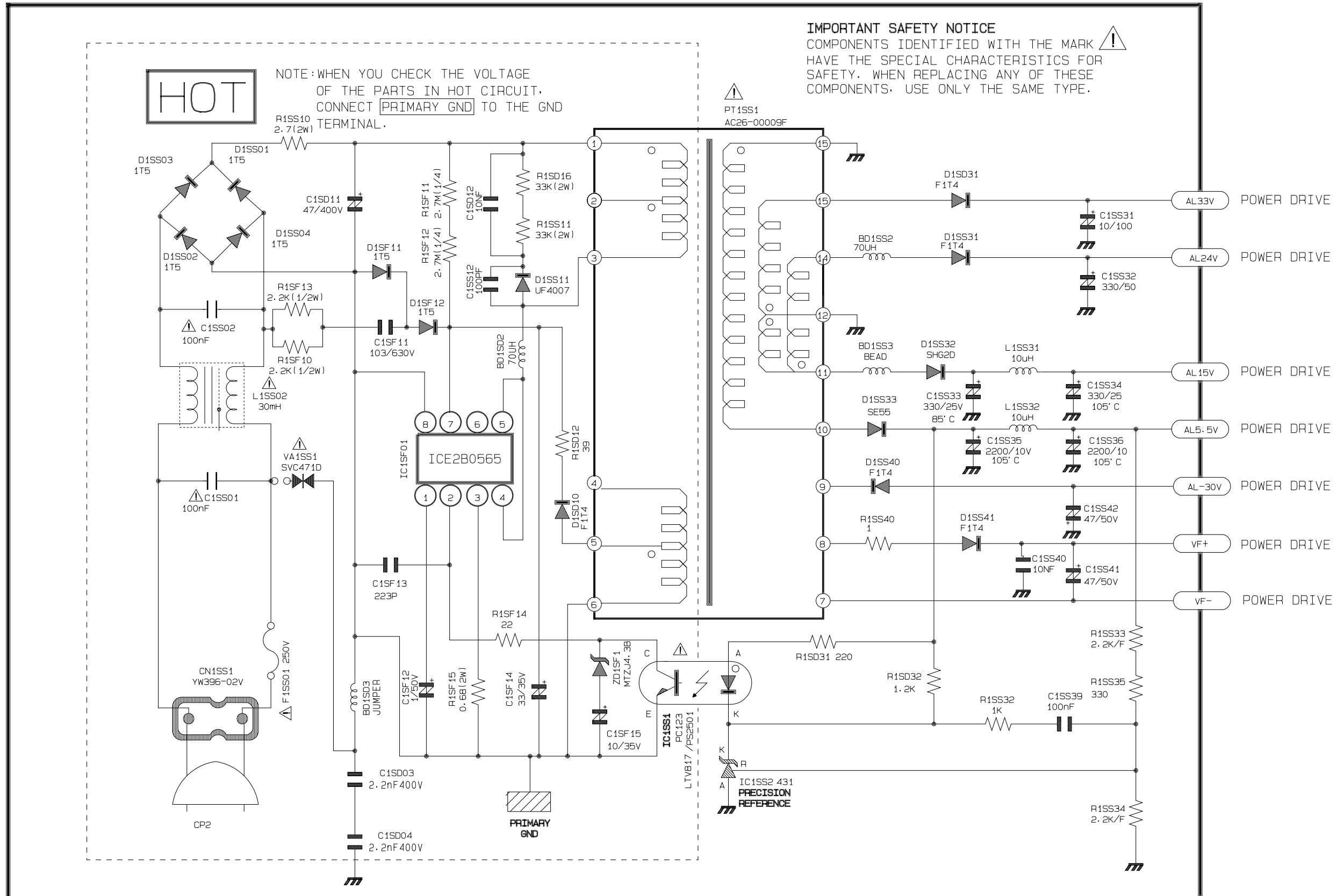



### 4-3 POWER (Main A model)

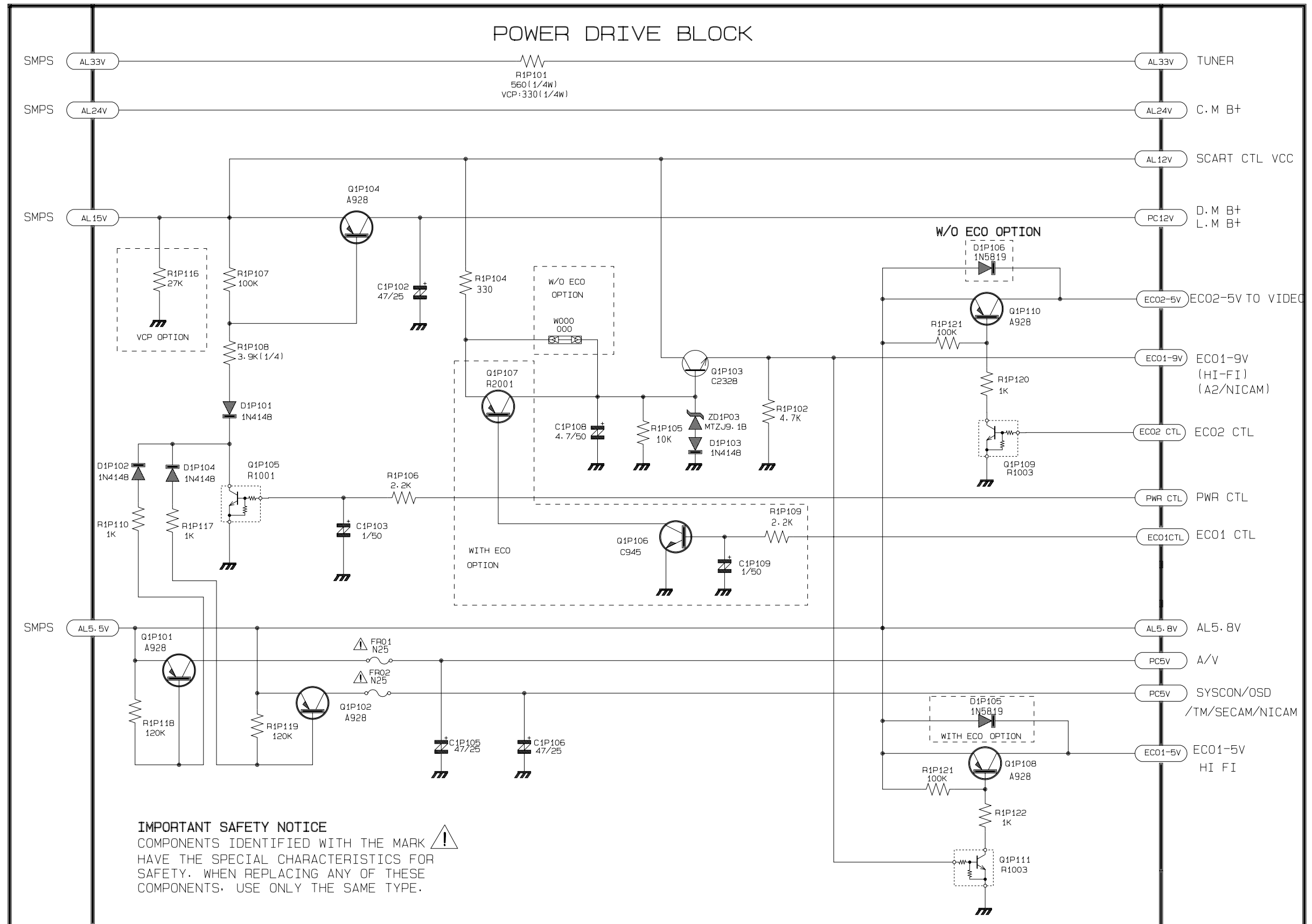

# 4-4 POWER (Main B model)

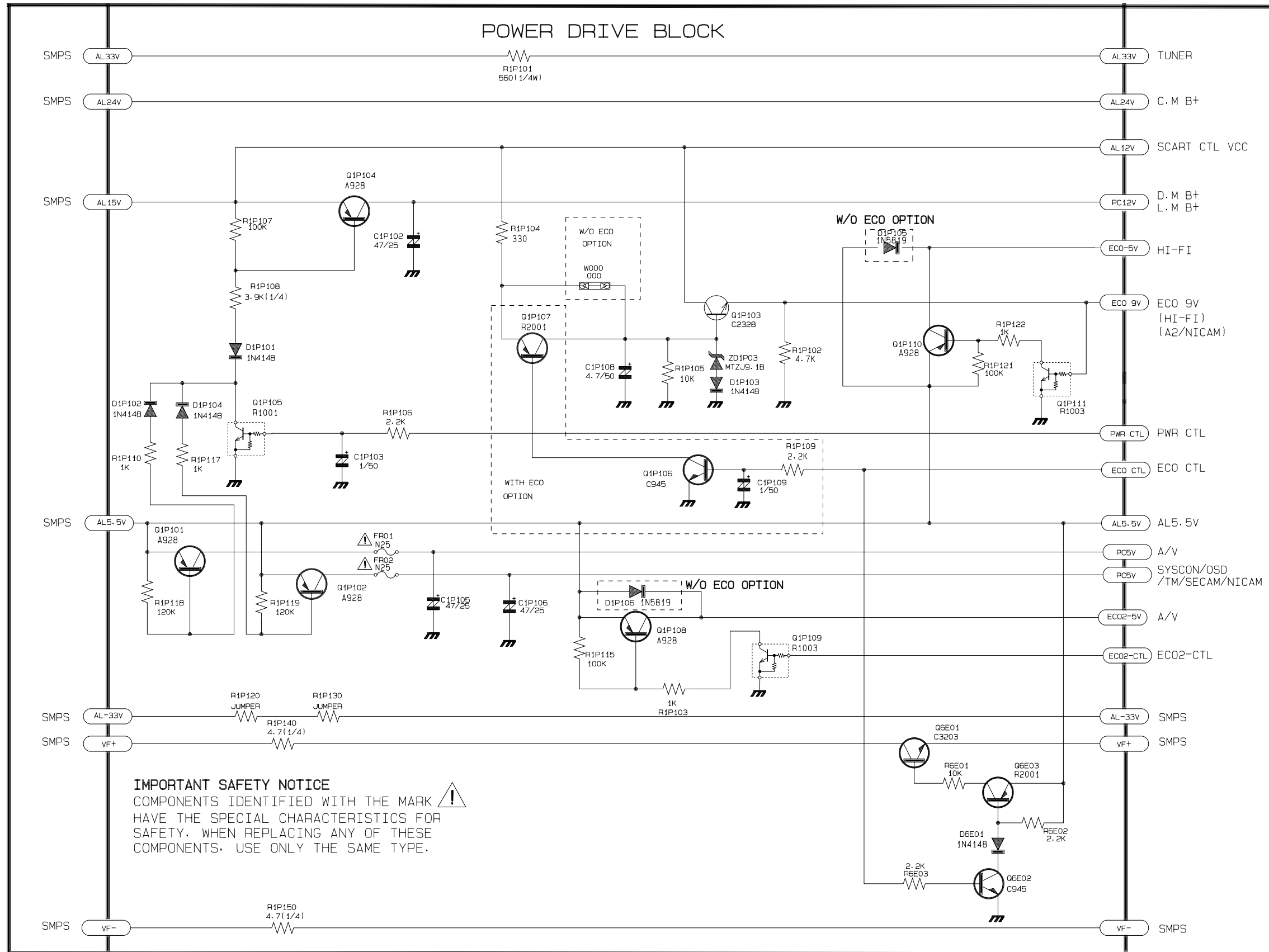

# 4-5 SYSTEM CONTROL/SERVO (Main A model)

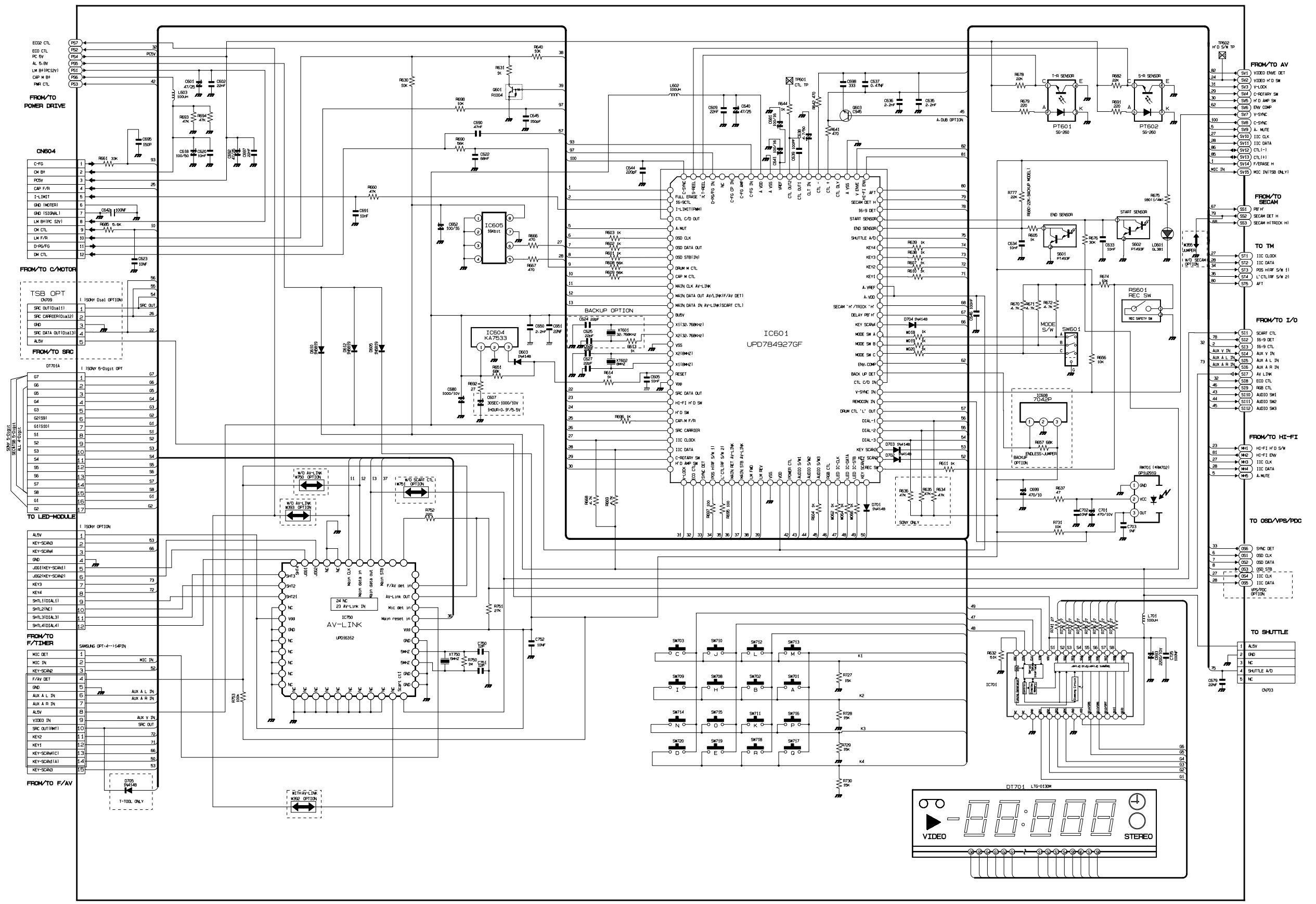

# 4-6 SYSTEM CONTROL/SERVO (Main B model)

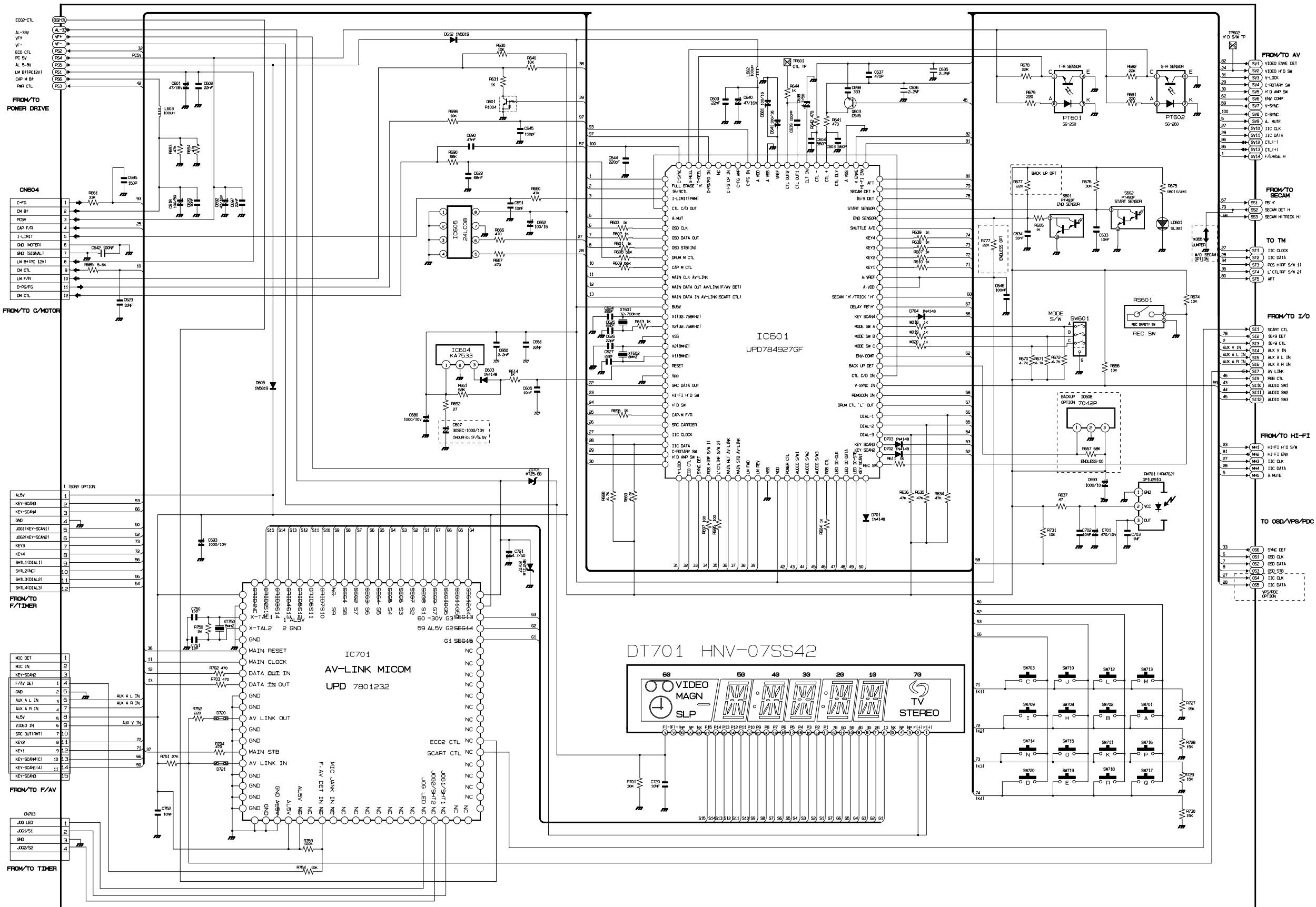

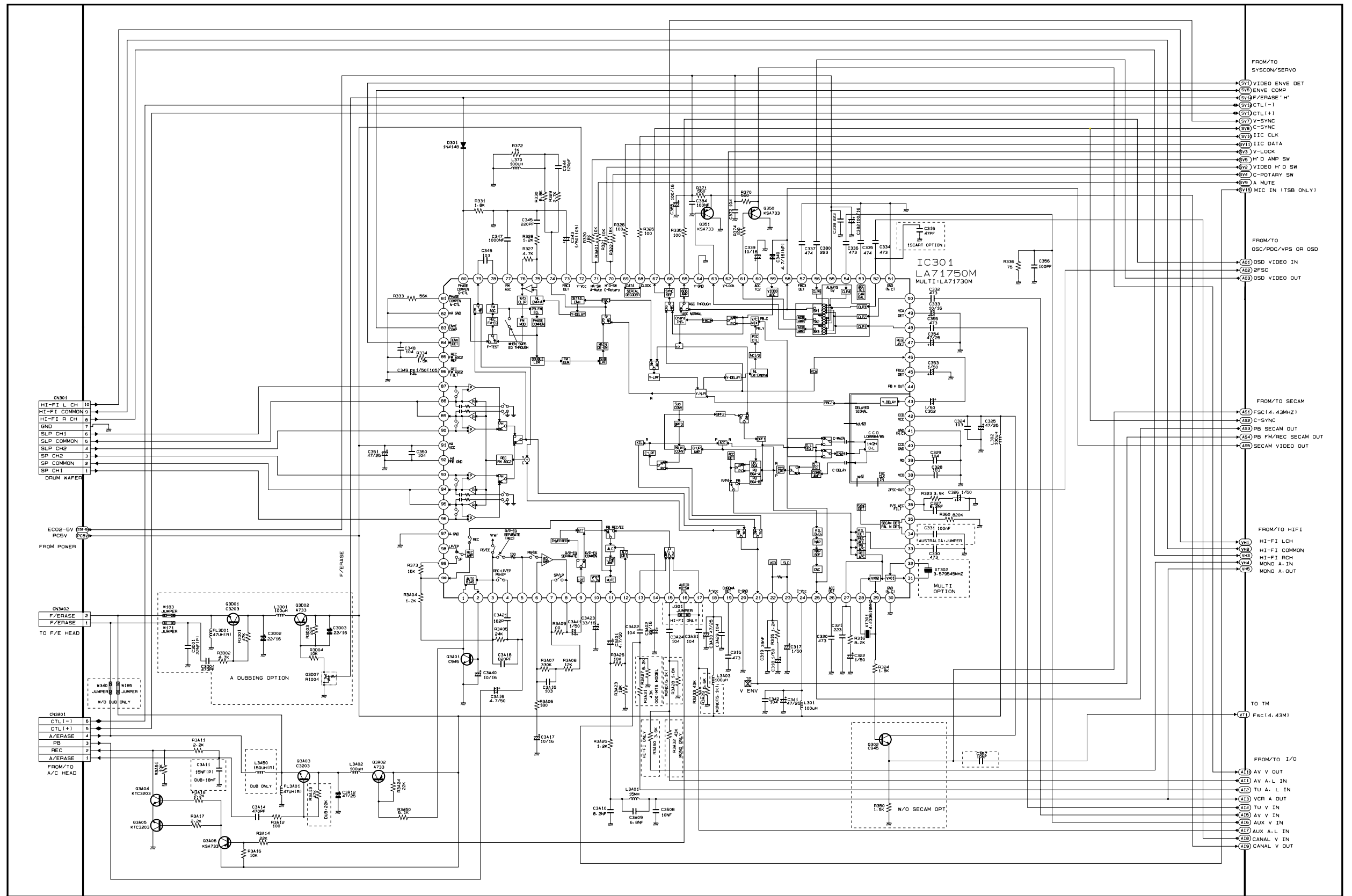

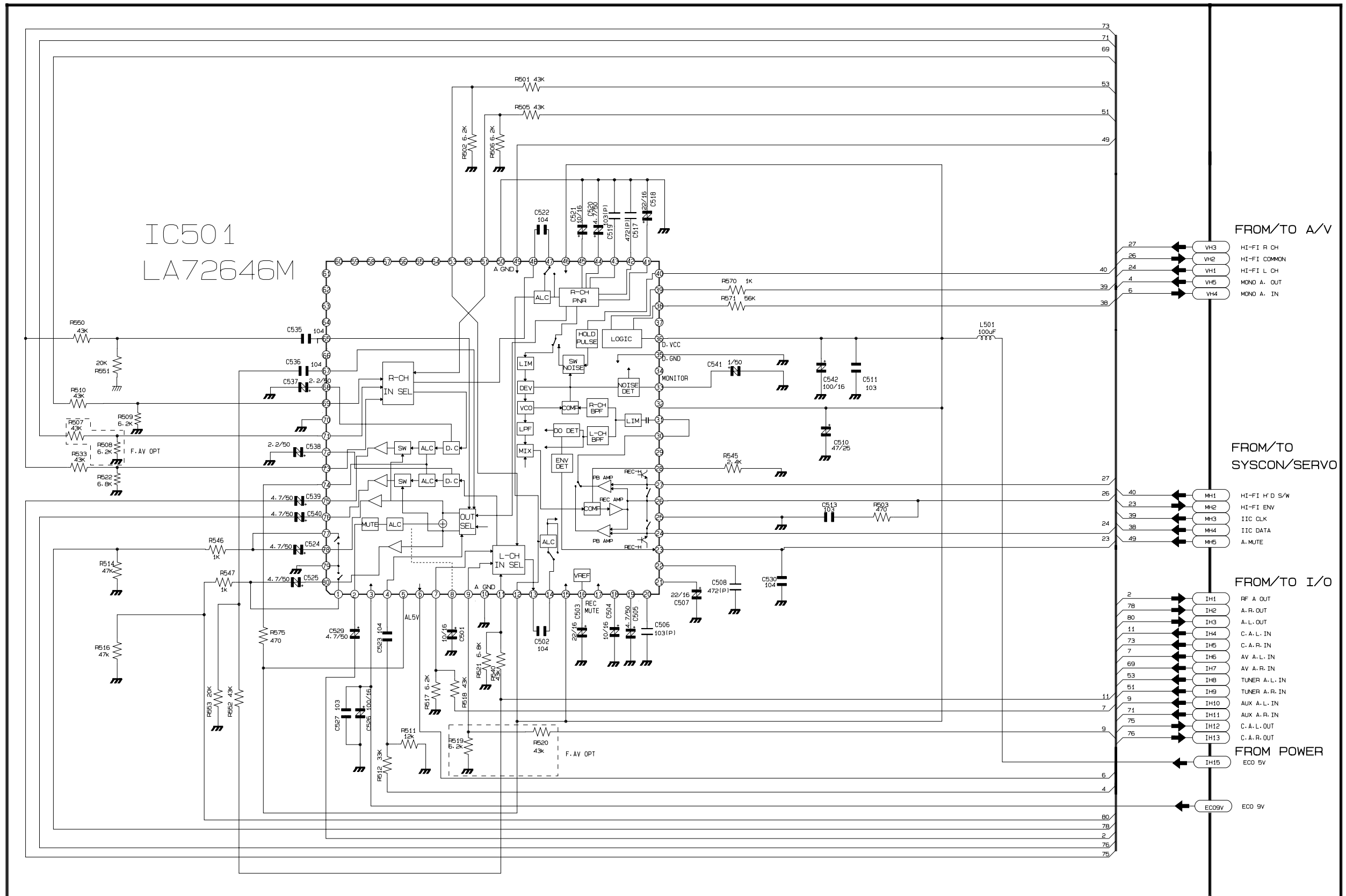

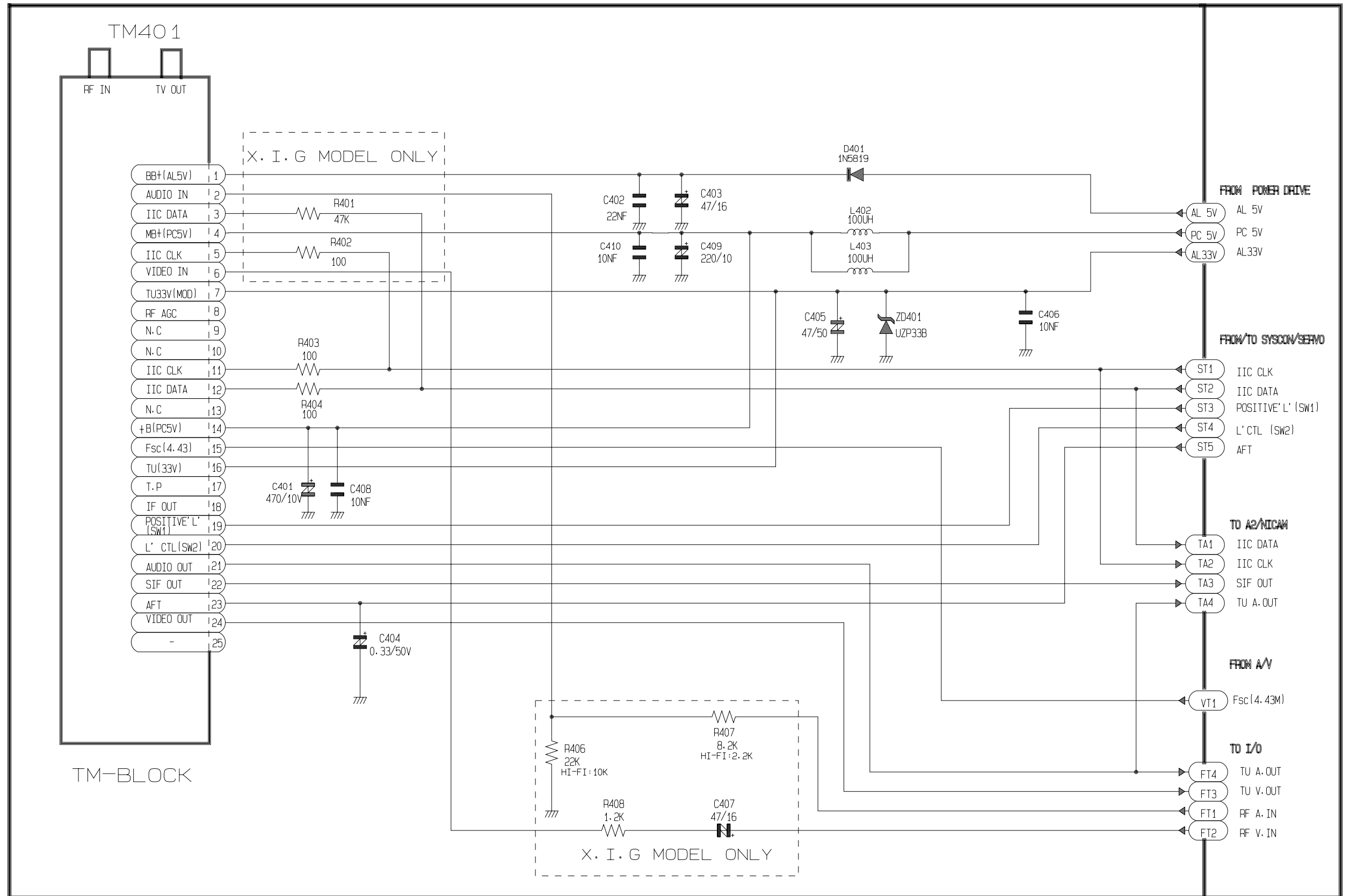

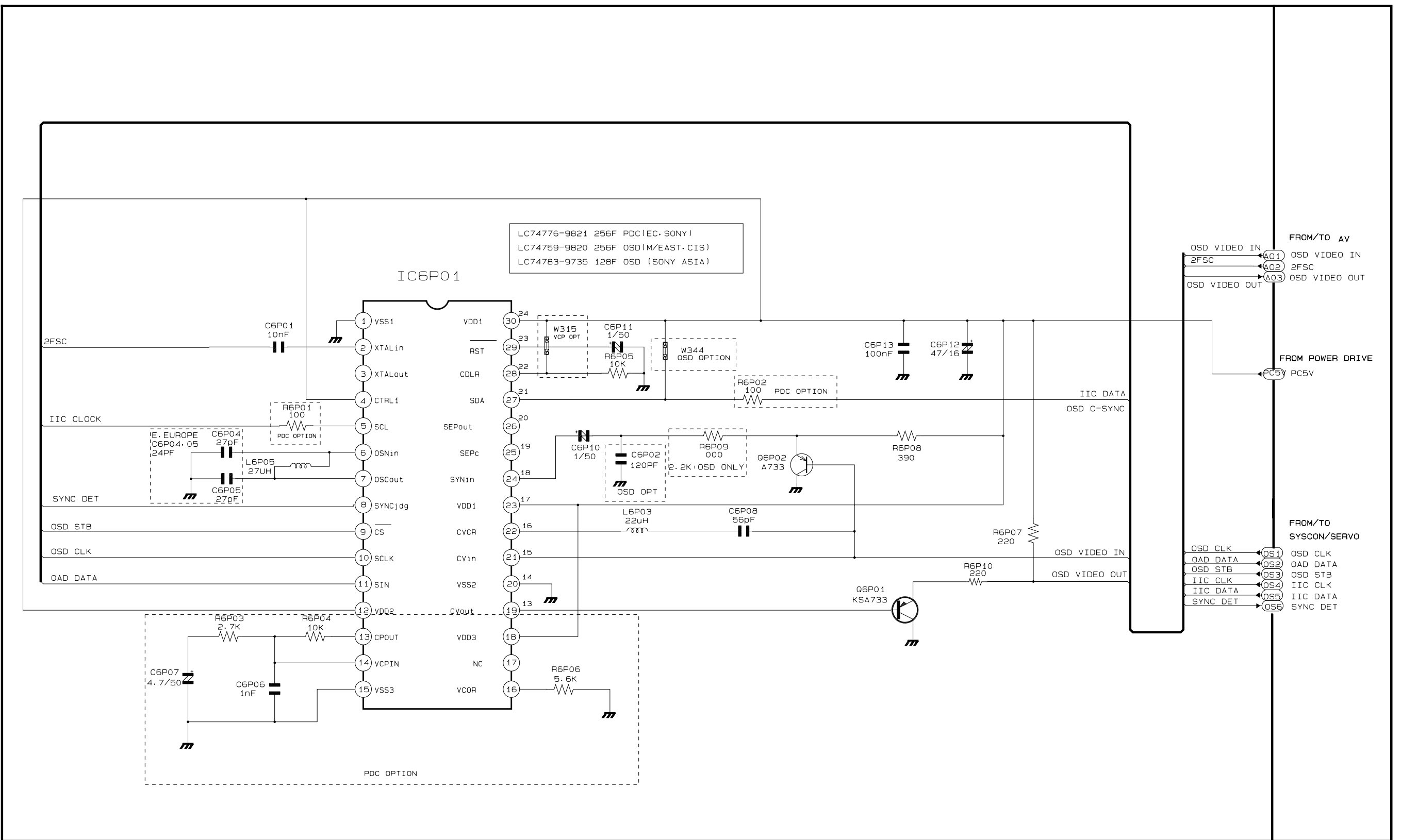



4-11 SECAM (SE230B/SE630B/SE730B/SE830B)

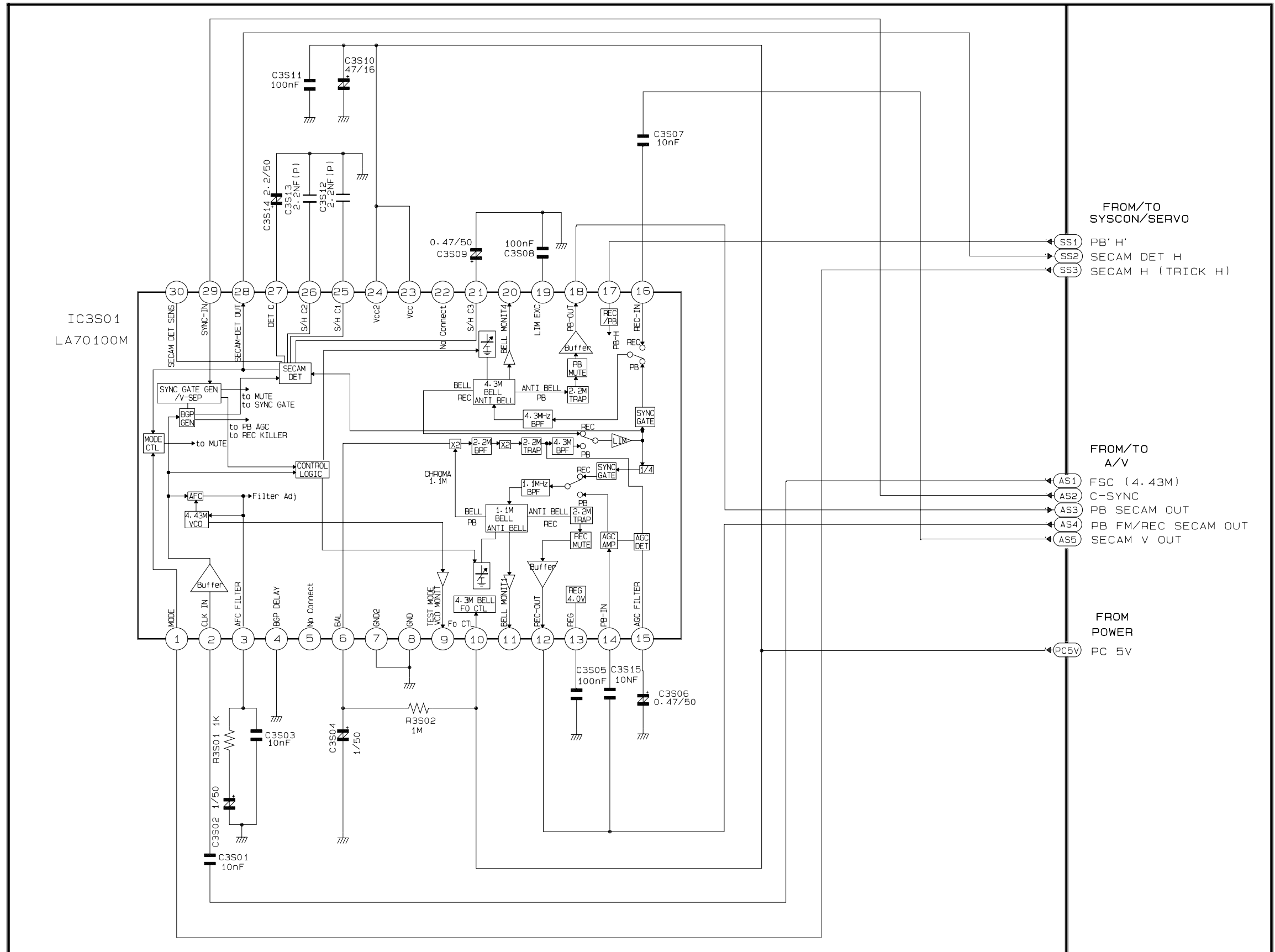

4-12 A2/NICAM (Hi-Fi model)

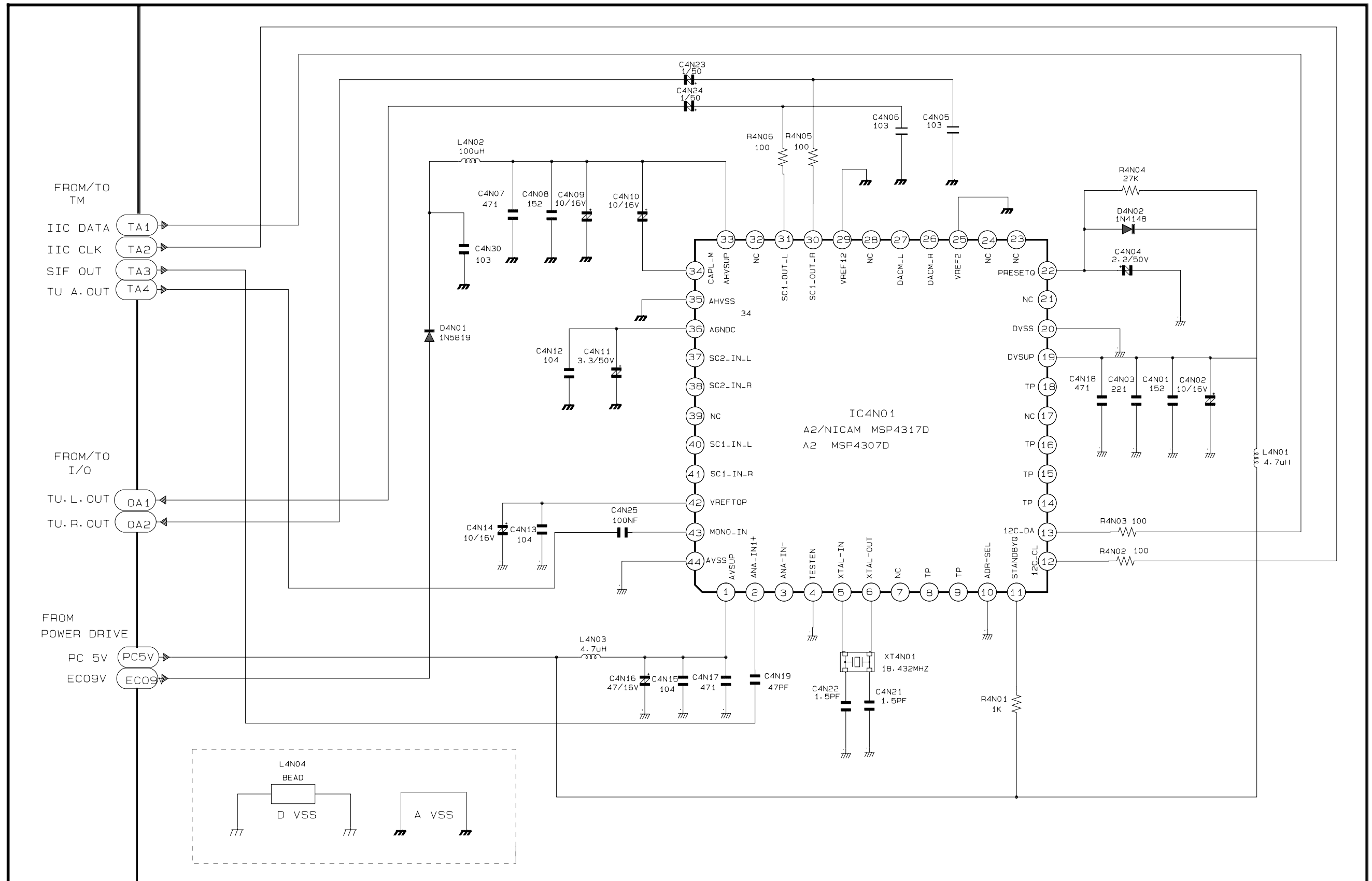

# 4-13 INPUT-OUTPUT (2 SCART JACK) (Main A model)

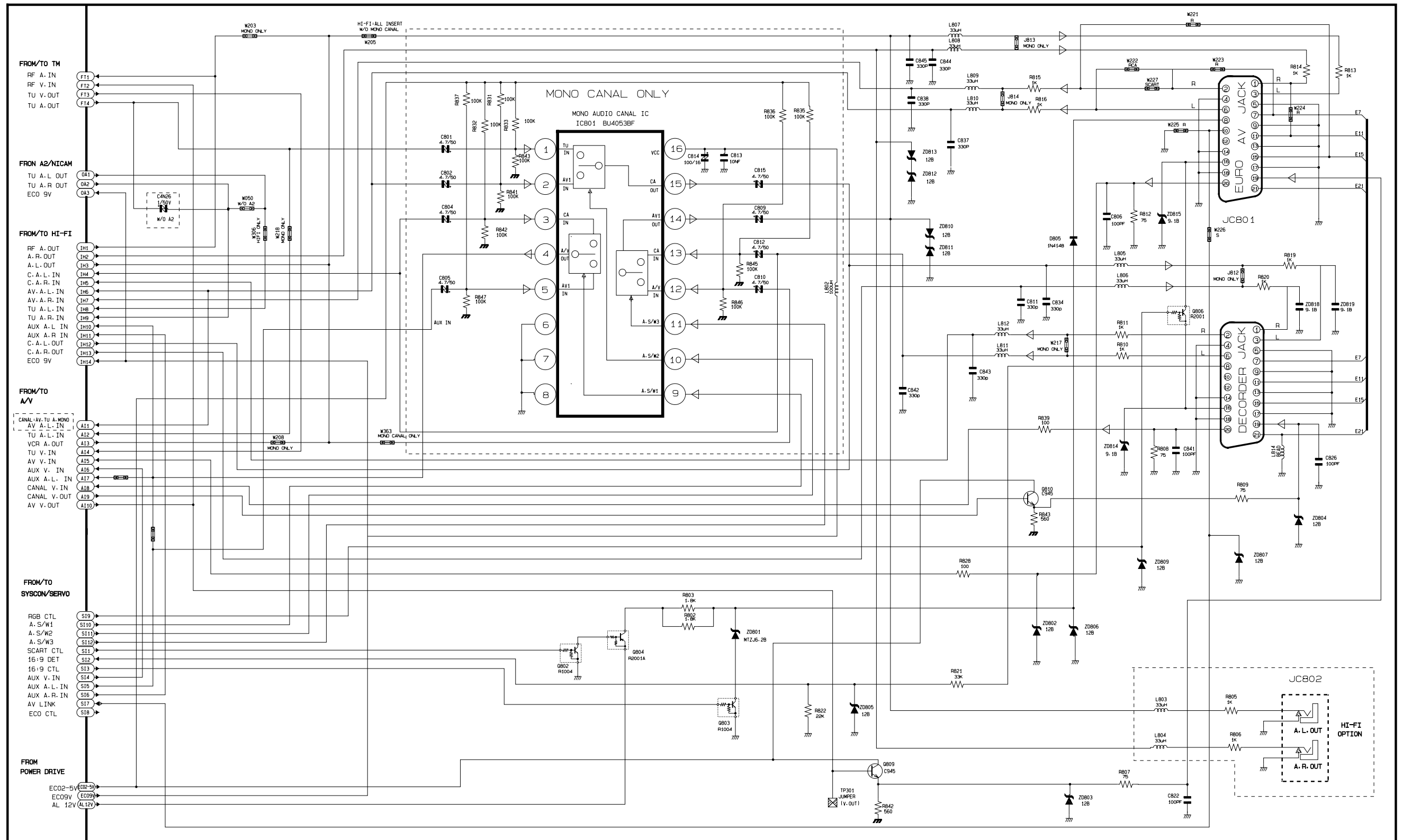

# 4-14 INPUT-OUTPUT (2 SCART JACK) (Main B model)

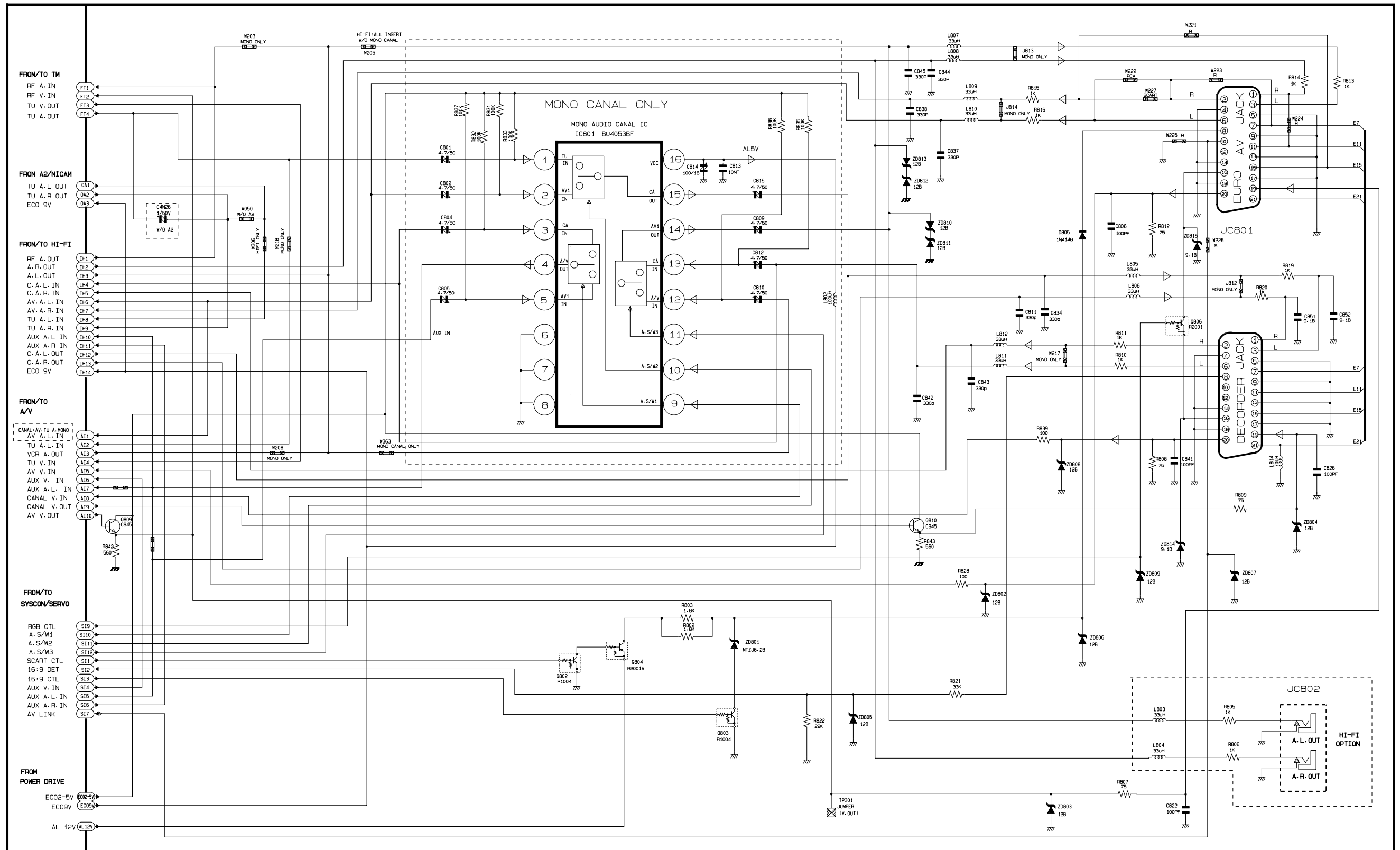

4-15 FUNCTION (SE630)

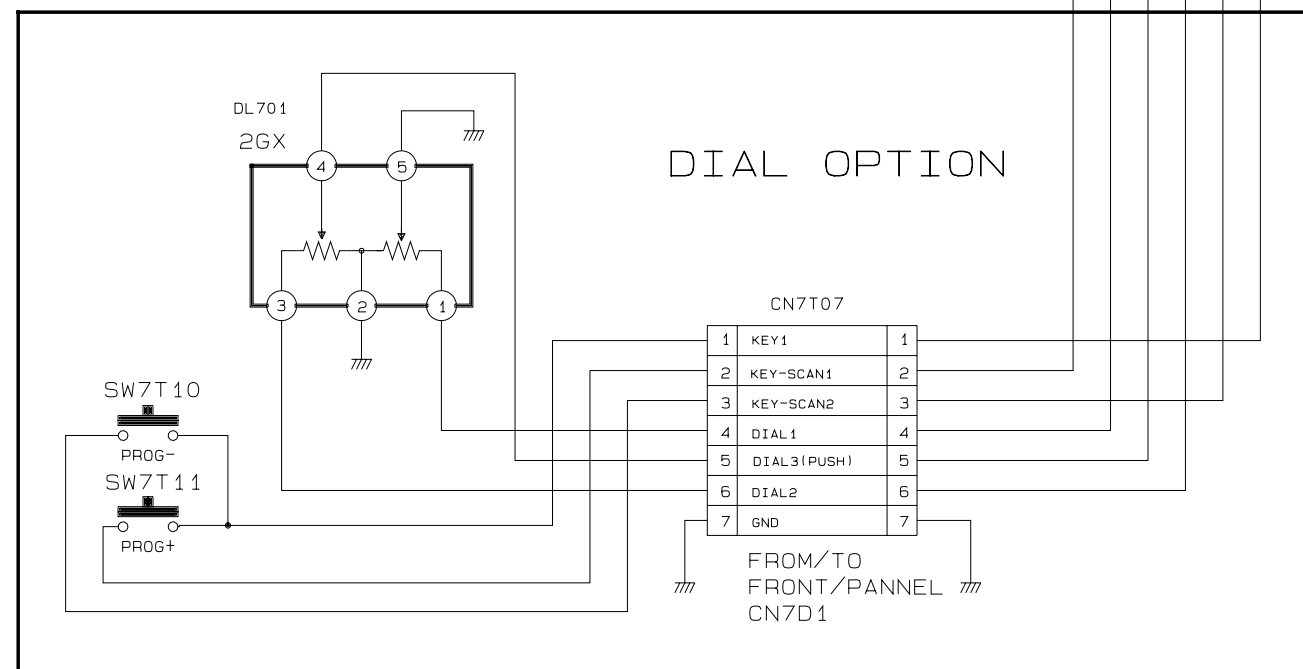
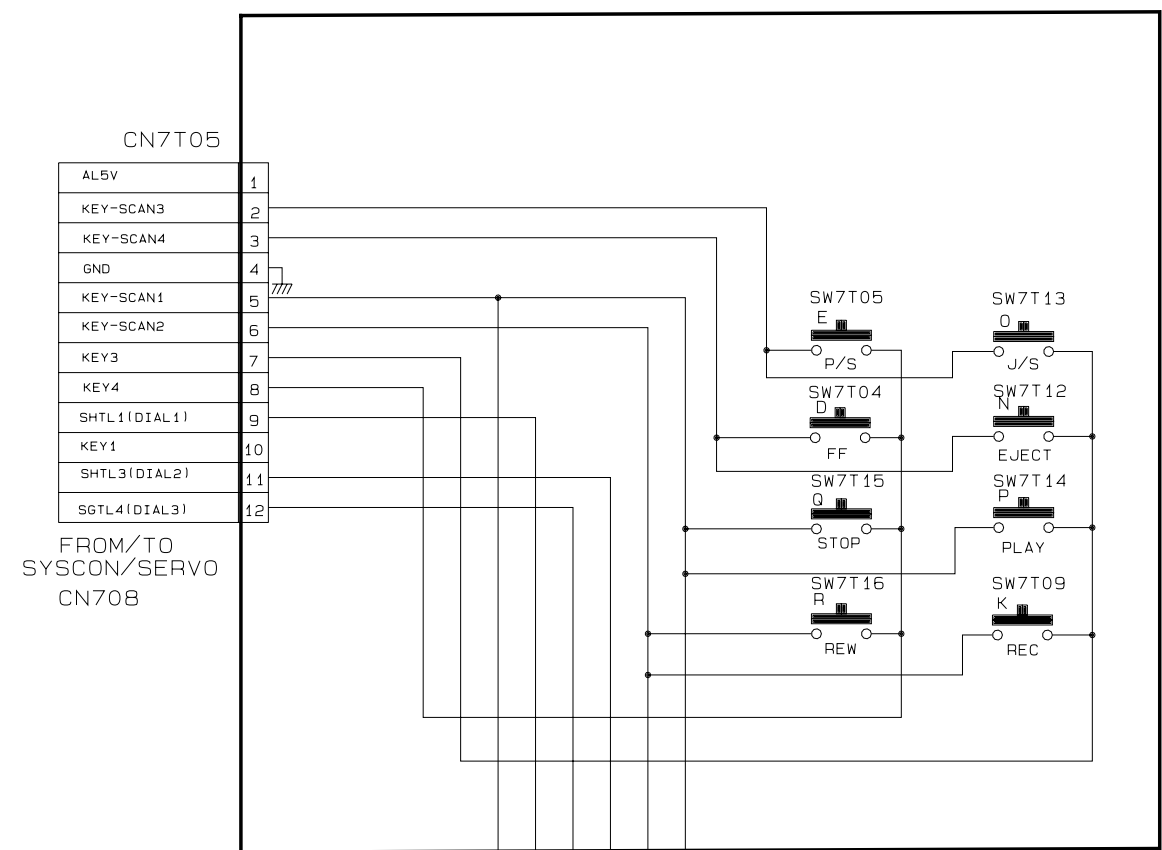
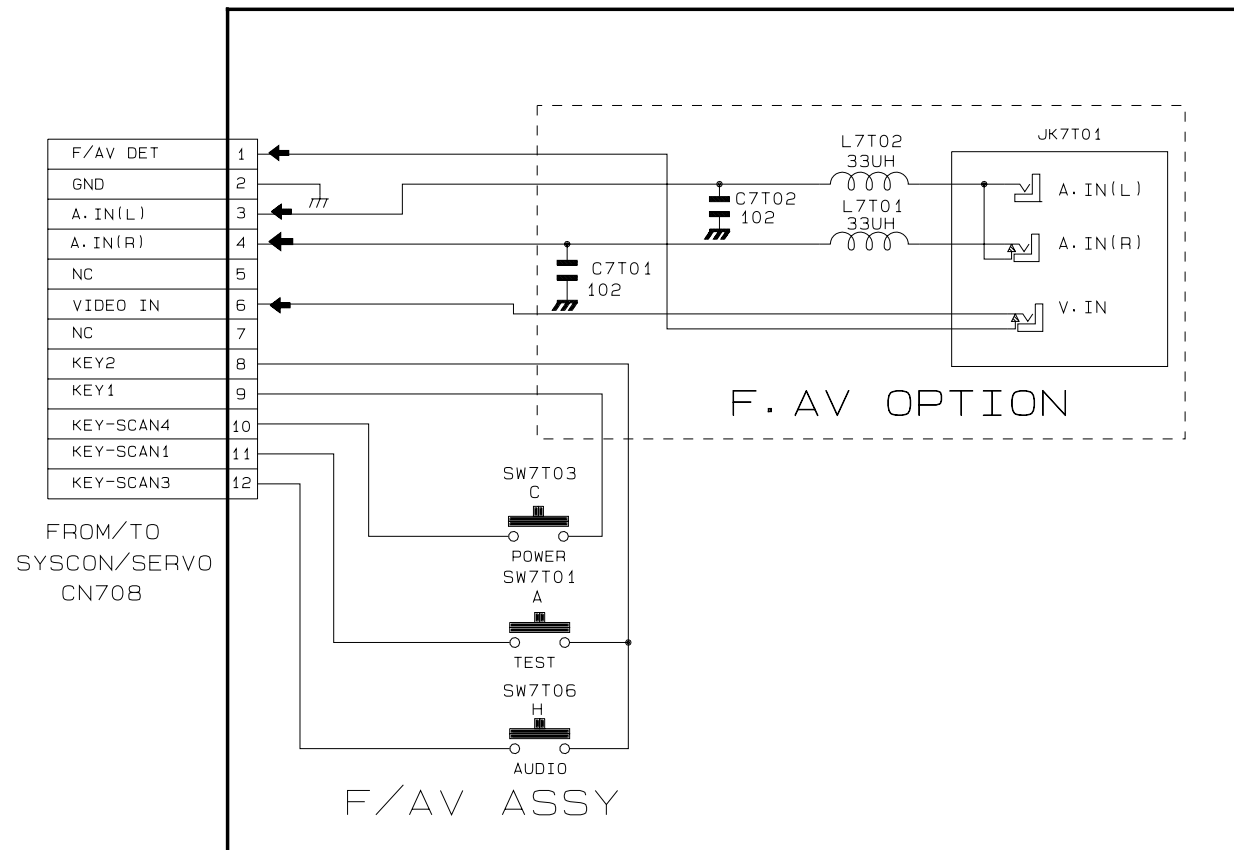

# 4-16 FUNCTION (Main B model)

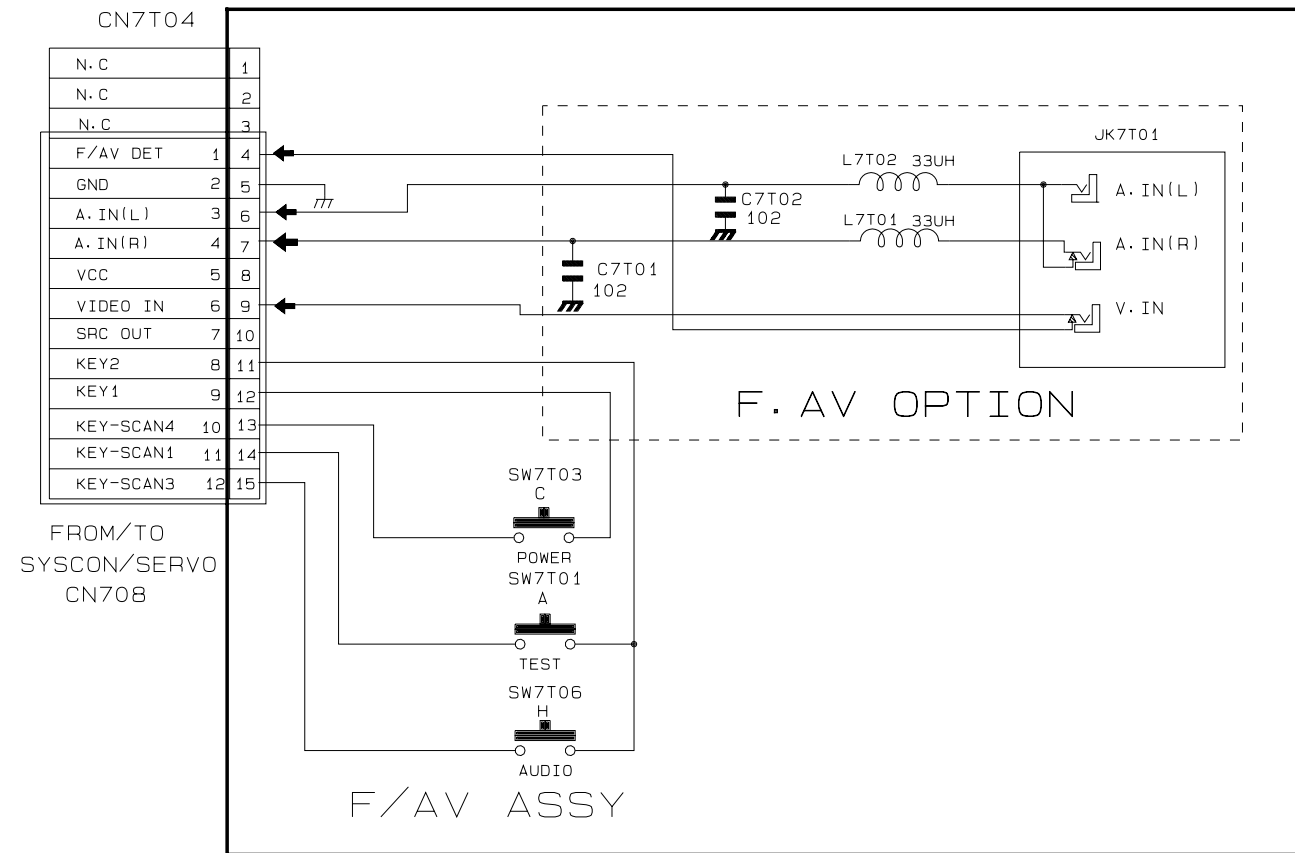

TO FRONT PANNEL

ROTARY SWITH (RDS-Y001)

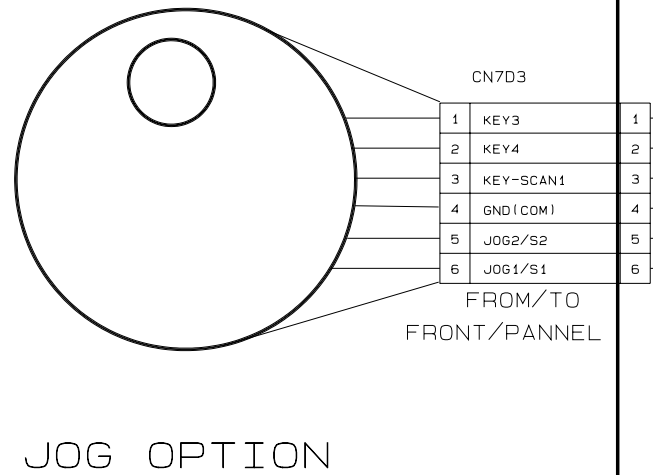

JOG OPTION

DIAL OPTION

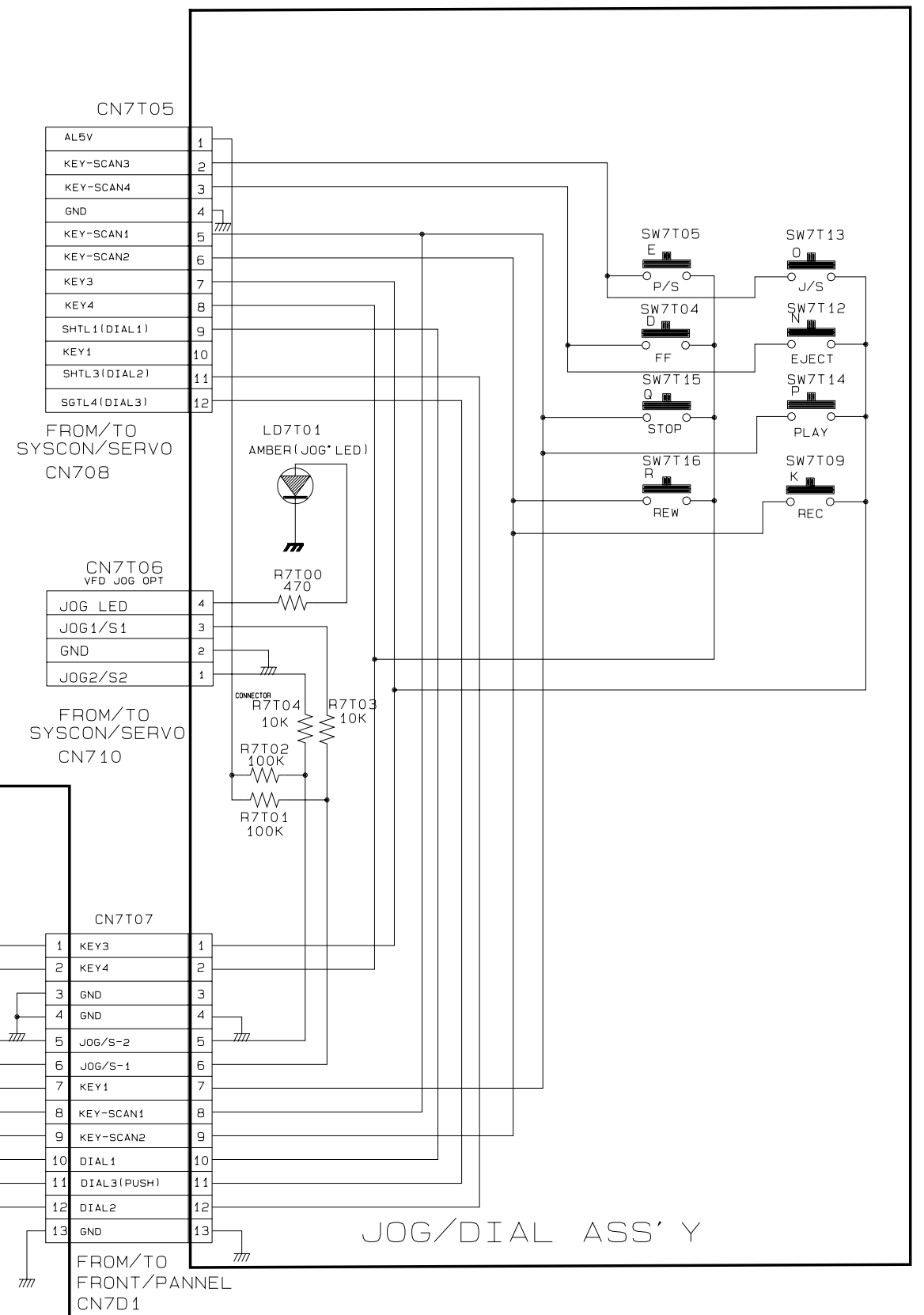

## 5. ALIGNMENT AND ADJUSTMENT

### 5-1 REFERENCE

- 1) X-Point (Tracking center) adjustment, "Head switching adjustment" and "NVRAM option setting" can be adjusted with remote control.
- 2) When replacing the Micom (IC601) and NVRAM (IC605 ; EEPROM) be sure to adjust the "Head switching adjustment" and "NVRAM option setting".
- 3) When replacing the cylinder ass'y, be sure to adjust the "X-Point" and "Head switching adjustment".
- 4) How to adjustment.
  - Press the "TEST" button on Main PCB/Function PCB to set the adjustment mode.
  - If the corresponding adjustment button is pressed, the adjustment is performed automatically.
  - If the adjustment is completed, be sure to turn the power off.

#### 5-1-1 Location of adjustment button of remote control

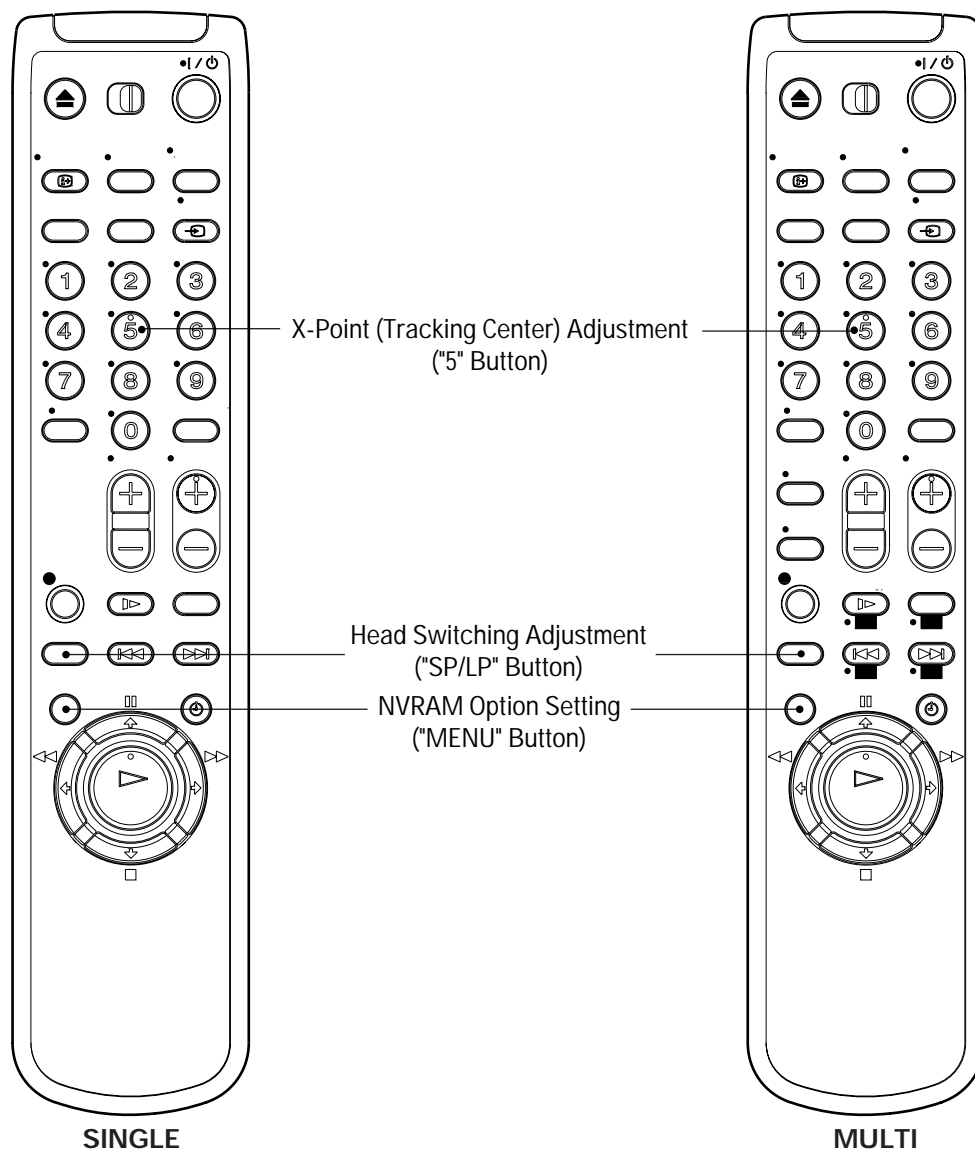

Fig. 5-1

## 5-1-2 Test point location for adjustment mode setting (Mono model)

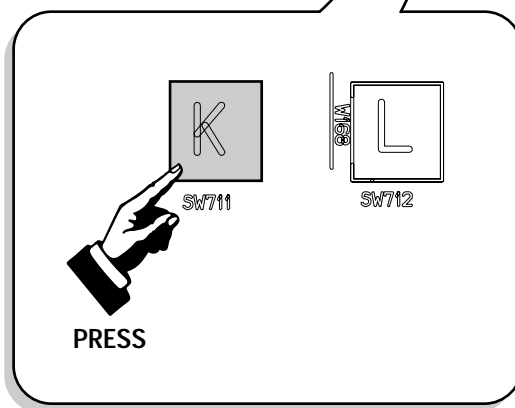
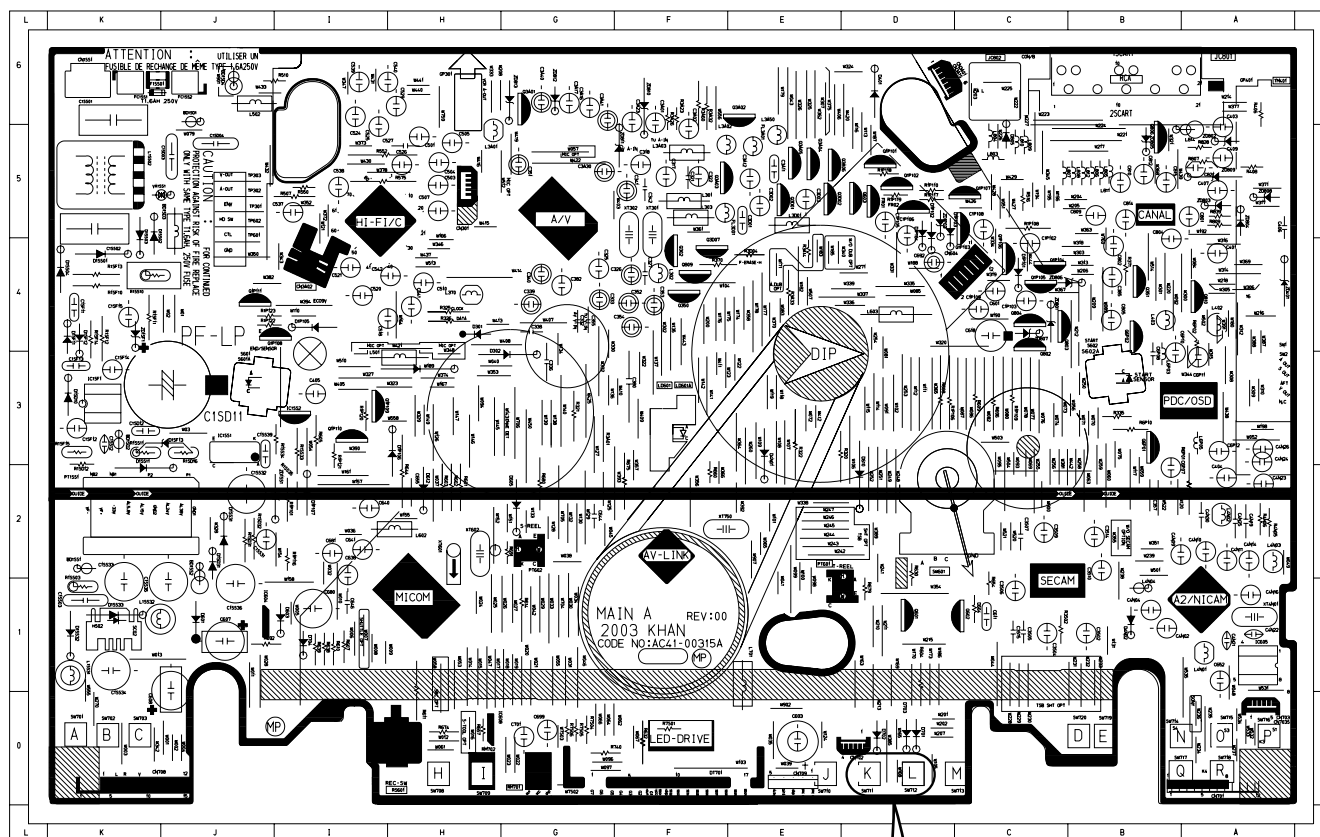

Fig. 5-2 Main PCB (Top View)

- Hi-Fi model: SE630/SE730/SE737/SE830/SX730/SX737
- Mono model: SE230/SE430



### 5-1-3 SW7T01 (TEST) location for adjustment mode setting (Hi-Fi model)

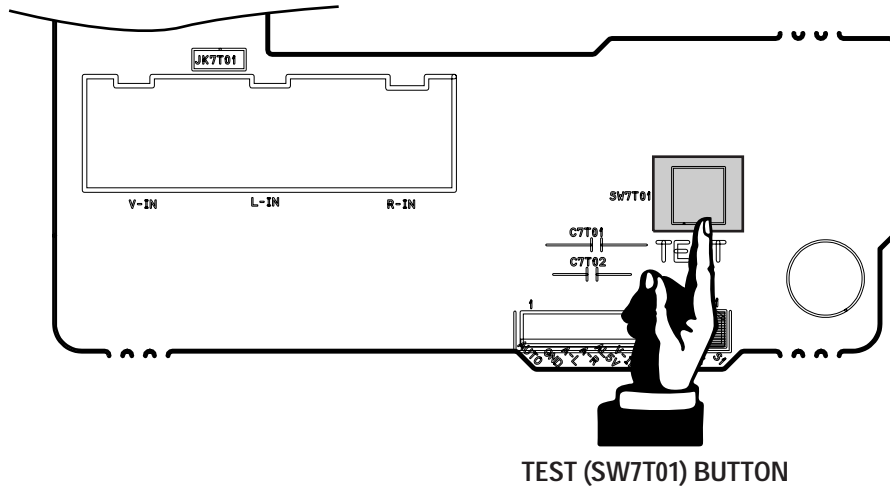

Fig. 5-3 Function PCB (Top View)

- Hi-Fi model: SE630/SE730/SE737/SE830/SX730/SX737  
Mono model: SE230/SE430

## 5-2 MECHANICAL ADJUSTMENT

Note : Refer to the Mechanical Manual for the adjustment and confirmation of ass'y deck.

### 5-2-1 The number and position of test point

**Test point :** TP602 (H'D S/W -Trigger)  
TP301 (Envelope)  
TP302 (Audio output)

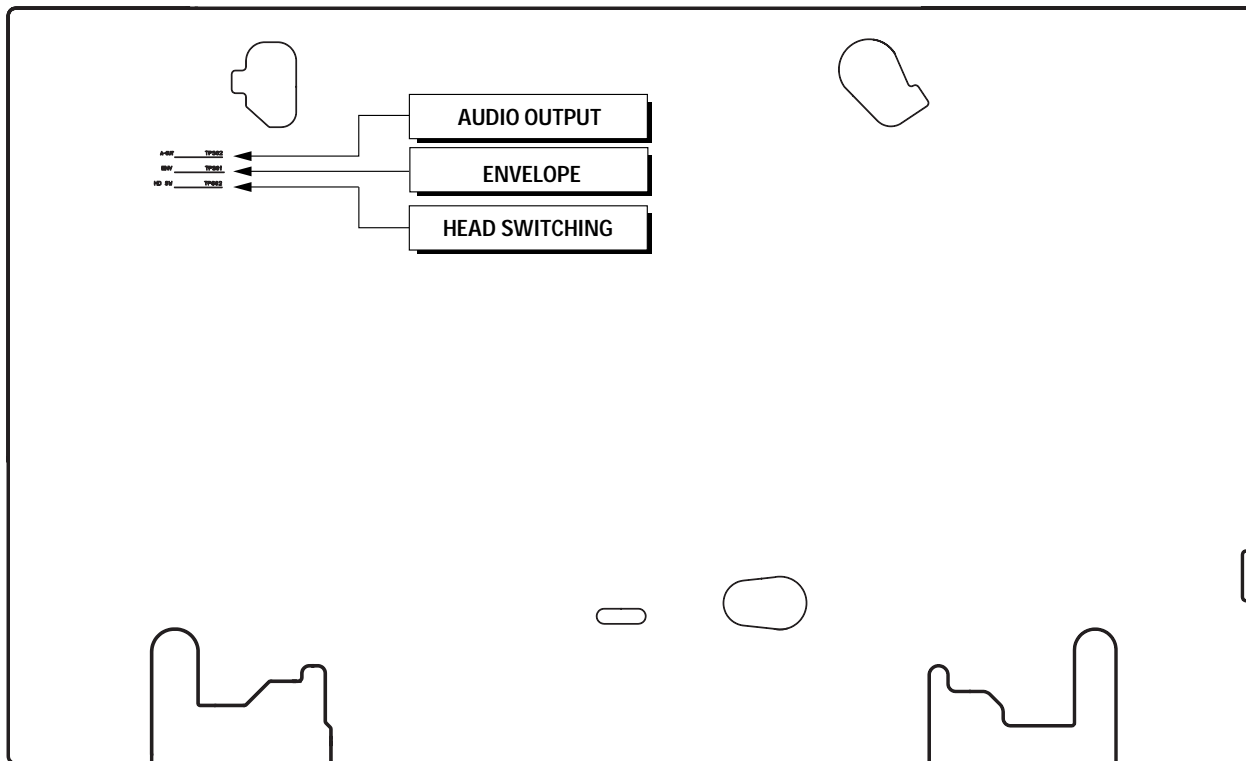

Fig. 5-4 Location of Test point (Main PCB-Top View)

### 5-2-2 ACE Head Position (X-Point) Adjustment (See the 2-2-1(d) ACE Head Position (X-Point) Adjustment on page 2-2 of the Mechanical Manual)

- 1) Playback the alignment tape (Color bar).
- 2) Press the "TEST" button on Main PCB/Function PCB to set the adjustment mode.  
(See Fig. 5-2 and 5-3)
- 3) Press the "5" button of remote control then adjustment is operated automatically. (See Fig. 5-1)

- 4) Connect the CH-1 probe to TP301 (Envelope) the CH-2 probe to TP602 (H'D switching pulse) and then trigger to CH-1.
- 5) Insert the (-) driver into the X-Point adjustment hole and adjust it so that envelope waveform is maximum.
- 6) Turn the Power off.

### 5-3 HEAD SWITCHING POINT ADJUSTMENT

- 1) Playback the alignment tape.
- 2) Press the “TEST” button on Main PCB/Function PCB to set the adjustment mode. (See Fig. 5-2 and 5-3)
- 3) Press the “SP/LP” button of remote control then adjustment is operated automatically. (See Fig. 5-1)
- 4) Turn the Power off.

### 5-4 NVRAM OPTION SETTING

1) NVRAM Option is adjusted at production line basically.  
2) In case Micom (IC601) and NVRAM (IC605 ; EEPROM) is replaced, be sure to set the corresponding option number of the required model. (If the option is not set, the unit is not operated.)

- 1) Press the “TEST” button on Main PCB/Function PCB to set the adjustment mode. (See Fig. 5-2 and 5-3)
- 2) Press the “MENU” button on the remote control about 5 seconds then option setting display is appeared. (See Fig. 5-5 and 5-6)
- 3) Select the option number (See Table 5-1) of corresponding model with “FF/REW/STOP/PAUSE” button on the remote control.
- 4) If selecting the option number is completed, press the “OK (PLAY)” button of remote control. (If “OK (PLAY)” button is pressed, the selected number is changes reversed color. ; See Fig. 5-5)
- 5) Press the “MENU” button of remote control again to store the option number. (“PLEASE WAIT” is displayed for a second as shown Fig. 5-6 and this setting is completed.)
- 6) Turn the Power off.

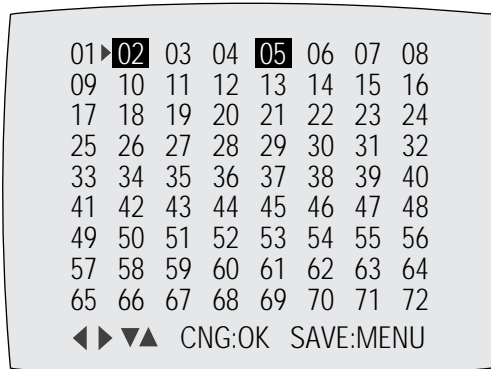

Fig. 5-5

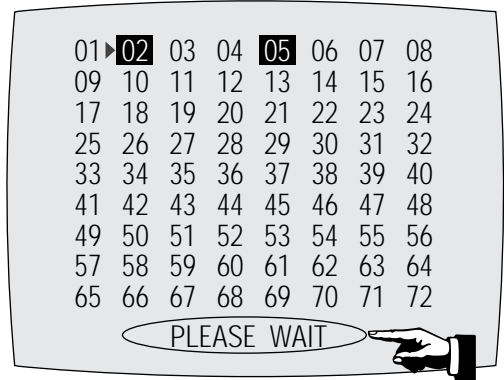

Fig. 5-6

&lt;Table 5-1&gt;

MODELS	OPTION NUMBER
SLV-SE230D	2, 4, 5, 11, 13, 14, 30, 34, 35, 38, 40, 42, 45, 47, 49, 60, 61, 63, 69, 72
SLV-SE230I	3, 4, 5, 10, 11, 13, 14, 25, 26, 30, 33, 34, 35, 38, 40, 43, 45, 47, 49, 60, 61, 63, 69, 72
SLV-SE230G	3, 4, 5, 10, 11, 13, 14, 27, 30, 33, 34, 35, 38, 40, 41, 45, 47, 49, 60, 61, 63, 69, 72
SLV-SE230B	2, 4, 5, 11, 13, 14, 20, 21, 26, 30, 33, 34, 35, 36, 38, 40, 45, 47, 49, 60, 61, 63, 69, 72
SLV-SE430K	9, 10, 11, 13, 14, 20, 30, 36, 38, 42, 45, 47, 49, 54, 60, 61, 63, 69, 72
SLV-SE630D	6, 7, 9, 10, 11, 12, 13, 14, 30, 34, 35, 38, 42, 45, 47, 49, 51, 60, 61, 63, 69, 72
SLV-SE630E	6, 7, 8, 9, 10, 11, 12, 13, 14, 30, 34, 35, 38, 42, 45, 47, 49, 51, 60, 61, 63, 69, 72
SLV-SE630B	6, 7, 8, 9, 10, 11, 12, 13, 14, 20, 21, 26, 30, 33, 34, 35, 36, 38, 45, 47, 49, 51, 60, 61, 63, 69, 72
SLV-SE630N	6, 7, 8, 9, 10, 11, 12, 13, 14, 20, 30, 36, 38, 42, 45, 47, 49, 51, 54, 60, 61, 63, 69, 72
SLV-SE730D/SX730D	2, 4, 5, 6, 7, 9, 10, 11, 12, 13, 14, 19, 30, 34, 35, 40, 42, 45, 47, 51, 60, 61, 63, 66, 69, 72
SLV-SE730E/SX730E	2, 4, 5, 6, 7, 8, 9, 10, 11, 12, 13, 14, 19, 30, 34, 35, 40, 42, 45, 47, 51, 60, 61, 63, 66, 69, 72
SLV-SE730G	3, 4, 5, 6, 7, 8, 9, 10, 11, 12, 13, 14, 19, 27, 30, 33, 34, 35, 40, 41, 45, 47, 51, 60, 61, 63, 66, 69, 72
SLV-SE730I	3, 4, 5, 6, 7, 8, 9, 10, 11, 12, 13, 14, 19, 25, 26, 30, 33, 34, 35, 40, 43, 45, 47, 51, 60, 61, 63, 66, 69, 72
SLV-SE730B	2, 4, 5, 6, 7, 8, 9, 10, 11, 12, 13, 14, 19, 20, 21, 26, 30, 33, 34, 35, 36, 40, 45, 47, 51, 60, 61, 63, 66, 69, 72
SLV-SX737D	2, 4, 5, 6, 7, 9, 10, 11, 12, 13, 14, 19, 30, 32, 34, 35, 40, 42, 45, 47, 51, 60, 61, 63, 66, 69, 72
SLV-SE737E	2, 4, 5, 6, 7, 8, 9, 10, 11, 12, 13, 14, 19, 30, 32, 34, 35, 40, 42, 45, 47, 51, 60, 61, 63, 66, 69, 72
SLV-SE730N/SX730N	2, 4, 5, 6, 7, 8, 9, 10, 11, 12, 13, 14, 19, 20, 30, 36, 42, 45, 47, 51, 54, 60, 61, 63, 66, 69, 72
SLV-SE830D	2, 4, 5, 6, 7, 9, 10, 11, 12, 13, 14, 15, 19, 23, 29, 30, 32, 34, 35, 40, 42, 45, 47, 48, 49, 50, 60, 61, 63, 64, 66, 69, 72
SLV-SE830E	2, 4, 5, 6, 7, 8, 9, 10, 11, 12, 13, 14, 15, 19, 23, 29, 30, 32, 34, 35, 40, 42, 45, 47, 48, 49, 50, 60, 61, 63, 64, 66, 69, 72
SLV-SE830G	3, 4, 5, 6, 7, 8, 9, 10, 11, 12, 13, 14, 15, 19, 23, 27, 29, 30, 32, 33, 34, 35, 40, 41, 45, 47, 48, 49, 50, 60, 61, 63, 64, 66, 69, 72
SLV-SE830B	2, 4, 5, 6, 7, 8, 9, 10, 11, 12, 13, 14, 15, 19, 20, 21, 23, 26, 29, 30, 32, 33, 34, 35, 36, 40, 45, 47, 48, 49, 50, 60, 61, 63, 64, 66, 69, 72
SLV-SE830N	2, 4, 5, 6, 7, 8, 9, 10, 11, 12, 13, 14, 15, 19, 20, 23, 29, 30, 32, 36, 42, 45, 47, 48, 49, 50, 54, 60, 61, 63, 64, 66, 69, 72

---

## 6. REPAIR PARTS LIST

---

	<b>Page</b>
<b>6-1 Exploded Views</b> - - - - -	<b>6-2</b>
<b>6-1-1 Instrument Assembly (Mono Models)</b> - - - - -	<b>6-2</b>
<b>6-1-2 Instrument Assembly (Hi-Fi Models)</b> - - - - -	<b>6-3</b>
<b>6-1-3 Mechanical Parts (Top Side)</b> - - - - -	<b>6-4</b>
<b>6-1-4 Mechanical Parts (Bottom Side)</b> - - - - -	<b>6-5</b>
<b>6-2 Electrical Parts List</b> - - - - -	<b>6-6</b>

# 6-1 EXPLODED VIEWS

**NOTE:**

- -XX, -X mean standardized parts, so they may have some differences from the original one.
- Items marked “\*\*” are not stocked since they are seldom required for routine service. Some delay should be anticipated when ordering these items.

- The mechanical parts with no reference number in the exploded views are not supplied.
- Abbreviation  
 AUS : Australia model  
 HK : Hong Kong model  
 ME : Middle East model

The components identified by mark  $\triangle$  or dotted line with mark  $\triangle$  are critical for safety. Replace only with part number specified.

- Hi-Fi model: SE630/SE730/SE737/SE830/SX730/SX737
- Mono model: SE230/SE430

## 6-1-1 Instrument Assembly (Mono Models)

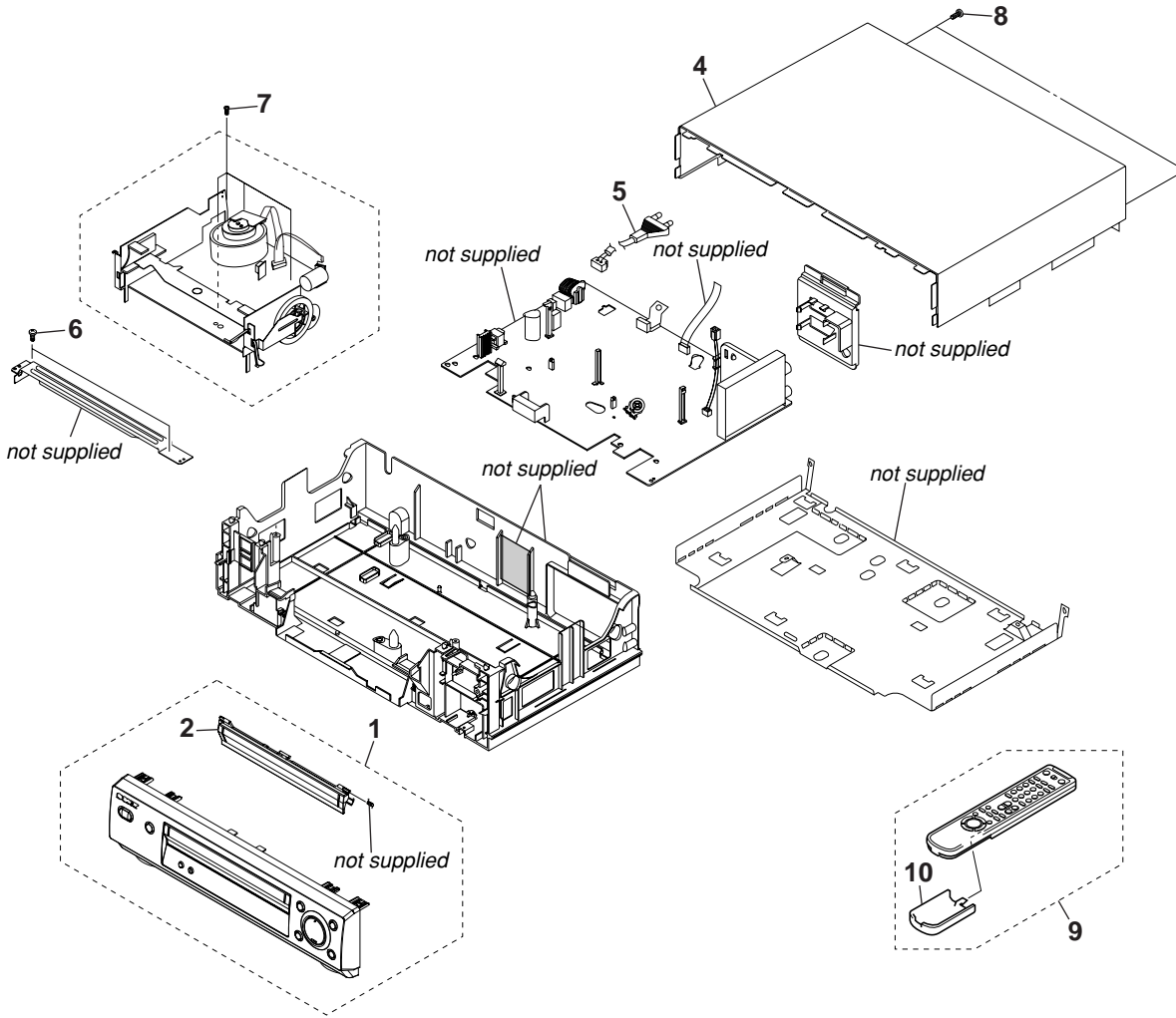

Ref. No.	Part No.	Description	Remarks
1	3-083-530-11	ASSY PANEL FRONT (SE230: D)	
1	3-083-531-01	ASSY PANEL FRONT (SE230: G, I)	
1	3-083-532-01	ASSY PANEL FRONT (SE230: B)	
1	3-083-533-11	ASSY PANEL FRONT (SE430)	
2	3-083-527-01	DOOR CASSETTE 360S	
4	3-075-020-01	CASE (360), UPPER	
$\triangle$ 5	1-823-023-11	POWER CORD KKP419C (SE230: B, D/SE430)	
$\triangle$ 5	1-823-025-11	POWER CORD Y352 (SE230: G, I)	
6	3-075-256-01	SCREW TAP 3X12	

Ref. No.	Part No.	Description	Remarks
7	3-075-262-01	SCREW BH 4X12	
8	3-083-523-01	SCREW TAP 3X10	
9	1-477-269-11	COMMANDER, STANDARD (RMT-V405)	(SE230: D, G, I/SE430)
9	1-477-270-11	COMMANDER, STANDARD (RMT-V405A)	(SE230: B)
10	3-075-088-01	COVER (S) REMOTE CONTROL BATTERY	(for RMT-V405/V405A)
11	3-075-258-01	SCREW TAP 4X16	

## 6-1-2 Instrument Assembly (Hi-Fi Models)

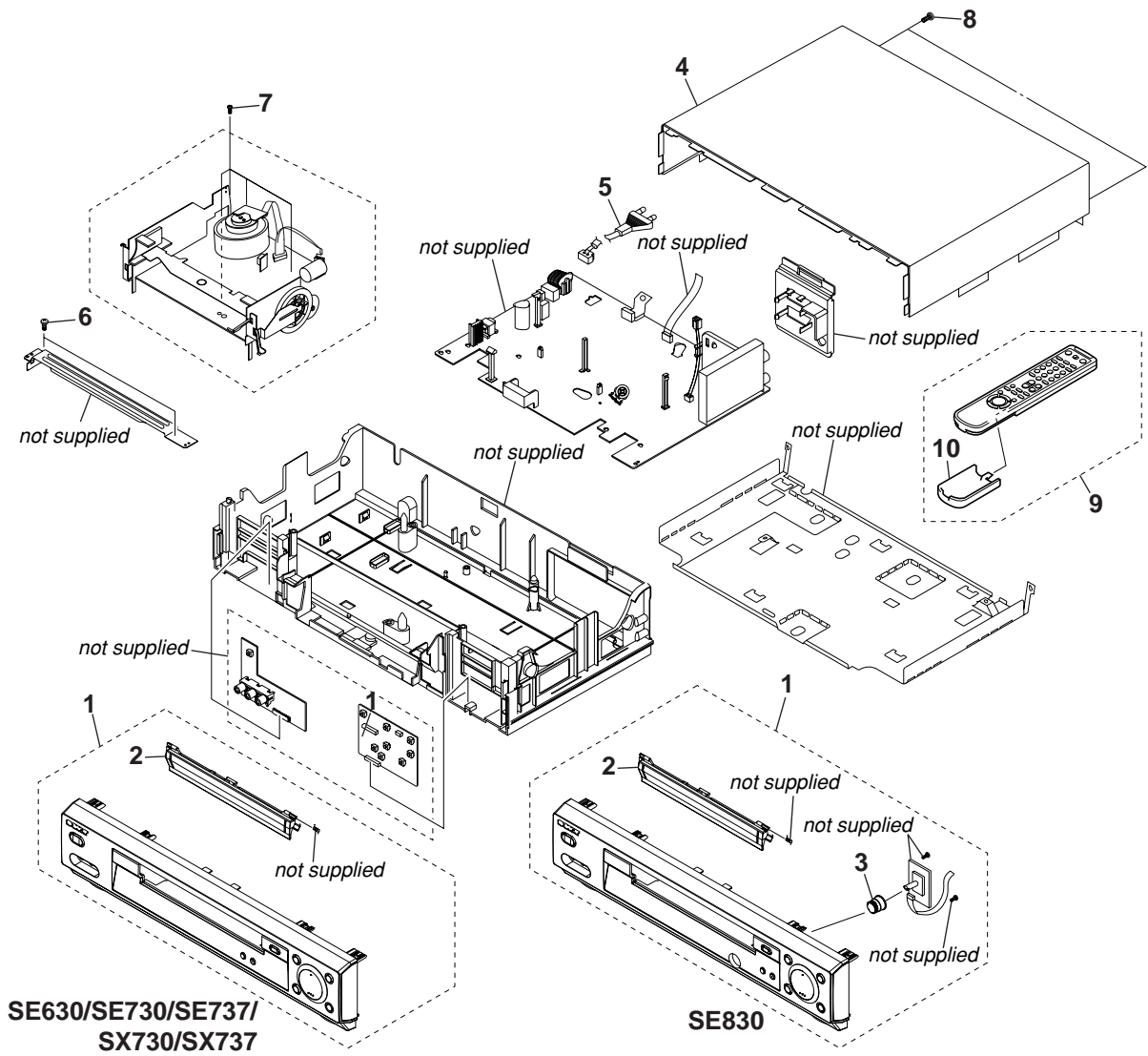

Ref. No.	Part No.	Description	Remarks
1	3-083-528-01	ASSY PANEL FRONT (SE630: D, E, N)	
1	3-083-529-01	ASSY PANEL FRONT (SE630: B)	
1	3-083-870-01	ASSY PANEL FRONT (SE830: G)	
1	3-083-871-01	ASSY PANEL FRONT (SE830: D, E, N)	
1	3-083-872-01	ASSY PANEL FRONT (SE830: B)	
1	3-083-873-01	ASSY PANEL FRONT (SE737)	
1	3-083-874-01	ASSY PANEL FRONT (SX737)	
1	3-083-875-01	ASSY PANEL FRONT (SE730: G, I)	
1	3-083-876-01	ASSY PANEL FRONT (SE730: D, E, N)	
1	3-083-877-01	ASSY PANEL FRONT (SE730: B)	
1	3-083-878-01	ASSY PANEL FRONT (SX730)	
2	3-083-526-01	DOOR CASSETTE 430S (SE630/SE730/SE737/SE830)	
2	3-083-879-01	DOOR CASSETTE 430B (SX730/SX737)	
3	1-786-352-11	SW-DIAL TIMER (SE830)	
4	3-075-019-01	CASE (430), UPPER (SE630/SE730/SE737/SE830/SX730: D, E)	
4	3-075-019-11	CASE (430), UPPER (SX730: N/SX737)	
△5	1-823-023-11	POWER CORD KKP419C (SE630/SE730: B, D, E, N/SE737/SE830: B, D, E, N/SX730/SX737)	

Ref. No.	Part No.	Description	Remarks
△5	1-823-025-11	POWER CORD Y352 (SE730: G, I/SE830: G)	
6	3-075-256-01	SCREW TAP 3X12	
7	3-075-262-01	SCREW BH 4X12	
8	3-083-523-01	SCREW TAP 3X10	
9	1-477-271-11	COMMANDER, STANDARD (RMT-V406) (SE630: E, N/SE730: E, G, I, N)	
9	1-477-272-11	COMMANDER, STANDARD (RMT-V406A) (SE630: B, D/SE730: B, D)	
9	1-477-273-11	COMMANDER, STANDARD (RMT-V407A) (SE737/SE830: D, E, G, N)	
9	1-477-274-11	COMMANDER, STANDARD (RMT-V407B) (SE830: B)	
9	1-477-275-11	COMMANDER, STANDARD (RMT-V407C) (SX737)	
9	1-477-276-11	COMMANDER, STANDARD (RMT-V406B) (SX730)	
10	3-075-088-01	COVER (S) REMOTE CONTROL BATTERY (for RMT-V406/V406A/V407A/V407B) (SE630/SE730/SE737/SE830)	
10	3-075-089-01	COVER (B) REMOTE CONTROL BATTERY (for RMT-V406B/V407C) (SX730/SX737)	
11	3-075-258-01	SCREW TAP 4X16	

## 6-1-3 Mechanical Parts (Top Side)

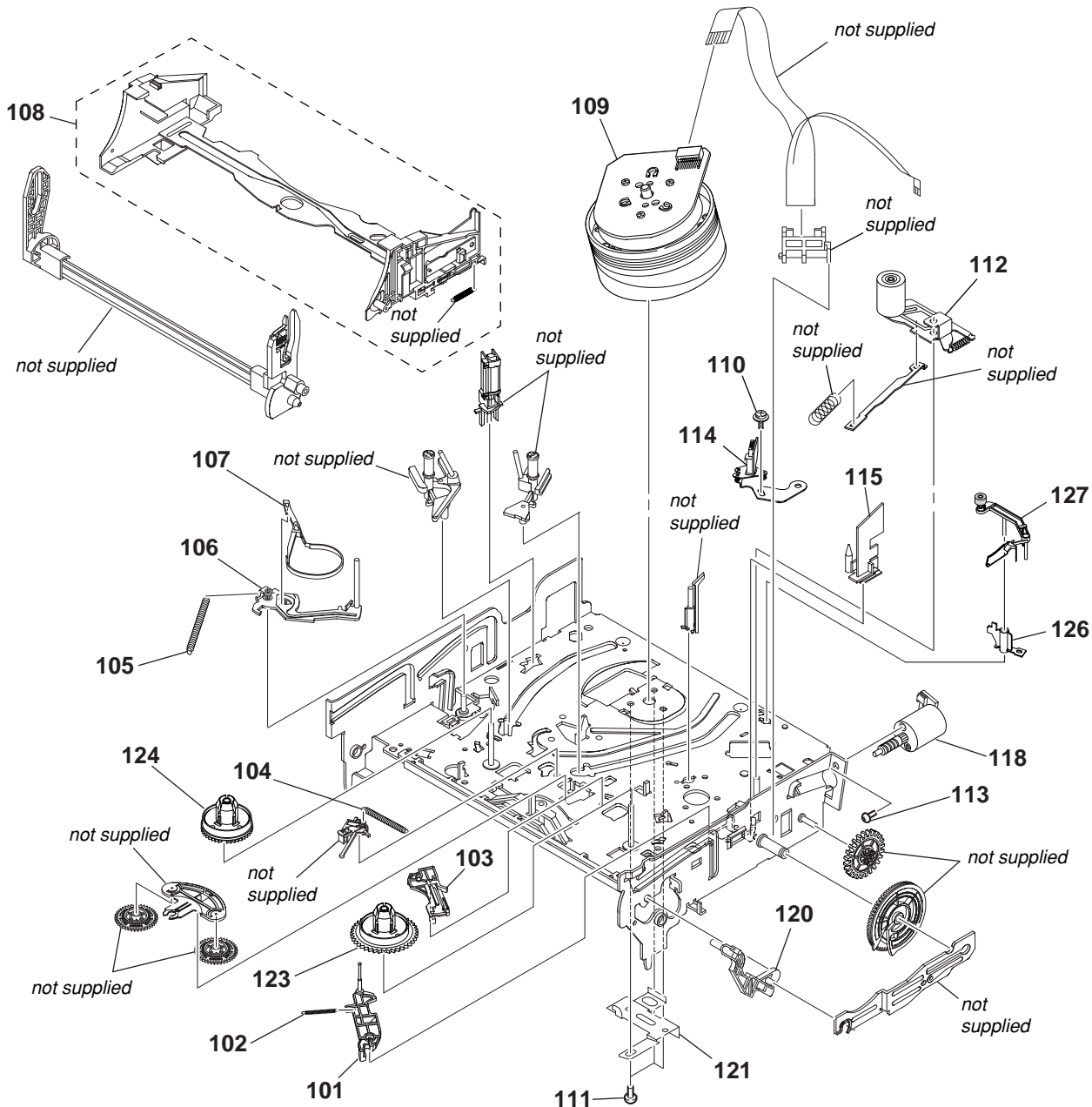

Ref. No.	Part No.	Description	Remarks
101	3-067-779-01	LEVER-#9 GUIDE	
102	3-067-780-01	SPRING-#9 GUIDE	
103	3-067-785-01	LEVER-T. BRAKE	
104	3-067-786-01	SPRING-BRAKE	
105	3-067-782-01	SPRING-TENSION LEVER	
106	3-067-781-01	LEVER-TENSION	
107	3-067-783-01	BAND-BREAK	
108	3-067-788-01	HOLDER-FL CASS.	
109	1-796-704-11	ASSY CLYNDER 6HD (SECAM)	(SE630: B/SE730: B/SE830: B)
109	1-796-705-11	ASSY CLYNDER 6HD	(SE630: D, E, N/SE730: D, E, G, I, N/SE737/SE830: D, E, G, N/SX730/SX737)
109	1-796-706-11	ASSY CLYNDER 2HD (SE230: B, D)	
109	1-796-707-11	ASSY CLYNDER 2HD (LP) (SE230: G, I)	
109	1-796-708-11	ASSY CLYNDER 4HD (SE430)	
110	3-075-253-01	SCREW ASSY MAC 2.6X5	

Ref. No.	Part No.	Description	Remarks
111	3-075-254-01	SCREW ASSY MAC 3X6	
112	3-067-784-01	LEVER-UNIT PINCH	
113	3-075-257-01	SCREW TAP 2.6X5	
114	3-709-671-01	ASSY HEAD ACE	
115	3-067-789-01	GUIDE-CASS. DOOR	
118	1-796-434-11	LOADING ASSY, MOTOR	
120	3-067-787-01	LEVER-FL DOOR	(SE630/SE730/SE737/SE830/SX730/SX737)
120	3-075-704-01	LEVER-FL DOOR (SE230/SE430)	
121	3-067-796-01	PLATE-GROUND DECK	
123	3-075-046-01	DISK T REEL	
124	3-075-047-01	DISK S REEL	
126	3-075-022-01	AUTO HEAD CLEANER (G681)	(SE630/SE730/SE737/SE830/SX730/SX737)
127	3-075-021-01	AUTO HEAD CLEANER (G680)	(SE630/SE730/SE737/SE830/SX730/SX737)



## 6-1-4 Mechanical Parts (Bottom Side)

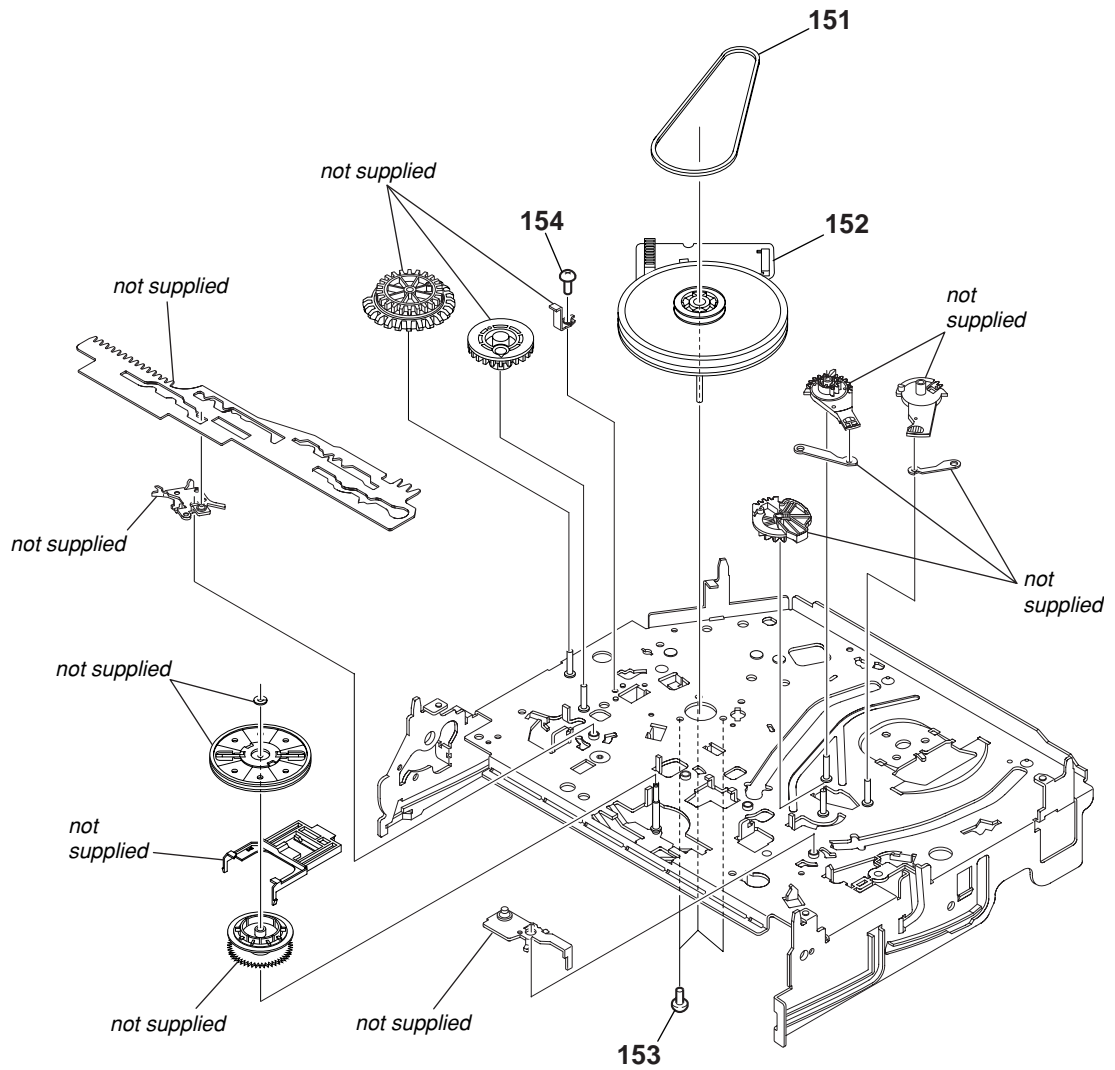

Ref. No.	Part No.	Description	Remarks	Ref. No.	Part No.	Description	Remarks
151	3-067-790-01	BELT-PULLEY		153	3-075-259-01	SCREW CAP 2.6X6	
152	1-796-432-11	MOTOR CAPSTAN		154	3-075-260-01	SCREW MAC 3X3	

## 6-2 ELECTRICAL PARTS LIST

**NOTE:**

- Due to standardization, replacements in the parts list may be different from the parts specified in the diagrams or the components used on the set.
- -XX, and -X mean standardized parts, so they may have some difference from the original one.
- RESISTORS  
All resistors are in ohms.  
METAL: metal-film resistor  
METAL OXIDE: Metal Oxide-film resistor  
F: nonflammable
- Not all of the parts are listed.

- Items marked “\*\*” are not stocked since they are seldom required for routine service. Some delay should be anticipated when ordering these items.
- SEMICONDUCTORS  
In each case, u:  $\mu$ , for example:  
uA...:  $\mu$ A..., uPA...,  $\mu$ PA...,  
uPB...,  $\mu$ PB..., uPC...,  $\mu$ PC...,  
uPD...,  $\mu$ PD...
- CAPACITORS:  
uF:  $\mu$ F
- COILS  
uH:  $\mu$ H

- Main A model: SE230/SE430/SE630  
Main B model: SE730/SE737/SE830/SX730/  
SX737  
Hi-Fi model: SE630/SE730/SE737/SE830/  
SX730/SX737  
Mono model: SE230/SE430

When indicating parts by reference number, please include the board name.

The components identified by mark  $\Delta$  or dotted line with mark  $\Delta$  are critical for safety. Replace only with part number specified.

Ref. No.	Part No.	Description	Remarks
		FUNCTION BOARD (Hi-Fi model) *****	
		< JACK >	
JK7T01	1-815-698-11	JACK PIN 3P (LINE-2) (SE830)	
		< DIODE >	
LD7T01	1-805-289-11	LED (JOG) (SE830)	
		< SWITCH >	
SW7T01	1-786-353-11	TACT SW (TAPPING 5mm) (TEST)	
SW7T03	1-786-353-11	TACT SW (TAPPING 5mm) (POWER)	
SW7T04	1-786-353-11	TACT SW (TAPPING 5mm) (FF)	
SW7T05	1-786-353-11	TACT SW (TAPPING 5mm) (PAUSE)	
SW7T06	1-786-353-11	TACT SW (TAPPING 5mm) (AUDIO) (SE830)	
SW7T09	1-786-353-11	TACT SW (TAPPING 5mm) (REC) (SE630/SE730/SE737/SX730/SX737)	
SW7T09	1-786-354-11	TACT SW (BULK 5mm) (REC) (SE830)	
SW7T12	1-786-353-11	TACT SW (TAPPING 5mm) (EJECT) (SE630/SE730/SE737/SX730/SX737)	
SW7T12	1-786-354-11	TACT SW (BULK 5mm) (EJECT) (SE830)	
SW7T13	1-786-354-11	TACT SW (BULK 5mm) (JOG) (SE830)	
SW7T14	1-786-353-11	TACT SW (TAPPING 5mm) (PLAY)	
SW7T15	1-786-353-11	TACT SW (TAPPING 5mm) (STOP)	
SW7T16	1-786-353-11	TACT SW (TAPPING 5mm) (REW)	
		MAIN BOARD *****	
CN3A1S	1-823-022-11	CABLE FLAT 6P	
FC1SS1	1-576-527-11	FUSE CLIP	
FC1SS2	1-576-527-11	FUSE CLIP	
S601A	3-075-066-01	HOLDER-SENSOR	
S602A	3-075-066-01	HOLDER-SENSOR	
SC02	3-075-255-01	SCREW TAP 3X8	
		< COIL >	
BD1SD1	1-400-085-11	INDUCTOR	0uH (Main A model)
BD1SD2	1-400-085-11	INDUCTOR	0uH
BD1SD3	1-400-086-11	INDUCTOR	0uH (Main A model)
BD1SD4	1-400-085-11	INDUCTOR	0uH (Main B model)
BD1SS1	1-400-085-11	INDUCTOR	0uH

Ref. No.	Part No.	Description	Remarks
BD1SS2	1-400-085-11	INDUCTOR	0uH
L502	1-400-086-11	INDUCTOR	0uH
L814	1-400-085-11	INDUCTOR	0uH
L4N04	1-400-085-11	INDUCTOR	0uH (Hi-Fi model)
$\Delta$ L1SS02	1-424-830-11	LINE FILTER	30mH
L1SS31	1-424-828-11	COIL CHOKE	10uH
L1SS32	1-424-828-11	COIL CHOKE	10uH
W179	1-400-086-11	INDUCTOR	0uH (Main A model)
W449	1-400-086-11	INDUCTOR	0uH (Main B model)
		< CAPACITOR >	
C1SD03	1-165-557-11	CONDENSER	2200PF
C1SD04	1-165-557-11	CONDENSER	2200PF
C1SD12	1-165-574-11	CONDENSER FILM	10000PF
C1SF11	1-165-574-11	CONDENSER FILM	10000PF
C1SF13	1-100-002-11	CONDENSER FILM	22000PF
$\Delta$ C1SS01	1-165-573-11	CONDENSER FILM	0.1uF
$\Delta$ C1SS02	1-165-573-11	CONDENSER FILM	0.1uF
C1SS12	1-100-530-11	CONDENSER CERAMIC DISC	100PF
C1SS39	1-165-999-11	CONDENSER FILM	0.1uF
		< CONNECTOR >	
CN301	1-815-685-11	CONNECTOR FPC 10P (Hi-Fi model)	
CN301	1-815-686-11	CONNECTOR FPC 6P (Mono model)	
CN1SS1	1-815-692-11	CONNECTOR HEADER 2P	
CN3A01	1-815-688-11	CONNECTOR FPC 6PSN	
		< DIODE >	
D301	1-804-407-11	DIODE	1N4148
D302	1-805-264-11	DIODE	1N5819
D401	1-805-264-11	DIODE	1N5819
D601	1-805-264-11	DIODE	1N5819 (Main B model)
D603	1-804-407-11	DIODE	1N4148
D605	1-805-264-11	DIODE	1N5819
D610	1-805-264-11	DIODE	1N5819 (Main A model)
D612	1-805-264-11	DIODE	1N5819
D701	1-804-407-11	DIODE	1N4148
D702	1-804-407-11	DIODE	1N4148
D703	1-804-407-11	DIODE	1N4148
D704	1-804-407-11	DIODE	1N4148
D805	1-804-407-11	DIODE	1N4148
D4N01	1-804-407-11	DIODE	1N4148 (SE630)

Ref. No.	Part No.	Description	Remarks	Ref. No.	Part No.	Description	Remarks
D4N01	1-805-264-11	DIODE 1N5819 (Main B model)				< IC >	
D4N02	1-804-407-11	DIODE 1N4148 (Hi-Fi model)		IC301	1-804-702-11	IC VIDEO	
D6E01	1-804-407-11	DIODE 1N4148 (Main B model)		IC501	1-804-703-11	IC HIFI (Hi-Fi model)	
D1P101	1-804-407-11	DIODE 1N4148		IC601	1-805-270-11	IC MICON (WE)	
D1P102	1-804-407-11	DIODE 1N4148				(SE230/SE630: B, D, E/SE730: B, D, E, G, I/ SE737/SE830: B, D, E, G/SX730: D, E/SX737)	
D1P103	1-804-407-11	DIODE 1N4148 (SE230: B/Hi-Fi model)		IC601	1-805-271-11	IC MICON (EE)	
D1P104	1-804-407-11	DIODE 1N4148 (SE230: D, G, I/SE430/Hi-Fi model)				(SE430/SE630: N/SE730: N/SE830: N/SX730: N)	
D1SD10	1-804-412-11	DIODE FIT4		IC604	1-804-444-11	IC KA7533	
D1SD31	1-804-412-11	DIODE FIT4		IC605	1-804-432-11	IC 524C80D81	
D1SF11	1-804-413-11	DIODE IT5		IC608	1-804-480-11	IC VOL-DETECTOR 7042 (SE430/SE630/SE730: N/SE830: N/SX730: N)	
D1SF12	1-804-413-11	DIODE IT5		IC701	1-804-706-11	IC LED DRIVER (Main A model)	
D1SS01	1-804-413-11	DIODE IT5		IC701	1-805-288-11	IC AV LINK (Main B model)	
D1SS02	1-804-413-11	DIODE IT5		IC801	1-804-700-11	IC CANAL (MONO) (Mono model)	
D1SS03	1-804-413-11	DIODE IT5		IC1SF1	1-805-268-11	IC PWM CONTROLLER	
D1SS04	1-804-413-11	DIODE IT5		△IC1SS1	1-804-784-11	IC PHOTO COUPLER	
D1SS11	1-804-408-11	DIODE UF4007		IC1SS2	1-804-445-11	IC KA4318	
D1SS31	1-804-412-11	DIODE FIT4		IC3S01	1-804-701-11	IC SECAM (SE230:B/SE630:B/SE730:B/SE830:B)	
D1SS32	1-804-411-11	DIODE UG2D		IC4N01	1-804-795-11	IC NICAM (SE630: B, E, N/SE730: B, E, G, I, N/SE737/ SE830: B, G, N/SX730: E, N)	
D1SS33	1-805-266-11	DIODE SCHOTTKY SE55		IC4N01	1-805-269-11	IC ZWIE (SE630: D/SE730: D, E, SE737/SE830:D/ SX730: D, E/SX737)	
D1SS40	1-804-412-11	DIODE FIT4 (Main B model)		IC6P01	1-804-453-11	IC PDC/OSD (SE230)	
D1SS41	1-804-412-11	DIODE FIT4 (Main B model)		IC6P01	1-804-454-11	IC OSD (EXCEPT SE230)	
LD601	1-804-438-11	LED-IR (T/S LED)		RM701	1-477-308-11	IC REMOCON MOD (TSOP2238WE1) (EXCEPT SE630)	
ZD401	1-804-414-11	DIODE ZENER UZP33B		RM702	1-477-308-11	IC REMOCON MOD (TSOP2238WE1) (SE630)	
ZD701	1-805-286-11	DIODE ZENER MTZJ5.6B (Main B model)				< JACK SCART >	
ZD702	1-805-287-11	DIODE ZENER MTZJ24D (Main B model)		JC801	1-815-697-11	JACK SCART 42P (LINE-1/2 or 3)	
ZD703	1-805-011-11	DIODE UDZ9.1B (Main B model)				< PHOTO INTERRUPTER >	
ZD801	1-805-153-11	DIODE ZENER MTZ6.2B		PT601	1-804-770-11	TRANSISTOR PHOTO INTERRUPTER	
ZD802	1-804-418-11	DIODE ZENER MTZJ12B		PT602	1-804-770-11	TRANSISTOR PHOTO INTERRUPTER	
ZD803	1-804-418-11	DIODE ZENER MTZJ12B				< TRANSFORMER >	
ZD804	1-804-418-11	DIODE ZENER MTZJ12B		△PT1SS1	1-439-880-11	TRANS SWITCHING EE2621 (Main B model)	
ZD805	1-804-418-11	DIODE ZENER MTZJ12B				< TRANSISTOR >	
ZD806	1-804-418-11	DIODE ZENER MTZJ12B		Q302	1-804-421-11	TRANSISTOR KSC945 (SE230: B/SE630: B/SE730: B/SE830: B)	
ZD807	1-804-418-11	DIODE ZENER MTZJ12B (Main B model)		Q350	1-804-420-11	TRANSISTOR KSA733	
ZD808	1-804-418-11	DIODE ZENER MTZJ12B		Q351	1-804-420-11	TRANSISTOR KSA733	
ZD809	1-804-418-11	DIODE ZENER MTZJ12B		Q601	1-804-428-11	TRANSISTOR KSR1004	
ZD810	1-804-418-11	DIODE ZENER MTZJ12B (Hi-Fi model)		Q603	1-804-421-11	TRANSISTOR KSC945 (SE830)	
ZD811	1-804-418-11	DIODE ZENER MTZJ12B (Hi-Fi model)		Q802	1-804-428-11	TRANSISTOR KSR1004	
ZD812	1-804-418-11	DIODE ZENER MTZJ12B		Q803	1-804-428-11	TRANSISTOR KSR1004	
ZD813	1-804-418-11	DIODE ZENER MTZJ12B		Q804	1-804-429-11	TRANSISTOR KSR2001	
ZD814	1-805-011-11	DIODE UDZ9.1B		Q806	1-804-429-11	TRANSISTOR KSR2001	
ZD815	1-805-011-11	DIODE UDZ9.1B		Q809	1-804-421-11	TRANSISTOR KSC945	
ZD1P03	1-804-417-11	DIODE ZENER MTZJ9.1B (SE230: B/Hi-Fi model)				< DISPLAY >	
ZD1SF1	1-805-265-11	DIODE ZENER MTZJ4.3B		DT701	1-518-816-11	VFD DISPLAY (Main B model)	
				DT701	1-518-907-11	LED DISPLAY (Main A model)	
						< FUSE >	
△F1SS01	1-576-526-11	FUSE T.L (1.6A/250V)					
△FR01	1-576-729-11	FUSE-RADIAL LEAD (1A)					
△FR02	1-576-729-11	FUSE-RADIAL LEAD (1A)					

**Note :**  
 The components identified by mark △ or dotted line with mark △ are critical for safety.  
 Replace only with part number specified.

**MAIN**

Ref. No.	Part No.	Description	Remarks
Q810	1-804-421-11	TRANSISTOR	KSC945
Q3A01	1-804-421-11	TRANSISTOR	KSC945
Q3A02	1-804-420-11	TRANSISTOR	KSA733
Q3A03	1-804-422-11	TRANSISTOR	KTC3023
Q3A04	1-804-422-11	TRANSISTOR	KTC3023
Q3A05	1-804-422-11	TRANSISTOR	KTC3023
Q3A06	1-804-420-11	TRANSISTOR	KSA733
Q3D02	1-804-420-11	TRANSISTOR	KSA733 (SE730: B/SE830)
Q3D01	1-804-422-11	TRANSISTOR	KTC3023 (SE830)
Q3D07	1-804-428-11	TRANSISTOR	KSR1004 (SE830)
Q3P01	1-804-420-11	TRANSISTOR	KSA733 (SE630: B, D)
Q3P02	1-804-420-11	TRANSISTOR	KSA733 (SE630: B, D)
Q6E01	1-804-422-11	TRANSISTOR	KTC3023 (Main B model)
Q6E02	1-804-421-11	TRANSISTOR	KSC945 (Main B model)
Q6E03	1-804-429-11	TRANSISTOR	KSR2001 (Main B model)
Q6P01	1-804-420-11	TRANSISTOR	KSA733 (Mono model/SE630: E, N/Main B model)
Q6P02	1-804-420-11	TRANSISTOR	KSA733 (Mono model/SE630: E, N/Main B model)
Q1P101	1-804-423-11	TRANSISTOR	KSA928AY
Q1P102	1-804-423-11	TRANSISTOR	KSA928AY
Q1P103	1-804-424-11	TRANSISTOR	KSC2328AY (Hi-Fi model)
Q1P104	1-804-423-11	TRANSISTOR	KSA928AY
Q1P105	1-804-427-11	TRANSISTOR	KSR1001
Q1P106	1-804-421-11	TRANSISTOR	KSC945 (Hi-Fi model)
Q1P107	1-804-429-11	TRANSISTOR	KSR2001 (Hi-Fi model)
Q1P108	1-804-423-11	TRANSISTOR	KSA928AY (Hi-Fi model)
Q1P109	1-805-267-11	TRANSISTOR	KSR1003
Q1P110	1-804-423-11	TRANSISTOR	KSA928AY
Q1P111	1-805-267-11	TRANSISTOR	KSR1003 (Hi-Fi model)
< RESISTOR >			
R1SD16	1-245-556-11	R-METAL OXIDE (S)	
R1SF15	1-245-555-11	R-METAL OXIDE	
R1SS10	1-244-373-11	RESISTOR	2.7
R1SS11	1-245-556-11	R-METAL OXIDE (S)	
R1SS33	1-244-371-11	RESISTOR	2.2K
R1SS34	1-244-371-11	RESISTOR	2.2K
< SWITCH >			
RS601	1-786-199-11	SWITCH REC (REC SWITCH)	
SW601	1-786-198-11	SWITCH MODE (MODE SWITCH)	
SW701	1-786-353-11	TACT SW (TAPPING 5mm) (POWER)	(Mono model)
SW703	1-786-353-11	TACT SW (TAPPING 5mm) (EJECT)	(Mono model)
SW708	1-786-353-11	TACT SW (TAPPING 5mm) (PROGRAM+)	(Mono model)
SW709	1-786-353-11	TACT SW (TAPPING 5mm) (PROGRAM-)	(Mono model)
SW711	1-786-353-11	TACT SW (TAPPING 5mm) (TEST)	(Main A model)
SW712	1-786-353-11	TACT SW (TAPPING 5mm) (PROGRAM+)	(SE630/SE730/SE737/SX730/SX737)
SW713	1-786-353-11	TACT SW (TAPPING 5mm) (PROGRAM-)	(SE630/SE730/SE737/SX730/SX737)
SW714	1-786-353-11	TACT SW (TAPPING 5mm) (PLAY)	(Mono model)
SW715	1-786-353-11	TACT SW (TAPPING 5mm) (REC)	(Mono model)

Ref. No.	Part No.	Description	Remarks
SW716	1-786-353-11	TACT SW (TAPPING 5mm) (FF)	(Mono model)
SW717	1-786-353-11	TACT SW (TAPPING 5mm) (STOP)	(Mono model)
SW719	1-786-353-11	TACT SW (TAPPING 5mm) (PAUSE)	(Mono model)
SW720	1-786-353-11	TACT SW (TAPPING 5mm) (REW)	(Mono model)
< PHOTO TRANSISTOR >			
S601	1-804-439-11	PHOTO TRANSISTOR	
S602	1-804-439-11	PHOTO TRANSISTOR	
< TUNER >			
TM401	1-693-584-11	TUNER PAL B/G (MONO)	(SE230: D)
TM401	1-693-585-11	TUNER PAL I (ALL)	(SE230: G/SE730: G/SE830: G)
TM401	1-693-589-11	TUNER PAL B/G/D/K/I	(SE230: I/SE430/SE630: D, E, N/SE730: D, E, I, N/SE737/SE830: D, E, N/SX730/SX737)
TM401	1-693-633-11	TUNER PAL	(SE230: B/SE630: B/SE730: B/SE830: B)
< VARISTOR >			
△ VA1SS1	1-804-437-11	VARISTOR	
< VIBRATOR >			
XT301	1-795-330-11	VIBRATOR CRYSTAL	(4.433619 MHz)
XT601	1-795-332-11	VIBRATOR CRYSTAL	(32.768 kHz)
XT602	1-795-331-11	VIBRATOR CRYSTAL	(8 MHz)
XT750	1-795-625-11	CRYSTAL	(5 MHz) (Main B model)
XT4N01	1-795-615-11	CRYSTAL	(18.432 MHz) (SE230: B/Hi-Fi model)
MISCELLANEOUS *****			
3	1-786-352-11	SW-DIAL TIMER	(SE830)
△ 5	1-823-023-11	POWER CORD KKP419C	(SE230: B, D/SE430)
△ 5	1-823-023-11	POWER CORD KKP419	(SE630/SE730: B, D, E, N/SX730/SX737)
△ 5	1-823-025-11	POWER CORD Y352	(SE230: G, I)
△ 5	1-823-025-11	POWER CORD Y352	(SE730: G, I/SE830: G)
109	1-796-704-11	ASSY CLYNDER 6HD (SECAM)	(SE630: B/SE730: B/SE830: B)
109	1-796-705-11	ASSY CLYNDER 6HD	(SE630: D, E, N/SE730: D, E, G, I, N/SE737/SE830: D, E, G, N/SX730/SX737)
109	1-796-706-11	ASSY CLYNDER 2HD	(SE230: B, D)
109	1-796-707-11	ASSY CLYNDER 2HD (LP)	(SE230: G, I)
109	1-796-708-11	ASSY CLYNDER 4HD	(SE430)
118	1-796-434-11	LOADING ASSY, MOTOR	
152	1-796-432-11	MOTOR CAPSTAN	

**Note :**  
The components identified by mark △ or dotted line with mark △ are critical for safety. Replace only with part number specified.

Ref. No.	Part No.	Description	Remarks
ACCESSORIES & PACKING MATERIALS			
*****			
1-477-269-11		COMMANDER, STANDARD (RMT-V405) (SE230: D, G, I/SE430)	
1-477-270-11		COMMANDER, STANDARD (RMT-V405A) (SE230: B)	
1-477-271-11		COMMANDER, STANDARD (RMT-V406) (SE630: E, N/SE730: E, G, I, N)	
1-477-272-11		COMMANDER, STANDARD (RMT-V406A) (SE630: B, D/SE730: B, D)	
1-477-273-11		COMMANDER, STANDARD (RMT-V407A) (SE737/SE830: D, E, G, N)	
1-477-274-11		COMMANDER, STANDARD (RMT-V407B) (SE830: B)	
1-477-275-11		COMMANDER, STANDARD (RMT-V407C) (SX737)	
1-477-276-11		COMMANDER, STANDARD (RMT-V406B) (SX730)	
1-823-126-11		CABLE RF SECAM (SE230: B/SE630: B/SE730: B/SE830: B)	
3-075-088-01		COVER (S) REMOTE CONTROL BATTERY (for RMT-V405/V405A/V406/V406A/V407A/V407B) (SE230/SE430/SE630/SE730/SE737/SE830)	
3-075-089-01		COVER (B) REMOTE CONTROL BATTERY (for RMT-V406B/V407C) (SX730/SX737)	
3-081-524-11		MANUAL, INSTRUCTION (FRENCH) (SE230: D/SE630: D, E/SE730: D, E/SE737: E/ SE830: D, E/SX730: D, E/SX737)	
3-081-524-21		MANUAL, INSTRUCTION (SPANISH) (SE230: D/SE630: E/SE730: E/SE737: E/SX730: E)	
3-081-524-41		MANUAL, INSTRUCTION (ITALIAN) (SE230: D/SE630: D/SE730: D/SE737: E/ SE830: D/SX730: D)	
3-081-524-51		MANUAL, INSTRUCTION (DUTCH) (SE230: D/SE630: D, E/SE730: D, E/SE737: E/ SE830: D, E/SX730: D, E)	
3-081-524-61		MANUAL, INSTRUCTION (PORTUGUESE) (SE230: D/SE630: E/SE730: E/SE830: E/SX730: E)	
3-081-524-71		MANUAL, INSTRUCTION (GREEK) (SE230: D/SE630: E/SE730: E/SE830: E/SX730: E)	
3-081-525-11		MANUAL, INSTRUCTION (SE630: E/SE730: E/SE737: E/SE830: E/SX730: E)	
3-081-525-21		MANUAL, INSTRUCTION (SE630: E/SE730: E/SE737: E/SE830: E/SX730: E)	
3-081-525-31		MANUAL, INSTRUCTION (SE630: E/SE730: E/SE737: E/SE830: E/SX730: E)	
3-081-621-11		MANUAL, INSTRUCTION (FRENCH) (SE230: B/SE630: B/SE730: B/SE830: B)	
3-081-622-11		MANUAL, INSTRUCTION (ENGLISH) (SE230: G, I/SE730: G, I/SE830: G)	
3-081-623-21		MANUAL, INSTRUCTION (RUSSIAN) (SE430/SE630: N/SE730: N/SE830: N)	
3-081-623-31		MANUAL, INSTRUCTION (SE430/SE630: N/SE730: N/SE830: N/SX730: N)	
3-081-623-41		MANUAL, INSTRUCTION (POLISH) (SE630: N/SE730: N/SE830: N/SX730: N)	
3-081-623-51		MANUAL, INSTRUCTION (HUNGARIAN) (SE630: N/SE730: N/SE830: N/SX730: N)	

**SLV-SE230/SE430/SE630/SE730/  
SE737/SE830/SX730/SX737**

**Sony Corporation**  
Home Video Company

— 94 —

2003C0500-1  
©2003.3

Published by Quality Assurance Dept.