

SERVICE MANUAL

AA-2U CHASSIS

<u>MODEL</u>	<u>COMMANDER</u>	<u>DEST</u>	<u>CHASSIS NO.</u>
KV-36FS12	RM-Y168	US	SCC-S44A-A
KV-36FS12	RM-Y168	CND	SCC-S45A-A
KV-36FS12	RM-Y168	HAWAII	SCC-S46A-A
KV-36FS16	RM-Y169	US	SCC-S44B-A
KV-36FS16	RM-Y169	CND	SCC-S45B-A
KV-36FS16	RM-Y169	HAWAII	SCC-S46B-A
KV-36FV16	RM-Y171	US	SCC-S44C-A
KV-36FV16	RM-Y171	HAWAII	SCC-S46C-A
KV-36FV26	RM-Y170	US	SCC-S44D-A
KV-36FV26	RM-Y170	CND	SCC-S45C-A
KV-36FV26	RM-Y170	HAWAII	SCC-S46D-A



KV-36FV26



RM-Y170

TRINITRON® COLOR TV
SONY®

SPECIFICATIONS

	KV-36FS12 KV-36FS16	KV-36FV16 KV-36FV26
Power requirements	120V, 60Hz	120V, 60Hz
Number of inputs/outputs		
Video ¹⁾	3	3
S Video ²⁾	1	2
Y, P _B , P _R ³⁾	1	1
Audio ⁴⁾	4	4
Audio Out ⁵⁾	1	1
Monitor Out	--	1
S-Link	--	3
Control-S (IN/OUT)	--	1
Speaker output(W)	5W x 2	15W x 2
Power Consumption(W)		
In use(Max)	190W	200W
In standby	2W	2W
Dimensions(W/H/D)		
(mm)	910 x 791 x 650	975 x 757 x 633
Mass		
(kg)	100 kg	107 kg
(lbs)	220 lbs.	236 lbs.

Television system

American TV standard, NTSC

Channel coverage

VHF:2-13/UHF:14-69/CATV:1-125

Picture tube

Trinitron® tube

Visible screen size

36-inch picture measured diagonally

Actual screen size

38-inch measured diagonally

Antenna

75 ohm external terminal for VHF/UHF

Supplied Accessories

RM-Y168 (KV-36FS12 ONLY)

RM-Y169 (KV-36FS16 ONLY)

RM-Y170 (KV-36FV26 ONLY)

RM-Y171 (KV-36FV16 ONLY)

Batteries size AA (R6) (2)

Wireless Stereo Headphones MDR-1F0230 (KV-36FV26 ONLY)

Battery for Headphones size AA (R6) (1) (KV-36FV26 only)

Optional Accessories

AV Cable: VMC-810/820/830 HG

Audio Cable: RKC-515HG

S-LINK Cable: RK-G69HG (KV-36FV16/36FV26 ONLY)

Component Video Cable: VMC-10/30 HG

TV Stand: SU-36FD3

Design and specifications are subject to change without notice.¹⁾ 1 Vp-p 75 ohms unbalanced, sync negative²⁾ Y: 1 Vp-p 75 ohms unbalanced, sync negative
C: 0.286 Vp-p (Burst signal), 75 ohms³⁾ Y: 1.0 Vp-p, 75 ohms, sync negative; PB: 0.7 Vp-p, 75 ohms;
PR: Vp-p, 75 ohms⁴⁾ 500 mVrms (100% modulation), Impedance: 47 kilohms⁵⁾ More than 408 mVrms at the maximum volume setting (variable)
More than 408 mVrms (fix); Impedance (output): 2 kilohms**(●) SRS (SOUND RETRIEVAL SYSTEM)**

The (●) SRS (SOUND RETRIEVAL SYSTEM) is manufactured by Sony Corporation under license from SRS Labs, Inc. It is covered by U.S. Patent No. 4,748,669. Other U.S. and foreign patents pending.

The word 'SRS' and the SRS symbol (●) are registered trademarks of SRS Labs, Inc.

BBE and BBE symbol are trademarks of BBE Sound, Inc. and are licensed by BBE Sound, Inc. under U.S. Patent No. 4,638,258 and 4,482,866.

TABLE OF CONTENTS

<u>Section</u>	<u>Title</u>	<u>Page</u>
	Warnings and Cautions	4
	Self-Diagnostic Function	4
	Safety Check-Out Instructions	7
1.	GENERAL	8
2.	DISASSEMBLY	
2-1.	Rear Cover Removal	13
2-2.	Chassis Assembly Removal	13
2-3.	Service Position	13
2-4.	Picture Tube Removal	14
3.	SET-UP ADJUSTMENTS	
3-1.	Beam Landing	15
3-2.	Convergence	16
3-3.	Focus	17
3-4.	Screen (G2)	18
3-5.	White Balance Adjustments	18
4.	SAFETY RELATED ADJUSTMENTS	
4-1.	☒ R530, R531 Confirmation Method (HV Hold-Down Confirmation and Readjustments)	19
4-2.	B+ Voltage Confirmation and Adjustment	19
5.	CIRCUIT ADJUSTMENTS	
5-1.	Setting the Service Adjustment Mode	20
5-2.	Memory Write Confirmation Method	20
5-3.	Adjust Buttons and Indicators	20
5-4.	Adjustment Items	21
5-5.	Feature ID Map	26
5-6.	Program Palette Settings	27
5-7.	A Board Adjustments	27
6.	DIAGRAMS	
6-1.	Block Diagram (1/2) (KV-36FS12/36FS16 ONLY)	31
6-2.	Block Diagram (1/2) (KV-36FV16/36FV26 ONLY)	33
6-3.	Block Diagram (2/2) (KV-36FS12/36FS16 ONLY)	35
6-4.	Block Diagram (2/2) (KV-36FV16/36FV26 ONLY)	37
6-5.	Circuit Board Location	39
6-6.	Printed Wiring Boards and Schematic Diagrams	39
	• A Board	40
	• UX Board	47
	• UX PIP Board	51
	• UY Board	55
	• UY PIP Board	59
	• AK Board	63
	• C Board	67
	• G Board	69
	• HA Board	71
	• HB Board	73
	• HX Board	73
	• HS Board	74
	• WA Board	75
	• T Board	77
6-7.	Semiconductors	79
7.	EXPLODED VIEW	
7-1.	Chassis (KV-36FS12/36FS16 ONLY)	80
7-2.	Picture Tube (KV-36FS12/36FS16 ONLY)	81
7-3.	Chassis (KV-36FV16/36FV26 ONLY)	82
7-4.	Picture Tube (KV-36FV12/36FV26 ONLY)	83
8.	ELECTRICAL PARTS LIST	84

WARNINGS AND CAUTIONS

CAUTION

SHORT CIRCUIT THE ANODE OF THE PICTURE TUBE AND THE ANODE CAP TO THE METAL CHASSIS, CRT SHIELD, OR CARBON PAINTED ON THE CRT, AFTER REMOVING THE ANODE.

WARNING!!

AN ISOLATION TRANSFORMER SHOULD BE USED DURING ANY SERVICE TO AVOID POSSIBLE SHOCK HAZARD, BECAUSE OF LIVE CHASSIS. THE CHASSIS OF THIS RECEIVER IS DIRECTLY CONNECTED TO THE AC POWER LINE.

SAFETY-RELATED COMPONENT WARNING!!

COMPONENTS IDENTIFIED BY SHADING AND MARK Δ ON THE SCHEMATIC DIAGRAMS, EXPLODED VIEWS, AND IN THE PARTS LIST ARE CRITICAL FOR SAFE OPERATION. REPLACE THESE COMPONENTS WITH SONY PARTS WHOSE PART NUMBERS APPEAR AS SHOWN IN THIS MANUAL OR IN SUPPLEMENTS PUBLISHED BY SONY. CIRCUIT ADJUSTMENTS THAT ARE CRITICAL FOR SAFE OPERATION ARE IDENTIFIED IN THIS MANUAL. FOLLOW THESE PROCEDURES WHENEVER CRITICAL COMPONENTS ARE REPLACED OR IMPROPER OPERATION IS SUSPECTED.

ATTENTION!!

APRES AVOIR DECONNECTE LE CAP DE L'ANODE, COURT-CIRCUITER L'ANODE DU TUBE CATHODIQUE ET CELUI DE L'ANODE DU CAP AU CHASSIS METALLIQUE DE L'APPAREIL, OU AU COUCHE DE CARBONE PEINTE SUR LE TUBE CATHODIQUE OU AU BLINDAGE DU TUBE CATHODIQUE.

ATTENTION!!

AFIN D'EVITER TOUT RESQUE D'ELECTROCUTION PROVENANT D'UN CHÂSSIS SOUS TENSION, UN TRANSFORMATEUR D'ISOLEMENT DOIT ETRE UTILISÉ LORS DE TOUT DÉPANNAGE. LE CHÂSSIS DE CE RÉCEPTEUR EST DIRECTEMENT RACCORDÉ À L'ALIMENTATION SECTEUR.

ATTENTION AUX COMPOSANTS RELATIFS A LA SECURITE!!

LES COMPOSANTS IDENTIFIES PAR UNE TRAME ET PAR UNE MARQUE Δ SUR LES SCHEMAS DE PRINCIPE, LES VUES EXPLOSEES ET LES LISTES DE PIECES SONT D'UNE IMPORTANCE CRITIQUE POUR LA SECURITE DU FONCTIONNEMENT. NE LES REMPLACER QUE PAR DES COMPOSANTS SONY DONT LE NUMERO DE PIECE EST INDIQUE DANS LE PRESENT MANUEL OU DANS DES SUPPLEMENTS PUBLIES PAR SONY. LES REGLAGES DE CIRCUIT DONT L'IMPORTANCE EST CRITIQUE POUR LA SECURITE DU FONCTIONNEMENT SONT IDENTIFIES DANS LE PRESENT MANUEL. SUIVRE CES PROCEDURES LORS DE CHAQUE REMPLACEMENT DE COMPOSANTS CRITIQUES, OU LORSQU'UN MAUVAIS FONCTIONNEMENT SUSPECTE.

SELF-DIAGNOSTIC FUNCTION

The units in this manual contain a self-diagnostic function. If an error occurs, the STANDBY/TIMER LED will automatically begin to flash. The number of times the LED flashes translates to a probable source of the problem. A definition of the STANDBY/TIMER LED flash indicators is listed in the instruction manual for the user's knowledge and reference. If an error symptom cannot be reproduced, the Remote Commander can be used to review the failure occurrence data stored in memory to reveal past problems and how often these problems occur.

Diagnostic Test Indicators

When an error occurs, the STANDBY/TIMER LED will flash a set number of times to indicate the possible cause of the problem. If there is more than one error, the LED will identify the first of the problem areas.

Results for all of the following diagnostic items are displayed on screen. No error has occurred if the screen displays a "0".

Diagnostic Item Description	No. of Times STANDBY/TIMER LED Flashes	Self-diagnostic Display/ Diagnostic Result	Probable Cause Location	Detected Symptoms
Power does not turn on	Does not light	N/A	<ul style="list-style-type: none"> Power cord is not plugged in. Fuse is burned out. (F601) (A Board) 	<ul style="list-style-type: none"> Power does not come on. No power is supplied to the TV. AC power supply is faulty.
+B overcurrent (OCP)*	N/A	N/A	<ul style="list-style-type: none"> H.OUT (Q502) is shorted. (A Board) IC1701 is shorted. (C Board) 	<ul style="list-style-type: none"> Power does not come on. Load on power line is shorted.
+B overvoltage (OVP)*	N/A	N/A	<ul style="list-style-type: none"> IC643 or T603 is open. (G Board) 	<ul style="list-style-type: none"> Power does not come on.
VSTOP*	4 times	4:0 or 4:1	<ul style="list-style-type: none"> +13V is not supplied. (A Board) IC502 is faulty. (A Board) 	<ul style="list-style-type: none"> Has entered standby state after horizontal raster. Vertical deflection pulse is stopped. Power line is shorted or power supply is stopped.
IK	5 times	5:0 or 5:1	<ul style="list-style-type: none"> Video OUT (IC502) is faulty. (A Board) IC1301 is faulty. (MB Board) Screen (G2) is improperly adjusted.** 	<ul style="list-style-type: none"> No raster is generated. CRT cathode current detection reference pulse output is small.

* If a +B overcurrent is detected, stoppage of the vertical deflection is detected simultaneously.

The symptom that is diagnosed first by the microcontroller is displayed on the screen.

** Refer to Screen (G2) Adjustments in Section 3-4 of this manual.

Display of Standby/Timer LED Flash Count

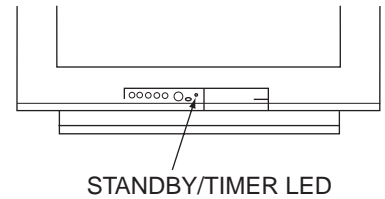
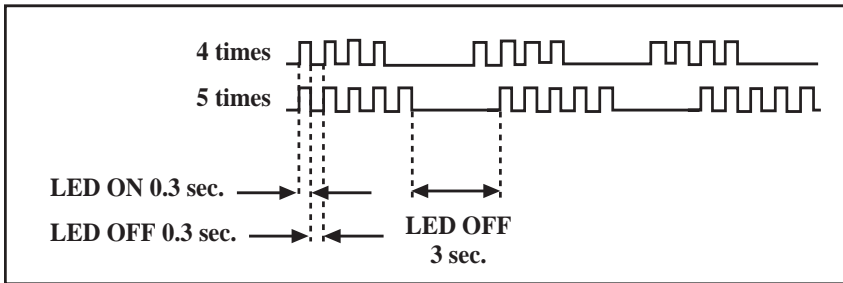

<u>Diagnostic Item</u>	<u>Flash Count*</u>
V-Stop	4 times
IK	5 times

*One flash count is not used for self-diagnostic.

Stopping the Standby/Timer LED Flash

Turn off the power switch on the TV main unit or unplug the power cord from the outlet to stop the STANDBY/TIMER LAMP from flashing.

Self-Diagnostic Screen Display

For errors with symptoms such as “power sometimes shuts off” or “screen sometimes goes out” that cannot be confirmed, it is possible to bring up past occurrences of failure on the screen for confirmation.

To Bring Up Screen Test

In standby mode, press buttons on the Remote Commander sequentially, in rapid succession, as shown below:

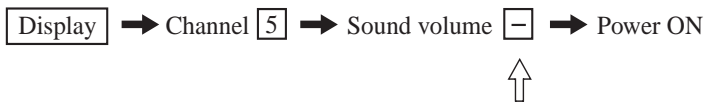

Note that this differs from entering the service mode (sound volume).

Self-Diagnostic Screen Display

SELF DIAGNOSIS	
2: +B OCP	N/A
3: +B OVP	N/A
4: VSTOP	0
5: AKB	1
101: WDT	24

← Numeral “0” means that no fault was detected.
 ← Numeral “1” means a fault was detected one time only.

Handling of Self-Diagnostic Screen Display

Since the diagnostic results displayed on the screen are not automatically cleared, always check the self-diagnostic screen during repairs. When you have completed the repairs, clear the result display to “0”.

Unless the result display is cleared to “0”, the self-diagnostic function will not be able to detect subsequent faults after completion of the repairs.

Clearing the Result Display

To clear the result display to “0”, press buttons on the Remote Commander sequentially when the diagnostic screen is displayed, as shown below:

Channel →

Quitting the Self-Diagnostic Screen

To quit the entire self-diagnostic screen, turn off the power switch on the Remote Commander or the main unit.

Self-Diagnostic Circuit

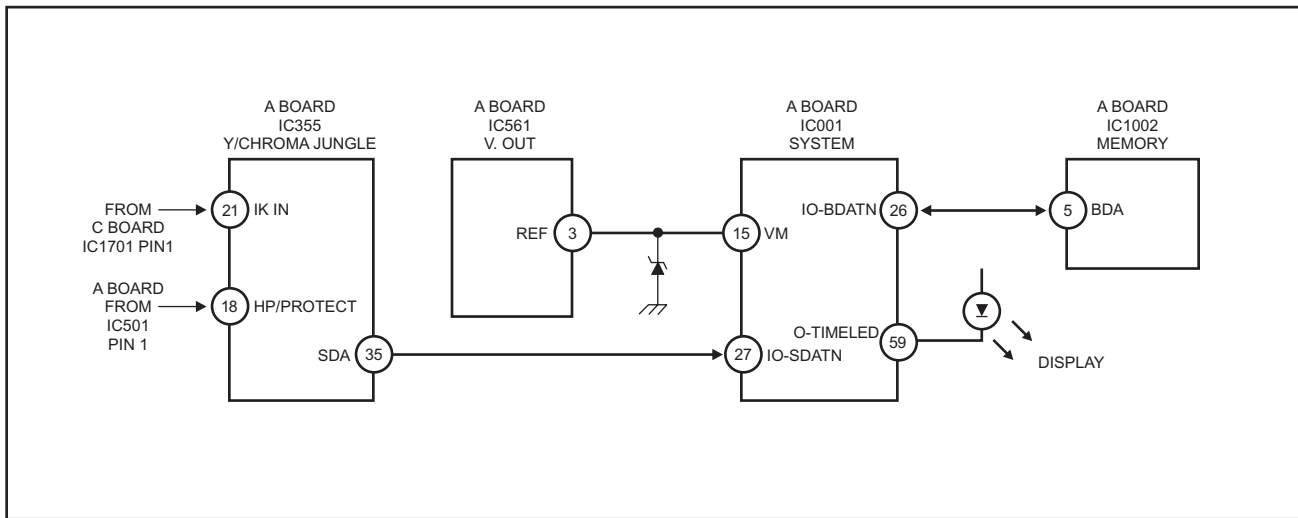

+B overcurrent (OCP)

Occurs when an overcurrent on the +B (135V) line is detected by pin 18 of IC355 (A Board). If the voltage of pin 18 of IC355 (A Board) is less than 1V when V.SYNC is more than seven verticals in a period, the unit will automatically turn off.

+B overvoltage (OVP)

Occurs when the feedback circuit from +B opens IC643 or T603 or any other associated feedback components.

V-Stop

Occurs when an absence of the vertical deflection pulse is detected by pin 15 of IC355 (A Board). Power supply will shut down when waveform interval exceeds 2 seconds.

IK (AKB)

If the RGB levels* do not balance within 2 seconds after the power is turned on, this error will be detected by IC355 (A Board). TV will stay on, but there will be no picture.

*(Refers to the RGB levels of the AKB detection Ref pulse that detects 1K).

NOTE:

Watch Dog Timer

Indicates how many times the Watch Dog Timer functions have been activated. Whenever micro is reset by the Watch Dog Timer, this number is incremented. Maximum number is 255.

SAFETY CHECK-OUT

After correcting the original service problem, perform the following safety checks before releasing the set to the customer:

1. Check the area of your repair for unsoldered or poorly soldered connections. Check the entire board surface for solder splashes and bridges.
2. Check the interboard wiring to ensure that no wires are "pinched" or touching high-wattage resistors.
3. Check that all control knobs, shields, covers, ground straps, and mounting hardware have been replaced. Be absolutely certain that you have replaced all the insulators.
4. Look for unauthorized replacement parts, particularly transistors, that were installed during a previous repair. Point them out to the customer and recommend their replacement.
5. Look for parts which, though functioning, show obvious signs of deterioration. Point them out to the customer and recommend their replacement.
6. Check the line cords for cracks and abrasion. Recommend the replacement of any such line cord to the customer.
7. Check the B+ and HV to see if they are specified values. Make sure your instruments are accurate; be suspicious of your HV meter if sets always have low HV.
8. Check the antenna terminals, metal trim, "metallized" knobs, screws, and all other exposed metal parts for AC leakage. Check leakage as described below.

Leakage Test

The AC leakage from any exposed metal part to earth ground and from all exposed metal parts to any exposed metal part having a return to chassis, must not exceed 0.5 mA (500 microamperes). Leakage current can be measured by any one of three methods.

1. A commercial leakage tester, such as the Simpson 229 or RCA WT-540A. Follow the manufacturers' instructions to use these instructions.
2. A battery-operated AC milliammeter. The Data Precision 245 digital multimeter is suitable for this job.
3. Measuring the voltage drop across a resistor by means of a VOM or battery-operated AC voltmeter. The "limit" indication is 0.75 V, so analog meters must have an accurate low voltage scale. The Simpson's 250 and Sanwa SH-63TRD are examples of passive VOMs that are suitable. Nearly all battery-operated digital multimeters that have a 2 VAC range are suitable (see Figure A).

How to Find a Good Earth Ground

A cold-water pipe is a guaranteed earth ground; the cover-plate retaining screw on most AC outlet boxes is also at earth ground. If the retaining screw is to be used as your earth ground, verify that it is at ground by measuring the resistance between it and a cold-water pipe with an ohmmeter. The reading should be zero ohms. If a cold-water pipe is not accessible, connect a 60- to 100-watt trouble- light (not a neon lamp) between the hot side of the receptacle and the retaining screw. Try both slots, if necessary, to locate the hot side on the line; the lamp should light at normal brilliance if the screw is at ground potential (see Figure B).

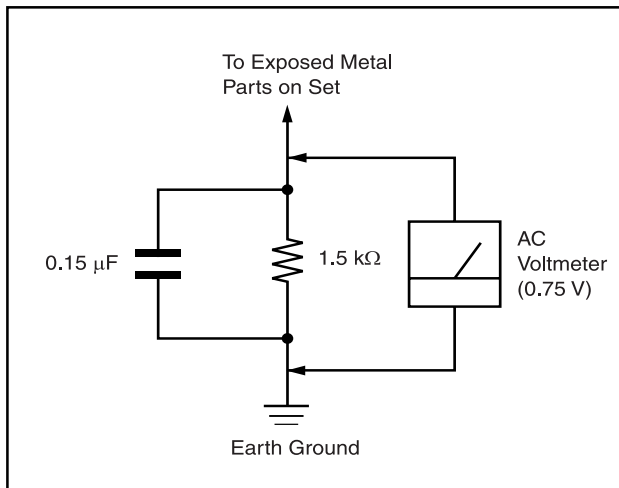

Figure A. Using an AC voltmeter to check AC leakage.

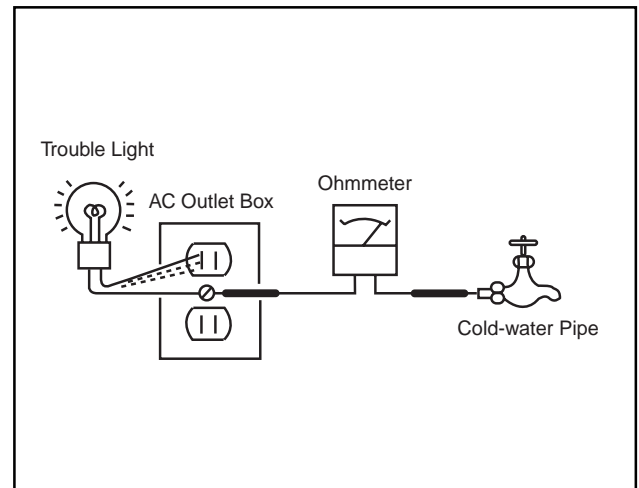

Figure B. Checking for earth ground.

The instructions mentioned here are partial abstracts from the Operating Instruction Manual.
The page numbers shown reflect those of the Operating Instruction Manual.

Installing the TV

Overview

This chapter includes illustrated instructions for setting up your TV:

Topic	Page
Connecting a Cable or Antenna	6
Connecting a VCR and Cable	9
Connecting a VCR and Cable Box	10
Connecting Two VCRs for Tape Editing	11
Connecting a Satellite Receiver	12
Connecting a Satellite Receiver with a VCR	13
Connecting an Audio Receiver	14
Connecting a DVD Player with Component Video Connectors	15
Connecting a DVD Player with A/V Connectors	16
Connecting a Camcorder	17
Using the CONTROL S Feature	18
Setting Up the TV Automatically	18

Note About the AC Power Cord

The AC power cord is attached to the rear of the TV with hooks. Use caution when removing the AC plug from its holder. Gently slide the cord in the upward direction, without removing the cord from the two lower hooks.

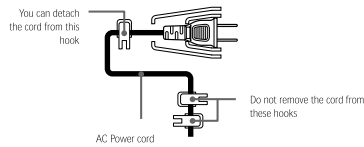

5

Installing the TV

Connecting a Cable or Antenna

Connecting Directly to Cable or an Antenna

The connection you choose depends on the cable found in your home. Newer homes are equipped with standard coaxial cable (see); older homes probably have 300-ohm twin lead cable (see); still other homes may contain both (see).

VHF Only or VHF/UHF or Cable

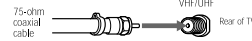

VHF Only or UHF Only or VHF/UHF

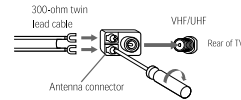

VHF and UHF

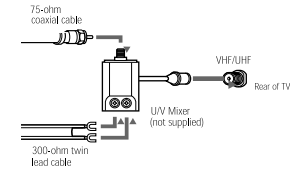

6

Installing the TV

Cable and Antenna

If your cable provider does not feature local channels, you may find this set up convenient.

This connection applies to all models except KV-36FS12.

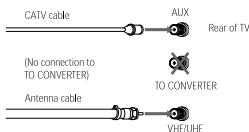

Select CABLE or antenna (ANT) mode by pressing ANT on the remote control.

In order to receive channels with an antenna, you need to turn your Cable to OFF and perform the Auto Program function (see page 29).

Cable Box Connections

Some pay cable TV systems use scrambled or encoded signals that require a cable box to view all channels.

Cable Box

- 1 Connect the coaxial connector from your cable service to the cable box's IN jack.
- 2 Using a coaxial cable, connect the cable box's OUT jack to the TV's VHF/UHF jack.

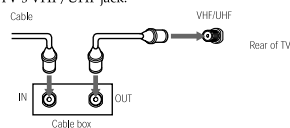

If you will be controlling all channel selection through your cable box, you should consider using the Channel Fix feature (see page 29).

7

Installing the TV

Cable Box and Cable

For this set up, you can switch between scrambled channels (through your cable box), and normal (CATV) channels by pressing ANT on the remote control.

This connection applies to all models except KV-36FS12.

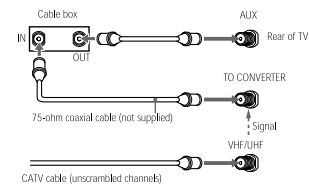

Your Sony remote control can be programmed to operate your cable box (see "Programming the Remote Control" on page 42).

When using Favorite Channel or PIP, you cannot view the AUX input in the window picture.

Pressing ANT switches between these inputs.

If you are connecting a cable box through the AUX input and would like to switch between the AUX and normal (CATV) input you should consider using the Channel Fix feature (see page 29).

8

Installing the TV

Connecting a VCR and Cable

- 1 Connect the cable TV cable to the VCR's IN jack.
- 2 Using a coaxial cable, connect the VCR's OUT jack to the TV's VHF/UHF jack.
- 3 Using an A/V cable, connect the VCR's A/V OUT jacks to the TV's A/V IN jacks.

If your VCR has an S VIDEO jack: For best picture quality, use an S VIDEO connection instead of the yellow video cable on your combined A/V cable. Using an S VIDEO cable, connect the VCR's S VIDEO OUT jack to the TV's S VIDEO IN jack. S VIDEO does not provide audio, so audio cables must still be connected to provide sound.

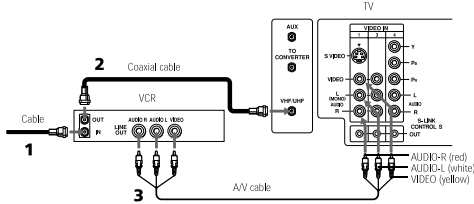

9

Installing the TV

Connecting a VCR and Cable Box

This connection applies to all models except KV-36FS12.

- 1 Connect your incoming cable connection to the TV's VHF/UHF jack.
- 2 Using a coaxial cable, connect the cable box's IN jack to the TV's TO CONVERTER jack.
- 3 Using a coaxial cable, connect the cable box's OUT jack to the VCR's VHF/UHF IN jack.
- 4 Using an A/V cable, connect the VCR's A/V OUT jacks to the TV's A/V IN jacks.

If your VCR has an S VIDEO jack: For best picture quality, use an S VIDEO connection instead of the yellow video cable on your combined A/V cable. Using an S VIDEO cable, connect the VCR's S VIDEO OUT jack to the TV's S VIDEO IN jack. S VIDEO does not provide audio, so audio cables must still be connected to provide sound.

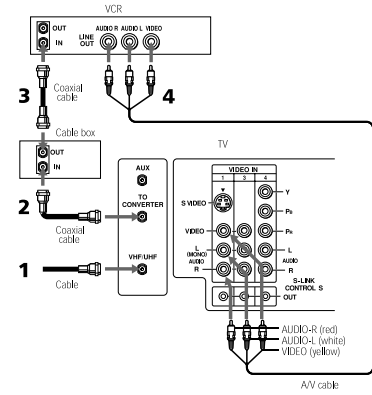

10

Installing the TV

Connecting Two VCRs for Tape Editing

This connection applies to all models except KV-36FS12 and 36FS16.

If you connect two VCRs, you can use the TV's MONITOR OUT feature to perform tape-to-tape editing. In the connection shown below, the TV functions as a monitor and sends the program being played by the playback VCR to the recording VCR.

- 1 Connect the VCR intended for playback using the connection instructions on page 10 of this manual.
- 2 Using A/V connectors, connect AUDIO and VIDEO IN on the VCR intended for recording to MONITOR AUDIO and VIDEO OUT on your TV.

You cannot record signals from equipment connected to the Y, Pa, Pb input.

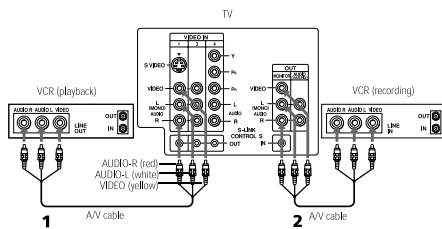

To perform tape editing, set the TV to the video input intended for playback by pressing the TV/VIDEO button on the remote control.

11

Installing the TV

Connecting a Satellite Receiver

- 1 Connect the satellite antenna cable to the satellite receiver's SATELLITE IN jack.
- 2 Using an A/V cable, connect the satellite receiver's A/V OUT jacks to the TV's A/V IN jacks.
- 3 Connect a coaxial cable from your cable or antenna to TV's VHF/UHF jack.

If your satellite receiver has an S VIDEO jack: For best picture quality, use an S VIDEO connection instead of the yellow video cable on your combined A/V cable. Using an S VIDEO cable, connect the satellite receiver's VIDEO OUT jack to the TV's S VIDEO IN jack. S VIDEO does not provide audio, so audio cables must still be connected to provide sound.

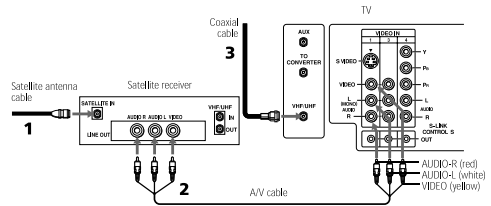

12

Installing the TV

Connecting a Satellite Receiver with a VCR

- 1 Connect the satellite antenna cable to the satellite receiver's SATELLITE IN jack.
- 2 Connect the CATV cable to the VCR's VHF/UHF IN jack.
- 3 Using a coaxial cable, connect the VCR's OUT jack to the TV's VHF/UHF jack.
- 4 Using an A/V cable, connect the satellite receiver's A/V OUT jacks to the VCR's A/V IN jacks.
- 5 Using an A/V cable, connect the VCR's A/V OUT jacks to the TV's A/V IN jacks.

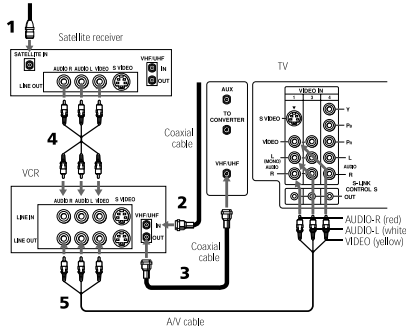

13

Installing the TV

Connecting an Audio Receiver

- 1 Using audio cables, connect the TV's AUDIO OUT jacks to the audio receiver's audio LINE IN jacks.

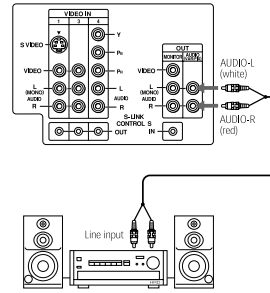

14

Installing the TV

Connecting a DVD Player with Component Video Connectors

- 1 Using three separate component video cables, connect the DVD player's Y, Pb, and Pr jacks to the TV's Y, Pb, and Pr jacks on the TV.

The Y, Pb, and Pr jacks on your DVD player are sometimes labeled Y, Cb, and Cr, or Y, B-Y, and R-Y. If so, connect the cables to like colors.

The Y, Pb, and Pr jacks do not provide audio, so audio cables must be connected to provide sound.

- 2 Using an audio cable, connect the DVD player's audio OUT jacks to the TV's audio IN jacks.

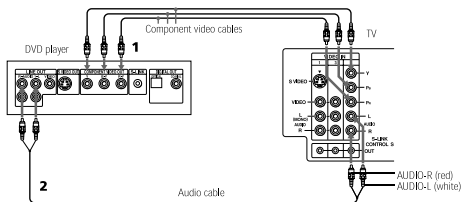

15

Installing the TV

Connecting a DVD Player with A/V Connectors

If your DVD player has video component output connectors: for best picture quality use the connection described on page 15.

- 1 Using audio cables, connect the DVD player's audio OUT jacks to the TV's audio IN jacks.
- 2 Using an S-VIDEO cable, connect the DVD player's S-VIDEO jack to the TV's S-VIDEO jack.

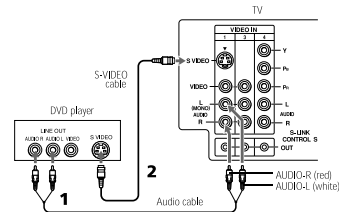

16

Installing the TV

Connecting a Camcorder

- Using A/V cables, connect the camcorder's A/V OUT jacks to the TV's A/V IN jacks.

If you have a mono camcorder, connect its left audio output to the TV's AUDIO L jack. For easy connection of the camcorder, the TV has front A/V inputs (shown below). However, if you prefer, you can also connect the camcorder to the TV's rear A/V IN jacks.

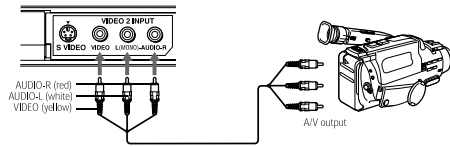

Installing the TV

Using the CONTROL S Feature

This CONTROL S feature applies to all models except KV-36FS12 and 36FS16.

CONTROL S allows you to control your TV system and other Sony equipment with one remote control.

To control your other Sony equipment with your TV's remote control, use a CONTROL S cable (not supplied) to connect the equipment's CONTROL S IN jack to the TV's CONTROL S OUT jack.

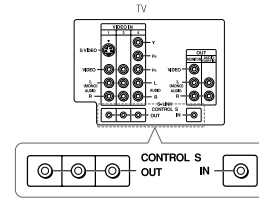

Setting Up the TV Automatically

After you finish connecting your TV, you need to run Auto Setup to set up your channels.

The Auto Setup feature does not apply for installations that use a cable box for all channel selection.

Using Auto Setup

- Press POWER to turn on the TV. The first time you turn on the TV, the Auto Setup screen appears.
- Press CH+ to run Auto Setup or press CH- to exit.

You can run Auto Program again by selecting it in the Channel menu, as described on page 29.

- To reset your TV to factory settings, turn the TV on. Then, while pressing the RESET button on the remote control, press the POWER button on the TV. The TV will turn itself off, then back on.

Other Information

TV Controls and Connectors

Front Panel Menu Controls

The front panel menu controls allow access to the on-screen menus without the use of a remote control. Pressing the MENU button brings up the on-screen menus. The arrow buttons () move the on-screen cursor in the menus and the (+) button selects the menu item.

TV Rear Panel

Model KV-36FS12

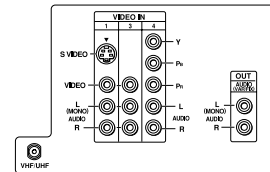

Model KV-36FS16

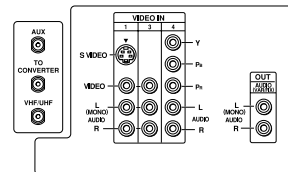

Other Information

Models KV-32FV16, 32FV26, 36FV16 and 36FV26

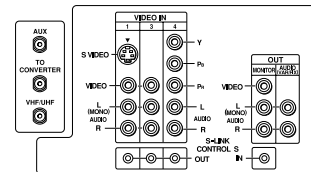

Back Panel Descriptions

Connection	Description
AUX (except KV-36FS12)	Allows you to view local (terrestrial) and cable channels if your cable provider does not feature local channels. You can switch between local and cable channels easily by pressing ANT on the remote control.
TO CONVERTER (except KV-36FS12)	Lets you set up your TV to switch between scrambled channels (through a cable box), and normal cable channels (CATV).
VHF/UHF	Connects to your VHF/UHF antenna or cable.
S VIDEO	Connects to the S VIDEO OUT jack of your VCR or other S VIDEO equipped video component.
MONITOR OUT (except models KV-36FS12 and 36FS16)	Lets you record the program you're watching to a VCR. When two VCRs are connected, (see page 11), you can use your TV as a monitor for tape to tape editing.
AUDIO (L/R)/VIDEO	Connects to the audio and video OUT jacks on your VCR or other video component. A third video input (VIDEO 2) is located on the front panel of the TV.
AUDIO OUT (VAR/FIX) L (MONO)/R	Connects to the right and left audio inputs of your audio or video component.
S-LINK CONTROL-S IN/OUT (except models KV-36FS12 and 36FS16)	Allows the TV to receive (IN) and send (OUT) remote control signals to other Sony infrared-controlled audio or video components.
Y, Pb, Pr, L, R	Connects to your DVD player's component video (Y, Pb, Pr) and audio (L, R) jacks.

Other Information

Troubleshooting

Problem	Possible Remedies
No picture (screen not lit), no sound	<p>If your TV does not turn on, and a red light keeps flashing, your TV may need service. Call your local Sony Service Center.</p> <p>Make sure the power cord is plugged in.</p> <p>Push the power button on the front of the TV.</p> <p>Check to see if the TV /VIDEO setting is correct: when watching TV, set to TV, and when watching connected equipment, set to VIDEO 1, 2, 3, or 4.</p> <p>Try another channel. It could be station trouble.</p>
Remote control does not operate	<p>Batteries could be weak. Replace the batteries.</p> <p>Press TV (FUNCTION) when operating your TV.</p> <p>Make sure the TV's power cord is connected securely to the wall outlet.</p> <p>Locate the TV at least 3-4 feet away from fluorescent lights.</p> <p>Check the orientation of the batteries.</p>
Dark, poor or no picture (screen lit), good sound	<p>Adjust the Picture setting in the Video menu (see page 26).</p> <p>Adjust the Brightness setting in the Video menu (see page 26).</p> <p>Check antenna/cable connections.</p>
Good picture, no sound	<p>Press MUTING so that "MUTING" disappears from the screen (see page 40).</p> <p>Make sure Speaker is set to ON in the Audio menu (see page 27).</p>
Cannot receive upper channels (UHF) when using an antenna	<p>Change Cable to Off (see page 29).</p> <p>Use Auto Program in the Channel menu to add receivable channels that are not presently in TV memory (see page 29).</p>
No color	<p>Adjust the Color settings in the Video menu (see page 26).</p>
Only snow and noise appear on the screen	<p>Check the antenna/cable connections.</p> <p>Make sure the channel is broadcasting programs.</p> <p>Press ANT to change the input mode (see page 40).</p>
Dotted lines or stripes	<p>Adjust the antenna.</p> <p>Move the TV away from noise sources such as cars, neon signs, or hair-dryers.</p>
TV is fixed to one channel	<p>Use Auto Program in the Channel menu to add receivable channels that are not presently in TV memory (see page 29).</p> <p>Check your Channel Fix settings (see page 29).</p>
Double images or ghosts	<p>Use a highly directional outdoor antenna or a cable (when the problem is caused by reflections from nearby mountains or tall buildings).</p>
Cannot operate menu	<p>If the item you want to choose appears in gray, you cannot select it.</p>
Cannot receive any channels when using cable TV	<p>Use Auto Program in the Channel menu to add receivable channels that are not presently in TV memory (see page 29).</p> <p>Check your cable settings.</p> <p>Make sure Cable is set to ON in the Channel menu (see page 29).</p>

Other Information

Problem	Possible Remedies
Cannot gain enough volume when using a cable box	<p>Increase the volume of the cable box using the cable box's remote control. Then press TV (FUNCTION) and adjust the TV's volume.</p>
Cannot receive channels	<p>Use Auto Program in the Channel menu to add receivable TV channels that are not presently in TV memory (see page 29).</p>
Unable to select a channel	<p>Use Auto Program in the Channel menu to add receivable TV channels that are not presently in TV memory (see page 29).</p>
Lost password	<p>In the password screen (see page 30), enter the following master password: 4357. The master password clears your previous password; it cannot be used to temporarily unblock channels.</p>

If, after reading these operating instructions, you have additional questions related to the use of your Sony television, please call our Direct Response Center at 1-800-222-SONY (7669) (U.S. residents only) or (416) 499-SONY (7669) (Canadian residents only).

SECTION 2 DISASSEMBLY

2-1. REAR COVER REMOVAL

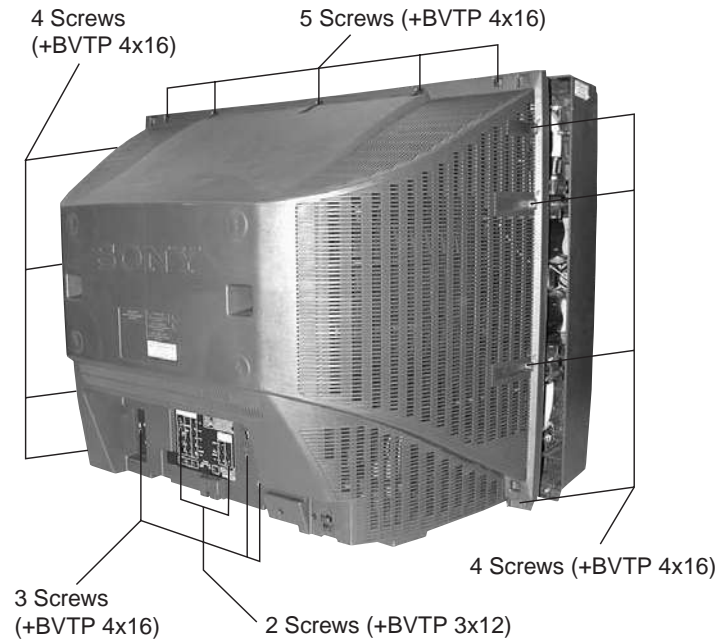

2-2. CHASSIS ASSEMBLY REMOVAL

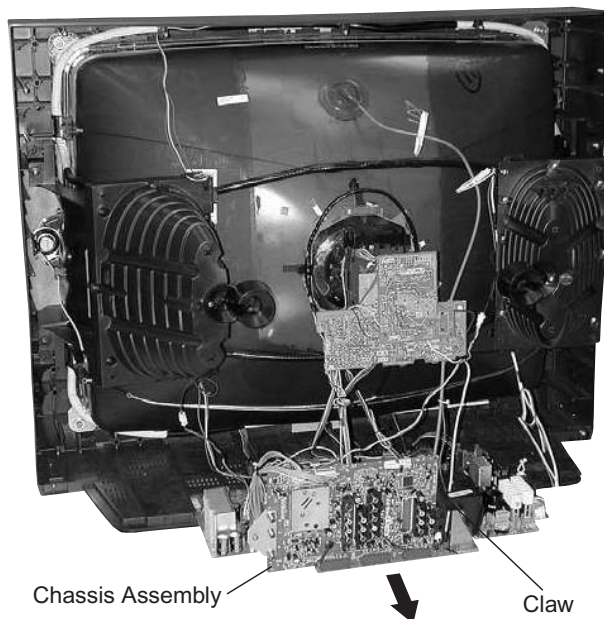

2-3. SERVICE POSITION

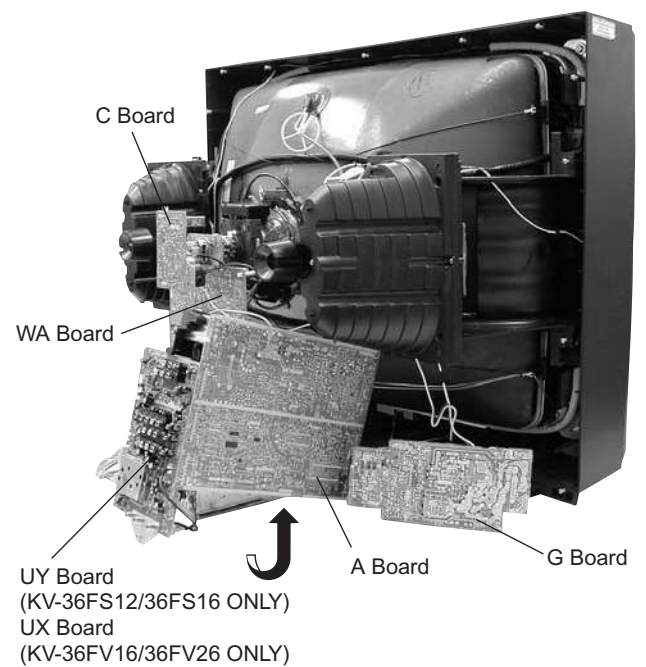

2-4. PICTURE TUBE REMOVAL

**WARNING:
BEFORE REMOVING
THE ANODE CAP**

High voltage remains in the CRT even after the power is disconnected. To avoid electric shock, discharge CRT *before* attempting to remove the anode cap. Short between anode and CRT coated earth ground strap.

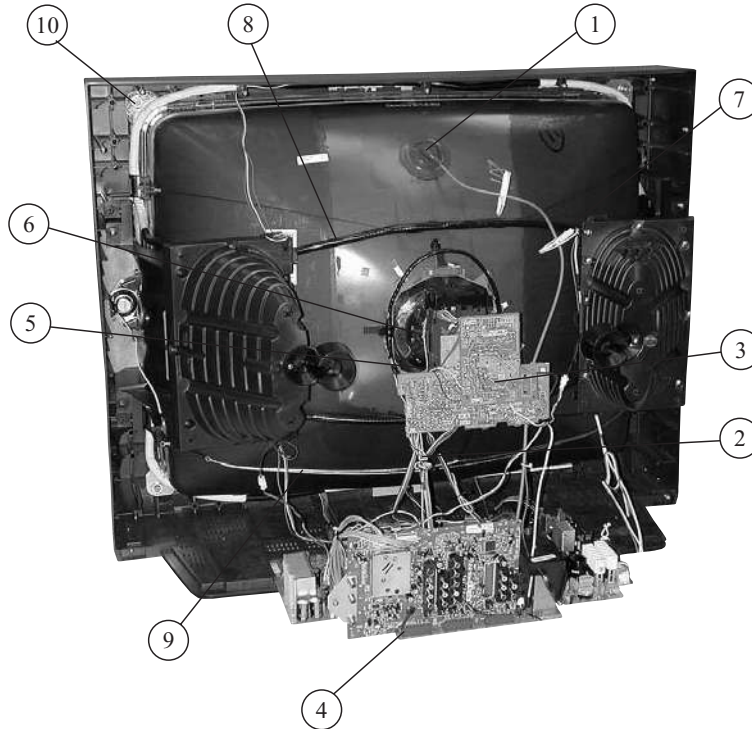
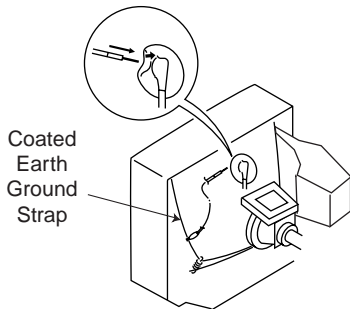

1. Discharge the anode of the CRT and remove the anode cap.
2. Unplug all interconnecting leads from the deflection yoke, neck assembly, degaussing coils and CRT grounding strap.
3. Remove the C Board from the CRT.
4. Remove the chassis assembly.
5. Loosen the neck assembly fixing screw and remove.
6. Loosen the deflection yoke fixing screw and remove.
7. Place the set with the CRT face down on a cushion and remove the degaussing coil holders.
8. Remove the degaussing coils.
9. Remove the CRT grounding strap and spring tension devices.
10. Unscrew the four CRT fixing screws [located on each CRT corner] and remove the CRT [Take care not to handle the CRT by the neck].

ANODE CAP REMOVAL

WARNING: High voltage remains in the CRT even after the power is disconnected. To avoid electrical shock, discharge the CRT *before* attempting to remove the anode cap. Short between anode and coated earth ground strap of CRT.

NOTE: After removing the anode, short circuit the anode of the picture tube and the anode cap to either the metal chassis, CRT shield, or carbon painted on the CRT.

REMOVAL PROCEDURES

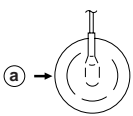

- ① Turn up one side of the rubber cap in the direction indicated by arrow (a).

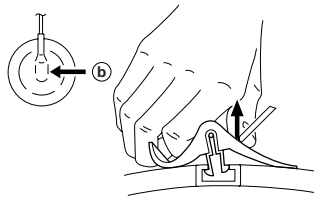

- ② Use your thumb to pull the rubber cap firmly in the direction indicated by arrow (b).

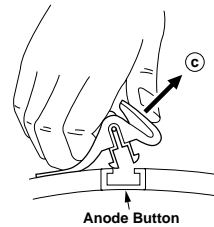

- ③ When one side of the rubber cap separates from the anode button, the anode cap can be removed by turning the rubber cap and pulling it in the direction of arrow (c).

HOW TO HANDLE AN ANODE CAP

- ① Do not use sharp objects which may cause damage to the surface of the anode cap.
- ② To avoid damaging the anode cap, do not squeeze the rubber covering too hard. A material fitting called a shatter-hook terminal is built into the rubber.
- ③ Do not force turn the foot of the rubber cover. This may cause the shatter-hook terminal to protrude and damage the rubber.

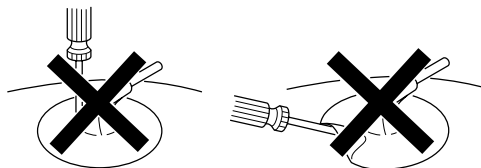

SECTION 3 SET-UP ADJUSTMENTS

The following adjustments should be made when a complete realignment is required or a new picture tube is installed.

These adjustments should be performed with rated power supply voltage unless otherwise noted.

The controls and switch should be set as follows unless otherwise noted:

PICTURE control normal

BRIGHTNESS control normal

Perform the adjustments in order as follows:

1. Beam Landing
2. Convergence
3. Focus
4. Screen (G2)/White Balance

Note: Test Equipment Required:

1. Color Bar Pattern Generator
2. Degausser
3. DC Power Supply
4. Digital Multimeter
5. Oscilloscope
6. CRT Analyzer

3-1. BEAM LANDING

Preparation:

- Input a white pattern signal.
- Face the picture tube in an East or West direction to reduce the influence of geomagnetism.

NOTE: Do not use the hand degausser because it magnetizes the CRT .

1. Input white pattern from pattern generator.
2. Loosen the deflection yoke mounting screw, and set the purity control to the center as shown below:

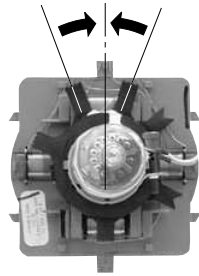

3. Input green pattern from pattern generator.
4. Move the deflection yoke backward, and adjust with the purity control so that green is in the center and red and blue are even on both sides.

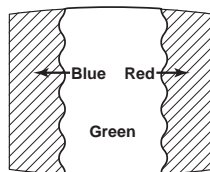

5. Move the deflection yoke forward, and adjust so that the entire screen becomes green.

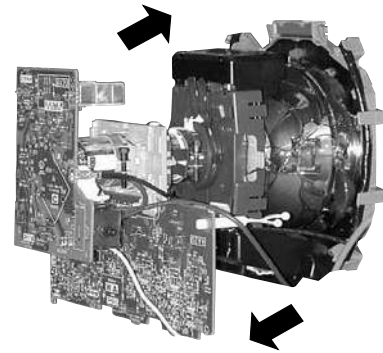

6. Switch over the raster signal to red and blue and confirm the condition.
7. When the position of the deflection yoke is determined, tighten it with the deflection yoke mounting screw.
8. When landing at the corner is not right, adjust by using the disk magnets.

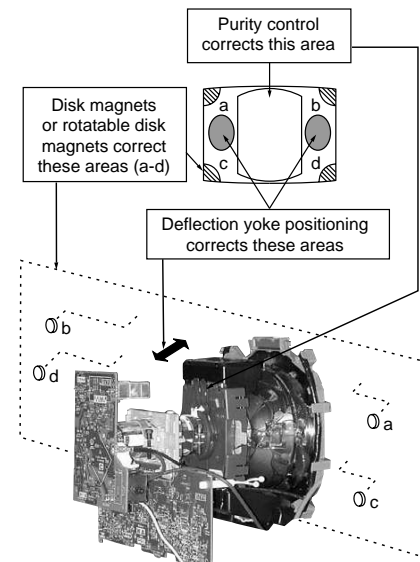

3-2. CONVERGENCE

Preparation:

- Perform FOCUS, V. LIN and V. SIZE adjustments.
- Set BRIGHTNESS control to minimum.
- Input dot pattern.

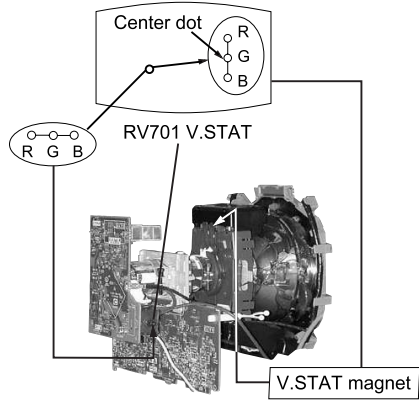

Vertical and Horizontal Static Convergence

1. Adjust V. STAT magnet to converge red, green and blue dots in the center of the screen (Vertical movement).

Tilt the V. STAT magnet and adjust static convergence to open or close the V. STAT magnet.

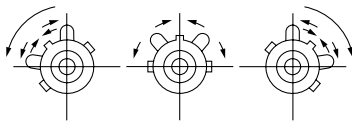

2. When the V. STAT magnet is moved in the direction of arrow a and b, red, green, and blue dots move as shown below:

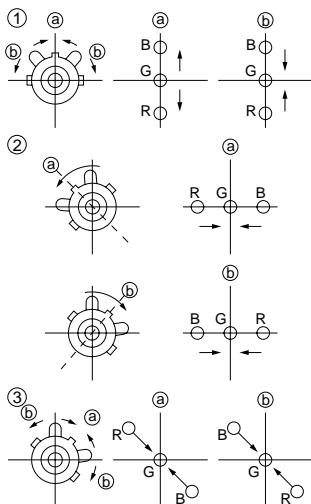

Operation of BMC (Hexapole) Magnet

The respective dot positions resulting from moving each magnet interact, so perform adjustment while tracking.

- 1 Use the V.STAT tabs to adjust the red, green, and blue dots so they line up at the center of the screen (move the dots in a horizontal direction).

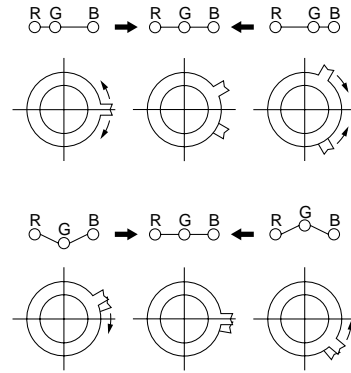

Y Separation Axis Correction Magnet Adjustment

1. Input cross-hatch pattern, adjust PICTURE to minimum and BRIGHTNESS to normal.
2. Adjust the deflection yoke upright so it touches the CRT.
3. Adjust so that the Y separation axis correction magnet on the neck assembly is symmetrical from top to bottom (open state).

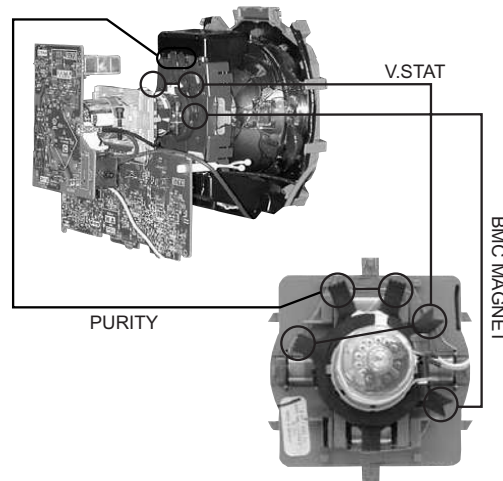

4. Return the deflection yoke to its original position.

Dynamic Convergence Adjustment

Before starting, perform Vertical and Horizontal Static Convergence Adjustment.

1. Slightly loosen deflection yoke screw.
2. Remove deflection yoke spacers.
3. Move the deflection yoke for best convergence as shown below:

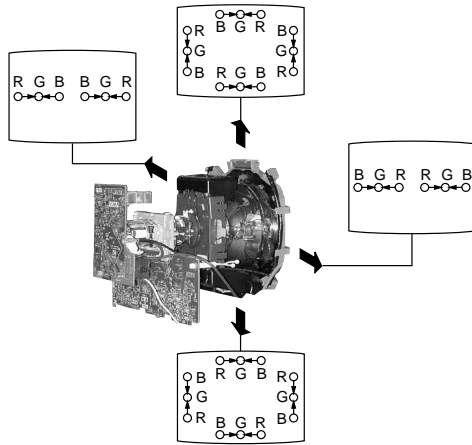

4. Tighten the deflection yoke screw.
5. Install the deflection yoke spacers.

Screen-corner Convergence

1. Affix a permalloy assembly corresponding to the misconverged areas:

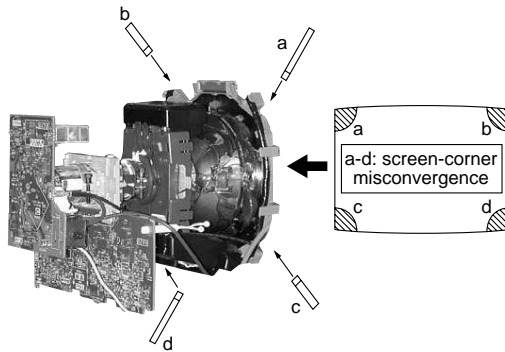

TLH Plate Adjustment

- Input crosshatch pattern.
- Adjust PICTURE QUALITY to standard, PICTURE and BRIGHTNESS to 50%, and OTHER to standard.
- Adjust the Horizontal Convergence of red and blue dots by tilting the TLH plate on the deflection yoke.

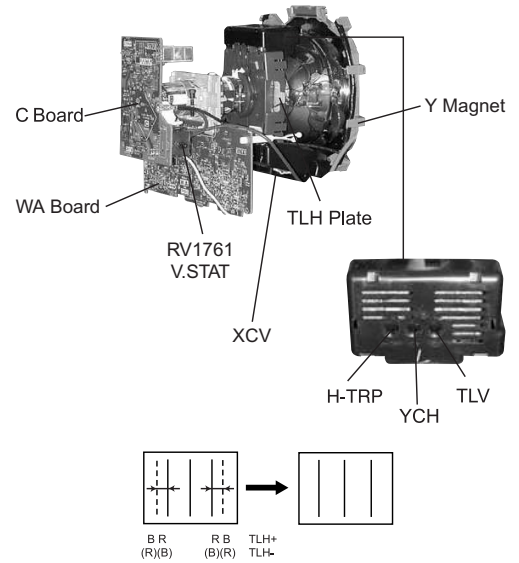

1. Adjust XCV core to balance X axis.
2. Adjust YCH VR to balance Y axis.
3. Adjust vertical red and blue convergence with V.TILT (TLV VR.)

Perform adjustments while tracking items 1 and 2.

4. Adjust Y MAGNET to correct V.BOW Geometry Distortion.
5. Adjust H-TRP to correct H.Trapezoid Geometry Distortion.

After adjusting items 4 and 5, confirm overall geometry again.

3-3. FOCUS

1. Input monoscope signal.
2. Set user controls to normal.
3. Set video mode to STANDARD.
4. Set the PICTURE to maximum.
5. Adjust at 325 Mark for best center/corner focus balance.
6. Receive an entire white signal. Make sure Magenta Ring is at an acceptable level.

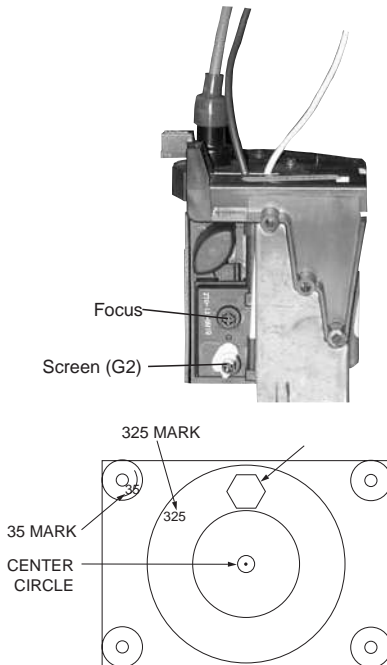

3-4. SCREEN (G2)

1. Input dot pattern from the pattern generator.
2. Set the user controls to NORMAL.
3. Attach the G2-Jig to the C Board.
5. Adjust RCUT, GCUT, BCUT, and SBRT in service mode with an oscilloscope so that voltages on the red, green, and blue cathodes are $170 \pm 2.0\text{Vdc}$.
5. Observe the screen and adjust SCREEN (G2) VR to obtain the faintly visible background of dot signal.
6. Push the TEST + JUMP (+ Channel) to cut off the signal. The screen should be bright or dark. Brightness of raster must be increased when adjusting.
7. Adjust screen VR until the screen is slightly cut off, or scarcely lights up. A signal cannot be seen when the brightness of the raster is high.
8. Push the JUMP again to release the cut off.

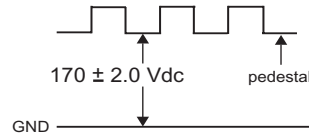

3-5. WHITE BALANCE ADJUSTMENTS

NO.	Disp.	Item	All Models
24	RDRV	Red Drive	*
25	GDRV	Green Drive	46
26	BDRV	Blue Drive	37
27	RCUT	Red Cut-off	14:Fix
28	GCUT	Green Cut-off	10
29	BCUT	Blue Cut-off	8
38	SBRT	Sub Bright	8

1. Set program palette to STANDARD and push RESET.
2. Input an entire white signal.
3. Set to Service Adjustment Mode.
4. Set the PICTURE and BRIGHT to minimum.
5. Adjust with SBRT if necessary.
6. Set RCUT to "14".
7. Select GCUT and BCUT with **1** and **4**.
8. Adjust with **3** and **6** for the best white balance.
9. Set the PICTURE and BRIGHT to maximum.
10. Select GDRV and BDRV with **1** and **4**.
11. Adjust with 3 and 6 for the best white balance.
12. Write into the memory by pressing **MUTING** then **ENTER**.
13. Repeat steps 1-12 for GDR4, BDR4, GCU4 and BCU4 using Video 4 input.

* Use values from Sub Contrast Adjustments



NOTE:

White balance should be adjusted after Sub Contrast because RDRV is also used in Sub Contrast Adjustment. (See page 27).

SECTION 4 SAFETY RELATED ADJUSTMENTS

4-1. R530, R531 CONFIRMATION METHOD (HOLD-DOWN CONFIRMATION) AND READJUSTMENTS

Always perform the following adjustments when replacing the following components marked with a  mark on the schematic diagram:

Part Replaced ()	Adjustment ()
R387, R550, R529, R530, R531, R532, R533, D519, D520, D521, IC501, C531, C532, T503, IC351, IC355, Q301, R356, R359, R361, D302 A Board	HV HOLD-DOWN R530, R531
IC643, R661 G Board	

Preparation before Confirmation

- Using a Variac, apply AC input voltage: $130 \pm 2.0 / -0.0$ VAC.
- Turn the POWER switch ON.
- Input a white signal and set the PICTURE and BRIGHT controls to maximum.
- Confirm that the voltage of more than 23.0 VDC appears between TP85 and ground on the A Board.

Hold-Down Operation Confirmation

- Connect the current meter between Pin 11 of the FBT (T503) and the PWB land where Pin 11 would normally attach (See Figure 1 above).
- Input a dot signal and set PICTURE and BRIGHTNESS to minimum: $IABL = 2175 + 100 / -325$ μ A.
- Confirm the voltage of A Board TP91 is 135 ± 1.5 VDC.
- Connect the digital voltmeter and the DC power supply to TP85 and ground. (See Figure 1 above).
- Increase the DC power voltage gradually until the picture blanks out.
- Turn DC power source off immediately.
- Read the digital voltmeter indication (standard = $27.24 + 0.0 / -0.1$ VDC).
- Input a white signal and set PICTURE and BRIGHTNESS to maximum: $IABL = 2175 + 100 / -325$ μ A.
- Repeat steps 4 to 7.

Hold-Down Readjustment



If the setting indicated in Step 2 of Hold-Down Operation Confirmation cannot be met, readjustment should be performed by altering the resistance value of R530, R531 component marked with  .

Figure 1

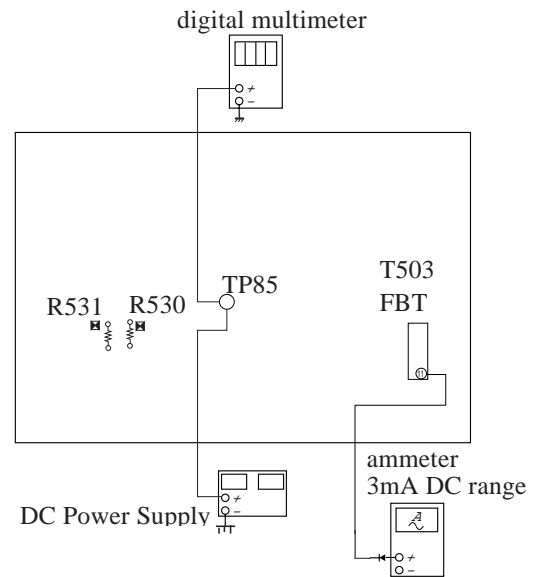

4-2. B+ VOLTAGE CONFIRMATION AND ADJUSTMENT

Note: The following adjustments should always be performed when replacing the following components, which are marked with  on the schematic diagram on the G Board.

G BOARD: IC643, R661

- Using a Variac, apply AC input voltage: $130 + 2.0 / -0.0$ VAC
- Input a monoscope signal.
- Set the PICTURE control and the BRIGHT control to initial reset value.
- Confirm the voltage of G Board CN641 between pin ① to ground is less than 136.5 VDC.
- If step 4 is not satisfied, replace the R661 and repeat the above steps.

SECTION 5 CIRCUIT ADJUSTMENTS

ELECTRICAL ADJUSTMENTS BY REMOTE COMMANDER

Use the Remote Commander (RM-Y168, RM-Y169, RM-Y170, RM-Y171) to perform the circuit adjustments in this section.

NOTE: Test Equipment Required:

- Pattern generator
- Frequency counter
- Digital multimeter
- Audio oscillator

5-1. SETTING THE SERVICE ADJUSTMENT MODE

1. Standby mode (Power off).
2. Press **Display** → Channel **5** → Sound volume **+** → Power on the Remote Commander (Press each button within a second).

Service Adjustment Mode In

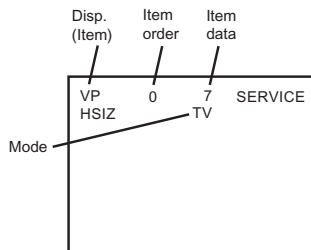

3. The CRT displays the item being adjusted.
4. Press **1** or **4** on the Remote Commander to select the item.
5. Press **3** or **6** on the Remote Commander to change the data.
6. Press **MUTING** then **ENTER** to write into memory.

Service Adjustment Mode Memory

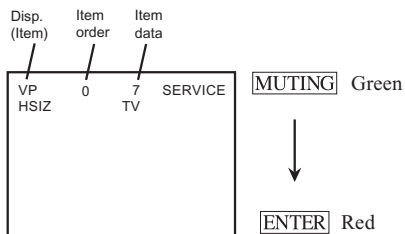

7. Press **8** then **ENTER** on the Remote Commander to initialize.

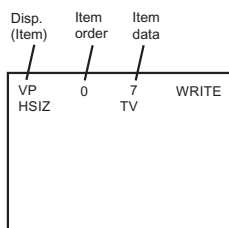

Carry out step 7 when adjusting IDs 0 to 7 and when replacing and adjusting IC002.

8. DO NOT turn off set until SERVICE appears.

5-2. MEMORY WRITE CONFIRMATION METHOD

1. After adjustment, pull out the plug from the AC outlet, then replace the plug in the AC outlet again.
2. Turn the power switch ON and set to Service Mode.
3. Call the adjusted items again to confirm they were adjusted.

5-3. ADJUST BUTTONS AND INDICATOR

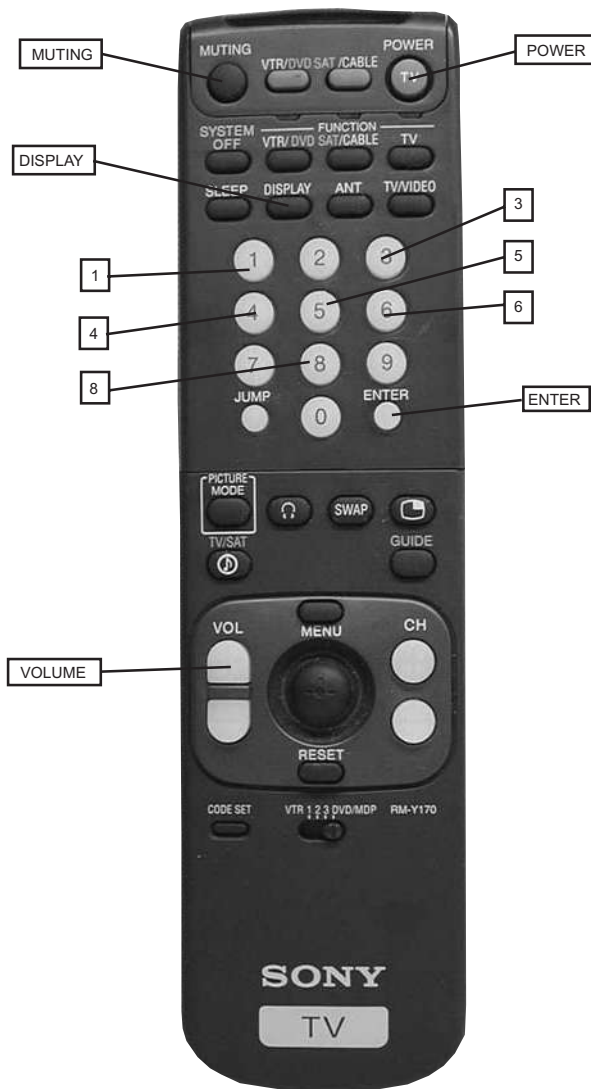

RM-Y170

5-4. ADJUSTMENT ITEMS

Register Name	Description	Data Range	Adj/Fix	Initial Data	36" Average Data			Comments
					FS	FV16	FV26	
0	HPOS	H-Position	0-63	Adj	7		9	0: 2ms delay, 63: 2ms advance
1	HSIZ	H-Size	0-63	Adj	10		15	EW DC bias, 0: -0.5V, 31: 0V, 63: +0.5V
2	VBOW	AFC Bow	0-15	Adj	6		7	0: top/bottom delay 900ns, 7: center, 15: top/bottom advance 900ns
3	VANG	AFC Angle	0-15	Adj	5		5	0: top delay/bottom advance 650ns, 7: center, 15: top advance/bottom delay 650ns
4	TRAP	Trapezium Adjustment	0-15	Adj	6		8	0: 1.5ms advance, 15: 1.5ms delay
5	PAMP	Pin Compensation	0-63	Adj	32		30	0: 0.15Vpp, 31: 0.7Vpp, 63: 1.3Vpp
6	UCPN	Upper Corner Pin	0-63	Adj	36		35	0: -0.4V, 63: +0.4V
7	LCPN	Lower Corner Pin	0-63	Adj	36		35	0: -0.4V, 63: +0.4V
8	VSIZ	V-Size	0-63	Adj	0		7	0: -15%, 31: 0%, 63: +15%
9	VPOS	V-Position	0-63	Adj	31		39	0: -0.1V, 31: 0V, 63: +0.1V
10	VLIN	V-Linearity	0-15	Adj	7		6	0: 85% top enlarged, 7: 100% top normal, 15: 115% top compressed
11	VSCO	S-Correction	0-15	Adj	7		9	0: 0V added to VD, 15: 100mVpp added to VD
12	VZOM	16:9 CRT Zoom Mode On/Off	0,1	FIX	0		0	0: Zoom Off, 1: Zoom On (top/bottom cut by 25% when ASPECT=31, RGB blanked in this interval)
13	EHT	Vertical Size High Voltage Correction	0-15	FIX	4		4	0: Picture adjusted 0%, 15: Picture Adjusted -5%
14	ASP	Aspect Ration Control 4:3 Mode	0-63	FIX	47		47	0: 75%(16x9 CRT Full), 31: 100%(4x3 CRT Full), 63: 110%
15	ASP1	Aspect Ration Control 16:9 Mode	0-63	FIX	47		47	0: 75%(16x9 CRT Full), 31: 100%(4x3 CRT Full), 63: 110%
16	SCRL	16:9 Vertical Scroll During Zoom	0-63	FIX	31		31	0: Scrolled toward top 32H, 63: Scrolled toward bottom 32H
17	HBSW	H Blanking Switch	0,1	FIX	1		1	0: OFF, 1: ON
18	LBLK	Left Blanking	0-15	FIX	15		15	0: +1.2ms, 7: Center, 15: -1.2ms
19	RBLK	Right Blanking	0-15	FIX	0		0	0: +1.2ms, 7: Center, 15: -1.2ms
20	HDW	H Drive Pulse Width	0,1	FIX	1		1	0: Normal Mode (25ms), 1: Narrow Pulse Width
21	EWDC	EW/DC Display 4x3 on 16x9 CRT	0,1	FIX	0		0	0: OFF, 1: ON
22	LVLN	Picture Bottom Lin Adjust	0-15	Adj	0		0	0: 100%, 15: 85% Picture top compressed
23	UVLN	Picture Top Lin Adjust	0-15	Adj	0		0	0: 100%, 15: 85% Picture bottom compressed
24	RDRV	Red Drive	0-63	Adj	31		54	0: 1.5Vpp, 63: 3.0Vpp Red Signal Output
25	GDRV	Green Drive	0-63	Adj	31		46	0: 1.5Vpp, 63: 3.0Vpp Green Signal Output
26	BDRV	Blue Drive	0-63	Adj	31		37	0: 1.5Vpp, 63: 3.0Vpp Blue Signal Output
27	RCUT	Red Cutoff	0-15	FIX	7		14	0: 3.5mA IK, 7: 13mA IK, 15: 22.7mA IK
28	GCUT	Green Cutoff	0-15	Adj	7		10	0: 3.5mA IK, 7: 13mA IK, 15: 22.7mA IK
29	BCUT	Blue Cutoff	0-15	Adj	7		8	0: 3.5mA IK, 7: 13mA IK, 15: 22.7mA IK
30	RDR4	Video 4 Red Drive	0-63	Adj	31		44	0: 1.5Vpp, 63: 3.0Vpp Red Signal Output
31	GDR4	Video 4 Green Drive	0-63	Adj	31		36	0: 1.5Vpp, 63: 3.0Vpp Green Signal Output
32	BDR4	Video 4 Blue Drive	0-63	Adj	31		29	0: 1.5Vpp, 63: 3.0Vpp Blue Signal Output
33	RCU4	Video 4 Red Cutoff	0-15	FIX	7		14	0: 3.5mA IK, 7: 13mA IK, 15: 22.7mA IK
34	GCU4	Video 4 Green Cutoff	0-15	Adj	7		14	0: 3.5mA IK, 7: 13mA IK, 15: 22.7mA IK
35	BCU4	Video 4 Blue Cutoff	0-15	Adj	7		10	0: 3.5mA IK, 7: 13mA IK, 15: 22.7mA IK
36	SBRT	Sub Brightness	0-31	Adj	15		8	Sub Brightness
37	RON	Red Off	0,1	FIX	1		1	0:OFF, 1:ON
38	GON	Green Off	0,1	FIX	1		1	0:OFF, 1:ON
39	BON	Blue Off	0,1	FIX	1		1	0:OFF, 1:ON
40	AXPL	Axis PAL	0,1	FIX	0		0	0: Normal Axis, 1: Forced PAL Asix
41	CBPF	Chroma BPF On/Off	0,1	FIX	1		1	0: BPF OFF, 1: BPF ON
42	COFF	Color On/Off	0,1	FIX	0		0	0: Chroma OFF, 1: Chroma ON
43	TSSP	Sub Sharpness for TV Input	0-15	Fix by model	6	5	6	0=-12dB, 7=+3.5dB, 15=+9dB
44	TSPF	Sharpness fo for TV Input	0,1	FIX	1		1	0=2.5MHZ, 1=3.0MHZ
45	VSSP	Sub Sharpness for Video Input	0-15	Fix by model	7	6	7	0=-12dB, 7=+3.5dB, 15=+9dB
46	VSPF	Sharpness fo for Video Input	0,1	FIX	1		1	0=2.5MHZ, 1=3.0MHZ
47	YSSP	Sub Sharpness for YUV Input	0-15	Fix by model	7	6	7	0=-12dB, 7=+3.5dB, 15=+9dB

VP
CXAX131AS

ADJUSTMENT ITEMS (cont.)

Register Name	Description	Data Range	Adj/Fix	Initial Data	36" Average Data			Comments
					FS	FV16	FV26	
48	YSPF	VP CXA2131AS	Sharpness fo for YUV Input	0,1	FIX	1	1	0=2.5MHZ, 1=3.0MHz
49	AXNT		Axis NTSC	0,1	FIX	0	0	0: Japan Axis, 1: US Axis
50	PREL		Pre/Overshoot Ratio	0,1	FIX	1	1	0: 1:1, 1: 2:1
51	DCT		DC Transmission Ratio	0,1	FIX	1	1	0:100%, 1:85%
52	ABLM		ABL Mode	0,1	FIX	1	1	0:Picture ABL, 1:Picture/Brightness ABL
53	FSC		FSC Output On/Off	0,1	FIX	1	1	0: FSC output OFF, 1: FSC output ON
54	HOSC		H VCO Frequency Adjustment	0-15	FIX	7	12	0: Low, 15: High (40 Hz Steps)
55	VSS		Vsync Slice Level	0,1	FIX	0	1	0: 1/3 from sync tip, 1: 1/4 from sync tip
56	HSS		Hsync Slice Level	0,1	FIX	0	1	0: 1/3 from sync tip, 1: 1/4 from sync tip
57	HMSK		Macrovision Countermeasure	0,1	FIX	1	1	0: Off, 1: ON
58	VTMS		Select Signal VTIM Pin	0-3	FIX	0	0	0: V retrace timing, 1: Hsync signal, 2: Vsync signal, 3: don't use
59	AFC		AFC	0-3	FIX	0	0	0: High Gain, 1: Medium Gain, 2: don't use, 3: Extremely low gain
60	REFP		REFP	0,1	FIX	0	0	0: R=20H/G=21H/B=22H, 1: R=23H/G=24H/B=25H
61	VBSW		VBLK Width Control	0-3	FIX	0	0	0: 9H from B, 1: 10H from B, 2: 11H from B, 3:12H from B (When JUMP SW=1)
62	BKOF	ABL Signal Detection Level	0,1	FIX	0	0	0: VTH=3V, 1: VTH=1V	
63	AGN2	Aging Mode 2 - Black Output Mode	0,1	FIX	0	0	0: Black Output Mode OFF, 1: Black Output Mode ON	
0	SREF	AP BH3868	Surround Effect	0-15	FIX	7	7	0: Min, 15: Max (8-15 LOOP=1)
1	BBLP		BBE Low PAss	0-15	FIX	5	5	0: 0.5dB, 15: 10dB
2	BBHP		BBE High Pass	0-15	FIX	3	3	0: 0.5dB, 15: 10dB
3	SVOL		Sub Volume	0-15	FIX	7	7	0:-0 volume steps, 15:-15 volume steps
4	SBAL		Sub Balance	0-15	FIX	7	7	0: +Right, 15:+Left
5	SBAS		Sub Bass	0-15	Fix by model	5	7 8	5
6	STRE	Sub Treble	0-15	Fix by model	3	10 8	3	0:-7 steps, 15: +8 steps
0	SPCA	SRS TDA7464	SRS Space Attenuation	0-63	FIX	0	0	0: 0dB, 63: -31dB (1dB steps)
1	CENA		SRS Center Attenuation	0-63	FIX	0	0	0: 0dB, 63: -31dB (1dB steps)
2	INPA	Input Attenuation	0-127	FIX	3	3	0: 0dB, 127: -31.5dB (0.5dB steps)	
0	COUT	3D COMB uPD64082	Chroma Signal Gain / BPF	0-3	FIX	3	3	Input/Output gain=1 / BPF ON
1	YAPS		Y V-Compensation/Peaking	0-3	FIX	3	3	Correctin enabled for digital/analog inputs
2	NSDS		Standard/Non-Standard Processing	0-3	FIX	0	0	Standard adaptive processing
3	MSS		Inter-frame/Inter-line Mode	0-3	FIX	0	0	Adaptive Processing
4	EXAD		External ADC Insert	0,1	FIX	0	0	Internal Y-ADC
5	PECS		Pedestal Error Correction	0-3	FIX	0	0	Standard
6	EXCS		C sync Input	0-3	FIX	1	1	Use CSI
7	CPP		Y ADC Amplitude/Clamp Method	0-3	FIX	0	0	Y-ADC & C-ADC Vtb=1.25V
8	HDP		H Phase Fine Adjustment	0-7	FIX	3	3	Phase +/- 0msec
9	CDL		C Output Delay Fine Adjustment	0-7	FIX	5	5	Y/C Delay +/- 0msec
10	DYCO		Y Moving Coring Level	0-15	FIX	2	2	0: Close to moving pictures, 15: Close to still pictures
11	DYGA		Y Moving Coring Gain	0-15	FIX	10	10	0: Close to still Pictures, 15: Close to moving Pictures
12	DCCO		C Moving Coring Level	0-15	FIX	2	2	0: Close to moving pictures, 15: Close to still pictures
13	DCGA		C Moving Coring Gain	0-15	FIX	9	9	0: Close to still Pictures, 15: Close to moving Pictures
14	YNRK		YNR Non-linear Filter Gain	0,1	FIX	1	1	x7/8 large noise reduction and large after image
15	YNRI		YNR Non-linear Filter Convergence	0,1	FIX	0	0	6LSB small noise reduction and small after image
16	YNRL		YNR Non-linear Filter Limit Level	0-3	FIX	1	1	0: YNR Off , 3: 3LSB large noise reduction
17	CNRK		CNR Non-linear Filter Gain	0,1	FIX	1	1	x7/8 large noise reduction and large after image
18	CNRI		CNR Non-linear Filter Convergence	0,1	FIX	0	0	6LSB small noise reduction and small after image
19	CNRL	CNR Non-linear Filter Limit Level	0-3	FIX	1	1	0: CNR OFF , 3: 3LSB large noise reduction	
20	ID1O	ID-1 Superimpose Signal	0,1	FIX	0	0	Through, no superimposition	
21	ID1W	Specifies bit A1 of Word 0	0,1	FIX	0	0	0: 4x3, 1: 16x9	
22	ID1N	Spedifies bit A2 of Word 0	0,1	FIX	0	0	0: normal, 1:letterbox	
23	CLK	CLK8 Pin Output	0,1	FIX	1	1	0: Output 8fsc, 1: Output OFF	

Register Name	Description	Data Range	Adj/Fix	Initial Data	36" Average Data			Comments
					FS	FV16	FV26	
24	ST0S	Select ST0 Pin Output Signal	0-3	FIX	1		1	External Y-ADC clamp pulse
25	WSC	Noise Detection Coring	0-3	FIX	1		1	1LSB coring for noise detection circuit
26	VTRH	H-sync Non-Standard Detection Hysteresis	0-3	FIX	1		1	Low hysteresis (2 clock pulses)
27	VTRR	H-sync Non-Standard Detection Sensitivity	0-3	FIX	1		1	Medium sensitivity (+/- 8 clock pulses)
28	LDSR	Frame Sync Non-Std Detection Sensativity	0-3	FIX	2		2	Low sensitivity (1.5 clock pulses)
29	PWRE	Internal ADC Input Range	0,1	FIX	0		0	Same input range on Y-ADC and C-ADC
30	VAPG	Vertical Aperture Compensation Gain	0-7	FIX	4		4	0: Correction OFF, 7: Max Correction
31	VAPI	Vertical Aperture Comp Convergence	0-31	FIX	12		12	0: Correction OFF, 31: Max Correction
32	TEST	Test Bit	0,1	FIX	0		0	Normal Mode
33	YPFT	Y Peaking Filter Center Frequency	0-3	FIX	3		3	4.22 MHz
34	YPPG	Y Peaking Filter Gain	0-15	FIX	7		6	0: -1 gain, 15: 0.875 gain
35	V1PS	Horizontal Dot Supression Level	0-3	FIX	2		2	Medium suppression
36	VEGS	Vertical Dot Supression Level	0-3	FIX	2		2	Medium suppression
37	CC3N	Line Comb C Separation Filter	0,1	FIX	0		0	Narrow bandwidth
38	C0HS	C Signal Delay Time at NR	0,1	FIX	0		0	1H Delay
39	CLPH	Y-ADC Clamp Test Bit	0,1	FIX	0		0	Normal Mode
40	SEL2	DC Detection High Freq Sensativity	0,1	FIX	0		0	Low sensitivity, Close to still pictures
41	SEL1	DY detection Low Freq Sensativity	0,1	FIX	0		0	Low sensitivity, Close to still pictures
42	YHCO	Y High Freq Coring	0-3	FIX	1		0	Small Amount of coring (+/- 1LSB)
43	YHCG	Y High Freq Coring Gain	0,1	FIX	0		0	Gain = 1
44	OVST	Non Standard Detection Test Bit	0,1	FIX	0		0	Normal Mode
45	CSHD	H/V counter Test Bit	0,1	FIX	0		0	Normal Mode
46	KCTT	H/V counter Test Bit	0-3	FIX	0		0	Normal Mode
47	SHT	Non Standard Detection Test Bits	0,1	FIX	0		0	Normal Mode
48	VCT	H/V counter Test Bit	0,1	FIX	0		0	Normal Mode
49	OTT	H/V counter Test Bit	0,1	FIX	0		0	Normal Mode
50	CL2D	Clock Generator Test Bit	0,1	FIX	1		1	Normal Mode
51	CGGT	Clock Generator Test Bit	0,1	FIX	0		0	Normal Mode
52	CLEB	Clock Generator Test Bit	0,1	FIX	0		0	Normal Mode
53	CGT	Clock Generator Test Bit	0,1	FIX	0		0	Normal Mode
54	HPLL	Horizontal PLL Filter	0,1	FIX	1		1	Quick convergence
55	BPLL	Burst PLL Filter	0,1	FIX	1		1	Quick convergence
56	FSCF	Burst Extraction Gain	0,1	FIX	0		0	High gain
57	PLLF	PLL Loop Gain	0,1	FIX	1		1	High gain, quick convergence
58	KILR	Killer Detection Reference	0-15	FIX	3		3	0: Detection off, 15: High detection sensitivity
59	HSSL	Horizontal Sync Slice Level	0-15	FIX	12		12	0: 4LSB, 15: 19LSB
60	VSSL	Vertical Sync Slice Level	0-15	FIX	8		8	0: HSSL + 0LSB, 15: HSSL + 15LSB
61	BGPS	Burst Gate Start Position	0-15	FIX	5		5	0: Hsync center + 2ms, 15: Hsync center +5.75ms
62	BGPW	Internal Burst Gate Pulse Width	0-15	FIX	10		10	0: 0.5ms, 15: 4.25ms
63	ADCL	ADC Clock Delay	0-3	FIX	3		3	0: 0ns, 3: 20.5ns (typical)
64	ADPD	ADC Power Down	0,1	FIX	1		1	Stop ADC when not in use
65	NSDW	Non Standard Detection Test Bit	0,1	FIX	0		0	Normal Mode
66	CNRF	CNR Section Test Bit	0,1	FIX	0		0	Normal Mode
0	SHPR	Controls both DL APACON and SRT	0-127	Fix by Model	52	59	52	0: Minimum, 127: Maximum
1	BLAD	Black Area Detect	0-3	FIX	0		0	0: 10IRE, 1: 20IRE, 2: 30IRE, 3: 40IRE
2	SRTS	SRT Start Amplitude	0-3	FIX	3		3	0: 7IRE, 1: 10IRE, 2: 14IRE, 3: 28IRE
3	YNR	Controls YNR ON/OFF	0,1	FIX	1		1	YNR ON
4	GIRE	Gamma Correction Start Point	0-3	FIX	3		3	0: 70IRE, 1: 80IRE, 2: 90IRE, 3: OFF
5	DAC1	1 bit DAC Output	0,1	FIX	0		0	Open
6	DAC2	1 bit DAC Output	0,1	FIX	0		0	Open

3D COMB
uPD64082

PIC IMP
TA1226N

ADJUSTMENT ITEMS (cont.)

Register Name	Description	Data Range	Adj/Fix	Initial Data	36" Average Data			Comments
					FS	FV16	FV26	
7	GCUR	PIC IMP TA1226N	Controls Curve of Gamma Correction	0,1	FIX	0	0	0: -2.4dB, -1.6dB
8	BLKC		Black Compensation	0,1	FIX	1	1	OFF
9	TEST		Test Bit	0-3	FIX	3	3	Pin 20 Output: 0=RS, 1=SHR, 2=RTC, 3=TEST3
10	RS		Gain of DL APACON at 8MHz Peak	0-7	FIX	0	0	0: 0dB, 7: +6dB
11	RTC		Compensation Ratio of SRT and DL APACON	0-7	FIX	4	4	0: Min, 7: Max
12	VMLO		Gain for Menu VM=LOW	0-2	FIX	1	1	0=off, 1=-6dB, 2=-3dB, 3=0dB
0	PIPH	PIP SDA856VX	PIP H-position	0-127	FIX	34	34	0:Right, 127:Left
1	PIPV		PIP V-position	0-63	FIX	22	22	0:Up, 63:Down
2	POFV		Position Offset Vertical	0-15	FIX	4	4	Vertical PiP Offset from Center
3	POFH		Position Offset Horizontal	0-31	FIX	17	17	Horizontal PiP Offset from Center
4	VACQ		PIP V-Acquisition Window	0-15	FIX	8	8	0: -8 lines up, 8: Center, 15: +7 pixels down
5	HACQ		PIP H-Acquisition Window	0-15	FIX	8	8	0: -16 pixels right, 8: Center, 15: +14 pixels left
6	PVID		PIP Vsync Delay	0-31	FIX	0	0	Step size 3.56ms< 1 step < 6.4ms
7	VERB		Vertical Blanking	0,1	FIX	0	0	0: DAC Blanking during line blanking interval, 1: DAC Blanking during line AND field intervals
8	PSEL		SELDOWN Bit Control	0,1	FIX	1	1	0:Open out, 1:TTL out
9	SELD		Select PYS Delay	0-15	FIX	8	8	0: -8 clock cycles, 8: NO delay, 15: +7 clock cycles
10	4SLD		Select PYS Delay YUV Input	0-15	FIX	8	8	0: -8 clock cycles, 8: NO delay, 15: +7 clock cycles
11	PCOR		Position Correction	0,1	FIX	1	1	0: OFF, 1: ON (Position correction during varying parent frequency)
12	AGCR		AGC Gain Control Reset	0,1	FIX	1	1	0: Normal, 1: Reset (transition of 0->1 resets AGC)
13	AGCM		AGC Mode	0-3	FIX	0	3	0: Sync height & ADC Overflow, 1: sync height, 2: ADC overflow, 3: AGC Fixed
14	AGCV		ADC Value	0-15	FIX	11	12	0: Input valtage 0.5Vpp, 15: Input Voltage is 1.5Vpp
15	CLMD		Clamp Pulse Duration	0-3	FIX	3	3	0: 0.5ms, 1: 0.9ms, 2: 1.2ms, 3: 1.5ms
16	CLMS		Clamp Pulse Start	0-3	FIX	2	2	0: 1.0ms, 1: 1.5ms, 2: 2.0ms, 3: 2.5ms
17	LMOF		Luminance Offset	0-3	FIX	3	3	0: NO OFFSET, 1: +16LSB, 2: -8LSB, 3: -16LSB
18	PYDL		Y/C Delay	0-15	FIX	8	2	0: -8 pixels, 15: +7 pixels
19	FRMY		Frame Y Level	0-15	Fix by Model	6	5	Adjusts 4 MSB of Frame Y Signal
20	FRSL		Frame Type Select	0,1	FIX	1	1	0: Normal frame, 1: 3D frame
21	FRWH		Frame Width Horizontal	0-7	FIX	4	4	0: No frame, 7: 7 pixels
22	FRWV		Frame Width Vertical	0-3	FIX	1	1	0: No frame, 3: 3 lines
23	PBSW	PiP Block Selection (PIPBG vs PIPBLK)	0,1	FIX	0	1	Blocking Type: 0= PIPBG(gray), 1=PIPBLK(black)	
0	CKIL	PIP-YC SDA956VX	Color Killer Threshold	0-3	FIX	0	0	0: -30dB, 1: -18dB, 2: -24dB, 3: color always off
1	COLO		Color Killer Off	0,1	FIX	0	0	0: Color killer active, 1: Color always on
2	PSHU		PiP Sub Hue	0-15	FIX	7	7	PiP sub hue
3	4PSU		PiP Sub Hue YUV Input	0-15	FIX	7	7	PiP sub hue
4	CPLL		Chroma PLL Off	0,1	FIX	0	0	0: Chroma PLL active, 1: Chroma PLL free running
5	SCAD		Sub Carrier Freq Fine Adjustment	0-31	FIX	5	6	0: -150 PPM, 7: default, 31: +310 PPM
6	PCON		PiP Contrast	0-15	FIX	0	0	0: nominal, 15: +30% increase
7	4PCN		PiP Contrast YUV Input	0-15	FIX	0	0	0: nominal, 15: +30% increase
8	PBRT		PiP Brightness	0-15	FIX	0	2	0: nominal, 15: +20% increase
9	4PBR		PiP Brightness YUV Input	0-15	FIX	0	2	0: nominal, 15: +20% increase
10	IPER		V Pedestal	0-15	FIX	0	0	0: nominal, 15: +15LSB offset
11	4IPR		V Pedestal YUV Input	0-15	FIX	4	0	0: nominal, 15: +15LSB offset
12	IPEG		Y Pedestal	0-15	FIX	0	0	0: nominal, 15: +15LSB offset
13	4IPG		Y Pedestal YUV Input	0-15	FIX	0	0	0: nominal, 15: +15LSB offset
14	IPEB		U Pedestal	0-15	FIX	1	1	0: nominal, 15: +15LSB offset
15	4IPB		U Pedestal YUV Input	0-15	FIX	1	1	0: nominal, 15: +15LSB offset
16	BLKR		Invert V Pedestal	0,1	FIX	1	0	0: Offset add during blanking, 1: Offset add during active
17	BLKB		Invert U Pedestal	0,1	FIX	0	1	0: Offset add during blanking, 1: Offset add during active
18	PVGA		Peak Level V Output	0-255	FIX	84	84	0: 0.3Vpp, 192: 1.0Vpp, 255: 1.2Vpp
19	4PVG	Peak Level V Output YUV Input	0-255	FIX	69	69	0: 0.3Vpp, 192: 1.0Vpp, 255: 1.2Vpp	

Register Name	Description	Data Range	Adj/Fix	Initial Data	36" Average Data			Comments		
					FS	FV16	FV26			
20	PUGA	Peak Level U Output	0-255	FIX	52	52		0: 0.3Vpp, 192: 1.0Vpp, 255: 1.2Vpp		
21	4PUG	Peak Level U Output YUV Input	0-255	FIX	36	36		0: 0.3Vpp, 192: 1.0Vpp, 255: 1.2Vpp		
22	PYGA	Peak Level Y Output	0-255	Fix by Model	104	35		0: 0.3Vpp, 192: 1.0Vpp, 255: 1.2Vpp		
23	4PYG	Peak Level Y Output YUV Input	0-255	Fix by Model	129	37		0: 0.3Vpp, 192: 1.0Vpp, 255: 1.2Vpp		
24	CHRO	UV Output Polarity	0,1	FIX	0	0		0: +U/+V output, 1: -U/-V output		
25	SATA	Color Saturation Adjustment	0-15	FIX	8	9		0: No color, 8: nominal saturation, 15: nominal x 1.875		
26	YPKG	Y Peaking Adjustment	0-7	FIX	7	7		0: No peaking, 7: Strongest Peaking		
27	4YPK	Y Peaking Adjustment YUV Input	0-7	FIX	7	7		0: No peaking, 7: Strongest Peaking		
28	YCOR	Y Coring Enable	0,1	FIX	1	1		0: OFF, 1: ON		
29	CLPL	Clamp Pulse Length	0-3	FIX	0	0		0=5ms, 1=3.75ms, 2=2.5ms, 3=1.25ms		
0	RTCO	Rotation Coil	0-63	FIX	31	31		Rotation coil adjustment for nominal value		
1	T2CO	Sub Color TV Input	0-7	Adj	120	104		TV Sub Color Adjustment (CXA2039 YUV Models AT DAC)		
2	V2CO	Sub Color Video Input	0-7	Adj	120	148		VIDEO1-3 Sub Color Adjustment (CXA2039 YUV Models at DAC)		
3	4COL	Sub Color YUV Input	0-7	Adj	120	137		YUV Sub Color Adjustment (CXA2039 YUV Models at DAC)		
4	T2HU	Sub Hue TV Input	0-7	Adj	15	16		TV Sub HUE Adjustment (CXA2039 YUV Models at DAC)		
5	V2HU	Sub Hue Video Input	0-7	Adj	15	18		VIDEO1-3 Sub HUE Adjustment (CXA2039 YUV Models at DAC)		
6	4SHU	Sub Hue YUV Input	0-7	Adj	15	16		YUV Sub HUE Adjustment (CXA2039 YUV Models at DAC)		
0	XJGL	Decoding Result Held For VCR Scanning	0,1	FIX	0	0		Hold data during VCR variable speed playback		
1	LNJ1	ID-1 Signal Location	0,1	FIX	0	0		Search for ID-1 data +/- one line in VBI		
0	DUM1	CCD Dummy Register						Used to display CC data in Service Mode		
1	VOSD	VChip OSD Test Register	0,1	FIX	0	0		Used to display VChip data in Service Mode		
0	DISP	OSD Position	0-63	Adj	15	16		OSD horizontal position		
1	RAMW	OSD RAM Window	0,1	FIX	0	0				
2	ICMP	OSD Non-interlace Threshold	0-15	FIX	4	4		0: 0 fields, 15: 15 fields		
3	IPOR	OSD Non-interlace Even/Odd Display	0-3	Fix	1	1		0=Even OSD display, 1= Odd OSD display, 2&3=N/A		
4	FAWD	Factory AutoWide Mode	0,1	Fix	0	0		0= No Autowide in RF mode, 1= Autowide in RF Mode		
5	TILT	Tilt Correction Spec	0,1	Fix	0	2		0= New Tilt Spec for AA2U (less VANG offset), 1= AA2W/AA2H Tilt Spec		
		PROGRAM FOR EACH PALETTE MODE				VIVID	STD	MOVIE	SPORTS	
0	VPIC	Set Current Program Palette PICTURE Reset Level	0-63	FIX by Palette	50	63	50	38	63	0=MIN, 63=MAX
1	VBRT	Set Current Program Palette BRIGHTNESS Reset Level	0-63	FIX by Palette	31	31	31	31	31	0=MIN, 63=MAX
2	VCOL	Set Current Program Palette COLOR Reset Level	0-63	FIX by Palette	31	38	31	31	38	0=MIN, 63=MAX
3	VSHP	Set Current Program Palette SHARPNESS Reset Level	0-63	FIX by Palette	31	31	31	31	31	0=MIN, 63=MAX
4	VVM	Set Current Program Palette VM Reset Level	0-3	FIX by Palette	1	2	1	0	2	0=OFF, 1=LOW, 2=HIGH, 3=N/A
5	VTRI	Set Current Program Palette Color Temp Reset Setting	0-3	FIX by Palette	1	0	1	2	0	0=COOL, 1=NEUTRAL, 2=WARM, 3=N/A
6	VGMA	Set Current Program Palette YC/J GAMMA	0-3	FIX by Palette	2	3	2	2	2	0=GAMMA CORRECTION OFF, 3=+12 IRE CORRECTION @ 40 IRE INPUT
7	VBLK	Set Current Program Palette Black Stretch	0,1	FIX by Palette	1	1	1	1	1	0=BLACK STRETCH OFF, 1=BLACK STRETCH ON
8	VAPA	Set Current Program Palette APACON	0,1	FIX by Palette	1	0	1	1	1	0=APACON OFF, 1=APACON ON
9	VSRT	Set Current Program Palette SRT	0,1	FIX by Palette	0	1	0	0	0	0=SRT OFF, 1=SRT ON
10	VNRM	Set Current Program Palette NRMD	0,1	FIX by Palette	0	0	0	0	1	0=3D YCS, 1=2D YCS

ADJUSTMENT ITEMS (cont.)

Register Name	Description	Data Range	Adj/Fix	Initial Data	36" Average Data			Comments
					FS	FV16	FV26	
0	RDOF	Red Drive offset for WARM	0-63	FIX	0	0	0	Red Drive MOVIE=RDRV(RDR4)-RDOF
1	GDOF	Green Drive offset for WARM	0-63	FIX	4	4	4	Green Drive MOVIE=GDRV(GDR4)-GDOF
2	BDOF	Blue Drive offset for WARM	0-63	FIX	15	15	15	Blue Drive MOVIE=BDRV(BDR4)-BDOF
3	RCOF	Red Cutoff offset for WARM	0-31	FIX	0	0	0	Red Cutoff MOVIE=RCUT(RCU4)-RCOF
4	GCOF	Green Cutoff offset for WARM	0-31	FIX	2	2	2	GREEN Cutoff MOVIE=GCUT(GCU4-GCOF)
5	BCOF	Blue Cutoff offset for WARM	0-31	FIX	7	7	7	BLUE Cutoff MOVIE=BCUT(BCU4)-BCOF
6	DCOF	Dynamic Color setting for WARM	0,1	FIX	0	0	0	0=OFF, 1=ON
0	ID-0	ID-0 (Language/Color Systems)	0-255	Fix by model	89	refer to NVM ID Chart	89	See ID map
1	ID-1	ID-1 (Input/Output Configuration)	0-255	Fix by model	63		63	See ID map
2	ID-2	ID-2 (Audio)	0-255	Fix by model	239		239	See ID map
3	ID-3	ID-3 (OSD/Timer/V-chip/Ch Fix)	0-255	Fix by model	99		99	See ID map
4	ID-4	ID-4 (CC/Spot Killer/etc)	0-255	Fix by model	139		139	See ID map
5	ID-5	ID-5 (V-series Features/etc)	0-255	Fix by model	181		181	See ID map
6	ID-6	ID-6 (PiP/Ant Sw related)	0-255	Fix by model	6		6	See ID map
7	ID-7	ID-7 (Special Models/etc)	0-255	Fix by model	24		24	See ID map

VALUE = Not Used for AA-2U
 VALUE = Fixed Item For AA-2U

5-5. FEATURE ID MAP

ID	7	24	SERVICE
ID7		TV	00011000
M306V5ME-1015P NVM:G			
VERSION: 1.0__			

Note: Check to be sure NVM is good (NVM: G)

Model	Destination	ID-0	ID-1	ID-2	ID-3	ID-4	ID-5	ID-6	ID-7
KV-36FS12	US	89	31	95	99	139	177	0	16
KV-36FS12	CND	89	31	95	83	139	177	0	16
KV-36FS12	HAW	89	31	95	99	139	177	0	16
KV-36FS16	US	89	31	95	99	139	177	6	16
KV-36FS16	CND	89	31	95	83	139	177	6	16
KV-36FS16	HAW	89	31	95	99	139	177	6	16
KV-36FV16	US	89	63	239	99	139	181	6	17
KV-36FV16	HAW	89	63	239	99	139	181	6	17
KV-36FV26	US	89	63	239	99	139	181	6	24
KV-36FV26	CND	89	63	239	83	139	181	6	24
KV-36FV26	HAW	89	63	239	99	139	181	6	24

5-6. PROGRAM PALETTE SETTINGS

		Vivid	Standard	Movie	Sports
Picture	(VPIC)	63	50	38	63
Brightness	(VBRT)	31	31	31	31
Color	(VCOL)	38	31	31	38
Sharpness	(VSHP)	31	31	31	31
VM ¹⁾	(VVM)	2	1	0	2
C Temp ¹⁾	(VTRI)	2	1	0	2
Gamma	(VGMA)	3	2	2	2
Blk Comp	(VBLK)	1	1	1	1
V Apa Comp	(VAPA)	0	1	1	1
SRT ON/OFF	(VSRT)	1	0	0	0
NRMD	(VNRM)	0	0	0	1

¹⁾ Setting of 3 is invalid for these registers

To Program Program Palette RESET Levels

1. Switch to Program Palette to edit.
2. Enter Service Mode.
3. Set desired values for current Program Palette settings.
4. Write into memory by **[MUTING]** then **[ENTER]**.
5. Repeat steps 1-4 for each palette.

Example

To Set RESET Level of Standard Mode to 60%

1. Switch to STANDARD Palette.
2. Enter Service Mode.
3. Change value of VPIC to 38 (38/63 = 60%)
4. Write into memory by **[MUTING]** then **[ENTER]**.
5. Enter Video Menu and press **[RESET]**.
6. Reset level of picture for STANDARD PALETTE ONLY is now 38 steps.

5-7. A BOARD ADJUSTMENTS

Sub Contrast Adjustment (RDRV, RDR4)

1. Input a 75% color-bar signal.
2. Set to: VIDEO mode = Standard, COLOR = Minimum, PICTURE = 100%, GON = 0 (OFF), BON = 0 (OFF)
3. Set to Service Adjustment Mode and connect an oscilloscope to pin ① of CN351 on the A Board.
4. Set RDRV with **[1]** and **[4]**.
5. Adjust with **[3]** and **[6]** for: 1.95 ± 0.05 Vp-p.
6. Write into memory by **[MUTING]** then **[ENTER]**.
7. Repeat steps 1-6 for RDR4 using Video 4 input.

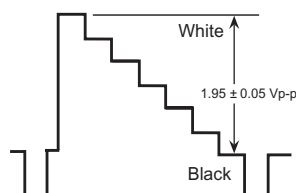

Sub Bright Adjustment (SBRT)

1. Set to Service Adjustment Mode.
2. Input a gray scale pattern signal.
3. Set the PICTURE to minimum, and BRIGHT to normal.
4. Select SBRT with **[1]** and **[4]**.
5. Adjust SUB BRIGHT level with **[3]** and **[6]** so that the stripe second from the right is faintly visible.
6. Write into the memory by pressing **[MUTING]** then **[ENTER]**.

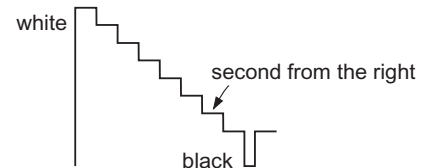

Sub Hue, Sub Color Adjustment (T2HU, T2CO, V2HU, V2CO, 4SHU, 4COL)

Note: T2HU and T2CO are for Tuner inputs.
V2HU and V2CO are for all other Video inputs.
4SHU and 4COL are for Video 4 input.

1. Input a 75% color-bar signal.
2. Set to Service Adjustment Mode and set: VIDEO mode = Standard, PICTURE = 100%, COLOR = 50%, HUE = 50%.
3. Connect an oscilloscope to Pin ③ of CN351 on the A Board.
4. Select T2HU and T2CO with **[1]** and **[4]**.
5. Adjust with **[3]** and **[6]** for the $V1 = V4 \pm 0.1$ Vp-p (T2CO) and $V2 = V3 \pm 0.1$ Vp-p (T2HU).
6. Write into memory by **[MUTING]** then **[ENTER]**.
7. Repeat steps 1-6 for V2HU & V2CO and 4SHU & 4COL.

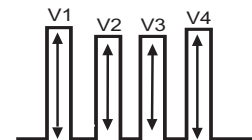

V. Size Adjustment (VSIZ)

1. Input a cross-hatch signal.
2. Set to Service Adjustment Mode.
3. Select VSIZ with **[1]** and **[4]**.
4. Adjust with **[3]** and **[6]** for the best vertical size.
5. Write into the memory by pressing **[MUTING]** then **[ENTER]**.

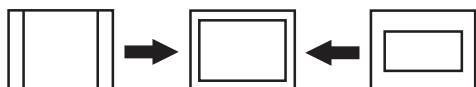

V. Position Adjustment (VPOS)

1. Input a cross-hatch signal.
2. Set to Service Adjustment Mode.
3. Select VPOS with **[1]** and **[4]**.
4. Adjust with **[3]** and **[6]** for the best vertical center.
5. Write into the memory by pressing **[MUTING]** then **[ENTER]**.

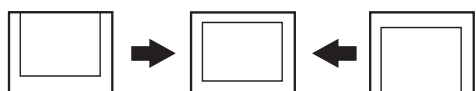

H. Size Adjustment (HSIZ)

1. Input a monoscope signal.
2. Set to Service Adjustment Mode.
3. Select HSIZ with **[1]** and **[4]**.
4. Adjust with **[3]** and **[6]** for the best vertical size.
5. Write into the memory by pressing **[MUTING]** then **[ENTER]**.

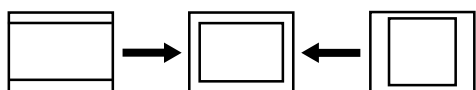

H. Position Adjustment (HPOS)

HPOS Range is from 0~15.

1. Input a monoscope signal.
2. Set the Service Adjustment Mode.
3. Select HPOS with **[1]** and **[4]**.
4. Adjust with **[3]** and **[6]** for the best horizontal center.
5. Write into the memory by pressing **[MUTING]** then **[ENTER]**.

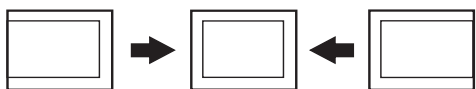

V Linearity (VLIN), V Correction (VSCO), Pin Amp (PAMP) And Pin Phase (PPHA) Adjustments

1. Input a cross-hatch signal.
2. Set to Service Adjustment Mode.
3. Select VLIN, VSCO, PAMP, and PPHA with **[1]** and **[4]**.
4. Adjust with **[3]** and **[6]** for the best picture.
5. Write the memory by pressing **[MUTING]** then **[ENTER]**.

V LINEARITY (VLIN)

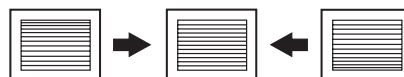

VS CORRECTION (VSCO)

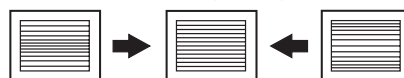

PIN AMP (PAMP)



PIN PHASE (PPHA)

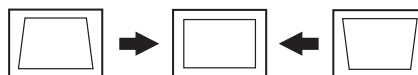

V Angle (VANG), V Bow (VBOW), Upper Pin (UPIN) And Low Pin (LPIN) Adjustments

1. Input a monoscope signal.
2. Set to Service Adjustment Mode.
3. Select VANG, VBOW, UPIN, and LPIN with **[1]** and **[4]**.
4. Adjust with **[3]** and **[6]** for the best picture.
5. Write the memory by pressing **[MUTING]** then **[ENTER]**.

V ANGLE (VANG)

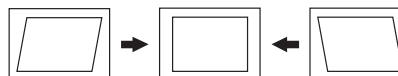

V BOW (VBOW)



UPPER PIN (UPIN)



LOW PIN (LPIN)



OSD Position Adjustment (DISP)

1. Input a color-bar signal.
2. Set to Service Adjustment Mode.
3. Select DISP with **[1]** and **[4]**.
4. Adjust with **[3]** and **[6]** for adjustment of characters to center.
5. Write the memory by pressing **[MUTING]** then **[ENTER]**.

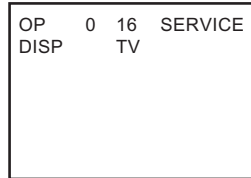

Rotation Coil Adjustment

1. Input a monoscope signal.
2. Push the Menu button on the Remote.
3. Select the "Set-up" mode.
4. Select "Tilt Correction". Confirm that number (0) color changes to red.
5. Push **↑ (+)** on the Remote. Confirm that the number increases up to +5 and the picture rotates clockwise.
6. Push **↓ (-)** on the Remote. Confirm that the number decreases down to -5 and the picture rotates counter-clockwise.
7. Push **↑ (+)** on the Remote. Return the value to 0.

Set-Up

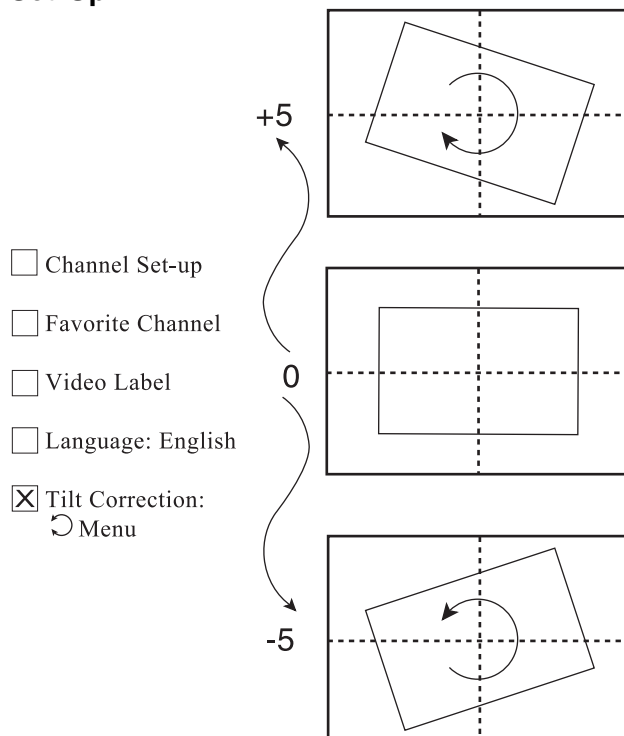

SECTION 6
DIAGRAMS

6-1. BLOCK DIAGRAM (1/4) (KV-36FS12/36FS16 ONLY)

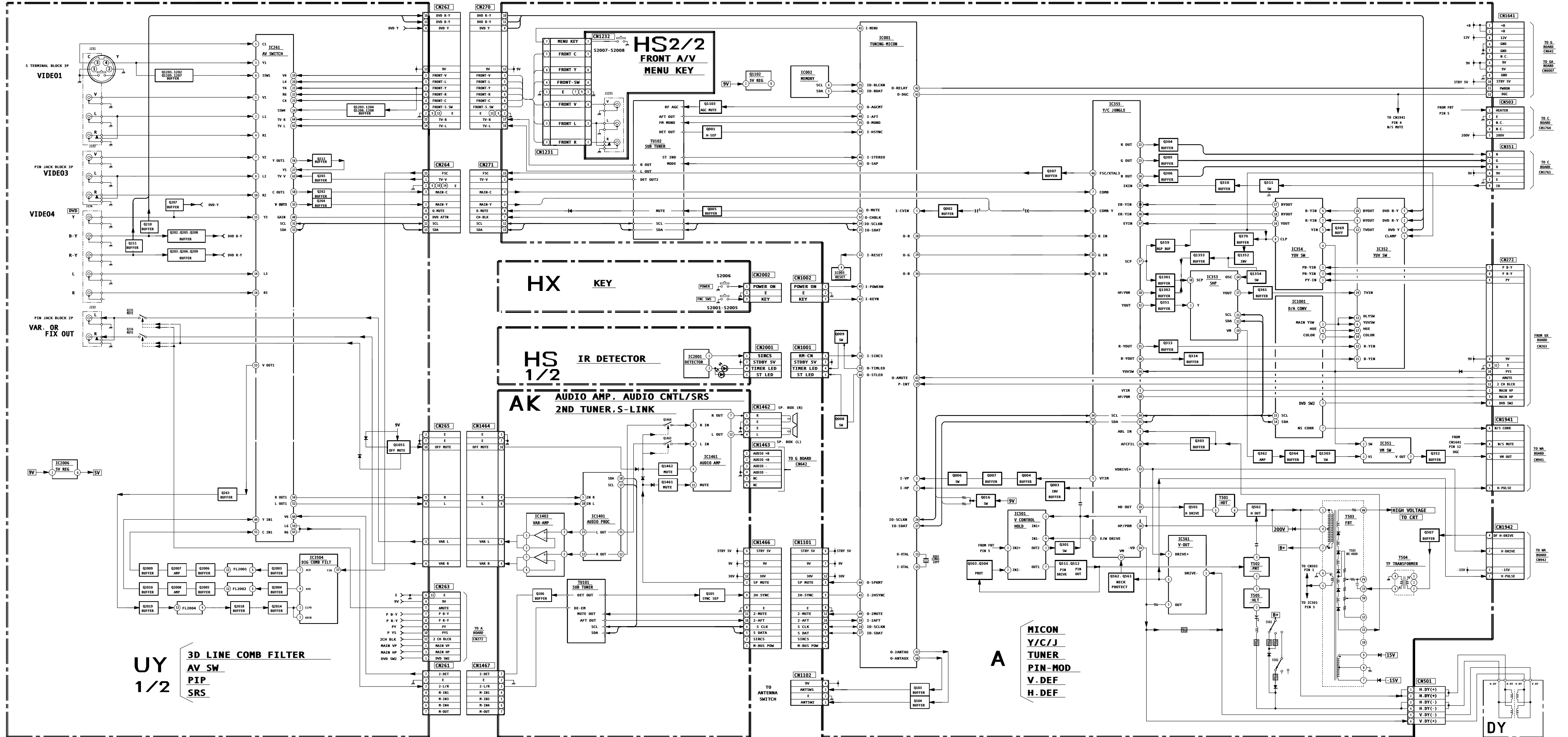

6-2. BLOCK DIAGRAM (2/4) (KV-36FV16/36FV26 ONLY)

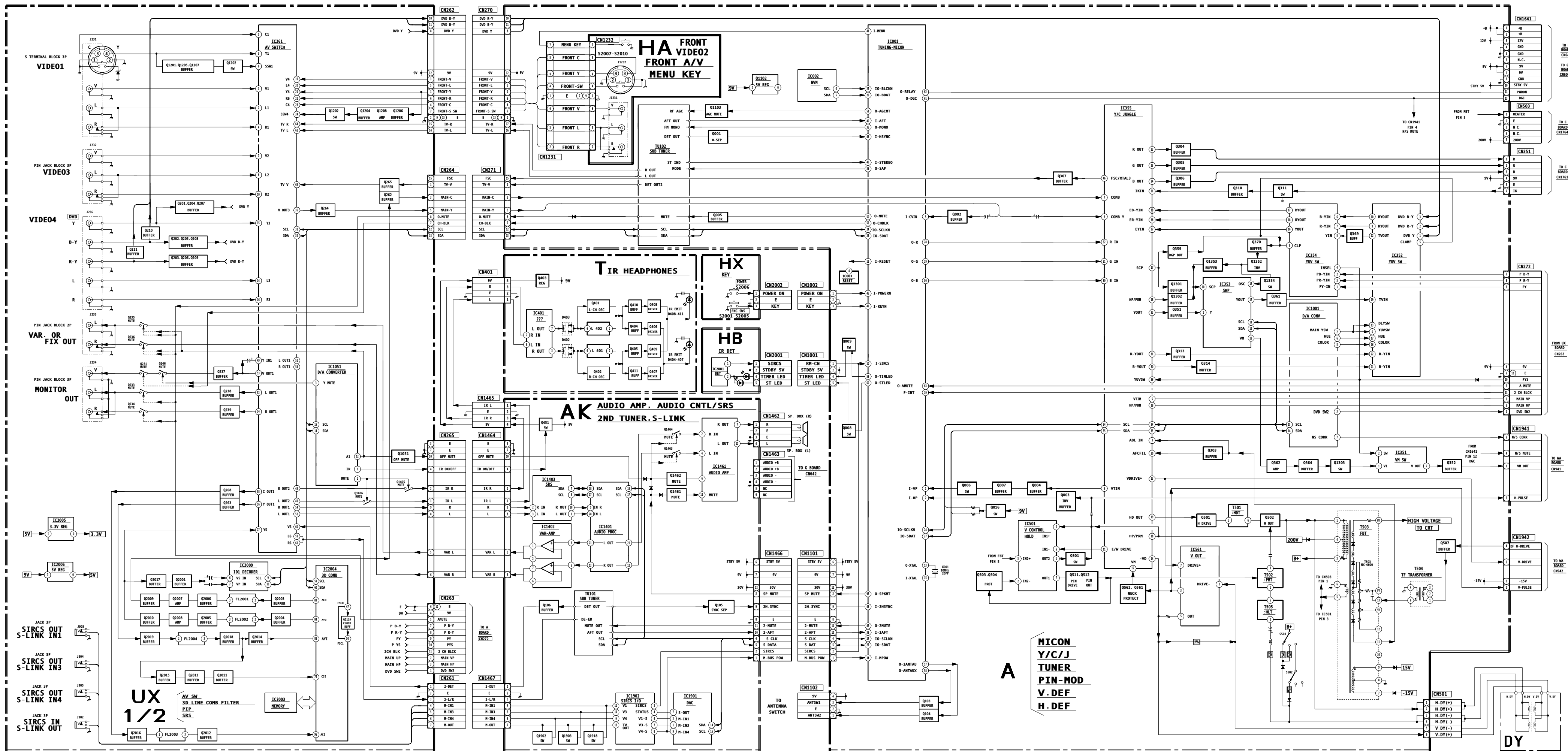

AZU-87-FV-80

6-3. BLOCK DIAGRAM (2/2) (KV-36FS12/36FS26 ONLY) see page 31 for 1/2 of this diagram

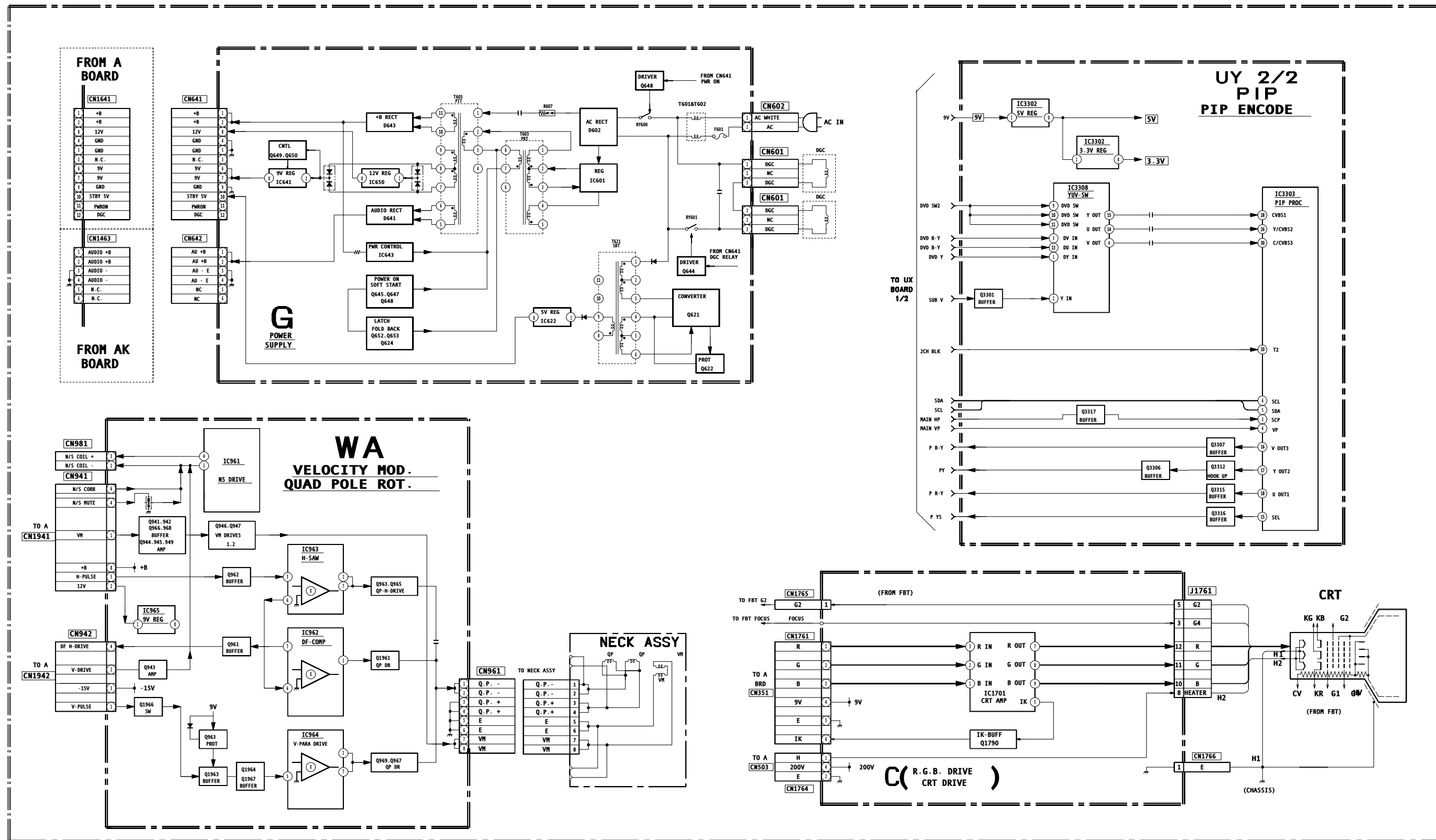

6-4. BLOCK DIAGRAM (2/2) (KV-36FV16/36FV26 ONLY) see page 33 for 1/2 of this diagram

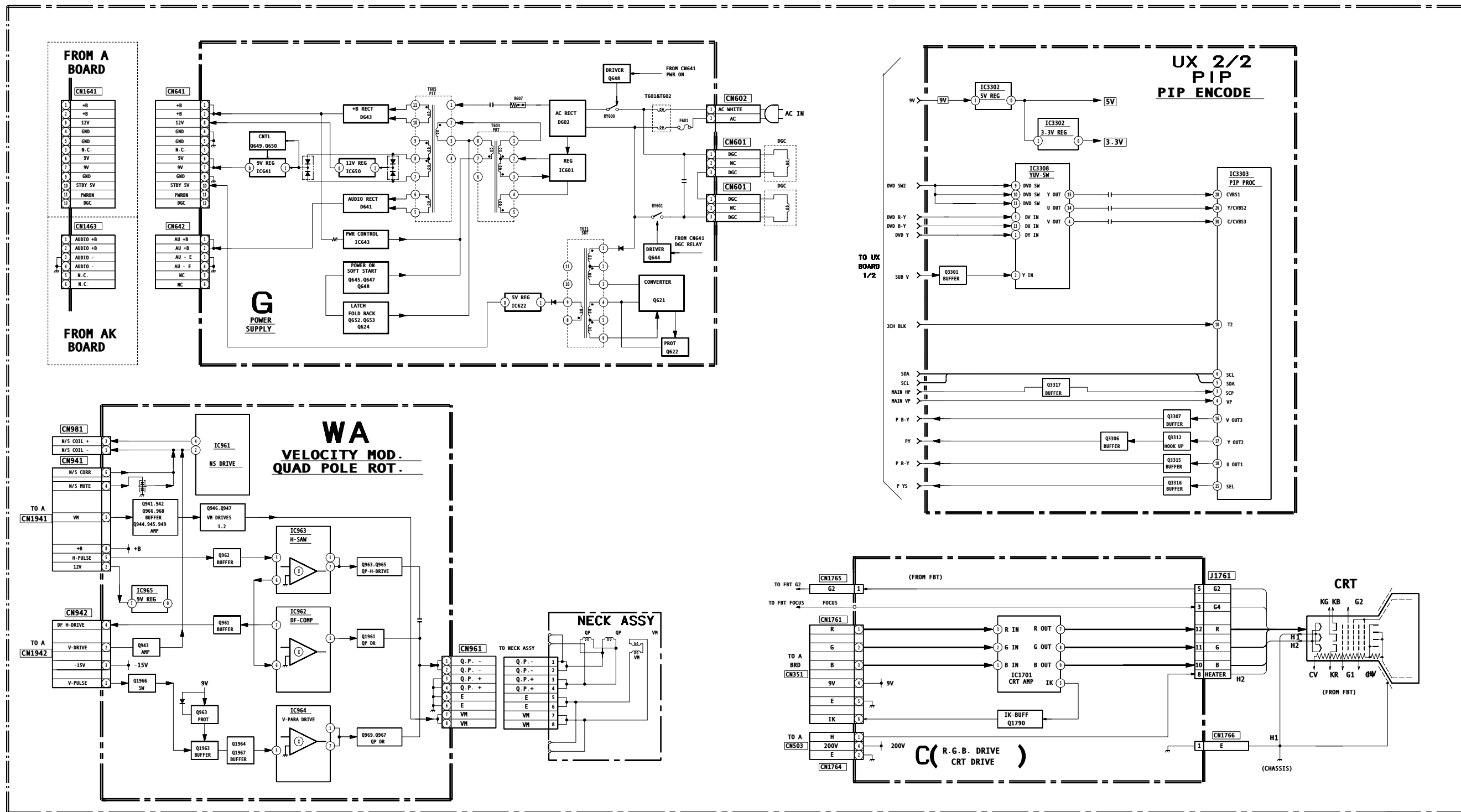

6-5. CIRCUIT BOARD LOCATIONS

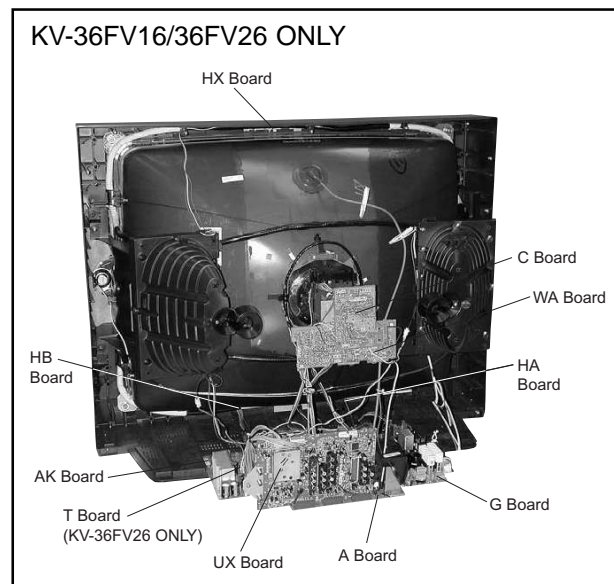
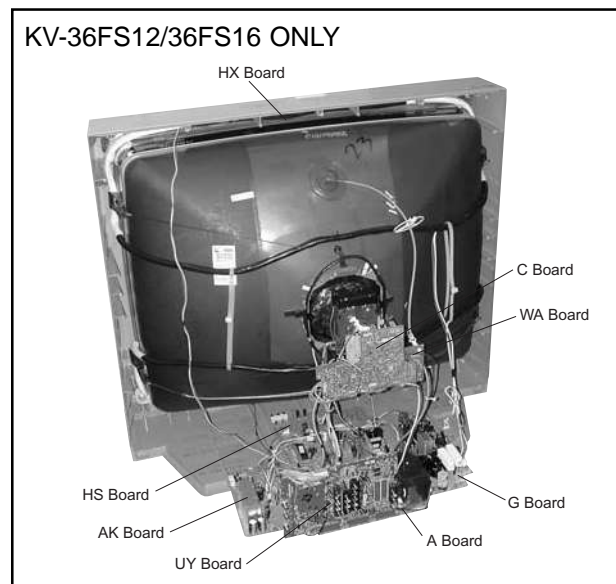

6-6. PRINTED WIRING BOARDS AND SCHEMATIC DIAGRAMS

- All capacitors are in mF unless otherwise noted. pF: mmF 50 WV or less are not indicated except for electrolytic and tantalums.
- All electrolytics are 50V unless otherwise specified.
- Indication of resistance, which does not have one for rating electrical power, is as follows:
Pitch: 5mm
Rating electrical power 1/4W (CHIP: 1/10W)
- All resistors are in ohms.
KW = 1000W MW = 1000KW
- ⎓ : nonflammable resistor
- ⎓ : fusible resistor
- △ : internal component
- : panel designation and adjustment for repair
- ⊥ : earth-ground
- ⏏ : earth-chassis
- All variable and adjustable resistors have characteristic curve B, unless otherwise noted.
- The components identified by in this manual have been carefully factory-selected for each set in order to satisfy regulations regarding X-ray radiation. Should replacement be required, replace only with the value originally used.
- When replacing components identified by , make the necessary adjustments indicated. If results do not meet the specified value, change the component identified by and repeat the adjustment until the specified value is achieved (refer to Safety Related Adjustments on page 19).
- When replacing parts shown in the table below, be sure to perform the related adjustments.

Part Replaced ()	Adjustment ()
R387, R550, R529, R530, R531, R532, R533, D519, D520, D521, IC501, C531, C532, T503, IC351, IC355, Q301, R356, R359, R361, D302 A Board IC643, R661 G Board	HV HOLD-DOWN R530, R531

- All voltages are in Volts
- Voltage is DC with respect to ground unless otherwise noted.

- Readings are taken with a 10MW digital multimeter.
- Readings are taken with a color-bar signal input.
- Voltage variations may be noted due to normal production tolerance.
- Circled numbers are waveform references.
- * : cannot be measured
- : B + Line
- - - - : B - Line
- ⇒ : Signal path

Reference Information

RESISTOR	: RN	METAL FILM
	: RC	SOLID
	: FPRD	NON FLAMMABLE CARBON
	: FUSE	NON FLAMMABLE FUSIBLE
	: RW	NON FLAMMABLE WIREWOUND
	: RS	NON FLAMMABLE METAL OXIDE
	: RB	NON FLAMMABLE CEMENT
	: *	ADJUSTMENT RESISTOR
COIL	: LF-8L	MICRO INDUCTOR
CAPACITOR	: TA	TANTALUM
	: PS	STYROL
	: PP	POLYPROPYLENE
	: PT	MYLAR
	: MPS	METALIZED POLYESTER
	: MPP	METALIZED POLYPROPYLENE
	: ALB	BIPOLAR
	: ALT	HIGH TEMPERATURE
	: ALR	HIGH RIPPLE

Note:

The components identified by shading and mark are critical for safety. Replace only with the part number specified. The symbol (displayed on component side of the circuit board) indicates fast operating fuse. Replace only with fuse of the same rating as marked.

Les composants identifiés par un tramé et une marque sont critiques pour la sécurité. Ne les remplacer que par une pièce portant le numéro spécifié. Le symbole indique une fusible a action rapide. Doit être remplacée par une fusible de meme valeur, comme marqué.

A BOARD IC BLOCK DIAGRAMS

A BOARD: IC355 CXA2131AS

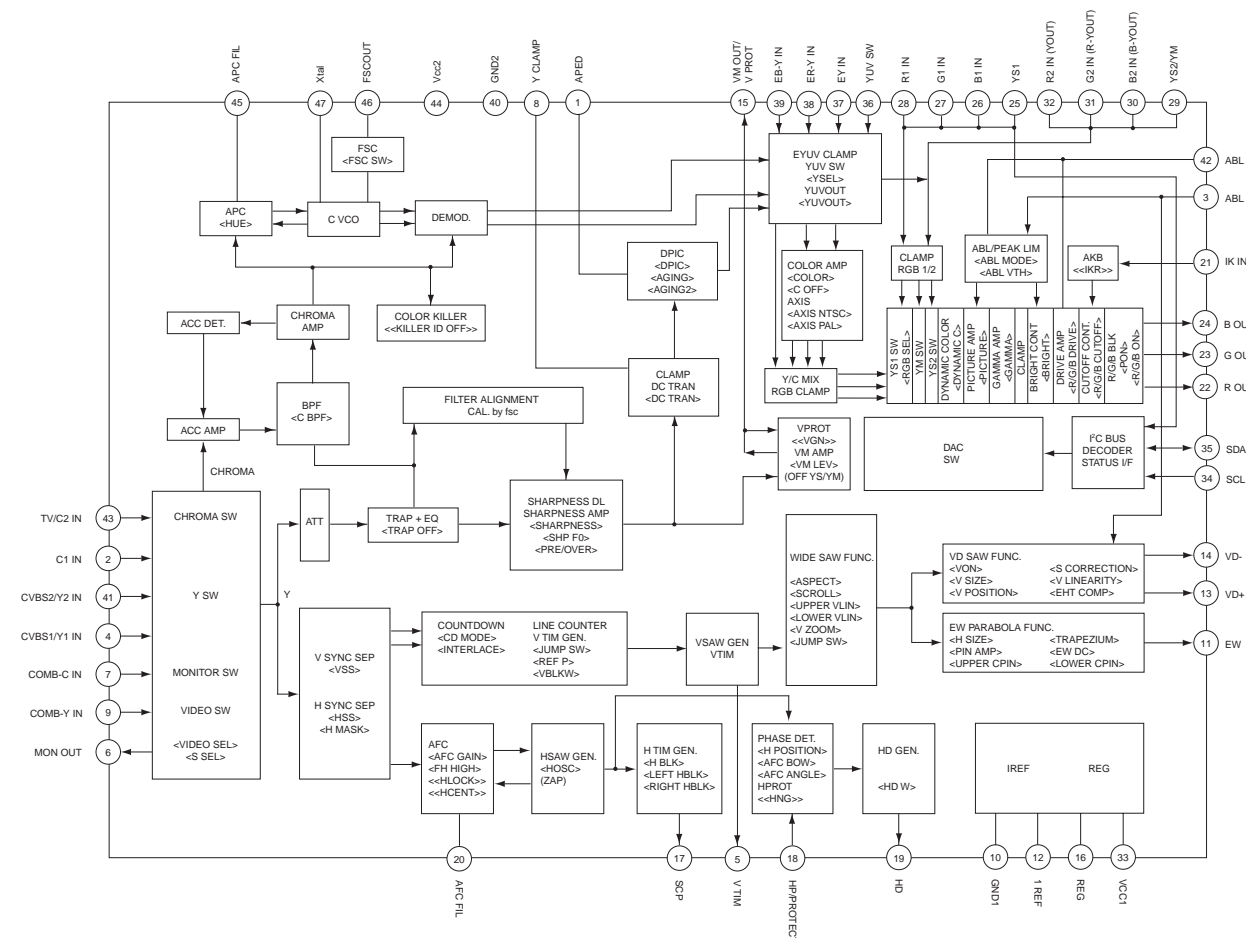

A BOARD: IC561 STV9379

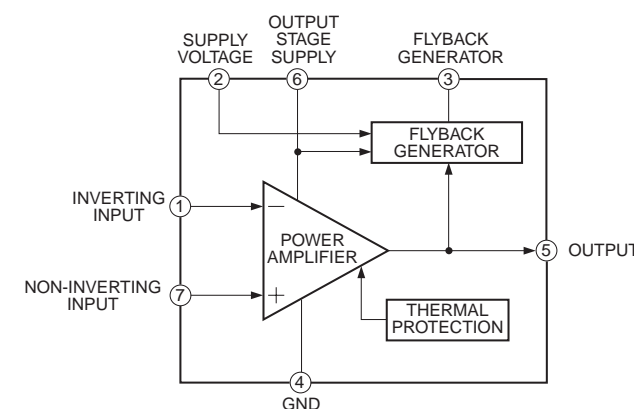

A

[MICON, Y/C/J, TUNER, PIN-MOD, V. DEF, H. DEF]

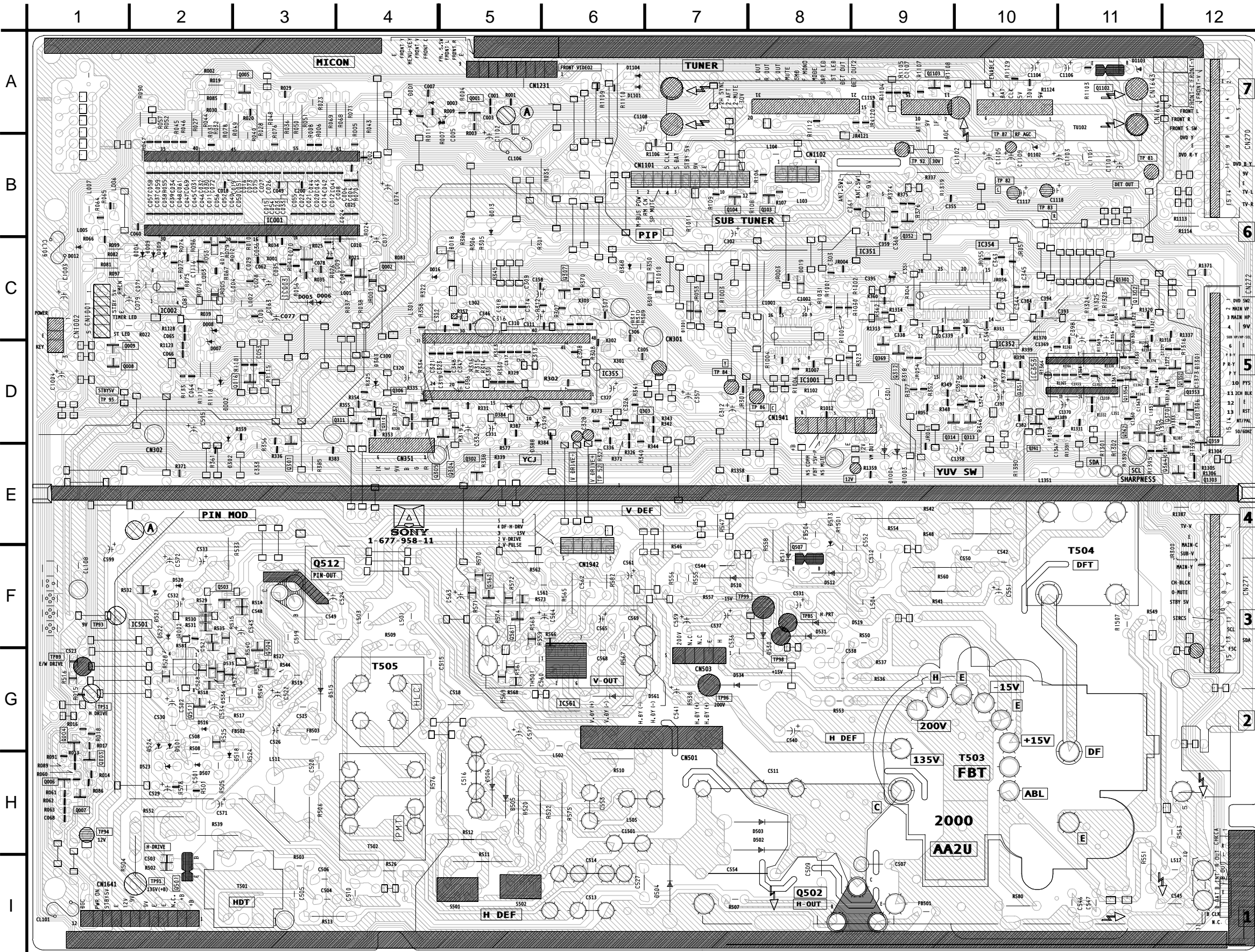

A BOARD LOCATOR LIST

DIODE	IC352	D-10	
D001	A-4	IC353	C-10
D002	D-2	IC354	C-10
D003	A-5	IC355	D-6
D005	C-3	IC501	F-2
D012	C-1	IC561	G-6
D013	B-5	IC1001	D-8
D016	C-4	TRANSISTOR	
D018	C-5	Q001	A-5
D019	C-8	Q002	C-4
D301	C-7	Q003	H-1
D302	E-2	Q004	G-1
D303	D-4	Q005	A-3
D368	C-6	Q006	H-1
D384	D-5	Q007	H-1
D388	D-5	Q008	D-10
D501	H-2	Q009	D-10
D502	H-8	Q016	D-2
D503	H-8	Q103	B-8
D504	I-7	Q104	B-7
D505	H-5	Q301	E-3
D506	H-5	Q303	D-6
D507	H-2	Q304	D-4
D510	F-7	Q305	D-4
D511	E-8	Q306	D-4
D512	F-8	Q307	C-6
D513	E-8	Q310	D-4
D515	G-3	Q311	D-3
D516	G-2	Q313	D-10
D518	H-3	Q314	D-9
D519	F-8	Q351	D-10
D520	F-2	Q352	B-9
D521	F-2	Q359	D-12
D522	F-2	Q361	D-10
D523	H-2	Q362	E-11
D524	H-2	Q364	E-12
D530	G-8	Q369	D-9
D531	F-8	Q370	D-11
D534	G-7	Q501	I-2
D535	G-2	Q502	I-8
D536	G-2	Q503	F-2
D561	G-7	Q504	F-3
D1003	E-9	Q507	F-8
D1004	E-9	Q511	G-2
D1101	A-6	Q512	F-3
D1102	B-10	Q561	F-4
D1103	A-11	Q562	F-4
D1104	A-6	Q1102	A-11
D1301	D-12	Q1103	A-9
D1302	C-11	Q1301	C-11
D1303	C-11	Q1302	C-11
D1304	C-11	Q1303	E-12
D1305	D-11	Q1352	D-11
D1306	D-12	Q1353	D-12
IC001	B-2	CRYSTAL	
IC002	C-2	X001	C-3
IC003	C-3	X302	D-6
IC351	C-9		

UX (MAIN) BOARD SCHEMATIC DIAGRAM (KV-36FV16/36FV26 ONLY)

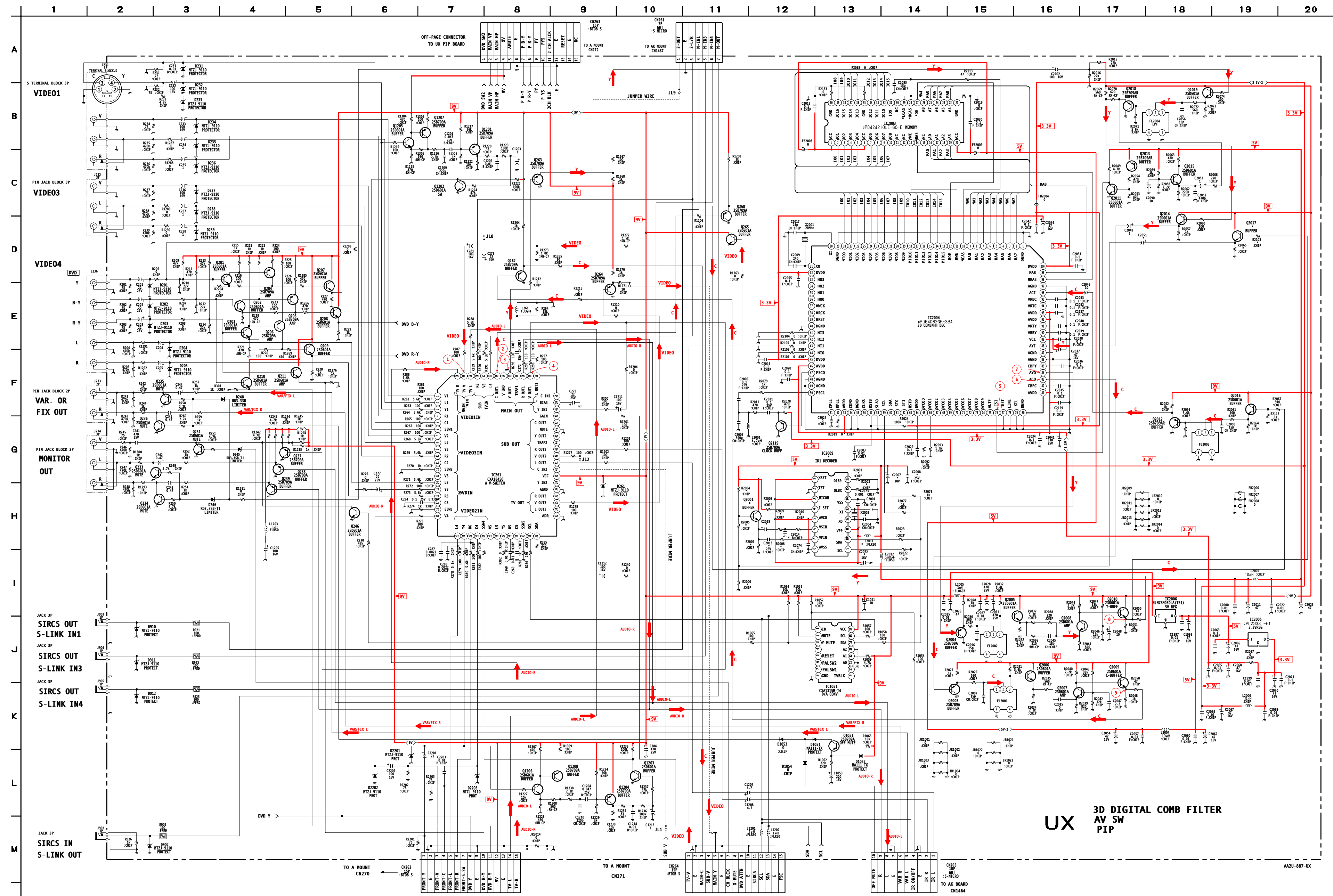

UX (MAIN) BOARD IC VOLTAGE LIST

IC261	29	4.5	59	4.5	5	1.6	35	GND	23	1.5	53	3.3	83	1.7	IC2009				
pin	volt	30	0.0	60	N/C	6	5.0	36	1.7	24	1.5	54	GND	84	1.7	pin	volt		
1	4.5	31	4.7	61	4.5	7	1.4	37	1.7	25	1.5	55	GND	85	1.0	1	4.8		
2	4.5	32	4.7	62	4.5	8	1.6	38	1.7	26	1.7	56	N/C	86	GND	2	GND		
3	4.5	33	GND	63	4.5	9	1.7	39	1.7	27	1.7	57	4.0	87	GND	3	4.8		
4	4.5	34	4.6	64	4.5	10	1.0	40	GND	28	1.7	58	GND	88	2.2	4	1.4		
5	4.5	35	4.2			11	N/C			29	GND	59	4.7	89	0.0	5	4.8		
6	4.5	36	4.6			pin	volt	12	N/C	pin	volt	30	1.5	60	4.7	90	N/C	6	1.8
7	4.5	37	GND	1	8.9	13	2.9	1	GND	31	1.5	61	0.1	91	N/C	7	1.6		
8	4.5	38	N/C	2	8.9	14	0.5	2	1.5	32	3.3	62	N/C	92	3.3	8	GND		
9	N/C	39	8.9	3	0.4	15	N/C	3	1.5	33	N/C	63	N/C	93	3.3	9	4.7		
10	4.5	40	N/C	4	N/C	16	1.5	4	1.5	34	N/C	64	3.3	94	3.3	10	4.7		
11	N/C	41	4.6	5	6.1	17	1.5	5	1.5	35	N/C	65	0.0	95	3.3	11	4.8		
12	0.0	42	4.4	6	N/C	18	1.5	6	1.5	36	N/C	66	0.0	96	0.0	12	2.5		
13	N/C	43	4.4	7	N/C	19	1.5	7	1.5	37	N/C	67	1.9	97	0.0	13	2.4		
14	4.5	44	N/C	8	GND	20	5.0	8	1.5	38	N/C	68	1.9	98	0.5	14	GND		
15	4.5	45	N/C	9	6.0	21	GND	9	1.5	39	N/C	69	1.9	99	1.7	15	0		
16	4.5	46	GND	10	N/C	22	1.7	10	1.0	40	GND	70	1.8	100	3.3	16	4.8		
17	4.5	47	N/C	11	GND	23	1.5	11	2.8	41	0.0	71	1.6						
18	0.0	48	GND	12	8.9	24	1.6	12	2.5	42	0.0	72	2.0	pin	volt				
19	4.5	49	4.5	13	GND	25	1.6	13	1.3	43	0.0	73	1.7	IN	5.0				
20	4.5	50	4.5	14	4.7	26	1.6	14	1.4	44	0.0	74	1.5	OUT	3.3				
21	4.5	51	N/C	15	4.7	27	2.5	15	1.8	45	3.3	75	1.7	GND	GND				
22	4.5	52	4.6	16	8.9	28	1.0	16	1.6	46	3.3	76	4.4						
23	4.5	53	4.4			IC2003	29	1.0	17	1.6	47	1.9	77	GND	pin	volt			
24	4.5	54	4.6	pin	volt	30	N/C	18	1.7	48	GND	78	GND	IN	8.9				
25	N/C	55	4.4	1	5.0	31	1.4	19	1.7	49	GND	79	GND	OUT	5.0				
26	N/C	56	4.4	2	1.7	32	1.5	20	1.7	50	1.5	80	GND	GND	GND				
27	4.5	57	GND	3	1.7	33	1.9	21	1.0	51	N/C	81	3.3						
28	4.5	58	4.4	4	1.7	34	1.6	22	1.6	52	N/C	82	1.0						

UX (MAIN) BOARD TRANSISTOR VOLTAGE LIST

Q201	Q208	Q235	Q263	Q1203	Q2003	Q2010	Q2017
pin	volt	pin	volt	pin	volt	pin	volt
B	2.6	B	3.9	B	0.1	B	4.5
C	2.6	C	8.9	C	0	C	GND
E	8.8	E	3.2	E	GND	E	5.1
pin	volt	pin	volt	pin	volt	pin	volt
B	2.6	B	3.9	B	0.1	B	5.2
C	7.9	C	8.9	C	0	C	GND
E	2.0	E	3.2	E	GND	E	4.8
pin	volt	pin	volt	pin	volt	pin	volt
B	2.6	B	2.6	B	4.4	B	4.7
C	7.9	C	8.9	C	GND	C	8.9
E	2.0	E	2.0	E	5.1	E	4.1
pin	volt	pin	volt	pin	volt	pin	volt
B	8.8	B	2.6	B	4.6	B	4.4
C	8.8	C	8.9	C	GND	C	8.9
E	2.6	E	2.0	E	5.2	E	5.1
pin	volt	pin	volt	pin	volt	pin	volt
B	7.9	B	0	B	4.6	B	8.9
C	3.9	C	5.1	C	GND	C	-0.1
E	8.5	E	GND	E	5.2	E	8.8
pin	volt	pin	volt	pin	volt	pin	volt
B	7.9	B	0.2	B	0.4	B	8.4
C	3.9	C	0	C	5.1	C	0
E	8.6	E	GND	E	GND	E	8.9
pin	volt	pin	volt	pin	volt	pin	volt
B	2.6	B	0.2	B	3.8	B	0.0
C	1.9	C	0	C	GND	C	4.4
E	8.9	E	GND	E	4.5	E	GND

UX (MAIN) BOARD MARK (*) LIST

REF. NO.	LOCATION	KV-36FV16	KV-36FV26	REF. NO.	LOCATION	KV-36FV16	KV-36FV26
C2001	H-13	#	22PF	R2002	H-13	#	10K
C2004	H-13	#	22PF	R2003	H-12	#	33K
C2007	G-14	#	1000µF 10V	R2004	H-11	#	2.2K
C2008	G-14	#	0.1µF 25V	R2005	H-11	#	0
C2013	H-12	#	0.1µF 25V	R2006	I-11	#	4.7K
C2014	H-12	#	0.001µF	R2007	H-12	#	470
C2019	H-12	#	1µF	R2008	H-12	#	100
C2051	D-17	#	10µF	R2009	H-12	#	100
C2072	I-13	#	100µF 16V	R2010	H-12	#	10
C2074	H-12	#	0.001µF	R2022	I-14	#	1K
IC2009	H-13	#	CXD2085M-T4	R2023	H-14	#	1K
L2001	G-12	#	560µH	R2065	D-19	#	1K
Q2001	H-12	#	2SD601A-QRS-TX	R2103	D-19	#	47
Q2017	D-19	#	2SD601A-QRS-TX	X2002	H-13	#	1-767-367-21
R2001	G-13	#	10K				

UX (MAIN) BOARD WAVEFORMS

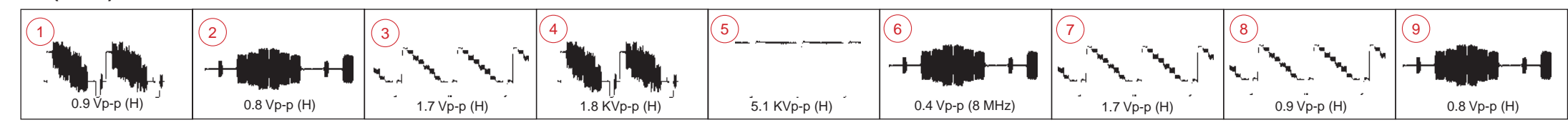

UX (PIP) BOARD SCHEMATIC DIAGRAM (KV-36FV16/36FV26 ONLY)

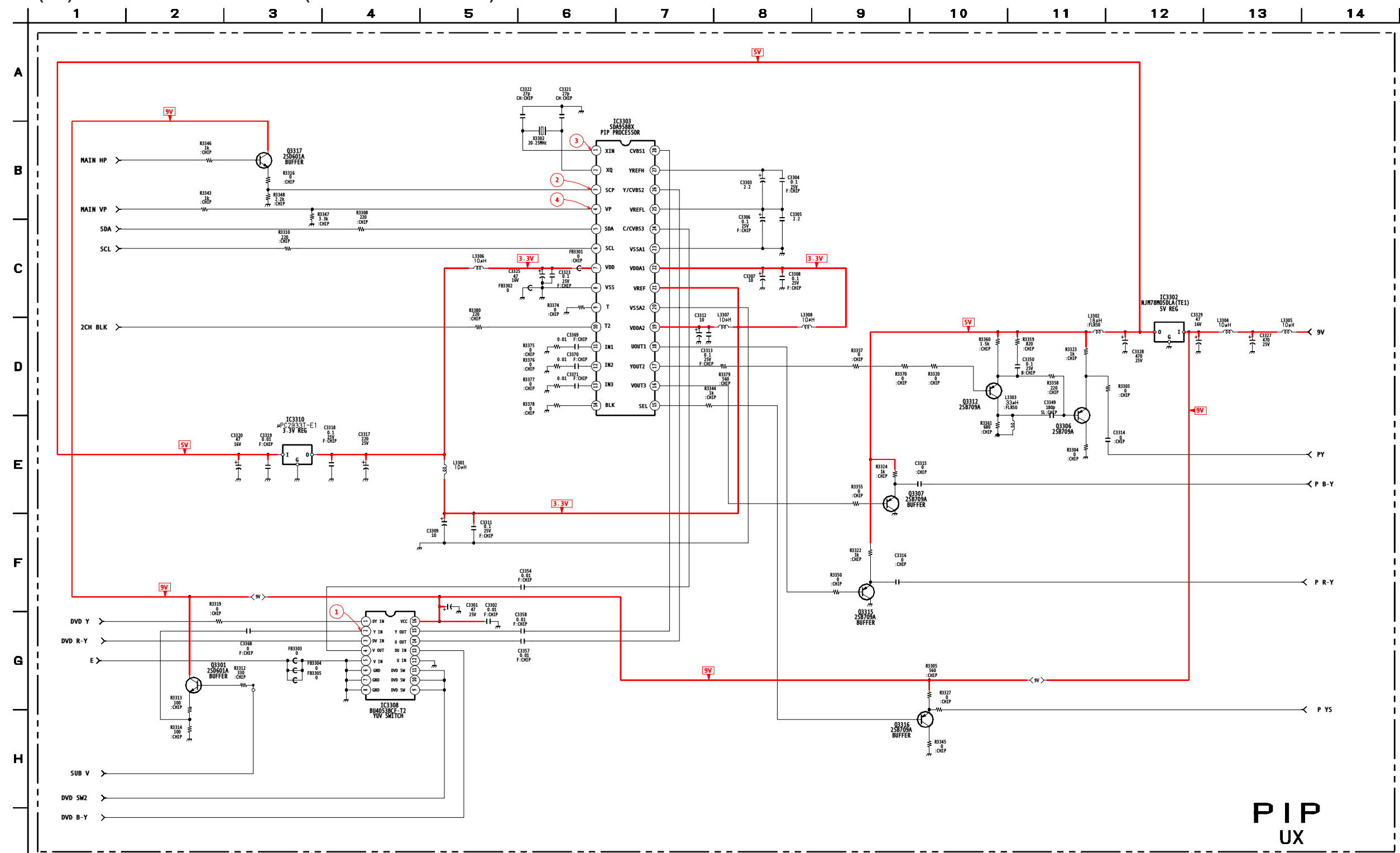

UX (PIP) BOARD WAVEFORMS

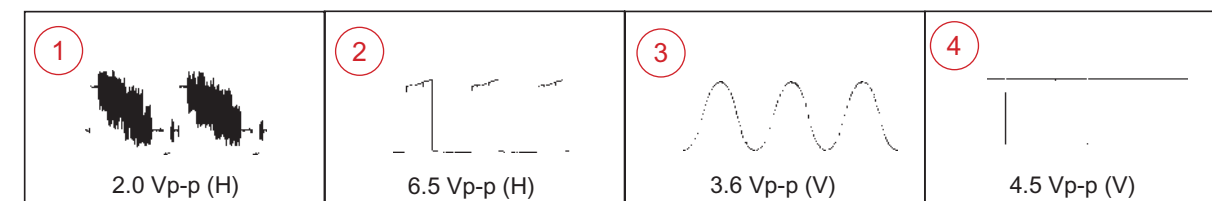

UX (PIP) BOARD IC VOLTAGE LIST

IC3302	18	0.5	12	2.7	
pin	volt	19	3.3	13	3.2
IN	8.7	20	GND	14	2.7
OUT	5.1	21	3.3	15	2.7
GND	GND	22	3.3	16	8.5
IC3303	23	GND	IC3310		
pin	volt	24	2.7	pin	volt
1	3.6	25	1.5	IN	5.0
2	3.6	26	2.7	OUT	3.3
3	6.5	27	1.5	GND	GND
4	4.5	28	2.7		
5	4.7			IC3308	
6	4.7	pin	volt		
7	3.3	1	3.5		
8	0.1	2	2.7		
9	1.2	3	3.2		
10	3.3	4	2.7		
11	1.2	5	2.7		
12	1.2	6	GND		
13	1.2	7	GND		
14	1.2	8	GND		
15	0.0	9	0.3		
16	0.1	10	0.3		
17	0.0	11	0.3		

All voltages are in V

UX (PIP) BOARD TRANSISTOR VOLTAGE LIST

Q3301		Q3307		Q3315		Q3317	
pin	volt	pin	volt	pin	volt	pin	volt
B	5.2	B	0.1	B	0.5	B	0.2
C	8.6	C	GND	C	1.2	C	0.7
E	4.5	E	0.7	E	GND	E	8.7
Q3306		Q3312		Q3316			
pin	volt	pin	volt	pin	volt		
B	0.6	B	0	B	0		
C	0	C	0	C	0.8		
E	1.2	E	0.6	E	0		

All voltages are in V



[3D DIGITAL COMB FILTER, AV SW, PIP]

COMPONENT SIDE (KV-36FV16/36FV26 ONLY)

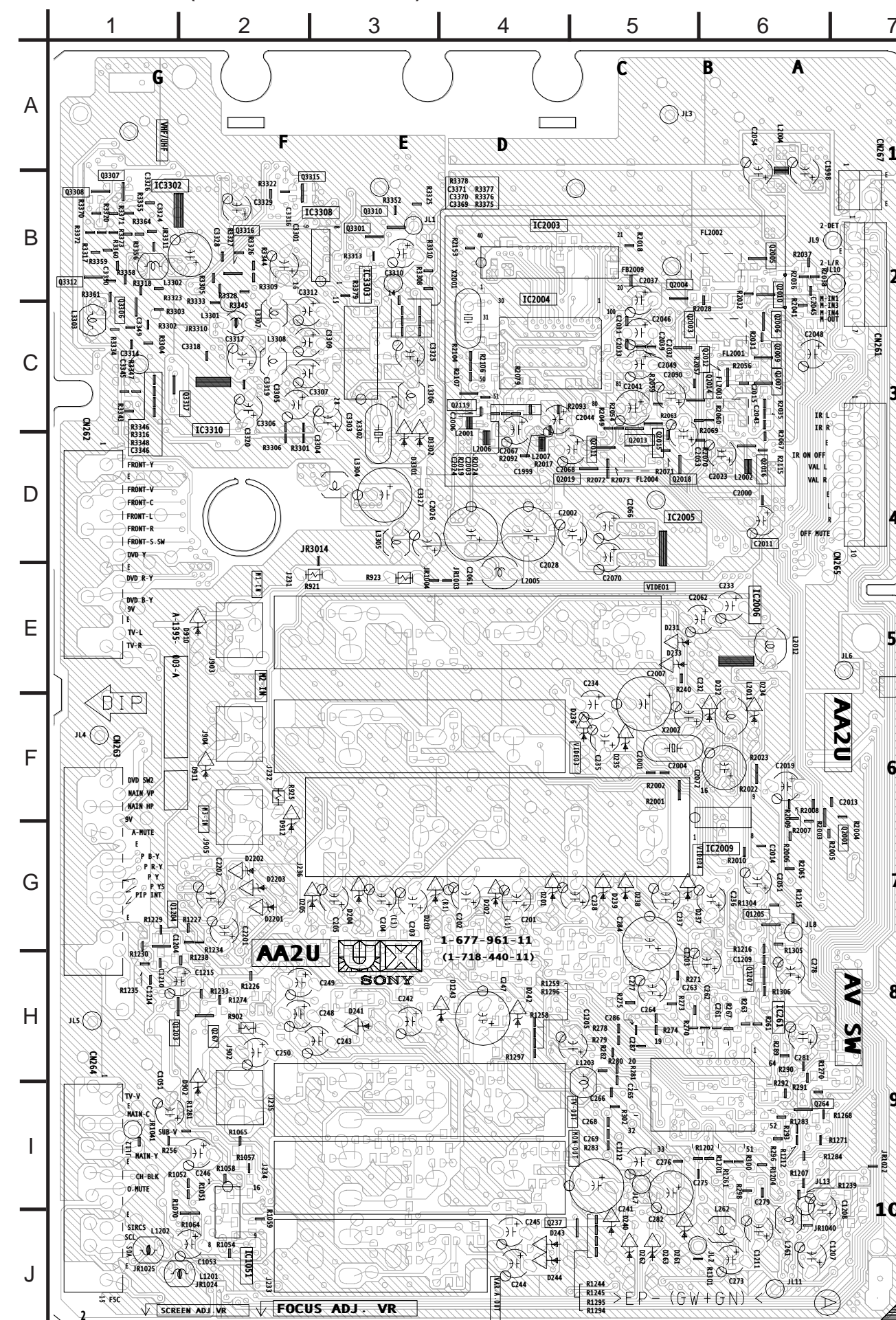

CONDUCTOR SIDE (KV-36FV16/36FV26 ONLY)

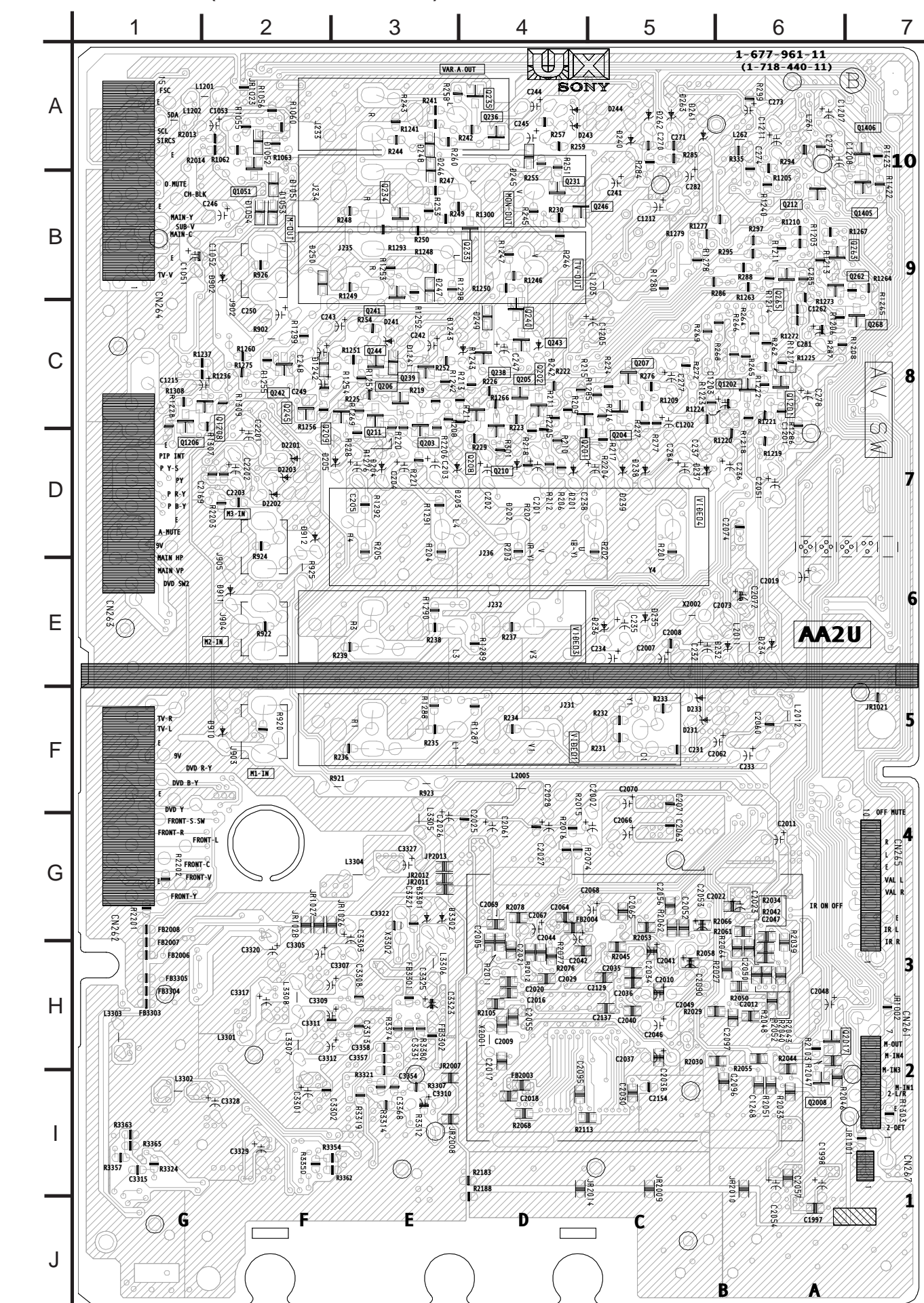

UX BOARD LOCATOR LIST

DIODE		COMP COND		IC		COMP COND		COMP COND		COMP COND		COMP COND	
D201	G-4	--	D245	--	B-5	IC261	H-6	--	Q203	--	D-3	Q238	--
D202	G-4	--	D246	--	B-3	IC1051	J-3	--	Q204	--	D-5	Q239	--
D203	G-3	--	D248	--	A-3	IC2003	B-4	--	Q205	--	C-4	Q246	--
D204	G-3	--	D261	--	A-5	IC2004	C-4	--	Q206	--	C-3	Q262	--
D205	--	D-3	D902	I-2	--	IC2005	D-5	--	Q207	--	B-6	Q263	--
D231	E-5	--	D910	E-2	--	IC2006	E-6	--	Q208	--	D-3	Q264	I-6
D232	E-6	--	D912	G-2	--	IC2009	F-5	--	Q209	--	C-2	Q265	--
D233	E-5	--	D1051	--	B-2	IC3302	B-1	--	Q210	--	D-4	Q268	--
D234	E-6	--	D1052	--	A-2	IC3303	B-3	--	Q211	--	C-4	Q1051	--
D235	F-5	--	D1053	--	B-2	IC3308	B-2	--	Q231	--	B-4	Q1201	--
D236	E-5	--	D1054	--	B-2	IC3310	B-3	--	Q233	--	B-4	Q1202	--
D237	G-5	--	D2201	--	D-2	TRANSISTOR		Q234	--	B-3	Q1203	H-2	--
D238	G-5	--	D2202	--	D-2	COMP	COND	Q235	--	A-4	Q1204	G-2	--
D239	G-5	--	D2203	--	D-2	Q201	D-4	--	Q236	--	A-4	Q1205	G-6

UY (MAIN) BOARD SCHEMATIC DIAGRAM (KV-36FS12/36FS16 ONLY)

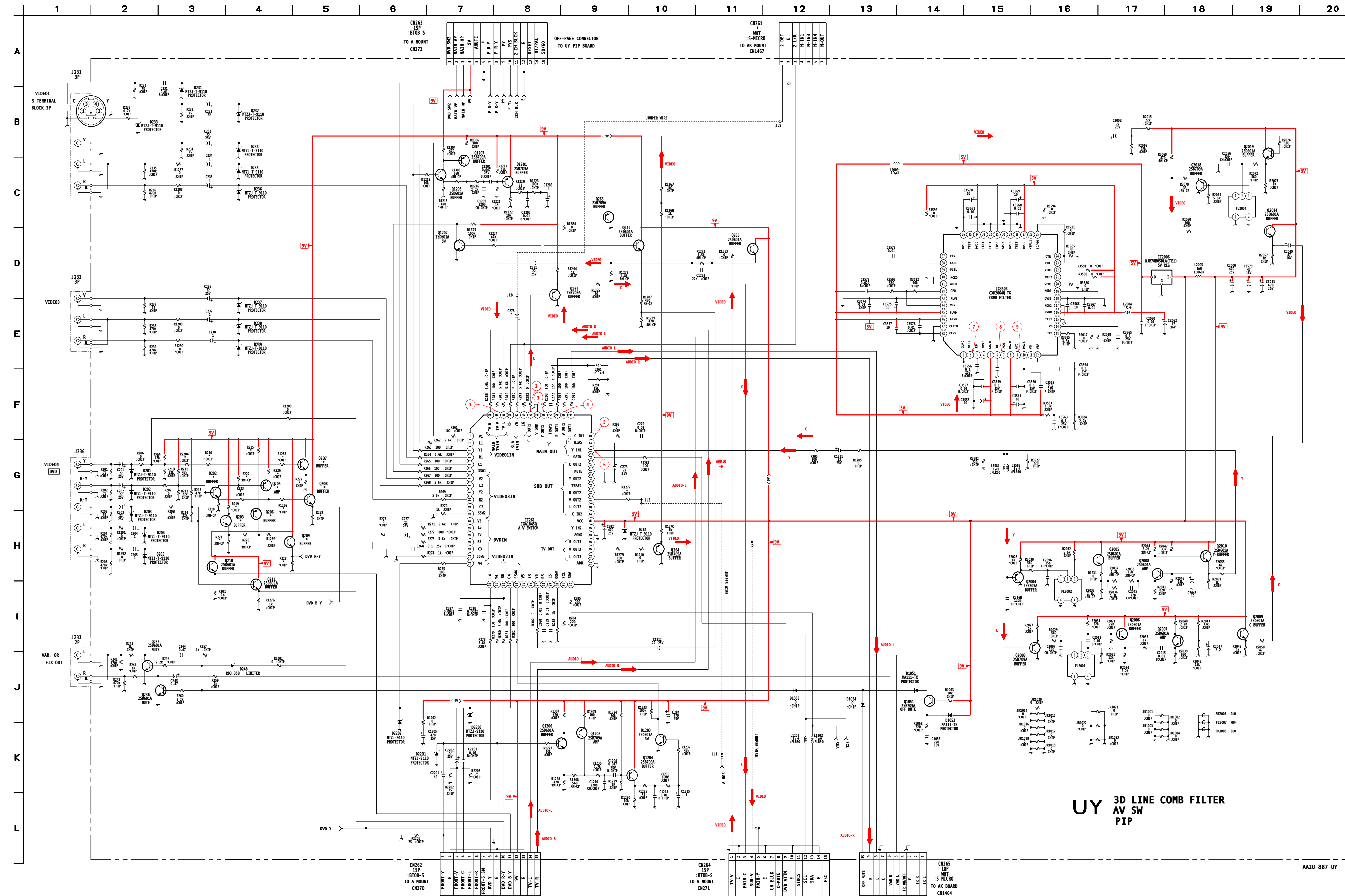

UY (MAIN) BOARD TRANSISTOR VOLTAGE LIST

Q202	Q209	Q262	Q1202	Q1208	Q2008
pin	volt	pin	volt	pin	volt
B 2.7	B 4	B 4.6	B 0	B 8.9	B 2.3
C 8.1	C 9.1	C GND	C 4.4	C 3.8	C 4.6
E 2.1	E 3.4	E 5.2	E GND	E 9.0	E 1.6
pin	volt	pin	volt	pin	volt
B 2.7	B 2.7	B 4.6	B 0	B 1.1	B 4.4
C 8.1	C 9.1	C GND	C 4.4	C GND	C 9.1
E 2.1	E 2.1	E 5.2	E GND	E 1.8	E 3.7
pin	volt	pin	volt	pin	volt
B 4.1	B 2.7	B 4.4	B 8.6	B 1.1	B 4.6
C 8.1	C 9.1	C GND	C 0	C GND	C 9.1
E 8.7	E 2.1	E 5.0	E 9.1	E 1.8	E 3.9
pin	volt	pin	volt	pin	volt
B 8.1	B 4.6	B 4.5	B 4.6	B 4.5	B 5.1
C 4.1	C 9.1	C 9.1	C 9.1	C 9.1	C 9.1
E 8.7	E 3.9	E 3.8	E 4.0	E 3.8	E 4.4
pin	volt	pin	volt	pin	volt
B 2.6	B -0.1	B 9.1	B 4.6	B 4.5	B 4.1
C 1.9	C 0	C -1.4	C 9.1	C 9.1	C GND
E 8.9	E GND	E 9.0	E 4.0	E 3.9	E 4.8
pin	volt	pin	volt	pin	volt
B 4	B -0.1	B 8.6	B 8.9	B 2.3	B 5.2
C 9.1	C 0	C 0	C 3.8	C 4.4	C 9.1
E 3.4	E GND	E 9.1	E 9.0	E 1.7	E 4.5

All Voltages are in V

UY (MAIN) BOARD MARK (*) LIST

REF. NO.	LOCATION	KV-36FS12	KV-36FS16
CN261	A-11	#	7P
Q202	G-3	#	2SD601A-QRS-TX
Q203	H-4	#	2SD601A-QRS-TX
Q205	G-4	#	2SB709A-QRS-TX
Q206	H-4	#	2SB709A-QRS-TX
Q207	G-5	#	2SD601A-QRS-TX
Q208	G-5	#	2SD601A-QRS-TX
Q209	H-5	#	2SD601A-QRS-TX
R216	G-3	#	100
R218	G-3	#	470
R219	G-4	#	1K
R220	H-4	#	100
R221	H-4	#	470
R222	G-4	#	1K
R223	G-4	#	100
R225	G-4	#	100
R226	G-4	#	100
R227	G-5	#	470
R228	H-5	#	1K
R229	H-5	#	1K
R290	F-8	#	100
R1266	G-4	#	470
R1269	H-4	#	470
R1277	G-9	#	100
R1285	G-4	#	470
R2204	G-3	#	0

#: Not Mounted

UY (MAIN) BOARD IC VOLTAGE LIST

IC261	26	NC	53	4.4	9	1.0	36	GND	
pin	volt	27	4.5	54	4.6	10	0	37	2.3
1	4.5	28	4.5	55	4.4	11	2.7	38	GND
2	4.5	29	4.5	56	4.4	12	2.0	39	GND
3	4.5	30	0	57	GND	13	2.0	40	2.2
4	4.5	31	4.7	58	4.4	14	1.0	41	2.2
5	4.5	32	4.7	59	4.5	15	GND	42	3.3
6	4.5	33	GND	60	4.5	16	4.8	43	0
7	4.5	34	NC	61	4.5	17	0.3	44	3.3
8	4.5	35	4.2	62	4.5	18	GND	45	4.8
9	NC	36	NC	63	4.5	19	0.3	46	4.8
10	4.5	37	GND	64	4.5	20	0	47	GND
11	NC	38	NC	65	4.8	21	4.8	48	GND
12	0	39	9	pin	volt	22	4.8		
13	4.5	40	NC	IN	9.0	23	0		
14	4.5	41	NC	OUT	4.9	24	0		
15	4.5	42	4.4	GND	GND	25	0		
16	4.5	43	NC	IC3504	26	0			
17	4.5	44	NC	pin	volt	27	4.8		
18	0	45	NC	1	1.4	28	GND		
19	4.5	46	GND	2	1.4	29	GND		
20	4.5	47	NC	3	0.5	30	GND		
21	4.5	48	GND	4	0	31	GND		
22	4.5	49	4.5	5	4.8	32	GND		
23	4.5	50	4.5	6	2.6	33	GND		
24	NC	51	4.5	7	1.0	34	4.8		
25	NC	52	4.6	8	4.8	35	GND		

All voltages are in V

UY 3D LINE COMB FILTER AV SW PIP

UY (MAIN) BOARD WAVEFORMS

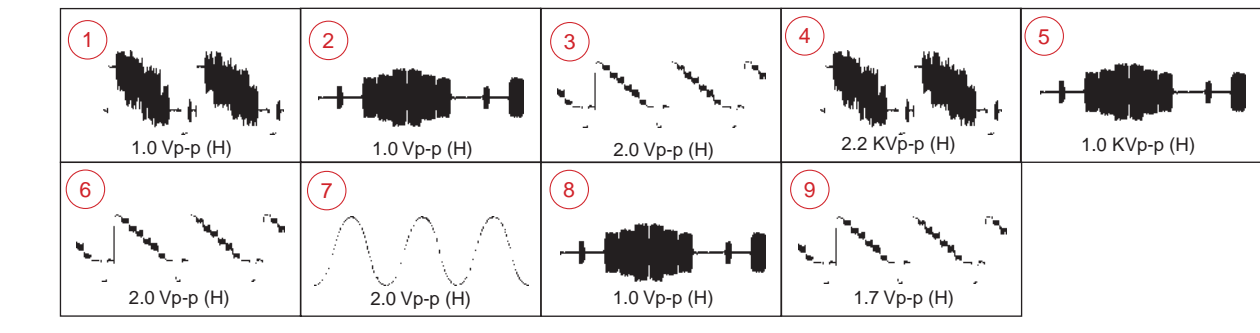

UY PIP BOARD SCHEMATIC DIAGRAM (KV-36FS12/36FS16 ONLY)

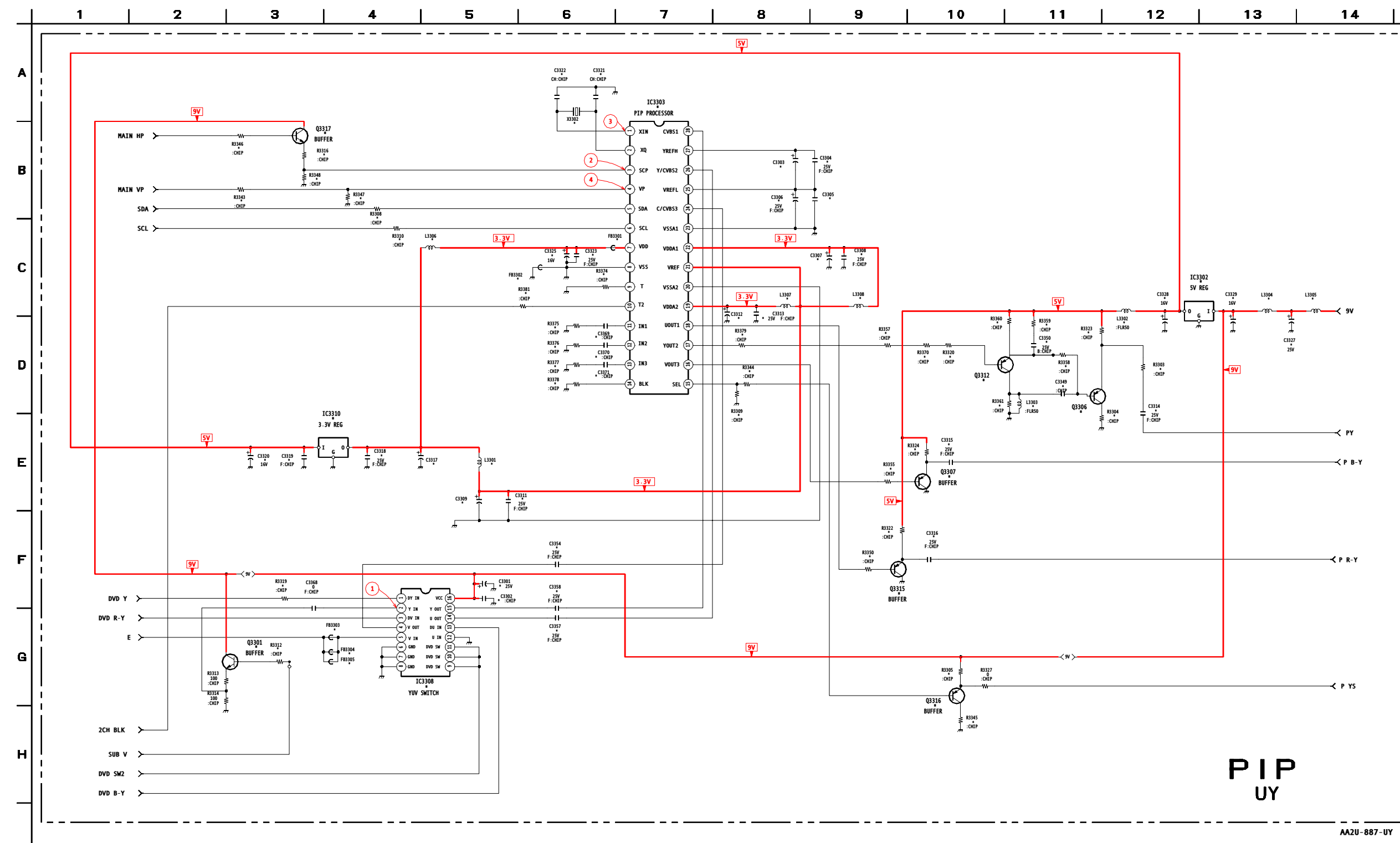

UY [3D DIGITAL, COMB FILTER, AV SW, AUDIO CONTROL, SRS, PIP ENCODE, CHROMA DECODE] COMPONENT SIDE (KV-36FS12/36FS16 ONLY)

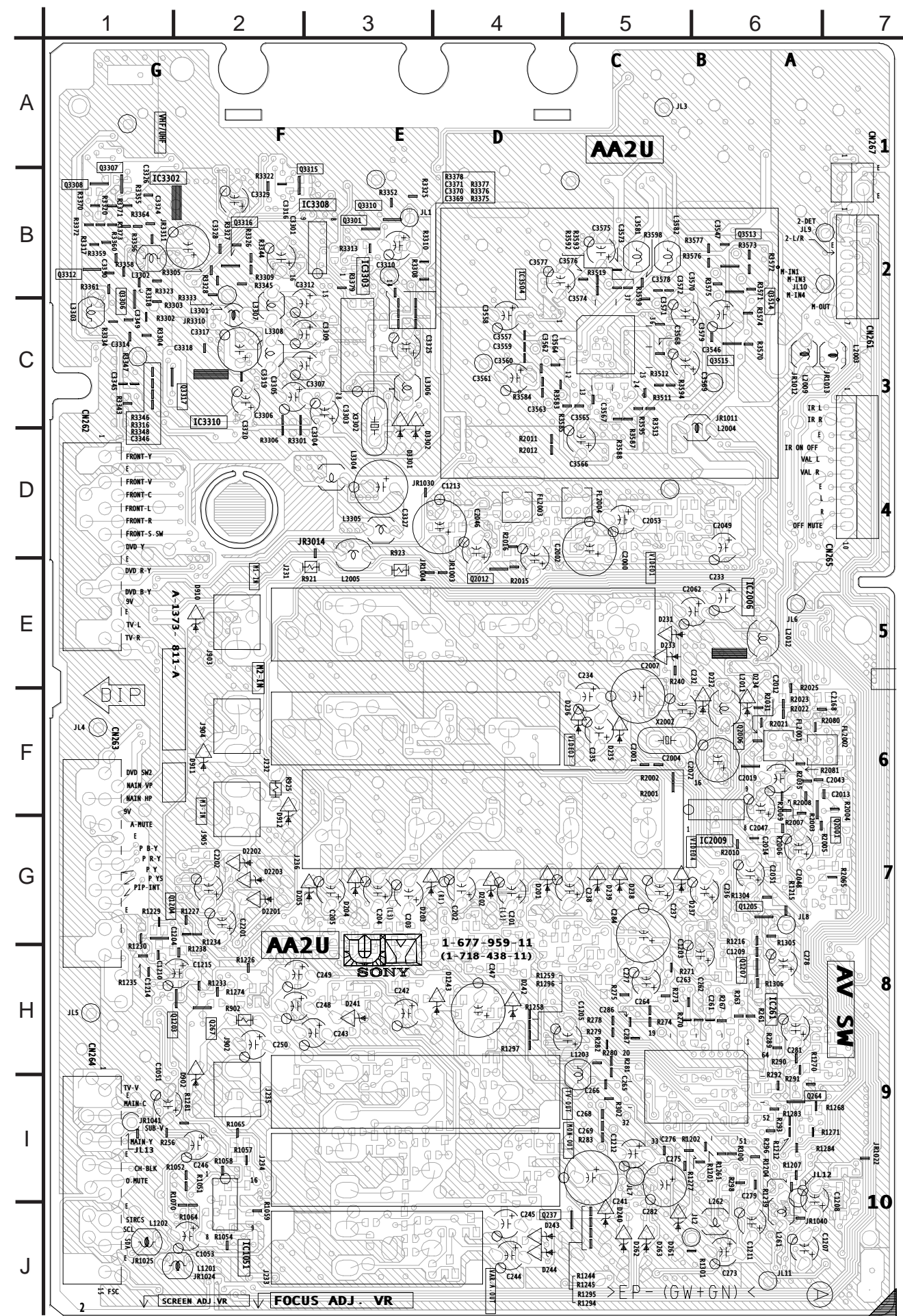

CONDUCTOR SIDE (KV-36FS12/36FS16 ONLY)

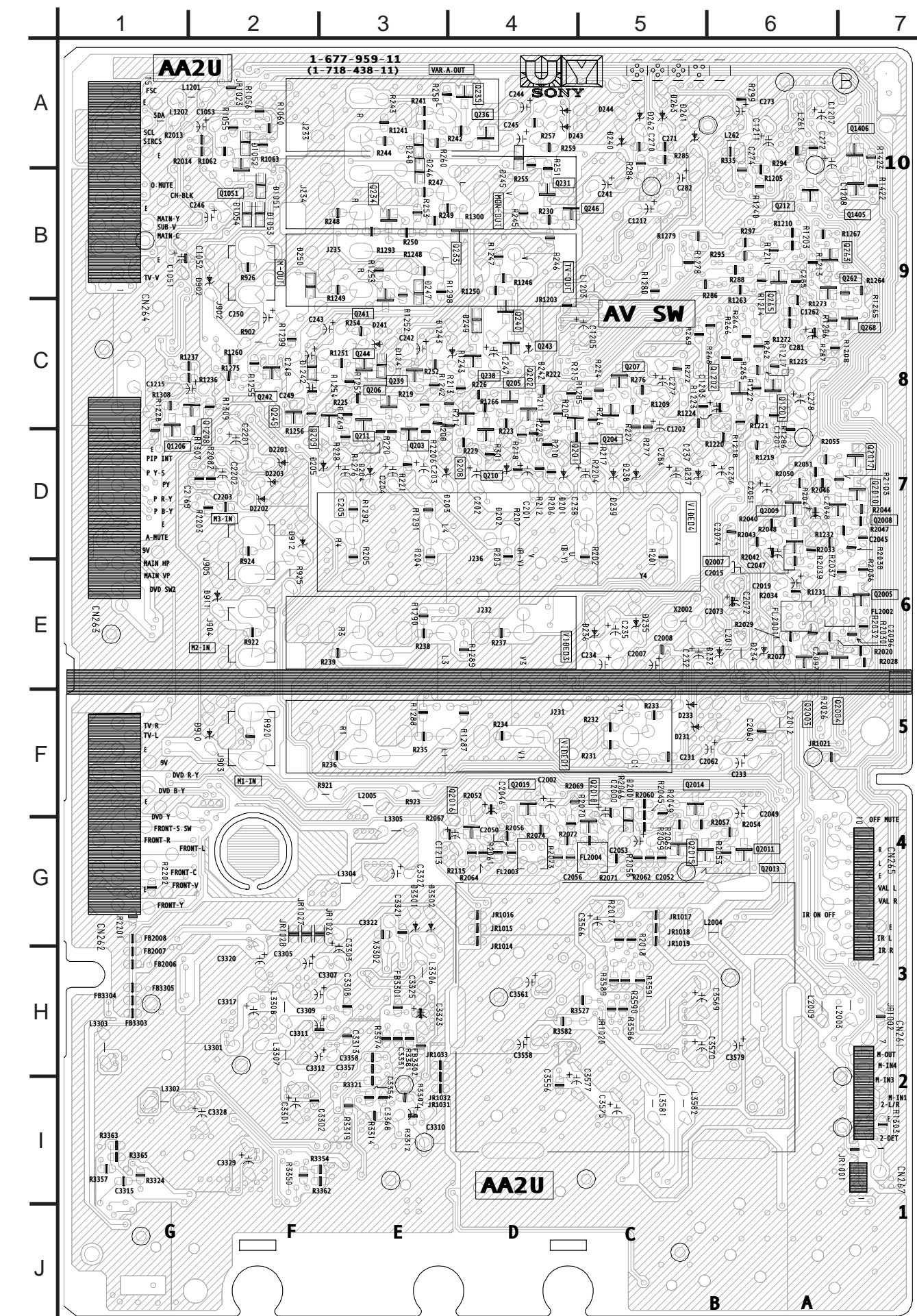

UY (PIP) BOARD WAVEFORMS

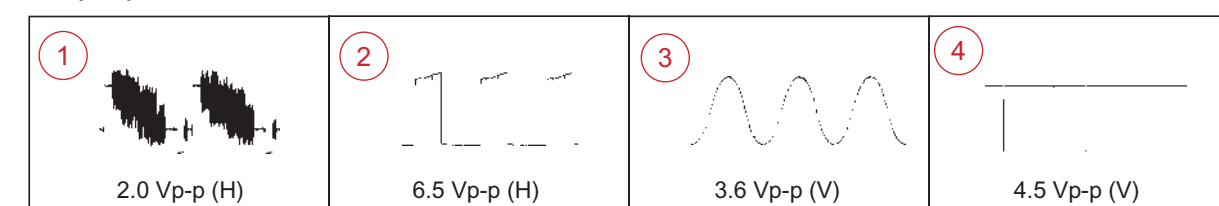

UY (PIP) BOARD IC VOLTAGE LIST

IC	pin	volt	IC	pin	volt
IC3302	11	1.2	IC3308	15	2.7
	12	1.2		16	8.5
	13	1.2			
	14	1.2			
	15	0.0			
IC3303	16	0.1	IC3310	1	3.5
	17	0.0		2	2.7
	18	0.5		3	3.2
	19	3.3		4	2.7
	20	GND		5	2.7
	21	3.3		6	GND
	22	3.3		7	GND
	23	GND		8	GND
	24	1.7		9	0.3
	25	2.5		10	0.3
Q3301	B	5.2	Q3306	B	0.6
	C	8.6		C	0.0
	E	4.5		E	1.2
				GND	0.8
					0.7
Q3307	B	0.1	Q3312	B	0.0
	C	0.0		C	0.0
	E	0.7		E	0.6
				GND	0.0
					8.7

UY (PIP) BOARD TRANSISTOR VOLTAGE LIST

Q3301	Q3306	Q3307	Q3312	Q3315	Q3316	Q3317	
pin	volt	pin	volt	pin	volt	pin	volt
B	5.2	B	0.6	B	0.1	B	0.0
C	8.6	C	0.0	C	GND	C	0.0
E	4.5	E	1.2	E	0.7	E	0.0

UY (PIP) BOARD MARK (*) LIST

REF. NO.	LOCATION	KV-36FS12	KV-36FS16	REF. NO.	LOCATION	KV-36FS12	KV-36FS16	REF. NO.	LOCATION	KV-36FS12	KV-36FS16	REF. NO.	LOCATION	KV-36FS12	KV-36FS16	REF. NO.	LOCATION	KV-36FS12	KV-36FS16
C3301	F-5	#	47µF 25V	C3319	E-3	#	.01µF	C3371	D-6	#	.01µF	L3308	C-8	#	10µH	R3316	B-3	#	0
C3302	F-5	#	.01µF	C3320	E-3	#	47µF	FB3301	C-7	#	0	Q3301	G-3	#	2SD601A-QRS-TX	R3319	F-3	#	0
C3303	B-8	#	2.2µF	C3321	A-6	#	27PF	FB3302	C-6	#	0µH	Q3306	D-12	#	2SB709A-QRS-TX	R3320	D-10	#	560
C3304	B-9	#	.1µF 25V	C3322	A-6	#	27PF	FB3303	G-4	#	0µH	Q3307	E-10	#	1K	R3370	D-10	#	0
C3305	B-9	#	2.2µF	C3323	C-6	#	.1µF 25V	FB3304	G-4	#	0µH	Q3312	D-10	#	1K	R3374	C-6	#	0
C3306	B-8	#	.1µF 25V	C3325	C-6	#	47µF 16V	FB3305	G-4	#	0µH	Q3315	F-9	#	1K	R3375	D-6	#	0
C3307	C-9	#	10µF	C3327	D-13	#	470µF 25V	IC3302	C-13	#	NJM78M05DLA (TE1)	Q3316	H-10	#	1K	R3376	D-6	#	0
C3308	C-9	#	.1µF 25V	C3328	C-12	#	470µF 10V	IC3303	A-7	#	SDA9588X	Q3317	B-3	#	1K	R3377	D-6	#	0
C3309	E-5	#	10µF	C3329	C-13	#	47µF 16V	IC3308	F-5	#	BU4053BCF-T2	R3303	D-12	#	0	R3378	D-6	#	0
C3311	E-5	#	.1µF 25V	C3349	D-11	#	180PF	IC3310	E-4	#	UPC2933T-E1	R3304	D-12	#	0	R3379	D-8	#	560
C3312	D-8	#	10µF	C3350	D-11	#	.1µF 25V	L3301	D-5	#	10µH	R3305	G-10	#	560	R3347	B-4	#	3.3K
C3313	D-8	#	.1µF 25V	C3354	F-6	#	.01µF	L3302	D-12	#	18µH	R3308	B-4	#	220	R3348	B-3	#	2.2K
C3314	B-8	#	0	C3357	G-6	#	.01µF	L3303	D-11	#	33µH	R3309	D-8	#	470	R3350	F-9	#	0
C3315	E-10	#	0	C3358	G-6	#	.01µF	L3304	C-13	#	10µH	R3310	C-4	#	220	R3355	E-9	#	0
C3316	F-10	#	0	C3368	F-3	#	0	L3305	C-13	#	10µH	R3312	G-3	#	330	R3357	D-9	#	0
C3317	E-5	#	220µF 25V	C3369	D-6	#	.01µF	L3306	C-5	#	10µH	R3313	G-2	#	470	R3358	D-11	#	220
C3318	E-4	#	.1µF 25V	C3370	D-6	#	.01µF	L3307	C-8	#	10µH	R3314	G-2	#	470	R3359	D-11	#	820

UY BOARD LOCATOR LIST

DIODE	COND	COMP	COND	COMP	COND	COMP	COND	COMP	COND	COMP	COND	COMP	COND
D201	G-4	--	D248	--	A-3	IC3308	B-2	--	Q236	--	A-4	Q2004	B-5
D202	G-4	--	D1051	--	B-2	IC3310	B-3	--	Q262	--	B-7	Q2005	B-6
D203	G-3	--	D1052	--	A-2	TRANSISTOR				Q264	I-6	Q2007	C-6
D204	G-3	--	D1053	--	B-2	Q202	--	C-4	Q265	--	B-6	Q2008	--
D205	--	D-3	D1054	--	B-2	Q203	--	D-3	Q1051	--	B-2	Q2009	C-6
D231	E-5	--	D2201	--	D-2	Q205	--	C-4	Q1201	--	C-6	Q2010	B-6
D232	E-6	--	D2202	--	D-2	Q206	--	C-3	Q1202	--	C-5	Q2014	C-5
D233	E-5	--	D2203	--	D-2	Q207	--	C-5	Q1203	H-2	--	Q2018	D-5
D234	E-6	--				IC	Q208	--	D-3	Q1204	G-2	--	Q2019
D235	F-5	--				COMP	COND	Q209	--	C-2	Q1205	G-6	--
D236	E-5	--	IC261	H-6	--	Q210	--	D-4	Q1206	--	D-1	Q3306	--
D237	G-5	--	IC2006	E-6	--	Q211	--	C-4	Q1207	H-6	--	Q3307	B-1
D238	G-5	--	IC3302	B-1	--	Q212	--	B-6	Q1208	--	C-2	Q3312	B-1
D239	G-5	--	IC3303	B-3	--	Q235	--	A-4	Q2003	C-5	--	Q3315	B-2

AK BOARD SCHEMATIC DIAGRAM

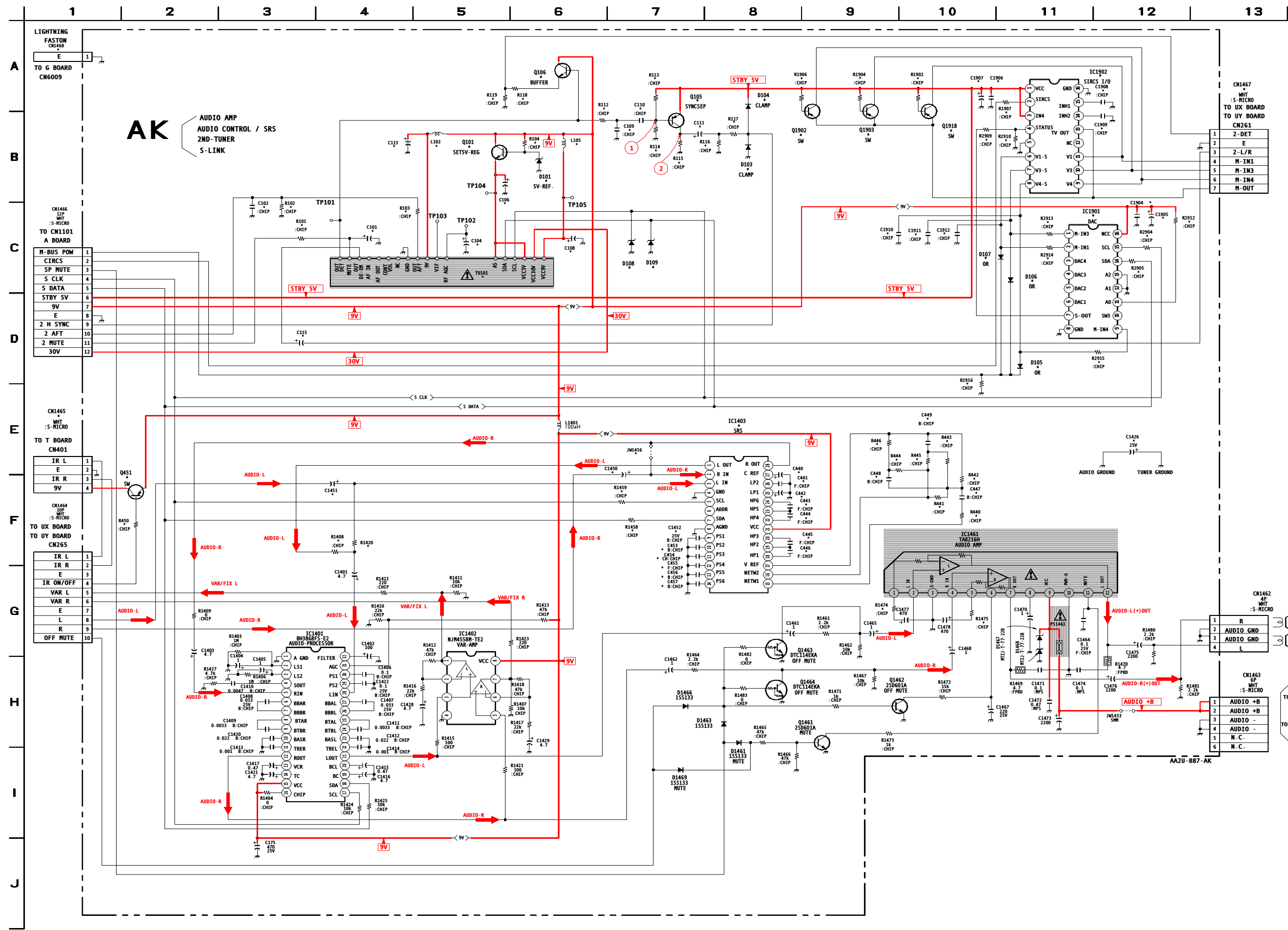

AK [AUDIO AMP, AUDIO CONTROL/SRS, 2ND-TUNER, S-LINK]

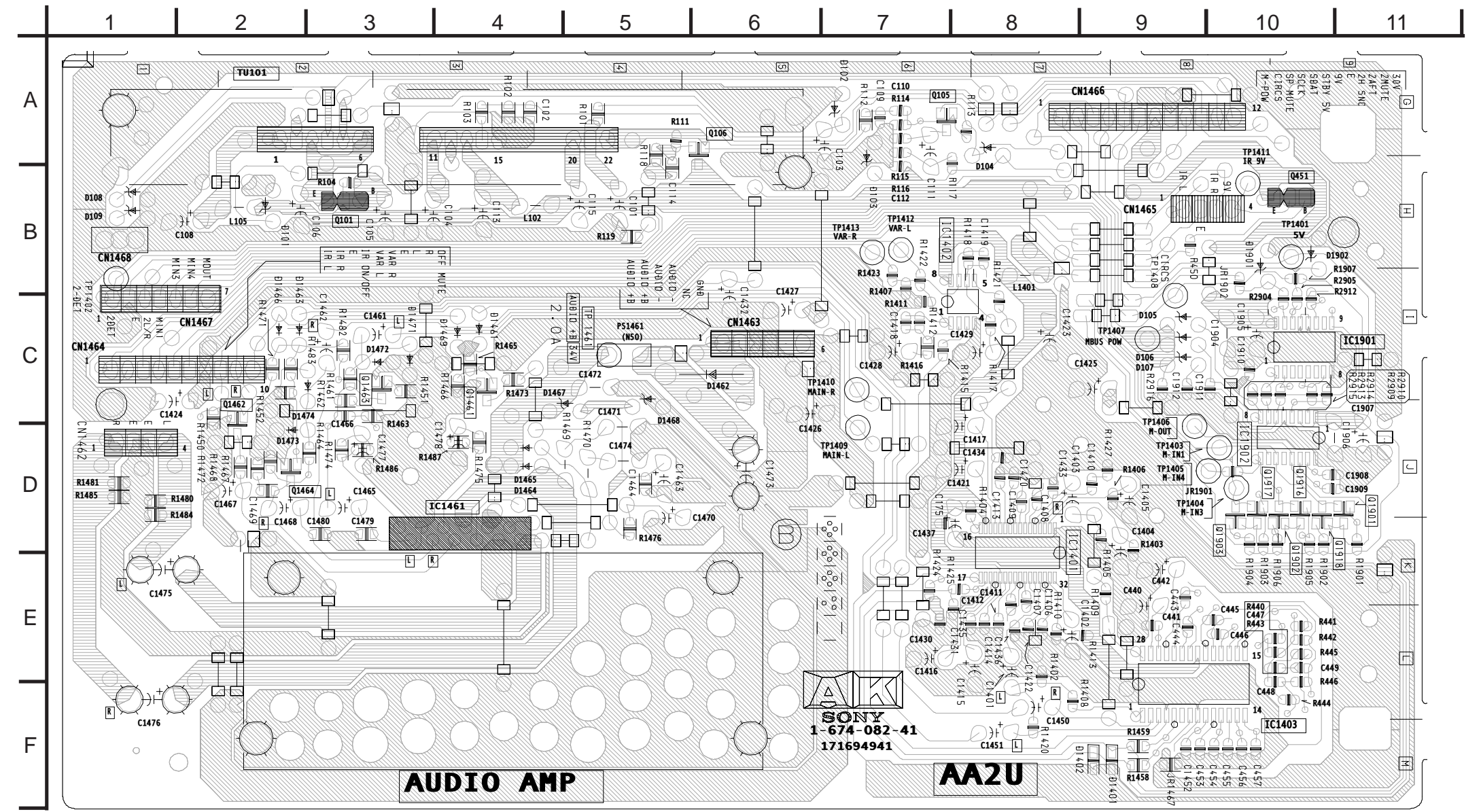

AK BOARD LOCATOR LIST

DIODE	IC1402	B-6	
D101	A-2	IC1403	E-8
D103	A-6	IC1461	D-3
D104	A-6	IC1901	B-8
D105	B-8	IC1902	C-8
D106	B-8	TRANSISTOR	
D107	C-8	Q101	A-2
D108	A-1	Q105	A-6
D109	B-1	Q106	A-4
D1461	B-3	Q1461	C-3
D1463	B-2	Q1462	C-2
D1466	B-2	Q1463	C-2
D1467	C-4	Q1464	C-2
D1468	C-4	Q1902	D-8
D1469	C-4	Q1903	D-9
IC			
IC1401	D-6		

AK BOARD IC VOLTAGE LIST

IC1401		12	4.5	25	4.5	4	GND	7	4.7	20	4.5	3	NC	2	0.4	15	4.7	10	0.7
pin	volt	13	1.0	26	4.5	5	4.5	8	GND	21	9.1	4	0	3	NC	16	9.3	11	0.7
1	GND	14	1.9	27	4.5	6	4.5	9	4.5	22	4.5	5	1.5	4	NC	17	9.3	12	NC
2	0.7	15	9.1	28	4.5	7	4.5	10	4.5	23	4.5	6	11.6	5	NC	pin	volt	13	0
3	1.2	16	9.1	29	4.5	8	9.1	11	4.5	24	4.5	7	16.0	6	NC	1	5.0	14	0.4
4	4.5	17	4.7	30	4.5	9	4.5	12	4.5	25	4.5	8	5.1	7	0.4	2	3.9	15	0.4
5	4.5	18	4.7	31	2.9	pin	volt	13	4.5	26	4.5	9	34.5	8	GND	3	5.0	16	GND
6	4.5	19	1.9	32	4.5	1	3.9	14	4.5	27	4.5	10	0	9	0	4	0.1		
7	4.5	20	1.0	IC1402		2	4.5	15	4.5	28	3.9	11	4.2	10	NC	5	GND		
8	4.5	21	4.5	pin	volt	3	4.5	16	4.5	IC1461		12	15.7	11	9.3	6	0		
9	4.5	22	4.5	1	4.5	4	GND	17	4.5	pin	volt	IC1901		12	0	7	0		
10	4.5	23	4.5	2	4.5	5	4.7	18	4.5	1	1.5	pin	volt	13	0	8	0		
11	0	24	4.5	3	4.5	6	NC	19	4.5	2	0	1	0	14	4.7	9	0.7		

TU101		12	NC
pin	volt	13	N/C
1	9.3	14	N/C
2	30.2	15	N/C
3	5.1	16	3.1
4	4.7	17	0
5	0	18	4
6	5		
7	7.9		
8	0		
9	9.4		
10	7.9		
11	GND		

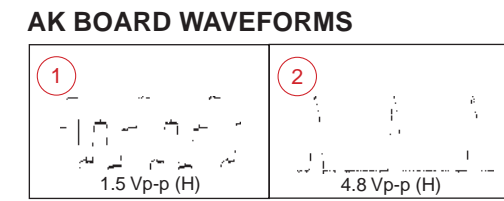

AK BOARD MARK (*) LIST

REF. NO.	LOCATION	KV-36FS12	KV-36FS16	KV-36FV16	KV-36FV26	REF. NO.	LOCATION	KV-36FS12	KV-36FS16	KV-36FV16	KV-36FV26	REF. NO.	LOCATION	KV-36FS12	KV-36FS16	KV-36FV16	KV-36FV26	REF. NO.	LOCATION	KV-36FS12	KV-36FS16	KV-36FV16	KV-36FV26							
C101	D-4	#	1μF	1μF	1μF	C454	F-7	#	#	470PF	470PF	D103	C-8	#	1SS133T-77	1SS133T-77	1SS133T-77	R102	C-3	#	33K	33K	33K	R1458	F-7	#	#	#	220	220
C102	C-3	#	0.0022μF	0.0022μF	0.0022μF	C455	F-7	#	#	0.1μF 25V	0.1μF 25V	D104	B-8	#	1SS133T-77	1SS133T-77	1SS133T-77	R103	C-5	#	22K	22K	22K	R1459	F-7	#	#	220	220	
C104	D-5	#	10μF	10μF	10μF	C456	G-7	#	#	0.015μF	0.015μF	D105	E-11	#	1SS133T-77	1SS133T-77	1SS133T-77	R104	C-6	#	1K	1K	1K	R1474	G-9	680	680	100	100	
C106	C-6	#	47μF 25V	47μF 25V	47μF 25V	C457	G-7	#	#	0.0022μF	0.0022μF	D107	D-11	#	1SS133T-77	1SS133T-77	1SS133T-77	R112	B-7	#	2.2K	2.2K	2.2K	R1475	G-10	680	680	100	100	
C108	D-6	#	1000μF 25V	1000μF 25V	1000μF 25V	C1426	E-12	#	#	470μF 25V	470μF 25V	D106	D-11	#	1SS133T-77	1SS133T-77	1SS133T-77	R113	B-7	#	100K	100K	100K	R1902	B-10	#	#	10K	10K	
C109	B-7	#	220PF	220PF	220PF	C1450	E-7	#	#	4.7μF	4.7μF	D108	D-7	#	MTZJ-T-77-10B	MTZJ-T-77-10B	MTZJ-T-77-10B	R114	B-7	#	1M	1M	1M	R1904	B-9	#	#	10K	10K	
C110	B-7	#	0.047μF 25V	0.047μF 25V	0.047μF 25V	C1451	F-4	#	#	4.7μF	4.7μF	D109	D-7	#	MTZJ-T-77-10B	MTZJ-T-77-10B	MTZJ-T-77-10B	R115	C-7	#	10K	10K	10K	R1906	B-9	#	#	10K	10K	
C111	C-7	#	1μF	1μF	1μF	C1452	F-7	#	#	0.027μF 25V	0.027μF 25V	IC1403	E-8	#		TDA7467D013TR	TDA7467D013TR	R116	C-8	#	10K	10K	10K	R1907	B-11	#	#	220	220	
C113	C-5	#	220μF 25V	220μF 25V	220μF 25V	C1904	C-12	#	#	0.01μF	0.01μF	IC1901	D-12	#		CXA1315M-T4	CXA1315M-T4	R117	C-8	#	4.7K	4.7K	4.7K	R2904	D-12	#	#	220	220	
C115	A-5	#	1μF	1μF	1μF	C1905	C-12	#	#	10μF	10μF	IC1902	B-11	#		NJM2145M-TE2	NJM2145M-TE2	R118	A-7	#	470	470	470	R2905	D-12	#	#	220	220	
C440	E-8	#	22μF	22μF	22μF	C1906	B-11	#	#	0.01μF	0.01μF	JW1456	E-7	15MM	15MM	#	#	R119	A-7	#	560	560	560	R2909	C-11	#	#	10K	10K	
C441	F-8	#	#	0.1μF 25V	0.1μF 25V	C1907	B-10	#	#	10μF	10μF	L102	C-5	#		10μH	10μH	R440	F-10	#	#	1K	1K	R2910	C-11	#	#	10K	10K	
C442	F-8	#	#	1μF	1μF	C1908	B-12	#	#	0.001μF	0.001μF	L105	C-6	#		100μH	100μH	R441	F-10	#	#	130K	130K	R2912	C-12	#	#	4.7K	4.7K	
C443	F-8	#	#	0.1μF 25V	0.1μF 25V	C1909	B-12	#	#	0.001μF	0.001μF	Q101	C-6	#		2SC3311A-QRSTA	2SC3311A-QRSTA	R442	E-10	#	#	43K	43K	R2913	C-11	#	#	10K	10K	
C444	F-8	#	#	1μF 16V	1μF 16V	C1910	D-10	#	#	0.001μF	0.001μF	Q105	B-7	#		2SB709A-QRS-TX	2SB709A-QRS-TX	R443	E-10	#	#	1.5K	1.5K	R2914	D-11	#	#	10K	10K	
C445	F-8	#	#	0.1μF 25V	0.1μF 25V	C1911	D-10	#	#	0.001μF	0.001μF	Q106	B-6	#		2SD601A-QRS-TX	2SD601A-QRS-TX	R444	E-10	#	#	47K	47K	R2915	E-12	#	#	10K	10K	
C446	F-8	#	#	1μF 16V	1μF 16V	C1912	D-10	#	#	0.001μF	0.001μF	Q451	F-2	#		2SB734-T-34	2SB734-T-34	R445	E-10	#	#	33K	33K	R2916	E-10	#	#	10K	10K	
C447	F-10	#	#	0.47μF 16V	0.47μF 16V	CN14																								

C BOARD SCHEMATIC DIAGRAM

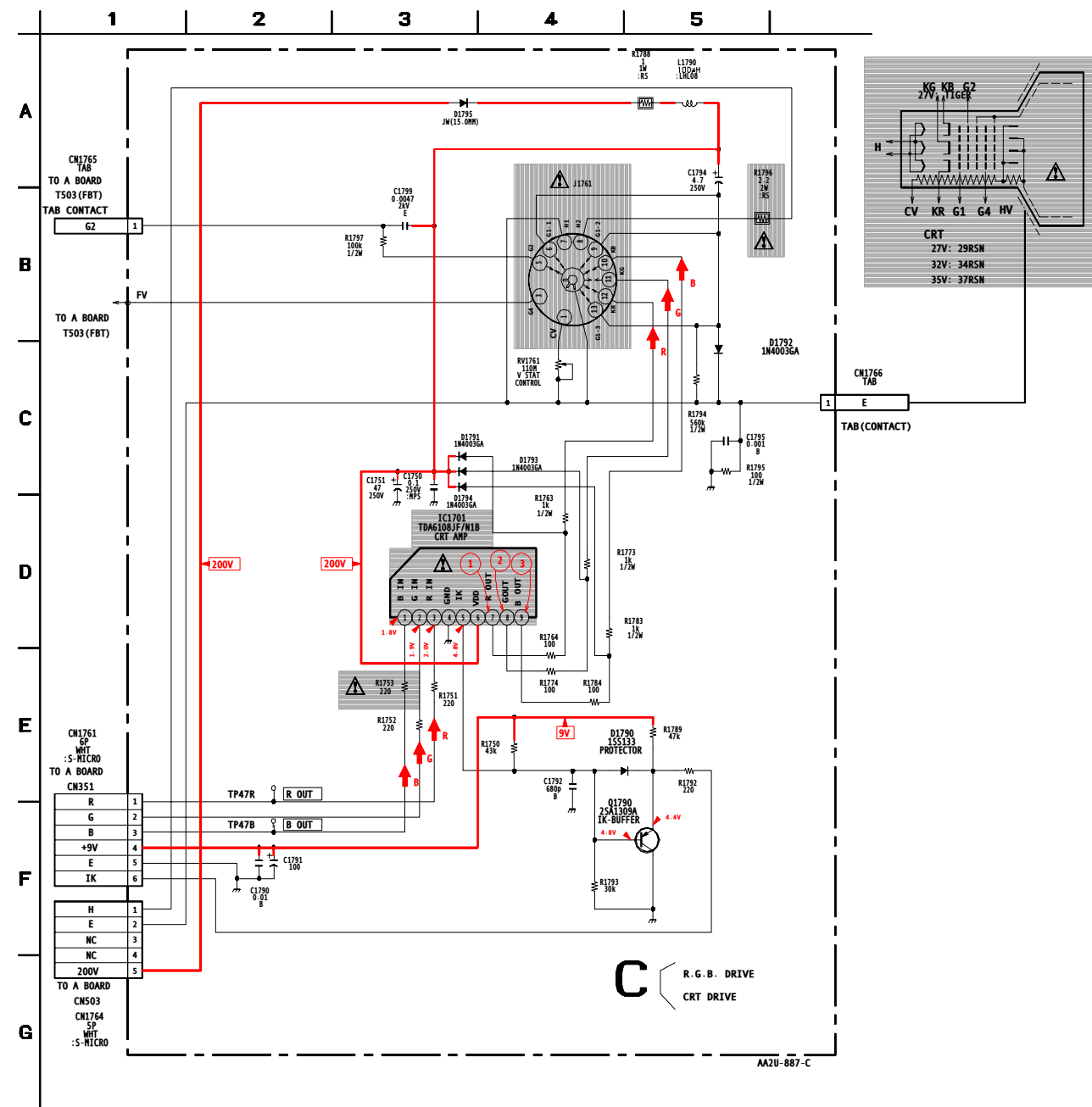

C [R.G.B. DRIVE, CRT DRIVE]

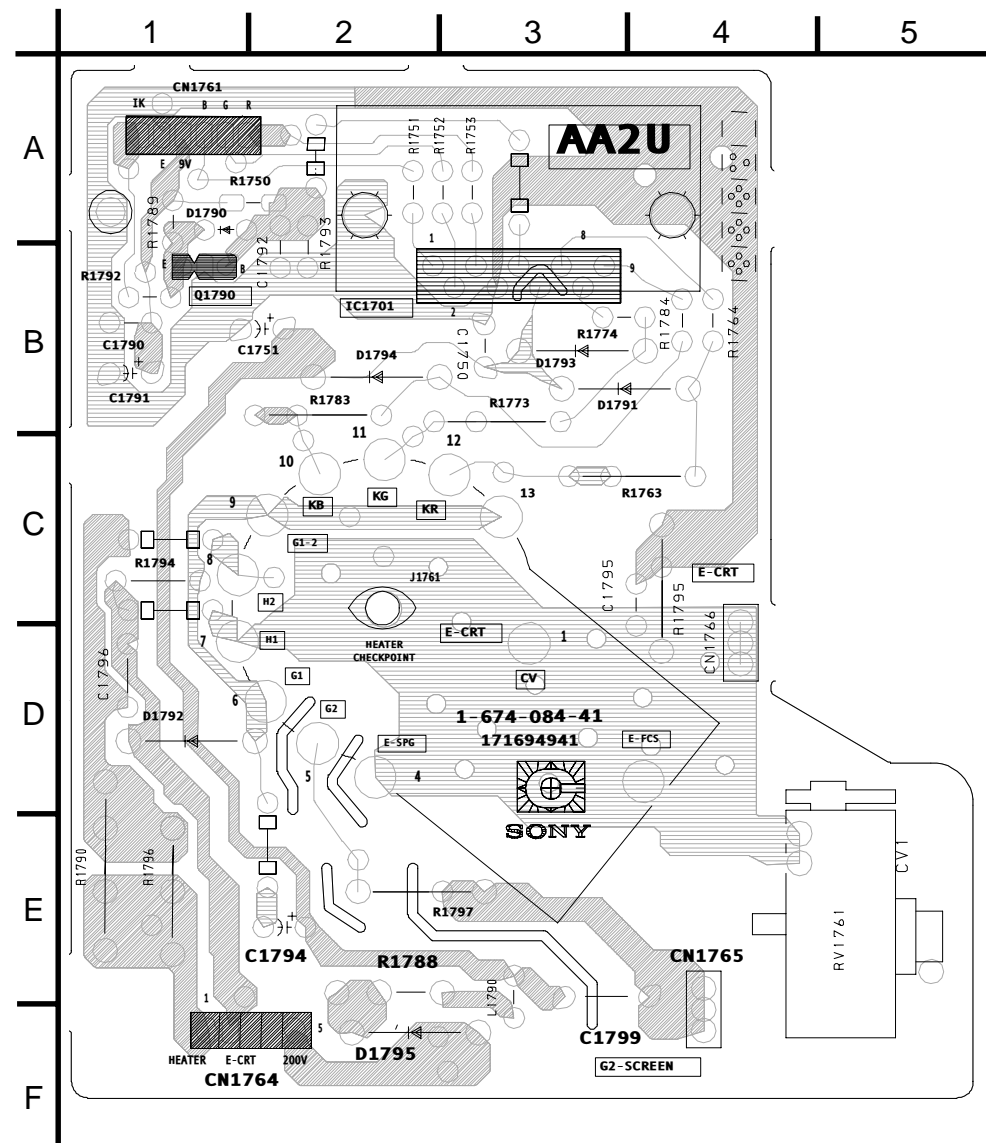

C BOARD WAVEFORMS

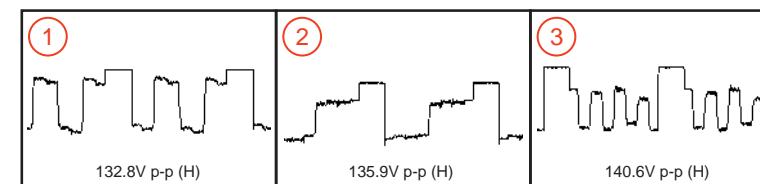

G BOARD SCHEMATIC DIAGRAM

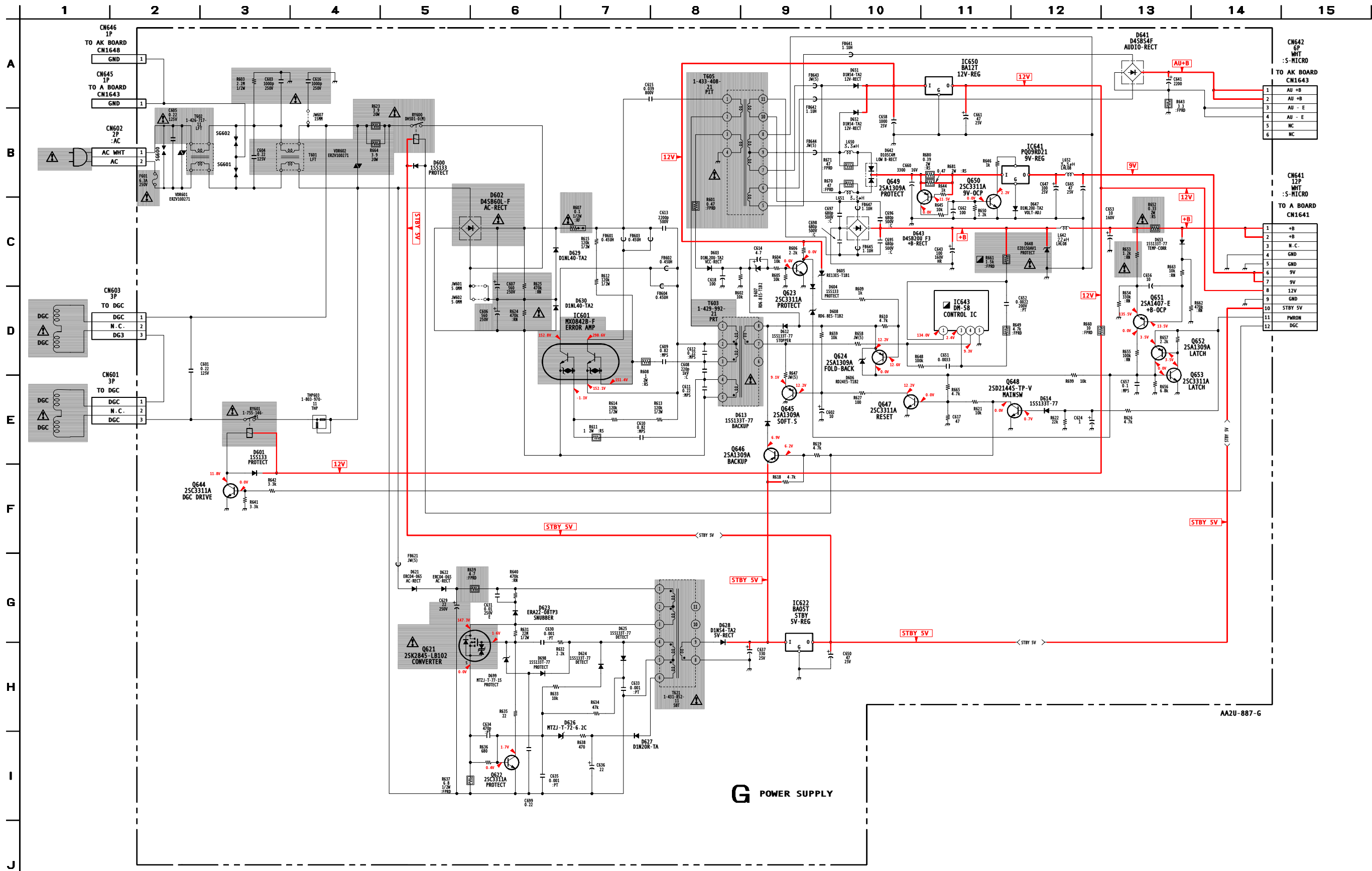

← C Board G Board →

G

[POWER SUPPLY]

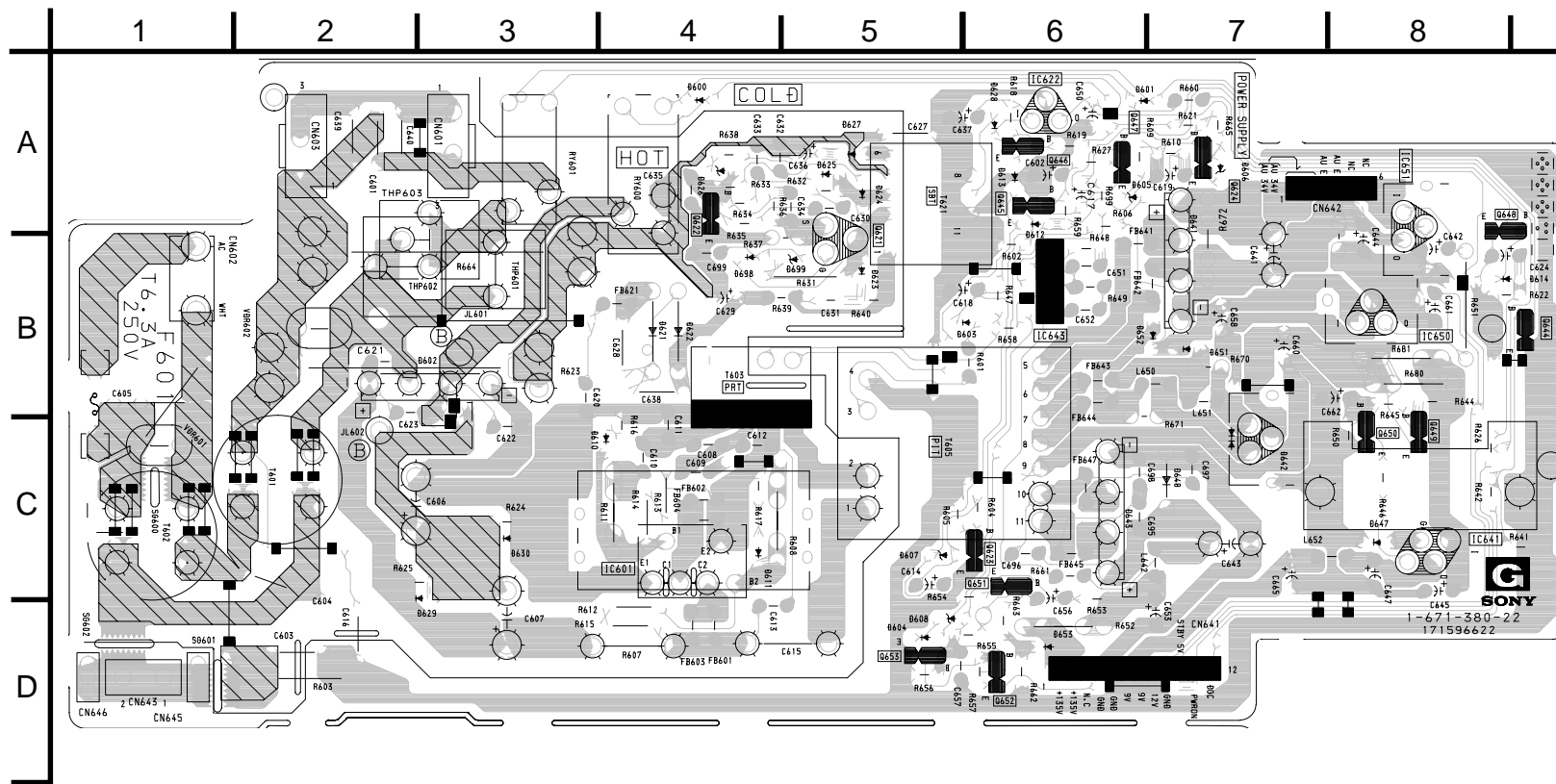

G BOARD LOCATOR LIST

DIODE	D648	C-7
D600	A-4	D651 B-7
D601	A-6	D652 B-7
D602	B-2	D653 D-6
D603	B-5	D698 B-4
D604	D-5	D699 B-5
D605	A-6	IC
D606	A-7	IC601 C-3
D607	C-5	IC622 A-6
D608	D-5	IC641 C-8
D612	A-6	IC643 B-6
D613	A-6	IC650 B-8
D614	B-8	TRANSISTOR
D621	B-4	Q621 A-5
D622	B-4	Q622 A-4
D623	B-5	Q623 C-6
D624	A-5	Q624 A-7
D625	A-5	Q644 B-8
D626	A-4	Q645 A-6
D627	A-5	Q646 A-6
D628	A-6	Q647 A-6
D629	C-2	Q648 A-8
D630	C-3	Q649 B-8
D641	B-7	Q650 B-8
D642	C-7	Q651 C-6
D643	C-6	Q652 D-6
D647	C-8	Q653 D-5

HA BOARD SCHEMATIC DIAGRAM (KV-36FV16/36FV26 ONLY)

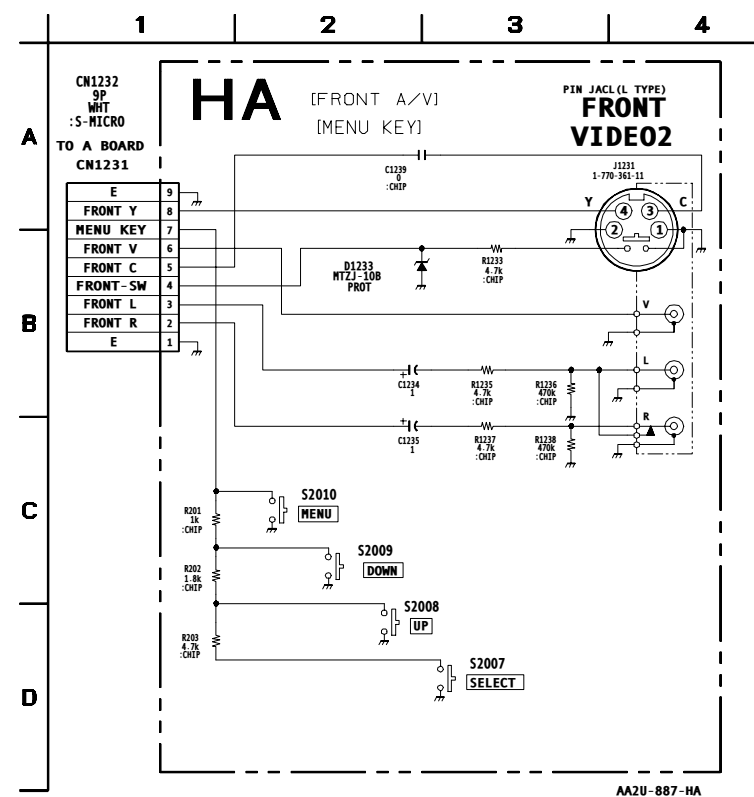

HA

[FRONT AV, MENU KEY] (KV-36FV16/36FV26 ONLY)

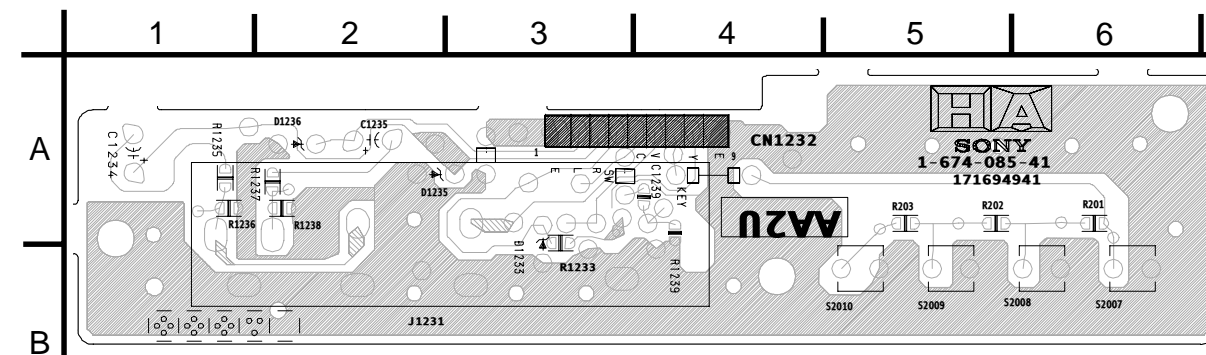

HB BOARD SCHEMATIC DIAGRAM (KV-36FV16/36FV26 ONLY)

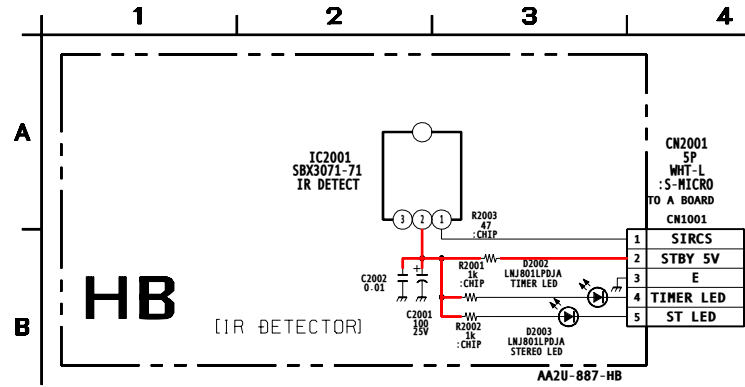

HB [IR DETECTOR]
(KV-36FV16/36FV26 ONLY)

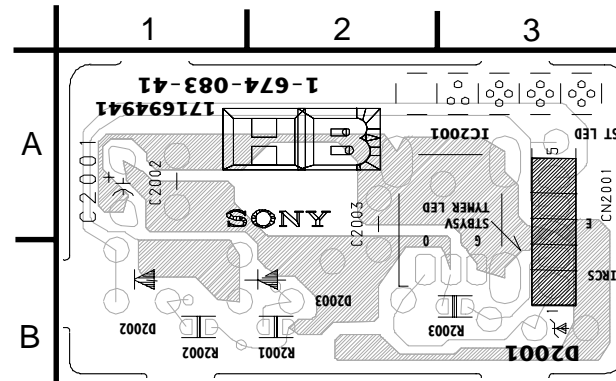

HS [FRONT A/V, MENU KEY, IR DETECTOR]
(KV-36FS12/36FS16 ONLY)

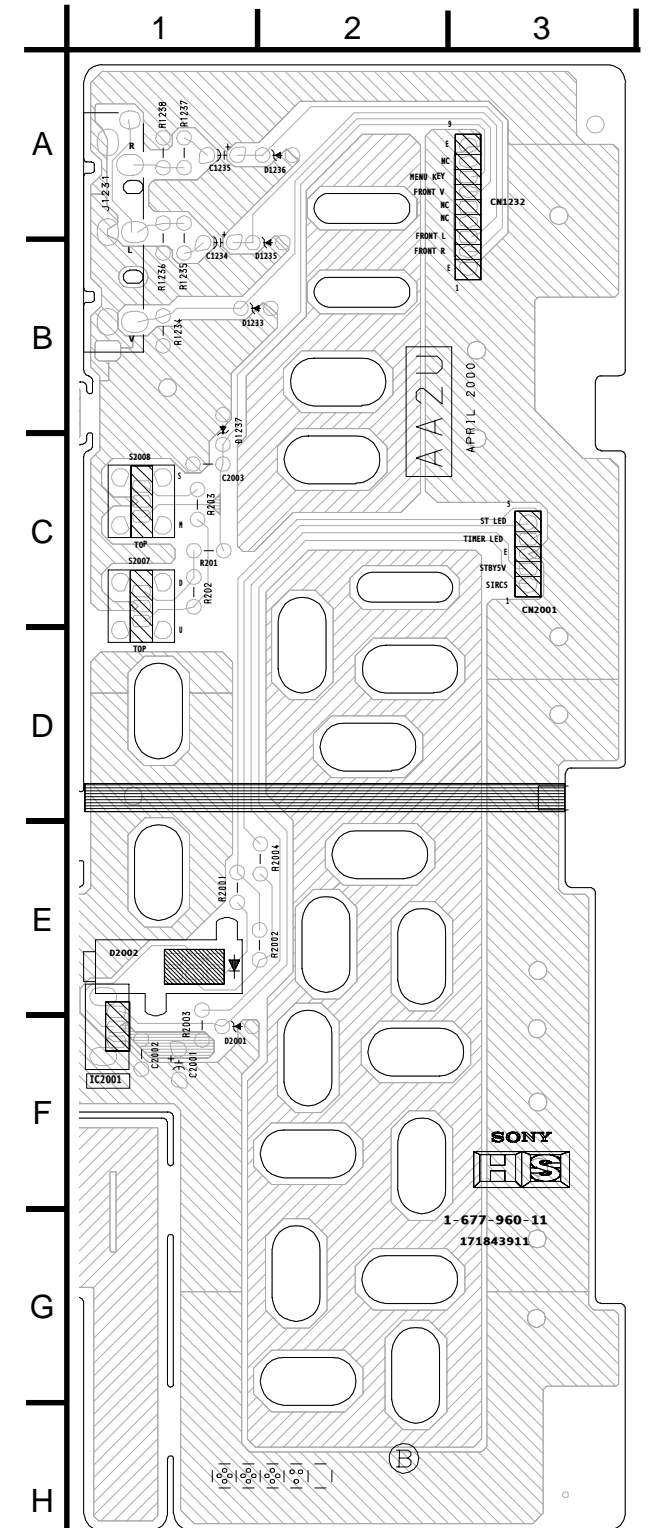

HX BOARD SCHEMATIC DIAGRAM

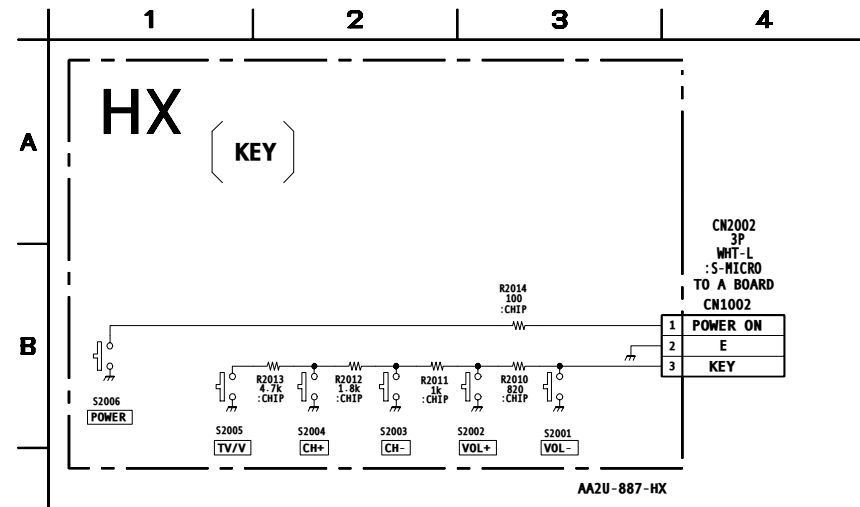

HS BOARD SCHEMATIC DIAGRAM (KV-36FS12/36FS16 ONLY)

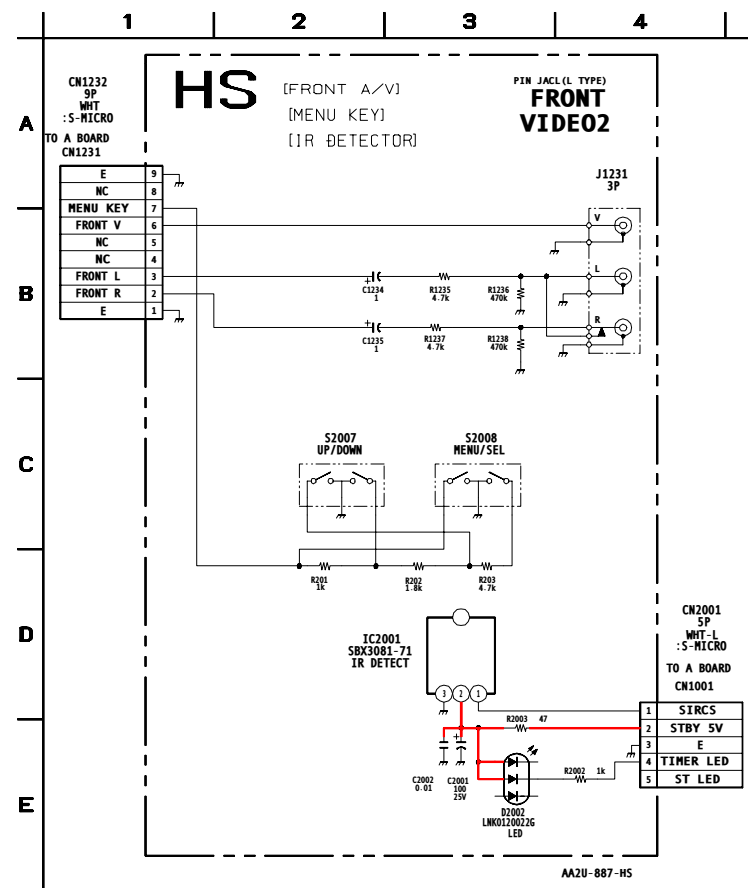

HX [KEY]

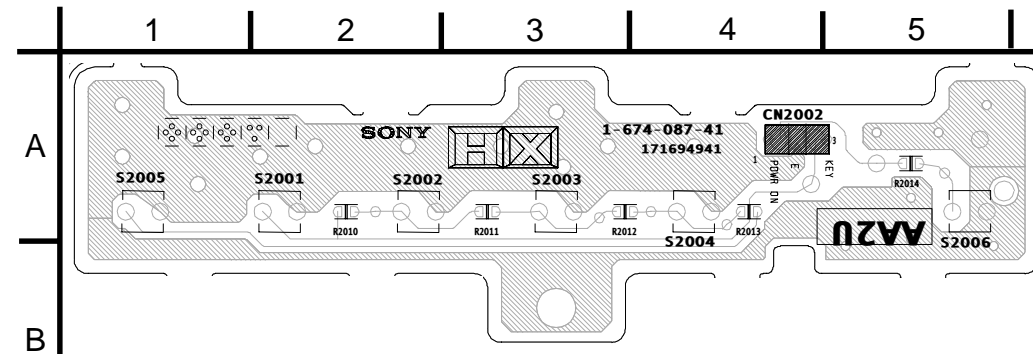

WA BOARD SCHEMATIC DIAGRAM

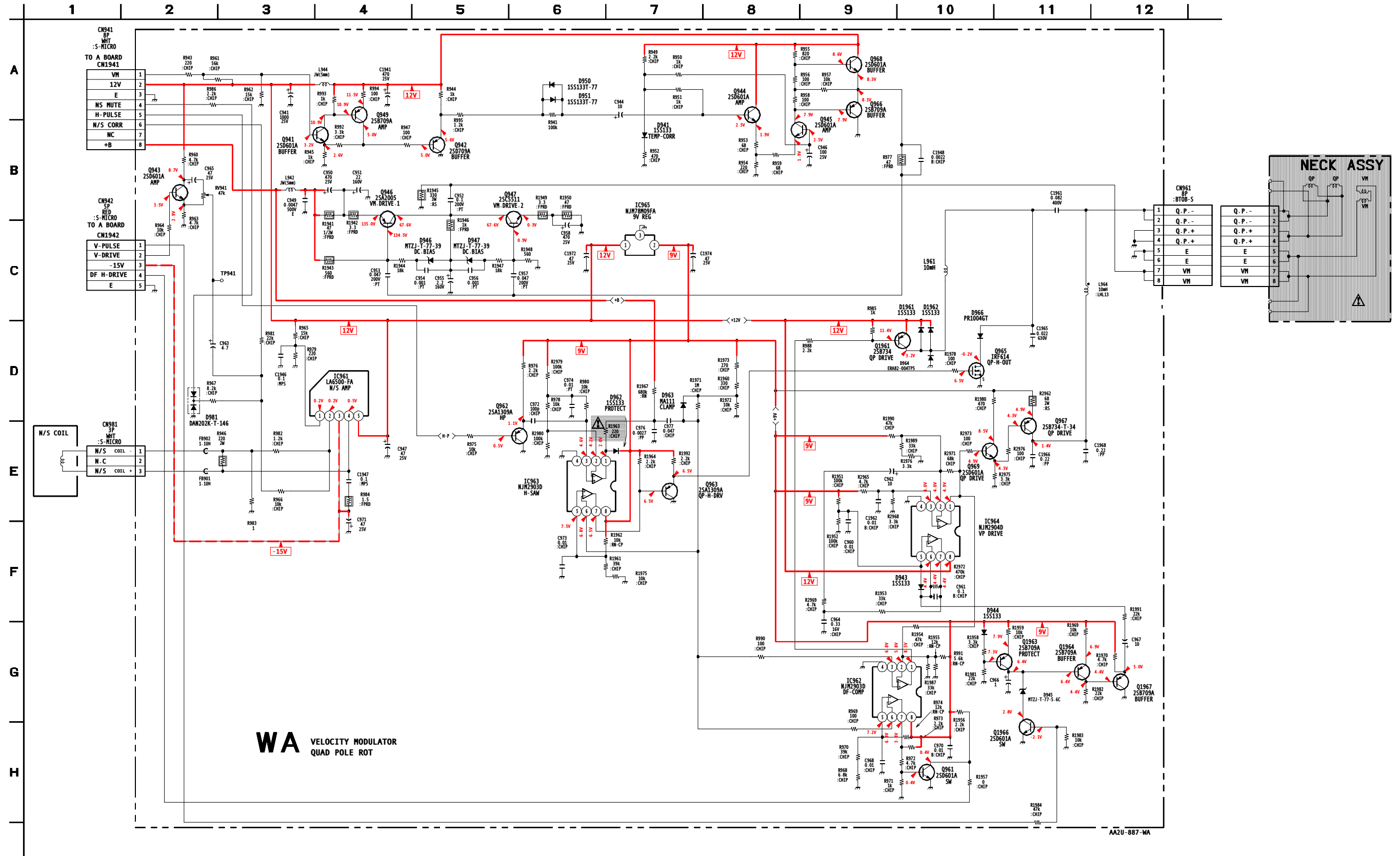



[VELOCITY MODULATOR, QUAD POLE ROT]

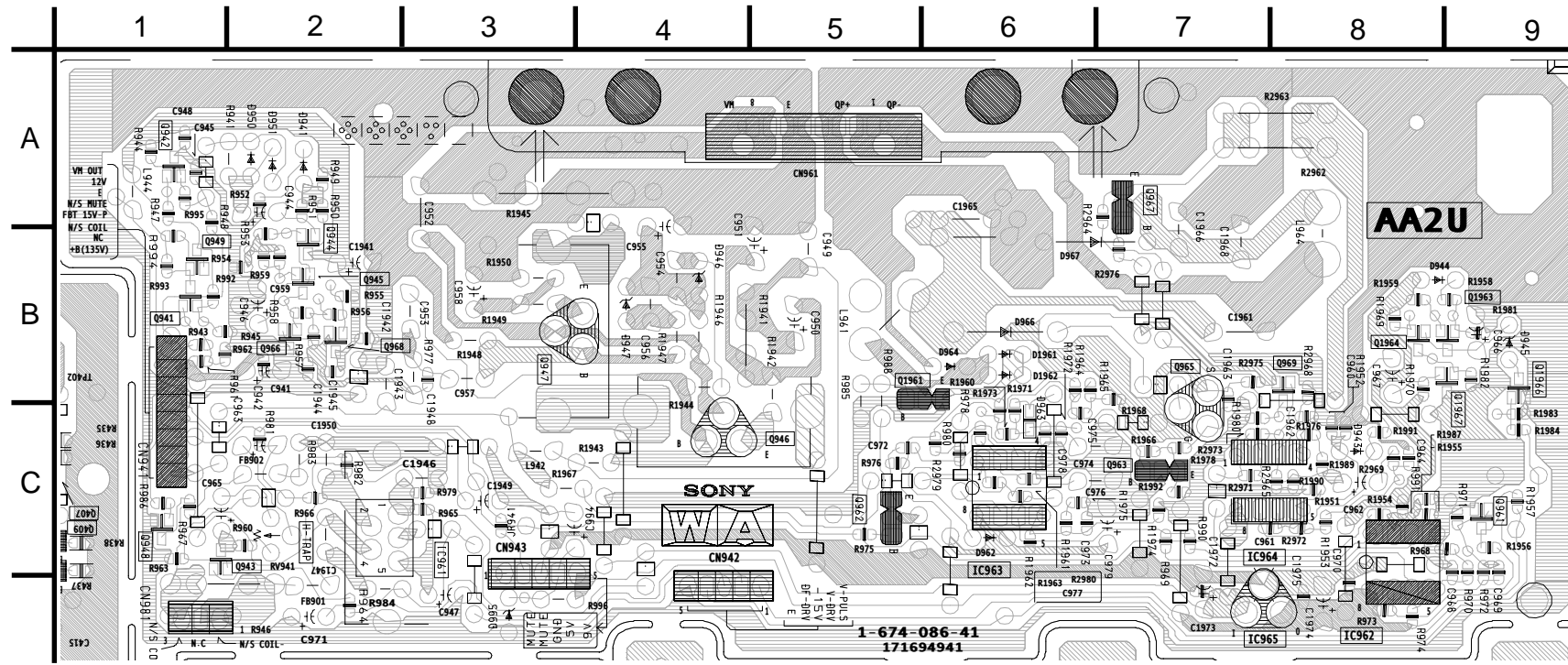

[IR HEADPHONES]

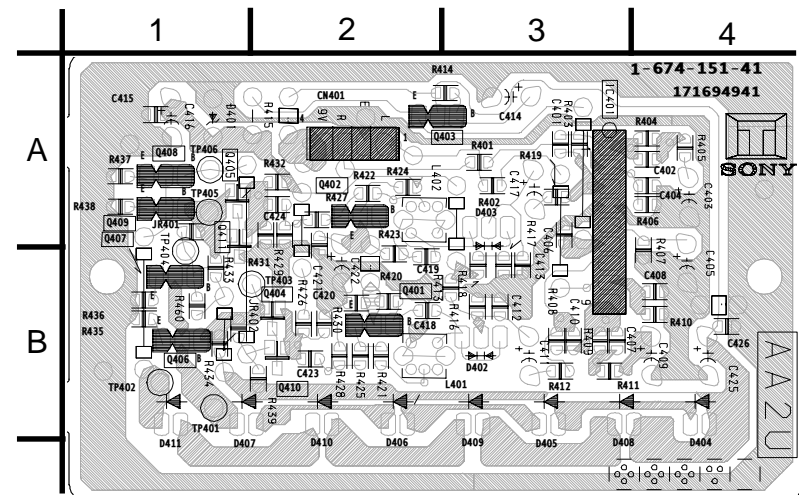

T BOARD SCHEMATIC DIAGRAM

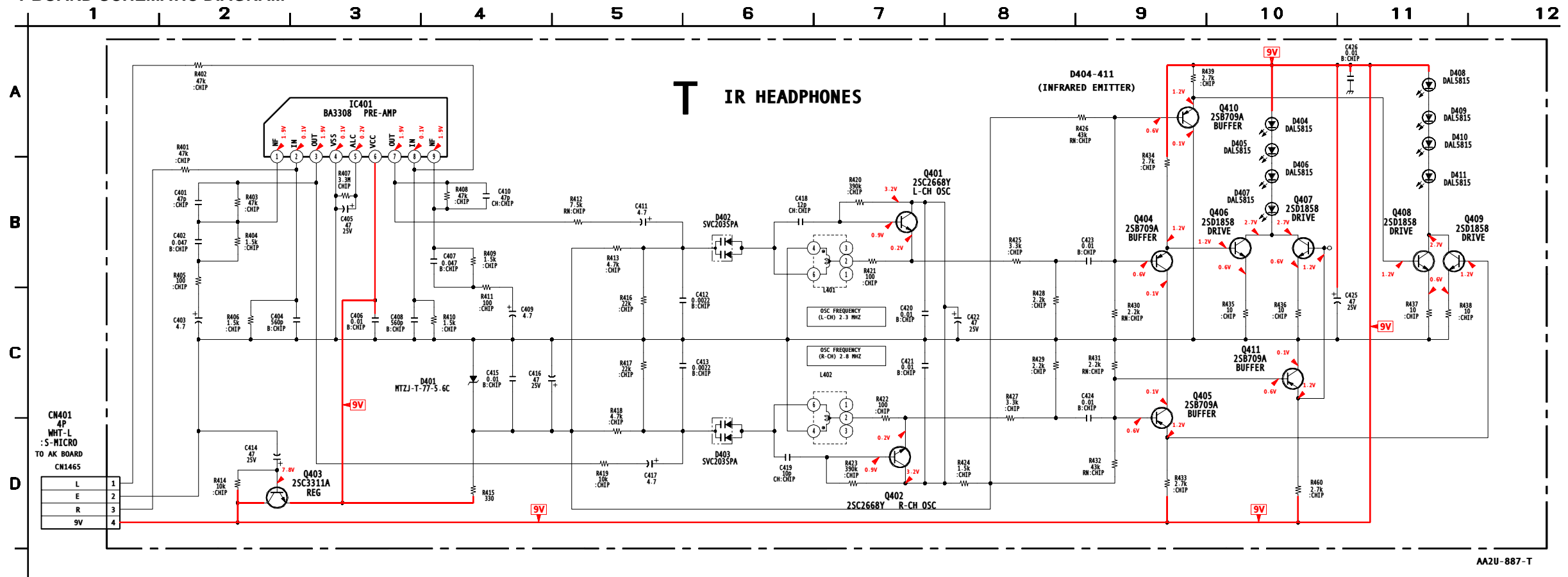

6-7. SEMICONDUCTORS

D1NL20U
D2L20U
EL1Z
EGP20G
EGP30G
ERA22-08
ERC06-15S
ERD29-08J
EZ0150AV1
GP08D
MTZJ-33A
1SS83

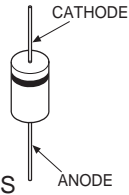

D1NS4
MTZJ-XXA
MTZJ-XXB
MTZJ-XXC
RDXXESB1
RDXXESB2
RDXXESB3
1SS119-25
1SS133T-77
(XX = VALUE)

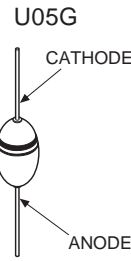
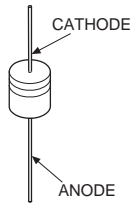

2SA1837
2SC4159-E
2SC4793
2SD2012

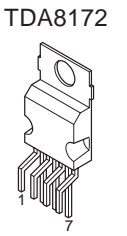
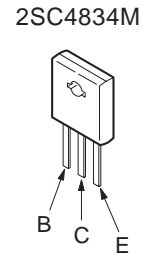

TDA2009A
TDA7262

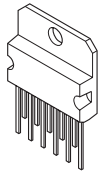

NJM78M05FA
PQ09RF21
TA7805S
BA05T

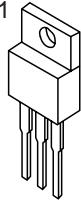

IC LINK
2A/90V



D10SC4M

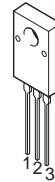

2SC3209LK

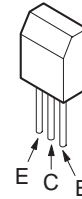

2SK2845-LB102

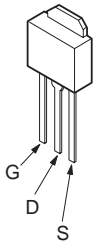

TSC5148
(LE SONY)

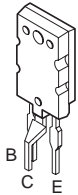

2SA1175-HFE
2SA933AS-QRT
2SC2785-HFE

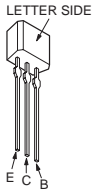

D10SBS4F
D6SB60L
D4SB60L

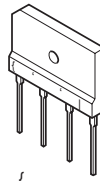

S-80748AL

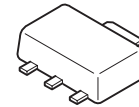

MA111
RD3.3SB
1SS355

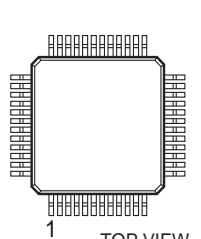
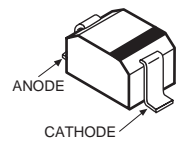

CXA2019Q

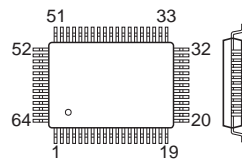

CXA1845Q - 64 pin
LC27016 - 80 pin
SAB9076AH
μPD6488GF-33A
μPD64081BGF-3BA - 100 pin

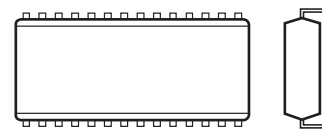

BH3868FS-E2
V53C16258SHK - 40 pin DIP

2SA1037K-T146-R
2SA1162-G
2SA1330-06
2SB709A
2SC1623-L5L6
2SD601A-Q

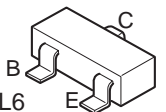

8 pin SOP
NJM2903D
NJM2903M
NJM2904D
ST24C02FM6TR
μPC4558G2
X24C04SB

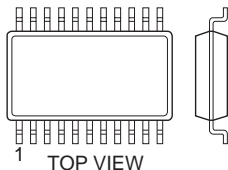

NJM2150M

16 pin SOP
BU4053BCF-T2
CXA1315M
MC14052BF
MC14538B
NJM2145M-TE2
CXD2064Q-T6

24 pin SOP
CXA2039M-T6
28 pin SOP
MN47V76ST1
MN47V77ST1
36 pin SOP
μPC1862GS-E2

DM-58

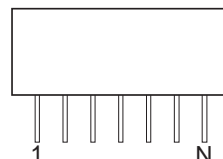

MARKING SIDE VIEW
Epin 1 ' N
EMt (one side, both sides)



NJM2902M
SDA9288XE

MM1093N
MM1311AD
MM1313AD

TA1226N
CXA2021S

TDA7467
CXP85856A-029S

CXD2073S

SECTION 7 EXPLODED VIEW

- Items with no part number and no description are not stocked because they are seldom required for routine service.
- The component parts of an assembly are indicated by the reference numbers in the remarks column.
- Items marked * are not stocked since they are seldom required for routine service. Some delay should be anticipated when ordering these items.

Note:

The components identified by shading and mark \triangle are critical for safety. Replace only with part number specified.

Note:

Les composants identifiés par un trame et une marque \triangle sont critiques pour la sécurité. Ne les remplacer que par une pièce portant le numéro spécifié.

7-1. CHASSIS (KV-36FS12/36FS16 ONLY)

- 7-685-648-79 SCREW +BVTP 3X12
- 7-685-663-79 SCREW +BVTP 4X16

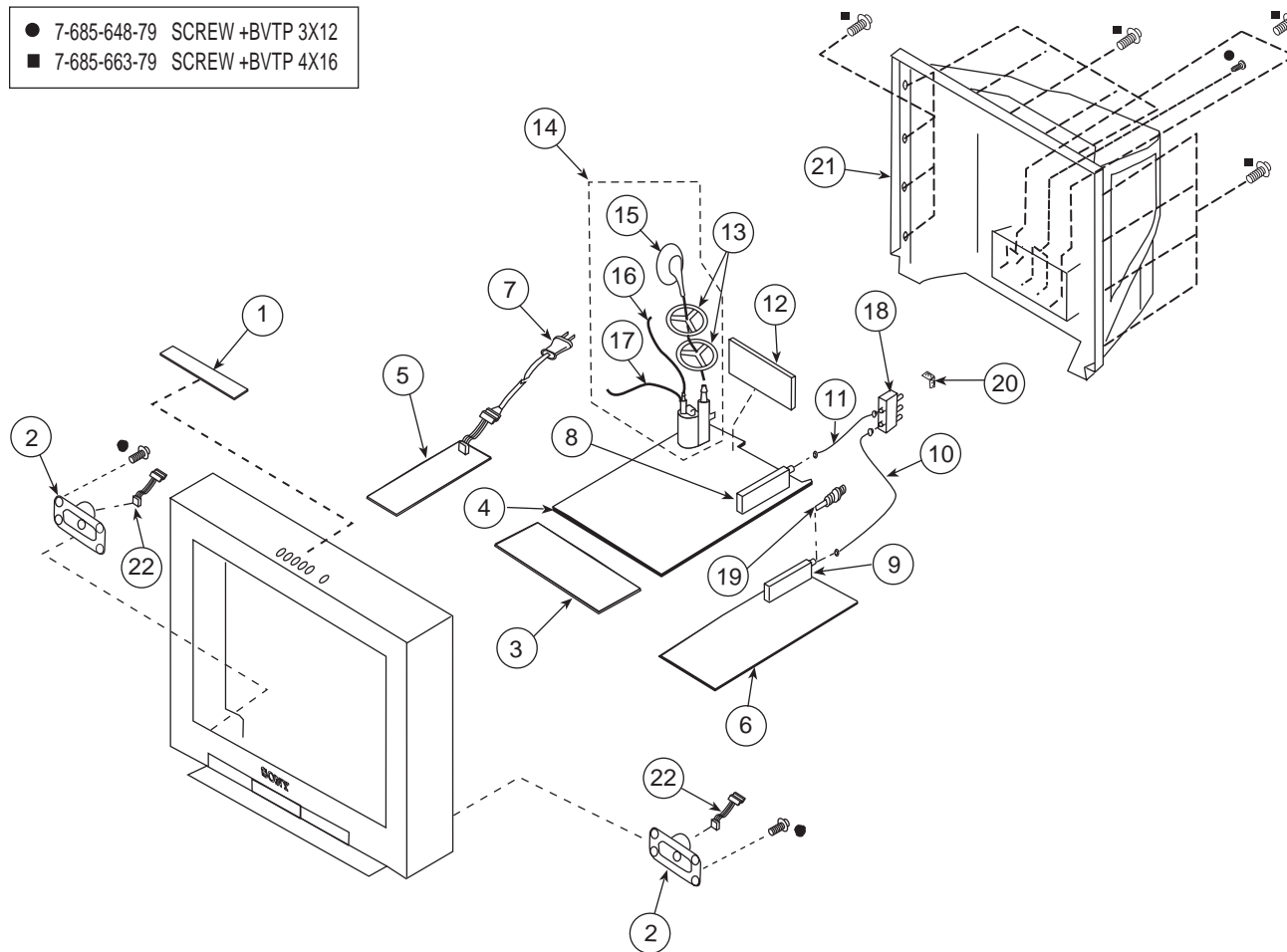

REF. NO.	PART NO.	DESCRIPTION	REMARK	
1	*	A-1372-636-A	HX MOUNTED PC BOARD	
2	*	1-504-531-11	SPEAKER (13.1X6.2CM)	
3	*	A-1372-822-A	HS MOUNTED PC BOARD	
4	*	A-1299-234-A	A COMPLETE PC BOARD	
The high-voltage leads associated with the FBT on this board are not included and must be ordered separately. (See 15-17)				
5	*	A-1316-397-A	G COMPLETE PC BOARD	
6	*	A-1299-235-A	AK COMPLETE PC BOARD (KV-36FS16 ONLY)	
6	*	A-1299-265-A	AK COMPLETE PC BOARD (KV-36FS12 ONLY)	
7	\triangle	1-790-316-21	CORD, AC POWER(WITH CONNECTOR)	
8	\triangle	8-598-542-00	TUNER, FSS BTF-WA412 (KV-36FS12 ONLY)	
9	\triangle	8-598-501-20	TUNER, FSS BTF-FA402 (KV-36FS16 ONLY)	
10		1-792-935-11	CABLE, PIN (KV-36FS16 ONLY)	
11	*	1-557-056-31	CABLE, P-P (KV-36FS16 ONLY)	
12	*	A-1394-994-A	UY COMPLETE PC BOARD (KV-36FS16 ONLY)	
12	*	A-1395-000-A	UY COMPLETE PC BOARD (KV-36FS12 ONLY)	
13		3-704-372-71	HOLDER, HV CABLE	
14	\triangle	1-453-338-21	FBT ASSY NX-4600	15-17
15		1-251-715-32	HV CAP ASSY	
16		1-900-805-19	FOCUS LEAD	
17		1-900-805-22	G2 LEAD	
18		8-598-414-10	CHANGER, ANTENNA AS-2F (KV36FS16 ONLY)	
19		1-766-374-11	PLUG, F-PIN (KV-36FS12 ONLY)	
20	*	3-696-606-02	HINGE, VI	
21		4-076-073-01	COVER, REAR	
22		1-900-805-21	CONNECTOR, SPEAKER	

Note:

The components identified by shading and mark  are critical for safety. Replace only with part number specified.



Note:

Les composants identifiés par un trame et une marque  sont critiques pour la sécurité. Ne les remplacer que par une pièce portant le numéro spécifié.

7-2. PICTURE TUBE (KV-36FS12/36FS16 ONLY)

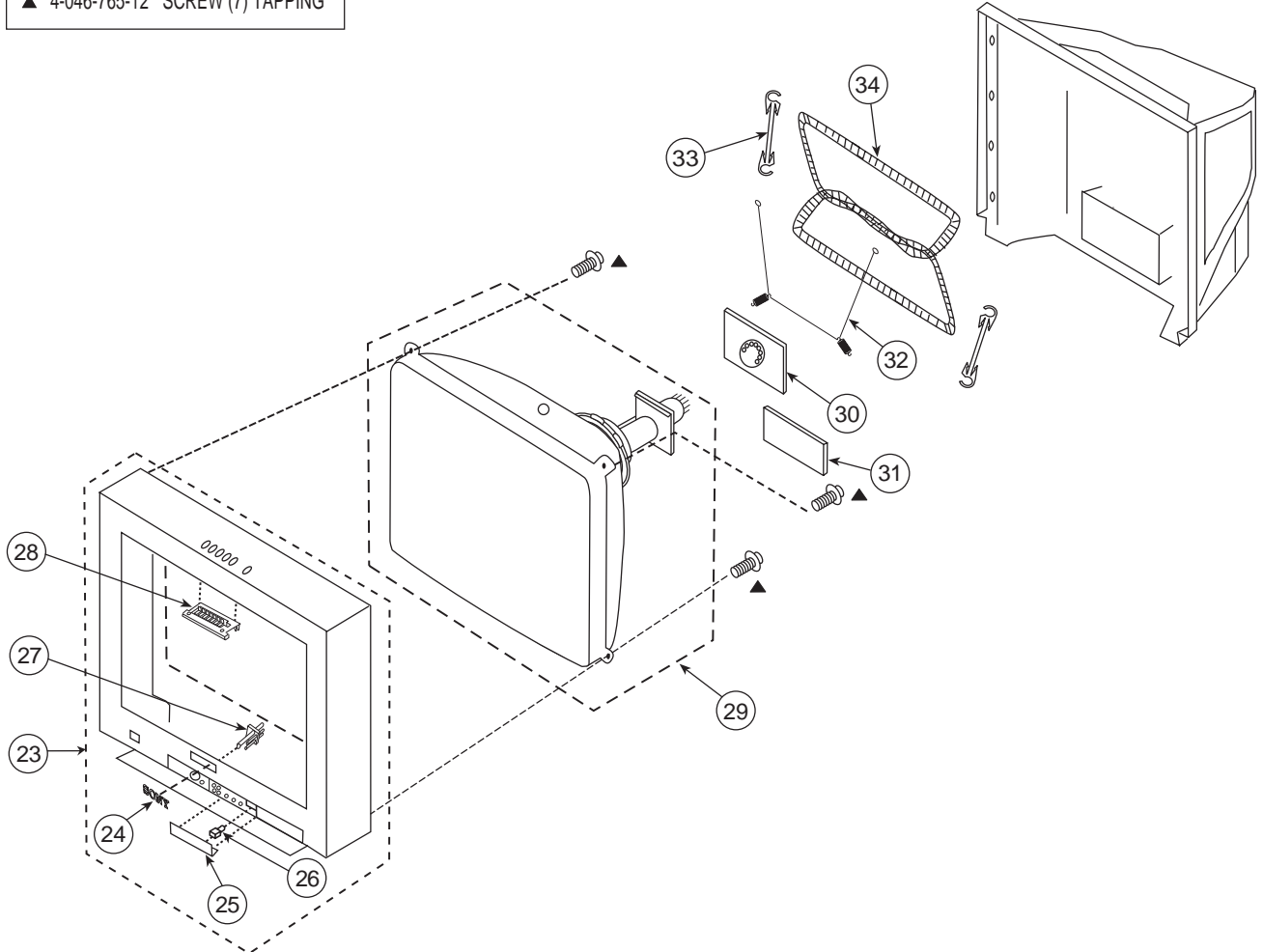
▲ 4-046-765-12 SCREW (7) TAPPING



REF.NO.	PART NO.	DESCRIPTION	REMARK
23	X-4037-665-1	BEZNET ASSY	24-26
24	3-704-179-31	EMBLEM (NO.9), SONY	
25	4-075-658-01	DOOR	
26	4-047-464-01	CATCHER, PUSH	
27	4-075-657-01	GUIDE, LED	
28	4-068-982-02	MULTI-BUTTON (TOP)	
29	 8-735-048-61	ITC 38RSN-A1 (US/Canada models only)	
29	 8-735-081-61	ITC 38RSN-A1M (Hawaii models only)	
30	* A-1331-942-A	C (VAR) MOUNTED PC BOARD	
31	* A-1375-191-A	WA COMPLETE PC BOARD	
32	4-036-329-01	SPRING (B), TENSION	
33	4-065-895-04	HOLDER, DGC	
34	 1-416-828-31	COIL, DEGAUSSING	

Note:

The components identified by shading and mark \triangle are critical for safety. Replace only with part number specified.

Note:

Les composants identifiés par un triangle et une marque \triangle sont critiques pour la sécurité. Ne les remplacer que par une pièce portant le numéro spécifié.

7-3. CHASSIS (KV-36FV16/36FV26 ONLY)

- 7-685-648-79 SCREW +BVTP 3X12
- 7-685-663-79 SCREW +BVTP 4X16

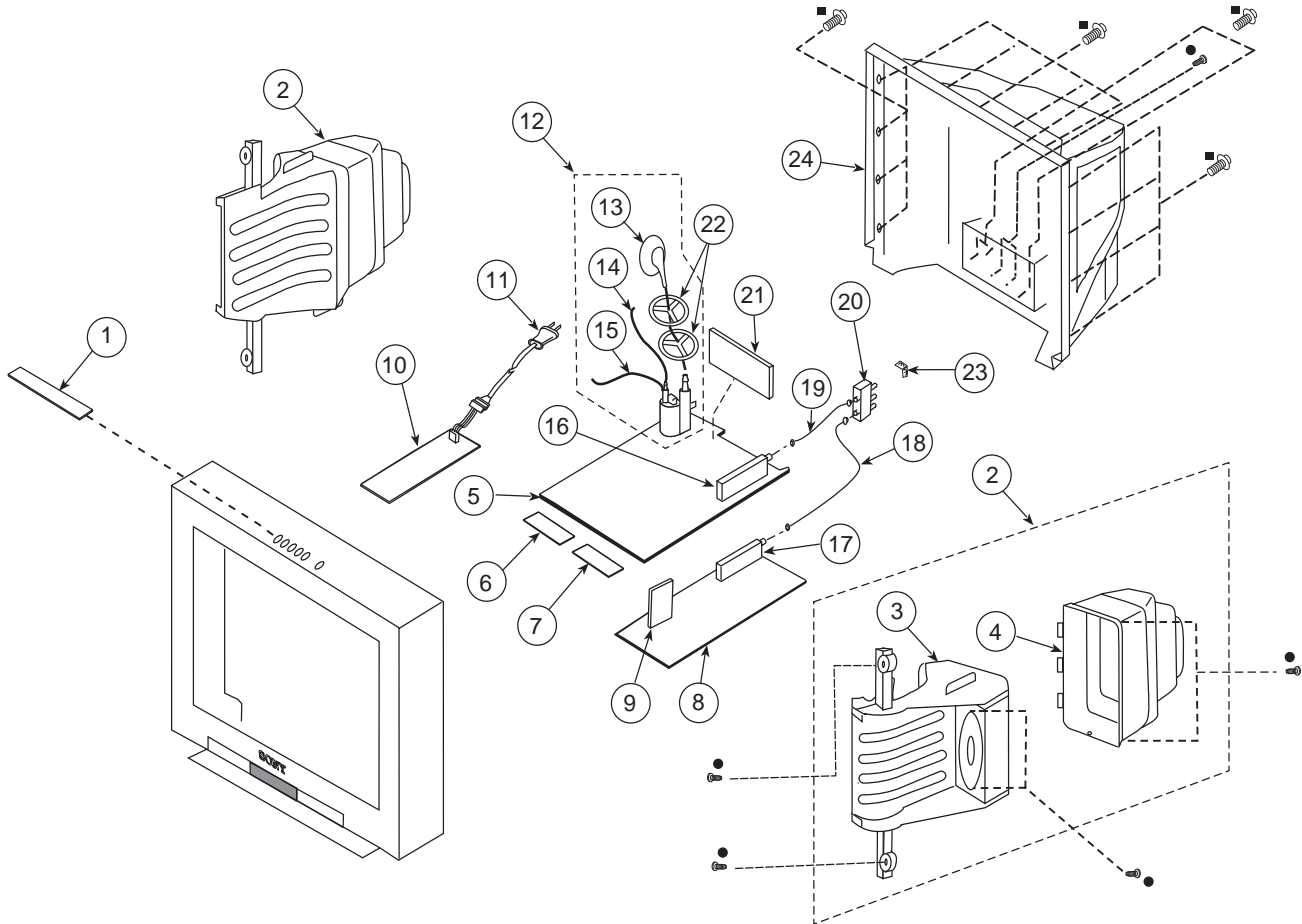

REF.NO.	PART NO.	DESCRIPTION	REMARK	REF.NO.	PART NO.	DESCRIPTION	REMARK
1	* A-1372-636-A	HX MOUNTED PC BOARD		11	\triangle 1-790-316-21	CORD, AC POWER(WITH CONNECTOR)	
2	* 1-529-336-11	BOX, 1 WAY SPEAKER (10CM)	3-4	12	\triangle 1-453-338-21	FBT ASSY NX-4600	13-15
2	* 1-529-358-11	SPEAKER, BOX (5,10CM)	3-4	13	1-251-715-32	HV CAP ASSY	
3	4-068-988-01	BAFFLE, SPEAKER		14	1-900-805-19	FOCUS LEAD	
4	* 4-068-987-01	COVER, SPEAKER		15	1-900-805-22	G2 LEAD	
5	* A-1299-234-A	A COMPLETE PC BOARD		16	\triangle 8-598-542-00	TUNER, FSS BTF-WA412	
The high-voltage leads associated with the FBT on this board are not included and must be ordered separately. (See 13-15)				17	\triangle 8-598-501-20	TUNER, FSS BTF-FA402	
6	* A-1372-634-A	HA MOUNTED PC BOARD		18	1-792-935-11	CABLE, PIN	
7	* A-1372-635-A	HB MOUNTED PC BOARD		19	* 1-557-056-31	CABLE, P-P	
8	* A-1299-282-A	AK COMPLETE PC BOARD (KV-36FV26 ONLY)		20	8-598-414-10	CHANGER, ANTENNA AS-2F	
8	* A-1299-281-A	AK COMPLETE PC BOARD (KV-36FV16 ONLY)		21	* A-1395-004-A	UX COMPLETE PC BOARD (KV-36FV26 ONLY)	
9	* A-1394-934-A	T COMPLETE PC BOARD (KV-36FV26 ONLY)		21	* A-1395-003-A	UX COMPLETE PC BOARD (KV-36FV16 ONLY)	
10	* A-1316-397-A	G COMPLETE PC BOARD		22	3-704-372-71	HOLDER, HV CABLE	
				23	* 3-696-606-02	HINGE, VI	
				24	4-068-998-01	COVER, REAR	

Note:

The components identified by shading and mark  are critical for safety. Replace only with part number specified.



Note:

Les composants identifiés par un triangle et une marque  sont critiques pour la sécurité. Ne les remplacer que par une pièce portant le numéro spécifié.

7-4. PICTURE TUBE (KV-36FV16/36FV26 ONLY)

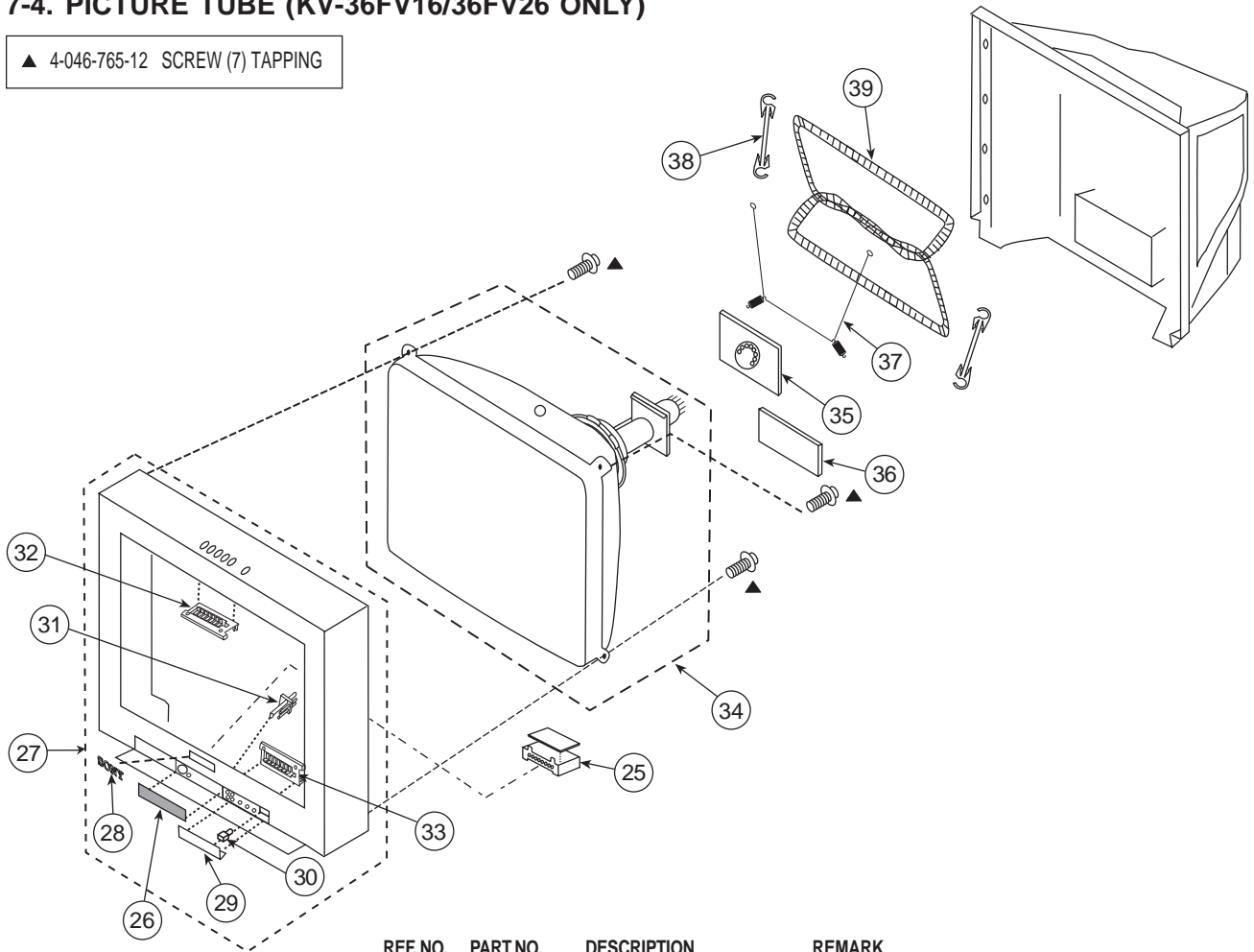
▲ 4-046-765-12 SCREW (7) TAPPING



REF.NO.	PART NO.	DESCRIPTION	REMARK
25	* 4-068-992-01	CASE, IR SHIELD (KV-36FV26 ONLY)	
26	4-068-991-01	PANEL, IR (KV-36FV26 ONLY)	
27	X-4037-910-1	BEZNET ASSY (KV-36FV26 ONLY)	28-30
27	X-4037-909-1	BEZNET ASSY (KV-36FV16 ONLY)	28-30
28	3-704-179-31	EMBLEM (NO.9), SONY	
29	4-068-985-04	DOOR	
30	3-703-574-00	RETAINER, DOOR	
31	4-068-986-01	GUIDE, LED	
32	4-068-982-02	MULTI-BUTTON (TOP)	
33	4-068-984-01	MULTI-BUTTON (BOTTOM)	
29	 8-735-048-61	ITC 38RSN-A1 (US/Canada models only)	
29	 8-735-081-61	ITC 38RSN-A1M (Hawaii models only)	
35	* A-1331-942-A	C (VAR) MOUNTED PC BOARD	
36	* A-1375-191-A	WA COMPLETE PC BOARD	
37	4-036-329-01	SPRING (B), TENSION	
38	4-065-895-04	HOLDER, DGC	
39	 1-416-828-31	COIL, DEGAUSSING	

Note:

The components identified by shading and mark \triangle are critical for safety. Replace only with part number specified.

Note:

Les composants identifiés par un trame et une marque \triangle sont critiques pour la sécurité. Ne les remplacer que par une pièce portant le numéro spécifié.

A

REF.NO.	PARTNO.	DESCRIPTION	REMARK	REF.NO.	PARTNO.	DESCRIPTION	REMARK
C384	1-163-038-91	CERAMIC CHIP	0.1 μ F 25V	C550	1-102-002-00	CERAMIC	680PF 10% 500V
C393	1-163-038-91	CERAMIC CHIP	0.1 μ F 25V	C551	1-109-954-11	ELECT	0.47 μ F 20% 160V
C394	1-163-038-91	CERAMIC CHIP	0.1 μ F 25V	C552	1-102-244-00	CERAMIC	220PF 10% 500V
C395	1-104-664-11	ELECT	47 μ F 20% 25V	C553	1-117-666-71	FILM	0.39 μ F 5% 250V
C396	1-163-021-91	CERAMIC CHIP	0.01 μ F 10% 50V	C554 \triangle	1-104-491-11	FILM	0.0047 μ F 3% 2KV
C397	1-104-664-11	ELECT	47 μ F 20% 25V	C561	1-126-967-11	ELECT	47 μ F 20% 50V
C398	1-126-961-11	ELECT	2.2 μ F 20% 50V	C563	1-104-666-11	ELECT	220 μ F 20% 25V
C501	1-102-110-00	CERAMIC	220PF 10% 50V	C564	1-126-960-11	ELECT	1 μ F 20% 50V
C502	1-126-959-11	ELECT	0.47 μ F 20% 50V	C565	1-126-969-11	ELECT	220 μ F 20% 50V
C503	1-163-133-00	CERAMIC CHIP	470PF 5% 50V	C568	1-136-169-00	MYLAR	0.22 μ F 5% 50V
C504	1-102-228-00	CERAMIC	470PF 10% 500V	C571	1-126-942-61	ELECT	1000 μ F 20% 25V
C505	1-102-228-00	CERAMIC	470PF 10% 500V	C572	1-126-942-61	ELECT	1000 μ F 20% 25V
C506	1-106-383-00	MYLAR	0.047 μ F 10% 200V	C599	1-126-935-11	ELECT	470 μ F 20% 16V
C507 \triangle	1-162-116-00	CERAMIC	680PF 10% 2KV	C1002	1-126-964-11	ELECT	10 μ F 20% 50V
C508	1-102-228-00	CERAMIC	470PF 10% 500V	C1003	1-126-961-11	ELECT	2.2 μ F 20% 50V
C509	1-162-116-00	CERAMIC	680PF 10% 2KV	C1004	1-126-960-11	ELECT	1 μ F 20% 50V
C510	1-137-150-11	MYLAR	0.01 μ F 10% 100V	C1101	1-126-943-11	ELECT	2200 μ F 20% 25V
C511 \triangle	1-137-347-11	FILM	0.022 μ F 3% 2KV	C1103	1-126-965-11	ELECT	22 μ F 20% 50V
C512	1-129-928-00	FILM	0.0027 μ F 10% 630V	C1104	1-104-664-11	ELECT	47 μ F 20% 25V
C513 \triangle	1-130-118-91	FILM	0.051 μ F 5% 400V	C1105	1-104-664-11	ELECT	47 μ F 20% 25V
C514 \triangle	1-115-521-11	FILM	0.82 μ F 5% 250V	C1106	1-126-964-11	ELECT	10 μ F 20% 50V
C515	1-104-987-11	MYLAR	0.001 μ F 10% 100V	C1107	1-163-037-11	CERAMIC CHIP	0.022 μ F 10% 50V
C516	1-115-521-11	FILM	0.82 μ F 5% 250V	C1108	1-128-551-11	ELECT	22 μ F 20% 25V
C517	1-107-649-11	ELECT	2.2 μ F 20% 250V	C1109	1-126-964-11	ELECT	10 μ F 20% 50V
C518	1-106-387-00	MYLAR	0.068 μ F 10% 200V	C1117	1-126-960-11	ELECT	1 μ F 20% 50V
C519	1-107-612-11	CERAMIC	100PF 5% 500V	C1118	1-126-960-11	ELECT	1 μ F 20% 50V
C520	1-164-646-11	CERAMIC	2200PF 10% 500V	C1351	1-163-237-11	CERAMIC CHIP	27PF 5% 50V
C521	1-163-010-11	CERAMIC CHIP	0.0012 μ F 10% 50V	C1355	1-163-009-11	CERAMIC CHIP	0.001 μ F 10% 50V
C522	1-126-960-11	ELECT	1 μ F 20% 50V	C1356	1-126-964-11	ELECT	10 μ F 20% 50V
C525	1-102-244-00	CERAMIC	220PF 10% 500V	C1357	1-164-005-11	CERAMIC CHIP	0.47 μ F 16V
C526	1-107-662-11	ELECT	22 μ F 20% 250V	C1358	1-126-940-11	ELECT	330 μ F 20% 25V
C527	1-162-116-00	CERAMIC	680PF 10% 2KV	C1359	1-163-038-91	CERAMIC CHIP	0.1 μ F 25V
C528	1-164-161-11	CERAMIC CHIP	0.0022 μ F 10% 50V	C1360	1-163-031-11	CERAMIC CHIP	0.01 μ F 50V
C529	1-128-551-11	ELECT	22 μ F 20% 25V	C1361	1-163-241-11	CERAMIC CHIP	39PF 5% 50V
C530	1-137-366-11	MYLAR	0.0022 μ F 5% 50V	C1362	1-163-017-00	CERAMIC CHIP	0.0047 μ F 10% 50V
C531	1-126-965-11	ELECT	22 μ F 20% 50V	C1363	1-163-031-11	CERAMIC CHIP	0.01 μ F 50V
C532	1-126-965-11	ELECT	22 μ F 20% 50V	C1367	1-163-038-91	CERAMIC CHIP	0.1 μ F 25V
C534	1-126-967-11	ELECT	47 μ F 20% 50V	C1369	1-163-038-91	CERAMIC CHIP	0.1 μ F 25V
C537	1-126-941-11	ELECT	470 μ F 20% 25V	C1370	1-126-964-11	ELECT	10 μ F 20% 50V
C539	1-126-941-11	ELECT	470 μ F 20% 25V	C1371	1-163-017-00	CERAMIC CHIP	0.0047 μ F 10% 50V
C540	1-107-995-11	ELECT	100 μ F 160V	C1372	1-163-017-00	CERAMIC CHIP	0.0047 μ F 10% 50V
C541	1-128-560-11	ELECT	22 μ F 20% 100V	C1373	1-163-133-00	CERAMIC CHIP	470PF 5% 50V
C543	1-104-666-11	ELECT	220 μ F 20% 25V	CONNECTOR			
C544	1-129-718-00	FILM	0.022 μ F 5% 630V	CN270 *	1-774-105-11	CONNECTOR, BOARD TO BOARD 15P	
C545	1-106-387-00	MYLAR	0.068 μ F 10% 200V	CN271 *	1-774-105-11	CONNECTOR, BOARD TO BOARD 15P	
C546	1-104-987-11	MYLAR	0.001 μ F 10% 100V	CN272 *	1-774-105-11	CONNECTOR, BOARD TO BOARD 15P	
C547	1-104-987-11	MYLAR	0.001 μ F 10% 100V	CN302 *	1-508-784-00	PIN, CONNECTOR (5MM PITCH) 1P	
C548	1-164-004-11	CERAMIC CHIP	0.1 μ F 10% 25V	CN351 *	1-564-509-11	PLUG, CONNECTOR 6P	
C549	1-106-375-12	MYLAR	0.022 μ F 20% 200V				



Note:

The components identified by shading and mark △ are critical for safety. Replace only with part number specified.

Note:

Les composants identifiés par un trame et une marque △ sont critiques pour la securite. Ne les remplacer que par une piece portant le numero specifiée.

REF.NO.	PART NO.	DESCRIPTION	REMARK	REF.NO.	PART NO.	DESCRIPTION	REMARK
CN501 *	1-580-798-11	CONNECTOR PIN (DY) 6P		D534	8-719-075-41	DIODE PR1004GT	
CN503 *	1-564-508-11	PLUG, CONNECTOR 5P		D535	8-719-073-01	DIODE MA111-TX	
CN1001*	1-564-508-11	PLUG, CONNECTOR 5P		D536	1-216-295-91	SHORT	
CN1002*	1-564-506-11	PLUG, CONNECTOR 3P		D561	8-719-075-33	DIODE 1N4003GA	
CN1102*	1-564-507-11	PLUG, CONNECTOR 4P		D1003	8-719-110-17	DIODE MTZJ-T-77-10B	
CN1231*	1-564-512-11	PLUG, CONNECTOR 9P		D1004	8-719-110-17	DIODE MTZJ-T-77-10B	
CN1643	1-695-915-11	TAB (CONTACT)		D1101	8-719-110-17	DIODE MTZJ-T-77-10B	
CN1941*	1-564-511-11	PLUG, CONNECTOR 8P		D1102	8-719-982-24	DIODE MTZJ-T-77-33A	
CN1942*	1-564-508-11	PLUG, CONNECTOR 5P		D1103	8-719-109-89	DIODE MTZJ-T-77-5.6C	
				D1104	8-719-110-17	DIODE MTZJ-T-77-10B	
DIODE							
D001	8-719-991-33	DIODE 1SS133T-77		D1301	8-719-073-01	DIODE MA111-TX	
D002	8-719-109-89	DIODE MTZJ-T-77-5.6C		D1302	8-719-991-33	DIODE 1SS133T-77	
D003	8-719-991-33	DIODE 1SS133T-77		D1303	8-719-073-01	DIODE MA111-TX	
D005	8-719-109-89	DIODE MTZJ-T-77-5.6C		D1304	8-719-073-01	DIODE MA111-TX	
D012	8-719-991-33	DIODE 1SS133T-77		D1305	8-719-073-01	DIODE MA111-TX	
D013	8-719-991-33	DIODE 1SS133T-77		D1306	8-719-073-01	DIODE MA111-TX	
D016	8-719-991-33	DIODE 1SS133T-77		FERRITE BEAD			
D018	8-719-073-01	DIODE MA111-TX		FB501	1-410-397-21	FERRITE	1.1µH
D019	8-719-073-01	DIODE MA111-TX		FB502	1-410-397-21	FERRITE	1.1µH
D301	8-719-073-01	DIODE MA111-TX		FB503	1-410-397-21	FERRITE	1.1µH
D302	8-719-991-33	DIODE 1SS133T-77		IC			
D303	8-719-921-44	DIODE MTZJ-T-77-5.1C		IC001	8-759-667-71	IC M306V5ME-XXXSP	
D368	8-719-991-33	DIODE 1SS133T-77		IC002	8-759-562-42	IC CAT24WC08J-TE13	
D384	8-719-921-80	DIODE MTZJ-T-77-11B		IC003	8-759-352-91	IC PST9143NL	
D388	8-719-921-80	DIODE MTZJ-T-77-11B		IC351	8-759-710-86	IC NJM2233BM(TE2)	
D501	8-719-109-89	DIODE MTZJ-T-77-5.6C		IC352	8-752-080-75	IC CXA2039M-T6	
D502	8-719-945-80	DIODE ERC06-15S		IC353	8-759-462-91	IC TA1226N	
D503 △	8-719-945-80	DIODE ERC06-15S		IC354	8-752-082-49	IC CXA2119M-T6	
D504	8-719-900-26	DIODE ERD29-08J		IC355 △	8-752-092-17	IC CXA2131AS	
D505	8-719-075-33	DIODE 1N4003GA		IC501	8-759-700-07	IC NJM2903M-TE2	
D506	8-719-075-33	DIODE 1N4003GA		IC561 △	8-759-192-71	IC STV9379	
D507	8-719-991-33	DIODE 1SS133T-77		IC1001	8-752-058-68	IC CXA1315M-T4	
D510	8-719-300-33	DIODE ERB44-06TP1		CHIP CONDUCTOR			
D511	8-719-970-87	DIODE ERA38-06TP1		JR001	1-216-295-91	SHORT	
D512	8-719-970-87	DIODE ERA38-06TP1		JR002	1-216-295-91	SHORT	
D513	8-719-110-41	DIODE MTZJ-T-77-15B		JR003	1-216-295-91	SHORT	
D515 △	8-719-075-41	DIODE PR1004GT		JR004	1-216-049-91	RES-CHIP	1K 5% 1/10W
D516	8-719-991-33	DIODE 1SS133T-77		JR005	1-216-295-91	SHORT	
D518	8-719-991-33	DIODE 1SS133T-77		JR051	1-216-295-91	SHORT	
D519 △	8-719-302-43	DIODE EL1Z-V1		JR053	1-216-295-91	SHORT	
D520	8-719-991-33	DIODE 1SS133T-77		JR054	1-216-295-91	SHORT	
D521	8-719-921-63	DIODE MTZJ-T-77-7.5X		JR4120	1-216-295-91	SHORT	
D522	8-719-991-33	DIODE 1SS133T-77					
D523	8-719-109-69	DIODE MTZJ-T-77-3.6B					
D524	8-719-109-97	DIODE MTZJ-T-77-6.8B					
D530 △	8-719-081-01	DIODE ER204					
D531	8-719-081-01	DIODE ER204					

Note:

The components identified by shading and mark \triangle are critical for safety. Replace only with part number specified.

Note:

Les composants identifiés par un trame et une marque \triangle sont critiques pour la sécurité. Ne les remplacer que par une pièce portant le numéro spécifié.

A

REF.NO.	PART NO.	DESCRIPTION	REMARK	REF.NO.	PART NO.	DESCRIPTION	REMARK
COIL				RESISTOR			
L001	1-414-857-11	INDUCTOR	100 μ H	Q361	8-729-422-27	TRANSISTOR 2SD601A-QRS-TX	
L002	1-414-857-11	INDUCTOR	100 μ H	Q362	8-729-422-27	TRANSISTOR 2SD601A-QRS-TX	
L003	1-414-856-11	INDUCTOR	10 μ H	Q364	8-729-216-22	TRANSISTOR 2SB709A-QRS-TX	
L004	1-414-182-11	INDUCTOR	6.8 μ H	Q369	8-729-422-27	TRANSISTOR 2SD601A-QRS-TX	
L005	1-410-506-11	INDUCTOR	5.6 μ H	Q370	8-729-422-27	TRANSISTOR 2SD601A-QRS-TX	
L006	1-410-506-11	INDUCTOR	5.6 μ H	Q501	8-729-140-50	TRANSISTOR 2SC3209LK-TP	
L007	1-410-506-11	INDUCTOR	5.6 μ H	Q502 \triangle	8-729-045-26	TRANSISTOR 2SD2580-YB	
L301	1-414-857-11	INDUCTOR	100 μ H	Q503	8-729-422-27	TRANSISTOR 2SD601A-QRS-TX	
L302	1-414-856-11	INDUCTOR	10 μ H	Q504	8-729-422-27	TRANSISTOR 2SD601A-QRS-TX	
L351	1-414-186-31	INDUCTOR	33 μ H	Q507	8-729-043-95	TRANSISTOR 2SC3840K	
L501	1-406-677-11	INDUCTOR	10mH	Q511 \triangle	8-729-422-27	TRANSISTOR 2SD601A-QRS-TX	
L502	1-412-552-11	INDUCTOR	2.2mH	Q512 \triangle	8-729-809-29	TRANSISTOR 2SC4159-E	
L503	1-406-677-11	INDUCTOR	10mH	Q561	8-729-422-27	TRANSISTOR 2SD601A-QRS-TX	
L504	1-406-677-11	INDUCTOR	10mH	Q562	8-729-422-27	TRANSISTOR 2SD601A-QRS-TX	
L505	1-406-976-11	INDUCTOR	68 μ H	Q1102	8-729-423-33	TRANSISTOR 2SC3311A-QRSTA	
L511	1-411-189-11	INDUCTOR	15mH	Q1103	8-729-422-27	TRANSISTOR 2SD601A-QRS-TX	
L517	1-412-552-11	INDUCTOR	2.2mH	Q1301	8-729-216-22	TRANSISTOR 2SB709A-QRS-TX	
L1101	1-414-857-11	INDUCTOR	100 μ H	Q1302	8-729-422-27	TRANSISTOR 2SD601A-QRS-TX	
L1102	1-414-856-11	INDUCTOR	10 μ H	Q1303	8-729-422-27	TRANSISTOR 2SD601A-QRS-TX	
L1351	1-414-856-11	INDUCTOR	10 μ H	Q1352	8-729-422-27	TRANSISTOR 2SD601A-QRS-TX	
L1352	1-412-754-21	INDUCTOR	39 μ H	Q1353	8-729-216-22	TRANSISTOR 2SB709A-QRS-TX	
Q001	8-729-216-22	TRANSISTOR 2SB709A-QRS-TX		Q1354	8-729-422-27	TRANSISTOR 2SD601A-QRS-TX	
Q002	8-729-422-27	TRANSISTOR 2SD601A-QRS-TX		RESISTOR			
Q003	8-729-422-27	TRANSISTOR 2SD601A-QRS-TX		R001	1-216-057-00	RES-CHIP	2.2K 5% 1/10W
Q004	8-729-216-22	TRANSISTOR 2SB709A-QRS-TX		R002	1-249-417-11	CARBON	1K 5% 1/4W
Q005	8-729-422-27	TRANSISTOR 2SD601A-QRS-TX		R003	1-216-097-91	RES-CHIP	100K 5% 1/10W
Q006	8-729-422-27	TRANSISTOR 2SD601A-QRS-TX		R004	1-216-121-91	RES-CHIP	1M 5% 1/10W
Q007	8-729-216-22	TRANSISTOR 2SB709A-QRS-TX		R005	1-216-033-00	RES-CHIP	220 5% 1/10W
Q008	8-729-422-27	TRANSISTOR 2SD601A-QRS-TX		R006	1-216-033-00	RES-CHIP	220 5% 1/10W
Q009	8-729-422-27	TRANSISTOR 2SD601A-QRS-TX		R007	1-216-073-00	RES-CHIP	10K 5% 1/10W
Q016	8-729-422-27	TRANSISTOR 2SD601A-QRS-TX		R008	1-216-033-00	RES-CHIP	220 5% 1/10W
Q103	8-729-216-22	TRANSISTOR 2SB709A-QRS-TX		R009	1-216-073-00	RES-CHIP	10K 5% 1/10W
Q104	8-729-216-22	TRANSISTOR 2SB709A-QRS-TX		R010	1-216-041-00	RES-CHIP	470 5% 1/10W
Q301	8-729-422-27	TRANSISTOR 2SD601A-QRS-TX		R011	1-216-065-91	RES-CHIP	4.7K 5% 1/10W
Q303	8-729-422-27	TRANSISTOR 2SD601A-QRS-TX		R012	1-216-033-00	RES-CHIP	220 5% 1/10W
Q304	8-729-216-22	TRANSISTOR 2SB709A-QRS-TX		R013	1-216-065-91	RES-CHIP	4.7K 5% 1/10W
Q305	8-729-216-22	TRANSISTOR 2SB709A-QRS-TX		R014	1-216-065-91	RES-CHIP	4.7K 5% 1/10W
Q306	8-729-216-22	TRANSISTOR 2SB709A-QRS-TX		R015	1-216-073-00	RES-CHIP	10K 5% 1/10W
Q307	8-729-422-27	TRANSISTOR 2SD601A-QRS-TX		R016	1-216-073-00	RES-CHIP	10K 5% 1/10W
Q310	8-729-216-22	TRANSISTOR 2SB709A-QRS-TX		R019	1-249-425-11	CARBON	4.7K 5% 1/4W
Q311	8-729-216-22	TRANSISTOR 2SB709A-QRS-TX		R020	1-216-065-91	RES-CHIP	4.7K 5% 1/10W
Q313	8-729-422-27	TRANSISTOR 2SD601A-QRS-TX		R021	1-216-073-00	RES-CHIP	10K 5% 1/10W
Q314	8-729-422-27	TRANSISTOR 2SD601A-QRS-TX		R022	1-249-429-11	CARBON	10K 5% 1/4W
Q351	8-729-422-27	TRANSISTOR 2SD601A-QRS-TX		R023	1-249-437-11	CARBON	47K 5% 1/4W
Q352	8-729-422-27	TRANSISTOR 2SD601A-QRS-TX		R024	1-249-417-11	CARBON	1K 5% 1/4W
Q359	8-729-216-22	TRANSISTOR 2SB709A-QRS-TX		R025	1-216-041-00	RES-CHIP	470 5% 1/10W
				R026	1-216-121-91	RES-CHIP	1M 5% 1/10W
				R027	1-249-417-11	CARBON	1K 5% 1/4W

A

Note:

The components identified by shading and mark \triangle are critical for safety. Replace only with part number specified.

Note:

Les composants identifiés par un trame et une marque \triangle sont critiques pour la sécurité. Ne les remplacer que par une pièce portant le numéro spécifié.

REF.NO.	PART NO.	DESCRIPTION	REMARK	REF.NO.	PART NO.	DESCRIPTION	REMARK
R028	1-249-429-11	CARBON	10K 5% 1/4W	R089	1-216-073-00	RES-CHIP	10K 5% 1/10W
R029	1-216-025-91	RES-CHIP	100 5% 1/10W	R090	1-249-409-11	CARBON	220 5% 1/4W
R030	1-216-065-91	RES-CHIP	4.7K 5% 1/10W	R096	1-216-033-00	RES-CHIP	220 5% 1/10W
R031	1-216-033-00	RES-CHIP	220 5% 1/10W	R097	1-249-425-11	CARBON	4.7K 5% 1/4W
R032	1-249-409-11	CARBON	220 5% 1/4W	R099	1-249-425-11	CARBON	4.7K 5% 1/4W
R033	1-249-425-11	CARBON	4.7K 5% 1/4W	R106	1-216-081-00	RES-CHIP	22K 5% 1/10W
R034	1-216-295-91	SHORT		R107	1-216-081-00	RES-CHIP	22K 5% 1/10W
R035	1-216-041-00	RES-CHIP	470 5% 1/10W	R108	1-216-081-00	RES-CHIP	22K 5% 1/10W
R036	1-249-417-11	CARBON	1K 5% 1/4W	R109	1-216-081-00	RES-CHIP	22K 5% 1/10W
R037	1-249-417-11	CARBON	1K 5% 1/4W	R133	1-216-037-00	RES-CHIP	330 5% 1/10W
R038	1-249-417-11	CARBON	1K 5% 1/4W	R302	1-208-291-11	RES-CHIP	4.7M 5% 1/10W
R040	1-249-409-11	CARBON	220 5% 1/4W	R304	1-216-033-00	RES-CHIP	220 5% 1/10W
R041	1-216-295-91	SHORT		R305	1-249-409-11	CARBON	220 5% 1/4W
R043	1-249-409-11	CARBON	220 5% 1/4W	R306	1-249-409-11	CARBON	220 5% 1/4W
R044	1-249-417-11	CARBON	1K 5% 1/4W	R307	1-216-295-91	SHORT	
R045	1-216-033-00	RES-CHIP	220 5% 1/10W	R309	1-216-295-91	SHORT	
R046	1-216-033-00	RES-CHIP	220 5% 1/10W	R311	1-216-073-00	RES-CHIP	10K 5% 1/10W
R047	1-216-049-91	RES-CHIP	1K 5% 1/10W	R313	1-216-065-91	RES-CHIP	4.7K 5% 1/10W
R048	1-249-417-11	CARBON	1K 5% 1/4W	R314	1-216-073-00	RES-CHIP	10K 5% 1/10W
R049	1-249-417-11	CARBON	1K 5% 1/4W	R315	1-216-073-00	RES-CHIP	10K 5% 1/10W
R052	1-216-049-91	RES-CHIP	1K 5% 1/10W	R316	1-216-073-00	RES-CHIP	10K 5% 1/10W
R053	1-216-025-91	RES-CHIP	100 5% 1/10W	R319	1-216-057-00	RES-CHIP	2.2K 5% 1/10W
R055	1-216-097-91	RES-CHIP	100K 5% 1/10W	R320	1-216-057-00	RES-CHIP	2.2K 5% 1/10W
R056	1-249-409-11	CARBON	220 5% 1/4W	R321	1-216-057-00	RES-CHIP	2.2K 5% 1/10W
R057	1-216-049-91	RES-CHIP	1K 5% 1/10W	R325	1-216-033-00	RES-CHIP	220 5% 1/10W
R060	1-216-073-00	RES-CHIP	10K 5% 1/10W	R326	1-216-085-00	RES-CHIP	33K 5% 1/10W
R061	1-216-073-00	RES-CHIP	10K 5% 1/10W	R327	1-216-033-00	RES-CHIP	220 5% 1/10W
R062	1-216-073-00	RES-CHIP	10K 5% 1/10W	R330	1-208-806-11	METAL CHIP	10K 0.50% 1/10W
R063	1-216-073-00	RES-CHIP	10K 5% 1/10W	R331	1-216-065-91	RES-CHIP	4.7K 5% 1/10W
R064	1-216-057-00	RES-CHIP	2.2K 5% 1/10W	R332	1-216-033-00	RES-CHIP	220 5% 1/10W
R065	1-216-057-00	RES-CHIP	2.2K 5% 1/10W	R334	1-216-033-00	RES-CHIP	220 5% 1/10W
R066	1-216-057-00	RES-CHIP	2.2K 5% 1/10W	R335	1-216-033-00	RES-CHIP	220 5% 1/10W
R067	1-216-057-00	RES-CHIP	2.2K 5% 1/10W	R336	1-216-049-91	RES-CHIP	1K 5% 1/10W
R068	1-249-429-11	CARBON	10K 5% 1/4W	R337	1-216-347-11	METAL OXIDE	0.68 5% 1W
R069	1-249-429-11	CARBON	10K 5% 1/4W	R340	1-216-105-91	RES-CHIP	220K 5% 1/10W
R070	1-216-057-00	RES-CHIP	2.2K 5% 1/10W	R341	1-216-073-00	RES-CHIP	10K 5% 1/10W
R071	1-249-409-11	CARBON	220 5% 1/4W	R342	1-216-097-91	RES-CHIP	100K 5% 1/10W
R072	1-216-033-00	RES-CHIP	220 5% 1/10W	R343	1-216-093-91	RES-CHIP	68K 5% 1/10W
R073	1-249-409-11	CARBON	220 5% 1/4W	R344	1-216-073-00	RES-CHIP	10K 5% 1/10W
R074	1-216-033-00	RES-CHIP	220 5% 1/10W	R346	1-216-023-00	RES-CHIP	82 5% 1/10W
R075	1-249-409-11	CARBON	220 5% 1/4W	R347	1-216-041-00	RES-CHIP	470 5% 1/10W
R076	1-216-033-00	RES-CHIP	220 5% 1/10W	R348	1-216-033-00	RES-CHIP	220 5% 1/10W
R078	1-249-417-11	CARBON	1K 5% 1/4W	R349	1-216-041-00	RES-CHIP	470 5% 1/10W
R079	1-216-033-00	RES-CHIP	220 5% 1/10W	R350	1-247-807-31	CARBON	100 5% 1/4W
R081	1-247-807-31	CARBON	100 5% 1/4W	R352	1-216-073-00	RES-CHIP	10K 5% 1/10W
R082	1-247-807-31	CARBON	100 5% 1/4W	R353	1-216-295-91	SHORT	
R083	1-249-429-11	CARBON	10K 5% 1/4W	R354	1-216-073-00	RES-CHIP	10K 5% 1/10W
R085	1-249-425-11	CARBON	4.7K 5% 1/4W	R355	1-216-069-00	RES-CHIP	6.8K 5% 1/10W
R086	1-216-073-00	RES-CHIP	10K 5% 1/10W	R356	1-216-025-91	RES-CHIP	100 5% 1/10W

Note:

The components identified by shading and mark \triangle are critical for safety. Replace only with part number specified.

Note:

The components identified by \square in this manual have been carefully factory-selected for each set in order to satisfy regulations regarding x-ray radiation. Should replacement be required, replace only with the value originally used.

A

REF.NO.	PART NO.	DESCRIPTION	REMARK	REF.NO.	PART NO.	DESCRIPTION	REMARK
R358	1-216-295-91	SHORT		R537	\triangle 1-260-288-11	CARBON	0.47 5% 1/2W
R359	1-216-073-00	RES-CHIP	10K 5% 1/10W	R538	1-247-887-00	CARBON	220K 5% 1/4W
R360	1-249-409-11	CARBON	220 5% 1/4W	R539	1-215-891-11	METAL OXIDE	680 5% 2W
R361	1-216-049-91	RES-CHIP	1K 5% 1/10W	R540	1-208-826-11	METAL CHIP	68K 0.50% 1/10W
R362	1-216-073-00	RES-CHIP	10K 5% 1/10W	R541	1-215-919-11	METAL OXIDE	2.2K 5% 3W
R370	1-216-049-91	RES-CHIP	1K 5% 1/10W	R542	1-215-921-11	METAL OXIDE	4.7K 5% 3W
R372	1-216-097-91	RES-CHIP	100K 5% 1/10W	R543	\triangle 1-249-377-11	CARBON	0.47 5% 1/4W
R373	1-216-121-91	RES-CHIP	1M 5% 1/10W	R544	1-216-113-00	RES-CHIP	470K 5% 1/10W
R374	1-216-041-00	RES-CHIP	470 5% 1/10W	R545	\triangle 1-249-387-11	CARBON	3.3 5% 1/4W
R375	1-216-049-91	RES-CHIP	1K 5% 1/10W	R546	1-215-453-00	METAL	22K 1% 1/4W
R376	1-216-025-91	RES-CHIP	100 5% 1/10W	R547	1-215-457-00	METAL	33K 1% 1/4W
R378	1-216-083-00	RES-CHIP	27K 5% 1/10W	R548	1-215-921-11	METAL OXIDE	4.7K 5% 3W
R383	1-216-025-91	RES-CHIP	100 5% 1/10W	R549	1-215-437-00	METAL	4.7K 1% 1/4W
R384	1-216-037-00	RES-CHIP	330 5% 1/10W	R550	\triangle 1-249-377-11	CARBON	0.47 5% 1/4W
R385	1-249-425-11	CARBON	4.7K 5% 1/4W	R551	1-215-873-00	METAL OXIDE	4.7K 5% 1W
R386	1-249-429-11	CARBON	10K 5% 1/4W	R552	1-216-455-21	METAL OXIDE	560 5% 2W
R387	1-216-037-00	RES-CHIP	330 5% 1/10W	R553	\triangle 1-260-288-11	CARBON	0.47 5% 1/2W
R398	1-216-095-00	RES-CHIP	82K 5% 1/10W	R554	1-215-894-11	METAL OXIDE	2.2K 5% 2W
R501	1-216-041-00	RES-CHIP	470 5% 1/10W	R555	1-249-441-11	CARBON	100K 5% 1/4W
R502	1-216-065-91	RES-CHIP	4.7K 5% 1/10W	R556	1-249-441-11	CARBON	100K 5% 1/4W
R503	1-249-425-11	CARBON	4.7K 5% 1/4W	R557	1-249-441-11	CARBON	100K 5% 1/4W
R504	1-216-455-21	METAL OXIDE	560 5% 2W	R559	1-216-017-91	RES-CHIP	47 5% 1/10W
R505	1-249-433-11	CARBON	22K 5% 1/4W	R560	1-215-919-11	METAL OXIDE	2.2K 5% 3W
R506	1-215-861-00	METAL OXIDE	47 5% 1W	R561	1-208-806-11	METAL CHIP	10K 0.50% 1/10W
R507	1-249-401-11	CARBON	47 5% 1/4W	R563	1-214-798-21	METAL	1.8 1% 1/2W
R508	1-249-425-11	CARBON	4.7K 5% 1/4W	R565	1-215-889-00	METAL OXIDE	330 5% 2W
R509	1-260-328-11	CARBON	1K 5% 1/2W	R566	1-208-802-11	METAL CHIP	6.8K 0.50% 1/10W
R510	\triangle 1-215-883-11	METAL OXIDE	33 5% 2W	R567	\triangle 1-249-385-11	CARBON	2.2 5% 1/4W
R512	1-215-910-00	METAL OXIDE	68 5% 3W	R568	1-208-802-11	METAL CHIP	6.8K 0.50% 1/10W
R514	1-216-081-00	RES-CHIP	22K 5% 1/10W	R569	1-208-806-11	METAL CHIP	10K 0.50% 1/10W
R515	1-208-812-11	METAL CHIP	18K 0.50% 1/10W	R570	1-216-097-91	RES-CHIP	100K 5% 1/10W
R516	1-208-790-11	METAL CHIP	2.2K 0.50% 1/10W	R571	1-216-081-00	RES-CHIP	22K 5% 1/10W
R517	1-249-417-11	CARBON	1K 5% 1/4W	R572	1-216-081-00	RES-CHIP	22K 5% 1/10W
R518	1-216-073-00	RES-CHIP	10K 5% 1/10W	R573	1-216-097-91	RES-CHIP	100K 5% 1/10W
R519	1-249-413-11	CARBON	470 5% 1/4W	R574	1-214-798-21	METAL	1.8 1% 1/2W
R520	1-215-907-11	METAL OXIDE	22 5% 3W	R576	1-215-905-11	METAL OXIDE	10 5% 3W
R521	1-216-081-00	RES-CHIP	22K 5% 1/10W	R577	1-216-049-91	RES-CHIP	1K 5% 1/10W
R523	1-208-808-11	METAL CHIP	12K 0.50% 1/10W	R578	1-216-057-00	RES-CHIP	2.2K 5% 1/10W
R524	1-249-429-11	CARBON	10K 5% 1/4W	R580	1-249-441-11	CARBON	100K 5% 1/4W
R525	1-208-804-11	METAL CHIP	8.2K 0.50% 1/10W	R581	1-247-887-00	CARBON	220K 5% 1/4W
R526	1-215-905-11	METAL OXIDE	10 5% 3W	R582	1-249-421-11	CARBON	2.2K 5% 1/4W
R527	1-216-097-91	RES-CHIP	100K 5% 1/10W	R1001	1-247-807-31	CARBON	100 5% 1/4W
R528	1-208-814-91	METAL CHIP	22K 0.50% 1/10W	R1002	1-247-807-31	CARBON	100 5% 1/4W
R529	1-208-814-91	METAL CHIP	22K 0.50% 1/10W	R1003	1-216-073-00	RES-CHIP	10K 5% 1/10W
\square R530	\triangle 1-208-808-11	METAL CHIP	12K 0.50% 1/10W	R1005	1-216-073-00	RES-CHIP	10K 5% 1/10W
\square R531	\triangle 1-216-091-00	RES-CHIP	56K 5% 1/10W	R1006	1-216-025-91	RES-CHIP	100 5% 1/10W
R532	1-208-760-11	METAL CHIP	120 0.50% 1/10W	R1007	1-216-025-91	RES-CHIP	100 5% 1/10W
R533	1-215-902-11	METAL OXIDE	47K 5% 1W	R1011	1-249-387-11	CARBON	3.3 5% 1/4W
R536	\triangle 1-260-288-11	CARBON	0.47 5% 1/2W	R1012	1-216-049-91	RES-CHIP	1K 5% 1/10W

A**Note:**

The components identified by shading and mark \triangle are critical for safety. Replace only with part number specified.

Note:

Les composants identifiés par un trame et une marque \triangle sont critiques pour la sécurité. Ne les remplacer que par une pièce portant le numéro spécifié.

REF.NO.	PART NO.	DESCRIPTION	REMARK	REF.NO.	PART NO.	DESCRIPTION	REMARK
R1030	1-216-065-91	RES-CHIP	4.7K 5% 1/10W	R1365	1-216-089-91	RES-CHIP	47K 5% 1/10W
R1031	1-216-065-91	RES-CHIP	4.7K 5% 1/10W	R1366	1-216-107-00	RES-CHIP	270K 5% 1/10W
R1101	1-216-049-91	RES-CHIP	1K 5% 1/10W	R1369	1-216-093-91	RES-CHIP	68K 5% 1/10W
R1102	1-215-900-11	METAL OXIDE	22K 5% 2W	R1371	1-216-295-91	SHORT	
R1103	1-216-049-91	RES-CHIP	1K 5% 1/10W	R1373	1-216-025-91	RES-CHIP	100 5% 1/10W
R1104	1-216-081-00	RES-CHIP	22K 5% 1/10W	R1374	1-216-089-91	RES-CHIP	47K 5% 1/10W
R1105	1-216-085-00	RES-CHIP	33K 5% 1/10W	R1385	1-216-049-91	RES-CHIP	1K 5% 1/10W
R1106	1-216-049-91	RES-CHIP	1K 5% 1/10W	R1387	1-249-429-11	CARBON	10K 5% 1/4W
R1107	1-216-065-91	RES-CHIP	4.7K 5% 1/10W	R1389	1-216-025-91	RES-CHIP	100 5% 1/10W
R1108	1-216-073-00	RES-CHIP	10K 5% 1/10W	R1390	1-249-417-11	CARBON	1K 5% 1/4W
R1109	1-216-025-91	RES-CHIP	100 5% 1/10W	R1391	1-216-081-00	RES-CHIP	22K 5% 1/10W
R1110	1-216-025-91	RES-CHIP	100 5% 1/10W	R1392	1-216-081-00	RES-CHIP	22K 5% 1/10W
R1113	1-249-417-11	CARBON	1K 5% 1/4W	R1395	1-216-049-91	RES-CHIP	1K 5% 1/10W
R1114	1-249-417-11	CARBON	1K 5% 1/4W	R1397	1-216-025-91	RES-CHIP	100 5% 1/10W
R1115	1-216-041-00	RES-CHIP	470 5% 1/10W	R1398	1-216-033-00	RES-CHIP	220 5% 1/10W
R1117	1-249-425-11	CARBON	4.7K 5% 1/4W	SWITCH			
R1118	1-249-425-11	CARBON	4.7K 5% 1/4W	S501	1-572-707-11	SWITCH, LEVER	
R1123	1-216-037-00	RES-CHIP	330 5% 1/10W	S502	1-572-707-11	SWITCH, LEVER	
R1128	1-216-037-00	RES-CHIP	330 5% 1/10W	TRANSFORMER			
R1129	1-216-295-91	SHORT		T501	1-437-195-11	TRANSFORMER, HORIZONTAL DRIVE	
R1301	1-249-401-11	CARBON	47 5% 1/4W	T502	\triangle 1-426-981-11	TRANSFORMER, FERRITE (PMT)	
R1302	1-249-401-11	CARBON	47 5% 1/4W	T503	\triangle 1-453-338-21	FBT ASSY, NX-4600	
R1303	1-216-065-91	RES-CHIP	4.7K 5% 1/10W	T504	\triangle 1-424-584-11	TRANSFORMER, DYNAMIC FOCUS	
R1304	1-216-051-00	RES-CHIP	1.2K 5% 1/10W	T505	\triangle 1-435-098-11	TRANSFORMER, HORIZONTAL LINEAR	
R1305	1-216-051-00	RES-CHIP	1.2K 5% 1/10W	THERMISTOR			
R1306	1-216-049-91	RES-CHIP	1K 5% 1/10W	TH501	1-800-193-00	THERMISTOR	
R1313	1-216-295-91	SHORT		TUNER			
R1314	1-216-049-91	RES-CHIP	1K 5% 1/10W	TU102	\triangle 8-598-542-00	TUNER, FSS BTF-WA412	
R1315	1-216-025-91	RES-CHIP	100 5% 1/10W	CRYSTAL			
R1316	1-216-091-00	RES-CHIP	56K 5% 1/10W	X001	1-781-931-21	VIBRATOR, CRYSTAL	
R1317	1-216-105-91	RES-CHIP	220K 5% 1/10W	X302	1-567-505-11	OSCILLATOR, CRYSTAL	
R1318	1-216-065-91	RES-CHIP	4.7K 5% 1/10W				
R1319	1-260-290-71	CARBON	0.68 5% 1/2W				
R1320	1-216-073-00	RES-CHIP	10K 5% 1/10W				
R1321	1-216-065-91	RES-CHIP	4.7K 5% 1/10W				
R1322	1-216-047-91	RES-CHIP	820 5% 1/10W				
R1323	1-216-049-91	RES-CHIP	1K 5% 1/10W				
R1324	1-216-295-91	SHORT					
R1325	1-216-057-00	RES-CHIP	2.2K 5% 1/10W				
R1330	1-216-065-91	RES-CHIP	4.7K 5% 1/10W				
R1333	1-216-065-91	RES-CHIP	4.7K 5% 1/10W				
R1337	1-216-049-91	RES-CHIP	1K 5% 1/10W				
R1358	1-216-025-91	RES-CHIP	100 5% 1/10W				
R1359	1-216-025-91	RES-CHIP	100 5% 1/10W				
R1360	1-216-049-91	RES-CHIP	1K 5% 1/10W				
R1361	1-216-049-91	RES-CHIP	1K 5% 1/10W				
R1362	1-216-113-00	RES-CHIP	470K 5% 1/10W				
R1363	1-216-057-00	RES-CHIP	2.2K 5% 1/10W				
R1364	1-216-097-91	RES-CHIP	100K 5% 1/10W				

**Note:**

The components identified by shading and mark \triangle are critical for safety. Replace only with part number specified.

Note:

Les composants identifies per un trame et une marque \triangle sont critiques pour la securite. Ne les remplacer que par une piece portant le numero specifie.

REF.NO.	PART NO.	DESCRIPTION	REMARK	REF.NO.	PART NO.	DESCRIPTION	REMARK
C1471	1-136-165-00	MYLAR	0.1 μ F 5% 50V	D107	8-719-991-33	DIODE 1SS133T-77	
C1472	1-137-194-81	MYLAR	0.47 μ F 5% 50V			(KV-36FV16/36FV26 ONLY)	
C1473	1-128-550-11	ELECT	2200 μ F 20% 50V	D108	8-719-110-17	DIODE MTZJ-T-77-10B	
C1474	1-136-165-00	MYLAR	0.1 μ F 5% 50V			(ALL EXCEPT KV-36FS12)	
C1475	1-128-550-11	ELECT	2200 μ F 20% 50V	D109	8-719-110-17	DIODE MTZJ-T-77-10B	
						(ALL EXCEPT KV-36FS12)	
C1476	1-128-550-11	ELECT	2200 μ F 20% 50V	D1461	8-719-991-33	DIODE 1SS133T-77	
C1477	1-126-971-11	ELECT	470 μ F 20% 50V	D1463	8-719-991-33	DIODE 1SS133T-77	
C1478	1-126-971-11	ELECT	470 μ F 20% 50V				
C1904	1-102-129-00	CERAMIC	0.01 μ F 10% 50V	D1466	8-719-991-33	DIODE 1SS133T-77	
		(KV-36FV16/36FV26 ONLY)		D1467	8-719-924-13	DIODE MTZJ-T-77-22B	
C1905	1-126-964-11	ELECT	10 μ F 20% 50V	D1468	8-719-924-13	DIODE MTZJ-T-77-22B	
		(KV-36FV16/36FV26 ONLY)		D1469	8-719-991-33	DIODE 1SS133T-77	
C1906	1-102-129-00	CERAMIC	0.01 μ F 10% 50V				
		(KV-36FV16/36FV26 ONLY)					
C1907	1-126-964-11	ELECT	10 μ F 20% 50V	IC			
		(KV-36FV16/36FV26 ONLY)		IC1401	8-759-578-88	IC BH3868FS-E2	
C1908	1-163-009-11	CERAMIC CHIP	0.001 μ F 10% 50V	IC1402	8-759-100-96	IC NJM4558M-TE2	
		(KV-36FV16/36FV26 ONLY)		IC1403	8-759-537-26	IC TDA7467D013TR	
C1909	1-163-009-11	CERAMIC CHIP	0.001 μ F 10% 50V			(KV-36FV16/36FV26 ONLY)	
		(KV-36FV16/36FV26 ONLY)		IC1461 \triangle	8-759-246-70	IC TA8216H	
C1910	1-163-009-11	CERAMIC CHIP	0.001 μ F 10% 50V	IC1901	8-752-058-68	IC CXA1315M-T4	
		(KV-36FV16/36FV26 ONLY)				(KV-36FV16/36FV26 ONLY)	
C1911	1-163-009-11	CERAMIC CHIP	0.001 μ F 10% 50V	IC1902	8-759-470-63	IC NJM2145M-TE2	
		(KV-36FV16/36FV26 ONLY)				(KV-36FV16/36FV26 ONLY)	
C1912	1-163-009-11	CERAMIC CHIP	0.001 μ F 10% 50V				
		(KV-36FV16/36FV26 ONLY)		CHIP CONDUCTOR			
				JR1901	1-216-295-91	SHORT	
CONNECTOR				JR1902	1-216-295-91	SHORT	
CN1462*	1-564-507-11	PLUG, CONNECTOR 4P					
CN1463*	1-564-509-11	PLUG, CONNECTOR 6P		COIL			
CN1464*	1-764-333-11	PLUG, CONNECTOR 10P		L102	1-414-856-11	INDUCTOR 10 μ H	
CN1465*	1-564-507-11	PLUG, CONNECTOR 4P				(ALL EXCEPT KV-36FS12)	
		(KV-36FV26 ONLY)		L105	1-414-857-11	INDUCTOR 100 μ H	
CN1466*	1-564-515-11	PLUG, CONNECTOR 12P				(ALL EXCEPT KV-36FS12)	
CN1467*	1-564-510-11	PLUG, CONNECTOR 7P		L1401	1-414-857-11	INDUCTOR 100 μ H	
		(ALL EXCEPT KV-36FS12)					
CN1468	1-695-915-11	TAB (CONTACT)		IC LINK			
		(ALL EXCEPT KV-36FS12)		PS1461 \triangle	1-532-984-11	LINK, IC 2A/90V	
DIODE				TRANSISTOR			
D101	8-719-109-89	DIODE MTZJ-T-77-5.6C		Q101	8-729-423-33	TRANSISTOR 2SC3311A-QRSTA	
		(ALL EXCEPT KV-36FS12)				(ALL EXCEPT KV-36FS12)	
D103	8-719-991-33	DIODE 1SS133T-77		Q105	8-729-216-22	TRANSISTOR 2SB709A-QRS-TX	
		(ALL EXCEPT KV-36FS12)				(ALL EXCEPT KV-36FS12)	
D104	8-719-991-33	DIODE 1SS133T-77		Q106	8-729-422-27	TRANSISTOR 2SD601A-QRS-TX	
		(ALL EXCEPT KV-36FS12)				(ALL EXCEPT KV-36FS12)	
D105	8-719-991-33	DIODE 1SS133T-77		Q451	8-729-140-97	TRANSISTOR 2SB734-T-34	
		(KV-36FV16/36FV26 ONLY)				(KV-36FV26 ONLY)	
D106	8-719-991-33	DIODE 1SS133T-77		Q1461	8-729-422-27	TRANSISTOR 2SD601A-QRS-TX	
		(KV-36FV16/36FV26 ONLY)					

Note:

The components identified by shading and mark \triangle are critical for safety. Replace only with part number specified.

Note:

Les composants identifiés par un trame et une marque \triangle sont critiques pour la sécurité. Ne les remplacer que par une pièce portant le numéro spécifié.



REF.NO.	PART NO.	DESCRIPTION	REMARK	REF.NO.	PART NO.	DESCRIPTION	REMARK
Q1462	8-729-422-27	TRANSISTOR 2SD601A-QRS-TX		R1406	1-216-121-91	RES-CHIP 1M	5% 1/10W
Q1463	8-729-900-53	TRANSISTOR DTC114EKA-T146		R1407	1-216-073-00	RES-CHIP 10K	5% 1/10W
Q1464	8-729-900-53	TRANSISTOR DTC114EKA-T146		R1408	1-216-295-91	SHORT	
Q1902	8-729-216-22	TRANSISTOR 2SB709A-QRS-TX (KV-36FV16/36FV26 ONLY)				(KV-36FV16/36FV26 ONLY)	
Q1903	8-729-216-22	TRANSISTOR 2SB709A-QRS-TX (KV-36FV16/36FV26 ONLY)		R1409	1-216-295-91	SHORT	
Q1918	8-729-216-22	TRANSISTOR 2SB709A-QRS-TX (KV-36FV16/36FV26 ONLY)		R1410	1-216-081-00	RES-CHIP 22K	5% 1/10W
				R1411	1-216-073-00	RES-CHIP 10K	5% 1/10W
				R1412	1-216-089-91	RES-CHIP 47K	5% 1/10W
				R1413	1-216-089-91	RES-CHIP 47K	5% 1/10W
				R1415	1-216-025-91	RES-CHIP 100	5% 1/10W
				R1416	1-216-081-00	RES-CHIP 22K	5% 1/10W
				R1417	1-216-081-00	RES-CHIP 22K	5% 1/10W
				R1418	1-216-089-91	RES-CHIP 47K	5% 1/10W
				R1420	1-216-295-91	SHORT	
						(KV-36FS12/36FS16 ONLY)	
				R1421	1-216-025-91	RES-CHIP 100	5% 1/10W
				R1422	1-216-033-00	RES-CHIP 220	5% 1/10W
				R1423	1-216-033-00	RES-CHIP 220	5% 1/10W
				R1424	1-216-073-00	RES-CHIP 10K	5% 1/10W
				R1425	1-216-073-00	RES-CHIP 10K	5% 1/10W
				R1427	1-216-065-91	RES-CHIP 4.7K	5% 1/10W
				R1458	1-216-033-00	RES-CHIP 220	5% 1/10W
						(KV-36FV16/36FV26 ONLY)	
				R1459	1-216-033-00	RES-CHIP 220	5% 1/10W
						(KV-36FV16/36FV26 ONLY)	
				R1461	1-216-057-00	RES-CHIP 2.2K	5% 1/10W
				R1462	1-216-073-00	RES-CHIP 10K	5% 1/10W
				R1464	1-216-057-00	RES-CHIP 2.2K	5% 1/10W
				R1465	1-216-089-91	RES-CHIP 47K	5% 1/10W
				R1466	1-216-089-91	RES-CHIP 47K	5% 1/4W
				R1467	1-216-073-00	RES-CHIP 10K	5% 1/4W
				R1469	1-249-389-11	CARBON 4.7	5% 1/10W
				R1470	1-249-389-11	CARBON 4.7	5% 1/10W
				R1471	1-216-049-91	RES-CHIP 1K	5% 1/10W
				R1472	1-216-077-91	RES-CHIP 15K	5% 1/10W
				R1473	1-216-049-91	RES-CHIP 1K	5% 1/10W
				R1474	1-216-045-00	RES-CHIP 680	5% 1/10W
						(KV-36FS12/36FS16 ONLY)	
				R1474	1-216-025-91	RES-CHIP 100	5% 1/10W
						(KV-36FV16/36FV26 ONLY)	
				R1475	1-216-045-00	RES-CHIP 680	5% 1/10W
						(KV-36FS12/36FS16 ONLY)	
				R1475	1-216-025-91	RES-CHIP 100	5% 1/10W
						(KV-36FV16/36FV26 ONLY)	
				R1480	1-216-057-00	RES-CHIP 2.2K	5% 1/10W
				R1481	1-216-057-00	RES-CHIP 2.2K	5% 1/10W
				R1482	1-216-295-91	SHORT	
				R1483	1-216-295-91	SHORT	
				R1902	1-216-073-00	RES-CHIP 10K	5% 1/10W
						(KV-36FV16/36FV26 ONLY)	
				R1403	1-216-121-91	RES-CHIP 1M	5% 1/10W
				R1404	1-216-295-91	SHORT	

**Note:**

The components identified by shading and mark \triangle are critical for safety. Replace only with part number specified.

Note:

Les composants identifiés par un trame et une marque \triangle sont critiques pour la sécurité. Ne les remplacer que par une pièce portant le numéro spécifié.

REF.NO.	PART NO.	DESCRIPTION	REMARK	REF.NO.	PART NO.	DESCRIPTION	REMARK
R1904	1-216-073-00	RES-CHIP 10K (KV-36FV16/36FV26 ONLY)	5% 1/10W	CONNECTOR			
R1906	1-216-073-00	RES-CHIP 10K (KV-36FV16/36FV26 ONLY)	5% 1/10W	CN1761*	1-564-509-11	PLUG, CONNECTOR 6P	
R1907	1-216-033-00	RES-CHIP 220 (KV-36FV16/36FV26 ONLY)	5% 1/10W	CN1764*	1-564-508-11	PLUG, CONNECTOR 5P	
R2904	1-216-033-00	RES-CHIP 220 (KV-36FV16/36FV26 ONLY)	5% 1/10W	CN1766	1-695-915-11	TAB (CONTACT)	
R2905	1-216-033-00	RES-CHIP 220 (KV-36FV16/36FV26 ONLY)	5% 1/10W	DIODE			
R2909	1-216-073-00	RES-CHIP 10K (KV-36FV16/36FV26 ONLY)	5% 1/10W	D1790	8-719-991-33	DIODE 1SS133T-77	
R2910	1-216-073-00	RES-CHIP 10K (KV-36FV16/36FV26 ONLY)	5% 1/10W	D1791	8-719-075-33	DIODE 1N4003GA	
R2912	1-216-065-91	RES-CHIP 4.7K (KV-36FV16/36FV26 ONLY)	5% 1/10W	D1792	8-719-075-33	DIODE 1N4003GA	
R2913	1-216-073-00	RES-CHIP 10K (KV-36FV16/36FV26 ONLY)	5% 1/10W	D1793	8-719-075-33	DIODE 1N4003GA	
R2914	1-216-073-00	RES-CHIP 10K (KV-36FV16/36FV26 ONLY)	5% 1/10W	D1794	8-719-075-33	DIODE 1N4003GA	
R2915	1-216-073-00	RES-CHIP 10K (KV-36FV16/36FV26 ONLY)	5% 1/10W	IC			
R2916	1-216-073-00	RES-CHIP 10K (KV-36FV16/36FV26 ONLY)	5% 1/10W	IC1701 \triangle	8-759-562-43	IC TDA6108JF/N1B	
TUNER				JACK			
TU101 \triangle	8-598-501-20	TUNER, FSS BTF-FA402 (ALL EXCEPT KV-36FS12)		J1761 \triangle	1-251-797-11	SOCKET, CRT	
CAPACITOR				COIL			
C1750	1-137-528-11	MYLAR 0.1 μ F	10% 250V	L1790	1-412-537-31	INDUCTOR 100 μ H	
C1751	1-107-655-11	ELECT 47 μ F	20% 250V	TRANSISTOR			
C1790	1-102-129-00	CERAMIC 0.01 μ F	10% 50V	Q1790	8-729-119-76	TRANSISTOR 2SA1309A-QRSTA	
C1791	1-126-968-11	ELECT 100 μ F	20% 50V	RESISTOR			
C1792	1-102-116-00	CERAMIC 680PF	10% 50V	R1750	1-247-870-11	CARBON 43K 5% 1/4W	
C1794	1-107-651-11	ELECT 4.7 μ F	20% 250V	R1751	1-249-409-11	CARBON 220 5% 1/4W	
C1795	1-102-074-00	CERAMIC 0.001 μ F	10% 50V	R1752	1-249-409-11	CARBON 220 5% 1/4W	
C1799	1-162-114-00	CERAMIC 0.0047 μ F	2KV	R1753 \triangle	1-249-409-11	CARBON 220 5% 1/4W	
				R1763	1-260-099-11	CARBON 1K 5% 1/2W	
				R1764	1-247-807-31	CARBON 100 5% 1/4W	
				R1773	1-260-099-11	CARBON 1K 5% 1/2W	
				R1774	1-247-807-31	CARBON 100 5% 1/4W	
				R1783	1-260-099-11	CARBON 1K 5% 1/2W	
				R1784	1-247-807-31	CARBON 100 5% 1/4W	
				R1788	1-216-349-00	METAL OXIDE 1 5% 1W	
				R1789	1-249-437-11	CARBON 47K 5% 1/4W	
				R1792	1-249-409-11	CARBON 220 5% 1/4W	
				R1793	1-247-866-11	CARBON 30K 5% 1/4W	
				R1794	1-260-132-11	CARBON 560K 5% 1/2W	
				R1795	1-260-087-11	CARBON 100 5% 1/2W	
				R1796 \triangle	1-216-373-11	METAL OXIDE 2.2 5% 2W	
				R1797	1-260-123-11	CARBON 100K 5% 1/2W	

* A-1331-942-A C (VAR) MOUNTED PC BOARD

4-382-854-11 SCREW (M3X10), P, SW (+)

Note:

The components identified by shading and mark Δ are critical for safety. Replace only with part number specified.

Note:

Les composants identifiés par un trame et une marque Δ sont critiques pour la securite. Ne les remplacer que par une piece portant le numero specifie.



Table with columns REF.NO., PART NO., DESCRIPTION, REMARK. Includes sections for VARIABLE RESISTOR, CAPACITOR, CONNECTOR, and DIODE. Rows include parts like RV1761, C601-C656, CN601-CN646, and D600-D648.



* A-1316-397-A G COMPLETE PC BOARD
1-533-223-11 HOLDER, FUSE
4-382-854-11 SCREW (M3X10), P, SW (+)



Note:

The components identified by shading and mark \triangle are critical for safety. Replace only with part number specified.

Note:

Les composants identifiés par un trame et une marque \triangle sont critiques pour la sécurité. Ne les remplacer que par une pièce portant le numéro spécifié.

REF.NO.	PART NO.	DESCRIPTION	REMARK	REF.NO.	PART NO.	DESCRIPTION	REMARK
D651	8-719-510-02	DIODE D1NS4-TA2		Q653	8-729-423-33	TRANSISTOR 2SC3311A-QRSTA	
D652	8-719-510-02	DIODE D1NS4-TA2		RESISTOR			
D653	8-719-991-33	DIODE 1SS133T-77		R601	\triangle 1-249-377-11	CARBON	0.47 5% 1/4W
D698	8-719-991-33	DIODE 1SS133T-77		R602	1-249-429-11	CARBON	10K 5% 1/4W
D699	8-719-923-86	DIODE MTZJ-T-77-15		R603	\triangle 1-219-776-11	CARBON	2.2M 10% 1/2W
FUSE				R604	1-249-429-11	CARBON	10K 5% 1/4W
F601	\triangle 1-532-506-51	FUSE 6.3A/250V		R605	1-249-429-11	CARBON	10K 5% 1/4W
FERRITE BEAD				R606	1-249-421-11	CARBON	2.2K 5% 1/4W
FB601	1-410-396-41	FERRITE	0.45 μ H	R607	\triangle 1-202-933-61	FUSIBLE	0.1 10% 1/2W
FB602	1-410-396-41	FERRITE	0.45 μ H	R608	1-216-369-00	METAL OXIDE	1 5% 2W
FB603	1-410-396-41	FERRITE	0.45 μ H	R609	1-249-417-11	CARBON	1K 5% 1/4W
FB604	1-410-396-41	FERRITE	0.45 μ H	R610	1-249-425-11	CARBON	4.7K 5% 1/4W
FB641	1-410-397-21	FERRITE	1.1 μ H	R611	1-216-369-00	METAL OXIDE	1 5% 2W
FB642	1-410-397-21	FERRITE	1.1 μ H	R612	1-260-124-11	CARBON	120K 5% 1/2W
FB645	1-410-397-21	FERRITE	1.1 μ H	R613	1-260-124-11	CARBON	120K 5% 1/2W
FB647	1-410-397-21	FERRITE	1.1 μ H	R614	1-260-124-11	CARBON	120K 5% 1/2W
IC				R615	1-260-124-11	CARBON	120K 5% 1/2W
IC601	\triangle 8-729-045-41	TRANSISTOR MX0842B-F		R618	1-249-425-11	CARBON	4.7K 5% 1/4W
IC622	8-759-450-47	IC BA05T		R619	1-249-425-11	CARBON	4.7K 5% 1/4W
IC641	8-759-653-07	IC PQ09RD21		R621	1-249-429-11	CARBON	10K 5% 1/4W
IC643	8-749-012-13	IC DM-58		R622	1-249-433-11	CARBON	22K 5% 1/4W
IC650	8-759-394-35	IC BA12T		R623	\triangle 1-240-257-11	CMT-MELF	3.9 5% 20W
COIL				R624	\triangle 1-215-485-00	METAL	470K 1% 1/4W
L642	1-412-529-11	INDUCTOR	22 μ H	R625	\triangle 1-215-485-00	METAL	470K 1% 1/4W
L650	1-412-519-11	INDUCTOR	3.3 μ H	R626	1-249-425-11	CARBON	4.7K 5% 1/4W
L651	1-412-519-11	INDUCTOR	3.3 μ H	R627	1-249-405-11	CARBON	100 5% 1/4W
L652	1-412-519-11	INDUCTOR	3.3 μ H	R631	1-240-205-91	CARBON	22M 5% 1/2W
TRANSISTOR				R632	1-249-421-11	CARBON	2.2K 5% 1/4W
Q621	\triangle 8-729-044-30	TRANSISTOR 2SK2845-LB102		R633	1-249-429-11	CARBON	10K 5% 1/4W
Q622	8-729-423-33	TRANSISTOR 2SC3311A-QRSTA		R634	1-249-437-11	CARBON	47K 5% 1/4W
Q623	8-729-423-33	TRANSISTOR 2SC3311A-QRSTA		R635	1-247-791-91	CARBON	22 5% 1/4W
Q624	8-729-119-76	TRANSISTOR 2SA1309A-QRSTA		R636	1-249-415-11	CARBON	680 5% 1/4W
Q644	8-729-423-33	TRANSISTOR 2SC3311A-QRSTA		R637	1-260-302-51	CARBON	6.8 5% 1/2W
Q645	8-729-119-76	TRANSISTOR 2SA1309A-QRSTA		R638	1-249-413-11	CARBON	470 5% 1/4W
Q646	8-729-119-76	TRANSISTOR 2SA1309A-QRSTA		R639	\triangle 1-249-389-11	CARBON	4.7 5% 1/4W
Q647	8-729-423-33	TRANSISTOR 2SC3311A-QRSTA		R640	1-215-485-00	METAL	470K 1% 1/4W
Q648	8-729-922-39	TRANSISTOR 2SD2144S-TP-V		R641	1-247-843-11	CARBON	3.3K 5% 1/4W
Q649	8-729-119-76	TRANSISTOR 2SA1309A-QRSTA		R642	1-247-843-11	CARBON	3.3K 5% 1/4W
Q650	8-729-423-33	TRANSISTOR 2SC3311A-QRSTA		R643	1-260-298-51	CARBON	3.3 5% 1/2W
Q651	8-729-802-71	TRANSISTOR 2SA1407-E		R644	1-249-417-11	CARBON	1K 5% 1/4W
Q652	8-729-119-76	TRANSISTOR 2SA1309A-QRSTA		R645	1-249-429-11	CARBON	10K 5% 1/4W
				R646	1-249-417-11	CARBON	1K 5% 1/4W
				R648	1-249-441-11	CARBON	100K 5% 1/4W
				R649	1-249-425-11	CARBON	4.7K 5% 1/4W
				R650	1-249-421-11	CARBON	2.2K 5% 1/4W
				R652	\triangle 1-216-363-00	METAL OXIDE	0.33 5% 2W
				R653	1-215-423-00	METAL	1.2K 1% 1/4W

Note:

The components identified by shading and mark \triangle are critical for safety. Replace only with part number specified.

Note:

Les composants identifiés par un trame et une marque \triangle sont critiques pour la sécurité. Ne les remplacer que par une pièce portant le numéro spécifié.

G	HA	HB
---	----	----

REF.NO.	PART NO.	DESCRIPTION	REMARK	REF.NO.	PART NO.	DESCRIPTION	REMARK
R654	1-215-481-00	METAL	330K 1% 1/4W	C1239	1-216-295-91	SHORT	
R655	1-215-469-00	METAL	100K 1% 1/4W				
R656	1-249-427-11	CARBON	6.8K 5% 1/4W				
R657	1-249-421-11	CARBON	2.2K 5% 1/4W				
R659	1-249-429-11	CARBON	10K 5% 1/4W				
R660	1-249-393-11	CARBON	10 5% 1/4W				
R661	\triangle 1-249-419-11	CARBON	1.5K 5% 1/4W				
R662	1-215-485-00	METAL	470K 1% 1/4W				
R663	1-215-445-00	METAL	10K 1% 1/4W				
R664	\triangle 1-240-257-11	CMT-MELF	3.9 5% 20W				
R665	1-249-425-11	CARBON	4.7K 5% 1/4W				
R670	1-260-312-11	CARBON	47 5% 1/2W				
R671	1-260-312-11	CARBON	47 5% 1/2W				
R680	1-216-364-11	METAL OXIDE	0.39 5% 2W				
R681	1-216-365-00	METAL OXIDE	0.47 5% 2W				
R699	1-249-429-11	CARBON	10K 5% 1/4W				
RELAY							
RY600	\triangle 1-755-266-11	RELAY, AC POWER					
RY601	\triangle 1-755-198-11	RELAY					
TRANSFORMER							
T601	\triangle 1-426-717-11	TRANSFORMER, LINE FILTER (LFT)					
T602	\triangle 1-426-717-11	TRANSFORMER, LINE FILTER (LFT)					
T603	\triangle 1-429-992-11	TRANSFORMER, CONVERTER (PRT)					
T605	\triangle 1-433-408-11	TRANSFORMER, CONVERTER (PIT)					
T621	\triangle 1-431-852-11	TRANSFORMER, CONVERTER (SRT)					
THERMISTOR							
THP603	1-803-629-11	THERMISTOR, POSITIVE					
VARISTOR							
VDR601	1-801-074-41	VARISTOR ERZV10D271					
VDR602	\triangle 1-801-074-41	VARISTOR ERZV10D271					
CAPACITOR							
C1234	1-126-960-11	ELECT	1 μ F 20% 50V				
C1235	1-117-534-91	ELECT	1 μ F 20% 100V				
				CONNECTOR			
CN1232*	1-564-512-11	PLUG, CONNECTOR 9P					
				DIODE			
D1233	8-719-110-17	DIODE MTZJ-T-77-10B					
				JACK			
J1231	1-770-361-11	TERMINAL BLOCK, S					
				RESISTOR			
R201	1-216-049-91	RES-CHIP	1K 5% 1/10W				
R202	1-216-055-00	RES-CHIP	1.8K 5% 1/10W				
R203	1-216-065-91	RES-CHIP	4.7K 5% 1/10W				
R1233	1-216-065-91	RES-CHIP	4.7K 5% 1/10W				
R1235	1-216-065-91	RES-CHIP	4.7K 5% 1/10W				
R1236	1-216-113-00	RES-CHIP	470K 5% 1/10W				
R1237	1-216-065-91	RES-CHIP	4.7K 5% 1/10W				
R1238	1-216-113-00	RES-CHIP	470K 5% 1/10W				
				SWITCH			
S2007	1-572-198-11	SWITCH, KEYBOARD					
S2008	1-572-198-11	SWITCH, KEYBOARD					
S2009	1-572-198-11	SWITCH, KEYBOARD					
S2010	1-572-198-11	SWITCH, KEYBOARD					
				CAPACITOR			
C2001	1-104-665-11	ELECT	100 μ F 20% 25V				
C2002	1-164-096-11	CERAMIC	0.01 μ F 50V				
				CONNECTOR			
CN2001*	1-564-520-11	PLUG, CONNECTOR 5P					

HA

* A-1372-634-A HA MOUNTED PC BOARD (KV-36FV16/36FV26 ONLY)

HB

* A-1372-635-A HB MOUNTED PC BOARD (KV-36FV16/36FV26 ONLY)

HB HS HX**Note:**

The components identified by shading and mark \triangle are critical for safety. Replace only with part number specified.

Note:

Les composants identifiés par un trame et une marque \triangle sont critiques pour la sécurité. Ne les remplacer que par une pièce portant le numéro spécifié.

REF.NO.	PART NO.	DESCRIPTION	REMARK	REF.NO.	PART NO.	DESCRIPTION	REMARK
DIODE				RESISTOR			
D2002	8-719-057-09	DIODE LNJ801LPDJA		R201	1-249-417-11	CARBON	1K 5% 1/4W
D2003	8-719-057-09	DIODE LNJ801LPDJA		R202	1-249-420-11	CARBON	1.8K 5% 1/4W
IC				R203	1-249-425-11	CARBON	4.7K 5% 1/4W
IC2001	8-742-211-20	HYB IC SBX3071-71		R1235	1-249-425-11	CARBON	4.7K 5% 1/4W
RESISTOR				R1236	1-247-895-91	CARBON	470K 5% 1/4W
R2001	1-216-049-91	RES-CHIP	1K 5% 1/10W	R1237	1-249-425-11	CARBON	4.7K 5% 1/4W
R2002	1-216-049-91	RES-CHIP	1K 5% 1/10W	R1238	1-247-895-91	CARBON	470K 5% 1/4W
R2003	1-216-017-91	RES-CHIP	47 5% 1/10W	R2002	1-249-417-11	CARBON	1K 5% 1/4W
				R2003	1-249-401-11	CARBON	47 5% 1/4W
				SWITCH			
				S2007	1-762-816-11	SWITCH, TACTILE	
				S2008	1-762-816-11	SWITCH, TACTILE	
HS				HX			
* A-1372-822-A HS MOUNTED PC BOARD (KV-36FS12/36FS16 ONLY)				* A-1372-636-A HX MOUNTED PC BOARD			
CAPACITOR				CONNECTOR			
C1234	1-126-960-11	ELECT	1 μ F 20% 50V	CN2002*	1-564-518-11	PLUG, CONNECTOR 3P	
C1235	1-126-960-11	ELECT	1 μ F 20% 50V	RESISTOR			
C2001	1-104-665-11	ELECT	100 μ F 20% 25V	R2010	1-216-047-91	RES-CHIP	820 5% 1/10W
C2002	1-164-096-11	CERAMIC	0.01 μ F 50V	R2011	1-216-049-91	RES-CHIP	1K 5% 1/10W
CONNECTOR				R2012	1-216-055-00	RES-CHIP	1.8K 5% 1/10W
CN1232*	1-564-512-11	PLUG, CONNECTOR 9P		R2013	1-216-065-91	RES-CHIP	4.7K 5% 1/10W
CN2001*	1-564-508-11	PLUG, CONNECTOR 5P		R2014	1-216-025-91	RES-CHIP	100 5% 1/10W
DIODE				SWITCH			
D2002	8-719-070-80	DIODE LNK0120022G		S2001	1-572-198-11	SWITCH, KEYBOARD	
IC				S2002	1-572-198-11	SWITCH, KEYBOARD	
IC2001	8-742-212-20	HYB IC SBX3081-71		S2003	1-572-198-11	SWITCH, KEYBOARD	
JACK				S2004	1-572-198-11	SWITCH, KEYBOARD	
J1231	1-691-110-11	JACK, PIN 3P		S2005	1-572-198-11	SWITCH, KEYBOARD	
				S2006	1-572-198-11	SWITCH, KEYBOARD	

Note:

The components identified by shading and mark \triangle are critical for safety. Replace only with part number specified.

Note:

Les composants identifiés par un trame et une marque \triangle sont critiques pour la sécurité. Ne les remplacer que par une pièce portant le numéro spécifié.

T

REF.NO.	PART NO.	DESCRIPTION	REMARK	REF.NO.	PART NO.	DESCRIPTION	REMARK
T				D409	8-719-992-13	DIODE DAL5815	
				D410	8-719-992-13	DIODE DAL5815	
				D411	8-719-992-13	DIODE DAL5815	
				IC			
				IC401	8-759-939-73	IC BA3308	
				COIL			
				L401	1-411-987-11	COIL (OSC)	
				L402	1-411-988-11	COIL (OSC)	
				TRANSISTOR			
				Q401	8-729-266-83	TRANSISTOR 2SC2668-YTP	
				Q402	8-729-266-83	TRANSISTOR 2SC2668-YTP	
				Q403	8-729-423-33	TRANSISTOR 2SC3311A-QRSTA	
				Q404	8-729-216-22	TRANSISTOR 2SB709A-QRS-TX	
				Q405	8-729-216-22	TRANSISTOR 2SB709A-QRS-TX	
				Q406	8-729-931-14	TRANSISTOR 2SD1858-Q-TV2	
				Q407	8-729-931-14	TRANSISTOR 2SD1858-Q-TV2	
				Q408	8-729-931-14	TRANSISTOR 2SD1858-Q-TV2	
				Q409	8-729-931-14	TRANSISTOR 2SD1858-Q-TV2	
				Q410	8-729-216-22	TRANSISTOR 2SB709A-QRS-TX	
				Q411	8-729-216-22	TRANSISTOR 2SB709A-QRS-TX	
				RESISTOR			
				R401	1-216-089-91	RES-CHIP	47K 5% 1/10W
				R402	1-216-089-91	RES-CHIP	47K 5% 1/10W
				R403	1-216-089-91	RES-CHIP	47K 5% 1/10W
				R404	1-216-053-00	RES-CHIP	1.5K 5% 1/10W
				R405	1-216-025-91	RES-CHIP	100 5% 1/10W
				R406	1-216-053-00	RES-CHIP	1.5K 5% 1/10W
				R407	1-216-133-00	RES-CHIP	3.3M 5% 1/10W
				R408	1-216-089-91	RES-CHIP	47K 5% 1/10W
				R409	1-216-053-00	RES-CHIP	1.5K 5% 1/10W
				R410	1-216-053-00	RES-CHIP	1.5K 5% 1/10W
				R411	1-216-025-91	RES-CHIP	100 5% 1/10W
				R412	1-208-803-11	METAL CHIP	7.5K 0.50% 1/10W
				R413	1-216-065-91	RES-CHIP	4.7K 5% 1/10W
				R414	1-216-073-00	RES-CHIP	10K 5% 1/10W
				R415	1-249-411-11	CARBON	330 5% 1/4W
				R416	1-216-081-00	RES-CHIP	22K 5% 1/10W
				R417	1-216-081-00	RES-CHIP	22K 5% 1/10W
				R418	1-216-065-91	RES-CHIP	4.7K 5% 1/10W
				R419	1-216-073-00	RES-CHIP	10K 5% 1/10W
				R420	1-216-111-00	RES-CHIP	390K 5% 1/10W
				R421	1-216-025-91	RES-CHIP	100 5% 1/10W
				R422	1-216-025-91	RES-CHIP	100 5% 1/10W
				CONNECTOR			
CN401 *	1-564-519-11	PLUG, CONNECTOR 4P					
				DIODE			
D401	8-719-109-89	DIODE MTZJ-T-77-5.6C					
D402	8-719-057-93	DIODE SVC203SPA-AL					
D403	8-719-057-93	DIODE SVC203SPA-AL					
D404	8-719-992-13	DIODE DAL5815					
D405	8-719-992-13	DIODE DAL5815					
D406	8-719-992-13	DIODE DAL5815					
D407	8-719-992-13	DIODE DAL5815					
D408	8-719-992-13	DIODE DAL5815					



Note:

The components identified by shading and mark \triangle are critical for safety. Replace only with part number specified.

Note:

Les composants identifiés par un trame et une marque \triangle sont critiques pour la sécurité. Ne les remplacer que par une pièce portant le numéro spécifié.

REF.NO.	PART NO.	DESCRIPTION	REMARK	REF.NO.	PART NO.	DESCRIPTION	REMARK
R423	1-216-111-00	RES-CHIP	390K 5% 1/10W	C268	1-163-021-91	CERAMIC CHIP	0.01 μ F 10% 50V
R424	1-216-053-00	RES-CHIP	1.5K 5% 1/10W	C269	1-163-021-91	CERAMIC CHIP	0.01 μ F 10% 50V
R425	1-216-061-00	RES-CHIP	3.3K 5% 1/10W	C272	1-163-231-11	CERAMIC CHIP	15PF 5% 50V
R426	1-208-821-11	METAL CHIP	43K 0.50% 1/10W	C273	1-128-551-11	ELECT	22 μ F 20% 25V
R427	1-216-061-00	RES-CHIP	3.3K 5% 1/10W	C277	1-128-551-11	ELECT	22 μ F 20% 25V
R428	1-216-057-00	RES-CHIP	2.2K 5% 1/10W	C278	1-128-551-11	ELECT	22 μ F 20% 25V
R429	1-216-057-00	RES-CHIP	2.2K 5% 1/10W	C281	1-126-933-11	ELECT	100 μ F 20% 16V
R430	1-208-790-11	METAL CHIP	2.2K 0.50% 1/10W	C284	1-126-941-11	ELECT	470 μ F 20% 25V
R431	1-208-790-11	METAL CHIP	2.2K 0.50% 1/10W	C286	1-164-161-11	CERAMIC CHIP	0.0022 μ F 10% 50V
R432	1-208-821-11	METAL CHIP	43K 0.50% 1/10W	C287	1-164-161-11	CERAMIC CHIP	0.0022 μ F 10% 50V
R433	1-216-059-00	RES-CHIP	2.7K 5% 1/10W	C1051	1-126-964-11	ELECT	10 μ F 20% 50V
R434	1-216-059-00	RES-CHIP	2.7K 5% 1/10W	C1053	1-126-934-11	ELECT	220 μ F 20% 16V
R435	1-216-001-00	RES-CHIP	10 5% 1/10W	C1201	1-163-809-11	CERAMIC CHIP	0.047 μ F 10% 25V
R436	1-216-001-00	RES-CHIP	10 5% 1/10W	C1202	1-163-021-91	CERAMIC CHIP	0.01 μ F 10% 50V
R437	1-216-001-00	RES-CHIP	10 5% 1/10W	C1203	1-126-960-11	ELECT	1 μ F 20% 50V
R438	1-216-001-00	RES-CHIP	10 5% 1/10W	C1204	1-163-809-11	CERAMIC CHIP	0.047 μ F 10% 25V
R439	1-216-059-00	RES-CHIP	2.7K 5% 1/10W	C1205	1-126-933-11	ELECT	100 μ F 20% 16V
R460	1-216-059-00	RES-CHIP	2.7K 5% 1/10W	C1207	1-126-963-11	ELECT	4.7 μ F 20% 50V
				C1208	1-126-963-11	ELECT	4.7 μ F 20% 50V
				C1209	1-163-259-91	CERAMIC CHIP	220PF 5% 50V
				C1210	1-163-259-91	CERAMIC CHIP	220PF 5% 50V
				C1211	1-126-933-11	ELECT	100 μ F 20% 16V
				C1212	1-126-933-11	ELECT	100 μ F 20% 16V
				C1214	1-163-021-91	CERAMIC CHIP	0.01 μ F 10% 50V
				C1215	1-126-960-11	ELECT	1 μ F 20% 50V
				C1997	1-163-031-11	CERAMIC CHIP	0.01 μ F 50V
				C1998	1-104-664-11	ELECT	47 μ F 20% 16V
				C1999	1-163-031-11	CERAMIC CHIP	0.01 μ F 50V
				C2000	1-163-031-11	CERAMIC CHIP	0.01 μ F 50V
				C2001	1-163-235-11	CERAMIC CHIP	22PF 5% 50V
						(KV-36FV26 ONLY)	
				C2002	1-126-933-11	ELECT	100 μ F 20% 16V
				C2003	1-163-031-11	CERAMIC CHIP	0.01 μ F 50V
				C2004	1-163-235-11	CERAMIC CHIP	22PF 5% 50V
						(KV-36FV26 ONLY)	
				C2005	1-163-131-00	CERAMIC CHIP	390PF 5% 50V
				C2006	1-163-038-91	CERAMIC CHIP	0.1 μ F 25V
				C2007	1-126-926-11	ELECT	1000 μ F 20% 10V
						(KV-36FV26 ONLY)	
				C2008	1-163-038-91	CERAMIC CHIP	0.1 μ F 25V
						(KV-36FV26 ONLY)	
				C2009	1-163-102-00	CERAMIC CHIP	24PF 5% 50V
				C2011	1-126-967-11	ELECT	47 μ F 20% 50V
				C2013	1-163-038-91	CERAMIC CHIP	0.1 μ F 25V
						(KV-36FV26 ONLY)	
				C2014	1-163-009-11	CERAMIC CHIP	0.001 μ F 10% 50V
						(KV-36FV26 ONLY)	
				C2015	1-216-295-91	SHORT	
				C2016	1-165-319-11	CERAMIC CHIP	0.1 μ F 50V
				C2017	1-163-102-00	CERAMIC CHIP	24PF 5% 50V
				C2018	1-165-319-11	CERAMIC CHIP	0.1 μ F 50V



- * A-1395-003-A UX COMPLETE PC BOARD (KV-36FV16 ONLY)
- * A-1395-004-A UX COMPLETE PC BOARD (KV-36FV26 ONLY)

CAPACITOR

C201	1-128-551-11	ELECT	22 μ F 20% 25V
C202	1-128-551-11	ELECT	22 μ F 20% 25V
C203	1-128-551-11	ELECT	22 μ F 20% 25V
C204	1-126-960-11	ELECT	1 μ F 20% 50V
C205	1-126-960-11	ELECT	1 μ F 20% 50V
C231	1-163-021-91	CERAMIC CHIP	0.01 μ F 10% 50V
C232	1-126-933-11	ELECT	100 μ F 20% 16V
C233	1-126-933-11	ELECT	100 μ F 20% 16V
C234	1-126-960-11	ELECT	1 μ F 20% 50V
C235	1-126-960-11	ELECT	1 μ F 20% 50V
C236	1-126-933-11	ELECT	100 μ F 20% 16V
C237	1-126-960-11	ELECT	1 μ F 20% 50V
C238	1-126-960-11	ELECT	1 μ F 20% 50V
C241	1-126-941-11	ELECT	470 μ F 20% 25V
C242	1-126-959-11	ELECT	0.47 μ F 20% 50V
C243	1-126-959-11	ELECT	0.47 μ F 20% 50V
C244	1-126-959-11	ELECT	0.47 μ F 20% 50V
C245	1-126-959-11	ELECT	0.47 μ F 20% 50V
C264	1-164-004-11	CERAMIC CHIP	0.1 μ F 10% 25V

Note:

The components identified by shading and mark \triangle are critical for safety. Replace only with part number specified.

Note:

Les composants identifiés par un trame et une marque \triangle sont critiques pour la sécurité. Ne les remplacer que par une pièce portant le numéro spécifié.



REF.NO.	PART NO.	DESCRIPTION	REMARK	REF.NO.	PART NO.	DESCRIPTION	REMARK
C2019	1-126-960-11	ELECT (KV-36FV26 ONLY)	1 μ F 20% 50V	C2069	1-163-031-11	CERAMIC CHIP	0.01 μ F 50V
C2020	1-165-319-11	CERAMIC CHIP	0.1 μ F 50V	C2070	1-104-664-11	ELECT	47 μ F 20% 16V
C2021	1-163-038-91	CERAMIC CHIP	0.1 μ F 25V	C2071	1-165-319-11	CERAMIC CHIP	0.1 μ F 50V
C2022	1-163-031-11	CERAMIC CHIP	0.01 μ F 50V	C2072	1-126-933-11	ELECT (KV-36FV26 ONLY)	100 μ F 20% 16V
C2023	1-126-967-11	ELECT	47 μ F 20% 50V	C2073	1-163-275-11	CERAMIC CHIP	0.001 μ F 5% 50V
C2024	1-216-295-91	SHORT		C2074	1-163-275-11	CERAMIC CHIP (KV-36FV26 ONLY)	0.001 μ F 5% 50V
C2025	1-163-031-11	CERAMIC CHIP	0.01 μ F 50V	C2090	1-126-964-11	ELECT	10 μ F 20% 50V
C2026	1-126-967-11	ELECT	47 μ F 20% 50V	C2095	1-163-231-11	CERAMIC CHIP	15PF 5% 50V
C2027	1-163-031-11	CERAMIC CHIP	0.01 μ F 50V	C2096	1-163-231-11	CERAMIC CHIP	15PF 5% 50V
C2028	1-126-941-11	ELECT	470 μ F 20% 25V	C2097	1-163-231-11	CERAMIC CHIP	15PF 5% 50V
C2029	1-165-319-11	CERAMIC CHIP	0.1 μ F 50V	C2129	1-165-319-11	CERAMIC CHIP	0.1 μ F 50V
C2030	1-165-319-11	CERAMIC CHIP	0.1 μ F 50V	C2137	1-165-319-11	CERAMIC CHIP	0.1 μ F 50V
C2031	1-165-319-11	CERAMIC CHIP	0.1 μ F 50V	C2201	1-126-965-11	ELECT	22 μ F 20% 50V
C2032	1-165-319-11	CERAMIC CHIP	0.1 μ F 50V	C2202	1-126-933-11	ELECT	100 μ F 20% 16V
C2033	1-165-319-11	CERAMIC CHIP	0.1 μ F 50V	C2203	1-163-021-91	CERAMIC CHIP	0.01 μ F 10% 50V
C2034	1-165-319-11	CERAMIC CHIP	0.1 μ F 50V	C3301	1-104-664-11	ELECT	47 μ F 20% 25V
C2035	1-165-319-11	CERAMIC CHIP	0.1 μ F 50V	C3302	1-163-031-11	CERAMIC CHIP	0.01 μ F 50V
C2036	1-165-319-11	CERAMIC CHIP	0.1 μ F 50V	C3303	1-126-961-11	ELECT	2.2 μ F 20% 50V
C2037	1-104-664-11	ELECT	47 μ F 20% 16V	C3304	1-163-038-91	CERAMIC CHIP	0.1 μ F 25V
C2038	1-165-319-11	CERAMIC CHIP	0.1 μ F 50V	C3305	1-126-961-11	ELECT	2.2 μ F 20% 50V
C2039	1-165-319-11	CERAMIC CHIP	0.1 μ F 50V	C3306	1-163-038-91	CERAMIC CHIP	0.1 μ F 25V
C2040	1-165-319-11	CERAMIC CHIP	0.1 μ F 50V	C3307	1-126-964-11	ELECT	10 μ F 20% 50V
C2041	1-126-940-11	ELECT	330 μ F 20% 25V	C3308	1-163-038-91	CERAMIC CHIP	0.1 μ F 25V
C2042	1-165-319-11	CERAMIC CHIP	0.1 μ F 50V	C3309	1-126-964-11	ELECT	10 μ F 20% 50V
C2044	1-104-664-11	ELECT	47 μ F 20% 16V	C3311	1-163-038-91	CERAMIC CHIP	0.1 μ F 25V
C2045	1-163-233-11	CERAMIC CHIP	18PF 5% 50V	C3312	1-126-964-11	ELECT	10 μ F 20% 50V
C2046	1-126-964-11	ELECT	10 μ F 20% 50V	C3313	1-163-038-91	CERAMIC CHIP	0.1 μ F 25V
C2047	1-164-505-11	CERAMIC CHIP	2.2 μ F 16V	C3314	1-216-295-91	SHORT	
C2048	1-126-964-11	ELECT	10 μ F 20% 50V	C3315	1-216-295-91	SHORT	
C2049	1-126-960-11	ELECT	1 μ F 20% 50V	C3316	1-216-295-91	SHORT	
C2050	1-163-231-11	CERAMIC CHIP	15PF 5% 50V	C3317	1-104-666-11	ELECT	220 μ F 20% 25V
C2051	1-126-964-11	ELECT (KV-36FV26 ONLY)	10 μ F 20% 50V	C3318	1-163-038-91	CERAMIC CHIP	0.1 μ F 25V
C2052	1-163-133-00	CERAMIC CHIP	470PF 5% 50V	C3319	1-163-031-11	CERAMIC CHIP	0.01 μ F 50V
C2053	1-126-960-11	ELECT	1 μ F 20% 50V	C3320	1-104-664-11	ELECT	47 μ F 20% 16V
C2054	1-104-664-11	ELECT	47 μ F 20% 16V	C3321	1-163-237-11	CERAMIC CHIP	27PF 5% 50V
C2055	1-165-319-11	CERAMIC CHIP	0.1 μ F 50V	C3322	1-163-237-11	CERAMIC CHIP	27PF 5% 50V
C2056	1-163-231-11	CERAMIC CHIP	15PF 5% 50V	C3323	1-163-038-91	CERAMIC CHIP	0.1 μ F 25V
C2057	1-163-031-11	CERAMIC CHIP	0.01 μ F 50V	C3325	1-104-664-11	ELECT	47 μ F 20% 16V
C2060	1-163-031-11	CERAMIC CHIP	0.01 μ F 50V	C3327	1-126-941-11	ELECT	470 μ F 20% 25V
C2061	1-126-941-11	ELECT	470 μ F 20% 25V	C3328	1-126-941-11	ELECT	470 μ F 20% 25V
C2062	1-104-664-11	ELECT	47 μ F 20% 16V	C3329	1-104-664-11	ELECT	47 μ F 20% 16V
C2063	1-165-319-11	CERAMIC CHIP	0.1 μ F 50V	C3349	1-163-123-00	CERAMIC CHIP	180PF 5% 50V
C2064	1-163-031-11	CERAMIC CHIP	0.01 μ F 50V	C3350	1-164-004-11	CERAMIC CHIP	0.1 μ F 10% 25V
C2065	1-163-031-11	CERAMIC CHIP	0.01 μ F 50V	C3354	1-163-031-11	CERAMIC CHIP	0.01 μ F 50V
C2066	1-104-664-11	ELECT	47 μ F 20% 16V	C3357	1-163-031-11	CERAMIC CHIP	0.01 μ F 50V
C2067	1-104-664-11	ELECT	47 μ F 20% 16V	C3358	1-163-031-11	CERAMIC CHIP	0.01 μ F 50V
C2068	1-104-664-11	ELECT	47 μ F 20% 16V	C3368	1-216-295-91	SHORT	

**Note:**

The components identified by shading and mark \triangle are critical for safety. Replace only with part number specified.

Note:

Les composants identifiés par un trame et une marque \triangle sont critiques pour la sécurité. Ne les remplacer que par une pièce portant le numéro spécifié.

REF.NO.	PART NO.	DESCRIPTION	REMARK	REF.NO.	PART NO.	DESCRIPTION	REMARK
C3369	1-163-031-11	CERAMIC CHIP	0.01 μ F 50V	FB3302	1-414-230-22	INDUCTOR CHIP	0 μ H
C3370	1-163-031-11	CERAMIC CHIP	0.01 μ F 50V	FB3303	1-414-230-22	INDUCTOR CHIP	0 μ H
C3371	1-163-031-11	CERAMIC CHIP	0.01 μ F 50V	FB3304	1-414-230-22	INDUCTOR CHIP	0 μ H
				FB3305	1-414-230-22	INDUCTOR CHIP	0 μ H
CONNECTOR				FILTER			
CN261 *	1-564-510-11	PLUG, CONNECTOR 7P		FL2001	1-239-848-21	FILTER, LOW PASS	
CN265 *	1-764-333-11	PLUG, CONNECTOR 10P		FL2002	1-239-848-21	FILTER, LOW PASS	
DIODE				IC			
D201	8-719-032-47	DIODE MTZJ-T-9110		IC261	8-752-066-69	IC CXA1845Q	
D202	8-719-032-47	DIODE MTZJ-T-9110		IC1051	8-752-058-68	IC CXA1315M-T4	
D203	8-719-032-47	DIODE MTZJ-T-9110		IC2003	8-759-568-27	IC UPD424210LE-60-E2	
D204	8-719-032-47	DIODE MTZJ-T-9110		IC2004	8-759-594-44	IC UPD64082GF-3BA	
D205	8-719-032-47	DIODE MTZJ-T-9110		IC2005	8-759-583-47	IC UPC2933T-E1	
D231	8-719-032-47	DIODE MTZJ-T-9110		IC2006	8-759-358-38	IC NJM78M05DLA(TE1)	
D232	8-719-032-47	DIODE MTZJ-T-9110		IC2009	8-752-395-13	IC CXD2085M-T4 (KV-36FV26 ONLY)	
D233	8-719-032-47	DIODE MTZJ-T-9110		IC3302	8-759-358-38	IC NJM78M05DLA(TE1)	
D234	8-719-032-47	DIODE MTZJ-T-9110		IC3303	8-759-658-34	IC SDA9588X	
D235	8-719-032-47	DIODE MTZJ-T-9110		IC3308	8-759-932-69	IC BU4053BCF-T2	
D236	8-719-032-47	DIODE MTZJ-T-9110		IC3310	8-759-583-47	IC UPC2933T-E1	
D237	8-719-032-47	DIODE MTZJ-T-9110		JACK			
D238	8-719-032-47	DIODE MTZJ-T-9110		J231	1-750-515-11	TERMINAL BLOCK, S 3P	
D239	8-719-032-47	DIODE MTZJ-T-9110		J232	1-750-517-11	JACK BLOCK, PIN 3P	
D245	8-719-157-94	DIODE RD3.3SB-T1		J233	1-750-516-11	JACK BLOCK, PIN 2P	
D246	8-719-157-94	DIODE RD3.3SB-T1		J234	1-750-517-11	JACK BLOCK, PIN 3P	
D248	8-719-157-94	DIODE RD3.3SB-T1		J236	1-774-358-11	JACK BLOCK, PIN	
D261	8-719-032-47	DIODE MTZJ-T-9110		J902	1-764-143-11	JACK	
D902	8-719-032-47	DIODE MTZJ-T-9110		J903	1-764-143-11	JACK	
D910	8-719-032-47	DIODE MTZJ-T-9110		J904	1-764-143-11	JACK	
D911	8-719-032-47	DIODE MTZJ-T-9110		J905	1-764-143-11	JACK	
D912	8-719-032-47	DIODE MTZJ-T-9110		CHIP CONDUCTOR			
D1051	8-719-073-01	DIODE MA111-TX		JR1001	1-216-295-91	SHORT	
D1052	8-719-073-01	DIODE MA111-TX		JR1002	1-216-295-91	SHORT	
D1053	1-216-295-91	SHORT		JR1003	1-216-295-91	SHORT	
D1054	1-216-295-91	SHORT		JR1004	1-216-295-91	SHORT	
D2201	8-719-032-47	DIODE MTZJ-T-9110		JR1021	1-216-295-91	SHORT	
D2202	8-719-032-47	DIODE MTZJ-T-9110		JR1022	1-216-295-91	SHORT	
D2203	8-719-032-47	DIODE MTZJ-T-9110		JR1023	1-216-295-91	SHORT	
FERRITE BEAD				JR2009	1-216-295-91	SHORT	
FB2003	1-414-233-22	INDUCTOR CHIP	0 μ H	JR2010	1-216-295-91	SHORT	
FB2004	1-414-230-22	INDUCTOR CHIP	0 μ H	JR2011	1-216-295-91	SHORT	
FB2006	1-414-230-22	INDUCTOR CHIP	0 μ H	JR2012	1-216-295-91	SHORT	
FB2007	1-414-230-22	INDUCTOR CHIP	0 μ H				
FB2008	1-414-230-22	INDUCTOR CHIP	0 μ H				
FB2009	1-414-233-22	INDUCTOR CHIP	0 μ H				
FB3301	1-216-295-91	SHORT					

Note:

The components identified by shading and mark \triangle are critical for safety. Replace only with part number specified.

Note:

Les composants identifiés par un trame et une marque \triangle sont critiques pour la sécurité. Ne les remplacer que par une pièce portant le numéro spécifié.



REF.NO.	PART NO.	DESCRIPTION	REMARK	REF.NO.	PART NO.	DESCRIPTION	REMARK
JR2013	1-216-295-91	SHORT		Q263	8-729-216-22	TRANSISTOR 2SB709A-QRS-TX	
JR2014	1-216-295-91	SHORT		Q264	8-729-216-22	TRANSISTOR 2SB709A-QRS-TX	
JR3014	1-216-295-91	SHORT		Q265	8-729-422-27	TRANSISTOR 2SD601A-QRS-TX	
COIL				Q268	8-729-216-22	TRANSISTOR 2SB709A-QRS-TX	
L261	1-414-857-11	INDUCTOR	100 μ H	Q1051	8-729-216-22	TRANSISTOR 2SB709A-QRS-TX	
L1201	1-408-591-11	INDUCTOR	1 μ H	Q1201	8-729-216-22	TRANSISTOR 2SB709A-QRS-TX	
L1202	1-408-591-11	INDUCTOR	1 μ H	Q1202	8-729-422-27	TRANSISTOR 2SD601A-QRS-TX	
L1203	1-408-591-11	INDUCTOR	1 μ H	Q1203	8-729-422-27	TRANSISTOR 2SD601A-QRS-TX	
L2001	1-412-056-11	INDUCTOR CHIP	4.7 μ H	Q1204	8-729-216-22	TRANSISTOR 2SB709A-QRS-TX	
L2002	1-412-058-11	INDUCTOR CHIP	10 μ H	Q1205	8-729-422-27	TRANSISTOR 2SD601A-QRS-TX	
L2004	1-412-058-11	INDUCTOR CHIP	10 μ H	Q1206	8-729-422-27	TRANSISTOR 2SD601A-QRS-TX	
L2005	1-410-494-11	INDUCTOR	1mH	Q1207	8-729-216-22	TRANSISTOR 2SB709A-QRS-TX	
L2006	1-412-058-11	INDUCTOR CHIP	10 μ H	Q1208	8-729-216-22	TRANSISTOR 2SB709A-QRS-TX	
L2011	1-410-116-11	INDUCTOR (KV-36FV26 ONLY)	560 μ H	Q2001	8-729-422-27	TRANSISTOR 2SD601A-QRS-TX (KV-36FV26 ONLY)	
L2012	1-410-116-11	INDUCTOR	560 μ H	Q2003	8-729-216-22	TRANSISTOR 2SB709A-QRS-TX	
L3301	1-414-856-11	INDUCTOR	10 μ H	Q2004	8-729-216-22	TRANSISTOR 2SB709A-QRS-TX	
L3302	1-410-473-11	INDUCTOR	18 μ H	Q2005	8-729-422-27	TRANSISTOR 2SD601A-QRS-TX	
L3303	1-410-476-11	INDUCTOR	33 μ H	Q2006	8-729-422-27	TRANSISTOR 2SD601A-QRS-TX	
L3304	1-414-856-11	INDUCTOR	10 μ H	Q2007	8-729-422-27	TRANSISTOR 2SD601A-QRS-TX	
L3305	1-414-856-11	INDUCTOR	10 μ H	Q2008	8-729-422-27	TRANSISTOR 2SD601A-QRS-TX	
L3306	1-414-856-11	INDUCTOR	10 μ H	Q2009	8-729-422-27	TRANSISTOR 2SD601A-QRS-TX	
L3307	1-414-856-11	INDUCTOR	10 μ H	Q2010	8-729-422-27	TRANSISTOR 2SD601A-QRS-TX	
L3308	1-414-856-11	INDUCTOR	10 μ H	Q2011	8-729-422-27	TRANSISTOR 2SD601A-QRS-TX	
TRANSISTOR				Q2012	8-729-216-22	TRANSISTOR 2SB709A-QRS-TX	
Q201	8-729-422-27	TRANSISTOR 2SD601A-QRS-TX		Q2013	8-729-216-22	TRANSISTOR 2SB709A-QRS-TX	
Q202	8-729-422-27	TRANSISTOR 2SD601A-QRS-TX		Q2014	8-729-422-27	TRANSISTOR 2SD601A-QRS-TX	
Q203	8-729-422-27	TRANSISTOR 2SD601A-QRS-TX		Q2015	8-729-422-27	TRANSISTOR 2SD601A-QRS-TX	
Q204	8-729-216-22	TRANSISTOR 2SB709A-QRS-TX		Q2016	8-729-422-27	TRANSISTOR 2SD601A-QRS-TX	
Q205	8-729-216-22	TRANSISTOR 2SB709A-QRS-TX		Q2017	8-729-422-27	TRANSISTOR 2SD601A-QRS-TX (KV-36FV26 ONLY)	
Q206	8-729-216-22	TRANSISTOR 2SB709A-QRS-TX		Q2018	8-729-216-22	TRANSISTOR 2SB709A-QRS-TX	
Q207	8-729-422-27	TRANSISTOR 2SD601A-QRS-TX		Q2019	8-729-422-27	TRANSISTOR 2SD601A-QRS-TX	
Q208	8-729-422-27	TRANSISTOR 2SD601A-QRS-TX		Q2119	8-729-216-22	TRANSISTOR 2SB709A-QRS-TX	
Q209	8-729-422-27	TRANSISTOR 2SD601A-QRS-TX		Q3301	8-729-422-27	TRANSISTOR 2SD601A-QRS-TX	
Q210	8-729-422-27	TRANSISTOR 2SD601A-QRS-TX		Q3306	8-729-216-22	TRANSISTOR 2SB709A-QRS-TX	
Q211	8-729-422-27	TRANSISTOR 2SD601A-QRS-TX		Q3307	8-729-216-22	TRANSISTOR 2SB709A-QRS-TX	
Q231	8-729-422-27	TRANSISTOR 2SD601A-QRS-TX		Q3312	8-729-216-22	TRANSISTOR 2SB709A-QRS-TX	
Q233	8-729-422-27	TRANSISTOR 2SD601A-QRS-TX		Q3315	8-729-216-22	TRANSISTOR 2SB709A-QRS-TX	
Q234	8-729-422-27	TRANSISTOR 2SD601A-QRS-TX		Q3316	8-729-216-22	TRANSISTOR 2SB709A-QRS-TX	
Q235	8-729-422-27	TRANSISTOR 2SD601A-QRS-TX		Q3317	8-729-422-27	TRANSISTOR 2SD601A-QRS-TX	
Q236	8-729-422-27	TRANSISTOR 2SD601A-QRS-TX		RESISTOR			
Q237	8-729-216-22	TRANSISTOR 2SB709A-QRS-TX		R201	1-216-022-00	RES-CHIP	75 5% 1/10W
Q238	8-729-216-22	TRANSISTOR 2SB709A-QRS-TX		R202	1-216-022-00	RES-CHIP	75 5% 1/10W
Q239	8-729-216-22	TRANSISTOR 2SB709A-QRS-TX		R203	1-216-022-00	RES-CHIP	75 5% 1/10W
Q246	8-729-422-27	TRANSISTOR 2SD601A-QRS-TX		R204	1-216-113-00	RES-CHIP	470K 5% 1/10W
Q262	8-729-216-22	TRANSISTOR 2SB709A-QRS-TX		R205	1-216-113-00	RES-CHIP	470K 5% 1/10W
				R206	1-216-295-91	SHORT	



Note:

The components identified by shading and mark \triangle are critical for safety. Replace only with part number specified.

Note:

Les composants identifiés par un trame et une marque \triangle sont critiques pour la sécurité. Ne les remplacer que par une pièce portant le numéro spécifié.

REF.NO.	PART NO.	DESCRIPTION	REMARK			REF.NO.	PART NO.	DESCRIPTION	REMARK		
R207	1-216-295-91	SHORT				R261	1-216-025-91	RES-CHIP	100	5%	1/10W
R208	1-216-295-91	SHORT				R262	1-216-067-00	RES-CHIP	5.6K	5%	1/10W
R209	1-216-089-91	RES-CHIP	47K	5%	1/10W	R263	1-216-025-91	RES-CHIP	100	5%	1/10W
R210	1-216-081-00	RES-CHIP	22K	5%	1/10W	R264	1-216-067-00	RES-CHIP	5.6K	5%	1/10W
R211	1-216-089-91	RES-CHIP	47K	5%	1/10W	R265	1-216-025-91	RES-CHIP	100	5%	1/10W
R212	1-216-081-00	RES-CHIP	22K	5%	1/10W	R266	1-216-025-91	RES-CHIP	100	5%	1/10W
R213	1-216-089-91	RES-CHIP	47K	5%	1/10W	R267	1-216-025-91	RES-CHIP	100	5%	1/10W
R214	1-216-081-00	RES-CHIP	22K	5%	1/10W	R268	1-216-067-00	RES-CHIP	5.6K	5%	1/10W
R215	1-216-049-91	RES-CHIP	1K	5%	1/10W	R269	1-216-067-00	RES-CHIP	5.6K	5%	1/10W
R216	1-216-025-91	RES-CHIP	100	5%	1/10W	R270	1-216-049-91	RES-CHIP	1K	5%	1/10W
R218	1-208-774-11	METAL CHIP	470	0.50%	1/10W	R271	1-216-067-00	RES-CHIP	5.6K	5%	1/10W
R219	1-216-049-91	RES-CHIP	1K	5%	1/10W	R272	1-216-025-91	RES-CHIP	100	5%	1/10W
R220	1-216-025-91	RES-CHIP	100	5%	1/10W	R273	1-216-067-00	RES-CHIP	5.6K	5%	1/10W
R221	1-208-774-11	METAL CHIP	470	0.50%	1/10W	R274	1-216-049-91	RES-CHIP	1K	5%	1/10W
R222	1-216-049-91	RES-CHIP	1K	5%	1/10W	R275	1-216-025-91	RES-CHIP	100	5%	1/10W
R223	1-216-025-91	RES-CHIP	100	5%	1/10W	R276	1-216-295-91	SHORT			
R224	1-216-025-91	RES-CHIP	100	5%	1/10W	R278	1-216-067-00	RES-CHIP	5.6K	5%	1/10W
R225	1-216-025-91	RES-CHIP	100	5%	1/10W	R279	1-216-025-91	RES-CHIP	100	5%	1/10W
R226	1-216-025-91	RES-CHIP	100	5%	1/10W	R280	1-216-067-00	RES-CHIP	5.6K	5%	1/10W
R227	1-216-041-00	RES-CHIP	470	5%	1/10W	R281	1-216-025-91	RES-CHIP	100	5%	1/10W
R228	1-216-049-91	RES-CHIP	1K	5%	1/10W	R282	1-216-025-91	RES-CHIP	100	5%	1/10W
R229	1-216-049-91	RES-CHIP	1K	5%	1/10W	R283	1-216-049-91	RES-CHIP	1K	5%	1/10W
R230	1-216-089-91	RES-CHIP	47K	5%	1/10W	R284	1-216-033-00	RES-CHIP	220	5%	1/10W
R231	1-216-022-00	RES-CHIP	75	5%	1/10W	R285	1-216-033-00	RES-CHIP	220	5%	1/10W
R232	1-216-022-00	RES-CHIP	75	5%	1/10W	R286	1-216-067-00	RES-CHIP	5.6K	5%	1/10W
R233	1-216-065-91	RES-CHIP	4.7K	5%	1/10W	R287	1-216-025-91	RES-CHIP	100	5%	1/10W
R234	1-216-022-00	RES-CHIP	75	5%	1/10W	R288	1-216-067-00	RES-CHIP	5.6K	5%	1/10W
R235	1-216-113-00	RES-CHIP	470K	5%	1/10W	R289	1-216-067-00	RES-CHIP	5.6K	5%	1/10W
R236	1-216-113-00	RES-CHIP	470K	5%	1/10W	R290	1-216-025-91	RES-CHIP	100	5%	1/10W
R237	1-216-022-00	RES-CHIP	75	5%	1/10W	R291	1-216-067-00	RES-CHIP	5.6K	5%	1/10W
R238	1-216-113-00	RES-CHIP	470K	5%	1/10W	R293	1-216-025-91	RES-CHIP	100	5%	1/10W
R239	1-216-113-00	RES-CHIP	470K	5%	1/10W	R294	1-216-077-91	RES-CHIP	15K	5%	1/10W
R241	1-216-113-00	RES-CHIP	470K	5%	1/10W	R295	1-216-025-91	RES-CHIP	100	5%	1/10W
R242	1-216-049-91	RES-CHIP	1K	5%	1/10W	R296	1-216-025-91	RES-CHIP	100	5%	1/10W
R243	1-216-113-00	RES-CHIP	470K	5%	1/10W	R297	1-216-025-91	RES-CHIP	100	5%	1/10W
R244	1-216-049-91	RES-CHIP	1K	5%	1/10W	R300	1-216-025-91	RES-CHIP	100	5%	1/10W
R245	1-216-022-00	RES-CHIP	75	5%	1/10W	R301	1-216-049-91	RES-CHIP	1K	5%	1/10W
R246	1-216-113-00	RES-CHIP	470K	5%	1/10W	R302	1-216-295-91	SHORT			
R247	1-216-113-00	RES-CHIP	470K	5%	1/10W	R902	1-249-405-11	CARBON	100	5%	1/4W
R248	1-216-113-00	RES-CHIP	470K	5%	1/10W	R921	1-249-405-11	CARBON	100	5%	1/4W
R249	1-216-065-91	RES-CHIP	4.7K	5%	1/10W	R923	1-249-405-11	CARBON	100	5%	1/4W
R250	1-216-065-91	RES-CHIP	4.7K	5%	1/10W	R925	1-249-405-11	CARBON	100	5%	1/4W
R251	1-216-065-91	RES-CHIP	4.7K	5%	1/10W	R926	1-216-049-91	RES-CHIP	1K	5%	1/10W
R252	1-216-049-91	RES-CHIP	1K	5%	1/10W	R1051	1-216-073-00	RES-CHIP	10K	5%	1/10W
R254	1-216-049-91	RES-CHIP	1K	5%	1/10W	R1052	1-216-073-00	RES-CHIP	10K	5%	1/10W
R257	1-216-049-91	RES-CHIP	1K	5%	1/10W	R1054	1-216-025-91	RES-CHIP	100	5%	1/10W
R258	1-216-057-00	RES-CHIP	2.2K	5%	1/10W	R1057	1-216-025-91	RES-CHIP	100	5%	1/10W
R259	1-216-049-91	RES-CHIP	1K	5%	1/10W	R1058	1-216-025-91	RES-CHIP	100	5%	1/10W
R260	1-216-057-00	RES-CHIP	2.2K	5%	1/10W	R1059	1-216-065-91	RES-CHIP	4.7K	5%	1/10W

Note:

The components identified by shading and mark \triangle are critical for safety. Replace only with part number specified.

Note:

Les composants identifiés par un trame et une marque \triangle sont critiques pour la sécurité. Ne les remplacer que par une pièce portant le numéro spécifié.



REF.NO.	PART NO.	DESCRIPTION	REMARK	REF.NO.	PART NO.	DESCRIPTION	REMARK
R1062	1-216-033-00	RES-CHIP	220 5% 1/10W	R1273	1-208-788-11	METAL CHIP	1.8K 0.50% 1/10W
R1063	1-216-073-00	RES-CHIP	10K 5% 1/10W	R1276	1-216-049-91	RES-CHIP	1K 5% 1/10W
R1064	1-216-073-00	RES-CHIP	10K 5% 1/10W	R1277	1-216-025-91	RES-CHIP	100 5% 1/10W
R1065	1-216-025-91	RES-CHIP	100 5% 1/10W	R1279	1-216-025-91	RES-CHIP	100 5% 1/10W
R1201	1-216-025-91	RES-CHIP	100 5% 1/10W	R1281	1-216-295-91	SHORT	
R1202	1-216-025-91	RES-CHIP	100 5% 1/10W	R1285	1-216-041-00	RES-CHIP	470 5% 1/10W
R1204	1-216-295-91	SHORT		R1287	1-216-295-91	SHORT	
R1206	1-216-295-91	SHORT		R1288	1-216-295-91	SHORT	
R1208	1-216-049-91	RES-CHIP	1K 5% 1/10W	R1289	1-216-295-91	SHORT	
R1209	1-216-295-91	SHORT		R1290	1-216-295-91	SHORT	
R1210	1-216-295-91	SHORT		R1291	1-216-295-91	SHORT	
R1212	1-216-295-91	SHORT		R1292	1-216-295-91	SHORT	
R1213	1-216-295-91	SHORT		R1293	1-216-049-91	RES-CHIP	1K 5% 1/10W
R1215	1-208-774-11	METAL CHIP	470 0.50% 1/10W	R1294	1-216-049-91	RES-CHIP	1K 5% 1/10W
R1216	1-216-057-00	RES-CHIP	2.2K 5% 1/10W	R1295	1-216-049-91	RES-CHIP	1K 5% 1/10W
R1217	1-216-091-00	RES-CHIP	56K 5% 1/10W	R1300	1-216-049-91	RES-CHIP	1K 5% 1/10W
R1219	1-216-073-00	RES-CHIP	10K 5% 1/10W	R1304	1-216-041-00	RES-CHIP	470 5% 1/10W
R1220	1-216-013-00	RES-CHIP	33 5% 1/10W	R1305	1-208-776-11	METAL CHIP	560 0.50% 1/10W
R1221	1-216-121-91	RES-CHIP	1M 5% 1/10W	R1306	1-216-025-91	RES-CHIP	100 5% 1/10W
R1222	1-216-073-00	RES-CHIP	10K 5% 1/10W	R1307	1-216-041-00	RES-CHIP	470 5% 1/10W
R1223	1-216-097-91	RES-CHIP	100K 5% 1/10W	R1308	1-208-776-11	METAL CHIP	560 0.50% 1/10W
R1224	1-216-089-91	RES-CHIP	47K 5% 1/10W	R1309	1-216-025-91	RES-CHIP	100 5% 1/10W
R1225	1-216-097-91	RES-CHIP	100K 5% 1/10W	R2001	1-216-073-00	RES-CHIP (KV-36FV26 ONLY)	10K 5% 1/10W
R1227	1-216-073-00	RES-CHIP	10K 5% 1/10W	R2002	1-216-073-00	RES-CHIP (KV-36FV26 ONLY)	10K 5% 1/10W
R1228	1-208-774-11	METAL CHIP	470 0.50% 1/10W	R2003	1-216-085-00	RES-CHIP (KV-36FV26 ONLY)	33K 5% 1/10W
R1229	1-216-121-91	RES-CHIP	1M 5% 1/10W	R2004	1-216-057-00	RES-CHIP (KV-36FV26 ONLY)	2.2K 5% 1/10W
R1230	1-216-073-00	RES-CHIP	10K 5% 1/10W	R2005	1-216-295-91	SHORT (KV-36FV26 ONLY)	
R1233	1-216-097-91	RES-CHIP	100K 5% 1/10W	R2006	1-216-065-91	RES-CHIP (KV-36FV26 ONLY)	4.7K 5% 1/10W
R1234	1-216-091-00	RES-CHIP	56K 5% 1/10W	R2007	1-216-041-00	RES-CHIP (KV-36FV26 ONLY)	470 5% 1/10W
R1235	1-216-013-00	RES-CHIP	33 5% 1/10W	R2008	1-216-025-91	RES-CHIP (KV-36FV26 ONLY)	100 5% 1/10W
R1236	1-216-097-91	RES-CHIP	100K 5% 1/10W	R2009	1-216-025-91	RES-CHIP (KV-36FV26 ONLY)	100 5% 1/10W
R1237	1-216-089-91	RES-CHIP	47K 5% 1/10W	R2010	1-216-001-00	RES-CHIP (KV-36FV26 ONLY)	10 5% 1/10W
R1238	1-216-057-00	RES-CHIP	2.2K 5% 1/10W	R2011	1-216-041-00	RES-CHIP	470 5% 1/10W
R1240	1-216-295-91	SHORT		R2015	1-216-081-00	RES-CHIP	22K 5% 1/10W
R1242	1-216-065-91	RES-CHIP	4.7K 5% 1/10W	R2016	1-216-081-00	RES-CHIP	22K 5% 1/10W
R1243	1-216-065-91	RES-CHIP	4.7K 5% 1/10W	R2017	1-216-295-91	SHORT	
R1244	1-216-049-91	RES-CHIP	1K 5% 1/10W	R2018	1-216-295-91	SHORT	
R1245	1-216-049-91	RES-CHIP	1K 5% 1/10W	R2019	1-216-295-91	SHORT	
R1261	1-216-025-91	RES-CHIP	100 5% 1/10W	R2022	1-216-049-91	RES-CHIP (KV-36FV26 ONLY)	1K 5% 1/10W
R1263	1-216-295-91	SHORT					
R1264	1-216-049-91	RES-CHIP	1K 5% 1/10W				
R1265	1-216-001-00	RES-CHIP	10 5% 1/10W				
R1266	1-216-041-00	RES-CHIP	470 5% 1/10W				
R1267	1-216-025-91	RES-CHIP	100 5% 1/10W				
R1268	1-216-049-91	RES-CHIP	1K 5% 1/10W				
R1269	1-216-041-00	RES-CHIP	470 5% 1/10W				
R1270	1-216-049-91	RES-CHIP	1K 5% 1/10W				
R1271	1-216-001-00	RES-CHIP	10 5% 1/10W				
R1272	1-216-655-11	METAL CHIP	1.5K 0.50% 1/10W				



Note:

The components identified by shading and mark \triangle are critical for safety. Replace only with part number specified.

Note:

Les composants identifiés par un trame et une marque \triangle sont critiques pour la sécurité. Ne les remplacer que par une pièce portant le numéro spécifié.

REF.NO.	PART NO.	DESCRIPTION	REMARK	REF.NO.	PART NO.	DESCRIPTION	REMARK
R2023	1-216-049-91	RES-CHIP (KV-36FV26 ONLY)	1K 5% 1/10W	R2073	1-216-049-91	RES-CHIP	1K 5% 1/10W
R2024	1-216-097-91	RES-CHIP	100K 5% 1/10W	R2074	1-216-025-91	RES-CHIP	100 5% 1/10W
R2027	1-216-049-91	RES-CHIP	1K 5% 1/10W	R2076	1-216-049-91	RES-CHIP	1K 5% 1/10W
R2028	1-216-049-91	RES-CHIP	1K 5% 1/10W	R2077	1-216-049-91	RES-CHIP	1K 5% 1/10W
R2029	1-216-043-91	RES-CHIP	560 5% 1/10W	R2078	1-216-041-00	RES-CHIP	470 5% 1/10W
R2030	1-216-043-91	RES-CHIP	560 5% 1/10W	R2079	1-216-049-91	RES-CHIP	1K 5% 1/10W
R2031	1-216-067-00	RES-CHIP	5.6K 5% 1/10W	R2092	1-216-055-00	RES-CHIP	1.8K 5% 1/10W
R2032	1-216-067-00	RES-CHIP	5.6K 5% 1/10W	R2093	1-216-055-00	RES-CHIP	1.8K 5% 1/10W
R2033	1-216-057-00	RES-CHIP	2.2K 5% 1/10W	R2103	1-216-017-91	RES-CHIP (KV-36FV26 ONLY)	47 5% 1/10W
R2034	1-216-057-00	RES-CHIP	2.2K 5% 1/10W	R2104	1-216-295-91	SHORT	
R2035	1-208-776-11	METAL CHIP	560 0.50% 1/10W	R2105	1-216-295-91	SHORT	
R2036	1-208-775-11	METAL CHIP	510 0.50% 1/10W	R2106	1-216-295-91	SHORT	
R2037	1-216-051-00	RES-CHIP	1.2K 5% 1/10W	R2107	1-216-295-91	SHORT	
R2038	1-216-033-00	RES-CHIP	220 5% 1/10W	R2113	1-216-017-91	RES-CHIP	47 5% 1/10W
R2039	1-216-047-91	RES-CHIP	820 5% 1/10W	R2115	1-216-049-91	RES-CHIP	1K 5% 1/10W
R2040	1-216-057-00	RES-CHIP	2.2K 5% 1/10W	R2153	1-216-295-91	SHORT	
R2041	1-216-047-91	RES-CHIP	820 5% 1/10W	R2201	1-216-022-00	RES-CHIP	75 5% 1/10W
R2042	1-216-075-00	RES-CHIP	12K 5% 1/10W	R2202	1-216-022-00	RES-CHIP	75 5% 1/10W
R2043	1-216-085-00	RES-CHIP	33K 5% 1/10W	R2203	1-216-022-00	RES-CHIP	75 5% 1/10W
R2044	1-216-057-00	RES-CHIP	2.2K 5% 1/10W	R2204	1-216-295-91	SHORT	
R2046	1-216-075-00	RES-CHIP	12K 5% 1/10W	R3303	1-216-295-91	SHORT	
R2047	1-216-085-00	RES-CHIP	33K 5% 1/10W	R3304	1-216-295-91	SHORT	
R2048	1-216-049-91	RES-CHIP	1K 5% 1/10W	R3305	1-216-043-91	RES-CHIP	560 5% 1/10W
R2049	1-216-065-91	RES-CHIP	4.7K 5% 1/10W	R3308	1-216-033-00	RES-CHIP	220 5% 1/10W
R2050	1-216-017-91	RES-CHIP	47 5% 1/10W	R3310	1-216-033-00	RES-CHIP	220 5% 1/10W
R2051	1-216-049-91	RES-CHIP	1K 5% 1/10W	R3312	1-216-037-00	RES-CHIP	330 5% 1/10W
R2052	1-216-049-91	RES-CHIP	1K 5% 1/10W	R3313	1-216-041-00	RES-CHIP	100 5% 1/10W
R2053	1-216-041-00	RES-CHIP	470 5% 1/10W	R3314	1-216-041-00	RES-CHIP	100 5% 1/10W
R2054	1-216-041-00	RES-CHIP	470 5% 1/10W	R3316	1-216-295-91	SHORT	
R2055	1-216-017-91	RES-CHIP	47 5% 1/10W	R3319	1-216-295-91	SHORT	
R2056	1-216-067-00	RES-CHIP	5.6K 5% 1/10W	R3320	1-216-295-91	SHORT	
R2057	1-216-049-91	RES-CHIP	1K 5% 1/10W	R3322	1-216-049-91	RES-CHIP	1K 5% 1/10W
R2058	1-216-057-00	RES-CHIP	2.2K 5% 1/10W	R3323	1-216-049-91	RES-CHIP	1K 5% 1/10W
R2059	1-216-049-91	RES-CHIP	1K 5% 1/10W	R3324	1-216-049-91	RES-CHIP	1K 5% 1/10W
R2060	1-216-025-91	RES-CHIP	100 5% 1/10W	R3327	1-216-295-91	SHORT	
R2061	1-216-043-91	RES-CHIP	560 5% 1/10W	R3343	1-216-049-91	RES-CHIP	1K 5% 1/10W
R2062	1-216-105-91	RES-CHIP	220K 5% 1/10W	R3344	1-216-049-91	RES-CHIP	1K 5% 1/10W
R2063	1-216-089-91	RES-CHIP	47K 5% 1/10W	R3345	1-216-295-91	SHORT	
R2064	1-216-049-91	RES-CHIP	1K 5% 1/10W	R3346	1-216-049-91	RES-CHIP	1K 5% 1/10W
R2065	1-216-049-91 (KV-36FV26 ONLY)	RES-CHIP	1K 5% 1/10W	R3347	1-216-061-00	RES-CHIP	3.3K 5% 1/10W
R2066	1-216-033-00	RES-CHIP	220 5% 1/10W	R3348	1-216-057-00	RES-CHIP	2.2K 5% 1/10W
R2067	1-216-048-00	RES-CHIP	910 5% 1/10W	R3350	1-216-295-91	SHORT	
R2068	1-216-295-91	SHORT		R3355	1-216-295-91	SHORT	
R2069	1-208-776-11	METAL CHIP	560 0.50% 1/10W	R3357	1-216-295-91	SHORT	
R2070	1-216-646-11	METAL CHIP	620 0.50% 1/10W	R3358	1-216-033-00	RES-CHIP	220 5% 1/10W
R2071	1-216-067-00	RES-CHIP	5.6K 5% 1/10W	R3359	1-216-047-91	RES-CHIP	820 5% 1/10W
R2072	1-216-043-91	RES-CHIP	560 5% 1/10W	R3360	1-216-053-00	RES-CHIP	1.5K 5% 1/10W
				R3361	1-216-045-00	RES-CHIP	680 5% 1/10W

Note:

The components identified by shading and mark \triangle are critical for safety. Replace only with part number specified.

Note:

Les composants identifiés par un trame et une marque \triangle sont critiques pour la sécurité. Ne les remplacer que par une pièce portant le numéro spécifié.



REF.NO.	PART NO.	DESCRIPTION	REMARK	REF.NO.	PART NO.	DESCRIPTION	REMARK
R3370	1-216-295-91	SHORT		C282	1-126-941-11	ELECT	470 μ F 20% 25V
R3374	1-216-295-91	SHORT		C284	1-126-941-11	ELECT	470 μ F 20% 25V
R3375	1-216-295-91	SHORT		C286	1-164-161-11	CERAMIC CHIP	0.0022 μ F 10% 50V
R3376	1-216-295-91	SHORT		C287	1-164-161-11	CERAMIC CHIP	0.0022 μ F 10% 50V
R3377	1-216-295-91	SHORT		C1053	1-126-934-11	ELECT	220 μ F 20% 16V
R3378	1-216-295-91	SHORT		C1201	1-163-809-11	CERAMIC CHIP	0.047 μ F 10% 25V
R3379	1-216-043-91	RES-CHIP	560 5% 1/10W	C1202	1-163-021-91	CERAMIC CHIP	0.01 μ F 10% 50V
R3380	1-216-033-00	RES-CHIP	220 5% 1/10W	C1203	1-126-960-11	ELECT	1 μ F 20% 50V
CRYSTAL				C1204	1-163-809-11	CERAMIC CHIP	0.047 μ F 10% 25V
X2001	1-767-606-11	VIBRATOR, CRYSTAL		C1205	1-126-941-11	ELECT	470 μ F 20% 25V
X2002	1-767-367-21	VIBRATOR, CERAMIC (KV-36FV26 ONLY)		C1209	1-163-259-91	CERAMIC CHIP	220PF 5% 50V
X3302	1-781-929-21	VIBRATOR, CRYSTAL		C1210	1-163-259-91	CERAMIC CHIP	220PF 5% 50V
UY				C1211	1-128-551-11	ELECT	22 μ F 20% 25V
* A-1395-000-A	UY COMPLETE PC BOARD (KV-36FS12 ONLY)			C1212	1-128-551-11	ELECT	22 μ F 20% 25V
* A-1394-994-A	UY COMPLETE PC BOARD (KV-36FS16 ONLY)			C1213	1-126-941-11	ELECT	470 μ F 20% 25V
CAPACITOR				C1214	1-163-021-91	CERAMIC CHIP	0.01 μ F 10% 50V
C201	1-128-551-11	ELECT	22 μ F 20% 25V	C1215	1-126-960-11	ELECT	1 μ F 20% 50V
C202	1-128-551-11	ELECT	22 μ F 20% 25V	C1262	1-216-081-00	RES-CHIP	22K 5% 1/10W
C203	1-128-551-11	ELECT	22 μ F 20% 25V	C2000	1-126-941-11	ELECT	470 μ F 20% 25V
C204	1-126-960-11	ELECT	1 μ F 20% 50V	C2002	1-128-551-11	ELECT	22 μ F 20% 25V
C205	1-126-960-11	ELECT	1 μ F 20% 50V	C2012	1-163-021-91	CERAMIC CHIP	0.01 μ F 10% 50V
C231	1-163-021-91	CERAMIC CHIP	0.01 μ F 10% 50V	C2015	1-163-021-91	CERAMIC CHIP	0.01 μ F 10% 50V
C232	1-126-965-11	ELECT	22 μ F 20% 50V	C2045	1-163-237-11	CERAMIC CHIP	27PF 5% 50V
C233	1-128-551-11	ELECT	22 μ F 20% 25V	C2047	1-126-961-11	ELECT	2.2 μ F 20% 50V
C234	1-126-960-11	ELECT	1 μ F 20% 50V	C2048	1-126-964-11	ELECT	10 μ F 20% 50V
C235	1-126-960-11	ELECT	1 μ F 20% 50V	C2049	1-104-664-11	ELECT	47 μ F 20% 16V
C236	1-128-551-11	ELECT	22 μ F 20% 25V	C2056	1-163-231-11	CERAMIC CHIP	15PF 5% 50V
C237	1-126-960-11	ELECT	1 μ F 20% 50V	C2060	1-163-031-11	CERAMIC CHIP	0.01 μ F 50V
C238	1-126-960-11	ELECT	1 μ F 20% 50V	C2062	1-104-664-11	ELECT	47 μ F 20% 16V
C244	1-126-959-11	ELECT	0.47 μ F 20% 50V	C2096	1-163-231-11	CERAMIC CHIP	15PF 5% 50V
C245	1-126-959-11	ELECT	0.47 μ F 20% 50V	C2097	1-163-231-11	CERAMIC CHIP	15PF 5% 50V
C264	1-164-004-11	CERAMIC CHIP	0.1 μ F 10% 25V	C2168	1-163-253-11	CERAMIC CHIP	120PF 5% 50V
C268	1-163-021-91	CERAMIC CHIP	0.01 μ F 10% 50V	C2201	1-126-965-11	ELECT	22 μ F 20% 50V
C269	1-163-021-91	CERAMIC CHIP	0.01 μ F 10% 50V	C2202	1-128-551-11	ELECT	22 μ F 20% 25V
C272	1-163-231-11	CERAMIC CHIP	15PF 5% 50V	C2203	1-163-021-91	CERAMIC CHIP	0.01 μ F 10% 50V
C273	1-128-551-11	ELECT	22 μ F 20% 25V	C3301	1-104-664-11	ELECT	47 μ F 20% 25V (KV-36FS16 ONLY)
C277	1-128-551-11	ELECT	22 μ F 20% 25V	C3302	1-163-031-11	CERAMIC CHIP	0.01 μ F 50V (KV-36FS16 ONLY)
C279	1-163-021-91	CERAMIC CHIP	0.01 μ F 10% 50V	C3303	1-126-961-11	ELECT	2.2 μ F 20% 50V (KV-36FS16 ONLY)
C281	1-128-551-11	ELECT	22 μ F 20% 25V	C3304	1-163-038-91	CERAMIC CHIP	0.1 μ F 25V (KV-36FS16 ONLY)
				C3305	1-126-961-11	ELECT	2.2 μ F 20% 50V (KV-36FS16 ONLY)
				C3306	1-163-038-91	CERAMIC CHIP	0.1 μ F 25V (KV-36FS16 ONLY)
				C3307	1-126-964-11	ELECT	10 μ F 20% 50V (KV-36FS16 ONLY)
				C3308	1-163-038-91	CERAMIC CHIP	0.1 μ F 25V (KV-36FS16 ONLY)

**Note:**

The components identified by shading and mark \triangle are critical for safety. Replace only with part number specified.

Note:

Les composants identifiés par un trame et une marque \triangle sont critiques pour la sécurité. Ne les remplacer que par une pièce portant le numéro spécifié.

REF.NO.	PART NO.	DESCRIPTION	REMARK	REF.NO.	PART NO.	DESCRIPTION	REMARK
C3309	1-126-964-11	ELECT (KV-36FS16 ONLY)	10 μ F 20% 50V	C3371	1-163-031-11	CERAMIC CHIP (KV-36FS16 ONLY)	0.01 μ F 50V
C3311	1-163-038-91	CERAMIC CHIP (KV-36FS16 ONLY)	0.1 μ F 25V	C3556	1-163-038-91	CERAMIC CHIP	0.1 μ F 25V
C3312	1-126-964-11	ELECT (KV-36FS16 ONLY)	10 μ F 20% 50V	C3557	1-163-021-91	CERAMIC CHIP	0.01 μ F 10% 50V
C3313	1-163-038-91	CERAMIC CHIP (KV-36FS16 ONLY)	0.1 μ F 25V	C3558	1-126-964-11	ELECT	10 μ F 20% 50V
C3314	1-216-295-91	SHORT (KV-36FS16 ONLY)		C3559	1-163-038-91	CERAMIC CHIP	0.1 μ F 25V
C3315	1-216-295-91	SHORT (KV-36FS16 ONLY)		C3560	1-163-038-91	CERAMIC CHIP	0.1 μ F 25V
C3316	1-216-295-91	SHORT (KV-36FS16 ONLY)		C3561	1-126-964-11	ELECT	10 μ F 20% 50V
C3317	1-104-666-11	ELECT (KV-36FS16 ONLY)	220 μ F 20% 25V	C3562	1-163-038-91	CERAMIC CHIP	0.1 μ F 25V
C3318	1-164-004-11	CERAMIC CHIP (KV-36FS16 ONLY)	0.1 μ F 10% 25V	C3563	1-163-038-91	CERAMIC CHIP	0.1 μ F 25V
C3319	1-163-031-11	CERAMIC CHIP (KV-36FS16 ONLY)	0.01 μ F 50V	C3564	1-163-038-91	CERAMIC CHIP	0.1 μ F 25V
C3320	1-104-664-11	ELECT (KV-36FS16 ONLY)	47 μ F 20% 16V	C3565	1-163-038-91	CERAMIC CHIP	0.1 μ F 25V
C3321	1-163-237-11	CERAMIC CHIP (KV-36FS16 ONLY)	27PF 5% 50V	C3566	1-126-964-11	ELECT	10 μ F 20% 50V
C3322	1-163-237-11	CERAMIC CHIP (KV-36FS16 ONLY)	27PF 5% 50V	C3567	1-163-021-91	CERAMIC CHIP	0.01 μ F 10% 50V
C3323	1-163-038-91	CERAMIC CHIP (KV-36FS16 ONLY)	0.1 μ F 25V	C3568	1-163-021-91	CERAMIC CHIP	0.01 μ F 10% 50V
C3325	1-104-664-11	ELECT (KV-36FS16 ONLY)	47 μ F 20% 16V	C3569	1-126-964-11	ELECT	10 μ F 20% 50V
C3327	1-126-941-11	ELECT (KV-36FS16 ONLY)	470 μ F 20% 25V	C3570	1-126-964-11	ELECT	10 μ F 20% 50V
C3328	1-126-925-11	ELECT (KV-36FS16 ONLY)	470 μ F 20% 10V	C3571	1-163-021-91	CERAMIC CHIP	0.01 μ F 10% 50V
C3329	1-104-664-11	ELECT (KV-36FS16 ONLY)	47 μ F 20% 16V	C3573	1-163-037-11	CERAMIC CHIP	0.022 μ F 10% 50V
C3349	1-163-123-00	CERAMIC CHIP (KV-36FS16 ONLY)	180PF 5% 50V	C3574	1-163-021-91	CERAMIC CHIP	0.01 μ F 10% 50V
C3350	1-164-004-11	CERAMIC CHIP (KV-36FS16 ONLY)	0.1 μ F 10% 25V	C3575	1-126-964-11	ELECT	10 μ F 20% 50V
C3354	1-163-031-11	CERAMIC CHIP (KV-36FS16 ONLY)	0.01 μ F 50V	C3576	1-163-021-91	CERAMIC CHIP	0.01 μ F 10% 50V
C3357	1-163-031-11	CERAMIC CHIP (KV-36FS16 ONLY)	0.01 μ F 50V	C3577	1-126-964-11	ELECT	10 μ F 20% 50V
C3358	1-163-031-11	CERAMIC CHIP (KV-36FS16 ONLY)	0.01 μ F 50V	C3578	1-163-021-91	CERAMIC CHIP	0.01 μ F 10% 50V
C3368	1-216-295-91	SHORT (KV-36FS16 ONLY)		C3579	1-104-664-11	ELECT	47 μ F 20% 16V
C3369	1-163-031-11	CERAMIC CHIP (KV-36FS16 ONLY)	0.01 μ F 50V	CONNECTOR			
C3370	1-163-031-11	CERAMIC CHIP (KV-36FS16 ONLY)	0.01 μ F 50V	CN261 *	1-564-510-11	PLUG, CONNECTOR 7P (KV-36FS16 ONLY)	
				CN265 *	1-764-333-11	PLUG, CONNECTOR 10P	
				DIODE			
				D201	8-719-032-47	DIODE MTZJ-T-9110	
				D202	8-719-032-47	DIODE MTZJ-T-9110	
				D203	8-719-032-47	DIODE MTZJ-T-9110	
				D204	8-719-032-47	DIODE MTZJ-T-9110	
				D205	8-719-032-47	DIODE MTZJ-T-9110	
				D231	8-719-032-47	DIODE MTZJ-T-9110	
				D232	8-719-032-47	DIODE MTZJ-T-9110	
				D233	8-719-032-47	DIODE MTZJ-T-9110	
				D234	8-719-032-47	DIODE MTZJ-T-9110	
				D235	8-719-032-47	DIODE MTZJ-T-9110	
				D236	8-719-032-47	DIODE MTZJ-T-9110	
				D237	8-719-032-47	DIODE MTZJ-T-9110	
				D238	8-719-032-47	DIODE MTZJ-T-9110	
				D239	8-719-032-47	DIODE MTZJ-T-9110	
				D248	8-719-157-94	DIODE RD3.3SB-T1	
				D261	8-719-032-47	DIODE MTZJ-T-9110	

Note:

The components identified by shading and mark \triangle are critical for safety. Replace only with part number specified.

Note:

Les composants identifiés par un trame et une marque \triangle sont critiques pour la sécurité. Ne les remplacer que par une pièce portant le numéro spécifié.



REF.NO.	PART NO.	DESCRIPTION	REMARK	REF.NO.	PART NO.	DESCRIPTION	REMARK
D1051	8-719-073-01	DIODE MA111-TX					
D1052	8-719-073-01	DIODE MA111-TX					
D1053	1-216-295-91	SHORT					
D1054	1-216-295-91	SHORT					
D2201	8-719-032-47	DIODE MTZJ-T-9110					
D2202	8-719-032-47	DIODE MTZJ-T-9110					
D2203	8-719-032-47	DIODE MTZJ-T-9110					
FERRITE BEAD				CHIP CONDUCTOR			
FB2006	1-414-230-22	INDUCTOR CHIP	0 μ H	JR1001	1-216-295-91	SHORT	
FB2007	1-414-230-22	INDUCTOR CHIP	0 μ H	JR1002	1-216-295-91	SHORT	
FB2008	1-414-230-22	INDUCTOR CHIP	0 μ H	JR1003	1-216-295-91	SHORT	
FB3301	1-216-295-91	SHORT		JR1004	1-216-295-91	SHORT	
FB3302	1-414-230-22	INDUCTOR CHIP (KV-36FS16 ONLY)	0 μ H	JR1014	1-216-295-91	SHORT	
FB3303	1-414-230-22	INDUCTOR CHIP (KV-36FS16 ONLY)	0 μ H	JR1015	1-216-295-91	SHORT	
FB3304	1-414-230-22	INDUCTOR CHIP (KV-36FS16 ONLY)	0 μ H	JR1016	1-216-295-91	SHORT	
FB3305	1-414-230-22	INDUCTOR CHIP (KV-36FS16 ONLY)	0 μ H	JR1017	1-216-295-91	SHORT	
				JR1018	1-216-295-91	SHORT	
				JR1019	1-216-295-91	SHORT	
				JR1020	1-216-295-91	SHORT	
				JR1021	1-216-295-91	SHORT	
				JR1022	1-216-295-91	SHORT	
				JR1023	1-216-295-91	SHORT	
				JR1203	1-216-295-91	SHORT	
FILTER				COIL			
FL2001	1-239-847-11	FILTER, LOW PASS		L261	1-414-857-11	INDUCTOR	100 μ H
FL2002	1-239-847-11	FILTER, LOW PASS		L1201	1-408-591-11	INDUCTOR	1 μ H
FL2004	1-239-847-11	FILTER, LOW PASS		L1202	1-408-591-11	INDUCTOR	1 μ H
				L2004	1-414-856-11	INDUCTOR	10 μ H
				L2005	1-410-494-11	INDUCTOR	1mH
				L2009	1-414-856-11	INDUCTOR	10 μ H
				L3301	1-414-856-11	INDUCTOR (KV-36FS16 ONLY)	10 μ H
				L3302	1-410-473-11	INDUCTOR (KV-36FS16 ONLY)	18 μ H
				L3303	1-410-476-11	INDUCTOR (KV-36FS16 ONLY)	33 μ H
				L3304	1-414-856-11	INDUCTOR (KV-36FS16 ONLY)	10 μ H
				L3305	1-414-856-11	INDUCTOR (KV-36FS16 ONLY)	10 μ H
				L3306	1-414-856-11	INDUCTOR (KV-36FS16 ONLY)	10 μ H
				L3307	1-414-856-11	INDUCTOR (KV-36FS16 ONLY)	10 μ H
				L3308	1-414-856-11	INDUCTOR (KV-36FS16 ONLY)	10 μ H
				L3581	1-408-591-11	INDUCTOR	1 μ H
				L3582	1-408-591-11	INDUCTOR	1 μ H
IC				TRANSISTOR			
IC261	8-752-066-69	IC CXA1845Q		Q202	8-729-422-27	TRANSISTOR 2SD601A-QRS-TX (KV-36FS16 ONLY)	
IC2006	8-759-358-38	IC NJM78M05DLA(TE1)		Q203	8-729-422-27	TRANSISTOR 2SD601A-QRS-TX (KV-36FS16 ONLY)	
IC3302	8-759-358-38	IC NJM78M05DLA(TE1) (KV-36FS16 ONLY)		Q205	8-729-216-22	TRANSISTOR 2SB709A-QRS-TX (KV-36FS16 ONLY)	
IC3303	8-759-658-34	IC SDA9588X (KV-36FS16 ONLY)					
IC3308	8-759-932-69	IC BU4053BCF-T2 (KV-36FS16 ONLY)					
IC3310	8-759-583-47	IC UPC2933T-E1 (KV-36FS16 ONLY)					
IC3504	8-752-390-37	IC CXD2064Q-T6					
JACK							
J231	1-750-515-11	TERMINAL BLOCK, S 3P					
J232	1-750-517-11	JACK BLOCK, PIN 3P					
J233	1-750-516-11	JACK BLOCK, PIN 2P					
J236	1-774-358-11	JACK BLOCK, PIN					

**Note:**

The components identified by shading and mark \triangle are critical for safety. Replace only with part number specified.

Note:

Les composants identifiés par un trame et une marque \triangle sont critiques pour la sécurité. Ne les remplacer que par une pièce portant le numéro spécifié.

REF.NO.	PART NO.	DESCRIPTION	REMARK	REF.NO.	PART NO.	DESCRIPTION	REMARK
Q206	8-729-216-22	TRANSISTOR 2SB709A-QRS-TX (KV-36FS16 ONLY)			RESISTOR		
Q207	8-729-422-27	TRANSISTOR 2SD601A-QRS-TX (KV-36FS16 ONLY)		R201	1-216-022-00	RES-CHIP 75	5% 1/10W
Q208	8-729-422-27	TRANSISTOR 2SD601A-QRS-TX (KV-36FS16 ONLY)		R202	1-216-022-00	RES-CHIP 75	5% 1/10W
Q209	8-729-422-27	TRANSISTOR 2SD601A-QRS-TX (KV-36FS16 ONLY)		R203	1-216-022-00	RES-CHIP 75	5% 1/10W
Q210	8-729-422-27	TRANSISTOR 2SD601A-QRS-TX (KV-36FS16 ONLY)		R204	1-216-113-00	RES-CHIP 470K	5% 1/10W
Q211	8-729-422-27	TRANSISTOR 2SD601A-QRS-TX		R205	1-216-113-00	RES-CHIP 470K	5% 1/10W
Q212	8-729-422-27	TRANSISTOR 2SD601A-QRS-TX		R206	1-216-295-91	SHORT	
Q235	8-729-422-27	TRANSISTOR 2SD601A-QRS-TX		R207	1-216-295-91	SHORT	
Q236	8-729-422-27	TRANSISTOR 2SD601A-QRS-TX		R208	1-216-295-91	SHORT	
Q262	8-729-216-22	TRANSISTOR 2SB709A-QRS-TX		R209	1-216-089-91	RES-CHIP 47K	5% 1/10W
Q263	8-729-216-22	TRANSISTOR 2SB709A-QRS-TX		R210	1-216-081-00	RES-CHIP 22K	5% 1/10W
Q264	8-729-216-22	TRANSISTOR 2SB709A-QRS-TX		R211	1-216-089-91	RES-CHIP 47K	5% 1/10W
Q265	8-729-422-27	TRANSISTOR 2SD601A-QRS-TX		R212	1-216-081-00	RES-CHIP 22K	5% 1/10W
Q1051	8-729-216-22	TRANSISTOR 2SB709A-QRS-TX		R213	1-216-089-91	RES-CHIP 47K	5% 1/10W
Q1201	8-729-216-22	TRANSISTOR 2SB709A-QRS-TX		R214	1-216-081-00	RES-CHIP 22K	5% 1/10W
Q1202	8-729-422-27	TRANSISTOR 2SD601A-QRS-TX		R216	1-216-025-91	RES-CHIP 100 (KV-36FS16 ONLY)	5% 1/10W
Q1203	8-729-422-27	TRANSISTOR 2SD601A-QRS-TX		R218	1-208-774-11	METAL CHIP 470 (KV-36FS16 ONLY)	0.50% 1/10W
Q1204	8-729-216-22	TRANSISTOR 2SB709A-QRS-TX		R219	1-216-049-91	RES-CHIP 1K (KV-36FS16 ONLY)	5% 1/10W
Q1205	8-729-422-27	TRANSISTOR 2SD601A-QRS-TX		R220	1-216-025-91	RES-CHIP 100 (KV-36FS16 ONLY)	5% 1/10W
Q1206	8-729-422-27	TRANSISTOR 2SD601A-QRS-TX		R221	1-208-774-11	METAL CHIP 470 (KV-36FS16 ONLY)	0.50% 1/10W
Q1207	8-729-216-22	TRANSISTOR 2SB709A-QRS-TX		R222	1-216-049-91	RES-CHIP 1K (KV-36FS16 ONLY)	5% 1/10W
Q1208	8-729-216-22	TRANSISTOR 2SB709A-QRS-TX		R223	1-208-758-11	METAL CHIP 100 (KV-36FS16 ONLY)	0.50% 1/10W
Q2003	8-729-216-22	TRANSISTOR 2SB709A-QRS-TX		R225	1-216-025-91	RES-CHIP 100 (KV-36FS16 ONLY)	5% 1/10W
Q2004	8-729-216-22	TRANSISTOR 2SB709A-QRS-TX		R226	1-216-025-91	RES-CHIP 100 (KV-36FS16 ONLY)	5% 1/10W
Q2005	8-729-422-27	TRANSISTOR 2SD601A-QRS-TX		R227	1-216-041-00	RES-CHIP 470 (KV-36FS16 ONLY)	5% 1/10W
Q2006	8-729-422-27	TRANSISTOR 2SD601A-QRS-TX		R228	1-216-049-91	RES-CHIP 1K (KV-36FS16 ONLY)	5% 1/10W
Q2007	8-729-422-27	TRANSISTOR 2SD601A-QRS-TX		R229	1-216-049-91	RES-CHIP 1K (KV-36FS16 ONLY)	5% 1/10W
Q2008	8-729-422-27	TRANSISTOR 2SD601A-QRS-TX		R231	1-216-022-00	RES-CHIP 75	5% 1/10W
Q2009	8-729-422-27	TRANSISTOR 2SD601A-QRS-TX		R232	1-216-022-00	RES-CHIP 75	5% 1/10W
Q2010	8-729-422-27	TRANSISTOR 2SD601A-QRS-TX		R233	1-216-065-91	RES-CHIP 4.7K	5% 1/10W
Q2014	8-729-422-27	TRANSISTOR 2SD601A-QRS-TX		R234	1-216-022-00	RES-CHIP 75	5% 1/10W
Q2018	8-729-216-22	TRANSISTOR 2SB709A-QRS-TX		R235	1-216-113-00	RES-CHIP 470K	5% 1/10W
Q2019	8-729-422-27	TRANSISTOR 2SD601A-QRS-TX		R236	1-216-113-00	RES-CHIP 470K	5% 1/10W
Q3301	8-729-422-27	TRANSISTOR 2SD601A-QRS-TX (KV-36FS16 ONLY)		R237	1-216-022-00	RES-CHIP 75	5% 1/10W
Q3306	8-729-216-22	TRANSISTOR 2SB709A-QRS-TX (KV-36FS16 ONLY)		R238	1-216-113-00	RES-CHIP 470K	5% 1/10W
Q3307	8-729-216-22	TRANSISTOR 2SB709A-QRS-TX (KV-36FS16 ONLY)		R239	1-216-113-00	RES-CHIP 470K	5% 1/10W
Q3312	8-729-216-22	TRANSISTOR 2SB709A-QRS-TX (KV-36FS16 ONLY)		R241	1-216-113-00	RES-CHIP 470K	5% 1/10W
Q3315	8-729-216-22	TRANSISTOR 2SB709A-QRS-TX (KV-36FS16 ONLY)		R242	1-216-049-91	RES-CHIP 1K	5% 1/10W
Q3316	8-729-216-22	TRANSISTOR 2SB709A-QRS-TX (KV-36FS16 ONLY)					
Q3317	8-729-422-27	TRANSISTOR 2SD601A-QRS-TX (KV-36FS16 ONLY)					

Note:

The components identified by shading and mark \triangle are critical for safety. Replace only with part number specified.

Note:

Les composants identifiés par un trame et une marque \triangle sont critiques pour la sécurité. Ne les remplacer que par une pièce portant le numéro spécifié.



REF.NO.	PART NO.	DESCRIPTION	REMARK	REF.NO.	PART NO.	DESCRIPTION	REMARK
R243	1-216-113-00	RES-CHIP	470K	5%	1/10W		
R244	1-216-049-91	RES-CHIP	1K	5%	1/10W		
R257	1-216-049-91	RES-CHIP	1K	5%	1/10W		
R258	1-216-057-00	RES-CHIP	2.2K	5%	1/10W		
R259	1-216-049-91	RES-CHIP	1K	5%	1/10W		
R260	1-216-057-00	RES-CHIP	2.2K	5%	1/10W		
R261	1-216-025-91	RES-CHIP	100	5%	1/10W		
R262	1-216-067-00	RES-CHIP	5.6K	5%	1/10W		
R263	1-216-025-91	RES-CHIP	100	5%	1/10W		
R264	1-216-067-00	RES-CHIP	5.6K	5%	1/10W		
R265	1-216-025-91	RES-CHIP	100	5%	1/10W		
R266	1-216-025-91	RES-CHIP	100	5%	1/10W		
R267	1-216-025-91	RES-CHIP	100	5%	1/10W		
R268	1-216-067-00	RES-CHIP	5.6K	5%	1/10W		
R269	1-216-067-00	RES-CHIP	5.6K	5%	1/10W		
R270	1-216-049-91	RES-CHIP	1K	5%	1/10W		
R271	1-216-067-00	RES-CHIP	5.6K	5%	1/10W		
R272	1-216-025-91	RES-CHIP	100	5%	1/10W		
R273	1-216-067-00	RES-CHIP	5.6K	5%	1/10W		
R274	1-216-049-91	RES-CHIP	1K	5%	1/10W		
R275	1-216-025-91	RES-CHIP	100	5%	1/10W		
R276	1-216-295-91	SHORT					
R278	1-216-067-00	RES-CHIP	5.6K	5%	1/10W		
R279	1-216-025-91	RES-CHIP	100	5%	1/10W		
R280	1-216-067-00	RES-CHIP	5.6K	5%	1/10W		
R281	1-216-025-91	RES-CHIP	100	5%	1/10W		
R282	1-216-025-91	RES-CHIP	100	5%	1/10W		
R283	1-216-049-91	RES-CHIP	1K	5%	1/10W		
R284	1-216-033-00	RES-CHIP	220	5%	1/10W		
R285	1-216-033-00	RES-CHIP	220	5%	1/10W		
R286	1-216-067-00	RES-CHIP	5.6K	5%	1/10W		
R287	1-216-025-91	RES-CHIP	100	5%	1/10W		
R288	1-216-067-00	RES-CHIP	5.6K	5%	1/10W		
R289	1-216-067-00	RES-CHIP	5.6K	5%	1/10W		
R290	1-216-025-91	RES-CHIP (KV-36FS16 ONLY)	100	5%	1/10W		
R291	1-216-067-00	RES-CHIP	5.6K	5%	1/10W		
R292	1-216-295-91	SHORT					
R293	1-216-025-91	RES-CHIP	100	5%	1/10W		
R294	1-216-077-91	RES-CHIP	15K	5%	1/10W		
R295	1-216-025-91	RES-CHIP	100	5%	1/10W		
R296	1-216-025-91	RES-CHIP	100	5%	1/10W		
R297	1-216-025-91	RES-CHIP	100	5%	1/10W		
R298	1-216-295-91	SHORT					
R300	1-216-025-91	RES-CHIP	100	5%	1/10W		
R301	1-216-049-91	RES-CHIP	1K	5%	1/10W		
R302	1-216-295-91	SHORT					
R1062	1-216-033-00	RES-CHIP	220	5%	1/10W		
R1063	1-216-073-00	RES-CHIP	10K	5%	1/10W		
R1205	1-216-295-91	SHORT					
R1207	1-208-774-11	METAL CHIP	470	0.50%	1/10W		
R1209	1-216-295-91	SHORT					
R1210	1-216-295-91	SHORT					
R1215	1-208-774-11	METAL CHIP	470	0.50%	1/10W		
R1216	1-216-057-00	RES-CHIP	2.2K	5%	1/10W		
R1217	1-216-091-00	RES-CHIP	56K	5%	1/10W		
R1219	1-216-073-00	RES-CHIP	10K	5%	1/10W		
R1220	1-216-013-00	RES-CHIP	33	5%	1/10W		
R1221	1-216-121-91	RES-CHIP	1M	5%	1/10W		
R1222	1-216-073-00	RES-CHIP	10K	5%	1/10W		
R1223	1-216-097-91	RES-CHIP	100K	5%	1/10W		
R1224	1-216-089-91	RES-CHIP	47K	5%	1/10W		
R1225	1-216-097-91	RES-CHIP	100K	5%	1/10W		
R1227	1-216-073-00	RES-CHIP	10K	5%	1/10W		
R1228	1-208-774-11	METAL CHIP	470	0.50%	1/10W		
R1229	1-216-121-91	RES-CHIP	1M	5%	1/10W		
R1230	1-216-073-00	RES-CHIP	10K	5%	1/10W		
R1231	1-216-295-91	SHORT					
R1233	1-216-097-91	RES-CHIP	100K	5%	1/10W		
R1234	1-216-091-00	RES-CHIP	56K	5%	1/10W		
R1235	1-216-013-00	RES-CHIP	33	5%	1/10W		
R1236	1-216-097-91	RES-CHIP	100K	5%	1/10W		
R1237	1-216-089-91	RES-CHIP	47K	5%	1/10W		
R1238	1-216-057-00	RES-CHIP	2.2K	5%	1/10W		
R1239	1-208-774-11	METAL CHIP	470	0.50%	1/10W		
R1261	1-216-025-91	RES-CHIP	100	5%	1/10W		
R1262	1-216-295-91	SHORT					
R1263	1-216-295-91	SHORT					
R1264	1-216-049-91	RES-CHIP	1K	5%	1/10W		
R1265	1-216-001-00	RES-CHIP	10	5%	1/10W		
R1266	1-216-041-00	RES-CHIP (KV-36FS16 ONLY)	470	5%	1/10W		
R1267	1-216-025-91	RES-CHIP	100	5%	1/10W		
R1268	1-216-049-91	RES-CHIP	1K	5%	1/10W		
R1269	1-216-041-00	RES-CHIP (KV-36FS16 ONLY)	470	5%	1/10W		
R1270	1-216-049-91	RES-CHIP	1K	5%	1/10W		
R1272	1-216-655-11	METAL CHIP	1.5K	0.50%	1/10W		
R1273	1-208-788-11	METAL CHIP	1.8K	0.50%	1/10W		
R1276	1-216-049-91	RES-CHIP	1K	5%	1/10W		
R1277	1-216-025-91	RES-CHIP (KV-36FS16 ONLY)	100	5%	1/10W		
R1279	1-216-025-91	RES-CHIP	100	5%	1/10W		
R1281	1-216-295-91	SHORT					
R1284	1-216-295-91	SHORT					
R1285	1-216-041-00	RES-CHIP (KV-36FS16 ONLY)	470	5%	1/10W		
R1287	1-216-295-91	SHORT					
R1288	1-216-295-91	SHORT					



Note:

The components identified by shading and mark \triangle are critical for safety. Replace only with part number specified.

Note:

Les composants identifiés par un trame et une marque \triangle sont critiques pour la sécurité. Ne les remplacer que par une pièce portant le numéro spécifié.

REF.NO.	PART NO.	DESCRIPTION	REMARK	REF.NO.	PART NO.	DESCRIPTION	REMARK
R1289	1-216-295-91	SHORT		R2202	1-216-022-00	RES-CHIP	75 5% 1/10W
R1290	1-216-295-91	SHORT		R2203	1-216-022-00	RES-CHIP	75 5% 1/10W
R1291	1-216-295-91	SHORT		R2204	1-216-295-91	SHORT	
R1292	1-216-295-91	SHORT				(KV-36FS16 ONLY)	
R1304	1-216-041-00	RES-CHIP	470 5% 1/10W	R3303	1-216-295-91	SHORT	
						(KV-36FS16 ONLY)	
R1305	1-208-776-11	METAL CHIP	560 0.50% 1/10W	R3304	1-216-295-91	SHORT	
R1306	1-216-025-91	RES-CHIP	100 5% 1/10W			(KV-36FS16 ONLY)	
R1307	1-216-041-00	RES-CHIP	470 5% 1/10W	R3305	1-216-043-91	RES-CHIP	560 5% 1/10W
R1308	1-208-776-11	METAL CHIP	560 0.50% 1/10W			(KV-36FS16 ONLY)	
R1309	1-216-025-91	RES-CHIP	100 5% 1/10W	R3308	1-216-033-00	RES-CHIP	220 5% 1/10W
						(KV-36FS16 ONLY)	
R2015	1-216-081-00	RES-CHIP	22K 5% 1/10W	R3309	1-216-041-00	RES-CHIP	470 5% 1/10W
R2016	1-216-081-00	RES-CHIP	22K 5% 1/10W			(KV-36FS16 ONLY)	
R2017	1-216-295-91	SHORT		R3310	1-216-033-00	RES-CHIP	220 5% 1/10W
R2018	1-216-295-91	SHORT				(KV-36FS16 ONLY)	
R2021	1-216-081-00	RES-CHIP	22K 5% 1/10W	R3312	1-216-037-00	RES-CHIP	330 5% 1/10W
						(KV-36FS16 ONLY)	
R2027	1-216-049-91	RES-CHIP	1K 5% 1/10W	R3313	1-216-041-00	RES-CHIP	100 5% 1/10W
R2028	1-216-049-91	RES-CHIP	1K 5% 1/10W			(KV-36FS16 ONLY)	
R2029	1-216-043-91	RES-CHIP	560 5% 1/10W	R3314	1-216-041-00	RES-CHIP	100 5% 1/10W
R2030	1-216-043-91	RES-CHIP	560 5% 1/10W			(KV-36FS16 ONLY)	
R2031	1-216-081-00	RES-CHIP	22K 5% 1/10W	R3316	1-216-295-91	SHORT	
						(KV-36FS16 ONLY)	
R2032	1-216-067-00	RES-CHIP	5.6K 5% 1/10W	R3319	1-216-295-91	SHORT	
R2033	1-208-790-11	METAL CHIP	2.2K 0.50% 1/10W			(KV-36FS16 ONLY)	
R2034	1-216-057-00	RES-CHIP	2.2K 5% 1/10W	R3320	1-216-295-91	SHORT	
R2035	1-216-049-91	RES-CHIP	1K 5% 1/10W			(KV-36FS16 ONLY)	
R2036	1-216-051-00	RES-CHIP	1.2K 5% 1/10W	R3322	1-216-049-91	RES-CHIP	1K 5% 1/10W
						(KV-36FS16 ONLY)	
R2037	1-208-784-11	METAL CHIP	1.2K 0.50% 1/10W	R3323	1-216-049-91	RES-CHIP	1K 5% 1/10W
R2038	1-208-762-11	METAL CHIP	150 0.50% 1/10W			(KV-36FS16 ONLY)	
R2039	1-216-047-91	RES-CHIP	820 5% 1/10W	R3324	1-216-049-91	RES-CHIP	1K 5% 1/10W
R2040	1-216-057-00	RES-CHIP	2.2K 5% 1/10W			(KV-36FS16 ONLY)	
R2041	1-216-047-91	RES-CHIP	820 5% 1/10W	R3327	1-216-295-91	SHORT	
						(KV-36FS16 ONLY)	
R2042	1-216-075-00	RES-CHIP	12K 5% 1/10W	R3343	1-216-049-91	RES-CHIP	1K 5% 1/10W
R2043	1-216-085-00	RES-CHIP	33K 5% 1/10W			(KV-36FS16 ONLY)	
R2044	1-208-790-11	METAL CHIP	2.2K 0.50% 1/10W	R3344	1-216-049-91	RES-CHIP	1K 5% 1/10W
R2046	1-216-075-00	RES-CHIP	12K 5% 1/10W			(KV-36FS16 ONLY)	
R2047	1-216-085-00	RES-CHIP	33K 5% 1/10W	R3345	1-216-295-91	SHORT	
						(KV-36FS16 ONLY)	
R2048	1-216-049-91	RES-CHIP	1K 5% 1/10W	R3346	1-216-049-91	RES-CHIP	1K 5% 1/10W
R2050	1-216-017-91	RES-CHIP	47 5% 1/10W			(KV-36FS16 ONLY)	
R2051	1-216-049-91	RES-CHIP	1K 5% 1/10W	R3347	1-216-061-00	RES-CHIP	3.3K 5% 1/10W
R2055	1-216-017-91	RES-CHIP	47 5% 1/10W			(KV-36FS16 ONLY)	
R2057	1-216-049-91	RES-CHIP	1K 5% 1/10W	R3348	1-216-057-00	RES-CHIP	2.2K 5% 1/10W
						(KV-36FS16 ONLY)	
R2060	1-216-025-91	RES-CHIP	100 5% 1/10W	R3350	1-216-295-91	SHORT	
R2069	1-208-774-11	METAL CHIP	470 0.50% 1/10W			(KV-36FS16 ONLY)	
R2070	1-216-615-91	METAL CHIP	33 0.50% 1/10W	R3355	1-216-295-91	SHORT	
R2071	1-216-067-00	RES-CHIP	5.6K 5% 1/10W			(KV-36FS16 ONLY)	
R2072	1-216-043-91	RES-CHIP	560 5% 1/10W	R3357	1-216-295-91	SHORT	
						(KV-36FS16 ONLY)	
R2073	1-216-049-91	RES-CHIP	1K 5% 1/10W				
R2074	1-216-025-91	RES-CHIP	100 5% 1/10W				
R2081	1-216-075-00	RES-CHIP	12K 5% 1/10W				
R2201	1-216-022-00	RES-CHIP	75 5% 1/10W				

Note:

The components identified by shading and mark \triangle are critical for safety. Replace only with part number specified.

Note:

Les composants identifiés par un trame et une marque \triangle sont critiques pour la sécurité. Ne les remplacer que par une pièce portant le numéro spécifié.



REF.NO.	PART NO.	DESCRIPTION	REMARK	REF.NO.	PART NO.	DESCRIPTION	REMARK
R3358	1-216-033-00	RES-CHIP (KV-36FS16 ONLY)	220 5% 1/10W	<div style="border: 1px solid black; padding: 5px; display: inline-block;">WA</div> <hr style="border: 1px solid black; margin: 5px 0;"/> <p>* A-1375-191-A WA COMPLETE PC BOARD</p> <p>4-382-854-11 SCREW (M3X10), P, SW (+)</p> <p>CAPACITOR</p> <p>C941 1-126-942-61 ELECT 1000μF 20% 25V</p> <p>C944 1-126-964-11 ELECT 10μF 20% 50V</p> <p>C946 1-104-665-11 ELECT 100μF 20% 25V</p> <p>C947 1-104-664-11 ELECT 47μF 20% 25V</p> <p>C949 1-161-830-00 CERAMIC 0.0047μF 500V</p> <p>C950 1-126-941-11 ELECT 470μF 20% 25V</p> <p>C951 1-107-645-11 ELECT 22μF 20% 160V</p> <p>C952 1-104-999-11 MYLAR 0.1μF 10% 200V</p> <p>C953 1-106-383-00 MYLAR 0.047μF 10% 200V</p> <p>C954 1-130-471-00 MYLAR 0.001μF 5% 50V</p> <p>C955 1-107-667-11 ELECT 2.2μF 20% 160V</p> <p>C956 1-130-471-00 MYLAR 0.001μF 5% 50V</p> <p>C957 1-106-383-00 MYLAR 0.047μF 10% 200V</p> <p>C958 1-126-941-11 ELECT 470μF 20% 25V</p> <p>C960 1-163-021-91 CERAMIC CHIP 0.01μF 10% 50V</p> <p>C961 1-164-004-11 CERAMIC CHIP 0.1μF 10% 25V</p> <p>C962 1-126-964-11 ELECT 10μF 20% 50V</p> <p>C963 1-126-963-11 ELECT 4.7μF 20% 50V</p> <p>C964 1-110-501-11 CERAMIC CHIP 0.33μF 10% 16V</p> <p>C965 1-104-664-11 ELECT 47μF 20% 25V</p> <p>C966 1-126-960-11 ELECT 1μF 20% 50V</p> <p>C967 1-126-964-11 ELECT 10μF 20% 50V</p> <p>C968 1-163-021-91 CERAMIC CHIP 0.01μF 10% 50V</p> <p>C970 1-163-021-91 CERAMIC CHIP 0.01μF 10% 50V</p> <p>C971 1-104-664-11 ELECT 47μF 20% 25V</p> <p>C972 1-163-251-11 CERAMIC CHIP 100PF 5% 50V</p> <p>C973 1-163-021-91 CERAMIC CHIP 0.01μF 10% 50V</p> <p>C974 1-137-150-11 MYLAR 0.01μF 5% 50V</p> <p>C976 1-130-967-00 FILM 0.0027μF 5% 50V</p> <p>C977 1-104-760-11 CERAMIC CHIP 0.047μF 10% 50V</p> <p>C1941 1-126-941-11 ELECT 470μF 20% 25V</p> <p>C1946 1-136-165-00 MYLAR 0.1μF 5% 50V</p> <p>C1947 1-136-165-00 MYLAR 0.1μF 5% 50V</p> <p>C1948 1-164-161-11 CERAMIC CHIP 0.0022μF 10% 50V</p> <p>C1961 1-129-725-00 FILM 0.082μF 5% 400V</p> <p>C1962 1-163-021-91 CERAMIC CHIP 0.01μF 10% 50V</p> <p>C1965 1-129-718-00 FILM 0.022μF 5% 630V</p> <p>C1966 1-137-378-11 MYLAR 0.22μF 5% 50V</p> <p>C1968 1-137-378-11 MYLAR 0.22μF 5% 50V</p>			
R3359	1-216-047-91	RES-CHIP (KV-36FS16 ONLY)	820 5% 1/10W				
R3360	1-216-053-00	RES-CHIP (KV-36FS16 ONLY)	1.5K 5% 1/10W				
R3361	1-216-045-00	RES-CHIP (KV-36FS16 ONLY)	680 5% 1/10W				
R3370	1-216-295-91	SHORT (KV-36FS16 ONLY)					
R3374	1-216-295-91	SHORT (KV-36FS16 ONLY)					
R3375	1-216-295-91	SHORT (KV-36FS16 ONLY)					
R3376	1-216-295-91	SHORT (KV-36FS16 ONLY)					
R3377	1-216-295-91	SHORT (KV-36FS16 ONLY)					
R3378	1-216-295-91	SHORT (KV-36FS16 ONLY)					
R3379	1-216-043-91	RES-CHIP (KV-36FS16 ONLY)	560 5% 1/10W				
R3381	1-216-033-00	RES-CHIP (KV-36FS16 ONLY)	220 5% 1/10W				
R3511	1-216-295-91	SHORT					
R3527	1-216-033-00	RES-CHIP	220 5% 1/10W				
R3582	1-216-033-00	RES-CHIP	220 5% 1/10W				
R3583	1-216-061-00	RES-CHIP	3.3K 5% 1/10W				
R3584	1-216-057-00	RES-CHIP	2.2K 5% 1/10W				
R3585	1-216-061-00	RES-CHIP	3.3K 5% 1/10W				
R3586	1-216-295-91	SHORT					
R3590	1-216-295-91	SHORT					
R3591	1-216-295-91	SHORT					
R3592	1-216-091-00	RES-CHIP	56K 5% 1/10W				
R3593	1-216-043-91	RES-CHIP	560 5% 1/10W				
R3594	1-216-295-91	SHORT					
R3595	1-216-295-91	SHORT					
R3599	1-216-295-91	SHORT					
CRYSTAL							
X3302	1-781-929-21	VIBRATOR, CRYSTAL (KV-36FS16 ONLY)					

**Note:**

The components identified by shading and mark \triangle are critical for safety. Replace only with part number specified.

Note:

Les composants identifiés par un trame et une marque \triangle sont critiques pour la sécurité. Ne les remplacer que par une pièce portant le numéro spécifié.

REF.NO.	PART NO.	DESCRIPTION	REMARK	REF.NO.	PART NO.	DESCRIPTION	REMARK
C1972	1-104-664-11	ELECT	47 μ F 20% 25V	Q944	8-729-422-27	TRANSISTOR 2SD601A-QRS-TX	
C1974	1-104-664-11	ELECT	47 μ F 20% 25V	Q945	8-729-422-27	TRANSISTOR 2SD601A-QRS-TX	
CONNECTOR				Q946	8-729-045-05	TRANSISTOR 2SA2005	
CN941 *	1-564-511-11	PLUG, CONNECTOR 8P		Q947	8-729-045-04	TRANSISTOR 2SC5511	
CN942 *	1-564-508-11	PLUG, CONNECTOR 5P		Q949	8-729-216-22	TRANSISTOR 2SB709A-QRS-TX	
CN961 *	1-770-723-11	CONNECTOR, BOARD TO BOARD 8P		Q961	8-729-422-27	TRANSISTOR 2SD601A-QRS-TX	
CN981 *	1-564-506-11	PLUG, CONNECTOR 3P		Q962	8-729-119-76	TRANSISTOR 2SA1309A-QRSTA	
DIODE				Q963	8-729-119-76	TRANSISTOR 2SA1309A-QRSTA	
D941	8-719-991-33	DIODE 1SS133T-77		Q965	8-729-931-45	TRANSISTOR IRF614	
D943	8-719-991-33	DIODE 1SS133T-77		Q966	8-729-216-22	TRANSISTOR 2SB709A-QRS-TX	
D944	8-719-991-33	DIODE 1SS133T-77		Q967	8-729-140-97	TRANSISTOR 2SB734-T-34	
D945	8-719-109-89	DIODE MTZJ-T-77-5.6C		Q968	8-729-422-27	TRANSISTOR 2SD601A-QRS-TX	
D946	8-719-110-88	DIODE MTZJ-T-77-39		Q969	8-729-422-27	TRANSISTOR 2SD601A-QRS-TX	
D947	8-719-110-88	DIODE MTZJ-T-77-39		Q1961	8-729-140-97	TRANSISTOR 2SB734-T-34	
D950	8-719-991-33	DIODE 1SS133T-77		Q1963	8-729-216-22	TRANSISTOR 2SB709A-QRS-TX	
D951	8-719-991-33	DIODE 1SS133T-77		Q1964	8-729-216-22	TRANSISTOR 2SB709A-QRS-TX	
D962	8-719-991-33	DIODE 1SS133T-77		Q1966	8-729-422-27	TRANSISTOR 2SD601A-QRS-TX	
D963	8-719-073-01	DIODE MA111-TX		Q1967	8-729-216-22	TRANSISTOR 2SB709A-QRS-TX	
D964	8-719-210-21	DIODE ERA82-004TP5		RESISTOR			
D966	8-719-075-41	DIODE PR1004GT		R941	1-249-441-11	CARBON	100K 5% 1/4W
D981	8-719-914-43	DIODE DAN202K-T-146		R943	1-216-033-00	RES-CHIP	220 5% 1/10W
D1961	8-719-991-33	DIODE 1SS133T-77		R944	1-216-049-91	RES-CHIP	1K 5% 1/10W
D1962	8-719-991-33	DIODE 1SS133T-77		R945	1-216-049-91	RES-CHIP	1K 5% 1/10W
FERRITE BEAD				R946	1-215-888-00	METAL OXIDE	220 5% 2W
FB901	1-410-397-21	FERRITE	1.1 μ H	R947	1-216-025-91	RES-CHIP	100 5% 1/10W
FB902	1-410-397-21	FERRITE	1.1 μ H	R949	1-216-057-00	RES-CHIP	2.2K 5% 1/10W
IC				R950	1-216-049-91	RES-CHIP	1K 5% 1/10W
IC961	8-759-803-42	IC LA6500-FA		R951	1-216-049-91	RES-CHIP	1K 5% 1/10W
IC962	8-759-659-67	IC NJM2903D		R952	1-216-041-00	RES-CHIP	470 5% 1/10W
IC963	8-759-659-67	IC NJM2903D		R953	1-216-021-00	RES-CHIP	68 5% 1/10W
IC964	8-759-700-42	IC NJM2904D		R954	1-216-033-00	RES-CHIP	220 5% 1/10W
IC965	8-759-701-59	IC NJM78M09FA		R955	1-216-047-91	RES-CHIP	820 5% 1/10W
COIL				R956	1-216-025-91	RES-CHIP	100 5% 1/10W
L961	1-459-104-00	COIL, WITH CORE		R957	1-216-073-00	RES-CHIP	10K 5% 1/10W
L964	1-406-989-21	INDUCTOR	10mH	R958	1-216-025-91	RES-CHIP	100 5% 1/10W
TRANSISTOR				R959	1-216-021-00	RES-CHIP	68 5% 1/10W
Q941	8-729-422-27	TRANSISTOR 2SD601A-QRS-TX		R960	1-216-065-91	RES-CHIP	4.7K 5% 1/10W
Q942	8-729-216-22	TRANSISTOR 2SB709A-QRS-TX		R961	1-216-091-00	RES-CHIP	56K 5% 1/10W
Q943	8-729-422-27	TRANSISTOR 2SD601A-QRS-TX		R962	1-216-077-91	RES-CHIP	15K 5% 1/10W
				R963	1-216-065-91	RES-CHIP	4.7K 5% 1/10W
				R964	1-216-073-00	RES-CHIP	10K 5% 1/10W
				R965	1-216-077-91	RES-CHIP	15K 5% 1/10W
				R966	1-216-073-00	RES-CHIP	10K 5% 1/10W
				R967	1-216-071-00	RES-CHIP	8.2K 5% 1/10W
				R968	1-208-802-11	METAL CHIP	6.8K 0.50% 1/10W
				R969	1-216-025-91	RES-CHIP	100 5% 1/10W
				R970	1-208-820-11	METAL CHIP	39K 0.50% 1/10W



Note:

The components identified by shading and mark △ are critical for safety. Replace only with part number specified.

Note:

Les composants identifiés par un trame et une marque △ sont critiques pour la sécurité. Ne les remplacer que par une pièce portant le numéro spécifié.

REF.NO.	PART NO.	DESCRIPTION	REMARK			
R971	1-216-049-91	RES-CHIP	1K	5%	1/10W	
R972	1-216-065-91	RES-CHIP	4.7K	5%	1/10W	
R973	1-216-057-00	RES-CHIP	2.2K	5%	1/10W	
R974	1-208-808-11	METAL CHIP	12K	0.50%	1/10W	
R975	1-216-073-00	RES-CHIP	10K	5%	1/10W	
R976	1-216-057-00	RES-CHIP	2.2K	5%	1/10W	
R977	1-249-401-11	CARBON	47	5%	1/4W	
R978	1-216-073-00	RES-CHIP	10K	5%	1/10W	
R979	1-216-033-00	RES-CHIP	220	5%	1/10W	
R980	1-216-073-00	RES-CHIP	10K	5%	1/10W	
R981	1-216-081-00	RES-CHIP	22K	5%	1/10W	
R982	1-216-051-00	RES-CHIP	1.2K	5%	1/10W	
R983	1-249-381-11	CARBON	1	5%	1/4W	
R984	1-249-383-11	CARBON	1.5	5%	1/4W	
R985	1-215-421-00	METAL	1K	1%	1/4W	
R986	1-216-057-00	RES-CHIP	2.2K	5%	1/10W	
R988	1-215-429-00	METAL	2.2K	1%	1/4W	
R990	1-216-025-91	RES-CHIP	100	5%	1/10W	
R991	1-208-800-11	METAL CHIP	5.6K	0.50%	1/10W	
R992	1-208-794-11	METAL CHIP	3.3K	0.50%	1/10W	
R993	1-216-049-91	RES-CHIP	1K	5%	1/10W	
R994	1-216-025-91	RES-CHIP	100	5%	1/10W	
R995	1-216-051-00	RES-CHIP	1.2K	5%	1/10W	
R1941	1-260-312-11	CARBON	47	5%	1/2W	
R1942	1-249-387-11	CARBON	3.3	5%	1/4W	
R1943	1-249-414-11	CARBON	560	5%	1/4W	
R1944	1-249-432-11	CARBON	18K	5%	1/4W	
R1945	1-215-914-11	METAL OXIDE	330	5%	3W	
R1946	1-249-417-11	CARBON	1K	5%	1/4W	
R1947	1-249-432-11	CARBON	18K	5%	1/4W	
R1948	1-249-414-11	CARBON	560	5%	1/4W	
R1949	1-249-387-11	CARBON	3.3	5%	1/4W	
R1950	1-249-401-11	CARBON	47	5%	1/4W	
R1951	1-216-097-91	RES-CHIP	100K	5%	1/10W	
R1952	1-216-097-91	RES-CHIP	100K	5%	1/10W	
R1953	1-216-085-00	RES-CHIP	33K	5%	1/10W	
R1954	1-208-822-11	METAL CHIP	47K	0.50%	1/10W	
R1955	1-208-808-11	METAL CHIP	12K	0.50%	1/10W	
R1956	1-216-057-00	RES-CHIP	2.2K	5%	1/10W	
R1957	1-216-295-91	SHORT				
R1958	1-216-061-00	RES-CHIP	3.3K	5%	1/10W	
R1959	1-216-073-00	RES-CHIP	10K	5%	1/10W	
R1960	1-216-037-00	RES-CHIP	330	5%	1/10W	
R1961	1-208-820-11	METAL CHIP	39K	0.50%	1/10W	
R1962	1-208-806-11	METAL CHIP	10K	0.50%	1/10W	
R1963	△ 1-216-033-00	RES-CHIP	220	5%	1/10W	
R1964	1-216-057-00	RES-CHIP	2.2K	5%	1/10W	
R1967	1-215-489-00	METAL	680K	1%	1/4W	
R1969	1-216-073-00	RES-CHIP	10K	5%	1/10W	

REF.NO.	PART NO.	DESCRIPTION	REMARK			
R1970	1-216-065-91	RES-CHIP	4.7K	5%	1/10W	
R1971	1-216-121-91	RES-CHIP	1M	5%	1/10W	
R1972	1-216-073-00	RES-CHIP	10K	5%	1/10W	
R1973	1-216-035-00	RES-CHIP	270	5%	1/10W	
R1975	1-216-073-00	RES-CHIP	10K	5%	1/10W	
R1976	1-208-794-11	METAL CHIP	3.3K	0.50%	1/10W	
R1978	1-216-025-91	RES-CHIP	100	5%	1/10W	
R1980	1-216-041-00	RES-CHIP	470	5%	1/10W	
R1981	1-216-081-00	RES-CHIP	22K	5%	1/10W	
R1982	1-216-081-00	RES-CHIP	22K	5%	1/10W	
R1983	1-216-073-00	RES-CHIP	10K	5%	1/10W	
R1984	1-216-089-91	RES-CHIP	47K	5%	1/10W	
R1987	1-208-818-11	METAL CHIP	33K	0.50%	1/10W	
R1989	1-208-818-11	METAL CHIP	33K	0.50%	1/10W	
R1990	1-216-089-91	RES-CHIP	47K	5%	1/10W	
R1991	1-216-081-00	RES-CHIP	22K	5%	1/10W	
R1992	1-216-057-00	RES-CHIP	2.2K	5%	1/10W	
R2962	1-215-885-00	METAL OXIDE	68	5%	2W	
R2965	1-216-065-91	RES-CHIP	4.7K	5%	1/10W	
R2968	1-208-794-11	METAL CHIP	3.3K	0.50%	1/10W	
R2969	1-216-065-91	RES-CHIP	4.7K	5%	1/10W	
R2971	1-208-826-11	METAL CHIP	68K	0.50%	1/10W	
R2972	1-216-113-00	RES-CHIP	470K	5%	1/10W	
R2973	1-216-025-91	RES-CHIP	100	5%	1/10W	
R2975	1-216-061-00	RES-CHIP	3.3K	5%	1/10W	
R2976	1-216-025-91	RES-CHIP	100	5%	1/10W	
R2979	1-216-097-91	RES-CHIP	100K	5%	1/10W	
R2980	1-216-097-91	RES-CHIP	100K	5%	1/10W	

VARIABLE RESISTOR

RV941 1-238-019-11 RES, ADJ, CARBON 47K

ACCESSORIES AND PACKAGING

- * 4-066-646-01 BAG, PROTECTION
- * 4-075-691-01 CARTON, INDIVIDUAL
(KV-36FS12/36FS16 ONLY)
- * 4-069-515-01 CARTON, INDIVIDUAL
(KV-36FV16/36FV26ONLY)
- * 4-075-048-01 CUSHION ASSY, FRONT (UPPER)
(KV-36FS12/36FS16 ONLY)
- 4-069-389-01 CUSHION ASSY, FRONT (UPPER)
(KV-36FV16/36FV26ONLY)
- * 4-075-047-01 CUSHION ASSY, LOWER
(KV-36FS12/36FS16 ONLY)

KV-36FS12/36FS16/36FV16/36FV26

Note:

The components identified by shading and mark  are critical for safety. Replace only with part number specified.

Note:

Les composants identifiés par un trame et une marque  sont critiques pour la securite. Ne les remplacer que par une piece portant le numero specifie.

REF.NO.	PART NO.	DESCRIPTION	REMARK	REF.NO.	PART NO.	DESCRIPTION	REMARK
*	4-069-390-01	CUSHION ASSY, LOWER (KV-36FV16/36FV26ONLY)					
	8-953-742-90	HEADPHONE MDR-IF0230//K SET (KV-36FV26 ONLY)					
	4-075-587-21	MANUAL, INSTRUCTION					
<u>REMOTE COMMANDER</u>							
	1-418-387-11	REMOTE COMMANDER (RM-Y168) (KV-36FS12 ONLY)					
	1-418-384-11	REMOTE COMMANDER (RM-Y169) (KV-36FS16 ONLY)					
	1-418-465-11	REMOTE COMMANDER (RM-Y170) (KV-36FV26 ONLY)					
	1-418-496-11	REMOTE COMMANDER (RM-Y171) (KV-36FV16 ONLY)					
	4-978-977-01	BATTERY COVER (FOR RM-Y168/RM-Y169/RM-Y170/RM-Y171)					

PRINTING THE SERVICE MANUAL

The PDF of this service manual is not designed to be printed from cover to cover. The pages vary in size, and must therefore be printed in sections based on page dimensions.

NON-SCHEMATIC PAGES

Data that does NOT INCLUDE schematic diagrams are formatted to 8.5 x 11 inches and can be printed on standard letter-size and/or A4-sized paper.

SCHEMATIC DIAGRAMS

The schematic diagram pages are provided in two ways, full size and tiled. The full-sized schematic diagrams are formatted on paper sizes between 8.5" x 11" and 18" x 30" depending upon each individual diagram size. Those diagrams that are LARGER than 11" x 17" in full-size mode have been tiled for your convenience and can be printed on standard 11" x 17" (tabloid-size) paper, and reassembled.

TO PRINT FULL SIZE SCHEMATIC DIAGRAMS

If you have access to a large paper plotter or printer capable of outputting the full-sized diagrams, output as follows:

- 1) Note the page size(s) of the schematics you want to output as indicated in the middle window at the bottom of the viewing screen.
- 2) Go to the File menu and select Print Set-up. Choose the printer name and driver for your large format printer. Confirm that the printer settings are set to output the indicated page size or larger.
- 3) Close the Print Set Up screen and return to the File menu. Select "Print..." Input the page number of the schematic(s) you want to print in the print range window. Choose OK.

TO PRINT TILED VERSION OF SCHEMATICS



Schematic pages that are larger than 11" x 17" full-size are provided in a 11" x 17" printable tiled format near the end of the document. These can be printed to tabloid-sized paper and assembled to full-size for easy viewing.

If you have access to a printer capable of outputting the tabloid size (11" x 17") paper, then output the tiled version of the diagram as follows:

- 1) Note the page number(s) of the schematics you want to output as indicated in the middle window at the bottom of the viewing screen.
- 2) Go to the File menu and select Print Set-up. Choose the printer name and driver for your printer. Confirm that the plotter settings are set to output 11" x 17", or tabloid size paper in landscape () mode.
- 3) Close the Print Set Up screen and return to the File menu. Select "Print..." Input the page number of the schematic(s) you want to print in the print range window. Choose OK.

TO PRINT SPECIFIC SECTIONS OF A SCHEMATIC

To print just a particular section of a PDF, rather than a full page, access the Graphics Select tool in the Acrobat Reader tool bar.

- 1) To view the Graphics Select Tool, press and HOLD the mouse button over the Text Select Tool which looks like: . This tool will expand to reveal to additional tools. Choose the Graphics Select tool by placing the cursor over the button on of the far right that looks like: 
- 2) After selecting the Graphics Select Tool, place your cursor in the document window and the cursor will change to a plus (+) symbol. Click and drag the cursor over the area you want to print. When you release the mouse button, a marquee (or dotted lined box) will be displayed outlining the area you selected.
- 3) With the marquee in place, go to the file menu and select the "Print..." option. When the print window appears, choose the option under the section called "Print Range" which says "Selected Graphic".

Select OK and the output will print only the area that you outlined with the marquee. 

(continued >)

ON-SCREEN SEARCH OPTION

All of the text within the service manual PDF is content searchable. This means that you can enter any text, word, phrase or reference number that appears in the manual, and the PDF software will search, find and move the cursor to the location where you requested text first appears. This feature can be particularly useful in locating components on a specific schematic or printed wire circuit board (PWB) diagrams.

Follow these steps to effectively locate a component on a schematic diagram:

- 1) Locate the schematic you want to search by clicking on the corresponding bookmark on the left side of the screen. The view on the right of the screen will then jump to the desired schematic page.
- 2) Magnify the diagram to at least 400% before conducting a component search. This will enable you to easily view the reference number when it is highlighted on screen. To do this, click on the magnifying glass button on the tool bar at the top of the screen. Move the cursor over the diagram and RIGHT click you mouse. Select the 400% magnification option on the pop-up menu. Click on the button with the icon of the open hand to deactivate the magnification tool
- 3) Search the diagram (or the entire manual) by clicking on the binocular button tool at the top of the screen. The "Find" window will appear and allow you to type in your desired text. Type in a reference designator, such as R502, and click on the "Find" button. If the component is not on the diagram, but is listed anywhere else in the manual, the cursor will jump to the first location the text is found in the file. To find another instance of that same text, click on the binocular button again and select "Find Again."

HISTORY INFORMATION FOR THE FOLLOWING MANUAL:

SERVICE MANUAL

AA-2U CHASSIS

<i>MODEL NAME</i>	<i>REMOTE COMMANDER</i>	<i>DESTINATION</i>	<i>CHASSIS NO.</i>
KV-36FS12	RM-Y168	US	SCC-S44A-A
KV-36FS12	RM-Y168	CND	SCC-S45A-A
KV-36FS12	RM-Y168	HAWAII	SCC-S46A-A
KV-36FS16	RM-Y169	US	SCC-S44B-A
KV-36FS16	RM-Y169	CND	SCC-S45B-A
KV-36FS16	RM-Y169	HAWAII	SCC-S46B-A
KV-36FV16	RM-Y171	US	SCC-S44C-A
KV-36FV16	RM-Y171	HAWAII	SCC-S46C-A
KV-36FV26	RM-Y170	US	SCC-S44D-A
KV-36FV26	RM-Y170	CND	SCC-S45C-A
KV-36FV26	RM-Y170	HAWAII	SCC-S46D-A
KV-38FS16	RM-Y169	MEXICO	SCC-S50F-A

ORIGINAL MANUAL ISSUE DATE: 5/2000

ALL REVISIONS AND UPDATES TO THE ORIGINAL MANUAL ARE APPENDED TO THE END OF THE PDF FILE.

REVISION DATE	REVISION TYPE	SUBJECT
5/2000	No revisions or updates are applicable at this time	
6/2000	CORRECTION-1	Added new Door Assy. to Exploded View. ITC Assy. Ref. No. Corrected
2/2001	CORRECTION-2	Tuner and Terminal Labels for Rear Cover
10/2001	SUPPLEMENT-1	New model added. New multi-button (top) P/N on exploded view. New instruction manual

TRINITRON® COLOR TELEVISION
SONY®

<i>MODEL</i>	<i>COMMANDER</i>	<i>DEST</i>	<i>CHASSIS NO.</i>
KV-36FS12	RM-Y168	US	SCC-S44A-A
KV-36FS12	RM-Y168	CND	SCC-S45A-A
KV-36FS12	RM-Y168	HAWAII	SCC-S46A-A
KV-36FS16	RM-Y169	US	SCC-S44B-A
KV-36FS16	RM-Y169	CND	SCC-S45B-A
KV-36FS16	RM-Y169	HAWAII	SCC-S46B-A
KV-36FV16	RM-Y171	US	SCC-S44C-A
KV-36FV16	RM-Y171	HAWAII	SCC-S46C-A
KV-36FV26	RM-Y170	US	SCC-S44D-A
KV-36FV26	RM-Y170	CND	SCC-S45C-A
KV-36FV26	RM-Y170	HAWAII	SCC-S46D-A

CORRECTION-1

**Subject: Add Door Assy to Exploded View.
ITC Assy Ref. No. Corrected**

**Correct the service manual as shown below.
File this correction with the service manual.**

- Section 7: Exploded Views (Pages 81, 83)
Door Assy added to Exploded View**
- Section 7: Exploded View (Page 83)
ITC Ref. No. Changed from 29 to 34**

 : Corrected Item

Note:

The components identified by shading and mark  are critical for safety. Replace only with part number specified.





Note:

Les composants identifiés par un trame et une marque  sont critiques pour la sécurité. Ne les remplacer que par une pièce portant le numéro spécifié.

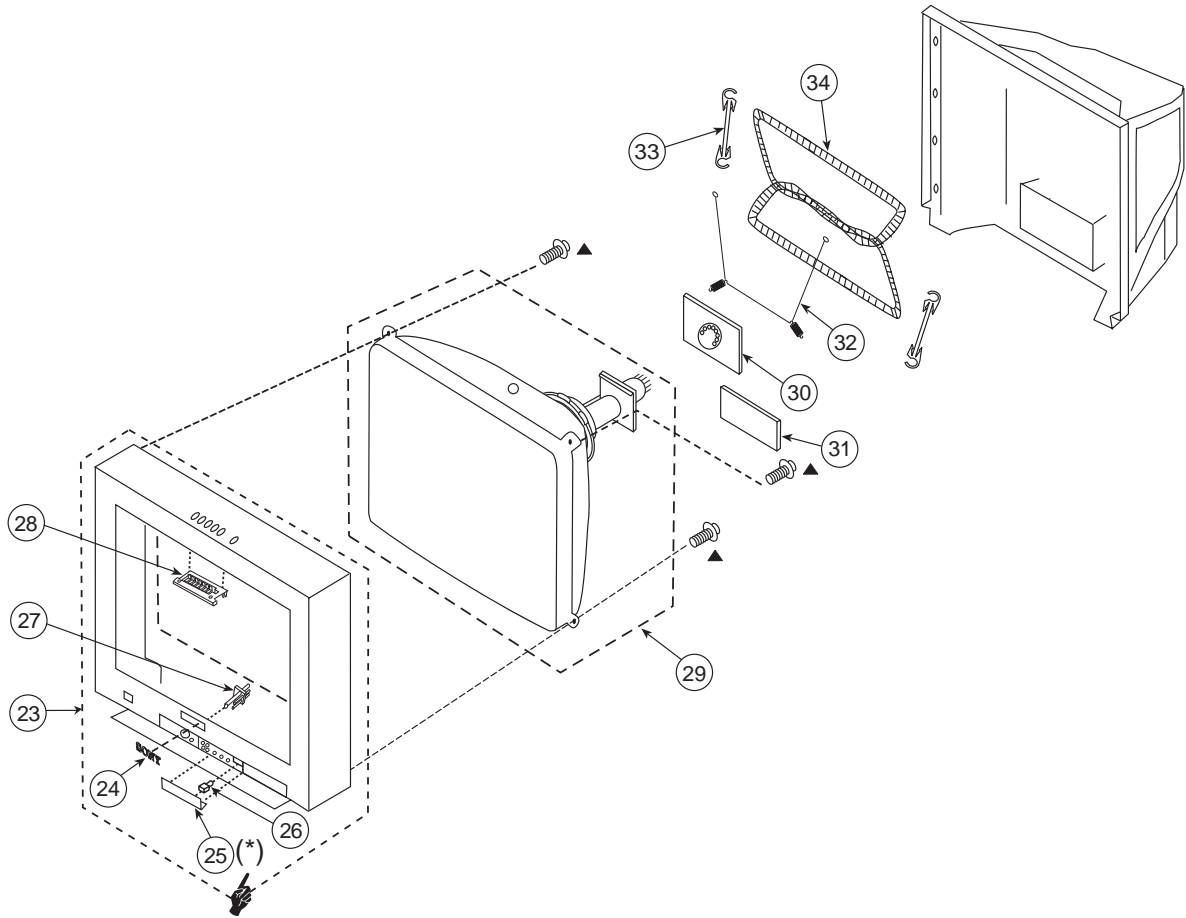
7-2. PICTURE TUBE (KV-36FS12/36FS16 ONLY)

 4-046-765-12 SCREW (7) TAPPING



REF. NO.	PART NO.	DESCRIPTION	REMARK
23	X-4037-665-1	BEZNET ASSY	24-26
24	3-704-179-31	EMBLEM (NO.9), SONY	
25	4-075-658-01	DOOR	
 25(*)	X-4037-631-3	DOOR ASSY	
(NOTE: The above part must be ordered when replacing the door only)			
26	4-047-464-01	CATCHER, PUSH	
27	4-075-657-01	GUIDE, LED	
28	4-068-982-02	MULTI-BUTTON (TOP)	
29 	8-735-048-61	ITC 38RSN-A1 (US/Canada models only)	
29 	8-735-081-61	ITC 38RSN-A1M (Hawaii models only)	
30	* A-1331-942-A	C (VAR) MOUNTED PC BOARD	
31	* A-1375-191-A	WA COMPLETE PC BOARD	
32	4-036-329-01	SPRING (B), TENSION	
33	4-065-895-03	HOLDER, DGC	
34 	1-416-828-31	COIL, DEGAUSSING	

Note:

The components identified by shading and mark ▲ are critical for safety. Replace only with part number specified.

Note:

Les composants identifiés par un triangle et une marque ▲ sont critiques pour la sécurité. Ne les remplacer que par une pièce portant le numéro spécifié.

7-4. PICTURE TUBE (KV-36FV16/36FV26 ONLY)

▲ 4-046-765-12 SCREW (7) TAPPING

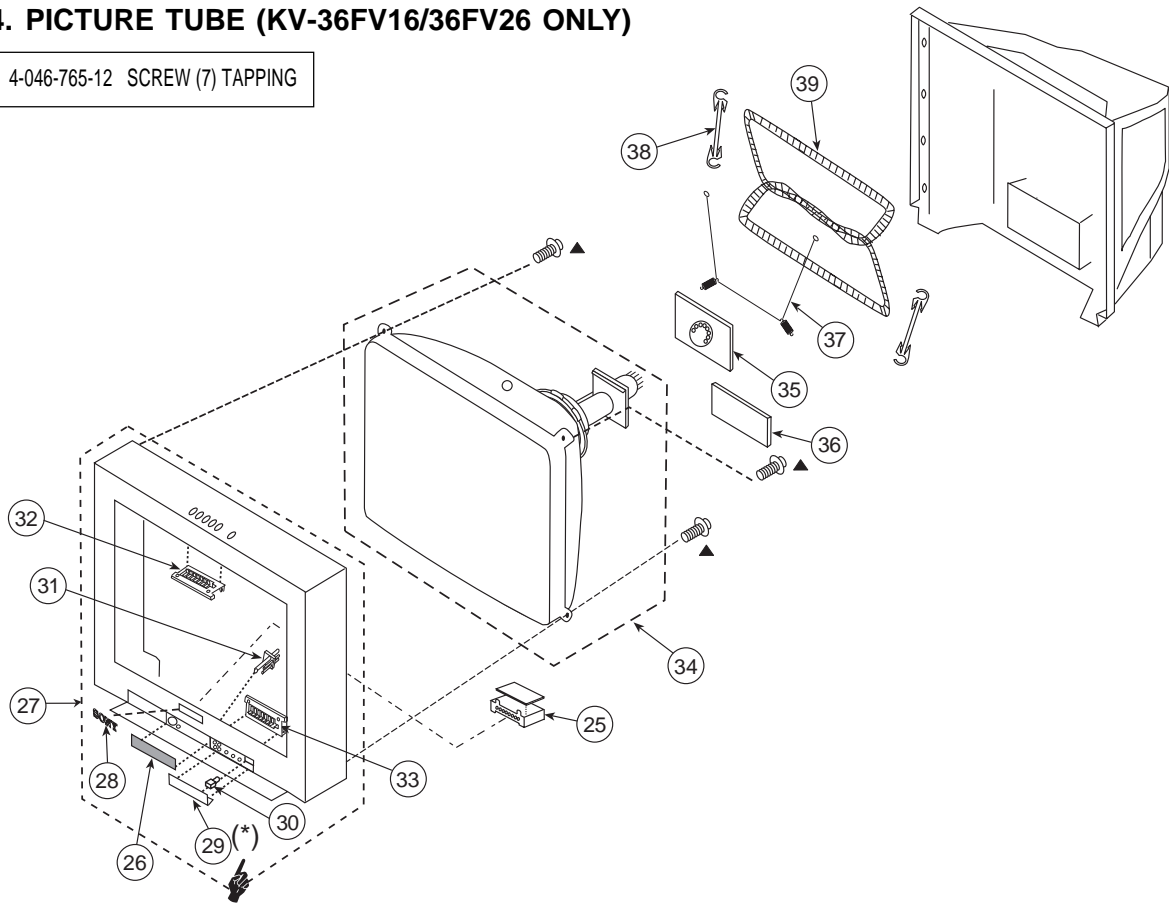

REF.NO.	PART NO.	DESCRIPTION	REMARK
25	* 4-068-992-01	CASE, IR SHIELD (KV-36FV26 ONLY)	
26	4-068-991-01	PANEL, IR (KV-36FV26 ONLY)	
27	X-4037-910-1	BEZNET ASSY (KV-36FV26 ONLY)	28-30
27	X-4037-909-1	BEZNET ASSY (KV-36FV16 ONLY)	28-30
28	3-704-179-31	EMBLEM (NO.9), SONY	
29	4-068-985-04	DOOR	
29(*)	X-4037-631-3	DOOR ASSY. (NOTE: The above part must be ordered when replacing the door only)	
30	3-703-574-00	RETAINER, DOOR	
31	4-068-986-01	GUIDE, LED	
32	4-068-982-02	MULTI-BUTTON (TOP)	
33	4-068-984-01	MULTI-BUTTON (BOTTOM)	
34	▲ 8-735-048-61	ITC 38RSN-A1 (US/Canada models only)	
34	▲ 8-735-081-61	ITC 38RSN-A1M (Hawaii models only)	
35	* A-1331-942-A	C (VAR) MOUNTED PC BOARD	
36	* A-1375-191-A	WA COMPLETE PC BOARD	
37	4-036-329-01	SPRING (B), TENSION	
38	4-065-895-03	HOLDER, DGC	
39	▲ 1-416-828-31	COIL, DEGAUSSING	

SERVICE MANUAL

AA-2U CHASSIS

<u>MODEL</u>	<u>COMMANDER</u>	<u>DEST</u>	<u>CHASSIS NO.</u>
KV-36FS12	RM-Y168	US	SCC-S44A-A
KV-36FS12	RM-Y168	CND	SCC-S45A-A
KV-36FS12	RM-Y168	HAWAII	SCC-S46A-A
KV-36FS16	RM-Y169	US	SCC-S44BA-A
KV-36FS16	RM-Y169	CND	SCC-S45B-A
KV-36FS16	RM-Y169	HAWAII	SCC-S46B-A
KV-36FV16	RM-Y171	US	SCC-S44C-A
KV-36FV16	RM-Y171	HAWAII	SCC-S46C-A
KV-36FV26	RM-Y170	US	SCC-S44D-A
KV-36FV26	RM-Y170	CND	SCC-S45C-A
KV-36FV26	RM-Y170	HAWAII	SCC-S46D-A

CORRECTION - 2



SUBJECT: Tuner and Terminal labels for rear cover must be ordered separately using the part numbers provided on this correction sheet.

**Correct the service manual as shown.
File this Correction with the service manual.**

Section 7: Exploded View - Page 82

7-3: CHASSIS (KV-36FV16/36FV26 ONLY)

 : Corrected Item

Incorrect			Correct		
REF NO.	PART NO.	DESCRIPTION	REF NO.	PART NO.	DESCRIPTION
20	4-068-998-01	COVER, REAR	 20	4-068-998-03	COVER, REAR (**SEE NOTE BELOW)
Not Listed	---->	Needs to be Added	 21	4-070-353-01	TUNER TERMINAL LABEL
Not Listed	---->	Needs to be Added	 22	4-076-655-21	TERMINAL LABEL

**** The rear cover does not include any terminal labels. These labels (items 21 and 22) must be ordered separately when ordering a replacement rear cover.**

TRINITRON® COLOR TV
SONY®

SERVICE MANUAL

AA-2U CHASSIS

<u>MODEL NAME</u>	<u>REMOTE COMMANDER</u>	<u>DESTINATION</u>	<u>CHASSIS NO.</u>
KV-36FS12	RM-Y168	US	SCC-S44A-A
KV-36FS12	RM-Y168	CND	SCC-S45A-A
KV-36FS12	RM-Y168	HAWAII	SCC-S46A-A
KV-36FS16	RM-Y169	US	SCC-S44B-A
KV-36FS16	RM-Y169	CND	SCC-S45B-A
KV-36FS16	RM-Y169	HAWAII	SCC-S46B-A
KV-36FV16	RM-Y171	US	SCC-S44C-A
KV-36FV16	RM-Y171	HAWAII	SCC-S46C-A
KV-36FV26	RM-Y170	US	SCC-S44D-A
KV-36FV26	RM-Y170	CND	SCC-S45C-A
KV-36FV26	RM-Y170	HAWAII	SCC-S46D-A
 KV-38FS16	RM-Y169	MEXICO	SCC-S50F-A

SUPPLEMENT - 1

SUBJECT: NEW MODEL ADDED. NEW MULTI-BUTTON (TOP) P/N ON EXPLODED VIEW. NEW INSTRUCTION MANUAL

Correct the service manual as shown.
File this Correction with the service manual.

TRINITRON® COLOR TELEVISION
SONY®

 : Modified Item

Section 7: Exploded View (Page 81)

7-2. Picture Tube (KV-36FS12/36FS16/38FS16)

INCORRECT

CORRECT

REF. NO.	PART NO.	DESCRIPTION	[Assembly Includes]	REF. NO.	PART NO.	DESCRIPTION
28	4-068-982-02	MULTI-BUTTON (TOP)		 28	4-068-982-06	MULTI-BUTTON (TOP)

Section 8: Electrical Parts List (Page 116)

ACCESSORIES AND PACKAGING

INCORRECT

CORRECT

REF. NO.	PART NO.	DESCRIPTION	[Assembly Includes]	REF. NO.	PART NO.	DESCRIPTION
4-075-587-21		MANUAL, INSTRUCTION (KV-36FS12/36FS16 ONLY)		4-075-587-23		MANUAL, INSTRUCTION (KV-36FS12/36FS16 ONLY) (English)
				4-081-776-42		MANUAL, INSTRUCTION (KV-38FS16 ONLY) (Spanish)