

## **Images from Philco's Past**

A Basement Gives Up Forgotten Gems (page 14)

**A.R.C. - The International Publication For  
Buyers & Sellers Of Old Radios & Related Items**

# Estes Auctions

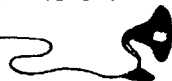

Specializing in Vintage Radios  
Complete Auction & Appraisal Service

## Vintage Radio Auction

**Saturday, July 21, 2012 - 10AM EST**

At the Expo Auction Center  
8157 Garman Rd., Burbank Ohio

From I-71 Exit #204 turn south on SR #83 then turn left at  
the Love's gas station onto Garman Rd., follow it ¾ mile to the auction.

Featuring radios of all types and includes a nice selection of amateur radio equipment listed on a separate flyer. This auction will offer a group of console style radios from a collection out of New York and they are all in very nice condition. Different makes of cathedral and tombstone radios with several Atwater-Kents, many battery sets, horn type speakers with a beautiful Burns petal style speaker. Magnavox, Atwater-Kent, Radiola and more. Lots of cone type speakers, Atwater-Kent, Crosley, several Western Electric needing reconditioned. Many headphones, different brands, lots of table radios to sell - wood type and bakelite types. There are table top wind-up phonographs, console phonographs, a large quantity of 78 RPM disc records, an Edison standard phonograph, Ediston cylinder records, Edison diamond disc records. We will offer a great selection of tubes including Western Electric tennis ball type and others. Lots of 201A, 301A, UX-199 - UV-199, Blue Arcturus, 112, 200, WD-11, WD12, 45, 47, 80, 6L6, 2A3, ST style 50, 26, 27, 30, and many amateur transmitting tubes. A big selection of radio test equipment, several tube checkers, signal generators, capacitor checkers, scope, volt meters, and more. Books and magazines - reference types, price guides, radio news, radio craft, Beitman radio repair manuals Riders, citizens radio call book, several early wireless age magazines, lots of radio parts - capacitors, resistors, knobs, tuning capacitors. We have several telegraph sounders, parts bins, utility cabinets and other radio related items. There are audio pieces, tuners, amps, reel to reel tape recorders, some audio tubes. This will be another good auction and we look forward to seeing you there and the week before at the Marc Extravaganza in Lansing. We will be auctioning a **RARE Spartan Nocturne** radio at the meet. This is the RAREST and most highly prized and sought after radio of the wonderful Art Deco period of the 1930's. Hope to see you there!

***Don't forget the Early Sale from 8:30 AM until 10 AM***

**Terms: Cash/Check/Visa/MasterCard; 5% Gallery Fee**

### **ESTES AUCTIONS**

7404 Ryan Road, Medina, Ohio 44256

Ph: 330-769-4992 • Toll Free: 888-769-4992 • Fax: 330-769-4116

[www.estesauctions.com](http://www.estesauctions.com) • Email: [estesauctions@aol.com](mailto:estesauctions@aol.com)

Richard Estes, Auctioneer -- Radio Call Sign K8LRY

John Estes, Auctioneer -- Radio Call Sign KB8GEC

Cledis Estes - Auctioneer • Mark Delauter - Auctioneer • Cindy Brown - Auctioneer • Bob Dobush - Tubes • Bob White - Tubes • Kim Graca - Tech. • Allan Ferris - Set up

***Call Us to Sell One Radio or Your Entire Collection! We offer pick-up service for your collection.***

***auctionzip.com #20507***

***Next Radio Sale August 18, 2012***



## THE HISTORY OF RADIO ON CD-ROM

Radio Era Archives produced the *QST-VIEW* series of CD's for the American Radio Relay League (ARRL) and over 1/2 million CD's have been sold. *QST* Magazine has been continuously published since 1915. We are now proud to announce that this small mountain of CD's (about 35) is now available exclusively from REA (All Sets) ! Every magazine published from 1915 to 1994, front cover to back cover, every article and column, all accessible with our database search engine.

**QST-VIEW CD Edition** truly captures the history of radio in 11 volumes. All CD's warranted to work on all Windows platforms from Windows 95 through XP. Each set is \$ 39.95 and we have all sets in stock. The sets are: 1915-1929, 1930-1939, 1940-1949, 1950-1959, 1960-1964, 1965-1969, 1970-1974, 1975-1979, 1980-1984, 1985-1989, 1990-1994. Each set of years is a self-contained set so you can operate one or all sets together. Now that large capacity hard drives are so inexpensive, the 36 CD's can be loaded on about 20Gb of hard disc space for instant searching and viewing without having to swap discs! Full information is provided with each purchase and *QST-VIEW* has on-line instructional help for operating the *QST-VIEW* browser!

**EACH SET \$ 39.95 (specify the years)**

**ALL 11 SETS \$ 379**

**S&H USA for first set is \$ 5.00, add \$ 1.00 each set thereafter**

**S&H Export first set is \$ 15.00, add \$ 2.00 for each set thereafter**

### 2009 1/2 PRICE SPECIAL (while supply lasts)

Don't forget, we have the entire John Rider's Perpetual Troubleshooters Manuals on a single DVD. All 23 Volumes of the Riders available at the click of a mouse! Over 120,000 different model radio schematics and related service information in an easy to use DVD. **Thousands sold at \$ 199. SPECIAL \$ 99 + \$ 6.00 S&H in the USA, add \$12 for worldwide delivery. Order Now while supply lasts !**

**We now have a small mountain of vacuum tubes at very competitive prices - Thousands sold since our first posting of these tubes. All types including receiving and transmitting types. Tube price listings on the web:**  
<http://www.radioera.com/tubes.asp>

### **SCHEMATIC DIAGRAM & MANUAL SERVICE**

Over a Million schematics & 100,000 manuals and growing! Schematics and most manuals may be emailed instantly via the internet

Check the web - On-line antique radio flea market - Radios for sale - Antique radio museum - Zenith Trans-Oceanic museum - thousands of old catalogs, manuals, literature, information, how-to data, reference, auction price section and much-much more! Visit antique radios largest web address today!

## **RADIO ERA ARCHIVES**

2043 Empire Central  
Dallas, Texas 75235  
Inquiries: 214-358-5195

OFFICE HOURS 10AM - 4PM DAILY M-F

**Visit us on the Internet:**  
[www.radioera.com](http://www.radioera.com)

# ANTIQUÉ RADIO CLASSIFIED

June 2012 • Volume 29 • Number 6

The International Publication for Buyers and Sellers of  
Old Radios and Related Items – Published Monthly

[www.antiqueradio.com](http://www.antiqueradio.com)

## 3 Publisher's Comments

## 4 Restoration of a Raytheon 10DX24 Television Set

By Lou Tramontozzi

## 7 The Visual Lee de Forest

By Mike Adams

## 11 A Visit to the Early Television Museum, Hillard, Ohio

By Jon Kummer

## 14 Photo Review – Special Edition

## 18 Classified Advertisements

## 28 Coming Radio Events

## 38 Radio Clubs

### Coming Up...

Writer Daniel Schoo describes his restoration of a Knight Model E-10803/E-10818 table radio and the unexpected request that led to it.

**Antique Radio Classified** (ISSN:8750-7471) is published monthly, 12 times per year, by Vintage Radio Publishing, LLC, PO Box 1558, Port Washington, NY 11050. Periodicals postage paid at Port Washington, NY, and additional mailing offices.

Annual subscription rates: U.S. - \$36.00 by Periodicals mail, \$48.00 by First Class mail; Canada - \$50.00; Mexico - \$60.00; other foreign countries - \$70.00. Web-Only - \$30.00. For multiple year rates see website.

© 2012 by Vintage Radio Publishing, LLC

POSTMASTER: Send address changes to  
**Antique Radio Classified**, PO Box 1558,  
Port Washington, NY 11050.

Printed in U.S.A.

**PURPOSE** - *Antique Radio Classified* is published for people involved in the radio collecting hobby. Its purpose is to stimulate growth of the hobby through the buying, selling and trading of radios and related items, and to provide a monthly forum for the interchange of ideas and information.

**Publisher:** Jon Kummer, **Editor/Art Director:** Edith Lennen, **Publisher/Editor Emeritus:** John Terrey, **Founding Publisher/Editor:** Gary B. Schneider, **Contributing Editor:** John Terrey, **Contributing Writers & Consultants:** Mike Adams, Ray Bintliff, Ray Chase, Dave Crocker, Alan Douglas, Richard Foster, Daniel Schoo, John Vuolu.

### CONTACTING ANTIQUÉ RADIO CLASSIFIED

All correspondence should be sent to:  
**A.R.C., PO Box 1558, Port Washington, NY 11050**  
**Telephone: (866) 371-0512; Fax: (516) 883-1077**  
**Email: [ARC@antiqueradio.com](mailto:ARC@antiqueradio.com)**  
**Web: [www.antiqueradio.com](http://www.antiqueradio.com)**

Unfortunately, A.R.C. is not staffed to answer all letters with questions about antique radios or requests for advice. However A.R.C. does solicit letters of interest from its readers and publishes them as space permits.

**ADVERTISING.** Display and Classified advertising rates and artwork specifications are available on the web site.

**CHANGE OF ADDRESS.** Please notify us in advance of a change of address. Send your new address, your old address, your SUB# and the effective date of the change.

**PUBLISHING RIGHTS.** Unless other arrangements are made: (1) All received materials (ads, articles, letters, correspondence, email, photos, artwork, etc.) become the property of A.R.C., may be edited, combined with other material, published, and will not be returned. (2) For all received materials, A.R.C. is granted publishing and reprint rights in all forms of media including the monthly printed magazine, internet, etc. (3) Publication is subject to approval by A.R.C. and to time and space constraints.

**DISCLAIMER.** The publisher is not responsible for any buying and selling transactions incurred, or for any other use of the contents of this publication.

**NOTICE.** Subscription rates, frequency of publication, content, policies, size and ad details, and rates are subject to change at any time by A.R.C.

**ATTENTION SUBSCRIBERS:** All paid subscribers receive a **FREE** classified ad of up to 50 words in each issue.



## Publisher's Comments

Over the past couple of years I've noticed a decrease in television receivers at many meets. It also seems that the number of TV-related auctions has gone down. If true, this is a real shame. Televisions represent another fascinating part of broadcasting history, one that *A.R.C.* certainly values. But while the number of TVs may have dropped a bit, the amount of vintage audio equipment has increased. I'm not sure if this is a trend that will continue or is just temporary, but it's worthy of notice. Other venues like eBay reflect what's happening at our meets. The number of vintage audio equipment auctions is huge. Even the audio vacuum tube auctions have taken off—not only in quantity but also in prices realized. Just recently I noticed an auction of used JAN 6SN7 tubes that garnered prices of \$100 each!

Let us know if you have made similar observations at the events and meets you attend or on the auction websites. We'd like to publish your findings.

But proudly bucking this maybe-trend this month, we're delighted to feature a nice television restoration article by Lou Tramontozzi. Lou brought back to life a rare 1948 Raytheon 10DX24 porthole-style TV. Restoring TVs has never been easy—every bad capacitor in the video circuits is always visible on the screen! It makes for an interesting challenge for any serious hobbyist.

If you live in or find yourself visiting eastern Ohio this summer, we suggest you stop in at the Early Television Museum in the town of Hilliard, near Columbus. This month we have an article on the history of the museum that also highlights some items in its impressive collection. Whether you collect TVs or not, it's a fantastic place to visit. The collection is nicely displayed and contains examples from the early mechanical to the electronic receivers we're all familiar with. Every May the museum also hosts an excellent television convention. Be sure to check it out.

In this issue *A.R.C.* also welcomes back Mike Adams, who shares an article on Lee de Forest. We all know de Forest and his radio contributions, but here Mike concentrates on de Forest's film and television work. And Mike really knows his stuff: he's the author of the recently published *Lee de Forest – King of Radio, TV, and Film*.

Finally, this month's "Photo Review" takes on a different format. Recently a box containing original photographic slides from the Philco Corporation were found in a murky basement (what could be better?!). There were some 80 color slides that were used in late 1954 by Philco salespeople to promote the upcoming 1955 line of radios, televisions, and phonographs. While some readers may feel this covers items that are "almost modern," it's fascinating to get a glimpse at how Philco marketed them, including using in-store merchandising displays. You can see the photographs in color on the *A.R.C.* website.

On a side note, we haven't been receiving many submissions for the "Photo Review," and we really need those to keep running the section. All you have to do is take a photo and send it in by mail or email with a short description. How about it?

As always, I would like to wish everyone happy collecting and a great summer!

Jon Kummer  
Publisher

### On The Cover

This month's cover features one of the 1955 Philco photographic slides from a recent basement "rediscovery" (see "Photo Review" starting on page 14). Philco called this merchandising display the "Finger Tip Wrap." It promoted the easy fingertip-tuning of the company's television receivers.

# TELEVISION RESTORATION

## Restoration of a Raytheon 10DX24 Television Set

BY LOU TRAMONTOZZI, KA1HIH

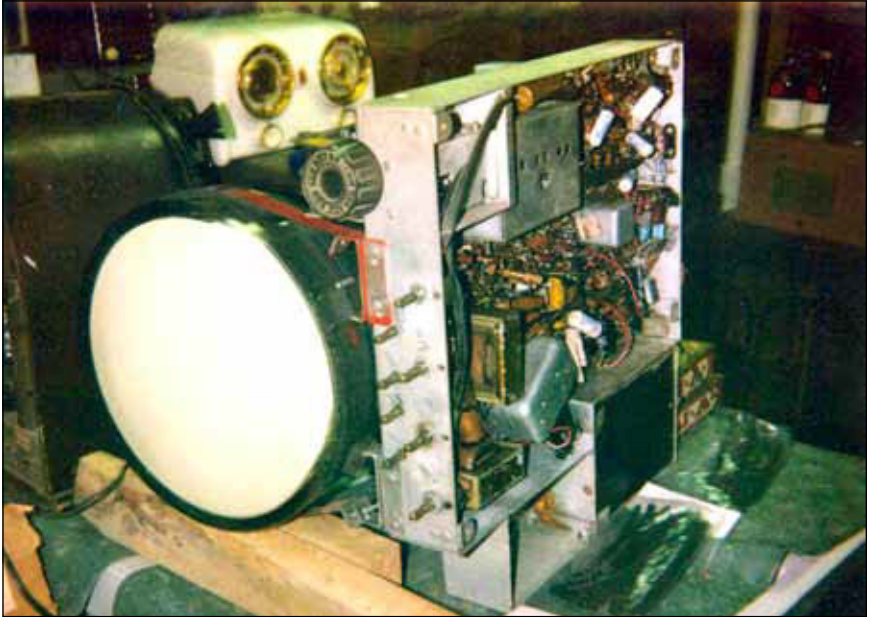

*Figure 1. Raytheon 10DX24 front view.*

I have restored a good number of old black & white television sets in my day, but I have to say that my restoration of a Raytheon 10DX24 was difficult! I acquired this TV in fairly decent shape from an owner advertising it on Craigslist.

It's a fairly rare TV, built in 1948. Officially, it is a Raytheon-Belmont TV; that is, it was marketed under the Belmont label, a Raytheon subsidiary for radio and television products. At that time, Raytheon had a brief flirtation with the marketing of commercial radio and television sets. Unfortunately, it was out of the commercial business by the 1960s. I obtained a SAMS Photofact schematic for this unit from a former Raytheon employee.

The set is transformerless, meaning that the AC line is brought directly in, is rectified, filtered, and sent on to provide various B+ supplies in the chassis. Manufacturers wanted to get rid of the heavy, bulky, and expensive power transformer. There were *no* fuses or circuit breakers in this unit, and a component failure could easily cause a fire or open a fuse or circuit breaker in the house power panel. It uses 25 tubes, including a 10BP4 CRT, which was a fairly common 10-inch round CRT in its day. While to this day some designs remain transformerless, the chassis of the newer sets are better isolated from the outside world. Yet, I see that manufacturers are still omitting any type of line protection!

## Getting Started

**Warning:** Television receivers operate at voltages as high as 20,000 volts. Unless you have experience and knowledge of electronic devices, do not attempt to work on them due to the possibility of electric shock. Make sure to have all the necessary test equipment. These voltages are lethal!

The first thing I noticed in this chassis was that the selenium rectifiers used to create the B+ in the power supply were bad, a common occurrence in transformerless designs. After many years of sustaining a surge current from TV turn-on the rectifiers become lossy, overheat, and can no longer provide sufficient B+. I replaced each of these units with silicon diodes (600 PIV, 1 amp) and 10 ohm, 10 watt resistors in series with each diode. The power resistor is there to more closely simulate the loss provided by the original selenium unit(s) in operation. Without it—in other words, blindly replacing a selenium unit with a silicon diode and *no* series resistor—the B+ is way too high and could result in damage to other components, such as the filter capacitors, and/or improper chassis operation.

Only *after* replacing the rectifiers *and* the electrolytic filter capacitors in the chassis did I turn the unit on. All tubes should also be tested on a quality tube tester before applying power.

(NOTE: Power should *NEVER* be applied to a chassis that hasn't been checked for bad rectifiers and electrolytic capacitors in the power supply because of the danger or damage and/or fire!) I measured the resulting B+ value at various points and found it to be within specifications. I obtained a raster by feeding the TV with test video on Channel 3 from a VCR and using a balun into the chassis input 300 ohm twin-lead terminals. The resulting raster was rolling, out of sync, and had poor focus. I did note, however, that the distorted screen raster was very bright, indicating a healthy CRT after 60-plus years!

I then replaced every wax capacitor in the unit. Interestingly, some wax capacitors were in the oscillator-type HV unit (two 35L6 tubes in an oscillator unit to drive a HV rectifier) and not a more modern, common flyback type unit. I left these wax capacitors alone only because the HV unit oscillated at a low frequency, meaning that the capacitors were not required to do critical service. This is *not* true for other wax capacitors in this chassis; some are called upon to pass critical horizontal and vertical timing pulses. If these are distorted by poor capacitor function, the picture will suffer. After I replaced all the capacitors the unit functioned properly.

An interesting note here is that the schematic of the unit did not agree with the as-built TV

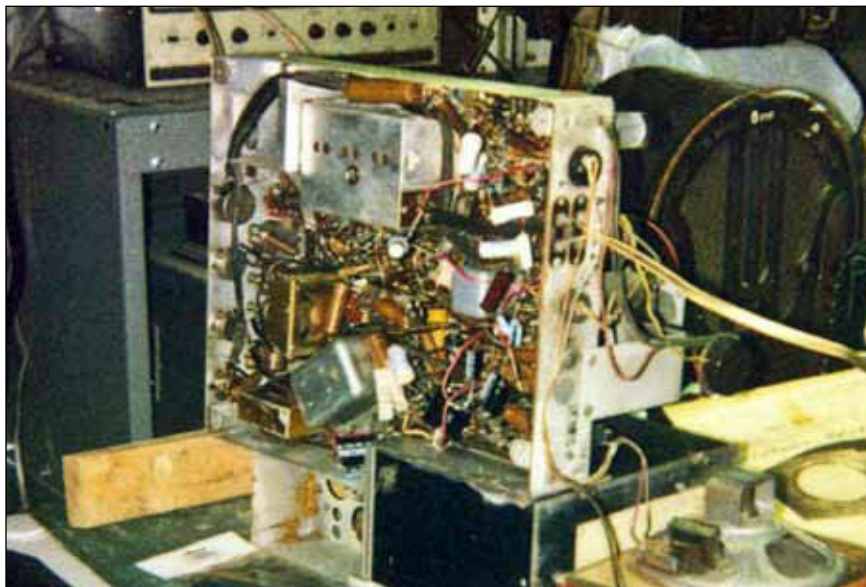

Figure 2. Raytheon 10DX24 bottom view.

in the area of the horizontal and vertical sweep drive circuitry. Perhaps there were changes in manufacturing being done “on the fly” for various lots of TVs being produced that did not get into the documentation, but it did cause me to scratch my head more than once!

## Restoration in Progress

**Figure 1** shows the Raytheon TV on the bench. Note the white ceramic capacitors (small, cylindrical units) that replaced the wax units previously used. An alternate view of the chassis is shown in **Figure 2**. The large black box shown attached to the chassis and sitting on the bench is the oscillator driven high voltage unit.

Not shown in these views is the RF tuner assembly, which employs several slug tuned coils attached to a moving carriage assembly. In the original design, the coils were attached to the carriage with retaining clips (see **Figure 3**).

As the carriage moved up and down in response to movement of the front rotary tuning dial, the tuning slugs moved up and down in concert with the carriage assembly. Most of the retaining clips for the slugs were either broken or missing. In an attempt to find a replacement for the clips, I discovered that plastic retaining clips with nails, as used to secure telephone wire to walls, had the proper



Figure 5. The restored TV in my guest room.

hole size to permit threading onto the slugs threaded rods. The nails that came with these clips were removed and the clips were threaded onto the slug rods and then secured to the moving carriage assembly using miniature tie wraps (see **Figure 4**).

With this arrangement, the tuner worked perfectly, once the slugs were aligned properly for channel tuning. Mechanical dimensions for alignment of the slugs were referenced in the SAMS Photofact.

Finally I sanded the cabinet for the unit and gave it several coats of lacquer for preservation. The end result is the completed 10DX24 with period rabbit ears and a digital converter box, which I keep in my guest room (see **Figure 5**).

With the clean signal provided by the box (no ghosts!) and the wide bandwidth provided by the TV, the picture detail is outstanding. Unfortunately, the tuning knob on the unit is not original, and I am currently searching for one. I have deliberately not added a reproduction back panel (which is available for sale, believe it or not) so that a visitor can easily look into the set from the rear and see it in operation.

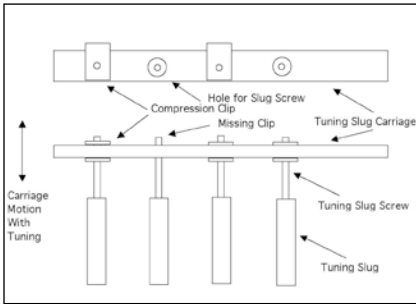

Figure 3. Slug tuned assembly.

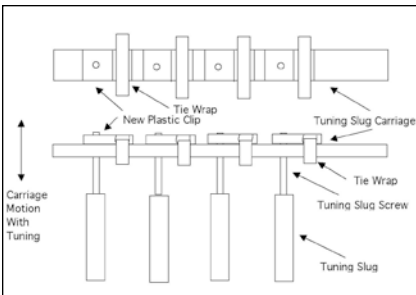

Figure 4. Slug tuned assembly with new clips.

*Lou Tramontozzi, KAIHIIH, an engineer for Raytheon Co. for 31 years specializing in RF and Microwave design, has been collecting and restoring vintage radio and television equipment since he was 12 years old. He is a long-time subscriber to A.R.C. and a member of the Antique Wireless Association and the American Radio Relay League (call). He is also the proprietor of the Retro Radio Shop, an antique radio restoration business. He may be reached by e-mail at louis226@juno.com, business phone 1-508-733-7778.*



# BROADCASTING HISTORY

## The Visual Lee de Forest

BY MIKE ADAMS



*Artist's rendering of Lee de Forest, inventor and visionary during broadcasting's infancy.*

As longtime radio fans and A.R.C. readers, you already know that Lee de Forest invented the triode radio tube and a sound film technology. But what you may *not* know is that he also participated in the invention of television, described in the 1920s as “radio with pictures” and “radio movies.” For a good part of the last century, de Forest developed technology, received patents, and even created content for popular media that we still consume today. It’s a fascinating story so let’s take a look at the life and inventing career of the scientist most responsible for the early devices that led to radio, film, and television.

Lee de Forest received his Ph.D. in physics and electricity from Yale in 1899, just as the new century was about to dawn on a world that was still silent, the world of the soundless film of Edison and others as depicted in the film *Hugo*, and of the voiceless key clicks of Marconi’s wireless telegraph. De Forest had studied and learned from those inventors, and by 1906, had patented his signature invention, a vacuum tube he called the “audion.” Because of his tube, radios, and later film and television, would be able to “speak.” De Forest turned the science of the 19th Century into the media technology and art of the 20th Century, supplying the missing voice.

## It Begins with Radio

In March 1907, a story in the *New York Times* describes how de Forest sent music from a location in New York to the Times building: “The perfection of the wireless telephone will also mean that houses will not have to be wired to receive music.” A few years later, working in a Palo Alto, California, lab he further developed his tube as an amplifier of audio. This would be his most important contribution to the media of the 20th Century. With amplification, radio technology



*The audion, de Forest's signature invention.*

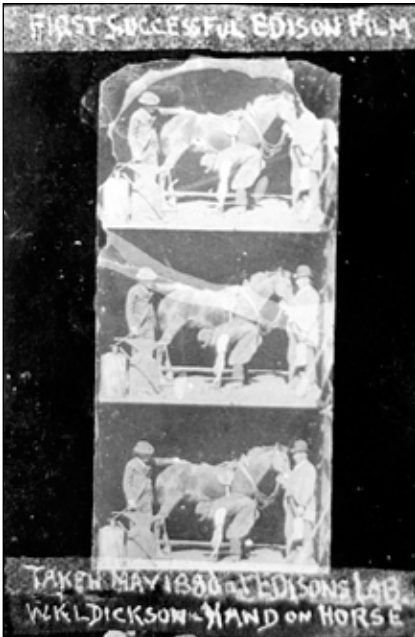

*Rough beginnings: an early Edison film.*

moved from being the province of amateurs with headphones to that of families listening to loudspeakers. He started several pre-1920 radio stations, in New York and in San Francisco at the California Theatre.

He turned to the cinema in 1918 and filed a patent for his sound-on-film system. By the early 1920s he had made a number of short movies and was showing them publicly. The tube he developed in Palo Alto was the key to this technological advance as it allowed playback of sound using loudspeakers, making it possible for mid-1920s audiences to experience for the first time both radio and talking pictures. For his tremendous contribution to the industry, de Forest received an Oscar in 1960. Film's transition from a silent media is well told in the movie *The Artist*.

A 1919 *Radio News* story suggested combining silent film and radio for “radio movies.” In New York opera singers would perform live while watching their filmed performance and try to remain in sync. A microphone would pick up the sound and send it over radio. In San Francisco a print of the film would be screened and the sound track picked up using a radio receiver. Practical amplifiers and loudspeakers were not available this early, but it was a prediction of how television might look.

Unlike the clear vision behind his major successes in radio and film, de Forest's early ideas about television technology were not fully formed. He told the *Los Angeles Herald* in 1923: “Moving pictures can be sent by radio just as still photographs are now sent. But it will be many years—I'm not afraid to



*Progress is evident in these phonofilm frames.*



*A DeForest phonofilm featuring President Calvin Coolidge.*

predict centuries—before radio movies will be practical. Modern science today is absolutely in the dark as to any discovery which would make the broadcasting of motion pictures anything as practical as the broadcasting of sounds.” Although he was being interviewed about his sound movie invention, he had not really thought about television, other than as an extension of radio and the movies, stating, “Broadcasting moving pictures by radio will be impossible during this generation due to prohibitive costs and other impractical considerations.” He understood bandwidth, a problem faced by his contemporaries Philo Farnsworth, working in San Francisco, and Charles Jenkins, in Los Angeles. De Forest himself filed several 1931 patents for the soon-to-be-doomed mechanical television. Those first electronic and mechanical systems for television were limited to a tiny picture of 40 or 50 lines of resolution, and the pictures were

broadcast using AM shortwave. Although the television resolution problem had been solved by the end of the 1930s, World War II delayed its development until the middle 1940s.

### Peering into the Future

But de Forest redeemed himself from that mistaken prediction with some other, very prescient ideas about television. In a series of articles in the *Hollywood Reporter* between 1943 and 1945, de Forest sounded a warning to the film industry about television: “For this new unknown stands in the minds capable of vague and mystical powers to rule or wreck what they have been earnestly building for the past three decades.” De Forest continued to frame the coming media war as a survival of the fittest: “It cannot be questioned, therefore, that television is certain to eat hungrily into the very vitals of the cine-theatre. Television is on the march, or will be after VE Day. It



*De Forest at the California Theatre.*



*With Charles Jenkins.*



*An early TV disc.*

is inevitable.” He warned about the ruinous effect of advertising on television: “Television advertisers must not attempt to blackjack the watching public with offensive television commercials. The surest way to smother television in its cradle is to expect to pour on the screen the same sort of vulgar bombast as now darkens millions of our radio dials except when news is on the air.”

De Forest correctly saw the new media evolving out of the old, stating, “Television will not create a radically new art, but a thousand new stars, new writers, new directors—a new industry, yet based chiefly on what the motion picture and the radio have taught us—with much of Hollywood’s lost motion and budget extravaganza deleted.” He also saw opportunity: “Let it be understood by the film fraternity that, in this younger branch of their art, lie immeasurable opportunities for developing new techniques, new modes of audience approach, opportunities vastly more varied than any the theatre can afford them, then the progressive, far-sighted leaders among them will eagerly grasp the new vehicle, ride along with it, have a friendly controlling hand in directing its course.”

In 1945 de Forest applied for a patent for a mechanical color television system, which he considered superior to the CBS color wheel. “I place before any kinescope face, even of a 16 inch diameter, a three-color mosaic screen,” he explained. “It oscillates in an orbital, circular movement.” Neither de Forest’s nor the CBS system was accepted, the winner instead being the compatible RCA all-electronic system. He did receive a patent for a videotape recorder, likely similar enough to the Ampex Quad sys-

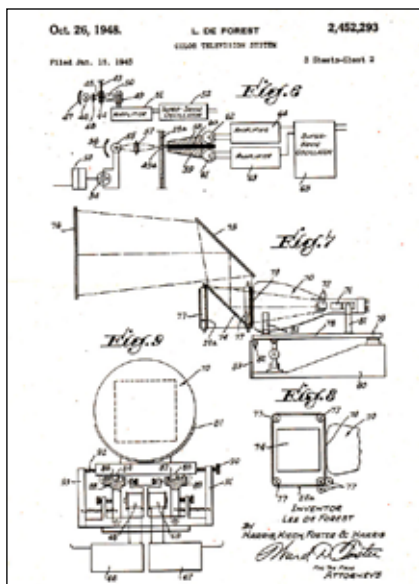

*DeForest's color TV patent.*

tem of 1956 to lose a patent challenge.

I’ll leave you with this interesting head scratcher from a 1957 article in the *Los Angeles Examiner* headlined: “De Forest Files for Patent on 4-Inch Thick Wall TV Set.” You may be saying to yourself, “well, I have one of those,” but in 1957 even the smallest television set was several feet thick. According to the inventor: “The new flat set...is made possible by the use of printed circuitry to condense the bulky TV tube into a flat picture-like package.” Prescient, indeed.

*Editor’s Note: You can read more about the topic in Mike Adams’ book, Lee de Forest, King of Radio, Television, and Film, Springer Science, New York, 2012, available through the A.R.C. Bookstore.*

*Mike Adams has been a radio personality and a filmmaker, and is currently a professor of radio, television, and film at San Jose State University, where he has been a department chair and an associate dean. He also created the Emmy-nominated PBS series “Radio Collector” and “Broadcasting’s Forgotten Father, the Charles Herrold Story.” Mike is a longtime contributing writer for A.R.C.*

*Contact Mike at [mike.adams@sjsu.edu](mailto:mike.adams@sjsu.edu).*

*Attention Subscribers: You can access a color version of this article on the A.R.C. website at [www.antiqradio.com](http://www.antiqradio.com).*

# A.R.C. RECOMMENDS...

## A Visit to the Early Television Museum, Hilliard, Ohio

BY JON KUMMER



*The Early Television Museum is a "must stop" for those interested in television history.*

Recently I had the opportunity to visit the Early Television Museum, located in the town of Hilliard, Ohio, near Columbus. I'm so glad I did—the museum is a "must stop" for historians and collectors of vintage televisions as well as anyone else interested in early communications.

While I was there, I also had the privilege of speaking with Steve McVoy, president of the museum, who gave me the museum's history first hand. The facility opened its doors in 2000 in what was a former warehouse in Hilliard. Steve's immersion in television goes back to his youth. As a teenager he had worked in a TV repair shop, and then later became a principle in a cable television business. After he sold the company in 1999 he was looking for a new challenge. He found his challenge in collecting vintage televisions. At first, all the televisions were located in his home and relegated to the basement. When his collection became too large he created the Early Television Museum. Lucky for us!

Initially occupying approximately 3,000 square feet of display space, the museum later expanded to 10,000 square feet, and today

there are over 150 televisions on display from the 1920s through the 1970s. The exhibits are well organized into different areas, and you'll find interesting examples of mechanical televisions, British televisions, pre-war electronic, post-war electronic, and more.

### Exhibits

The museum's collection consists of many early televisions made by companies such as Baird, Western Empire State, Daven, Dumont,



*The 1946 RCA TS630 was the first TV model mass produced in the United States.*

National, RCA, Muntz, and Admiral. British manufacturers represented include HMV, RGD, and Cossor.

Each item on display has a full description of the piece with dates and important technical information. Most of the televisions are black & white sets, but you'll also find a nice collection of early color TVs, such as the RCA CT100.

I asked Steve which is his favorite television. He told me that many hold a special place in his collector's heart, but admitted that as far as style goes, his favorite is the 1938 British RGD 382-RG. The WGSF mobile truck also takes a pride of place.



1939 RCA TRK-5 pre-war receiver.



A 1954 RCA CT-100, one of the first color sets.



1938 HMV 904 and HMV 905 British Receivers



1930/1931 Hollis Baird 60 Line Receiver - R-7-T receiver and C-3-5 television adapter chassis.

## Early Television Convention

Since 2002, the museum has sponsored the annual Early Television Convention. Attendees from all over the world attend the gathering, which is held for three days during the month of May. Highlights of the convention include presentations on early television, a television auction of items from the museum, a swap meet, workshops, and a Saturday night banquet.

This year the convention was held on May 4 through 6 and A.R.C. plans to have a report on it in an upcoming issue. Perhaps you'll want to mark your calendar for 2013's event!



1949 WGSF remote van.



A handsome example of the 1931 Western Empire State 45 line disk receiver.



Various TV receivers from the 1940s.

## Visiting

The museum is a 501 C 3 non-profit foundation. There is no official admission charge to visit the museum but there is a small suggested donation.

TV fans and others interested in early broadcasting can visit on Saturday from 10 a.m. to 6 p.m. and Sunday from noon to 5 p.m.

If you're ever in the area we recommend a visit. You won't be disappointed!

Early Television Museum  
 5396 Franklin Street  
 Hilliard, OH 43026  
 614-420-1263  
[www.earlytelevision.org](http://www.earlytelevision.org)





## PHOTO REVIEW



This month we present a very special “Photo Review.” This unique pictorial reminiscence all started about three months ago when my friend Pat came by to “browse” through my basement. During that visit, I discovered that I had a few items I’d purchased a long time ago for some project or other—and then immediately forgot about them. They just ended up underneath, on top of, or behind a different item. I think you all can sympathize.

My friend asked, “What’s in that green box?” The box in question measured 10 x 5 x 2 inches, and I really had no idea. I figured it had to be “valuable parts.” Upon opening it I was delighted to find 80 photographic color slides. Inside was a description of the rediscovered treasure trove: “Philco Radio and Television Line – Presentation Slides – Mid Summer 1954.” This was visual accompaniment for the “dog and pony show” a Philco salesperson would perform as he traveled from dealer to dealer, presenting the upcoming 1955 radio and television models.

I had the slides digitized to share with our readers. Here, then, is a selection of 1955 Philco radio, television, and phonograph product shots, as well as in-store merchandise displays.

Look for more in the future. And, remember, you can see these in full color on the A.R.C. website. Coming up, we hope to have the entire slide show on the site.



**Radio Title Slide**



**Model 720** – Transitone series clock radio combination. Tuning range: 540 to 1630kc; power supply: AC; Tubes: five.



**Radio Merchandiser** – Point of sale display showing 12 of the latest Philco radios.



**Model 660** – Tuning range: 540 to 1630kc. Power supply: battery, 1.5 volts and 75 volts; tubes: four.

*Attention Subscribers: You can access a color version of this article on the A.R.C. website...*



## PHOTO REVIEW



**Model 4412** – TV with 21-inch CRT, three-speed record changer, and AM radio. Record changer is concealed in a pull-out drawer and the radio is hidden under a panel on the top.



**UHF Tuner** – Close up of the optional new UHF frequency tuner.



**Television Title Slide**



**Inserting UHF Tuner** – A service tech installing the optional UHF frequency tuner.

*...find out how by visiting us today at [www.antiqueradio.com](http://www.antiqueradio.com).*

---

## PHOTO REVIEW

---



**Finger Tip Wrap** – Point of sale display illustrates the “exclusive” new finger tip tuning system.

---

**Model 6112** – TV with 24-inch CRT and new “Finger Tip Tuning System.”

---



**TV Window Kit** – How a store window display should be set up to promote TV sales.

---

*Attention Subscribers: You can access a color version of this article on the A.R.C. website...*

---

## PHOTO REVIEW

---

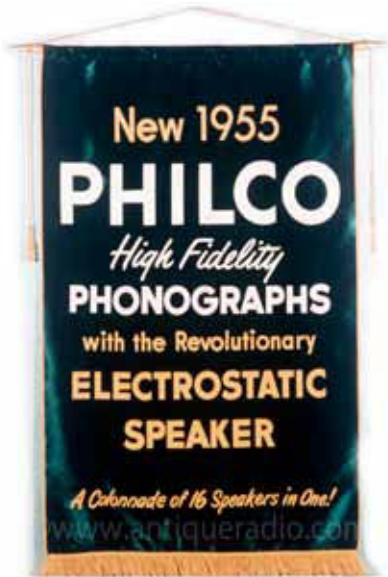

**Hi-Fi Banner**



**Model 1755 Open** – Hi-Fi system consisting of three-speed record changer and a three-tube, 6 watt audio amplifier.



**Model 1755 Closed** – Hi-Fi system's attractive cabinetry.



**Original Philco Slide Box** – Where it all started.



**Model 1332 Turntable Display** – How to set up in-store display, explaining the three-speed feature and \$29.95 price. Amplifier consists of one tube.

*...find out how by visiting us today at [www.antiqueradio.com](http://www.antiqueradio.com).*

# CLASSIFIED ADVERTISEMENTS



**FOR SALE:** BANG-BANG! 4th of July specials! Turner Model 251 desk mike. Has push-to-talk and on/off switch. Nice plating all over, \$45. Also, Ampex Model H-1390, with adjustable stem and push-to-talk button. Excellent chrome finish throughout! \$75. Dave Crocker, 35 Santuit Pond Rd., #4B, Mashpee, Cape Cod, MA 02649. Tel. (508) 477-1578, before 9 p.m. please.

**FOR SALE:** Heathkit AM tuner, FM tuner, preamp. Make offer. Lee Elkins, 3016 Jasmine Rd. NW, Carrollton, OH 44615. (330) 627-4922.

**FOR SALE:** Music Master (Philadelphia) model, bed and tube holder all intact \$50; RCA M60T1 bc/sw tombstone clean \$75; Philco M60 cathedral clean \$85; Queen MTR203 transistor \$70; Zenith Royal 59-1 w/ case clean \$30; Zenith model L speaker clean \$80. Can send photos. Bernie Samek, 113 Old Palmer Rd., Brimfield, MA 01010. (413) 245-7174. E-mail: bernies@samnet.net.

**FOR SALE:** RF generator with probes working \$15; 2 Heathkit 10-105 dual trace scopes with probes \$25 each; Majestic 41 tombstone like new chrome grille; Kadette 1933 bakelite like new very small; Crosley D28TN dashboard clock radio looks new; Predicta 19" table TV Chinese red beautiful; Hallicrafters SX101 communications receiver works and looks great \$50; Hallicrafters S20R Sky Champion beautiful and working; 4 crystal sets; many Allied and Lafayette radio catalogs 1929 to 1960; Readrite tube checker in oak case working 1929-1960 \$30; Atwater Kent 82 cathedral working in nice condition; Crosley 150 cathedral looks new beautiful original grille cloth; RCA 5T working tombstone radio; Motorola tombstone excellent; Musicaire 19A66 looks new all original; 100 Shortwave Craft, etc. magazines 1930s to 1940s. Call with your needs. Very reasonable. Bill Kalcik, Meadowbrook Resort, 1533 River Rd., Wisconsin Dells, WI 53965. (608)-253-9855.

**FOR SALE:** Crosley 52-SD w/ 3 Cunningham 199 tubes lid top left need a little work; Motorola M-68 L11 ch HS-119 cosmetics good \$35; Sanyo M-RP1250 3v transistor w/ strap yellow good cosmetics Hong Kong \$12; Bulova M-2YO-23 bc/sw red/ivory/chrome Japan heavy good condition chassis clean \$40; Prcor Micro M-550 w/ box color green very clean \$15. Can send photos. Bernie Samek, 113 Old Palmer Rd., Brimfield, MA 01010. (413) 245-7174. E-mail: bernies@samnet.net.

**FOR SALE:** Grundig mini 300 world band receiver AM/FM/SW includes clock and FM/SW antenna \$75 includes shipping. Albert Casolari Jr., 1812 Albany, Springfield, IL 62702. (217) 544-2187.

**FOR SALE:** Traveler 5008 1946 \$20; Philco 40-120 1940 wood \$25; RCA 4-C-672 clock radio \$35; Simpson 488 fieldstrength meter \$20; Motorola C16W clock radio \$20; Zenith C520W clock radio \$20; Philco 48-461 wood \$20; Automatic CL152 clock radio wood \$25; GE 547PH clock radio \$25. Paul Lisowski, 5603 E. 100 N., Knox, IN 46534. (574) 772-2021.

**FOR SALE:** Tube socket adapter kit contains 7 prong miniature, 9 prong miniature, 4,5,6, and 2 sizes of 7 prong, loctal and octal sockets with top test tabs for above chassis testing. Metal container is beat up but sockets are in good condition \$25. Cecil McLaggan Jr., 513 Hummingbird Ct., Hahira, GA 31632. (229) 794-1787.

**FOR SALE:** Idler wheels for all brands of record players. Over 150 different types in stock! Tape recorder wheels and rollers too. Changer power cords with Amplock or Molex plugs. Large needle selection (including 78 rpm tips!) Many more phono / tape recorder parts. Gary Stork, 37530 E. Meadowhill, Northville, MI 48167. (248) 478 0990. Visit [www.thevoiceofmusic.com](http://www.thevoiceofmusic.com) or email [info@thevoiceofmusic.com](mailto:info@thevoiceofmusic.com).

**FOR SALE:** American Bosch console radio Model 58, 1930's serial no. 47967 44"Hx28"Wx13"D, \$40 obo, see pictures at, [www.buyat.20m.com](http://www.buyat.20m.com). Alex Taranko, 3515 Old Yorktown Rd., Yorktown Heights NY 10598. (914) 962-2350. E-mail: [sci983art@aol.com](mailto:sci983art@aol.com).

**FOR SALE:** Ham license plates: 1976 Indiana "Heritage State" WB9FML; (2) 1634 Maryland "350th Anniversary" W3FXF; 1976 Indiana blue & beige WB9FML; (2) Maryland red & white W3FXF; (2) Maryland black & white W3FXF. \$10 each free shipping. David Edwards Jr., 114 Lakeside Dr., Laurel, MD 19956. (302) 875-3176.

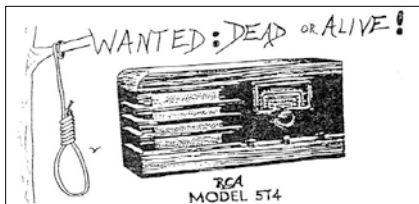

**WANTED:** RCA 5T4 wood-case table radio and Philmore 1001C kit set. Contact me for e-mail picture if desired for identification. 5T4 was an export unit sold mainly in Europe before WWII. Dave Smith, k9uim, Box 81, Olney, ILL. 62450 618-843-6601 or k9uim@frontier.com.

**WANTED:** Chassis and pushbuttons for 1941 Stewart-Warner Model 11-9B7 (11-9B chassis). Need not work. Brian Belanger, Natl. Capital Radio & Television Museum, 2608 Mitchellville Rd., Bowie, MD 20716. (301) 390-1020. E-mail: bbelanger@ncrtv.org.

**WANTED:** Volume control 63-1122 used in Zenith 7S633 ch 7B01R or parts chassis for 7S633; Zenith 807 chassis and speaker; glassware for Baradio partial or complete. Ye Olde Radio Shoppe, 228 Beck Rd., Avon Lake, OH 44012. (440) 933-5668 (440) 933-8864. E-mail: yeolderadioshoppe@oh.rr.com.

**WANTED:** Professional model TC101 tube chart date book. Roy Cameron, 114 E 2nd, Pana, IL 62557.

**WANTED:** Desk microphone 1930s, 1940s display only. Type used by ham, aircraft, marine base stations. Thomas Larry, 8750 S. Ocean Dr. Apt. 636, Jensen Beach, FL 34957. (772) 229-5243.

**WANTED:** Pilot light shields that slip over pilot lights to direct the light to the dial. I need several or a source. Edwin Rogers, 6938 E. Waco Dr., Syracuse, IN 46567. (574) 457-8886. E-mail: edrogers@mchsi.com.

**WANTED:** Gloritone model 27 radio control knob. Dudley Townsend, 1901 US Hwy 17-92 Lot 107, Lake Alfred, FL 33850. (863) 956-4569.

**WANTED:** Information for RCA WV-98C senior volttohmmyst. Michael Morrell, 70 Brumley Dr. N., Greeneville, TN 37743. (423) 639-8381.

**WANTED:** Sams TR-220 service manual for Akai cassette recorder GXC 709D. Good readable copy OK. Anton Johannes, 3503 State Route 52, Pine Bush, NY 12566. (845-744-2148).

**WANTED:** 1965 Radio Shack catalog with Archer Space Patrol walkie-talkie cover; Lafayette Radio catalogs: 1959, 1960, 1961, 1963, 1964, 1966, 1967; Burstein-Applebee catalogs: 1960, 1961, 1962, 1964, 1965, 1966, 1968. Harry Schools, 1091 Penn Circle Apt GT15, King of Prussia, PA 19046.

**WANTED:** Both dial escutcheons and push buttons for Motorola Model 103 CK2. Paul Cowlishaw, 1424 25th St., Ogden, UT 84401. (801) 393-8703.

# audioXpress

The Audio Technology Authority

Subscribe to  
12 Great Issues of  
Hands-on Audio...

## BUILDING RESTORING MODIFYING

From vintage tubes to classic speaker designs and cutting-edge uses of today's technologies...find all of this and more in the pages of each monthly issue of *audioXpress*.

-----  
**SUBSCRIBE TODAY!**  
Only \$50 for 12 monthly issues  
-----

To subscribe call 860-875-2199  
or order online at  
[www.audioXpress.com](http://www.audioXpress.com)



### audioXpress

4 Park Street, Vernon, CT 06066 USA  
P 860-875-2199 F 860-871-0411  
email: [custserv@audioXpress.com](mailto:custserv@audioXpress.com)  
[www.audioXpress.com](http://www.audioXpress.com)

# CQ Amateur Radio



CQ is devoted entirely to the things that Hams care about. It's a fine blend of technical ideas and projects, news and reviews of new Ham products and operating information, written and edited by a group of people who are absolutely crazy about this hobby!

## SUBSCRIBE TODAY!

	USA	VE/XE	FN
1 yr	\$36.95	\$ 49.95	\$ 61.95
2 yrs	\$66.95	\$ 92.95	\$116.95
3 yrs	\$96.95	\$135.95	\$171.95

### Monthly issues include:

- \* Hamfest/Special Event Listings
  - \* Hobby News
  - \* New Product Info/Reviews
  - \* Kit-Building & Projects
  - \* CQ WW Contests Info/Results
- and much, much more!*

## CQ Amateur Radio

25 Newbridge Rd, Hicksville, NY 11801

Phone 516-681-2922

[www.cq-amateur-radio.com](http://www.cq-amateur-radio.com)

**FOR SALE:** See items at <http://antiqueradioexchange.com/http://antiqueradioexchange.com/> sold by richsequip, most listed under TEST EQUIPMENT with photos & detailed descriptions. Many seldom offered for sale & going back as far as 1936. Richard Flaws, 212 Mondovi Dr., Oswego, IL 60543. (630) 554-9207 (Before 9pm CT). E-mail: [flaws2@att.net](mailto:flaws2@att.net)

**FOR SALE:** Antique radio schematics \$4, TV \$5 postpaid. Joseph R. Forth, 119 Long Vue Acres Rd., Wheeling, WV 26003.

**FOR SALE:** Books on Wireless & Pre 1920 Radio, Medical Electricity and X-Rays. Also books by and about Nikola Tesla and Tesla Coils. To see our listings, visit our web page [www.beqbooks.com](http://www.beqbooks.com) Direct orders get 10% discount. BEQUAERT OLD BOOKS, PO Box 775, Fitzwilliam, NH 03447. (603) 585-3448. E-mail: [info@beqbooks.com](mailto:info@beqbooks.com)

**FOR SALE:** FSOT, CMPD, FOR SALE OR TRADE, CONSIDER MERE PAPER DOLLARS!: Heathkit DX 100 super clean original outside and inside; Heath Apache also very nice; BC 375 E working with several tuning units and PE 73 Dynamotor/cables. GRC 9, very good, working with DY 88, cables, and T17 mic. All you need is a ticket. Hammarlund SP 600 in case, very nice, works fine; HRO RAS Navy version, several coils and power supply; BC 654, nice all original and working, also have new/old stock PE 103 Dynamotor; Collins 323 V nice, working; BC 669 transceiver with original power supply; Drake TR7 with PS 7, very nice and working; HRO 50T1, rackmount, nice working, have several coil sets; HRO 50T1 cabinet model, has been recapped, was working fine, now need to find error in recapping! Several coils available. HRO Senior rackmount power supply, several coils; Webcor 210-1-C collectible early Webcor wire. ALWAYS BUYING: Early and interesting wire and tape recorders, disc cutters, broadcast and recording mics, tube pre-amps, compressors, early hi-fi, cash or trade for any of above. Prefer pick-up on heavy items, but can ship. Ward Kremer, K14JHA, 57262 Poppy Rd., South Bend, IN 46619. (574) 204-2877. E-mail: [witzend99@comcast.net](mailto:witzend99@comcast.net), website: <http://www.radioattic.com/kremer>

**FOR SALE:** Federal 8, 9, 55, 56 reproduction cabinets. For details, contact John Terrey, Old Tech - Books & Things, PO Box 803, Carlisle, MA 01741. E-mail: [jvt@oldtech.com](mailto:jvt@oldtech.com).

**FOR SALE:** Huge Quantities, Tubes, Picture Tubes, Needles, Cartridges, Zenith Parts, Semiconductors, Data, Radios, Phonographs, Televisions and Test Equipment. Collector, Restorer and Volume Pricing. Sales support our self-funded Sunshine Radio Museum. Ray Seppeler, SunRad, 8 East Main St., So-dus, NY 14551. (315) 483-8451. E-Mail: [sunshine.radio@sunrad.com](mailto:sunshine.radio@sunrad.com). Web: <http://radios.sunrad.com>.

**FOR SALE:** Antique radio collection. Don Rein-sma, 2805 Thrush Dr., Clarksville, TN 37040. (931) 624-8263.



**WANTED:** (Photo above) RCA 143 tombstone. Mark Murphy, 931 Village Blvd., Ste. 905-381, West Palm Beach, FL 33409; (561) 801-1478; E-mail: markmmurphy@att.net.

**WANTED:** Electroncis Illustrated: 6/61, 8/61, 10/61, 12/61; Radio-TV Experimenter: Feb/Mar 64, Aug/Sept 64, Feb/Mar 65, Apr/May 65; PF Reporter: 1959 to 1962; Elementary Electronics: 1961 to 1968; S9 Magazine: Dec 62 to Dec 63; CB Horizons: 1961 to 1964; 10-4 Magazine: 1961 to 1964; CB Magazine: 1964 to 1969. Harry Schools, 1091 Penn Circle Apt GT15, King of Prussia, PA 19046.

**WANTED:** Grunow Radio model 660 antenna output coil. Chassis 6-C. Lee Elkins, 3016 Jasmine Rd. NW, Carrollton, OH 44615. (330) 627-4922.

**WANTED:** NOS Bud CB-38 or Premier equivalent open-end chassis – 7" x 6" x 2". Louis L. D'Antuono, 8802 Ridge Blvd. Apt. C-2, Brooklyn, NY 11209. (718) 748-9612 after 6pm EST.

**WANTED:** Grigsby Grunow (Majestic) AM radio models 61, 62 (1928). These radios can be in any condition, working or not working, for a refurbishment project. If you have any or all of these radios available for sale, please contact me. If you know of anyone interested in selling any of these models, please contact me with their information. Richard Blum, PO Box 2626, Palos Verdes Peninsula, CA 90274. E-mail: richieraider@juno.com.

**WANTED:** Philco Chevron Grille Cloth, Silvertone 1650 speaker, Zenith 12 S 265 outer dial shell, Silvertone 4792 dial bezel & Insert, Breting 14 cover. Keith Park, 31 Barkwood Ln., Clifton Park, NY 12065. (518) 373-0417. E-mail: topnotch@nycap.rr.com.

**WANTED:** Desperately, a Tuning meter for Philco 29 or similar, complete & working, P/N 6497, P/N on meter 45-2028. Irv Sanders, 100 N. Larkspur Dr., Palmyra, PA, 17078. (717) 832-7338. E-mail: radio-irv@comcast.net.

**WANTED:** LOOKING TO BUY SHORTWAVE/HAM/CB RADIO COLLECTIONS, ANY CONDITION IN NY TRI STATE AREA. CASH PAID ASAP. Juan Remus KC2ZTE, 2 Springbriar Ln., Kings Park, NY 11754. (631) 697-5850. E-mail: stocpro47@yahoo.com

**WANTED:** Stereo/Hifi/Commercial Tube Gear, Amps/Speakers/Parts/etc, Guitars, Guitar amps/ Pedals/Parts, Tube Testers and Audio Tubes. Sonny Goldson, 520 Pocahontas Dr., Fort Walton Beach, FL 32547. (850) 314-0321. E-mail: sonnysound@aol.com.

**WANTED:** Do you have so many vacuum tubes that you don't know what to do with them? Before you trash those tubes call me and I'll try to find a home for them. Jeff Arndt, 4021 S. Parker Way, De Pere, WI 54115. (920) 323-6789.

**WANTED:** Collector seeks early RCA type electron microscope – finders fee paid. Also need Zenith type 33X. Allan Weiner, 274 Britton Rd., Monticello, ME 04760. (207) 286-5483.

**FOR SALE/TRADE:** Beautiful Western Electric WE-540 Double Cone Speaker, fully restored with an exact reproduction cone by Buford Chidester. Great ORIGINAL paint and decal on an excellent frame and driver, the best sounding battery set speaker, \$350. See my previous ads for many great consoles still available. **WANTED:** Airite/Kadette Desksset and/or pen & clock. C.R. Nevins Museum of Radio, Ken Nevins, 406 Jipson St., Blissfield, MI 49228. (517) 486-3019 evenings. E-mail: mailto:ken@kennevins.com>ken@kennevins.com.

**WANTED:** Still looking for an 8" Arvin speaker to go in an Arvin Rhythm Maid tombstone radio. Speaker is 1100 ohms. Hey guys check all of your parts units I really need this one... All help greatly appreciated. Charlie Poplin, 3518 Courtland Dr., Durham, NC 27707. E-mail: Popawapado1@Yahoo.com.

**WANTED:** Teleflash: Philco tabletop loudspeaker cabinet, c.1940. Parts, modules for National R-1490/GRR-17 receiver. Manual or schematic for the National R-1230/FLR countermeasures receiver. Hal Layer, PO Box 620660, Woodside, CA 94062. E-mail: kk6hy@arrl.net.

**WANTED:** MM5313, MM5311 or MM5309 clock chips to restore old binary clock. Paul Seidel, N2OPB, 30 Vista Way, Port Washington NY 11050. (516) 767-0948. E-mail: pauls30@aol.com.

**WANTED:** a 1940 Majestic model 5T radio for parts, I need a good glass dial window. Richard Majestic, 5640 Superstition Dr., Las Cruces, NM 88011. (575) 521-0018. E-mail: rmajestic@msn.com.

**WANTED:** Restorable Kellogg or Federal radio (s) from the early 1920's. Such as Federal 59, etc....lots of knobs and dials! David Boyle, 1058 Colt Circle, Castle Rock, CO 80109. (303) 681-3258. E-mail: djboylesr@msn.com

**WANTED:** Blaupunkt Ballett in fine cosmetic and operating condition. Jeff Forrest, 1920 S. Hammond Lake Dr., Bloomfield Hills, MI 48302. (734) 751-3305. E-mail: Drforrest3515@sbcglobal.net.



**FOR SALE:** Hand crafted crystal set. Previous owner bought it from the guy who built it same year he was born! (1925). Extremely well built. Not your typical "home built" this one is real nice! has Pacent glass-enclosed detector at rear. \$165. "I sell best in radio!" Dave Crocker 35 Santuit Pond Rd., #4B, Mashpee, Cape Cod, MA 02649. Tel. (508) 477-1578, before 9 p.m. please.

**FOR SALE:** Old and new test equipment: BK Precision 1474 30 MHz oscilloscope \$50; BK Precision E-301B sine/square wave generator \$30; Sony ICF-9650W AM/FM table radio \$15; Heathkit IM-2410 digital frequency meter \$30; Paco T-62 circa 1962 tube tester unassembled it - minus box \$35; Knight 600A tube checker & manual \$55; Precision EV-20 VTVM \$25; NRI 88 signal generator 170kc to 60mc \$25; Weston 985 VHF calibrator \$30; Data Instruments 555 oscilloscope \$60; Wavesforms 512 oscillator \$20; RCA WA-44C audio oscillator \$30; Heathkit GD-1B grid dip meter \$15. Old radios: Crosley super tridyne regen/reflex circa 1925 restorable \$50; David Grimes 5B baby grand reflex restorable \$60; AK 40 with good audios \$15; Hallicrafters S19 Sky Buddy restorable \$30; CF Cannon headphones 1920s \$20; 1920s audio transformers good \$20 each. Books/Manuals: RCA RC12 reprint, RC14, RC16, RC19, RC30 \$10 each. Prices include shipping. Harvey Faulkner Jr., PO Box 1731, Elkton, MD 21922. (302) 521-3683. E-mail: yevrah75@gmail.com.

**FOR SALE:** DeVry Institute Of Technology/Bell and Howell Schools\*\*\*\*4 books( 9" x11" color blue)--describing oscilloscope operation\*\*\*\*4 books( 9" x11" color brown)--describing construction of transistorized multimeter (includes Multimeter (Incomplete) \*\*\*\*1 volume (9"x11"--brown) describing the DeVry Design Console--manual #9009A(includes Console).The following receivers--Hammarlund BC-794-B(40 mhz) with power supply RA-74-C//Lafayette HA-52(FM)//Part of RAK-7 (15khz to 600khz) with home built power supply/// Harvey-Wells ATR-13/// RCA Service Data--stack 17 inches tall--all 50's stuff--TV, radio, phonos, projectors--weight is 52 lbs ///information please on a Radio Allocchio Bacchini /// I have tube testers (12) ///oscilloscopes (6)/// Loewe-Opta Stereo Hi-Fi console (blond)///Battery Burgess #G6B60 ///catalogs--HP T&M 1995--Radio Shack 1993/// Pictogrand radio loudspeaker - base is in pieces, but transducer and horn (black) are in good shape \$40 plus s/h; 7 text books in Dutch - good shape \$30 ; 3 text books in German - poor condition but readable - 4" x 6" - one is from 1906; 11 bound volumes of "Electronics" - 1949 through 1954; Zenith radios B600, T600, 6G001Y; Granco stereo companion model SC-4 white or brown MIB, Reel-to-Reel: VOM (2), Pentron (2), RCA (1). state wants/// all items plus shipping(some items pickup only) located in Winslow in southern NJ. Bryan Hodgson, 11 Fox Trot Ct., Sicklerville, NJ 08081. (609) 567-6248. E-mail: bhodgson1@comcast.net

**FOR SALE:** Collector since WW II wants out. Early radio, boat anchors, test equipment, military sets. What are you looking for? Howard Felder, 7517 Granada Dr., Bethesda, MD 20817. (301) 320-3028.

**FOR SALE:** Tube tester manuals for Heathkit TC-1, TC-2, TC-3, TT-1, TT-1A and all Allied Knight, Lafayette, Hickok, Radio Shack, Archer, EICO, Jackson, Sencore, EMC, Supreme, Precision, Accurate, Mercury, and Superior tube testers. Also manuals for all EICO, Heath, Allied Knight, and Lafayette ham and test equipment. Also handbooks, tube manuals, transistor manuals, catalogs and magazines. A.J. Bernard, P.O. Box 690098, Orlando, FL 32869. (407) 351-5536. E-mail: NI4Q@juno.com.

**Philco knobs, pushbuttons, and escutcheons!**

1941 models 41-250, 255, 256, 280, 285, 287, 290, 296, and 610

1942 models 42-355, 355T, 380, 380X, 390, and 390X

**For 1940 models:**  
Translucent wine red pushbuttons, set of eight \$16.

**For 1941 models:** Escutcheon \$29.95, Knobs, set of four \$20, Pushbuttons, set of eight \$16 opaque brown. **For 1942 models:** Escutcheon with gold trim as per original \$32.95. Knobs, set of four \$20, Pushbuttons, set of nine \$31.50.

Money order gets immediate shipment. Add \$5 s&h. California residents add 9.75% sales tax.





**OLD TIME REPLICATIONS, 5744 Tobias Ave.**  
Sherman Oaks, CA 91411. Phone 818-786-2500. Email oldtimerep@aol.com. [www.antiqueradioknobs.com](http://www.antiqueradioknobs.com)



# Estes Auctions



Specializing in Vintage Radios  
Complete Auction & Appraisal Service

## Amateur Radio Auction

**Saturday, July 21, 2012 - 10AM EST**

At the Expo Auction Center  
8157 Garman Rd., Burbank Ohio

From I-71 Exit #204 turn south on SR #83 then turn left at  
the Love's gas station onto Garman Rd., follow it ¾ mile to the auction.

We are pleased to offer this exceptional quality amateur radio collection with items from these makes, Collins, Drake, Heathkit, Hammarlund, Hallicrafters, National, Ten-Tec, Icom and others. Keys and Keyers, SWR meters, coax cable, lots of coax fittings, matching factory spec paints, call books, crystals, dummy loads, knobs for Collins, knobs for Heathkits, Rotors, transmitting tubes, amateur radio handbooks, many original Drake manuals and many original Heathkit manuals, speakers for Collins, speakers for Drake, speakers for Hammarlund, speakers for Heathkits, headphones, insulators, hardware for antennas and lots of other amateur radio items. Some of the radios to be included in this sale are Collins-Rockwell Pro-Mark, Hammarlund HX-Fifty, Hammarlund HQ-180A, Hammarlund SP-600, Hammarlund HQ-100, Hammarlund HQ-160, Collins KWM-2, 51J5 Collins, Collins S10B-1, Collins 32V-2, CollinsV-3, Collins KWM-1, Drake TR-4, Drake MS-4, Collins 75S-3B, Collins 32S-3, Collins 51S-1, Collins 75S-3, Drake T4X, Drake TR3, Drake R4, Drake TC2, Drake HD-10, Drake R4-C, Drake RV-4C, Drake SW-4, Drake T4XB, Drake TR-3. Heathkit SB-102, Heathkit SB-401, Heathkit SB110, Heathkit SB-300, Heathkit SB-400, Heathkit SB-310, Heathkit SB-630, Heathkit Seneca, Heathkit Freq-Counter, and many more items in this sale. All the ham gear pieces are excellent condition and will look good in any shack. Hope to see you at the sale!

***Don't forget the Early Sale from 8:30 AM until 10 AM***

**Terms: Cash/Check/Visa/MasterCard; 5% Gallery Fee**

### **ESTES AUCTIONS**

7404 Ryan Road, Medina, Ohio 44256

Ph: 330-769-4992 • Toll Free: 888-769-4992 • Fax: 330-769-4116

[www.estesauctions.com](http://www.estesauctions.com) • Email: [estesauctions@aol.com](mailto:estesauctions@aol.com)

Richard Estes, Auctioneer -- Radio Call Sign K8LRY

John Estes, Auctioneer -- Radio Call Sign KB8GEC

Cledis Estes - Auctioneer • Mark Delauter - Auctioneer • Cindy Brown - Auctioneer • Bob Dobush - Tubes • Bob White - Tubes • Kim Graca - Tech • Allan Ferris - Set up

***Call Us to Sell One Radio or Your Entire Collection! We offer pick-up service for your collection.***

[auctionzip.com](http://auctionzip.com) #20507

***Next Radio Sale August 18, 2012***

**WANTED:** Vintage Movie Posters, Lobby Cards, still photos, Live Music Posters. All Sizes, Any Condition. Will buy entire collections! Ralph DeLuca, 157 Park Ave., Madison, NJ 07940. (800) 392-4050. E-mail: Ralph@ralphdeluca.com.

**WANTED:** Philco Chevron Grille Cloth, Silvertone 1650 speaker, Zenith 12 S 265 outer dial shell, Silvertone 4792 dial bezel & Insert, Breting 14 cover. Keith Park, 31 Barkwood Ln, Clifton Park, NY 12065. (518) 373-0417. E-mail: topnotch@nycap.rr.com.

**WANTED:** Trim pieces for Hallicrafters SX-28 case or a complete case if not willing to part out. Will take a junker radio with case also. Chris Kucera, 103 Morris, Monte Vista, CO 81144. (719) 588-3408.

**WANTED:** Radiola 18 lamp hood (reproduction okay). Also knob for Radiola 18. Looking for cheap fixer-upper cathedrals and tombstones (all brands). Finally, looking for Rogers sets, any condition (prices must be reasonable). Please email or write with pictures and prices. Jason Wiles, 130 Clocktower Ln., Harrisville, PA 16038 E-mail: jason@wileselectronics.com

**WANTED:** Coto-coil Radio; RCA Radiola Horn Speaker UZ-1320. Edmond Levesque, 126 Friends Cove, Somerset, MA 02726. (508) 674-1169. E-mail: Radiocove@aol.com.

**WANTED:** Broken, incomplete Military AN/ARC-5 Radio Receivers or miscellaneous parts that you can't use, for any model Army-Navy ARC-5 type Receiver. Please be reasonable on your price for this material you are not going to use. Jim Inglett, 94 Leawood Dr., Midway, AR 72651. E-mail: jims75@suddenlink.net.

**WANTED:** Tuning knob for a Crosely 51. Zenith dial pointer for round dial sets, 5" long, has "Z" in the middle of pointer. Al Anderson, 510 Park Ave., Mechanicville, NY 12118. (518) 664-6846. E-mail: aanders1@nycap.rr.com.

**WANTED:** ANY Panoramic Radio Corp Items - Panadaptors Spectroscopes, Panaramoscopes, Panalyzers, Spectrum Analyzers, Test Equipment, Manuals etc. Also need clean Hallicrafters SX 28A, AN/GRR-2 and R595 Receiver in R45/ARR7AX. Robert Zollinger W7RMZ, 5296 N Via Sempreverde, Tucson, AZ 85750. (520) 299-2529. E-mail: robertmzollinger@comcast.net.

**WANTED:** McMurdo-Silver Model 802 Superhet Rcvr & Model 701 Xmtr. Also B&W Junior Coils, 5 pin horizontal, no 21XX or freq stamped on their unglazed porcelain base. William Ross W9WR, 300 Oxford Rd., Kenilworth, IL. (847) 251-7447. E-mail: william.ross@comcast.net

**WANTED:** ARC-5/SCR-274-N type transmitters, receivers, connectors, cables, accessories, etc. Single items or more. Mark McKeown WOPXM, 14725 W. 30th Pl, Golden, CO 80401. (303) 278-3908. E-mail: mmckeown@tde.com.

**WANTED:** Copy of schematic for PRECISION 915 Tube tester. FOR SALE: ARRL HANDBOOK 1991 Hardback, like new condition, \$12 original price was \$25. Jim Gauldin, 134 Hawthorne Dr., Danville, VA 24541. (434) 792-2286. Email: jimgauldinsr@earthlink.net.

**WANTED:** Emerson model BA 199 or 126 table radio in white color. Jack Heffernan, 16 Waumbekket Way, Bridgton, ME 04009. (207) 647-8562. E-mail: jvheffernan@gmail.com.

**WANTED:** A 32 volt mid-western farm set. There were some without vibrators - worked on 32 volts as B+. What do you have? Working or restore-able. Gordon O. Trump, 688 E. Berlin Rd., York Springs, PA 17372. (717) 528-4049. Email: trumpgordon@embarqmail.com.

**WANTED:** For RCA console mod 911K: curved bezel/escutcheon; dial glass; ten push-buttons. Barney Wooters, 8303 East Mansfield Ave., Denver, CO 83237. (303) 770-5314. E-mail: bnjwooters@gmail.com.

**WANTED:** BATTERY ELIMINATER for 6-tube (5-01A & 71A) early radio. Needs 45, 90, and 135 VDC B-supply, 5-6 VDC A-supply and (-4 to -12 range) VDC C-supply. Clifford Huff, 2215 Ridge-wood St., Carrollton, TX 75006. (972) 416-7713. E-mail: cliffhuff@verizon.net.

**WANTED:** Collector looking to buy a Sparton - Catalin/Cloisone - 1939 radio, also looking for interesting radio advertising, no magazine ads please, thanks. Kirk Lahey, 58 Fury Dr., Dartmouth, N.S., B3A 4Y2 Canada. (902) 468-9642. E-mail: radios@ns.sympatico.ca.

**SERVICES:** Utah Reconing your full service speaker reconing and repair shop. Fast turn around specializing in antique radio speakers as well as a full service reconer. 22 years experience, reasonable prices, quick turn around. Matt Shelton, Utah Reconing, 7120 Camelot Way, West Jordan, UT 84084. (801) 694-0166. E-mail: redmatt2@juno.com.

**SERVICES:** Do you need your test equipment repaired or calibrated? I can help. Very reasonable rates. Rod Galloway, 2961 SE 152nd Ave., Morris-ton, FL 32668. (352) 528-9499. E-mail: rodgall@wildblue.net  
**WANTED:** HH Scott 135 in good condition. Al Dean, 295 Pierce St., Leominster, MA 01453. (978) 537-7563. E-mail: ahdean@verizon.net.

**SERVICES:** All American table radio restoration specials: 5-tube \$49.99; 6-tube \$59.99. Other flat rate restorations for larger radios, car rdios & TVs. Send E-mail, write, call, or visit my web sites for details. Dave's Antique Radio and TV Restorations, PO Box 285, Liverpool, NY 13088. E-mail: dave2@dreamscape.com or dave2@tube-sandtransistorsandmore.com. Web sites: www.dreamscape.com/dave2/daves.htm or www.tube-sandtransistorsandmore.com. (315) 944-0265.

**FOR SALE:** Tombstone battery radios: Coronado 550 and Silvertone 1928 at \$80 each plus shipping; Sutdebaker Philco Starline car radio for '50 through '52 cars \$85. Harry Schesnik, PO Box 2162, Newport, WA 99156. (509) 447-4630.

**FOR SALE:** German table radios. Use your tax return for excellent to near mint and working units. Grundig 3035, \$150; 4019, \$200; 4090, \$200; 5299, \$225; 5490, \$250; 6199, \$350. Emud T-7 \$100, Senior 60 (blonde, and dark), \$100 each; Siemens 1135W super S4 \$150; Korting 1030 \$200, 1085FX Stereo, \$200. Philips Saturn 653 \$150, Capella Tonmeister 842, \$225. Blaupunkt Granada 60, \$150; Nordmende 3004, \$250, Graetz Fantasia 1022ES, \$275. Kuba Console, \$75 pick up only, Tandberg portable TP-41. Parts sets too. All plus shipping. Ed Kalpa, 4622 Melbourne Ave, Los Angeles, CA 90027. (310) 795-7925.

**FOR SALE:** Simpson 260; Seco model 88; Motorola C2W clock radio; Motorola 56W1B; Motorola 5P32Y 600 series; 66L1U; Jan 5FP7A CRT; B-K 400 CRT checker; UTC PA2L6 transformer; 262kc coils; Fujiya 5" R2R; 78 RPM wireless changer by Galvin. Robert Rossi, 10936 Melbourne Ave., Allen Park, MI 48101. (313) 386-8321.

**FOR SALE:** Superior Instruments 670A tester; 1938 Oldsmobile car radio 982126. Gordon Shimmel, Box 101, Hannawa Falls, NY 13647. (315) 265-4638.

**FOR SALE:** NOS Tubes: USN JAN CRC 6L6 10 @ \$15 each; NU46 6 @ \$5 each; 42 3 @ \$2 each; used tested ballon CX326, 327, NU171A, RCA 71A all at \$15 each; CX301A, JX201A, UX201A @ \$20 each; used tested 27 3 @ \$5 each, 41 @ \$5, 42 5 @ \$5 each, 2A3 2 @ \$45 each, 6V6 @ \$10, 6V6GT 3 @ \$15 each. Plus shipping. Ray Schneider, 903 Rodney Dr., San Leandro, CA 94577. (510) 352-4766.

**FOR SALE:** Crosley E15TN \$75; Zenith K725 \$35; Airline 943R \$40. Adrian La Pierre, 1314 E. Gardner Rd., Fort Mohave, AZ 86426. (928) 758-6352.



**FOR SALE:** Six (6) type 80 tubes. All test good, goes well over into the green on my tester. All eight for just \$49. Dave Crocker, 35 Santuit Pond RD., #4B, Mashpee, Cape Cod, MA 02649. Tel. (508) 477-1578, before 9 p.m. please.

**FOR SALE:** AK-24 (AK-20 Delux) Restored and refinished-good 301A tubes. Excellent condition \$345.00 plus shipping. Bob Nicholson, 1424 SW Birch Ln., Topeka, KS 66615. E-mail: wahoul@cox.net.

**FOR SALE:** Yamaha PX-3 linair tracking turntable Excellent cosmetic condition Make offer Untested Picture available. William Mittler, 4575 Sleepy Hollow Rd., Medina, OH 44256. (330) 225-3667. E-mail: wvm42@yahoo.com.

**FOR SALE:** AK70 in custom cabinet. Pictured in Smithsonian Magazine. Atlas, lions heads. Zenith models 39 & 40. Model 40 has a 39 chassis and is missing speaker grille & phonograph drawer, but cabinet is VG+. Jim Leckrone, 6683 Spruce Dr., Benzonia, MI 49616. (231) 383-4077. E-mail: click-away75@yahoo.com.

**FOR SALE:** Projects I won't get to: Radiola #44 \$50; #80 \$60, American Bosch #28 \$50; EH Scott Metropolitan \$75 pick up in Ann Arbor, MI preferred. Also a table radio collection - List available. Radley Smith, 3188 Runsey Dr., Ann Arbor, MI 48105. (734) 769-2663. E-mail: wesmiths@comcast.net.

**FOR SALE:** Many Sams sets \$2 each plus postage. Riders 6 to 17, \$15 each plus shipping. Old broadcast equipment, list for SASE. Pix and list e-mail. Tom Earnest, PO Box 62032, San Angelo, TX 76906. E-mail: theufol@wcc.net.

**FOR SALE:** Stewart Warner Cathedral model 102A, \$225; Grebe MU1 \$200; Stromberg Carlson 58T tombstone \$150; Bendix 526E \$50. All sets working. David Sacco, 223 Deerfield Dr., Rochester, NY 14609. (585) 654-8146. E-mail: dsacco@rochester.rr.com.

**FOR SALE:** 1947 Scott Radio Labs 800B AM/FM/SW receiver. Two chrome-plated chassis, 24 tubes and motorized push-button tuning. Works, but speaker is not original field-coil type, and phono turntable & pre-amp removed. Original mahogany veneer Chippendale cabinet. Comes with copies of Scott, Sams & Rider documentation. \$495 plus shipping (buyer-pickup preferred). Photos available via e-mail, if requested. Ken Higgins, 6304 Pine Slash Rd., Mechanicsville, VA 23116. (804) 559-0083. E-mail: k.s.higgins@comcast.net.

**FOR SALE:** National Radio Service Notes (called "Service and Test Data") issued 1949--covers NC-33, NC-46, NC-57, NC-108, NC-173 NC-183, NC-200, HRO-5A1, HRO-7, and misc equipment including televisions -7 & -10. 60 page copy. \$13 post paid cont-48. Gary A. Micanek, 226 Henry Ave., Manchester, MO 63011. (636) 227-7046. E-mail: micanek@att.net.

**FOR SALE:** Collector since WWII wants out early radios, boat anchors, test equipment, military sets, etc. What are you looking for? Howard Felder, 7517 Granada Dr., Bethesda, MD 20817. (301) 320-3028.

**SERVICES:** Logan's TV & Radio Repair. Logan's has over 3,000 rare radio tubes for sale. We also repair old radios, through our repair and ship service. Please contact: George for further details at Logan's, Rear 526 Mt. Pleasant St., Greensburg, PA 15601. (724) 836-2163 or (724) 837-5580.

**SERVICES:** Since 1987 Sound Remedy has specialized in reconditioning vintage loudspeakers used in antique radios, automobiles, jukeboxes and musical instruments as well as stereo and high-power Pro speakers. Our repair work is meticulous and guaranteed. Contact Sound Remedy, 331 Virginia Ave, Collingswood, NJ 08108. (856) 869-0238. E-mail: soundremedy@aol.com.

**SERVICES:** Antique Radio of Iowa & vintage furniture restorations. All bands electronic chassis repair. Sorry, no foreign units or conversions. Speaker service wood & veneer cabinet restoration. Plasti/bakelite repair and painting. Vintage auto radio repair. Tybe hybrid, all transistor, 8 track, 1930s to 1960s. Check out my eBay Store: iowacollectablesusa. PayPal and cashiers check welcome. 7 days a week. Don Nordboe, 3131 Avenue A, Council Bluffs, IA 51501. (712) 322-2255. E-mail: dnordboe@aol.com. Web: www.antiqueradioofiowa.com

**SERVICES:** Tube radio and some instrument repairs for the Rocky Mtn. region. For Sale: Selection of repaired, refurbished, and calibrated radio and TV test equipment. Includes RCA, EICO, Heathkit, PACO, etc. David Boyle 1058 Colt Cir. Castle Rock, CO, 80109, (303) 681-3258, djboylesr@msn.com

**SERVICES:** Northern Arizona sales, service, and parts for tube radios, amplifiers, auto radios. Vintage Radio, 440 W. Palomino Dr., Chino Valley, AZ 86323 next to our Radio Shack store. (928) 636-5140. E-mail: info@azvintageradio.com. www.azvintageradio.com.

**SERVICES:** Antique Radio Collectors and Historians of Greater St.Louis (A.R.C.H) Auction. Sunday, November 4, 2012 10AM, Depke Auction, 102 Brook Dr, Fenton MO 63026. CONSIGNMENTS NEEDED! Contact: Paul or Noel Barlows, 314-308-9337, bean@gameon.net.

**SERVICES:** Repairs to vintage tube equipment including home receivers, phonographs, and auto radios. South Bay Radio, 7187 Lakeshore Rd., Cicero, NY 13039. (315) 699-7341.

**SERVICES:** Repair of old radio, car radio, audio, stereo. Free estimate, reasonable cost, #1 Google "Vintage Hi-Fi repair". Mike Urban, 37 Elm St., Windsor, CT 06095. (203) 877-2409. Web: www.urban-antiqueradio.com

**Looking to buy or sell that special piece of equipment?**

**Place your classified ad today!**

**Find out how at**  
**www.antiqueradio.com**

**BOB'S ANTIQUE RADIOS & ELECTRONICS**  
SERVING THE VINTAGE RADIO COMMUNITY WITH QUALITY  
AND LOW COST PRODUCTS FOR OVER 25 YEARS !!

<u>*CAPACITORS</u>		<u>*ELECTROLYTICS</u>	
<u>630 VOLT AXIAL</u>		<u>160 VOLT AXIAL</u>	
<u>VALUE</u>	<u>PRICE/25</u>	<u>VALUE</u>	<u>PRICE/25</u>
.001	\$6.00	10	\$13.00
.0022	6.15	22	16.00
.0033	6.20	33	21.00
.0047	6.25	47	24.00
.0068	6.35	100	30.00
.01	6.50		
.022	7.00	<u>450 VOLT AXIAL</u>	
.047	7.50	10	\$18.75
.1	8.00	22	28.00
.22	15.00	33	36.00
.47	20.00	47	45.00
1.	26.00	<u>10-PACK</u>	
		47	\$20.00
		100	28.00

**NO MINIMUM ORDER!**

- \*STARTER KITS**  
(CAPACITOR, MOST COMMON)
- \*TWO STAGE FILTERS**
- \*pilot lamps**
- \*NEON LAMPS**
- \*DIAL CORDS**

FOR FURTHER INFO VISIT  
RADIOANTIQUES.COM

**\$1.75 FLAT RATE SHIPPING WITHIN THE USA**

**BOB'S ANTIQUE RADIOS AND ELECTRONICS**  
111 EAST 29TH STREET  
LAGRANGE PARK, IL 60526  
PHONE: 1-708-352-0648  
FAX: 1-708-352-0647  
radiobob1@radioantiques.com

**FOR SALE:** Nice Orpheus Console (early 1920's, complete w/ papers! St. Paul MN), Sony KV-1922 Color TV, Radiola 30 (large), Radiola 17, 18, 33, 60 and speakers 100 and 100A and some parts for these sets. Philco 95, 96, 37-650, 38-2 and others, also parts for many Philcos, Zeniths, more..... Several Nice Vintage Stereo Speaker Pairs, RCA Color TV (25-inch, late 1960's, CTC-38 series) and much more radios and parts for sale, send me your updated "want" lists. Wanted: Emerson chassis for model 134 tombstone cabinet (I believe the 133 and perhaps the 140 chassis also will fit). Sonoret Cathedral chassis (half round dial, three knob, full size cathedral radio made in Wilkes Barre by Sonnenberg Radio). Contact Wilbur Gilroy, PO Box 459, Lake Winola, PA 18625. (570) 378-2508. E-Mail: radiowilbur@frontiernet.net.

**FOR SALE:** Zenith Transoceanic Parts and Parts sets Tube and Transistor. Let me know what you are looking for. Claude Chafin NØFMO, 4223 E 42nd St Way, Independence, MO 64055. (816) 786-2313. E-mail: NØFMO@sbcglobal.net.

**FOR SALE:** Arvin 840 \$35. Coronadas: C6D613 \$45, 438305, \$45. Emerson 349, \$85. Hallicrafters: S38A \$35, S120 \$35. Heathkit AR3, \$30. Philco PT30 \$35. RCA 75X12 \$40 Zenith 6D029 \$50. Victrolas: VVIX \$200, VV50 \$75. H B McMahan, 313 W Shaw, Tyler, TX 75701. (903) 593-5433. E-mail: hbmc@att.net

## **A.G. Tannenbaum**

### **Electronic Service Data**

2043 Empire Central  
Dallas, Texas 75235  
Phone 214-654-0033

## **STILL THE**



## **FOR**

*Service Data - 1920's - Present  
Newly Expanded Library*

**Now selling tubes, equipment,  
test equipment and much more !**

Browse our expanded web offerings at  
<http://www.agtannenbaum.com>

**FOR SALE:** Philco Mystery Control (wireless remote) matches receiver model 39-116, \$50. Zenith Trans-Oceanic Model R-520 for restoration, \$350. Mike Grimes, 5306 Creekside Ct., Plano, TX 75094. (972) 898-7251. E-mail: K5MLG@verizon.net.

**FOR SALE:** Pickup only: Atwater Kent models 20, 35, 37, 40, 52; RCA Victor 16T3; Stewart Warner 325; Philco 49-504; Stromberg Carlson 10 console; Philco 37-61 console. Various conditions, poor to good. Also: Crosley Dynacone Type F speaker. Photos available. Richard Brockelman, 56 Cross St., Lunenburg, MA 01462. (978) 582-7958. E-mail: rbrockelman@verizon.net.

**FOR SALE:** Zenith 12-S-370 speaker tests good. Pick up only \$300. Claude Chafin NØFMO, 4223 E 42nd St Way, Independence, MO 64055. (816) 786-2313. E-mail: NØFMO@sbcglobal.net.

**FOR SALE:** Kenwood TH22 Walke-Talke Ham radio, works good some extra batteries manual. Also Uniden BC235 XLT 300 channel Trunk scanner works and has book and extra batteries. \$35 each plus shipping. Melvin Breyfogle W0MDM, 18 N 7th St., Estherville, IA 51334. (712) 362-4704 days (712) 362-5353 after 3pm. E-mail: mbrey@rconnect.com.

**FOR SALE:** Book, The Jazz Age, 1959, 208 pages Fine, hardcover, dust jacket has some wear, 250 vintage photos of performers, \$13 postpaid. H. Loos, 542 Tomahawk Ct., Palm Beach Gardens, FL 33410. (561) 352-8172. E-mail: hcloos@comcast.net.

**FOR SALE:** Eico 666 tube tester, complete and working, \$100. Panasonic RF-93 orange teardrop, excellent, \$75. Plus shipping. German radio parts. Ed Kalpa, 4622 Melbourne Ave, Los Angeles, CA 90027. (310) 795-7925.

**FOR SALE:** Specialty tubes: CK5702 subminiature pentodes, Dumont #6292 PMT, 3BP1 CRT, 3CP1 CRT, FX-1 EG&G straight flash tube, 1D21 Sylvania, 1P39 RCA photodetector, 1P40 photodetector, CE-18D Centron photodetector, 1B59 Sylvania photodetector, GL917 RCA photodetector, GL919 photodetector, 5819 photodetector, 931A photodetector. John Zima, 1360 Reed Rd., Churchville, NY 14428. (585) 293-3023. E-mail: jfz\_rhy@yahoo.com

**FOR SALE:** Sound Powered WWII US Navy RCA Big Cans MI-2045-E. They are in musum ready condition nearly "new old stock". The rubber ear pices show a little age but are soft and comfortable. These ear phones are well known for use with DXing crystal sets. Chuck Davis, 7666 Aldridge Pl., Dublin, OH 43017. (614) 792-6237. E-mail: chucksued@sbcglobal.net.

**FOR SALE:** Decade Resistor Checker, Type 1432P, Made by General Radio Company. Works Good. \$50 shipped. Fielding Grigsby, PO Box 2601, Ardmore, OK 73402. (580) 222-9408.

**FOR SALE:** Field carrying case for military BC800 transceiver \$45 plus shipping. Bernard Hassab, 4152 Honolulu Dr., Sarasota, FL 34241. (941) 284-8863. E-mail: shortwave\_6@verizon.net.



**OHIO – June 2**  
**SOCIETY FOR PRESERVATION**  
**OF ANTIQUE RADIO KNOWLEDGE**  
**(SPARK)**

Old Radio Swap Meet 7am  
 Gerhardt Civic Center, Moraine, OH  
 Info: Dan Casey (513) 265-8466  
 dansradioland@gmail.com

**OKLAHOMA – June 9**  
**OKLAHOMA VINTAGE RADIO**  
**COLLECTORS**

Meeting, Hometown Buffet  
 3900 N.W. 63rd St. Dinner 6:00pm,  
 Meeting 7:00pm, Oklahoma City, OK  
 Info: Jim Collings - (405) 755-4139  
 jrradio@cox.net - www.okvrc.org

**CALIFORNIA – June 2**  
**CALIFORNIA HISTORICAL RADIO**  
**SOCIETY**

Swap Meet & General Meeting – 9:00am  
 KRE Building, Berkeley, CA  
 Info: www.californiahistoricalradio.com

**WASHINGTON – June 10**  
**PUGET SOUND ANTIQUE RADIO**  
**ASSN. MEETING**

Seattle, WA - Seattle Scottish Rite Masonic  
 Center  
 1207 N. 152nd, Seattle  
 10:00 am - 12 noon: Tailgate Swap  
 12 noon: Meeting, Program, Show & Tell  
 Info: Lynda Glaspey (425) 478-3643  
 http://www.eskimo.com/~hhagen/psara

**CONNECTICUT – June 2**  
**VINTAGE RADIO & COMM. MUSE-**  
**UM OF CONNECTICUT**

Outdoor Summer Swap Meet – 8:00am  
 115 Pierson Ln., Windsor, CT  
 Info: www.vrcmct.org

**TEXAS – June 10**  
**TEXAS ANTIQUE RADIO CLUB**  
**MEETING**

Schertz, TX – VFW Hall – 2pm  
 Info: Ed Engelken - EdEngel@gvtc.com  
 (830) 899-3864  
 Web: www.gvtc.com/~edengel/TARC.htm

**NEW YORK – June 3**  
**GREATER NEW YORK VINTAGE**  
**WIRELESS ASSOCIATION**

Swap Meet & Meeting  
 Long Island, NY - Seaford Train Station  
 Parking Lot, 7 am - 11 am  
 Info: Jim Koehler - (516) 623-0035  
 Rich Lee - (914) 589-3751  
 Web site: www.nyantiqueradio.orgvv

**GEORGIA – June 11**  
**SOUTHEASTERN ANTIQUE RADIO**  
**SOCIETY**

Meeting – 6:30pm  
 Norcross, GA - Fire Mountain Rest. Jimmy  
 Carter Blvd.  
 Info: Rich Rodgers - (678) 591-3619  
 Web Site: www.sarsradio.comv

**NEW JERSEY – June 8**  
**NEW JERSEY ANTIQUE RADIO CLUB**

Princeton, NJ – Bowen Hall  
 70 Prospect Ave. - 7:30 pm  
 Info: Marv Beeferman (609) 693-9430  
 Rich Lee (914) 589-3751  
 E-mail: radiorich@prodigy.net  
 Join us on our live webcast: www.njarc.org

**PENNSYLVANIA –**  
**June 12**  
**DELAWARE VALLEY HISTORIC**  
**RADIO CLUB**

Monthly Mtg., Pennsylvania Radios, 7:30pm  
 Telford Community Center, Telford, PA  
 Info: www.dvhrc.info

# ELECTRIC RADIO



Are you tired of plastic modern radios that you can't work on and are hard to understand? Are you looking for information on restoration of quality vintage receivers and transmitters? Electric Radio is the magazine for you! In print since May, 1989, we also have the largest vintage-only Ham classified section available. Please send \$1 for a sample copy to:

ER, PO Box 242, Bailey CO, 80421  
720-924-0171 email: [1editor2@indra.com](mailto:1editor2@indra.com)  
[WWW.ERMAG.COM](http://WWW.ERMAG.COM)



## Join the **AWA** ANTIQUÉ WIRELESS ASSOCIATION

THE ORIGINAL AND LARGEST HISTORICAL RADIO-COLLECTOR GROUP

- Publishes *AWA Journal* with:
  - Battery and AC receiver restoration
  - Vacuum-tube history and collecting
  - Old-time amateur-radio contests
  - Communications receivers
  - Free want-sell-swap ads
  - Early television
  - Horn loudspeakers
  - Reviews of current books
  - Keys and land-line telegraphy
  - News of U. S. and foreign clubs
  - Information on public radio museums.
- Maintains unique radio-TV museum.
- Produces the annual Rochester meet.
- Co-sponsors local meets.
- Publishes the annual *AWA Review*.



Membership is only \$25 per year U.S.A. (\$30 per year elsewhere). Write to:

AWA Membership Director  
PO Box 421, Bloomfield, NY 14469-0421  
[www.antiquewireless.org](http://www.antiquewireless.org)

## OLD TECH BOOKS & THINGS



A 2,000 sq. ft. museum is not enough space for my 1000+ set collection. And, hundreds of boxes await either space in the museum or sale. Some things must go! Choices must be made. As the late Dr. Muchow said, "As collectors, we truly are temporary caretakers of these historical artifacts."

Items for sale are either duplicates or the result of fine-tuning the scope of my collection.

For details on these items and much more, visit:

[www.oldtech.com](http://www.oldtech.com)

or contact:

**John Terrey**

**Old Tech - Books & Things**

P.O. Box 803, Carlisle, MA 01741

[jvt@oldtech.com](mailto:jvt@oldtech.com) — (978) 369-9770

### For Sale

#### Western Electric Items

**6004-B Radio Receiving Outfit** (*rare*)

(4B Radio Receiver,

Loop Antenna, 10-A Battery Box)

**6204-D Radio Receiving Outfit** (*rare*)

(4D Radio Receiver,

2-B Tuning Unit, 20-A Filter)

3B Radio Receiver

4C Radio Receiver

2-A Tuning Unit

2-A Current Supply

7-A Amplifier

14-A Ampifier/Speaker

"STANRAD" 1-tube RF Amp matches

the W. E. Radio Receivers

3A Radio Receiver-SOLD

24-B Amplifier-SOLD

#### Marconi of America Items

Type CM294A Receiver

Magnetic Detector

Type 122-SOLD

#### RCA Items

106D (Factory Conversion from 106C)

**OHIO – June 12**  
**SOCIETY FOR THE PRESERVATION**  
**OF ANTIQUE RADIO KNOWLEDGE**  
(SPARK)

Meeting Kettering, OH, Parkview Comm. Ctr  
2012 Annual Swap Meet – 7:00am  
Moraine Gerhardt Civic Center  
3050 Kreitzer Rd., Moraine, OH 45439  
Info: Dan Casey (513) 265-8466  
E-mail: dansradioland@gmail.com

**MISSOURI – June 12**  
**ANTIQUÉ RADIO COLL. & HIST. OF**  
**GREATER ST. LOUIS MEETING**

Kirkwood, MO - Kirkwood Comm. Ctr  
111 S. Geyer Rd., Room 201-A  
7:30 pm Meeting, Show & Tell, Swap Table  
Info: Joe Tauser - (314) 616-0745  
joe@jtauser.com  
Web site: www.archradioclub.com

**NEW YORK – June 15**  
**HUDSON VALLEY ANTIQUÉ RADIO**  
**& PHONOGRAPH SOCIETY**

Club Meeting  
Episcopal Church of Suffern  
65 Washington Street 7:30pm  
Info: Dale Cranston (845) 357-1615

**CALIFORNIA –**  
**June 16**  
**SOUTHERN CALIFORNIA ANTIQUÉ**  
**RADIO SOCIETY**

Swap Meet – 7:00am to Noon  
JL Fisher, Burbank, CA  
Info: Barry Dagestino (714) 281-5190  
www.antiqueradios.org

**TEXAS – June 16**  
**VINTAGE RADIO & PHONOGRAPH**  
**SOCIETY MEETING**

Garden and Arts Building – 1pm to 5pm  
Irving, TX  
Info: (817) 292-7435  
Web Site: www.vrps.org

**NEW HAMPSHIRE –**  
**June 16**  
**NEW ENGLAND ANTIQUÉ RADIO CLUB**

Antique Radio Show 7:30am  
Brookline Event Center  
Brookline, NH  
Info: www.nearc.net

**ILLINOIS – June 17**  
**ANTIQUÉ RADIO CLUB OF**  
**ILLINOIS**

Outdoor Swap Meet 7:00am – 11:00am  
DuPage County Fairgrounds, Wheaton, IL  
Info: www.antique-radios.org

**FLORIDA – June 18**  
**JACKSONVILLE ANTIQUÉ RADIO**  
**SOCIETY**

Monthly Meeting 1:30pm  
Countryside Village Clubhouse,  
19060 Beach Blvd.  
Info: Sean Olin – (904) 386-8332  
Web Site: www.jarsradioclub.com

**OHIO – June 20**  
**CENTRAL OHIO ANTIQUÉ RADIO**  
**ASSOCIATION**

Quarterly Meeting  
DeVry University – 7:30pm  
Info: Dave Poland (614) 890-5422  
Barry Gould (614)442)1518  
Web Site: www.meemembers.tripod.com/  
~coara/index.html

**MARYLAND –**  
**June 21-23**  
**MID-ATLANTIC ANTIQUÉ**  
**RADIO CLUB**

RadioActivity 2012  
Beltsville, MD  
Sheraton Washington North Hotel  
Info: Geoff Shearer - (703) 818-2686  
web site: www.maarc.org

**PENNSYLVANIA –**  
**June 23**  
**PITTSBURGH ANTIQUÉ RADIO**  
**SOCIETY**

Club Meeting – 10:00am to 2:00pm  
Patriotic & Military Radios  
Brentwood Presbyterian Church  
3725 Brownsville Rd., Brentwood, PA  
Info: Chris Wells (724) 942-1113  
Regis Flaherty (724) 969-0643  
Web site: www.pittantiqueradios.org



**OKLAHOMA - June 23**  
**HEARTLAND ANTIQUE RADIO**  
**ASSOCIATION**

Summer Sizzler  
Annual Swap Meet, Auction, and Contest  
Free Admission  
Broken Arrow Church of Christ  
505 E Kenosha St  
Broken Arrow, OK 74012  
8:00 A.M. Info:

**TEXAS - June 23**  
**HOUSTON VINTAGE RADIO ASSOC.**

Monthly Meeting - 9:30am  
Bayland Park Community Center  
6400 Bissonnet, Houston, TX  
Info: Bill Werzner 713-721-2242  
E-mail: werz1943@gmail.com  
Web Site: www.hvra.org

**NEW YORK - June 24**  
**SCHENECTADY ANTIQUE RADIO CLUB**

St. Roses College, Madison Ave.  
Albany, NY - Noon  
Info: Louis DeGonzague  
E-mail: zenith6@verizon.net\

**ALABAMA - June 25**  
**ALABAMA HISTORICAL RADIO SOC.**  
Mtg, Birmingham, AL, Alabama Power Bldg.  
1801 Abraham Woods Blvd. - 7:00pm  
Info: Dee Haynes (205) 841-4630  
www.alabamahistoricalradiosociety.org

**VIRGINIA - June 26**  
**TIDEWATER ANTIQUE RADIO &**  
**PHONOGRAPH ASSOC. (TARPA)**

Club Meeting - 7pm  
Norfolk, VA - Pretlow Library, Ocean View  
Info: Barry Callis (757) 427-9667  
E-mail: betty3689@aol.com

**OHIO - June 27**  
**CINCINNATI ANTIQUE RADIO SOCIETY**

Club Meeting  
Fairfield Pavillion, Rte 4, Fairfield, OH  
Info: Bob Pohl E-mail: bobpohl@fuse.net

**NEW YORK - July 1**  
**GREATER NEW YORK VINTAGE**  
**WIRELESS ASSOCIATION**

Swap Meet & Meeting  
Long Island, NY - Seaford Train Station  
Parking Lot, 7 am - 11 am  
Info: Jim Koehler - (516) 623-0035  
Rich Lee - (914) 589-3751  
Web site: www.nyantiqueradio.org

**COLORADO - July 8**  
**COLORADO RADIO COLLECTORS**

Meeting - 1pm  
Info: David Boyle - (303) 681-3258  
www.radioace.com

**GEORGIA - July 9**  
**SOUTHEASTERN ANTIQUE RADIO**  
**SOCIETY**

Meeting - 6:30pm  
Norcross, GA - Fire Mountain Rest.  
Jimmy Carter Blvd.  
Info: Rich Rodgers - (678) 591-3619 web site:  
www.sarsradio.com

**OHIO - July 10**  
**SOCIETY FOR THE PRESERVATION**  
**OF ANTIQUE RADIO KNOWLEDGE**  
**(SPARK)**

Meeting Kettering, OH  
Parkview Comm. Ctr  
4100 Glenheath 7:30 pm  
Info: Dan Casey (513) 265-8466 E-mail:  
dansradioland@gmail.com

**PENNSYLVANIA - July 10**  
**DELAWARE VALLEY HISTORIC**  
**RADIO CLUB**

Monthly Meeting, Annual Tailgate Auction  
7:30pm  
Telford Community Center, Telford, PA  
Info: www.dvhrc.info

**MISSOURI - July 10**  
**ANTIQUARIAN RADIO COLL. & HIST. OF**  
**GREATER ST. LOUIS**

Meeting, Kirkwood, MO  
Kirkwood Comm. Ctr  
111 S. Geyer Rd., Room 201-A  
7:30 pm Meeting, Show & Tell, Swap Table  
Info: Joe Tauser - (314) 616-0745  
joe@jtauser.com  
Web site: www.archradioclub.com

**MICHIGAN – July 12-14**  
**MICHIGAN ANTIQUE RADIO CLUB**  
Extravaganza '12  
Lansing, MI – Causeway Bay Hotel  
28600 W Mile Rd  
Info: Mark Goodwin (734) 944-0730  
Web Site: [www.michiganantiqueradio.org](http://www.michiganantiqueradio.org)

**NEW JERSEY – July 13**  
**NEW JERSEY ANTIQUE RADIO CLUB**  
Princeton, NJ – Bowen Hall  
70 Prospect Ave. - 7:30 pm  
Info: Marv Beeferman (609) 693-9430  
Rich Lee (914) 589-3751  
E-mail: [radiorich@prodigy.net](mailto:radiorich@prodigy.net)  
Join us on our live webcast: [www.njarc.org](http://www.njarc.org)

**WEST VIRGINIA –**  
**July 13-14**  
**MUSEUM OF RADIO &**  
**TECHNOLOGY**  
Summer Heat Traders Show & Auction  
1640 Florence Ave., Huntington, WV  
Info: 304-525-8890  
Web Site: [www.mrtwv.org](http://www.mrtwv.org)

**OKLAHOMA – July 14**  
**OKLAHOMA VINTAGE RADIO**  
**COLLECTORS**  
Oklahoma City, OK, 3900 N.W. 63rd St.  
Meeting, Hometown Buffet  
Dinner 6pm, Meeting 7pm  
Info: Jim Collings - (405) 755-4139  
[jrcradio@cox.net](mailto:jrcradio@cox.net) - [www.okvrc.org](http://www.okvrc.org)

**WASHINGTON – July 15**  
**PUGET SOUND ANTIQUE RADIO**  
**ASSOCIATION**  
Meeting Seattle, WA  
Seattle Scottish Rite Masonic Center  
1207 N. 152nd, Seattle  
10:00 am - 12 noon: Tailgate Swap  
12 noon: Meeting, Program, Show & Tell  
Info: Lynda Gaspey (425) 478-3643  
Web site: [www.eskimo.com/~hhagen/psara](http://www.eskimo.com/~hhagen/psara)

**FLORIDA – July 16**  
**JACKSONVILLE ANTIQUE RADIO**  
**SOCIETY**  
Monthly Meeting 1:30pm  
Countryside Village Clubhouse,  
19060 Beach Blvd.  
Info: Sean Olin – (904) 386-8332  
Web Site: [www.jarsradioclub.com](http://www.jarsradioclub.com)

**OKLAHOMA – July 19**  
**HEARTLAND ANTIQUE RADIO**  
**ASSOCIATION**  
Monthly Meeting  
1920's Radios by Bob Shindhelm  
Tulsa, OK Hardesty Library  
8316 E 93rd St 6:30 PM  
Info: [www.hlara.org](http://www.hlara.org)

**NEW YORK – July 20**  
**HUDSON VALLEY ANTIQUE RADIO**  
**& PHONOGRAPH SOCIETY**  
Club Meeting  
Episcopal Church of Suffern  
65 Washington Street 7:30pm  
Info: Dale Cranston (845) 357-1615

**CALIFORNIA – July 21**  
**CALIFORNIA HISTORICAL RADIO**  
**SOCIETY**  
LIVE! at KRE 2012  
Radio Day by the Bay – 10:00am  
Annual Fund Raising Event –  
Auction, Live Music  
KRE Building, Berkeley, CA  
Info: [www.californiahistoricalradio.com](http://www.californiahistoricalradio.com)

**TEXAS – July 21**  
**VINTAGE RADIO & PHONOGRAPH**  
**SOCIETY**  
Repair Session, 8:00am to 12Noon  
Senter East Building, Irving, TX  
Info: (817) 292-7435  
Web Site: [www.vrps.org](http://www.vrps.org)

**TEXAS – July 21**  
**TEXAS ANTIQUE RADIO CLUB**  
Meeting, Kyle, TX  
Railroad BBQ 9:30 am  
Info: Ed Engelken - [EdEngel@gvtc.com](mailto:EdEngel@gvtc.com)  
(830) 899-3864  
Web: [www.gvtc.com/~edengel/TARC.htm](http://www.gvtc.com/~edengel/TARC.htm)

**INDIANA – July 21**  
**INDIANA HISTORICAL RADIO**  
**SOCIETY**  
Summer Meet, Silent Auction  
8:00am to 11:00am  
Columbus 4H Fairgrounds  
Family Arts Build  
Info: Fred Prohl (812) 988-1761  
[www.indianahistoricalradio.org](http://www.indianahistoricalradio.org)



Michigan Antique Radio Club's

# Extravaganza '12

at Best Western Plus Lansing

(formerly the Causeway Bay Hotel)

6820 S. Cedar Street, Lansing, MI 48911 (517)694 8123

If you can only attend one out-of-state radio meet this year it should be *Extravaganza '12*

### Highlights:

1. **Huge 2 Day Flea Market**  
(Note: Flea market opens Friday)
2. **Hospitality under the Big Top**
3. **Saturday Auction with Rich Estes**
4. **Equipment contest**
5. **Informal Social Hour with live entertainment**
6. **4 Informative programs**
7. **Daily prize drawings**

# Extravaganza

July 12, 13 and 14

2012

For information note our contact: Mark Goodwin, 9225 Moon Road Saline, MI 48176, Email: [mrkgoodwin@comcast.net](mailto:mrkgoodwin@comcast.net) or check our web page at [www.michiganantiqueradio.org](http://www.michiganantiqueradio.org)

Family registration (all registrants must live at the same address)  
 Current MARC or TCI member (\$25)-----\$ \_\_\_\_\_  
 Non - MARC or TCI member (\$35)-----\$ \_\_\_\_\_

Outdoor Flea Market Space  
 First outdoor space (\$35)-----\$ \_\_\_\_\_  
 Additional outdoor spaces:  
 \_\_\_\_\_ Additional spaces X \$25 ea. -----\$ \_\_\_\_\_

8' Tables to rent  
 \_\_\_\_\_ Tables X \$15 each -----\$ \_\_\_\_\_

Under Tent Flea Market Sellers, 8' tables with 1 chair  
 \_\_\_\_\_ First table X \$45 each -----\$ \_\_\_\_\_  
 \_\_\_\_\_ Additional tables at \$40 each-----\$ \_\_\_\_\_

Total -----\$ \_\_\_\_\_

The Michigan Antique Radio Club and Telephone Collectors International are pleased to announce this year's theme:

## BAKELITE AND BEYOND

Please make your check to MARC for the total and mail it to Mark Goodwin, 9225 Moon Road, Saline, MI 48176

Please NOTE: To encourage participation by the general public, buyer's access to the flea market is free but we request that everyone attending EXTRAVAGANZA must register! The monies collected as a result of registrations are a major source of revenue that helps pay for the event. Your cooperation is greatly appreciated.

**WISCONSIN – July 22**  
**WISCONSIN ANTIQUE RADIO CLUB**  
Swap Meet 8:00am to 11:00am  
Milwaukee, WI  
5917 S. Howell  
Info: [www.warci.org](http://www.warci.org)

**NEW YORK – July 22**  
**SCHENECTADY ANTIQUE RADIO CLUB**

St. Roses College, Madison Ave., Albany,  
NY – 12Noon  
Info: Louis DeGonzague  
E-mail: [zenith6@verizon.net](mailto:zenith6@verizon.net)

**ALABAMA – July 23**  
**ALABAMA HISTORICAL RADIO SOCIETY**

Meeting, Birmingham, AL  
Alabama Power Bldg.  
1801 Abraham Woods Blvd. – 7:00 pm  
Info: Dee Haynes (205) 841-4630  
Web Site: [www.alabamahistoricalradiosociety.org](http://www.alabamahistoricalradiosociety.org)

**VIRGINIA – July 24**  
**TIDEWATER ANTIQUE RADIO & PHONOGRAPH ASSOC. (TARPA)**

Club Meeting – 7pm  
Norfolk, VA – Pretlow Library, Ocean View  
Info: Barry Callis (757) 427-9667  
E-mail: [betty3689@aol.com](mailto:betty3689@aol.com)

**OHIO – July 25**  
**CINCINNATI ANTIQUE RADIO SOCIETY**

Club Meeting  
Fairfield Pavillion, Rte 4, Fairfield, OH  
Info: Bob Pohl  
E-mail: [bobpohl@fuse.net](mailto:bobpohl@fuse.net)

**TEXAS – July 28**  
**HOUSTON VINTAGE RADIO ASSOCIATION**

Monthly Meeting – 9:30am  
Bayland Park Community Center  
6400 Bissonnet, Houston, TX  
Info: Bill Werzner 713-721-2242  
E-mail: [werz1943@gmail.com](mailto:werz1943@gmail.com)  
Web Site: [www.hvra.org](http://www.hvra.org)

**MISSOURI – July 29**  
**MID AMERICA ANTIQUE RADIO CLUB**

Swap Meet – 8:00am  
Leawood Aquatic Center  
10601 Lee Blvd., Leawood, KS  
Info: Bob Lutz (913) 634-0816  
Web site: <http://sites.google.com/site/midamericaantiqueradioclub/>

**ILLINOIS – August 2-4**  
**ANTIQUERADIO CLUB OF ILLINOIS**

RadioFest 2012 – 7:00pm Thursday to  
1:00pm Saturday  
Willowbrook Holiday Inn, Willowbrook, IL  
Info: [www.antique-radios.org](http://www.antique-radios.org)

**CALIFORNIA – August 4**  
**CALIFORNIA HISTORICAL RADIO SOCIETY**

Swap Meet – 9:00am  
Foothill College, Los Altos Hills, CA  
Info: [www.californiahistoricalradio.com](http://www.californiahistoricalradio.com)

**NEW YORK – August 5**  
**GREATER NEW YORK VINTAGE WIRELESS ASSOCIATION**

Swap Meet & Meeting  
Long Island, NY - Seaford Train Station  
Parking Lot  
7 am - 11 am  
Info: Jim Koehler - (516) 623-0035  
Rich Lee - (914) 589-3751  
Web site: [www.nyantiqueradio.org](http://www.nyantiqueradio.org)

**NEW JERSEY – August 10**  
**NEW JERSEY ANTIQUE RADIO CLUB**

Princeton, NJ – Bowen Hall  
70 Prospect Ave. - 7:30 pm  
Info: Marv Beeferman (609) 693-9430  
Rich Lee (914) 589-3751  
E-mail: [radiatorich@prodigy.net](mailto:radiatorich@prodigy.net)  
Join us on our live webcast: [www.njarc.org](http://www.njarc.org)

**OKLAHOMA – August 11**  
**OKLAHOMA VINTAGE RADIO COLLECTORS**

Meeting, Hometown Buffet  
Oklahoma City, OK  
3900 N.W. 63rd St. Dinner 6:00pm, Meeting  
7:00pm  
Info: Jim Collings - (405) 755-4139  
[jrcradio@cox.net](mailto:jrcradio@cox.net) - [www.okvrc.org](http://www.okvrc.org)

**ILLINOIS –  
August 11-12  
CHICAGOLAND ANTIQUE RADIO  
SHOW**

Lake County Fairgrounds  
1060 E. Peterson Rd., Grayslake, IL  
Info: [www.zurkopromotions.com](http://www.zurkopromotions.com)

**GEORGIA – August 13  
SOUTHEASTERN ANTIQUE RADIO  
SOCIETY**

Meeting – 6:30pm  
Norcross, GA - Fire Mountain Rest.  
Jimmy Carter Blvd.  
Info: Rich Rodgers - (678) 591-3619  
Web site: [www.sarsradio.com](http://www.sarsradio.com)

**MISSOURI – August 14  
ANTIQUERADIO COLL. & HIST. OF  
GREATER ST. LOUIS**

Meeting, Kirkwood, MO  
Kirkwood Comm. Ctr  
111 S. Geyer Rd., Room 201-A  
7:30 pm Meeting, Show & Tell, Swap Table  
Info: Joe Tauser - (314) 616-0745  
E-mail: [joe@jtauser.com](mailto:joe@jtauser.com)  
Web site: [www.archradioclub.com](http://www.archradioclub.com)

**OHIO – August 14  
SOCIETY FOR THE PRESERVATION  
OF ANTIQUE RADIO KNOWLEDGE  
(SPARK)**

Meeting Kettering, OH  
Parkview Comm. Ctr  
4100 Glenheath 7:30 pm  
Info: Dan Casey (513) 265-8466  
E-mail: [dansradioland@gmail.com](mailto:dansradioland@gmail.com)

**PENNSYLVANIA –  
August 14  
DELAWARE VALLEY HISTORIC  
RADIO CLUB**

Monthly Meeting  
Advertising & Ephemera – 7:30pm  
Telford Community Center, Telford, PA  
Info: [www.dvhrc.info](http://www.dvhrc.info)

**OHIO – August 15  
CINCINNATI ANTIQUE RADIO SOCIETY  
Club Meeting**

Fairfield Pavilion, Rte 4, Fairfield, OH  
Info: Bob Pohl E-mail: [bobpohl@fuse.net](mailto:bobpohl@fuse.net)

**CHICAGOLAND  
ANTIQUERADIO SHOW  
AUGUST 11 & 12, 2012**



**Phonograph, Mechanical Music, Coin-Op,  
Music Box, Antique Radios, HAM,  
Records, 33's-45's-78's & More!**  
Show Hours: Sat. 10am - 4pm • Sun. 8am - 3pm / \$6

Held during the Premiere Grayslake Antique Market



**LAKE COUNTY FAIRGROUNDS**

1060 E. PETERSON RD., GRAYSLAKE, IL 60030  
1/2 W. of Rl. 45 on Peterson Rd & Midlothian Rd.  
IF USING A GPS, PLEASE ENTER THIS ADDRESS:  
19822 PETERSON ROAD, LIBERTYVILLE, IL 60048



Zurko Promotions • 715-526-9769 • [www.zurkopromotions.com](http://www.zurkopromotions.com)

**GRAYSLAKE, IL • LAKE COUNTY FAIRGROUNDS • VENDORS WELCOME!**

**NEW YORK – August 17  
HUDSON VALLEY ANTIQUE RADIO  
& PHONOGRAPH SOCIETY**

Club Meeting  
Episcopal Church of Suffern  
65 Washington Street 7:30pm  
Info: Dale Cranston (845) 357-1615

**TEXAS – August 18  
VINTAGE RADIO & PHONOGRAPH  
SOCIETY**

Meeting, Senter East Building  
1:00pm to 5:00pm  
Irving, TX  
Info: (817) 292-7435  
Web Site: [www.vrps.org](http://www.vrps.org)

**TEXAS – August 19  
TEXAS ANTIQUE RADIO CLUB**

Meeting, VFW Hall – 2pm  
Schertz, TX  
Info: Ed Engelken - [EdEngel@gvtc.com](mailto:EdEngel@gvtc.com)  
(830) 899-3864  
Web Site: [www.gvtc.com/~edengel/](http://www.gvtc.com/~edengel/)  
TARC.htm

**FLORIDA – August 20  
JACKSONVILLE ANTIQUE RADIO  
SOCIETY**

Monthly Meeting 1:30pm  
Countryside Village Clubhouse,  
19060 Beach Blvd.  
Info: Sean Olin – (904) 386-8332  
Web Site: [www.jarsradioclub.com](http://www.jarsradioclub.com)

**WASHINGTON –  
August 21**

**PUGET SOUND ANTIQUE RADIO ASSN.**  
Annual Swap Meet, Seattle, WA  
Shoreline-Lake Forest Park Center  
15800 1st Avenue NE, Shoreline, WA  
10:00 am - 12 noon: Tailgate Swap  
12 noon: Meeting, Program, Show & Tell  
Info: Lynda Glaspey (425) 478-3643  
Web: [www.eskimo.com/~hhagen/psara](http://www.eskimo.com/~hhagen/psara)

**TEXAS – August 25  
HOUSTON VINTAGE RADIO ASSN.**

Monthly Meeting – 9:30am  
Bayland Park Community Center  
6400 Bissonnet, Houston, TX  
Info: Bill Werzner (713) 721-2242  
E-mail: [werz1943@gmail.com](mailto:werz1943@gmail.com)  
Web Site: [www.hvra.org](http://www.hvra.org)

**NEW YORK – August 26  
SCHENECTADY ANTIQUE RADIO  
CLUB**

St. Roses College, Madison Ave.,  
Albany, NY – 12 Noon  
Info: Louis DeGonzague  
E-mail: [zenith6@verizon.net](mailto:zenith6@verizon.net)

**ALABAMA – August 27  
ALABAMA HISTORICAL RADIO  
SOCIETY**

Meeting, Birmingham, AL  
Alabama Power Bldg.  
1801 Abraham Woods Blvd. – 7:00 pm  
Info: Dee Haynes (205) 841-4630  
[www.alabamahistoricalradiosociety.org](http://www.alabamahistoricalradiosociety.org)

**VIRGINIA – August 28  
TIDEWATER ANTIQUE RADIO &  
PHONOGRAPH ASSOC. (TARPA)**

Club Meeting – 7pm  
Norfolk, VA – Pretlow Library, Ocean View  
Info: Barry Callis (757) 427-9667  
E-mail: [betty3689@aol.com](mailto:betty3689@aol.com)

**UPCOMING INTERNATIONAL  
EVENTS**

*(A.R.C. would like to hear about other international radio events)*

**AUSTRALIA – June 2  
HISTORICAL RADIO SOCIETY OF  
AUSTRALIA**

Sydney Meeting and Workshop  
Info: <http://hrsa.asn.au/>

**HOLLAND – June 2  
NEDERLANDSE VERENIGING VOOR  
DE HISTORIE VAN DE RADIO (NVHR)**

Old Technology Convention  
Info: [www.nvhr.nl/agenda.asp](http://www.nvhr.nl/agenda.asp)

**CANADA – June 3  
CANADIAN VINTAGE RADIO SOCIETY**

BC Lower Mainland – Monthly Meeting  
Info: [www.canadianvintageradio.com](http://www.canadianvintageradio.com)

**CANADA – June 9  
LONDON VINTAGE RADIO CLUB**

Annual Fleamarket  
Info: <http://lvrc.homestead.com/index.html>

**CANADA – June 10  
ONTARIO VINTAGE RADIO  
ASSOCIATION**

Club Meeting  
Info: [www.ovra.ca](http://www.ovra.ca)

**ENGLAND – June 10  
BRITISH VINTAGE WIRELESS  
SOCIETY**

Swapmeet and Auction  
Info: [bvws.org.uk](http://bvws.org.uk)

**CANADA – June 13  
OTTAWA VINTAGE RADIO CLUB**

Club Meeting  
Info: [www.ovrc.org](http://www.ovrc.org)

**GERMANY – June 16  
GESELLSCHAFT DER FREUNDE  
DER GESCHICHTE DES  
FUNKWESENS E.V.**

Amateur Radio and Technology Fleamarket  
Info: [www.gfgf.org](http://www.gfgf.org)

**CANADA – June 17**  
**CANADIAN VINTAGE RADIO SOCIETY**  
Alberta Meeting  
Info: [www.canadianvintageradio.com](http://www.canadianvintageradio.com)

**AUSTRALIA – June 21**  
**HISTORICAL RADIO SOCIETY OF AUSTRALIA**  
Melbourne Meeting  
Info: <http://hrsa.asn.au/>

**GERMANY – June 22-24**  
**HAM RADIO FRIEDRICHSHAFEN**  
International Ham Radio &  
Antique Radio Exhibition  
Friedrichshafen, Germany  
Web: [www.hamradio-friedrichshafen.de](http://www.hamradio-friedrichshafen.de)

**HOLLAND – June 23**  
**NEDERLANDSE VERENIGING VOOR DE HISTORIE VAN DE RADIO (NVHR)**  
Jukebox Gallery  
Info: [www.nvhr.nl/agenda.asp](http://www.nvhr.nl/agenda.asp)

**AUSTRALIA – June 23**  
**AUSTRALIA VINTAGE RADIO SOCIETY**  
Club Meeting  
Info: [www.avrs.org.au](http://www.avrs.org.au)

**AUSTRALIA – June 24**  
**HISTORICAL RADIO SOCIETY OF AUSTRALIA**  
Adelaide Meeting and Workshop  
Info: <http://hrsa.asn.au/>

**ENGLAND – July 1**  
**BRITISH VINTAGE WIRELESS SOCIETY**  
Swapmeet and Auction  
Info: [bvws.org.uk](http://bvws.org.uk)

**HOLLAND – July 7**  
**NEDERLANDSE VERENIGING VOOR DE HISTORIE VAN DE RADIO (NVHR)**  
NVHR Swap Meet  
Info: [www.nvhr.nl/agenda.asp](http://www.nvhr.nl/agenda.asp)

**CANADA – July 21**  
**QUEBEC SOCIETY FOR VINTAGE RADIO COLLECTORS**  
Meeting of the Board  
Info: [www.sqcra.qc.ca/](http://www.sqcra.qc.ca/)

**AUSTRALIA – August 4**  
**HISTORICAL RADIO SOCIETY OF AUSTRALIA**  
Sydney Meeting  
Info: <http://hrsa.asn.au/>

**AUSTRALIA – August 25**  
**AUSTRALIA VINTAGE RADIO SOCIETY**  
Club Meeting  
Info: [www.avrs.org.au](http://www.avrs.org.au)

**GERMANY – August 25**  
**24TH HISTORIC RADIO & COMMUNICATION FLEA MARKET MELLENDORF**  
Info: [www.gfgf.org](http://www.gfgf.org)

**Attention All Radio Clubs!**

Publicize your upcoming event for free. Send the details to A.R.C. today at [arc@antiqueradio.com](mailto:arc@antiqueradio.com).

*NOTE: Changes, cancellations and errors do occur. To avoid disappointment, verify place, date and time, especially for events which are new to you.*



*CLUBS: Send antique radio club and meet information to A.R.C. for free listing here, as space permits. Sorry, we don't have room for hamfests. Always send a SASE when writing to clubs!*

### **NATIONAL CLUBS**

**Antique Wireless Association (AWA).** PO Box 421, Bloomfield, NY 14469. Pub: The AWA Journal, quarterly. Dues: \$25(U.S.A) \$30 (elsewhere). National annual conference and regional meets. Museum. [www.antiquewireless.org](http://www.antiquewireless.org). AWA World Convention: <http://awamuseum.org/>

### **REGIONAL CLUBS**

**Alabama Historical Radio Society (AHRs).** PO Box 131418, Birmingham, AL 35213. Pub: The Superflex, monthly. Dues: \$20. Meetings, Every Sat. morning and 4th Mon. evening each month but Dec., annual show/swap meet. Don Kresge Radio Museum, Lobby of the Alabama Power Bldg., 600 North 18th Street, Birmingham, AL 35203. Contact Dee Haynes (205) 841-4630. [www.alabamahistoricalradiosociety.org](http://www.alabamahistoricalradiosociety.org).

**Antique Radio Club of Illinois (ARCI).** PO Box 1139, LaGrange Park, IL 60526. Art Bils-ki (630) 739-1060. Pubs: ARCI News, monthly and ARCI Update, periodically. Dues \$20. Annual August Radiofest and bimonthly swap meets. [www.antique-radios.org](http://www.antique-radios.org). [clubinfo@antique-radios.org](mailto:clubinfo@antique-radios.org).

**Antique Radio Collectors Club of Ft. Smith, Arkansas (ARCC).** Paul Tucker 479-782-8178, 4700 N. "N" St., Fort Smith, AR 72904. Dues: \$10. Meets first Thursday of month.

**Antique Radio Collectors & Historians (ARCH)** of Greater St. Louis. Joe Tauser, [joe@jtauser.com](mailto:joe@jtauser.com). Dues: \$15. Monthly newsletter and meetings, annual picnic/swap meet. [www.archradioclub.com](http://www.archradioclub.com).

**Antique Radio Collectors of Ohio (ARCO).** Karl Koogle, 2929 Hazelwood Ave., Dayton, OH 45419. E-mail: [karlkrad@gmail.com](mailto:karlkrad@gmail.com).

**Arizona Antique Radio Club (AZARC).** 1080 E. Pecos Rd., Suite 18, PMB 105, Chandler, AZ 85225-2426. Pub: The Arizona Antique Radio Club News, quarterly. Dues: \$20. Meetings, swap meets, Arizona Radio Round-up. [www.azarc.org](http://www.azarc.org).

**Buckeye Antique Radio and Phonograph Club (BARPC).** Jon Jansma, 31051 Fox Hollow Dr., Pepper Pike, OH 44124. (216) 591-0121. Pub: Soundings, bimonthly. Dues: \$10.00. Monthly meetings in Akron, Spring and Fall auctions, April joint meeting with PARS.

**California Historical Radio Society (CHRS).** Bay Area Radio Museum (BARM) and the Society of Wireless Pioneers (SOWP). CHRS, PO Box 31659, San Francisco, CA 94131. CHRS Hotline: (415) 821-9800. Steve Kushman, President [kushseal@flash.net](mailto:kushseal@flash.net). Pubs: CHRS Journal, Hints and Kinks: 20 Years of CHRS free with membership. 13 events per year. Dues: \$30. [www.californiahistoricalradio.com](http://www.californiahistoricalradio.com).

**CHRS/Central Valley Chapter.** Monthly meetings, Eddie Enrique [fantomradio@sbcglobal.net](mailto:fantomradio@sbcglobal.net), [www.cvantiqueradio.com](http://www.cvantiqueradio.com).

**CHRS/Sacramento Chapter (CHRS).** Monthly meetings, Dale Tucker, chairman [daletucker@surewest.net](mailto:daletucker@surewest.net).

**Carolinas Chapter/AWA (CC-AWA).** Ron Lawrence, PO Box 3015, Matthews, NC 28106. Pub: Radio Daze, quarterly. Dues: \$10. Quarterly swapmeets. [www.cc-awa.org](http://www.cc-awa.org).

**Central Ohio Antique Radio Association (COARA).** Dave Poland, Westerville, OH (614) 890-5422. E-mail: [dcp944@yahoo.com](mailto:dcp944@yahoo.com). Quarterly meetings in March, June, September, and December. January Cabin Fever & July Tailgate Meet. Dues: \$12. [www.members.tripod.com/~COARA/index.html](http://www.members.tripod.com/~COARA/index.html).

**Cincinnati Antique Radio Society. (CARS)** Cheri Schuster E-mail: [besomvix@hotmail.com](mailto:besomvix@hotmail.com). Meets the 4th Wednesday of each month.



**Colorado Radio Collectors (CRC).** David Boyle, 1058 Colt Cir., Castle Rock, CO 80109. (303) 681-3258. Newsletter "The Flash", bimonthly starting in Jan. Dues: \$20. Annual Spring Show & Fall BBQ/Auction. [www.radioace.com](http://www.radioace.com).

---

**Delaware Valley Historic Radio Club (DVHRC).** DVHRC PO Box 5053, New Britain, PA 18901. Pub: The Oscillator, monthly. Dues: \$20. Monthly meetings with swap meet in July. Sponsors twice-yearly Kutztown Radio Show (May and Sept). Web site: [www.dvhrc.info](http://www.dvhrc.info).

---

**Greater New York Vintage Wireless Association (GNYVWA).** Jim Koehler 516-623-0035, Rich Lee 914-589-3751. Swap meet first Sunday of the month at Seaford, NY Long Island Rail Road Parking Lot. Web site: [www.nyantiqueradio.org](http://www.nyantiqueradio.org).

---

**Heartland Antique Radio Association (HLARA).** Gene Vickery, 7201 E. 64th St., Tulsa, OK 74133. E-mail: [gene.vickery@hlara.org](mailto:gene.vickery@hlara.org). Dues \$15. See Web site for more info. [www.hlara.org](http://www.hlara.org).

---

**Houston Vintage Radio Association (HVRA).** PO Box 31276, Houston, TX 77231-1276. Membership info: Tom Burslem, [tomburslem@yahoo.com](mailto:tomburslem@yahoo.com). Pub: The Grid Leak, bi-monthly. Dues: \$20. Monthly meetings and auctions held 4th Saturday of each month. Web site: [www.hvra.org](http://www.hvra.org).

---

**Hudson Valley Antique Radio and Phonograph Society-AWA (HARPS).** meets third Friday of the month at the Episcopal Church of Suffern, 65 Washington St., Suffern, NY 10901. Info: Dale Cranston (845) 357-1615 [dale.cranston@gmail.com](mailto:dale.cranston@gmail.com).

---

**Indiana Historical Radio Society (IHRS).** 245 N. Oakland Ave., Indianapolis, IN 46201-3360. Pub: IHRS Bulletin, quarterly. Dues: \$15 per year. Quarterly swap meets in various areas of the state. Web site: [www.indianahistoricalradio.org](http://www.indianahistoricalradio.org).

---

**Iowa Antique Radio Club and Historical Society (IARCHS).** Dwight Baker, President. E-mail: [vtaudio@hotmail.com](mailto:vtaudio@hotmail.com). Pub: IARCHS Newsletter, quarterly. Dues: \$10. Annual Radiofest. [www.iowa-antique-radio-club.com](http://www.iowa-antique-radio-club.com).

---

**Jacksonville Antique Radio Society (JARS).** Sean Olin (904) 386-8332, [oldradios@bell-south.net](mailto:oldradios@bell-south.net). [www.jarsradioclub.com](http://www.jarsradioclub.com).

---

**Long Island Radio and TV Historical Society (LIRTVHS).** 43 Sayville Blvd., Sayville, NY 11782. Membership \$25 per year. E-mail: [liwhs@gmail.com](mailto:liwhs@gmail.com). Web site: [www.lirtvhs.org](http://www.lirtvhs.org).

---

**Memphis Antique Radio Club (MARC).** President, Ray Eaton, 459 Second St., Henderson, TN 38340. E-mail: [MARCMemphis@gmail.com](mailto:MARCMemphis@gmail.com).

---

**Michigan Antique Radio Club (MARC).** Don Colbert, MARC, [membership@michiganantiqueradio.org](mailto:membership@michiganantiqueradio.org). Pub: The Michigan Antique Radio Chronicle, quarterly. Dues: \$20. Annual Extravaganza and other quarterly meets. [www.michiganantiqueradio.org](http://www.michiganantiqueradio.org).

---

**Mid-America Antique Radio Club (MAARC).** Claude Chafin, 4223 E. 42nd St. Way, Independence, MO 64055. Pub: The Broadcaster, quarterly. Dues: \$15. Semi-annual auctions and swap meets. <http://sites.google.com/site/midamericaantiqueradioclub/>.

---

**Mid-Atlantic Antique Radio Club (MAARC).** Geoff Shearer, 14408 Brookmere Dr., Centreville, VA 20120 (703) 818-2686. E-mail: [gshearer2@verizon.net](mailto:gshearer2@verizon.net). Pub: Radio Age, monthly. Dues: \$20. Monthly meetings. [www.maarc.org](http://www.maarc.org).

---

**Mid-South Antique Radio Collectors (MSARC).** Terry Layman, 130 Saint Margaret Dr., Lexington, KY 40502. E-mail: [layvinrad@insightbb.com](mailto:layvinrad@insightbb.com). Meets last Saturday in April and October.

---

**Military Radio Collectors Association (MRCA).** Pete Hamersma, PO Box 467, Holderness, NH 03245. Web site: [www.mrca.ar88.net](http://www.mrca.ar88.net).

---

**Military Radio Collector's Group (MRCG).** Lynn Fielding KE6JZD, PO Box 11322, Torrance, CA 90501-1322. [lfielding@elcamino.edu](mailto:lfielding@elcamino.edu); Web site: [www.syzen.com/milradio/](http://www.syzen.com/milradio/).

---

**Museum of Broadcast Communications.** 360 N. State St., Chicago, IL 60654. Dues: \$30. (312) 245-8200. Web site: [www.museum.tv](http://www.museum.tv).

---

**Museum of Radio & Technology.** 1640 Florence Ave., Huntington, WV 25701. Web site: [www.mrtwv.org](http://www.mrtwv.org).

---

**Nashville Vintage Radio Club (NVRC).** 514 E. Kings Rd., Smyrna, TN 37167. (615) 355-2005. Web site: [www.musiccityvintage-radio.org](http://www.musiccityvintage-radio.org).

---

**New England Antique Radio Club (NE-ARC).** Info: (603) 898-4821. Charlie Perket, 16 Sunset Rd., Salem, NH 03079-1704. Pub: NEARC Radio News, quarterly. Dues: \$12. Two swap meets/year in April and October. Web site: [www.nearc.net](http://www.nearc.net).

---

**New Jersey Antique Radio Club (NJARC).** Richard Lee - President (914) 589-3751; radio rich@prodigy.net. Membership: Marsha Simkin, 33 Lakeland Dr., Barnegat, NJ 08005. Meetings are 2nd Friday of the month from 7 to 10 pm alternating between Info Age, 2201 Marconi Rd., Wall Township, NJ 07719 and Bowen Hall, Princeton University. Monthly newsletter "The Jersey Broadcaster." Dues \$20. 3 swap meets and 4 repair clinics a year. December holiday party. Web site: [www.njarc.org](http://www.njarc.org).

---

**New Mexico Radio Collectors Club (NMRCC).** Contact Ron Monty at ronmonty@comcast.net. Pub: New Mexico Radio Collectors Club Newsletter, monthly. Dues: \$20. Annual Sale & Show and monthly meetings. Web site: [www.newmexicoradiocollectorsclub.com/](http://www.newmexicoradiocollectorsclub.com/).

---

**Niagara Frontier Wireless Association (NFWA).** Gary Parzy, 135 Autumnwood, Cheektowaga, NY 14227. Regional meets. Display at the Amherst Museum, Amherst, NY.

---

**Northland Antique Radio Club (NARC).** PO Box 18362, Minneapolis, MN 55418. Pub: The NARC Newsletter, four/year. Dues: \$10. Four meets (including 2 swap meets) per year and Radio Daze event. Web site: [www.northlandantiqueradioclub.com](http://www.northlandantiqueradioclub.com).

---

**Northwest Vintage Radio Society (NWVRS).** PO Box 82379, Portland, OR 97282-0379. Pub: The Call Letter, monthly. Dues: \$25 a year. Monthly meetings. <http://nwvrs.org>.

---

**Oklahoma Vintage Radio Collectors, OK City Chapter (OKVRC).** Jim Collings, jrradio@cox.net, PO Box 50625, Midwest City, OK 73140-5625. Pub: OKVRC Broadcast News, monthly. Dues: \$15 per year. Monthly meetings, spring and fall swap meets. For more information, vist <http://www.okvrc.org>.

---

**Pittsburgh Antique Radio Society, Inc. (PARS).** Chris Wells, 110 Fawn Valley Dr., McMurray, PA 15317. (724) 942-1113. Pub: The Pittsburgh Oscillator, quarterly. Dues: \$10. Eight meets a year including the April Tri State Radio Fest. [www.pittantiqueradios.org](http://www.pittantiqueradios.org).

---

**Puget Sound Antique Radio Association (PSARA).** PO Box 7567, Tacoma, WA 98417. Contact Linda Glaspey (425) 478-3643. Pub: The Horn of Plenty, monthly. Dues: \$25 per year. Monthly meetings & swap meets, Nov. show & Aug. swap meet. [www.eskimo.com/~hhagen/psara/index.html](http://www.eskimo.com/~hhagen/psara/index.html).

---

**Radio Enthusiasts of Puget Sound (REPS).** REPS Membership, 17334 Densmore Ave. N, Shoreline, WA 98133. Pub: Air Check, 9 times a year. Dues: \$20 per year. Monthly meetings, annual Radio Showcase. [www.reps-online.org](http://www.reps-online.org).

---

**Radio History Society, Inc. (RHS).** Radio & Television Museum, 2608 Mitchellville Rd., Bowie MD 20716. Rusty Wallace, Membership Chair. Quarterly publication: Dials and Channels. Dues: \$25 per year. E-mail: radiotvmuseum@verizon.net. [www.radiohistory.org](http://www.radiohistory.org).

---

**Schenectady Antique Radio Club (SARC).** Louis DeGonzague, 15 Gail Ln., Latham, NY 12110. (518) 391-9239. E-mail: zenith6@verizon.net. Dues: \$3. Meets the 4th Sunday of each month at St. Roses College, Madison Ave., Albany, NY at 12 noon.

---

**Society for the Preservation of Antique Radio Knowledge (SPARK).** Dues: \$15. Annual Swap Meet, Monthly meeting, 7:30 pm Parkview Community Center, Kettering, OH. Contact: Dan Casey (513) 265-8466; E-mail: dansradioland@gmail.com. [www.antiqueradios.com/spark](http://www.antiqueradios.com/spark).

---

**Southeastern Antique Radio Society (SARS).** Rich Rodgers, President, 113 Laurel Ridge Dr., Alpharetta, GA 30004. Pub: Newsletter, quarterly. Dues: \$16. Spring, Fall and Winter swap meets. Monthly dinner meetings, 2nd Monday of each month, in Norcross, GA. [www.sarsradio.com](http://www.sarsradio.com).

---

**Southern California Antique Radio Society (SCARS).** Jim Garrett, 15621 Fox Hills St., Westminster, CA 92683. (714) 891-1689. wa6yos@juno.com. Pub: SCARS Gazette, quarterly. Dues: \$20. Web site: [www.antique-radios.org](http://www.antique-radios.org).

---

**Texas Antique Radio Club (TARC).** Ed Engelken, 680 Lake Forest, Canyon Lake, TX 78133. Pub: Lone Star Waveform, monthly. Monthly meetings. Web site: [www.tarc.gvtc webspace.net](http://www.tarc.gvtc webspace.net).

---

**Texas Panhandle Vintage Radio Society (TPVRS).** Eloy A. Heras, 4086 Business Park Dr., Amarillo, TX 79110. Dues: \$5. Quarterly meetings.

**Tidewater Antique Radio and Phonograph Association (TARPA).** Barry Callis, 3689 N. Landstown Rd., Virginia Beach, VA 23456. (757) 427-9667. E-mail: betty3689@aol.com. Meets last Tuesday of each month at the Mary Pretlow Library.

**Vintage Radio & Communications Museum (VRCM).** 115 Pierson Ln., Windsor, CT 06095. (860) 683-2903. Web site: www.vrcmct.org.

**Vintage Radio & Phonograph Society (VRPS).** PO Box 165345, Irving, TX 75016. Pub: The Soundwaves is published quarterly. Dues: \$20.00 annually. Monthly meetings, swap meets, Spring auction, annual convention. More information at Web site: www.vrps.org.

**W. Va. Chapter, AWA (AWA-WVC).** Geoff Bourne, 405 8th Ave., St. Albans, WV 25177. Newsletter, monthly. Dues: \$25.00 (includes museum membership). Quarterly meets, monthly meetings, classes.

**Wisconsin Antique Radio Club, Inc. (WARCI).** Bill Engaas, 18265 W. Thornapple Ln., New Berlin, WI 53146. Dues: \$15. Web site: www.warci.org.

## A Special Invitation to International Clubs...

*A.R.C.* wants to highlight your club and its events. Let our readers know what you're up to. Contact us today with your story.

Send an email to:  
[editor@antiqueradio.com](mailto:editor@antiqueradio.com)

## INTERNATIONAL CLUBS

*(A.R.C. would like to hear about other international antique radio clubs.)*

**Australia: Historical Radio Society of Australia (HRSA).** Membership Secretary, PO Box 2283, Mt. Waverley, Victoria 3149, Australia. Pub: Radio Waves, quarterly. Dues: \$35 Australian. Monthly Meetings. <http://hrsa.asn.au>.

**Australia: Historical Wireless Society of South East Queensland (HWS of SEQ).** Pub: Wireless Review, quarterly. Membership: membership@hws.org.au. Web: www.hws.org.au.

**Australia: Vintage Radio Club of North Eastern Victoria.** Meetings 4th Saturday of the month. Alternate between R.I.S.E. Special Needs Centre, Shepparton, Vic. and Uniting Church Benalla Vic. (no December meeting). Info: Marcus Chick, PO Box 637, Wangaratta, Vic 3676. 03 5725 3276. Web: chickmbv@bigpond.com.

**Australia: Australia Vintage Radio Society Inc.** Monthly meetings, workshops, tech. assistance, etc. Bi-monthly newsletter. Overseas memberships are \$35pa + \$5 joining fee. AVRS Secretary, PO Box 3099, Syndal LPO, Victoria, Australia 3150. Web: www.avrs.org.au.

**Belgium: Belgische Radio Club.** Francois Marschang, Kromvendreef 53, B-2900, Schoten, Belgium.

**Belgium: Vlaamse Liefhebbers Van Der Historische Radiotechniek (VLHR).** Rudi Sillen, Limberg 31, B-2230, Herselt, Belgium. Pub: Retro-Radio, quarterly. Dues: \$20.

**Bosnia: Radio Historijsko Udruzenje Jelah.** Web: www.rhu.jelah.ba.

**Brazil: Antique Radios in Brazil.** João Mello, PO Box 101, São Roque, Brazil 18130-000.

**Canada: Canadian Vintage Radio Society (CVRS).** CVRS, 10271 Algonquin Dr., Richmond, British Columbia V7A 3A5. membership@canadianvintageradio.com. Newsletter is available by print or email. See web site for dues. www.canadianvintageradio.com.

**Alberta Chapter/CVRS,** Rick Williams, rich@canadianvintageradio.com. Secretary CVRS Alberta, 9611 142 St., Edmonton, Alberta T5N 2M8.

**British Columbia Chapter/CVRS,** Bill West-Sells, westsells@telus.net.

**Manitoba Chapter/CVRS**, volunteer needed, [vactube@hotmail.com](mailto:vactube@hotmail.com).

**New Brunswick Chapter/CVRS**, W.H. Gentleman, [bill@canadianvintageradio.com](mailto:bill@canadianvintageradio.com). 17 Maple Cresc., Rothesay, New Brunswick E2E 2A4.

**Newfoundland Chapter/CVRS**, John Bray, [john@canadianvintageradio.com](mailto:john@canadianvintageradio.com).

**Nova Scotia Chapter/CVRS**, Brian McKeigan, [brian@canadianvintageradio.com](mailto:brian@canadianvintageradio.com). 4 Baird St., North Sydney, Nova Scotia B2A 2B3.

**Ontario Chapter/CVRS**, Paul Martin, [paulmartin8@yahoo.com](mailto:paulmartin8@yahoo.com).

**Saskatchewan Chapter/CVRS**, Stan Marlin, [smarlin@sasktel.net](mailto:smarlin@sasktel.net).

**Yukon and NWT Chapter/CVRS**, volunteer needed.

**Canada, British Columbia:** Antique Radio Club of Victoria, BC. Meets 3rd Wednesday of the month at Pluto's, 1150 Cook St., Victoria, BC 7:00pm to 8:30pm. <http://groups.yahoo.com/group/VicRadioGroup/>.

**Canada: Society for the Preservation of Antique Radio in Canada (SPARC)**. Bruce Winter, 4757 London Green Pl., Delta, BC V4K4X1 Canada E-mail: [winter@dcnet.com](mailto:winter@dcnet.com). Pub: Periodic newsletters. Dues: \$20. Annual open house and show, periodic shows and displays, and museum. [www3.bc.sympatico.ca/radiomuseum/](http://www3.bc.sympatico.ca/radiomuseum/).

**Canada, Ontario: London Vintage Radio Club (LVRC)**. Davd Noon, 19 Honeysuckle Crescent, London, ON N5Y4P3, Canada E-mail: [va3dn@execulink.com](mailto:va3dn@execulink.com). Pub: LVRC Newsletter "The Loudspeaker," bimonthly. Dues: \$15 Canadian. Six meetings yearly. [www.lvrc.homestead.com/index.html](http://www.lvrc.homestead.com/index.html).

**Canada, Ontario: Ottawa Vintage Radio Club (OVRC)**. Lea Barker, [barker@ca.inter.net](mailto:barker@ca.inter.net). Pub: OVRC. Monthly meetings. [www.ovrc.org](http://www.ovrc.org).

**Canada, Ontario: Ontario Vintage Radio Association (OVRA)**. Ted Catton. [www.ovra.ca](http://www.ovra.ca).

**Canada, Quebec: Quebec Society for Vintage Radio Collectors (QSVRC)**. SQCRA, Daniel Labelle, 538 Judd, St-Eustache, Quebec, Canada J7R 4N8. Pub: Radiophilie Quebec, bimonthly. [www.sqcr.qc.ca](http://www.sqcr.qc.ca).

**Czech Republic: Historicy Radioclub Ceskoslovensky (HRCS)**. Nadrazni 1394/53, CZ 589 01 Trest. Pub: Radiojournal, 3 per year. Meetings: 4 per year. Dues: 25 Euro/Year. Web: [www.radiojournal.cz](http://www.radiojournal.cz).

**England: British Vintage Wireless Society (BVWS)**. Mike Barker, Pound Cottage, Coate, Devizes, Wiltshire SN10 3LG, England. Pubs: BVWS Bulletin, quarterly; BVWS Newsletter, five times/year. Dues: £25. Meetings and swap. [www.bvws.org.uk](http://www.bvws.org.uk).

**England: Eddystone User Group (EUG)**. Online only. Web Site: [www.eddystoneuser-group.org.uk/](http://www.eddystoneuser-group.org.uk/).

**France: Association des Amis du Musée de l'Electro-Acoustique les Radiophiles Français (A.E.A.)**. Jean-Claude Montagné, President, 35 rue Salvador Allende, F92220, Bagneux, France. Pub: Bulletin of the A.E.A. Dues: \$46. <http://perso.wanadoo.fr/clubaea/gindex.htm>.

**France: Club Histoire et Collection Radio (CHCR)**. Chez Gilbert Gorin, 3 rue Capitaine H. Maizan, 80160 Plachy-Buyon, France. Pub: Telegraphie et Telephonie Sans Fil Electricite Ancienne, quarterly. Library. Annual May event in Riquewihr, Sept. Bar Le Duc event, meetings. Website: [www.chcr.asso.fr](http://www.chcr.asso.fr).

**France: Radiofil**. Jean-Paul Delattre, Secretaire general, 2 Rue de la Clairiere, 54425, Pulnoy, France. Email: [secretaire-general@radiofil.com](mailto:secretaire-general@radiofil.com). Pub: Radiofil Magazine, 6 issues/year. Dues: euro 39/year. <http://www.radiofil.com>.

**Germany: Gesellschaft der Freunde der Geschichte des Funkwesens e.V. (German Society of Wireless History)**. Germany's largest radio and tube collectors and historians association with app. 2500 members) Publication: Funkgeschichte, bimonthly, many events, website: [www.gfgf.org](http://www.gfgf.org).

**Hungary: Hungarian Radio Collectors Club**. Laszlo Koger, H-8900 Szekesfehervar Sajo U 9. Meetings twice a year, bi-monthly news.

**Ireland: Irish Vintage Radio & Sound Society**. Irish Vintage Radio & Sound Society. [www.irishvintageradio.com](http://www.irishvintageradio.com).

**Israel: Antique Radio and Broadcasting Museum**. Museum in Tel-Aviv. Bruno Pinto, 24 Remez St., #7, Tel-Aviv, Israel 62192.

**Italy: Associazione Italiana per la Radio d'Epoca (AIRE)**. Nerio Neri, President, Museo della Comunicazione, via de Ricasoli 22, 52100 Arezzo, Italy. Pub: La Scala Parlante, bimonthly. Web site: <http://www.aireradio.org>.

**Japan: Antique Wireless Club (AWC).** Noriyoshi Tezuka, JAINTF, Secretary AWC, Telephone: +81-45-949-3195, Kagahara 1-24-6-115, Tsuzuki-ku, Yokohama 224-0055, Japan. Monthly meetings and newsletter. E-mail: n-tezuka@pop16.odn.ne.jp. Web site: <http://blog.goo.ne.jp/vrc-tezuka>.

**Netherlands: Nederlandse Vereniging voor de Historie van de Radio (NVHR).** Van Aduardstraat 21, 6671 ZD Zetten, The Netherlands. [www.nvhr.nl](http://www.nvhr.nl).

**New Zealand: New Zealand Vintage Radio Society (NZVRS).** David Crozier, PO Box 13873, Onehunga, Auckland, New Zealand 1643. NZVRS Bulletin, quarterly, monthly meetings. Dues: \$15. [www.nzvrs.pl.net](http://www.nzvrs.pl.net).

**Norway: The Norwegian Radiohistoric Society.** Mekanikerveien 32, N-0683 Oslo, Norway. Pub.: Hallo Hallo, quarterly. Dues: \$40. Regular meetings every Tuesday; Auctions a couple of times per year. Web site: [www.nrhf.no](http://www.nrhf.no).

**Romania: Pro Radio Antic.** P-ta. Acad. Caius Iacob, Nr.4, Bl.R, Sc.A, Et.8, Ap.29; 310136 Arad, Romania. [www.proradioantic.ro](http://www.proradioantic.ro).

**Spain: Spanish Vintage Wireless Club (Asociacio Cultural Amicos de la Radio).** Rei Jaume, 55, 08840 Cardedeu, Spain. <http://rt00117m.eresmas.net/amg-2.htm>.

**Sweden: The Radio History Society of West Sweden.** Anders Carlssons, Gata 2, SE-417 55 Gothenburg, Sweden. Pub: Audionen. Amateur radio station: SK6RM. Museum: [www.radiomuseet.se](http://www.radiomuseet.se). E-mail: [info@radiomuseet.se](mailto:info@radiomuseet.se).

**Sweden: Sveriges Radio Historiska Forening (SRHF).** Contact Johan van der Levin: [johan@johansoldradios.se](mailto:johan@johansoldradios.se). [www.radiohistoriska.se](http://www.radiohistoriska.se).

**Switzerland: Club der Radio-und Grammosammler (CRGS).** Johannes M. Gutekunst, Lenzhardstrasse 22, 5102 Rupperswil, Switzerland. Quarterly newsletter. [www.crgs.ch/](http://www.crgs.ch/).

**Tube Collectors Association.** PO Box 636, Ashland, OR 97520 USA. Pub: Tube Collector, 6 times a year. Dues: \$20 per year to the US and Canada. See the web site for multiple year dues and foreign membership dues. [www.tubecollectors.org](http://www.tubecollectors.org).

*From Antique Radio Classified (Copyright 2011 by Vintage Radio Publishing LLC.)*

## RCA Tube Manuals – All Tubes All The Time!



### RCA Cunningham Radiotron Manual RC-12

*Now available again as a reprint, this is the RCA Cunningham Radiotron Tube Manual RC-12 originally published in 1934. All the information you need on pre-1934 tubes. Soft cover, 154 pages. \$16.95*

### RCA Receiving Tube Manual RC-14

*The reprint of the 1940 RCA Receiving Tube Manual RC-14. Final manual produced by RCA before WWII, contains data on many tubes which were obsolete by publication of the next manual. Valuable historical data. Soft cover, 255 pages. \$11.95*



**Everything stocked & shipped promptly. Radio is our middle name.**

A.R.C., PO Box 1558, Port Washington, NY 11050

Toll Free: (866) 371-0512 • Fax: (516) 883-1077

E-mail: [ARC@antiqueradio.com](mailto:ARC@antiqueradio.com); Web: [www.antiqueradio.com](http://www.antiqueradio.com)

**Order today. We gladly accept:**



*\$3.00 shipping & handling on all U.S. orders (typical U.S. order will be received within 7 days, but allow 2-3 weeks). Non-U.S. orders, write for shipping costs, or use credit card. Most orders shipped by next business day. If using credit card, include name on card, card number and expiration date. Send payment with order. New York residents must add sales tax.*

## BUSINESS CARD ADS - \$53.00 FOR 3 MONTHS

Free Estimates  
Hrs. - 9 AM - 5 PM EST  
Tues. - Sat.

Tel./Fax (860) 928-2628  
E-mail: bob@oldradiodoc.com  
www.oldradiodoc.com



### ANTIQUÉ RADIO RESTORATION & REPAIR

1920 - 1960's

Buy & Sell

Reasonable Rates, Tubes, Professional Overhauls, Cabinet Refinishing, Service For All Antique Car, Table & Console Radios, Communication Receivers & Tube Amplifiers.

20 Gary School Road  
Pomfret Center, CT 06259



BOB ESLINGER

## ANTIQUÉ RADIOS

WANTED



DAVE CROCKER  
35 Santuit Pond Rd. #4B  
Mashpee, MA 02649

E-mail: radio-1@comcast.net

(508) 477-1578

## URBAN ANTIQUÉ RADIO AND VINTAGE HI-FI

Mike Urban  
Restoration and Sales

800-594-4359

www.urban-antiqueradio.com

## Repro Dial Covers

<http://jmpalm.home.mindspring.com>

Mark Palmquist

Retro Radio Repair

5033 Arbor Lane

Lilburn, GA 30047

770-923-8929 \$18 ppd

Free mounting in your bezel

(add \$3.00 for Priority Mail Shipping)

jmpalm@mindspring.com



## SOUND REMEDY

Loudspeaker Repair Service

Tel (856) 869-0238  
Fax (856) 869-6880

www.soundremedyNJ.com • email: soundremedy@aol.com

Richard G. Stamer  
Reliable-Prompt Guaranteed

331 Virginia Avenue  
Collingswood, NJ 08108



## ESTES AUCTIONS

Specializing in Vintage Radios  
& Radio Appraisal Service  
www.estesauctions.com

7404 Ryan Road  
Medina, Ohio 44256

Phone: (330) 769-4992  
Fax: (330) 769-4116

E-mail: estes\_auctions@aol.com

## WANTED PRE 1900 ELECTRICITY

MEDICAL • X-RAY  
TELEGRAPHY • TELEPHONE

PRE 1925

RADIO • WIRELESS

PRE 1940

TELEVISION

BOOKS • TUBES • ARTIFACTS  
MAGAZINES • AUTOGRAPHS  
CATALOGS • EPHEMERA



NEW WIRELESS PIONEERS

1541 BRONSON RD

GRAND ISLAND, NY 14072

(716) 773-4999 • Fax: (716) 773-5757

E-mail: wireless@pcc.net

www.marconi-wireless.com



Just  
Radios



Capacitors & Schematics for Tube Radios

David and Babylyn Cantelon  
6 Ferncrest Gate, Scarborough,  
Ontario, Canada, M1W 1C2

www.justradios.com  
justradios@yahoo.com  
(416) 502-9128

## ANTIQUÉ TELEPHONES

RADIOS • MICROPHONES • EDISON-VICTOR • EARLY FANS • TOYS  
BARBER POLES • RESTORATION • REPAIR • BUY • SELL • TRADE

FIRE & POLICE  
CALL BOXES

E-MAIL: AMPW@PACBELL.NET  
WEBSITE: VINTAGEPHONE.COM

EKKEHART



"His Master's Voice"

PH./FAX (650) 571-9070

1128 EL CAMINO REAL

SAN CARLOS, CA 94070

(650) 631-1600

OPEN DAILY 10.00-6.00



## WANTED FISHER RADIO/PHONO CONSOLE

SERVICE MANUALS • OWNERS MANUALS  
ADVERTISING MATERIALS

1945 THROUGH 1972

Contact: Jon Kummer • Antique Radio Classified  
Web: www.antiqueradio.com • Email: arc@antiqueradio.com

Tel: 866-371-0512

## Play Things of Past

Vintage Radios, Tubes and Parts

Service early Radios, TV's,  
Phonographs & Telephones

Play Things of Past  
2324 Fawn Haven Dr.  
Medina, Ohio 44256  
330-558-0247 Work

Gary B. Schneider  
gbstopt@aol.com  
www.oldradioparts.com  
330-558-0208 Home



Buying radio tubes, parts, radio literature, telephone parts

## Vintage Electronics

Cartridges/Needles, Phono & Tape Idlers,  
New/Rebuilt

Ed Crockett  
128 Buccaneer Drive  
Hattiesburg, MS 39402  
(601) 264-4755

Monday - Friday  
9am - 5pm CST Only  
www.vintageelectronics.com  
E-mail: phonoed@aol.com

## BUSINESS CARD ADS - \$53.00 FOR 3 MONTHS

### BETA-TEK ANTIQUÉ RADIO SERVICE

- Quality Radio Repair & Restoration
- Prompt Service ■ Free Estimates
- Radios Bought & Sold

**RAY BINTLIFF**  
2 Powder Horn Lane  
Acton, MA 01720  
978-263-7435  
w1ry@msn.com



### Great Northern Vintage Radios



Vintage Radio  
Bought • Sold • Repaired  
Knobs • Parts

Advertising • Antiques • Collectibles

**Alan Jesperson**  
5200 Bloomington Ave. S.  
Minneapolis, MN 55417

Tel: (612) 727-2489  
Email: alanjesp@gmail.com  
Web: www.gn4radios.com

### Antique Electric Radios

**Repair, Restore, Buy & Sell**  
Vintage table and console radios, phono, Hi-Fi  
audio, auto radios, crank phonographs  
**Hear them play again!**

John Hartman      PO Box 201, Eaton, NH 03832  
(603) 447-4821      E-mail: nm1h@hotmail.com  
Sales web site:      www.radioattic.com/nm1h

### www.renovatedradios.com

*specializing in rubber & plastic repros*

grommets  
washers  
bushings  
RF isolation  
cushions  
bumpers  
feet



radio knobs  
clock knobs  
TV knobs  
TV masks  
pushbuttons  
CDs  
R/P rubber

Ed Schutz (596) 697-6153  
5209 St. Richard Dr., Shelby Twp., MI 48316  
blacksmith@renovatedradios.com

### RADIO BOOKS WANTED

**Always buying: Books, Magazines and Manuals.**  
Single items or collections. Call us toll free: 888-447-5037  
We have a large selection of books on radio and related  
technology for sale. Call us about our shop and catalogs or  
**visit our web site: <http://www.beqbooks.com>**

**BEQUAERT OLD BOOKS**  
P.O. BOX 775, FITZWILLIAM NH 03447  
(603)-585-3448    info@beqbooks.com

### Replica knobs and small parts

PUSHBUTTONS • ESCUTCHEONS • PLASTIC GRILLES

**Larry Bordonaro**, Old Time Replications  
5744 Tobias Ave., Sherman Oaks, CA 91411  
Phone (818) 786-2500 • Fax (818) 909-0241  
email: oldtimerep@aol.com  
[www.antiqueradioknobs.com](http://www.antiqueradioknobs.com)

# knobs



### Vintage Electronics

*Our Specialty - Phonograph  
Cartridges/Needles*



*Phono / Tape Idlers - Rebuilt*



**Ed Crockett**  
128 Buccaneer Drive  
Hattiesburg, MS 39402  
e-mail: phonoed@aol.com

(601) 264-4755  
Monday - Friday  
9am - 5pm CST Only  
[www.vintageelectronics.com](http://www.vintageelectronics.com)



**The Voice of Music®**

#### V-M MANUFACTURED:

- Phono & Tape Service Parts
- Service and Owner's Manuals
- 45 Adapters and Accessories
- Component Record Changer Sales
- Changer Restoration Services



#### ALL BRANDS:

- Wheels, Needles/Cartridges and more!



#### V-M Audio Enthusiasts

37530 E. Meadowhill, Northville, MI 48167 • (248) 478-0990  
[www.thevoiceofmusic.com](http://www.thevoiceofmusic.com) • [info@thevoiceofmusic.com](mailto:info@thevoiceofmusic.com) • Gary Stork

### ADAMS MANUFACTURING CO.

## RADIO DIAL BELTS

To Fit All Radios

Visit our website  
[www.Adamsradio.com](http://www.Adamsradio.com)

*IF YOU VISIT THE BRIMFIELD FLEA MARKET...  
STOP BY FIRST!*

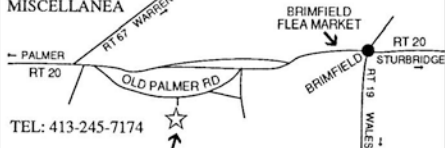

COUNTRY ROAD BARN - BERNIE SAMEK  
OLD PALMER ROAD, BRIMFIELD, MASS.



### WAVES L.L.C.

ANTIQUES  
EARLY RADIOS  
&  
PHONOGRAPHS  
BOUGHT • SOLD  
RENTALS • REPAIRED

11-5 WED-SUN  
MON & TUES BY APPOINTMENT  
WEBSITE: [WavesLLC.com](http://WavesLLC.com)  
e-mail: [WavesLLC@gmail.com](mailto:WavesLLC@gmail.com)  
212-273-9616  
201-461-7121 FAX  
201-461-7121 FAX

SHOWPLACE ANTIQUE CENTER 40 W. 25 ST. NY, NY 10010 # 107  
PROPRIETORS Bruce and Charlotte Majer

PUT  
YOUR BUSINESS CARD  
HERE!

\$53 for 3 months - \$90 for 6  
months

Don't have one? Send an extra \$7  
and we will typeset one for you.



# ANTIQUE RADIO CLASSIFIED BOOKSTORE



**200 Meter and Down - The Story of Amateur Radio.** DeSoto. Originally published in 1936, this book chronicles the exciting evolution of Amateur Radio from the pioneers who perfected the wireless art, through the technical advances of the mid-1930s. Reprint, soft cover, 184 pages .....\$12.00

**A. Atwater Kent - The Man, The Manufacturer.** Compilation of articles by Ralph Williams and John P. Wolkonowicz on Atwater Kent sets from the 1920s. 108 pgs.....\$25.95

**The All-American Five Radio.** McWhorter. Ideal for radio collectors and anybody wanting to learn how radio receivers work and how to repair them. 96 pages .....\$21.95

**ARRL's Vintage Radio.** ARRL's Vintage Radio is a collection of articles published in QST magazine describing vintage equipment and restoration. 192 pages .....\$19.95

**Audio Amateur Power Amp Projects.** This profusely illustrated handbook features 26 of the best articles on power amps published between 1970 and 1989 (mostly solid state.). 205 pages, soft cover .....\$19.95

**Audio Measurements.** Crowhurst. A classic reprint that is a complete compendium of measurement and testing techniques for audio equipment including discussions of all the instruments needed to use them. 233 pages .....\$12.95

**Basic Theory & Application of Electron Tubes.** US Army. Reprint of 1952 Army and Air Force manual from U.S. Government. Electronics training manual originally used to teach electronics to U.S. Army and Air Force members. Soft cover, 215 pages.....\$16.95

**Beginner's Guide to Reading Schematics,** Traister & Lisk. Takes you step by step through every phase of understanding and using electronic circuit diagrams or schematics. 129 pages, soft cover .....\$15.95

**Beginner's Guide to Tube Audio Design.** Rozenblit. Explains what vacuum tubes do and how to use them for tube audio design. 134 pages, soft cover.....\$24.95

**Cathedral and Tombstone Radios.** Stein. For identification of 1,500 cathedral & tombstone sets. Soft cover, 288 pages.....\$29.95

**Classic Cones,** Chidester. Pictorial reference & value guide for 1920s radio cone speakers. 100s of color photos. 2001. 122 pgs.....\$25.95

**Collector's Guide to Antique Radios, 7th Edition,** Slusser. Covers the 1920s to the 1950s. Plus 14 additional manufacturers. Over 10,000 models. 1,200 color photos, (15% more than the last edition). 320 pgs.....\$24.95

**Collector's Vacuum Tube Handbook.** Millard. Hard-to-find electrical data on 200+ tube types that pre-date the RMA standardized numbering system. 196 pgs.....\$25.95

**Compleat Talking Machine.** Reiss. A guide to antique phonographs. Revised price guide. Covers construction, cleaning and repairing of parts and cabinets. 249 pages .....\$29.95

**The Complete Price Guide to Antique Radios: Pre-War Consoles,** Stein. Identifies, grades, values & pictures 3,500 models. Tube & band count information & variations. Resource section. 240 pgs.....\$29.95

**The Complete Price Guide to Antique Radios: Sears Silvertone Catalogs 1930-1942,** Stein. 1,000+ radios. Original advertising, options, specs & pricing. Full model cross reference matrix with tube & band counts, variations. 240 pgs.....\$34.95

**Crystal Clear - Vintage American Crystal Sets, Crystal Detectors and Crystals,** Sievers.  
Vol. 1 - Comprehensive reference with 750 illustrations, 570 crystal sets, 341 detectors, 207 crystals, 282 pgs .....\$29.95  
Vol. 2 - 479 all new & different illustrations, more crystal sets, detectors and crystals identified, 252 pgs.....\$29.95

**Early Radio Development in Canada 1901-1930.** Murray. Illustrated history of Canada's radio pioneers, broadcast receiver manufacturers and their products. 154 pages .....\$26.95

**Electric Guitar Amplifier Handbook.** Darr. New reprint of the fourth edition, originally published in 1973. Everything you need to know about how each part of the amp works and what to do about it if it doesn't work. Soft cover, 384 pages .....\$29.95

**Electrostatic Loudspeaker Design.** Wagner. Reprint of the 1993 book by Ronald Wagner. Considered "the bible" of electrostatic speaker design. 241 pages.....\$19.95

**Fabulous Victrola "45".** Vourtsis. History of the "45" record players with descriptions and a price guide. 176 pgs.....\$29.95

**Fixing Up Nice Old Radios,** Romney. Written by a retired radio instructor; this book covers Ohm's law, through battery sets, superhets and communications receivers. 1990. 300+ figures, 185 pgs.....\$35.00

**Genuine Plastic Radios of the Mid Century,** Jupp & Oina. Colorful and collectable, mid-century table radio are examples of popular culture and industrial design, 439 color photos. 208 pages.....\$39.95

**The Idea Factory: Bell Labs and the Great Age of American Innovation.** Gertner. A history of Bell Laboratories and its influence on modern technology. 442 pages. Hard cover .....\$29.95

**Lee de Forest - King of Radio, Television, and Film.** Adams. A fascinating view into the early role he played in the development of mass media. 2011 .....\$27.95

**The LP is Back.** From the pages of Audio Amateur magazine and other sources, absolutely everything you need to get the most out of your vintage LPs or new audiophile quality pressings. 160 pages, soft cover. ....\$7.95

**Mil Spec Radio Gear.** Francis. From the publishers of CQ Magazine a book on military radio gear. 235 pages.....\$15.00

**A.R.C., PO Box 1558, Port Washington, NY 11050  
Toll Free: (866) 371-0512 • Fax: (516) 883-1077**

**E-mail: ARC@antiqueradio.com; Web: www.antiqueradio.com**

**Everything stocked & shipped promptly. Radio is our middle name.**





# ANTIQUE RADIO CLASSIFIED BOOKSTORE



**Old-Time Radios! Restoration and Repair**, Carr. *How to repair vacuum-tube and transistor radios. A self-paced training guide.* 200 illustrations, 256 pgs.....**\$21.95**

**Perera's Telegraph Collectors Guide**, Perera. *Basic info & reference material, 300 pictures, descriptions & current prices.* 104 pgs.....**\$14.95**

**Philco Condensers and More, Fourth Edition**, Bintliff. *Updated and expanded service data.* 300 illustrations, 74 pgs.....**\$18.95**

**Philco Radio: 1928-1942, 2nd Ed.**, Ramirez. *Reference book on Philco. Shows receivers and company history by year.* 464 color photos, 364 B & W photos and drawings. 160 pgs.....**\$29.95**

**Practical Radio Repair, A Handbook for Radio Collectors**, Bintliff. *Provides practical information on how to repair and restore vacuum tube radios and related electronic devices. More than 270 illustrations & tables,* 140 pgs.....**\$25.95**

**Practical Radio Repair, Volume II**, Bintliff. *This book complements Volume I and provides additional information regarding special tools, test adapters, supplies, chemicals, and shop set-up. An excellent reference for both the experienced restorer as well as the novice learning repair.* Soft cover, 126 pages, 315 illustrations.....**\$22.95**

**Radio Craft - 50 Years of Radio (reprint)**, March 1938 issue of *Radio Craft* magazine. Numerous articles on the development of radio, then 50 years old & on early radio pioneers. 144 pgs.....**\$15.95**

**Radio Dial Belts, 2nd Ed.**, Bintliff. *Guide to selection and replacement of dial belts in radios from the 1930s & 1940s*.....**\$15.95**

**Radio Manufacturers of the 1920's**, Douglas. 3 volumes.  
Vol. 1: *A-C Dayton thru Ferguson*, 225 pgs.....**\$29.95**  
Vol. 2: *Freed-Eisemann thru Priess*. 266 pgs.....**\$29.95**  
Vol. 3: *RCA thru Zenith*. 292 pgs.....**\$29.95**

**Radiola - The Golden Age of RCA, 1919-1929**, Wenaas. *Documents & pictures every radio receiver & the major accessories sold by RCA during the first decade.* 700 color photos, 485 pgs. Hardcover.....**\$45.00**

**Radios by Hallicrafters**, Dachis. *From the 1930s until the 1980s Hallicrafters led the shortwave radio boom with innovative design and cutting edge technology.* Over 1,000 photos and 225 pages.....**\$29.95**

**RCA Cunningham Radiotron Tube Manual RC-12**. *This is a nice reprint of the RCA Cunningham Radiotron Tube Manual RC-12. Originally published in 1934.* 154 pages, soft cover.....**\$16.95**

**RCA Receiving Tube Manual RC-14**. *This is a nice reprint of the RCA Receiving Tube Manual RC-14 originally published in 1940.* 255 pages.....**\$11.95**

**RCA Transmitting Tubes Manual TT-4**. *This is a nice reprint of the RCA Transmitting Tubes Manual TT-4 dated 1956.* 257 pages.....**\$11.95**

**S. Gernsback Radio Encyclopedia (reprint)**. *1927 classic encyclopedia on radio. From "A" battery to Zirconium, with 1000s of entries in between.* 100s of illustrations, 175 pgs.....**\$9.95**

**Speaker Building 201**, Alden. *Learn the concepts you need or choose any of the eleven tested and proven speaker designs included in this book.* 153 pages.....**\$34.95**

**Tickling the Crystal**, Sanders. *Comprehensive coverage of British crystal sets from the 1920s.* 200+ B & W photos. 2001. 256 pgs.....**\$59.95**

**Tickling the Crystal 2**, Sanders. *Domestic British Crystal Sets of the 1920s.* 2004. 208 pgs.....**\$59.95**

**Tickling the Crystal 3**, Sanders. *Domestic British Crystal Sets of the 1920s.* 2004. 240 pgs.....**\$59.95**

**Tickling the Crystal 4**, Sanders. *Next in a series on domestic British crystal sets. Many color photos in addition to B&W. Cumulative index to Vols. 1, 2, 3 & 4.* 2008. 280 pgs.....**\$59.95**

**The Tube Amp Book**, Pittman. *Deluxe edition revised. Already known as the bible of guitar tubes and guitar tube amps, The Tube Amp Book is now even better! This deluxe revised edition contains 40% new material.* 416 pages, hard cover, CD ROM included.....**\$39.95**

**Tubes Testers & Classic Electronic Test Gear**, Douglas. *Overview of pre-1970 radio test equipment. Over 300 photos and illustrations from 23 different manufacturers.* 166 pages.....**\$25.95**

**Where Discovery Sparks Imagination**, Jenkins. *Highlights the collection in the American Museum of Radio and Electricity in Bellingham, WA.* 218 pages.....**\$34.95**

**Zenith Radio Corporation (reprint)**. *The instructions for installation and operation for Models 39-39A Models 392-392A, and Electric Zenith Receivers.* 3 schematics, 3 photos. 16 pgs.....**\$4.50**

**Zenith The Early Years, 1919-1935**, Cones, Bryant & Blankinship. *Explains the Zenith story. Discover never published photos, documents and information.* 300 photos and illustrations, 120 in color. 224 pages.....**\$29.95**

**Zenith The Glory Years, 1936-1945**, Cones, Bryant & Blankinship. *Illustrated Catalog & Database, 520 B & W images,* 182 pages.....**\$29.95**

**Zenith The Glory Years, 1936-1945**, Cones, Bryant & Blankinship. *History and products,* 180 color photos, 183 B & W photos, 256 pages.....**\$34.95**

**The Zenith Tran-Oceanic**, Bryant & Cones. *The untold story of the Zenith Tran-Oceanic now in a newly revised and expanded edition. A wealth of never before published photos.* 226 photos with price guide, 128 pages, soft cover.....**\$34.95**

**Zenith Transistor Radios, Evolution of a Classic**, Smith. *A complete listing of all transistor radio models created by Zenith during the "Magic Years" from 1955-65. Color photos and price guide.* 1998. 160 pgs.....**\$29.95**

**Order today. We gladly accept:**



*\$3.00 shipping & handling on all U.S. orders (typical U.S. order will be received within 7 days, but allow 2-3 weeks). Non-U.S. orders, write for shipping costs, or use credit card. Most orders shipped by next business day. If using credit card, include name on card, card number and expiration date. Send payment with order. New York residents must add sales tax.*

## DO YOU KNOW YOUR A.R.C. SUBSCRIBER BENEFITS?

Since becoming publisher I've asked many of our subscribers about the benefits that come with a subscription to *Antique Radio Classified*.

These have included both our print subscribers as well as our online edition subscribers. The only difference between the print and online subscribers is that the online subscribers pay a reduced subscription rate and don't receive the print magazine.

Many of the people I spoke with didn't know about our subscription benefits.

Let's take a look at them:

### ABILITY TO LOOK AT THE MAGAZINE ONLINE

As a print or online subscriber you can look at the latest issue of the magazine online on our web site. This is the entire issue of the magazine and not an abbreviated edition. Subscribers can look at the last four issues of the magazine. Non-subscribers can look at earlier editions of the magazine at no cost.

One advantage of the online edition is that any photograph sent to us in color is posted in color!

### ABILITY TO LOOK AT PAST AUCTION RESULTS

Almost every month we publish auction results in the magazine. Did you know that we have a database of the auction prices online on our web

site? Subscribers can look at the auction results and they are SEARCHABLE! If you want to see if a specific radio, piece of equipment, tube, magazine, etc. that has been sold, all you have to do is enter the item and see every time the item has been sold as well as the price, auction house, and date!

### ABILITY TO LOOK AT ONLY THE CLASSIFIED ADS

Subscribers can also look only at the classified ads without downloading the entire magazine. This is very useful for readers who just want to read the classified ads. Readers with dial up Internet service will save a lot of downloading time.

### FREE MONTHLY CLASSIFIED AD

Each month a paid subscriber is entitled to place a free classified ad in the magazine. The classified ad can be up to 50 words. Additional words are 10 cents each. Classified ads can be submitted by email, fax, or mail. Typewritten preferred to reduce possible errors. Name, address and telephone number count as 6 words. Full name and address are required in all classified ads.

Of course the most important benefit to the subscribers of *Antique Radio Classified* are the articles containing information that will help you in increasing your knowledge of our hobby.

## HOW DO I ACCESS THESE BENEFITS?

**1**

ANTIQUE RADIO CLASSIFIED PERIODICALS Postage PAID

A.R.C., P.O. Box 1106, Fort Washington, NY 11000

2NDZ 1507 \*\*\*\*\*AUTOMATED ARCD 37899  
SUB# 69929(4444) EXP-MAY 11  
John Doe  
123 Main St  
East City NJ 07033-1234

www.antiqueradio.com  
CLASSIFIED AD  
DEADLINE JAN 19  
Noon Eastern Time

Your print subscriber user ID and password are on your mailing label. Online subscribers are emailed their user ID and password. Your user ID is the number after "SUB#" on your mailing label. Your password is the digits in brackets [xxxx] after your "SUB#".

**2**

Antique Radio Classified Home Page

http://www.antiqueradio.com/

HOME  
ABOUT US  
CONTACT US  
SUBSCRIBER ONLY PAGE  
CLASSIFIED ADS  
Auctions  
Auction Results

ANTIQUE RADIO CLASSIFIED

A.R.C.—The National Publication Of Old Radios And Related Items

LATEST A.R.C. WEB SITE

The February 2011 Issue is in it!

Go to A.R.C.'s home page [www.antiqueradio.com](http://www.antiqueradio.com) and click on Subscriber Only Page.

**3**

### Subscriber-Only Access

Not a subscriber?  
[Click here to subscribe and receive an ID/Password by email](#)

Full Issue PDFs	Classified Ads
January 2011 Issue (33 MB)	January 2011 Issue - Ads Only (100 KB)
November/December 2010 Issue (45 MB)	November/December 2010 Issue - Ads Only (78 KB)
September/October 2010 Issue (30 MB)	September/October 2010 Issue - Ads Only (13 MB)
August 2010 Issue (31 MB)	August 2010 Issue - Ads Only (11 MB)
Full Issue PDF Archive	

On the Subscriber-Only Access page you can click on the Full Issue you would like to view or click on the Classified Ads section from that issue.

**4**

ANTIQUE RADIO CLASSIFIED

A.R.C.—The National Publication For Buyers And Sellers Of Old Radios And Related Items—Published Monthly

### A.R.C. AUCTION PRICES DATABASE

24,891 Auction Prices from 165 Auction Venues  
Selected Auctions from 1997 to 2009  
More prices and venues continually added!

Search [ ] [ ] Include detailed Venue information [ Search hints ]

Disclaimer: These prices are not current values, but past auction prices [ more... ]  
[ Price Comments, Sources, Reports, Abbreviations, Categories & Venue comments ]

Or you can click on the Auction Prices Data Base. Just enter the item that you are researching.



# Radiofest 2012

**August 2-4**

*Thursday – Friday – Saturday*



**Willowbrook Holiday Inn**  
7800 South Kingery Hwy (Rte 83 & I-55)  
Willowbrook, IL 60527 (1-630-325-6400)

## **MARCONI / TITANIC CENTENNIAL COMMEMORATION**

Plus: "Lee de Forest: King of Radio, Television & Film" - Book Signing By Mike Adams

### **THURSDAY**

- Setup Day (**NO SALES**)
- Main Auction 6:30pm in the Ballroom using big screen video. Followed By A Free Pizza Party!! (ARCI Members)
- Pre-Registration Packets Available After 5pm

### **FRIDAY**

- 7am Radiofest Opens
- Registration open
- Flea Market open All Day
- Noon - Ladies Luncheon
- Educational Programs
- Ham Radio Ops All Day
- Hospitality Tent All Day
- Hotel Food Service

### **MARCONI / TITANIC SPECIAL EXHIBIT**

- Emergence of Wireless Rescue Radio
- Marconi Artifacts & Documentation
- Titanic Items

### **EQUIPMENT CONTEST**

- 1 Radios Pre 1930
- 2 Radios Pre WWII (1945)
- 3 Radios Post WWII (1946)
- 4 Art Deco Radios
- 5 Catlin, Rare, Plastic Radios
- 6 Speakers
- 7 Transistor, Novelty Radios
- 8 Vacuum Tube Audio
- 9 Radios Made In Midwest
10. Ham/Military Radio
11. Open

### **LADIES LUNCHEON Noon**

### **FRIDAY NIGHT BANQUET**

Book Signing: *Lee de Forest: King of Radio, Television & Film*  
By Mike Adams  
Dinner  
Recognition Awards  
Contest Awards

### **ENTERTAINMENT**



### **SATURDAY**

- Free Sellers' Raffle 9:15am
- Donation Auction 9:30am
- Ham Radio License VE Tests
- Flea Market Until Noon

### **FRIDAY PROGRAMS**

**Vacuum Tube Audio Panel** - *Karl Johnson, Pete Nauseda and Terry Shaver*

**Museum Tour: Pavek Museum Of Broadcasting in Minnesota** - *Steve Raymer*

**The Ham Radio Forum** (*Heavy Metal – WLW Cincinnati*) - *Bill Ross (W9WR)*

**E. H. Scott** - *Kent King, Scott Historian*

**Lee de Forest: Movies & Sound** – Presentation & Book Signing - *Mike Adams*

### **IMPORTANT INFORMATION**

**ARCI Registration Form:** <http://www.antique-radios.org>. **Pre-Registration Deadline:** July 1.

**Hotel Reservations:** Front Desk 1-630-325-6400. Ask for ARCI room rate of \$99.00 per night.

**Seller Fees:** 1st space: \$45 pre-reg./\$50 onsite. Additional spaces: \$25 pre-reg./\$35 onsite. Saturday Only \$30. Banquet tickets: \$25/person, \$45/couple. **8' TABLE RENTALS** \$15 each (pre-registration only). No charge for general admission. Membership required to attend programs.

**Questions?** Call 630-739-1060. See [www.antique-radios.org](http://www.antique-radios.org).



A.R.C., PO Box 1558, Port Washington, NY 11050

[www.antiqueradio.com](http://www.antiqueradio.com)

**CLASSIFIED AD  
DEADLINE JUNE 30  
Noon Eastern Time**