

Emerson Radio & Phonograph Corp.

Model: 516

Chassis:

Year: Pre 1948

Power:

Circuit:

IF:

Tubes:

Bands:

Resources

[Riders Volume 17 - CHANGES 17-1](#)

[Riders Volume 15 - EMERSON 15-11](#)

[Riders Volume 15 - EMERSON 15-12](#)

Ansley 32A

The model 32A is the same as the model 32, shown on page 15-1, 2 of *Rider's Volume XV*, with the following exceptions: the 240-ohm resistor connected to prong 5 of the plug is deleted as is also the 12-ohm resistor connected to the one just mentioned. The 10,000-ohm resistor that was in series with the deleted 12-ohm resistor is now connected to ground.

A permanent-magnet loudspeaker has replaced the dynamic speaker and the following changes have been made in this circuit: as there is now no field or bucking coils, the leads to these coils from terminals 1, 5, and 8 have been removed. Instead of the bucking coil (B.C. in the schematic), the voice coil is connected directly across the secondary of the output transformer.

Chevrolet 985792

In the production of this model between serial numbers B46-130000 and B46-136522 the following changes have been made: the 22,000-ohm resistor, 24, has been changed to 33,000 ohms; and the 0.01 μ f capacitor, 14, has been moved

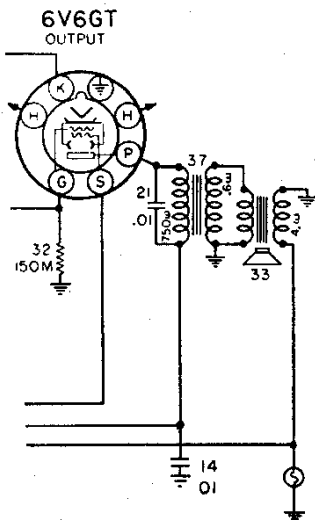

Partial schematic of Chevrolet 985792 showing changes.

from between the 33,000-ohm resistor, 25, and ground to the primary of the output transformer, 37, which is connected through the capacitor to ground, as shown in the accompanying illustration.

In the production of this model starting upward with serial number B46-136523, the 6SA7GT oscillator-translator tube has been changed to a type 7Q7. The voltages shown in the bottom view of the sockets on page 13-2 of *Rider's Volume XIII* are the same for the 7Q7 as for the 6SA7GT, except that the socket prong designations have been shifted.

Starting upward with serial number B47-1001, the tube complement is changed with the exception of the 7Q7 and the 0Z4G tubes. The i-f tube is changed from a 6SK7GT to a 7A7; the 6SQ7GT detector is changed to a 7B6, and the output tube is changed from a 6V6GT to a 7C5. The voltage readings on these tubes are the same as those noted above with the exception of the reading on the cathode of 7C5 which is 4.5 instead of 9.5 volts.

The early production schematic appears on page 13-1 of *Rider's Volume XIII*.

Crosley 56PA, 56PB

Recently it has been discovered that some of the models 56PA and 56PB radios, shown on page 15-29 of *Rider's Volume XV*, are more efficient on power line operation than they are on battery operation. This condition may exist in certain areas, even though the batteries are in good condition.

If a condition of this nature is encountered in your area, it is suggested that one lead wire of the 0.05- μ f capacitor, which is item 13 in the schematic, should be disconnected from the terminal strip. This lead wire should be extended, covered with sleeving, and attached to the red wire in the interlock switch, as shown in Fig. 1.

In a later production of these models, a 1U5 tube has been substituted for the 1S5 Det.-AVC, 1st A.F. Amp. tube. All components connecting to the tube remain the same; the only difference occurs in the wiring to the tube socket.

Capacitor (15) which was formerly connected across the output transformer (5), is now connected from the plate pin 2 to F+ pin 7 of the 354 output tube.

A 12- μ f capacitor (46) part No. C-137727-13 has been added across the oscillator tank circuit as shown in Fig. 2. The ground symbol in the oscillator tank circuit was omitted from the original schematic and should be inserted on Crosley page 15-29 and also the added 12- μ f capacitor.

Fig. 1, right. The changing of a lead of item 13 in the Crosley 56PA, 56PB in some cases gives more efficient operation from power lines than from batteries. Fig. 2, below. The ground symbol in the oscillator tank circuit was omitted from the original schematic and should be inserted on Crosley page 15-29 and also the added 12- μ f capacitor.

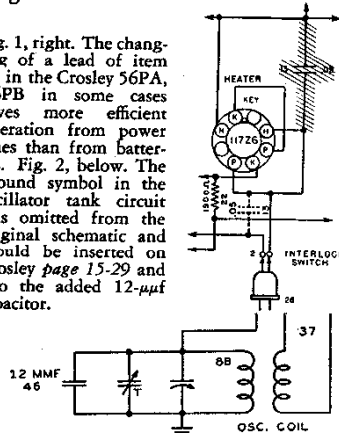

Emerson 512, 515, 516, 550. Chassis 120006, 120056

These models incorporating the 120006 chassis are the same as model 512 shown on page 15-11 of *Rider's Volume XV*. These models using the 120056 chassis are the same as those mentioned above, except for the replacing of the octal tubes with the following loctal tubes:—7B7, 14B6, 14Q7, 50A5, and a 35Y4. The circuit diagram and the voltage readings remain the same, except for the base pin numbers.

Emerson 550, Chassis 120,006

This model is the same as models 512, 515, and 516, chassis 120,006, shown on pages 15-11 and 15-12 of *Rider's Volume XV*.

Electronic Laboratories 2701, ISSUE B

This model from serial number 211,001 and up, is similar to the 2701 receiver shown on pages 15-1 and 15-2 of *Rider's Volume XV*, except for the following changes:

A 27-ohm 10-watt wire-wound resistor, part W-284C has been added to the filament line, between pin 7 of the 35Z5GT/G rectifier and pin 2 of the 50L6GT/G output tubes.

In the alignment procedure for a frequency setting of 700 kc, the following note has been added in the last column: If more than one turn is required, the trimming 1400 kc should be repeated and the 700 kc padding of the tuning core also repeated until correct alignment has been reached.

Farnsworth ET-061

The following information is of use to those who have experienced finding turned-up edges in the cabinet of the Farnsworth model ET-061:

The Dynox or simulated wood wrap-around has a tendency to curl at the edge on early shipments of some table models. This can usually be firmly recemented by applying a heated dull knife blade between the Dynox and the cabinet. The heated blade should then be applied to the outside surface of the Dynox pressing it firmly against the cabinet. It will help to stroke the blade toward the edge of the Dynox while applying firm pressure. Care must be used to see that the knife blade is not hot enough to burn or discolor the finish of the Dynox.

FARNSWORTH ET-069

The Farnsworth Model ET-069 is the same as the Farnsworth Model ET-066 except that Model ET-069 uses cabinet No. H-247 and knob No. 59423. The schematic for the ET-066 is found on page 15-5 of *Rider's Volume XV*.

EMERSON RADIO & PHONO. CORP.

MODELS 512, 515,
516, Ch. 120006

PART NO. 950006

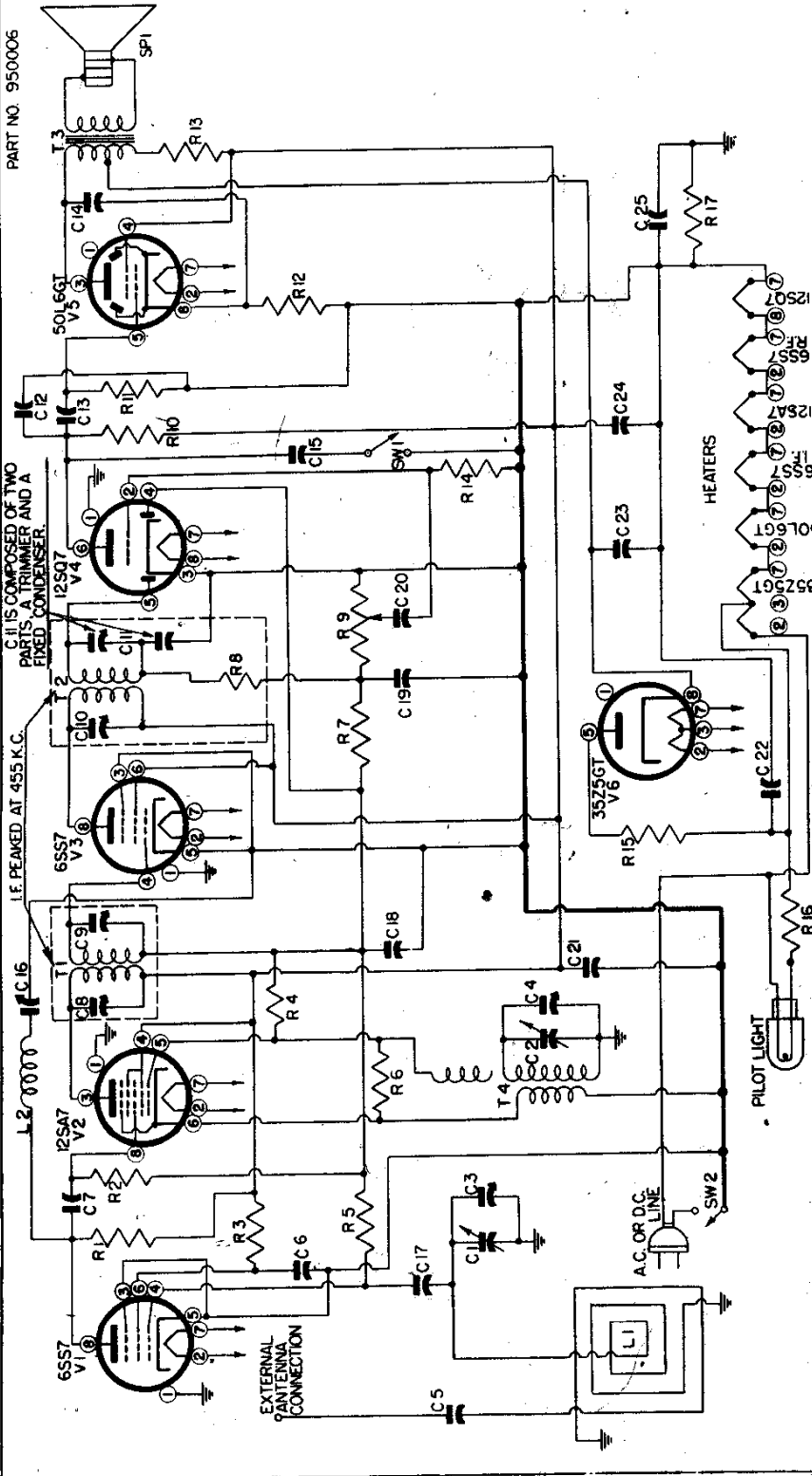

SCHEMATIC WIRING DIAGRAM
FOR
CHASSIS NO 120006

| REV. | CH | DATE | REVISIONS |
|------|------|----------|----------------|
| 1 | L.C. | 12-25-36 | INITIAL DESIGN |
| 2 | L.C. | 1-15-37 | REVISIONS |
| 3 | L.C. | 2-15-37 | REVISIONS |
| 4 | L.C. | 3-15-37 | REVISIONS |
| 5 | L.C. | 4-15-37 | REVISIONS |
| 6 | L.C. | 5-15-37 | REVISIONS |
| 7 | L.C. | 6-15-37 | REVISIONS |
| 8 | L.C. | 7-15-37 | REVISIONS |
| 9 | L.C. | 8-15-37 | REVISIONS |
| 10 | L.C. | 9-15-37 | REVISIONS |
| 11 | L.C. | 10-15-37 | REVISIONS |
| 12 | L.C. | 11-15-37 | REVISIONS |
| 13 | L.C. | 12-15-37 | REVISIONS |
| 14 | L.C. | 1-15-38 | REVISIONS |
| 15 | L.C. | 2-15-38 | REVISIONS |
| 16 | L.C. | 3-15-38 | REVISIONS |
| 17 | L.C. | 4-15-38 | REVISIONS |
| 18 | L.C. | 5-15-38 | REVISIONS |
| 19 | L.C. | 6-15-38 | REVISIONS |
| 20 | L.C. | 7-15-38 | REVISIONS |
| 21 | L.C. | 8-15-38 | REVISIONS |
| 22 | L.C. | 9-15-38 | REVISIONS |
| 23 | L.C. | 10-15-38 | REVISIONS |
| 24 | L.C. | 11-15-38 | REVISIONS |
| 25 | L.C. | 12-15-38 | REVISIONS |

| ITEM | RES. PART NO. | RES. PART |
|------|---------------|-----------------------------|
| C1 | 907070 | TWO GANG VARIABLE CONDENSER |
| C2 | PT. OF C1 | TRIMMER |
| C3 | PT. OF C2 | TRIMMER |
| C4 | 902000 | .002 MF 600 VOLT |
| C5 | 902000 | .002 MF 600 VOLT |
| C6 | 902000 | .002 MF 600 VOLT |
| C7 | 902000 | .002 MF 600 VOLT |
| C8 | 902000 | .002 MF 600 VOLT |
| C9 | 902000 | .002 MF 600 VOLT |
| C10 | PT. OF T1 | TRIMMER & FIXED CONDENSER |
| C11 | 902000 | .002 MF 600 VOLT |
| C12 | 902000 | .002 MF 600 VOLT |
| C13 | 902000 | .002 MF 600 VOLT |
| C14 | 902000 | .002 MF 600 VOLT |
| C15 | 902000 | .002 MF 600 VOLT |
| C16 | 902000 | .002 MF 600 VOLT |
| C17 | 902000 | .002 MF 600 VOLT |
| C18 | 902000 | .002 MF 600 VOLT |
| C19 | 902000 | .002 MF 600 VOLT |
| C20 | 902000 | .002 MF 600 VOLT |

| ITEM | RES. PART NO. | RES. PART |
|------|---------------|----------------------|
| R1 | 301000 | 10,000 OHMS 1/4 WATT |
| R2 | 301000 | 10,000 OHMS 1/4 WATT |
| R3 | 301000 | 10,000 OHMS 1/4 WATT |
| R4 | 301000 | 10,000 OHMS 1/4 WATT |
| R5 | 301000 | 10,000 OHMS 1/4 WATT |
| R6 | 301000 | 10,000 OHMS 1/4 WATT |
| R7 | 301000 | 10,000 OHMS 1/4 WATT |
| R8 | 301000 | 10,000 OHMS 1/4 WATT |
| R9 | 301000 | 10,000 OHMS 1/4 WATT |
| R10 | 301000 | 10,000 OHMS 1/4 WATT |
| R11 | 301000 | 10,000 OHMS 1/4 WATT |
| R12 | 301000 | 10,000 OHMS 1/4 WATT |
| R13 | 301000 | 10,000 OHMS 1/4 WATT |
| R14 | 301000 | 10,000 OHMS 1/4 WATT |
| R15 | 301000 | 10,000 OHMS 1/4 WATT |
| R16 | 301000 | 10,000 OHMS 1/4 WATT |
| R17 | 301000 | 10,000 OHMS 1/4 WATT |
| R18 | 301000 | 10,000 OHMS 1/4 WATT |
| R19 | 301000 | 10,000 OHMS 1/4 WATT |
| R20 | 301000 | 10,000 OHMS 1/4 WATT |
| R21 | 301000 | 10,000 OHMS 1/4 WATT |
| R22 | 301000 | 10,000 OHMS 1/4 WATT |
| R23 | 301000 | 10,000 OHMS 1/4 WATT |
| R24 | 301000 | 10,000 OHMS 1/4 WATT |
| R25 | 301000 | 10,000 OHMS 1/4 WATT |

| ITEM | RES. PART NO. | RES. PART |
|------|---------------|-----------|
| T1 | 700000 | 500 VOLT |
| T2 | 700000 | 500 VOLT |
| T3 | 700000 | 500 VOLT |
| T4 | 700000 | 500 VOLT |
| T5 | 700000 | 500 VOLT |
| T6 | 700000 | 500 VOLT |
| T7 | 700000 | 500 VOLT |
| T8 | 700000 | 500 VOLT |
| T9 | 700000 | 500 VOLT |
| T10 | 700000 | 500 VOLT |
| T11 | 700000 | 500 VOLT |
| T12 | 700000 | 500 VOLT |
| T13 | 700000 | 500 VOLT |
| T14 | 700000 | 500 VOLT |
| T15 | 700000 | 500 VOLT |
| T16 | 700000 | 500 VOLT |
| T17 | 700000 | 500 VOLT |
| T18 | 700000 | 500 VOLT |
| T19 | 700000 | 500 VOLT |
| T20 | 700000 | 500 VOLT |

| ITEM | RES. PART NO. | RES. PART |
|------|---------------|-----------|
| V1 | 6S57 | 6S57 |
| V2 | 12S07 | 12S07 |
| V3 | 6S57 | 6S57 |
| V4 | 12S07 | 12S07 |
| V5 | 501.6GT | 501.6GT |
| V6 | 35Z5GT | 35Z5GT |

MODELS: 512, 515, 516

EMERSON RADIO & PHONO. CORP.
REV. TUNE CITY
MODEL: 120006, 120006-C
ARTICLE: SCHEMATIC
DATE: 8-1-38 DR. L.C. CR. L.C. TYPE: Y-15

EMERSON RADIO & PHONO. CORP.

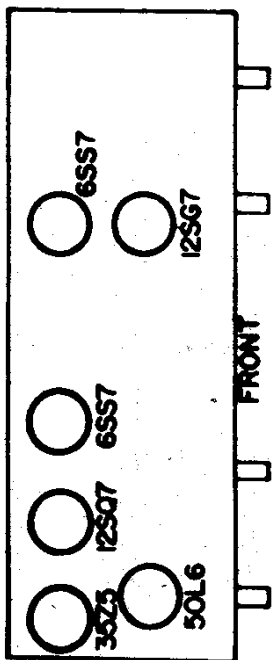

MODELS: 513, 514

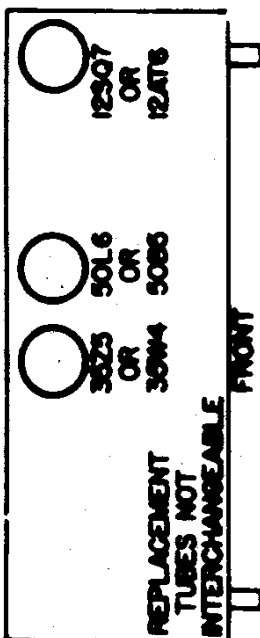

MODELS: 521, 542

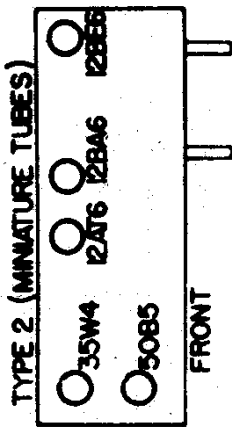
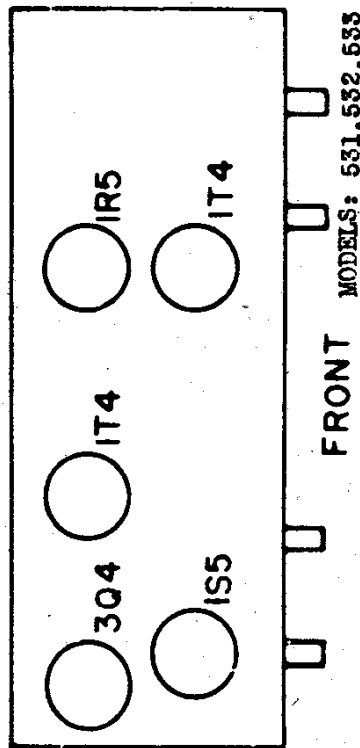

MODELS: 501, 502, 503, 504, 507, 509, 510, 511, 517, 518, 519, 520, 525, 539, 541

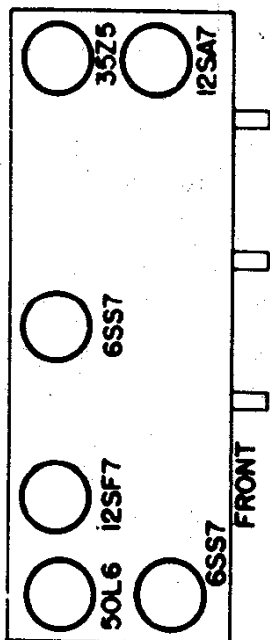

MODEL 506

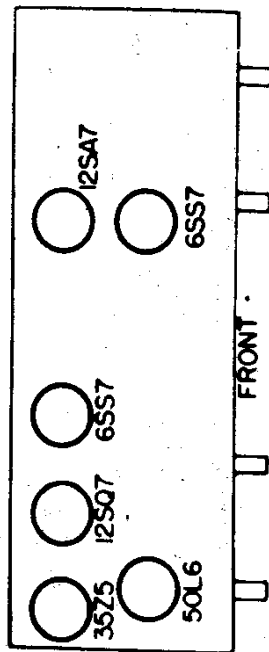
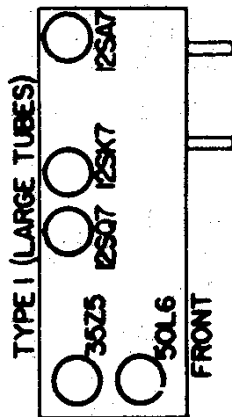

MODELS: 512, 515, 516