

PL-880
PLL MULTI BAND RADIO
WITH
EXCELLENT PERFORMANCE

OPERATION MANUAL



TECSUN RADIOS AUSTRALIA

24/9 Powells Road, Brookvale, NSW 2100 Australia
Email: info@tecsunradios.com.au

Ph: +61 2 9939 4377
www.tecsunradios.com.au

CONTENT

LOCATION OF CONTROLS.....	3
LCD SYMBOL DESCRIPTION.....	5
INSTRUCTION	
TURN ON/OFF THE RADIO.....	6
USING THE ANTENNA.....	7
VOLUME ADJUSTMENT.....	8
VF(view frequency)/VM(view memory) MODE.....	8
TUNING INTO STATIONS.....	9
• MANUAL TUNING	
• AUTO BROWSE	
• DIRECT KEYPAD ENTRY	
WORKING WITH STATION MEMORIES	10
• STORING STATIONS MANUALLY	
• SEMI-AUTO STORAGE	
• AUTO TUNING STORAGE (ATS)	
• MEMORY PAGE SELECTION	
LISTENING TO STORED STATIONS.....	13
• MANUALLY BROWSE STORED STATIONS	
• AUTO BROWSE STORED STATIONS	
• DIRECT ENTRY INTO STORED STATIONS	
DELETING STATION MEMORIES.....	14
• MANUALLY DELETE A SINGLE STATION	
• SEMI-AUTO DELETE A SINGLE STATION	
• MANUALLY DELETE ALL STATIONS (WITHIN A PAGE)	
SLEEP TIMER	16
TIME SETTING.....	16
ALARM SETTING (by radio).....	17
• ACTIVATE/DEACTIVATE THE ALARM	
• ALARM STATION SETTING	
• TURNING OFF THE ALARM	
• SNOOZE FUNCTION	
LCD BACKLIGHT.....	18

FM STEREO.....	19
AM BW (BANDWIDTH) SELECTION.....	19
ENHANCING SW SENSITIVITY USING ANT. GAIN.....	20
TONE CONTROL.....	20
KEY LOCK FUNCTION.....	20
DISPLAY MODE CONVERSION.....	20
LINE-OUT FUNCTION.....	20
SINGLE SIDE BAND (SSB).....	21
ENHANCING SHORTWAVE RECEPTION.....	21
CHARGING FUNCTION.....	22
RESET FUNCTION.....	22
SYSTEM SETTING (In Power Off Mode).....	23
FM FREQUENCY RANGE	
• TURN ON/OFF THE LW	
• MW (AM) 9K/10K TUNING STEPS	
• AUTO-SORTING STATION LIST	
RADIO MAINTENANCE	24
LITHIUM BATTERY SAFETY INFORMATION (IMPORTANT).....	24
TROUBLE SHOOTING.....	25
SPECIFICATIONS.....	27

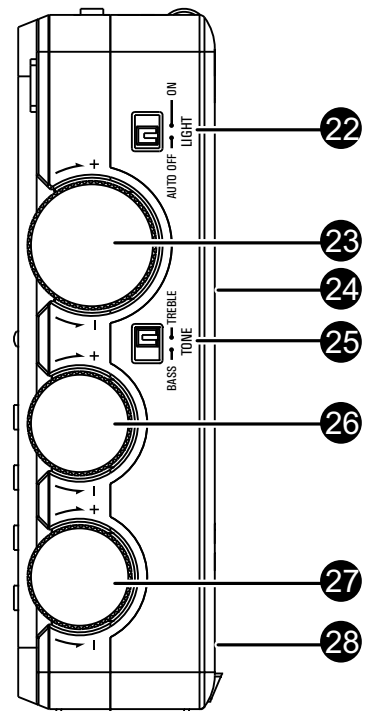
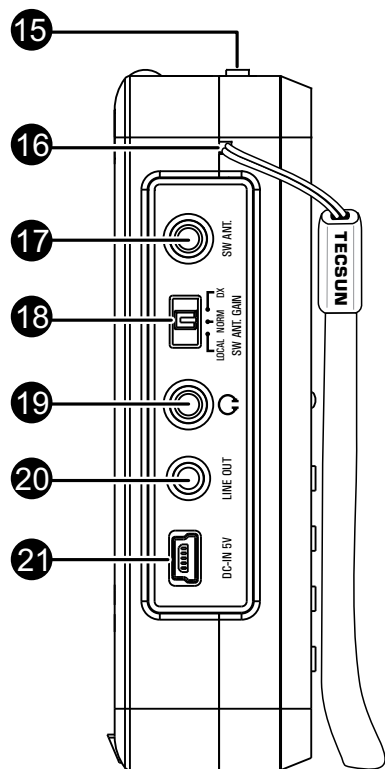
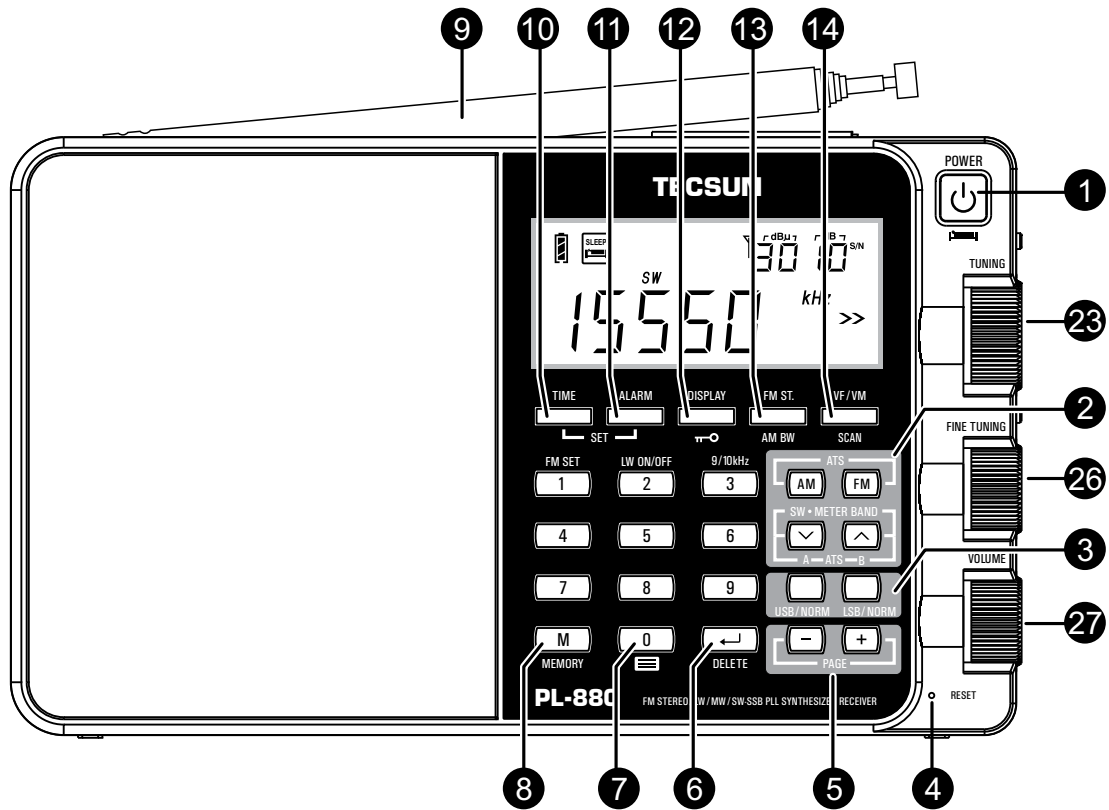

LOCATION OF CONTROLS

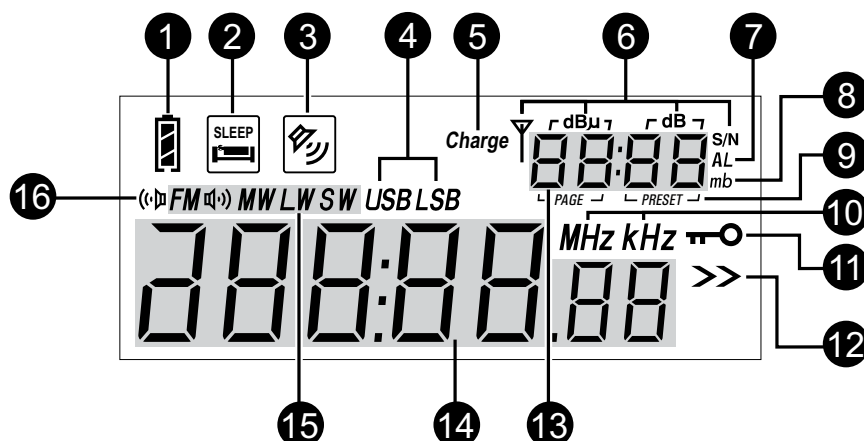

-
- ① Power / Sleep button
 - ② FM / AM / LW / SW & ATS (Auto Tuning Storage)
 - ③ USB/LSB/NORM
 - ④ - / + Memory page selection
 - ⑤ Reset
 - ⑥ Delete / Confirm (←) button
 - ⑦ Auto-sorting station list
 - ⑧ Memory (storing stations manually)
 - ⑨ FM & SW telescopic antenna
 - ⑩ Time set
 - ⑪ Alarm set (by radio only)
 - ⑫ Display mode / Key lock
 - ⑬ FM stereo & AM bandwidth
 - ⑭ VF / VM / SCAN
 - ⑮ Snooze
 - ⑯ Carrying strap
 - ⑰ SW external antenna jack
 - ⑱ SW ANT. Gain (DX / Normal / Local)
 - ⑲ Earphone jack
 - ⑳ Line-out jack
 - ㉑ USB 5V DC-IN jack
 - ㉒ LCD backlight control
 - ㉓ Multifunctional tuning knob
 - ㉔ Back stand
 - ㉕ Tone selection
 - ㉖ Fine tuning knob
 - ㉗ Volume control
 - ㉘ Battery compartment

LCD SYMBOL DESCRIPTION



- | | |
|--|---|
| <p>1 Battery power indicator</p> <ul style="list-style-type: none"> ● “” Full power ● “” Almost no power, recharging or replacement is required. <p>2 Sleep timer indicator</p> <p>3 Alarm On / Off indicator</p> <p>4 SSB indicator (USB/LSB)</p> <p>5 Charging indicator</p> <p>6 Signal indicator</p> <p>dBμ : Signal strength unit</p> <p>dB : SNR unit</p> <p>7 Alarm time indicator (by radio only)</p> <p>8 Shortwave meter band indicator</p> <p>9 PAGE: Stored page indicator</p> <p>PRESET: Stored address indicator</p> | <p>10 kHz: Frequency unit of MW, LW and SW</p> <p>MHz: Frequency unit of FM</p> <p>11 Key lock indicator</p> <p>12 Tuning speed indicator</p> <p>“>>” Fast tuning</p> <p>“>” Slow tuning</p> <p>13 Small digital display area</p> <ul style="list-style-type: none"> ● Radio OFF status: Radio alarm time ● Radio ON status: Signal strength/SNR, time, alarm time, stored address, shortwave meter band <p>14 Large digital display area</p> <ul style="list-style-type: none"> ● Radio OFF status: Time display, system settings ● Radio ON status: Radio frequency <p>15 Band indicator</p> <p>16 FM stereo status indicator</p> |
|--|---|

Signal strength (unit: dBu): This is the value to measure radio reception strength; a higher value indicates a stronger reception.

SNR S/R (unit: dBu): Signal to Noise Ratio: a higher value indicates less background noise.

TURN ON/OFF THE RADIO

1. Open the battery compartment located at the back of the unit, properly install the included 18650 lithium battery by following the polarity diagram, then close the battery door.

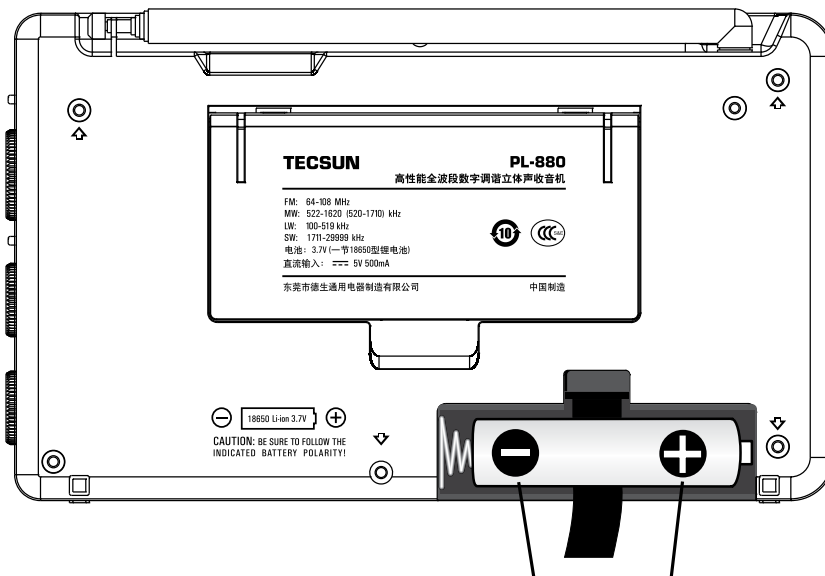

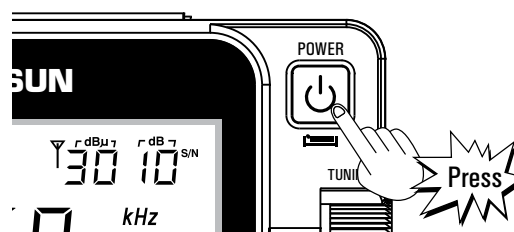

be sure to follow the indicated battery polarity.

2. Press the [POWER] button to turn ON/OFF the device.



Note:

If the radio is unable to turn on, please make sure the battery has sufficient power, is installed correctly, and whether the key lock function has not been switched on. If the device is locked, the display will show []; to unlock, press and hold the [] button until the key symbol disappears from the display.

USING THE ANTENNA

FM / Shortwave (SW):

When listening to FM or shortwave radio, extend the antenna and adjust its length and direction in order to get the optimum reception.

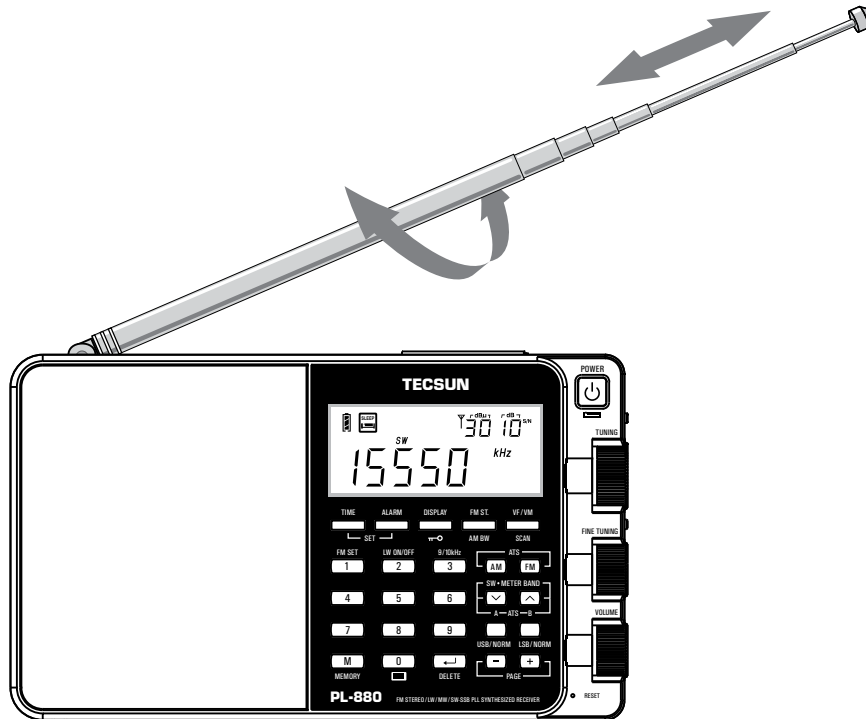

Medium Wave (MW) / Long Wave (LW):

This radio uses an internal ferrite bar antenna to receive medium wave and long wave broadcasts, the quality of which can be enhanced by changing the device's position and direction.

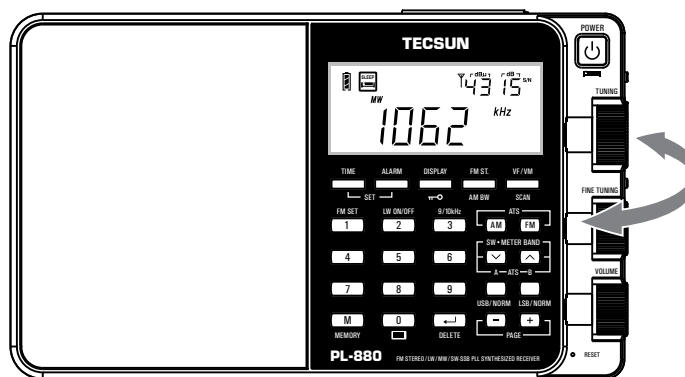

VOLUME ADJUSTMENT

Rotate the [VOLUME] knob upward or downward to adjust to your desired volume level.

VF(VIEW FREQUENCY)/VM (VIEW MEMORY) MODE

VF: Press the [VF/VM] button. When the station frequency indicator flashes twice, the VF mode is activated.

VM: Press the [VF/VM] button. When the station memory indicator in the top right corner of the display flashes, the VM mode is activated.

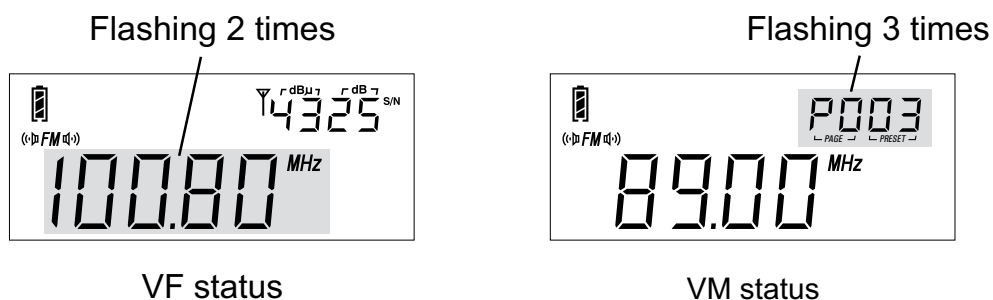

Note:

When the memory contains no stored stations, it is not possible to switch between the VF (View Frequency) and VM (View Memory) mode. If there are no stored stations in memory, then the device will automatically be in VF mode.

TUNING INTO STATIONS

Turn on the radio, then select your desired band by pressing on either the FM, AM or SW buttons.

Now, you can tune into your favorite stations using any of the following tuning methods:

MANUAL TUNING

In View Frequency (VF) mode, rotate the [TUNING] knob to search for your desired stations.

AUTO BROWSE

In VF mode, press & hold the [VF/VM] button. The " >> " symbol advances from left to right and the device will automatically browse the available stations, staying on each station for about 5 seconds.

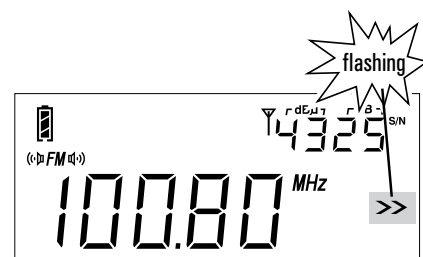

Auto browse station

To stop the auto browse function, simply rotate the [TUNING] knob or press the [VF/VM] button to confirm your desired station.

Note:

While operating the "AUTO BROWSE" function, you can press the [MEMORY] button anytime to store the station into memory, the radio will keep on browsing to the next available station.

DIRECT KEYPAD ENTRY

In "VF" mode, you can press the numeric keys [0 - 9] to directly enter a station frequency.

Note:

1. For FM band, ignore the decimal point when inputting frequency numbers. For example: enter 8, 9, 3 for FM 89.3 MHz.
2. If the entered frequency is not within the covering range, the error "Err" symbol will be displayed.

WORKING WITH STATION MEMORIES

There are 3050 station memories for this device, with great flexibility in memory storage. Please refer to the chart below:

1. Memory PAGE 0, noted as "P0", consists of 650 station memories, 100 assigned for FM/MW/LW/SSB and 250 for SW.
2. Memory PAGE 1 to 24, noted as "P1", "P2" etc., each page consists of 100 station memories, in total 2400 station memories.

Memory Band	Memory for each band (650)		Memory amount all bands (2400)	
	Page 0 [P0]	ATS	Page 01-24	ATS
FM	100	✓	Each memory page can store 100 station memory	✓
MW	100	✓		✓
LW	100	✓		✓
SW	250	✓		✓
SSB	100	✓		✓

Note:

When viewing the stored stations in P0, it will only show the stations of the band that was selected when entering the VM mode. If you wish to see the stored stations from a different band, select the band of your preference and reenter the VM mode. In all other pages (P1 – P24), it is not necessary to preselect the band; the device will show the stored stations from all bands.

STORING STATIONS MANUALLY

1. In VF mode, press the [FM], [AM], [SW] button for band selection, then tune into your desired station.
2. Press the [MEMORY] button, "PRESET" will flash in the top right corner of the display, then rotate the [TUNING] button to select a memory address.
3. Press the [MEMORY] button again to confirm or wait for about 3 seconds to automatically store the station into memory.

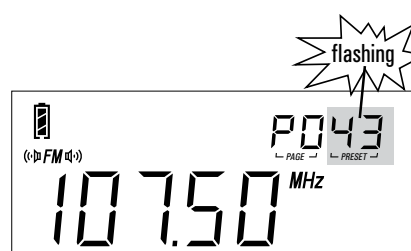

SEMI – AUTO STORAGE

While operating the "Auto Browse" function, you can press the [MEMORY] button to store stations into memory, thereby avoiding any unwanted stations.

In VF mode, press & hold the [VF/VM] button. The " >> " symbol advances from left to right and the device will automatically browse the available stations, staying on each station for about 5 seconds.

To stop the auto browse function, simply rotate the [TUNING] knob or press on the [VF/VM] button to confirm your desired station.

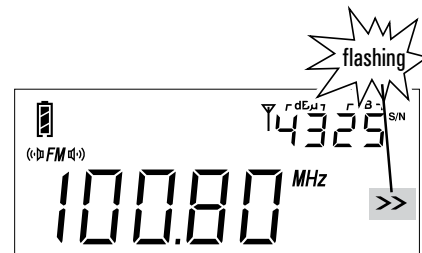

Auto browse station

AUTO TUNING STORGARE (ATS)

1. In VF mode, fully extend the telescopic antenna, and press the [FM] button to select the FM band.
2. Press & hold the [FM] button. "PRESET" flashes in the upper right corner and the station frequency starts running.
3. When the frequency stops running, it means the ATS operation has been completed; all available stations are now stored into memory. You can rotate the [TUNING] knob to view all the stored stations.

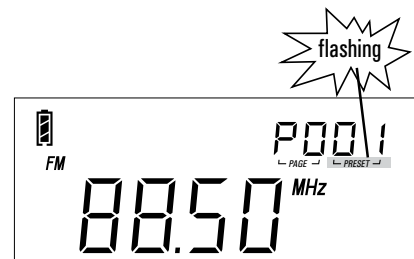

Auto tuning storage (ATS) status

MW/LW ATS:

1. Press the [AM] button to select MW or LW band.
2. Press & hold [AM] button to operate the ATS function.

SW ATS:

1. Fully extend the telescopic antenna and press the SW [√] or [^] button to select SW band.
2. There are two modes for ATS tuning:
Mode A: Press & hold the [√] button to operate ATS for stations within all meter bands;
Mode B: Press & hold the [^] button to operate ATS only for stations within the present meter band.

Note:

1. When using the ATS function for FM, MW/LW or SW mode A, previously stored radio stations will be replaced automatically by the newly found stations.
2. When using the ATS function in SW mode B, previously stored radio stations will not be replaced; all newly found radio stations will be stored in the blank memory addresses.
3. If there is too much interference in your surrounding, or many mirrors or blank stations are stored during ATS operation, you should extend the telescopic antenna to enhance FM & SW reception, or rotate the radio for better reception of MW & LW. You can also push the [ANT. GAIN] switch to the position [NORMAL] or [LOCAL] to enhance the ATS function.

MEMORY PAGE SELECTION

1. Press the [FM], [MW/LW] or [SW] button for band selection, then tune into your desired station.
2. Press the [MEMORY] button. The memory address flashes in the upper right corner of the display.
3. Press the [- PAGE +] buttons to choose your desired memory page, then rotate the [TUNING] knob to select your preferred memory address. Press the [MEMORY] button again to confirm, or wait for 3 seconds to automatically store the station into memory.

LISTENING TO STORED STATIONS

MANUALLY BROWSE STORED STATIONS

Select the band of which you want to view the stored stations, then press the [VF/VM] button to enter the VM mode. Rotate the [TUNING] knob to view the stored stations within a memory page. To view the stored stations of other memory pages, press the [- PAGE +] buttons to change the page.

Note:

When viewing the stored stations in P0, it will only show the stations of the band that was selected when entering the VM mode. If you wish to see the stored stations from a different band, select the band of your preference and reenter the VM mode. In all other pages (P1 – P24), it is not necessary to preselect the band; the device will show the stored stations from all bands.

AUTO BROWSE STORED STATIONS

Select the band of which you want to view the stored stations, then press the [VF/VM] button to enter the VM mode. Press & hold the [VF / VM] button until “PRESET” flashes in the upper right corner of the display. The device will auto browse all stations in the selected memory page, staying on each station for about 5 seconds. To stop browsing, rotate the [TUNING] knob or press the [VF / VM] button again. To view the stored stations of other memory pages, press the [- PAGE +] buttons to change the page.

Note:

When viewing the stored stations in P0, it will only show the stations of the band that was selected when entering the VM mode. If you wish to see the stored stations from a different band, select the band of your preference and reenter the VM mode. In all other pages (P1 – P24), it is not necessary to preselect the band; the device will show the stored stations from all bands.

DIRECT ENTRY INTO STORED STATIONS

In VM mode, first enter the memory page from which you want to select the address. To select a memory page, press the [- PAGE +] buttons. While it flashes, type in the page number (0 - 24) by pressing the corresponding numeric keys [0 - 9].

When entered the preferred memory page, select the address by pressing the corresponding numeric keys [0 - 9].

Note:

If the display shows “----” behind the page number after changing pages, it means there are no stored stations on that page.

If “----” is shown after entering an address in a page that has stored stations, it means the selected memory address does not exist.

DELETING STATION MEMORIES

MANUALLY DELETE A SINGLE STATION

Rotate the [TUNING] knob to select the memory that you want to delete, press & hold the [DELETE] button, “dEL” & “Preset” will flash on the display. Press the [DELETE] button again to remove the unwanted memory address.

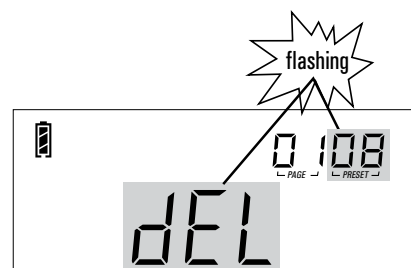

Note:

If the [DELETE] button is not pressed for confirmation within 3 seconds, the delete function is exited automatically.

SEMI-AUTO DELETE A SINGLE STATION

In VM mode, press & hold the [VF/VM] button. “PRESET” will flash and the device will automatically browse the stored stations within the selected memory page, staying on each station for about 5 seconds. While operating this “Auto Browse” function within the memory, you can press the [DELETE] button to remove stations from the memory. No confirmation is required and the browsing continues immediately. To stop the auto browse function, rotate the [TUNING] knob or press on the [VF/VM] button.



MANUALLY DELETE ALL STATIONS (WITHIN A PAGE)

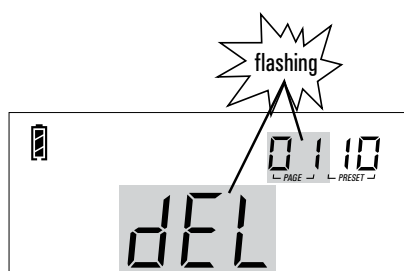

Press & hold the [DELETE] button for 3 seconds and notice that both the page number as well as “dEL” flashes on the display; press the [DELETE] button again to delete all stored stations within the selected memory page.





Note:

If the [DELETE] button is not pressed for confirmation within 3 seconds, the delete function is exited automatically.

SLEEP TIMER

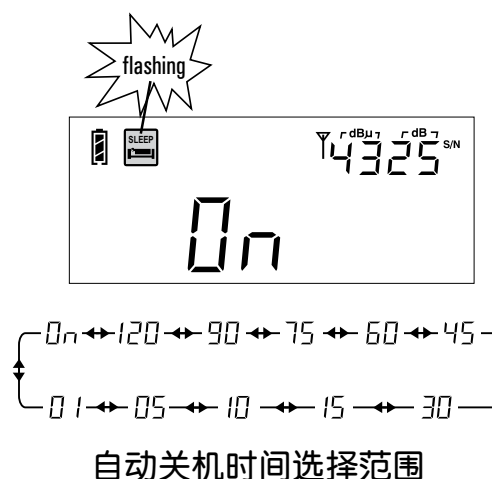
1. In POWER OFF mode, press & hold the [POWER] button until the sleep timer symbol “” flashes on the display.
2. Rotate the [TUNING] knob immediately to select a sleep timer from 1 - 120 minutes or select “” for POWER ON mode (the radio will be turned on after 1 second).



Note: The default setting of the sleep timer is “”.

TIME SETTING

1. Press & hold the [TIME] button until the hours indicator starts flashing. Rotate the [TUNING] knob to adjust the hours, or directly input the time by pressing the [0 – 9] numeric keys.
2. While the hours indicator is flashing, press the [TIME] button again to select the minutes indicator. Rotate the [TUNING] knob to adjust the minutes, or directly enter it by pressing the [0 – 9] numeric keys.
3. Short press the [TIME] button to confirm, or wait for 3 seconds to automatically confirm the time setting.

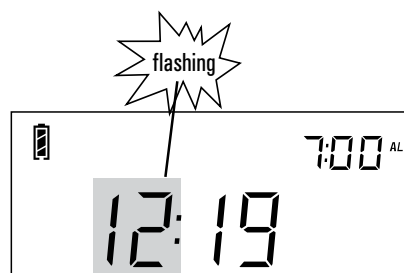

ALARM SETTING (By Radio)

1. Press & hold the [ALARM] button until the hours indicator starts flashing in the upper right corner of the display. Rotate the [TUNING] knob to adjust the hours, or directly enter the alarm time by pressing the [0 – 9] numeric keys.

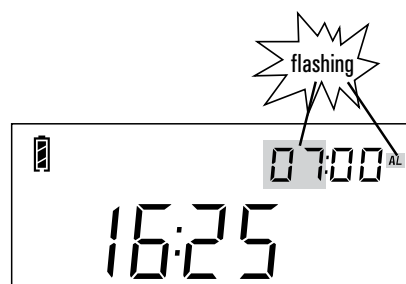

2. While the hours indicator flashes, press the [ALARM] button to select the minutes indicator. Rotate the [TUNING] knob to adjust the minutes, or directly enter it by pressing the [0 – 9] numeric keys.

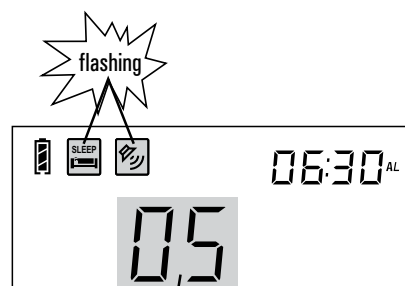

3. Press the [ALARM] button again, then rotate the [TUNING] knob to select from 1 - 90 minutes to set the "Alarm Off Timer". This is the duration after which the radio will turn off automatically.



Alarm off timer

4. Press the [ALARM] button to confirm the setting or wait for 3 seconds, the unit will automatically confirm the alarm setting.

ACTIVATE / DEACTIVATE THE ALARM

This device has a radio alarm, the duration of which can be set from 1 - 90 minutes. To activate the alarm function, press the [ALARM] button. The alarm “” symbol appears on the display. To deactivate the alarm function, press the [ALARM] button again. The alarm “” symbol will disappear.

ALARM STATION SETTING

1. Turn on the device and select your preferred station for the alarm sound. Adjust your desired alarm volume level.
2. Press the [MEMORY] button to store the alarm station.
3. Immediately press the [ALARM] button to select the stored station. If the station is selected successfully, the alarm time is briefly shown on the upper right corner of the display.
4. You may now turn off the device.

TURNING OFF THE ALARM

When the alarm goes off, press the [POWER] button to turn off the alarm and enter the radio listening mode. Press the [POWER] button again to turn off the radio.

SNOOZE FUNCTION

When the alarm goes off, press the [SNOOZE] button to temporarily turn off the alarm. The alarm will go off again after 5 minutes.

LCD BACKLIGHT

This device has an intelligent backlight function, meaning the orange backlight is lit for about 5 seconds after operating any keys or knobs.

You can also push the [ON/OFF LIGHT] switch to “ON” to keep the backlight of the LCD lit.

FM STEREO

1. When listening to radio broadcastings through stereo earphones, press the [FM.ST] button to activate the stereo function; the “ (◀▶) ” symbol appears on the display. If the FM signal is too weak, it is advisable to turn off the stereo function by pressing the [FM ST.] button again; the “ (◀▶) ” symbol disappears.
2. When listening to FM stereo through a speaker, it is advisable to turn off the stereo function to improve sound quality.
3. The stereo function will not be activated and the “ (◀▶) ” symbol will not appear if the FM station is not in stereo broadcasting.

AM BW (BANDWIDTH) SELECTION

Press the [AM BW] button to select your desired bandwidth for MW, LW, SW and SSB.

In SW, MW, LW mode: Press the [AM BW] button repeatedly to select 9、 5、 3.5、 2.3 kHz AM bandwidth.

In SSB mode (with LSB/USB displayed on top of the frequency): Press the [AM BW] button repeatedly to select 4、 3、 2.3、 1.2、 0.5 kHz AM bandwidth.

Wide Band:

It has better audio fidelity when receiving strong signals or local stations.

Narrow Band:

It is suitable to receive weak and long distance stations as the narrow band is able to limit the interference from adjacent strong signals and reduce background noise.



ENHANCING SW SENSITIVITY USING ANT. GAIN

While listening to SW, push the [ANT.GAIN] switch to “DX” position for normal listening. For stations with a strong signal or strong electrical interference, push the [ANT.GAIN] switch to either “NORMAL” or “LOCAL” to achieve better sensitivity.

TONE CONTROL

Push the [TONE] switch upward for “TREBLE” listening, downward or “BASS” tone.

KEY LOCK FUNCTION

To activate the key lock function, press & hold the [] button; the “  ” symbol appears on the display.

Press & hold the [] button again to unlock.

DISPLAY MODE CONVERSION

In POWER ON mode, repeatedly press the [DISPLAY] button to view the time, alarm setting, or Signal Strength/SNR in the upper right corner of the display.

LINE-OUT FUNCTION

The device is able to output the signal by using an audio cable to connect either an external amplifier or recording device.

Note: While connected, the volume can only be adjusted on the external device.

SINGLE SIDE BAND (SSB)

1. In Shortwave mode, press the [USB/NORM] or [LSB/NORM] button to select either Upper Side Band (USB) or Lower Side Band (LSB).
2. Enter the SSB frequency directly by pressing the numeric keys [0 – 9].
3. Then dial the [FINE TUNING] knob to achieve a better quality reception.
4. Press the [USB/NORM] or [LSB/NORM] button again to exit the SSB mode.

USB or LSB shows

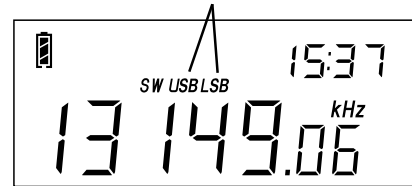

Note:

When there is too much interference on AM or SW from adjacent stations, it is advised to activate the SSB function by selecting USB/LSB and then fine tune the frequency to eliminate the interference. Be aware that this method cannot eliminate strong adjacent station interference or same station interference.

ENHANCING SHORTWAVE RECEPTION

Use the external wire antenna to plug into the [SW ANT] jack, then position the opposite end outside the window for better SW reception.

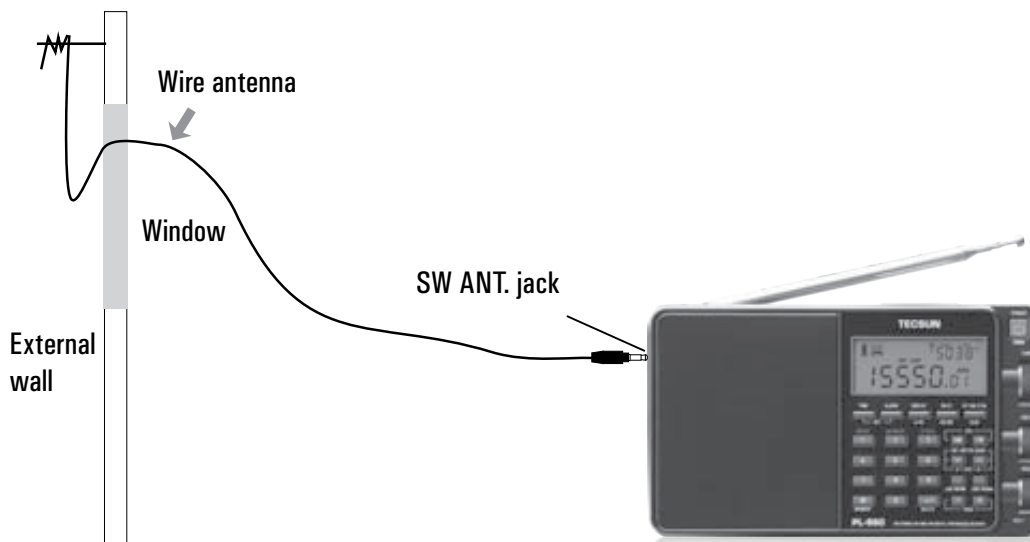

CHARGING FUNCTION

To utilize the built-in charging function, connect a 5V external power source with mini-USB plug to the device. The symbol “” will advance from down to up while charging. It stops when the battery is fully charged.

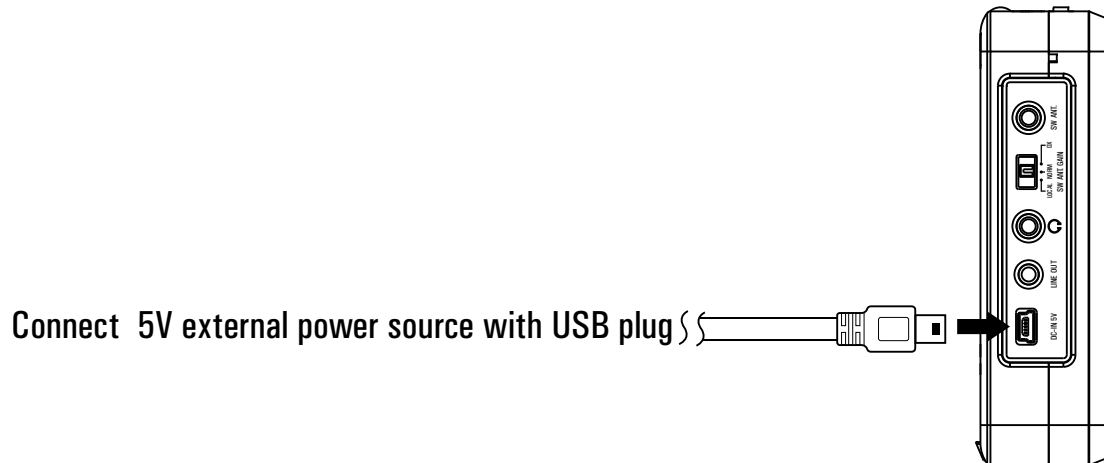

Note:

In case the device is not used for an extended period, it is advisable to charge the included rechargeable battery once every 3 months for about 4 hours. This will extend the battery's life span and keeps it in good condition.

RESET FUNCTION

If not functioning properly, you can reset the device by sticking a pointed object (such as a straightened paper clip) into the reset hole and gently press the [RESET] button.

Note:

Resetting the device will not delete any station memories.

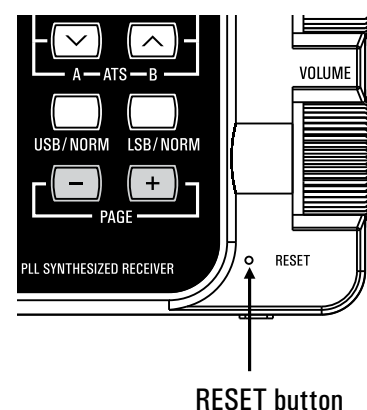

SYSTEM SETTING (In Power Off Mode)

FM FREQUENCY RANGE

Press & hold the [FM SET] button until 88-108MHz, 76-108MHz or 87-108MHz appears on the display. Press the [FM SET] button to select a suitable frequency range for FM.

TURN ON/OFF LW

To turn ON/OFF LW, press & hold the [MW/LW] button until “LW ON” or “LW OFF” appears on the display.

MW (AM) 9K/10K TUNING STEPS

To select your desired AM tuning steps, press & hold the [9/10kHz] button until “9kHz” or “10kHz” appears on the display.

AUTO-SORTING STATION LIST

In POWER OFF mode, to automatically sort all stored station memories, press & hold the [] button for about 2 seconds until the memory page number in the upper right corner starts running.

This function is able to:

1. Remove all duplicate stations. Especially useful after storing stations manually, as you may sometimes store a station more than once.
2. Auto-sorting the sequence of stored stations.
 - In page P0, select your desired band to find all stored stations in sequence of frequency (from low to high).
 - In page P01-24, all stored stations are placed in sequence of frequency (from low to high), and in sequence of FM, SW, MW, LW.

Note:

After auto sorting the station memories, the station sequence will be re-arranged.

RADIO MAINTENANCE

1. Keep it dry. Rain, humidity and other types of liquids or moisture can contain minerals that may cause corrosion to components. If the device does accidentally get wet, remove the battery and wait for the radio to dry completely before placing it back.
2. Do not store the device in hot areas above +50°C. High temperatures can shorten the life span of certain components.
3. Do not place or store the device in cold environments lower than -50°C . Otherwise, when the surrounding temperature rises to room temperature, internal moisture may develop and damage the circuit board and LCD display.
4. Do not drop, hit, or smash the device.
5. Do not use harsh chemicals, cleaning solvents, or strong detergent to wash the device. Use a clean, soft, dry cloth to clean the screen.
6. Do not attempt to disassemble the device to adjust internal parameters.

LITHIUM BATTERY SAFETY INFORMATION (IMPORTANT)

Improper use of the lithium battery may result in an explosion, please read the below information carefully:

1. Do not expose the battery to heat or high pressure, do not drop the battery, prevent children from playing with electric currents.
2. Replace with the same type of lithium battery for the usage of this device.
3. Do not short-circuit the battery, do not open or amend, do not expose it to damp environments.
4. If not using for an extended period of time, remove the battery and store in a safe manner. Please use a non-conductive material to wrap the battery in order to avoid direct contact with metal. You can avoid damage by keeping the battery in a cool dry place.

5. Dispose of the battery properly; do not put into fire or water. Do not expose to direct sunlight for a prolonged period, avoid heat, deformation or smoldering. This will reduce the performance and life span of the battery.
6. Please consciously abide by aviation regulations; lithium batteries are strictly prohibited from placing into checked luggage.

TROUBLE SHOOTING

QUESTIONS	ANSWERS	SOLUTIONS
Cannot turn on the radio.	<ul style="list-style-type: none"> - Battery has no power. - Battery is installed incorrectly. - Key lock function is turned on. 	<ul style="list-style-type: none"> - Replace or charge the battery. - Take note of the correct polarity direction, then reinstall the battery. - Press the [] button to deactivated it.
Radio turns off while listening.	<ul style="list-style-type: none"> - Battery has no power. - Sleep timer is activated. 	<ul style="list-style-type: none"> - Replace or charge the battery. - Turn the radio on again.
During ATS, some stations cannot be stored. Some stored stations have noise.	<ul style="list-style-type: none"> - Frequency of stations is too weak. - There is interference near by your area. 	<ul style="list-style-type: none"> - Search the station manually. - Contract the antenna or move to other location and try again.
Only few FM stations can be received.	<ul style="list-style-type: none"> - FM frequency may have been set to 76 - 90MHz accidentally. 	<ul style="list-style-type: none"> - Turn off the radio, press & hold the [FM SET] button to select the accurate FM frequency range.

QUESTIONS	ANSWERS	SOLUTIONS
Poor AM reception in USA.	- USA uses 10kHz AM tuning steps, the device may still be set to 9kHz.	- Turn off the radio press the [9/10kHz] button to select accurate tuning step.
The sound of SW SSB broadcasting is too low.	The default bandwidth is Narrow band.	Press the [AM BW] button to select the Wide band.
When the alarm goes off, there is only noise in the broadcasting.	<ul style="list-style-type: none"> - Did not set the proper radio station for the alarm. - Or there is no broadcasting at that frequency. 	<ul style="list-style-type: none"> - Preset your alarm station properly. - Make sure it is possible to receive radio broadcastings at your location.
The charging time becomes shorter and shorter.	The rechargeable battery is getting old.	Replace the old rechargeable battery with a new one.
Radio malfunction	There may be some form of interference, causing the microchip to not function properly.	Remove the battery. Reinstall the battery once the device's display has turned off completely. If the device is still not working, please press the reset button with a pointed object.

SPECIFICATIONS

1. Frequency Range:

FM: 87–108 / 87.5–108 / 76–108 / 64–108 MHz , Tuning Step: 0.01MHz / 0.1 MHz

SW: 1711 – 29999 kHz Tuning Step: 1kHz/ 5 kHz

MW: 522 – 1620 kHz with 1 kHz / 9kHz tuning step

520 – 1710 kHz with 1kHz / 10kHz tuning step

LW: 100 – 519 kHz, Tuning Step: 1kHz / 9 kHz

2. Sensitivity

FM (S / N = 30dB) < 3 μ V

MW (S / N = 26dB) < 3mV / m

LW (S / N = 26dB) < 5mV / m

SW (S / N = 26dB) < 20 μ V

SSB (S / N = 10dB) < 3 μ V

3. SELECTIVITY (Factory default of AM IF bandwidth is Narrow Band):

FM > 35 dB (\pm 200kHz)

MW / LW > 40 dB (\pm 9kHz)

SW > 40 dB (\pm 5kHz)

4. S/N Ratio

FM > 65dB

MW/LW > 40dB

SW > 45dB

5. AM Frequency

SSB, AM 1st IF: 55.845MHz

2nd IF: 10.7 kHz

FM: 10.7MHz

6. FM Stereo crosstalk > 35 dB

7. Output Power (distortion 10%) \geq 450 mW

8. Station Memory 3050M in total

- PER BAND AT PAGE "0" (total 650 memories)
 - FM with 100 memories
 - MW with 100 memories
 - LW with 100 memories
 - SW with 250 memories
 - SBB with 100 memories
- MIXTURE AT PAGE 1-24 (total 2400 memories)

9. Alarm Mode: by Radio only**10. Quiescent Current**

FM < 30mA

MW/LW < 70mA

SW < 75mA

SSB < 75mA

Off mode < 80 μ A**11. Speaker:** Diameter 40mm / Impedance 4 Ohm / Power 3W**12. Earphone Jack:** Diameter 3.5mm**13. Power supply:**

Rechargeable battery: Li-ion 3.7V

External adaptor: USB jack, DC 5V, Current > 300mA

14. Unit Dimensions: approx. 192(W) X 113(H) X 33(D) mm**15. Weight:** 520g (battery not included)