

INSTRUCTION BOOK for FL-200-B SSB TRANSMITTER

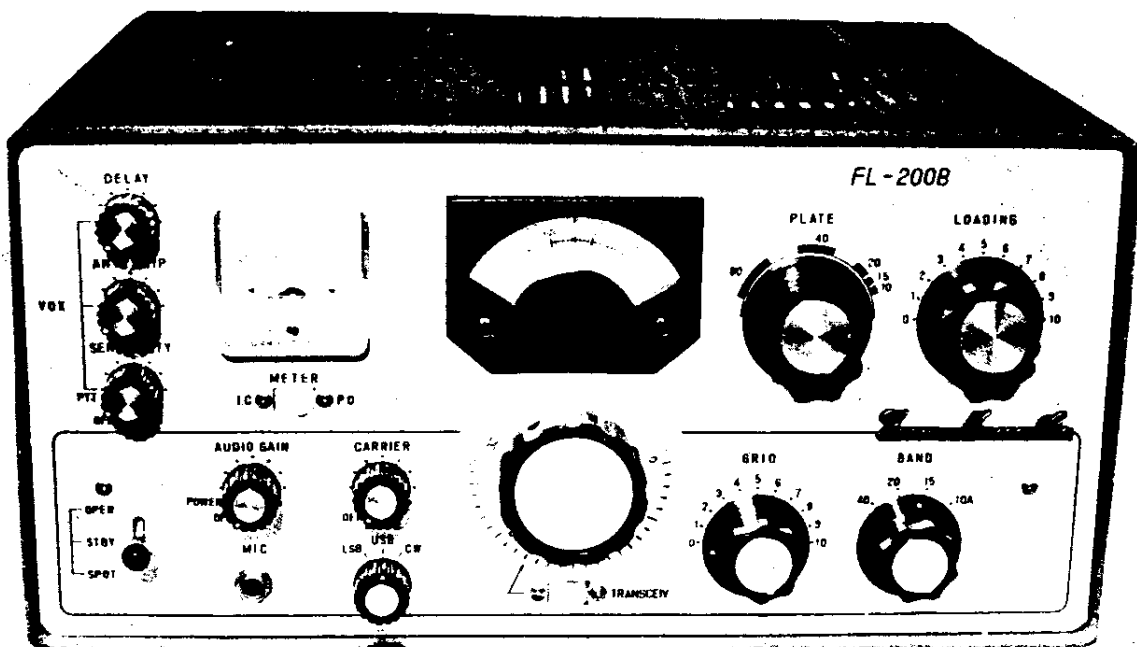

INSTRUCTION BOOK

FOR

FL-200-B SSB TRANSMITTER

GENERAL

The model FL-200-B SINGLE SIDEBANDER is a precision built, compact, high performance top SSB transmitter with CW, AM, LSB and USB modes of operation. All modes, except AM, this transmitter works at an input of 240 watts on all band through 80 to 10 meters. The AM mode consists of transmitted carrier and one sideband. The SSB is generated by a **MECHANICAL FILTER**.

SPECIFICATIONS

Mode of emission	CW, AM, SSB (upper/lower selectable)
Operation	VOX, PTT (push-to-talk), manual and break-in CW
Power input	240 watts PEP
Output impedance	50 to 120 ohms
Frequency range	3.5—4.1Mc, 6.9—7.5Mc 13.9—14.5Mc 20.9—21.5Mc 27.9—28.5Mc 28.5—29.1Mc
Frequency stability	100 cps after warm-up for 10% drift of line voltage.
Carrier suppression	50 db below peak output
Band suppression	50 db below peak output
Distortion product	better than 25 db
Frequency response	6 db at 400 to 2700 cps
Power requirement	100/110/200/220/234V AC 50/60 cps, 350 watts
Net size	7-1/8" high, X 15" wide X 11-3/4" deep
Weight	18 kgs.

TUBE AND DIODE COMPLEMENT

6U8	1	speech amplifier	6U8	1	carrier osc. & antitrip amplifier
1S1007	2	balance modulator	12AU7	1	sideband oscillator
6U8	1	VOX amplifier, relay	6BA6	1	IF amplifier
SH-1	2	VOX, antitrip rectifier	6CB6	1	VFO mixer
12AT7	1	sideband mixer	6JS6A	2	linear amplifier
6AW8A	1	heterodyne osc. & mixer	5GL	4	rectifier
12AU7	1	VFO	SH-1	2	Automatic level control
12BY7	1	driver			
SH-1	1	bias rectifier			
1S1007	1	output rectifier			

IMPORTANT

Do not operate the FL-200-B equipment before coming completely familiar with the instructions in this manual. The block diagram and circuit descriptions will provide you with better understanding of this transmitter.

CIRCUIT DESCRIPTION

(1) SPEECH AMPLIFIER, CATHODE FOLLOWER

The pentode section of a 6U8 tube is used as a speech amplifier. The amplified speech signal is coupled through capacitor and MIC GAIN CONTROL to the grid of the cathode follower, triode section of the same tube. A cathode follower circuit is used to match the low impedance of the diode balance modulator. These circuits are inoperative in the case of CW operation and SPOT.

(2) VOX AMPLIFIER, ANTITRIP AMPLIFIER, RELAY CONTROL

The speech signal amplified at speech amplifier is coupled to the grid of a pentode section of 6U8, VOX amplifier through the VOX SENSITIVITY CONTROL. The signal thus amplified is then fed to the diode to develop DC voltage which controls the relay tube. This DC voltage is directly coupled to the grid of the relay control tube to control the relay with speech signal. The relay control tube is cathode biased to cut-off without DC voltage which is applied by speech signal. In PTT (push-to-talk) operation, the cathode of this tube is grounded through a 200 ohms resistor, by a switch on the microphone. On VOX OFF position, the cathode is also grounded through a 200 ohms resistor which closes the relay. The audio signal from the station receiver is coupled to the antitrip amplifier tube through the ANTITRIP CONTROL. Amplified signal is then rectified to the polarity which makes the grid of the relay tube negative, preventing the relay from activation by the audio signal from the station receiver. In CW operation, 6.3 volts AC voltage is applied to the grid of the VOX amplifier tube through the VOX SENSITIVITY control and a 1 meg ohms resistor for BREAK-IN CW operation. The delay control is furnished on front panel to adjust the drop-out time of the relay.

(3) CARRIER OSCILLATOR, BALANCE MODULATOR, MECHANICAL FILTER

The carrier oscillator utilizes a triode section of a 6U8 tube. Frequency is controlled by a quartz crystal matched to the MECHANICAL FILTER to place the carrier at a point which provides proper audio response and excellent carrier suppression. The balance modulator circuit consists of four matched diodes with carrier null potentiometer. A trimmer capacitor is used in conjunction with the carrier null potentiometer to balance out external circuit capacity. The MECHANICAL FILTER is used for the generation of single sideband. Excellent carrier and unwanted sideband suppression is obtained by the use of the MECHANICAL FILTER.

(4) SIDEBAND MIXER, SIDEBAND OSCILLATOR

The upper sideband generated by the balance modulator and the mechanical filter is then fed to the grid of the sideband mixer tube 12AT7. This balance mixer mixes 455kc upper sideband signal with either 8545kc or 9455kc signal from the sideband oscillator. The sum of the 455kc and 8545kc produces the upper sideband 9mc IF signal. The difference between the 455kc and 9455kc produces the lower sideband 9mc IF signal. The sideband oscillator tube is a dual triode tube 12AU7, each section of which is used in a Colpitts circuit. The sideband is selected from the front panel by the mode switch which removes blocking bias from the proper oscillator tube. The crystal frequency is adjusted by a trimmer capacitor to set the carrier on frequency.

(5) INTERMEDIATE FREQUENCY AMPLIFIER

The 9mc IF signal is coupled, through IF transformer, to the grid of the IF amplifier tube 6BA6, IF transformer T3 and T4 are double tuned to pass only 9mc energy. This stage is controlled by the automatic level control bias voltage which is delivered from the grid circuit of the final linear amplifier to prevent the overdrive.

(6) HETERODYNE MIXER, HETERODYNE OSCILLATOR

The pentode section of a 6AW8A tube is used as a mixer to combine the sum of the 9mc IF signal and the heterodyne oscillator signal from the triode section of the same tube. The grid circuit of this mixer is grid-block-keyed for CW operation. The plate circuit of the mixer is tuned as follows;

BAND	FREQUENCY
80 meters	untuned, resistance coupled to 9mc
40 "	12.4 mc
20 "	19.4 mc
15 "	16.4 mc
10A "	33.4 mc
10B "	34.0 mc

The heterodyne oscillator frequency is as follows:

BAND		FREQUENCY
80	meters	not in operation
40	"	3.4 mc
20	"	10.4 mc
15	"	17.4 mc
10A	"	24.4 mc
10B	"	25.0 mc

(7) VFO MIXER, VFO OSCILLATOR

As a VFO mixer, a 6CB6 tube is used to combine heterodyne mixer output and VFO signal which is delivered from the VFO tube, 12AU7. The difference between the two is now transmitting frequency. Temperature compensated VFO circuit will provide excellent frequency stability. External VFO can be used by a switch for Transceive operation or fixed crystal controlled operation.

(8) DRIVER, FINAL LINEAR AMPLIFIER

The driver stage uses a 12BY7 tube as a linear voltage amplifier. Grid of this stage is biased to cut-off at stand-by and the bias is removed by the keying or transmitting. The final linear amplifier utilizes two 6JS6A as class AB linear amplifier. This tube has a merit of high power output with relatively low plate voltage. The amplifier is neutralized by the capacitive bridge system with a variable capacitor connected from the plate of the tube to the bottom of the circuit. The grid of this tube is also biased to cut-off in stand-by and proper bias is supplied for transmitting. The amplifier output is a shunt fed pi network capable of working into 50 to 120 ohm load on all bands.

The output side of the pi network is connected to a diode rectifier through the voltage divider to measure the relative power output. In SSB operation, the automatic level control is circuited to the grid circuit to prevent overdrive.

(9) POWER SUPPLY

Four silicon diodes are used for high voltage rectifier instead of the conventional tube to improve the voltage regulation and overall efficiency. By the bridge connection, 600 volts for the final plate supply and 300 volts for low voltage are available without large power wasting resistor. Bias supply is half wave rectifier circuit with a silicon diode supplying -100 volts. Grid bias for final is regulated by neon lamp. Screen grid of final tube and plate supply for all oscillators are stabilized by 6BM8 tube instead of usual gas diode. Power transformer has five windings including two primary windings. Connecting the primary in parallel or series, 100 volts or 220 volts operation is possible.

(10) METERING, OPERATION SWITCH, ACCESSORY SOCKET

Metering is provided by a milliammeter connected to a meter switch which selects final cathode current and relative power output. Operation switch changes the bias voltage for each stage as follows:

TUBE	OPERATION	STAND-BY	SPOTTING
6AW8A	0 volts	-100 volts	0 volts
6CB6	"	"	"
12BY7	"	"	"
6JS6A	-40 volts approx.	"	-100 volts

In transmitting, the receiver mute voltages (-100 volts) appears on pin 8 of an accessory socket on the rear apron of the chassis. Accessory socket provides following functions;

pin	1	2	3	4	5	6	7	8
	ground	-100 volts for external equipment bias if used	antitrip input from the station receiver	connect to pin 5 on stand-by	connect to pin 4 on stand-by and pin 6 on transmitting	connect to pin 5 on transmitting		receiver mute voltage (-100 volts)

OPERATION

FUNCTION OF OPERATING CONTROLS

(1) OPER-STBY-SPOT

In OPER position, plate voltage is supplied through relay winding to the relay tube and the transmitter is ready to operate. In SPOT position, the blocking bias except final are removed and a weak signal is transmitted to spot the frequency on the station receiver. Speech amplifier circuit is made unoperative to avoid the feed back of receiver output through microphone. In STBY position, the plate voltage is removed from the relay tube and receiver mute voltage (-100 volts) is disappeared from pin 8 of the accessory socket.

(2) MIC GAIN AND POWER

The mic gain control is made up of two controls. In the OFF position, all power is disconnected from the circuitry. In the ON position and up, the MIC GAIN varies the audio level from the microphone amplifier stages to the balance modulator. The control has sufficient range to permit of any high-level crystal microphone or low level dynamic microphone.

(3) MIC

Microphone jack has three poles, that are, microphone input, push-to-talk circuit and ground connection.

(4) CARRIER

This control is used to insert carrier for CW and AM operation. Carrier is inserted into the sideband mixer grid. For SSB operation, this control must be turned off fully counterclockwise.

(5) MODE

This switch is used to select the mode of operation. Sideband is selected by removing the blocking bias from the appropriate oscillator. On CW position, USB oscillator works and audio signal to balance modulator and ALC voltage are shorted to the ground. For CW break-in operation, AC voltage is applied to the grid of VOX amplifier through the 1-megohm resistor to activate the relay.

(6) VOX SENSITIVITY

This control sets the operation level for the VOX relay, adjusting input voltage for VOX amplifier tube. On OFF position, cathode bias is removed to close the relay for manual operation with operation switch. On PTT position, the relay does not work with speech voltage and thus push-to-talk operation is possible, shorting the cathode bias to the ground through 100 ohms resistor by a switch on microphone.

(7) VOX DELAY

This control is used to adjust a holding time of relay for VOX and break-in CW operation. Delay time increases with clockwise rotation.

(8) ANTITRIP

This control is used to set a level of the input signal from the station receiver to prevent transmitter activation by the receiver output.

(9) METER IC-PO

Meter is selected to measure the total cathode current at IC position and relative power output at PO position.

(10) VFO

The VFO tuning dial consists of two dials, kilocycle main dial and 50 division sub-dial on tuning knob. The main dial has two calibrated scales which are coloured red and black to match the colour of the band indication on the Band switch. The scales are 10 kc per division. The sub-dial on tuning knob is divided in 50 division, and 1 division is approximately equal to 1 kc.

(11) GRID

This control is used to tune the plate circuit of VFO mixer and driver stages.

(12) BAND

This control is used to select the amateur band upon which operation is desired. 10 meter is covered in 2 bands.

BAND	FREQUENCY RANGE		DIAL COLOUR
80 meters	from 3500	to 4100 kc	red
40 "	6900	7500	black
20 "	13900	14500	black
15 "	20900	21500	black
10A "	27900	28500	black
10B "	28500	29100	red

(13) PLATE

This control is used to tune the output circuit of the final linear amplifier. Approximate tuning area for the bands is shown on the panel.

(14) LOADING

This control is used to match the output impedance of the pi network.

INSTALLATION

It is recommended to avoid excessively warm location. The transmitter should be placed in a location that provides adequate space around it, permitting free air circulation through the cabinet openings. This transmitter is designed to operate on either 100 volts or 220 volts, AC 50/60 cps. Check AC input voltage of your transmitter prior to connection to power line outlet. The peak power consumption is approximately 350 watts.

(1) ACCESSORY SOCKET CONNECTION

Connections from this socket to the station receiver, antenna and any other additional equipment which may be used are shown in figures and are to be made as follows.

- pin 1 common ground for the station receiver and the others.
- pin 2 to external linear amp. bias source if desired.
- pin 3 to the station receiver voice coil or 600 ohms output.
- pin 4 FR-100-B Mute Terminal.
- pin 5 ground
- pin 6 Relay terminal of FL-1000-Linear amplifier
- pin 8 to the mute terminal of the station receiver with negative-mute.

See figure illustrated in following page.

(2) GROUND

The chassis grounding connection that is provided on the rear apron of the transmitter should be connected to an actual earth ground by a heavy lead. It is not recommended to use a gas pipe or electrical conduit pipes. This ground lead should be as short as possible.

(3) ANTENNA

The pi network output impedance is designed to match 50 to 120 ohms feeder. Most commercial antenna and feeder are designed between 50 to 75 ohms. If the impedance is far from this value, the use of an antenna matching device is recommended.

OPERATION

It will be assumed all connections are in place as illustrated in page 12.

(1) CW OPERATION

Set the controls as follows;

operation switch	STBY
BAND	desired band
MIC GAIN	OFF
MODE	CW
VOX SENS	OFF
VOX DELAY	fully counterclockwise
ANTITRIP	"
VFO	desired frequency
LOADING	3 0'clock position
PLATE	desired band area indicated
CARRIER	OFF

Turn on the power and wait for warm up. Throw the operation switch to SPOT position. Tune the station receiver to the frequency selected. Tune the VFO to zero beat with receiving frequency. If the spotting signal is too weak to zero beat, advance the CARRIER control until zero beat is heard. Tune the grid and plate tuning for the loudest beat. Throw the operation switch on OPER position. Close a key. Advance the CARRIER control until plate current (IC) increases to approximately 100 ma. Tune the GRID for maximum plate current and PLATE for dip. Increase the LOADING for maximum power output. CARRIER control should be adjusted at a point that plate current ~~drops~~ to increase. It should be between 280 to 300 ma. These tuning procedures must be done quickly. The transmitter is now fully tuned for manual CW operation. For break-in operation, connect the key as illustrated in figures. Advance the VOX SENS control until the relay close by keying. Adjust the VOX DELAY control for the desired drop-out delay; delay time increases with clockwise rotation.

(2) AM OPERATION

Tune up in CW mode exactly as described above. Reduce the plate current to 150 ma with the CARRIER control. Change the mode switch to USB or LSB position and advance the MIC GAIN control till the plate current kicks up to 160 ma speaking into the microphone normally. In the case of PTT (push-to-talk), Place the VOX SENS control to the position marked PTT. For VOX operation, advance the VOX SENS until the relay activates the transmitter instantly when speaking into the microphone normally. Adjust the station receiver gain control to the desired listening level. Advance the ANTITRIP control clockwise until received signals do not actuate the VOX relay. Use no more antitrip gain than necessary. For Push-to-talk operation, antitrip control may be turned off. This method of transmitting is carrier and one sideband system.

(3) SSB OPERATION

Tune up in AM mode exactly as is described above and then turn the CARRIER control to OFF position. Increase audio gain until meter shows about ~~250~~ ¹⁵⁰ mA at ~~500~~ ^{SSB} speaking into microphone. Operate as described in AM operation. VFO scale on the knob is adjustable. Move the scale holding the knob firmly for scale calibration.

ALIGNMENT PROCEDURES

The FL-200-B SINGLE SIDEBANDER has been aligned and calibrated at the factory with proper test equipments and will not require realignment for long period of operation. Service or replacement of a major component may require subsequent realignment but do not attempt to make any adjustment unless operation of this transmitter is fully understood.

(1) CHASSIS REMOVAL FROM THE CABINET;

Remove the four screws on the side of the cabinet and a screw on the bottom of the cabinet and carefully slide the chassis and panel assembly out from the front of the cabinet.

(2) TEST EQUIPMENT REQUIRED;

Recommended service equipments for alignment are;

- A. vacume tube volt-ohm-meter with a RF probe
- B. signal generator covering 455 kc to 35 mc
- C. calibrated communication receiver
- D. oscilloscope
- E. audio oscillator
- F. dummy load

Downloaded by

Amateur Radio Directory

(3) VOLTAGE MEASUREMENTS;

Set the operation switch to STBY and allow the transmitter to warm up. Check the voltages of the tube at the tube socket by VTVM. The standard values are given on the chart. 600 volts DC is only used for final plate supply and 300 volts for the other. Regulated supply is set at 150 volts by a potentiometer which is located by 6BM8 tube on the chassis.

(4) 455KC CARRIER OSCILLATOR AND BM CIRCUIT;

Tune the transmitter up on 3.8 mc (80 meter band) in CW mode into dummy load. Switch to upper sideband (USB on mode switch). Connect a VTVM RF probe to a center of the series connected BM diodes. Adjust a slug of T1 for maximum VTVM reading and turn half rotation to clock-wise direction. Disconnect a VTVM. Adjust a carrier null potentiometer and a trimmer capacitor located close a mechanical filter assembly for minimum power output. VTVM with RF probe a one-volt scale at the dummy load can be used to indicate minimum power output. If a VTVM is not available, a station receiver may be used for carrier balance indication. Connect an audio oscillator to MIC jack and tune it to 1500 cps and adjust two pot cores in mechanical filter assembly for maximum output.

(5) SIDEBAND OSCILLATOR AND 9MC 1F AMPLIFIER;

Set the mode switch to LSB and tune the station receiver to zero beat. Do not touch to the receiver for following procedures. Switch to USB. Adjust a trimmer located close to sideband crystals for zero beat. Repeat this procedure until both sidebands are exactly on frequency. Adjust slugs on T3 and T4 for maximum output on CW mode.

(6) HETERODYNE MIXER AND OSCILLATOR;

Set the band switch to 10B and operation switch to SPOT. Connect a signal generator to pin 7 of 6AW8A and a VTVM with RF probe to pin 1 of V7, 6CB6. Remove VFO injection by external VFO switch. Tune a signal generator to 34mc exactly and adjust plate coil of 6AW8 tube marked 10B for maximum output reading of VTVM. Repeat this procedure with band switch to 10A, 15, 20 and 40 meters. The signal generator settings are 33.4mc for 10A, 26.4mc for 15, 19.4mc for 20 and 12.4mc for 40 meter. Set the band switch to 20 meter. Tune the signal generator to 9mc and adjust the slug of trap coils marked 20 T for minimum VTVM reading.

Readjust 20 meter plate coil for maximum reading on 19.4mc because of interaction between two coils. Repeat this procedure for 40 meter at the setting of signal generator of 6.8mc for the 40 meter trap and 12.4mc for the plate coil. Disconnect the signal generator and VTVM from the circuit and turn VFO switch back. Readjust all coils for maximum output except 40T & 20T trap coils.

This is necessary to eliminate the errors due to VTVM's input capacity and unaccurate setting of signal generator. Connect a VTVM to output pin of T4 (9mc output transformer). Turn off the CARRIER control fully counterclockwise. Set the band switch to 10B. Adjust a slug of heterodyne oscillator coil marked 10B for 0.5 volts RMS VTVM reading. Repeat this procedure for 10A, 15, 20 and 40 meters.

(7) VFO MIXER AND DRIVER PLATE COILS;

Connect a resistive dummy load to antenna terminal. Tune the transmitter up on 28.8mc on CW mode. Set the GRID control to center. Adjust the slugs marked 10 for maximum output. Repeat this procedure for all bands.

(8) VFO CALIBRATION;

If the dial error increased, VFO corrector coil and trimmer should be readjusted. Proceed as follows; Set the band switch to 80 meter band. Tune the station receiver exactly to 3.3mc. Set the VFO dial to 3.5mc and adjust a slug on the bottom of the VFO box for zero beat. Tune the receiver to 4.1mc exactly and set VFO to 4.1mc. Adjust a corrector trimmer on the VFO chassis for zero beat. Repeat this procedures until both 3.5mc and 4.1mc are exactly on frequency.

IMPORTANT: Donot use any oil for VFO gear. Donot touch a red marked screw. This screw is adjustable temperature compensator.

(9) BIAS SETTING FOR FINAL TUBE;

Set the transmitter to CW mode and turn CARRIER control OFF. Set the bias control potentiometer on rear apron of the chassis to a point which 1C (total cathode current) shows 60 milliampere.

(10) FINAL AMPLIFIER NEUTRALIZATION

The final amplifier may be neutralized as follows. Tune the transmitter up on 21.3 mc (15 meter band) in CW function. Carefully tune the plate tuning and observe the plate current dip and relative power output peak. If both occur at the same setting, the amplifier is neutralized. If both do not occur together, adjust the neutralizing capacitor, in small increment ($\frac{1}{4}$ - $\frac{1}{2}$ turn) with insulated screw driver from the opening on rear apron of the chassis until neutralization is accomplished.

VOLTAGE CHART

TUBE	PIN NUMBER												
	1	2	3	4	5	6	7	8	9	10	11	12	P
V 1 6 U 8	185	0	27	0	* 6	65	0.6	2.8	0	-	-	-	-
V 2 12AT7	150	0	4.5	* 6	* 6	150	0	4.5	0	-	-	-	-
V 3 6 BA 6	0	2	* 6	0	290	125	2	-	-	-	-	-	-
V 4 12AU7	125	115	3	* 6	* 6	125	13	3	0	-	-	-	-
V 5 6 U 8	100	0	45	0	* 6	125	1	0.1	0	-	-	-	-
V 6 6 AW 8	0	0.5	150	0	* 6	2	0	115	300	-	-	-	-
V 7 6 CB 6	0	2	* 6	0	300	150	2	-	-	-	-	-	-
V 8 12BY7	5	0	0	* 6	* 6	0	300	280	0	-	-	-	-
V 9 12AU7	120	0	0	* 6	* 6	120	0	3	0	-	-	-	-
V10 6 U 8	110	0	45	0	* 6	115	1.0	1.3	0.5	-	-	-	-
V11 6 BM 8	50	150	138	0	* 6	300	300	50	138	-	-	-	-
V12 6JS6A	* 6	0	150	0	(-)50	(-)50	0	NC	(-)50	0	150	0	600
V13 6JS6A	* 6	0	150	0	(-)50	(-)50	0	(-)50	(-)50	0	150	0	600

Note : value are measured by VTVM in transmitting condition.

LSB position.

refer to page 4 of this instruction book for stand-by and spotting conditions.

* AC value.

**TRANSMITTER
FL-100B or 200B**

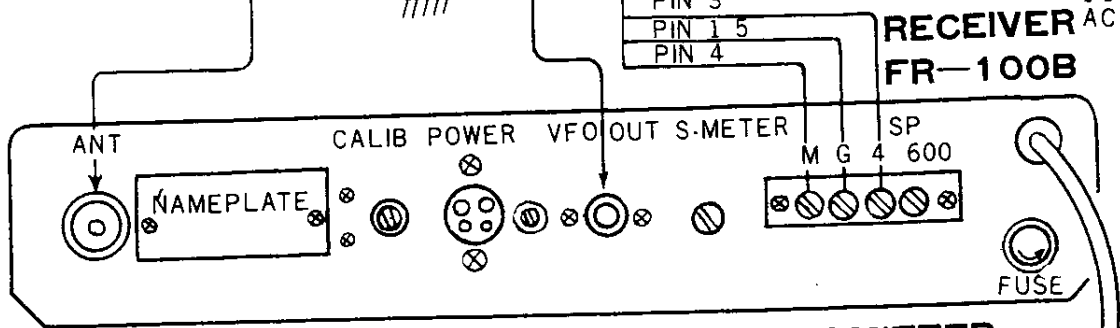
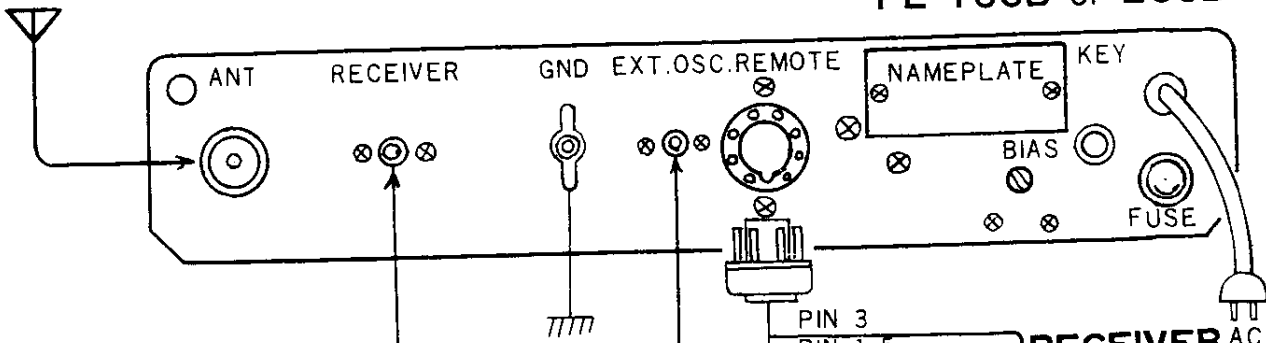

**TRANSMITTER
FL-100B or 200B**

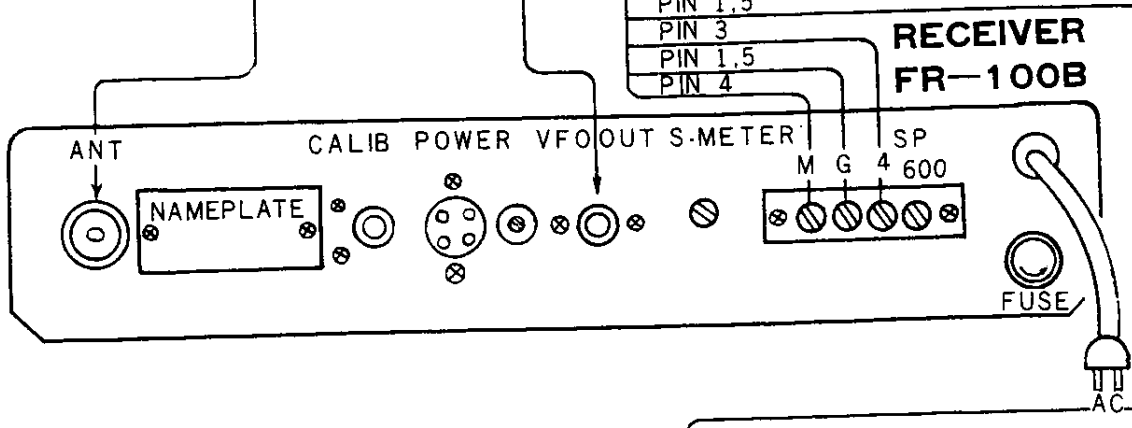
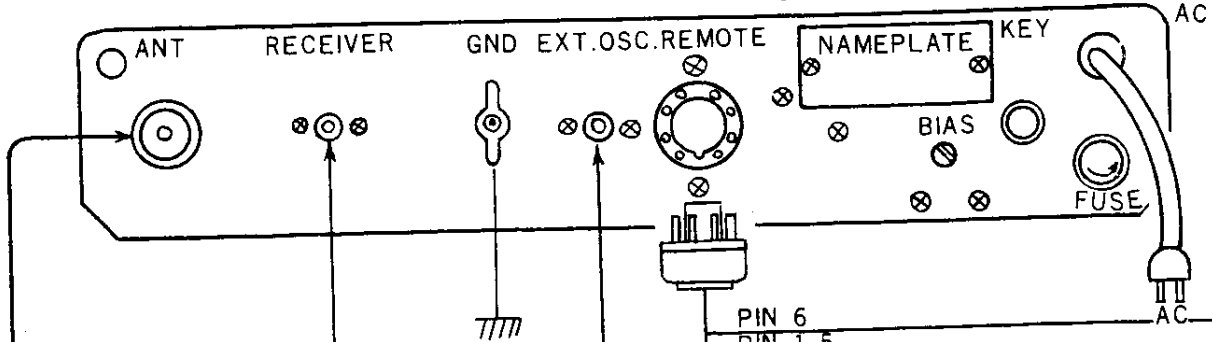

LINEAR AMP. FL-1000

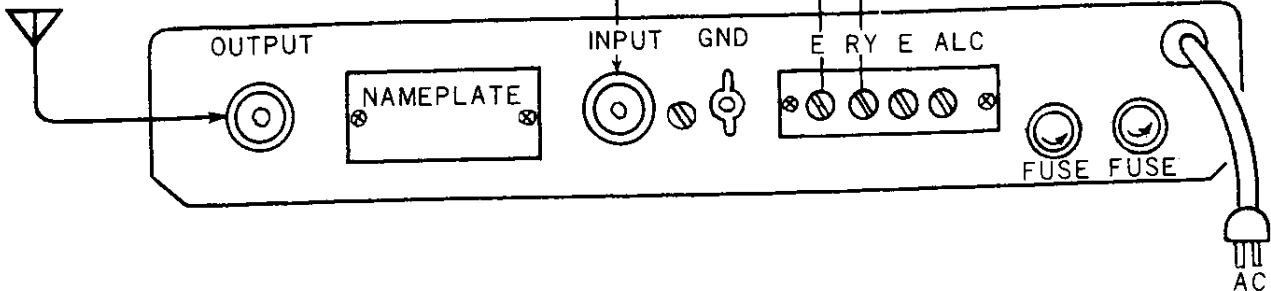

BLOCK DIAGRAM

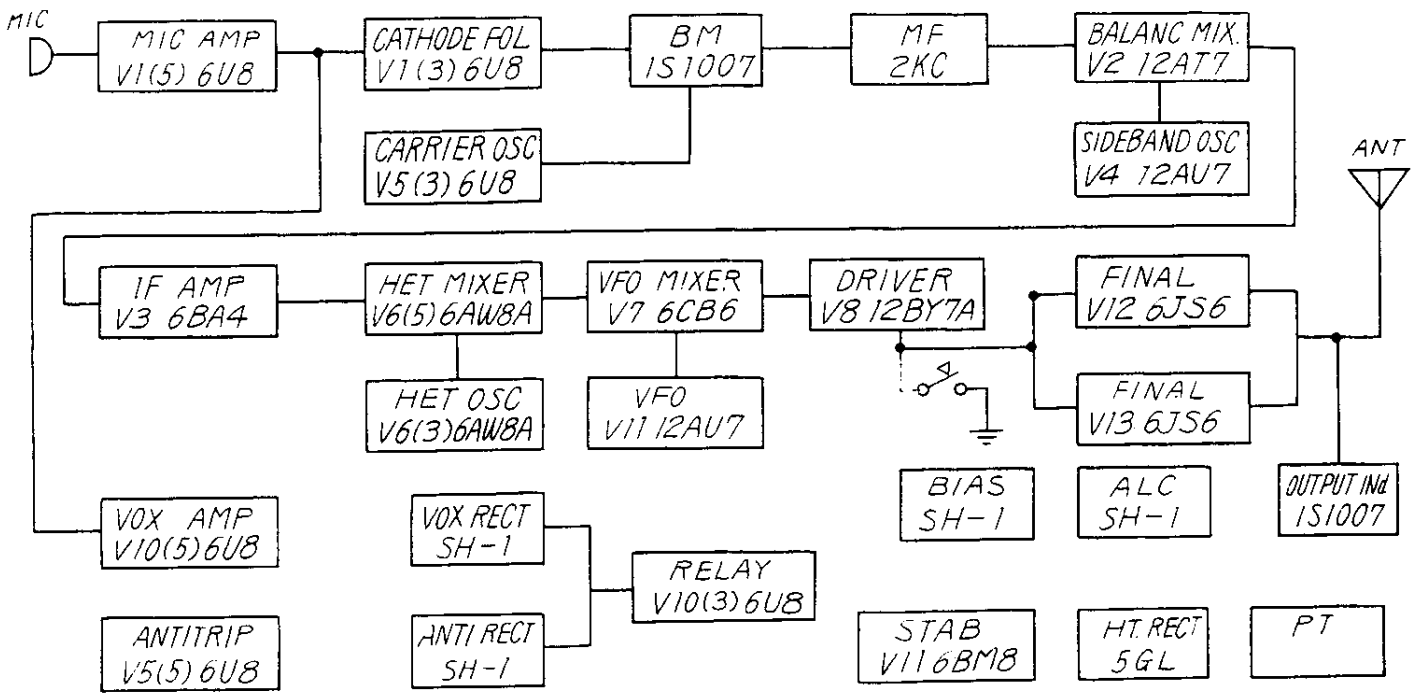

Downloaded by

Amateur Radio Directory

Connect a key plug as follows for break-in keying.

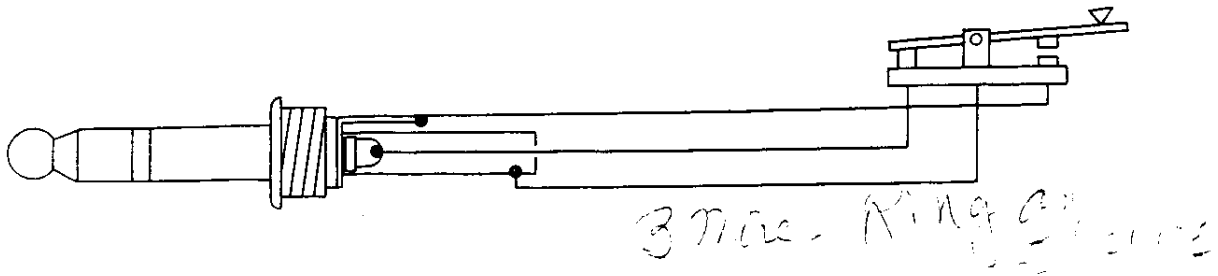

Connect a mic plug as follows for PTT operation.

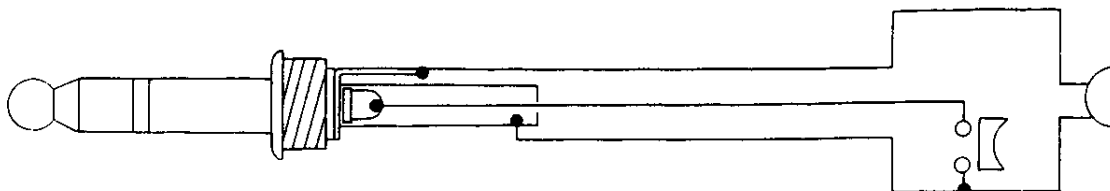

V1 6U8

V2 12AT7

V3 6BA6

V10A 6U8 (5)

V10B 6U8(3)

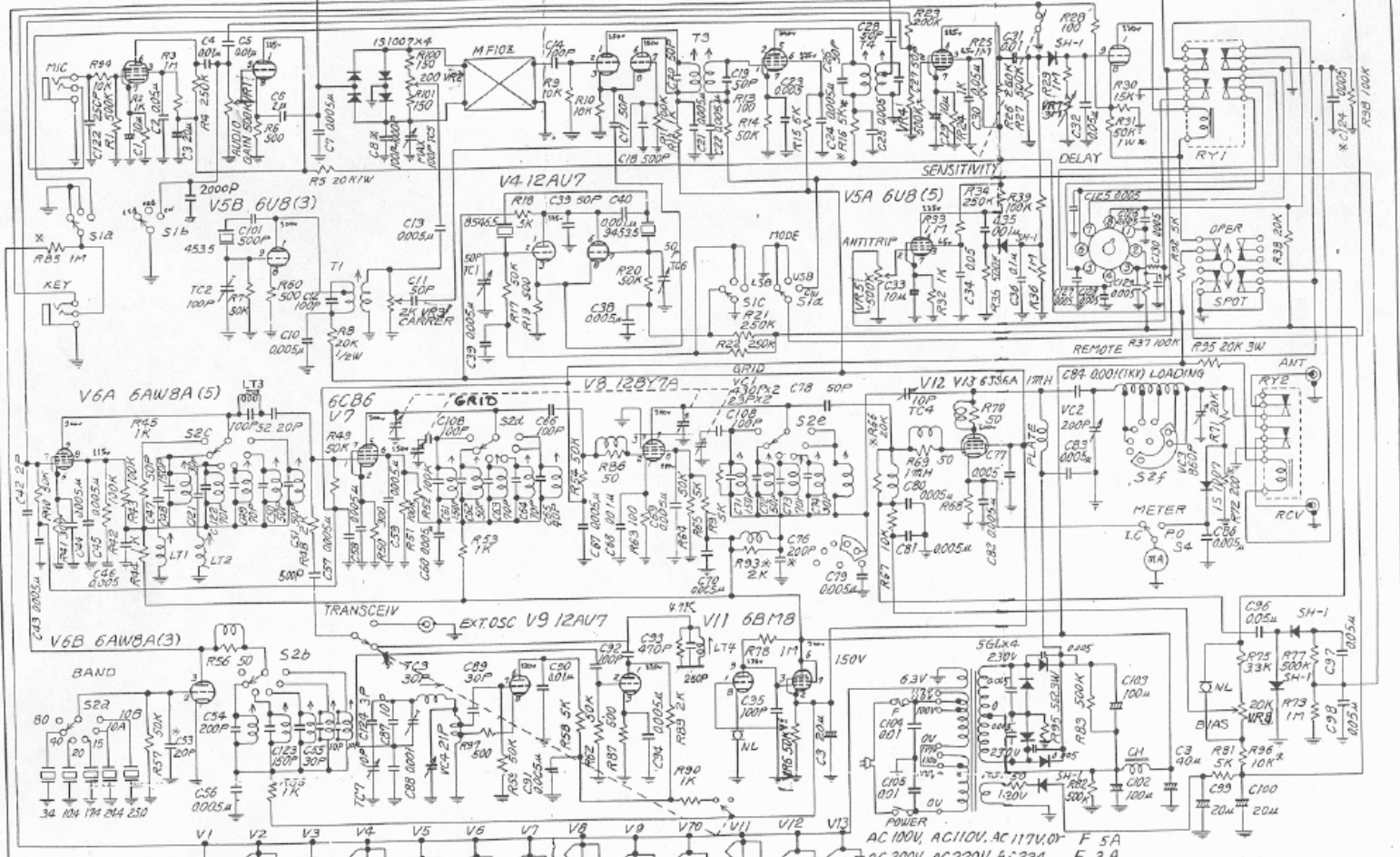

Downloaded by

Amateur Radio Directory

- V1 6U8
- V2 12AT7
- V3 6BA6
- V4 12AU7
- V5 6U8
- V6 6AW8A(5)
- V7 6CB6
- V8 12BY7A
- V9 12AU7
- V10A 6U8 (5)
- V10B 6U8(3)
- V11 6BM8
- V12 6X4
- V13 6X4

POWER
AC 100V, AC 110V, AC 117V, 0V F 5A
AC 200V, AC 220V, A; 234 F 3A

V1 6V8

V2 12AT7

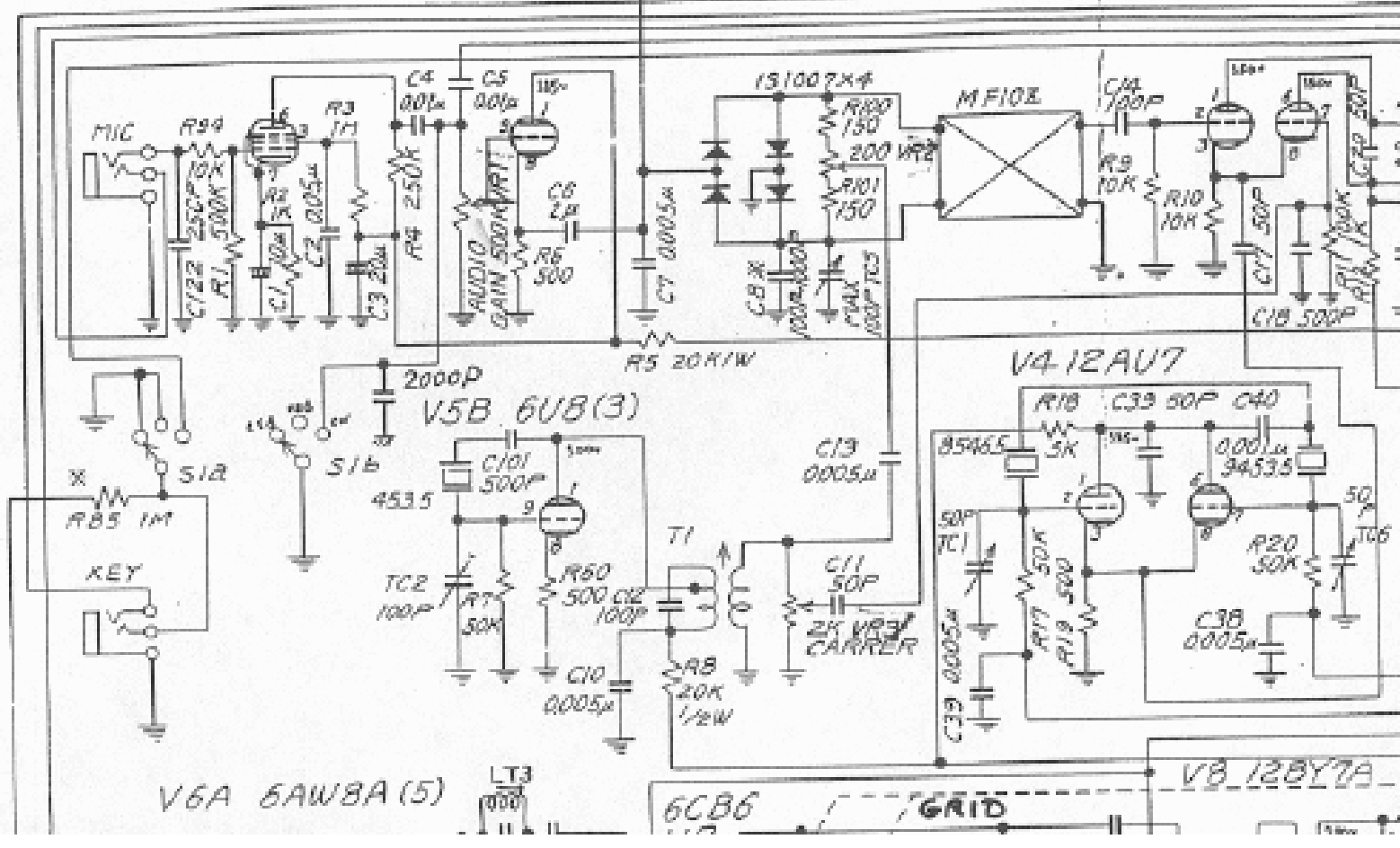

2AT7

V3 6BA6

V10A 6U8 (5)

V10B 6U8 (3)

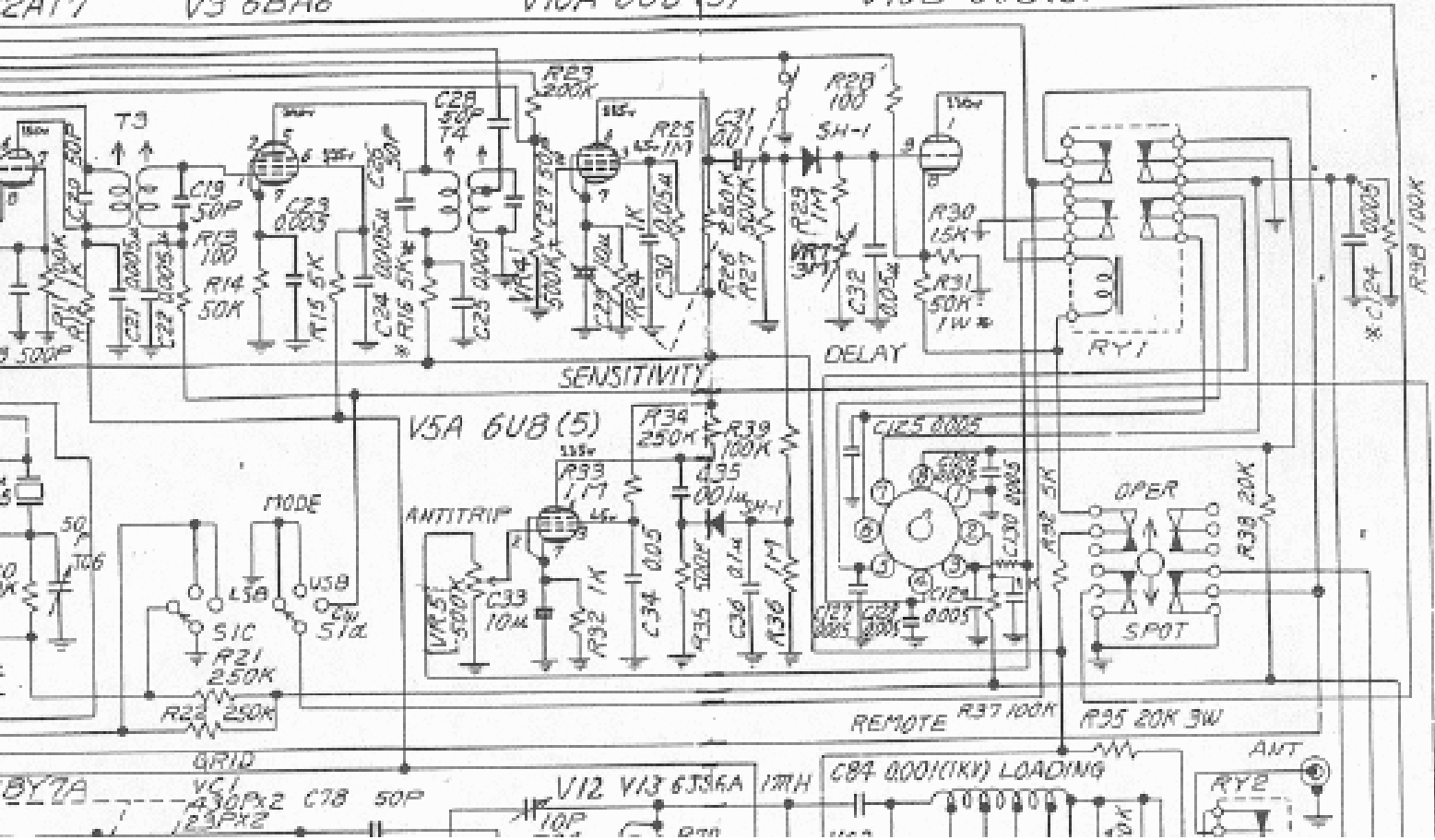

V6A 6AW8A(3)

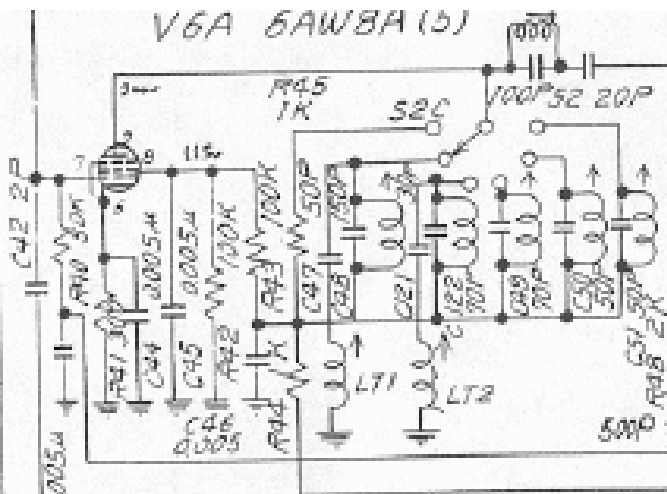

6CB6 V7 GRID

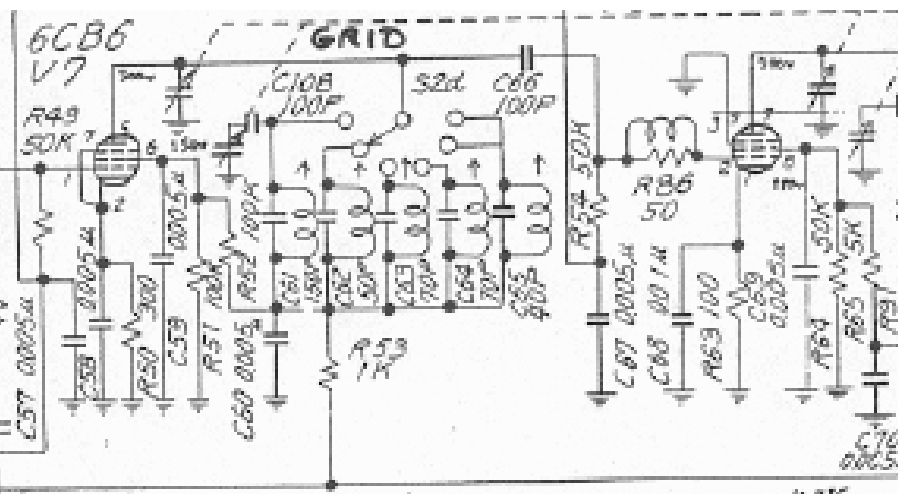

V6B 6AW8A(3)

