

LTDZ_35-4400M 频谱仪使用说明

LTDZ_35-4400M Spectrum Analyzer Instructions

35-4400M Spectrum Analyzer

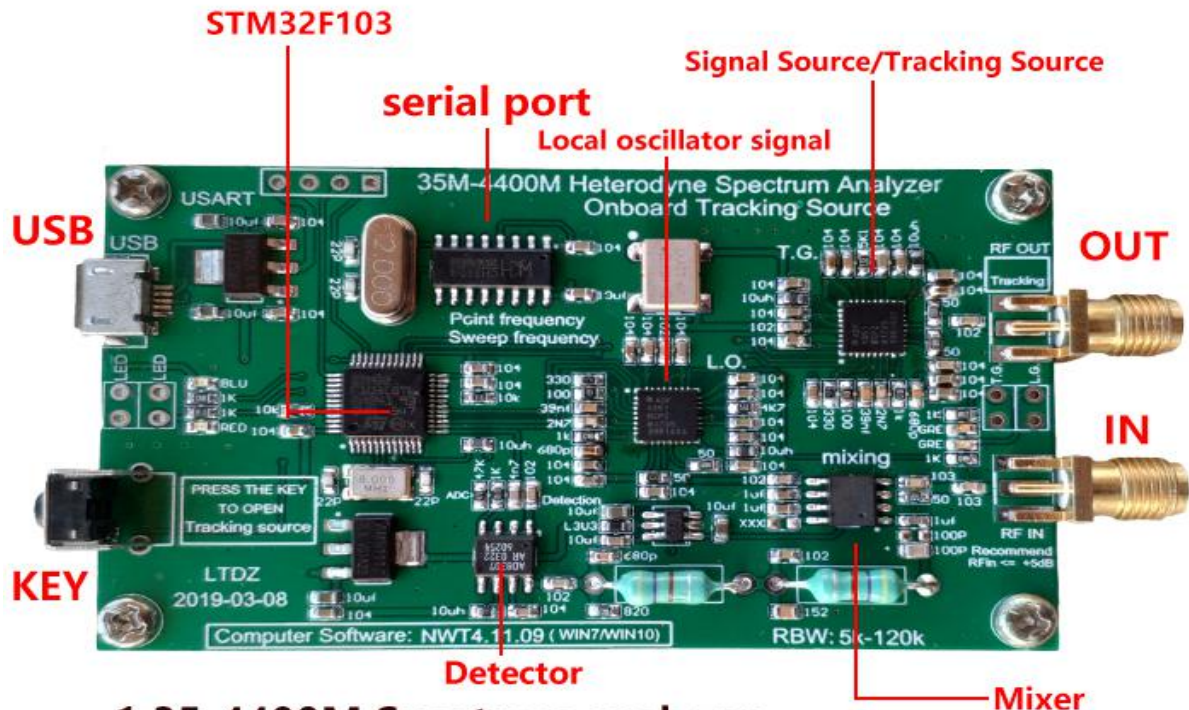

- 1.35-4400M Spectrum analyzer
- 2.35-4400M signal source
- 3.On-board tracking source
- 4.Serial Communication
- 5.Computer-side software: Win NWT4



1、功能介绍 Product Introduction

(1) 【35-4400M 信号源】 【35-4400M Signal Source】

通过电脑软件 (winNWT4) 可以控制板载锁相环芯片 ADF4351 输出 35M-4400M 基准信号。

The computer software (winNWT4) can control the output of 35M-4400M reference signal from ADF4351.



(2) 【35-4400M 频谱仪】 【35-4400M Spectrum analyzer】

通过电脑软件 (WinNWT4) 可以作为一个最大扫频范围 35-4400M 的频谱仪使用。使用超外差式扫频频谱仪，本振信号由 ADF4351 产生，待测信号

和本身信号经过混频器产生差频信号，差频信号经过 RBW:5k-120k 的带通滤波器和检波器，最后由 STM32ADC 采样通过串口送入电脑端，显示扫频频谱。



扫频参数如下: The sweep parameters are as follows:

&扫频步进: Sweep step:

$\geq 33 \sim 68.75\text{MHz}/125\text{Hz}$,
 $68.75 \sim 137.5\text{MHz}/250\text{Hz}$,
 $137.5 \sim 275\text{MHz}/500\text{Hz}$,
 $275 \sim 550\text{MHz}/1\text{kHz}$
 $550 \sim 1100\text{MHz}/2\text{kHz}$,
 $1100 \sim 2200\text{MHz}/4\text{kHz}$,
 $2200 \sim 4400\text{MHz}/8\text{kHz}$,

&扫频速度: ≥ 800 点/秒

Sweep Speed: > 800 Points/sec

&扫频动态对数比: $> 50\text{dB}$

Sweep Dynamic Logarithmic Ratio: $> 50\text{dB}$

&输入检测: $\leq 10\text{dbm}$

Input detection: < 10 dBm

(3) 【板载跟踪源】 【On-board tracking source】

按下按键，即可打开板载跟踪源，跟踪源信号与本振信号相差 120K。有了跟踪源，你可以测量网络的 S12 和 S21 参数，可以通过反射电桥测量天线的参数。



By pressing the key, the onboard tracking source can be opened, and the difference between the tracking source signal and the local oscillator signal is 120K. With a tracking source, you can measure the parameters of S12 and S21 of the network, and the parameters of the antenna can be measured by a reflection bridge.

2、电脑端软件的安装 Installation of Computer-side Software

(1) 安装 winnwt_4_09.exe 软件。支持电脑的操作系统为 winxp, win7, win10。安装完成后，电脑桌面会出现图一。即上位机操作软件。



Install Winnwt_4_09.exe software and support the computer operating system winxp, win7, win10. After installation, the computer desktop will appear in Figure 1. That is the upper computer operation software.

(2) 安装 CH341SER.EXE 串口驱动程序。

Install CH341SER.EXE serial driver.

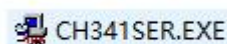

(3) 查看串口号 Query serial slogans

桌面“我的电脑”图标上点击鼠标右键 - 管理 - 设备管理器 - 端口 (com/LPT) 查看并记录串口号。

On the desktop "My Computer" icon, click the right mouse button - Management - Device Manager - Port (com/LPT) to view and record serial passwords.

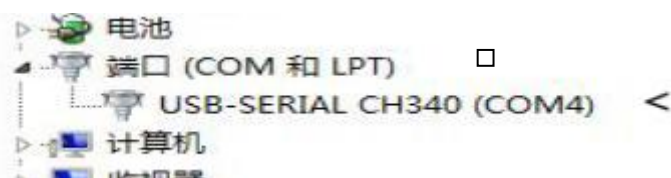

3、WinNWT4 软件设置 WinNWT4 Software Settings

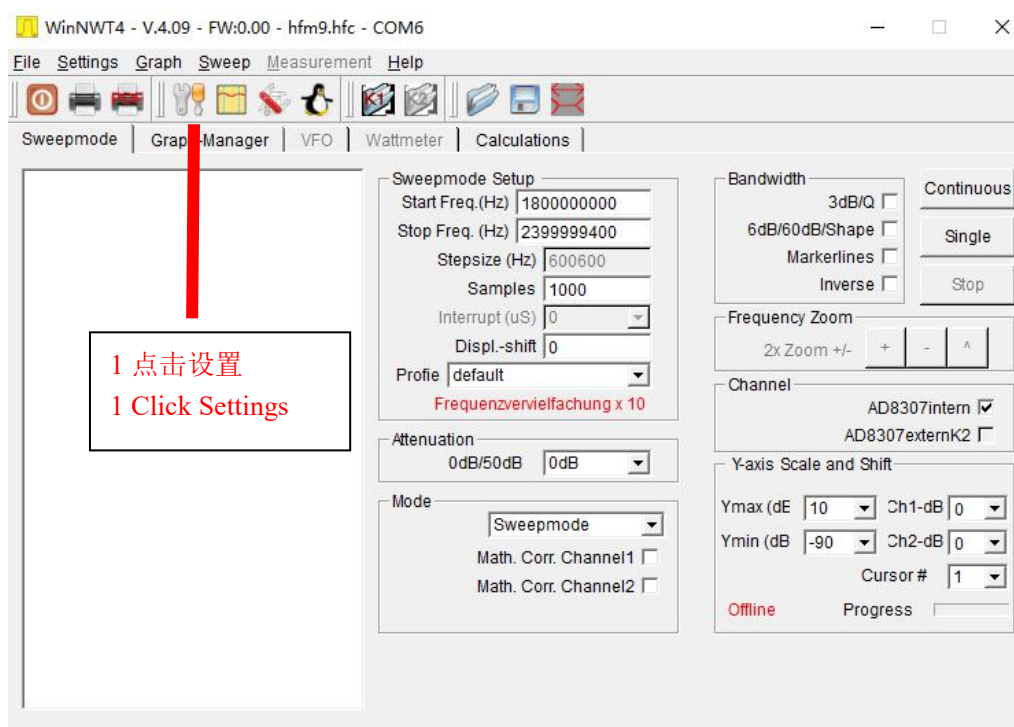

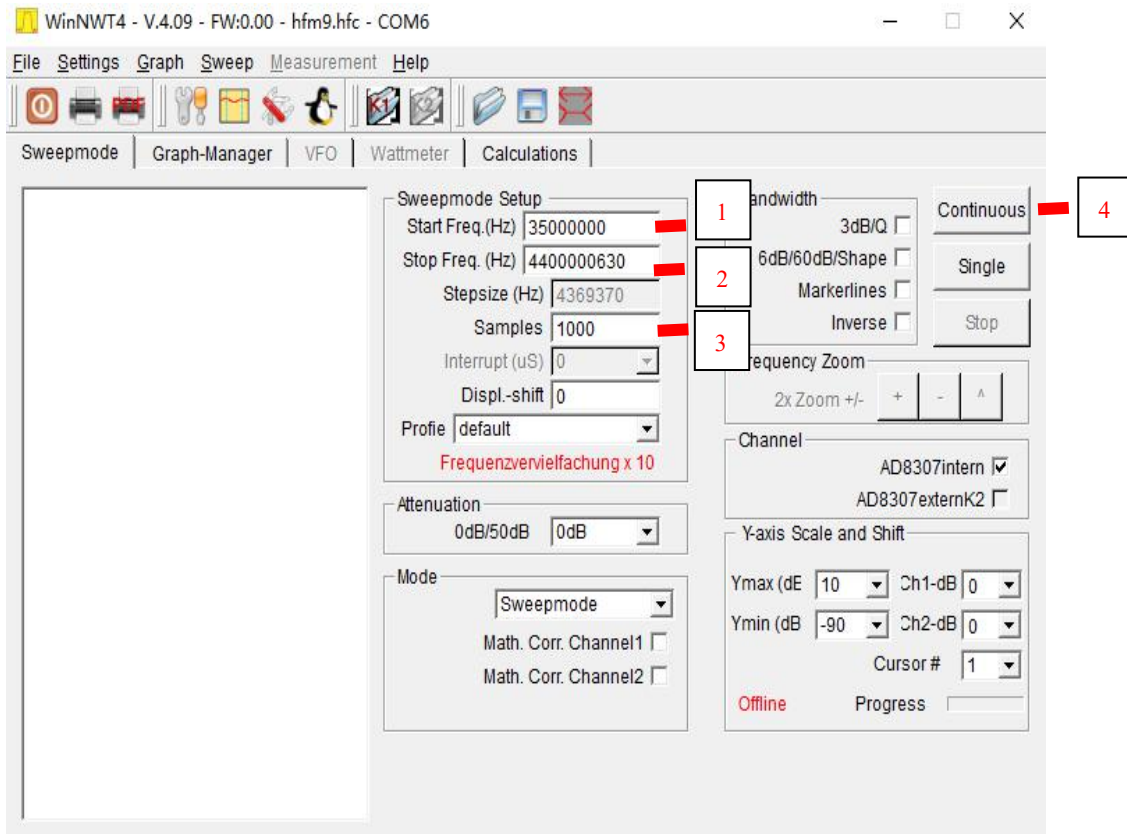
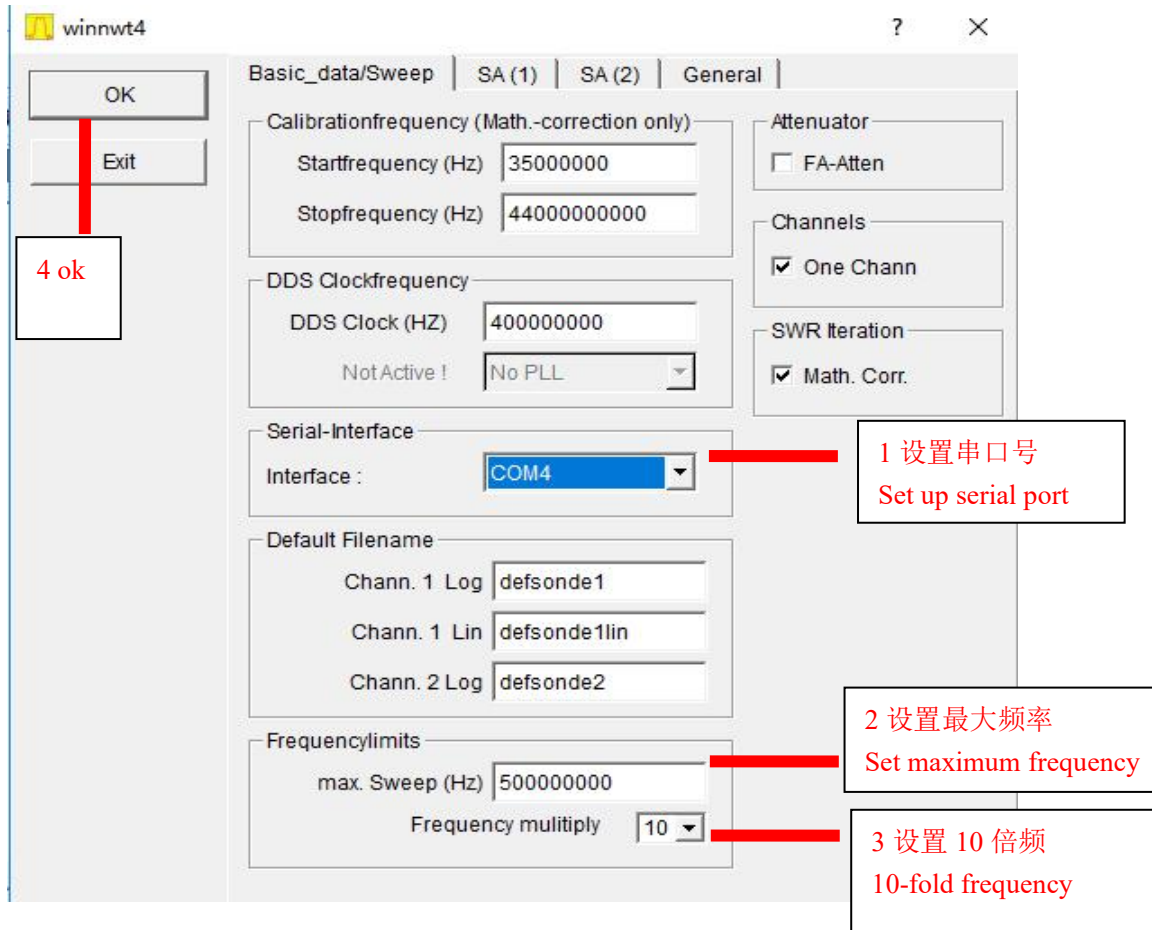

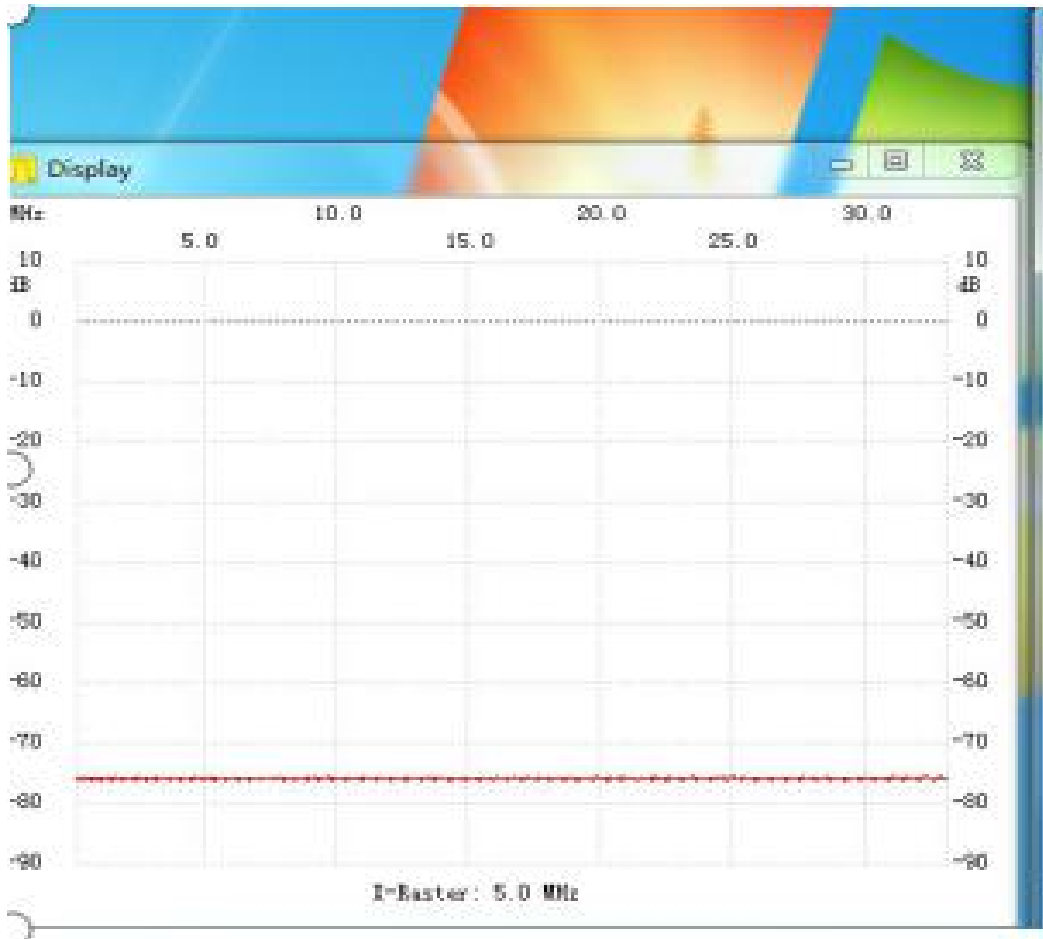

4 应用场景 Application scenario

(1) 【对讲机频谱观察】 【Interphone Spectrum Observation】

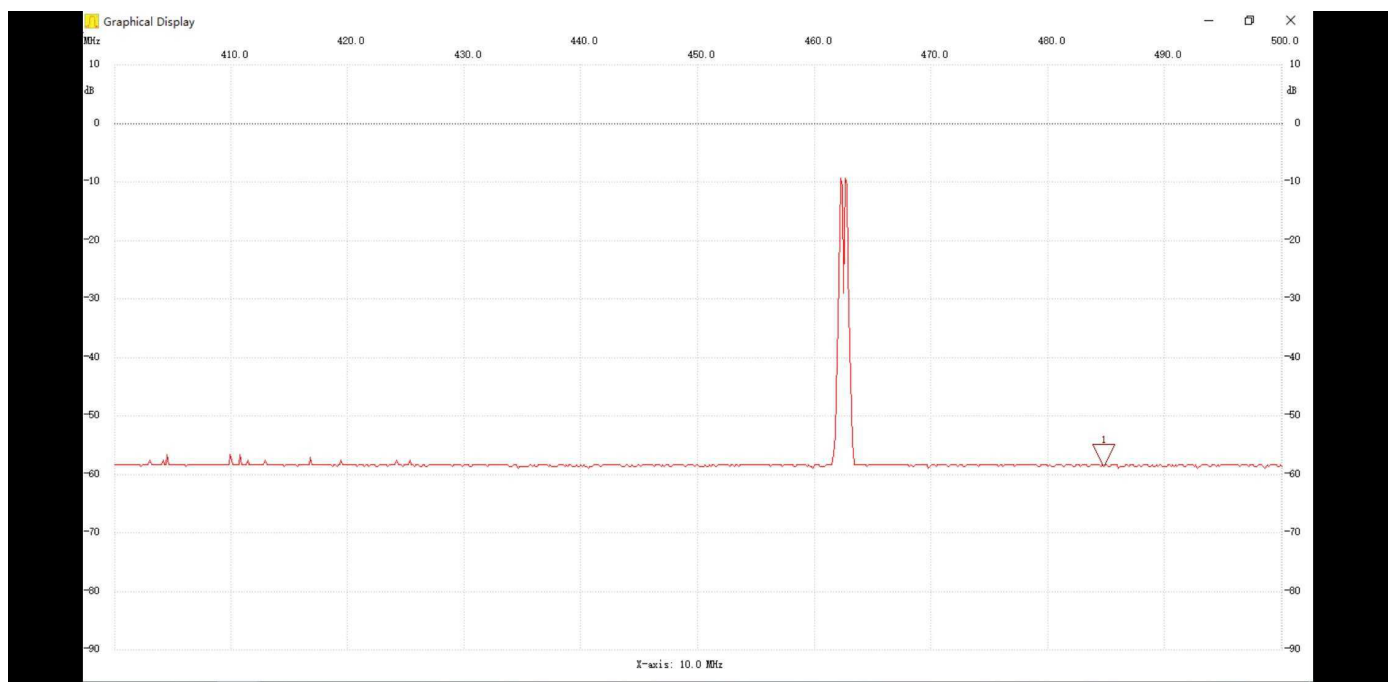

需要在“IN”接口接入天线。Interphone antennas need to be connected to the IN interface. (and so is in other test, you should use appropriate antenna)

(2) 【车钥匙频谱观察】 【Spectrum Observation of Car Key】

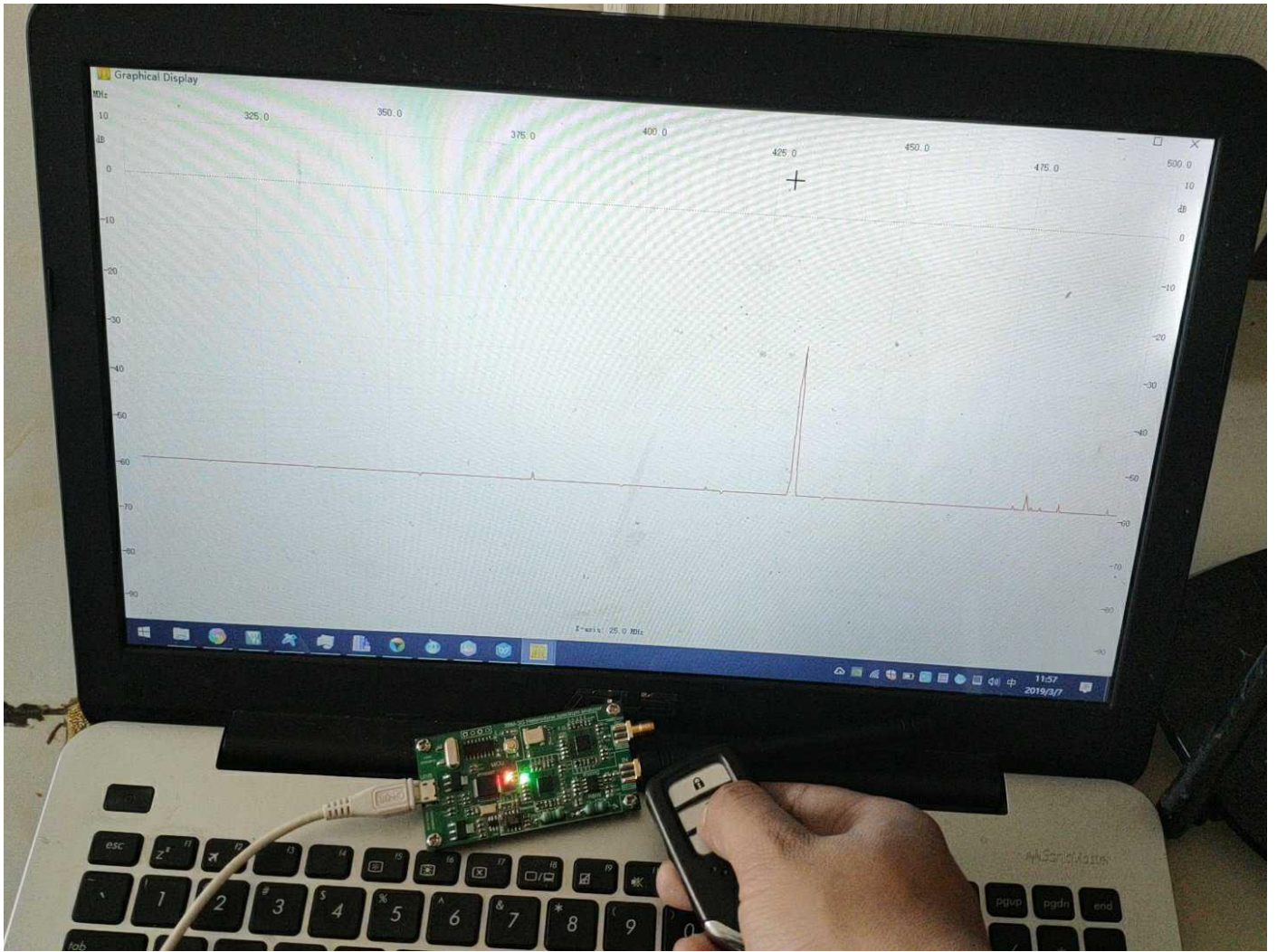

(3) 【wifi 信号频谱观察】 【Wifi Signal Spectrum Observation】

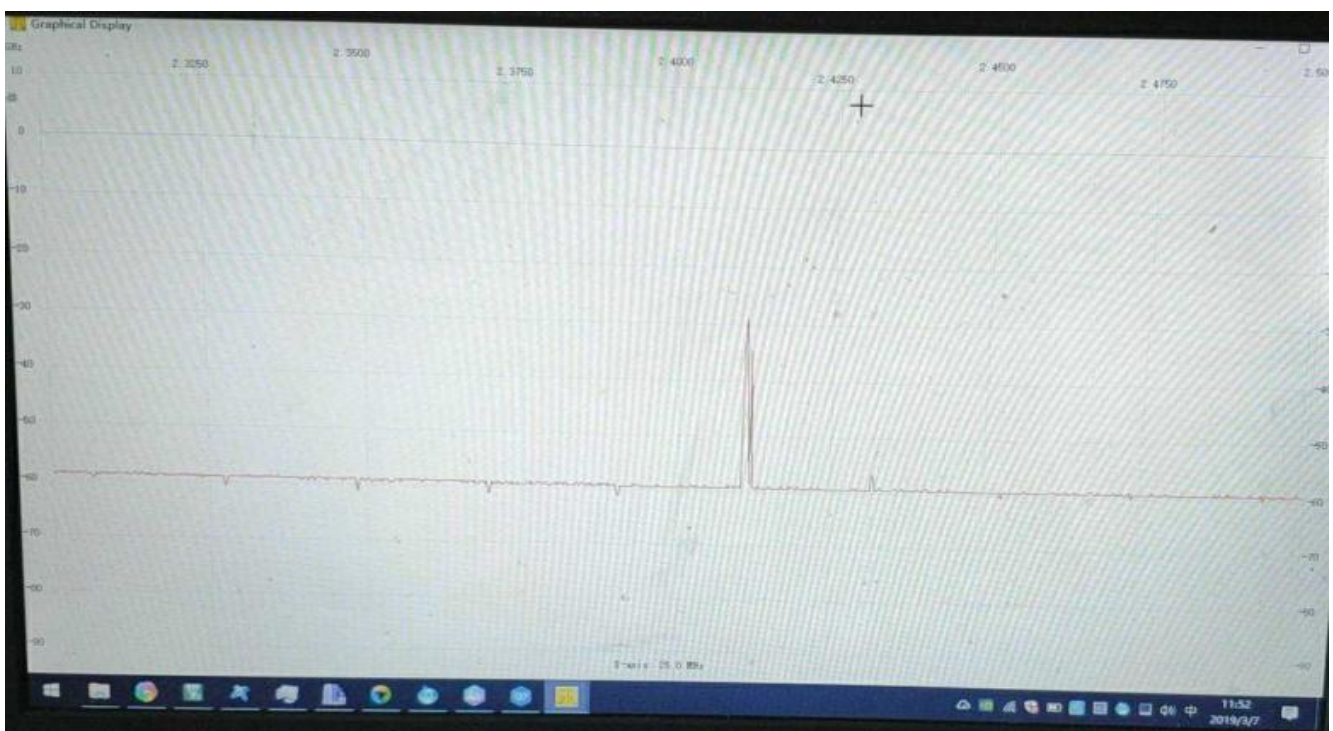

(4) 【基准信号源】 【Reference signal source】

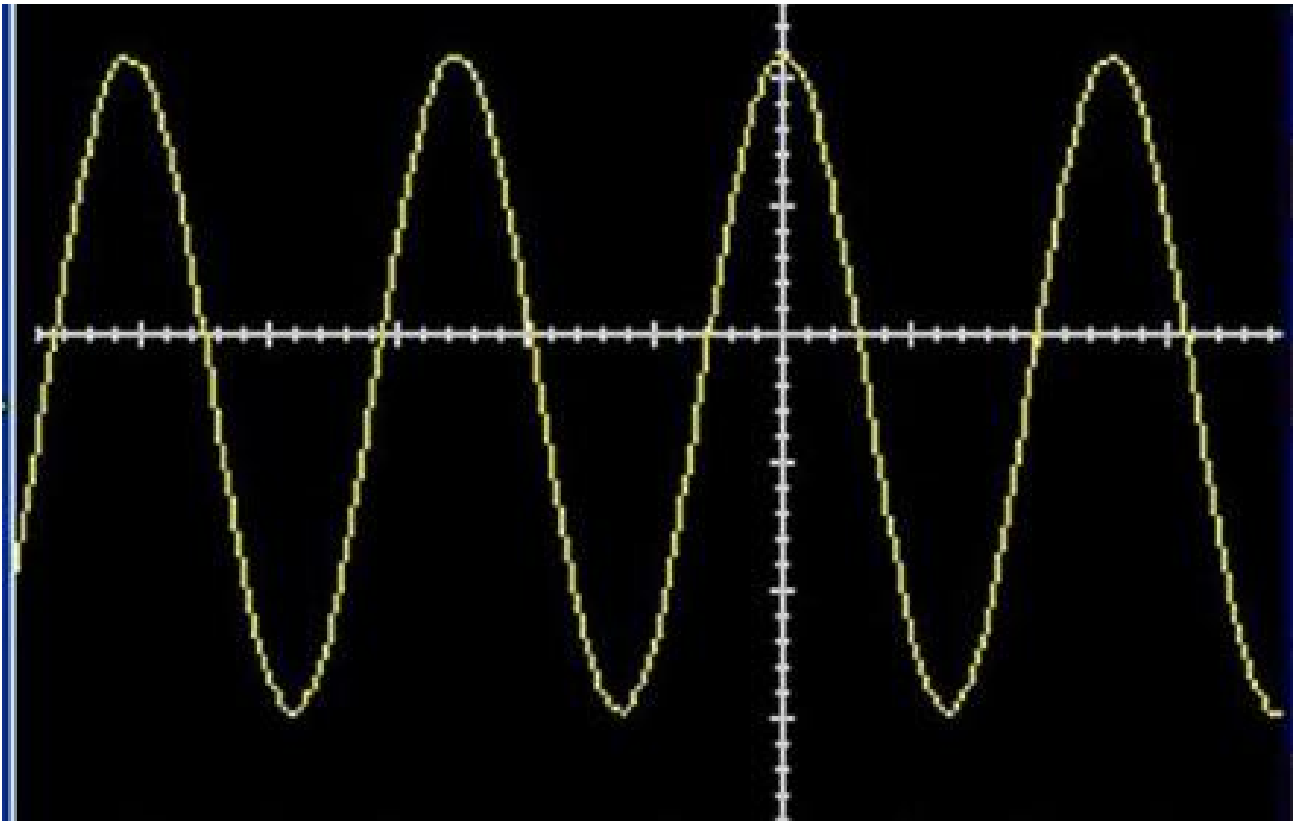

(5) 【天线测试】 【Antenna test】

通过跟踪源和射频反射电桥可以观测天线基本参数。注意，天线测试需要配合电桥反射板，提供电桥板的原理图，需要你自己动手制作。

The basic parameters of antenna can be observed by tracking source and radio frequency reflection bridge. Note that the antenna test needs to cooperate with the bridge reflector board to provide the schematic diagram of the bridge board, which needs to be manufactured by yourself.

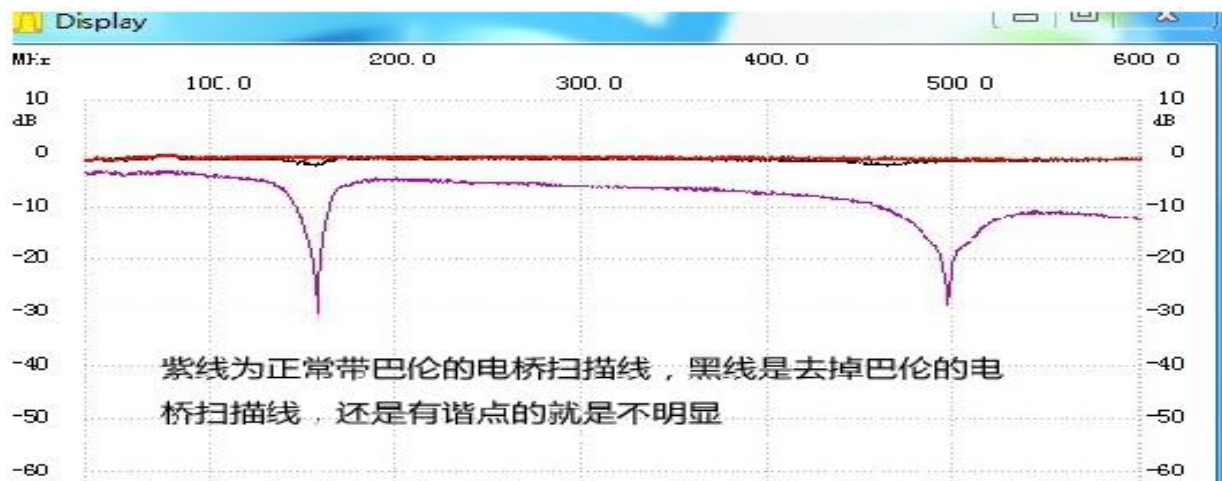

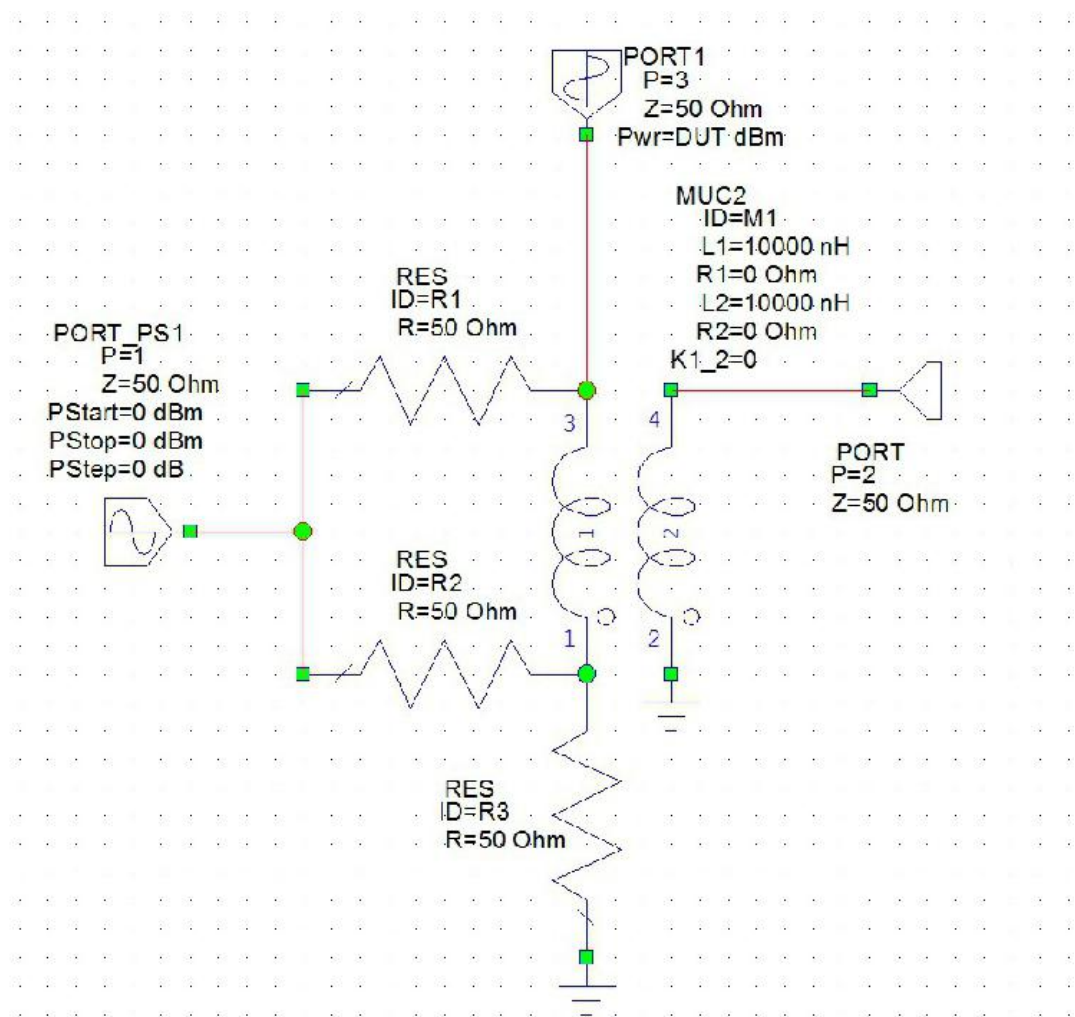
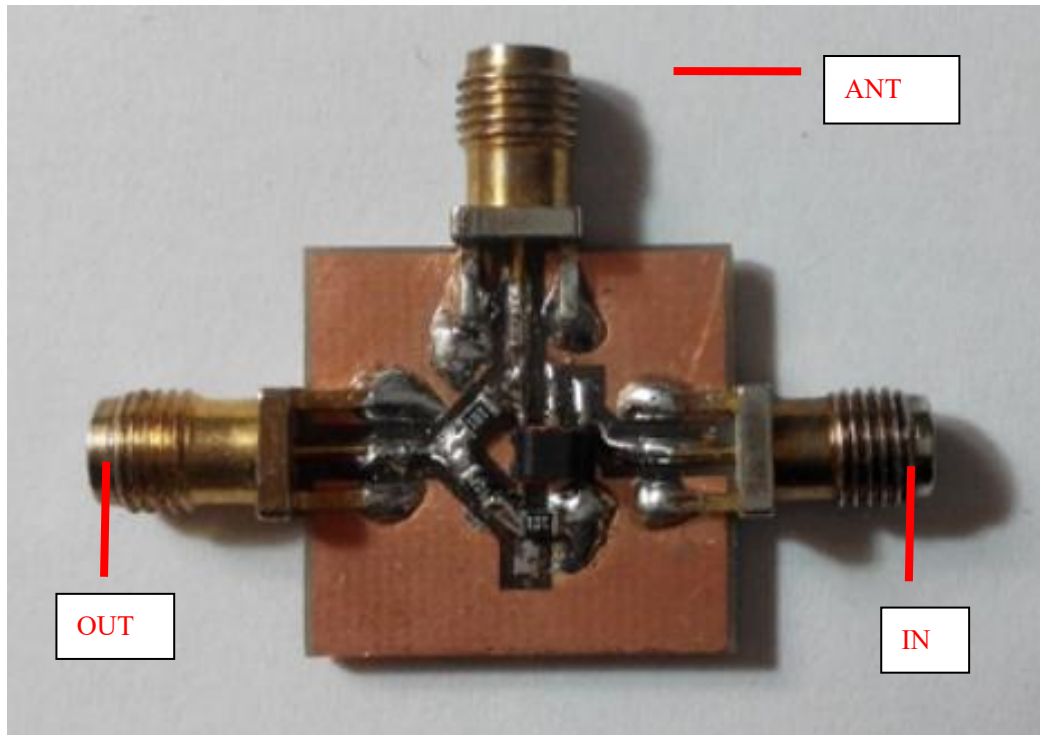

射频反射电桥原理图 Schematic diagram of radio frequency reflection Bridge

5、结语 epilogue

非常感谢您使用本频谱仪，本产品以最低价格出售，所以没有配备 usb 线、sam 线、天线，需要您根据需要另行自己配置，深感抱歉。如果您在使用出现问题可以联系邮箱 1348805494@qq.com。

Thank you very much for using this spectrum analyzer. This product is sold at the lowest price. So it is not equipped with USB line, Sam line and Ant. I am sorry about that you need to configure it separately according to your needs.. If you have problems in using it, you can contact email 1348805494@qq.com.

结束！ 谢谢！

Over! Thanks!