

Rogers Electronic Tubes & Components

8B8
16A8

Description: Triode pentode; triode section for use as frame time base oscillator and A.F. amplifier; pentode section for use as frame output tube and A.F. output tube.

Mechanical data

Cathode	coated, unipotential
Base	E9-1
Bulb	T6 1/2
Outline	6-4
Basing	9EX
Mounting position	any

TUBE OUTLINE

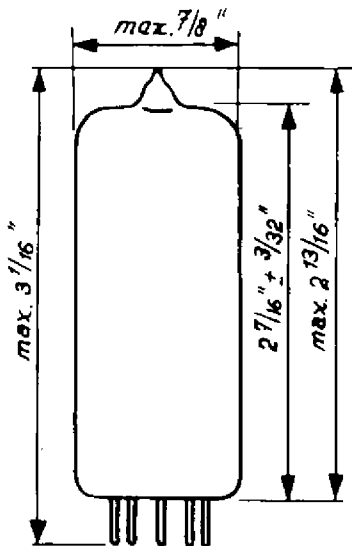

BOTTOM VIEW OF BASE

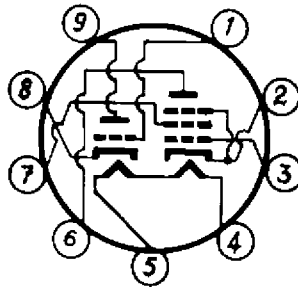

BASE PIN No.

1	Triode grid
2	Pentode cathode and grid No.3, internal shield
3	Pentode grid No.1
4	Heater
5	Heater
6	Pentode plate
7	Grid No.2
8	Triode cathode
9	Triode plate

HEATER DATA

	<u>8B8</u>	<u>16A8</u>	
Heater voltage	8	16	volts
Heater current	600	300	mamps

DIRECT INTERELECTRODE CAPACITANCES

Triode section

Grid to all other elements except plate	2.7 μ F
Plate to all other elements except grid	4.3 μ F
Plate to grid	4.2 μ F
Grid to heater	max. 0.02 μ F

Pentode section

Grid No.1 to all other elements except plate	9.3 μ F
Plate to all other elements except grid No.1	8.0 μ F
Plate to grid No.1	max. 0.3 μ F
Grid No.1 to heater	max. 0.3 μ F

DIRECT INTERELECTRODE CAPACITANCES (continued)Between triode and pentode section

Triode plate to pentode grid No.1	max.	0.02 μF
Triode grid to pentode plate	max.	0.02 μF
Triode grid to pentode grid No.1	max.	0.025 μF
Triode plate to pentode plate	max.	0.25 μF

MAXIMUM RATINGS (design center values)Pentode section

Plate voltage without plate current	550 volts max.
Plate voltage	250 volts max.
Peak plate voltage	2500 volts max. 1)
Peak inverse plate voltage	500 volts max.
Plate dissipation	5 watts max. 2)
Plate dissipation	7 watts max. 3)
Grid No.2 voltage without current	550 volts max.
Grid No.2 voltage	250 volts max.
Grid No.2 dissipation	1.8 watts max.
Peak grid No.2 dissipation	3.2 watts max.
Cathode current	50 mamps max.
Grid No.1 circuit resistance with automatic bias	2 megohms max.
Grid No.1 circuit resistance with fixed bias	1 megohm max.
Voltage between heater and cathode	200 volts max.
Circuit resistance between heater and cathode	20000 ohms max.

Triode section

Plate voltage without plate current	550 volts max.
Plate voltage	250 volts max.
Peak plate voltage	600 volts max. 1)
Plate dissipation	1 watt max.
Cathode current	15 mamps max.
Grid circuit resistance with automatic bias	3 megohms max.
Grid circuit resistance with fixed bias	1 megohm max.
Voltage between heater and cathode	200 volts max.
Circuit resistance between heater and cathode	20000 ohms max.
Grid circuit impedance (freq. = 50 c/s)	0.5 megohm max.

1) Maximum pulse duration 4% of one cycle with a maximum of 0.8 milli second.

2) For frame output application

3) For audio output application

TYPICAL CHARACTERISTICSPentode section

Plate voltage	100	170	200	200 volts
Grid No.2 voltage	100	170	200	200 volts
Grid No.1 bias	-6.0	-11.5	-12.5	-16 volts
Plate current	26	41	35	35 mamps
Grid No.2 current	5.0	8.0	6.5	7.0 mamps
Transconductance	6800	7500	6800	6400 micromhos
Plate resistance	15000	16000	20500	20000 ohms
Amplification factor of grid No.2 with respect to grid No.1	10	9.5	9.5	9.5

Triode section

Plate voltage				100 volts
Grid voltage				0 volt
Plate current				3.5 mamps
Transconductance				2500 micromhos
Amplification factor				70

OPERATING CHARACTERISTICS of the pentode section as audio output tube,
class A

Plate voltage	100	170	200	200 volts
Grid No.2 voltage	100	170	200	200 volts
Grid No.1 bias	-6.0	-11.5	-12.5	-16 volts
Plate current	26	41	35	35 mamps
Grid No.2 current	5.0	8.0	6.5	7.0 mamps
Load resistance	3900	3900	5600	5600 ohms
Power output at a harmonic distortion of 10%	1.05	3.3	3.4	3.5 watts
Required input A.F. voltage	3.8	6.0	5.8	6.6 volts(rms)
Required input A.F. voltage at a power output of 50 milliwatts	0.65	0.59	0.56	0.60 volt (rms)

OPTIMUM PEAK PLATE CURRENT OF THE PENTODE SECTION IN FRAME OUTPUT APPLICATION

To allow for tube spread and for deterioration during life the circuit should be designed around a peak plate current not exceeding 85 mA at 50 volts plate voltage and 170 volts grid No.2 voltage. At underheating (nominal heater current -7%) the following values of peak plate current must be considered:

70 mA at 50 volts plate voltage and
170 volts grid No.2 voltage

80 mA at 50 volts plate voltage and
190 volts grid No.2 voltage

The peak plate current of an average new tube is:

135 mA at 50 volts plate voltage and
170 volts grid No.2 voltage
and 0.3 μ A positive grid No.1 current

OPTIMUM PEAK CATHODE CURRENT OF THE TRIODE SECTION AS FRAME TIME BASE OSCILLATOR

To allow for tube spread, for deterioration during life and for emission drop at underheating the equipment should be so designed that it still operates satisfactorily with a peak cathode current of 200 mA (max. pulse duration 4% of a cycle, with a maximum of 0.8 msec) The amplitude of the peak current occurring with new tubes should be limited automatically to this max. value of 200 mA. (e.g. by non-bypassed resistances in the grid lead)

If no automatic limitation is present the equipment should be designed around a peak cathode current of 100 mA

OBSERVATIONS

If the tube is fed from a mains that is not synchronised with the video frequency, image interference may be caused. A curve is given showing the relation between the permissible grid No.1 circuit impedance of the pentode section and the A.C. voltage between pin 4 and cathode. For this curve it has been assumed that capacitances between grid No.1 and the heater (inclusive of wiring and tube socket) is 0.8 μ F and that the negative feedback-coupling for 50 to 400 cycles/second is at least a factor 2

The triode section can be used without special precautions against microphonic effect and hum in circuits in which an input voltage of at least 10 millivolts gives an output power of 50 milliwatts. The A.C. voltage between pin 4 and cathode should not exceed 6.3 volts

OPERATING CHARACTERISTICS OF THE TRIODE SECTION AS A.F. AMPLIFIER

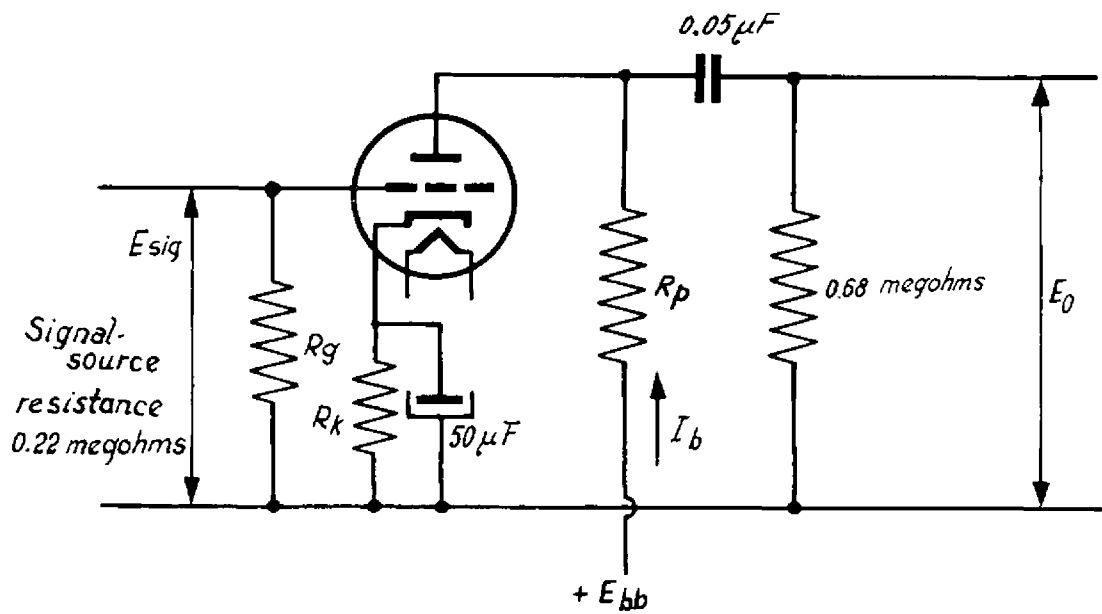

E_{bb} volts	R_g megohms	R_k ohms	R_p megohms	I_b mamps	E_o volts(rms)	$\frac{E_o}{E_{sig}}$ (1)	total har- monics %
200	3	2200	0.22	0.52	26	52	1.6 (2)
170	3	2700	0.22	0.43	25	51	2.3 (2)
100	3	2700	0.22	0.23	15	47	4.0 (2)
200	22	0	0.1	1.05	24	50	1.5 (3)
170	22	0	0.1	0.86	19	49	1.4 (3)
100	22	0	0.1	0.37	8	42	1.3 (2)
200	22	0	0.22	0.61	25	55	1.4 (3)
170	22	0	0.22	0.50	20	53	1.4 (3)
100	22	0	0.22	0.22	9	46	1.5 (2)

1) Measured at small input voltage

2) At lower output voltages the distortion is proportionally lower

3) At lower output voltages the distortion remains approx. constant up to $V_o = 5 V_{eff}$. At values $< 5 V_{eff}$ the distortion is proportionally lower.

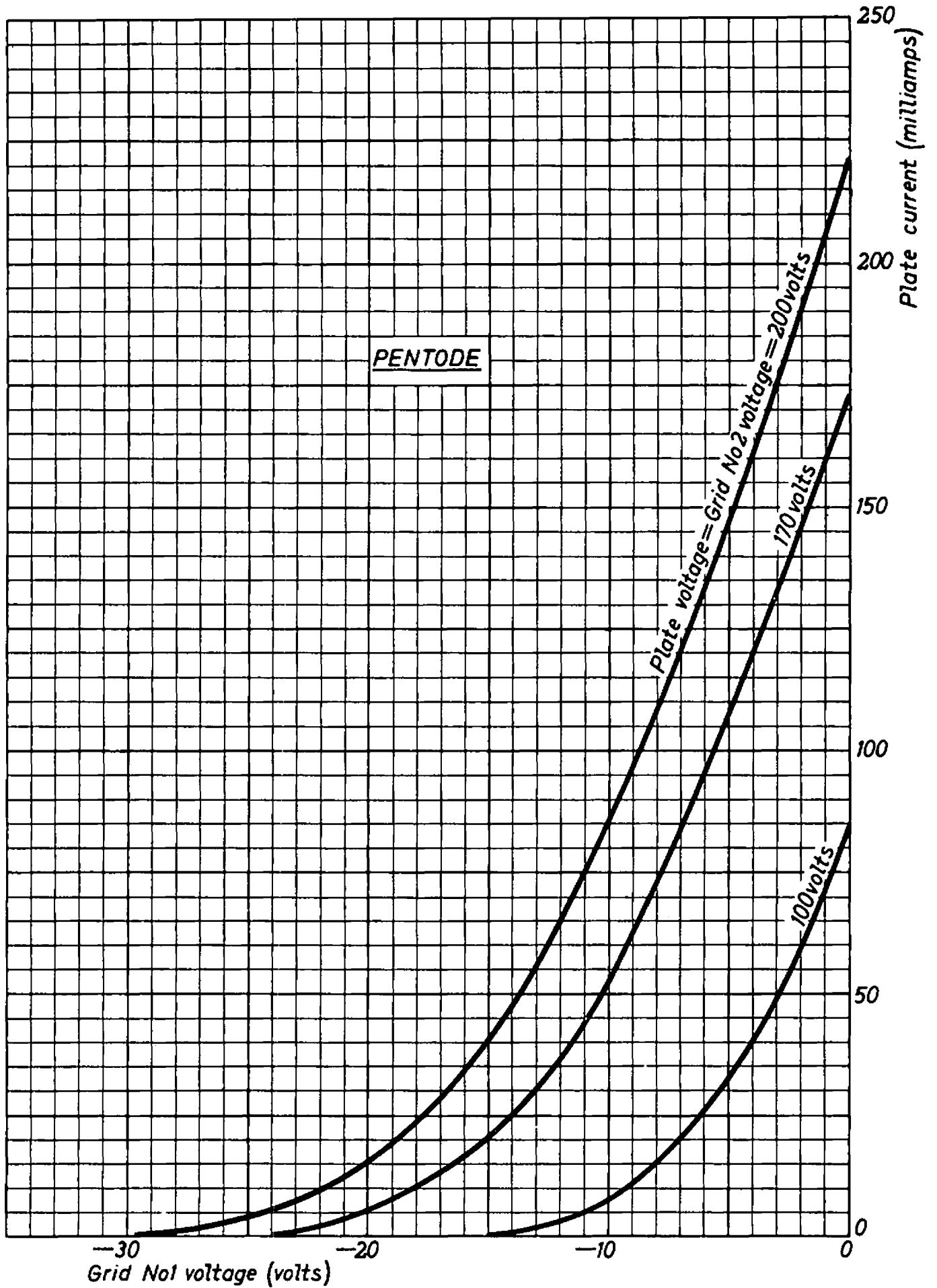

8B8
16A8

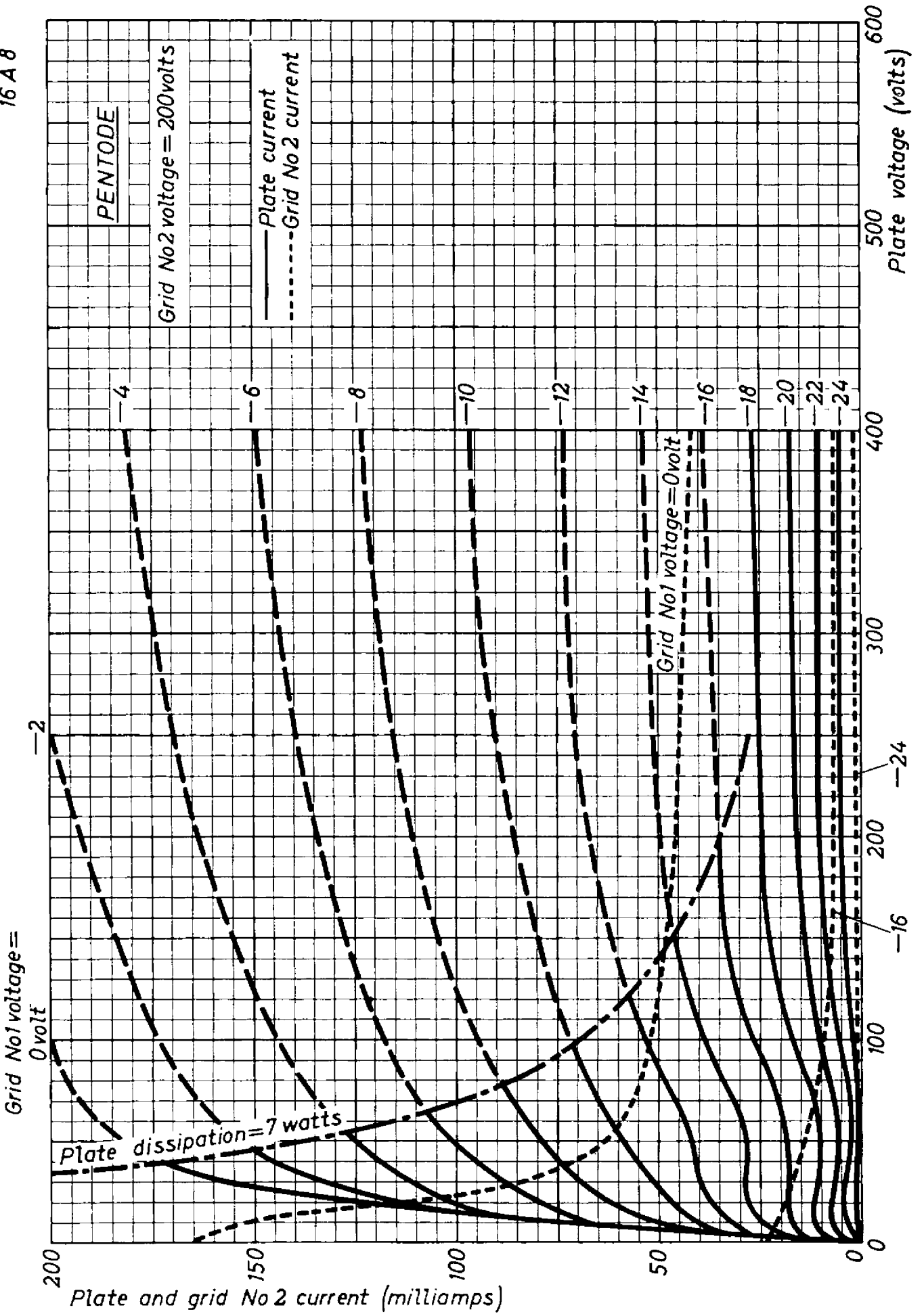

8B8
16A8

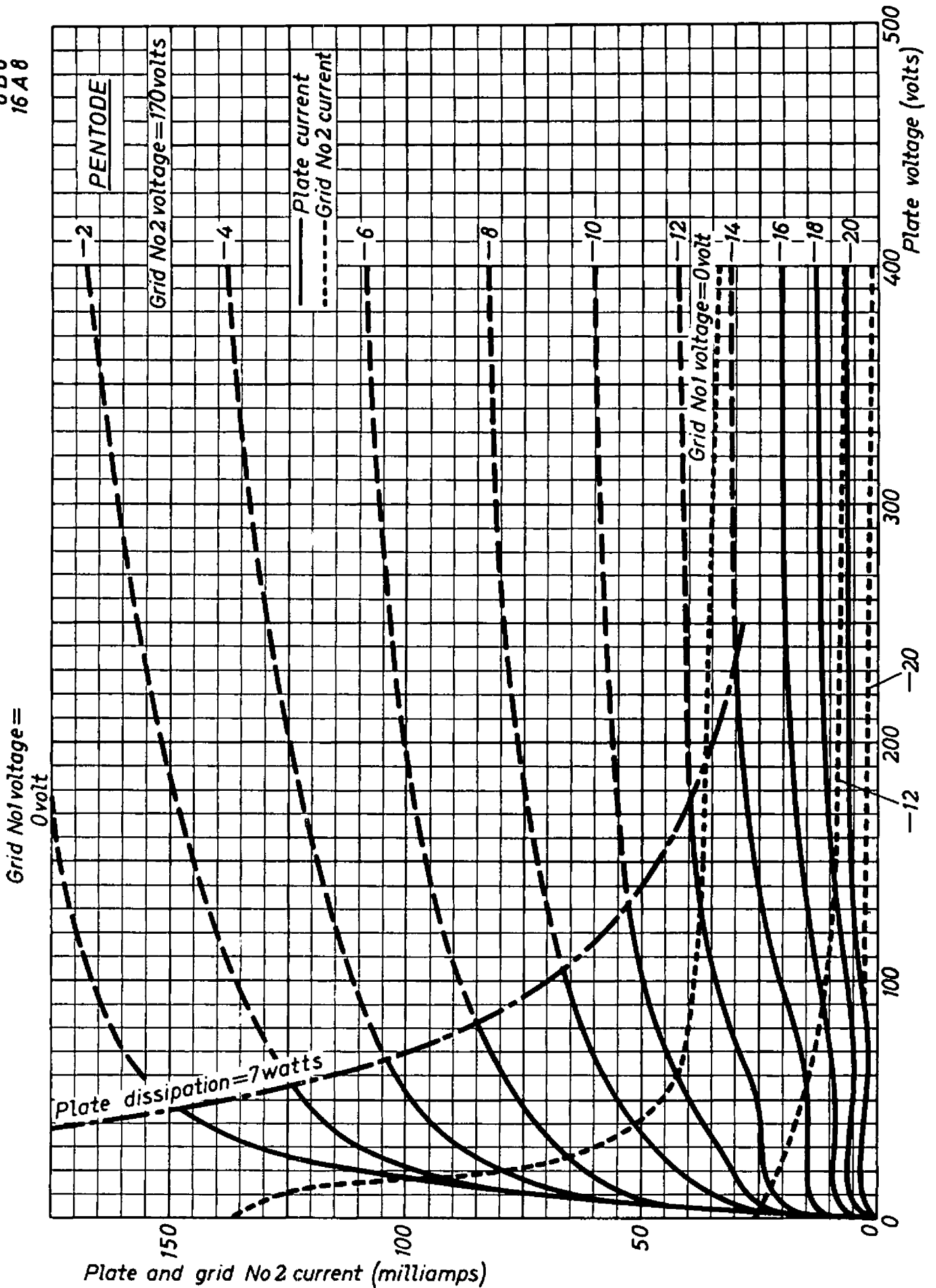

8B8
16A8

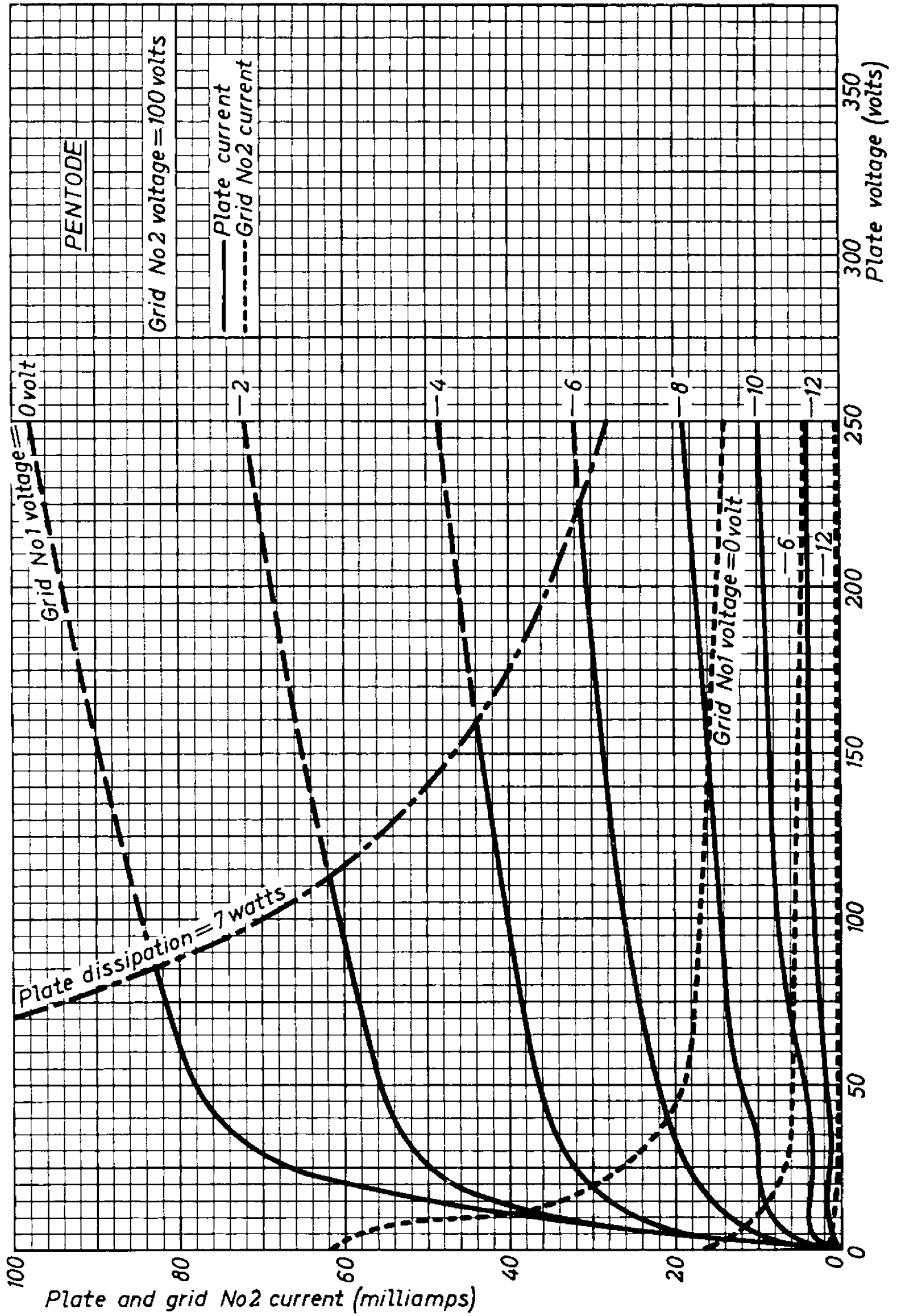

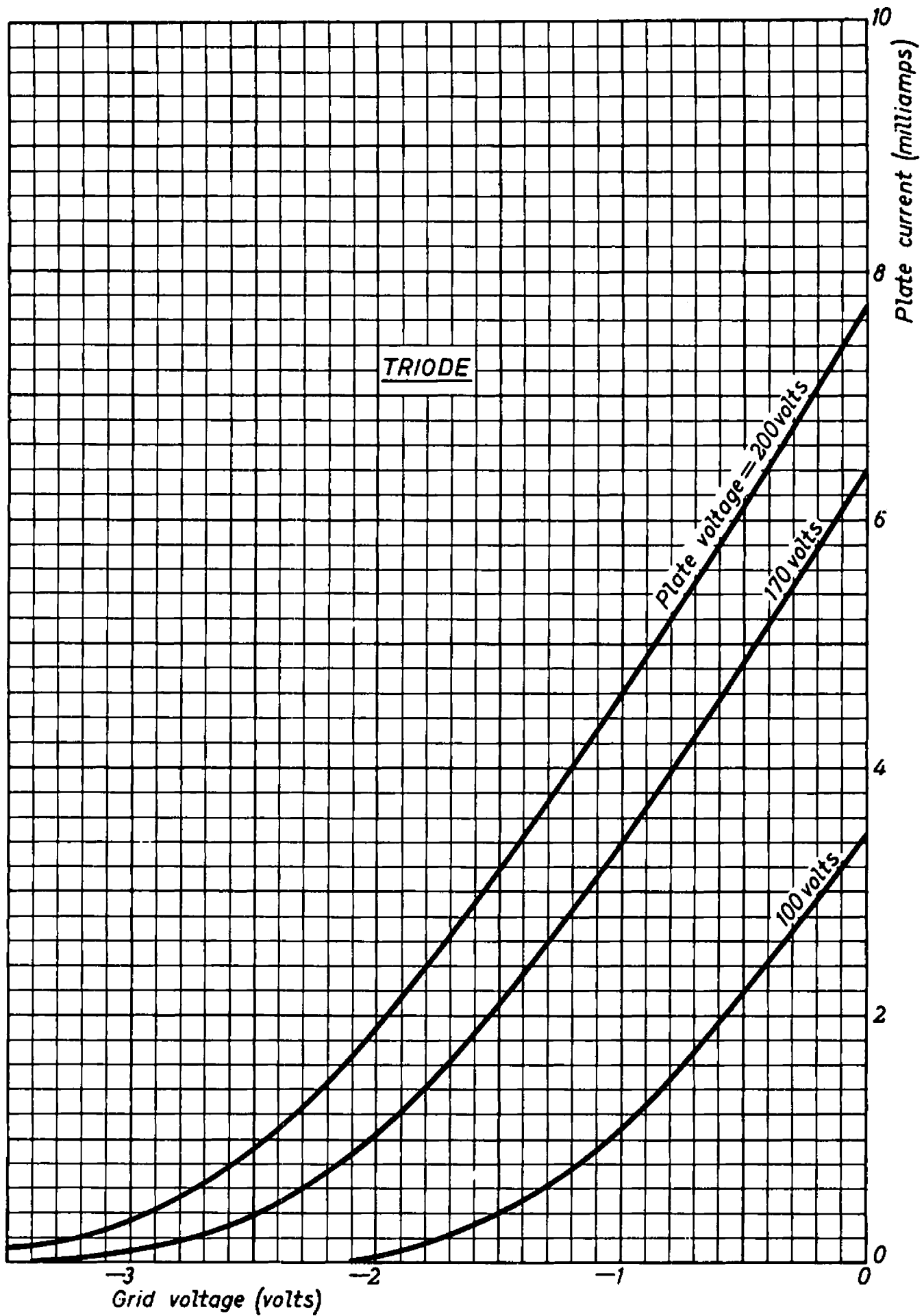

8B8
16A8

