

Care and
Feeding of
Power Grid
Tubes



CARE AND FEEDING OF POWER GRID TUBES

PREPARED BY THE STAFF OF
CPI, EIMAC DIVISION



Communications & Power Industries

CPI, EIMAC DIVISION
301 INDUSTRIAL ROAD
SAN CARLOS, CA 94070
USA

CARE AND FEEDING OF POWER GRID TUBES
5th Edition

Copyright© 2003 by Eimac Division of CPI, Inc. All rights reserved. Printed in the United States of America. This book, or parts thereof may not be reproduced in any form without permission of the publisher.

Table of Contents

SECTION 1 **1**

INTRODUCTION **1**

SECTION 2 **3**

WHAT IS A POWER GRID TUBE? **3**

2.1 TRIODES 3

2.2 TETRODE 8

2.3 PENTODES 13

2.4 Current Division 14

2.5 INDUCTIVE OUTPUT TUBE (IOT) 16

**2.6 MULTISTAGE DEPRESSED COLLECTOR IOT
(MSDC IOT)** 21

2.7 CATHODE EMITTERS 24

2.8 GRIDS 29

2.9 ANODES 31

2.10 VACUUM PUMPS 32

SECTION 3 **35**

ELECTRICAL DESIGN CONSIDERATIONS **35**

3.1	CLASS OF OPERATION	35
3.2	TUBE PERFORMANCE COMPUTER FOR R-F AMPLIFIERS	37
3.3	TYPICAL RF AMPLIFIER CIRCUIT DESIGNS	52
3.4	COMPONENT PARTS	57
3.5	LEAD LENGTHS	58
3.6	FILAMENT BY-PASSING	60
3.7	SCREEN AND SUPPRESSOR GRID BY-PASSING AND SCREEN TUNING	62
3.8	GROUNDING-GRID CIRCUITS	63
3.9	PROTECTION	65
3.10	KEYING	70
3.11	AMPLITUDE MODULATION	73
3.12	POWER SUPPLY CONSIDERATION	75
3.13	STABILIZING THE AMPLIFIER	76
3.14	NOISE IN TUBE AMPLIFIERS	81

SECTION 4 83

<u>LINEAR AND SINGLE SIDEBAND SERVICE</u>		83
4.1	WHY SINGLE SIDEBAND	83
4.2	RATING TUBES FOR LINEAR AMPLIFIER SERVICE	84

- 4.3 **SELECTION OF TUBES FOR SINGLE SIDEBAND SERVICE 92**
- 4.4 **LINEAR AMPLIFIER DESIGN 100**
- 4.5 **ADJUSTING AND MONITORING THE LINEAR AMPLIFIER 105**

SECTION 5 109

NEUTRALIZATION		109
5.1	NEUTRALIZATION BELOW VHF	109
5.2	PUSH-PULL NEUTRALIZATION	111
5.3	SINGLE-ENDED NEUTRALIZATION	111
5.4	NEUTRALIZING GROUNDED-GRID AMPLIFIERS	113
5.5	NEUTRALIZATION PROCEDURE	117
5.6	SELF-NEUTRALIZING FREQUENCIES OF TETRODES AND PENTODES	120

SECTION 6 125

OPERATING CONDITIONS		125
6.1	ADJUSTMENT OF LOADING AND EXCITATION	125
6.2	OPERATING VOLTAGES AND CURRENTS	126
6.3	EFFECT OF DIFFERENT SCREEN VOLTAGES	127

6.4	THE THREE HALVES POWER LAW	127
6.5	BALANCE OF AMPLIFIERS	128
6.6	HARMONIC AMPLIFIER AND CONTROL OF HARMONICS	130
6.7	SHIELDING	133
6.8	DRIVE POWER REQUIREMENTS	135
6.9	VHF AND UHF OPERATING CONDITIONS FOR SATISFACTORY ANODE EFFICIENCY AND MINIMUM DRIVE	137
6.10	COOLING TECHNIQUES	137
6.11	TUBE LIFE	162

BIBLIOGRAPHY	168
---------------------	------------

Index	169
--------------	------------

Illustrations

Figure 1:	Constant current curves for 3CX3000A1 ($\mu = 5$).	5
Figure 2:	Constant current curves for 3CX3000A7 ($\mu = 160$).	5
Figure 3:	Constant current curves for a zero-bias triode with a μ of 200.	6
Figure 4:	Internal configuration of a planar triode.	7
Figure 5:	Incorrect screen circuit for tube.	10
Figure 6:	A correct screen circuit for tube.	11
Figure 7:	Another approach to swamping the screen circuit.	11
Figure 8:	Typical curve of grid current.	12
Figure 9:	Secondary-emission characteristics of the metals.	13
Figure 10:	Eimac K2 IOT Amplifier	17
Figure 11:	Eimac K2 Inductive Output Tube	19
Figure 12:	Typical tuning curves for UHF TV IOT.	21
Figure 13:	Equipotential lines in a three stage collector.	22
Figure 14:	Electron trajectories at near to ideal power.	23
Figure 15:	Electron trajectories at higher than ideal power.	23
Figure 16:	Typical MSDC IOT power supply schematic	24
Figure 17:	Pulse derating curve.	25
Figure 18:	Typical oxide cathode.	26
Figure 19:	Typical bar tungsten filament.	27
Figure 20:	Typical mesh tungsten filament.	27
Figure 21:	Typical Focus Cathode (LPT-62)	28
Figure 22:	Tungsten Matrix (Dispenser) Cathode.	29
Figure 23:	Anode efficiency vs. Conduction angle.	36
Figure 24:	Variation of anode and grid voltage	38
Figure 25:	Anode voltage and grid voltage scales.	39
Figure 26:	Instantaneous values of anode and grid current.	40
Figure 27:	Constant current characteristics for 4CX20,000A/8990 tetrode.	40
Figure 28:	Constant current characteristics for 4CW100,000D tetrode.	50
Figure 29:	A typical circuit for an RF amplifier.	52
Figure 30:	Relative harmonic vs. Resonant circuit Q.	53
Figure 31:	Determination of input capacitor C1.	53
Figure 32:	Determination of loading Capacitor C2.	54
Figure 33A:	Determination of Inductor L	55
Figure 33B:	Reactance of an RF choke vs. Frequency.	56
Figure 34:	A typical circuit using “zero-bias” triodes.	63
Figure 35:	A typical circuit using “Zero-bias” triodes.	64
Figure 36:	3CX5000A7 with integral grid flange	64
Figure 37:	Tetrode and pentode protection chart.	66
Figure 38:	Triode protection chart.	67
Figure 39A:	Screen voltage control circuit for exciter keying.	71
Figure 39B:	A typical method of keying a tetrode or pentode amplifier.	72
Figure 40:	Basic screen and anode modulation circuits.	73
Figure 41:	Usual circuit supporting VHF parasitic oscillation.	78
Figure 42:	Placement of parasitic suppressors.	79
Figure 43:	Relative spectrum space occupied by AM and SSB signals.	84

Figure 44.	R-F output of SSB transmitter with single-tone modulation.....	85
Figure 45.	Spectrum of SSB transmitter modulated by two-tone signal.....	86
Figure 46.	Spectrum of SSB transmitter modulated by 1500-Hz tone.....	86
Figure 47.	R-f output of SSB transmitter modulated by two-tone signal.....	87
Figure 48.	Single-tone condition.....	89
Figure 49.	Two-tone condition.....	91
Figure 50.	Three-tone condition.....	91
Figure 51.	Spectrum at the output of a non-linear device.....	95
Figure 52.	Ideal grid-anode transfer curve for Class AB operation.....	97
Figure 53.	Block diagram of Intermodulation Distortion Analyzer.....	98
Figure 54.	Intermodulation distortion products may be predicted.....	100
Figure 55.	IM Distortion Test Data for EIMAC 4CX1500B (EC2 = 225V) ...	102
Figure 56.	IM Distortion Test Data for EIMAC 4CX1500B (EC2 = 250V) ..	103
Figure 57.	Wire neutralizing system.....	110
Figure 58.	Push-pull grid neutralization, basic circuit.....	111
Figure 59.	Single-ended grid neutralization.....	111
Figure 60.	Single-ended anode neutralization, basic circuit.....	112
Figure 61.	Single-ended anode neutralization.....	113
Figure 62.	Neutralization of a symmetrical grid-excited amplifier.....	115
Figure 63.	Neutralization by cross-connected capacitors.....	115
Figure 64.	Neutralization by cross-connected capacitors.....	116
Figure 65.	Circuit of grounded-grid amplifier.....	117
Figure 66.	Tetrode characteristics involved in feedback circuit.....	119
Figure 67.	Graphical presentation of components of output circuit.....	119
Figure 68.	Components of output voltage of a tetrode.....	122
Figure 68A.	Components of output voltage of a tetrode.....	123
Figure 69.	Components of output voltage of a tetrode.....	123
Figure 70.	Three-halves power of commonly-used factors.....	128
Figure 71.	Anode-Current Pulse Length and Power Output.....	131
Figure 72.	Typical air cooling system.....	139
Figure 73.	Tube mounting providing cooling, shielding and isolation.....	140
Figure 74.	Chassis mounting providing cooling, shielding and isolation....	140
Figure 75.	Example of a badly overheated tetrode.....	141
Figure 76.	Measuring back-pressure ²⁴	141
Figure 77.	Cooling Airflow Requirements.....	143
Figure 78.	Combined correction factors for land-based installations.....	146
Figure 79.	Conversion of mass airflow rate to volumetric airflow rate.....	147
Figure 80.	Typical vapor-phase cooling system.....	152
Figure 81.	EIMAC vapor-cooled tubes for mounting in boilers.....	152
Figure 82.	Cutaway of "classic" boiler and tube combination.....	153
Figure 83.	Cutaway view of typical Control Box.....	154
Figure 84.	Typical 4-tube vapor cooling system.....	155
Figure 85.	Cutaway of pressure equalizer fitting.....	156
Figure 86.	Typical 4-tube system using "steam-out-the-bottom" boilers....	156
Figure 87.	Cutaway view of "steam-out-the-bottom" boilers.....	159
Figure 88.	Useful conversion factors.....	161

SECTION I

INTRODUCTION

The original Care and Feeding of Power Grid Tubes was published in 1967. Since then, Care and Feeding has been through four printings. This new, 5th edition includes most of the original material, but updates the book with some presently available technology, including added sections on Inductive Output Tubes and Multiphase Cooling.

This handbook analyzes the operation of EIMAC power grid tubes and provides design and application information to assist the user of these tubes to achieve long tube life, maximum operating efficiency and circuit stability consistent with the full tube capacity.

THE CARE AND FEEDING OF POWER GRID TUBES has been prepared in answer to thousands of questions asked of the EIMAC engineering and laboratory staff over a period of years. Data contained in this updated volume represents the combined efforts of these staff members to provide meaningful information on all phases of the design of equipment using power grid tubes, and the techniques recommended for the application of power grid tubes in modern circuits.

EIMAC transmitting and industrial power tubes are recommended for new equipment design and for replacement of older triode, tetrode and pentode tubes in the redesign of older equipment. Compact EIMAC tubes feature reduced internal coupling between input and output circuits, low internal inductance and capacitance, improved linearity and high operating efficiency. EIMAC tubes are built for long operating life and are rated for use well into the VHF or UHF regions. EIMAC tubes are designed to be rugged and can operate under extreme environmental conditions. The high power gain and excellent efficiency of EIMAC tubes permits design of equipment that operate with a minimum of drive power, allowing a minimum number of stages to achieve the desired power level.

Circuit design and application information in this book are applicable to all EIMAC power grid tubes. For specific ratings, operating parameters and information dealing with a particular tube type, refer to the Technical Data Sheet for the tube in question. Designers of new equipment are urged to contact EIMAC to get information on the range of the more important tube characteristics. Free copies of the data sheet may be obtained upon request to: Marketing Department, CPI, EIMAC Division, 301 Industrial Road, San Carlos, CA USA, 94070 or check EIMAC'S web site www.eimac.com.

For further technical information, contact EIMAC or your nearest CPI field sales office.

SECTION 2

WHAT IS A POWER GRID TUBE?

A power grid tube is a device utilizing the flow of free electrons in a vacuum. It has an emitting surface called the cathode, and one or more grids controlling the flow of electrons. An element called the anode collects the electrons. EIMAC manufactures gridded tubes which handle large amounts of power, as contrasted to receiving type tubes; hence, the term "Power Grid Tubes."

All gridded tubes must have a cathode and an anode. The general class of a tube, described by the terms "triode," "tetrode," and "pentode", is determined by the total number of elements within the tube envelope. Therefore, these terms also indicate the number of grids. A triode has one grid, a tetrode has two grids, and a pentode has three grids.

2.1 TRIODES

The total current flow from the cathode of a three-electrode tube is determined by the electrostatic field near the cathode. The electrostatic field is a function of E_c , the grid to cathode potential, and E_b/μ , the potential due to the anode voltage electrostatic flux penetrating between the grid wires. The " μ " is a characteristic of a triode which in turn is a function of the physical size and location of the grid structure. The total cathode current of an ideal triode can

be determined by the equation:

$$I_k = K \left(E_c + \frac{E_b}{\mu} \right)^{3/2}$$

I_k = cathode current

K = a constant determined by tube dimensions

E_c = grid voltage

E_b = **anode** voltage

μ = amplification factor of tube

One of the more important parameters of a triode is the amplification factor or “ μ ”. The μ of a triode can be determined from the equation:

$$\mu = \frac{\Delta E_b}{\Delta E_c} \quad \text{with the **anode** current held constant}$$

ΔE_b = change in **anode** voltage

ΔE_c = change in grid voltage

EIMAC manufactures triodes with μ values ranging from 5 to 200. The low μ tubes are generally used in audio service or any application which requires a large change in anode current without driving the tube into the positive grid region. The difference between a tube with a μ of 5 and one with a μ of 160 can be seen by comparing Figure 1 to Figure 2.

Observe how much more anode current at a given anode voltage can be obtained from the 3CX3000A1 (Figure 1) without driving the grid into the positive grid region. Note how much more bias voltage is required for the 3CX3000A1 to cut the anode current off at some given anode voltage. With this increased bias there is a corresponding increase in grid voltage swing to drive up to the zero grid voltage point on the curve. Low μ tubes have lower voltage gain by definition, and this fact can be seen by comparing Figure 1 and Figure 2.

Low μ tubes also are an excellent choice for series pass tubes in a voltage regulator. They operate over a wide range of load current (pass tube anode current) with low anode voltage drop.

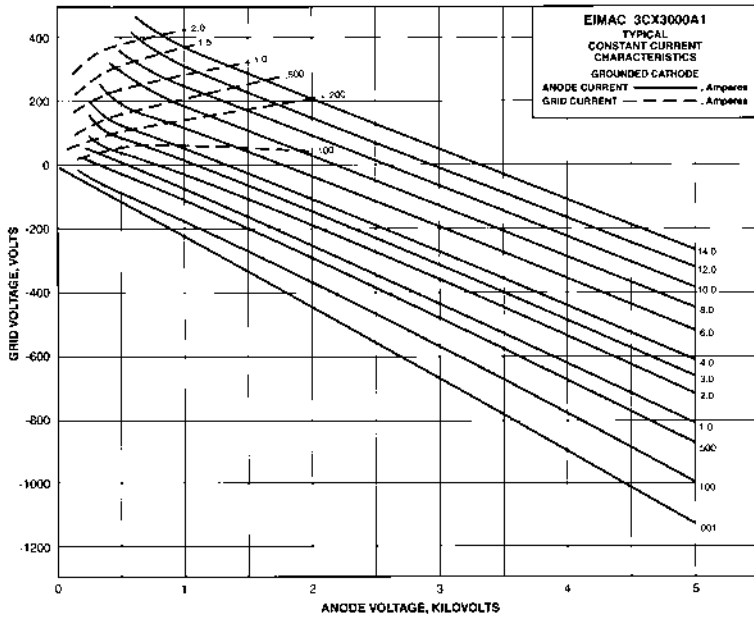

Figure 1: Constant current curves for 3CX3000A1 ($\mu = 5$).

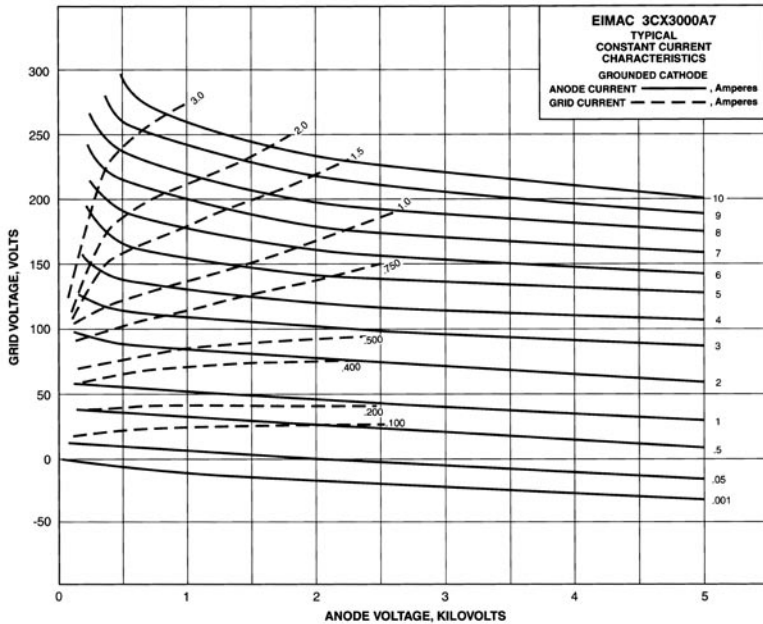

Figure 2: Constant current curves for 3CX3000A7 ($\mu = 160$).

Medium μ , (20-50) triodes are generally used in radio frequency amplifiers and oscillators. They are also good audio amplifiers and modulators.

The high μ (50 - 200) triodes have been designed so that the operating bias is zero in most applications (See Figure 3). EIMAC has developed a line of zero-bias triodes with anode dissipation ratings of from 400 to 30,000 Watts. The zero-bias triode is an excellent choice for grounded-grid radio frequency and audio frequency amplifiers. The main advantages are power gain and circuit simplicity. No bias supply is required. No protection circuits for loss of bias or drive are required.

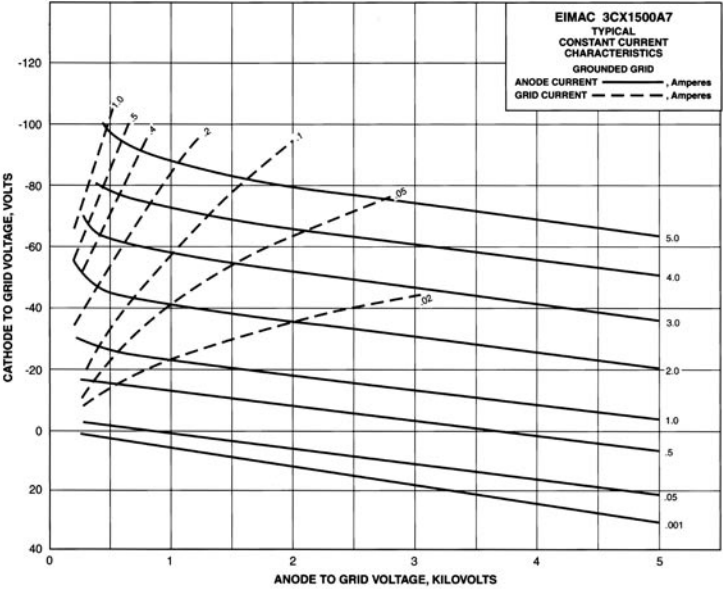

Figure 3: Constant current curves for a zero-bias triode with a μ of 200.

Low and medium μ rather than high μ tubes are usually preferred for industrial heating applications, such as simple oscillators constructed for induction and dielectric heating. The low-to-medium μ tubes are preferred because of the wide variation in load into which an industrial heating oscillator normally works. Low and medium μ triodes have a much lower grid current variation with the changing load. The grid current of a triode with a μ of 20 will rise far less than the grid current of a triode with a μ of 40 under no load conditions. High μ triode oscillators can be designed but extra consideration must be given to the grid current rise under the no load condition. EIMAC has developed a line of triodes specifically for industrial heating applications. These tubes have rugged mounting

flanges and flexible filament leads for ease of mounting in the circuit. Tubes are available with water cooling or forced air cooling. The filament structures are large with adequate cathode emission. The grid structures are ruggedly constructed with ample dissipation capability. The grid must be rugged for industrial heating triodes because of the wide variations in load. As the load decreases the grid dissipation increases. A good industrial triode must therefore be capable of operating with a reasonably wide range of load variations. For more information on tubes for industrial heating and related application notes, see Eimac's industrial catalog, "Rugged Triodes for R. F. Heating".

Most of the triodes manufactured by EIMAC are cylindrically symmetrical. That is, the filament or cathode structure, the grid, and the anode are all cylindrical in shape and are mounted with the axis of each cylinder along the center line of the tube. Some triodes are manufactured with the cathode, grid and anode in the shape of flat surfaces. The triodes so constructed are called "Planar" triodes (see Figure 4). This construction technique is necessary to provide very small spacing between the elements, and to achieve very short lead lengths within the tube. The very close spacings are necessary to reduce electron transit time¹ and therefore allow the tube to be used at frequencies up to 3 GHz and higher. The short leads also increase the operating frequency by reducing lead inductance. Planar triodes are normally used in radio frequency amplifiers in both the continuous wave and pulse modes. The contacting surfaces of the planar triode tubes are arranged for ease of design into coaxial and waveguide resonators.

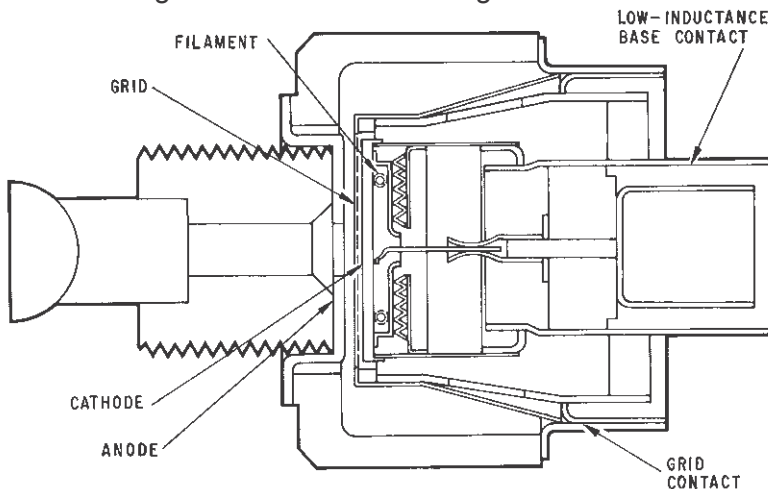

Figure 4: Internal configuration of a planar triode.

1 See section 6.8(d)

2.2 TETRODE

The tetrode is a four-element tube with two grids. The control grid serves the same purpose as the grid in a triode, while a second grid with the same number of bars as the control grid is mounted between the control grid and the anode. The grid bars of the second grid are mounted behind the control grid bars as observed from the cathode surface. Careful alignment of the grids is necessary to assure proper tetrode performance. The additional grid serves as a shield, or screen, between the input circuit and the output circuits of the tetrode, and is called a "screen grid." In addition to serving as a shield, the screen is the accelerating element attracting the electrons from the cathode. The total current from the cathode of a four-element tube is determined by the electrostatic field near the cathode, just as in the triode. The electrostatic field is a function of E_{c1} , the grid to cathode potential, and E_{c2}/μ_s , the potential due to the screen voltage electrostatic flux penetrating through the control grid wires. The anode voltage also contributes a small amount in the ratio of E_b/μ_p ; μ_p is usually so large in value that the anode voltage contribution is negligible. In an ideal tetrode there will be no anode current change with a change in anode voltage. A tetrode is therefore a constant current device. The screen voltage and control grid voltage determine the amount of anode current that will flow.

The total cathode current of an ideal tetrode can be obtained by the equation:

$$I_k = K \left(E_{c1} + \frac{E_{c2}}{\mu_s} + \frac{E_b}{\mu_p} \right)^{3/2}$$

I_k = cathode current

K = a constant determined by tube dimensions

E_{c1} = control grid voltage

E_{c2} = screen grid voltage

μ_s = screen amplification factor

μ_p = anode amplification factor

E_b = anode voltage

The arithmetic value of the screen μ (μ_s) is generally not used in the design of radio frequency and audio frequency amplifiers.

In most tetrode applications the screen amplification factor is useful to roughly categorize the performance to be expected.

The main advantages of a tetrode over a triode are:

- a. Internal anode-to-grid feedback is much lower due to the shielding effect of the screen grid.
- b. Tetrodes permit the design of amplifier stages, which can operate with driving power less than one per cent of the output power in most cases, and with negligible driving power in many audio applications.
- c. Tetrodes operate efficiently and with good life at audio and radio frequencies, including the VHF region (30 to 300 MHz) and in some cases into the UHF region (300 to 3000 MHz).
- d. Tetrodes allow designers to build compact, simple, flexible equipment with little spurious radiation.
- e. Tetrodes permit the designer to build linear amplifiers with low inter-modulation distortion products. (See Section 4.)

In designing equipment using power grid tubes, consideration must be given to unwanted electron emission from the control and screen grids. The grid materials will emit electrons as a primary emitter if the work function² of the grid surface material is low enough. The grid must be at a sufficiently high temperature for primary emission to occur. Primary grid emission is usually quite low in a thoriated tungsten filament type tube, because grid materials can be used which have high work functions. Also, the work function normally should not change significantly during the life of the tube. In the case of the oxide cathode emitter, the grid materials find themselves in a totally different environment. During the life of the tube, free barium evaporates from the cathode coating material. The rate of evaporation is a function of time and cathode temperature. Some of the free barium finds its way to the grids and they become another emitting surface. The hotter the grid, the more emission. Grids in oxide cathode tubes are often gold plated to reduce the amount of primary emission.

Another type of grid emission is secondary emission from the screen grid. The screen grid, which accelerates the electrons emitted from the cathode, is operated at a relatively low potential compared to the anode. Not all of the electrons pass through the screen grid on the way to the anode: some electrons are intercepted by the screen grid. In the process of striking the screen grid, other

2 Work Function - Expressed in electron volts. Electron Work Function represents the energy that must be supplied to an electron to cross over the surface barrier of a metal. The thermionic work function is of interest with power grid tubes. - See Data for Radio Engineers 5th edition Chap. 4-1.

low energy electrons are emitted, and are called “secondary electrons.” If these secondary electrons feel a stronger attraction by the screen, they will fall back into the screen. If, however, they find themselves out in the region between the screen grid and the anode, there is a very good chance that the much higher anode potential will attract them. The result is an electron flow from screen to anode. The control grid is not in this region and so has virtually no control over the number of secondary electrons flowing. During any part of the operating cycle of the tube it is possible that more electrons will leave the screen grid than will arrive. If this occurs, a dc current meter will indicate a reverse electron flow. On the other hand, if more electrons on the average are arriving than are leaving the screen grid, then the dc screen meter will indicate a forward electron flow. Reverse screen electron flow is quite normal for high power tetrodes. **The circuit designer must provide a low impedance path for the reverse electron flow.** EIMAC normally states on the data sheet the amount of bleeding current that must be provided from the screen power supply to counteract the emission current (see Figures 5, 6 and 7). If the screen power supply impedance is too high in the reverse electron flow direction, the screen voltage will attempt to rise to the anode voltage. Note the emphasis on low impedance in the reverse electron flow direction. Most regulated power supplies are low impedance in the forward electron flow direction only. If the supply is not well bled, the reverse electrons will try to flow in the negative direction in the screen supply regulator and cause the screen voltage to increase. As the screen voltage rises, the secondary and anode currents increase, and the tube is in a runaway condition.

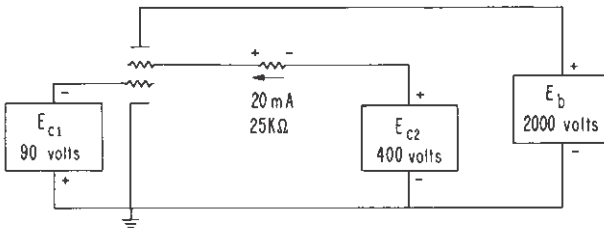

Figure 5: Incorrect screen circuit for tube requiring low impedance screen supply.

OBSERVATION

Assume that at some time during the tube’s operating cycle, the reverse electron flow is 20 mA. The voltage drop across the 25 K resistor will be 500 volts. Note the polarities. The effective screen-to-cathode voltage will be 900 volts. The increased screen voltage will increase the secondary emission.

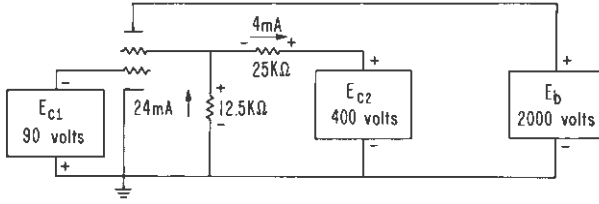

Figure 6: A correct screen circuit for tube requiring low impedance screen supply.

OBSERVATION

By the addition of a 12.5 K resistor from screen to ground, there will be a path for the grid emission 20 mA electron flow.

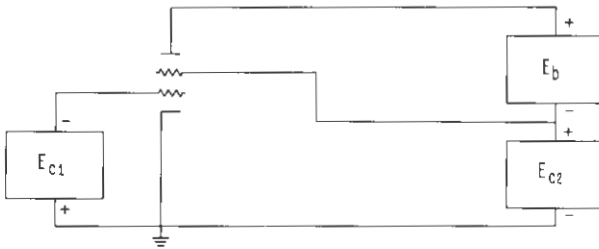

Figure 7: Another approach to swamping the screen circuit.

OBSERVATION

In the circuit of Figure 7, the anode current flows through the screen power supply, swamping the screen power supply. The screen power supply must carry the normal screen and anode current. This scheme is used quite extensively in circuits where the screen is operated at dc ground. The anode to cathode voltage is the sum of the \$E_b\$ and \$E_{c2}\$ power supplies.

The circuit designer must also consider the impedance of the control grid circuit. Primary grid emission can cause trouble if the grid circuit has too high an impedance.

The size and power of gridded tubes dictate certain characteristics of electrical potential. As this geometry increases in electrical

terms, secondary electron emission from the control grid can occur. The control grid secondary emission can be present whether the cathode is a thoriated tungsten or an oxide emitter, and can occur in a triode, tetrode or pentode. A typical curve of grid current as a function of grid voltage for a high power thoriated tungsten filament tetrode is shown in Figure 8.

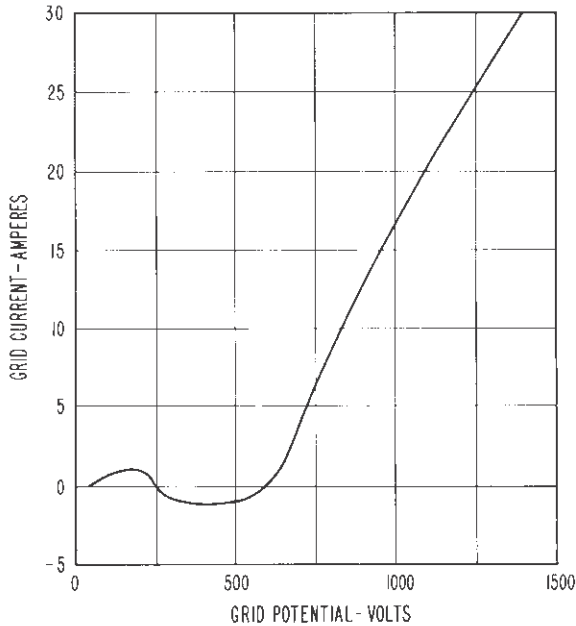

Figure 8. Typical curve of grid current as a function of control grid voltage for a high power thoriated tungsten filament tetrode.

OBSERVATION

In Figure 8, grid current decreases and eventually takes a reverse direction as the grid voltage increases. This reduction and reversal of grid current can be explained by the normal secondary emission characteristics of the metals used in the grid structure. In Figure 9, we see the secondary characteristics of the common metals presented in curve form, giving the ratio of secondary-to-primary electron current as a function of the primary electron potential.

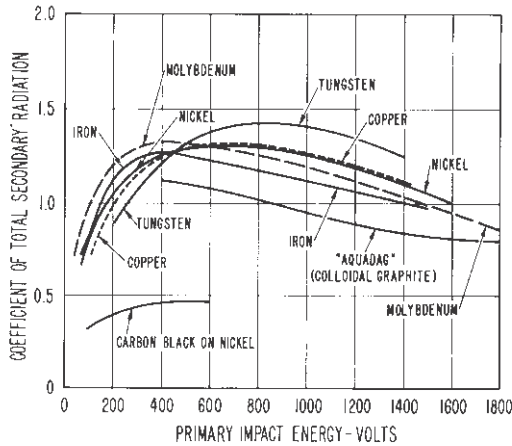

Figure 9. Secondary-emission characteristics of the metals under ordinary conditions. The curve shows the ratio of the number of secondary to primary electrons for various primary-electron impact velocities expressed in volts.

OBSERVATION

A study of Figure 9 shows the region between 200 and 600 volts to be a rather critical one as far as secondary emission is concerned. Any power grid tube which normally operates with 200 to 600 volts on the grid can exhibit the negative resistance characteristic of decreasing grid current with increasing grid voltage when another electrode, such as the anode in a triode or the screen grid in a tetrode, is at a sufficiently high potential to attract the emitted electrons. A driver stage which works into such a non-linear load normally must be designed in such a manner as to tolerate this condition. One technique would be to swamp the driver so that the change in load due to secondary grid emission is a small percentage of the total load the driver works into.

2.3 PENTODES

The pentode is a five-electrode tube; it has three grids. The control grid and screen grids perform the same function as in the tetrode. The third grid, the suppressor grid, is mounted in the region between the screen grid and the anode. The suppressor grid produces a potential minimum in the anode-screen space. This potential minimum prevents secondary electrons from being interchanged between screen and anode.

Following the analogy with the tetrode tube, the electrostatic field at the surface of the cathode is proportional to the anode voltage in a pentode.

The anode voltage in a pentode has even less effect on the total space current than in the tetrode. The same total space current equation holds:

$$I_k = K \left(E_{c1} + \frac{E_{c2}}{\mu_s} \right)^{3/2}$$

The suppressor grid may be operated negative or positive with respect to the cathode, and may be operated at cathode potential. It is possible to control the anode current by means of adjusting the suppressor grid potential. Because of this characteristic, it is possible to amplitude modulate an amplifier by applying the modulating voltage to the suppressor grid. The modulating power will be quite low because of the very low electron interception of the typical suppressor grid.

The main advantages of a pentode are:

- a. Secondary emission effects reduced.
- b. An approach to better linearity when used in linear amplifier service.
- c. It is possible to swing the anode voltage below the screen voltage without exceeding screen dissipation. This characteristic sometimes allows slightly higher power output for a given anode voltage.

Since the suppressor grid reduces the effects of secondary emission, screen grid power supply requirement to provide a reverse electron flow path may be reduced. The screen current requirement for a pentode may be somewhat higher than that for a tetrode of the same general characteristics; control grid power supply requirements will be the same as outlined for tetrodes.

2.4 Current Division

The actual value of cathode current in a power grid tube is the sum of the control grid current, the screen grid current in a tetrode, suppressor grid current in a pentode, and the anode current.

The term *current division* is used to describe the process where electrons on the way to the anode are intercepted by the control grid (or the screen grid in a tetrode). Control grid interception is inevitable when the grid is positive with respect to the cathode, due

to the proximity of the two elements. The screen grid is shadowed behind the control grid to minimize interception. But, due to it being substantially positive in voltage, the actual screen current will depend on anode voltage; because, as the anode voltage drops, the screen current increases.

By examining the constant-current curves for a particular power grid tube, one can see the effects of electron intercept. At positive grid voltages, the instantaneous values of grid current rise exponentially as the voltage is increased. Grid conductance draws power from the driving signal and the result is waveform distortion, an important consideration in linear amplifiers.

It can be seen that the anode-current curves begin to slope upward at low plate voltage, this is called the *saturation region*. In a triode all additional cathode current will begin flowing to the grid if the tube is in saturation, because as the anode voltage is decreasing it attracts fewer electrons. In tetrodes the screen current rises similarly. This loss of cathode current results in less available anode current, which is the equivalent of reduced output, but a more serious consequence is increased dissipation of the grid(s).

Using the constant-current curves for the 3CX1500A7 (Fig. 3) as an example, we see a worst-case condition where a current division of 20% may occur. Note that with a grid voltage of 100 Volts above zero (the polarity in grounded-grid curves is opposite that of cathode driven curves) an anode current of 5 amperes is obtained at $e_{b_{min}} = 500$ V and at this point the grid current will be 1 ampere. The total peak cathode current in this example is 6 amperes. It should be noted that these are instantaneous values; average (dc) current values will be considerably less. It is permissible to operate a tube under these conditions if the average current and dissipation ratings are not exceeded. Pulse modulators and switch tube applications make use of this. A method of using constant-current curves to calculate the average values of current that will be obtained in a sine-wave amplifier will be discussed in sec. 3.2.

It should be pointed out that secondary emission currents are an integral part of constant current curves. Any signs of an "island" or sudden departure from a normally smooth curve indicate the effects of secondary emission. An example of this can be seen in fig. 27 the screen current of 0.4 ampere can be seen as an "S" shape where it crosses the zero grid voltage line. Likewise, the control grid current rises from 0.25 ampere at a grid voltage of approx. 35 Volts, to 0.48 ampere at 50 Volts, then at approx. 120 volts it drops back to 0.25 ampere. This non-monotonic behavior clearly indicates secondary emission and is normal phenomena in power grid tubes.

Special factory tests are performed against test specifications that measure secondary emission of individual tube elements, allowing Quality Assurance to monitor parameters that would be otherwise difficult to measure in the field. The product uniformity that results from this care helps to maintain performance in product manufactured over long periods of time with little or no change in operating conditions. A wise circuit designer will however provide sufficient control over power supply voltages in order to accommodate slight variations in tube geometry as well as the fact that cathode emission does not remain constant over the life of a tube.

2.5 **INDUCTIVE OUTPUT TUBE (IOT)**

The Eimac Division of CPI, Inc. pioneered the introduction of one of the most significant energy efficient tubes, the IOT. Originally it was used mainly in UHF TV broadcasting, but has since then found applications in industrial and scientific markets.

2.5.1 The History of the IOT

Invented by Haeff and Nergaard, the IOT was first described by Haeff in 1939 (*Electronics*) and again, with Nergaard in 1940 (*Proceedings IRE*). In the early 1980's, Shrader and Preist³ developed a commercial version which Eimac introduced as the Klystrode® IOT – a name coined by realizing the device had the properties of a **klystron** and **tetrode**. This energy saving device was more efficient than klystrons then used in UHF television broadcast. The first IOT began broadcast service in 1988 at WCES, and as a result Eimac was awarded an Emmy for engineering excellence in 1990.

Today, most high power UHF television stations utilize IOT power amplifiers for both NTSC and 8-VSB digital television. Other applications in the scientific community also employ IOT power amplifiers.

Present day IOT amplifiers consist of both the Inductive Output Tube (IOT) and cavity hardware (see Figure 10).

3 D. Preist, M. Shrader, "The Klystrode, an Unusual Transmitting Tube with Potential for UHF-TV", IEEE Proc., Vol 70, No. 11, Nov. 1982

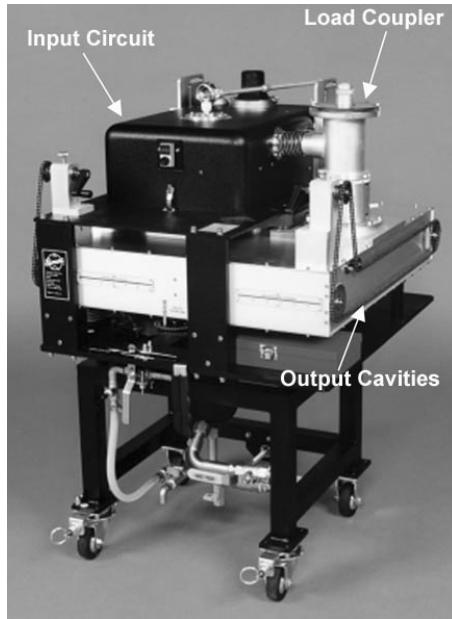

Figure 10: Eimac K2 IOT Amplifier

The hardware has an input cavity that is usually driven by a wide-band solid-state driver. The input is tuned by varying the input cavity dimensions and is matched to the driver with a stub tuner. The IOT forms a density modulated linear beam that traverses a short drift tube and is coupled to the output cavities at the tube's output gap. The kinetic energy of the high-velocity beam at the output gap is transformed to electromagnetic energy in the primary output cavity. A secondary cavity creates an over-coupled double-tuned response to obtain the 7 to 9 MHz bandwidth needed for UHF-TV application. The amplified RF signal is then coupled to the antenna system by a probe in the secondary cavity. The spent beam is intercepted by the water-cooled collector and is dissipated as heat.

2.5.2 IOT System Considerations

UHF-TV IOT systems operate at between 27 kV and 38 kV anode accelerating voltage. The anode and collector are at ground potential with the cathode operated at -27 to -38 kV with respect to the anode. With these potential levels, consideration has to be given to high voltage arcing. The small interior volume of the IOT requires that the tube be protected from internal arcs. This arc protection is accomplished by crowbar circuitry, which monitors any

sharply increased cathode current and causes either a thyratron or spark gap to conduct the arc energy directly to ground, diverting an arcing event from being absorbed by tube components.

Early IOT amplifiers were completely air-cooled. However, with the trend to higher power, a combination of air and water cooling is used. Generally, the cathode, grid, input cavity and output cavities are air-cooled. The collector is usually water-cooled (or a 50% water/glycol mixture). Higher power amplifiers may also require water cooling of the IOT anode and/or output cavity assemblies. New developments in multi-staged, depressed collector IOTs may require oil, deionized water or other collector cooling schemes.

2.5.3 IOT System Description

The major assemblies of an IOT are the gun, anode, output gap and collector assemblies (see Figure 11). The gun assembly includes the source for the electron beam and the control grid. The geometry of these components starts shaping the electron beam. A major component of the anode assembly is the drift tube through which the modulated, laminar beam is directed. Ideally, the anode intercepts none of the beam current.

IOT electron emission starts with an indirectly heated dispenser cathode. The cathode is concave, which, in conjunction with the corresponding anode and focus electrode geometry, starts shaping and focusing the electron beam to pass through the drift tube in the anode on its way to the output gap. An applied magnetic field aids in keeping the beam coherent through the drift tube and output gap.

A pyrolytic graphite control grid is mounted in very close proximity to the cathode. This grid must conform to the cathode radius with a very high degree of accuracy. Pyrolytic graphite is used for the grid because it is a rugged material that can handle high operating temperatures while retaining its shape. Pyrolytic graphite grids are formed by depositing a graphite cup on a mandrel in a high-vacuum, high-temperature furnace. The graphite cups are then cut with a laser beam to form the final grid.

The cathode is operated at -27 kV to -38 kV with respect to the anode. The grid is biased from -45 to -80 Volts with respect to the cathode. The level of grid bias determines the operating mode of the IOT amplifier.



Figure 11: Eimac K2 Inductive Output Tube

An RF signal is coupled between the cathode and grid, causing the electron beam to be density modulated. The focused and modulated beam then goes through the drift tube in the anode to the output gap where the kinetic energy of the beam is converted into electromagnetic energy in the output cavities.

Typical IOT conversion efficiencies at peak power can be in the range of 30 -55%, depending upon the type signal. This means that the remaining 70-45% power in the lower power, spent beam will be dissipated as heat in the collector. This heat is carried away by water cooling the collector.

The IOT hardware consists of three basic active parts, the input tuning section, the output cavities and the output load coupler. The hardware also provides for air and water cooling of the IOT and cavity systems. Additionally, the hardware frame is part of the IOT focus magnet frame.

The input circuit is designed to cover the full UHF (470-860 MHz) frequency band. It forms a resonator, which imparts a RF field between the cathode and grid of the IOT. A paddle inside the cavity and a shorting stub on the top portion of the input circuit are adjusted for resonance and impedance matching at the desired frequency. Shorting pins are used in the input resonator to determine the

range covered by the paddle tuner. DC electrical connections for the heater, cathode, grid and Vaclon pump are located in the input circuit assembly.

The output cavity assembly has a primary and secondary cavity. An adjustable iris opening capacitively couples these cavities. Both the primary and secondary cavity walls are movable to make the output circuit resonant at a selected frequency within the UHF TV band. The bandwidth of the system is adjusted by the position of the iris paddle.

Energy in the secondary output cavity is extracted through a coaxial probe located in the secondary cavity. Adjustment of the output probe depth controls the secondary cavity loading.

2.5.4 IOT Tuning

Eimac Inductive Output Tubes use indirectly heated tungsten-matrix type (dispenser) cathodes. This requires a warm-up period for the cathode heater before high voltage is applied to the IOT. When the cathode heater is first switched on, the heater current must be limited to 15 Amps maximum. As the heater warms up, the heater current will stabilize at approximately 8.0 to 9.0 amps. The heater power should be nominally 80 Watts at normal operating temperatures. Once the heater current is stabilized, the high voltage may be applied between the cathode and anode.

Grid bias should be adjusted to obtain a quiescent (no RF) beam current of 400 to 800 mA. The quiescent beam current will determine the basic operating mode of the IOT amplifier (class A, B, AB, C). Class AB is the usual TV mode of operation.

It is important to remember that input RF power should be limited until course tuning of both the input and output cavities is finished. This prevents dissipating too much power in the collector.

Input tuning of the IOT amplifier is best accomplished using a sweep generator and spectrum analyzer as instrumentation. The sweep generator is set at the center frequency of the channel being tuned. The sweep width is adjusted between 10 MHz to 25 MHz. The wider bandwidth is used for rough tuning, with the narrower bandwidth being used for final adjustments.

The frequency range of the input cavity is determined by shorting pins in the cavity. Normally, this range is set at the factory and

requires change only if the TV channel will be changed. Fine tuning of the input frequency is accomplished by a ten-turn adjusting knob on the front of the input circuit assembly. The input is matched to the drive with a stub tuner (see Figure 12 for an example of input tuning using the reflected drive signal. The lowest part of the reflected signal is generally set at the center frequency of the channel. The stub tuner is set to obtain the deepest response of the reflected signal.)

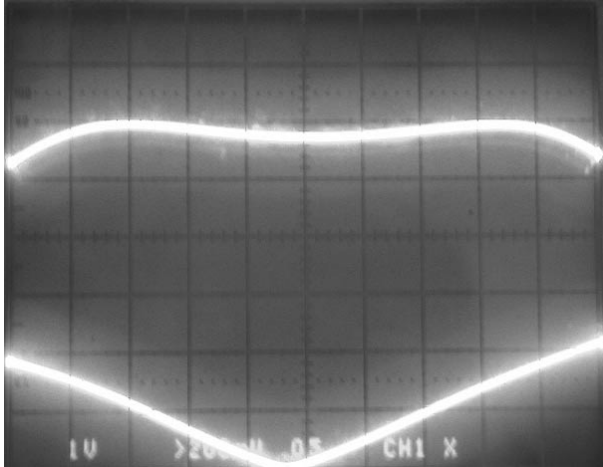

Figure 12: Typical tuning curves for UHF TV IOT. The lower curve is the reflected drive signal. The upper curve shows the output tuning.

For output tuning, the spectrum analyzer is connected to the sampled output power of the transmitter. Basically, the primary output cavity tuning controls the low frequency side of the pass band and the secondary cavity tuning controls the high frequency side of the bandpass signal. The iris coupler between the cavities controls the bandwidth and the load coupler adjustment controls the dip in the middle of the signal (see Figure 12).

2.6 MULTISTAGE DEPRESSED COLLECTOR IOT (MSDC IOT)

Because of significantly higher efficiency, i.e., the ratio of RF power out to total input power, standard IOT amplifiers have almost completely replaced previous types of power amplifiers for high power UHF broadcast transmitters. Higher efficiencies result in lower electricity usage. One way of further increasing the efficiency of IOT amplifiers is Multistage Depressed Collector technology.

A portion of the IOT's electron beam is not converted to RF energy at the output gap of the tube. This portion is called the spent beam. The spent beam can be between 50% to 70% of the total beam power.

This spent beam is directed to a collector, where most of the electron energy is dissipated as heat. This heat is wasted power, which can be partially recovered as electrical power.

Multistage Depressed Collector Inductive Output Tubes slow down electrons before they strike the surface of the collector, thereby, allowing recovery of electrical power from the spent beam by collecting the electrons as electrical current instead of generating heat. Basically, the collector is divided into one or more stages that are biased at increasing percentages of the cathode to anode potential. All of these stages are at a lower (or equal) voltages than the cathode to anode voltage. Therefore, they are called depressed voltages or depressed collectors. These depressed voltages set up equipotential fields in the collector that slow down electrons in the spent beam (see Figure 13). Ideally, the electrons are nearly stopped when they strike the collector (see Figures 14 & 15).

The number of depressed collectors and the voltages on the collectors is highly dependent upon the distribution of electron velocities in the spent electron beam. IOTs have a very uniform electron energy distribution in their spent beam. This is largely because of the more efficient density modulation (as opposed to bunching) used for IOTs. The result is that excellent power recovery can be accomplished with few depressed collector stages.

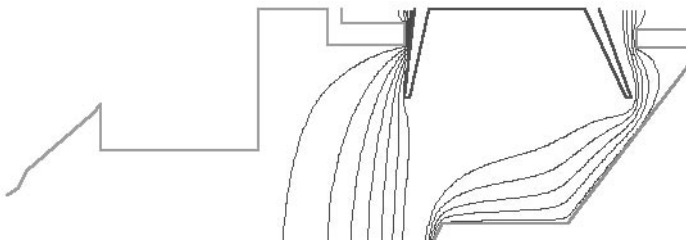

Figure 13: Equipotential lines in a three stage collector. The potentials are determined by collector geometry and collector voltages.

Ultimately, the number of collector stages used is a trade-off between the efficiency gained and the complexity of the power supply and tube fabrication. Multistage Depressed Collector

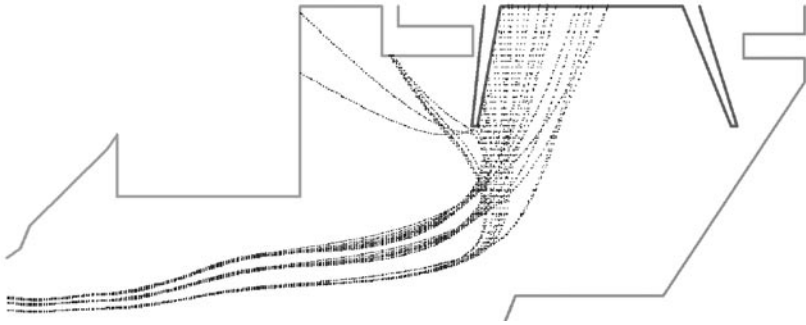

Figure 14: Electron trajectories at near to ideal power. The tube gap is at the left side of the image, which is only half the collector. The right collector element is at cathode to anode potential. The middle section is approximately half the cathode voltage. The left side collector element could be at ground potential.

Inductive Output Tubes have been demonstrated with three to five stages. Adding additional stages brings very little more efficiency gain.

One of the consequences of depressed collector design is more complex collector cooling considerations. Standard IOTs have a single collector at ground potential. This type of collector can be directly cooled by water, or a water/glycol mixture. The MSDC IOT has several collector stages at differing voltages ranging from ground to cathode potential. Cooling these collector stages requires some dielectric material to carry the heat away from the collector. MSDC collectors are commonly cooled by using air, deionized water or dielectric oil.

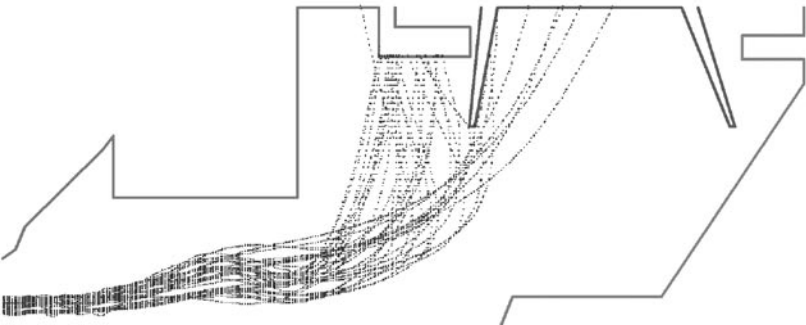

Figure 15: Electron trajectories at higher than ideal power. Less power is recovered in the middle, depressed collector segment.

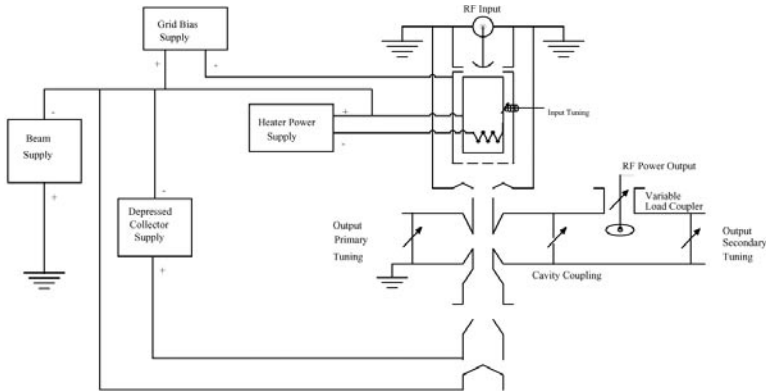

Figure 16: Typical MSDC IOT power supply schematic

2.7 CATHODE EMITTERS

2.7.1 Oxide Cathodes

The typical production-type oxide cathode is a coating of barium and strontium oxides on a base metal such as nickel. The oxide layer is formed by first coating a nickel can or disc with a mixture of barium and strontium carbonates, suspended in a binder material. The mixture is approximately 60 per cent barium carbonate and 40 per cent strontium carbonate. During vacuum processing of the tubes, they are baked out at high temperature. The binder is burned away, and the carbonates are subsequently reduced to oxides. The cathode is now “activated” and will emit electrons when hot. The typical oxide cathode operates at 1000° Kelvin and is capable of 200 mA to 300 mA per cm² of CW emission. High emission current capability for each Watt of heating power is one of the main advantages of the oxide cathode. Other advantages are high peak emission capability for short pulses, a low operating temperature and greater mechanical ruggedness compared to some other cathode configurations.

The high peak emission for short pulse operation (defined as approximately 10-20 μs) is often considered the most significant advantage of the oxide cathode. Oxide cathodes can provide peak emission in the range of 1 to 3 A/cm² for short pulse applications. The wide range reflects variation in factors such as cathode temperature, spacing, desired operation life and other details of the tube design and operating conditions. Peak emission for a given tube type is related to pulse width and duty. This is due to the fact that the ability of the cathode to emit electrons is rapidly depleted in high current density operation and, thus, a recovery time is needed between pulses. Figure 17 shows a pulse derating curve that is typical for oxide cathode tubes.

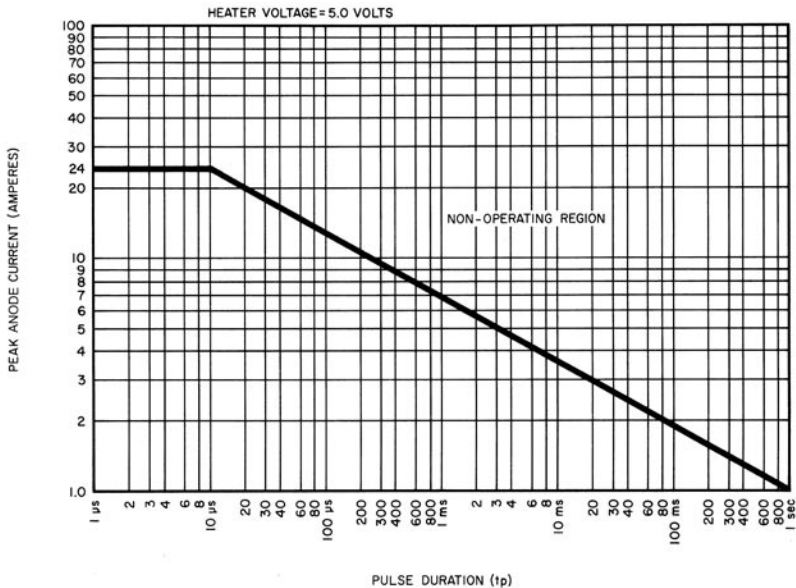

PULSE DERATING DATA, TYPE 3CPX1500A7 - PULSE MODULATOR OR REGULATOR SERVICE
 Peak (pulse) anode current capability is dependent on pulse duration (tp) and duty factor (Du).
 Maximum peak anode current for a given value of tp is shown. Maximum Du may then be
 derived from the relationship: $1.0 = i_b \sqrt{D_u}$

Figure 17: Pulse derating curve

Oxide cathodes are susceptible to deterioration due to ion bombardment. Thus, oxide-cathode tubes are usually operated at lower anode voltages because of this characteristic. Fortunately, higher voltage is very seldom needed because of the high currents available at lower voltage. Backheating is of similar concern in oxide cathode tubes operating at UHF. See Section 6.11.4

The oxide cathode material will evaporate during the life of the tube, causing free barium to migrate to other areas within the tube. The evaporation can be minimized in the design by means of a high efficiency cathode which runs as cool as possible but still is not emission-limited at the desired heater voltage. In the field, the heater voltage must not exceed the rated nominal value. An oxide cathode which is overheated gives very little more useful emission, but the life of the tube is shortened significantly. Reducing the heater voltage in an oxide cathode tube will conserve oxide material but this reduces emission capabilities. Fortunately most applications use far less than the available cathode emission, so heater voltage reduction will, if properly performed, result in a worthwhile increase in tube life.

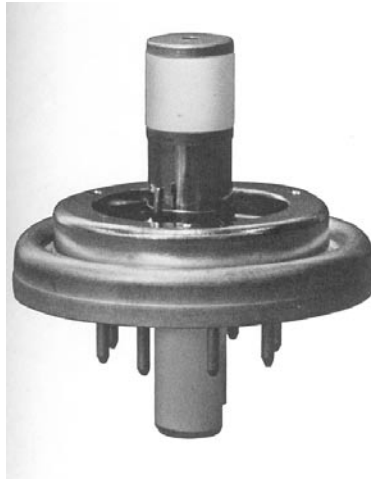

Figure 18: Typical oxide cathode.

It should be noted that because a reduction in heater voltage to an optimum value will increase the life of a tube, an even greater reduction is not likely to prove worthwhile because chemical degradation may begin to occur, sometimes referred to as “poisoning” of the cathode. This is when the temperature of the cathode is too low to prevent the rate of absorption of gas into the cathode and emission is reduced to the point that sparking may occur, causing irreversible damage to the cathode. Under these conditions the cathode may induce a localized arc and the resultant gas may ionize and precipitate a plate-to-cathode arc. Arc protection is discussed further in sec. 3.9.1. Figure 18 is representative of an oxide cathode.

2.7.2 Thoriated Tungsten Cathodes

A thoriated tungsten filament is one form of an atomic-film emitter. Thorium is added to the tungsten in the process of making tungsten wire. Typically, about 1.5 per cent of thorium in the form of thoria (thorium oxide, ThO_2) is added. By proper processing during vacuum pumping of the tube envelope, the metallic thorium is brought to the surface of the filament wire, and emission increases approximately 1000 times. The thoriated tungsten filament is also carburized. The small amount of tungsten carbide formed in the carburizing process reduces the evaporation rate of the thorium and thus increases the life of the filament. At a typical operating temperature of approximately 1900°K , a thoriated tungsten filament will produce a specific peak emission of about 500 mA/cm^2 .



Figure 19: Typical bar tungsten filament

For a thoriated tungsten cathode, peak and average emission are essentially the same. A thoriated tungsten filament is more tolerant of ion bombardment than an oxide cathode, and, therefore, higher voltages can be applied to the tube.

Thoriated tungsten filaments can be assembled in several different configurations. Figures 19 and 20 show typical bar and mesh filament construction techniques. As the size of the tube increases, mechanical considerations dictate the bar filament construction technique with spring loading to compensate for thermal expansion. The mesh filament can be used on both small and larger tubes, and is more rugged, therefore, less subject to damage from shock and vibration.

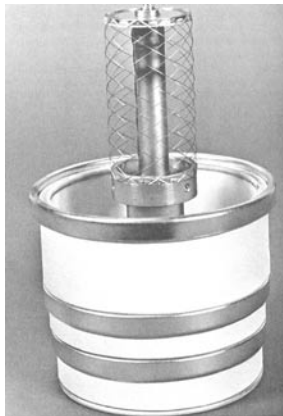

Figure 20. Typical mesh tungsten filament.

2.7.3 Gun Type Emitters

Some power grid tubes are designed as a series of electron gun structures arranged in a cylinder around a center line. This type of construction allows large amounts of anode current to flow and be controlled with a minimum amount of grid interception. With reduced grid interception, less power is dissipated in the grid structures. In the case of the control grid, less driving power is required. The typical configuration used by Eimac is called a focus cathode. This structure is essentially an oxide cathode emitter where the emitting material is applied in stripes to the cathode substrate. The tube is assembled such that these stripes of emitting material are aligned with the opening between grid bars. Thus, the grid can produce the voltage gradient needed to accelerate the electrons from the cathode while interception of electrons by the grid is minimized.

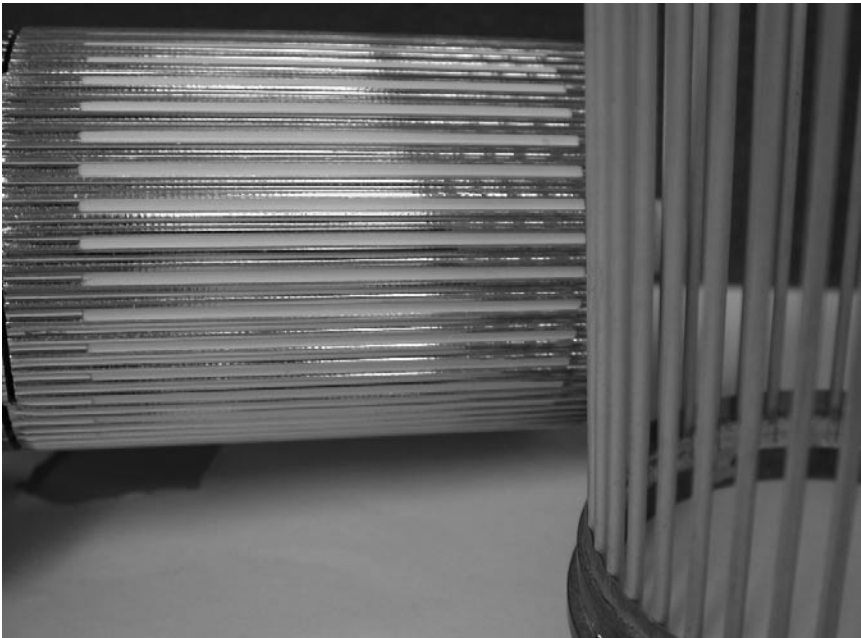

Figure 21: Typical Focus Cathode (LPT-62). The horizontal assembly is the cathode assembly. The white area between the shiny bars is the actual cathode emitting areas. The shiny bars are essentially shadow grids. This cathode assembly is mounted inside the grid assembly (shown vertically at the right) with the shadow grid bars lined-up exactly with the control grid bars. This minimizes control grid interception of electrons.

2.7.4 Tungsten Matrix Cathodes (Dispenser Cathode)

Tungsten matrix (also known as dispenser) cathodes are widely used in linear beam devices such as the klystron, traveling wave tube or IOT, but are also finding wider use in power grid tubes. The Klystrode® IOT discussed in Section 2.4 is a good example of a gridded tube that uses a tungsten-matrix cathode. The matrix cathode design takes advantage of some of the best attributes of both oxide and thoriated tungsten cathodes. This cathode is made of a porous tungsten “sponge” that is impregnated with electron emitting materials similar to those used in oxide cathode tubes. It is generally indirectly heated as is an oxide cathode. Tungsten-matrix cathodes are very rugged both mechanically and electrically. They are much more resistant to damage by ion bombardment than is the oxide cathode. Although heating power requirements are greater than for a similar size oxide cathode, these requirements are significantly less than needed for a thoriated tungsten cathode. The matrix cathode can provide peak emissions of 10 A/cm² and average emission of 1 A/cm². The large amount of emitting material dispersed throughout the tungsten “sponge” results in long operating life for tubes with a matrix cathode.

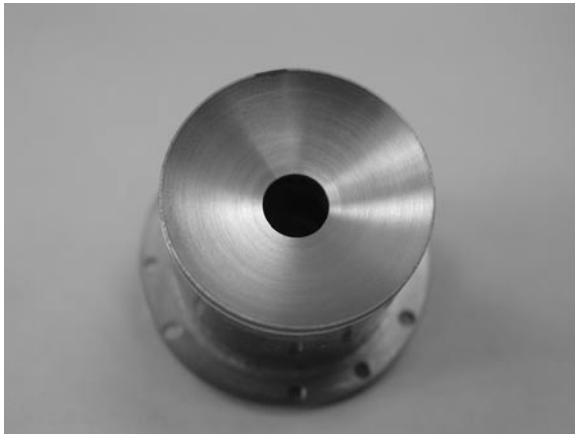

Figure 22: Tungsten Matrix (Dispenser) Cathode from a K2 series Inductive Output Tube.

2.8 GRIDS

The electrical performance of a power grid tube is determined to a high degree by the type and quality of the grid(s) employed in it. A grid must be thin enough that it appears almost “transparent” to the flow of electrons, yet thick enough that it is a rugged, self-supporting

structure capable of withstanding shock and vibration. Cylindrical shaped grid structures must retain their shape after many thermal cycles, to prevent shorting to the filament or cathode.

Grids in most power grid tubes are made from wire or bars of tungsten or molybdenum, elements that are capable of withstanding the high operating temperatures encountered without melting. These wires are welded at many points to produce the desired shape, then coated with materials that assure low secondary emission. The coating material specified is determined by the final product design. Grids used in high μ tubes often employ platinum cladding, while tubes in medium and low μ tubes employ an Eimac-proprietary coating called Y3. Grids used in oxide cathode tubes use gold plating, as described previously.

A relatively new grid material is pyrolytic graphite (PG). PG is made in a special chemical vapor deposition (CVD) process. In this CVD process, a mixture of methane and hydrogen gas under specific conditions of pressure and temperature are applied to a polished graphite mandrel. The grain growth that occurs at the molecular level results in a unique material that has thermal conductivity in certain directions that is very similar to that of metals. The fact that PG withstands extreme temperatures makes it desirable for use in high power tubes like the 4CM2500KG, which has a screen grid dissipation rating of 20 kilowatts.

PG has a very low coefficient of expansion, almost identical to that of copper. This ensures the internal spacing between the filament or cathode and the control grid will not vary significantly, regardless of grid temperature. Over the life of the tube, the shape of a PG grid will not change, ensuring uniform performance

PG is easily machined after it is removed from the mandrel and it can be cut into an almost infinite variety of apertures using a computer-controlled laser. This procedure provides for excellent parts-uniformity, thereby, guaranteeing consistent tube-to-tube performance.

Grid dissipation ratings must be respected to prevent loss of coating or possible melting of the base metal. Conventional wire grids have dissipation ratings that vary from 25 Watts in small tubes and, in very high power tubes, may have dissipation ratings as high as 20 kilowatts.

Grids in planar triodes are made from very thin tungsten wire, as small as 0.8 mils, and are gold plated to reduce primary and secondary grid emission. Grid dissipation ratings of planar triodes

are low, compared to larger power grid tubes, and are typically on the order of 1.5 to about 2 Watts.

The subject of grid protection is discussed in sec. 3.9 and should be considered one of the circuit designer's most important items of concern.

2.9 Anodes

In addition to being the area with the greatest mass in most tubes, the anode (in most cases the anode cooler, actually) serves as a contact point for external circuitry. Larger power grid tubes employ a lifting device such as handles or points where a hoist may be applied for lifting the tube from the packing crate and installation into equipment.

Electrons arriving at the anode (or collector in the case of an IOT) impart energy, depending on the accelerating voltage and the value of electron current. In addition to heat from the impact of electrons, there is some energy arriving from the filament in thoriated-tungsten tubes. Of the total power applied to the filament approx. 80 to 85% appears as heat on the anode surface. Heating from this effect is minimal in oxide cathode tubes and not generally considered as part of the total anode heating. The subject of anode cooling is covered in more detail in sec. 6.10.

The anode in most power grid tubes is fabricated using a particular grade of Oxygen Free, High Conductivity (OFHC) copper, deep drawn and machined. A few high voltage switch tubes are made using anodes consisting of vacuum-cast copper; in this technique gases are removed from the copper while it is molten and the shape determined by molding process.

Great care during vacuum pumping is necessary to remove gases that are trapped in all materials. During this process, the tube is heated by an application of external power. This "bake-out" process is very effective in removing internal gas down to the molecular level, thereby, achieving a good vacuum; only then is the tube sealed-off and removed from the pump.

However, free gas molecules will always be present to some degree in a fully processed tube. Gas, particularly oxygen containing compounds, may chemically combine with the cathode material to either permanently or temporarily destroy the electron emission capability. Free gas molecules, when struck by electrons moving from cathode to anode, may be ionized by having one or more electrons knocked from their molecular structure. If enough

such ions, plus the freed electrons from the ionization process, are present in the tube, a conduction path is provided, which is not subject to control by the grid. This can result in runaway arcing, which may involve all elements of the tube.

The anode is intentionally spaced fairly close to the grid/cathode structure to attract electrons, but far enough away to prevent breakdown or arcing under normal operating conditions. Although the anode is machined to a smooth surface, microscopic points, which grow from grain boundaries, project from all such metallic surfaces. These tiny projections can develop voltage gradients large enough, that when combined with free electrons, can promote low current paths (arcing) between tube elements. Free electrons are electrons from sources other than the cathode, such as electrons freed from molecules by ionization.

These tiny metallic projections must be removed by a process called “spot knocking” or “debarnacling.” In this process, controlled energy is applied at increasingly higher voltages to induce field emission until controlled arcing occurs at these undesirable points, thereby, melting the projections and leaving a smooth surface.

In some power grid tubes, particularly those that operate at anode voltages greater than 10 kilovolts, a reprocessing in the field may be recommended if the tube has been in storage for a substantial period of time.

It is, however, recommended that only an experienced professional who is trained in the use of high voltage equipment attempt this processing. Of equal importance is the need for using the correct power source otherwise more harm than good may result. The actual energy available to the tube during this process is determined by the value of capacitance used for an energy storage device, as well as the series resistance chosen.

Application Bulletin No. 21, “Conditioning of Large Radio-Frequency Power Tubes,” describes this subject in greater detail and is available at the Eimac web site, www.eimac.com, under Applications.

2.10 VACION PUMPS

Power grid tubes used in very high power amplifiers use anode voltages that may exceed 20 kV. Some pulse modulator tubes operate at 100 kV or higher.

At these voltages, any residual gas that may accumulate in the vacuum space will ionize and an internal arc may occur (this subject is discussed in detail in section 3.9). To prevent arc damage, a means of detecting and measuring gas within the tube is desirable.

Several Eimac high power tubes have a device called a Vaclon pump incorporated that acts as a vacuum gauge for the tube and preserves the high vacuum necessary for proper operation. The Vaclon pump captures any gas molecules that enter it by forcing the molecules to collect on a gettering surface (gettering devices use a chemically active material to trap and hold gas molecules in its molecular structure).

Vaclon pumps are basically diodes with a cold cathode (field emission device) that emits electrons when high voltage is applied between the anode and cathode. These electrons are sent into a spiraling path by an applied magnetic field toward the anode. Any gas molecules that are encountered along the way are ionized. Ionization produces further electrons, which continue the process in an avalanche manner. The positive gas ions are accelerated to the negative electrode, which is fabricated from titanium, where the ion is either implanted or is trapped chemically in the negative electrode.

High voltage power for Vaclon pumps is usually 3 to 4 kV and current limited to less than approximately 5 mA dc. The current is metered. Because ionization of gas molecules produce additional free electrons, any current that flows is directly related to the amount of gas ions that are present in the vacuum space. Thus, the ion pump current can be used to monitor the relative quality of the vacuum in the tube over a period of time.

Under operating conditions, the ion pump current can be a sensitive indication of tube elements that are near the upper limits of rated dissipation capability. For instance, if anode dissipation limits, which can be in the range of hundreds of Watts per cm² in high power amplifiers, are exceeded, localized tube element melting may occur. This melting will release gas molecules into the vacuum. These molecules will cause higher ion pump current, which, once certain current levels are exceeded, will cause a fault condition in interlock circuits and will remove power from the tube.

Once a fault is detected, the ion pump, performing its primary function, brings the tube back down to standard operating vacuum levels, if possible.

High power amplifiers using Vaclon pump equipped tubes can be designed to allow monitoring for internal gas that may be released under worst-case situations, making the ion pump a handy tool for the system operator. Using Vaclon monitoring, a system operator can make corrections to prevent tube damage, thereby improving overall reliability.

SECTION 3

ELECTRICAL DESIGN CONSIDERATIONS

3.1 CLASS OF OPERATION

Most power grid tubes used in AF or RF amplifiers can be operated over a wide range of grid bias voltage (or in the case of grounded grid configuration, cathode bias voltage) as determined by specific performance requirements such as gain, linearity and efficiency. Changes in the bias voltage will vary the *conduction angle* (that being the portion of the 360° cycle of varying anode voltage during which anode current flows.)

A useful system has been developed that identifies several common conditions of bias voltage (and resulting anode current conduction angle). The classifications thus assigned allow one to easily differentiate between the various operating conditions.

Class A is generally considered to define a conduction angle of 360°, class B is a conduction angle of 180°, with class C less than 180° conduction angle.

Class AB defines operation in the range between 180° and 360° of conduction. This class is further defined by using subscripts 1 and 2. Class AB₁ has no grid current flow and class AB₂ has some grid current flow during the anode conduction angle.

Example Class AB₂ operation - denotes an anode current conduction angle of 180° to 360° degrees and that grid current is flowing.

The class of operation has nothing to do with whether a tube is grid-driven or cathode-driven. The magnitude of the grid bias voltage establishes the class of operation; the amount of drive voltage applied to the tube determines the actual conduction angle.

The anode current conduction angle will determine to a great extent the overall anode efficiency. Anode efficiency in an amplifier is defined as the conversion of dc power into useful output power. Any power not delivered to the load is given off as heat, which must be removed from the anode to prevent damage to the tube.

System efficiency is often an important factor, particularly if prime power is obtained from a non-stationary source such as a diesel generator used in mobile systems. In applications where a power tube is operated continuously over a long period of time, improving the anode efficiency a few percent will result in considerable savings. Conversely, a reduction in anode efficiency not only raises operating costs for anode power to the tube but may also increase the cooling requirements to the extent that a larger blower motor (or water pump in the case of water-cooled tubes) is required, further raising operating costs.

Heat exchangers are needed to cool most power grid tubes, thermal energy from the anode must be removed by means of an air mover (blower), vapor-phase cooling system, water cooling, thermal link (i.e. conduction cooled) or by radiation (normally employed only in tubes with glass envelopes). Figure 23 illustrates the theoretical efficiency attainable with a tuned or resistive load, assuming the peak ac anode voltage is equal to the dc anode supply voltage.

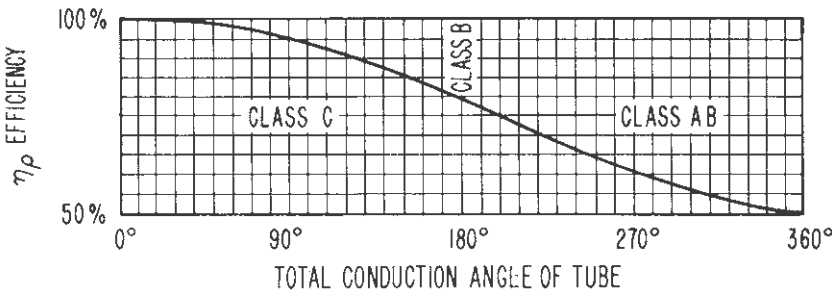

Figure 23. Anode efficiency vs. Conduction angle for an amplifier with tuned load. (From Thomas L. Martin, Jr., "Electronic Circuits," p. 452, Prentice-Hall, Inc., Englewood Cliffs, N.J., 1955).

A Class A power amplifier is used in applications requiring large amounts of low harmonic distortion power output. Class A amplifiers can be operated with very low intermodulation distortion in linear RF amplifier service (see section 4). Typical anode efficiency for a Class A amplifier is about 30 percent. The power gain is quite high due to the very low drive power required. Gains as high as 30 dB are typical. Class A service is widely used in audio amplifier and regulator service.

A Class AB power amplifier is capable of generating more power, with the same tube, than the Class A amplifier, but more

intermodulation distortion is generated at the same time. A Class B RF linear amplifier will generate still more intermodulation distortion, but is acceptable in certain applications. The anode efficiency is typically 66 percent, and stage gain is about 20 to 25 dB. Class B is used widely in audio amplifier applications, such as modulators for high level amplitude modulation.

Class C power amplifiers are used where large amounts of r-f power are to be generated with high efficiency. A Class C amplifier operates much like a limiter; therefore, it cannot amplify a modulated driver without serious distortion. Class C amplifiers are used for high level amplitude modulation wherein the anode voltage, or anode and screen voltage for tetrodes, is varied at an audio rate. Class C amplifiers must be used with tuned circuits or with a commutating output circuit with filtering. Class C cannot be used in a normal audio amplifier circuit. Class C amplifiers are also typically used in FM transmitters and in industrial applications, where large amounts of RF power are needed, but linearity is not an important factor

Class D⁴ describes a non-linear switch, where a square wave is applied to the grid and the anode alternates between non-conduction and saturation. Rise and fall times should be as fast as possible to ensure lowest losses. Practical anode efficiencies of an amplifier operating in Class D may exceed 85%, but significant harmonic energy is generated, thereby, raising filter requirements.

This class of operation requires the lowest possible saturation voltage. Therefore, significant grid current may be required while the tube is in conduction. A triode would be preferred over a tetrode because of its lower $e_{b_{min}}$.

3.2 TUBE PERFORMANCE COMPUTER FOR R-F AMPLIFIERS

It is quite easy to closely estimate the performance of a vacuum tube in radio-frequency power amplifier service, or an approximation in the case of harmonic amplifier service. Such estimates will give RF output power, dc input power, grid driving power, and all dc current values.

⁴ F.H. Raab, et al, "Power Amplifiers and Transmitters for RF and Microwave", IEEE Trans. Microwave Theory Tech., vol. 50, no. 3, pp 814-826, March 2002.

These estimates can be easily made by using the EIMAC Tube Performance Computer. This can be obtained at no cost by writing to: Application Engineering Department, CPI, EIMAC Division, 301 Industrial Road, San Carlos, CA 94070 USA. The computer is used with the characteristic curves of the tube, as plotted on the anode voltage/grid voltage coordinates (constant current curves).

By graphically laying out the trace of the anode and grid voltages as they rise and fall about the applied dc anode voltage and dc grid bias, a clear understanding of the action taking place within a tube is possible. With such an understanding, the operating conditions can be readily altered to suit individual requirements.

3.2.1 Simple Action in Class C RF Amplifiers

In an amplifier varying voltage is applied to the control grid of the tube. Simultaneously the anode voltage will vary in a similar manner, due to the action of the amplified current flowing in the anode circuit. In radio-frequency applications with resonant circuits, these voltage variations are smooth sine-wave variations, 180° out of phase (as the grid voltage rises and becomes **more** positive, the anode voltage falls and becomes **less** positive), as indicated in Figure 24. Note how these variations center about the dc anode voltage and the dc control grid bias.

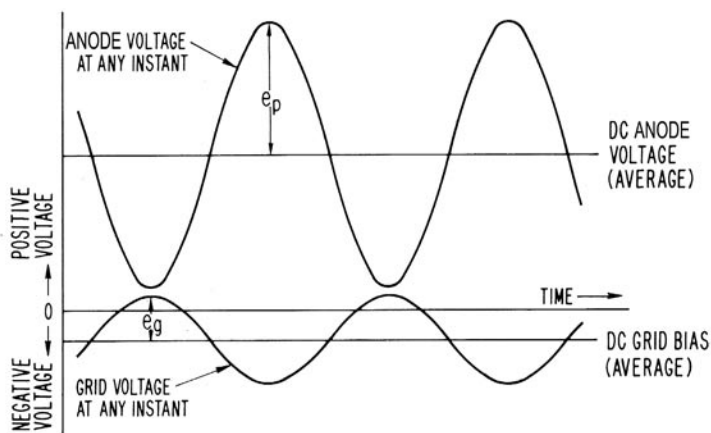

Figure 24. Variation of anode and grid voltage

Now let us see how such variations of the anode and grid voltages of a tube appear on the constant-current curves of a tube. In Figure 25 these variations have been indicated next to the anode voltage and grid voltage scales of a typical constant current curve. At some instant of time, shown as "t" on the time scales, the grid voltage has a value which is the point marked "e_g" on the grid-voltage sine wave. If one finds the point on the tube curves corresponding to these values (where a line drawn from "e_g" and a line drawn from "e_p" cross) he will be at Point A in Figure 25. As the values of the grid voltage "e_g" and anode voltage "e_p" vary over the RF cycle, Point A moves up and down a line, which in the case of the normal RF power amplifier is a straight line. This line is called the "Operating Line."

Any point on the operating line (when drawn on constant current curves as illustrated in Figures 25 or 27) tells the instantaneous values of anode current, screen current, and grid current which must flow when these particular values of grid and anode voltage are applied to the tube. Thus, by reading off the values of the currents and plotting them against time "t", one can obtain a curve of instantaneous values of anode and grid current (Figure 26).

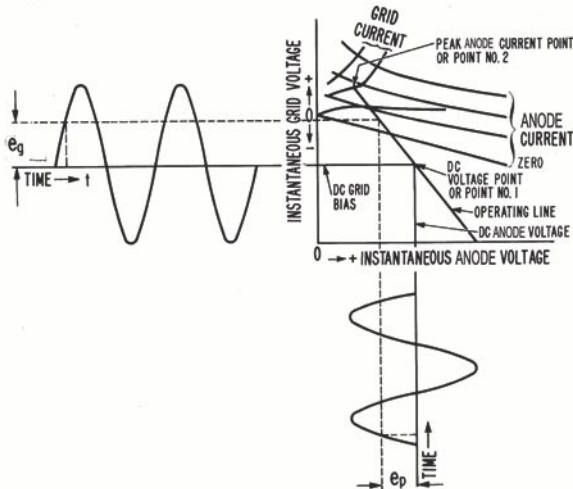

Figure 25. Anode voltage and grid voltage scales

If we analyze the anode and grid current values shown, we can predict that they will cause a dc ammeter to show a particular reading. This is called the dc component of the current. Also, we can predict that if the anode current flows through a properly-loaded resonant RF circuit, a certain amount of radio-frequency power

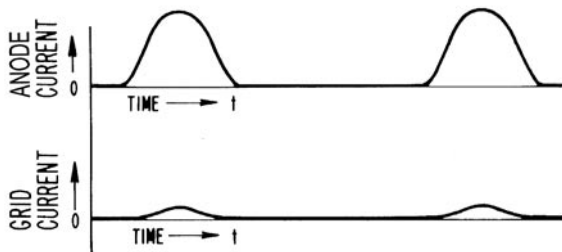

Figure 26. Instantaneous values of anode and grid current.

will be delivered to that circuit. If the circuit is tuned to the fundamental frequency (same frequency as the RF grid voltage), the power delivered will be due to the fundamental, or principal, radio-frequency component of anode current. If the circuit is tuned to a harmonic of the grid-voltage frequency, e.g., two or three times the frequency, the power delivered will be due to a harmonic component of the anode current.

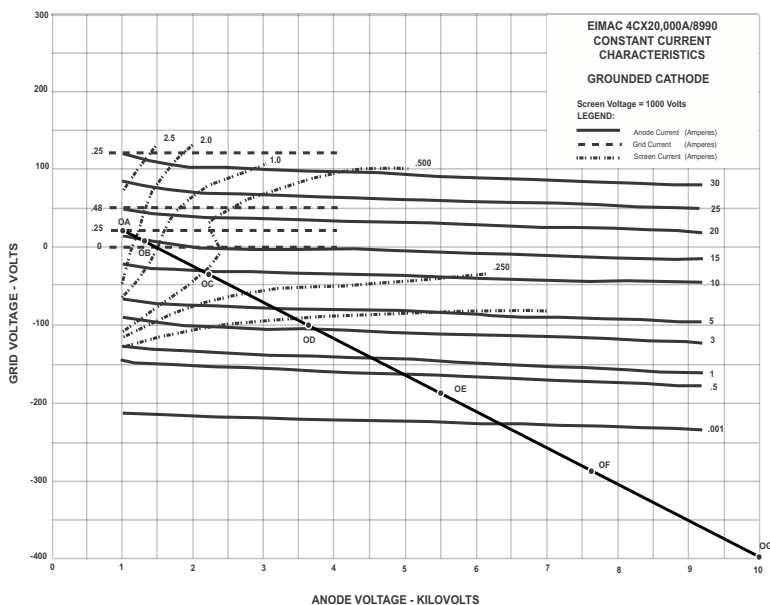

Figure 27. Constant current characteristics for 4CX20,000A/8990 tetrode.

3.2.2 Use of the EIMAC Tube Performance Computer

The EIMAC Tube Performance Computer provides the means to make these simple calculations. It is a means to determine the dc component, the fundamental RF component, or the approximate harmonic component of the current flowing in a tube when the tube is operating as a radio-frequency amplifier. It also enables one to determine what all the meter readings will be, and to predict the RF output power and the required drive power. With these factors known, we are able to forecast what will happen if any of the operating conditions are changed.

The EIMAC Tube Performance Computer

The EIMAC Tube Performance Computer consists of a transparent, graduated "Cosine Scale" overlay, which is used with the Constant-Current Characteristic curves for the tube under consideration. The transparent overlay is used to facilitate the determination of instantaneous current values of the tube at intervals of 15° along a 90° segment of the operating line of the tube, as plotted on the Constant-Current Characteristic curves. Simple arithmetic operations then yield the desired dc and peak fundamental values of the tube currents.

The EIMAC Tube Performance Computer is based on graphical methods of Fourier analysis as applied to the operation of power amplifiers and oscillators.

The EIMAC Tube Performance Computer is a simple aid to enable the selection of suitable values from the characteristic curves of a tube, and, by means of simple calculations, to forecast the performance of the tube in radio-frequency power amplifier applications.

The basic steps are outlined under "Instructions" on the Performance Computer. This requires selecting dc anode and grid-bias voltages, being guided by the typical operating values given on the technical data sheet for the tube type under investigation. Next, a suitable "operating line" must be chosen on the constant-current curves for the tube type (plotted on the grid-voltage/anode-voltage coordinates).

The computer, when properly placed over this operating line, permits one to obtain instantaneous values of the currents flowing at every 15° of the electrical cycle. The formulas given on the computer were derived by Chaffee⁵ to give the various average

5 E. L. Chaffee "A Simplified Harmonic Analysis," Review - Sci. Inst. 7, October 1936, p. 384.

and harmonic components of the resulting currents. Knowing these current component values and the radio-frequency voltage values which are determined through use of the computer, one can readily calculate the complete performance of the tube.

The fundamental methods of making such computations, the considerations necessary to stay within the ratings of the tube types while accomplishing various forms of modulation have been covered in literature.^{6, 7, 8, 9, 10} The method used for harmonic amplifier service is approximate and should be used only for tetrode and pentode tubes, where the anode voltage has little effect on the amount of anode current flowing. A more exact method, showing that for harmonic operation, the operating line is a simple Lissajou Figure, has been described by Brown.

The results obtained by using the Tube Performance Computer are a good first approximation for power amplifier design and will give good accuracy for most applications. The resulting accuracy is well within the normal tolerances of tube characteristics due to the normal variation in manufacturing dimensions of a tube. Since the published curves are only typical of the characteristics to be expected of a particular tube type, the calculated performance will be well within the values obtained when different tubes of a given tube type are operated under the assumed conditions.

3.2.3 Example Showing Detailed Use of the Computer in Class C RF Power Amplifiers

Assume that we have an EIMAC 4CX20,000A/8990 tetrode and want to make it work efficiently. Also assume that we have a 10 kilovolt dc power supply available.

Within frequency limits, we know that a tube should be able to run in Class C amplifier service with about 75% efficiency or higher, or, in other words, to convert 75% of the dc anode input power

-
- 6 H. P. Thomas, "Determination of Grid Driving Power in Radio Frequency Power Amplifiers," Proc. IRE, Vol. 21, Aug. 1933, pp. 1134-1141.
 - 7 W. G. Wagener, "Simplified Methods for Computing Performance of Transmitting Tubes," Proc. IRE, January 1937.
 - 8 R. 1. Sarbacher, "Graphical Determination of PA Performance," Electronics, December 1942.
 - 9 R. 1. Sarbacher, "Performance of Self Biased Modulated Amplifier," Electronics, April 1943.
 - 10 Robert H. Brown, "Harmonic Amplifier Design," Proc. IRE, Vol. 35, August 1947, pp. 771 - 777.

to RF output power. The difference, or 25% of the input power, is dissipated and lost as heat on the anode of the tube. The dc anode input power is then about four times the power dissipated on the anode.

The 4CX20,000A/8990 tetrode has a maximum rated anode dissipation of 20 kilowatts. To illustrate performance near the maximum rating, we will choose an input power about 1.5 to 2 times the dissipation rating, or about 30 - 40 kilowatts. At 10 kilovolts the dc anode current must then be 3 to 4 A. We will use 3.2 Amperes of anode current for our example, striving for 80% efficiency. We hope to obtain at least 25 kilowatts of output power. It is normal practice with tetrodes and medium or low μ triodes in Class C amplifier service for the dc grid bias voltage to be roughly two to three times the grid voltage necessary to cut off the flow of anode current. By referring to the curves for the 4CX20,000A/8990, it is decided to use a dc grid bias voltage of -400 volts. Higher bias voltage may be employed in applications where highest possible efficiency is desired (and additional drive power is available). In such a case, points will have to be established below the bottom-most line in the data sheet, which is -400 Volts, by scaling a new grid voltage line horizontally below the existing line. Scaling for higher anode voltage can also be done in this way (within the absolute maximum ratings established for a given tube type).

Now locate the operating line on the constant-current curves for the 4CX20,000A/8990. (See Figure 27). First, mark the point where the dc grid bias and dc anode voltage cross. The operating line must go through this point, which can be referred to as "Point No. 1." Next, the peak value of the anode current and how low we can let the instantaneous value of anode voltage ($e_{b_{min}}$) be when the tube is passing this much current must be decided. This is necessary in order to locate the other end of the operating line, e.g., "Point No. 2".

The peak value of anode current in Class C amplifiers can range from three to five times the value of average dc anode current, the actual value being determined by the conduction angle (narrower conduction angles result in a higher peak-to-dc ratio). Less than 120 degrees is a typical conduction angle and a peak-to-average ratio of 5 is typical in high efficiency class-C service. The minimum value of $e_{b_{min}}$ is usually limited by the fact that if it is too low, the grid current in triodes or the screen current in tetrodes will be needlessly high, resulting in high grid or screen dissipation. Little will be gained as far as output power is concerned if the tube is

driven “harder.” The minimum value of anode voltage is usually in the region where the anode constant-current curves bend upward (entering saturation, see Figure 27.) In the case of triodes, this is near the “diode line,” where the instantaneous anode and grid voltages are equal. The practical procedure in calculating tube performance is to arbitrarily choose Point No. 2, complete the calculations, and compare the data to target values and repeat the process until the desired results are obtained.

In the case of the 4CX20,000A/8990, let us choose a peak value of anode current about five times that of the dc anode current of 3.2 Amperes, or approx. 16 A. Let us choose a minimum instantaneous anode voltage of 1 kilovolt, the same value of screen voltage used when the curves were taken. This defines the upper end of the *operating line*. Locate this point on the tube curves, and refer to it as Point No. 2 in Figure 27. (The anode currents which flow at various combinations of anode and grid voltages are shown by the anode-current lines.) The value of current for each line is noted. In-between values can be estimated closely enough for our purposes. Draw a straight line between Points 1 and 2. This line is the *operating line*, and shows the current and voltage values at each instant in the RF cycle when the current is being taken from the tube. The nonconducting half of the RF cycle would be shown by extending the line an equal distance on the opposite side of Point No. 1. There is little to be gained by this line extension, since no current flows during this half of the cycle.

The EIMAC Tube Performance Computer can now be used to obtain the average currents (what will become meter readings in actual operating conditions) and anticipated power values from this *operating line*. Overlay the computer on the constant-current curve so that the “guide lines” of the computer are parallel with the *operating line*. Slide the computer (without turning it) until the line **OG** passes through the dc voltage point No. 1, and line **OA** passes through the peak-current Point No. 2. Be sure the guide lines are still parallel to the *operating line*.

Note that the lines OB, OC, OD, OE, and OF all cross over the *operating line*.

At each point where the lines OA, OB, etc. cross the *operating line*, we must determine the instantaneous values of anode current and grid current (and screen current if a tetrode or pentode is used) which are flowing at that particular moment in the RF cycle.

Later, from these key values of current, values of anode current, grid current, screen current, and the RF components of the anode current may be calculated.

These current values should be listed for each point where the lines OA, OB, etc. cross the *operating line* so that they can be combined later to calculate the various tube currents. At points where OE and OF cross, the current values are insignificant or zero in Class C operation.

In the examples chosen, read off the instantaneous anode current values where these lines cross the operating line. At the point where the line OA crosses the operating line, the anode current is 16 A. Where OB crosses the operating line, the anode current is 15 A. At OC the anode current is about 9 A, OD is 3 A, OE is 0.25 A, and OF and OG are 0 mA. Similarly, the instantaneous screen current at the crossing of OA and the operating line is 2.25 A, and the instantaneous grid current is 0.25 A. Values are read for the other crossover points and written down. These values are put into columns for calculation:

Instantaneous current values				
Crossing of Line	Simplified name in Formulas	Anode	Screen	Control Grid
OA	A	16A	2.25A	0.25A
OB	B	15	1.5	0.14
OC	C	9	0.5	0
OD	D	3	0.1	0
OE	E	0.25	0	0
OF	F	0	0	0

In order to obtain the dc value of anode, screen, and control grid currents the formula (see computer) indicated that the above values should be added, using only one-half the A values (giving 8 A for anode, 1.125 A for screen, and 125 mA for grid), and then divided by 12 (or multiplied by .0833), as follows

D-C meter reading = 1/12 times (0.5A+B+C+D+E+F)

Anode	Screen	Control Grid
8A	1.125A	125 mA
15	1.5	140
9	0.5	0
3	0.1	0
0.25	0	0
0	0	0

D-C current = 1/12 totals = (approximately)

2.9A	269mA	22mA
------	-------	------

To calculate the RF output power it is necessary to use the formula for the peak RF current which is present in the tube anode current. Since the tube is being used as a straight RF power amplifier, use the formula for "Peak Fundamental RF" as shown on the computer. If estimating the performance of a doubler or tripler, use the formula for "Peak 2nd Harmonic RF" or "Peak 3rd Harmonic RF."

From the computer, it may be seen that the formula for the peak fundamental RF current is:

$$\begin{array}{rcl}
 & 1/12 (A+1.93B+1.73C+1.41D+E+0.52F) & \\
 A & = & 8 & = & 16 \text{ A} \\
 1.93B & = & 1.93 \times 15 & = & 28.95 \\
 1.73C & = & 1.73 \times 9 & = & 15.57 \\
 1.41D & = & 1.41 \times 3 & = & 4.23 \\
 E & = & 0.25 & = & 0.25 \\
 \text{Total} & & & & 65.0 \text{ A}
 \end{array}$$

Peak fundamental current = 1/12 total or 65/12 = 5.4 A

The various current values are now at hand. In order to calculate the powers involved, it is necessary to know not only the dc voltage values but also the greatest amount each value swings away from the dc value. This is known as the peak value of the RF voltage. Because the anode voltage swings from 10 kilovolts down to 1 kV, the peak RF anode voltage is the difference between these two Figures, or 9 kilovolts. Similarly, the grid voltage must rise and fall between the operating points No. 1 and No. 2, or from -400 volts to +20 volts. This is a peak swing of 420 volts, and the peak RF grid voltage is +20 volts. Now use the formula for output power and driving power: Output power = one-half RF anode current x peak RF anode voltage.

The peak RF anode current is found to be 5.4 ampere, and the peak RF anode voltage is found to be 9 kilovolts.

$$\begin{aligned}
 \text{So: Output Power} &= 5.4 \times 9000 \times 0.5 = 24.3 \text{ kilowatts.} \\
 \text{and Input Power} &= \text{dc Anode Current} \times \text{dc Anode Voltage} = 2.9 \times 10,000 = 29 \text{ kilowatts} \\
 \text{Anode Dissipation} &= \text{dc Input Power} - \text{RF Output Power} = 29 - 24.3 = 4.7 \text{ kilowatts} \\
 \text{Efficiency} &= \text{r - f Output Power divided by d - c Input Power} \\
 &= 24.3/29 = 83\% \\
 \text{Driving Power} &= \text{dc Grid Current} \times \text{Peak RF Grid Voltage} \\
 &= 0.0265 \times 420 = 111 \text{ Watts}
 \end{aligned}$$

The power consumed by the bias source is the product of the dc grid current and the dc grid voltage, or $0.022 \times 400 = 88$ Watts.

The difference between the driving power and the power consumed by the bias source is the power dissipated on the control grid, or $111 - 88 = 23$ Watts.

The power dissipated on the screen grid is the product of the dc screen current and the dc screen voltage, because the screen grid has no impedance between it and the dc screen supply. Thus it is $0.269 \times 1000 = 269$ Watts.

The performance of the tube can be summarized:

dc Anode Voltage	10,000	Volts	Driving Power	111	Watts
dc Screen Voltage	1000	Volts	Grid Dissipation	23	Watts
dc Grid Voltage	-400	Volts	Screen Dissipation	269	Watts
dc Anode Current	2.9	A	Anode Input Power	29	kW
dc Screen Current	269	mA	Anode Output Power	24.3	kW
Peak RF Grid Voltage	420	Volts	Anode Dissipation	4.7	kW
calculated efficiency	83%				

We see that the resulting calculated value of dc anode current (2.9 A) is lower than our initially chosen value of 3.2 by approx. ten percent, evidence that calculated efficiency of 83% is higher than the target value of 80% we initially anticipated. In the "real world" actual transmitter output power will be somewhat lower than calculated values because of RF losses in the output matching network. One should also be aware that there may be variations in output from one tube to another due to varying electrical characteristics and that a tube that has been in service for an appreciable length of time may deliver less output than it did when it was new. Varying the dc screen voltage on a tetrode is an excellent method for

varying output power and is employed for maintaining a fixed power requirement; as a given tube ages and loses emission from the filament its output power will decline. Compensating for losses over time is easily accomplished by using a voltage source for the screen that is adjustable by means of a closed-loop regulator system. If one wishes to calculate tube performance of a tetrode at screen voltages other than those at which the constant current curves were taken, a compensating factor using the three-halves power law can be employed (see sec 6.4). To account for loss of output over time a good designer will choose a tube that has output power capabilities well above the specified requirement, using as much conservatism as practicable. In the case of the 4CX20,000A/8990 in FM broadcast service actual tube life of 10,000 to 20,000 hours is common, indicating this tube is a good choice for supplying RF power from approx. 20 to 30 kilowatts in continuous commercial service.

3.2.4 Use of EIMAC Tube Performance Computer for Class A, AB, and B Service

While the EIMAC Tube Performance Computer is primarily designed for use in Class C service, it may be used for Class A, AB, and B service where the idling (quiescent) anode current is not zero. To calculate performance for operating conditions having a large order of idling anode current, the anode current flow during the positive half of the anode voltage swing becomes appreciable and cannot be ignored. When the tube functions over 180 degrees or more of the operating cycle, a full set of ordinate points must be employed for the computations. The computer is therefore used in a two-step process.

First, determine the operating line. The computer is used in the normal fashion to derive the instantaneous values of anode, screen, and grid current during the negative half of the anode voltage swing. These current points are logged as explained under the Class C service description.

Now, determine the instantaneous current points over the positive portion of the anode voltage cycle. Combine these with the points taken for the negative half of the cycle. This is done in the following fashion: a line is penciled on the computer over the operating line, and of equivalent length. The computer is now inverted and rotated 180° and again aligned with the chosen operating line on the constant current curve, so that inverted point G falls on the idling current value (Point No. 1) and inverted point A passes through a minimum peak current point representing maximum positive anode

voltage swing. The penciled line on the computer now represents an extension of the operating line into the area of positive peak voltage swing. The extended operating line is a straight line, twice as long as the original operating line. Instantaneous values of anode, screen, and grid current (if any) are those observed where the reversed ordinate lines on the computer cross the extended operating line.

The current points measured with the computer inverted are logged and these, together with the points obtained in the first operation (computer right side up) provide a full set of instantaneous peak current values necessary for the calculation of Class A, AB, or B parameters. With the first set of computer readings termed A, B, C, D, E, F and G, the second (inverted) set of Figures may be termed A', B', C', D', E', and F', with the sets used in the following formulae, which are modifications of Chaffee's permitting the use of current values directly from the constant current curves:

$$(1) \text{ D. C. Current (Meter Reading)} = \frac{1}{12} \left[\frac{A + A'}{2} + (B + B') + (C + C') + (D + D') + (E + E') + (F + F') + G \right]$$

$$(2) \text{ Peak Fundamental RF Current} = \frac{1}{12} [(A - A') + 1.93 (B - B') + 1.73 (C - C') + 1.41 (D - D') + (E - E') + 0.52 (F - F')]$$

$$(3) \text{ Approx. 2d Harmonic RF current (tetrodes or pentodes only)} = \frac{1}{12} [(A + A') + 1.73 (B + B') + (C + C') - (E + E') - 1.73 (F + F') - 2G]$$

$$(4) \text{ Approx. 3d Harmonic RF current (tetrodes or pentodes only)} = \frac{1}{12} [(A - A') + 1.41 (B - B') - 1.41 (D - D') - 2(E - E') - 1.41 (F - F')]$$

$$(5) \text{ Power Output} = \frac{\text{Peak Fundamental RF current} \times \text{Peak RF voltage}}{2}$$

$$(6) \text{ Resonant Load Impedance} = \frac{\text{Peak RF Voltage}}{\text{Peak Fund. RF Current}}$$

3.2.5 An Example: Using the Computer for Class AB₁ Service

Operating data is to be derived for an EIMAC 4CW100,000D tetrode operating at a anode potential of 10 kV with a screen potential of 1.5 kV. Assume that power output design goal for this particular application is about 60 kW. Grid current is zero; that is, the tube is operated in the Class AB₁ mode, with the grid never being driven positive.

Within frequency limits, an anode circuit efficiency of about 55-60% may be assumed for Class AB₁ operation. Maximum dc anode input is therefore 2.2 to 2.75 times the anode dissipation. A maximum power input of 2.2 x 50,000 = .110 kW is chosen. At 10 kV, the maximum dc anode current is then 11.0 A. This is within the maximum rated anode current of 15 A for Class AB₁ service as specified on the data sheet.

For Class AB₁ service the tube does not operate in a cut-off condition, but rather a certain value of idling anode current exists. This must be taken into account when choosing Point 1 on the constant current curve. Generally speaking, high levels of resting anode current provide reduced levels of intermodulation distortion products and somewhat lower anode efficiency. Idling anode current is usually chosen so that anode dissipation under quiescent conditions is about 50-70% of the maximum dissipation rating. In the following example, idling anode current is chosen to be 4.5 amperes. From Figure 28, it may be determined that a grid potential of about -295 volts is required to produce the desired anode current at the chosen screen and anode potentials. The intersection of the -295 volt bias line and the 10 kV anode line determines the idling point on the operating line (Point No. 1).

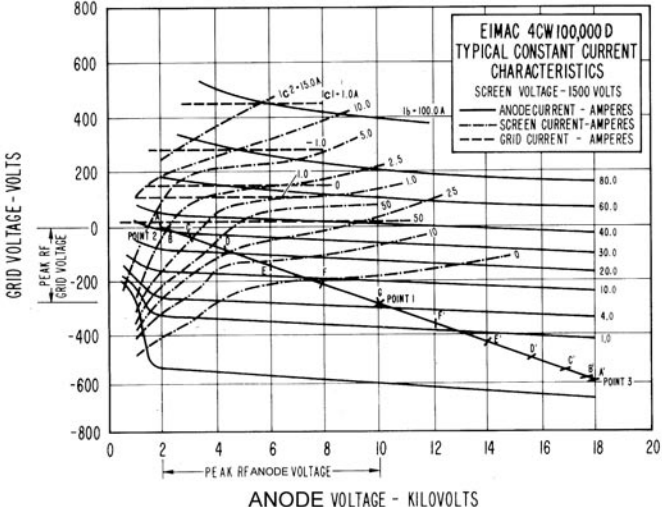

Figure 28. Constant current characteristics for 4CW100,000D tetrode.

Next, the peak value of anode current must be determined, and the minimum amount of instantaneous anode voltage chosen to pass this amount of current. Determination of these values will locate Point No. 2 and will thus define the operating line.

Class AB₁ service limits grid voltage excursions to negative grid regions on the constant current graph. Point No. 2 therefore may never be located above the zero grid voltage line. In addition, the minimum instantaneous anode voltage is usually not allowed to swing as low as the dc screen potential, since screen dissipation tends to become abnormally high. The location of Point No. 2 thus has certain restrictive limits defined by screen dissipation

and the maximum positive grid signal voltage. In this case, for the 4CW100,000D, minimum instantaneous anode voltage is about 2 kV. Peak RF voltage is thus 10,000 - 2,000 = 8,000 volts.

Peak RF anode current in a Class AB₁ amplifier usually runs about 2.5 to 3.0 times the average dc anode current. In this case, a maximum peak anode current of about 2.9 times the maximum signal dc anode current of 11.0 A, or 32 amperes, is chosen. This defines Point No. 2, which is at the intersection of the 2 kV minimum anode voltage line and thus falls within the limits discussed in the preceding paragraph. A straight line is drawn between Point No. 1 and Point No. 2 which is the negative anode cycle portion of the operating line.

When the operating line is extended to the right of Point No. 1, it can be observed that the tube conducts over the rest of the cycle where (by virtue of the "flywheel" effect of the resonant tank circuit) the instantaneous anode voltage swings as far above the normal dc value as it swings below. It is important to note that operation with less than cutoff bias requires that the EIMAC Tube Performance Computer employ points on the operating line falling to the right of Point No. 1. The operating line is accordingly extended and the computer is used in a two-part operation, as shown in the following example:

4CW100,000D COMPUTATIONS

d-c Plate Voltage = 10 kV	Power Input	= 110 kW
d-c Screen Voltage = 1.5 kV	Max. d-c Plate Current =	11 amp.
	Zero-Signal Plate Current =	4.5 amp.
	d - c Grid Voltage =	-295 volts
Constant Current Graph and	Peak Plate Current =	32 amp.
Operating Line determine:	Peak RF Voltage =	8,000

Step One

EIMAC Computer Readings		
Instantaneous Peak Current (amps)		
Ordinate Crossing	Plate	Screen
A	32	3
B	31	2
C	28	1.2
D	22	0.25
E	15	0.07
F	9	—
G	4.5	—

Step Two

Inverted Computer Readings		
Instantaneous Peak Current (amps)		
Ordinate Crossing	Plate	Screen
A'	0.20	—
B'	0.25	—
C'	0.30	—
D'	0.50	—
E'	0.80	—
F'	1.50	—

d-c Plate Current = $\frac{1}{12} \left[\frac{32^2}{2} + 31.25 \cdot 28.3 + 22.5 \cdot 15.8 + 10.5 \cdot 4.5 \right]$ 10.75 amp.

Plate Power Input = 10 kV x 10.75A = 107,500 watts

Peak Fundamental RF Current = $\frac{1}{12} \left[31.5 \cdot 59.4 + 47.7 \cdot 30.3 + 14.2 \cdot 3.9 \right]$ = 15.6 amp.

Power Output = $\frac{15.6 \times 8000}{2}$ = 62,500 watts

Plate Dissipation = 45,000 watts

Efficiency = $\frac{62,500}{107,500} \times 100$ = 58.2%

Resonant Load Impedance = $\frac{8000}{15.6}$ = 512 ohms

d-c Screen Current = $\frac{1}{12} \left[\frac{3}{2} + 2 + 1.2 + 0.25 + 0.07 \right]$ = .417 mA.

3.3 TYPICAL RF AMPLIFIER CIRCUIT DESIGNS

In the previous discussion of tube performance calculations, an example was worked out using the 4CX20,000A in class C service. Using the obtained operating parameters, it is now possible to demonstrate the next step in the circuit design. For the benefit of discussion, it will be assumed that the output circuit is a shunt-fed pi-network; it will also be assumed that the grid circuit is to be tuned by a conventional parallel tuned circuit. The circuit will be as shown in Figure 29.

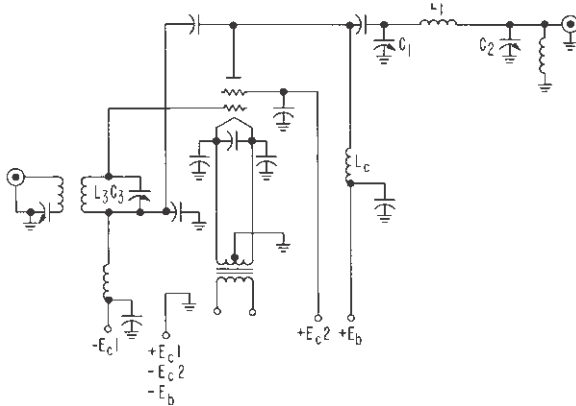

Figure 29. A typical circuit for an RF amplifier.

The first step in designing the output circuit is to specify the resonant load impedance of the tube, the loaded Q of the circuit and the desired output impedance of the network. The resonant load impedance for the 4CX20,000A is determined by dividing the anode peak RF voltage swing by the anode peak fundamental RF current.

Resonant Load Impedance = Peak RF Voltage/Peak Fundamental RF Current

$$RL = 9000 \text{ volts}/5.4 \text{ amperes}$$

$$= 1667 \text{ Ohms}$$

If it is assumed that the output impedance of the network is to be 50 Ohms and the loaded Q is to be 15, the output tuned circuit may now be designed.

The output impedance of 50 Ohms will match into a properly terminated 50-Ohm transmission line. The loaded Q of 15 is a compromise between circuit efficiency and harmonic attenuation

(see Fig. 30). Figures 31, 32, and 33 are design graphs for matching typical tube load impedances into 50 Ohms with a loaded Q of 15. The general equations are given for other load

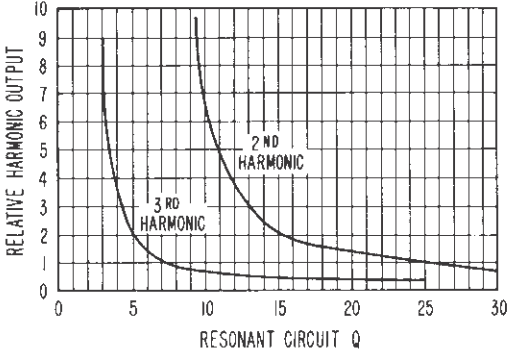

Figure 30: Relative harmonic vs. Resonant circuit Q.

impedances and other Q's. For the purpose of this example, the parameters for 2 MHz will be determined. At this frequency the value of C1 (Figure 31) will be 700 pF, C2 will be 4000 pF and the value of L1 will be 9.5 microhenries. The C1 value includes the tube output capacitance, the stray capacitance from tube to ground

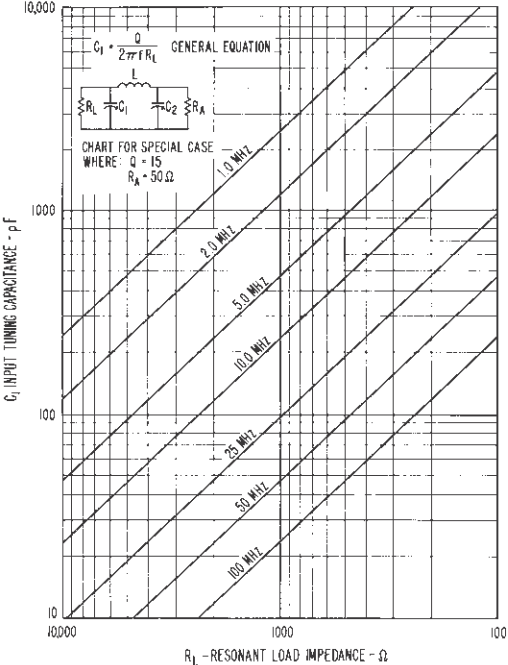

Figure 31: Determination of input capacitor C1.

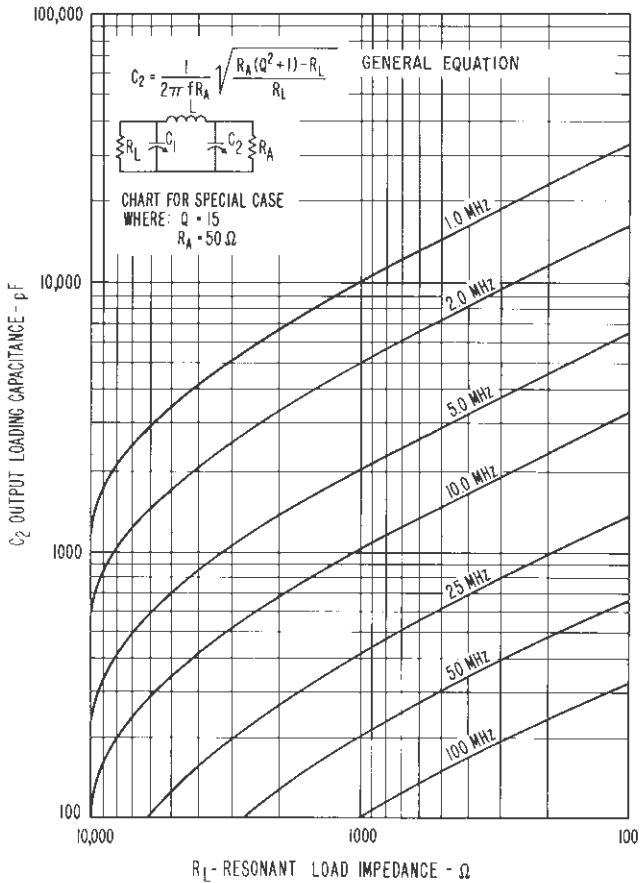

Figure 32: Determination of loading Capacitor C₂.

and the lumped capacitance added to the circuit. The output capacitance of the tube is given on the Eimac technical data sheet. Tube capacitance is measured in a shielded fixture (using a 4-wire bridge at 100 kHz), therefore the value that is obtained is one that is confined to the tube alone. Stray capacitance becomes increasingly important at higher frequencies; at 2 MHz it may be neglected.

The inductance of the anode choke (L_C in Figure 29) may be determined by noting that it is in shunt with the tuned circuit. If the RF current through the choke is to be limited to one percent of the tuned circuit circulating current, the inductance of L_C must then

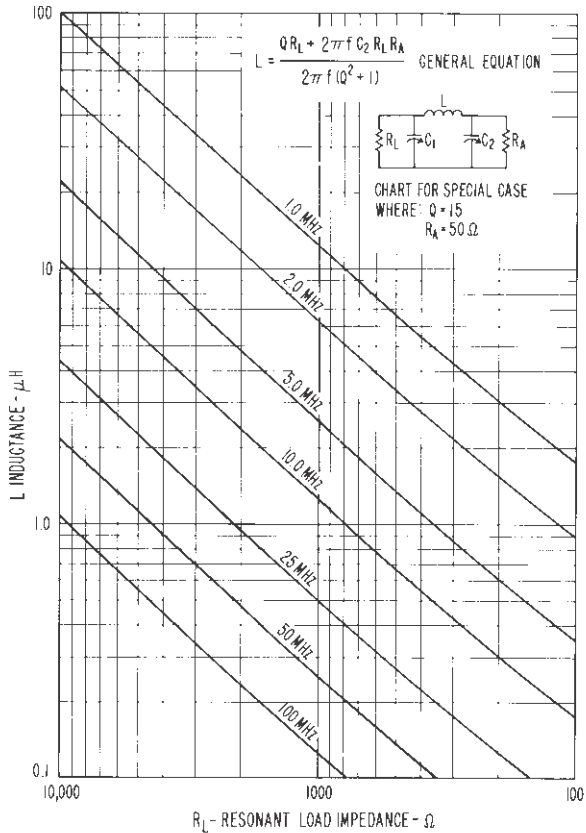

Figure 33A. Determination of Inductor L

be 100 times that of coil L. The inductance of L_c would then be 950 microhenries. The series resonant frequency of the anode choke must be determined to assure that it is outside the normal operating frequency range of the amplifier. This can be checked by shorting the ends of the choke together using a low inductance strap and measuring the resonant frequency by means of a grid-dip meter or impedance bridge. Building an amplifier that covers a wide range of frequencies (for example 2 to 30 MHz) may present such a demand on the anode choke that the easiest and most effective solution is to use two RF chokes in series, shorting out one section on all but the lowest frequency band. Varying the pitch of a portion of the solenoid windings is another technique for avoiding a series resonance at an undesired frequency. Pi-wound chokes are often riddled with resonances and are generally not used in high power amplifiers.

$$R = \frac{P}{I^2}$$

R = input resistance
P = power delivered to grid
I = d-c grid current

$$R = \frac{1.4 \text{ watts}}{(.014 \text{ amps})^2} = 7140 \text{ ohms}$$

$$X_C = X_L = \frac{R}{Q}$$

X_C = capacitive reactance of input circuit
 X_L = inductive reactance of input circuit
Q = loaded Q of grid circuit
 $X_C = X_L = \frac{7140}{15} = 476 \text{ ohms}$

It is also important to determine the parallel-resonant frequency of the anode choke due to the stray capacitance involved. A choke will exhibit inductive reactance below the parallel resonance and capacitive reactance above the resonance. The parallel resonant frequency must therefore be above the operating frequency of the amplifier by a small amount.

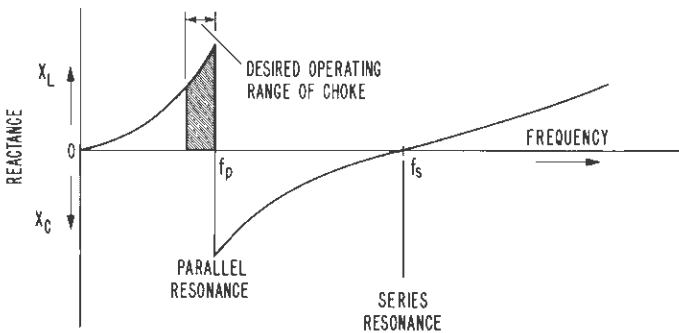

Figure 33B. Reactance of an RF choke vs. Frequency.

The design of a typical grid-tuned circuit is quite similar to the design of the anode resonant circuit. For class C operation, or any class where grid current is flowing, the input circuit must have sufficient Q to maintain a sinusoidal grid wave shape. The tube's input resistance loads the input circuit. It is considered good engineering practice to have a circuit Q of between 12 and 15. In any class of operation with no grid current, the grid circuit requirements are not as stringent, provided broad bandwidth is not a factor. Applications where broad frequency coverage is desired may better utilize a ferrite loaded impedance matching transformer terminated into a non-inductive resistor (typically 400 Ohms to 1K Ohms); this is

then coupled to a parallel resonant circuit at the control grid. The net power gain resulting from such a circuit is somewhat less than that of a conventional high-impedance grid-tuned circuit but this circuit generally does not require as much neutralization, due to the swamping effect of the low grid impedance.

For the 4CX20,000A example using a parallel tuned matching circuit (Fig. 27), the tube's input resistance is approx. the power delivered to the grid of the tube divided by the square of the dc grid current.

The input circuit capacitance C3, for 2 MHz operation will therefore be approx. 1250 pF. The input circuit inductance L3 will be approx. 5 microhenries.

A further point of interest is the magnitude of the current necessary to charge the tube's interelectrode capacitances; these must be charged and discharged during each RF cycle. The input capacitance of the 4CX20,000A is approx. 190 pF and the output capacitance is approx. 24 pF. With these values of capacitance, the input capacitive reactance at 2 MHz is 418 Ohms, and the output reactance is about 3300 Ohms. In the 4CX20,000A example, the grid voltage swing is 420 Volts; therefore, the grid charging current will be $420/418$ or about 1 Ampere. The anode voltage swing is 9000 Volts; therefore, the anode charging current will be $9000/3300$ or 2.72 Amperes. Current values for this tube are quite low in this case because the frequency is relatively low. Operating this tube under the same conditions at fifty times this frequency (100 MHz) the charging currents will be fifty times the 2 MHz example. The greater the charging current the greater the tube seal heating, electrode heating, circuit losses and the greater the current in the screen bypass capacitor. At higher frequencies it is better to limit the anode voltage swing and raise the anode current to supply the same power output. This technique reduces the magnitude of the anode charging current with generally only a slight loss of anode efficiency.

3.4 COMPONENT PARTS

If one is to maintain good isolation of the output and input circuits, some thought must be given to the location of the component parts of the amplifier. All component parts of the grid or input circuit and any earlier stages must be kept out of the anode circuit compartment. Similarly, anode circuit parts must be kept out of the input compartment. A discussion of compartmental enclosures is presented in sec. 6.7.3.

Proper choice of materials for interconnecting the tube and circuit is also important where long life and good performance is concerned. Copper is the preferred material for connection straps although brass and aluminum are also suitable in most cases; surface plating is optional in low power applications and not generally necessary, except for cosmetic reasons or corrosion prevention. Silver plating is preferred in components used for VHF and UHF, especially where high power (over approx. 10 KW) is anticipated; oxidized or tarnished silver does not exhibit significantly more loss than its untarnished state, due to the fact that it is still a good conductor. Nickel plating is often employed where cost may be a factor; its greater resistance to chemicals is another advantage. Components used with water-cooled tubes or tubes designed to be immersed in insulating oil or gas are often nickel plated. Gold plating is preferred in microwave cavities to reduce losses due to skin effect and because gold does not oxidize. Steel and stainless steel alloys should be avoided in RF power amplifiers because of the high RF losses associated with those materials in the presence of RF fields. If steel hardware is necessary for the mechanical strength, it can be copper plated; at HF and above, RF current will flow primarily through the plating. At LF iron or steel should be avoided due to increased skin depth and losses associated with its ferromagnetic properties.

3.5 LEAD LENGTHS

Most of the connecting leads should be designed with extremely low inductance to minimize the possible VHF parasitic circuits. Filament and screen bypass leads, suppressor bypass leads, leads to the grid and the anode tuning capacitors, and interconnections between tubes in both push-pull and parallel circuits are in this category. An exception is a parasitic suppressor (if used), which must have an inductance selected according to the operating frequency. For a lead to have low inductance, it must have a relatively large surface area and be short in length, as in a strap or ribbon shape. This consideration also applies to that portion of a lead inside a bypass capacitor or connecting from the tube to a bypass capacitor. If two or more tubes are used, they should be placed reasonably close together to help provide short lead lengths. At HF the length of leads connecting RF tuned circuits to the tube(s) can usually be much longer than bypass capacitor lead lengths. The dc supply, keying, modulating and control circuit wires can be quite long if properly filtered or shielded and arranged out of any RF fields.

It should be noted that the lead connecting to the screen grid for tetrodes and pentodes is common to both the output and input

resonant circuits. Due to the anode-to-screen capacitance of a tetrode or pentode, the RF anode voltage (developed in the output circuit) causes an RF current to flow through the screen bypass capacitor to the chassis. In the case of a push-pull stage this current may flow from the screen terminal of one tube to the screen terminal of the other tube. Similarly, due to the grid-to-screen capacitance of the tube, an RF voltage in the input circuit will cause an RF current to flow in this same screen lead to the chassis, or to the opposite tube in the push-pull circuit.

The inductance of the lead common to both the output and input circuits has the desirable feature of providing voltage of opposite polarities to neutralize the feedback voltage of the residual anode-to-control grid capacitance in the tube (this is discussed under "Neutralization" in section 5). It should be noted, however, that the mutual coupling from the screen lead to the input resonant circuit may be a possible source of trouble if the inductance is excessive.

With common-grid (cathode-driven) triode circuits, the control grid and associated leads are common to the output and input circuits. The inductance of the control grid lead can help or hinder the stabilization of a grounded grid amplifier (this is discussed under "Neutralization" in section 5).

In common-cathode (grid-driven) circuits, excessive cathode lead inductance can be detrimental to good performance. RF current through any inductance in the cathode (or in the case of thoriated tungsten tubes the filament) lead to ground will cause an RF voltage to appear across the grid-to-cathode region and, due to phase relationships, will decrease the input conductance. This will result in increased drive power requirements as the frequency is raised. The net anode (output) efficiency can also be reduced by this effect. A mathematical formula for power loss vs. frequency due to cathode lead inductance is presented in sec. 6.8. In large power grid tubes, this loss of efficiency and low gain may begin to occur at frequencies above 20 to 30 MHz, depending on the physical size of the filament. Some Eimac triodes using filament leads (also called flying leads) are provided with threaded holes for connecting the input circuit directly to the tube's filament ring; this is also the correct point for a filament bypass capacitor, not at the tube lug ends. At VHF and UHF frequencies it often becomes necessary to utilize an input tuned circuit that is a direct extension of the tube, i.e., there is no discrete socket. This so-called "cavity" structure eliminates series inductance, which is so detrimental at these frequencies.

3.6 *FILAMENT BY-PASSING*

Tubes having thoriated tungsten filaments generally use AC voltage supplied from a filament transformer with the center tap used as the “cathode” dc return. DC is also used in some applications to prevent hum or modulation of the rf. In either case, with grid-driven (common cathode) circuits, RF bypassing the filament to ground is necessary to ensure that stability is maintained and that power gain is not lost as the operating frequency increases (see Section 3.5). This path must be of sufficiently low inductance to prevent the filament from becoming above ground with respect to the RF. It may be preferable to ground one filament terminal directly to the chassis and bypass the other (hot) terminal. Ceramic and multi-layer mica capacitors are suitable for bypassing the filaments up to and above HF frequencies. With tubes having concentric isolated cone terminals (for an example, see Figure. 19), the preferred VHF circuit design will avoid straps altogether. In this case, an effective method is to bypass the filaments directly to ground through low inductance film capacitors mounted against the same chassis deck or cavity wall to which the screen grid is bypassed. The Eimac SK-350 is an example of a VHF socket with integral film capacitors used for the filament bypass.

In cathode-driven (grounded grid) circuits, the filament terminals are isolated from ground in order to apply RF drive to that element. Any stray capacitance here can present a problem, because it is in shunt with applied RF voltage as well as being part of the input tuned circuit. The Eimac SK-375 is an example of a low capacitance socket available for use with certain tetrode tubes.

Inductance in the thoriated-tungsten filament structure itself may be resonant at the fundamental or some harmonic frequency. To prevent this resonance from absorbing a portion of the applied drive power, a bypass capacitor directly across the filament terminals is used. This applies to both grid-driven and cathode-driven circuits, because RF fields exist within the tube between the control grid and filament in both cases. In some VHF fixed-frequency applications using thoriated tungsten tubes, a variable capacitor is connected directly across the filament terminals to effect a series resonance, which allows for optimizing the anode efficiency. This is believed to peak filament emission at the crest of the applied RF sine wave. RF chokes are often used in the filament leads even with the filament bypassed to ground. This will help reduce RF from appearing at the filament supply, because filament bypassing tends to be less than perfect even in the best designs, due to finite series internal inductances, which exists in nearly all capacitors.

Indirectly heated oxide-cathode tubes may exhibit a broad gain variation vs. frequency in some VHF and UHF applications. This effect is caused by absorption of some of the applied drive power by the low impedance heater coil at its resonant frequency. The distributed capacitance from the heater coil to the cathode can, in effect become a helical resonator. The frequency of this resonance is typically in the high VHF to UHF range and is of relatively low Q , because of the fairly low resistance of the heater at operating temperature. A solution for this is to use RF chokes in both heater leads, with a capacitor connected across the heater to de-tune the resonance. The exact value of capacitance may need to be determined empirically. Looking for minute changes in the heater current with and without RF drive is a test for determining whether heater resonance is occurring.

In the grounded grid configuration at HF with either a triode or tetrode having a cathode that is electrically separated from the heater (for example 4CX250B and 3CX1500A7 tubes), ferrite-loaded chokes in the heater supply leads are sometimes employed, although not absolutely necessary. Even though the heater-to-cathode capacitance is relatively low, there is a small reactance that can lead to stray RF if the leads are not well shielded. The use of heater chokes in this configuration becomes more necessary at VHF and UHF. Some designers choose to “common mode” the heater and the cathode by bypassing these elements together, assuring that the RF potential between them will be insignificant. This requires using RF chokes in all three leads; a trifilar choke could also be employed. The maximum dc voltage rating between heater and cathode is in the range of only a few hundred volts in small tubes.

In this context, one scenario should be examined; namely, if anode voltage goes to ground in a fault condition. Referring to Figure 34, one would note that if E_{b+} is grounded, the full potential E_b appears across the 20 Ohm resistor and, if this resistor fails (opens), the cathode voltage approaches the same potential as the anode supply, but negative in polarity. Stored energy in the E_b supply will be applied to the cathode end of the tube (although a filament type tube is illustrated) and cathode bypass capacitors, the cathode and grid current meter as well as the secondary windings of the heater transformer will receive considerable energy. Heater (and cathode) bypass capacitors should be protected from fault conditions of this nature by clamping the B- side of the anode supply to ground using diodes capable of handling high peak current. Devices such as metal oxide varistors (MOV's) are available and worth investigating. The center tap of the heater supply transformer (if one is present) employed with oxide cathode tubes should not be grounded. See further discussion on fault protection in sec. 3.9.

3.7 SCREEN AND SUPPRESSOR GRID BY-PASSING AND SCREEN TUNING

Low inductance leads are generally advisable for screen and suppressor grid terminal connections. For all frequencies, it is a good practice to route the screen and suppressor bypass capacitors directly from one filament terminal. The suppressor grid is bypassed in the same manner when the suppressor is operated at other than cathode potential. With the suppressor operating at cathode potential, the suppressor should be grounded to the chassis directly.

Above the self-neutralization frequency (see "Neutralization" Section 5) of the tetrode or pentode, the screen bypass capacitors are sometimes variable. By proper adjustment of this capacitance the amount and phase of the screen RF voltage can be made to cancel the effects of the feedback capacitance within the tube. Thus, neutralization is accomplished. It is worth noting that the screen lead inductance and the variable capacitor are not series resonant, the variable capacitor is adjusted so that a net inductive reactance remains to provide the proper voltage and phase for neutralization.

The preceding paragraphs apply directly to tubes having the screen and suppressor grids mounted on supporting rods, notably tubes with glass envelopes. Ceramic tubes having concentric isolated cone terminals use a series of collets to connect to the tube. The screen collet may be bypassed with ceramic "doorknob" capacitors at HF. At VHF frequencies, the preferred bypass capacitor is made from a film-type dielectric mounted directly against the chassis deck, with the collet connected directly to a plate, which rests against the adjacent side of the dielectric. Dielectric materials can be Teflon[®], Mica, or Mylar[®]. A modern material named Kapton[®] is also desirable, because opposing surfaces can be metallized for increasing the effective capacitance per unit area. The Eimac SK-840 is an example of a socket for the 5CX1500B pentode having the screen bypass capacitor built into mounting plate. This allows excellent stability up to several hundred MHz.

Many FM broadcast transmitters use a simple, effective scheme in which the length of several straps between the screen collet and chassis ground plane are adjusted according to operating frequency, establishing the proper neutralization. The theory of this is discussed in sec. 5.5.4

® Registered - E. I. du Pont de Nemours and Company - 100 Market Street, Wilmington, Delaware 19898, USA

Another method of assuring that the screen grid is at RF ground is to use a quarter-wavelength coaxial stub, shorted at one end and resonant at the operating frequency, connected from the screen to ground. A blocking capacitor is required to prevent shorting the screen dc supply voltage to ground. This is generally used in an amplifier operating at a single fixed frequency at VHF. The length of the stub becomes physically too long at lower operating frequencies.

3.8 GROUNDED-GRID CIRCUITS

Zero-bias, high μ triodes employed in RF power amplifiers for general purpose RF amplification, linear and even class-C FM service are typically used only in the grounded-grid configuration. The control grid is operated at RF ground, similar to the screen grid in a tetrode or pentode; therefore, good isolation is obtained between the input and output. The control grid may be bypassed directly at the socket or grounded directly to the chassis. The dc-grounded approach is favored, because no bypass capacitor is required and stability is optimum. Figures 34 and 35 illustrate the two circuit configurations.

Above 30 MHz the example in Figure. 35 should be avoided because of less than ideal RF grounding associated with this configuration. A case can also be made wherein Figure. 35 has less inherent reliability. In the event of an internal or external arc from anode to grid, the grid bypass capacitor and metering circuit could be destroyed, unless the available energy is limited to less than a few joules. Protection diodes connected across the meters are highly recommended in both circuits.

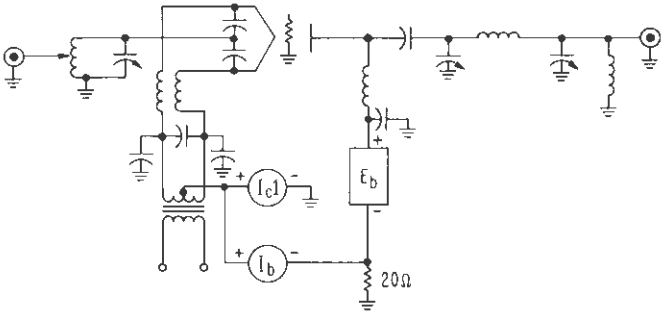

Figure 34. A typical circuit using “zero-bias” triodes showing metering circuits and method of grounding the grid to RF. The grid current is measured in the return lead from ground to filament.

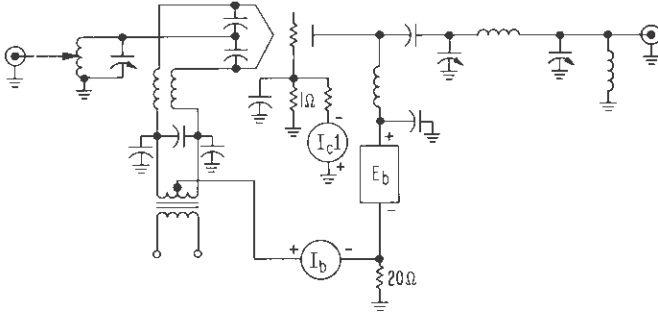

Figure 35. A typical circuit using “Zero-bias” triodes showing metering circuits. The grid is grounded to RF with a bypass capacitor. The grid is raised 1Ω above dc ground to allow the grid current to be measured.

Some Eimac triodes are designed with a grid flange that support the tube directly on the chassis and thereby provides the lowest inductance connection possible (see Figure. 36), while simultaneously eliminating the need for a socket.



Figure 36. 3CX5000A7 with integral grid flange

In grounded-grid circuits, the cathode lead inductance must be minimized to prevent loss of drive power before it reaches the grid-cathode region of the tube. The problem is similar to that seen in grid-driven circuits (discussed in Section 3.5.5). Several Eimac triodes have more than one cathode terminal (for example the 3CX800A7 has 6 of the 11 pins connected to the cathode). In

VHF circuits all of the available cathode pins should be utilized to assure that series inductance is as low as possible. The 3CX800A7 is useful to frequencies over 450 MHz with these pins connected directly to the cathode matching network.

3.9 PROTECTION

EIMAC Power Grid Tubes are designed to stand considerable abuse. For instance, the excess anode dissipation resulting from detuning the anode circuit of the tube will have no ill effects if not applied for periods of time sufficient to overheat the envelope and the seal structure.

Similarly, the control, screen and suppressor grids will stand some excess dissipation. The maximum dissipation for each grid indicated on the data sheet should not be exceeded except for time intervals of a few milliseconds. The maximum dissipation rating for each grid structure is usually considerably above typical values used for maximum output so that ample operating leeway is provided. The time of duration of overloads on a grid structure is necessarily short because of the small heat storage capacity of the wires. Furthermore, grid temperatures cannot be seen, so no visual warning of accidental overload is apparent.

The type and degree of protection required in an RF amplifier against circuit failure will vary with the type of screen and grid voltage supply. Figure 37 is a chart of tetrode and pentode protection as related to certain kinds of circuit failures.

For screen voltage taken through a dropping resistor from the anode supply, an anode relay provides almost universal protection. For a fixed screen supply a relay provides protection in most cases. For protection against excess antenna loading and consequent high anode dissipation, a screen undercurrent interlock may also be used in some services.

The anode, screen and bias voltages may be applied simultaneously to a tetrode. The same holds true for a pentode, plus the application of the suppressor voltage. In a grid driven amplifier, the grid bias and excitation can usually be applied alone to the tube, especially if a grid leak resistor is used for bias voltage. Anode voltage can be applied to the tetrode and pentode before the screen voltage with or without excitation to the control grid. **NEVER APPLY SCREEN VOLTAGE BEFORE ANODE VOLTAGE.** The only exception would be when the tube is cut off so that no space current (screen or anode current) will flow, or when the excitation and screen voltage are low. If screen voltage is applied before the anode voltage and screen current can flow,

CIRCUIT FAILURE	FIXED SCREEN SUPPLY		SCREEN VOLTAGE THROUGH DROPPING RESISTOR	
	FIXED GRID BIAS	RESISTOR GRID BIAS	FIXED GRID BIAS	RESISTOR GRID BIAS
Loss of Excitation	No Protection Required	Anode Current Relay	Anode Current Relay	Anode Current Relay or Screen Control Circuit
Loss of Antenna Loading	Screen Current Relay	Screen Current Relay	Grid Current Relay	Nothing Required
Excess Antenna Loading	Screen UnderCurrent Relay	Screen UnderCurrent Relay	Anode Current Relay	Anode Current Relay
Failure of Anode Supply	Screen Current Relay	Screen Current Relay	Grid Current Relay	Nothing Required
Failure of Screen Supply	Grid Current Relay	Nothing Required	—	—
Failure of Grid Bias Supply	Anode Current Relay or Screen Current Relay	—	Anode Current Relay & Grid Current Relay	—

Figure 37. Tetrode and pentode protection chart. This chart indicates the location of a suitable relay which should act to remove the principal supply voltage from the stage or transmitter to prevent damage to the tubes.

the maximum allowable screen dissipation will almost always be exceeded and tube damage will result.

Figure 38 is a chart for the protection of a triode tube. This chart covers the grid driven triode amplifier and the high- μ (zero bias) cathode driven triode amplifier. **DRIVE VOLTAGE MUST NEVER BE APPLIED TO A ZERO-BIAS TRIODE AMPLIFIER WITHOUT ANODE VOLTAGE BEING APPLIED.**

CIRCUIT FAILURE	TRIODE		ZERO-BIASED TRIODE
	FIXED GRID BIAS	RESISTOR GRID BIAS	
Loss of Excitation	No Protection Required	Anode Overcurrent Relay	No Protection Required
Loss of Antenna Loading	RF Output Detector & Relay	RF Output Detector & Relay	Grid Over-Current Relay
Excess Antenna Loading	RF Output Dtectro & Relay	RF Output Detector & Relay	RF Output Detector & Relay
Failure of Anode Supply	No Protection Required	No Protection Required	Grid Over-Current Relay
Failure of Grid Bias Supply	Anode Over-Current Relay	—	—

Figure 38. Triode protection chart. This chart indicates the location of a suitable relay which should act to remove the principal supply voltage from the stage or transmitter to prevent damage to the tube or transmitter.

3.9.1 Arc Protection

The damaging effects of electrical arcing is an important subject for any circuit designer.

Capacitors used as filters in high voltage power supplies can store substantial energy, more than enough to damage tubes and other circuit components. The level of energy available can be determined in the formula $Q=1/2CE^2$, where Q is the stored energy in Joules (or Watt-seconds), C is the power supply filter capacitance in Farads and E is the dc voltage across the capacitor. It is obvious from this formula that increasing the voltage increases the stored energy exponentially.

As an example, a 20 microfarad capacitor charged to 5 kilovolts represent 250 Joules of stored energy; enough to melt metal or ceramic-to-metal seals, which are commonly used as part of a vacuum envelope in power grid tubes. Catastrophic loss of vacuum during operation causes rapid oxidation of the filament or cathode, making the tube inoperable and usually beyond repair.

Arcing is a phenomena that occurs when the atmosphere between conductors breaks down in the presence of a high voltage field

and becomes ionized. Electrical charges build up and eventually cross the gap between the conductors to form a path of hot, ionized gas with an equivalent resistance of a few tenths of an ohm. The presence of metallic ions from vaporized metal that may exist at the terminus of an arc further reduces the impedance. Unpredictable by nature, arcing under fault conditions can be the result of power surges, parasitic oscillations, unloaded conditions in an RF amplifier, dirt build-up across a ceramic or a number of other causes.

Internal arcing in a power grid tube is the result of the same mechanism, but may be aggravated by residual gases within the vacuum space. Arcing can also be caused by exceeding the breakdown rating between tube elements.

Internal arcing at the cathode of oxide cathode tubes may eventually occur as a result of normal evaporation of oxide material. The remaining oxide must then supply considerably more current per unit area than for which it was designed. For instance, if 50% of the oxide becomes depleted, then the remaining oxide material must supply twice the normal current.

The process of an internal arc caused by sparking at the cathode can best be understood by first examining the electrical function of the cathode material. There is an Ohmic factor at the oxide barrier; that molecular region where the oxide material meets the base metal and forms an electrochemical junction. Oxide material has relatively high electrical loss. When electron current through the resistive oxide layer is increased substantially above normal limits, localized heating occurs due to I^2R losses. This heating takes place at microscopic points on the cathode surface. The additional heat, added to oxide material already at high working temperature, will cause a rapid decomposition of cathode material, which then releases gases that will ionize in the presence of high voltage, leading to an internal arc. Additional heat is generated by the arc energy, releasing more gas. A sustained arc can result if fuses, overload circuit or other protection devices are not present to interrupt the high voltage to the tube.

Although good design measures can be taken to prevent arcing, ionization and arcing will occur whenever high voltage exists. The task then, to prevent internal damage to the tube, is to remove or divert the stored energy away from the power grid tube if an arc should occur.

Since power grid tubes are made in various sizes, internal tube elements will have varying mass. Some tubes can safely withstand more arc energy than others. Two general types of fault protection are used for power grid tubes, depending upon whether they are operated at low energy or high energy.

Systems using power grid tubes with oxide cathodes and tubes with thoriated tungsten with small diameter wire grids generally operate at low power and are classified as low energy tubes. Anode dissipation ratings for low energy tubes typically range from a few Watts up to approximately 25 kW. Generally, any arcing associated with these tubes should be limited to less than 4 Joules of energy if catastrophic damage is to be prevented.

A simple technique for protecting low energy tubes is to use a protection resistor in the high voltage supply lead, coupled with a fuse or circuit breaker to quickly remove power from the high-voltage transformer. The resistor should have a fairly high power rating. Bulk-carbon Carborundum™ or large wire wound resistors are recommended. Typical values range from 10 to 50 ohms. Additionally, in a tetrode, a protection resistor should also be used in the screen power supply, especially if it contains considerable filter capacitance.

It is recommended that the largest resistance value that will still conduct the full average (dc) anode current without overheating be used. The fuse or fast acting circuit breaker completes the protection circuit. This prevents follow-on energy, which must be interrupted to prevent the resistor from failing.

Power grid tubes operating at substantially higher voltages are subjected to far greater arc energies than low power tubes. Large power grid tubes used for high energy operation are generally capable of withstanding arc energy of up to 50 Joules of total energy.

High energy power grid tubes are generally protected by a special circuit, the so-called “crowbar”, that shunts all the stored power supply energy to ground. A series protection resistor will not work for these applications, because anode currents used for these tubes are typically 20 to 200 A, which would cause excessive voltage drop across the resistor.

A typical crowbar uses a shunt device such as a hydrogen thyratron, an ignitron or a triggered spark gap. If an arc is detected, the crowbar device is activated, shorting the power supply filter

capacitor to ground. The crowbar must be fast acting and be able to absorb large levels of energy without failure.

A specially designed high-voltage switch-mode power supply can be used as an alternative to crowbar shunt protection. Operating at a high switching rate, this type of supply requires very low values of filter capacitance. Therefore the stored energy is low. At the same time, the ability to quickly interrupt the oscillator or switching devices (within tens of microseconds) insures that follow-on energy is minimal.

Eimac Application Bulletin AB-17 "Fault Protection" is available on Eimac's web site (www.eimac.com) under Applications.

3.10 KEYING

Although "keying" in the traditional sense of turning an amplifier on and off to generate Morse code is no longer used, there are instances where it is useful to switch an amplifier on and off. Thus, this section is included for reference.

The tetrode and pentode power amplifier can be keyed using the same basic principles employed with any power amplifier. In addition, the screen electrode provides another low power circuit where keying can be introduced. Suitable filters must be used so that the make and break is slow enough to avoid high frequency sidebands known as "key clicks." The usual "key click" filter techniques apply.

There are several good methods of controlling the tetrode and pentode RF power amplifier when exciter keying is used. With the screen voltage fixed and with fixed bias greater than cutoff, the tube will pass no current when the excitation is removed. A low or medium- μ triode amplifier can be keyed in the same manner. With the high- μ (zero bias) triodes, it is even simpler. When the drive is removed, the anode current falls to the normal, safe quiescent anode current.

It is also possible to key the exciter stage when the screen voltage for a tetrode or pentode is obtained through a dropping resistor and grid leak bias is used (see Figure 39A). In this system a high transconductance, low- μ triode is connected between screen and cathode, and the controlling bias for the small triode is taken from

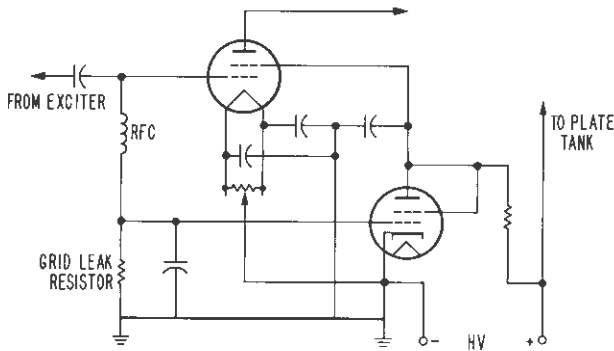

Figure 39A. Screen voltage control circuit for exciter keying or protection against loss of excitation when supplying screen from high voltage source.

the tetrode or pentode bias developed in the grid leak resistor. When normal excitation is present on the RF amplifier and grid bias is developed, the triode control tube is cut off and the screen voltage circuit operates normally. If excitation voltage is removed from the tetrode or pentode power amplifier, the bias voltage developed in the resistor drops to zero and the control triode becomes conducting. The current drawn by the triode control tube will increase the voltage drop across the series screen resistor and lower the screen voltage to a very low value.

There is still some voltage on the tetrode or pentode screen and a small static anode current flows. Usually this remaining current is not enough for the anode dissipation rating to be exceeded. This value can be reduced further by the use of a second control triode in parallel with the first (this redundancy is also insurance against failure of the single triode), by putting a gas regulator tube in series with the lead to the screen before the screen RF by-pass capacitor, or by introducing a small amount of fixed bias on the power amplifier between the grid resistor and the power tube grid.

Figure 39B shows a method of keying a tetrode or pentode RF power amplifier where the low voltage power supply for the screen of the power tube and for the anode and screen of the driver stage is keyed directly. This permits keying in a relatively low voltage, low current circuit. The key click filter capacitor, resistor, and choke are simple and assure positive control of the keying wave shape.

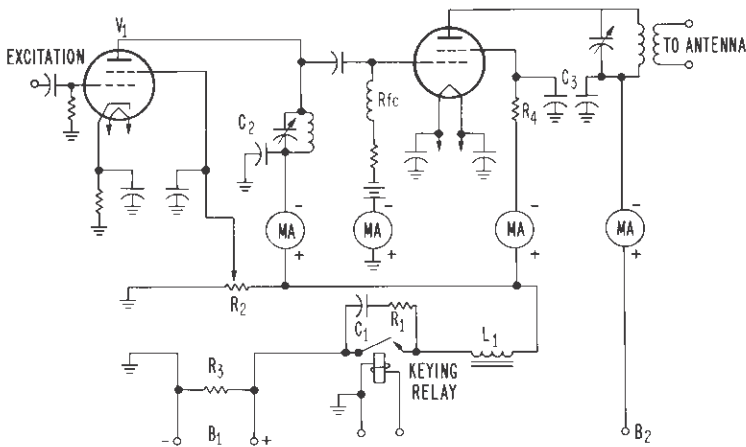

Figure 39B. A typical method of keying a tetrode or pentode amplifier.

One important point should be made regarding keying. Some circuit designers may be tempted to disconnect the cathode return to the anode supply, B-, to key-off a power grid tube. This action can have extremely serious consequences. If the cathode return (or the center tap of a filament transformer used with a thoriated tungsten filament tube) is open-circuited, the potential at the cathode will rise to nearly that of the anode supply. Internal arcing from the cathode or filament to the control grid would be likely. Under such conditions, a tube will saturate, or "run-away", and draw excessive anode and screen currents. External arcing in the socket would also be likely, because insulation ratings would be inadequate for fault conditions of this type. Cathode circuit components such as bypass capacitors and the secondary winding of the filament or heater transformer may also be subject to voltages well beyond normal design values. **To prevent such possibilities, the cathode return must always have a secure path to ground and, ultimately, the B- of the anode supply.**

Similar conditions could exist if a fuse is placed in the cathode return. If the fuse should open, the circuit has infinite resistance, causing the cathode voltage to raise to nearly the anode potential. To prevent this, one should shunt the fuse (if used) with a fairly high value resistor. The current through the resistor will develop a bias voltage that will act to cut-off the anode current, or hold it to a very

low value. A resistance of approximately 5,000 ohms is used in most applications to provide this protection. A better solution would be to use a high voltage fuse in the anode supply instead of fusing the cathode return.

3.11 AMPLITUDE MODULATION

A triode RF amplifier can be anode, grid or cathode modulated. Anode modulation is the type most extensively used. A triode may also be operated under a linear set of conditions for amplifying an amplitude modulated driver.

A tetrode or pentode RF amplifier can be anode and screen, screen grid, control grid or cathode modulated. Usually the system chosen is a combination of any of the previously listed

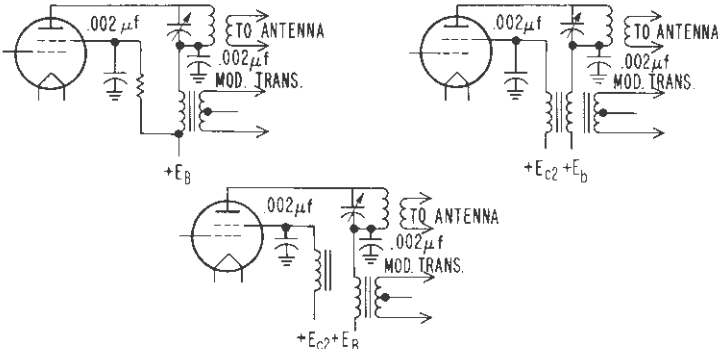

Figure 40. Basic screen and anode modulation circuits.

techniques. The most extensively used technique is a combination of anode and screen modulation. Often additional modulation must be provided on the control grid to reach 100 per cent modulation on the positive peaks. Figure 40 shows three of the basic anode and screen modulation circuits.

In anode and screen modulation it is necessary to introduce not only amplitude modulation of the anode voltage, but also to develop 70 to 100 per cent amplitude modulation of the screen voltage for 100 per cent carrier modulation. Modulation of the screen voltage can be developed in one of the following three ways:

- (a) By supplying the screen voltage through a dropping resistor connected to the unmodulated dc anode supply.
- (b) When a low voltage fixed screen supply is used, a modulation choke is placed in series with the supply. In the case of voice modulation, this is about a 5 to 10 henry choke.
- (c) A third winding on the modulation transformer designed to develop the required screen modulation voltage.

It is interesting to note that in all three cases the screen of the tetrode or pentode tube supplies the necessary audio power. During the portion of the modulation cycle, when the anode voltage is increased, the screen current decreases. If the screen is supplied through an impedance, such as the screen dropping resistor of a modulation choke, the voltage drop in this series impedance becomes less and the screen voltage rises in the desired manner. On the part of the modulation cycle when the anode voltage is decreased, the screen current increases causing a greater voltage drop in the screen series impedance and thus lowering the voltage on the screen of the tube. The screen by-pass capacitor value in the Class C stage is a compromise between good RF bypassing and the shunting effect of this capacitance on the screen modulation circuit.

Where 100 per cent modulation capabilities are desired, the tube efficiency under carrier conditions is about half that expected in the RF amplifier when anode and screen modulation is used. This efficiency is usually on the order of 35 to 40 per cent. Grid and screen modulation is used when there is a desire to save on physical size and cost of the modulation source.

When grid modulation is used, the screen voltage and grid bias must be taken from sources with good regulation. This usually means a separate low voltage power supply source. In the case of screen modulation, the grid bias should be taken from a grid leak bias resistor to provide some drive modulation.

The output of a pentode Class C amplifier can be controlled by applying to the suppressor grid a modulating voltage superimposed upon a suitable bias. As the suppressor grid in such an arrangement becomes more negative, the minimum instantaneous anode potential at which current can be drawn to the anode is increased. Thus, as the modulation varies the suppressor-grid potential, the output varies.

The suppressor-grid modulated amplifier has about the same anode efficiency as the grid modulated Class C amplifier. The

overall efficiency is somewhat less because of the screen-grid losses. The modulating power is about the same. The linearity of modulation is not particularly high.

The screen-grid losses are higher because as the anode potential decreases, the current to the screen increases. This tendency toward high screen losses is the factor that usually limits the output power obtainable from a suppressor-grid modulated amplifier.

3.12 POWER SUPPLY CONSIDERATION

The power supply requirements for a triode are straightforward. The degree of regulation and ripple depends upon the requirements of the system. In the case of a linear RF amplifier, it is important to have good anode power supply regulation. Without good regulation, the anode voltage will drop during the time the anode is conducting current heavily. This tendency for the voltage to drop will cause “flat topping” and will appear as distortion in the output. In a push-pull audio application where grid current flows, it is important to keep the grid circuit resistance to a minimum. If this is not done, positive peak clipping will occur. In the case of the tetrode and pentode, the need for screen voltage introduces some new considerations and provides some new possibilities.

Voltage for the screen grid of a low power tetrode or pentode can readily be taken from the power supply used for the anode of the tube. In this case, a series resistor, or potential dividing resistor, is chosen so that with the intended screen current flowing the voltage drop through the resistor is adequate to give the desired screen voltage. The potential dividing resistor is the preferred technique for those tubes with significant secondary screen emission (see Figure 6).

It is possible to take the screen voltage from a low voltage supply, frequently using an already available source in the equipment. There is considerable latitude so that an available voltage can be used. Sometimes a combination might be employed, where a dropping resistor is used in conjunction with a low voltage or intermediate voltage supply. Frequently a combination of series resistor and voltage source can be chosen so that the rated screen dissipation will not be exceeded regardless of the variations in screen current. With a fixed screen supply, there are advantages in using an appreciable amount of fixed grid bias so as to provide protection against loss of excitation, or for cases where the driver stage is being keyed.

If the screen voltage is taken through a dropping resistor from the anode supply, there is usually little point in using a fixed grid bias because an unreasonable amount of bias would be required to protect the tube if the excitation failed. When a screen dropping resistor is used, most of the bias is normally supplied through a grid resistor and other means are used for tube protection.

Under operating conditions with normal screen voltage, the cutoff bias is low (screen voltage divided by the screen μ). When a stage loses excitation and runs statically, the screen current falls close to zero. (See static curves of tube in question.) If the screen voltage is obtained through a simple dropping resistor from the anode supply, the screen voltage will then rise close to full anode voltage. Because the cutoff bias required is proportional to the screen voltage, the grid bias required will be much greater than the amount of bias desired under normal operating conditions.

The power output from a tetrode or pentode is very sensitive to screen voltage. For this reason, any application requiring a high degree of linearity through the amplifier requires a well regulated screen power supply. A screen dropping resistor from the anode supply is not recommended in such applications.

The suppressor grid power supply requirements are quite similar to the control grid power supply. The suppressor grid intercepts very little current, and therefore a low power supply may be used. Any variation in suppressor voltage due to ripple or lack of regulation will appear in the output of the amplifier due to the suppressor grid modulation of the anode current.

3.13 STABILIZING THE AMPLIFIER

3.13.1 Testing for parasitic oscillations

In the case of an RF amplifier, it will be necessary to investigate not only the possibility of self-oscillation, but also lack of feedback on the fundamental frequency. The basic steps of checking for self oscillation are threefold:

- (a) The amplifier should be operated without RF excitation and without fixed grid bias, with light loading and with low voltages applied to the anode and to the screen of a tetrode or pentode.

The voltage should be high enough to develop full anode

dissipation. For this test, grid leak bias should be used. If the screen and anode voltage supplied cannot be adjusted directly to low voltages, suitable series resistance should be used, either in series with the rectifier output or transformer primary so that the voltages developed at the tube will be low.

Light bulbs of the correct size will serve as resistors in series with the primary of the rectifier transformers. The RF circuits should be tuned off-resonance to see if self-oscillation of the amplifier can be started. The indication of any current by the grid milliammeter means that self-oscillation is present.

- (b) The frequency of the self-oscillation must be determined. A simple neon bulb taped to a long rod (for safety reasons), will, indicate whether the frequency of oscillation is high or low when it is held near the anode of the tube. The lower the frequency the more orange will be the glow. A purple color indicates a VHF or UHF oscillation. With a little experience, it will become possible to guess the approximate frequency very closely. A wavemeter or an oscilloscope will then determine the exact frequency.
- (c) After the frequency of oscillation is measured, it remains to identify the circuit supporting the oscillation. The circuit must then be altered without disturbing the performance of the amplifier on the normal frequency of the amplifier.

3.13.2 Correction of Parasitic Oscillations

The usual self-oscillations in RF power amplifiers have been found to fall in the following three classes:

- (a) Oscillation at VHF from about 40 MHz to 200 MHz, regardless of the normal frequency of the amplifier.
- (b) Self-oscillation on the fundamental frequency of the amplifier.
- (c) Oscillation at a low radio frequency below the normal frequency of the amplifier.

The low frequency oscillation in an amplifier usually involves the RF chokes, especially when chokes are used in both the output and input circuits.

Oscillation near the fundamental frequency involves the normal resonant circuits, and brings up the question of neutralizing the RF power amplifier. This general subject is discussed under "Neutralization," Section (5).

When a parasitic self-oscillation is found on a very high frequency, the interconnecting leads of the tube, the tuning capacitor and the by-pass capacitors are involved. This type of oscillation does not usually occur when the power amplifier is designed for operation in the VHF region and where the RF circuits external to the tube have negligibly small tuning capacitors. Without tuning capacitors, the highest frequency oscillating circuit possible is then the fundamental, and there would be no higher frequency circuit available for the parasitic. The only exception would be where higher order modes of transmission line circuits might provide a parasitic circuit.

VHF parasitic oscillation may occur in amplifiers where the RF circuits consist of coils and capacitors. In Figure 41, the capacitors and associated grid and anode leads act as inductances for the parasitic oscillation circuit. The tube capacitances help form the tuned-anode tuned-grid oscillation circuits. The circuit is indicated by the heavy lines in Figure 41.

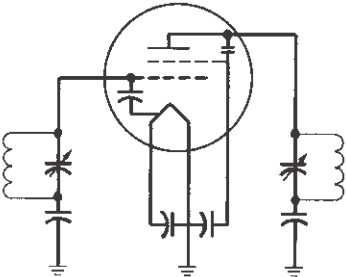

Figure 41. Usual circuit supporting VHF parasitic oscillation in HF RF amplifiers.

There are several straightforward ways to suppress VHF parasitic oscillation. In general, it will probably be more easily suppressed if the general layout and by-passing methods indicated earlier are followed.

It turns out that the frequency at which a VHF parasitic oscillation occurs is well above the self-neutralizing frequency of the tube (see Section 5). However, if the self-neutralizing frequency of the tube can be increased and the frequency of the parasitic lowered,

complete suppression of the parasitic will result, or its suppression by resistor-inductor (R-L) parasitic suppressors may be made easier.

It is also possible to predict fairly closely with a grid dip wavemeter the parasitic frequency to be expected in a given equipment. The circuit should be complete and with no voltages on the tube. Couple the meter to the anode or screen lead and determine the resonant frequency. The following two methods of eliminating the VHF parasitic oscillation have been used successfully:

- (a) Place a small R-L combination in the anode lead between the anode of the tube and the tank circuit (see Figure 42). The R-L combination is usually made up of a non-inductive resistor of about 25 to 100 ohms, shunted by three or four turns of wire or copper strap, frequently wound right around the resistor. In some cases (with a common cathode - grid driven circuit), it may be necessary to use such a suppressor in both the anode and grid leads. The R-L combination operates on the principle that the resistor

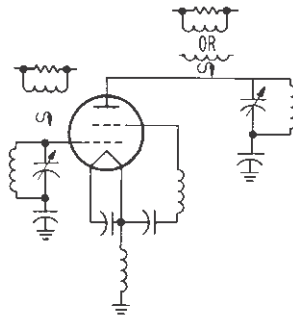

Figure 42: Placement of parasitic suppressors to eliminate VHF parasitic oscillations in HF r-f amplifiers.

loads the VHF circuit but is shunted by the coil for the lower fundamental frequency. IF it is found that the resistor runs too hot, the inductance in the coil may be excessive. Just enough inductance should be used to suppress the parasitic and no more; otherwise, excessive fundamental energy will cause the resistor to overheat. Once the parasitic has been suppressed there will be no parasitic voltage or current present. Therefore, there is no parasitic power to be dissipated.

- (b) Use small parasitic chokes in the anode lead (see Figure 42).

The size of this coil will vary considerably depending upon the tube and the circuit layout, and may run from about four to ten turns of about a one-half inch diameter. The presence of this choke in the frequency determining part of the circuit lowers the frequency of a possible VHF parasitic so that it falls near the self-neutralizing frequency of the tube and bypass leads. In addition to varying the size of the suppressor choke, the amount of inductance common to the screen and filament in the filament grounding strap may be a factor. This can be varied simultaneously with the suppressor choke.

Of the two methods indicated above for suppressing VHF parasitic oscillations, the first one is probably the simpler to use and has been widely employed. The popular belief that a "low Q VHF parasitic choke" is beneficial can be de-bunked by realizing that any parasitic choke has low Q, because of the loading caused by the low resistance across the choke (20-50 ohms). Special nichrome wire is unnecessary - regular copper wire or strap is recommended for the inductor in a parasitic choke.

In rf amplifiers, which operate between 25 MHz and 50 MHz, the selection of a proper parasitic suppressor is more difficult, especially with high output power. A parasitic inductor for these frequencies may consist of a simple loop or "U" shaped strap (approximately 0.5 inches in width and 6 to 8 inches in length, prior to bending) with a resistor connected across the open end. A bulk carbon rod (Carborundum) type of resistor (20 to 50 Ohms) is recommended.

VHF amplifiers operating above 50 MHz seldom use a parasitic suppressor, because excessive power would be induced in the "R" component and the "L" component would have an exceedingly low value. Fortunately, the excellent isolation provided by many modern ceramic-metal tubes allow stable operation at high VHF frequencies without a parasitic choke.

The procedure of checking for self-oscillation in an RF power amplifier described previously will normally show up most trouble and allow for its correction. If, however, the correction is marginal, it may sometimes happen that under operating conditions the self-oscillation will be triggered off. The oscillation may occur only on the peaks of amplitude modulation or on keying surges. By observing the RF envelope on a cathode ray oscilloscope, the oscillation can usually be seen. The trouble can be fully eliminated by pursuing further the outlined corrective procedure.

A more difficult self-oscillation to locate is one occurring on a harmonic of the fundamental frequency and occurring only when

the stage is operating. It will show up when testing for the presence of abnormal power in the harmonics under operating conditions.

In audio amplifiers employing tetrodes or pentodes, small non-inductive resistors of about 100 ohms resistance should be placed in series with the anode, and possibly the grid as well, in case self-oscillation of the amplifier occurs in the very high frequency portion of the RF spectrum. Should the audio or dc voltage drop in the resistor be objectionable, it can be shunted with a small coil.

Another form of commonly encountered self-oscillation is known as “dynatron” oscillation. Dynatron oscillation is caused when any electrode in a vacuum tube has negative resistance. Secondary emission characteristics of the screen grid in a tetrode were discussed in Section 2.2; it was pointed out that at times there may be more electrons leaving the screen grid than are arriving. If the screen voltage is allowed to increase under these conditions, even more electrons will leave the grid; the phenomenon implies a negative resistance characteristic. If there is high alternating current impedance in the circuit from the screen grid through the screen grid power supply, and from the anode power supply to the anode, dynatron oscillation may be sustained.

Dynatron oscillation typically occurs in the region of one to 20 Hz. This low-frequency oscillation is usually accompanied by another oscillation in the 1000-2000 kHz region. Suppression of these oscillations can be accomplished by placing a large bypass capacitor (1000 μ F) across the output of the screen grid power supply. The circuit supporting the oscillation can also be detuned by a large inductor. Increasing the circuit losses at the frequency of oscillation is also effective.

3.14 NOISE IN TUBE AMPLIFIERS

Power grid tube designers often come across descriptions of various types of noise associated with electron tubes. Phenomena such as random noise from electron-thermal agitation or shot noise have been well described. These types of noise, which affect small signal, high voltage gain tubes, are usually of very little concern for large triode and tetrode power amplifier applications. Filament induced random noise in the output of power amplifiers is, typically, so far below the full output value that it is virtually non-measurable using common instrumentation

Power grid tubes with thoriated-tungsten filaments may, however, exhibit low levels of hum in the output if ac filament power is used.

This phenomena is well understood¹¹; basically, electrons at the crest of the negative voltage excursion are accelerated more at one end of the filament than the other end. This ac difference slightly modulates overall cathode emission and the net plate current will, therefore, contain energy at the second harmonic of the filament ac voltage. The use of center-tapped secondary winding on the filament transformer, with the center tap representing the cathode or common return point, will reduce hum to the point that it is generally insignificant.

However, when a complete absence of any ac-related component in the output is required, dc filament power is recommended. An example of this is analog (NTSC) television transmitters. Any line frequency AM component in the filament may beat with the precise sync pulses that are being amplified in the tube. Television transmitters, which use power grid tubes in the power amplifier stage, typically use a three-phase, rectified and filtered dc power supply for filament voltage.

Radar switch tubes often have very low noise requirements. Mechanical movement of the filament, grids or anode may induce artifacts in the anode current during conduction. Liquid cooled tetrodes, with specially designed, low-turbulence anode coolers that reduce mechanically induced noise, are available.

FM broadcast transmitter amplifiers sometimes encounter a form of noise called synchronous noise (also called "Incidental AM"). Synchronous noise occurs when a FM signal is applied to a narrow-band circuit, causing an AM component to be added to the signal. This noise is generally not noticeable on the main FM program, but it can cross-modulate any sub-carrier (SCA) program material.

Synchronous noise is generally the result of using a high-Q tuned circuit, typically in the grid input of the tetrode used in the IPA stage (although it may sometime be developed in the Power Amplifier input circuit). Saturating the grid by slightly over-driving the input, which, thereby, loads the circuit and reduces Q, minimizes this effect.

Proper input tuning is critical in most cases to reduce synchronous noise. Grounded-grid FM amplifiers generally never exhibit synchronous AM noise, because the bandwidth of the cathode input circuit is significantly greater than the applied FM signal bandwidth, and the circuit Q is quite low.

11 F. E. Terman, Radio Engineers Handbook 13th Edition, p. 617

SECTION 4

LINEAR AMPLIFIER AND SINGLE SIDEBAND SERVICE

4.1 WHY SINGLE SIDEBAND

The increase in commercial and military communication traffic has become so great that a need exists for faster, more reliable, spectrum-conserving systems. **Single-sideband** (SSB) operation meets this need and makes more efficient use of the available spectrum.

The advantages of single-sideband transmission over conventional amplitude-modulated transmission have been discussed in literature^{12, 13, 14, 15} and are summarized as follows:

1. The bandwidth requirement of the transmitted signal is less than half that of conventional double-sideband systems. For example, if a signal carrying the normal speech spectrum of 200 to 3000 Hz is transmitted via conventional amplitude-modulation-with-carrier systems the bandwidth required is twice the highest frequency being transmitted, or 6000 Hz. Elimination of the carrier and one sideband (neither of which is essential to the transmission of intelligence) permits the bandwidth to be reduced to 2800 Hz (Figure 43). The audio improvement in intelligence is enhanced because of the elimination of interfering audio heterodynes caused by adjacent channel signals.

12 J. F. Honey, "Performance of AM and SSB Communications," TeleTech. September, 1953.

13 Fundamentals of Single Sideband, Collins Radio Company, September, 1960.

14 E. W. Pappenfus, Warren B. Bruene, and E. O. Schoenike, Single Sideband Principles and Circuits, New York, McGraw-Hill, 1964.

15 Proceedings of the I.R.E. (Single Sideband Issue), December, 1956.



Figure 43. Relative spectrum space occupied by AM signal and SSB signal modulated by frequencies of 200 to 3000 Hz.

2. The narrower frequency band required for SSB operation allows bandwidth reduction of the selective circuits in the receiver to only that width needed to receive the signal without distortion. While there is some improvement in signal-to-noise ratio, the greatest improvement is the reduction in the strength (at the detector) of some of the interfering signals which would otherwise be admitted with the wider passband.
3. A relatively high level of information-bearing sideband power can be obtained without the use of a high-power modulator. This permits a lower average power in the final radio-frequency stage, and substantial reductions in total power input, total weight, and total cost of the transmitting equipment.
4. SSB operation greatly reduces the audio distortion often encountered over long-path transmissions using conventional amplitude-modulated signals.

4.2 RATING TUBES FOR LINEAR AMPLIFIER SERVICE

The power-handling capability of a given tube in single-sideband service depends upon the nature of the signal being transmitted and the power dissipating capability. In addition, the method of establishing single-sideband service ratings should be such that relatively simple test equipment can be used to determine whether or not a tube is operating within its maximum ratings.

It is impractical to establish a rating based on voice-signal modulation because of the irregular waveforms encountered and the varying ratios of peak-to-average signal power found in various voices. The most convenient rating method, and probably the most practical, employs a single-tone driving signal (such as

that from a sine-wave audio-signal generator) to modulate the SSB transmitter. By using this test signal at its full modulation capability, the amplifier will operate under steady, maximum-signal conditions which are easily duplicated and observed.

When a single sine-wave tone modulates a single-sideband transmitter, the RF output seen on an oscilloscope (Figure 44a) appears as a steady, unmodulated signal (resembling an unmodulated AM carrier) because the output is a continuous signal having a frequency removed from that of the carrier by the modulating frequency, as shown in Figure 44b.

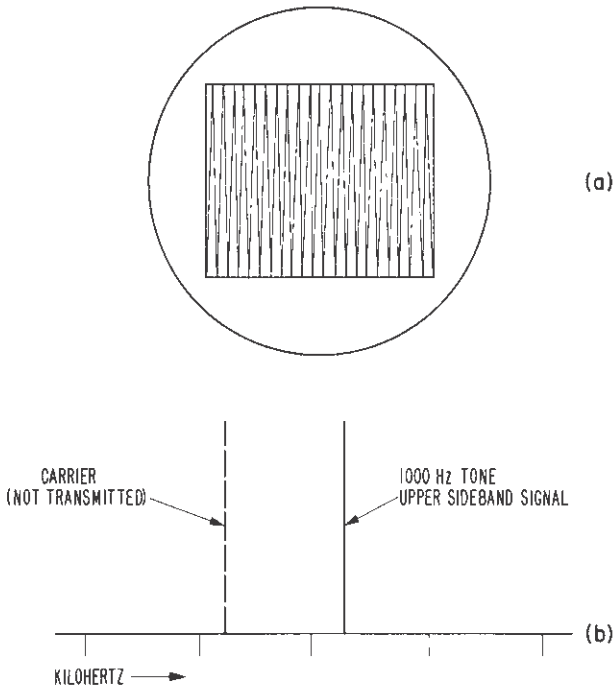

Figure 44. R-F output of SSB transmitter with single-tone modulation. (a) Oscilloscope pattern (b) Spectrum for 1000-Hz tone

Consequently, the operation of a linear amplifier under single-tone modulation is comparable to that of a telegraph transmitter under key-down conditions. As such, the performance of the stage at maximum signal (or peak) conditions can be ascertained by meter readings. However, this simple test lacks information on the linearity of the stage. To study linearity thoroughly by observing the amplifier output, some means must be provided to vary the output

level from zero to maximum signal with a regular pattern that is easily interpreted. A simple means is to use two audio tones of equal amplitude to modulate the single-sideband transmitter. This is termed a **two-tone** test. This procedure causes the transmitter to emit two steady signals separated by the frequency difference of the two audio tones (Figure 45).

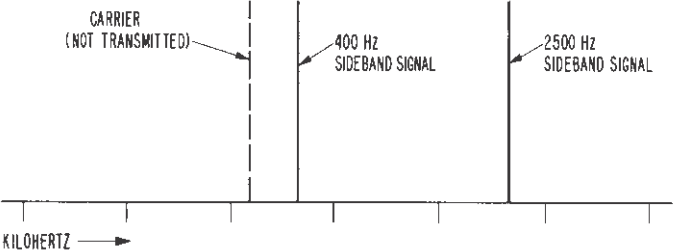

Figure 45. Spectrum of SSB transmitter modulated by two-tone test signal containing 400- and 2500-Hz tones and transmitting upper sideband.

In some single-sideband generators, this type of signal is obtained by impressing a single tone at the audio input and injecting the carrier (by unbalancing a balanced modulator) to provide the second equal amplitude RF signal (Figure 46). The resultant, or beat between the two RF signals, produces a pattern which, when observed on an oscilloscope, has the appearance of a carrier, 100 per cent amplitude modulated by a series of half sine waves as shown in Figure 47.

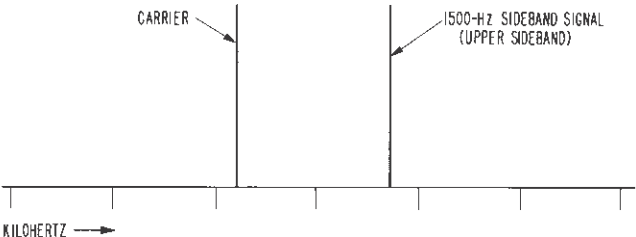

Figure 46. Spectrum of SSB transmitter modulated by 1500-Hz tone and injecting carrier to obtain second RF signal equal in amplitude to tone.

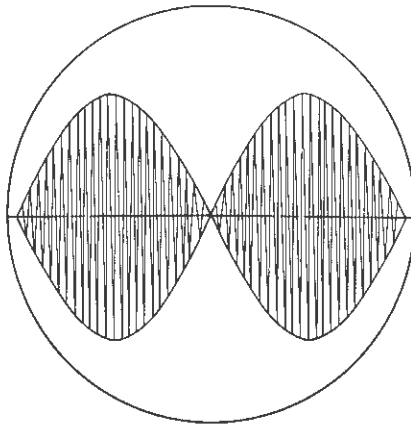

Figure 47. R-f output of SSB transmitter modulated by two-tone test signal as seen on the oscilloscope.

When measuring the distortion of a linear RF amplifier or a chain of linear RF amplifiers by the two-tone technique, it is sometimes more expedient to use two RF signal sources separated in frequency by the desired number of hertz, and then to combine them in a manner which will minimize the interaction of the two signals. The two RF signals represent the two equivalent sideband frequencies generated by the two audio-tone system and when viewed on an oscilloscope appear exactly the same.

A linear amplifier is usually rated at peak envelope input or output power level. **Peak envelope power (PEP)** is the root-mean-square (rms) power generated at the peak of the modulation envelope. With either a two-equal-tone test signal or a single-tone test signal, the following equations approximate the relationships between single-tone and two-tone meter readings, peak envelope power, and average power for Class B or Class AB operation.

4.2.1 Single Tone

$$\text{DC Plate Current} \quad I_b = \frac{I_{pm}}{\pi} \quad (1)$$

$$\text{Plate Input Watts} \quad P_{in} = \frac{I_{pm} E_b}{\pi} \quad (2)$$

$$\begin{array}{l} \text{Average Output Watts} \\ \text{and PEP} \end{array} \quad P_o = \frac{i_{pm} e_p}{4} \quad (3)$$

$$\text{Plate Efficiency} \quad \eta_p = \frac{\pi e_p}{4E_b} \quad (4)$$

4.2.2 Two Equal Tones

$$\text{DC Plate Current} \quad I_b = \frac{2 i_{pm}}{\pi^2} \quad (5)$$

$$\text{Plate Input Watts} \quad P_{in} = \frac{2 i_{pm} E_b}{\pi^2} \quad (6)$$

$$\text{Average Output Watts} \quad P_o = \frac{i_{pm} e_p}{8} \quad (7)$$

$$\text{PEP Watts} \quad P_o = \frac{i_{pm} e_p}{4} \quad (8)$$

$$\text{Plate Efficiency} \quad \eta_p = \left(\frac{\pi}{4}\right)^2 \frac{e_p}{E_b} \quad (9)$$

4.2.3 Definition of Symbols:

i_{pm} = Peak of the plate current pulse—the plate current pulse is not sinusoidal.

e_p = Peak value of plate swing, assumed to be sinusoidal when plate tank “Q” is sufficiently high.

π = 3.14

E_b = d-c plate voltage

The approximate equations given above are for single-tone and two-tone conditions, the most common test situations. In some multi-channel transmitter applications, many more tones are used and the following method will determine the peak-envelope-power to average-power ratio. For the purposes of this explanation, it is assumed that all the tones are equal, however, unequal tones can be employed with this technique.

The following examples demonstrate two important relationships of single and multitone signals amplified by a linear system.

1. The amplifier is set up for a single-tone driving signal and a Point "A" (see Figure 48) on the operating line is established. A definite PEP output is developed under this condition. To drive this linear amplifier to the same PEP output with a multitone signal, the drive signal voltage for each tone must be $1/n$ th (n = number of tones) the amplitude of the single-tone signal.
2. By assuming a perfectly linear amplifier wherein the input signal wave shape is exactly reproduced in the output load, these grid wave shapes can be used to demonstrate the relationship of PEP to Average Power.

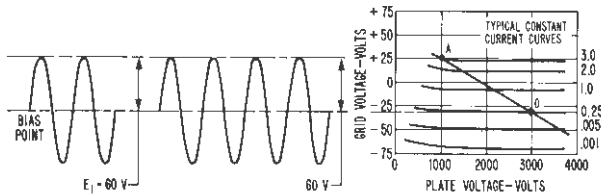

Figure 48. Single-tone condition.

4.2.4 Single-Tone Signal

$$P_{\text{avg}} = \frac{E_1(\text{rms})^2}{R_L} = \frac{\left(\frac{60}{\sqrt{2}}\right)^2}{R_L} = \frac{1800}{R_L} \text{ W} \quad (10)$$

$$\text{PEP} = \frac{E_1(\text{rms})^2}{R_L} = \frac{\left(\frac{60}{\sqrt{2}}\right)^2}{R_L} = \frac{1800}{R_L} \text{ W} \quad (11)$$

$$\text{Therefore, PEP} = P_{\text{avg}} \quad (12)$$

4.2.5 Two-Tone Signal

$$\begin{aligned} P_{\text{avg}} &= P_{1 \text{ avg}} + P_{2 \text{ avg}} \quad (13) \\ &= \frac{(E_{1(\text{rms})})^2}{R_L} + \frac{(E_{2(\text{rms})})^2}{R_L} \\ &= \frac{\left(\frac{30}{\sqrt{2}}\right)^2}{R_L} + \frac{\left(\frac{30}{\sqrt{2}}\right)^2}{R_L} \\ &= \frac{450}{R_L} + \frac{450}{R_L} = \frac{900}{R_L} \text{ W} \end{aligned}$$

$$\begin{aligned}
 \text{PEP} &= \frac{(E_{1\text{rms}} + E_{2\text{rms}})^2}{R_L} & (14) \\
 &= \frac{\left(\frac{30}{\sqrt{2}} + \frac{30}{\sqrt{2}}\right)^2}{R_L} \\
 &= \frac{\left(\frac{60}{\sqrt{2}}\right)^2}{R_L} = \frac{1800}{R_L} \text{ W}
 \end{aligned}$$

$$\text{Therefore, PEP} = 2 \times P_{\text{avg}} \quad (15)$$

The two frequencies (f_1 and f_2) are equal in amplitude but slightly different in frequency. As a result, when they are exactly in phase, the two crest voltages add directly to produce the crest of the two-tone envelope. When the two frequencies are exactly out of phase, then the cusp of the two-tone envelope results (see Figure 49). Note that the voltage amplitude at the crest of the resultant two-tone envelope is equal to that of the single-tone envelope and therefore the tube is driven to the same point "A" on the operating line in each case. If the tube is driven to the same peak anode current and the same peak anode voltage swing by different exciting signals, then the Peak Envelope Power Output for both signals is the same.

4.2.6 Three-Tone Signal

$$\begin{aligned}
 P_{\text{avg}} &= P_{1 \text{ avg}} + P_{2 \text{ avg}} + P_{3 \text{ avg}} & (16) \\
 &= \frac{(E_{1\text{rms}})^2}{R_L} + \frac{(E_{2\text{rms}})^2}{R_L} + \frac{(E_{3\text{rms}})^2}{R_L} \\
 &= \frac{\left(\frac{20}{\sqrt{2}}\right)^2}{R_L} + \frac{\left(\frac{20}{\sqrt{2}}\right)^2}{R_L} + \frac{\left(\frac{20}{\sqrt{2}}\right)^2}{R_L} \\
 &= \frac{200}{R_L} + \frac{200}{R_L} + \frac{200}{R_L} = \frac{600}{R_L} \text{ W}
 \end{aligned}$$

$$PEP = \frac{(E_{1rms} + E_{2rms} + E_{3rms})^2}{R_L} \quad (17)$$

$$= \frac{\left(\frac{20}{\sqrt{2}} + \frac{20}{\sqrt{2}} + \frac{20}{\sqrt{2}}\right)^2}{R_L}$$

$$= \frac{\left(\frac{60}{\sqrt{2}}\right)^2}{R_L} = \frac{1800}{R_L} \text{ W}$$

Therefore, $PEP = 3 \times P_{avg}$ (18)

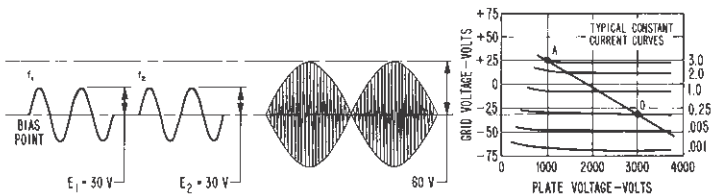

Figure 49. Two-tone condition.

Note that the sum of the three individual tone crest exciting voltages add in phase to drive the tube to the same peak current and peak anode voltage swing as that of the single-tone case (see Figure 50). The PEP output will therefore be the same as for the single-tone and two-tone examples.

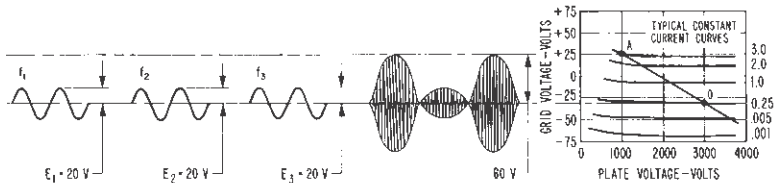

Figure 50. Three-tone condition.

The above results for equal amplitude tones may be summarized by the following expressions:

$$PEP = n P_{avg} \quad (19)$$

and $PEP = n^2 \times P_t$ (20)

where P_{avg} = average power of composite signal

P_t = average power in each tone

n = number of tones

Example:

An FM mobile radiotelephone mountain-top repeater is to be designed to simultaneously rebroadcast one to eight channels. Each channel must have an average power output of 100 Watts. How much Peak Envelope Power must the linear amplifier deliver?

Each channel can be considered to be a single-tone signal. Therefore, the PEP of each channel is equal to the average power of each channel. The maximum power output requirement of the amplifier will be under the 8-tone condition. The average power output for the composite 8-tone signal will be 8 times the 100 Watts-per-channel power. Therefore, the linear amplifier must be capable of 800 Watts of average power output. The Peak Envelope Power will be 8 times the average power of the composite signal ($PEP = nP_{avg}$) or 6400 Watts. A tube must be selected to deliver this peak envelope and average power at an intermodulation distortion level compatible with the degree of inter-channel cross-talk that can be tolerated.

4.3 SELECTION OF TUBES FOR SINGLE SIDEBAND SERVICE

As a guide in selecting tubes for various power levels of single-sideband service, typical operating conditions for various EIMAC tubes are included in this section. These data give values at the maximum signal condition for sustained singletone modulation, and also give the average current values (as read on a dc meter) using a two-tone test signal adjusted to the same peak envelope power as the single-tone condition. Voice-signal average currents will, of course, be lower than the two-tone condition by an amount depending upon the peak-to-average ratio of the voice signal, which is less than that of a two-tone signal in all cases. Typical third- and fifth-order intermodulation distortion product levels for maximum drive conditions are also given for the two-tone condition.

GUIDE FOR SELECTION OF TUBES FOR SSB SERVICE

Tube Type	Plate Voltage Vdc	Screen Voltage Vdc	Suppressor Voltage Vdc	Bias Voltage Vdc	Filament Voltage V	Filament Current A	Zero Signal Plate Current mA	Single Tone Plate Current mA	Two Tone Plate Current mA	Useful PEP Output W	3rd Order Distortion Products dB	5th Order Distortion Products dB	Class of Service	Resonant Plate Load Ω
3CX800A7	2200	—	—	8.2	13.5	1.5	15	500	313	750	-36	-32	AB ₂	2700
3CX1000A7	2500	—	—	0	5.0	33	270	800	560	1270	-32	-38	AB ₂	1650
3CX1500A7	3500	—	—	8.2	5.0	10.5	182	1000	675	2075	-38	-41	AB ₂	2000
3CX10,000A3	6000 7000	—	—	-270 -325	7.5	104	500 500	4000 4000	—	8000 20,000	—	—	AB ₂ AB ₂	1020 1135
3CX10,000A7	7000 7000	—	—	0	7.5	104	600 600	3720 5000	—	17,700 24,000	—	—	AB ₂ AB ₂	1020 1745
4CX250B	2000	325	—	-56	6.0	2.9	90	277	196	348	-25	-25	AB ₁	4500
4CX250R	2000	400	—	-72	6.0	2.9	95	322	225	475	-25	-35	AB ₁	4000
4CX300A	2000	325	—	-56	6.0	3.9	90	277	196	348	-25	-25	AB ₁	4500
4CX300Y	2000	400	—	-72	6.0	3.9	100	312	222	423	-28	-30	AB ₁	3500
4CX350A	2200	300	—	-20	6.0	3.6	100	215	167	318	-29	-30	AB ₁	6000
4CX350F	2200	300	—	-20	26.5	0.81	100	215	167	318	-29	-30	AB ₁	6000
4CX600A	2000 2500	400 300	—	-50 -31	6.0	4.8	200 200	465 400	343 304	500 524	-30 -32	-47 -41	AB ₁ AB ₁	2000 4100
4CX1000AK	3000	310	—	-63	6.0	9.9	250	750	540	1400	-23	-26	AB ₁	2200
4CX1500B	2500 2750 2900	225 225 225	—	-34 -34 -34	6.0	9.9	300 300 300	720 755 710	530 555 542	890 1100 1100	-40 -41 -44	-47 -48 -48	AB ₂ AB ₂ AB ₂	1900 1900 2200
4CX3000A	5000	850	—	-180	9.0	43.5	500	1650	1100	5300	-32	-35	AB ₁	1700
4CX5000A	5000 7500	1000 1250	—	-210 -307	7.5	78	670 450	1670 1900	1240 1590	5260 11,910	-36 -24	-36 -34	AB ₁ AB ₁	1790 1580
4CX5000R	5000 7500	1000 1250	—	-197 -300	7.5	78	800 500	2010 1900	1460 —	5700 10,000	-35 —	-40 —	AB ₁ AB ₁	1450 2460
4CX10,000D	7500 7500	1350 1500	—	-262 -340	7.5	78	900 500	2300 3330	1770 —	11,022 15,950	-35 —	-42 —	AB ₁ AB ₁	1600 2250
4CX15,000A	7000 7500 10,000	1250 1500 1500	—	-240 -350 -370	6.3	168	1500 1000 1000	3090 4400 4250	2380 — —	11,300 20,800 28,500	-49 — —	-45 — —	AB ₁ AB ₁ AB ₁	1350 865 1260
4CX40,000GM	10,000	1400	—	-169	15.0	170	2200	5530	—	50,000	-54	-52	AB ₁	780
5CX1500A	2500 3000 4000	500 500 500	0 0 0	-87 -89 -90	5.0	40	250 250 250	660 690 690	468 482 485	1090 1330 1785	-38 -36 -33	-39 -41 -42	AB ₁ AB ₁ AB ₁	2340 3000 4000
5CX3000A	4000 6000 6000	800 700 800	0 0 -160	-142 -128 -137	9.0	43.5	500 450 450	1570 1340 1475	1100 950 1025	3820 4910 5870	-40 -39 -40	-43 -45 -43	AB ₁ AB ₁ AB ₁	1550 2825 2330

The intermodulation distortion products will be as specified or better for all levels from zero-signal to maximum output power and are referenced against one tone of a two equal tone signal.

4.3.1 Intermodulation Distortion

In general, the criteria used in the selection of operating parameters for tubes in high-fidelity audio-amplifier service are applicable when selecting the operating conditions for linear RF amplifiers. In the case of the sideband linear amplifier, the degree of linearity of the stage is of considerable importance. Intermodulation distortion products in linear power-amplifier circuits can be caused by either amplitude gain nonlinearity or phase shift with change in input signal level. Intermodulation distortion products appear only when the RF signal has a varying envelope amplitude. A single continuous frequency wave will be amplified a fixed amount and shifted in phase a fixed amount. The nonlinearity of the amplifier will produce only harmonics of the input wave. If the input RF wave changes at an audio rate, however, the nonlinearity of the amplifier will cause undesirable intermodulation distortion products to appear. Previously, it was pointed out that a two-tone signal offers a convenient means of measuring distortion. If these two RF tones are equal in amplitude, the resultant signal envelope varies from zero to maximum, so that this signal can be used to test an amplifier over its entire dynamic amplitude range.

When an RF signal with varying amplitude is passed through a nonlinear device, many new products are produced. The frequency and amplitude of each component can be determined mathematically since the nonlinear device can be represented by a power series expanded about the zero-signal operating point. An excellent mathematical discussion of intermodulation distortion appears in "Single Sideband Principles and Circuits."

An example of a typical two-tone signal serves to summarize this mathematical presentation. Assume that two equal amplitude test signals ($f_1 = 2.001$ MHz and $f_2 = 2.003$ MHz) are applied to a linear amplifier. Figure 51 shows the output spectrum of the device.

Many of the distortion-product currents are seen to fall outside the passband of the amplifier tuned circuits. If no impedance exists at the frequencies of the distortion component, then no voltage can be developed. Further study of this spectrum discloses that no even-order products fall near the two desired signals. Some odd-order products, however, fall near the desired frequencies

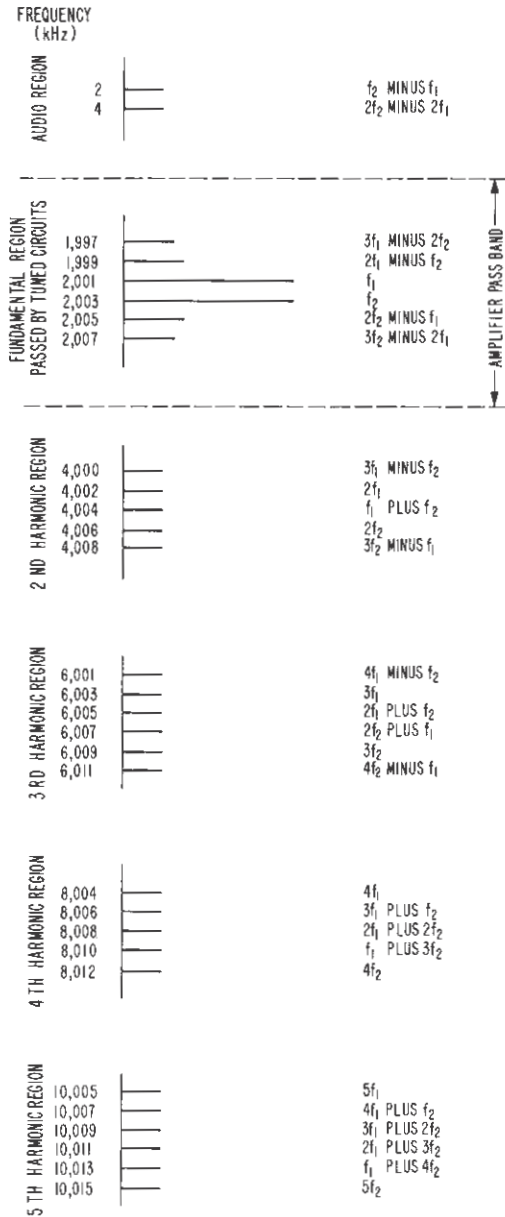

Figure 51. Spectrum at the output of a non-linear device with an input of two equal amplitude sine waves of $f_1 = 2.001$ MHz and $f_2 = 2.003$ MHz.

and possibly within the passband of the tuned circuits. The distortion products which are usually given in tube data sheets are the third- and fifth-order intermodulation-distortion products which can fall within the amplifier passband. Using the same f_1 and f_2 frequencies of the previous example, the frequencies of the third-order products are:

$$2f_1 - f_2 = 1.999 \text{ MHz}$$

$$2f_2 - f_1 = 2.005 \text{ MHz}$$

and the frequencies of the fifth-order products are:

$$3f_1 - 2f_2 = 1.997 \text{ MHz}$$

$$3f_2 - 2f_1 = 2.007 \text{ MHz}$$

These frequencies are well within the passband of a tuned circuit intended to pass voice frequencies and therefore power will be delivered to the antenna at these frequencies. **All intermodulation distortion power is wasted and serves no purpose other than to cause interference to adjacent channels.** The adjacent channels may be other services using nearby frequencies or other channels on the same transmitter. In any case, an interfering signal is created by the generation of distortion products in the (nearly) linear system.

4.3.2 What Makes A Tube Linear?

Intermodulation distortion in a power amplifier tube is mainly caused by its transfer characteristics. An ideal transfer-characteristic curve is shown in Figure 52.

Even-order products do not contribute to the intermodulation distortion problem because they fall outside the amplifier passband. Therefore, if the transfer characteristic produces an even-order curvature at the small-signal end of the curve (from Point A to Point B) and the remaining portion of the curve (Point B to Point C) is linear, the tube is considered to have an ideal transfer characteristic. If the operating point of the amplifier is set at Point 0 (located midway horizontally between Point A and Point B), there will be no distortion in a Class AB amplifier. However, no tube has this idealized transfer characteristic. It is possible, by clever manipulation of the electron ballistics within a given tube structure, to alter the transfer characteristic and minimize the distortion products. Several tubes developed recently by EIMAC have transfer characteristics which significantly reduce intermodulation distortion.

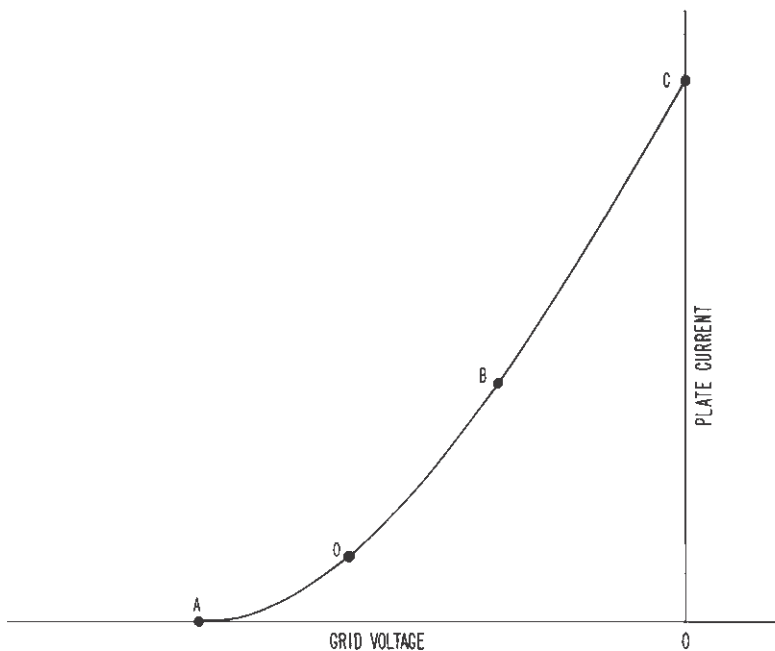

Figure 52. Ideal grid-anode transfer curve for Class AB operation.

4.3.3 A Two Tone Intermodulation Distortion Test Analyzer

The Intermodulation Distortion Test Console at EIMAC uses two separate RF signal sources 2000 Hz apart. The two test signals are at 2.001 and 2.003 MHz. The signals are combined in a toroidal hybrid combiner and amplified by a 4CX5000A operating as a Class A amplifier. The 4CX5000A stage is loaded with a 50-ohm non-inductive load in addition to the impedance of the input circuit of the tube under test. The test amplifier can evaluate many different tube types and is capable of all classes of operation. It may be grid-driven or cathode-driven. See Figure 53 for a block diagram of an IMD test setup.

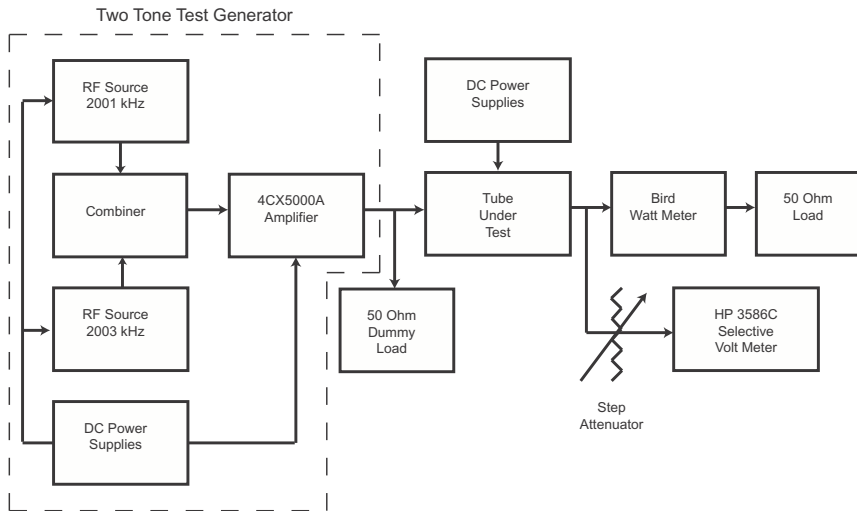

Figure 53. Block diagram of Intermodulation Distortion Analyzer. A low-distortion two-tone RF signal is generated at 2 MHz and applied to the test amplifier. The output of the amplifier is dissipated in a dummy load and a portion of the output signal is examined by a tunable voltmeter. Distortion products as low as -75 decibels below one tone of a two equal tone signal may be studied.

4.3.4 Standards of Measurement

To adequately describe the performance of a tube in single sideband linear service, it is necessary to determine many parameters. The normal electrode voltages and currents must be specified plus the two-tone currents, the operating point, the peak envelope power (PEP), and the magnitude of the intermodulation-distortion products.

These parameters are defined as follows: The term **peak envelope power** is the root-mean-square power at the crest of the envelope.

This term is usually shortened to PEP.

The idling anode current determined by the operating point is called the **zero-signal anode current** and is designated I_{b0} .

The other two anode current values of significance are the **single-tone anode current** and the **two-tone anode current**. The ratio of single-tone to two-tone current is 1.57:1 in a true Class B amplifier (180° anode conduction angle). For other classes of linear operation and for different zero-signal anode currents, this ratio may vary from 1.1:1 to 1.57:1.

The standard method of specifying the magnitude of the distortion products is to specify the reduction in decibels of one product from one tone of a two-equal-tone signal. For example:

Assume that a particular tube under a given set of operating conditions has third-order distortion products of -35 dB and fifth-order distortion products of -50 dB. This means the third-order product has an amplitude of 35 dB below one of the two test tones and the fifth-order product has an amplitude 50 dB below one of the two test tones. (It is also correct to add the amplitudes of the two third-order products and compare them to the **sum** of the two tones. The decibel ratio is still the same as the example.) It is **NOT** correct to compare one distortion product to the sum of the two tones; that is to say, the PEP value of the signal. The resulting distortion Figure would be 6 dB better than the correct example• (-41 dB rather than -35 dB and -56 dB rather than -50 dB).

It is a normal test procedure to adjust the tube under test to the full drive condition and to measure all the pertinent parameters. The drive signal is then reduced in a predetermined manner. At each test point, all of the previously noted parameters are again measured. The resulting data can then be plotted as a function of drive voltage. It should be noted that maximum intermodulation distortion does not necessarily occur at maximum drive level, and it can be shown mathematically that an intermodulation characteristic like Figure 54 can be expected. There is very good correlation between mathematical prediction and actual test results.

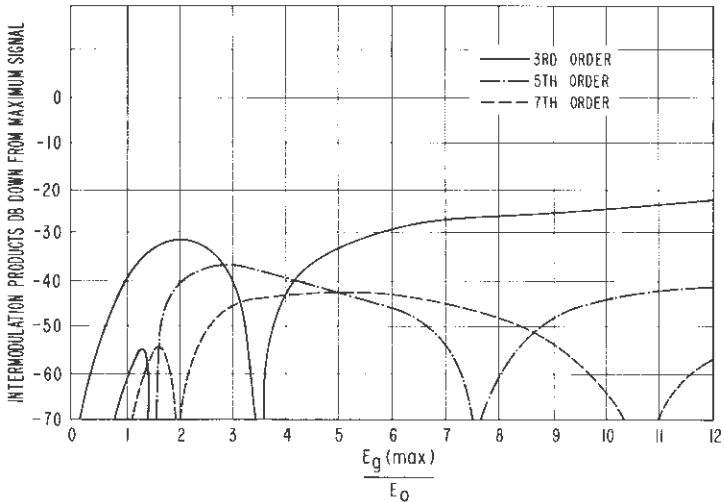

Figure 54. Intermodulation distortion products may be predicted mathematically. This universal family of IMD curves applies to all perfect tubes obeying the 3/2-power law. (See Section 6.4.) The curves are plots of IMD level (Y axis) referred to the driving signal expressed as a ratio of drive to operating bias. As the drive is increased, the various IMD products pass through maxima and minima. Misleading conclusions of amplifier performance may be drawn if the equipment happens to be tested near a cusp on the IMD curve, where a particular product drops to an extremely low level. The whole operating range of the equipment must be examined to draw a true picture of IMD performance.

4.4 LINEAR AMPLIFIER DESIGN

The following features are desirable for tubes used in RF linear amplifier service, in addition to other elements discussed in Section 6, "Operating Conditions for Various Applications."

1. High power gain
2. Low anode-to-grid capacitance
3. Good efficiency
4. Linear characteristics which are maintained without degradation across the desired operating range.

For linear service, RF amplifiers may be operated in Class A, AB, AB₂, or B modes. The choice of tube may be triode, tetrode, or pentode, either grid or cathode driven. The choice of mode, tube, and driving method will depend upon the operational specifications of each individual case.

4.4.1 The Triode Amplifier

The triode tube having a large anode-to-grid interelectrode capacitance always requires neutralization in grid-driven service to prevent oscillation. A triode having a low amplification factor is suitable for Class AB₁, and AB₂ grid-driven operation. The RF grid excitation voltage for this type of service will be quite high and grid excursions into the positive region are normal for Class AB₂ service. A swamping resistor should be used across the input tuned circuit to maintain a constant input impedance to the stage and for stability. With a low value of swamping resistance, the grid current drawn is only a small part of the total grid load and the driver load impedance is relatively constant. The swamping resistor improves RF stability by providing a low impedance to ground for regenerative feedback through the anode-to-grid capacitance.

The high-amplification-factor triode performs exceptionally well in circuits where the grid is grounded and the cathode is driven. Under these conditions, the control grid acts as a shield between the input and output circuits. Neutralization, therefore, is not normally required. EIMAC has developed a line of high amplification ("zero bias") triodes for cathode driven linear-amplifier service, producing stage gains of 10 decibels or more. These tubes operate in the Class AB₂ mode and require only filament, anode, and drive power. For optimum linear operation, a tuned circuit is placed in the cathode RF return path to maintain a sinusoidal wave shape over the drive cycle. The tuned circuit will reduce the intermodulation distortion produced by the amplifier and will also reduce drive power requirements.

The tuned-cathode circuit can be the output circuit of the previous stage if it is located close to the amplifier stage. If, however, the amplifier is far removed and coupled by a length of coaxial cable, it is recommended that a tuned cathode circuit with a "Q" of between two and four be used.

In all linear amplifier systems, the driver output impedance should be very low because of the nonlinear input loading characteristics of the amplifier tube as it approaches maximum power output. The lower the driver amplifier impedance, the smaller will be the effect of the nonlinear input loading.

4.4.2 Effects of Idling Anode Current

The choice of the bias point for a linear amplifier used in single-sideband service is critical. The anode current at the zero-signal operating point is chosen for the best compromise between zero-signal anode dissipation and low intermodulation distortion. The bias point establishes the operating point on the tube transfer curve. The effect upon distortion of the operating point was discussed earlier in Section 4.3.2. Intermodulation distortion test data for the EIMAC 4CX1500B is shown in Figure 55. This illustration is a plot of intermodulation distortion and peak envelope output power as a function of zero-signal anode current (I_{b0}). Typically, the zero-signal anode current for minimum distortion will produce about two thirds of the rated anode dissipation.

4.4.3 Effects of Screen Voltage

Choice of screen voltage is a compromise between power output, zero-signal anode current, and intermodulation distortion. Usually, the lowest value of dc screen voltage compatible with a given power output will produce the lowest intermodulation distortion. Figures 55 and 56 show a comparison of the effects of screen voltage on distortion products for the EIMAC 4CX1500B.

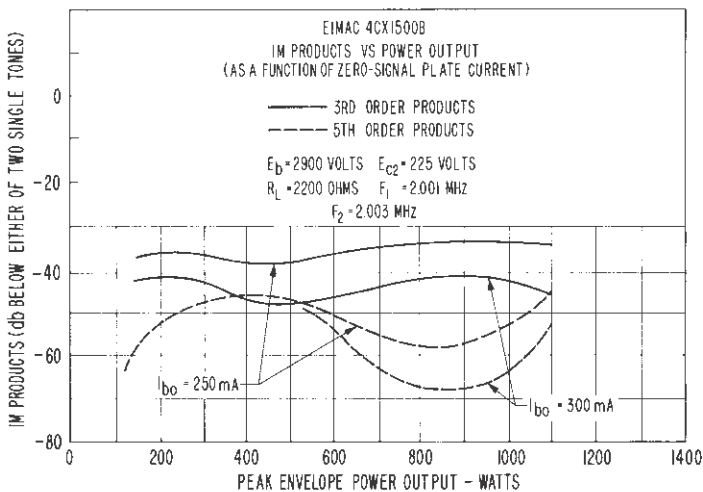

Figure 55. IM Distortion Test Data for EIMAC 4CX1500B ($E_{C2} = 225V$)

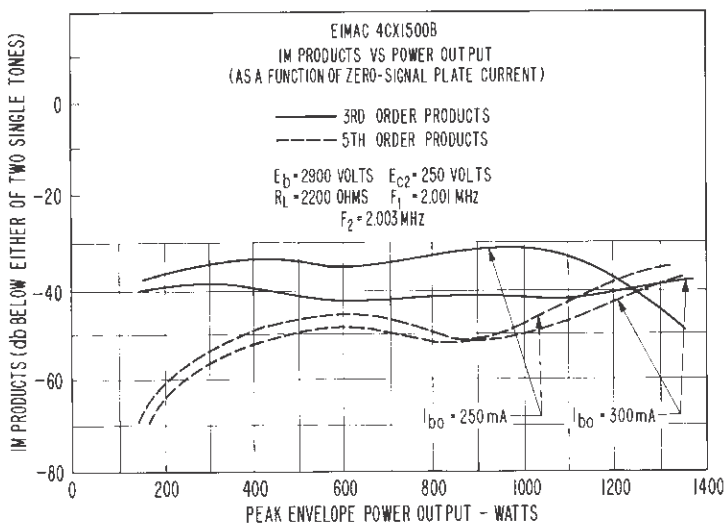

Figure 56. IM Distortion Test Data for EIMAC 4CX1500B ($E_{C2} = 250V$)

4.4.4 Grid Driven Linear Amplifiers

The tetrode or pentode linear amplifier is usually grid driven in order to take advantage of the inherent high gain of the tube. A grid-driven amplifier can be driven into the grid current region under proper circumstances. In any case, the input circuit will be loaded by the tube grid. The no-grid current case will have the input conductance loading, while the grid-current case will have this degree of loading plus grid-current loading. It is therefore desirable (and necessary in the grid-current case) to swamp the input circuit with an appropriate non-inductive resistor. The resistor will maintain an almost constant load on the driver and minimize the effects of any nonlinearity in grid loading.

4.4.5 Cathode Driven Linear Amplifiers

The cathode driven amplifier may use either triode, tetrode, or pentode tubes. The drive signal is applied to the cathode in this class of operation. This technique is often referred to as **grounded grid** since the control grid is usually at radio frequency ground. The cathode-driven amplifier is particularly suitable for high power stages using high- μ triodes in the HF and VHF region. This class of operation normally eliminates the need for neutralization, as the control grid screens the anode from the input circuit. The power

gain for suitable triode Class AB cathode-driven amplifiers is in the order of 7 to 20. The actual tube power gain is very nearly the ratio of radio frequency anode voltage to radio-frequency cathode voltage because the fundamental component of the anode current is common to the input and output circuits.

Tetrode tubes can be used in cathode-driven operation. Power gain is considerably higher than that of triodes, and is in the order of 20 to 50. It is important to recognize that screen-grid current loads the input circuit just as control-grid current does. It is necessary that control grid and screen grid voltages be applied to tetrodes to establish normal operating conditions. Dc grounded grids are not recommended for tetrodes in cathode driven service. Excessive grid dissipation will result if tetrodes are used without bias and screen voltages applied.

For an amplifier located some distance from the driver, an improvement in intermodulation distortion can be realized by tuning the cathode circuit. When the driver is located very close to the amplifier (1/10 wavelength, or so) other means may be used to minimize the nonlinear loading of the cathode driven stage.

4.4.6 Tetrode and Pentode Amplifiers for Television Service

Most tetrode and pentode amplifiers are designed to be grid-driven to take advantage of the high power gain available, approx. 20 dB in most cases. An exception is RF power amplifiers used for analog television where broad bandwidth is required to pass the complex video signal. Depending on the type of amplifier (visual or visual plus aural) and what system is involved (NTSC, etc.) the amplifier must have a minimum power bandwidth of from 4.25 to 6 MHz (measured at 1 dB points) and minimum pulse-top ripple. This requires a low-Q tuned circuit (typically a Q of 1 or 2); the lower input capacitance of a cathode-driven tetrode as well as the lower impedance of this configuration helps improve bandwidth. The gain of a cathode-driven tetrode at VHF is typically 15 dB up to about 200 MHz.

Linearity in Class B is often adequate for visual service, although Class AB is used in most analog TV systems.

4.5 ADJUSTING AND MONITORING THE LINEAR AMPLIFIER

The individual tube data sheet includes all the necessary parameters required to make first approximation adjustments for optimum linearity. A spectrum analyzer or frequency tunable voltmeter, in conjunction with a two-tone drive signal, is necessary to make the final adjustments on a linear amplifier. The following procedures may be helpful in setting up a single-sideband linear amplifier and monitoring its operation:

The first step is to apply anode, screen, and suppressor voltages of the recommended values to the pentode linear amplifier and adjust the bias for the specified zero-signal anode current. Once this adjustment is made the operating point has been established.

The second step is to apply single-tone modulation to the amplifier. In a complete transmitter system which includes the audio amplifiers, sideband generator, and interstage amplifiers, the single tone may be obtained from an audio oscillator. For Class AB1 amplifiers, the drive should be increased until grid current **barely** starts to flow in the stage under test. Next the audio signal is reduced slightly until no current flows. For Class AB2 amplifiers, the drive should be increased until recommended grid current flows. It will be necessary to resonate the various tuned circuits before the drive is increased to full level. After the drive level has been fixed, the anode loading must be adjusted until recommended single-tone anode current flows (in the case of a triode), or until recommended screen current flows and is obtained (in the case of a tetrode or a pentode).

Note that the above procedure depends upon fixing the zero signal level point by adjusting the bias and the maximum-signal point with a single-tone test signal. This is an approximate procedure and is useful when only meters and a single-tone test signal are available. A two-tone test signal is required to make meaningful linearity measurements.

4.5.1 Adjustment With Two Tone Drive

Initial adjustments should be made with single-tone drive, as outlined in the previous paragraph, to obtain zero-signal and maximum-signal operating conditions. Once these conditions have been established, the amplifier is then driven with a two tone test signal **to the same peak grid voltage as that determined for**

the single-tone case. The anode current will be considerably less than for the single-tone condition. The ratio of single-tone to two-tone anode current varies between 1.1: 1 and 1.57:1. Adjustments in anode loading should not be made before the output of the amplifier has been sampled and observed on a panoramic analyzer or a tunable voltmeter. The actual intermodulation-distortion ratios may be measured and then grid drive and anode loading may be adjusted for minimum distortion compatible with the required peak envelope power output.

4.5.2 Adjusting And Monitoring With Envelope Detectors

In addition to the above methods for adjusting the SSB linear amplifier at maximum-signal level with single-tone modulation and for obtaining optimum linearity with two-tone modulation, it may be convenient to use still another procedure¹⁶ to make linearity adjustments and to provide a means of monitoring transmitted signals.

A pair of envelope detectors in conjunction with an oscilloscope can be employed to observe the linearity of an SSB amplifier regardless of the waveform of the modulating signal. Also, this technique affords instant observation of the effects of amplifier adjustments.

4.5.3 Loading

The RF anode load of the tube in the linear amplifier has a great effect upon power output and linearity. Once the loading has been adjusted to provide the desired power output and distortion level, it is desirable to have a circuit in the transmitter to continually monitor the loading. A practical circuit should include a system for detecting the input RF voltage and the output RF voltage. Then, two detected signals are compared and displayed on a zero-center-scale meter or oscilloscope. With the correct ratio of output to input voltages, there will be no deflection of the meter. Under proper loading adjustment, this condition can be satisfied.

To achieve the proper resistive load to the tube, a method of tuning the anode circuit to the same frequency as the drive signal is required. Such systems have been devised making use of phase detectors. By comparing the phase of the anode voltage to that of the drive signal, one can tell when the anode circuit is resistive. This type of circuit is useful for continuous monitoring while the

¹⁶ Pappenfus, et al, op. cit.

transmitter is in service. If the anode circuit is off-resonance, the anode load impedance will have a reactive component and hence will create an elliptical operating line. The elliptical operating line reduces efficiency and power output and distorts the linearity characteristic of the stage.

SECTION 5

NEUTRALIZATION

A completely neutralized amplifier must fulfill two conditions. The first is that the interelectrode capacitance between the input and output circuits be cancelled. The second requirement is that the inductance of the screen grid and cathode assemblies and leads be completely cancelled. Cancellation of these common impedances between the input and output will theoretically prevent oscillation. This also applies in practice, but often not without some difficulty.

There are a variety of methods of accomplishing these ends that will fulfill the two conditions. At frequencies up to about 500 KHz it is not normally necessary to neutralize a grid-driven triode. A grounded-grid cathode-driven ceramic-metal triode can usually be operated up into the VHF range without neutralization. Tetrode and pentode amplifiers generally will operate into the HF range without neutralization. As the gain of the amplifier increases, the need to cancel feedback voltage becomes that much more necessary. For this reason, it is usually necessary to neutralize tetrodes and pentodes at the higher frequencies.

5.1 NEUTRALIZATION BELOW VHF

At frequencies below the VHF region, neutralization usually employs a capacitance bridge circuit to balance out the feedback due to the residual anode-to-grid capacitance. This assumes that the screen is well by-passed to ground and so provides the expected screening action. In the VHF and UHF regions the screen is not necessarily at RF ground potential. The neutralizing circuit, therefore, becomes more involved.

If neutralization on the fundamental frequency below the VHF region is found desirable, normal cross-neutralization of push-pull amplifiers is simplest. The neutralizing capacitors are small. In the case of triodes, special neutralization capacitors are manufactured and are available as catalog items.

In the case of the small tetrode or pentode each capacitor need only be a wire connected to each side of the grid circuit, brought through the chassis deck, and allowed to “look” at the anode of the tube on the opposite half of the circuit. This is illustrated in Figure 57.

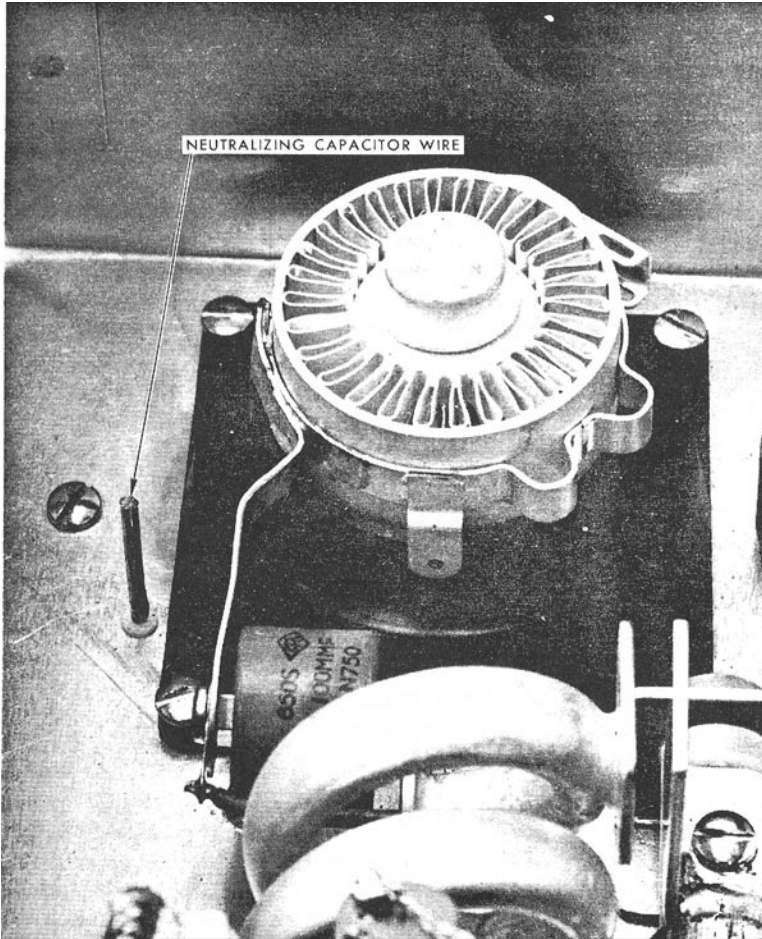

Figure 57. Wire neutralizing system.

The wire or rod can be one-half to one inch away from the tube; by adjusting its length or spacing the last trace of coupling can be eliminated from the amplifier. A simple insulating collet mounted on the chassis deck will support the wire or rod and allow it to be adjusted.

5.2 PUSH-PULL NEUTRALIZATION

In the case of a single-ended stage, either a push-pull output or a push-pull input circuit can be used to provide the out-of-phase voltage necessary for neutralization. Because of the lower voltage and the smaller size of the RF input circuit, it is usually simpler to make the input circuit push-pull and the circuit becomes a “grid-neutralization” circuit (see Figure 58). The neutralizing capacitor, C_n , is small and similar to those described above under cross-neutralization. To maintain the balance of the input circuit while tuning, it is desirable to have a padding capacitor, C_1 , equal in size to the input capacitance of the tube.

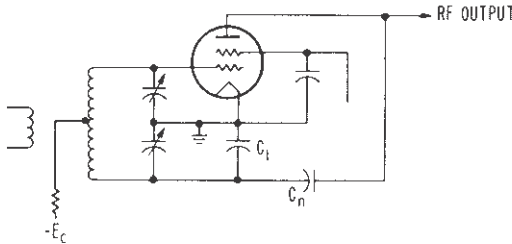

Figure 58. Push-pull grid neutralization, basic circuit.

5.3 SINGLE-ENDED NEUTRALIZATION

Single-ended tetrode and pentode RF amplifier stages can also be grid-neutralized without using a conventional push-pull input circuit (see Figure 59). In this method, the input resonant circuit is taken off ground a small amount by making the input circuit by-pass capacitor, C , somewhat smaller than usual. The voltage to ground across the capacitor, C , is out of phase with the grid voltage and can be fed back to the anode to provide neutralization. In this case the neutralizing

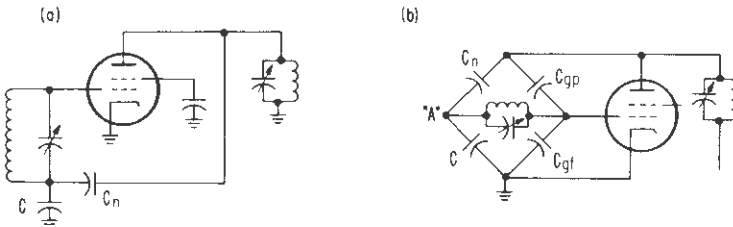

Figure 59. Single-ended grid neutralization described by Bruene, basic circuit.

capacitor, C_n , is considerably larger than the grid-to-anode capacitor and is about the size of those used for neutralizing triodes.

The basic circuit of this neutralization scheme is shown in Figure 59a. It can be redrawn as a capacitance bridge showing clearly the grid neutralization circuit (see Figure 59b). Balance is obtained when

$$\frac{C_n}{C} = \frac{C_{gp}}{C_{gf}}$$

where C_{gp} is the feedback capacitance grid-to-anode of the tetrode or pentode, the C_{gf} is the total input capacitance, including tube and stray capacitance.

A single-ended amplifier can also be neutralized by taking the anode circuit a small amount off ground as was done in the single-ended grid neutralizing scheme, and by using the tube capacitances as part of the bridge circuit (see Figure 60).

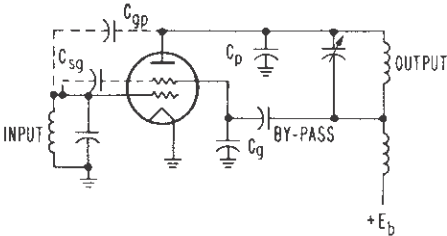

Figure 60. Single-ended anode neutralization, basic circuit.

This circuit differs from the usual RF amplifier circuit in that the anode by-pass capacitor is returned to the screen side of the screen by-pass capacitor, C_s , and in adding stray capacitance from anode to ground, C_p . The size of screen by-pass capacitor, C_s , and the amount of stray capacitances in C_p are chosen to balance out the voltages induced in the input by the internal tube capacitances anode-to-grid, C_{pg} , and screen to grid, C_{sg} .

The circuit is redrawn in Figure 61 in the usual bridge form. Balance is obtained when

$$\frac{C_p}{C_s} = \frac{C_{gp}}{C_{sg}}$$

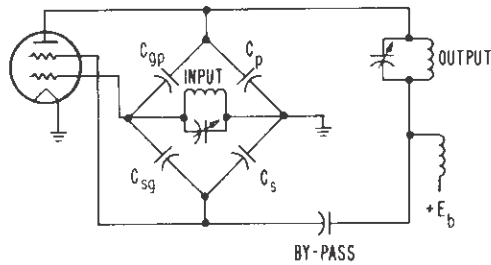

Figure 61. Single-ended anode neutralization showing capacitance bridge circuit present.

In usual tetrode and pentode structures the capacitance from screen-to-grid is roughly half the published tube input capacitance. The tube input capacitance is mainly the sum of the capacitance of the grid-to-screen and the capacitance grid-to-cathode. At first guess these two capacitances are roughly equal, so one is not far off in using half the listed tube input capacitance.

Note that in all neutralizing capacitance bridge circuits, it is assumed that the frequency is low enough so that inductances in the connecting leads and tube structures can be neglected. This is usually not the case in the VHF region, especially in single-ended tetrode and pentode stages where bridge circuits balance with a very small voltage in part of the bridge circuit. At VHF the small amount of voltage developed in the residual inductance of the screen circuit can be enough to accomplish neutralization in itself.

5.4 NEUTRALIZING GROUNDED-GRID AMPLIFIERS

Grounded-grid triode amplifiers offer an attractive alternative to the more usual grid-driven amplifier. The control grid is operated at RF ground and serves as a shield to capacitive currents from the output to the input circuit. Generally, neutralization is not required until the control grid lead inductive reactance becomes significant. The feedback from the output to the input circuit is no longer due only to the anode-to-filament capacitance. The physical size of the tube and the operating frequency will determine when neutralization is required.

Two methods of neutralization are commonly used with grounded grid amplifiers. In the first method, the grids of a push-pull amplifier are connected to a point having zero impedance to ground, and a bridge of neutralizing capacitances is used which is equal to the anode-filament capacitances of the tubes.

The second method of neutralization requires an inductance between the grid and ground or between the grids of a push-pull amplifier of a value that will compensate for the coupling between input and output circuits resulting from the internal capacitances of the tubes.

Behavior of these two circuits are quite different. They may be considered as special forms of the more general case in which the neutralizing capacitors have values differing from the internal capacitances of the tubes, and in which an appropriate reactance is connected between the grids.

Under these conditions, the value of neutralizing capacitance permits continuous variation of the power amplification, stability, and negative feedback.

The purpose of neutralization is to make the input and output circuits independent of each other with respect to reactive currents. The input current must be independent of the output voltage, and reciprocally. This condition is necessary to permit independent tuning of the input and output circuits, so that the variations in output voltage do not produce variations of phase angle of the input impedance, resulting in phase modulation.

This condition of independence between input and output circuits, which may be called the "neutralized condition," does not necessarily imply stability. This is because the suppression of coupling by capacitive currents between input and output circuits is not sufficient to remove the effect of the output voltage on the cathode-to-grid voltage. A second condition, distinct from neutralization, must be met for complete stability. The effect of the control grid lead inductance must be cancelled.

5.4.1 Symmetrical Grid-Driven Amplifiers

A symmetrical or push-pull grid excited amplifier with grounded cathode is shown in Figure 62. If the inductance of the leads is considered to be negligible at the operating frequency, independence between the input and output circuits is generally obtained by cross-connecting the grids and anodes through capacitors C_n having values equal to the internal grid-anode capacitance, C_{gp} , of the vacuum tubes. The requirements of stability and neutralization are fulfilled simultaneously because the input circuit is connected between the grids (in the case of a symmetrical stage) or between the cathode and grid (in a single-ended amplifier).

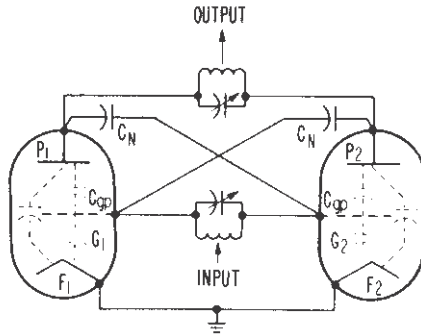

Figure 62. Neutralization of a symmetrical grid-excited amplifier by cross-connected capacitors.

5.4.2 Symmetrical Cathode-Driven Amplifiers

The same method of neutralization may be applied in symmetrical cathode-driven amplifiers where the grids are grounded and the lead inductances are considered to be negligible at the operating frequency. The grids and cathodes are inverted and the neutralizing capacitors, C_N , have a value equal to the internal cathode-anode capacitance, C_{fp} , of the vacuum tubes as shown in Figure 63.

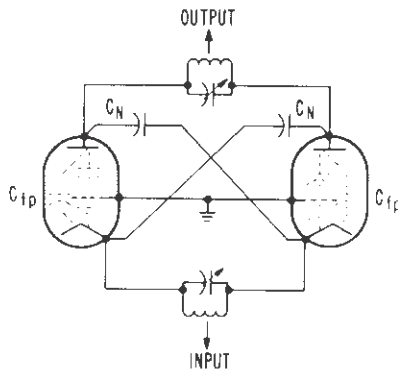

Figure 63. Neutralization by cross-connected capacitors of a symmetrical cathode-excited amplifier with grounded grids.

If the grids are not at ground potential because the inductance of the leads is not negligible, coupling may exist between the input and output circuits through the anode-grid capacitances, cathode-grid capacitances, and grid-to-grid inductance. One method of reducing this coupling is to insert between the grids, a series tuned circuit which has zero reactance at the operating frequency as shown in Figure 64.

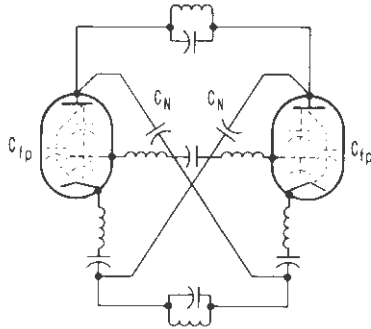

Figure 64. Neutralization by cross-connected capacitors of a symmetrical cathode-excited amplifier with compensation of lead inductance.

The neutralization scheme just described is useful only for the case where no grid current flows. If grid current flows, a grid resistance will appear in parallel with the grid-to-filament capacitance. If the resistance is small in comparison to the reactance of this grid-to-filament capacitance, phase modulation will be produced.

Another important property of the preceding neutralizing method is that power amplification is a function of the neutralizing capacitance while the independence of cathode and anode circuits from the viewpoint of reactive currents may be obtained with any value of neutralizing capacitance. If the neutralizing capacitance is less than the anode-to-filament capacitance of the tube, the stage will operate with low excitation power and high power amplification.

If the neutralizing capacitance is greater than the anode-to-filament capacitance, the power amplification would be quite low, but the total output power possible would be increased. A more complete discussion of grounded grid amplifier neutralization can be found in the references.^{17, 18}

17 "The Inverted Amplifier," C. E. Strong, *Elect. Comm.*, V. 19, No. 3, 1941.

18 "Cathode Excited Linear Amplifiers," J. J. Muller, *Elect. Comm.*, V. 23, 1946.

5.4.3 Grounded-Grid Amplifiers with Grid Impedance

In the special case for the grounded-grid amplifier having a grid impedance and the reactive currents neutralized, the following equations and Figure 65 apply.

$$C_n = C_{fp} - \frac{C_{fg}}{\mu}$$

$$Z_g = - \frac{1}{[j\omega C_{fg} + C_{gp} (1 + \mu)]}$$

If in solving the equation for C_n the sign is negative, this indicates in-phase neutralization is required. Conversely, if the sign of C_n is positive, then out-of-phase neutralization is required.

A negative value of Z_g indicates capacitive reactance required and a positive value requires an inductive reactance to be used.

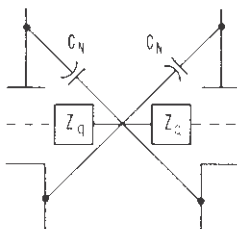

Figure 65. Circuit of grounded-grid amplifier having grid impedance and neutralized for reactive currents.

5.5 NEUTRALIZATION PROCEDURE

5.5.1 Breaking D-C Current Path

The first step to roughly adjust the neutralization is to break the dc connections of the anode voltage and screen voltage leaving the RF circuits intact. If the dc current path is not broken, some current can flow in either one of these circuits even though the voltages are zero. The presence of this current causes the amplifier to work in the normal manner, generating RF power in the anode circuit. It will then be incorrect to adjust for zero power in the anode circuit. Sufficient RF grid drive must be applied to provide some grid current or to cause a sensitive RF meter coupled to the anode to

give an indication of feed through power. When the anode circuit is tuned through resonance, the grid current will dip when the circuit is out of neutralization or the RF meter will peak. The neutralization adjustments are made until the indication is minimum.

5.5.2 Feeding the Grid Circuit

Another very powerful tool for roughly neutralizing the amplifier is to feed the output from a signal generator into the grid circuit. A sensitive RF detector is inserted between the output connector and the load. The neutralization can then be adjusted for minimum feed through. This technique is very useful in working with the prototype equipment. Actual quantitative measurements can be made. If the insertion loss of the amplifier is less than the expected gain, oscillation will occur. Circuit modification can be made until the isolation is sufficient to warrant a test with high voltages applied. The advantages of this "cold" system: (a) no components are subjected to unusual stress if the amplifier is unstable, and (b) safer, more convenient circuit modifications may be made.

5.5.3 Final Trimming

For the final trimming of the neutralization adjustment, the stage should be returned to operating condition at reduced power similar to that used when testing for parasitic oscillations, or under the final loaded operating conditions. At the higher frequencies and in the VHF region, it will be found that a small additional trimming adjustment of the neutralizing circuit is usually required. When the anode circuit is tuned through resonance, the minimum anode current and maximum control grid current should occur simultaneously. In the case of the tetrode and pentode the dc screen current should be maximum at the same time.

The neutralizing procedures indicated above apply not only to the HF radio frequencies, but also apply in the VHF or UHF regions. In the latter cases the neutralizing circuit is different and the conventional cross-neutralization schemes may not apply.

As the radio frequency is increased, the reactance of the screen lead inductance of a tetrode or pentode no longer is negligible.

5.5.4 Feedback Circuits in Tetrodes and Pentodes

Careful analysis of the feedback circuits of tetrodes in the VHF region has been made and the basic concepts follow.

The same analysis applies to a pentode. In Figure 66 the tetrode circuit elements involved in the feedback circuits are indicated. These circuit elements are inherent and involve the residual capacitance anode-to-grid, the capacitance from anode-to-screen, the capacitance from screen-to-grid, and the inductance of the screen lead to the tube. It will be noted that the RF voltage developed in the anode circuit E_p causes a current, I , to flow through the anode-to-screen capacitance, C_{ps} , and the inductance, L , in the screen leads. The passage of this current through the inductance L develops a voltage $-E$ which has a polarity opposite to that of the anode voltage, E_p .

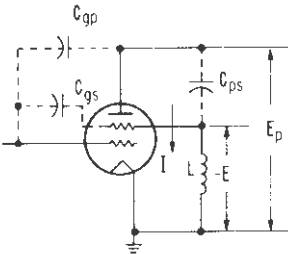

Figure 66. Tetrode characteristics involved in feedback circuit.

In Figure 67 the same circuit elements and voltages have been arranged with a graphical representation where the height above or below the zero line represents magnitude and polarity of the RF voltage of that part of the circuit with respect to zero. Because all of the circuit components involved are pure reactances, the voltages are either in phase or out of phase, and so can be represented as positive and negative with respect to each other. The voltages plotted are the components only of the RF output circuit voltage, E_p , and no attempt is made to show the normal driving voltage

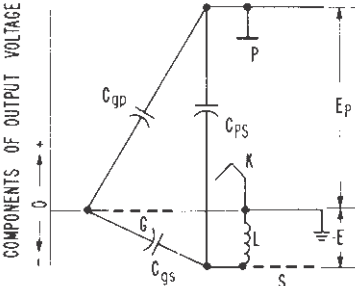

Figure 67. Graphical presentation of components of output circuit voltages in tetrode when self neutralized.

on the grid. The anode "P" is shown at a high positive potential above zero and the magnitude is represented by the distance above the zero line as shown by the dimension, E_p . The voltage developed in the screen lead inductance places the screen at a negative voltage with respect to the anode voltage. The screen of the tube, S, is shown to be below the filament line, or negative, by the amount $-E$. If the circuit were perfectly neutralized, the control grid, G, would lie on the zero potential line or a filament potential insofar as any action of the RF anode voltage, E_p , on the input circuit is concerned. If there is no component of output voltage developed between grid and filament, the circuit is neutralized.

The total RF voltage between anode and screen comprises anode voltage and screen lead inductance voltage $-E$. This total voltage is applied across a potential divider consisting of the capacitance anode-to-grid, C_{pg} , in series with the capacitance grid-to-screen, C_{gs} . When this potential divider is suitably matched to the magnitudes of the voltage, E_p , and screen lead voltage, $-E$, the control grid will have no voltage difference to filament as a result of the output circuit voltage, E_p .

5.6 SELF-NEUTRALIZING FREQUENCIES OF TETRODES AND PENTODES

It should be noted in Figure 67 that the potential dividing action between capacitances anode-to-grid, C_{pg} , and grid-to-screen, C_{gs} , will not be affected by the operating frequency. It should also be noted that the division of voltage between anode and screen and screen and ground due to the charging current, I , will vary greatly with frequency. There will, therefore, be some particular frequency at which this potential dividing circuit places the grid at filament potential as far as the anode circuit action is concerned, and this is called the **self-neutralizing frequency** of the tetrode. At this particular frequency the tetrode, or pentode, is inherently neutralized due to the circuit elements within the tube structure and any external added screen lead inductance to ground. Typical self-neutralizing frequencies with normal screen by-passing are as follows:

APPROXIMATE SELF-NEUTRALIZING FREQUENCIES OF SOME EIMAC TETRODES AND PENTODES

TUBE TYPE	SOCKET	FREQUENCY (MHz)
3CX3000A7	—	275 - 365
3CX10,000A7	—	180 - 320
4-1000a	See Note	25 - 30
4-400A	See Note	45 - 50
4X150A	SK-600	535 - 540
4CX250B	SK-600	545 - 555
4CX250R	Sk-600	565 - 570
4CX300A	SK-710	400 - 490
4CX350A	SK-600	460 - 470
4CX1000K	SK-820	385 - 395
4CX1000A	SK-810	380 - 390
4CX1500B	SK-810	380 - 390
4CX3000A	SK-1400A	125 - 130
4CX5000A	SK-300A	140 - 170
4CX15,000A	SK-300A	120 - 150
8973	—	70 - 99
8974	—	45 - 70
5CX1500A	SK-840	115 - 120
5CX1500A	SK-840*	190 - 300

* Air holes screened.

Note: Sockets are not called out for these tubes because the recommended sockets do not contain integral bypass capacitors. In these cases, bypass consideration depends on the individual circuit designer.

5.6.1 Operation Below Self-Neutralizing Frequency

When the tube is operated below the self-neutralizing frequency, the normal cross-neutralization circuits apply in this case, a neutralizing capacitor approximately equal to the anode-to-grid capacitance of the tube brings voltage of opposite polarity from the output circuit to the grid, or from the input circuit to the anode.

that the neutralizing series capacitor can be made to operate over the total desired frequency range. Obviously, if the range is too great, switching of neutralizing circuits will be required. A small 50 to 100 pF variable capacitor in the screen lead has been found to be satisfactory.

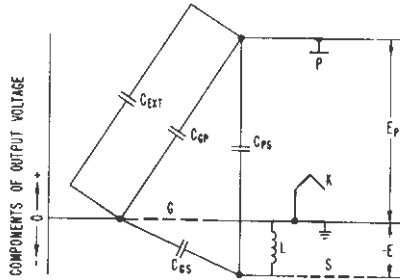

Figure 68A. Components of output voltage of a tetrode when neutralized by added external grid-to-anode capacitance.

Another method of changing the self-neutralizing frequency of a tetrode or pentode is obtained when using the general by-passing arrangement of the screen and the filament shown in Figure 69. The screen lead by-passed with minimum inductance to the filament terminal of the tube. Some inductance is introduced in the common filament and screen grounding lead.

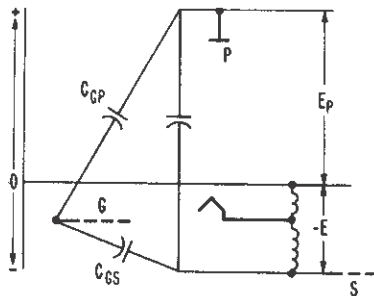

Figure 69. Components of output voltage of a tetrode neutralized by adding inductance common to screen and cathode return.

The grid is shown below the zero voltage or chassis potential, indicating that the voltage developed in the total screen lead inductance to chassis is excessive. If now the filament is tapped up on this inductance, a point can be found where the voltage difference between grid and filament is zero as far as the components of anode voltage are concerned. The arrangement will be found to self-neutralize at a higher frequency than if the filament and screen were separately by-passed to the chassis. Thus, by increasing the self-neutralizing frequency of the tube and screen by-pass arrangement, the tendency of the VHF parasitic to occur is reduced.

If now the frequency of the VHF parasitic is reduced by increasing the inductance of the anode lead (presuming this is the principle frequency defining circuit), it can be made to approach the self-neutralizing frequency of the tube and so suppress the parasitic.

SECTION 6

OPERATING CONDITIONS FOR VARIOUS APPLICATIONS

6.1 ADJUSTMENT OF LOADING AND EXCITATION

In a typical transformer-coupled audio amplifier, the anode-to-anode load impedance required is given in the technical data sheet for the tube type under consideration or can be calculated. The secondary load impedance is normally defined by the application. It only remains to specify the turns ratio of the transformer.

Once the proper output transformer and secondary load are adjusted, the proper excitation is determined by the anode current. If a means is available to measure the grid voltage swing, this can also be used to indicate proper excitation.

In adjusting tetrode or pentode RF amplifier for proper excitation and loading, it will be noticed that the procedure is different, depending upon whether the screen voltage is taken from a fixed supply or a dropping resistor supply with poor regulation. In the case where both the screen supply and grid bias are from fixed sources with good regulation, the anode current is almost entirely controlled by the RF excitation. One should first vary excitation until the desired anode current flows. The loading is then varied until the maximum power output is obtained. Following these adjustments the excitation is then trimmed along with the loading until the desired control grid, and screen grid currents are obtained.

In the case of an RF amplifier where both the screen and grid bias are taken from sources with poor regulation, the stage will tune very much like a triode RF power amplifier. The anode current will be adjusted principally by varying the loading, and the excitation will be trimmed to give the desired control grid current. In this case the screen current will be almost entirely set by the choice of the

dropping resistor. It will be found that excitation and loading will vary the screen voltage considerably and these should be trimmed to give about normal screen voltage.

The grounded-grid amplifier has been used for many years, but with the advent of new high power “zero bias” triodes it has become more common. To adjust the excitation and loading of a grounded-grid RF amplifier requires a slightly different procedure. A means of monitoring power output is usually necessary. The anode voltage (anode and screen voltage in the case of a tetrode or pentode) must be applied before the excitation. If this precaution is not followed, there is a very good chance of damage being done to the control grid. The loading is increased as the excitation is increased. When the desired anode current is reached the power output should be noted. The loading can be reduced slightly and the excitation increased until the anode current is the same as before.

If the power output is less than before, a check can be made with increased loading and less excitation. By proper trimming the proper grid current, anode current and optimum power output can be attained.

In a grounded-grid circuit the cathode, or input circuit, is in series with the anode circuit. Because of this, any change made in the anode circuit will have an effect on the input circuit. Therefore, the driver amplifier does not see its designed load until the driven stage is up to full anode current.

6.2 OPERATING VOLTAGES AND CURRENTS

The simplest way to get an idea of the capabilities of the tube, and the voltages and currents to be used on the various electrodes, is to refer to the technical data sheet for that tube type. A number of typical operating conditions are given for various classes of service. A great many other operating conditions are possible, but those in the data sheet are selected to show the maximum capabilities of the tube for different anode voltages. At no time should the maximum ratings for that class of service be exceeded.

As long as none of the maximum ratings of the tube are exceeded, a wide choice of voltages on the anode, screen, or grid is available and a wide range of anode current values may be chosen.

In referring to the characteristic curves of a tube type, it should be recognized that these curves are typical of a normal tube. As in all manufactured products, some tolerance is allowed. For all tube

types manufactured there is an established test specification giving the most important parameter ranges used for the quality control of the product.

6.3 EFFECT OF DIFFERENT SCREEN VOLTAGES

Typical operating values for a tetrode or pentode for a particular value of screen voltage are given on the published technical data sheet. The screen voltage is not critical for most applications and the value used has been chosen as a convenient value consistent with low driving power and reasonable screen dissipation. If lower values of screen voltage are used, more driving voltage will be required on the grid to obtain the same anode current. If higher values of screen voltage are used less driving voltage will be required. Thus, high power gain can be had provided the circuit has adequate stability. Care should be observed that the screen dissipation limit is not exceeded. The value of screen voltage can be chosen to suit available power supplies or amplifier conditions.

The published characteristic curves of tetrodes and pentodes are shown for the commonly used screen voltages. Occasionally it is desirable to operate the tetrode or pentode at some screen voltage other than that shown on the characteristic curves. It is a relatively simple matter to convert the published curves to corresponding curves at a different screen voltage by the method to be described.

This conversion method is based on the fact that if all interelectrode voltages are either raised or lowered by the same relative amount, the shape of the voltage field pattern is not altered, nor will the current distribution be altered. The current lines will simply take on new proportionate values in accordance with the three halves power law. The method fails only where insufficient cathode emission or high secondary emission affects the current values.

6.4 THE THREE HALVES POWER LAW

For instance, if the characteristic curves are shown at a screen voltage of 250 volts and it is desired to determine conditions at 500 screen volts, all voltage scales should be multiplied by the same factor that is applied to the screen voltage (in this case, 2). The 1000 volt anode voltage line now becomes 2000 volts, the 50 volt grid voltage line 100 volts, etc.

The current lines then all assume new values in accordance with the 3/2 power law. Since the voltage was increased by a factor of 2, the Current lines will all be increased in value by a factor of $2^{3/2}$

or 2.8. Then all the current values should be multiplied by the factor 2.8. The 100 mA line becomes a 280 mA line, etc.

Likewise, if the screen voltage given on the characteristic curve is higher than the conditions desired, the voltage should all be reduced by the same factor that is used to obtain the desired screen voltage. Correspondingly, the current values will all be reduced by an amount equal to the $3/2$ power of this factor.

For convenience the $3/2$ power of commonly used factors is given in Figure 70.

VOLTAGE FACTOR	CURRENT FACTOR
0.25	0.125
0.50	0.35
0.75	0.65
1.00	1.00
1.25	1.40
1.50	1.84
1.75	2.30
2.00	2.80
2.25	3.40
2.50	4.00
2.75	4.60
3.00	5.20

Figure 70. Three-halves power of commonly-used factors.

6.5 BALANCE OF AMPLIFIERS

6.5.1 Push-Pull Amplifiers

The push-pull configuration utilizes two tubes with excitation applied 180° out of phase, and the outputs connected likewise. One advantage of using tubes in push-pull for an amplifier is that even order harmonics and even order combination frequencies are cancelled in the output.

Optimum performance from a push-pull RF amplifier requires careful balancing. The physical layout of a push-pull amplifier is substantially more demanding than that of a single-ended amplifier,

and special matched components must be used for the tuned circuits. For this reason the push-pull configuration has lost favor in most modern RF amplifier designs.

Tubes are still employed in push-pull audio amplifiers. Tetrodes or triode-connected tetrodes in class AB are commonly used up to an output power of approx. 50 kW. Class B is acceptable if the small level of crossover distortion that accompanies that class of operation is acceptable.

Circuit diagrams of an RF amplifier using triodes in push-pull are shown in sec. 5.4.1.

In a push-pull RF amplifier, imbalance in the anode circuit or of anode dissipation is usually due to lack of symmetry in the RF circuit. Normally, the tubes are similar enough that such unbalance is not associated with the tube or its characteristics. This can readily be checked by interchanging the tubes in the sockets (provided both tubes have common dc voltages to anode, screen, and grid), and observing whether the unbalanced condition remains with the socket location, or moves with the tube. If it remains with the socket location, the circuit requires adjustment. If appreciable unbalance is associated with the tube, it is possible that one tube is not normal and should be investigated further.

The basic indicators of balance are the anode current per tube and the anode dissipation of each tube. It is assumed that the circuit applies the same dc anode voltage, dc screen voltage (if a tetrode or pentode), and dc grid bias to each tube from common supplies. Also, it is initially assumed that the anode circuit is mechanically and electrically symmetrical or approximately so.

Unbalance in a push-pull RF amplifier is usually caused by unequal RF voltages applied to the grids of the tubes, or by the RF anode circuit applying unequal RF voltages to the anodes of the tubes. The RF grid excitation should first be balanced until equal dc anode currents flow in each tube. Then the RF anode circuit should be balanced until equal anode dissipation appears on each tube, or equal RF anode voltage.

The balance of anode current is a more important criterion than equality of screen current (in a tetrode or pentode) or grid current. This results from the fact that tubes tend to be more uniform in anode current characteristics. However, the screen current is very sensitive to lack of voltage balance in the RF anode circuit and may be used as an indicator.

Once the dc anode currents per tube have been made equal by adjusting the RF grid circuit, the RF anode circuit can be adjusted to give equal anode dissipations. Or, if the tetrodes or pentodes have equal screen current characteristics, the RF anode circuit could be balanced until equal screen currents results. If the tubes differ somewhat in screen current characteristics, and the circuit has common dc supply voltages, the final trimming of the anode circuit balance may be made by interchanging tubes and adjusting the circuit to give the same screen current for each tube regardless of its location. Note that the dc grid current has not been used as an indicator of balance of the RF power amplifier. It is probable that after following the foregoing procedure the grid currents will be fairly well balanced, but this condition in itself is not a safe indicator of balance of grid excitation.

6.5.2 Parallel Tube Amplifiers

The previous discussion has been oriented toward the RF push-pull amplifier. The same comments can be directed to parallel tube RF amplifiers. The problem of balance to be certain each tube carries its fair share of the load must still be considered.

In audio power amplifiers operating in Class AB₁ or Class AB₂, the idle dc anode current per tube should be balanced by separate bias adjustments for each tube. In many cases some lack of balance of the anode currents will have negligible effect on the overall performance of the amplifier.

When tubes are operating in the idle position, close to cut-off, anode current cannot be held to a close percentage of tolerance. At this operating point, the action of the anode and screen voltages is in a delicate balance with the opposing negative grid voltage. The state of this balance is indicated by the anode current. Very minor variations of individual grid wires or diameter of grid wires can upset the balance, and it is practically impossible to control such minor variations during manufacturing. In many audio amplifier applications, especially where the larger power tetrodes are used, the circuit should be designed to permit the bias to be adjusted individually for each tube.

6.6 *HARMONIC AMPLIFIER AND CONTROL OF HARMONICS*

A pulse of anode current delivered by the tube to the output circuit contains components of the fundamental and most harmonic frequencies. To generate output power that is a harmonic of the

exciting voltage applied to the control grid, it is merely necessary to resonate the anode circuit to the desired harmonic frequency. To optimize the performance of the amplifier, it is necessary to adjust the angle of anode current flow to maximize the desired harmonic. The shorter the length of the current pulse for a particular harmonic, the higher will be the anode efficiency; but the bias, exciting voltage, and driving power are also increased. If the pulse is too long or too short, the output power drops off appreciably.

The harmonic power output that is obtainable decreases with the order of the harmonic. The relative harmonic output obtainable from a given tube compared with normal Class C output with the same peak space current is approximately inversely proportional to the order of the harmonic. The table given in Figure 71 may be used to estimate performance of a harmonic amplifier.

HARMONIC	Optimum Length of pulse, electrical degrees at the fundamental frequency	Approximate Power output assuming that normal Class C output is 1.0
2	90-120	0.65
3	80-120	0.40
4	70-90	0.30
5	60-72	0.25

Figure 71. Anode-Current Pulse Length and Power Output of Harmonic Amplifiers.

The "Tube Performance Computer" described in Section 3 may be used to estimate the harmonic amplifier performance for tetrodes and pentodes because anode voltage has only a small effect on anode current. It has been found that the anode circuit efficiency of tetrode and pentode harmonic amplifiers is quite high. In triode amplifiers, if feedback of the output harmonic occurs, the phase of the voltage feedback usually reduces the harmonic content of the anode pulse, and thereby lowers the anode circuit efficiency. Since tetrodes and pentodes have negligible feedback, the efficiency of a harmonic amplifier is usually comparable to that of other amplifiers.

Also, the high amplification factor of a tetrode or pentode causes the anode voltage to have little effect on the flow of anode current, and it is easier to obtain anode pulses with high harmonic energies

without using excessive grid bias. A well designed tetrode or pentode also permits large RF voltages to be developed in the anode circuit while still passing high peaks of anode current in the RF pulse. These two factors help further to increase the anode efficiency.

The previous discussion of harmonics has been for the situation where harmonic power in the load is desirable and has been the design objective. Normally, the generation and radiation of harmonic energy must be kept at a minimum in a fundamental frequency RF amplifier.

It is not generally appreciated that the pulse of grid current also contains harmonic frequency energy. Control of these harmonic energies may be quite important. The ability of the tetrode and pentode to isolate the output circuit from the input circuit for a very wide range of frequencies is important in avoiding feed-through of harmonic voltages from the grid circuit. An important part of this isolation is the fact that properly designed tetrodes and pentodes permit the construction of complete shielding in the amplifier layout so that coupling external to the tube is also prevented.

In RF amplifiers operating either on the fundamental or a desired harmonic frequency, the control of unwanted harmonics is very important. The following steps permit reduction of the unwanted harmonic energies present in the output circuit:

- (a) The circuit impedance between anode and cathode should be very low for the high harmonic frequencies. This may be obtained by having some or all of the tuning capacitance of the resonant circuit close to the tube.
- (b) Complete shielding of the input and output compartments.
- (c) The use of inductive output coupling from the resonant anode circuit and possibly a capacitive or Faraday shield between the coupling coil and the tank coil, or a high frequency attenuating circuit such as a Pi, or Pi-L network.
- (d) The use of low pass filters for all supply leads and wires coming into the output and input compartments.
- (e) The use of resonant traps for particular frequencies.
- (f) The use of a low pass filter in series with the output transmission line.

6.7 SHIELDING

In an RF amplifier the shielding between the input and output circuits must be considered. Triode amplifiers are more tolerant of poor shielding because power gain is relatively low. If the circuit layout is reasonable and no inductive coupling is allowed to exist, quite often the triode amplifier can be built without shielding and it will perform adequately. It would be better engineering practice to shield the input and output circuits. Even if the shielding is not necessary to prevent fundamental frequency oscillation, it will most certainly aid in eliminating any tendency toward parasitic oscillation. The higher the gain of an amplifier the more important the shielding.

6.7.1 Pierced Shields

Tetrode and pentode amplifiers require excellent shielding to prevent input to output circuit coupling. It is advisable to use non-magnetic materials such as copper, aluminum, or brass in the RF fields to provide the shielding. Quite often a shield must have holes through it to allow the passage of cooling air. In the LF and part of the HF range, the presence of small holes will not impair the shielding. As the frequency is increased the RF currents flowing around the hole in one compartment cause fields to pass through the hole. Currents are, therefore, induced on the shield in the other compartment. This type of problem can be eliminated by using holes which have significant length. A piece of pipe with a favorable length to diameter ratio as compared to the frequency of operation will act as a "waveguide beyond cutoff attenuator."¹⁹ If more than one hole is required to pass air, a material resembling a honeycomb may be used. The material is commercially available²⁰ and provides excellent isolation with a minimum air pressure drop. Several sockets manufactured by EIMAC have this waveguide beyond cutoff air path. These sockets allow the tube in the amplifier to operate at very high gain and up through VHF.

6.7.2 Metal Base Shells and Submounted Sockets

Some tetrodes and pentodes have metal base shells. The shell should be grounded by the clips provided with the socket. This completes the shielding between the output and input circuits since the base shell of the tube comes up opposite the screen shield within the tube itself.

19 Simon Ramo and John R. Whinnery "Fields and Waves in Modern Radio," New York, Wiley, 1953.

20 Hexcel Products, Inc., 281 Tresser Blvd., Stamford, CT 203-969-0666, www.hexcelcomposites.com.

Some pentodes use this metal base shell as the terminal for the suppressor grid. If the suppressor is to be at some potential other than ground, then the base shell must not be dc grounded. The base shell would be bypassed to ground for RF and insulated from ground for dc.

There is a family of tetrodes and pentodes without the metal base shell. It is good practice for this type of tube structure to submount the socket so that the internal screen shield is at the same level as the chassis deck. This technique will improve the input to output circuit shielding. It is very important in submounting a tube that adequate clearance be provided around the base of the tube for passage of cooling air.

6.7.3 Compartments

By placing the tube and circuits in completely enclosed compartments and by properly filtering incoming supply wires, it is possible to prevent coupling out of radio frequency energy by means other than the desired output coupling.

Such filtering prevents the coupling out of energy which may be radiated or be fed back to the input or earlier stages to cause trouble. Energy fed back to the input circuit causes undesirable interaction in tuning, or self-oscillation. If energy is fed back to the earlier stages, the trouble may be greater due to the larger power gain over several stages.

Audio amplifiers using high gain tubes require similar layout consideration. Quite often in the design of an RF amplifier doors or removable panels must be used. The problem of making a good, low resistance joint at the discontinuity must be met. There are several materials available commercially for this application. Finger stock²¹ has been used for many years. "Teknit"²² is also a practical solution. Sometimes it is found that after the wiring has been completed, further shielding of a wire is required. There are various types of shielding tapes²³ that can be wound on as a temporary or even permanent solution.

21 Finger stock is manufactured by: Tech-Etch, Inc. 45 Aldrin Road, Plymouth, MA 02360; Laird Technologies 1 800.843.4556;.

22 "Teknit" is manufactured by: Technical Wire Products, Inc., 129 Dermody Street, Cranford, New Jersey.

23 Magnetic Shield Division, Perfection Mica Co., 742 N. Thomas Dr., Bensonville, Illinois 60106-1643.

6.8 DRIVE POWER REQUIREMENTS

The technical data sheet for a particular tube gives the approximate drive power required. As the frequency of operation increases and the physical size of the tube structure becomes large with respect to this frequency, the drive power requirement will also increase.

The drive power requirements of a grounded-cathode amplifier consists of six major parts:

- (a) The power consumed by the bias source.

$$P_1 = I_{c1} E_{c1}$$

- (b) The power dissipated in the grid due to rectified grid current.

$$P_2 = I_{c1} e_{cmp}$$

- (c) The power consumed in the tuned grid circuit.

$$P_3 = i_{c_{rms}}^2 R_{rf}$$

- (d) The power loss due to transit time.

$$P_4 = \left(\frac{e_{c_{rms}}}{R_t} \right)^2$$

Where R_t is that part of the resistive component of the tube input impedance due to transit time.

$$R_t = \frac{1}{K g_m f^2 T^2}$$

- (e) The power consumed in that part of the resistive component of the input impedance due to the cathode lead inductance.

$$P_5 = \frac{e_g^2}{R_s}$$

Input resistance resulting from the inductance of the cathode lead equals

$$R_s = \frac{1}{\omega^2 g_m L_k C_{gk}}$$

- (f) Power dissipated in the tube envelope due to dielectric loss.

$$P_6 = 1.41 f E_1^2 \epsilon$$

I_{c1}	= d-c grid current
E_{c1}	= d-c grid voltage
e_{cmp}	= maximum positive grid voltage
i_{crms}	= r.m.s. value of r-f grid current
R_{rf}	= r-f resistance of grid circuit
e_{crms}	= r.m.s. value of r-f grid voltage
R_t	= resistance due to transit time loading
K	= a constant function of tube geometry
g_m	= transconductance
f	= frequency, in hertz
T	= transit time, cathode to grid
R_s	= cathode lead inductance input resistance loading
ω	= $2\pi f$
L_k	= cathode lead inductance in henries
C_{gk}	= grid to cathode capacitance in farads
E_1	= voltage gradient in kilovolts per inch, r.m.s.

The total driving power in the VHF and UHF region is often greater than the grid dissipation capability of the tube.

6.9 VHF AND UHF OPERATING CONDITIONS FOR SATISFACTORY ANODE EFFICIENCY AND MINIMUM DRIVE

When operating a tube in the VHF and UHF region the driving power can usually be minimized without appreciably affecting the anode conversion efficiency, by the following steps:

- (a) A minimum dc control grid bias should be used. Frequently, it is advisable to bring this down to approximately cut-off.
- (b) A high value of dc screen voltage is advisable even though it appears to increase the fraction of the cycle during which anode current flows.
- (c) Using the minimum RF excitation voltage necessary to obtain anode circuit performance, even though the dc grid current is considerably lower than one would expect at lower frequencies.
- (d) The cathode lead inductance to the output and input circuits should be kept to a low value. This can be accomplished by using short and wide straps, by using two separate return paths for the input and output circuits or by proper choice of cathode bypass capacitor.

It has been found that the choice of driving conditions as indicated does not necessarily decrease the anode efficiency as much as at lower radio frequencies. The steps indicated should be tried experimentally to determine whether or not the anode circuit efficiency is appreciably affected. It is preferable to sacrifice anode efficiency somewhat and improve the life expectancy of the tube in the VHF and UHF region.

Optimum output power at these frequencies is obtained when the loading is greater than would be used at lower frequencies. Apparently the use of lower RF voltage in the anode circuit is desirable. Fortunately, this same condition reduces driving power and screen current (in the tetrode and pentode) and improves life expectancy.

6.10 COOLING TECHNIQUES

Adequate cooling of the tube envelope and seals is one of the principle factors affecting tube life. Deteriorating effects increase directly with the temperature of the tube envelope and seals. The technical data sheet for the particular tube type should be studied thoroughly with reference to the cooling requirements.

Even if no cooling is specified, ample free space for circulation of air around the tube is required or else some air must be forced past the tube.

Excess cooling will have only beneficial results and inadequate cooling is almost certain to invite premature failure of the tube.

Tubes operated in the VHF and UHF region are inherently subjected to greater heating action than tubes operated at lower frequencies. This results directly from the flow of larger RF charging currents into the tube capacitances, by dielectric losses, and through the tendency of electrons to bombard parts of the tube structure other than the normal grid and anode. Greater cooling is therefore required at these higher frequencies. The technical data sheet for the particular tube type specifies the maximum allowable temperature. For the forced air and water cooled tubes, the recommended amount of air or water is also specified in the technical data sheet. Both the temperature and quantity of coolant should be measured to be certain the cooling is adequate. The problem of making temperature measurements is severe.

6.10.1 Making Temperature Measurements

Thermocouples, contact pyrometers, and other devices sensitive to radiant heat may be used to make temperature measurements, but these devices are often not available or not suited to the particular conditions under which a measurement must be made. For this reason, EIMAC recommends the use of a temperature-sensitive paint such as "Tempilaq," available from local laboratory supply houses in the United States and Canada, and manufactured by the Tempil Division, Illinois Tool Works, Hamilton Blvd., So. Plainfield, New Jersey 07080, www.tempil.com.

Tempilaq dries to a powdery coat after application. At its critical temperature it melts and virtually disappears. After subsequent cooling it has a crystalline appearance which adequately indicates that the surface with which it is in contact has exceeded the critical temperature. Each sample should be melted on a test piece so that the observer can familiarize himself with the appearance before and after the critical temperature has been passed.

Reliable temperature measurements can be made with Tempilaq provided that it is applied in very thin coats and over small areas of the surface to be measured. The substance as supplied by the manufacturer is too thick for use in the presence of forced-air

cooling. It should be thinned, using only the thinner recommended by the manufacturer, and it should be applied with an air brush or atomizer through a paper mask to limit the area covered.

The manufacturer recommends the use of a well-diluted spray of Tempilaq, stating that the amount required to produce a reliable indication is virtually unweighable. This is particularly true when making measurements in the presence of forced-air cooling or on glass envelopes where radiant heat may be intercepted by the Tempilaq itself.

A convenient set of equipment for making measurements with these temperature-sensitive paints is an atomizer with several vials, each equipped with an air-tight cap. One vial may be filled with thinner for cleaning the atomizer, while the remainder may be filled with properly thinned Tempilaq sensitive to several different critical temperatures.

Considering the importance of tube temperatures, every design engineer should familiarize himself with the use of Tempilaq or some other similar substance. Measurements of this kind yield basic information sometimes obtainable in no other way.

6.10.2 Forced air and convection cooling

Some of the lower power vacuum tubes may be cooled by normal free convection around the base and envelope of the tube. Figure 72 illustrates a typical air cooling system.

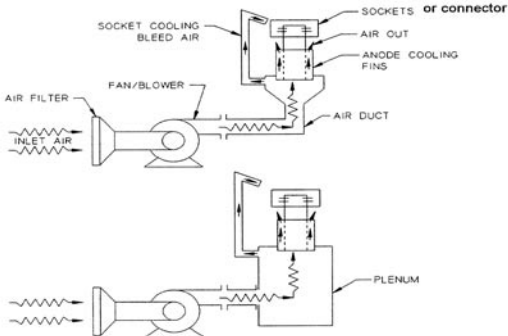

Figure 72. Typical air cooling system.

The tube and socket must be mounted in such a position as to allow unobstructed air flow. See Figures 73 and 74.

If the flow of cooling air is upward it will be consistent with the normal flow of convection currents. In all cases the socket is an open structure or has adequate vent holes to allow cooling of the base end of the tube. Cooling air enters through the grid circuit compartment below the socket through a screened opening, passes through the socket to cool the base end of the tube, sweeps upward

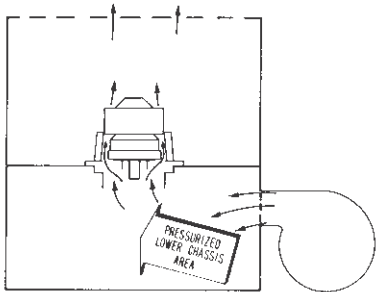

Figure 73. Tube mounting providing cooling, shielding and isolation of output and input compartments.

to cool the envelope and enters the output circuit compartment. The output compartment also has a mesh-covered opening which permits the air to vent out readily. These arrangements apply whether the tube is cooled by forced air or convection circulated air. If the tube is to be forced-air cooled, a suitable fan or blower is used to pressurize the compartment below the tubes. No holes should be provided for some air to pass from the lower to the upper compartment other than the passages through the socket and tube base. Some pressure must be built up to force the proper amount of air through the socket. In the case of convection cooling, open louvers or screened areas permit ready entrance of cool air, and all access holes or vents should have large areas to provide a minimum resistance to the flow of air.

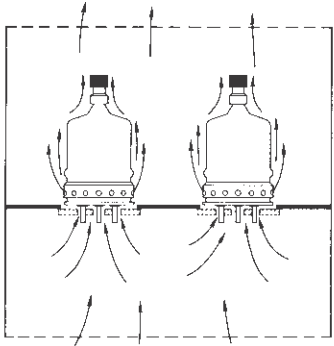

Figure 74. Chassis mounting providing cooling, shielding and isolation of output and input compartments.

The method of supplying the cooling air to the tube, shown in Figures 73 and 74, has worked successfully, provided the desired flow is obtained. It is preferred over methods which try to force cooling air transversely across the tube base.

In many cases, there are complete air system sockets and chimneys designed specifically for a tube or family of tube types. The technical data sheet for each tube type specifies the recommended socketing for adequate cooling.



Figure 75 Example of a badly overheated tetrode. The anode fins are badly oxidized and distorted because of inadequate air flow.

The technical data sheet specifies the back pressure, in inches of water, and the cubic feet per minute required for adequate cooling. In an actual application the back pressure may be measured by means of a simple manometer. This consists of a simple U-shaped glass tube partially filled with water (see Figure 76), which is very useful in measuring low pressure values in connection with air flow. If an air pressure (P) of low value is introduced by connecting the air hose to the left branch of the U, the value of this pressure in inches of water column may be determined by measuring the height (h) between the two water levels.

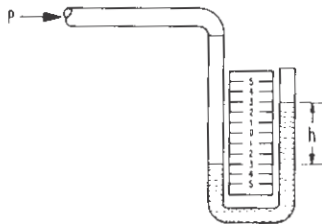

Figure 76. Measuring back-pressure²⁴.

²⁴ See www.dwyer-inst.com for information about manometer theory and applications.

Forced-air cooling systems are capable of removing approximately 50 Watts per square centimeter of effective internal anode area.

6.10.3 Use of Cooling Airflow Data

EIMAC graphically presents minimum cooling airflow requirements for its large external anode tubes in the form of Total Power Dissipated in Watts/Tube Temperature Rise in degrees Centigrade ($P_t/\Delta T$) **versus** Mass Airflow Rate in pounds of air per minute (M). These graphs are used in calculating the cooling requirements listed in the data sheets and copies are available from EIMAC.

The graphs apply to a specified tube and socket-chimney combination; further, the direction of airflow is specified. When reverse airflow, i.e., anode-to-base, is to be used, cooling requirements are sharply increased. This is because the air applied to the tube's base seals has already been heated by its passage through the anode cooler, losing much of its cooling effectiveness.

The procedure for using these graphs to determine the minimum cooling requirements is presented in the following:

- (a) The total power dissipated (P_t) is determined by adding all of the power dissipated by the tube during operation in its particular installation. This includes anode and filament dissipations plus maximum anticipated grid and screen dissipations where applicable.

Example

Anode Dissipation	5000 Watts
Filament Dissipation	350
Screen Dissipation	100
Grid Dissipation	50
Total Dissipation (P_t):	5500 Watts

- (b) The tube-temperature rise (ΔT) is found by taking the difference between the maximum-rated tube temperature specified in the appropriate data sheet and the maximum air inlet temperature expected.

Example

Assume maximum tube temperature rating = 250°C
Expected maximum cooling air inlet temperature 50°C
Safety margin = 25°C (advisable; not required but recommended)

$$\Delta T = 250 - (50 + 25) = 175^\circ\text{C}$$

$$\text{Thus: } Pt/\Delta T = 500/175 = 31.4 \text{ Watts}/^\circ\text{C}$$

- (c) From EXAMPLE Cooling Airflow Requirements shown in Figure 77, $Pt/\Delta T = 31.4 \rightarrow 7.9$ lbs/min mass airflow rate. This is the mass airflow rate required at any altitude and for the given inlet air temperature to assure a maximum tube temperature of 225°C (250°C rating, minus 25°C safety margin) when the tube is dissipating a total of 5500 Watts. Volumetric airflow and pressure drop requirements, however, vary with altitude and inlet air temperature.

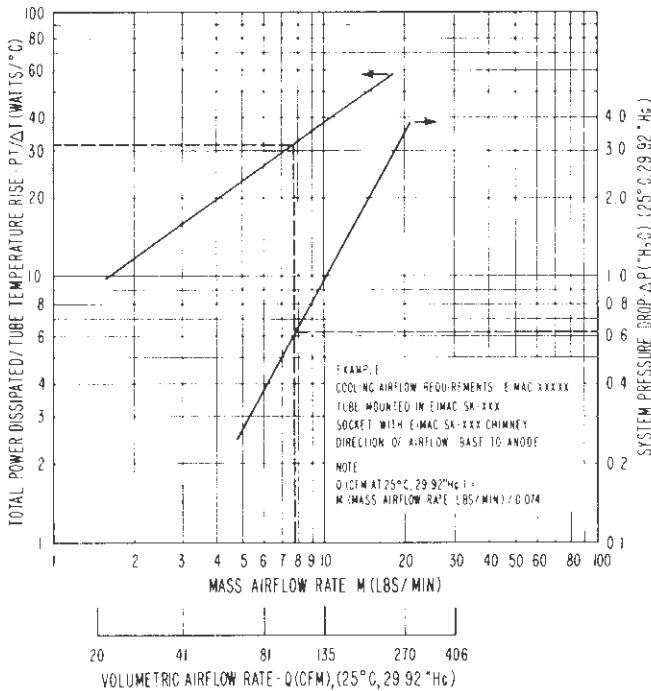

Figure 77. Cooling Airflow Requirements

- (d) To convert the mass airflow rate M (lbs/min) to volumetric airflow rate Q (cfm) at 25°C and at sea level, divide the mass airflow rate by the density of air at 25°C and 29.92 inches Hg (In-Hg).

Note that the density of air = $0.737 \times \text{In-Hg}/(273 + ^\circ\text{C}) \text{ lbs/ft}^3$.

Example

$$\begin{aligned} \text{Density } (25^\circ\text{C}, 29.92 \text{ In-Hg}) &= 0.737 (29.92)/(273 + 25) \\ &= 0.074 \text{ lbs/ft}^3 \end{aligned}$$

$$Q = 7.9/0.074 = 106.8 \text{ CFM (25°C, 29.92 In-Hg)}$$

- (e) The curve on the right side of the graph in Figure 77 is the pressure drop (ΔP) in inches of H_2O across the tube and its specified socket-chimney combination, and is valid at **25°C at sea level only**.

Example

$Q = 106.8 \text{ CFM (7.9 lbs/min)}$ requires a pressure drop

$$\Delta P = 0.61 \text{ H}_2\text{O}^{\text{in}} \text{ (25°C, 29.92 In-Hg)}$$

- (f) To adjust the 25°C sea-level laboratory test conditions to any other atmospheric (socket-inlet) condition, multiply both the Q and ΔP values by the ratio of this laboratory standard density (0.074 lbs/ft³; 25°C at sea level) to the density at the new socket-inlet condition.

Examples

- 1) The installation requirements for the EXAMPLE tube with 50°C socket inlet air and at sea level (29.92 In-Hg) are:

$$\text{Density (50°C, 29.92 In-Hg)} = 0.737 \times (29.92)/(273 + 50) = 0.0683 \text{ lbs/ft}^3$$

$$\text{Density ratio} = 0.074/0.0683 = 1.084$$

$$Q = 1.084 \times 106.8 = 115.5 \text{ CFM}$$

$$\Delta P = 1.084 \times 0.61 = 0.66 \text{ in-H}_2\text{O}$$

- (2) The installation requirements for the EXAMPLE tube with 25°C socket inlet air and at 10,000 feet (20.58 In-Hg) are:

$$\text{Density (25°C, 20.58 In-Hg)} = 0.737 \times (20.58)/(273 + 25) = 0.0508 \text{ lbs/ft}^3$$

$$\text{Density ratio} = 0.074/0.0508 = 1.455$$

$$Q = 1.455 \times 106.8 = 155.5 \text{ CFM}$$

$$\Delta P = 1.455 \times 0.61 = 0.89 \text{ in-H}_2\text{O}$$

- (3) The installation requirements for the EXAMPLE tube with 50°C socket inlet air and at 10,000 feet (20.58 In-Hg) are:

$$\text{Density (50°C, 20.58 In-Hg)} = 0.737 \times (20.58)/(273 + 50) = 0.0469 \text{ lbs/ft}^3$$

$$\text{Density ratio} = 0.074/0.0469 = 1.573$$

$$Q = 1.576 \times 106.8 = 168.5 \text{ CFM}$$

$$\Delta P = 1.578 \times 0.61 = 0.96 \text{ in-H}_2\text{O}$$

- (g) A shorter method may be used to correct the 25°C sea-level requirements to both a different temperature and/or barometric socket inlet condition.

These corrections are made by multiplying the Q and ΔP values (determined in Examples 1 through 3) by the appropriate correction factors listed below:

<u>Socket Inlet Air Temperature (°C)</u>	<u>Q and ΔP Correction Factor</u>
0	0.917
5	0.933
10	0.950
15	0.967
20	0.983
25	1.000
30	1.017
35	1.034
40	1.051
45	1.067
50	1.084

<u>Socket Inlet Air Pressure (in-Hg)</u>	<u>Altitude (Ft)</u>	<u>Q and ΔP Correction Factor</u>
29.92	0	1.00
24.90	5,000	1.20
20.58	10,000	1.46
16.89	15,000	1.77
13.75	20,000	2.17
11.10	25,000	2.69
8.89	30,000	3.37
7.04	35,000	4.25

Example

The installation requirements for the EXAMPLE tube with 50°C socket inlet air and at 10,000 feet (20.58 in-Hg) are:

$$Q = 1.084 \times 1.46 \times 106.8 = 168.5 \text{ CFM}$$

$$\Delta P = 1.084 \times 1.46 \times 0.61 = 0.96 \text{ in-H}_2\text{O}$$

(h) Figure 78 is a graph of the combined correction factors that can be applied to the 25°C sea-level information for land-based installations located at elevations up to 10,000 feet, and for socket-inlet air temperatures between 10°C and 50°C.

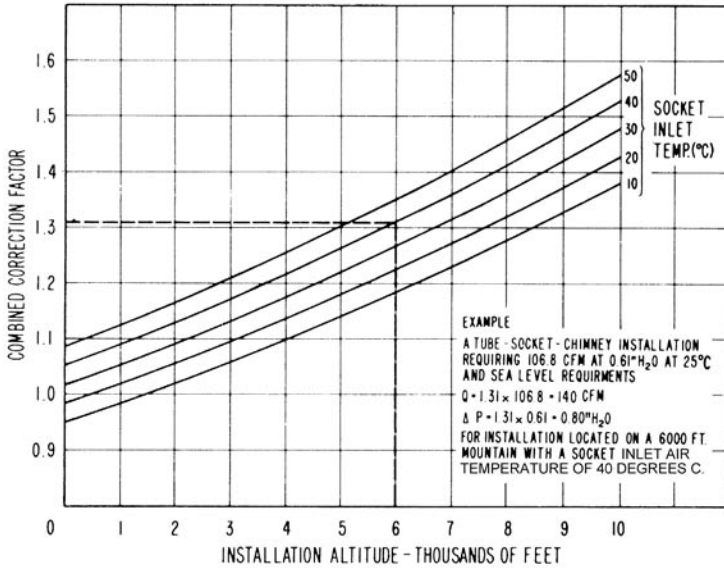

Figure 78. Combined correction factors for land-based installations.

Example

The installation requirements for the EXAMPLE tube with 50°C socket inlet air at 10,000 feet are:
 $Q = 1.579 \times 106.8 = 168.5 \text{ CFM}$

$$\Delta P = 1.579 \times 0.61 = 0.96 \text{ in-H}_2\text{O}$$

Good engineering judgment must be used when applying altitude and temperature corrections to the 25°C sea-level cooling requirements for airborne installations. Although the air outside the aircraft may be very cold at high altitudes, the air actually entering the tube socket may be many degrees warmer. This inlet temperature (and pressure) is affected by each installation design (compressed, ram, static, or recirculating air in a pressurized heat exchanger).

Figure 79 is a convenient curve used to convert Mass Airflow Rate (lbs/min) into volumetric airflow rate (cfm) at 25°C and sea-level.

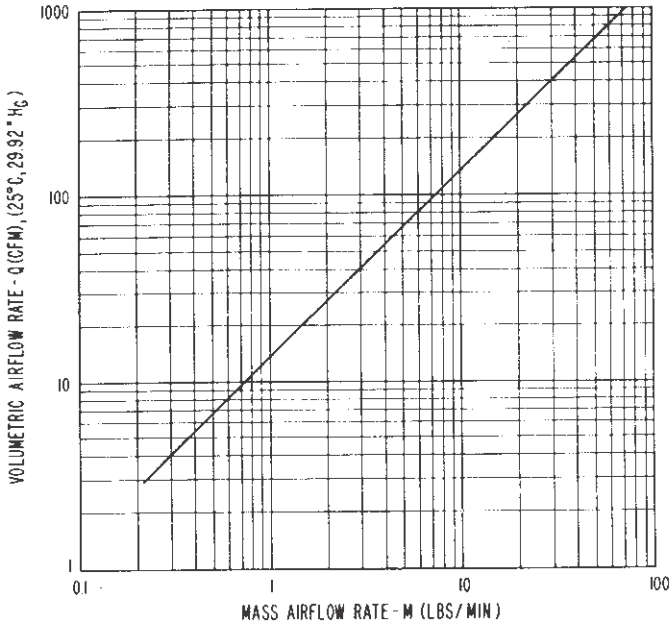

Figure 79. Conversion of mass airflow rate to volumetric airflow rate.

6.10.4 Blower Selection for Elevated Tube Installations

In the section immediately preceding, a method of determining minimum air-cooling requirements for external anode tubes was described, pertaining to any altitude and air temperature. Since most blower manufacturers furnish catalog data on their products in the form of volumetric airflow, Q (cfm) versus Operating Back Pressure, ΔP (inches of water) for **sea level conditions only**, the information gained by the foregoing procedure cannot be compared directly with the data furnished by the blower manufacturers, for the purpose of selecting the proper blower. The following method is recommended for use in selecting a blower for altitude applications from existing blower catalog data:

- (a) Determine the Q and ΔP requirements for the tube-socket-chimney combination for an ambient air temperature of 25°C at sea level. Include estimated ΔP of duct and filter.
- (b) The system's corrected Q and ΔP requirements for the actual inlet temperature and altitude conditions are determined by multiplying by the correction factor shown in Figure 78.
- (c) Again multiply the ΔP , but not the Q, requirement by the correction factor cited in Step b.
- (d) The corrected Q factor and doubly-corrected ΔP value are then used to select a blower from the manufacturer's published sea-level curves. Although this blower will overcool the tube at sea level when operated in an ambient temperature of 25°C, it will provide adequate cooling at the actual inlet temperature and altitude conditions.

An example:

Given: A tube-socket-chimney requires 100 CFM at 1.0 in-H₂O at 25°C and sea level. (Normally determined as per step a).

Required: Determine the requirements for selecting a blower from manufacturer's catalog data (25°C, Sea Level Conditions) to insure that the system is adequately cooled in a 40°C ambient air temperature at an altitude of 8000 feet.

Solution: Step 1) Given

Step 2) From Fig. 78, it is determined that the correction factor for a combined environment of 8000 feet altitude at 40°C inlet temperature is 1.42.

The corrected Q and ΔP is then,

$$Q = 1.42 \times 100 = 142 \text{ CFM}$$

$$\Delta P \quad 1.42 \times 1.0 = 1.42 \text{ In-H}_2\text{O}$$

- Step 3) The doubly corrected ΔP is then,
 $\Delta P = 1.42 \times 1.42 = 2.02 \text{ in-H}_2\text{O}$
- Step 4) The blower selected from the manufacturer's catalog must be capable of delivering 142 CFM at 2.02 in-H₂O in an ambient temperature of 25°C at sea level in order that the tube socket-chimney system will be supplied with 142 CFM at 1.42 in-H₂O at 40°C and 8000 feet.

For further information pertaining to sub-critical air flow through an orifice, refer to MARKS ENGINEER'S HANDBOOK, 5th edition, pg. 334.

6.10.5 Water Cooling

Three types of water cooling techniques are used for power grid tubes, direct anode water cooling, vapor phase cooling and multiphase cooling.

Water-cooled tubes depend upon an adequate flow of water to carry away heat fast enough to maintain the cooled parts at a safe operating temperature. The recommended flow as specified by the technical data sheet should be maintained at all times when the tube is in operation. Inadequate flow of water at high temperature may cause formation of steam bubbles at the anode surface where the water is in direct contact with it. This can contribute to premature tube failure, or "burnout".

By electrolysis and scale formation, hard water may cause a gradual constriction of some part of the water system. Therefore, water flow and plumbing fittings must be inspected regularly. The fittings on the positive potential end of an insulating section of hose or ceramic water coil or column are particularly subject to corrosion or electrolysis unless they have protective "targets." Targets should be checked periodically and replaced when they have disintegrated.

Cooling water temperature is important. The tube technical data sheet should be consulted to be sure operation is within safe limits.

Purity of cooling water is important. The specific resistivity must be maintained at 1 megohm-cm minimum at 25°C. Distilled or de-ionized water should be used and the purity and flow protection

should be periodically checked to insure against excessive degradation. Oxygen and carbon dioxide in the coolant will form copper oxide reducing cooling efficiency and electrolysis may destroy the coolant passages. In addition, a filter screen should be installed in the tube inlet line to trap any circulating debris which might clog coolant passages within the tube.

If the air is humid and the cooling water is cold, condensation accumulates on the surfaces of all pipes, tube jackets and other parts carrying water. This condensation may decrease surface leakage resistance, or drops of water may fall on some electrical component and cause erratic operation or failure. Some means is then necessary to control the temperature of the incoming water to keep it above the dew point. Control is rather easy in a closed cooling system, but in a system which employs tap water and drains the exhaust water into a sewer, control is difficult.

Connecting lines should be of an insulating material such as polypropylene, but chlorinated polyvinyl chloride (CPVC) is also acceptable and is stronger.

Circulating water can remove up to 1000 Watts per square centimeter of effective internal anode area. In practice, the temperature of water leaving the tube is limited to 70°C to preclude the possibility of spot boiling. This water is then passed through a heat exchanger where it is cooled to 30°C–40°C before being pumped over the tube anode again.

Refer to the EIMAC Application Bulletin 16 for additional details concerning liquid cooling systems.

6.10.6 Vapor-Phase Cooling

Vapor-phase cooling offers some advantages over water cooling systems by exploiting the latent heat of the evaporation of water. Raising the temperature of one gram of water from 40°C to 70°C (as in a water system) requires 30 calories of energy. **Transforming one gram of water at 100°C to steam vapor requires 540 calories.** In a vapor-cooling system, then, a given quantity of water will remove nearly twenty times as much energy as in a water-cooling system. Power densities as high as 135 Watts per square centimeter of effective internal anode surface have been attained through vapor cooling.

A typical vapor-phase installation consists of a tube with a specially designed anode immersed in a “boiler” filled with distilled water.

When power is applied to the tube, anode dissipation heats the water to 100°C; further applied energy causes the water to boil and be converted into steam vapor. The vapor is passed through a condenser where it gives up its energy and is converted back into the liquid state. This condensate is then returned to the boiler, completing the cycle. The result is a system that reduces the water flow requirement nearly 20 times and due to the thermo-syphoning action which results in a natural circulation of the water, eliminates the need for the pump required in a circulating water system. A bonus effect of vapor cooling is almost complete silence during operation.

A dramatic improvement over water-cooling systems is a reduction in the size of the condenser required. A condenser of any given thermal capacity can be reduced in size if the mean temperature gradient (ΔT_m) between the cooled liquid and the secondary coolant can be increased. In a practical water-cooling system like the one just described, water enters the heat exchanger at 70°C and leaves at about 40°C, the mean temperature being 55°C. With air as a secondary coolant (or heat sink) at about 30°C, there is a mean temperature differential, ΔT_m , of 25°C. In a typical vapor cooling system, vapor enters the condenser at 100°C, and water leaves at 100°C, resulting in a mean temperature of 100°C. The mean temperature differential ΔT_m then between the steam-water and air is now 100°C - 25°C = 75°C, or **three times that of the water-cooled system**. Tests at EIMAC have confirmed this and have shown that heat exchanger equipment for a vapor-cooled system will require only about one-third to one-quarter the capacity associated with water cooling systems.

Where air-cooled condensers are preferred, this higher thermal gradient can be exploited in reducing the size of condenser equipment and in lowering the blower horsepower requirement. In some instances where sufficient area is available, natural convection alone is used to cool the steam condensers, resulting in complete elimination of the condenser blower.

Where water is preferred as the secondary coolant, similar ratios apply and water consumption is drastically reduced. For example, a water cooling system at the 100 kW dissipation level will require about 100 cubic feet of secondary water per hour, or 500,000 cubic feet over 5000 hours. With vapor-cooling, this is reduced to one-third, a savings of 333,333 cubic feet. With a water cost of \$19.00 per 1000 cubic feet, about \$6300 in water cost alone is saved over a 5000 hour period. In addition, a five-horsepower pump is eliminated. This pump requires about 25,000 kW-hr of electrical power over the same period, at a cost of about \$2500.

Thus the vapor-cooling system would save the user about \$8800 in operating costs over a 5000 hour period.

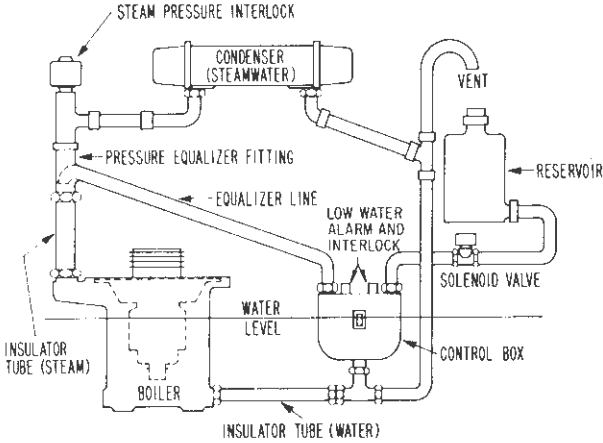

Figure 80. Typical vapor-phase cooling system.

(1) INSTALLATION NOTES

A typical vapor-phase cooling system is shown in Figure 80. It consists of the power tube, boiler, condenser, insulating tubing, control box, reservoir, and associated plumbing. Detailed installation suggestions for the various components are discussed below.

Boiler—The boiler supports the power tube and contains the water used for cooling. In addition, it acts as the high voltage anode connector. The boiler should be mounted so that the axis of the tube is vertical. For effective cooling, the tilt should be limited to less than 2° to insure that the anode is covered with water and the steam outlet is clear.



Figure 81. EIMAC vapor-cooled tubes for mounting in boilers.

The tube's anode flange must seal securely against the o-ring provided on the boiler. A locking flange presses the anode flange against the o-ring for a vapor-tight seal. The steam outlet at the top of the steam separation chamber on the boiler and the water inlet at the bottom of the boiler are equipped with fittings for attaching the pyrex insulating tubing. A "target" to inhibit electrolytic action is provided in the inlet water fitting.

Since in most cases the boiler is at high potential relative to ground, it must be electrically insulated from the rest of the system. It should be mounted on insulators and the steam and water connections should be made through pyrex insulating tubing. Boilers can be constructed with provisions for mounting two or three tubes in parallel. These would contain single water inlet and steam outlet fittings.

Insulating Tubing—Length of the steam and water insulating lines will vary with individual installation requirements, but will always be shorter than would be needed in a circulating water system. The length of the insulating tubing is dependent on the voltage to be applied, the purity of the water, and the volume of returned cooling water. In the vapor-cooling system, water is constantly being re-distilled, there is a minimum of contamination, and only pure distilled water is introduced into the boiler. In addition, the water inlet line is of smaller diameter—because of the low water flow rate—and has inherently higher resistance. Therefore, a two-foot section of pyrex tubing has the capability of preventing voltage flashover up to 2° kV, and will also have negligible leakage current. Because of the excellent insulating properties of steam (and the purity of any condensate) the outlet steam line can be made equally short.

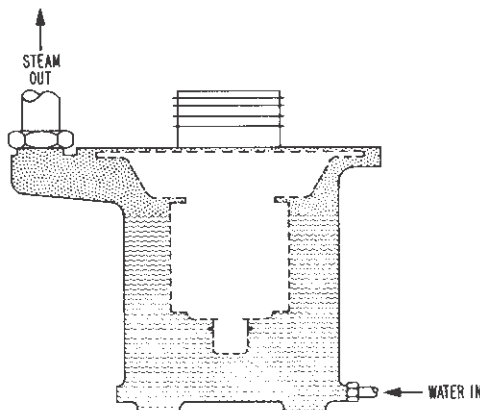

Figure 82 Cutaway of "classic" boiler and tube combination.

Control Box - The control box serves as a partial reservoir, and is an air-tight vessel containing an overflow siphon and two float switches. When the water level drops approximately 1/4" below the recommended level, the first switch is closed. It may at the same time be used to activate a solenoid-controlled water valve to admit more distilled water from an external reservoir, and/or actuate a warning alarm.

The second float switch is operated if and when the water level should drop approximately 1/2" below the optimum level. This would be tantamount to a water failure, and the switch would be used to open the control circuit interlocks and remove tube power.

For the control box to perform its protective function properly, its water level mark must be precisely level with the water level mark on the boiler. For electrical reasons, the control box will generally be mounted some distance from the boiler, and therefore leveling of the two components should be carefully checked during installation. Figure 82 shows a cutaway drawing of a "classic" boiler and tube combination, and Figure 83 is a cutaway drawing of a control pipe box, showing the position of the float switches and the overflow pipe.

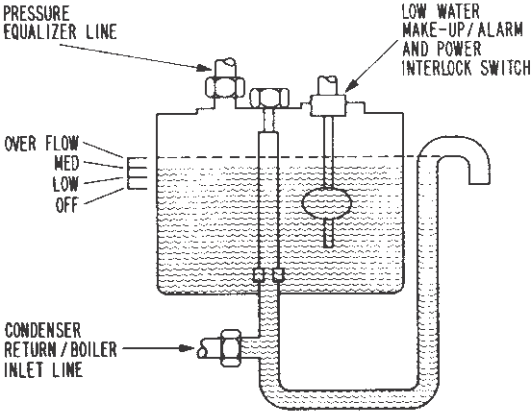

Figure 83. Cutaway view of typical Control Box showing position of float switches and overflow pipe.

The control box also serves a secondary function as a reservoir. During extended operation, some quantity of water and steam is being circulated through the condenser, and some will be lost through the air vent. The amount is, of course, dependent on the size of the system. The water level in the boiler will gradually drop. The use of the control box as a reservoir minimizes this effect. In large or multiple-tube installations, the use of an auxiliary reservoir

connected to the control box is recommended to increase the ratio of stored water to circulating water and steam. Where it may be necessary to operate multiple tubes at different physical elevations, individual control boxes are required. A multiple-tube system is shown in Figure 84.

Equalizer Line—In order for the control box to “see” the same pressure conditions that exist in the boiler, the vapor-phase system should be fitted with an equalizer line. This length of tubing connects the steam side of the system with the top of the control box. As a partial steam pressure begins to build up in the boiler, the equalizer line allows this same pressure to appear in the control box. Steam pressure is low—less than 0.5 psi above atmosphere—but would introduce error in the control box water level unless equalized.

The fitting used to connect the equalizer line to the steam outlet tube must be constructed to prevent a venturi effect from developing

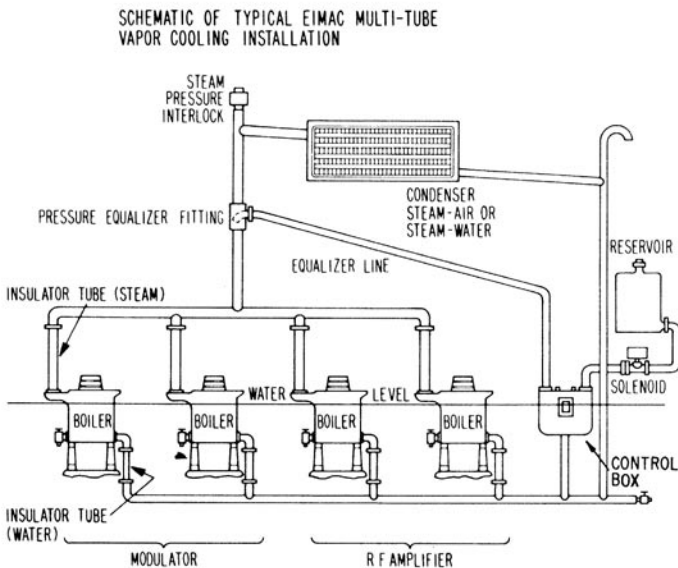

Figure 84. Typical 4-tube vapor cooling system with common water supply.

because of the velocity of the vapor. This is best accomplished by directing an elbow within the adapter fitting toward the boiler, as shown in Figure 85.

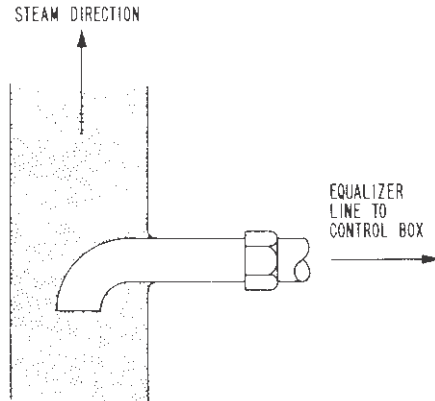

Figure 85. Cutaway of pressure equalizer fitting.

Condensers—Both air-cooled and water-cooled are available for vapor-cooling systems. Condensers should be chosen with good reserve capabilities and low pressure drop. The air-cooled and water-cooled condensers may be mounted in any position, providing they allow the condensed water to flow freely by gravity to the boiler return line. Water must not be allowed to stand in the condenser where it might cause back-pressure to the entering stream.

The condenser should be mounted above the level of the boiler(s) so that water will drain from it to the boiler return line. Where it is necessary to mount the condenser at a lower physical level than the system water level, an auxiliary pump should be used to return water to the boiler. This arrangement is recommended for the “steam-out-the-bottom” boiler system to be discussed later under “Alternate Vapor-cooling Systems.” A “steam-out-the-bottom” system is shown in Figure 86.

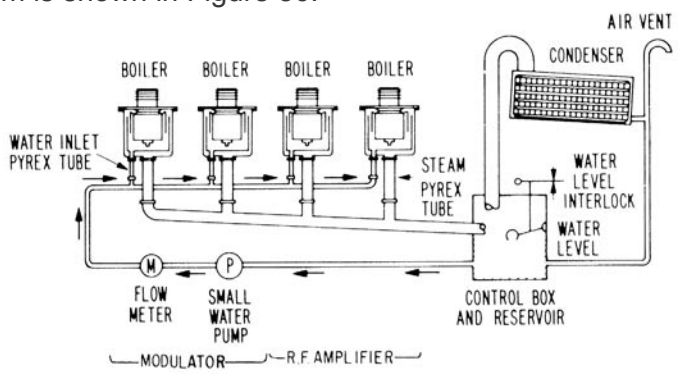

Figure 86. Typical 4-tube system using “steam-out-the-bottom” boilers.

Pressure Interlock—It is suggested that the use of a steam pressure interlock switch on the steam or inlet side of the condenser is advisable. This switch, set at about 0.5 lbs. per square inch, is used as a power interlock that senses any abnormal steam pressure due to constrictions in the condenser or piping.

Piping—Piping should be of copper or glass throughout the system. The steam piping should be the same diameter as the pyrex tube from the boiler. The size is dependent on power level and the volume of generated steam, and will range from 1-3/4" at the 8 kW level to 6" for the 250 kW level of dissipation. The steam path should be as direct as is practical and must be sloped to prevent condensate from collecting at some low point where it might cause backpressure. All low spots should be drained back to the inlet water line.

Water return piping from the condenser to the control box will vary from 3/4" to 1-3/4" in diameter, depending again on the power level. This tubing should be the same diameter as the boiler inlet water fitting. It should be sloped so that water or vapor pockets do not exist, and must allow the condensate to return by gravity to the control box and the boiler. A vent to air on the outlet side of the condenser should be incorporated to maintain the water side of the system at atmospheric pressure. Provisions for draining the distilled water should be provided at the system's lowest level.

The equalizer line should also be sloped from the adapter fitting on the steam line to the top of the control box. This will allow the condensate to return to the control box.

Automatic Refilling System—Figures 80 and 86 show typical vapor-cooling systems with provisions to provide additional water to the control box. An auxiliary reservoir is connected through a solenoid-operated water valve to the control box. When accumulated water loss due to evaporation causes the water level in the boiler and the control box to drop about 1/4" below normal, the first float switch in the control box closes and actuates the solenoid-controlled valve to permit makeup water to enter the system. When the proper level is restored, the switch opens, the valve closes, and the flow of makeup water is stopped.

6.10.7 Maintenance

Maintenance problems associated with circulating water systems are practically eliminated through vapor cooling systems. As mentioned earlier, **systems can be designed to eliminate all rotating machinery or moving parts.**

System cleanliness does, however, require periodic attention. The glass insulator tubes should be inspected occasionally to be sure they contain no deposits which might cause voltage flashover. Water conductivity should be checked periodically by measuring the dc resistance, as in a typical circulating water system. Water should be replaced if its dc resistance drops below 20,000 ohms/cm².

In practice, the vapor-cooling system will remain cleaner longer than a water-cooled system. In the vapor-cooled boiler, the water is continually being redistilled and only pure water is introduced at the bottom of the boiler. Any contaminants will tend to remain in the boiler itself, where they can be easily removed. The periods between equipment shutdowns for draining and cleaning will be at least twice as long for the vapor-cooling system because of this inherent self-cleaning action.

Each time a tube is removed or replaced, the rubber o-ring between the boiler and the tube should be inspected and replaced if necessary. At the same time the inside of the boiler and the control box should be inspected and cleaned if necessary.

The electrolytic target should be replaced whenever its metallic end is no longer visible in the inlet water line.

6.10.8 Alternate Vapor Cooling Systems

The system described thus far is the so-called "classic" system which consists of a separate tube, boiler, condenser, and level control box. Variations on these schemes are numerous. One such alternate system, offered for use with the larger tubes, uses a "steam-out-the-bottom" boiler. This configuration makes it possible to keep the steam and water systems, plus the plumbing, below the tubes. Figure 86, shows a typical "steam-out-the-bottom" system and Figure 87 shows a boiler associated with this particular cooling technique. This approach has the advantages of keeping the plumbing away from the input circuitry.

A small water pump circulates a continuous flow of water over a weir, or baffle, in the boiler, maintaining a constant water level. Generated steam is forced under slight pressure out-of-the-bottom of the boiler, through an insulator tube in the condenser. Water from the condenser flows into the control box before being pumped back into the boiler. Protective devices must include a water flow interlock and the usual level control in the control box to insure an adequate water supply.

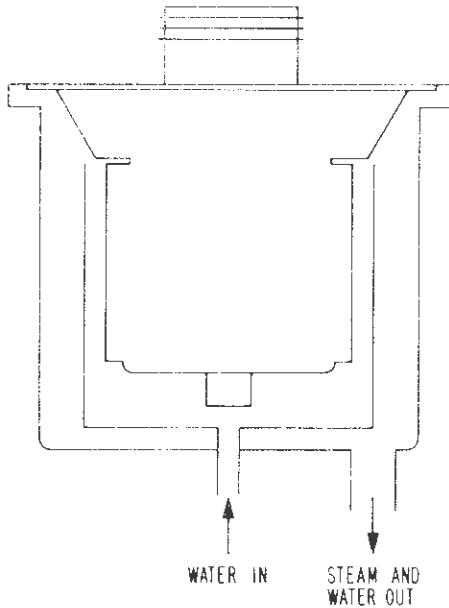

Figure 87. Cutaway view of “steam-out-the-bottom” boilers.

6.10.9 Multiphase Cooling

Another liquid/vapor-based cooling technique is called multiphase cooling. Multiphase cooling utilizes a combination of pure cool water cooling and a 100% heated surface boiling condition, as found in vapor phase cooling. Multiphase cooling is capable of anode surface heat transfer rates up to 2.5 kW/cm^2 . This is several times the thermal dissipation rates achieved by standard 100% vapor-phase techniques.

Multiphase cooling is accomplished by pumping cooling water through narrow channels in the anode at relatively high velocities, wherein part of the liquid phase water in contact with the anode channel walls flashes to steam phase bubbles. These steam phase bubbles are instantly removed from the heated anode surface by the high velocity bulk liquid water. The extracted steam bubbles then condense in the cooler bulk water flow before leaving the tube. Although the bulk cooling water may enter the tube at below 50°C and exit at less than 90°C , local surface boiling occurs at spots along the heated surface of the anode.

No steam venting is necessary with multiphase cooling because the steam generated is condensed back into the bulk cooling water before leaving the tube.

Multiphase cooling is efficient. With the increased cooling effectiveness of multiphase cooling, a tetrode, such as the 4CM2500KG, can be cooled with approximately one third the volumetric water flow that an equivalent standard water cooled tube version would require.

From a maintenance point of view, multiphase cooling systems should be supplied with very pure water and as little dissolved air and oxygen in the water as possible. Since the anode surface is essentially acting as a boiler, it will extract out all solids in the water, leaving them as deposits on the anode.

Similarly, air and oxygen in the water will cause oxidation of the anode's surface. Both of these mechanisms can cause overheating of the tube and should be avoided.

CAUTION: Multiphase cooled tubes have special anode designs to promote conversion of water to steam and then rapidly removing the steam. Do not try to operate tubes designed for water or pure vapor phase cooling as multiphase cooled tubes. This will result in tube failure.

USEFUL CONVERSION FACTORS

ENERGY

BTU	= energy required to raise one pound of water one degree fahrenheit
CALORIE	= energy required to raise one gram of water one degree centigrade
KILOGRAM-CALORIE	= 1000 calories
1 kW	= 3413 Btu/hr = 57 Btu/min = 860 kg-calories/hr = 14.34 kg-calories/min
1 Btu	= 252 calories

BOILING

Latent heat of vaporization (water at atmospheric pressure)	= 540 calories/gram = 970 Btu/lb
1 kW dissipation	= 3.53 pounds H ₂ O/hr at 100°C transformed into steam at 100°C
1 cubic foot water	= 0.42 gallons/hr = 62.4 pounds of water = 7.48 gallons of water = 1600 cubic feet of steam

GENERAL

C	= $\frac{5}{9}(F - 32)$
F	= $\frac{9}{5}(C + 32)$
1 inch H ₂ O	= 0.036 psi = 0.58 oz/in ²
1 inch Hg	= 0.49 psi

Figure 88. Useful conversion factors.

6.10.10 Conduction Cooling

As power tubes become more compact, the problems of removing the heat increase. All of the previously mentioned cooling techniques can and have been used with compact equipment. There are certain applications where conduction cooling is the preferred technique. A typical application of a conduction cooled tube would be in airborne equipment. The skin of the aircraft, or other vehicle, may be used as an infinite heat sink. No pressurization is required as is for convection and forced air cooling. No liquid and associated circulating system is required. Another application is in shipborne equipment. The hull of the ship is a perfect heat sink.

Quite often in mobile and fixed applications it is desirable to conduct all heat in the equipment to one cold plate which can be air or liquid cooled.

Large tubes can use liquid cooled conduction clamps. This technique will permit the replacement of the tube without exposure of the liquid system to the atmosphere.

In conduction cooled power tubes, the cooling system is an integral part of the electrical circuit. The thermal link between the anode and the heat sink can, in certain applications, add to the output capacitance. The method of contacting the base of the tube must satisfy both the electrical and heat transfer requirements.

6.11 TUBE LIFE

6.11.1 Maximum Tube Ratings

The technical data sheet for each tube type gives the basic maximum ratings for each class of service. The data sheet also gives references to the type of cooling required and how much. The maximum temperature permissible for reasonable life is also specified. Careful observance of the information on the data sheet will avoid damage to the tube and shortening of its useful life.

The typical life expectancy will depend upon a great many factors. In general, operation below the maximum ratings will increase the life expectancy of the tube. This is especially true with reduction in the anode dissipation of the tube.

If tubes are to be used in pulse service with short pulses and

appreciable off-time between pulses, the tube ratings are quite different.

A very large factor in tube life is the temperature of the thoriated-tungsten cathode. The equipment manufacturer and the end user of the equipment have more control over tube life through proper adjustment of filament voltage (filament power) than is generally realized. This is true because tube ratings and equipment designs are conservative in peak cathode emission required of the tube compared with peak cathode emission available at nominal rated filament voltage.

It is good practice to determine, in the field for each particular combination of equipment and operating power level, the nominal filament voltage for best life. This is best done in the field by measuring some important parameter of performance such as anode current, power output, or distortion, while filament voltage on the power tube is reduced. At some point in filament voltage there will be a noticeable reduction in anode current, or power output, or an increase in distortion. Safe operation may be at a filament voltage slightly higher than that point at which performance appeared to deteriorate. A recheck should be made in 12 to 24 hours to make certain the emission is stable.

The thoriated-tungsten filament or cathode is processed in a hydrocarbon atmosphere to form a deep layer of di-tungsten carbide on the surface. Stable emission is not possible without the carbide. If the carbide layer is too deep, the filament becomes too brittle to withstand shipping and handling. The end of useful life for this type of filament occurs when most of the carbon has evaporated or combined with residual gas, depleting the carbide surface layer. During this process, the value of filament current increases approximately 5% above the initial new-tube value.

Theoretically a 3% increase in filament voltage will result in a 20° Kelvin increase in temperature, a 20% increase in peak emission, and a 50% decrease in life due to carbon loss. This, of course, works the other way, too. For a small decrease in temperature and peak emission, life of the carbide layer and hence tube life can be increased by a substantial percentage. Peak emission as meant here is the emission obtained in the test for emission described in the Test Specification. This is normally many times the peak emission required in communication service.

EIMAC Applications Bulletin AB-18 covers this subject in detail. See www.eimac.com under Applications.

6.11.2 VHF and UHF Life Considerations

A tube designed for VHF and UHF work must be very small if practical resonant circuits are to be built around them. Furthermore, these tubes operate less efficiently and have much greater incidental losses than at a lower frequency. For these reasons, the power which must be dissipated from the electrodes and tube envelope seals is much greater per unit of area than for tubes designed solely for low frequency.

If the tubes are to become part of a UHF line circuit or cavity UHF circuit, the inductance associated with the electrode supports and leads must be reduced to a very small value. In the case of the 4CPX250K, 4CX250B and 3CX10,000U7 type structures, some of the electrode leads and supports take the form of large surfaces, conical or cylindrical in shape, and extremely short. This means that the amount of heat conducted out through the metal-to-ceramic seals is greatly increased. It also means that the terminal connections of the tube are large surfaces with relatively thin walls.

The mechanical layout of sockets, connections and circuits close to the tube must allow ample cooling air to be blown against the tube seals and surfaces. Also, ample contacting surface must be provided to carry heavy radio frequency charging currents. Since these two requirements may tend to conflict, considerable thought must be given to an adequate layout.

6.11.3 Connectors

Where the tube terminals are large cylindrical surfaces, the contacting portions of the socket are either spring collets or a multiplicity of spring fingers. Usually these multiple contacting surfaces are made of beryllium copper to preserve the spring tension at the relatively high temperatures present on the tube terminals, and are silver plated to reduce RF resistance.

Rigid clamping connectors should be avoided even though the radius of the curvature seems to be close to that of the cylindrical contacting surface of the tube. It has been found that such rigid clamping connectors will distort the tube terminal and fracture the adjacent seal. Similarly set screw connecting devices are questionable on large cylindrical tube terminals unless they act to distribute the pressure uniformly and without any distorting effects.

If the connectors fail to provide multiple contacts to the cylindrical tube seals, concentration of RF charging current will result and the local overheating may be destructive. Once the connector loses its spring action the heating is aggravated and damage to the tube is very apt to occur. All tube connectors should be inspected and serviced regularly to be sure that uniform, good contact to the tube results.

It is never advisable to drill holes in any part of the tube structure to provide contact. Many of the metal parts are only 10 to 15 thousandths of an inch thick.

6.11.4 Backheating by Electrons

Another action involving the motion of electrons within the tube is present at VHF and UHF and has been commonly referred to as backheating of the cathode. Due to the fact that the time of flight of the electrons (also called transit time) from the cathode through the grid structure to the anode becomes an appreciable part of the cycle, the electrons can be stopped in flight and turned back by the rapidly changing grid voltage. Under these conditions the electrons are turned back or deflected from their normal paths and given excess energy with which the electrons bombard the cathode and other portions of the tube structure. This effect can be greatly aggravated by the choice of operating conditions to the extent that very destructive effects occur. The tube can even be destroyed within a few minutes under severe conditions.

Fortunately, the conditions which tend to minimize this back bombardment by electrons are the same as those giving minimum driving voltage as discussed under "VHF Operating Conditions." The tendency for electrons to be turned back in flight is reduced by the use of the lowest possible RF grid voltage on the tube. This is obtained by using the lowest possible dc grid bias. In tetrodes this effect is inherently much lower because of the action of the dc accelerating the electrons toward the anode, and also inherently permits the use of much smaller grid voltages. Consequently, under favorable conditions the number of electrons turned back to heat the cathode and tube structure can be kept to a practical low level. In addition to the use of low dc grid bias, a high screen voltage is desirable.

At the same time, the anode circuit should always operate with heavy loading (low external anode impedance) so that the minimum instantaneous value of anode voltage shall stay sufficiently positive to continue accelerating electrons to the anode. For this reason,

best life is had when the tetrode amplifier is heavily loaded as indicated by having small values of dc screen and dc control grid current.

NEVER OPERATE WITH LIGHT ANODE LOADING. If the anode load is removed so that the minimum instantaneous anode voltage tends to fall to values around cathode potential (as it must do when the loading is removed completely and excitation is present), the number of electrons turned back can be completely destructive to the tube. It has been found that under conditions of "no loading" the electron bombardment and increased electric field heating of the insulating portion of the tube is often sufficient to cause a suck-in of the glass, or even cause cracking of a ceramic envelope. Automatic protection should be installed to remove all voltages from the tube when the anode circuit loading becomes too light for the amount of excitation applied.

It should be noted that parasitic oscillations are seldom loaded heavily, as indicated by the high grid currents often had during such self-oscillation. Thus, excessive RF anode voltages are developed which, at VHF, can be damaging in the same manner as unloaded operation on a VHF fundamental frequency. Should such unloaded VHF parasitic oscillation be present simultaneously with apparently satisfactory operation on the fundamentals, unexplained reduction of life may result.

Occasionally, also, an output line circuit can resonate simultaneously to a harmonic frequency as well as to the fundamental frequency. The higher resonant modes of practical line circuits are not normally harmonically related, but sometimes the tuning curve of a mode will cross the fundamental tuning curve and at that point the circuit will build up resonant voltages at both the harmonic frequency and fundamental frequency. The harmonic resonance is usually lightly loaded and the damaging action is similar to that of lightly loaded parasitic or fundamental operation. Again, the operation of the tube and circuit on the fundamental may appear normal, but with lower than expected efficiency, damaging action can occur to some degree.

In addition to operating the tube with minimum bias, high screen voltage, and heavy loading on the anode circuit, some degree of compensation for the remaining backheating of the cathode may be required. This can be accomplished by lowering the filament voltage or heater voltage until the cathode operates at normal temperature. It has been found with tetrodes and pentodes that by

taking precautions necessary to minimize back-bombardment by electrons the compensation for backheating of the cathode is not large and may often be neglected.

END