

### Wichtige Hinweise

Die Sicherheit des Gerätes muß nach einer Reparatur oder Überprüfung erhalten bleiben. Es dürfen deshalb keine konstruktiven Merkmale des Gerätes sicherheitsmindernd verändert werden (z. B. müssen Abdeckungen ordnungsgemäß angebracht sein).

Ersatzteile müssen hinsichtlich ihrer Daten und ihrer Merkmale dem getauschten Teil entsprechen, damit die Sicherheit des Gerätes nicht vermindert wird. Verwenden Sie deshalb nur Original-Ersatzteile.

### Avvisi importanti

La sicurezza dell'apparecchio deve rimanere conservata anche dopo una riparazione o un controllo. Perciò non è permesso di variare connotati costruttivi dell'apparecchio in modo che non garantiscono la sicurezza originaria (p. es. gli schemi di protezione devono essere fissati a regola d'arte).

I pezzi di ricambio devono corrispondere al pezzo da sostituire nei loro dati e nei loro connotati per garantire la stessa sicurezza dell'apparecchio. Usate perciò solo ricambi originali.

### Ausbauhinweise

Gehäuseschrauben entfernen.  
Gehäuseoberteil hinten anheben und vorsichtig aus den Haltetaschen im Frontrahmen aushängen.

### Indicazione di smontaggio

Togliere le viti del telaio.  
Sollevare un poco il telaio superiore di dietro e sganciare attentamente del coprigiunto di arresto del telaio frontale.

### Important note

The unit must remain safe after repair or checking. Therefore, no design features of the unit may be altered which would result in a reduction of safety (e. g. covers must be properly replaced).

With regards to their data and technical features, spare parts must correspond with the replaced part, so as not to reduce the safety of the unit. Therefore, only use original spare parts.

### Recommandations importantes

L'appareil doit remplir les mêmes conditions de sécurité après une réparation ou une révision. Aucune caractéristique de construction de l'appareil ne doit donc être modifiée de telle sorte que la sécurité de l'appareil en soit diminuée (par ex., les couvercles doivent être remis en place correctement).













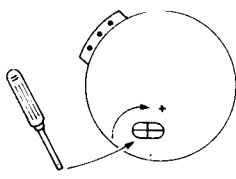
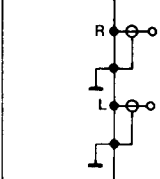
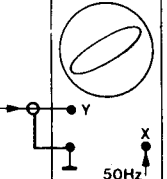
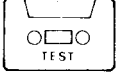

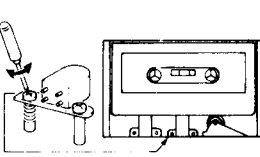
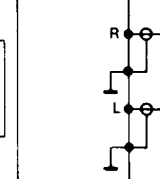
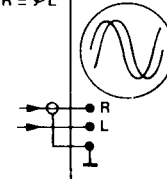
Les caractéristiques et les propriétés des pièces de rechange doivent coïncider avec celles de la pièce qui est remplacée afin de ne pas réduire la sécurité de l'appareil. N'utilisez donc que des pièces de rechange d'origine.

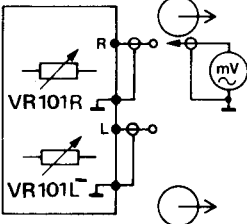
### Instructions for removal

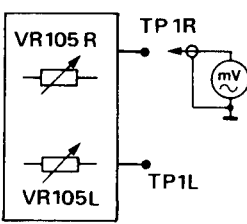
The cabinet screws are removed.  
The upper section of the housing is lifted at the rear and carefully removed from the retaining strips in the front frame.

### Démontage

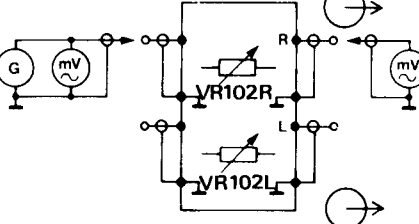
Dévissez les vis du boîtier.  
Soulevez l'arrière du capot supérieur du boîtier avec précaution et dégagez-le des languettes de retenue du cadre frontal.

<p>1</p> <p>Bandzug Tensione del nastro Tape tension Tension de bande</p>			<p>«—&gt;» 40 g/cm &lt; &lt; 60 g/cm</p> <p>«&lt;&lt;»«&gt;&gt;» 80 g/cm &lt; &lt; 140 g/cm</p>
<p>2</p> <p>Bandgeschwindigkeit Velocità del nastro Tape speed Vitesse de défilement</p>	  <p>f = 50 Hz</p>	 	 <p>50Hz<sup>2</sup></p>
<p>3</p> <p>Tonkopfeinstellung Regolazione di azimuth Azimuth adjustment Réglage d'azimut</p>	  <p>f = 6,3 kHz</p>	 	<p>∅ R = ∅ L</p> 
<p>4</p> <p>Wiedergabeempfindlichkeit Sensibilità di riproduzione Playback sensitivity Gain en lecture</p>	  <p>0dB</p> <p>F = 1kHz</p>		<p>V = 500 mV ± 2 dB</p>
<p>5</p> <p>Vormagnetisierung Corrente di premagnetizzazione Bias adjustment Courant de prémagnétisation</p>	  <p>1) Normal</p> <p>2 CrO<sub>2</sub></p> <p>3) Metal</p>		<p>F = 85 kHz</p> <p>1) V = 3,4 mV ± 0,5 dB</p> <p>2) v = 6mV ± 0,5dB</p> <p>3) V = 9,3mV ± 0,5dB</p>
<p>6</p> <p>Aufnahmeempfindlichkeit Sensibilità registrazione Record sensitivity Gain en enregistrement</p>	   <p>V<sub>e</sub> = 68mV ± 1dB</p> <p>F = 400 Hz</p>		 <p>V = 500mV</p>

re, no design  
reduction of

arts must  
safety of the

après une  
instruction de  
sécurité de  
être remis en

ange doivent  
ne pas  
pièces de

arefully

auton et

Schaltbild · Schema · Circuit Diagram · Schéma

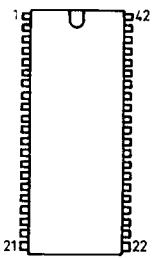
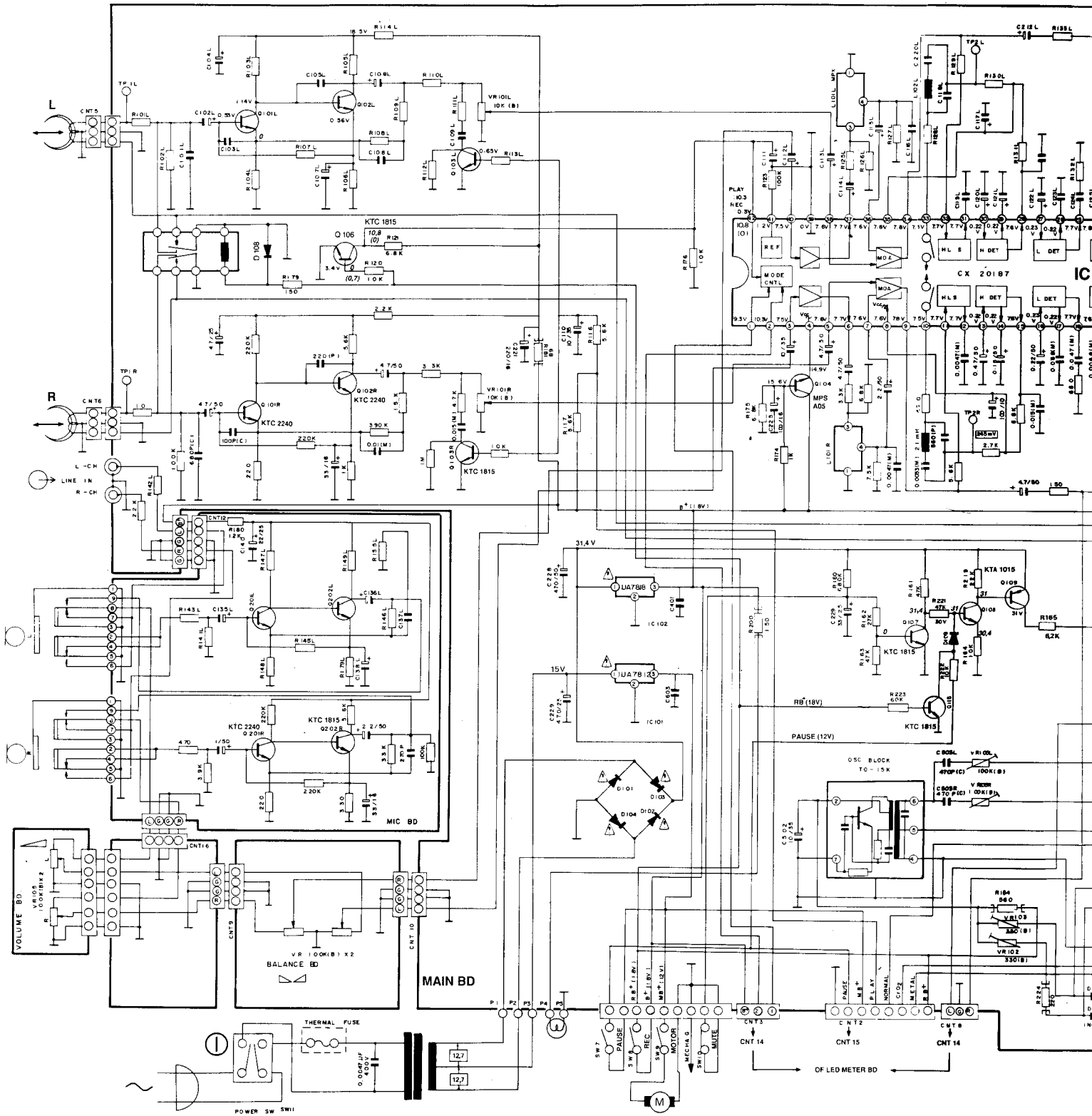

CX 20187

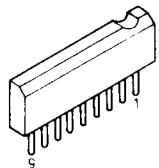

BA 6124

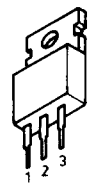

µA 7812  
µA 7818



MPS A05

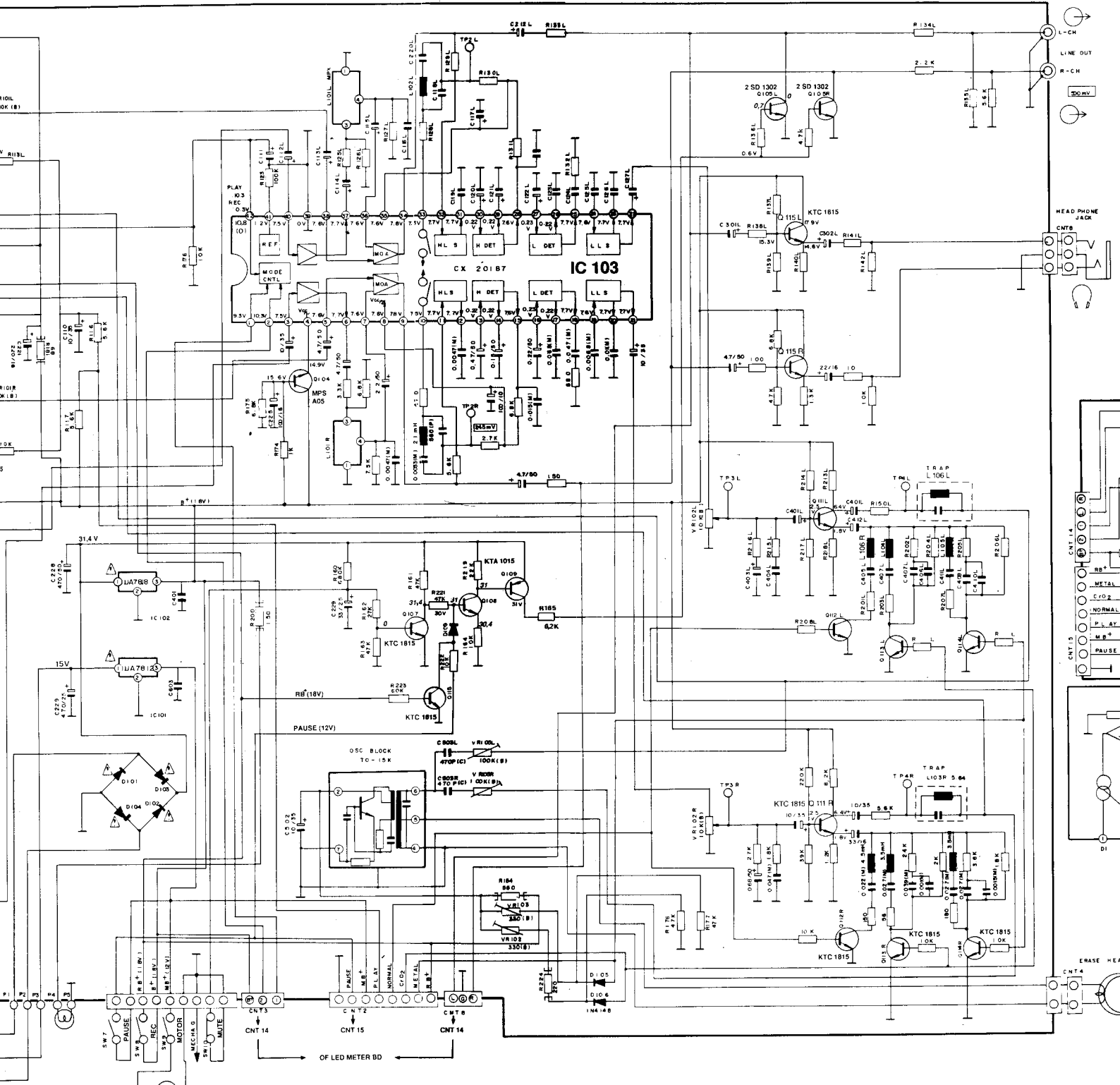

BA 6124

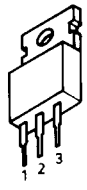

μA 7812  
μA 7818



MPS A05



KTA 1015Y  
KTC 1815Y  
KTC 2240  
2SD 1302

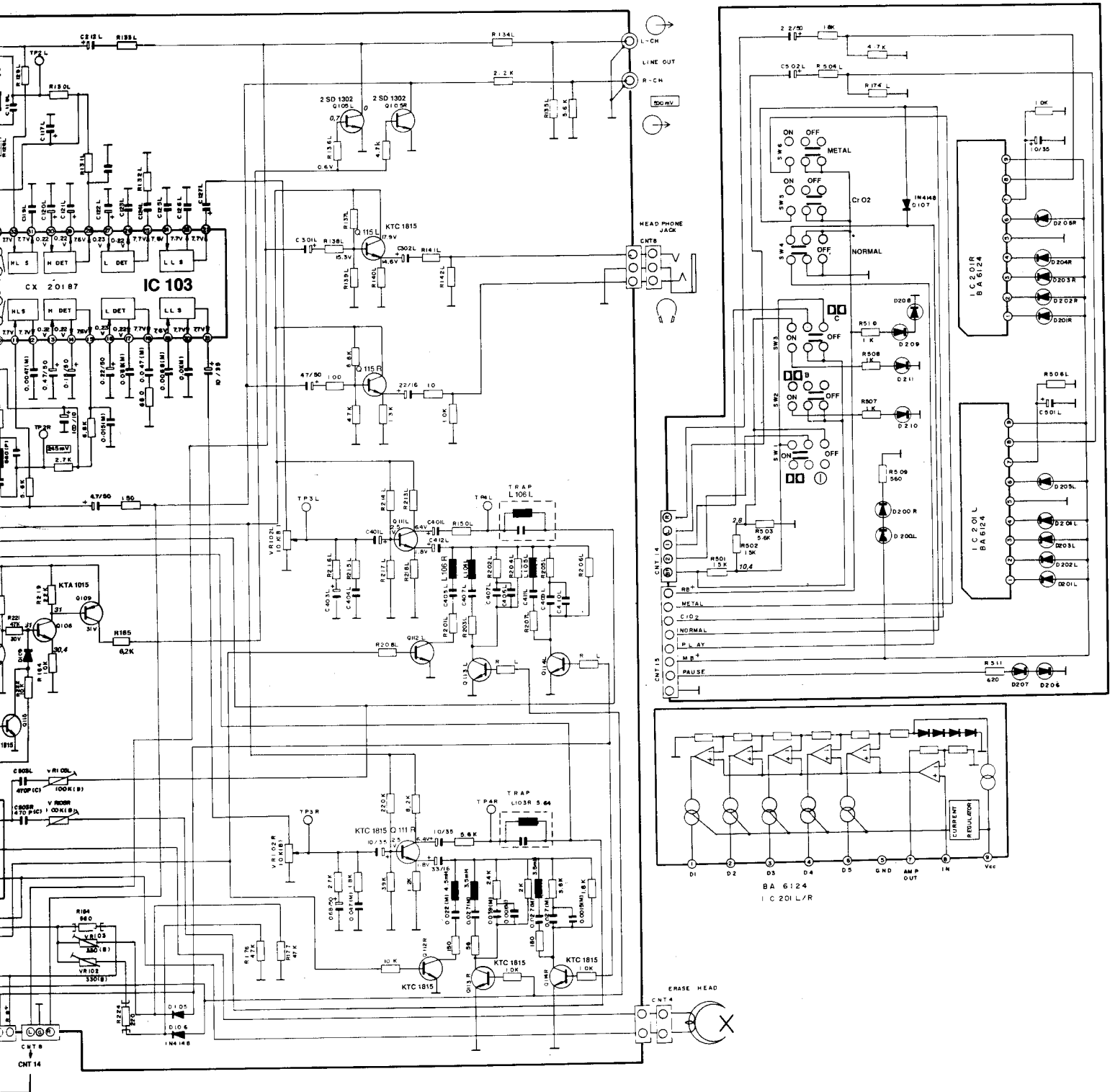

MPS A05

KTA 1015Y  
 KTC 1815Y  
 KTC 2240  
 2SD 1302

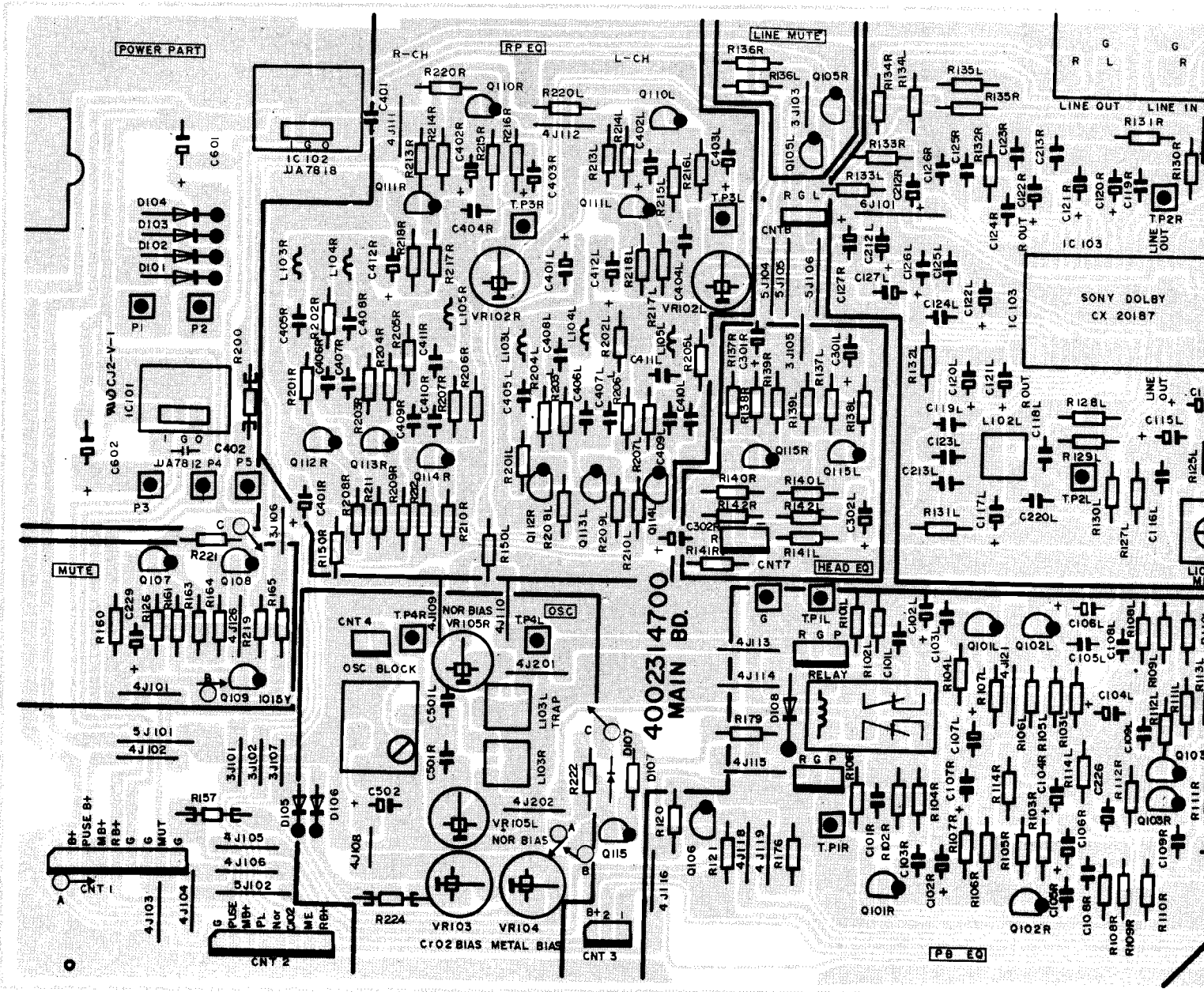
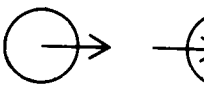

Ausgangsleistungsanzeige  
Piastra indicatore del livello  
P.C.B. output level  
Platine indicateur de niveau

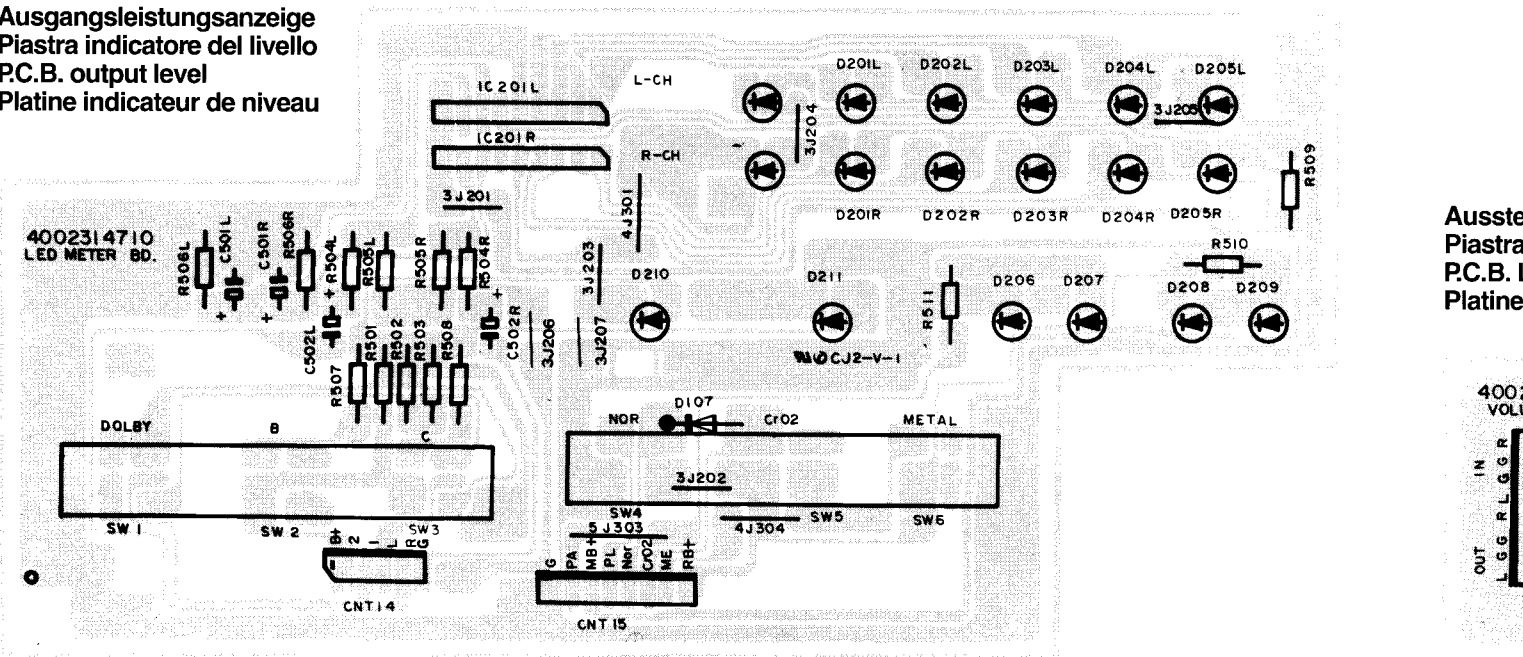

Ausste  
Piastra  
P.C.B. L  
Platine

4002  
VOLL  
IN  
LGG R L G G R  
OUT

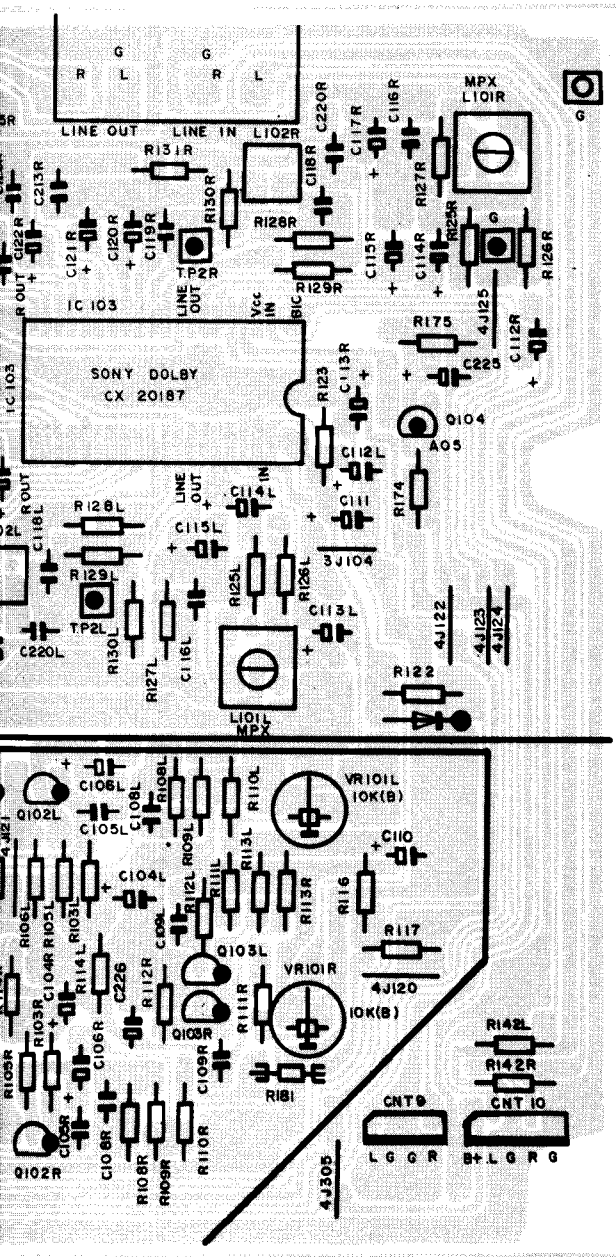
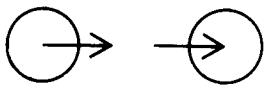

**Grundplatte**  
**Piastra principale**  
**Main P.C.B.**  
**Platine principale**

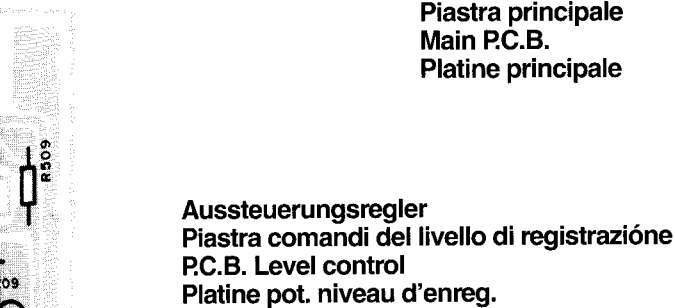

**Aussteuerungsregler**  
**Piastra comandi del livello di registrazione**  
**P.C.B. Level control**  
**Platine pot. niveau d'enreg.**

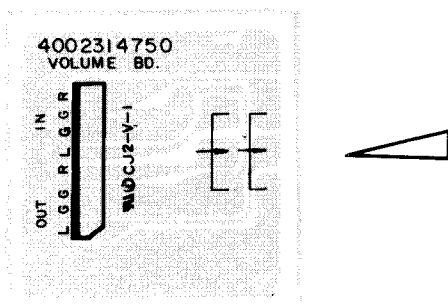

**Microfonbuchsen**  
**Piastra prese microfoni**  
**P.C.B. Micro-jack**  
**Platine prises micro**

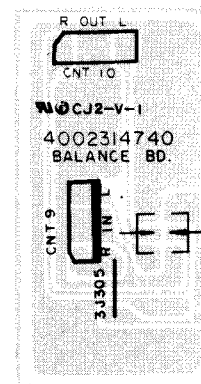
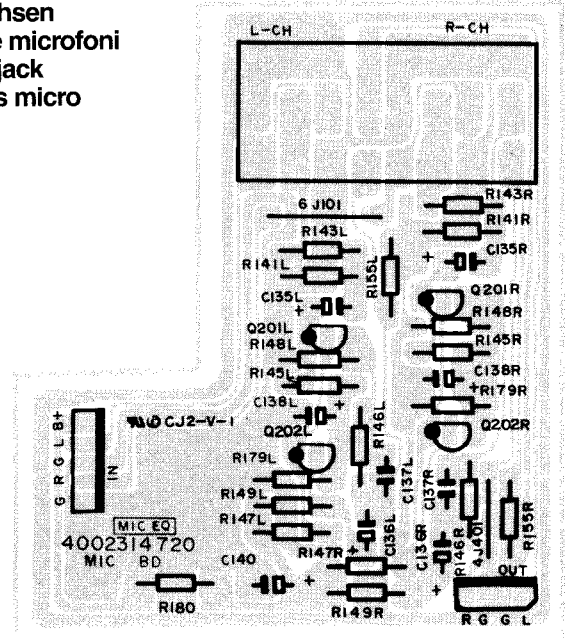

**Balance**  
**Platina Balanza**  
**Balance P.C.B.**  
**Platine Balance**

**Kopfhörerbuchse**  
**Piastra presa per cuffia**  
**P.C.B. headphone-jack**  
**Platine prise-casque**

