

9097247 TOSHIBA, ELECTRONIC

02E 17425 D

T-77-05-05

**TA7613AP****AM/FM RADIO IC WITH POWER AMPLIFIER**

- TA7613AP is Suitable for Use in AM/FM Portable Radios or Main-fed AM/FM Clock Radios.
- It Incorporates : AM RF Amp, AM Local Oscillator, AM Mixer, AM/FM IF Amp, AM/FM Detector, AM AGC Circuit, FM AFC Circuit and B Class-Audio Power Amplifier.
- Using the TA7613AP, Plus the Discrete Input Stage (for FM : RF Amp and Converter), It is Possible to Construct a Complete AM/FM Radios Receivers.
- It Features Wide Operating Voltage Range : from 3 Volts to Approximately 13 Volts, Depending on the Internal Regulator Tolerance.
- As the Internal Shunt Voltage Regulator Circuit is Connected to the Supply Voltage Terminal, it Permits a Constant Current Mode (Approximately 42mA) of Operation which is Desirable for Line-Operated Equipments.
- AM to FM Switching is Accomplished by Switching Only DC Circuitly.

Unit in mm

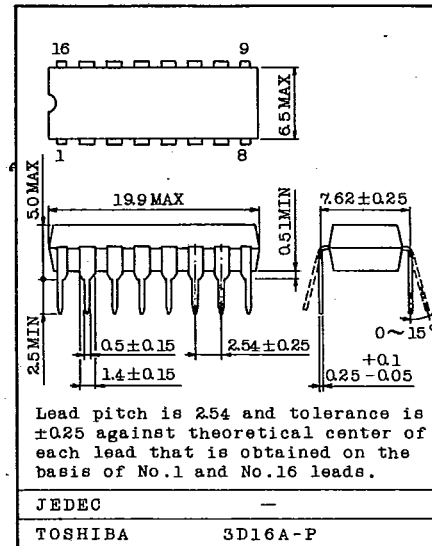
**MAXIMUM RATINGS ( $T_a=25^\circ\text{C}$ )**

CHARACTERISTIC	SYMBOL	RATING	UNIT
Supply Voltage	$V_{CC}$	11	V
Supply Current	$I_{CC}$	44	mA
Power Dissipation (Note) ( $T_a \leq 65^\circ\text{C}$ )	$P_D$	600	mW
Thermal Resistance	$R_{J-A}$	100	$^\circ\text{C}/\text{W}$
Operating Temperature	$T_{opr}$	-18 ~ 65	$^\circ\text{C}$
Storage Temperature	$T_{stg}$	-40 ~ 125	$^\circ\text{C}$

Note : Derated above  $T_a=25^\circ\text{C}$  in the proportion of 10mW/ $^\circ\text{C}$ . **$V_{CC}$  vs  $R_L$** 

$V_{CC}$ \ $R_L$	4.5V	6V	7.5V	9V	Line Operated
8 $\Omega$	○	○	○	×	×
16 $\Omega$	○	○	○	○	×
45 $\Omega$	○	○	○	○	○

**TOSHIBA**

# TA7613AP

T-77-05-05

## ELECTRICAL CHARACTERISTICS

(Unless otherwise specified,  $T_a=25^\circ\text{C}$ ,  $f(\text{AM})=1\text{MHz}$ ,  $\text{Mod}=30\%$ ,  $f(\text{FM})=10.7\text{MHz}$   
 $\Delta f=22.5\text{kHz}$ ,  $f_m=1\text{kHz}$ ,  $V_{IN}=\text{SG Open Voltage } -6\text{dB}$ )

CHARACTERISTIC	SYMBOL	TEST CIRCUIT	TEST CONDITION	MIN.	TYP.	MAX.	UNIT
Quiescent Current	I <sub>CCQ</sub>		SW1 → FM, V <sub>CC</sub> =3V	7	12	17	mA
			SW1 → FM, V <sub>CC</sub> =9V	10	17	23	
Pin 16 Terminal Voltage	V <sub>16(FM)</sub>		SW1 → FM, I <sub>CC</sub> =42mA, No Signal	2.0	2.4	3.1	V
Limiting Voltage	V <sub>IN(1im)</sub>		SW1 → FM, V <sub>CC</sub> =5.5V, -3dB V <sub>16</sub> =2.4V, V <sub>R</sub> =Min.	-	57	-	dB $\mu$ V
Internal Regulated Voltage	V <sub>CC</sub>		SW1 → AM, I <sub>CC</sub> =42mA	12.5	13.2	14.0	V
Pin 16 Terminal Voltage	V <sub>16(AM)</sub>		SW1 → AM, V <sub>CC</sub> =9V, No Signal	1.4	-	1.9	V
Maximum Sensitivity	V <sub>0</sub>		SW1 → AM, V <sub>CC</sub> =12V, V <sub>IN</sub> =37dB SW2 → 45 $\Omega$ , V <sub>16</sub> =1.4V	1.5	3.0	-	V
Quieting Sensitivity	S/N		SW1 → AM, V <sub>CC</sub> =5.5V SW2 → 8 $\Omega$ , V <sub>IN</sub> =37.5dB	15	20	-	dB
Power Stage	Output Power	P <sub>OUT</sub>	SW2 → 8 $\Omega$ , V <sub>CC</sub> =5.5V, f=1kHz V <sub>R</sub> =Min. THD=10%	0.28	-	-	W
	Total Harmonic Distortion	THD	SW2 → 45 $\Omega$ , I <sub>CC</sub> =42mA, f=1kHz V <sub>R</sub> =Min. V <sub>OUT</sub> =2V	-	0.5	4.0	%
	Voltage Gain	G <sub>v</sub>	SW2 → 8 $\Omega$ , V <sub>CC</sub> =5.5V, f=1kHz V <sub>R</sub> =Min.	-	40	-	dB

## BLOCK DIAGRAM

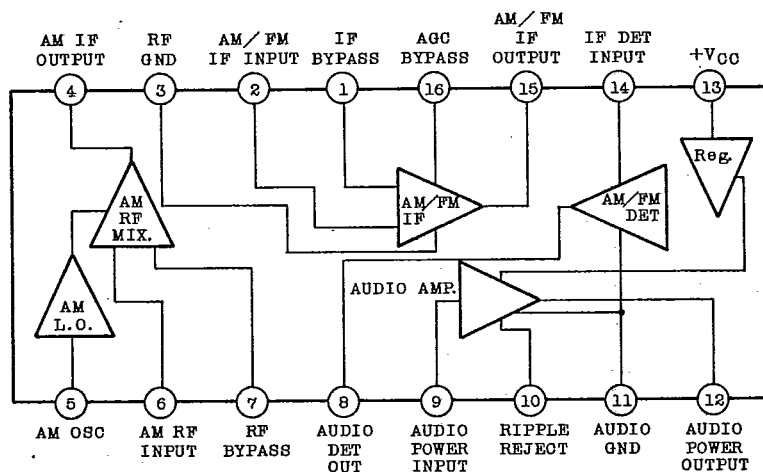

AUDIO LINEAR IC

9097247 TOSHIBA. ELECTRONIC

02E 17427 D

**TA7613AP**

T-77-05-05

INPUT-OUTPUT IMPEDANCE (Ta=25°C, V<sub>CC</sub>=6V)

CHARACTERISTIC	SYMBOL	TEST CONDITION	MIN.	TYP.	MAX.	UNIT
Pin 2 Input Impedance (AM)	R <sub>ip2</sub> (AM)	f=455kHz	-	200	-	kΩ
	c <sub>ip2</sub> (AM)	f=455kHz	-	3	-	pF
Pin 2 Input Impedance (FM)	R <sub>ip2</sub> (FM)	f=10.7MHz	-	30	-	kΩ
	c <sub>ip2</sub> (FM)	f=10.7MHz	-	3.5	-	pF
Pin 4 Output Impedance	R <sub>op4</sub>	f=455kHz	-	300	-	kΩ
	c <sub>op4</sub>	f=455kHz	-	6	-	pF
Pin 6 Input Impedance	R <sub>ip6</sub>	f=1MHz	-	50	-	kΩ
	c <sub>ip6</sub>	f=1MHz	-	5	-	pF
Pin 14 Input Impedance (AM)	R <sub>ip14</sub> (AM)	f=455kHz	-	300	-	kΩ
	c <sub>ip14</sub> (AM)	f=455kHz	-	3.5	-	pF
Pin 14 Input Impedance (FM)	R <sub>ip14</sub> (FM)	f=10.7MHz	-	300	-	kΩ
	c <sub>ip14</sub> (FM)	f=10.7MHz	-	4	-	pF
Pin 15 Output Impedance (AM)	R <sub>op15</sub> (AM)	f=455kHz	-	300	-	kΩ
	c <sub>op15</sub> (AM)	f=455kHz	-	5.5	-	pF
Pin 15 Output Impedance (FM)	R <sub>op15</sub> (FM)	f=10.7MHz	-	300	-	kΩ
	c <sub>op15</sub> (FM)	f=10.7MHz	-	6	-	pF

**TOSHIBA**

# TA7613AP

T-77-05-05

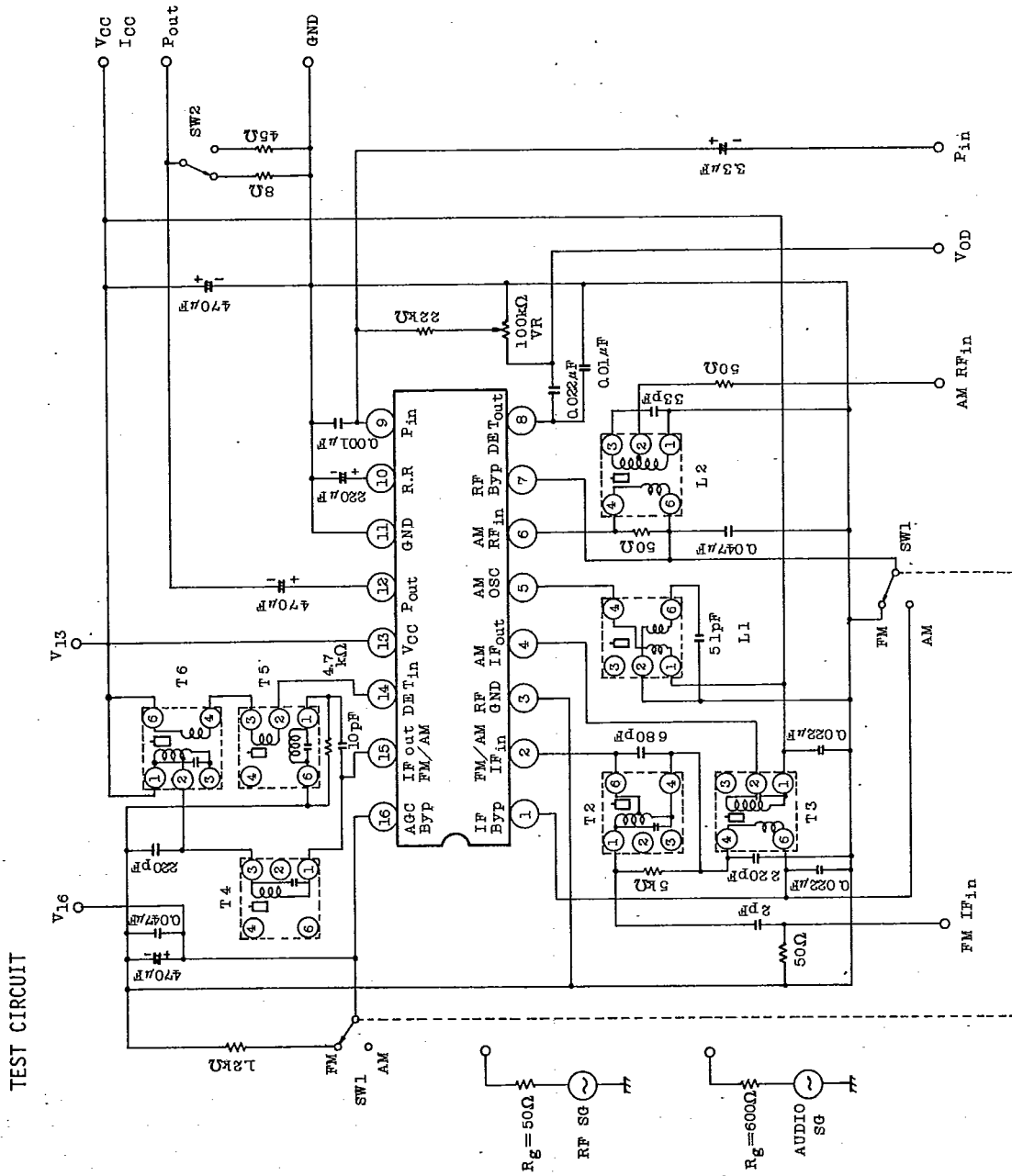

AUDIO LINEAR IC

# TA7613AP

T-77-05-05

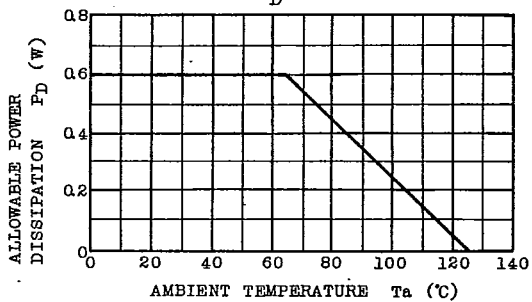
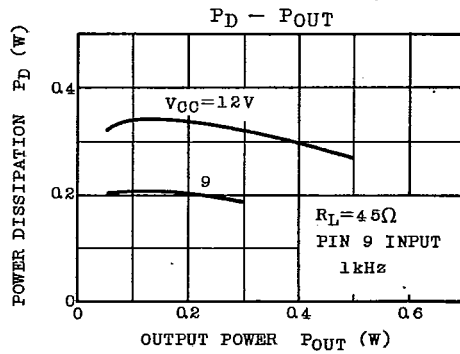
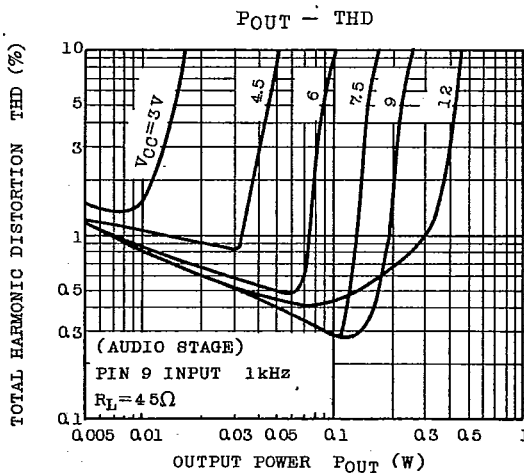
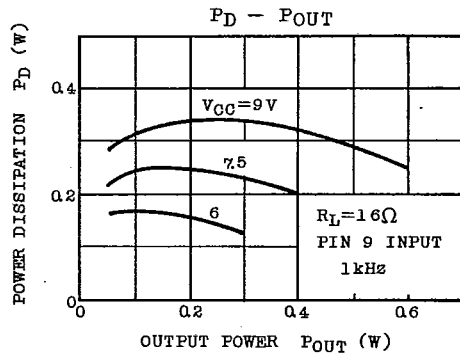
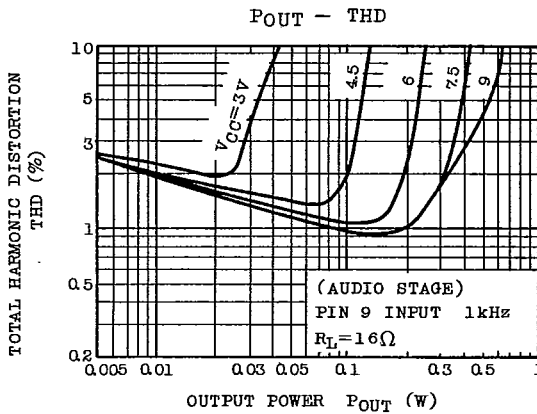
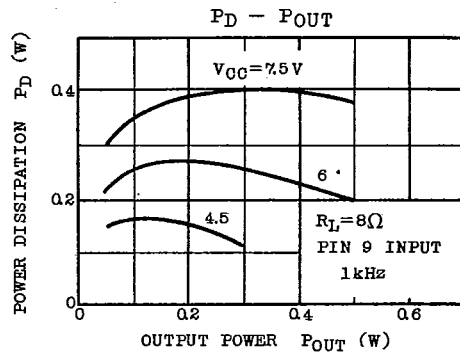
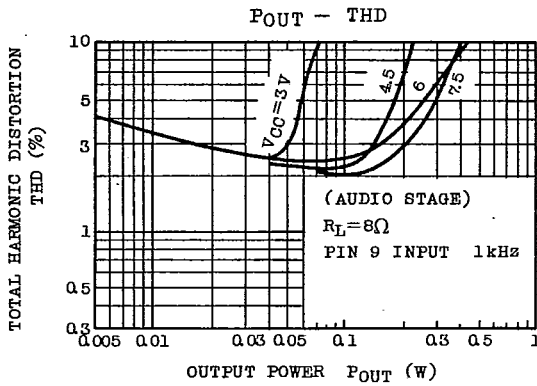

TA7613AP

T-77-05-05

APPLICATION CIRCUIT

AM/FM AUDIO LINE OPERATION

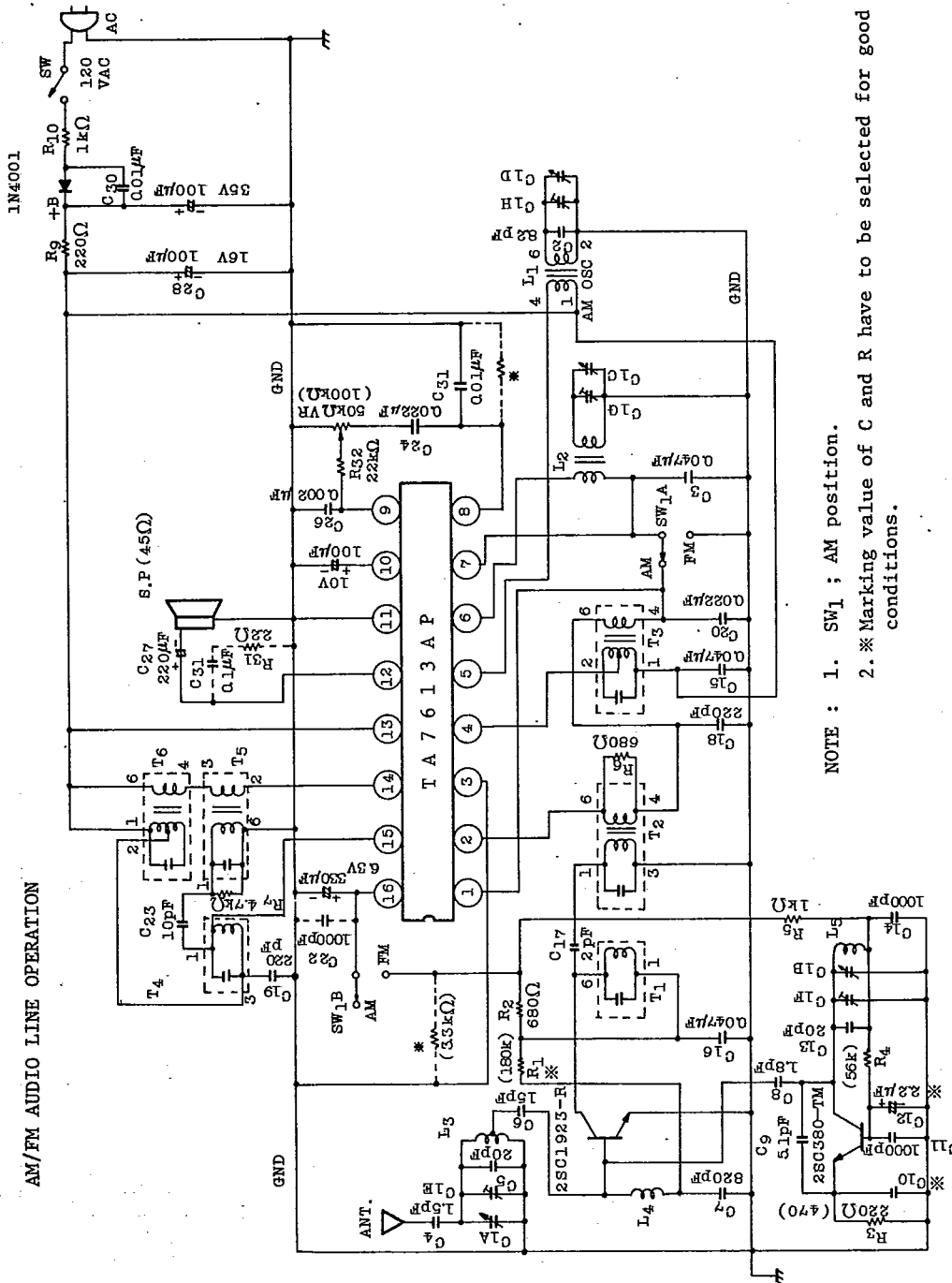

NOTE : 1. SW<sub>1</sub> ; AM position.  
 2. \* Marking value of C and R have to be selected for good conditions.

AUDIO LINEAR IC

## TA7613AP

T-77-05-05

## COIL DATA

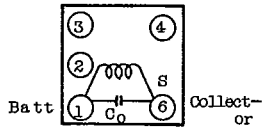
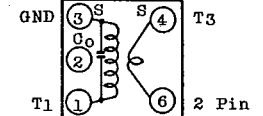
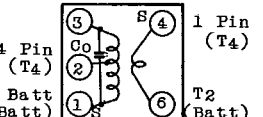
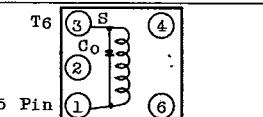
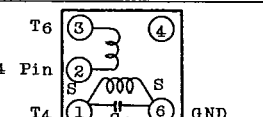
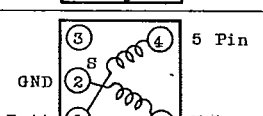
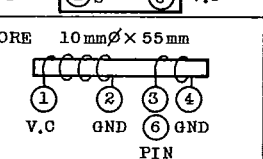
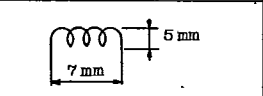
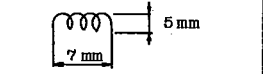
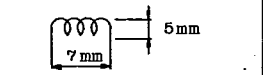
COIL No.	f	Q0	TURNS	C <sub>0</sub>	
T1	10.7MHz	120	6-1 8T	150pF	
T2	10.7MHz	95	3-1 5T 4-6 2T	400pF	
T3 (T6)	455kHz	130	1-2 45T 2-3 110T 4-6 55T	150pF	
T4	10.7MHz	80	3-1 6T	300pF	
T5	10.7MHz	70	6-1 7 1/2 T 2-3 7T	180pF	
L1	AM LOCAL OSCILLATOR	90	2-6 82 1/2 T 1-4 8 1/2 T		
L2	AM ANTENNA	200	① - ② 138T (L=560μH) ③ - ④ 9T	-	
L3	FM ANTENNA	-	0.8mmφ UEW 4T TAP 0.5T	-	
L4	Trap	-	0.32mmφ UEW 10T	-	
L5	FM OSCILLATOR	-	0.8mmφ UEW 4T	-	

1983-2-5

TOSHIBA CORPORATION

EJB-TA7613AP-7

TOSHIBA