

# SERVICE MANUAL



Stereo Integrated Amplifier

# LV-107u



---

## Contents

---

Specifications .....	3
Connection Guidelines .....	4
Reference Illustrations .....	5 to 6
Controls Switches, Jacks & Terminals .....	7 to 9
Operation Guidelines .....	9 to 10
Disassembly Instructions .....	11 to 15
Adjustment Procedures .....	16
Adjustment Locations .....	17
Block Diagram .....	18
Schematic Diagram .....	19 to 21
Parts Layout on P. C. Boards and Wiring Diagram (1/3) .....	22 to 24
Parts Layout on P. C. Boards and Wiring Diagram (2/3) .....	25 to 27
Parts Layout on P. C. Boards and Wiring Diagram (3/3) .....	28 to 30
Electrical Parts List .....	31 to 36
Packing Assembly Parts List .....	37
Packing Method View .....	37
Cabinet Assembly Parts List .....	38
Exploded View (Cabinet) (1/2) .....	39 to 40
Exploded View (Cabinet) (2/2) .....	41
Semi-conductor Lead Identifications .....	42 to 43

Additional Schematic Diagram Inserted.

---

# Specifications

Power Output (0.25%THD at 1KHz) .....	80W
Headphones Output (80W/8 ohm - 1KHz) .....	650mV ± 10%
Input Sensitivity (1KHz) .....	CD : 140mV ± 15%
	Tuner : 140mV ± 15%
	Tape - 1, 2 : 140mV ± 15%
	AV - 1, 2 : 140mV ± 15%
	Adaptor : 140mV ± 15%
	Phono (MM) : 2mV ± 15%
	Phono (MC) : 140μV ± 15%
Input Impedance (1KHz) .....	CD : 47K ohm ± 15%
	Tuner : 47K ohm ± 15%
	Tape - 1, 2 : 47K ohm ± 15%
	AV - 1, 2 : 47K ohm ± 15%
	Adaptor : 47K ohm ± 15%
	Phono (MM) : 47K ohm ± 15%
	Phono (MC) : 100 ohm ± 15%
Frequency Response .....	CD : 10 - 100KHz + 0.6 - 2dB
	Tuner : 10 - 100KHz + 0.6 - 2dB
	Tape - 1, 2 : 10 - 100KHz + 0.6 - 2dB
	Phono (MM) : 100Hz ± 0.5dB
	Phono (MC) : 10KHz ± 0.5dB
Loudness Control (VR - 30dB) .....	(100Hz) + 8.5 ± 2dB
	(10KHz) + 6.5 ± 2dB
Signal to Noise Ratio (input Shorted) .....	CD : 81.5dB
	Tuner : 81.5dB
	AV - 1, 2 : 81.5dB
	Adaptor : 81.5dB
	Phono (MM) : 69.4dB
	Phono (MC) : 47.5dB
Cross Talk .....	CD : 45dB
	Tuner : 45dB
	AV : 45dB
	Tape : 45dB
	Adaptor : 45dB
	Phono : 40dB
Power Supply .....	100V, 50/60Hz (JA Model Only)
	220V, 50Hz (AD Model Only)
Power Consumption .....	185W (JA Model Only)
	3.5A (AD Model Only)
Semiconductors .....	7 IC's, 43 Transistors, 14 Zener Diodes, 10FETs, 33 Diodes, 2 Vacuum Tubes
Dimension .....	470 (W) × 160 (H) × 353 (D) mm (JA Model Only)
	438 (W) × 160 (H) × 353 (D) mm (AD Model Only)
Weight .....	14.4Kg (JA Model Only)
	13.8Kg (AD Model Only)

**NOTE:** Due to continuing product improvement, specifications and design are subject to change without notice

# CONNECTION GUIDELINES

## BEFORE MAKING CONNECTIONS

It is always wise to ensure that all AC power cords of the various components that you are interconnecting are unplugged from the wall outlets during the hook-up process. This will prevent any inadvertent damage to your speakers or LV-104u/LV-107u from incorrect control settings or connections.

## INTERCONNECTING LEADS (Patch Cords)

Be sure that left and right channel identification is correct when making interconnections. Most patch cords are color coded with RED ends for the right channel and BLACK or WHITE ends for the left channel, to make this job easier.

In addition, all jacks on the rear of the LV-104u/LV-107u have red centers for right channel, white for left channel and yellow for each video jack.

## CONNECTING THE RECORD PLAYER (TURNTABLE)

In addition to the audio lead connections, be sure to always connect the ground lead from the player to the GND terminal (item #23) on the LV-104u/LV-107u.

## CONNECTION OF AUDIO AND VIDEO TAPE DECKS

One of the common problems in connecting tape decks is confusing the LINE IN and LINE OUT connections to the amplifier, resulting in no output even in the SOURCE modes. To prevent this, always connect the LINE OUT jacks of the deck to the IN (monitor) input jacks of the LV104u/LV-107u and connect the LINE IN jacks of the deck to the OUT (record out) jacks on the LV104u/LV-107u.

## CONNECTION OF VIDEO EQUIPMENT

Follow the connection diagram carefully when connecting video equipment to the LV-104u/LV-107u. In addition, be sure to read the owner's manuals of such equipment fully, to ensure proper operation. It is recommended that only the highest quality TV monitor, Hi-Fi VCR, LD, etc. be used to complement the high performance standards of the Luxman LV-104u/LV-107u.

## SPEAKER CONNECTIONS

The following items should be observed carefully when connecting your speakers:

1. Be sure phasing is correct by connecting the RED (+) and the BLACK (-) terminals of the LV-104u/LV-107u to the RED (+) and the BLACK (-) terminals of your speakers on each channel. Failure to do so will result in drastically reduced bass response and unstable, irregular stereo imaging.
2. To prevent the possibility of shorts, strip back the ends of the speaker leads about 1 cm and carefully twist the strands together. Loosen the speaker terminal knob by rotating it counter-clockwise. Insert the twisted end and turn clockwise to tighten.  
  
Inspect carefully to ensure that no frayed strands exist that may short against the metal rear panel.
3. It is recommended that 16 AWG gauge wire, or larger, be used to prevent losses. You may wish to consider some of the commercially available speaker cables that are specifically designed to improve the amplifier to speaker interface.

## SIGNAL PROCESSOR CONNECTIONS

Like tape decks, most of these types of equipment have LINE IN and LINE OUT jack identifications. Be sure LINE IN and LINE OUT jacks of the signal processor are connected to the LV104u/LV-107u SIGNAL PROCESSOR OUT and IN jacks respectively.

# REFERENCE ILLUSTRATIONS

Fig. 1

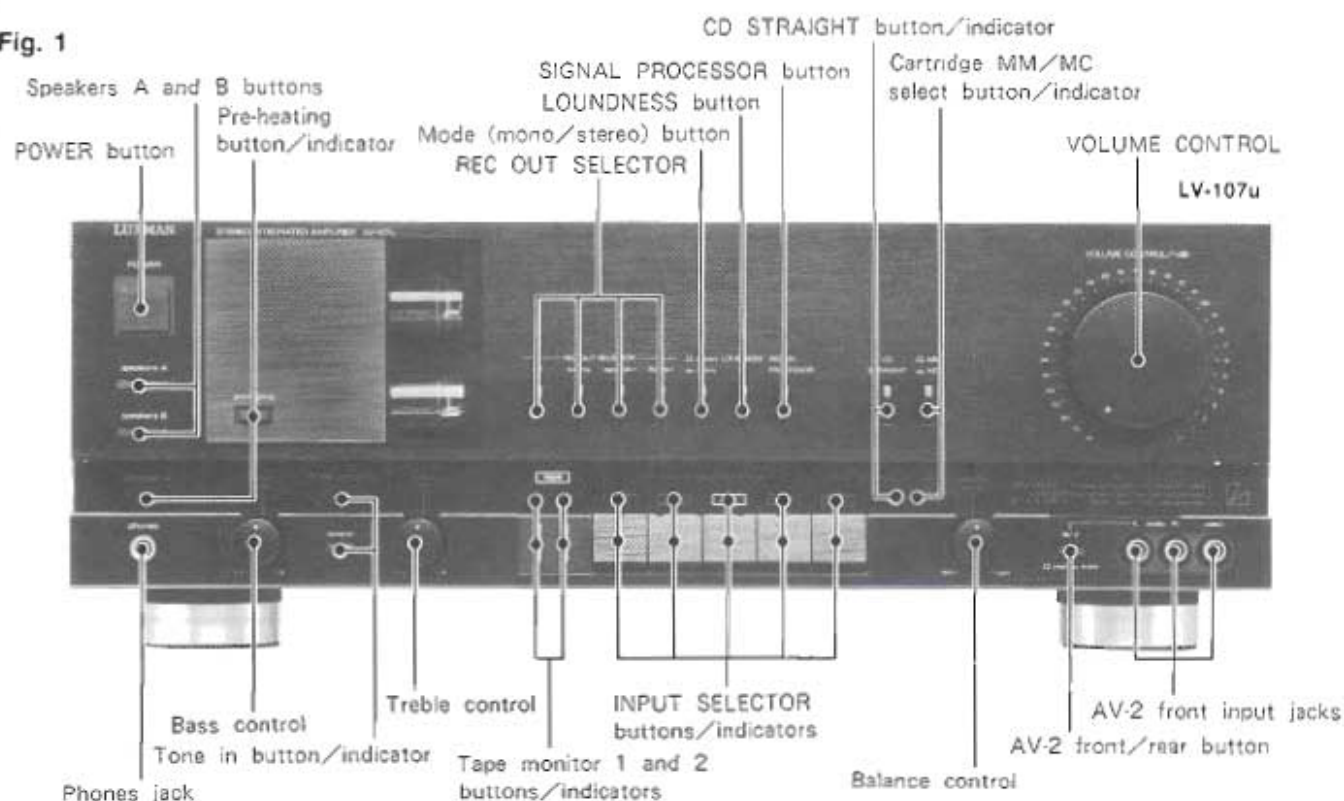
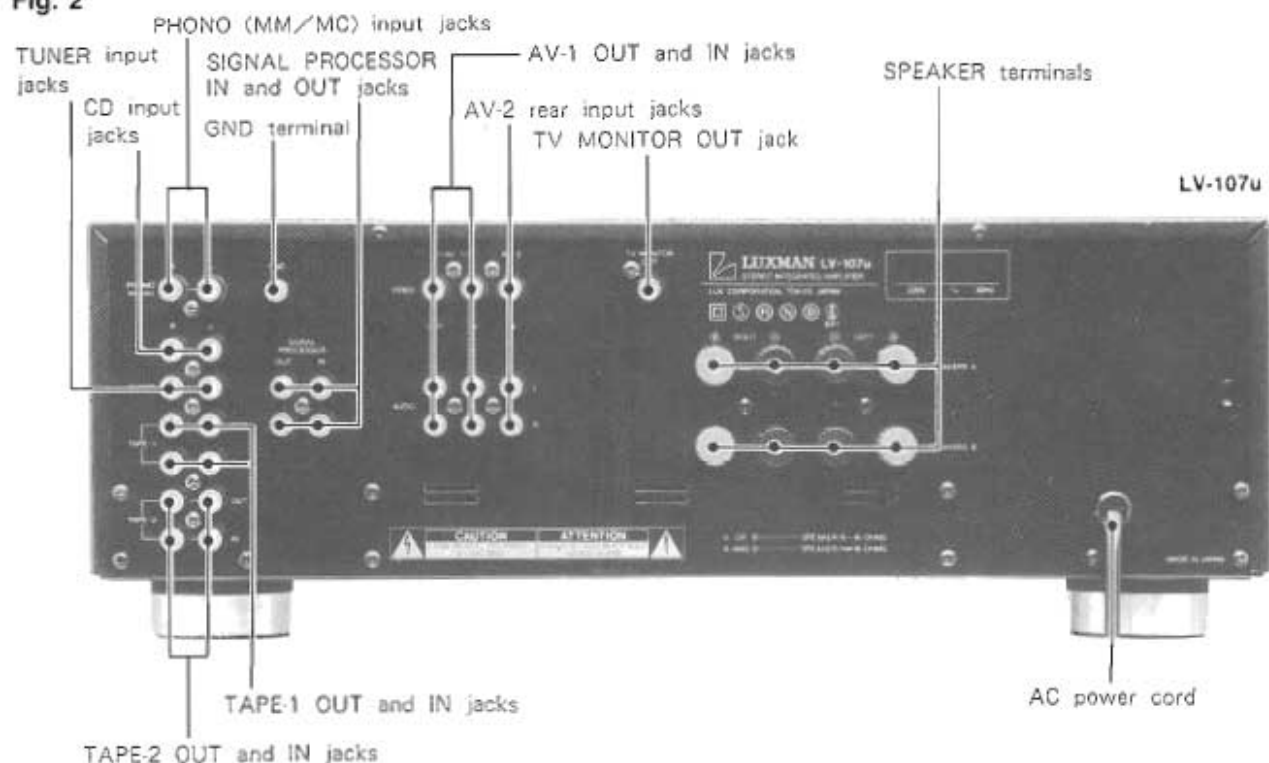
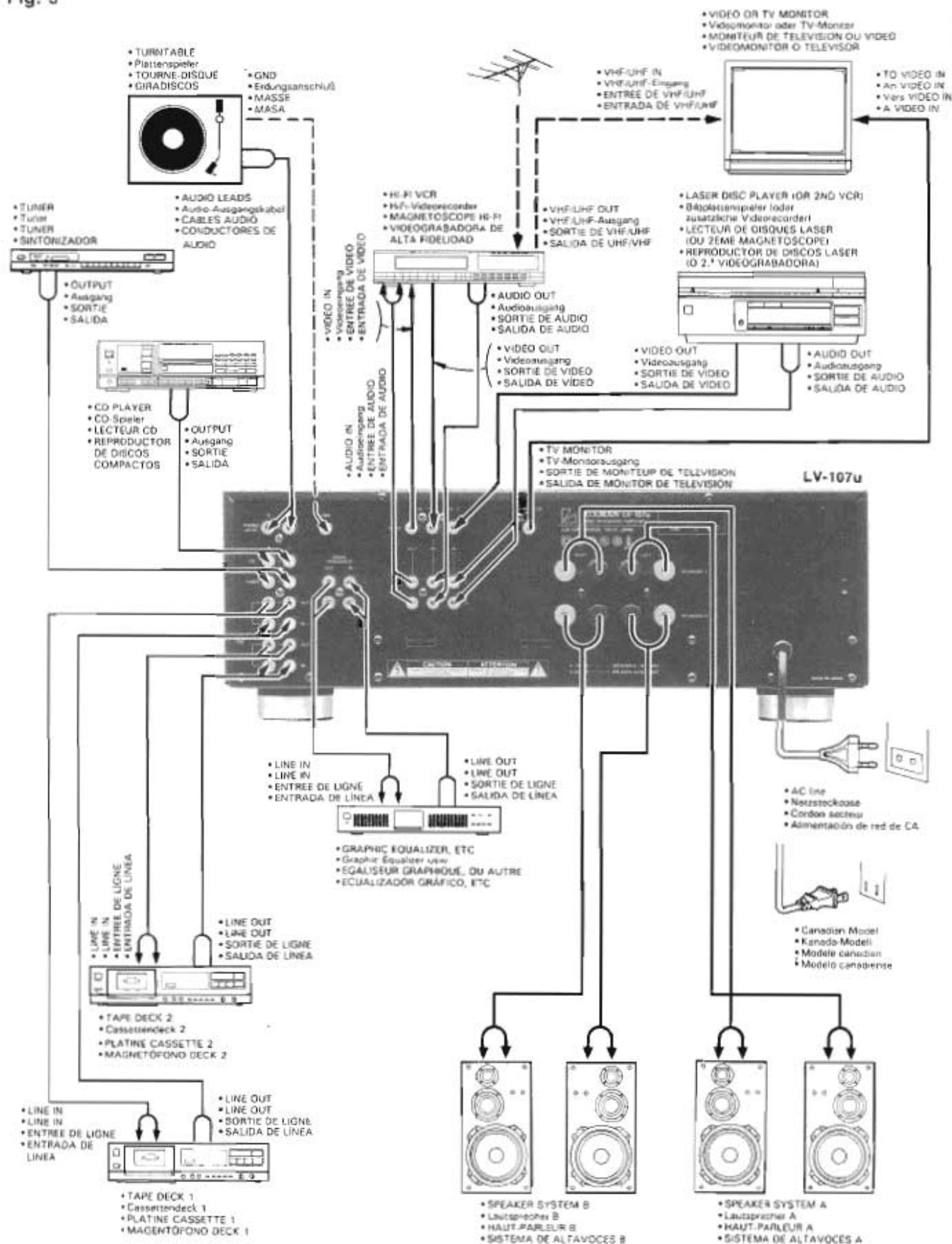

Fig. 2



# REFERENCE ILLUSTRATIONS

Fig. 3



# CONTROLS SWITCHES, JACKS & TERMINALS

## FRONT PANEL

(See Fig. 1 on page 5.)

### 1. POWER button

Pressing this button turns the unit on. If the pre-heating button was previously depressed, the unit will operate immediately. However, if the pre-heating button is in the off position, approximately 30 seconds will be required to allow the vacuum tubes to warm up.

### 2. speakers A and B buttons

Two sets of stereo speaker systems may be used with the LV-104u/LV-107u; A and B buttons corresponding with A and B speaker terminals on the rear panel (item #28). You may choose independent or simultaneous operation of the two systems by using these buttons.

**NOTE:** The impedance of each speaker system should equal or exceed 16 ohms when driving two sets at the same time.

### 3. pre-heating button/indicator

Press this button to the in position to activate the pre-heating mode. The pre-heating indicator will light and lower, quiescent operating conditions will occur when the POWER button is turned off.

### 4. REC OUT SELECTOR

These buttons allow you to record any source selected by the INPUT SELECTOR and to dub audio or video tapes. The REC OUT SELECTOR has four positions: off, source, tape-2 ► 1, and AV-2 ► 1.

When in the source position, any signal selected by the INPUT SELECTOR will appear at the TAPE-1 and TAPE-2 OUT jacks. These sources will not appear at the AV-1 AUDIO OUT jacks.

Press the TAPE-2 ► 1 button when you wish to copy (dub) an audio tape from deck 2 to deck 1. In a like manner, a video dub can be made by pressing the AV-2 ► 1 button. Press the off button when recordings or dubs are not being made.

### 5. mode (mono/stereo) button

Place in mono (in) position for mono sources, for balance control adjustment, for lower noise operation from high noise stereo sources, or for checking speaker phasing. Otherwise, leave it in the stereo (out) position.

### 6. LOUDNESS button

Depressing this button introduces a moderate boost of the very low and high frequencies when the volume control is set below the -14 dB position. This compensates for the human ear's characteristic at low listening levels.

### 7. SIGNAL PROCESSOR button

When depressed, this button engages an equalizer or other signal processor connected to the rear panel SIGNAL PROCESSOR jacks.

### 8. CD STRAIGHT button/indicator

For optimum sound quality in CD operation, press this button to bypass the INPUT SELECTOR, tape monitor 1 and 2, mode, TONE CONTROLS, balance and SIGNAL PROCESSOR switching functions.

**NOTE:** BE SURE CD STRAIGHT BUTTON IS IN THE OUT POSITION (CD STRAIGHT INDICATOR OFF) WHEN USING SOURCES OTHER THAN CD.

### 9. cartridge MM/MC select button/indicator

Allows the use of either a moving magnet (MM) or a moving coil (MC) magnetic phono cartridge. For MM cartridges, the button must be placed in the out position. For MC cartridges, the MC (in) position must be used (MC indicator will light).

### 10. VOLUME CONTROL

Allows precision, low noise adjustment of volume level. It is recommended that the volume control be set to a low position prior to power turn on and when switching between sources.

### 11. AV-2 front input jacks

These jacks allow the temporary connection of a VCR, Video Disc Player, CD, Cassette Deck, etc. Be sure that front/rear button (item #12) and the AV-2 INPUT SELECTOR button (item #14) are both pushed in when using these jacks.

### 12. AV-2 front/rear button

Selects the front AV-2 jacks in the in position and the rear AV-2 jacks in the out position.

# CONTROLS SWITCHES, JACKS & TERMINALS

## 13. balance control

Adjust for unequal volume level between channels. Normally, with today's high quality sources, it is seldom necessary to move this control from its precision center detent position.

## 14. INPUT SELECTOR buttons/indicators

Press one of these buttons to select any one of five sources: phono, tuner, CD, AV-2 and AV-1. A corresponding indicator will light up when a button is pressed.

## 15. tape monitor 1 and 2 buttons/indicators

For selection of connected tape decks 1 or 2. When depressed, a corresponding indicator will light up.

**NOTE:** When both buttons are depressed, only the tape 1 position will function.

## 16. treble control

This control will increase or decrease high frequency content in the program material. At the center detent position, a flat frequency response results.

**NOTE:** The tone in button must be depressed to activate the treble control.

## 17. tone in button/indicator

When depressed, the bass and treble tone control circuits are activated. On the out position, the tone circuits are completely bypassed, resulting in ruler-flat frequency response. The TONE CONTROL indicator lights up in the in position.

## 18. bass control

This control will increase or decrease low frequency content in the program material. At the center detent position, a flat frequency response results.

**NOTE:** The tone in button must be depressed to activate the bass control.

## 19. phones jack

Connection of stereophonic headphones to this jack allows private listening. There is signal at the jack at all times. Placing the speaks A and B buttons (item #2) in the out position, will allow private listening.

## REAR PANEL

(See Fig. 2 on page 5.)

## 20. TUNER input jacks

These input jacks are for connection to the output jacks of your tuner.

## 21. CD input jacks

These input jacks are for connection of a CD (Compact Disc) player. They may also be used for any other high level signal source.

## 22. PHONO (MM/MC) input jacks

MC or MM type cartridges may be connected to these inputs. Be sure to set the front panel cartridge MM/MC select button (item #9) to match the cartridge type (MM or MC) being used.

## 23. GND terminal

Connect the common (ground) lead of your record player to this terminal.

## 24. SIGNAL PROCESSOR IN and OUT jacks

For connection of a surround sound processor (Luxman F-105), an equalizer (Luxman G-100, G-111, etc.) or other signal processor as desired. They are switched in or out by the front panel SIGNAL PROCESSOR button (item #7).

## 25. AV-1 OUT and IN jacks

Use these for the connection of a video cassette recorder (VCR). Be sure to correctly connect the audio LINE IN and LINE OUT jacks of the VCR to the AV-1 AUDIO OUT and IN jacks of the LV-104u/LV-107u and the VIDEO IN and VIDEO OUT jacks of the VCR to the VIDEO OUT and IN jacks of the LV-104u/LV-107u respectively.

## 26. AV-2 rear input jacks

Connect a VCR, Laser/Video Disc Player, etc., to these input jacks for playback purposes only. Connect the audio LINE OUT and VIDEO OUT jacks of the VCR, LD, etc. to the AV-2 AUDIO and VIDEO IN jacks of the LV-104u/LV-107u respectively.

## 27. TV MONITOR OUT jack

Connect this TV MONITOR OUT jack to the video input jack of a video monitor or to a TV receiver that has a video input jack.



## CONTROLS SWITCHES, JACKS & TERMINALS

### 28. SPEAKER terminals

You may connect 2 pairs of stereo speaker systems to these terminals, one pair to the upper "A" terminals and a 2nd pair to the lower "B" terminals.

When connecting, be sure to observe correct phasing by connecting of the RED (+) and the BLACK (-) terminals of the LV-104u/LV-107u to the corresponding RED (+) and BLACK (-) terminals of your speakers on each channel.

The speaker systems may be switched on and off by the front panel speakers A and B buttons (item #2).

### 29. AC power cord

Insert the AC plug of the LV-104u/LV-107u into any wall outlet.

**CAUTION: NO RELATION TO THE POWER BUTTON.  
AN APPARATUS FALLS INTO CURRENT-CARRYING CONDITION WHEN PRE-HEATING BUTTON IS ON, AS SOON AS THE AC POWER CORD IS CONNECTED.**

### 30. TAPE-1 OUT and IN jacks

Connect the LINE IN and LINE OUT jacks of your audio tape deck to these OUT and IN (monitor) jacks of the LV-104u/LV-107u respectively.

### 31. TAPE-2 OUT and IN jacks

Connect a 2nd tape deck to these jacks in the same manner as item #30 above.

**NOTE:** See Fig. 3, page 4, for typical connections to all jacks and terminals (item #20 to item #31).

## OPERATION GUIDELINES

### POWER AND SOURCE SWITCHING

To prevent the possibility of excessive, sudden sound levels, it is recommended that the volume control be placed at a low level position each time the power button is turned on or when switching between sources.

This is particularly true when using the pre-heating mode. In this mode there is no delay and output will occur immediately when the power switch is turned on.

### PRE-HEAT OPERATION

It is recommended that the pre-heating mode be selected on a full time basis, except for long periods of non-use (vacations, etc.). Since the tubes, the power output stages and all other circuits are left operating under quiescent conditions in the pre-heat mode, full sonic quality will result immediately each time the power button is turned on.

### TAPE RECORDING OPERATIONS

To make a tape recording of any source, proceed as follows:

- (1) Depress the INPUT SELECTOR button for the source you wish to record.
- (2) Depress the source button on the REC OUT SELECTOR.
- (3) The source signal will now be fed to the tape deck.  
Follow the recording instructions for the tape deck in use.
- (4) If you have a 3-head deck, you can monitor the actual recording by depressing the corresponding tape monitor (1 or 2) button on the LV104u/LV-107u. The MONITOR position must also be selected on your tape deck.

### TAPE PLAYBACK

Playback from either tape deck can be heard by depressing the corresponding tape monitor (1 or 2) button on the LV-104u/LV-107u.

# OPERATION GUIDELINES

## TAPE DUBBING (Audio)

Tape copies can be made from TAPE-2 to TAPE-1 as follows:

- (1) Depress the tape-2 ► 1 button on REC OUT SELECTOR.
- (2) Place tape deck 2 in the PLAY mode and deck 1 in the RECORD mode.
- (3) Again, if deck 1 is a 3-head machine, the actual recording can be monitored by depressing tape 1 monitor button.

- NOTES:**
1. If both tape 1 and 2 monitor buttons are depressed simultaneously, only tape 1 will function.
  2. You may make dubs while simultaneously listening to any source selected by the INPUT SELECTOR. Both tape monitor buttons must be in the out position.

## SIGNAL PROCESSOR JACKS

When using this facility, the following items should be kept in mind:

- (1) Since the signal processor jacks are located downstream from the mode, TONE and balance controls, the effect of these functions should always be considered relative to the operation of the external processor.

For instance "double boosting" effects can occur with a connected equalizer, causing severe over-load distortion, if both the equalizer and TONE CONTROLS are boosted together in the same frequency range.

- (2) When in CD straight operation, the SIGNAL PROCESSOR is completely bypassed.

## VIDEO PLAYBACK

Both audio and video playback from the connected A/V systems can be selected by depressing either the AV-1 or AV-2 buttons on the INPUT SELECTOR.

## VIDEO TAPE RECORDING AND DUBBING

Both the audio sound tracks and video signals from any A/V source can be recorded by a video cassette recorder (VCR) through the LV-104u/LV-107u.

To record a laser disc (LD), a TV stereo tuner or a VCR connected to the AV-2 inputs, proceed as follows:

- (1) Depress the AV-2 ► 1 button on the REC OUT SELECTOR.
- (2) The A/V signals will now be fed to the VCR connected to the AV-1 jacks. Follow the recording instructions for the VCR in use, being sure to set its input selector to "EXTERNAL" position.
- (3) Set the AV-2 front/rear button to the rear (out) position, unless you wish to record from an A/V source connected to the front input jacks.

**NOTE:** You can listen to and view the A/V signal at either the AV-1 or AV-2 positions of the INPUT SELECTOR. However, since some switching noise may appear on the recorded image, it is recommended that these buttons not be manipulated during the recording process.

## TV OPERATIONS

You can watch and/or record off-the-air (or cable) TV programs with high quality sound, using a HI-FI VCR.

With a video monitor or TV receiver connected according to the CONNECTION DIAGRAM, page 4, proceed as follows:

- (1) Set the INPUT SELECTOR of the HI-FI VCR, connected to the AV-1 inputs, to the TV or TUNER position.
- (2) Depress the AV-1 button on the INPUT SELECTOR of the LV-104u/LV-107u.
- (3) You can now view any channel selected by the HI-FI VCR's tuner.
- (4) A recording of the selected TV program can also be made, while watching and listening to high quality sound, by placing the VCR in the RECORD mode.

If you have a TV monitor with stereo audio outputs, these may be connected to the AV-2 front or rear input jacks for independent TV operation with high quality stereo sound. Proceed as follows:

- (1) Turn the power off to the VCR connected to the AV-1 jacks on the LV-104u/LV-107u.
- (2) Place the INPUT SELECTOR of the LV-104u/LV-107u in the AV-2 position.
- (3) Set the INPUT SELECTOR of the TV to the TV position and tune desired channels.

- NOTES:**
1. The above procedures assume that you have made all connections according to the CONNECTION DIAGRAM, page 4.
  2. Be sure to consult the owner's manuals of the VCR, TV monitor and other A/V units for specific operational details.

# Disassembly Instructions

## 1. Removal of Top Cover

- (1) Remove six screws marked "A" as shown in Figures 1 and 2.
- (2) Pull out the top cover in the direction of the arrow as shown in Figure 1.

## 1. 上蓋の外し方

- (1) 8本のネジ(A印)を外します。(1、2図参照)
- (2) 上蓋を矢印の方向に引き上げれば、上蓋は外れます。(1図参照)

## 2. Removal of Front Panel

- (1) Remove the volume control knob as shown in Figure 1.
- (2) Remove three screws marked "B" as shown in Figure 3.
- (3) The Front Panel can be removed by pulling it forward. But when the panel is engaged tightly, pull the panel end little by little, and the panel will be removed easily.

## 2. フロント・パネルの外し方

- (1) ボリューム調整ツマミを外します。(1図参照)
- (2) 3本のネジ(B印)を外します。(3図参照)
- (3) 手前に引けばフロント・パネルは外せます。パネルがきつくはまっている場合は、少しずつ引きます。パネルは簡単に外せます。

## 3. Removal of Front Escutcheon

- (1) After removal of The Front Panel, remove three control knobs (bass, treble, balance), remove two hooks (A), and remove six screws marked "C" as shown in Figures 1, 2 and 4.
- (2) Disconnect all wires from the Front Escutcheon.
- (3) The Front Escutcheon with Function LED, Tone and Headphone P. C. Boards can be removed completely.

## 3. フロント・エスカッションの外し方

- (1) フロント・パネルを外してから、3個の調整ツマミ(バス、トレブル、バランス)、2箇所のフック(A)及び6本のネジ(C印)を外します。(1、2、4図参照)
- (2) フロント・エスカッションから出ている全てのリード線を外します。以上でフロント・エスカッションと一緒にファンクションLED基板、トーン及びヘッドホン基板は外れます。

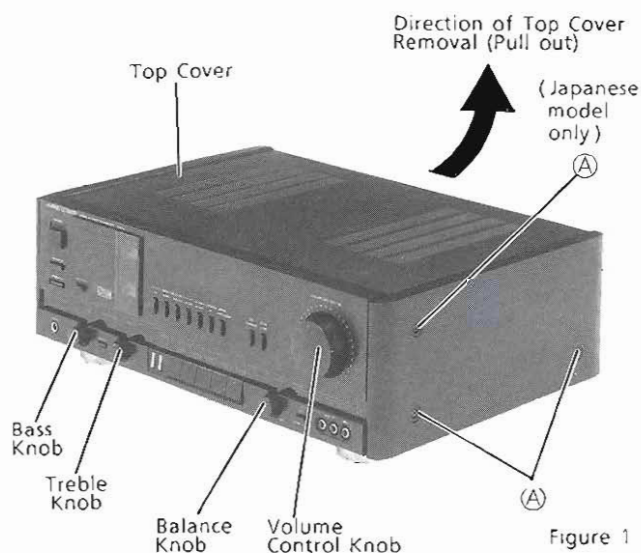

Figure 1  
<1図>

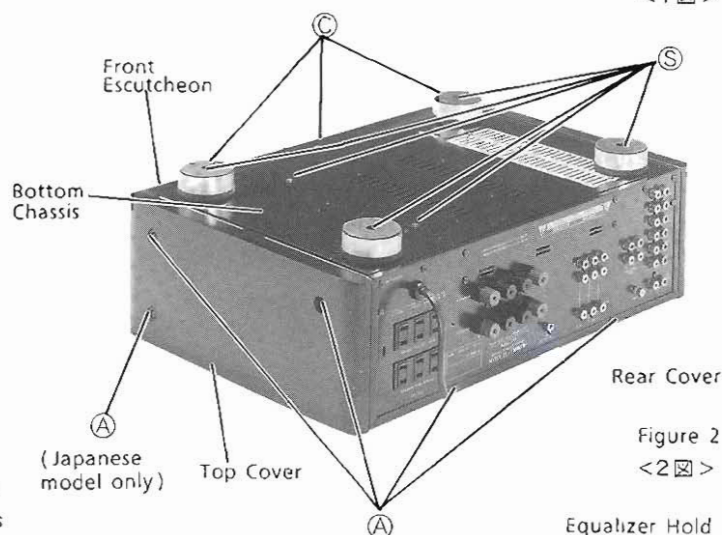

Figure 2  
<2図>

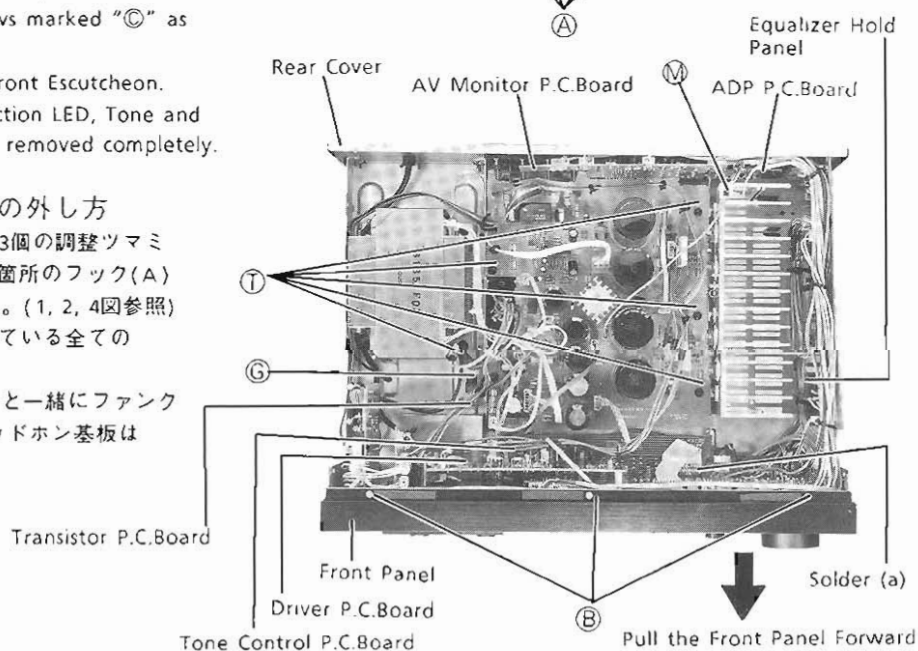

Figure 3  
<3図>

#### 4. Removal of Function LED P. C. Board

- (1) After removal of Front Escutcheon, remove four hooks (B) as shown in Figure 5.

#### 4. ファンクションLED基板の外し方

- (1) フロント・エスカッションを外してから、4箇所のフック(B)を外します。(5図参照)

#### 5. Removal of Tone Control LED P. C. Board

- (1) After removal of Front Escutcheon, remove two hooks (C) as shown in Figure 5.

#### 5. トーン・コントロールLED基板の外し方

- (1) フロント・エスカッションを外してから、2箇所のフック(C)を外します。(5図参照)

#### 6. Removal of Headphone P. C. Board

- (1) After removal of Front Escutcheon, remove two screws marked "D" as shown in Figure 5.

#### 6. ヘッドホン基板の外し方

- (1) フロント・エスカッションを外してから、2本のネジ(D印)を外します。(5図参照)

#### 7. Removal of Front Chassis

- (1) After removal of Front Escutcheon, remove seven screws marked "E" as shown in Figure 6.  
(2) Remove Front Chassis upward and then proceed to items 7-1~7-10.

#### 7. フロント・シャーシの外し方

- (1) フロント・エスカッションを外してから、7本のネジ(E印)を外します。(6図参照)  
(2) フロント・シャーシを上方に外します。続いて項目7-1から7-10に進みます。

#### 7-1 Removal of Driver P. C. Board

- (1) Remove two screws marked "D" as shown in Figure 6.  
(2) Disconnect all wires from the Driver P. C. Board.

#### 7-1 ドライバー基板の外し方

- (1) 2本のネジ(D印)を外します。(6図参照)  
(2) ドライバー基板から出ている全てのリード線を外します。

#### 7-2 Removal of Transistor P. C. Board

- (1) Removal a screw marked "E" as shown in Figure 3.  
(2) Disconnect all wires from the Transistor P. C. Board.

#### 7-2 トランジスター基板の外し方

- (1) 1本のネジ(E印)を外します。(3図参照)  
(2) トランジスター基板から出ている全てのリード線を外します。

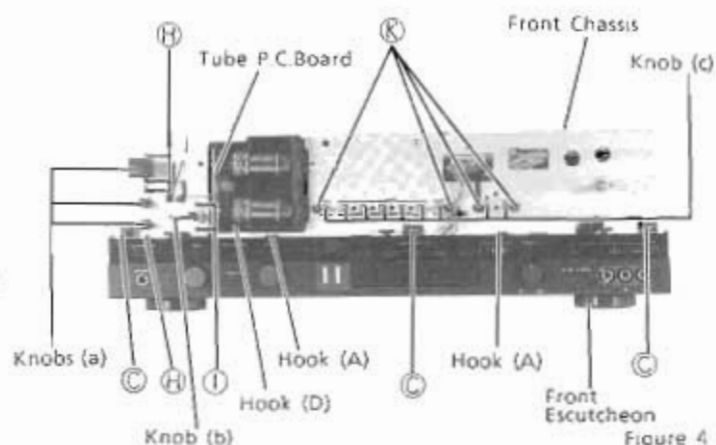

Figure 4  
<4図>

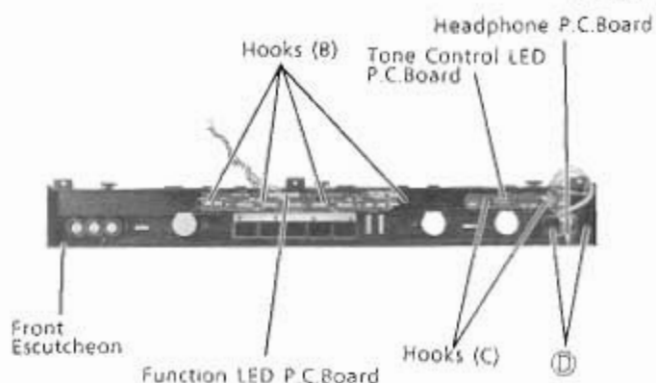

Figure 5  
<5図>

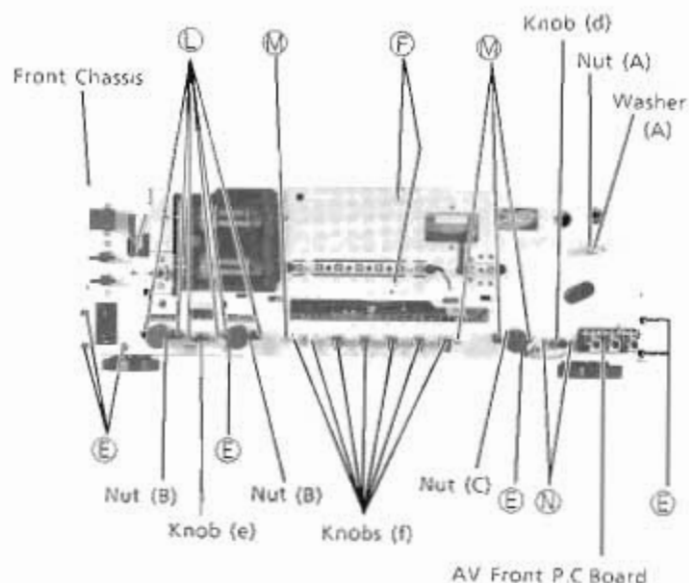

Figure 6  
<6図>

### 7-3 Removal of AC P.C. Board

- Remove three knobs (a) and remove four screws marked "ⓐ" as shown in Figure 4.
- Disconnect all wires from the AC P.C. Board.

### 7-3 AC基板の外し方

- 3個のつまみ(a)と4本のネジ(ⓐ印)を外します。(4図参照)
- AC基板から出ている全てのリード線を外せば、基板は外せます。

### 7-4 Removal of Heat-UP Switch P.C. Board

- Remove one knob (b) and remove two screws marked "ⓑ" as shown in Figure 4.
- Disconnect all wires from the Heat-up Switch P.C. Board.

### 7-4 ヒートアップ・スイッチ基板の外し方

- 1個のつまみ(b)と2本のネジ(ⓑ印)を外します。(4図参照)
- ヒートアップ・スイッチ基板から出ている全てのリード線を外せば、基板は外せます。

### 7-5 Removal of Tube P.C. Board

- Remove two screws marked "ⓓ" as shown in Figure 7.
- Remove one hook (D) as shown in Figure 4.
- Disconnect all wires from the Tube P.C. Board.

### 7-5 チューブ基板の外し方

- 2本のネジ(ⓓ印)を外します。(7図参照)
- 1箇所のフック(D)を外します。(4図参照)
- チューブ基板から出ている全てのリード線を外します。

### 7-6 Removal of REC P.C. Board

- Remove four screws marked "ⓔ" and remove nine knobs (C) as shown in Figure 4.
- Remove two solders (b) as shown in Figure 7.
- Disconnect all wires from the REC P.C. Board.

### 7-6 REC基板の外し方

- 4本のネジ(ⓔ印)と9個のつまみ(C)を外します。(4図参照)
- 2箇所の半田(b)を外します。(7図参照)
- REC基板から出ている全てのリード線を外します。

### 7-7 Removal of Volume Control P.C. Board.

- Remove one nut (A) and one washer (A) as shown in Figure 6.
- Disconnect all wires from the Volume Control P.C. Board.

### 7-7 ボリューム・コントロール基板の外し方

- 1個のナット(A)とワッシャー(A)を外します。(6図参照)
- ボリューム・コントロール基板から出ている全てのリード線を外します。

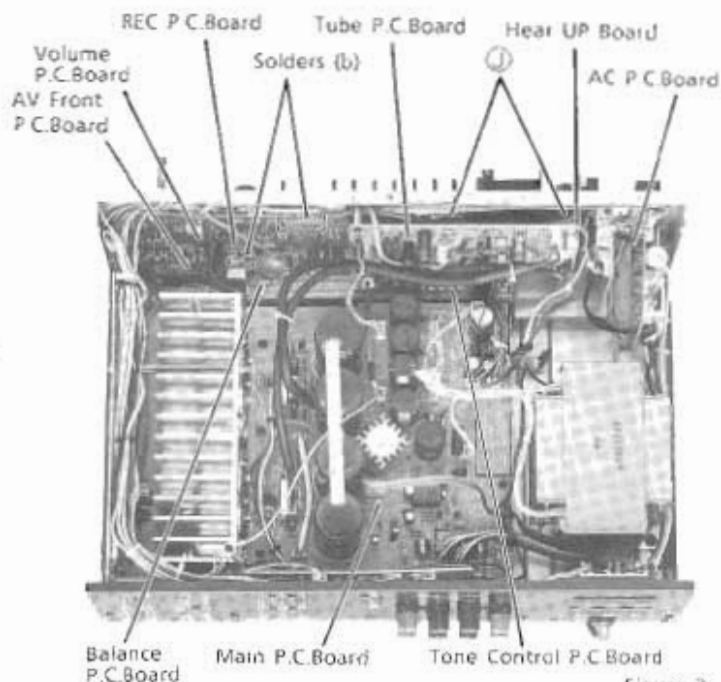

Figure 7  
<7図>

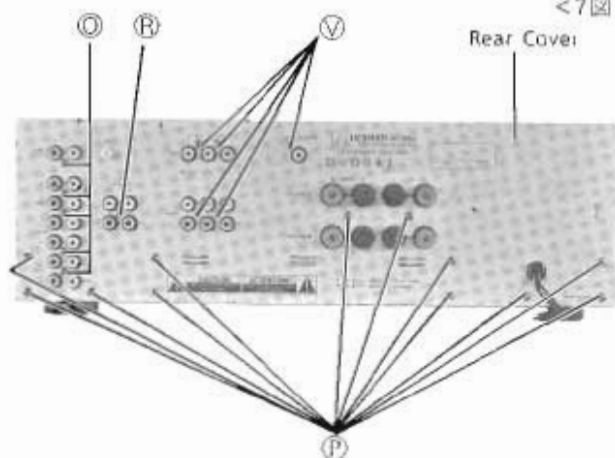

Figure 8  
<8図>

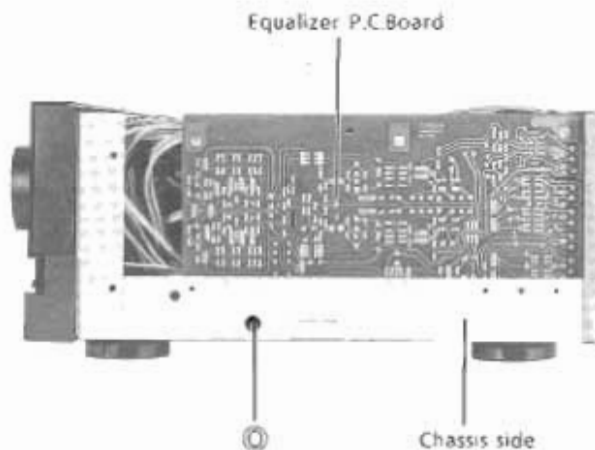

Figure 9  
<9図>

### 7-8 Removal of Tone Control P. C. Board

- (1) Remove one knob (e) and six screws marked "①" as shown in Figure 6.
- (2) Remove two nuts (B) as shown in Figure 6
- (3) Disconnect all wires from the Tone Control P. C. Board.

### 7-8 トーン・コントロール基板の外し方

- (1) 1個のつまみ(e)と6本のネジ(①印)を外します。(6図参照)
- (2) 2個のナット(B)を外します。(6図参照)
- (3) トーン・コントロール基板から出ている全てのリード線を外せば基板は外せます。

### 7-9 Removal of Function P. C. Board and Balance P. C. Board and

- (1) Remove seven knobs (f) and remove five screws marked "②" as shown in Figure 3 and 6.
- (2) Remove one nut (c) as shown in Figure 6
- (3) Remove a solder (a) as shown in Figure 3
- (4) Disconnect all wires from the Function P. C. Board and Balance P. C. Board.

### 7-9 ファンクション基板及びバランス基板の外し方

- (1) 7個のつまみ(f)と5本のネジ(②印)を外します。(3, 6図参照)
- (2) 1個のナット(c)を外します。(6図参照)
- (3) 1箇所(半田(a))を外します。(3図参照)
- (4) ファンクション基板とバランス基板から出ている全てのリード線を外します。

### 7-10 Removal of AV Front P. C. Board

- (1) Remove one knob (d) and remove two screws marked "③" as shown in Figure 6.
- (2) Disconnect all wires from the AV Front P. C. Board.

### 7-10 AVフロント基板の外し方

- (1) 1個のつまみ(d)と2本のネジ(③印)を外します。(6図参照)
- (2) AVフロント基板から出ている全てのリード線を外せば基板は外れます。

### 8. Removal of Equalizer P. C. Board.

- (1) Remove six screws marked "④" as shown in Figures 8 and 9.
- (2) Remove the Equalizer Hold Panel as shown in Figure 3
- (3) Disconnect all wires from the Equalizer P. C. Board.

### 8. イコライザー基板の外し方

- (1) 6本のネジ(④印)を外します。(8, 9図参照)
- (2) イコライザー・ホールドパネルを外します。(3図参照)
- (3) イコライザー基板から出ている全てのリード線を外します。

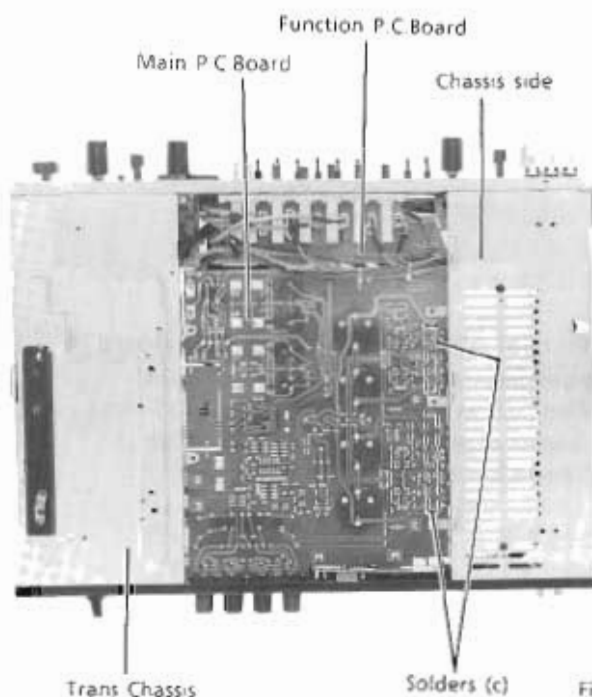

Figure 10  
<10図>

## 9. Removal of Rear Cover

- (1) Remove twelve screws marked "Ⓟ" as shown in Figure 8.
- (2) Disconnect all wires from the AC Outlet, AV Monitor and ADP P.C. Board.
- (3) The rear cover with AV Monitor and ADP P.C. Board can be removed Completely.

## 9. 後面カバーの外し方

- (1) 12本のネジ(Ⓟ印)を外します。(8図参照)
- (2) ACアウトレット基板、AVモニター基板及びADP基板から出ている全てのリード線を外します。
- (3) 後面カバーには、AVモニター基板とADP基板がついてますので、これらの基板を一括に外すことができます。

## 10. Removal of AV Monitor P. C. Board

- (1) Remove five screws marked "Ⓢ" as shown in Figure 8.

## 10. AVモニター基板の外し方

- (1) 5本のネジ(Ⓢ印)を外せば、基板は外せます。(8図参照)

## 11. Removal of ADP P. C. Board

- (1) Remove one screw marked "Ⓡ" as shown in Figure 8.

## 11. ADP基板の外し方

- (1) 1本のネジ(Ⓡ印)を外せば、基板は外れます。(8図参照)

## 12. Removal of Bottom Chassis

- (1) Remove six screws marked "Ⓣ" as shown in Figure 2.

## 12. 底面シャーシの外し方

- (1) 6本のネジ(Ⓣ印)を外せば底面シャーシは外せます。(2図参照)

## 13. Removal of Main P. C. Board

- (1) Remove five screws marked "Ⓛ" and two solders (c) as show in Figures 3 and 10.
- (2) Disconnect all wires from the Main P.C. Board.

## 13. メイン基板の外し方

- (1) 5本のネジ(Ⓛ印)と2箇所の半田(c)を外します。(3,10図参照)
- (2) メイン基板から出ている全てのリード線を外せば、基板は外れます。

# Adjustment Procedures

## 1. Connections

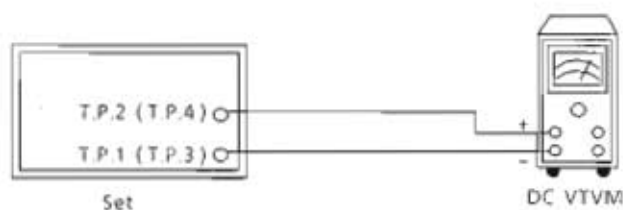

Figure 11

## 2. Control Settings

Power Switch .....	ON	Bass Control Knob .....	Center Position
Volume Control Knob .....	Minimum	Balance Control Knob .....	Center Position
	(fully counterclockwise)	Others .....	OFF
Treble Control Knob .....	Center Position		

## 3. Adjustment Procedures

### (1) Idling Adjustment (Figure 11)

Adjust VR7301 (VR7302) until  $45 \pm 3\text{mV}$  is obtained between T.P.1 (T.P.3) and T.P.2 (T.P.4)

Note: This adjustment should be made approx. 3 minutes after the power on.

## 調整方法

### 1. 接続図

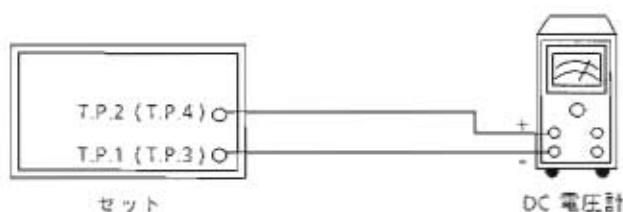

< 11図 >

### 2. スイッチ類の位置

電源スイッチ .....	ON	バス調整つまみ .....	中央
ボリューム調整つまみ .....	最小	バランス調整つまみ .....	中央
	(反時計方向)	その他 .....	OFF
トレブル調整つまみ .....	中央		

### 3. 調整方法

#### (1) アイドリング調整 (11図参照)

テストポイント1 (3) と2 (4) の間が  $45 \pm 3\text{mV}$  になるまで、VR7301、(VR7302)で調整します。

注: この調整は電源を入れてから最低3分後に行います。



# Adjustment Locations

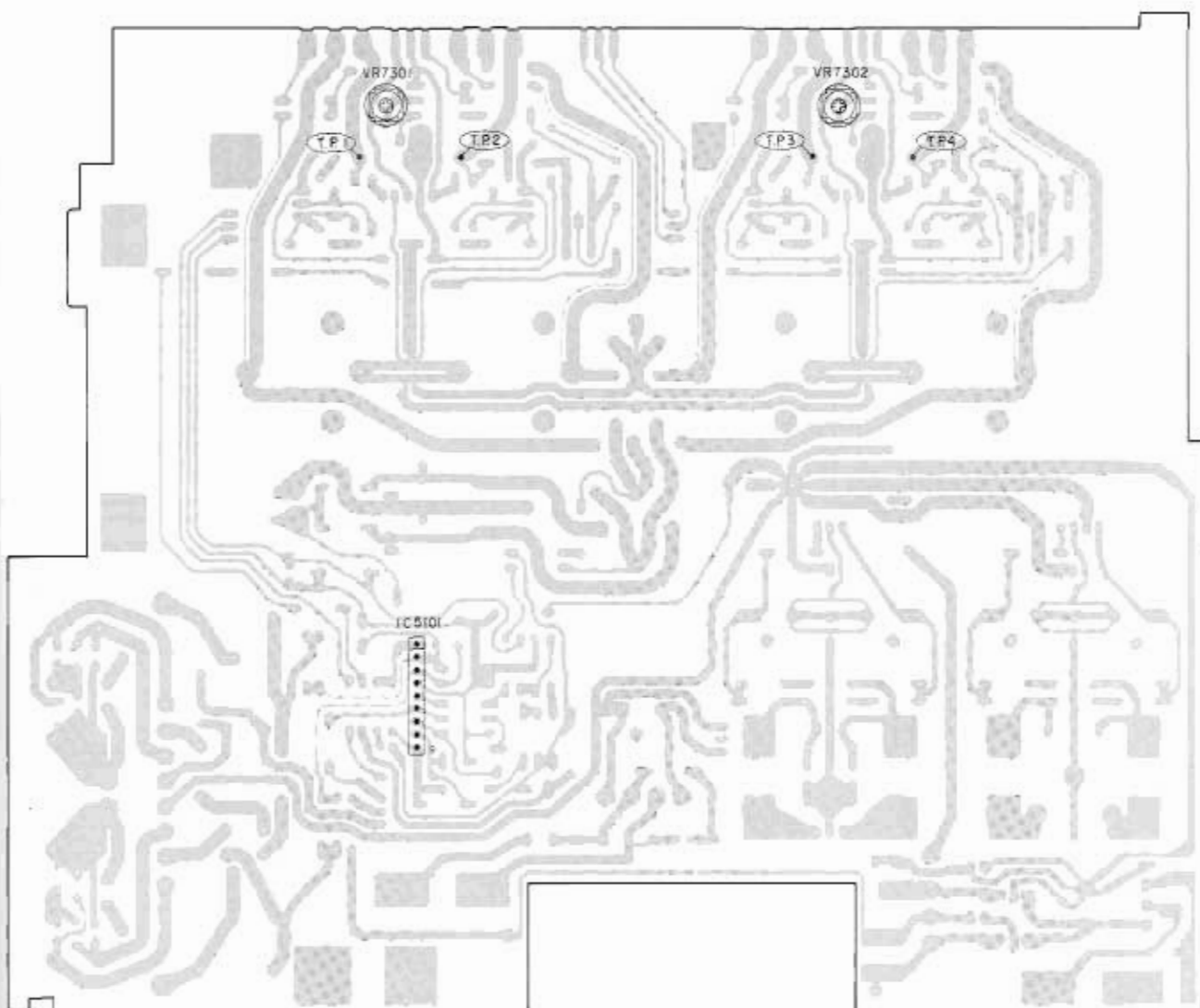

Main P. C. Board (Component Side)

メイン基板 (部品取付側)

Figure 12

<12図>

# Block Diagram

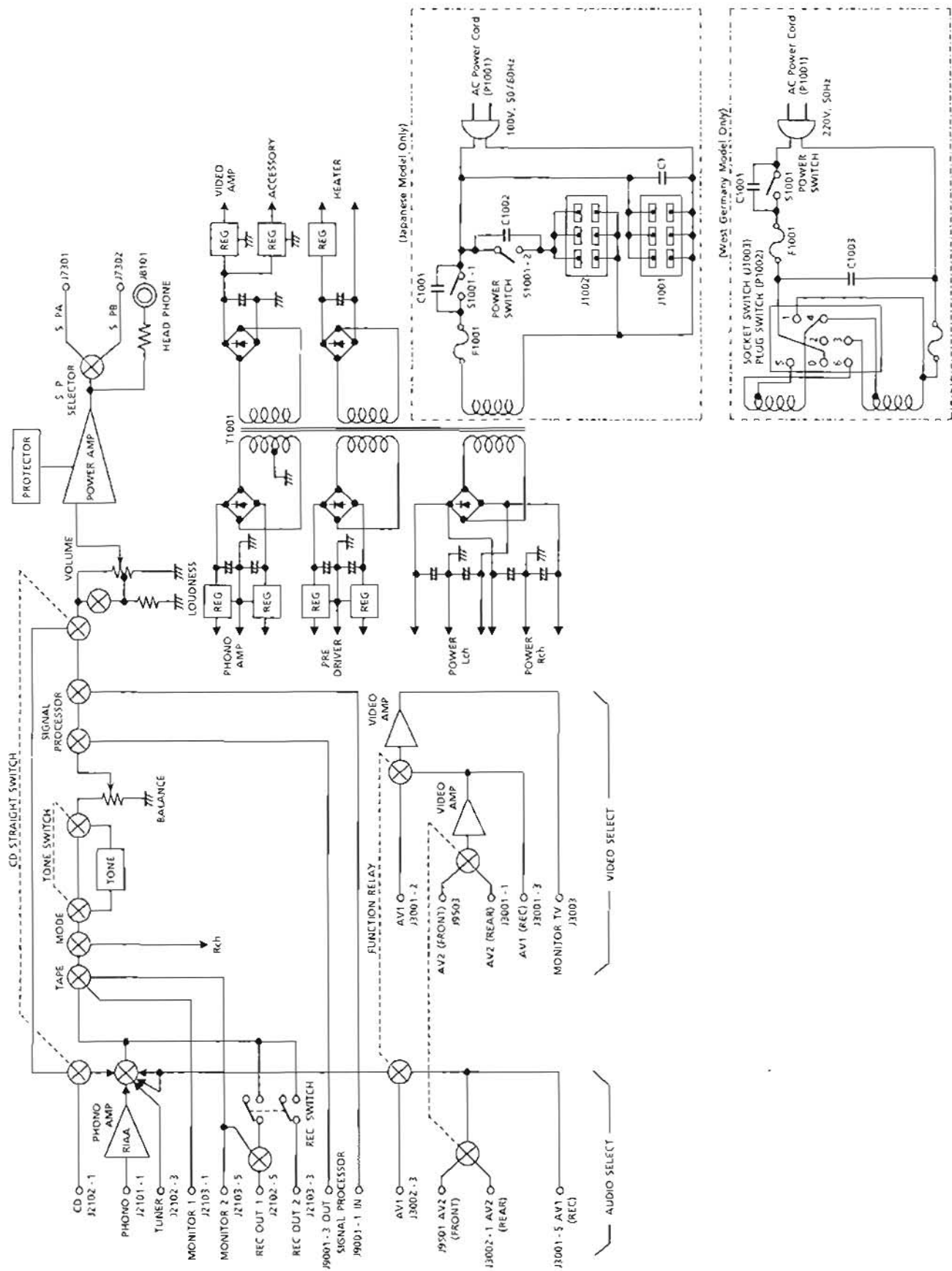

# Schematic Diagram

1

IC	IC 500	IC 201-1	IC 201-2	IC 201-3	IC 201-4	IC 201-5
Transistor (Q)	Q201-1 2N3638	Q201-2 2N3638	Q201-3 2N3638	Q201-4 2N3638	Q201-5 2N3638	Q201-6 2N3638

2

3

4

5

Equalizer P.C. Board

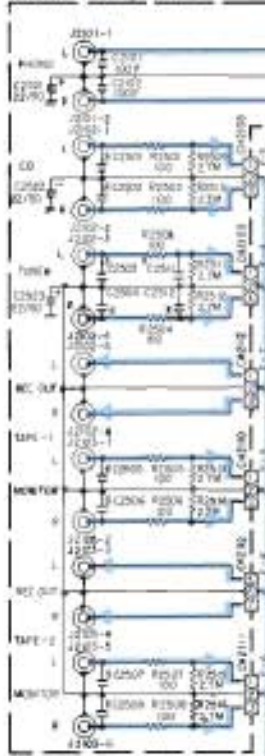

ADP P.C. Board

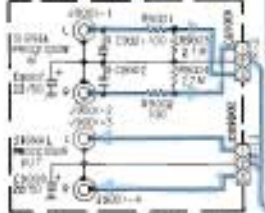

AV Monitor P.C. Board

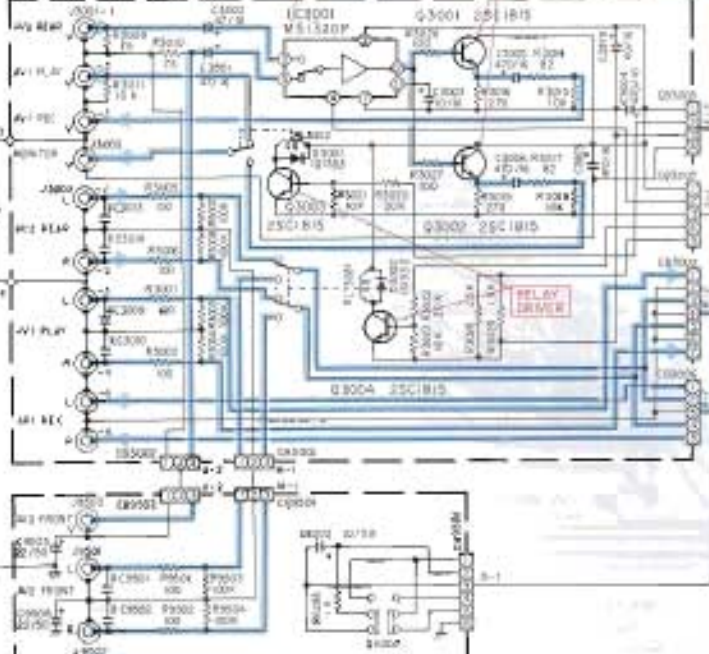

AV Front P.C. Board

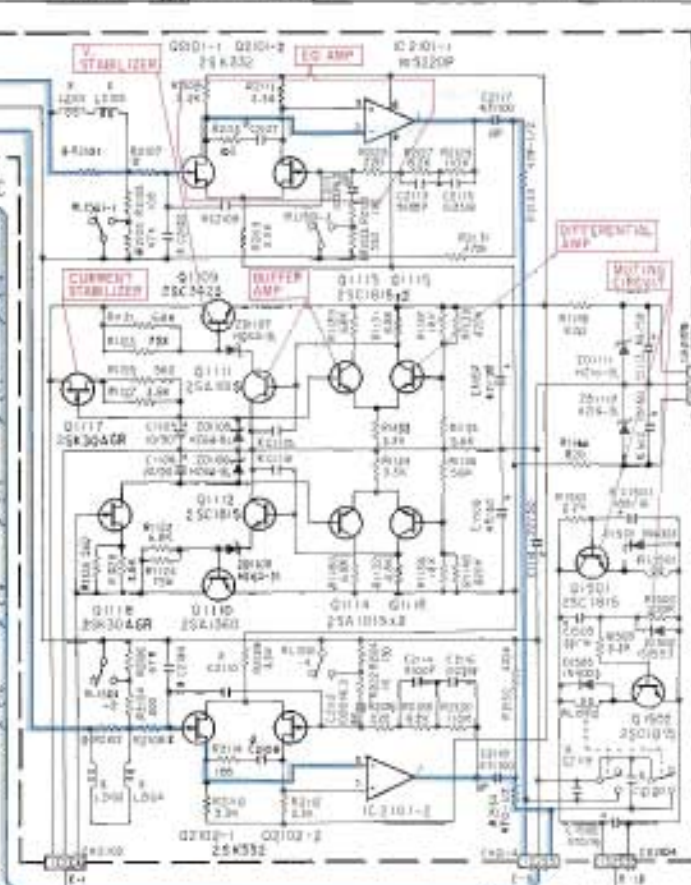

Driver P.C. Board

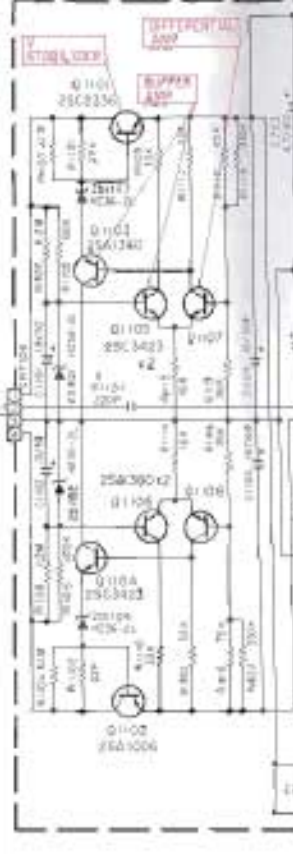

Rec. P.C. Board

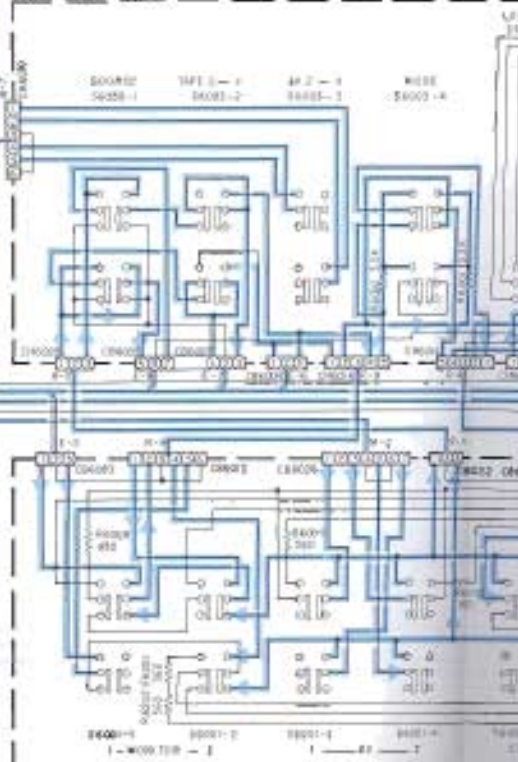

Function P.C. Board

PC Board

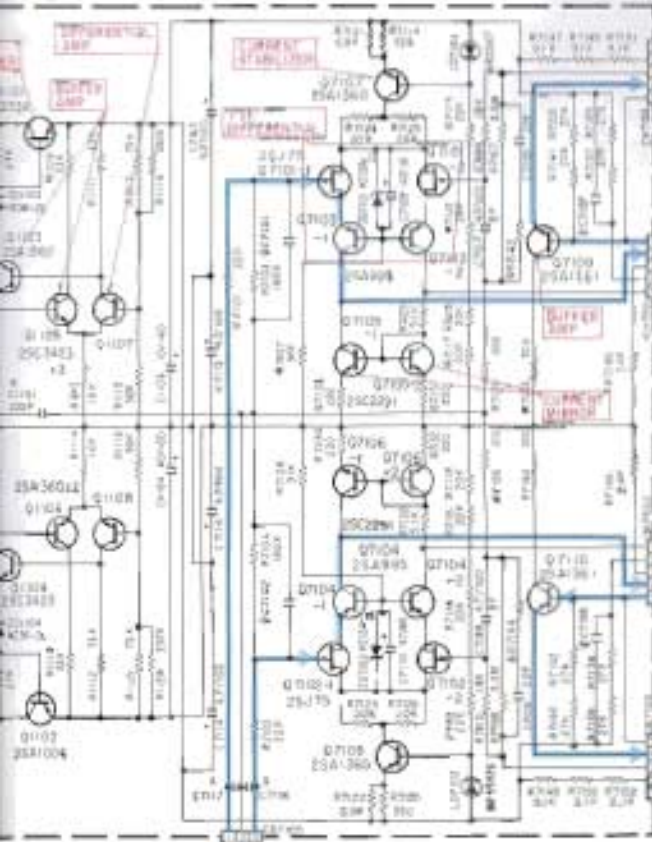

Main PC Board

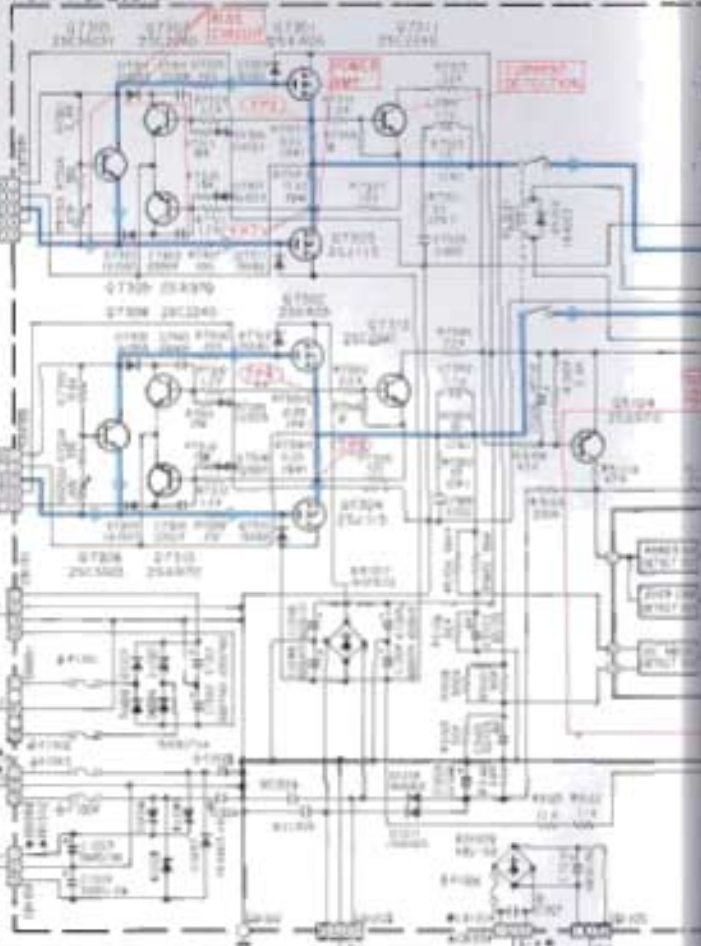

Tube PC Board

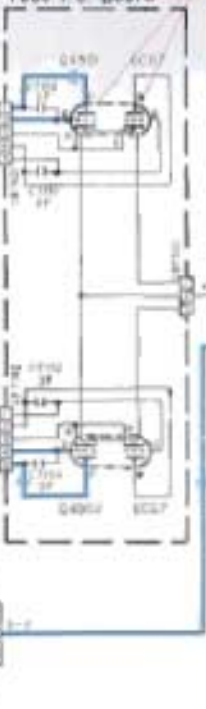

Volume PC Board



Function LED PC Board

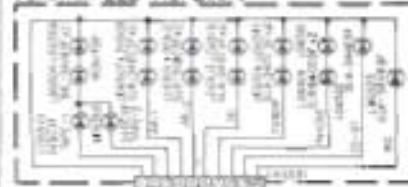

YC LED PC Board

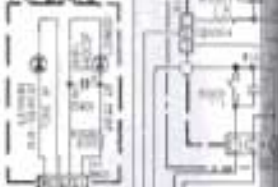

Tone Control PC Board

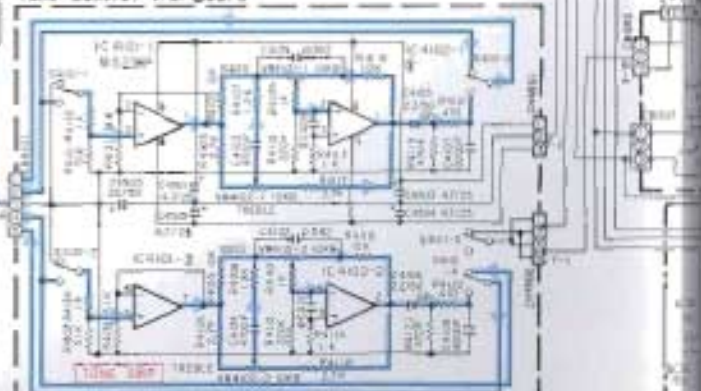

Source PC Board

NOTES

- 1 All resistance values are in ohms. K = 1,000
- 2 All capacitance values are in microfarads. P =  $\frac{1}{1,000,000}$

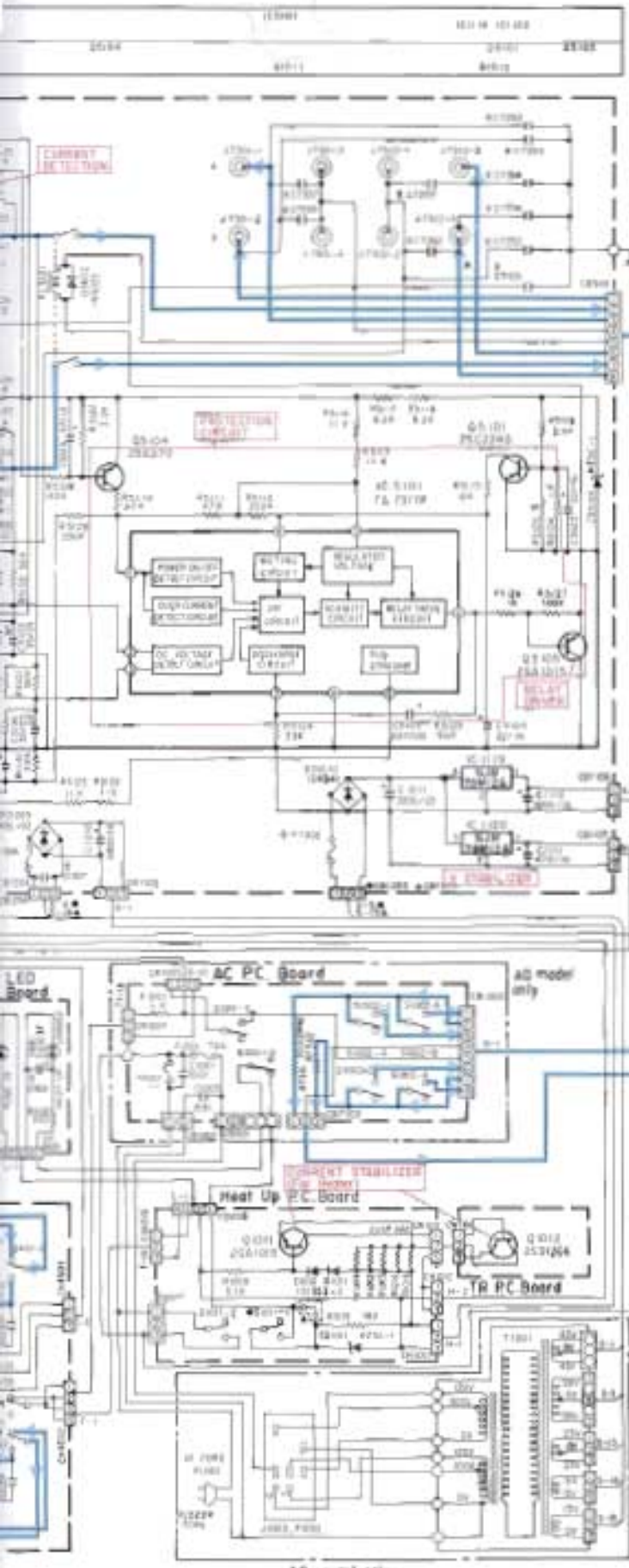

Part No.	Value	Part No.	Value
R101	2.7K	R102	1.5K
R103	5.1K	R104	4.7K
R105	10K	R106	100K
R107	100K	R108	100K
R109	100K	R110	100K
R111	100K	R112	100K
R113	100K	R114	100K
R115	100K	R116	100K
R117	100K	R118	100K
R119	100K	R120	100K
R121	100K	R122	100K
R123	100K	R124	100K
R125	100K	R126	100K
R127	100K	R128	100K
R129	100K	R130	100K
R131	100K	R132	100K
R133	100K	R134	100K
R135	100K	R136	100K
R137	100K	R138	100K
R139	100K	R140	100K
R141	100K	R142	100K
R143	100K	R144	100K
R145	100K	R146	100K
R147	100K	R148	100K
R149	100K	R150	100K
R151	100K	R152	100K
R153	100K	R154	100K
R155	100K	R156	100K
R157	100K	R158	100K
R159	100K	R160	100K
R161	100K	R162	100K
R163	100K	R164	100K
R165	100K	R166	100K
R167	100K	R168	100K
R169	100K	R170	100K
R171	100K	R172	100K
R173	100K	R174	100K
R175	100K	R176	100K
R177	100K	R178	100K
R179	100K	R180	100K
R181	100K	R182	100K
R183	100K	R184	100K
R185	100K	R186	100K
R187	100K	R188	100K
R189	100K	R190	100K
R191	100K	R192	100K
R193	100K	R194	100K
R195	100K	R196	100K
R197	100K	R198	100K
R199	100K	R200	100K

Part No.	Value	Part No.	Value
C101	100P	C102	100P
C103	100P	C104	100P
C105	100P	C106	100P
C107	100P	C108	100P
C109	100P	C110	100P
C111	100P	C112	100P
C113	100P	C114	100P
C115	100P	C116	100P
C117	100P	C118	100P
C119	100P	C120	100P
C121	100P	C122	100P
C123	100P	C124	100P
C125	100P	C126	100P
C127	100P	C128	100P
C129	100P	C130	100P
C131	100P	C132	100P
C133	100P	C134	100P
C135	100P	C136	100P
C137	100P	C138	100P
C139	100P	C140	100P
C141	100P	C142	100P
C143	100P	C144	100P
C145	100P	C146	100P
C147	100P	C148	100P
C149	100P	C150	100P
C151	100P	C152	100P
C153	100P	C154	100P
C155	100P	C156	100P
C157	100P	C158	100P
C159	100P	C160	100P
C161	100P	C162	100P
C163	100P	C164	100P
C165	100P	C166	100P
C167	100P	C168	100P
C169	100P	C170	100P
C171	100P	C172	100P
C173	100P	C174	100P
C175	100P	C176	100P
C177	100P	C178	100P
C179	100P	C180	100P
C181	100P	C182	100P
C183	100P	C184	100P
C185	100P	C186	100P
C187	100P	C188	100P
C189	100P	C190	100P
C191	100P	C192	100P
C193	100P	C194	100P
C195	100P	C196	100P
C197	100P	C198	100P
C199	100P	C200	100P

- (Recommended Components)
- Power Supply Filter: N1000 L201 - N1000 000
  - Resistor: Metal Film, Carbon Film, Wirewound
  - Resistor: Metal Film, Carbon Film, Wirewound
  - Resistor: Carbon Film, Wirewound
  - Resistor: Carbon Film, Wirewound

Part No.	Value	Part No.	Value
R201	100K	R202	100K
R203	100K	R204	100K
R205	100K	R206	100K
R207	100K	R208	100K
R209	100K	R210	100K
R211	100K	R212	100K
R213	100K	R214	100K
R215	100K	R216	100K
R217	100K	R218	100K
R219	100K	R220	100K
R221	100K	R222	100K
R223	100K	R224	100K
R225	100K	R226	100K
R227	100K	R228	100K
R229	100K	R230	100K
R231	100K	R232	100K
R233	100K	R234	100K
R235	100K	R236	100K
R237	100K	R238	100K
R239	100K	R240	100K
R241	100K	R242	100K
R243	100K	R244	100K
R245	100K	R246	100K
R247	100K	R248	100K
R249	100K	R250	100K
R251	100K	R252	100K
R253	100K	R254	100K
R255	100K	R256	100K
R257	100K	R258	100K
R259	100K	R260	100K
R261	100K	R262	100K
R263	100K	R264	100K
R265	100K	R266	100K
R267	100K	R268	100K
R269	100K	R270	100K
R271	100K	R272	100K
R273	100K	R274	100K
R275	100K	R276	100K
R277	100K	R278	100K
R279	100K	R280	100K
R281	100K	R282	100K
R283	100K	R284	100K
R285	100K	R286	100K
R287	100K	R288	100K
R289	100K	R290	100K
R291	100K	R292	100K
R293	100K	R294	100K
R295	100K	R296	100K
R297	100K	R298	100K
R299	100K	R300	100K

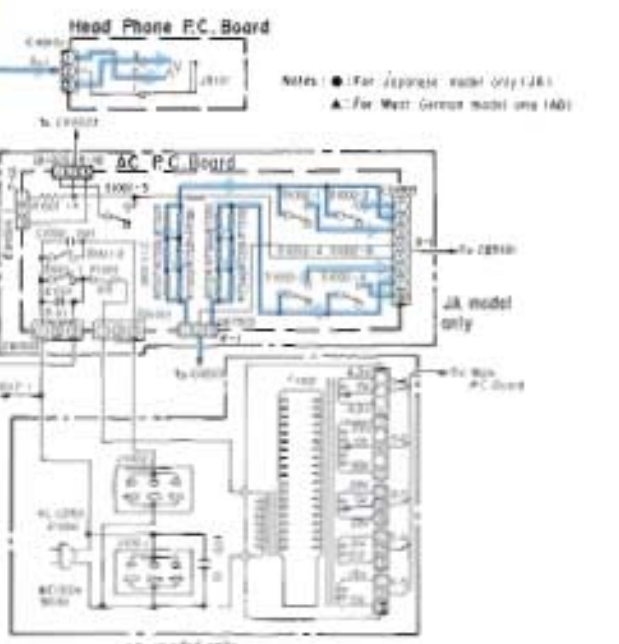

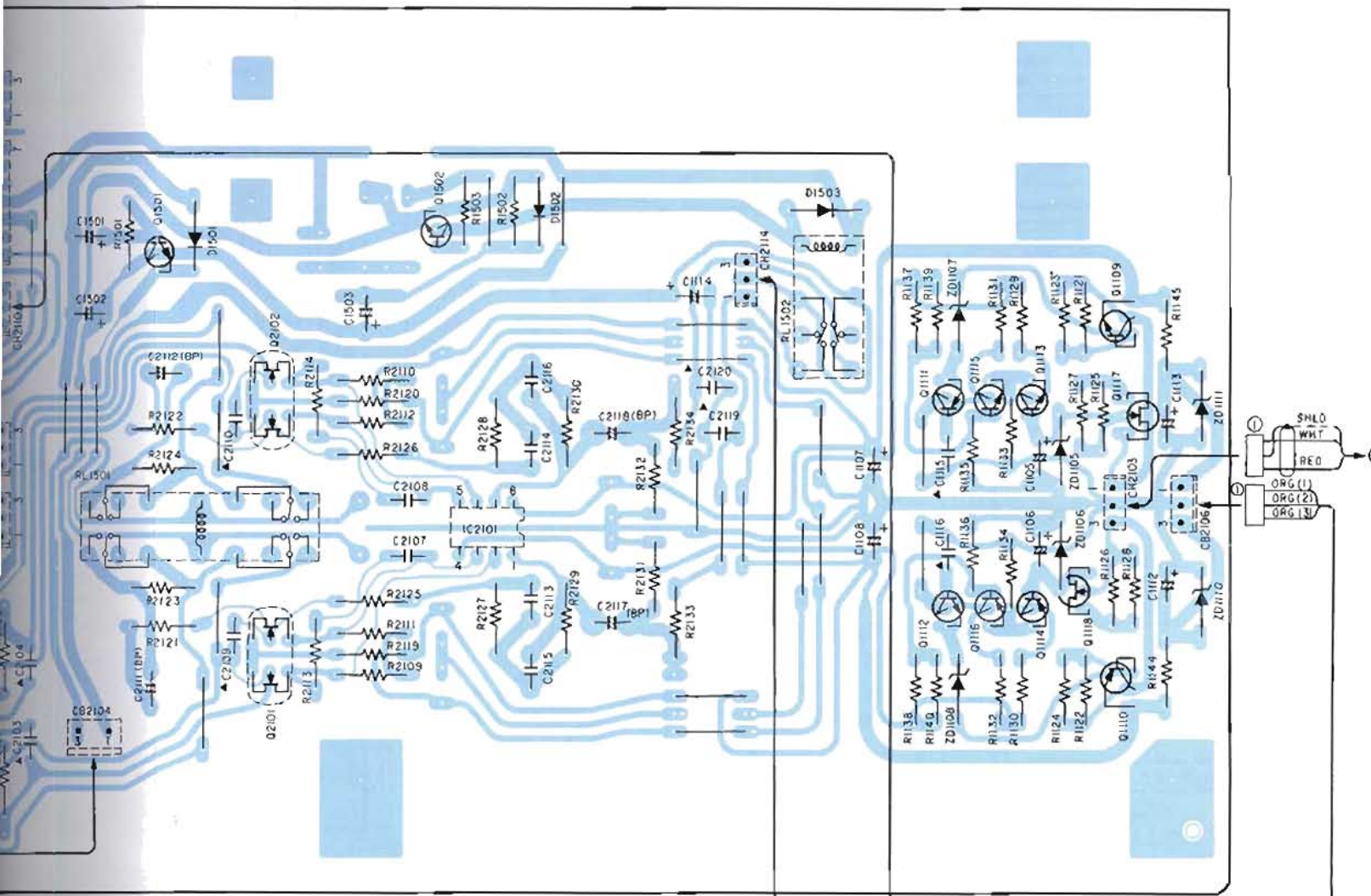

Equalizer P.C. Board

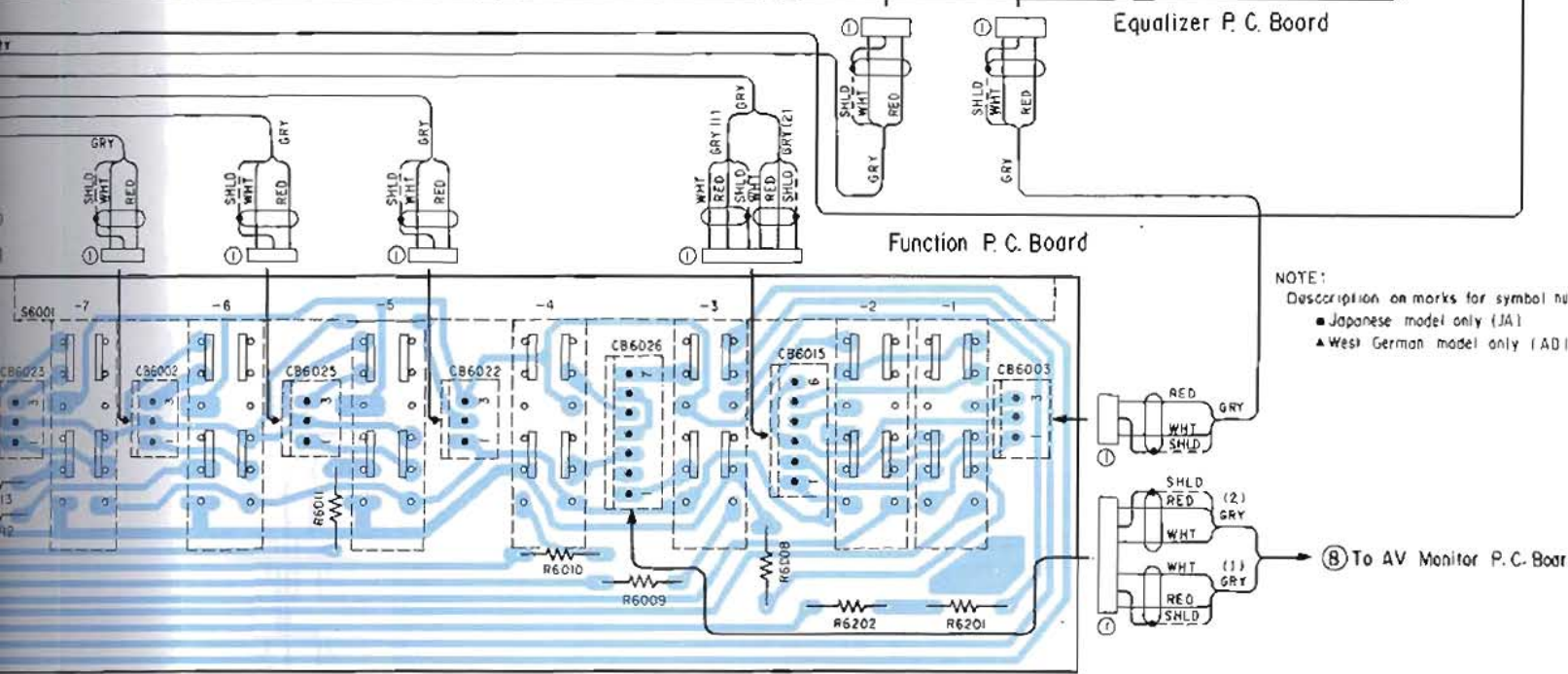

Function P.C. Board

NOTE:  
Description on marks for symbol nu  
 ■ Japanese model only (JA)  
 ▲ West German model only (AD)

- |           |       |           |        |               |             |               |              |
|-----------|-------|-----------|--------|---------------|-------------|---------------|--------------|
| BLU ..... | Blue  | WHT ..... | White  | YEL .....     | Yellow      | GRY/WHT ..... | Gray/White   |
| GRN ..... | Green | RED ..... | Red    | PNK .....     | Pink        | GRY/YEL ..... | Gray/Yellow  |
| BLK ..... | Black | BRN ..... | Brown  | VIO .....     | Violet      | GRN/YEL ..... | Green/Yellow |
| GRY ..... | Gray  | ORG ..... | Orange | GRN/WHT ..... | Green/White | SHLD .....    | Shield       |

② To AV Monitor P.C. Board

(1/3)

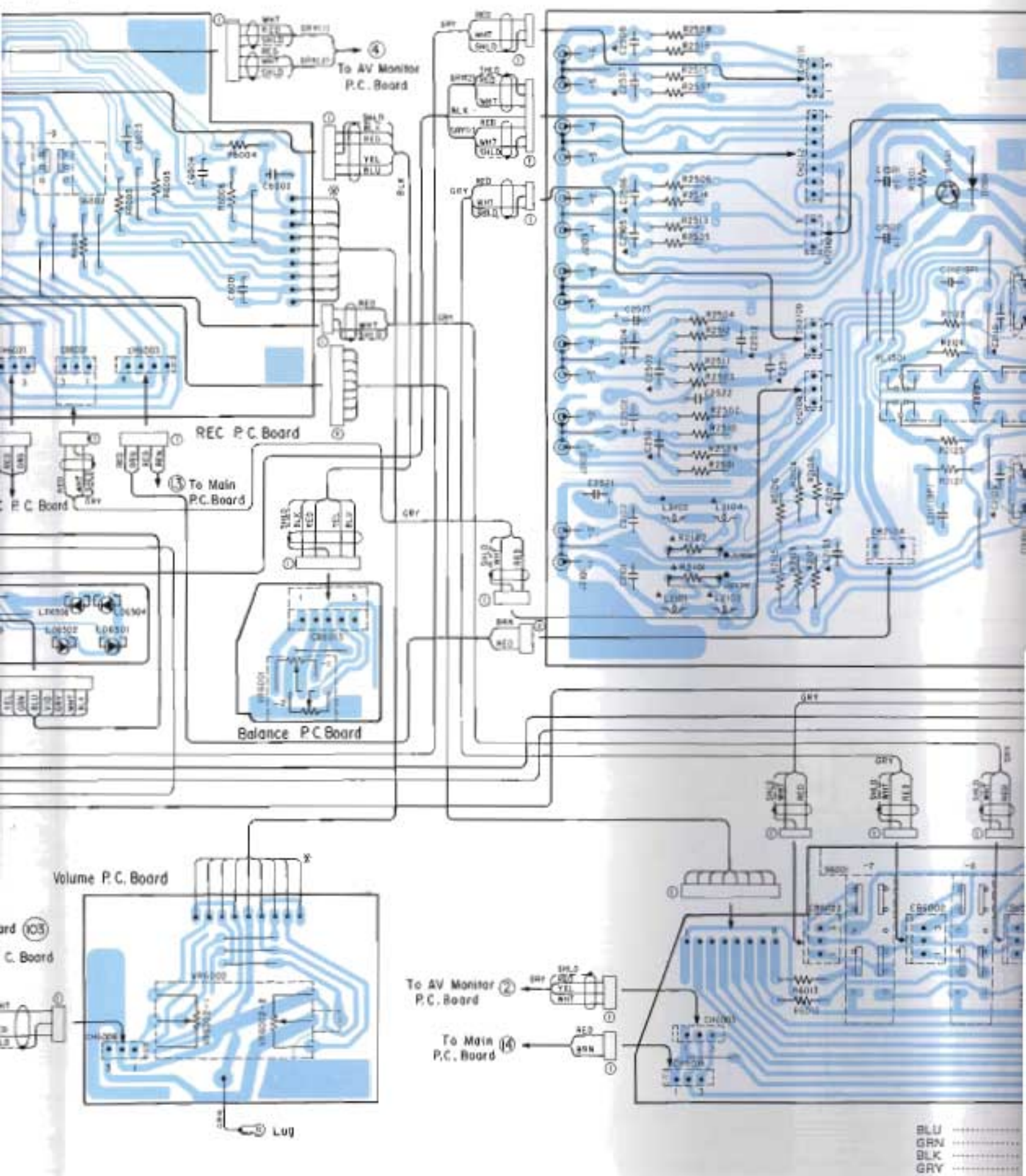

# Parts Layout on P.C. Boards and Wiring Diagram (1/3)

1  
2  
3  
4  
5

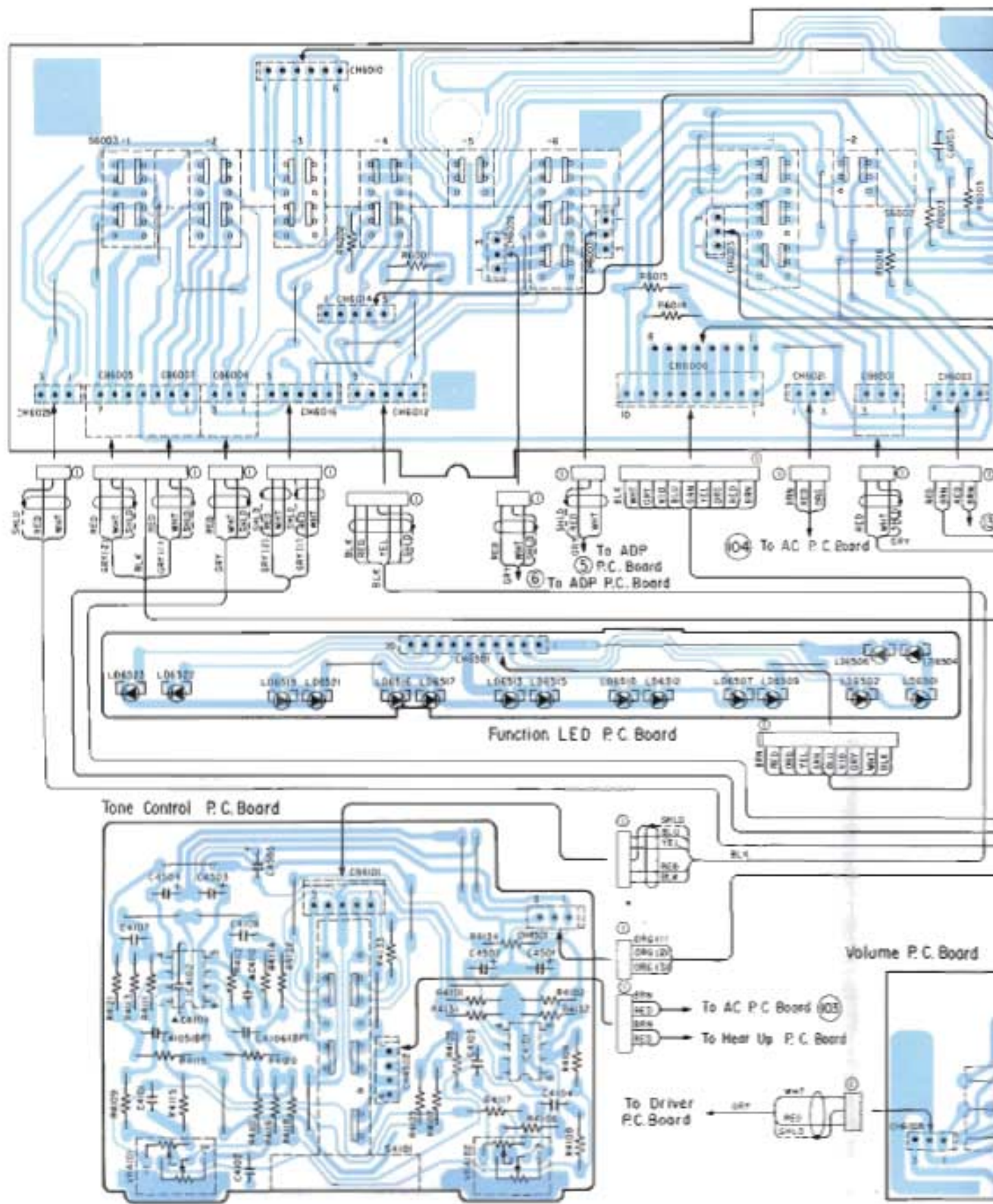



# Parts Layout on P.C. Boards and Wiring Diagram (2/3)

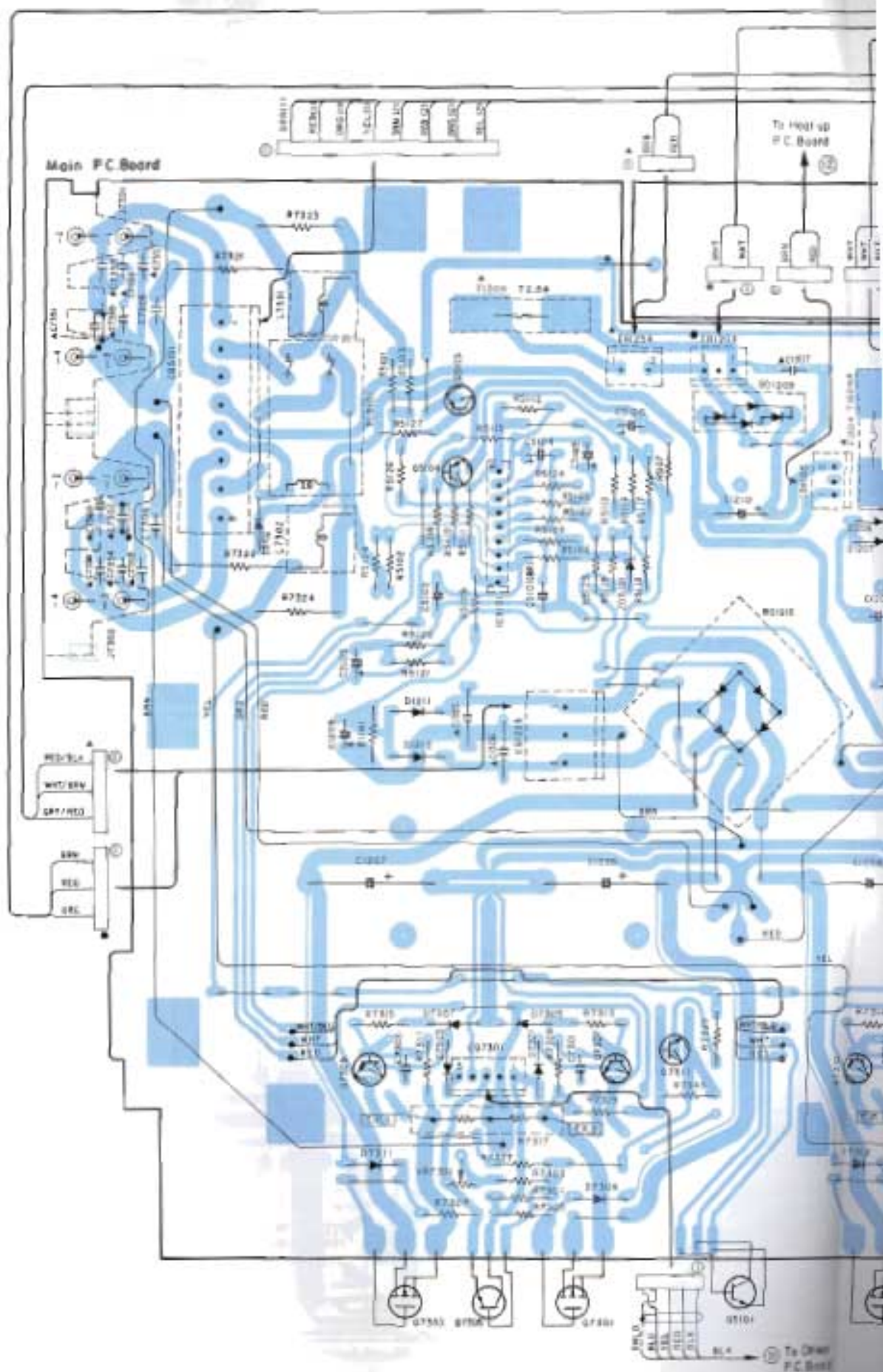

A

B - 25 -

C

D

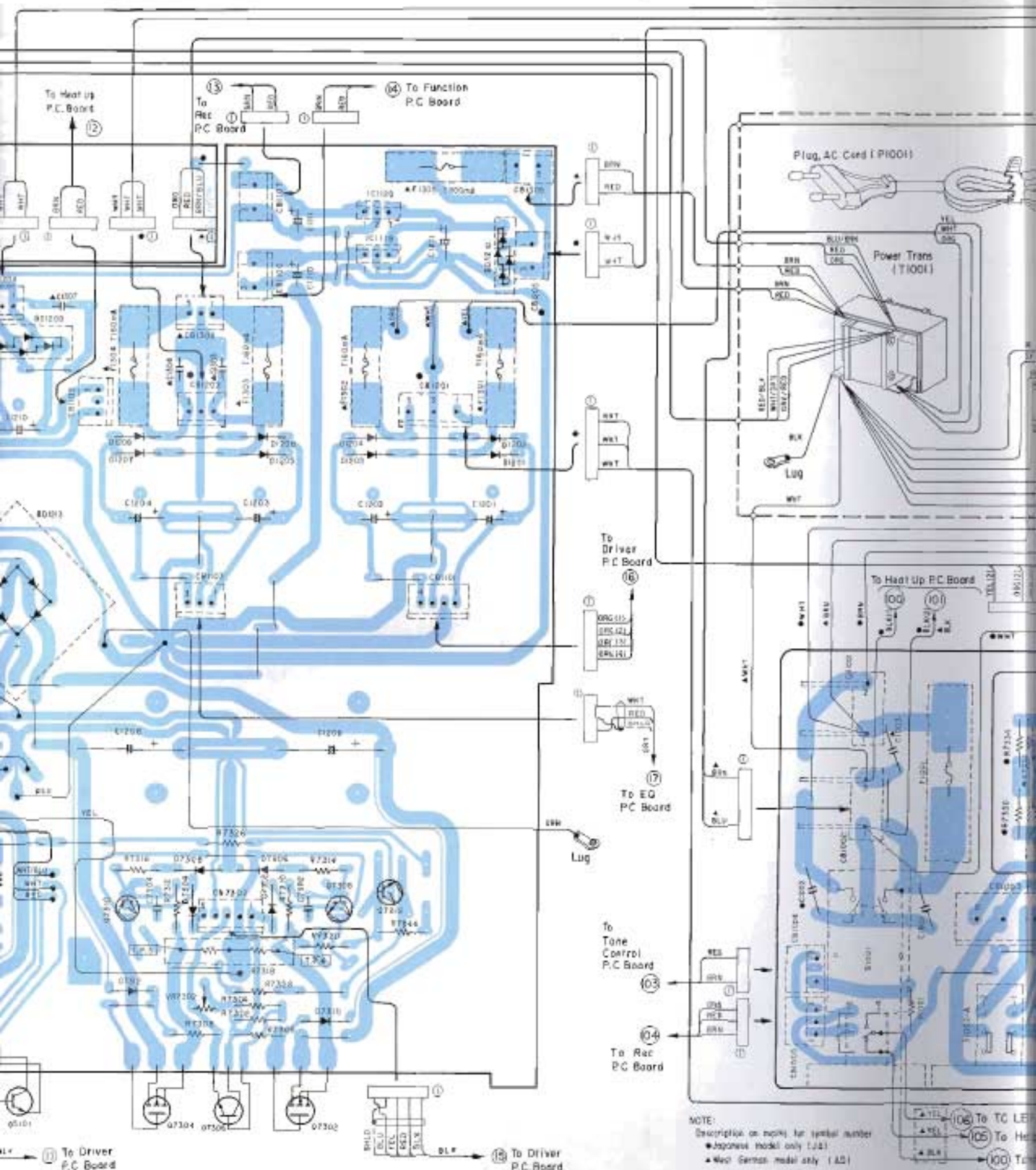

- BLU ..... Blue
- GRN ..... Green
- BLK ..... Black
- GRY ..... Gray
- WHT ..... White
- RED ..... Red
- BRN ..... Brown
- ORG ..... Orange
- YEL ..... Yellow
- PNK ..... Pink
- VIO ..... Violet
- GRN/WHT ..... Green/White
- GRY/WHT ..... Gray/White
- GRY/YEL ..... Gray/Yellow
- GRN/YEL ..... Green/Yellow
- SHLD ..... Shield

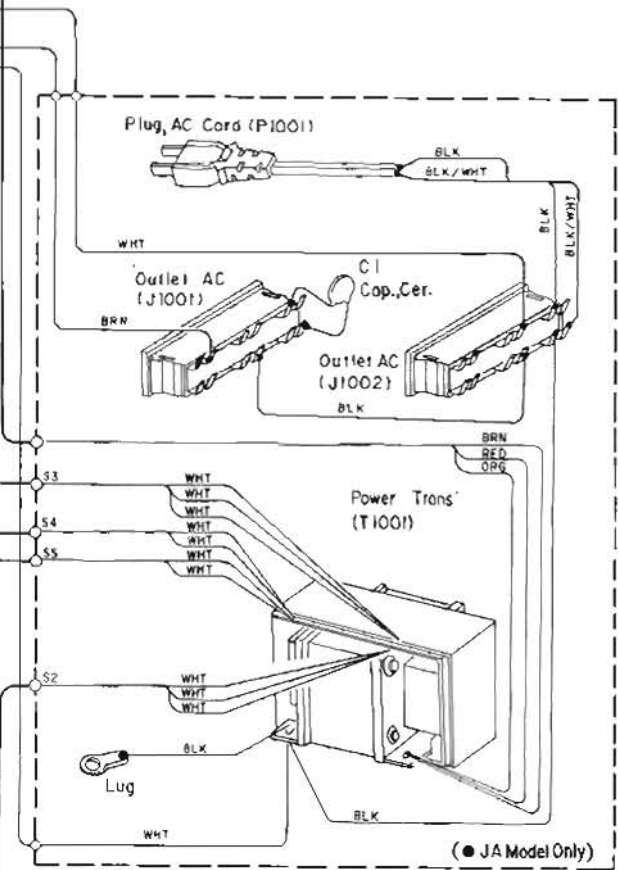
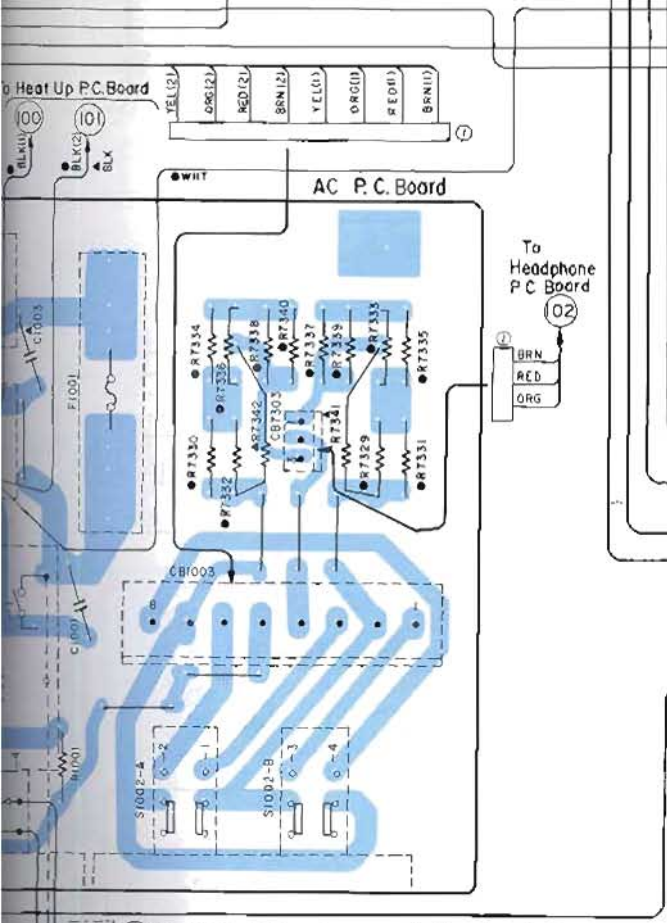
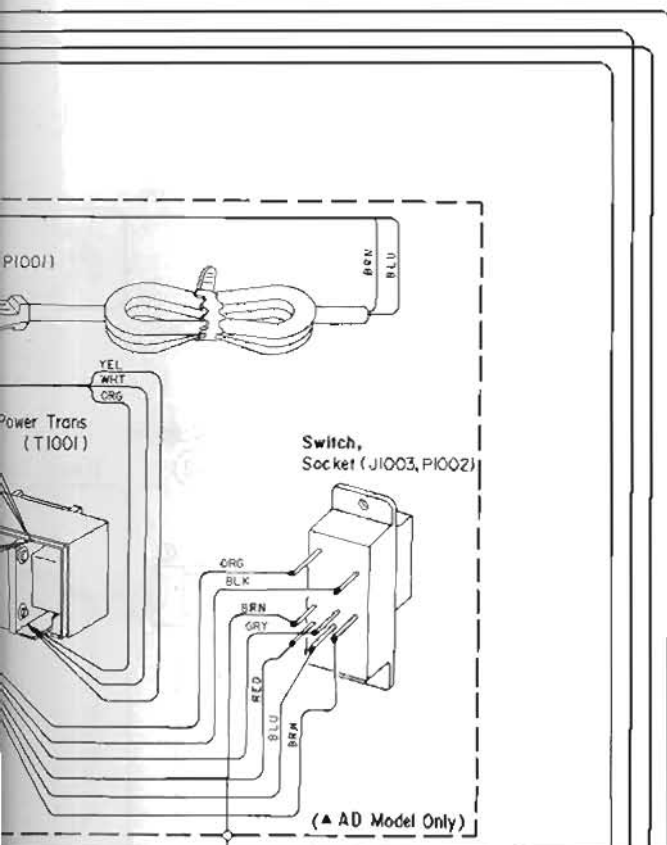

\* These three lead wires are attached to the terminal on the upper side of S1001

- ⑩⑥ To TC LED P.C. Board
- ⑩⑤ To Heat Up P.C. Board
- ⑩④ To Heat Up P.C. Board

Van P.C. Board

(11)

Driver P.C. Board

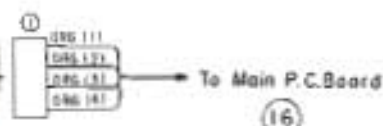
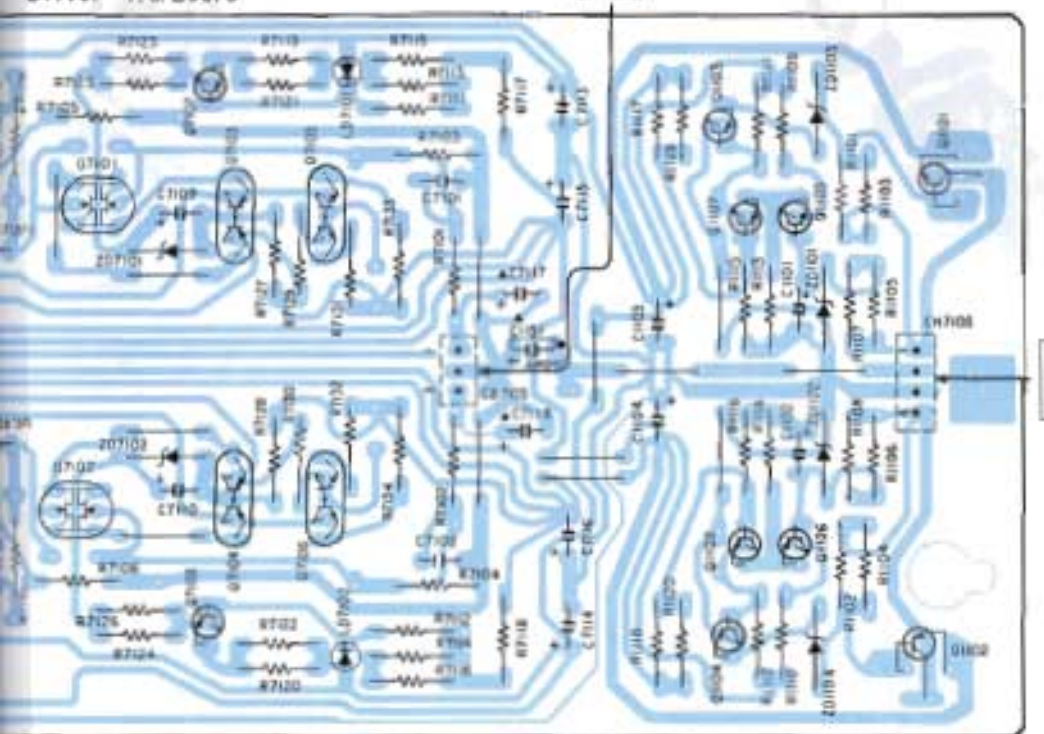

(16)

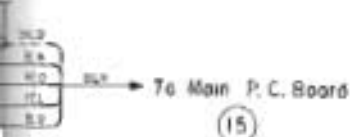

(15)

NOTE:  
 Description on marks for symbol Number.  
 ● Japanese model only (JA)  
 ▲ West German model only (AD)

Tube P.C. Board

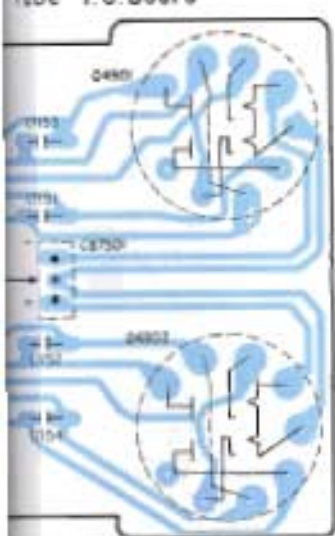

To REC P.C. Board

(5)

(6)

ADP P.C. Board

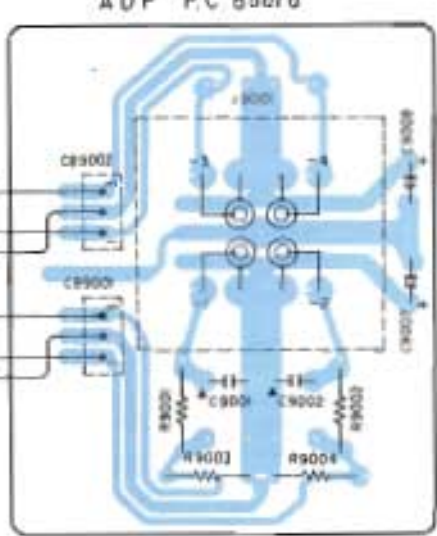

BLU	.....	Blue
GRN	.....	Green
BLK	.....	Black
GRY	.....	Gray
WHT	.....	White
RED	.....	Red
BWN	.....	Brown
ORG	.....	Orange
YEL	.....	Yellow
PNK	.....	Pink
VIO	.....	Violet
GRN/WHT	.....	Green/White
GRY/WHT	.....	Gray/White
GRY/YEL	.....	Gray/Yellow
GRN/YEL	.....	Green/Yellow
SHLD	.....	Shield

3)

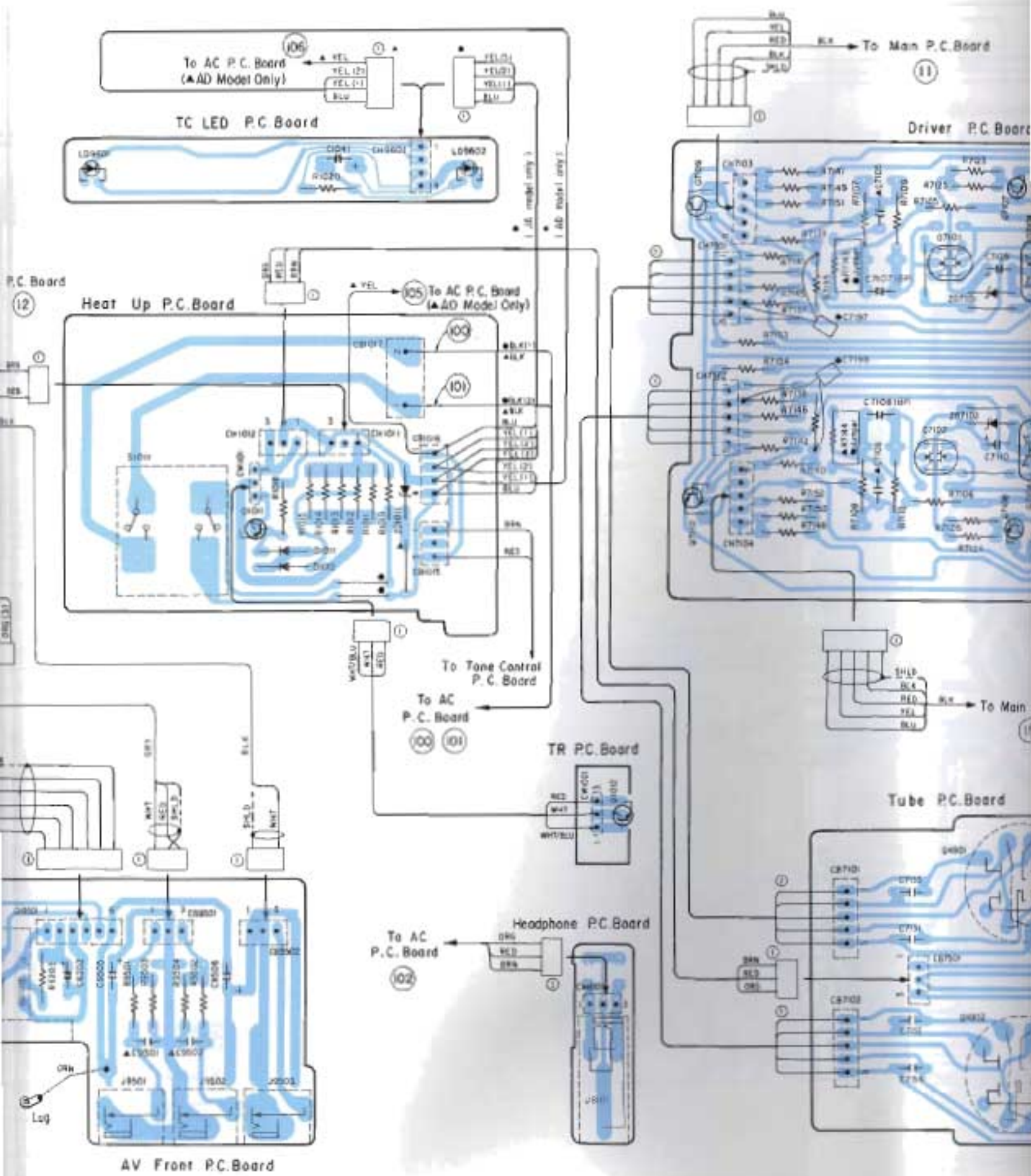

AV Front P.C. Board

Driver P.C. Board

Tube P.C. Board

TR P.C. Board

Headphone P.C. Board

Heat Up P.C. Board

TC LED P.C. Board

P.C. Board

12

To Main P.C. Board

To Main

To Tone Control P.C. Board

To AC P.C. Board

To AC P.C. Board (▲AD Model Only)

To AC P.C. Board (▲AD Model Only)

To AC P.C. Board

# Parts Layout on P.C. Boards and Wiring Diagram (3/3)

1

2

3

4

5

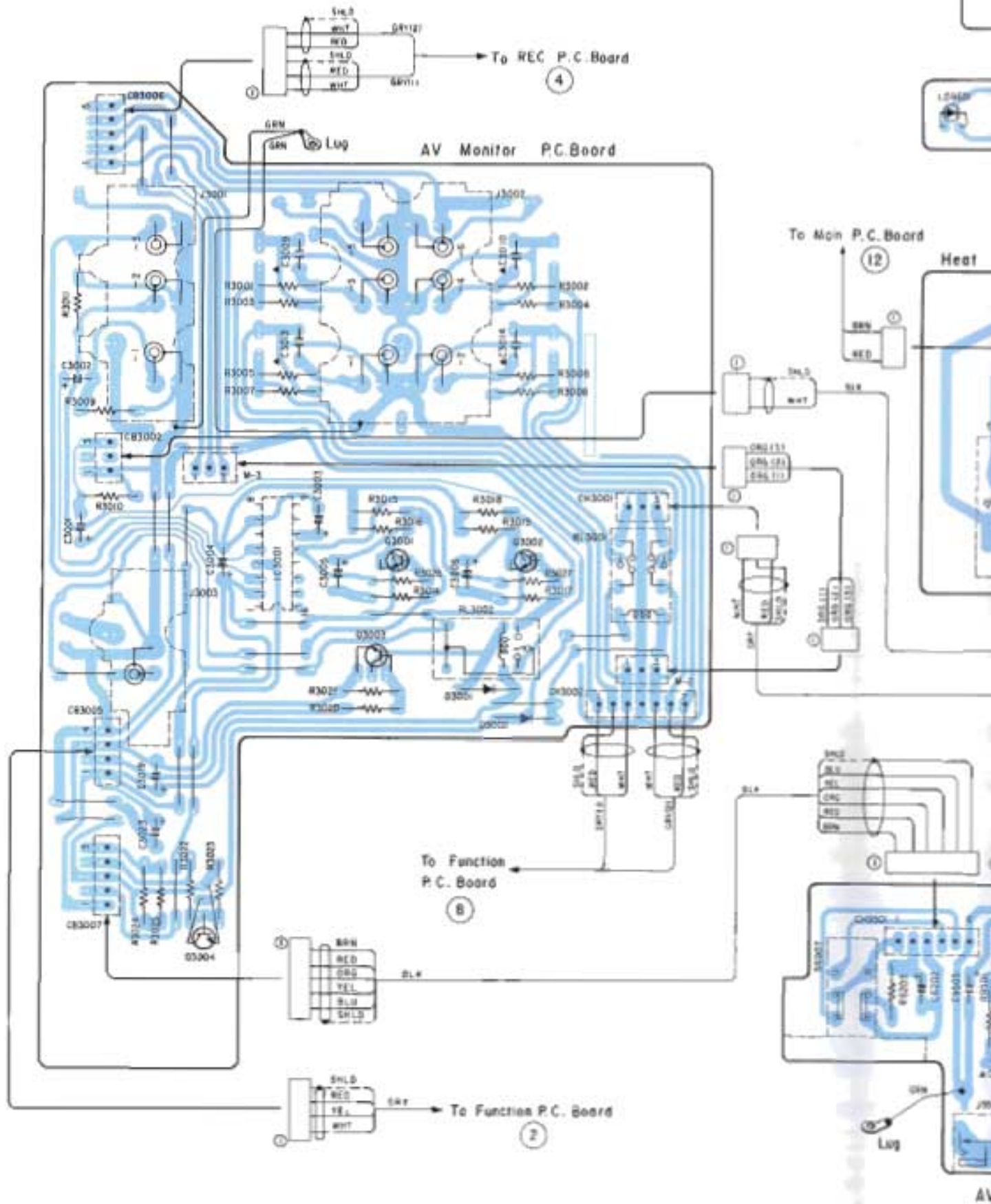

A

B - 28 -

C

D

AV

# Electrical Parts List

Resistor: Carbon resistors under 1/4 watts are not mentioned in the parts list, please confirm them by schematic diagram.  
 $\mu$  F = microfarads, pF = picofarads

Abbreviations				Symbol No.	Part No.	Description		
RES. = Resistor				CAP. = Capacitor				
C.F. = Carbon Film				E.L.Y. = Electrolytic				
M.F. = Metal Film				CER. = Ceramic				
M.O. = Metal Oxide Film				M.Y.L. = Mylar				
M.P. = Metal Plate				TAN. = Tantalum				
TR. = Transistor				POLY. = Polystyrol				
TRANS. = Transformer				PP. = Polypropylene				
CP. = Chip				PLT. = Polyethylene				
Symbol No.	Part No.	Description						
AC P. C. Board								
Switches								
● S1001	40T61963F02	Push SDU3P (Power)						
▲ S1001	40T68579F01	Push SDU3P-E (Power)						
S1002	40T67388F01	Push SUL231A (Speaker A, B)						
Capacitors								
● C1001	08T57437F11	CER., 0.01 $\mu$ F						
C1002	08T57437F11	CER., 0.01 $\mu$ F						
Resistors								
▲ R7341	06T00007L52	M.O., 300 ohm 2W						
▲ R7342	06T00007L52	M.O., 300 ohm 2W						
Heat Up P. C. Board								
Transistor/Diodes								
Q1011	48T81102F01	TR., 2SA1015						
D1011	48T71195F01	1S1553						
D1012	48T71195F01	1S1553						
ZD1011	48T52739F31	Zener HZ5C-1						
Switch								
S1011	40T92612F01	Push SDDFA3 (Pre-Heating)						
Equalizer P. C. Board								
IC/Transistors								
IC2101	51T00038L01	M5220P						
Q1109	48T64376F01	TR., 2SC3423						
Q1110	48T64375F01	TR., 2SA1360						
Q1111	48T81102F01	TR., 2SA1015						
Q1112	48T81101F01	TR., 2SC1815						
Q1113	48T81101F01	TR., 2SC1815						
Q1114	48T81102F01	TR., 2SA1015						
Q1115	48T81101F01	TR., 2SC1815						
Q1116	48T81102F01	TR., 2SA1015						
Q1117	48T52152F01	FET, 2SK30A						
Q1118	48T52152F01	FET, 2SK30A						
Q1501	48T81101F01	TR., 2SC1815						
Q1502	48T81101F01	TR., 2SC1815						
Q2101	48T72887F02	FET, 2SK332						
Q2102	48T72887F02	FET, 2SK332						
Diodes								
D1501	48T55186F01	1N4003						
D1502	48T71195F01	1S1553						
D1503	48T55186F01	1N4003						
ZD1105	48T52741F03	Zener HZ6A-3L						
ZD1106	48T52741F03	Zener HZ6A-3L						
ZD1107	48T52741F03	Zener HZ6A-3L						
ZD1108	48T52741F03	Zener HZ6A-3L						
ZD1110	48T40059U51	Zener HZ16-3L						
ZD1111	48T40059U51	Zener HZ16-3L						
Coils								
▲ L2101	24T83130F02	Inductor, 33 $\mu$ H						
▲ L2102	24T83130F02	Inductor, 33 $\mu$ H						
▲ L2103	24T83130F02	Inductor, 33 $\mu$ H						
▲ L2104	24T83130F02	Inductor, 33 $\mu$ H						
Relays								
RL1501	80T72831F01	G6A-434P-12VDC						
RL1502	80T83717F02	DS2Y-S-DC12V						
Jacks								
J2101	09T15457W02	Pin 2P T6105 (CU)						
J2102	09T81364F03	Plate, PH6 T6078 (AU)						
J2103	09T81364F03	Plate, PH6 T6078 (AU)						

Notes: ●: For Japanese model only (JA). ▲: For West German model only (AD), Others: Common.

Symbol No.	Part No.	Description			Symbol No.	Part No.	Description		
Capacitors					Resistors				
C1105	23T00138L49	ELY., 10 $\mu$ F/50V			R2133	06T00147L57	C.F., 470 ohm 1/2W		
C1108	23T00138L49	ELY., 10 $\mu$ F/50V			R2134	06T00147L57	C.F., 470 ohm 1/2W		
C1107	23T00132L25	ELY., 47 $\mu$ F/50V			R2501	06T00147L41	C.F., 100 ohm 1/2W		
C1108	23T00132L25	ELY., 47 $\mu$ F/50V			R2502	06T00147L41	C.F., 100 ohm 1/2W		
C1112	23T00154L33	ELY., 10 $\mu$ F/50V			Driver P. C. Board				
C1113	23T00154L33	ELY., 10 $\mu$ F/50V			Transistors				
C1114	23T00180L26	ELY., 22 $\mu$ F/50V			Q1101	48T62642F01	2SC2336		
▲ C1115	08T81196F34	Mica, 100pF			Q1102	48T62641F01	2SA1006		
▲ C1116	08T81196F34	Mica, 100pF			Q1103	48T64375F01	2SA1360		
C1501	23T00138L21	ELY., 100 $\mu$ F/16V			Q1104	48T64376F01	2SC3423		
C1502	23T00138L24	ELY., 470 $\mu$ F/16V			Q1105	48T64376F01	2SC3423		
C1503	23T00138L19	ELY., 33 $\mu$ F/16V			Q1106	48T64375F01	2SA1360		
C2101	08T61630F73	POLY., 100pF			Q1107	48T64376F01	2SC3423		
C2102	08T61630F73	POLY., 100pF			Q1108	48T64375F01	2SA1360		
▲ C2103	08T61630F26	POLY., 220pF			Q7101	48T62284F02	FET, 2SJ75		
▲ C2104	08T61630F26	POLY., 220pF			or	48T62284F03	FET, 2SJ75		
● C2107	08T00151L19	PP., 3300pF			Q7102	48T62284F02	FET, 2SJ75		
▲ C2107	08T00151L23	PP., 6800pF			or	48T62284F03	FET, 2SJ75		
● C2108	08T00151L19	PP., 3300pF			Q7103	48T72597F01	2SA995		
▲ C2108	08T00151L23	PP., 6800pF			Q7104	48T72597F01	2SA995		
▲ C2109	21S40855F25	CER., 150pF			Q7105	48T72598F01	2SC2291		
▲ C2110	21S40855F25	CER., 150pF			Q7106	48T72598F01	2SC2291		
C2111	23T00153L01	ELY., (B.P.) 1000 $\mu$ F/6.3V			Q7107	48T64375F01	2SA1360		
C2112	23T00153L01	ELY., (B.P.) 1000 $\mu$ F/6.3V			Q7108	48T64375F01	2SA1360		
C2113	08T00015L38	PP., 9100pF			Q7109	48T71448F01	2SA1361		
C2114	08T00015L38	PP., 9100pF			Q7110	48T71448F01	2SA1361		
C2115	08T71458F39	PP., 0.0318 $\mu$ F			Diodes/LED's				
C2116	08T71458F39	PP., 0.0318 $\mu$ F			LD7101	48T52953F03	LED BR5507S (RED)		
C2117	23T61177F06	ELY., (B.P.) 4.7 $\mu$ F/100V			LD7102	48T52953F03	LED BR5507S (RED)		
C2118	23T61177F06	ELY., (B.P.) 4.7 $\mu$ F/100V			ZD1101	48T52741F74	Zener HZ36-2L		
▲ C2119	08T00015L18	PP., 2700pF			ZD1102	48T52741F74	Zener HZ36-2L		
▲ C2120	08T00015L18	PP., 2700pF			ZD1103	48T52741F74	Zener HZ36-2L		
▲ C2501	08T61630F34	POLY., 470pF			ZD1104	48T52741F74	Zener HZ36-2L		
▲ C2502	08T61630F34	POLY., 470pF			ZD7101	48T52741F38	Zener HZ12A-2L		
▲ C2503	08S40805F05	CER., 470pF			ZD7102	48T52741F38	Zener HZ12A-2L		
▲ C2504	08S40805F05	CER., 470pF			Capacitors				
▲ C2505	08S40805F05	CER., 470pF			C1101	23T00138L49	ELY., 10 $\mu$ F/50V		
▲ C2506	08S40805F05	CER., 470pF			C1102	23T00138L49	ELY., 10 $\mu$ F/50V		
▲ C2507	08S40805F05	CER., 470pF			C1103	23T00138L86	ELY., 10 $\mu$ F/160V		
▲ C2508	08S40805F05	CER., 470pF			C1104	23T00138L86	ELY., 10 $\mu$ F/160V		
▲ C2511	08S40805F05	CER., 470pF			▲ C1151	08T81196F42	Mica, 220pF		
▲ C2512	08S40805F05	CER., 470pF							
C2521	23T00180L26	ELY., 22 $\mu$ F/50V							
C2522	23T00181L45	ELY., 22 $\mu$ F/50V							
C2523	23T00180L26	ELY., 22 $\mu$ F/50V							

Notes : ● : For Japanese model only (JA). ▲ : For West German model only (AD). Others : Common.



Symbol No.	Part No.	Description		
● C7101	08T00125L04	POLY., 100pF		
● C7102	08T00125L04	POLY., 100pF		
C7105	08T00125L06	POLY., 22pF		
C7106	08T00125L06	POLY., 22pF		
C7107	23T61177F06	ELY., (B.P.) 4.7 $\mu$ F/100V		
C7108	23T61177F06	ELY., (B.P.) 4.7 $\mu$ F/100V		
C7109	23T00154L12	ELY., 47 $\mu$ F/16V		
C7110	23T00154L12	ELY., 47 $\mu$ F/16V		
C7113	23T00138L85	ELY., 4.7 $\mu$ F/160V		
C7114	23T00138L85	ELY., 4.7 $\mu$ F/160V		
C7115	23T00138L85	ELY., 4.7 $\mu$ F/160V		
C7116	23T00138L85	ELY., 4.7 $\mu$ F/160V		
▲ C7117	08T61630F22	POLY., 150pF		
▲ C7118	08T61630F22	POLY., 150pF		
● C7197	08T94456F05	PF., 1000pF		
● C7198	08T94456F05	PF., 1000pF		

Resistors (All resistors are carbon film 1/2W $\pm$ 5% unless otherwise noted.)

R7101	06T00147L49	220 ohm		
R7102	06T00147L49	220 ohm		
R7103	06T00148L20	180k ohm		
R7104	06T00148L20	180k ohm		
R7105	06T00147L41	100 ohm		
R7106	06T00147L41	100 ohm		
R7107	06T00147L95	18k ohm		
R7108	06T00147L95	18k ohm		
R7109	06T00148L50	3.3M ohm		
R7110	06T00148L50	3.3M ohm		
R7153	06T69013F41	Fuse 100 ohm 1/4W		
R7154	06T69013F41	Fuse 100 ohm 1/4W		

## Main P. C. Board

IC's				
IC1119	S1T72375F01	NJM78M12A		
IC1120	S1T72375F01	NJM78M12A		
IC5101	S1T67437F01	TA7317P		

Symbol No.	Part No.	Description		
Transistors				
Q5104	48T52545F02	2SA970		
Q5105	48T81102F01	2SA1015		
Q7307	48T53301F02	2SC2240		
Q7308	48T53301F02	2SC2240		
Q7309	48T52545F02	2SA970		
Q7310	48T52545F02	2SA970		
Q7311	48T53301F02	2SC2240		
Q7312	48T53301F02	2SC2240		

## Diodes

D1201	48S40477U07	IN4007		
D1202	48S40477U07	IN4007		
D1203	48S40477U07	IN4007		
D1204	48S40477U07	IN4007		
D1205	48T55186F01	IN4003		
D1206	48T55186F01	IN4003		
D1207	48T55186F01	IN4003		
D1208	48T55186F01	IN4003		
D1211	48T55186F01	IN4003		
D1212	48T55186F01	IN4003		
D5102	48T55186F01	IN4003		
O7301	48T71195F01	1S1553		
O7302	48T71195F01	1S1553		
O7303	48T71195F01	1S1553		
O7304	48T71195F01	1S1553		
O7305	48T71195F01	1S1553		
O7306	48T71195F01	1S1553		
O7307	48T71195F01	1S1553		
O7308	48T71195F01	1S1553		
O7309	48T73079F02	1SS82		
O7310	48T73079F02	1SS82		
O7311	48T73079F02	1SS82		
O7312	48T73079F02	1SS82		
ZD5101	48T52739F31	Zener HZ5C-1		
8D1209	48T71451F01	KSL-02		
8D1210	48T61415F03	1G4841		
8D1213	48T67435F01	D5FB20		

## Coils/Relay

L7301	24T74614F01	Inductor 1.1 $\mu$ H		
L7302	24T74614F01	Inductor 1.1 $\mu$ H		
RL5101	80T95099F01	Relay. DH12D2-0T		

Notes: ● : For Japanese model only (JA), ▲ : For West German model only (AD), Others : Common.

Symbol No.	Part No.	Description		
<b>Jacks</b>				
J7301	09T81893F02	Terminal SP T5957L		
J7302	09T81893F01	Terminal SP T5957		
<b>Capacitors</b>				
C1110	23T00137L49	ELY., 1000 $\mu$ F/16V		
C1111	23T00138L24	ELY., 470 $\mu$ F/16V		
C1201	23T00142L40	ELY., 220 $\mu$ F/160V		
C1202	23T00142L40	ELY., 220 $\mu$ F/160V		
C1203	23T00142L39	ELY., 3300 $\mu$ F/35V		
C1204	23T00142L39	ELY., 3300 $\mu$ F/35V		
C1205	23T00022L05	ELY., 8200 $\mu$ F/71V		
C1206	23T00022L05	ELY., 8200 $\mu$ F/71V		
C1207	23T00022L05	ELY., 8200 $\mu$ F/71V		
C1208	23T00022L05	ELY., 8200 $\mu$ F/71V		
C1209	23T00138L72	ELY., 1 $\mu$ F/100V		
C1210	23T00142L38	ELY., 6800 $\mu$ F/16V		
C1211	23T00137L48	ELY., 3300 $\mu$ F/25V		
▲ C1303	08T57705F27	MYL., 0.068 $\mu$ F		
▲ C1304	08T57705F27	MYL., 0.068 $\mu$ F		
▲ C1305	08T57705F28	MYL., 0.082 $\mu$ F		
▲ C1306	08T57705F28	MYL., 0.082 $\mu$ F		
▲ C1307	08T57705F28	MYL., 0.082 $\mu$ F		
C5101	23T00140L25	ELY., (B.P.) 33 $\mu$ F/25V		
C5102	23T00140L25	ELY., (B.P.) 33 $\mu$ F/25V		
C5103	23T00138L71	ELY., 0.47 $\mu$ F/100V		
C5104	23T00138L18	ELY., 22 $\mu$ F/16V		
C5105	23T00138L18	ELY., 22 $\mu$ F/16V		
C5106	23T00138L11	ELY., 47 $\mu$ F/10V		
C7301	08T00015L17	PP., 2200pF		
C7302	08T00015L17	PP., 2200pF		
C7303	08T00015L17	PP., 2200pF		
C7304	08T00015L17	PP., 2200pF		
C7305	08T00015L29	PP., 0.022 $\mu$ F		
C7306	08T00015L29	PP., 0.022 $\mu$ F		
▲ C7351	08T57851F24	PF., 1000pF		
▲ C7352	08T57851F24	PF., 1000pF		
▲ C7353	08T57851F24	PF., 1000pF		
▲ C7354	08T57851F24	PF., 1000pF		
▲ C7355	08T57851F24	PF., 1000pF		
▲ C7356	08T57851F24	PF., 1000pF		
▲ C7357	08T57851F24	PF., 1000pF		
▲ C7358	08T57851F24	PF., 1000pF		
▲ C7359	08T57851F24	PF., 1000pF		
▲ C7360	08T57851F24	PF., 1000pF		

Symbol No.	Part No.	Description		
<b>Resistors</b>				
R7305	06T69013F41	Fuse100 ohm 1/4W		
R7306	06T69013F41	Fuse100 ohm 1/4W		
R7307	06T69013F41	Fuse100 ohm 1/4W		
R7308	06T69013F41	Fuse100 ohm 1/4W		
R7317	06T67307F01	M.P. 0.22 ohm 5W		
R7318	06T67307F01	M.P. 0.22 ohm 5W		
R7321	06T00007L29	M.O., 33 ohm 2W		
R7322	06T00007L29	M.O., 33 ohm 2W		
R7323	06T00005L17	M.O., 10 ohm 1W		
R7324	06T00005L17	M.O., 10 ohm 1W		
VR7301	18B44064J01	Variable, 470 ohm 1/2W		
VR7302	18B44064J01	Variable, 470 ohm 1/2W		
<b>AV Monitor P. C. Board</b>				
<b>IC/Transistors</b>				
IC3001	51T80995F01	M51320P		
Q3001	48T81101F01	TR., 2SC1815		
Q3002	48T81101F01	TR., 2SC1815		
Q3003	48T81101F01	TR., 2SC1815		
Q3004	48S43525F05	TR., 2SC1815		
<b>Diodes/Relays</b>				
D3001	48T71195F01	1S1553		
D3002	48T71195F01	1S1553		
RL3001	80T73804F02	Relay, FBR42NG012-P		
RL3002	80T15383W01	Relay, NXE-12K		
<b>Jacks</b>				
J3001	09T81368F02	Plate, PH3 T6186		
J3002	09T81367F02	Plate, PH6 T6187		
J3003	09T81370F02	Plate, PH1 T6147		
<b>Capacitors</b>				
C3001	23T16145W28	ELY., 47 $\mu$ F/16V		
C3002	23T16145W28	ELY., 47 $\mu$ F/16V		
C3003	23T16145W10	ELY., 10 $\mu$ F/16V		
C3004	23T00205L05	ELY., 470 $\mu$ F/16V		
C3005	23T00205L05	ELY., 470 $\mu$ F/16V		

Notes : ● : For Japanese model only (JA), ▲ : For West German model only (AD). Others : Common.

Symbol No.	Part No.	Description		
C3006	23T00205L05	ELY., 470 $\mu$ F/16V		
▲ C3009	08S40805F05	CER., 470pF		
▲ C3010	08S40805F05	CER., 470pF		
▲ C3013	08S40805F05	CER., 470pF		
▲ C3014	08S40805F05	CER., 470pF		
C3019	23T16145W10	ELY., 10 $\mu$ F/16V		
C3023	23T00205L05	ELY., 470 $\mu$ F/16V		

### Tone Control P. C. Board

#### IC's/Switch

IC4101	51T80136F01	M5238P		
● IC4102	51T52383F01	NJM4558D		
▲ IC4102	51S43471U02	$\mu$ PC4558C		
S4101	40T81347F01	Switch, Push SUL122A (Tone In)		

#### Capacitors

C4101	08T90316F28	TF., 0.082 $\mu$ F		
C4102	08T90316F28	TF., 0.082 $\mu$ F		
C4103	08T90316F13	TF., 4700pF		
C4104	08T90316F13	TF., 4700pF		
C4105	23T00140L37	ELY., (B. P.) 2.2 $\mu$ F/50V		
C4106	23T00140L37	ELY., (B. P.) 2.2 $\mu$ F/50V		
C4107	08T00151L24	PP., 8200pF		
C4108	08T00151L24	PP., 8200pF		
▲ C4109	08T61642F27	Mica, 100pF		
▲ C4110	08T61642F27	Mica, 100pF		
C4501	23T00138L26	ELY., 4.7 $\mu$ F/25V		
C4502	23T00138L26	ELY., 4.7 $\mu$ F/25V		
C4503	23T00138L26	ELY., 4.7 $\mu$ F/25V		
C4504	23T00138L26	ELY., 4.7 $\mu$ F/25V		
C4505	23T00180L26	ELY., 22 $\mu$ F/50V		

#### Volumes

VR4101	18T67394F01	Control, 10KB $\times$ 2 (BASS)		
VR4102	18T67394F01	Control, 10KB $\times$ 2 (TREBLE)		

Symbol No.	Part No.	Description		
Function LED P. C. Board				
LED's				
LD6501	48T72813F02	SLR-34DC3F (ORG)		
LD6502	48T72813F02	SLR-34DC3F (ORG)		
LD6504	48T60947F05	SLH-34VR3F (RED)		
LD6506	48T60947F05	SLH-34VR3F (RED)		
LD6507	48T72813F02	SLR-34DC3F (ORG)		
LD6509	48T72813F02	SLR-34DC3F (ORG)		
LD6510	48T72813F02	SLR-34DC3F (ORG)		
LD6512	48T72813F02	SLR-34DC3F (ORG)		
LD6513	48T72813F02	SLR-34DC3F (ORG)		
LD6515	48T72813F02	SLR-34DC3F (ORG)		
LD6516	48T72813F02	SLR-34DC3F (ORG)		
LD6517	48T72813F02	SLR-34DC3F (ORG)		
LD6519	48T72813F02	SLR-34DC3F (ORG)		
LD6521	48T72813F02	SLR-34DC3F (ORG)		
LD6522	48T60947F05	SLH-34VR3F (RED)		
LD6523	48T60947F05	SLH-34VR3F (RED)		

### AV Front P. C. Board

#### Switch/Jacks

S6007	40T81346F01	Switch, Push SUL121A (AV-2)		
J9501	09T67396F01	Plate, Phone (AV2, L)		
J9502	09T67396F01	Plate, Phone (AV2, R)		
J9503	09T67396F01	Plate, Phone (AV2, V)		

#### Capacitors

C6202	23T00138L49	ELY., 10 $\mu$ F/50V		
▲ C9501	08S40805F05	CER., 470pF		
▲ C9502	08S40805F05	CER., 470pF		
C9505	23T00180L26	ELY., 22 $\mu$ F/50V		
C9506	23T00180L26	ELY., 22 $\mu$ F/50V		

### Function P. C. Board

#### Switch

S6001	40T81348F01	Push SUL702A (Tape-1, 2, AV-1, 2, CD Tuner, Phone)		
-------	-------------	---	--	--

Notes: ● : For Japanese model only (JA), ▲ : For West German model only (AD), Others : Common.

Symbol No.	Part No.	Description		
<b>Rec P. C. Board</b>				
<b>Switches</b>				
S6002	40T82248F01	Push Spec 2 (CD Straight, Cartridge)		
S6003	40T81349F01	Push Spec 7 (Source, Tape2→1, AU2-1 Mode, Loudness.Signal Processor)		
<b>Capacitors</b>				
C6001	08T90316F04	TF., 820pF		
C6002	08T90316F04	TF., 820pF		
C6003	08T90316F19	TF., 0.015 $\mu$ F		
C6004	08T90316F19	TF., 0.015 $\mu$ F		
<b>Tube P. C. Board</b>				
<b>Capacitors</b>				
C7151	08T81196F03	Mica, 3pF		
C7152	08T81196F03	Mica, 3pF		
C7153	08T81196F03	Mica, 3pF		
C7154	08T81196F03	Mica, 3pF		
<b>ADP P. C. Board</b>				
<b>Jack/Capacitors</b>				
J9001	09T81475F01	Jack, Plate (T5881 - AABC)		
▲ C9001	08S40805F05	CER., 470pF		
▲ C9002	08S40805F05	CER., 470pF		
C9007	23T00180L26	ELY., 22 $\mu$ F/50V		
C9008	23T00180L26	ELY., 22 $\mu$ F/50V		
<b>Miscellaneous</b>				
● C1	08T57437F11	CAP., CER., 0.01 $\mu$ F		
▲ C1001	08T57437F11	CAP., CER., 0.01 $\mu$ F		
▲ C1003	08T57437F11	CAP., CER., 0.01 $\mu$ F		
▲ C1041	23S43247F20	ELY., 470 $\mu$ F/8.3V		
● F1001	65T55050F19	Fuse F611 (8A - 125V)		

Symbol No.	Part No.	Description		
▲ F1001	65T42077U21	Fuse Semko (3.15A)		
▲ F1301	65T42077U08	Fuse Semko (160mA)		
▲ F1302	65T42077U08	Fuse Semko (160mA)		
▲ F1303	65T42077U08	Fuse Semko (160mA)		
▲ F1304	65T42077U08	Fuse Semko (160mA)		
▲ F1305	65T42077U15	Fuse Semko (800mA)		
▲ F1306	65T42077U20	Fuse Semko (2.5A)		
● J1001	09T67405F02	Outlet AC		
● J1002	09T67405F02	Outlet AC		
▲ J1003	09T51831F01	Socket, Switch M-1615		
J8101	09T66672F04	Jack Headphone		
LD9601	48T60947F05	LED, SLH-34VR3F (RED)		
LD9602	48T72813F02	LED, SHR-34DC3F (ORG)		
● P1001	28T43812P01	Plug, AC Cord (12A)		
▲ P1001	28T81592F05	Plug, AC Cord (12A)		
▲ P1002	09T51830F01	Plug, Switch P-2180		
Q1012	48T56031F01	TR., 2SD1266		
● Q4901	65T00091L03	Vacuum Tube 6CG7GE (Sink)		
▲ Q4901	65T00091L01	Vacuum Tube 6CG7GE (Sink)		
● Q4902	65T00091L03	Vacuum Tube 6CG7GE (Sink)		
▲ Q4902	65T00091L01	Vacuum Tube 6CG7GE (Sink)		
Q5101	48T53301F02	TR., 2SC2240		
Q7301	48T67399F03	FET, 2SK405		
Q7302	48T67399F03	FET, 2SK405		
Q7303	48T67398F03	FET, 2SJ115		
Q7304	48T67398F03	FET, 2SJ115		
Q7305	48T64376F01	TR., 2SC3423		
Q7306	48T64376F01	TR., 2SC3423		
● T1001	25T81356F05	Trans., Power		
▲ T1001	25T81356F04	Trans., Power		
VR6001	18T82249F01	Volume, Control 250k ohm (Balance)		
● VR6002	18T71727F03	Volume, Control 150k ohm x2		
▲ VR6002	18T71727F02	Volume, Control 150k ohm x2 (CT)		

Notes : ● : For Japanese model only (JA), ▲ : For West German model only (AD), Others : Common.

## Packing Assembly Parts List

Symbol No.	Part No.	Description			Symbol No.	Part No.	Description		
● 101	56B40442T17	Front Frame, Packing			104	56B40230G08	Sack, Polyethylene		
● 102	56D21441W01	Tray, Packing			● 105	56A52079F12	Sheet, Packing		
▲ 102	56D22101W01	Tray, Packing			● 106	68P96552F85	Owner's, Manual		
● 103	56S10005W61	Carton, Packing			▲ 106	68P96552F87	Owner's, Manual		
▲ 103	56S10005W66	Carton, Packing							

Notes : ● : For Japanese model only (JA), ▲ : For West German model only (AD), Others : Common.

## Packing Method View

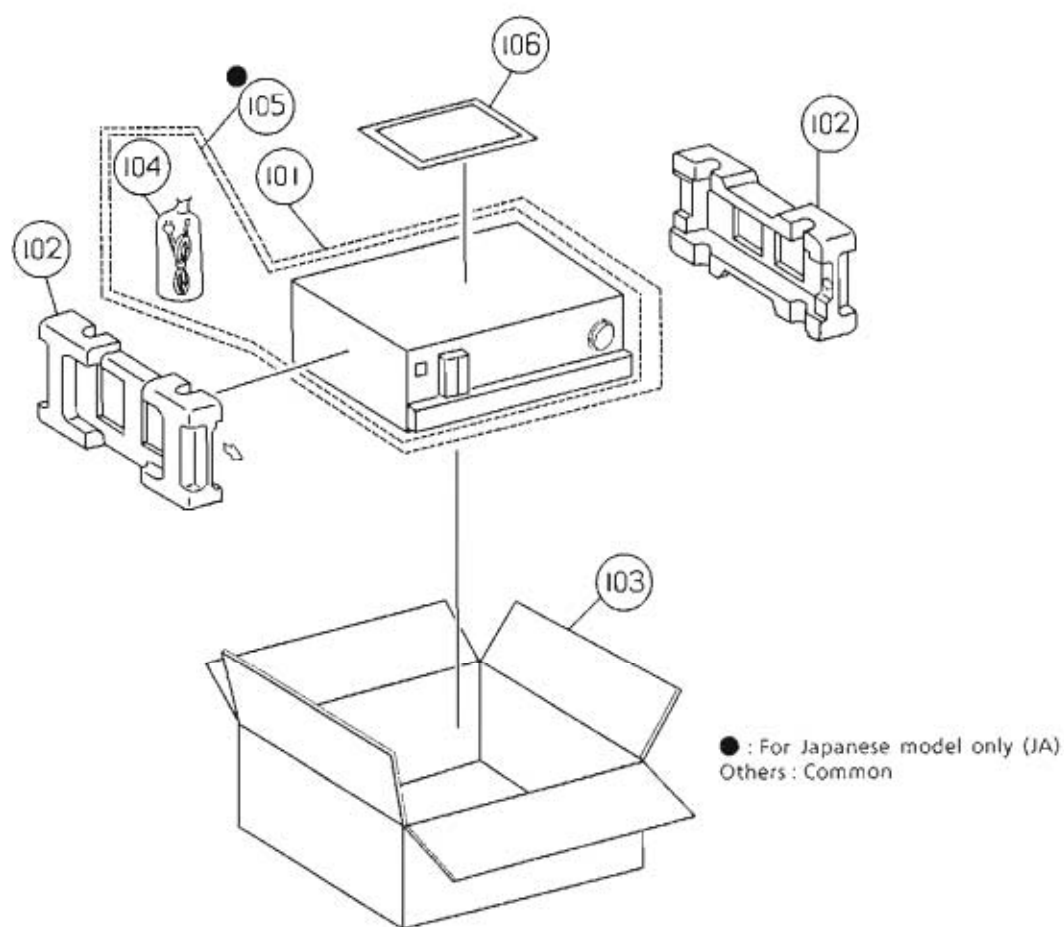

## Cabinet Assembly Parts List

Symbol No.	Index	Part No.	Description	Symbol No.	Index	Part No.	Description
	1	4-A 01B21433W01	Assy., Escutcheon Knob	37	5-B 03S44205G28	Screw, Bind (M4×16)	
	3	1-A 15D67323F02	Cover, Top	38	03A82468F01	Screw, Bind (M3×10)	
●	7	2-H 15C21432W01	Cover, Rear	39	03S40018G08	Screw, Tapping (M3×8)	
▲	7	2-H 15C21432W02	Cover, Rear	40	03S71031F04	Screw, Bind (M3×8)	
	8	3-B 36A67330F01	Knob, Power	41	03S40038U01	Screw, W/Washer (M4×8)	
	9	3-B 36A67331F01	Knob, Push (SP)	42	4-C 04S40070G23	Washer, Flat (M3.3)	
	10	4-C 36A21439W01	Knob, Push	45	03S40012G98	Screw, Counterstnk (M3×8)	
	11	36A67333F01	Knob, Push	46	3-G 03D40121T18	Screw, W/Double Washer (M3×10)	
	12	4-C 36A67334F02	Knob, Push (AV)	47	4-F 75S12196W81	Cushion, Rubber	
●	13	4-A 36A21555W01	Knob, Main Volume	48	2-A 75S72374F70	Cushion, Rubber	
▲	13	4-A 38821438W01	Knob, Main Volume	49	5-B 07B67320F01	Frame, LED	
	14	5-A 36A21437W01	Knob, Tone Volume	50	4-A 14S58462F59	Insulator, Cover	
	15	4-C 43A67342F01	Spacer, Switch	51	3-E 09T64527F02	Socket, Tube 9Pin	
	17	3-G 07R51146F01	Support, TR	52	3-A 14S81481F12	Insulator, Cover	
	18	1-H 29T66964F01	Terminal, GND	53	41A88570F01	Spring, Volume	
●	19	1-G 43B41625J05	Support, Cord	54	2-H 28T51067F01	Plug, Short Phone	
▲	19	1-G 43B41625J02	Support, Cord	55	5-B 01V23700W92	Assy., Function LED P.C.B	
●	20	1-F 43T53136F01	Bush, Cap.	●	68	3-A 01V23700W96	Assy., Front Panel
▲	20	2-D 43T53136F04	Bush, Cap	▲	68	3-A 01V24700W18	Assy., Front Panel
	21	29A41814G01	Lug	70	3-E 47A81445F01	Shaft, P. C. Board	
	22	03D4001AG04	Screw, W/Washer (M3×6)	74	5-B 03S82672F20	Screw, Bind (M3×8)	
	23	03D40121T17	Screw, W/Double Washer (M3×8)	●	77	03A92739F02	Screw, Wood Cap (M4×25)
	24	2-F 07C67319F01	Frame, Tube	78	5-B 75A13129W02	Pad, Trans-Leg	
	25	29C41045P05	Lug, Wrap 54mm	81	2-A 75S12196W73	Cushion, Rubber	
●	26	2-C 54B62268F36	Label, Fuse 8A-125V	82	4-D 14S81482F64	Insulator, Cover	
	27	3-E 47A82105F01	Shaft, P. C. Board	●	83	2-A 75A21556W01	Cushion, Wood (L)
	28	3-C 15A69033F01	Guide, Volume	84	3-G 03S71677F05	Screw, Pan (M3×8)	
	29	3-F 75A67341F01	Cushion, Tube	●	85	2-D 16B21554W01	Wood, Cab VL107 (R)
●	31	3-C 09T51960F01	Holder, Fuse	●	86	1-A 16B21554W02	Wood, Cab VL107 (L)
▲	31	09T45548F01	Holder, Fuse	●	87	2-C 75A21556W02	Cushion, Wood (R)
	32	29C41045P06	Lug, Board-In 50mm	●	88	14S53018F43	Insulator, Cover
	33	4-G 75A82703F01	Cushion, Rubber				
	34	14S53018F43	Insulator, Cover				
	35	5-B 75B80720F03	Trans-Leg				
	36	5-B 75A80719F01	Pad, Trans-Leg				

Notes : ● : For Japanese model only (JA). ▲ : For West German model only (AD). Others : Common.

# Exploded View (Cabinet) (1/2)

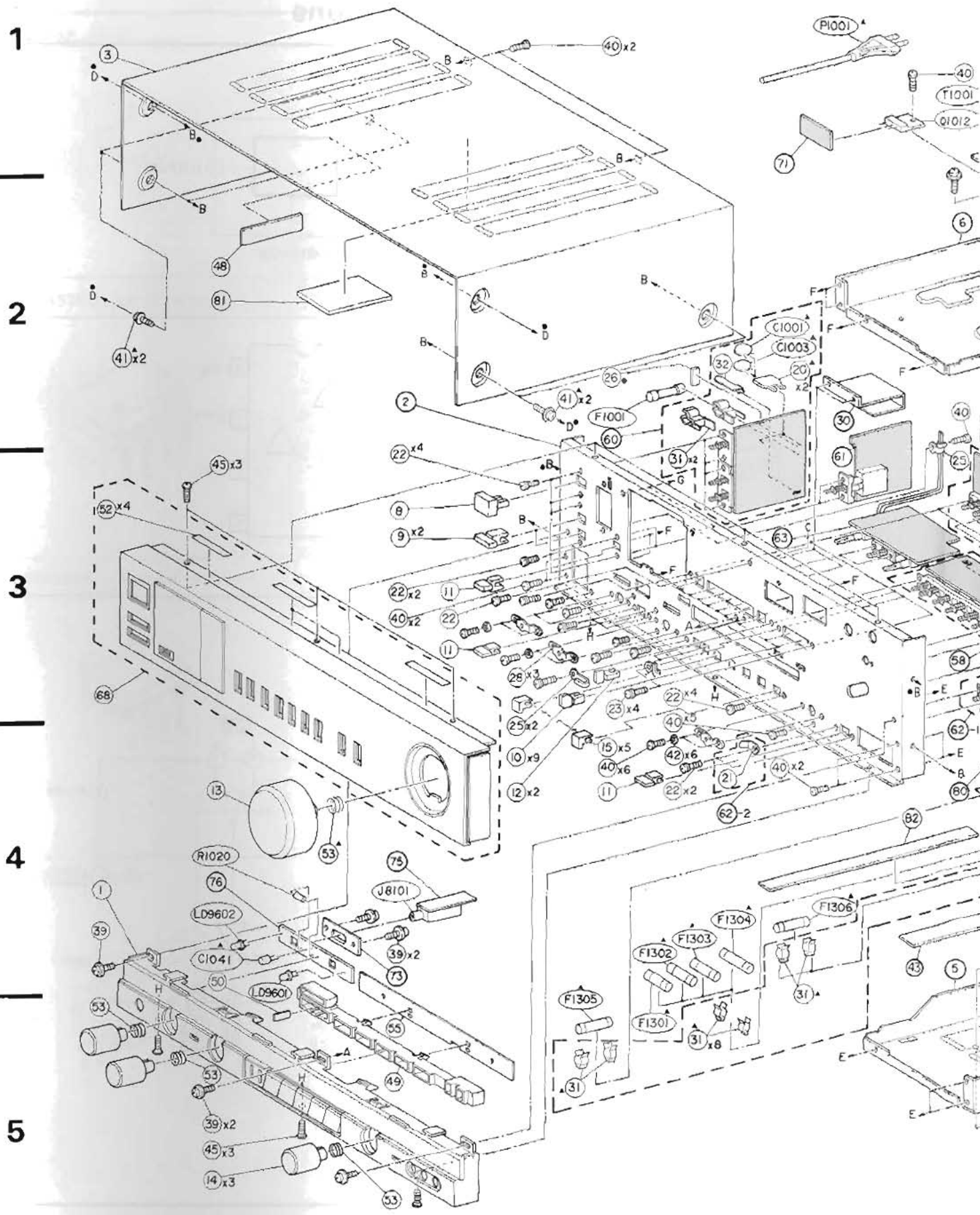

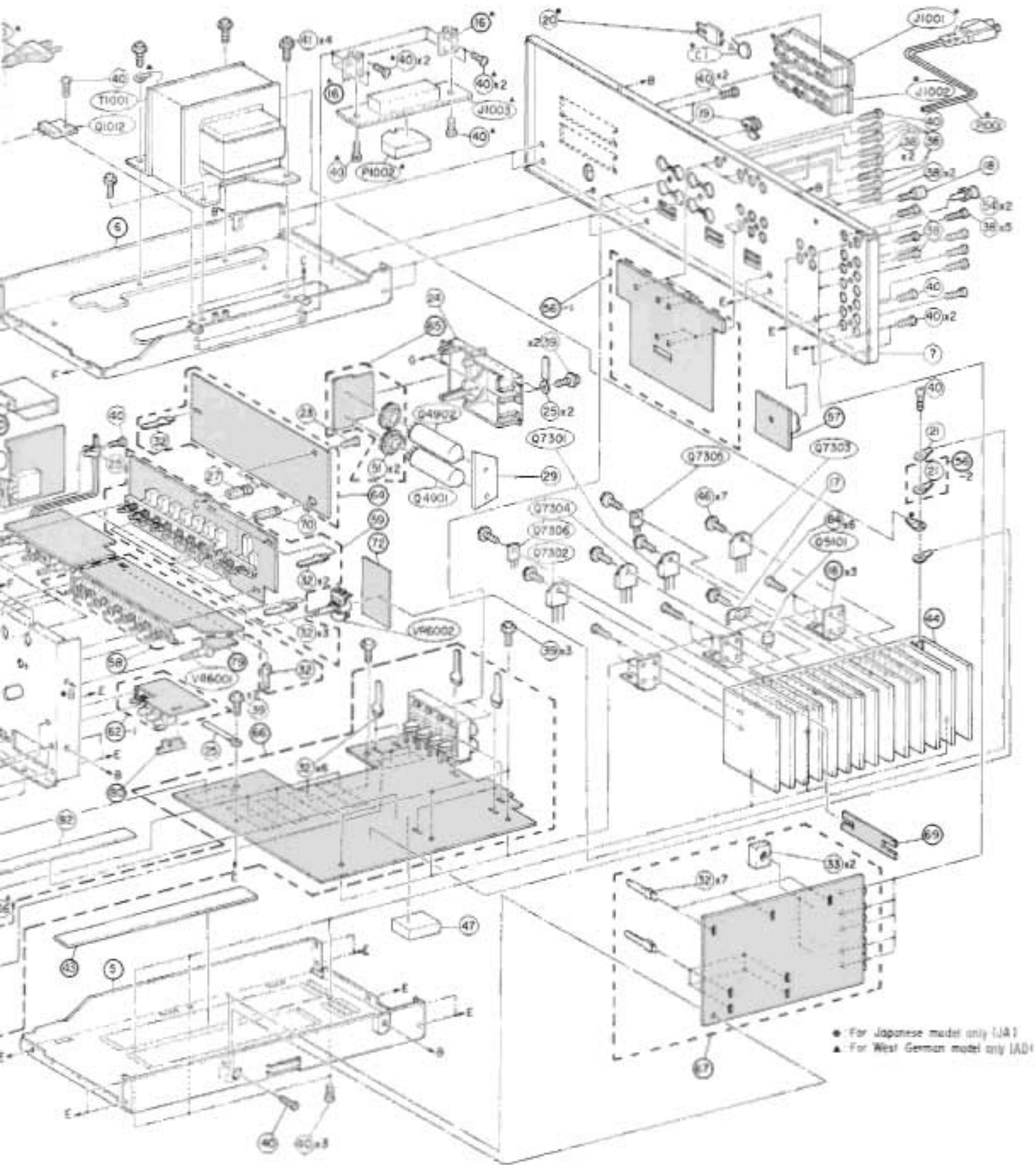



## Exploded View (Cabinet) (2/2)

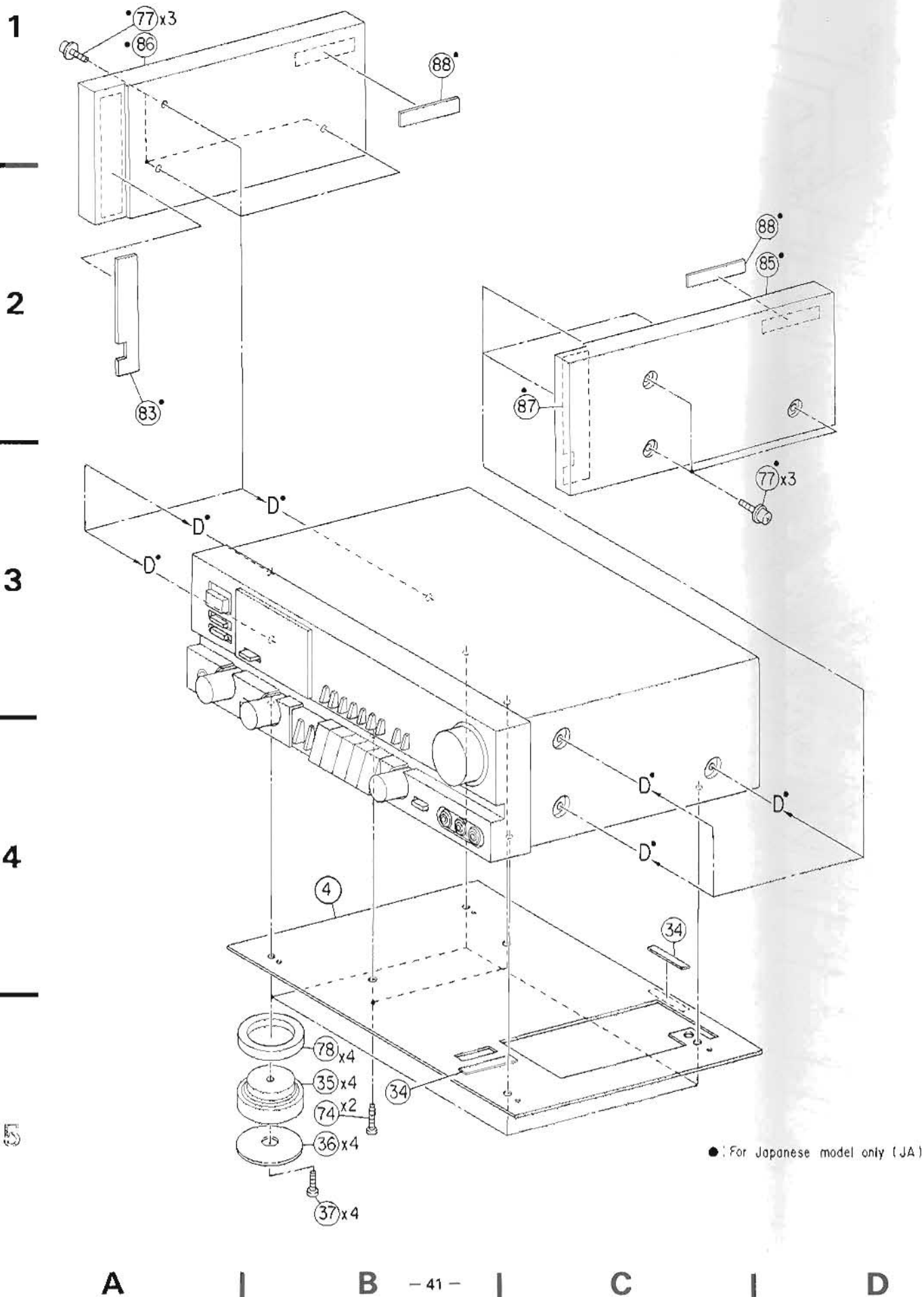

## Semi-Conductor Lead Identifications

NJM78M12A : IC1119, 1120



1: OUTPUT  
2: COMMON  
3: INPUT

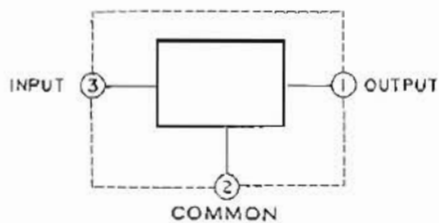

M5220P : IC2101

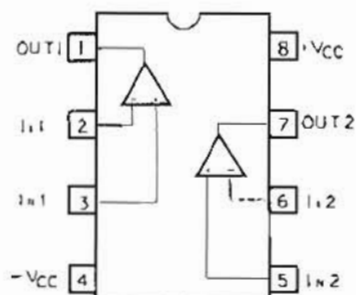

M51320P : IC3001

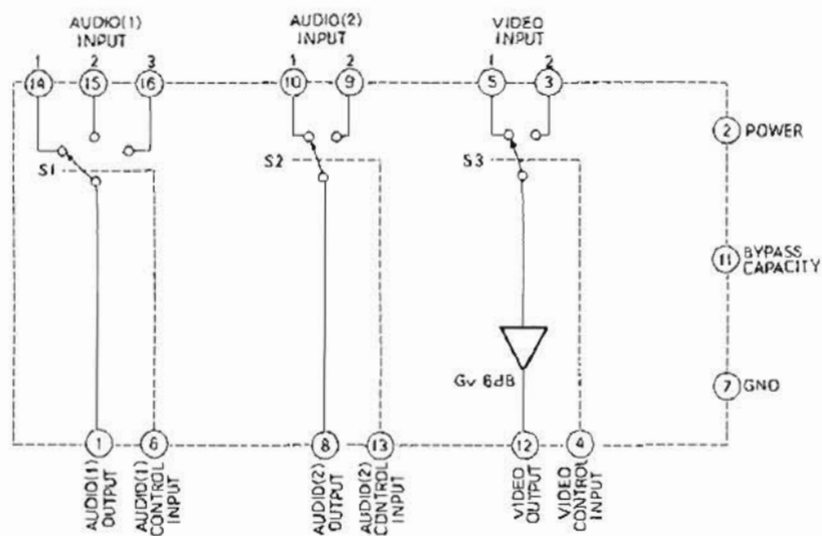
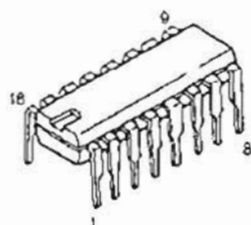

MS238P : IC4101

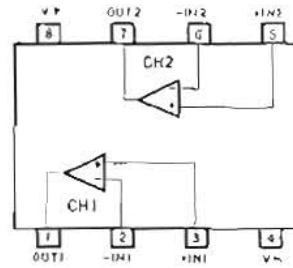
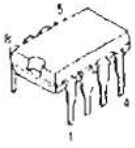

NJM4558D : IC4102 (JA Model Only)

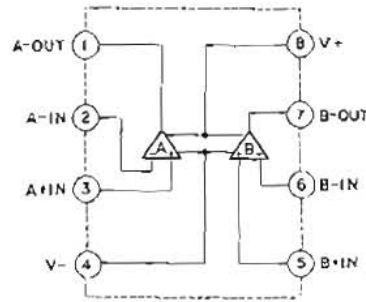
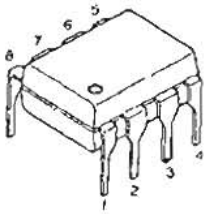
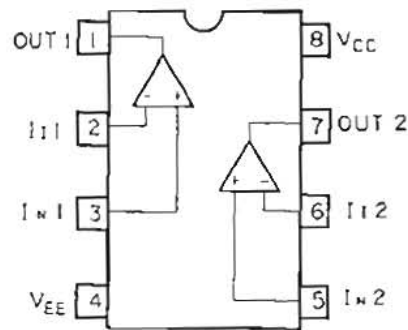
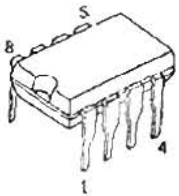
 $\mu$ PC4558C : IC4102 (AD Model Only)

TA7317P : IC5101

