

High Fidelity

JUNE

THE MAGAZINE FOR MUSIC LISTENERS

50 CENTS



FRÉDÉRIC CHOPIN

A DISCOGRAPHY BY HAROLD SCHONBERG

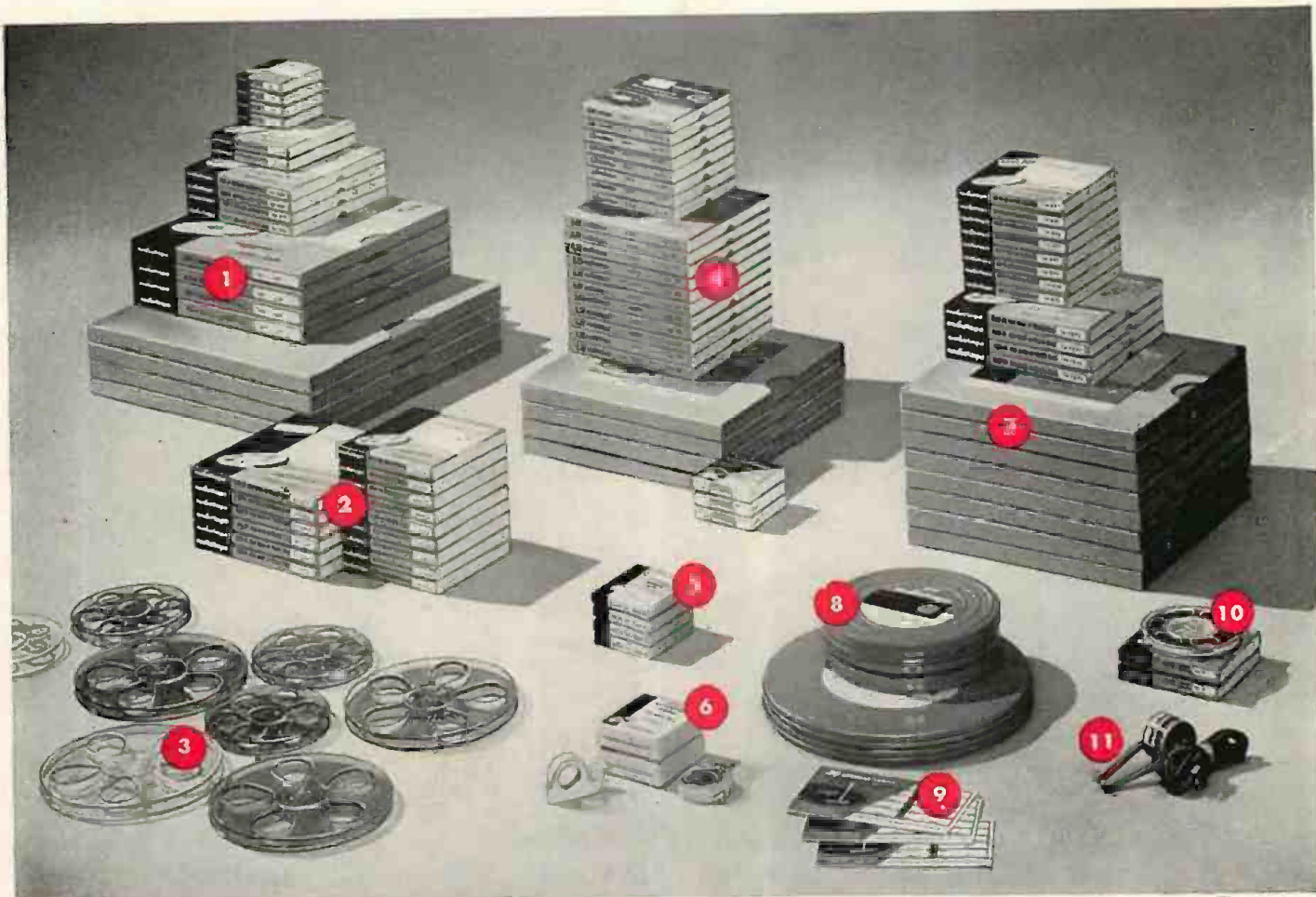

audiotape now offers you

THE MOST COMPLETE LINE

of recording tape and accessories

1 PLASTIC-BASE AUDIOTAPE

The finest, professional quality recording tape obtainable — with maximum fidelity, uniformity, frequency response and freedom from background noise and distortion.

2 COLORED AUDIOTAPE

Same professional quality as above, but on blue or green plastic base. Used in conjunction with standard red-brown tape, it provides instant visual identification of recorded selections spliced into a single reel — fast, easy color cueing and color coding. Available at *no extra cost!*

3 COLORED AUDIOTAPE REELS

Plastic 5" and 7" Audiotape reels in attractive, jewel-tone colors — red, yellow, green and blue — provide still greater flexibility of color coding any tape recorded material according to subject matter, tape speed, single or dual track, etc. Also available at no extra cost.

4 TYPE "LR" AUDIOTAPE

Made on 1-mil Mylar® polyester film, it provides *50% more* recording time per reel. The thinner, stronger base material assures maximum durability and longer storage life even under adverse conditions.

5 SELF-TIMING LEADER TAPE

A durable, white plastic leader with spaced markings for accurate timing of leader intervals.

6 SPLICING TAPE

Permaceel 91 splicing tape is specially formulated to prevent adhesive from squeezing out, drying up or becoming brittle.

7 STANDARD AUDIOTAPE ON "MYLAR" POLYESTER FILM

High-strength, super-durable Audiotape that meets highest professional standards of performance. Available in 1, 1½ and 2 mil base thickness.

8 TYPE "EP" AUDIOTAPE

Extra Precision magnetic recording tape for telemetering, electronic computers and other specialized data recording applications.

9 ADHESIVE REEL LABELS

Provide positive identification of your tapes, right on the reel.

10 HEAD ALIGNING TAPE

Test frequencies, pre-recorded with precisely correct azimuth alignment, permit accurate aligning of magnetic recording heads.

11 AUDIO HEAD DEMAGNETIZER

Completely removes permanent magnetism from recording heads in a few seconds.

This complete Audiotape line is backed by more than 16 years of specialized experience in the sound recording field, by America's largest exclusive manufacturer of sound recording media, both discs and tape. For full details on any of these items, see your Audiotape dealer, or write to Audio Devices.

AUDIO DEVICES, Inc.

444 Madison Avenue, New York 22, New York • Offices in Hollywood — Chicago

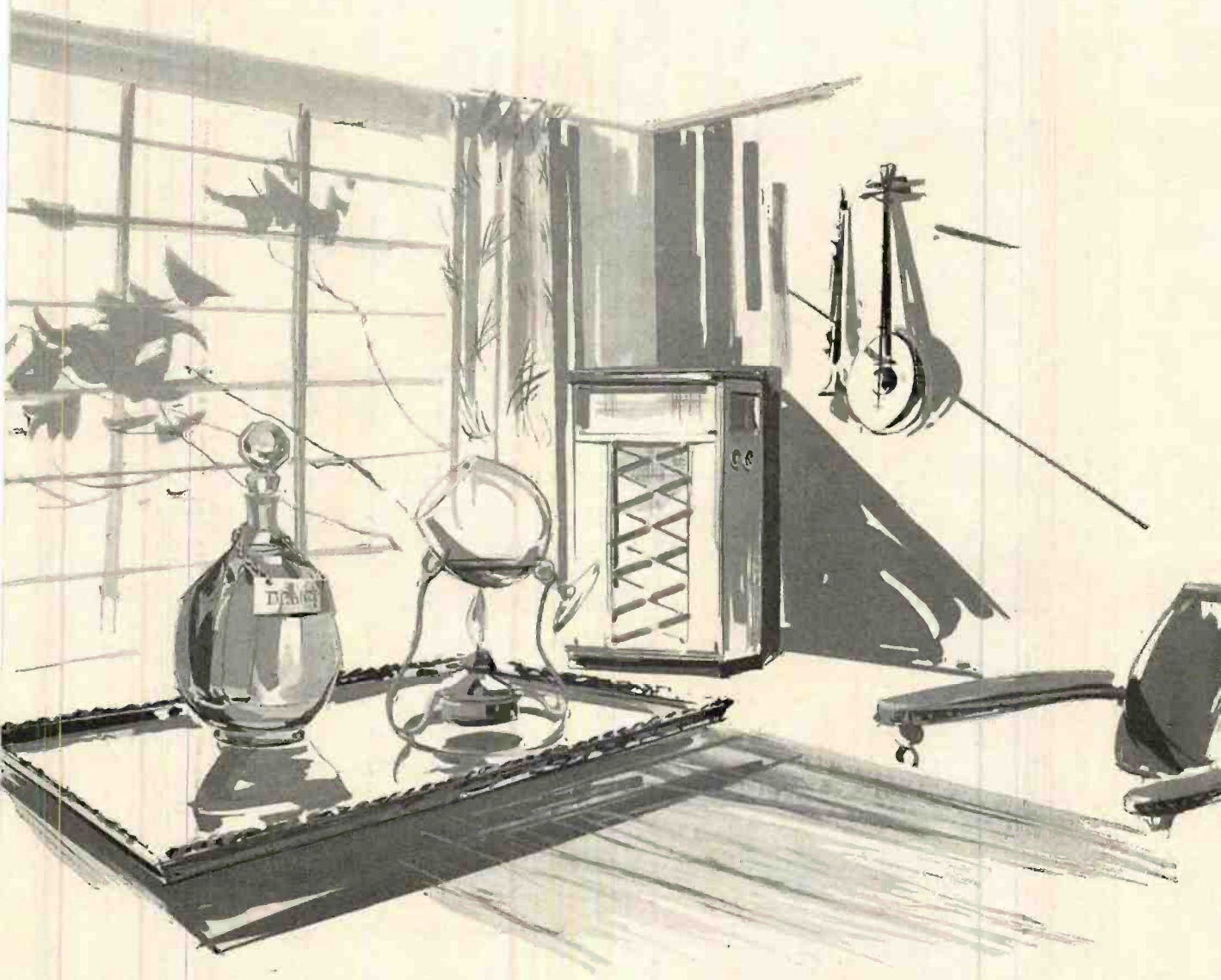

for connoisseurs . . .

Authentic High Fidelity by **Jensen**

The man who owns a Jensen Imperial takes it for granted that his loudspeaker has all of the acoustical perfection possible to achieve with the latest science and engineering. Seeking all of the finer things of life, he has a natural appreciation for the complete authenticity and blending of sound . . . the subtle separation of instruments . . . the sheer realism that uniquely characterizes the Imperial. He is the man who has bought a loudspeaker for the utmost exhilaration and delight that great music can give when it is a truly great *repeat* performance with *authentic* high fidelity by Jensen.

A Jensen Imperial is an indulgence in excitement. Do you dare to contemplate this luxury?
In selected Mahogany \$525.00. Satin Korina blonde \$535.00.

JENSEN MANUFACTURING COMPANY Division of The Muter Company
6601 S. Laramie, Chicago 38, Illinois • IN CANADA: Copper Wire Products, Ltd., Licensee

PICKERING models **220** / cartridges
240

*The Most Nearly
Perfect Phono Pickups
Ever Produced . . .*

they are sold separately for all standard arms or
mounted back-to-back to make up the famous
PICKERING 260 TURNOVER PICKUP.

MODEL 220—for 78 rpm records
diamond or sapphire stylus



MODEL 240—for 33½
and 45 rpm records
diamond stylus only

MODEL 260—turnover
cartridge for 78 or 33½
and 45 rpm records
(the 220 and 240
back-to-back)



The **220** and **240** are engineered to
maximize performance. By comparison they
are without equal . . .

The **220** and **240** are
Lighter—5½ grams
Smaller—5/8 by 3/4 by 3/8 inches

The **220** and **240** have
Highest Output—30 millivolts/10cm/sec.
More Compliance with Less Tracking Force
Lower Overall Distortion
Less Moving Mass
Wider Frequency Response
Mu-Metal Shielding for Less Hum

These characteristics have real meaning to those who understand that
maximum performance depends upon components which meet professional
standards. If you want the best that high fidelity can offer, ask your dealer
to demonstrate the 220, 240 and 260 Pickering cartridges . . .

The Most Nearly Perfect Phono Pickups Ever Produced

PICKERING and company incorporated • Oceanside, L. I., New York



PICKERING COMPONENTS ARE PROFESSIONAL QUALITY

“For those who can hear the difference”

. . . Demonstrated and sold by Leading Radio Parts Distributors everywhere. For the one nearest you and for detailed literature, write Dept. H-7

High Fidelity

THE MAGAZINE FOR MUSIC LISTENERS

The Cover. To nearly every one of us, no doubt, has come the experience of dreaming, while asleep, the solution of a great problem, or the creation of a splendid poem, or some kindred achievement. When we awake, in most cases, if we recall the dream-accomplishment at all, it seems nonsense by the light of day. But get this: Art Director Roy Lindstrom, at home in bed, dreamt he was in his office, indulging in witty banter with his associates. Turning from them (in his dream) he saw lying on his drawing-board a Chopin cover, which he had just finished. In case you want to see exactly the same cover . . . well, your left hand is touching it. All he had to do was copy from memory. He swears this is true.

This Issue. If you want to get attention, beat a drum. This expression usually is used metaphorically, but in the case of Hermann Scherchen it applies almost literally. Five years ago he passed out scores, gave instructions to a pair of drummers and conducted a recording session. The results were to give some thousands of listeners a new view of "Papa" Haydn, to put the name Westminster on all collectors' lips, and hugely to increase the fidelity-consciousness of the whole recording industry. Scherchen became (perhaps along with Ernest Ansermet) the musician most beloved of audio-enthusiasts, and his version of the "Military" Symphony a staple at all audio shows. It wasn't accident, as Robert Marsh makes clear in the lead article this time.

CHARLES FOWLER, *Publisher*
 JOHN M. CONLY, *Editor*
 ROY H. HOOPES, JR., *Managing Editor*
Associate Editors
 ROY F. ALLISON FRANK R. WRIGHT
 ROY LINDSTROM, *Art Director*
Editorial Assistants
 Miriam D Manning, Cora R. Hoopes
 ROLAND GELATT, *New York Editor*
Contributing Editors
 C. G. BURKE
 JAMES G. DEANE
 JAMES HINTON, JR.
 MANSFIELD E. PICKETT, *Director of*
Advertising Sales
 WARREN B. SYER, *Business Manager*
 CHRISTINE KORTE, *Circulation Manager*

Branch Offices (Advertising only): New York: Room 600, 6 East 39th Street. Telephone: Murray Hill 6-6382. Fred C. Michalove, Eastern Manager.-Chicago: John R. Rutherford and Associates, 230 East Ohio St., Chicago, Ill. Telephone: Whitehall 4-5716.-Los Angeles: 1052 West 6th Street. Telephone: Madison 6-1371. Edward Brand, West Coast Manager.

Volume 5 Number 4 June 1955

AUTHORitatively Speaking	4
Noted With Interest	9
Letters	22
As The Editors See It	33
The Triple Life of Dr. Hermann Scherchen, by Robert Charles Marsh	34
<i>Why should a conductor decorate his acreage with three recording studios?</i>	
The Day They Almost Got My Number, by Herbert Kupferberg	37
<i>A short (but heart-rending) story.</i>	
"Baha, Berofen, and Bramsu," by George E. Posner and Robert Fink	38
<i>The fi is high as Fujiyama in Old Nippon</i>	
The Well-Adjusted Watt, by Irving M. Fried	40
<i>A critical look at amplifiers and amplifier-standards.</i>	
Custom Installations	42
You Meet the Nicest People, But . . ., by Albert J. Franck	44
<i>A former record-dealer reveals some of the weirder aspects of the trade.</i>	
Music Makers, by Roland Gelatt	49
Record Section	51-89
<i>Records in Review; Dialing Your Disks; Building Your Record Library; Frédéric Chopin: A Discography by Harold Schonberg</i>	
FM Antenna Installation, by L. B. F. Carini	90
Tested in the Home	95
<i>Scott 210-C Amplifier; V-M Model 700 Tape Recorder; Sonotone 1P Cartridges; Browning FM Tuner; Quiet; Lang 15W Speaker System; The Regency Radio; Collaro RC-54 Changer; Pyramid Symphonette Player.</i>	
The Listeners' Bookshelf, by R. D. Darrell	106
Audio Forum	118
Traders' Marketplace	116
Professional Directory	124
Advertising Index	127

High Fidelity Magazine is published monthly by Audiocom, Inc., at Great Barrington, Mass. Telephone: Great Barrington 1300. Editorial, publication, and circulation offices at: The Publishing House, Great Barrington, Mass. Subscriptions: \$6.00 per year in the United States and Canada. Single copies: 50 cents each. Editorial contributions will be welcomed by the editor. Payment for articles accepted will be arranged prior to publication. Unsolicited manuscripts should be accompanied by return postage. Entered as second-class matter April 27, 1951, at the post office at Great Barrington, Mass., under the act of March 3, 1879. Additional entry at the post office, Pittsfield, Mass. Member Audit Bureau of Circulation. Printed in the U. S. A. by the Ben Franklin Press, Pittsfield, Mass. Copyright 1955 by Audiocom, Inc. The cover design and contents of High Fidelity magazine are fully protected by copyrights and must not be reproduced in any manner.

THE SOUND OF GENIUS...

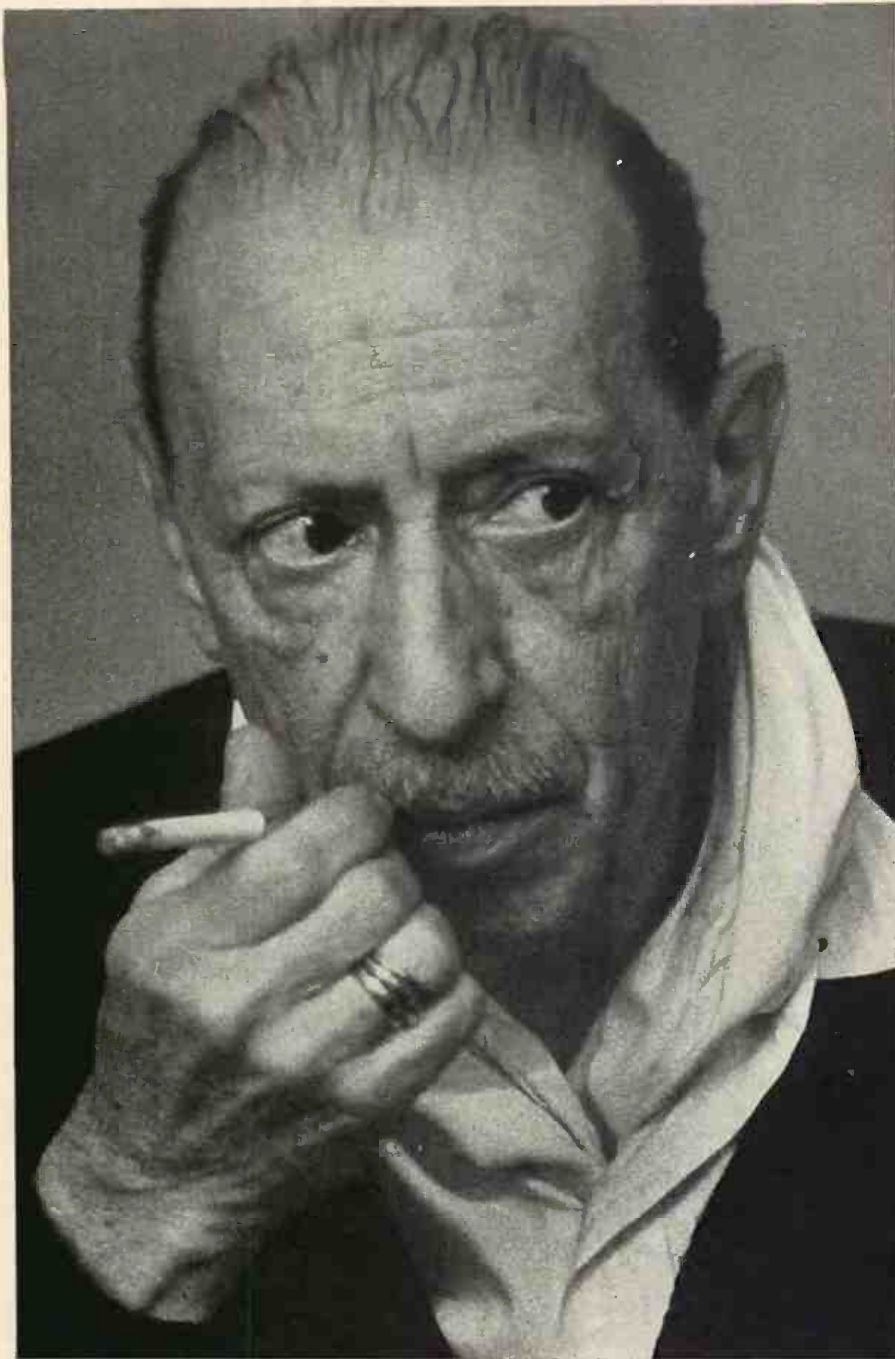

PHOTOGRAPH BY DENNIS STOCK

The world's greatest living composer, Igor Stravinsky, is known to millions for his breathtaking compositions. But as brilliant as Stravinsky the composer, is Stravinsky the conductor. To hear his music interpreted by the master is to hear the sound of genius. This unique experience is offered on many Columbia "Lp" Records whose quality has been carefully approved by Stravinsky himself. Igor Stravinsky has chosen to record *exclusively* for Columbia Masterworks Records.

COLUMBIA RECORDS

"COLUMBIA," "MASTERWORKS" TRADE-MARKS REG. U. S. PAT. OFF. MARCAS REGISTRADAS. © T. M. PRICES ARE SUGGESTED ONLY.

Recent Columbia Masterworks "Lp" Records by Igor Stravinsky include:

Stravinsky: L'histoire du Soldat—
ML 4964. \$5.95

Stravinsky: Symphony in C—
ML 4899. \$5.95

■ We will be pleased to send you a copy of the above photograph, suitable for framing. Write Columbia Records, Room 4-H, 799 7th Avenue, N. Y. C.

AUTHORitatively Speaking

This issue we begin a regular books column, by a man whose name nearly every record collector knows. He supplies it thus: R (obert) D (onaldson) Darrell—accent on the first syllable, as in "Roll out the Darrell." With pride, we roll out the Darrell column: "Listener's Bookshelf," page 106. Born in Newton, Mass., he studied music at the New England Conservatory and has been reviewing records and music-books since he was 23. He edited the first American record magazine (*The Phonograph Monthly Review*) and compiled the first discographic volume, the 1936 *Gramophone Shop Encyclopedia of Recorded Music*, as well as Schirmer's *Guide to Books on Music and Musicians*. He is author of *Good Listening* (Knopf, 1953; Mentor, 1955) and of innumerable articles.

Harold C. Schonberg, who contributes our Chopin discography, is a native of New York, which he calls "my city." Appropriately, he is a music and record critic on the *New York Times*. He is, also, almost certainly, the only music critic who has made nine parachute jumps (he was a paratroop officer during World War II) and has batted against (and been struck out by) a Major League pitcher. Schonberg can remember, he says, when the Astatic B-10 arm and the Cinaudagraph woofer-tweeter were the last word in hi-fi. He owned both. He seriously studied piano; a great help when he turns his typewriter on Chopin-interpreters. He is author of *Chamber and Solo Instrument Music*, one of the three volumes of Knopf's *Guide to Long Playing Records* (\$3.50 per volume), just published.

Two blocks south of Harold Schonberg works Herbert Kupferberg, who is record-reviewer, as well as editorial writer, for the *New York Herald Tribune*. He is likewise a New Yorker "by birth, upbringing, and inclination." He worked his way into musical writing while a reporter, covering such events as the Salzburg and Edinburgh festivals. Kupferberg is married and has a five-year-old son who, his father reports sadly, is "supremely indifferent to all forms of music except the modern music he emits himself." This note of pathos is evident also in our first short story, Kupferberg's "The Day They Almost Got My Number."

Third native New Yorker of the month: Albert J. Franck, author of "You Meet the Nicest People, But . . .," who was born in the Yorkville sector and never spoke English till he went to school—Yorkville was strictly German then. He got his first phonograph in 1902, and has been listening to records ever since, not always happily. He went to work in 1921 for the Edison Diamond Disc Shop in Brooklyn. On the sly, he made amateur recordings after hours at the Polonia studios, and projected a method of photographic tape recording, never realized. In 1929 he organized the International Records Agency, which he finally disbanded in 1953. IRA, he is pretty sure, handled more labels than any other dealer in the United States, perhaps in the world. Now what he does mostly, and enjoys best, is traveling, by rail and air.

Summertime

and the *Listenin'* is easy



Stephens Patio Enclosures let you enjoy your Music Out-of-Doors

Seasoned to your taste by Stephens Tru-Sonic quality speakers, these patio enclosures serve up your high fidelity in grand style. Imagine relaxing amid the cool breezes of your terrace or fragrance of your garden—all this and your favorite music, too, faithfully brought to you by Stephens.



Patio enclosures may be installed under the eaves or against existing walls.

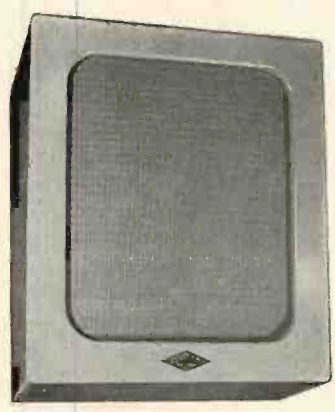

- Model 660** Bass-reflex enclosure with Stephens 12" full range speaker, 112 FR. 16" wide, 18" high, 10" deep. Shipping Weight 28 lbs. Net Complete \$67.50
- Model 662** Rear horn-loaded enclosure, 29½" wide, 20½" high, 17½" deep at top, 6½" deep at bottom.
Complete with 122AX 12" coaxial Stephens speaker. Shipping Weight 49 lbs. Net \$112.50
Complete with 112FR 12" full range Stephens speaker. Shipping Weight 48 lbs. Net \$90.00
- Model 663** Similar to Model 662 but for larger speakers. 33½" wide, 20½" high, 17½" deep at top, 6½" deep at bottom.
Complete with 206AXA 15" coaxial Stephens speaker. Shipping Weight 72 lbs. Net \$192.00
Complete with 152AX 15" coaxial Stephens speaker. Shipping Weight 67 lbs. Net \$147.00
Complete with 102FR 15" full range Stephens speaker. Shipping Weight 68 lbs. Net \$129.00
Complete with 101FR 15" full range Stephens speaker. Shipping Weight 64½ lbs. Net \$117.00



STEPHENS MANUFACTURING CORPORATION
8538 Warner Drive • Culver City, California

Cable Address: "Morhanex", Export Address: 458 Broadway, New York 13, N. Y.

*Exclusive
Flexibility*



McIntosh

C-8 PROFESSIONAL AUDIO COMPENSATOR and PRE-AMPLIFIER

The beautiful new McIntosh C-8 puts at your fingertips complete and precise audio control. The ultimate in playback performance is achieved with five Bass (turnover) and five Treble (de-emphasis) switches which operate independently and cumulatively. Innumerable compensation settings create fine degrees of sound shading. (Bass switches provide *progressive* turnover from 1200 to 280 cycles per second. Treble switches provide *progressive* roll-off from 0 to -25 db in 1 or 2 db steps!) Additional features: separate wide-range bass and treble FINE controls, a five-program-source selector, a rumble filter, an aural compensator to preserve correct tone balance at low listening levels. Hear the flawless reproduction possible with McIntosh *uncompromising* audio control at your dealer's.



\$88⁵⁰ for C-8 less cabinet; C-8M in cabinet illustrated, \$96.50 (for use with McIntosh amplifier); self-powered model C-8P (less cabinet) \$99.50; C-8PM (with cabinet) \$107.50.

Here's a miracle in music — unbelievable realism and clarity without listening fatigue. The incomparable McIntosh MC-30 main power amplifier sets a new standard of performance — GUARANTEES full 30 watts (60 watts peak) at all frequencies 20 to 20,000 cycles. Full reproduction of the highest and lowest frequencies is assured with unparalleled low distortion. Harmonic distortion guaranteed below 1/3% at 30 watts, 1/10% at 15 watts; IM distortion below 1/2% even at full 60 watts! Inaudible hum level, highest efficiency, longest life — more plus values from the exclusive potentiated McIntosh Circuit with Unity Coupling*. At your dealer's. \$143.50. * Patented 1949.



Why McIntosh has GREATER LISTENING QUALITY

The McIntosh C-8 is the most flexible audio compensator ever devised. It is fundamental to High Fidelity sound reproduction principles, which are reviewed below.

Why is compensation, or equalization, for the recording process necessary?

The recording process requires that the loudness of the music over portions of the sound spectrum be artificially raised or lowered to get the most on the record. To obtain realism in playback results we must exactly reverse this curve, thus equalizing its effect.

Why is so much flexibility necessary?

There are over 1000 recording companies using various and changing recording curves. The McIntosh can reproduce any recording curve, present or future. More important even, is its ability to adjust precisely to varying room conditions, ear preferences and speaker characteristics. The vast tonal possibilities of the McIntosh let you be your own conductor. Weathers, or constant amplitude cartridges can be switched into the equalizer, if desired, for full compensation control.

Is the McIntosh easy to operate?

Your ear will quickly get you acquainted with the tonal effects of this flexible instrument. The switches are large and easily seen. Operation is surprisingly easy and satisfying.

How do I know how to set the controls for a particular record?

Recommended playback characteristics are often given on the record jacket. McIntosh supplies a convenient Record Compensation Chart covering 55 record manufacturers, and giving 32 progressive bass turnover and treble roll-off settings.

Can control settings be relocated accurately?

The finest degree can be re-located quickly and exactly. Your own preference, once selected, can be permanently indicated on a McIntosh label and applied to the record or jacket for ready reference.

Can I connect the McIntosh to my present equipment?

Any system can now be easily altered to professional standards with the self-powered C-8P. Separate power supply, 5½" x 4¾" x 2¾", allows smaller main control unit and prevents any possible induced hum problem.

MORE EASE IN INSTALLATION

Versatile back panel features five inputs (can include two phonograph cartridges), three outputs, equalization switch for magnetic or amplitude cartridges. Variable load resistor (1,000 to 100,000 ohms) adjusts for optimum magnetic cartridge performance. Three AC outlets for master system on-off feature. Great stability, adequate frequency response and typical McIntosh lowest distortion — less than .3% at full 4 volts, 20-20,000 cycles. All controls silently operated.

Send today for details and McIntosh Master Compensation Chart for finest playback results.



Pioneer Specialists in High Fidelity Amplification

McIntosh LABORATORY, INC.

322 Water Street • Binghamton, N. Y.
Export Division: 25 Warren St., New York 7, N. Y.

Cable: SIMONTRICE N. Y.



Especially...

where
 SPACE
 is
 LIMITED

What can be said for the Axiette among high quality loudspeakers generally, is one thing. But, more significant is the fact that the Axiette has become the ideal solution to the limited space problem . . . and who hasn't such a problem!

Many would-be high fidelity enthusiasts have been discouraged by the lack of available space. While there are smaller tuners and amplifiers, little has been done to relieve the speaker situation. Most smaller speakers and enclosures don't quite have 'what it takes' for good high fidelity systems.

The little Axiette has changed this. Used in a suitable enclosure and operating at normal living room volume, it is doubtful whether a group of critical listeners could consistently distinguish between the 8-inch Axiette and a costlier, larger system. This listening quality has never before been achieved in a loudspeaker of such small proportions.

If you are being denied the enjoyment of high fidelity because of space limitations, you have the answer in the Goodmans Axiette . . . *the good little speaker that was designed to be heard — not seen.*



Complete Service Facilities maintained for your convenience

GOODMANS

Axiette
 MADE IN ENGLAND

\$23²⁰
*Slightly Higher
 on West Coast*

Sold by Leading Sound Dealers
 For Complete Literature write to: Dept. GF-2

ROCKBAR CORPORATION • 215 East 37th Street, New York 16, N. Y.



The Answer's in the Bristles

We know that many of our readers are also interested in photography, but we don't know how many of them read *Modern Photography* or of those who do how many saw the Nuclear Products ad in the February 1955 issue. One reader read both that ad and our TITH report on the Nuclear Products Staticmaster Record Brush and was puzzled over the difference in prices quoted in the two places: the ad in *MP* gave the price of \$12.50 for the 3-inch brush (advertised for use in cleaning negatives and slides), while we said that it costs \$17.85. Our reader was no more puzzled than we, so we asked for and got what seems to be a most satisfactory explanation of the discrepancy in prices: while the two brushes look alike, the hair in the hi-fi model is packed more tightly in the ferrule and is trimmed shorter in order to reach the bottom of the microgrooves. Also, and more important, the radioactive element is four times as powerful as that used in the photographic model.

Run a Loan Library?

Jokes about book borrowers are legion. It probably won't be long before there are as many about record borrowers and, with that in mind, the far-sighted McKean-Colwell Co., 400 Madison Avenue, New York 17, N. Y., has announced "record plates" — little stickers reading "From the record collection of . . ." which can be attached in a jiffy to record jacks. Size is 4 by 1 in.; cost, 50 for \$1. — Nice idea, we think.

Hi-Fi Openings

Ozarkians and their neighbors, please note: Frank Peters has opened a hi-fi store at 1104 North Jefferson in Springfield, Mo., offering service as well as sales.

In Pittsburgh, at 633 Liberty Ave., Lomakin Music is the name of the new hi-fi shop.

Continued on page 12

Get the most for your money in quality KNIGHT HIGH FIDELITY COMPONENTS



Knight "Bantam" Hi-Fi Amplifier

Compact—no cabinet required. Full 12 watts output; response, ± 5 db, 20-20,000 cps; 3-position record compensation; loudness-volume control; tape recorder input and output jacks; microphone input; separate bass-treble controls; handsome black metal cabinet with etched gold trim, $3\frac{1}{2} \times 13 \times 10\frac{1}{4}$ ".
93 SX 312. Net only. \$59.50



"Golden Knight" 24 Watt Hi-Fi Amplifier

Brilliant performance; response, ± 0.75 db, 20-40,000 cps; less than 1% harmonic distortion at 24 watts; 3 positions of record equalization; separate bass and treble controls; 4 inputs; 8 and 16 ohms speaker output impedance. Rich satin gold finish, $8 \times 14 \times 9$ ". Removable escutcheon for custom panel mount.
93 SX 321. Net only. \$79.50

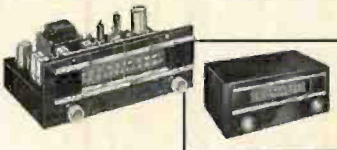

Knight FM-AM Hi-Fi Tuner

The ideal "space-saver" tuner. Highly sensitive drift-compensated circuit with AFC. RF stage on AM and FM. Loop for AM. Sensitivity: FM, 5 mv. for 20 db quieting; AM, 5 mv. Controls: tuning and selector. 10 tubes plus rectifier. Measures only $5\frac{1}{2} \times 13\frac{3}{4} \times 7\frac{1}{2}$ ".
94 SX 728. Net only. \$89.50
As above, but in black and gold metal cabinet, $6 \times 13\frac{3}{4} \times 8\frac{3}{4}$ ".
94 SX 729. Net only. \$95.50



Knight Self-Powered Preamp-Equalizer

Efficient, versatile control unit for any basic Hi-Fi amplifier. Response, ± 1 db, 30-30,000 cps; 3-position record compensator; 4 inputs; magnetic phono, tuner or crystal phono, tape, microphone; output, 2.5 volts; tape output, 1 volt; hum, -65 db. In compact black and gold metal cabinet, $3\frac{1}{2} \times 11\frac{1}{2} \times 5\frac{1}{2}$ ".
93 SX 315. Special Price Until Sept. 1, 1955. \$32.95

designed and built to ALLIED'S specifications

KNIGHT High Fidelity components give you the most for your money in performing quality, appearance and dependability. These units are designed and built to ALLIED'S own high specifications by outstanding makers of hi-fi equipment. Because these components are offered as ALLIED'S own private-brand products, large savings are passed on to you. KNIGHT quality is backed by an unconditional guarantee for one full year, and a 15-day trial offer with money-back guarantee. KNIGHT gives you the best Hi-Fi for less.

Knight System Value



"Space Saver II" Hi-Fi Phono System

Here's authentic Hi-Fi performance that fits in the smallest available space. No cabinets required. System includes: Knight 12 watt "Bantam" Amplifier, Webcor 3-Speed Changer (in Russet and Beige or Burgundy and Beige) with G.E. RPK-050 magnetic cartridge and dual-tip sapphire stylus; Electro-Voice "Baronet" enclosure with SP8-B speaker (in Mahogany or Blonde). Ready to plug in; hi-fi record included. Specify colors.
94 PA 159. Net only. \$157.95

FREE ALLIED'S 68-Page Hi-Fi Catalog

Your guide to a complete understanding of Hi-Fi. Shows you simply and clearly how to select a Hi-Fi music system at lowest cost; contains many hand-

some do-it-yourself installation ideas. Offers you the world's largest selection of complete systems and individual units (amplifiers, tuners, speakers, enclosures, changers, recorders, accessories) from which to make your money-saving choice. To understand Hi-Fi, to own the best for less, write for this FREE book.

ALLIED RADIO CORP., Dept. 49-F-5
100 N. Western Ave., Chicago 80, Ill.

Send FREE 68-Page Hi-Fi Catalog.

Ship the following: \$ enclosed

Name

Address

City Zone State

ALLIED RADIO

America's Hi-Fi Center

Send for FREE
Hi-Fi Catalog



Ask Your
Authorized
Fleetwood Dealer
for Free Booklet of
Installation Ideas
or write

CONRAC, INC., Glendora, California

ARIZONA

AUDIO SPECIALISTS

333 E. Camelback Rd., Phoenix
Phone: AMherst 5-0447

ELECTRICAL COMMUNICATION CO.

202 E. Fillmore, Phoenix
Phone: ALpine 2-8248

CALIFORNIA

TALK-O COMMUNICATION

407-J Commercial Center St., Beverly Hills
Phone: CRestview 1-4548

TURNTABLE HI-FI

116 West Wilshire, Fullerton
Phone: LAmbert 5-0811

HOLLYWOOD ELECTRONICS

7460 Melrose Ave., Hollywood 46
Phone: WEbster 3-8208

PACIFIC HI FI HOUSE

1320 Cahuenga Blvd., Hollywood 28
Phone: HO 2-6767

DACKNEY ELECTRONICS

343 E. Market Street, Long Beach 5
Phone: 206-491

FIGART'S SOUND UN-LTD.

6320 Commodore Slaat Dr., Los Angeles 48
Phone: YO. 6218

HENRY RADIO

11240 W. Olympic Blvd., Los Angeles 64
Phone: BRadshaw 2-1440, ARizona 3-0518

CUSTOM AUDIO

413 29th St., Newport Beach
Phone: HARbor 1444-W

COAST ELECTRONIC SUPPLY CO.

"STAIRWAY TO SOUND"
4166 Broadway, Oakland 11
Phone: OLYmpic 3-7138

HIGH-FIDELITY HOUSE

536 S. Fair Oaks Ave., Pasadena 1
Phone: RYan 1-8171

SOUND SHOPPE

1910 16th St., Sacramento 14
Phone: GILbert 3-6660

HOLLYWOOD HI-FI SHOP

1839 E Street, San Bernardino
Phone: 83-6101

CONNECTICUT

DAVID DEAN SMITH

262 Elm Street, New Haven
Phone: UNiversity 5-1101

METTLER PIANO SHOWROOM

Westfair Center, Post Rd., Westport
Phone: Fairfield CLEARwater 9-8391

GEORGIA

BAKER FIDELITY CORP.

1140 Peachtree St., NE, Atlanta
Phone: EMerson 2156

ILLINOIS

ALLIED RADIO CORPORATION

100 N. Western Ave., Chicago 80
Phone: HAYmarket 1-6800

ELECTRONIC EXPEDITERS

THE HI-FI CENTER
2909 W. Devon Ave., Chicago 30
Phone: RO. 4-8640

VOICE & VISION, INC.

53 E. Walton Place, Chicago 11
Phone: WHitehall 3-1166

KANSAS

PHIL WOODBURY SOUND

1103 Com'l, Emporia
Phone: 20

MASSACHUSETTS

LAFAYETTE RADIO

110 Federal St., Boston 10
Phone: HUbbard 2-7850

MICHIGAN

MODERN SOUND

5151 Adams, Birmingham
Phone: MIdwest 4-8494

WEST MICHIGAN SOUND COMPANY

1932 Peck St., Muskegon
Phone: 2-5910

NEW JERSEY

INTERNATIONAL DISTR.

185 Central Ave., E. Orange
Phone: ORange 5-1927

FEDERATED PURCHASER

1021 U.S. Rt. #22, Mountinside
Phone: WEstfield 2-0310

LAFAYETTE RADIO CORP.

24 Central Ave., Newark
Phone: MArket 2-1661

THE JABBERWOCK

104 Somersset St., New Brunswick
Phone: CHarter 9-1900

BREMY ELECTRONICS

394 E. 18th St., Paterson
Phone: LAmbert 5-1191

LAFAYETTE RADIO CORP.

139 West 2nd St., Plainfield
Phone: PLainfield 6-4718

JOHN J. CASEY CO.

856 Lincoln Place, Teaneck
Phone: TE. 6-7761

NEW YORK

COMMERCIAL SOUND SYSTEMS, INC.

11 N. Pearl St., Albany 7

BROOKLYN HI-FI CENTER

2128 Coton Ave., Brooklyn
Phone: BUckminster 2-5300

MILAU ELECTRONICS

7854 79th St., Glendale, L.I.
Phone: EVERgreen 6-1690

ISLAND RADIO DISTRIBUTORS, INC.

412 Fulton Ave., Hempstead, L.I.
Phone: IVanhoe 1-8160

ELECTRONIC SUPPLY CORP.

41-08 Greenpoint Ave., Long Island City 4
Phone: Stillwell 6-2730

ARROW AUDIO CENTER

65 Cortlandt St., New York
Phone: Dlgby 9-4714

FEDERATED PURCHASER

66 Dey St., New York
Phone: Dlgby 9-3050

HARVEY RADIO COMPANY, INC.

103 West 43rd St., New York 36
Phone: JUdson 2-1500

LAFAYETTE RADIO CORP.

100 Sixth Ave., New York
Phone: REctor 2-8600

LEONARD RADIO, INC.

"AUDIO MART"
69 Cortlandt St., New York 7
Phone: CO. 7-0315

SUN RADIO & ELECTRONICS CORP.

650 Sixth Avenue, New York
Phone: OREGon 5-8600

SUTTON AUDIO SYSTEMS

970 First Avenue, New York 22
Phone: PL. 3-7224

TERMINAL RADIO CORPORATION

85 Cortlandt St., New York 7
Phone: WOOrth 4-3311

NEW YORK (Continued)

JULIUS WEIKERS & CO.

307 Audubon Ave., New York 33
Phone: TOMpkins 7-2971

JERRY FINK CO.

644 Clinton Ave., South, Rochester 20
Phone: BRowning 3503

SEGEN ELECTRONICS

118 Glen Cove Rd., Roslyn Heights, L.I.
Phone: ROSlyn 3-4950

WESTLAB

2475 Central Ave., Yonkers
Phone: SPencer 9-6400

OHIO

AUDIO CRAFT CO.

2915 Prospect Ave., Cleveland 15
Phone: CHerry 1-5560

CUSTOM ELECTRONICS, INC.

1000 So. Main Street, Dayton 9
Phone: ADams 3158

CUSTOM CLASSICS

13421 Euclid Ave., E. Cleveland 12
Phone: GL. 1-4868

COUNTERPOINT

20971 Westgate Shopping Center,
Fairview Park 26
Phone: ED. 1-6448

R.S.T. LABS

14511 Granger Rd., Maple Heights
Phone: MOntrorse 2-3213

OREGON

L. D. HEATER MUSIC CO.

1001 S.W. Morrison, Portland 5
Phone: ATwater 8455

PENNSYLVANIA

HI FIDELITY ELECTRONIC SOUND CORP.

368 Montgomery Ave., Marion
Phone: WE. 4-3404 — GR. 3-6767

DANBY RADIO CORP.

19 South 21st St., Philadelphia 3
Phone: RIttenhouse 6-5686

RADIO ELECTRIC SERVICE CO.

HIGH FIDELITY SOUND STUDIO
709 Arch Street, Philadelphia 6
Phone: LOmbard 3-7390

TEN CATE ASSOCIATES

6128 Morton St., Philadelphia 44
Phone: GERMantown 8-5448

TENNESSEE

BLUFF CITY DISTRIBUTING CO.

234 East St., Memphis 2
Phone: 36-4501

TEXAS

CRABTREE'S

2608 Ross Avenue, Dallas
Phone: STerling 5361

TOWN NORTH MUSIC CORP.

5328 W. Lovers Lane, Dallas 9
Phone: ELMhurst 6477

CLIFFORD HERRING SOUND EQUIPT. CO.

W. Lancaster at Burnet Sts., Fort Worth 3
Phone: FO. 4877

GULF COAST ELECTRONICS

1110 Winbern St., Houston 4
Phone: JUstin 1551

WASHINGTON

OLYMPIC ENGINEERING CO.

2008 Westlake Ave., Seattle 1
Phone: ELiot 4650

UNIVERSITY HI-FI SHOP

4111 — University Way, Seattle 5
Phone: ME. 6000

WISCONSIN

THE HI-FI CENTER, INC.

2630 No. Downer Ave., Milwaukee 11
Phone: WOODruff 4-3344

CUSTOM TELEVISION WITH . . .

easy installation

Whenever you want your television set built in — in Grandma's old breakfront, a room divider, the wall or custom installed in any manner — Fleetwood's the television system for you. It's designed for custom installation, designed for convenience, too. Full electronic remote tuning control lets you tune your set without ever leaving your chair.

The picture's extraordinary, too. It's the sharp, clear picture usually seen only on TV station monitors (also built by Fleetwood). Supplies audio power for your speaker and has high fidelity output to connect to your sound system.

Fleetwood readily adapts to U.H.F. Both remote (2 chassis) and non-remote Fleetwood units are available for 21", 24" and 27" picture tubes.

Fine Fleetwood performance is available in units starting at \$199.50. Write for complete information and name of dealer nearest you.

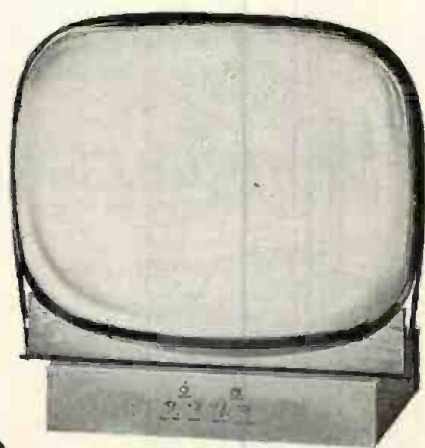

Fleetwood

CUSTOM TELEVISION

Manufactured by CONRAC, INC., Dept. A, Glendora, California

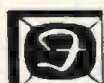

true audio-video fidelity

Export Division: Frazar & Hansen, Ltd., 301 Clay St., San Francisco 11, Calif.

Announcing!



THE NEW
HIGH-QUALITY
LOW-COST
FAIRCHILD 255
25 WATT

**POWER
AMPLIFIER**

Here's a mighty twin to Fairchild's big-power 260 Professional Amplifier. The new 255 delivers a full 25 watts of undistorted power for the finest sound, best reproduction!

This is the ideal power amplifier for the average home or apartment. The Fairchild 255 gives you full power from deepest bass to highest treble, and an instrument especially designed for minimum transient distortion as

well as lowest IM and harmonic distortion, resulting in exceptionally true natural sound. Superbly engineered, the 255 has a controlled frequency response of +0 to -1/2 db, from 20 to 20,000 cps.

You can always restore "new amplifier" performance to the Fairchild 255, even if tubes age unequally, by Fairchild's simple, exclusive distortion-cancelling balance control.

COMPACT: Only 6" x 9 1/2" base and 6 1/2" high
INPUT IMPEDANCE: 100K
POWER GAIN: 42db
HIGH SENSITIVITY: Less than one volt input required for full output

and it's only \$89.50



FAIRCHILD 260
50 WATT

**PROFESSIONAL
AMPLIFIER**

When you need full 50 watts of power, get the Fairchild 260!

This high-power instrument offers complete stability under all loading conditions — won't ring with most

severe transients! And, thanks to Fairchild's exclusive distortion-cancelling balance control, you can always restore "new-amplifier" performance.

only \$149.50

**FAIRCHILD RECORDING
EQUIPMENT**
10th AVENUE AND 154th STREET, WHITESTONE, NEW YORK

NOTED WITH INTEREST

Continued from page 9

Edisons At Work

As though in direct response to our "Edison" article, February issue, British Industries informs us that their Garrard changers are now equipped with a spring mounting assembly which allows the user easily to adjust the level of the changer (each spring mounting) from the top of the unit plate with an ordinary screwdriver.

And Browning Laboratories has a new AM shortwave tuner (See their ad p. 115) which seems to be just what the doctor ordered.

Columbia Records, 1954

We just received CBS's 1954 Annual Report, and in the 9-page chapter devoted to Columbia Records we ran across a few items which might interest you.

Their single LP "best-sellers" were orchestral, overwhelmingly: 1st place, Kostelanetz' *Carmen* for Orchestra, and 4th place, his *La Traviata* for Orchestra. Mitropolous and the New York Philharmonic-Symphony took 2nd place with *Caucasian Sketches*. 3rd, 6th, 7th, 8th, and 10th places went to Ormandy and The Philadelphia Orchestra for recordings of *Capriccio Espagnol*, a Wagner program, *Gaité Parisienne*, *Les Sylphides*, *Scheherazade*, and *Ein Heldenleben*, in that order.

E. Power Biggs' recording of works by Liszt and Reubke, recorded at Methuen, Mass., was the only solo work in the list and it took 5th place.

Ninth-ranking best-seller was the Prades Festival (1953) recording of the Schumann Concerto in A minor for Cello and Orchestra.

Brubeck topped jazz record sales.

News from Remington Records

As though \$2.99 weren't a pretty darned decent price for a record, Remington announces a reduction to \$1.95 for their 12-inchers. In addition, all their records are now factory-sealed in polyethylene envelopes.

Apologia

The fine photograph of Wilhelm Furtwängler used in our April issue was by

Continued on page 14

To Ad Agency
This ad answers an important question.
Run it again.

"Which Rek-O-Kut Turntable Shall I Buy...

George Silber

the RONDINE, the RONDINE Deluxe or the RONDINE Jr.?"

*In previous years, the question was: "Shall I buy a turntable or a record changer?" And about eight months ago we released an advertised statement in answer to this question. Thus far, more than 40,000 people have requested reprint copies of this statement.**

This year, we presented the Rondine line in Chicago. At the very first showing we knew that we had passed the severest test. The acclaim was overwhelming. It exceeded our wildest hopes and expectations. And the pattern has since been the same... New York... Boston... everywhere. Now the one question that stands out is: "Which shall I choose: the Rondine at \$69.95, the Rondine Deluxe at \$119.95 or the Rondine Jr. at \$49.95?"

The RONDINE Deluxe (3-speed) priced at \$119.95 is powered by a hysteresis motor. The speed of a hysteresis motor is synchronous with the frequency of the line current. Like the motor of an electric clock (which it resembles in principle only) the speed is constant and accurate to the split second. It has the least vibration of any motor, and therefore, the least rumble. The Rondine Deluxe represents the very finest equipment available. It is the indicated choice where the system and speaker with which it is to be used are capable of reproducing low frequencies to below 40 cycles.

The RONDINE (3-speed) priced at \$69.95 is driven by a specially built 4-pole induction motor. Vibration and noise have been effectively reduced through the use of selected motor bearings, dynamically balanced rotors and perfectly concentric drive pulleys. Each motor is individually tested for speed under load conditions, and permanent compensations are introduced for accurate timing. Rumble content is so low that in a system capable of reproducing 40 cycles, it can be detected only with appreciable bass boost. The Rondine meets the requirements of most high quality home systems.

The RONDINE Jr. (2-speed) priced at \$49.95 is driven by the same type of motor as the Rondine, and what has been said for the Rondine is equally applicable here. Where the user can dispense with the 78 rpm record speed, the Rondine Jr. represents true economy — without the slightest sacrifice in quality over the Rondine. It is the ideal home system turntable where there is no accumulated 78 rpm library, and where future record purchases will be limited to the modern 33 $\frac{1}{3}$ and 45 rpm types.

Select the Rek-O-Kut turntable suitable for your particular needs. For, whether you choose the Rondine, the Rondine Deluxe or Rondine Jr., you can expect rugged, reliable construction and precision performance. You can expect constant, steady motion — freedom from wow and flutter — and you can be sure of smooth, quiet operation.

So certain are we that the speeds, once set, are critically accurate that we make no provision for external adjustments by you — except for occasional maintenance. And we include a built-in strobe disc capable of revealing as little as $\frac{1}{10}$ th of 1% speed discrepancy. We know of no manufacturer who places greater reliance upon the dependability of his product.

Basically, this is all the result of specialized experience gained over many years in the service of recording and broadcast studios. It is this store of engineering 'know-how' which has enabled us to develop a completely simplified mechanics in turntable design; to streamline every operation with no more parts than are absolutely essential for efficient, functional performance. These efforts have been repaid in enabling us to achieve greater noise reduction, easier maintenance and added years of useful service.

No matter what turntable or record changer you now use, a Rek-O-Kut Rondine — any one of the three — will make a marked improvement in the performance of your high fidelity system.

*You may obtain a reprint of: "Shall I Buy a Turntable or Record Changer?", plus complete Rondine specifications, by writing Dept. VF-2



REK-O-KUT COMPANY

Makers of Fine Recording and Playback Equipment
Engineered for the Studio • Designed for the Home
38-01 Queens Boulevard, Long Island City 1, N. Y.

THE EXCEPTION TO THE RULE

Weathers' Decorator



... **NOT just another SPEAKER!** It is an integrated acoustical system capable of astounding performance.

- A Decorator's delight and an Audiophile's dream come true.
- Solid mahogany under all finished surfaces by master craftsmen.
- Full range natural reproduction of sound; "lows" which you feel.
- All engineered to produce extraordinary presence, clean dynamics and transients, voice reproduction with startling realism.
- All done by the same technical magic which produced the world's finest phonograph pickup, the famous WEATHERS FM 1-gram pickup.

Try it in your home. It weighs only 45 lbs. and this package of sound realism is packed into a space of 8 3/4" deep, 32" long and 26" high!

The price—Audiophile Net \$135.00 Write for full information



66 E. Gloucester Pike, Barrington, N. J.

EXPORT OFFICE

401 Broadway, New York 13, N. Y.

NOTED WITH INTEREST

Continued from page 12

Roger Hauert, of Paris. We deeply regret that credit to that artist was inadvertently omitted.

Tape (1)

Three-year-old World Tape Pals is due a brisk pat on the back for their achievements in providing a means for people throughout the world to exchange tapes. They started with a form letter to newspapers in the main cities in every country which resulted in obtaining twenty members in six countries. Their roster now lists nearly one thousand members in forty-six countries. If you're interested in knowing more about this club write to them at Box 9211, Dallas, Tex.

Tape (2)

Ever have a hankering to sit back and have music without having to listen to it? . . . for hours on end without even 25-minute plops and crashes as records drop? Background music on tape is the answer, and Electrosonic Specialties, 7230 Clinton Road, Upper Darby 1, Pa., has it—in the form of Fidelivox Tapes, which feature pipe organ music played by Robert Elmore. In 2, 4, 6, and 8-hour sections, dual track. Drop them a line for more information.

Tape (3)

Everyone heard about the Recorded Tape-of-the-Month Club? Half-hour, 7-inch reel, recorded at 7½ ips single track, for \$5.95? You pay a \$2.00 membership fee which brings you six monthly preview tapes; you have to order a minimum of two regular reels per six-month period; if you order three, you get a bonus reel free. Or, as an introduction, send 50c for one Preview tape; no obligation. Write them at Radio City Station Box 195, New York City.

Tape (4)

Anyone interested in a tape-recorded "Story of Jujitsu"? It has just been made available by the Institute of Integration (Pyramid, Nev.), which is something we don't understand since we thought jujitsu was an orderly (sometimes disorderly) method of physical disintegration. Anyway, the

Continued on page 16

Incomparable...

Since 1935
the Garrard has been
sold and serviced
throughout the United States.

It is recognized every where
for superior
performance, ruggedness
and reliability.

**CHECK CRAFTSMANSHIP, FEATURES,
PRICE AND SERVICE . . .**

and you will understand clearly why this is
the world's No. 1 high-fidelity record changer.

"RIGHTS" and "WRONGS"
of record changer design
(Important in protecting your records).



RIGHT:

Garrard Precision Pusher Platform . . .
the only record changing device that insures
positive, gentle handling of records with standard
center holes.

WRONG:

"Overhead Bridges" (as on ordinary changers)
. . . which may damage or dislodge records
accidentally.



RIGHT:

Garrard removable and interchangeable
spindles . . . Easily inserted; accommodate all
records, all sizes, as they were made to be
played; pull out instantly to facilitate removal of
records from turntable.

WRONG:

Fixed Spindles (as on ordinary changers) . . .
which require ripping records upwards over
metallic spindle projections after playing.

Other Garrard features include: a pole meter
—no rumble, no induced hum • heavy drive shaft
—no wows, no waves • weighted turntable-
flywheel action, constant speed • muting switch
—silence between records • silent automatic
stop—shuts off after last record; no disturbing
"plop". • easy stylus weight adjustment—pro-
tects long-playing records • balanced-mounted
tone arm—true tangent tracking • universal shell
—fits all popular high fidelity cartridges

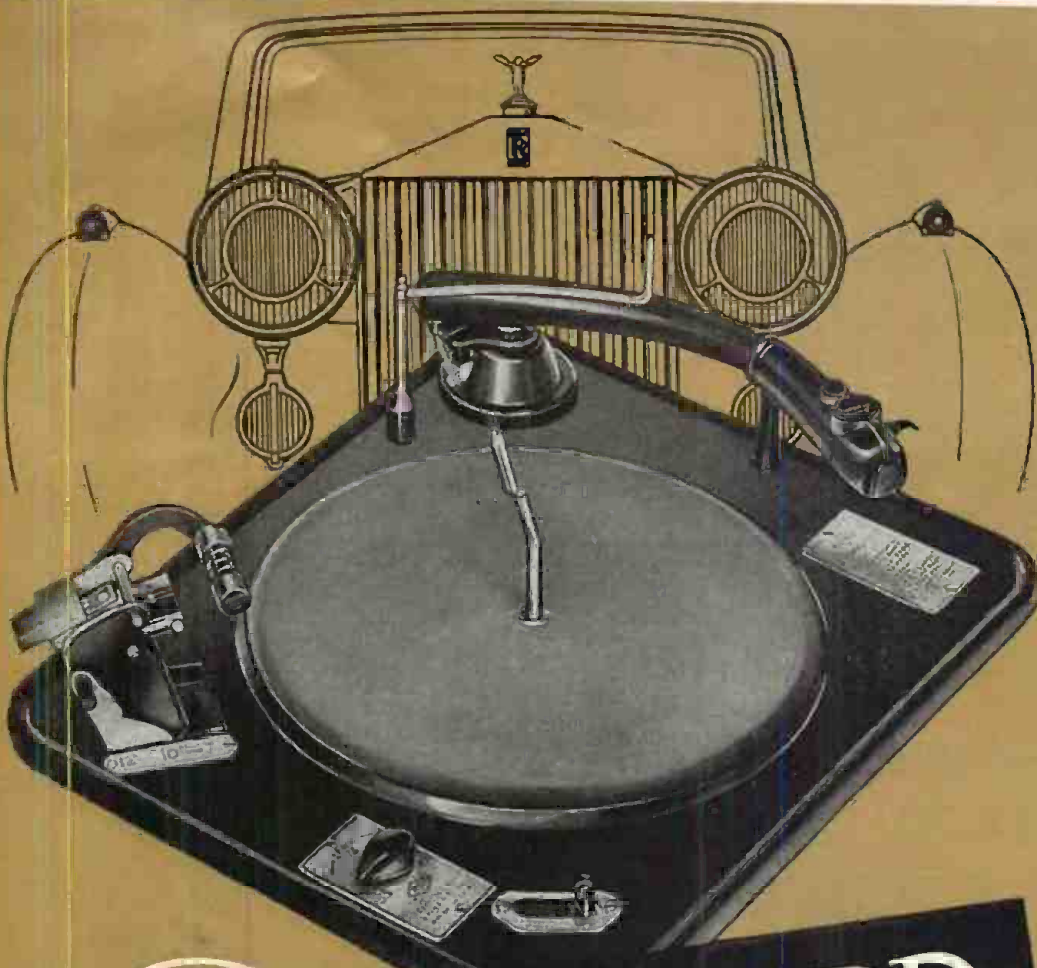

GARRARD "Triumph"

World's Finest Record Changer

A Quality Endorsed Product of the BRITISH INDUSTRIES GROUP,
which also includes

WHARFEDALE LOUDSPEAKERS . . . designed and built under the personal super-
vision of G. A. Briggs . . . world renowned authority on sound. Wharfedale Loudspeakers
offer the unique construction feature of cloth suspension—a felt buffer between speaker
frame and cone—and cast chassis.

LEAK TL/10—High fidelity AMPLIFIER complete with "Point One" REMOTE CON-
TROL PRE-AMPLIFIER. Most economical amplifier combination ever built by Leak.
Harmonic distortion only one tenth of one percent. Insures flawless reproduction.
EXCLUSIVE FEATURE! Convenient tape recorder jacks (input and output) on front panel
for instantaneous use!

R-J LOUDSPEAKER ENCLOSURES—"Maximum Bass—Minimum Space" Hearing
is believing! R-J Speaker Enclosures have established an entirely new trend in audio
design with thrilling performance from any loudspeakers, Bookshelf and Floor Models.

THE R-J WHARFEDALE . . . First and only complete R-J unit! Two great products—
the R-J single shell ENCLOSURE and a special WHARFEDALE SPEAKER have been
brilliantly matched in this . . . the definitive combination among compact high-
performance speakers.



**WRITE FOR A COPY OF
"SOUND CRAFTSMANSHIP"**

Mail coupon today for a complimentary
copy of "Sound Craftsmanship" 16
pages illustrating and describing all
products of the British Industries Group.



BRITISH INDUSTRIES CORP., Dept. HF6-5
164 Duane Street
New York 13, N. Y.

Please send "Sound Craftsmanship" to:

Name _____
Address _____
City _____ Zone _____ State _____



**CANADA'S FIRST HIGH-FIDELITY RADIO,
PHONOGRAPH, RECORD AND TELEVISION CENTRE**

Complete stock of Stromberg-Carlson, Fisher, Hallicrafters, Concertone, Brociner, Scott, Freed-Eisemann, Sonotone, Electro-Voice, RCA Victor and General Electric Hi-Fi equipment.

Prompt attention to mail orders — We ship from coast to coast in Canada, aircargo, express or freight.

Custom Sound and Vision Ltd.

390 Eglinton West Telephone HUDson 9-2117 Toronto, Ontario

**HERE IS TELEVISION
FOR YOUR
HIGH FIDELITY
SOUND SYSTEM**

Designed and custom-built to operate through your high fidelity amplifier and speaker system (or independently, if you wish). In this way, you enjoy the VIDEO quality of Tech-Master's advanced 630-type design and the AUDIO quality of your own high fidelity system.

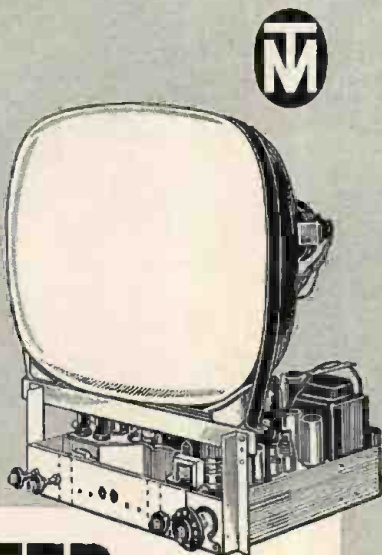

**TECH-MASTER GOLD MEDAL
TV CHASSIS**

Designed for use with Home High Fidelity Systems

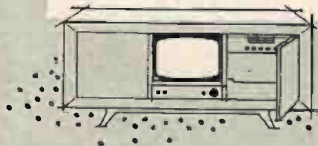

Illustrated Brochure Upon Request
TECH-MASTER CORPORATION
75 Front Street, Brooklyn 1, N. Y.

NOTED WITH INTEREST

Continued from page 14

Institute has put a whole bunch of lectures onto tape. If you get the one on jujitsu (No. 4), you'd better follow up with No. 10, "The Parts of Man," then No. 34, "The Four Degrees of Integration," thence quickly to No. 6, "The Fully Integrated Man," and wind up catching your breath with No. 37, "The Second Silence."

That's just five of the forty taped lectures available from the Institute. If you're interested, write for their list and price information.

Jazz from Belcourt

Once again the good word is in from Newport, R. I., that plans are underway for a summer jazz festival. Naturally, it will be bigger and better than last year's which, according to one of our men who attended, was pretty good. This year's festivities will take place July 15, 16, and 17, on



Belcourt

the grounds of "Belcourt," one of the largest of Newport's renowned mansions, large enough, in fact, to accommodate 10,000 people. Some 150 jazzmen will be on hand including Louis Armstrong, Count Basie, Duke Ellington, Woody Herman, The Modern Jazz Quartet, Chet Baker, Louis Bellson, Errol Garner, Coleman Hawkins, Gerry Mulligan, and Lester Young.

Tickets are being sold now for reserved seats only. If anyone wants more information, a letter addressed to The Newport Jazz Festival, Belcourt, Newport, R. I., should bring the answers.

Hi-Fi Concert

If Emory Cook will kindly allow us the use of his trade name we would like to report on what is definitely a "Sound of Our Time." Down in Owning Mills, Md., the Chestnut Ridge Fire Protection Assn., in an attempt to raise funds for community fire fighting

Continued on page 18



HARVEY the House of Audio



The NEW REK-O-KUT *Rondine* 3-Speed, 12-inch PRECISION TURNTABLES

Represented to be the result of more than 5 years study, these new record playback units are offered at the closest approach to perfection in turntable performance. Like all Rek-O-Kut units, the turntable is cast Aluminum and exerts no pull on magnetic cartridges.

The following new features have been included: • single selector knob for setting speed: 33 1/3, 45 and 78 rpm. • built-in retractable hub for 45 rpm records—requires no external adapter • permanently affixed 3-speed strobe discs for instantaneous speed checking • neon pilot lights as "on/off" indicator • special cork-neoprene mat material to eliminate record slippage • rectangular deck to fit conventional record changer boards.

Two identical Rondine models are available which differ only in the type of motor employed.

Randluxe Daluxe Model B-12M hysteresis synchronous motor. **\$119.95**
Rondine Model B-12 with 4-pole induction motor. **74.95**

New ELECTRO-SONIC Concert Series Electro Dynamic PHONO CARTRIDGE



Designed for use only in high quality pickup arms, the Concert Series Cartridge provides performance in home systems equalled only by the Professional unit. As with other ESL cartridges, the Concert Series is built around D'Arsonval moving coil. Dynamic mass has been kept to .001 gram with unusually high compliance. Frequency response extends from 16 to beyond 30,000 cycles. Intermodulation distortion is immeasurably small. Because of the low output voltage and impedance, a matching step-up transformer may be required. The output of this transformer feeds directly into the magnetic phono input of any conventional preamp-equalizer.

ESL Concert Series diamond stylus only. **\$35.95**
Specify .001" or .003".

Matching Transformer Assembly Model ESL 201M—consists of an ESL 201 transformer mounted on small chassis with input jack and output shielded cable with pin plug. **11.00**



Deluxe 3-Way Speaker System WHARFEDALE Loudspeakers RIVEREDGE 'Briggs' Corner Enclosure

An unusual reproducer system employing recognized high quality components. Consists of Wharfedale W15/CS 15" 20 watt woofer, Wharfedale Super 8/CS/AL 8" mid-range loudspeaker, and the Wharfedale Super 5 cone

tweeter, electrically isolated and balanced by means of a Wharfedale 3-speaker Crossover Network.

The enclosure is built in accordance with acoustical specifications of Briggs, famous British designer. Entire front is sand filled for added stiffness and to eliminate spurious resonances.

The performance of this system will be a distinct revelation. Efficient loading gives clean fundamentals to below 35 cycles. Use of similar material (cones) in all three speakers provides smooth response up to the 20,000 cycle limit of the tweeter. Finishes available: Mahogany, Walnut, Fruit Wood, Blonde on Birch and Maple veneers.

Deluxe 3-Way Speaker System complete with speakers, crossover, enclosure and specially treated sand. **\$259.50**

NOTE: Prices Net, F.O.B., N.Y.C. Subject to change without notice

ESTABLISHED 1927
HARVEY RADIO COMPANY, INC.
103 W. 43rd Street, New York 36 • JU 2-1500



MAGNECORD M81 Series Portable TAPE RECORDER

The basic tape transport mechanism operates at 15 and 7 1/2"/sec. A switch is used for speed selection. Other controls are push-button operated. Accommodates reels up to 10 1/2". Frequency response at 15"/sec. extends from 40-15,000 cycles ± 2 db. Employs 3 heads: erase, record and playback. In 'record' position playback head serves as monitor.

Separate record and playback amplifiers are available thus permitting simultaneous monitoring from tape. Record amplifier has high impedance, unbalanced microphone input and unbalanced bridge input. Balanced 50 ohm mike input and balanced bridge input available through use of optional plug-in transformer. Meter is provided for bias, record and playback. Has cathode follower output. Optional plug-in transformer provides balanced 600 ohm output.

M81-A	Recorder Mechanism in portable case	\$635.00
M81-AX	Same as above but less case, for rack mounting	575.00
91X1552	Case only for recorder mechanism (with blower assembly)	62.50
M81-C	Record/Playback Amplifier in portable case	245.00
M81-CX	Same as above but less case, for rack mounting	225.00
81D50	Case only for Record/Playback Amplifier	28.00
M81-AC	Recorder Mechanism and Amplifier combination in portable carrying case	870.00

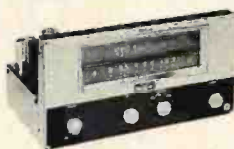

New PILOT AM-FM TUNER

PILOTUNER Model AF-850

A newly designed broadcast tuner featuring the illuminated Micro-Meter for greater ease and accuracy in tuning. FM Section employs Armstrong dual cascade, limiter-discriminator circuit. Sensitivity is better than 1.5 uv for 20db quieting. Micro-Meter tuning indicator employs a laboratory-sensitive micro-ammeter. AFC is continuously variable from complete cutoff to maximum. AM Section employs two-stage IF amplifier with selector for either sharp or broadband AM, plus a 10kc cutoff filter. Tuner has dual cathode follower output permitting up to 100 feet of interconnecting cable. Power supply is self-contained. **\$154.50**
Complete with tubes.

The New GRAY Viscous-Damped High Fidelity ARM Model 108C



Viscous fluid suspension provides automatic regulation of both the vertical and lateral movements of the arm. Improves tracking and minimizes groove jumping and skidding. Protects records because arm will not drop suddenly. Mechanical resonance is virtually eliminated. Simple slide-in feature permits instant interchange of cartridges. Handles records up to 16" diameter. Has adjustments for viscosity and stylus pressure.

Model 108C **\$39.95**

HARVEY SHIPS EVERYWHERE. Use this handy coupon

HARVEY RADIO CO., Dept. HF-6, 103 W. 43rd St., New York 36, N.Y.
Please ship the following _____

I enclose check money order for \$_____ including estimated shipping charges. Unused surplus will be refunded.

Send: New FREE High Fidelity Catalog
 Details of your TIME PAYMENT PLAN

NAME _____

ADDRESS _____

City _____ Zone _____ State _____

Klipschorn®

CORNER HORN
LOUDSPEAKER SYSTEM

... the finest creation of Paul W. Klipsch,
fabricated individually under
his personal supervision.



Write for the name of your
Klipschorn distributor and our
latest literature on the Klipschorn
and Shorthorn speaker systems.



KLIPSCH AND ASSOCIATES
HOPE, ARKANSAS

TELEPHONES PRospect 7-3395
PRospect 7-4398
PRospect 7-9575
PRospect 7-5514

NOTED WITH INTEREST

Continued from page 16

equipment, sponsored a High Fidelity Symphony Concert. Tickets were sold (a dollar per) and programs were printed same as for a live concert performance. They used no super-duper dozen-loud-speaker array with professional tape machinery, but a simple, conventional, home-type system — amplifier, turntable, and speaker-system, all housed in cabinets pleasing to the eye (so as to "show that hi-fi can have eye as well as ear appeal").

This seems to us to be a very practical, well-thought-out program and possibly a precedent for similar groups in small communities faced with an age-old problem — raising money.

Hi-Fi Clubs

Some of you readers who have successfully organized local audio clubs could do us a considerable favor if you would give a helping hand to others who want to start clubs in their respective cities. Just recently we've received letters from three would-be club starters asking for such information as how to contact people who might be interested, what types of programs should be arranged so as to interest the greatest number, etc. True, their problems would be of local nature to some degree, but if you could outline your original plans for getting started and how you overcame particular obstacles, it would be of great help to them.

The three people we have in mind at present are: L. P. Resweber, 300 West Walnut, Bastrop, La. (wants to organize in Monroe, La.); Joe Schwartz, 7940 Temple Rd., Philadelphia 33, Pa.; and C. H. Marino, 2299 Rochester Rd., Pittsburgh 37, Pa. As well as hearing from those who might have suggestions or workable outlines for starting a new club (and we'd like to have a carbon copy), these gentlemen would also appreciate hearing from those in their respective communities, or from nearby, who would be interested in participating in an audio club.

Schwann Has Moved

Those of you who get your Schwann Long Playing Record Catalogues direct

Continued on page 20

CHOOSE **Regency**

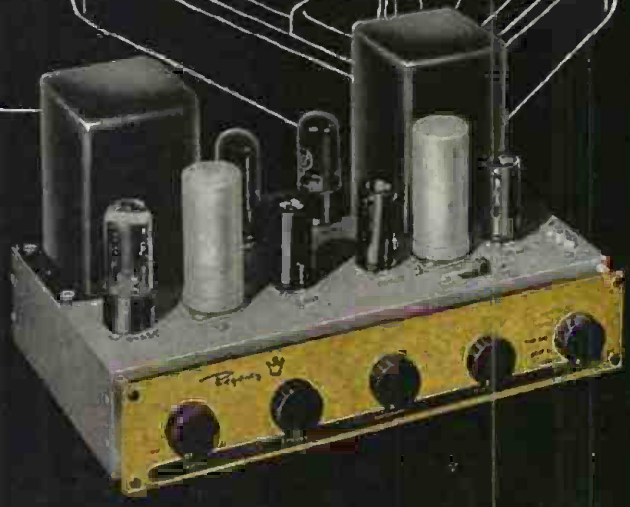

**CUSTOMIZED
HIGH FIDELITY**



for greatest enjoyment... biggest dollar value!

Let the thrill of true, life-like reproduction of your favorite records be the guide to selecting your high fidelity equipment. For supreme listening pleasure, your **REGENCY** dealer has assembled a special collection of finest individual components . . . custom mounted in beautiful **REGENCY** cabinets.

Ask to hear this ensemble. You'll understand better why true fidelity of tone depends upon these two important points:

1. High fidelity requires the finest possible components, suitably matched.
2. High fidelity must have the speaker separate. Any system with amplifier, changer and speaker in the same cabinet cannot produce true fidelity of tone over the full audible range, because of necessary compromise in amplifier design.

At any price you wish to pay—beginning around \$185.00—you can get a **REGENCY** *customized* system. Compare any "all-in-one-cabinet" set with a comparably priced **REGENCY** *customized* system. You'll agree that—dollar-for-dollar—**REGENCY** *customized* high fidelity is your best investment.

Write for name of nearest dealer.

TYPICAL CUSTOMIZED SYSTEM

Components illustrated here, for example, can be selected for installation in **REGENCY**-designed custom cabinet. Cost given is approximate retail price.

REGENCY -designed Cabinet	\$ 55.95
REGENCY Amplifier HF80	69.95
High Fidelity 3-Speed Record Changer	51.75
Two-way Speaker with Enclosure	62.50
Approximate Retail price of complete Customized High Fidelity System	\$240.15

REGENCY DIVISION, I.D.E.A., Inc.
7900 PENOLETON PIKE, INDIANAPOLIS 26, INDIANA
Makers of World's First All-Transistor Radio



**Build it
YOURSELF**

HEATHKIT
High Fidelity
"BUILD IT YOURSELF"
**amplifier
kits**

Heathkit
WILLIAMSON TYPE
(ACRO-SOUND
TRANSFORMER)

This dual-chassis high fidelity amplifier kit provides installation flexibility. It features the Acro-sound "ultra-linear" output transformer, and has a frequency response within 1 db from 10 cps to 100,000 cps. Harmonic distortion and intermodulation distortion are less than .5% at 5 watts, and maximum power output is well over 20 watts. A truly outstanding performer. W-3M consists of main amplifier and power supply. Shpg. Wt. 29 lbs., Express only. **\$49.75**
Model W-3 consists of W-3M plus WA-P2 Preamplifier listed on this page. Shpg. Wt. 37 lbs., Express only. **\$69.50**

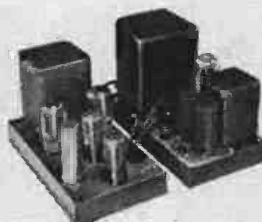

Heathkit
WILLIAMSON TYPE
(CHICAGO TRANSFORMER)

This hi-fi amplifier is constructed on a single chassis, thereby affecting a reduction in cost. Uses new Chicago high fidelity output transformer and provides the same high performance as Model W-3 listed above. An unbeatable dollar value. The lowest price ever quoted for a complete Williamson Type Amplifier circuit. Model W-4M consists of main amplifier and power supply on single chassis. Shpg. Wt. 28 lbs., Express only. **\$39.75**
Model W-4 consists of W-4M plus WA-P2 Preamplifier. Shpg. Wt. 35 lbs., Express only. **\$59.50**

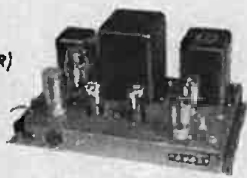

Heathkit
HIGH FIDELITY
PREAMPLIFIER



MODEL WA-P2

performance and most attractive in appearance. Fulfills every requirement for true high fidelity performance. Shpg. Wt. 7 lbs. **\$19.75**

Here is the complete preamplifier. Designed specifically for use with the Williamson Type circuit, it provides equalization for LP, RIAA, AES, and early 78 records, 5 switch-selected inputs with individually preset level controls, separate bass and treble tone controls, special hum control, etc. Outstanding in performance and most attractive in appearance. Fulfills every requirement for true high fidelity performance. Shpg. Wt. 7 lbs. **\$19.75**

Heathkit
WILLIAMSON TYPE
25 WATT AMPLIFIER
(PEERLESS TRANSFORMER)

This latest and most advanced Heathkit hi-fi amplifier has all the extras so important to the super-critical listener. Featuring KT-66 tubes, special Peerless output transformer, and new circuit design, it offers brilliant performance by any standard.

Bass response is extended more than a full octave below other Heathkit Williamson circuits, along with higher power output, reduced intermodulation and harmonic distortion, better phase shift characteristics and extended high frequency response. A new type balancing circuit makes balancing easier, and at the same time permits a closer "dynamic" balance between tubes.

Aside from these outstanding engineering features, the W-5 manifests new physical design as well. A protective cover fits over all above-chassis components, forming a most attractive assembly—suitable for mounting in or out of a cabinet. All connectors are brought out to the front chassis apron for convenience of connection.

Model W-5M consists of main amplifier and power supply on single chassis with protective cover. Shpg. Wt. 31 lbs., Express only. **\$59.75**
Model W-5 consists of W-5M, plus WA-P2 Preamplifier shown on this page. Shpg. Wt. 38 lbs., Express only. **\$79.50**

COMBINATION
W-5M and WA-P2



Heathkit
HIGH FIDELITY
20 WATT AMPLIFIER

This particular 20 watt Amplifier combines high fidelity with economy. Single chassis construction provides preamplifier, main amplifier and power supply function. True hi-fi performance ± 1 db. 20 cps to 20,000 cps. Preamplifier affords 4 switch-selected compensated inputs. Push-pull 6L6 tubes used for surprisingly clean output signal with excellent response characteristic and adequate power reserve. Full tone control action. Extremely low cost for real high fidelity performance. Shpg. Wt. 18 lbs. **\$35.50**

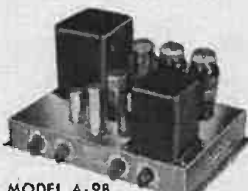

MODEL A-9B

**HEATH
COMPANY**
A SUBSIDIARY OF DAYSTROM, INC.

**BENTON HARBOR 8,
MICHIGAN**

NOTED WITH INTEREST

Continued from page 18

from the publisher will be interested to know that they've moved to a new, and from the size of their catalogue we would guess larger, location: 137 Newbury St., Boston, Mass.

McIntosh's (same, old) Contest

By now I suppose that any of you who entered the "Name the McIntosh Circuit" contest have either heard that you won one of their six grand prizes, or you've decided that the whole thing was a big hoax, or you're still waiting very, very patiently for the list of winners to appear. To you in the last two categories we now bring you the (bad) word:

1st Prize: A. B. Kilburn, Chicago; 2nd: John Barberie, Caldwell, N. J.; 3rd: Frank Groeneveld, Jr., Lansing, Mich.; 4th: William C. Shultz, Milwaukee, Wis.; 5th: O. R. Seidner, Alhambra, Calif.; 6th: John F. Cummins, Worcester, Mass.

We still don't know what the winning names for the circuit are!

Back Copies

Pat Neels, 1722 Second Ave., New York 28, will sell his set, complete to date, for \$40 prepaid postage.

D. E. McVittie, 647 Academy Rd., Winnipeg, Manitoba, Canada, has complete set for sale.

Charles Conrard, 418 Four Mile Rd., Racine, Wis., will trade copies Nos. 1 through 23 for a magnetic LP cartridge.

S. F. Salerno, 2212 Hudson Blvd., Jersey City, N. J., has complete set through February 1955 for sale.

William A. Murphy, 1227 Cedar Rd., Ambler, Pa., will ship his complete set express collect to highest bidder.

Ralph Libbey, 1222 33rd St., N. W., Washington 7, D. C., has a complete set—minus "Records in Review"—for highest bidder.

Jack Katzen, 1030 E. Phil-Ellena St., Philadelphia 19, Pa., complete set to trade for a piece of hi-fi equipment of comparable value, preferably amplifier or speaker.

Robert Couchman, Jr., 81 Pesante Canyon Rd., Salinas, Calif., copies 1 through 8, and 10, for sale.

Lloyd C. McGowan, Jr., Box 3732, Route 1, Imperial, Mo., copies 1-15.

Write FOR FREE CATALOG AND SCHEMATICS

One of a series on what makes one magnetic recording tape better than another

Let's look at
Soundcraft PLUS 50

50% Extra Playing Time

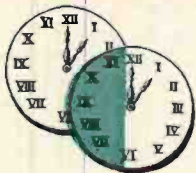

Extra Strength
Mylar® Base

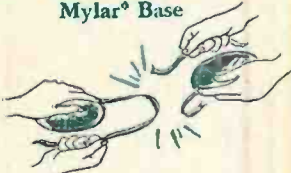

Full Depth Oxide Coating

Micro-Polished®

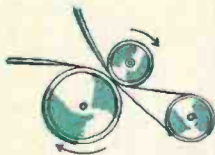

Lubricated Both Sides...

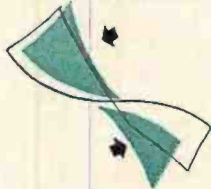

**YET
COSTS
NO
MORE**



The tape that has EVERYTHING!

PLUS 50 Magnetic Recording Tape—newest in the famous Soundcraft line—brings you a combination of superior qualities that no other tape possesses. Qualities that let you capture and hear the true sense of violin strings, all the brilliance of brass, the color of wood winds... that faithfully record the human voice

in all of its varied subtleties.

Plus 50's uniform output, inherently low signal-to-noise ratio, its 50% extra playing time, added strength and flexibility... its dimensional stability in any climate. These are the special qualities that make it the choice of professionals and amateurs, alike, wherever tape perfection is required.

And Soundcraft Plus 50 adds this special bonus: Its "Mylar" base assures virtually a lifetime of smooth, trouble-free service at no more cost per foot than other quality tapes. Like all Soundcraft products, Plus 50 is engineered and made by tape recording specialists. Get some Soundcraft Plus 50 Tape at your dealer's today.

FOR EVERY SOUND REASON

REEVES SOUND CRAFT CORP.

Dept. F-6, 10 East 52nd Street, New York 22, N. Y.

*Trade-Mark For DuPont Polyester Film

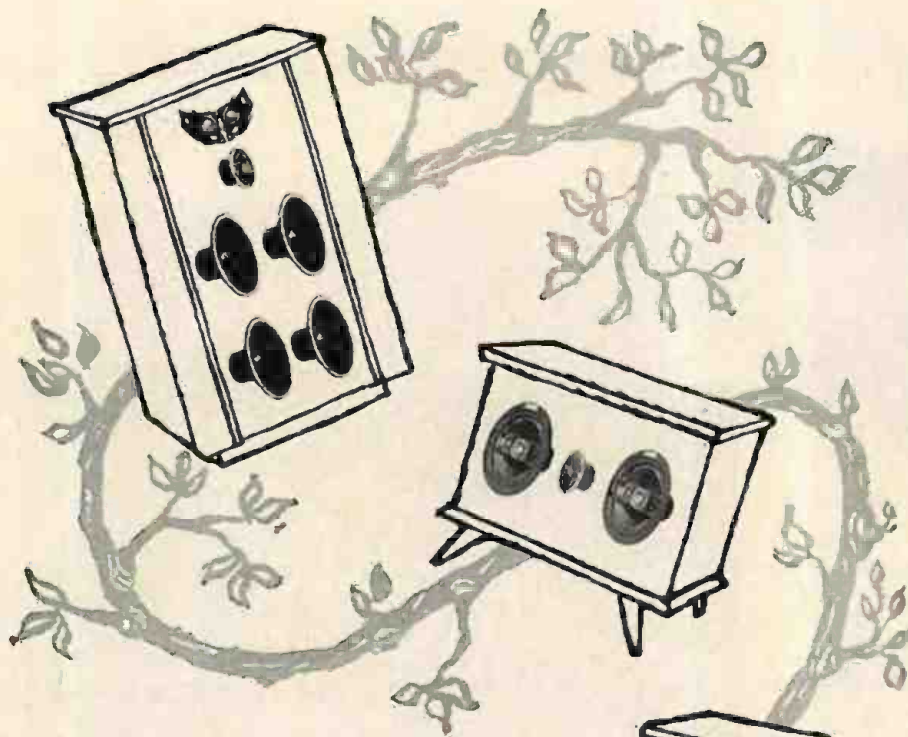

SYSTEMATIC GROWTH

Start with Quality—
add Power and Realism as you wish.

With Bozaks you will enjoy, at every step,
the greatest listening ease your dollar can buy.

Build with Bozak.
The three matched drivers
—Bass, Mid-Range and Treble—
combine smoothly into two-way and three-way
speaker systems from the modest B-207A to the
supreme B-310, each peerless in its class.

You can build Power and Realism with Bozak Quality,
without the hearaches of scrapping "outgrown"
speakers, the tedious matching and balancing of
incompatible units, and the fruitless tuning of a
resonant enclosure to reduce bass deficiency.

The recommended infinite baffling of Bozak Speakers
preserves their vanishingly-low level of distortion,
perfection of transient response and unequalled
balance—over the widest usable frequency and
dynamic ranges available today.

Bozak Speaker Systems stand unchallenged for
The Very Best in Sound.



BOZAK

THE R. T. BOZAK COMPANY

Quality Loudspeakers

PLANT AT: WEST POST ROAD • NORWALK, CONN.
Export Office: Electronics Manufacturers' Export Co., Hicksville, N.Y.
MAIL ADDRESS: P.O. BOX 966 • DARIEN, CONN.



SIR:

A correspondent of your magazine, Mr. G. Fred, scolds you for giving a forename to a pianist [April 1955]. I do not think that the magazine does this: as a contributor I have done it and am still awaiting Mr. Solomon's thanks for giving him status.

This pianist has existed for some years in public as Solomon *10th Court*. Since a surname alone, in Anglo-American tradition, distinguishes either the uniquely eminent (Washington, Cromwell), a mountebank, or a clown, I grieved for Mr. Solomon, who is none of those, and supplied him with identification among the five thousand musicians with the same last name, who might have thought the pianist presumptuous, almost as if he called himself The Solomon.

At first I dubbed him Thersites, because no one outside of *Troilus and Cressida* seemed to use it, but after someone had told me that Cutner was his surname I restored those syllables to him. I put them before the Solomon because no one has ever heard of a pianist named Cutner.

Now Solomon is a tremendous name pre-empted by history for a King who wrote Proverbs and a fine erotic poem. The name belongs to that king. I should feel like a fool and a thief if I stole it from the unique king to hand over to a piano player with a publicity man.

In transactions involving legal paper the poor devil will need a specific identity—if he marries, or inherits, or appears before a Bow Street magistrate for speeding an automobile or an arpeggio. I have made his identity specific for such emergencies, and it must serve until he himself supplies something grander, and something appropriate.

C. G. Burke

SIR:

I would like to reply to some of the letters and queries which have come to

Continued on page 25

NOW supreme fidelity costs 1/9 as much



Today the Ampex 600 is a tape recorder in a class by itself. At \$545 it provides a degree of fidelity that is beyond reproach — and it is a modest machine that weighs only 28 pounds. It is a professional recorder priced within reach of thousands of critical music listeners and tape recording enthusiasts.

In 1947 this same class of fidelity could only be had by buying an Ampex 200 for \$5200. It was worth its price because it was the only thing of its kind. It was the first commercial recorder that made radio transcriptions sound like live broadcasts. But the Ampex 200 weighed 250 pounds. Few, if any, were bought for home use.

AMPEX 600 PORTABLE MAGNETIC TAPE RECORDER

- 40 to 15,000 cycles response at 7½ in./sec.
- Over 55 db. signal-to-noise ratio
- Flutter and wow under 0.25% rms.
- Separate record and playback heads to permit monitoring while recording
- Built-in mixing between microphone and line
- Prices — \$498 unmounted, \$545 in portable case

AMPEX 620 PORTABLE AMPLIFIER-SPEAKER

A companion unit that not only matches the 600 in portability and appearance, but also in quality as well. Price is \$149.50 in portable case.

The man who has seen it all has this to say:

"When I bought the first Ampex Model 200, folks thought I was a goner, springing for \$5200.00. But it was a bargain — transcribing my radio program without losing any of the freshness of a live appearance. Some of my records came off the same tape. I could be three places at once. But now here's an Ampex I can carry with one hand. Records and reproduces perfectly, but costs little compared with the first one. So I have a commercial recording studio wherever I roam."



For full information, write today to Dept. F-1888

AMPEX
CORPORATION

Signature of Perfection in Sound

934 CHARTER STREET • REDWOOD CITY, CALIFORNIA
Distributors in principal cities (see your local telephone directory under "Recording Equipment");
Canadian distribution by Canadian General Electric Company.

It Has Everything . . .

Beauty – Operating Convenience – Quiet Performance



Quiet, constant-speed operation is obtained with a precision helical gear drive. This was developed for H. H. SCOTT by international authority Professor Earle Buckingham of M. I. T., designer of the drive mechanism for the Mt. Palomar 200 inch telescope.

FREE
TECHNICAL
BULLETIN
HF-655

THE NEW

H. H. Scott

STROBOSCOPIC TURNTABLE

The 710-A incorporates major new contributions to turntable engineering. These include: dual-stage mechanical and torsional filtering, expanded-scale optical stroboscope, Dynacone vernier speed drive, integral connection of pickup mounting-board to turntable bearings.

Revolutionary NEW design

1. Expanded scale optical stroboscope, with electronic peak pulsing for greatest clarity, is visible even with record in place for exact speed control at all times.

2. Precision helical drive gears, of hardened steel and nylon, for smooth silent flow of power to turntable. Gears housed in an oil-filled transmission for quiet trouble-free operation.

3. High-compliance torsional filtering reduces annoying speed variations, such as wow and flutter, to less than 0.1%, far below audibility.

6. "Dynacone" speed drive with special long-life neoprene idlers permits separate adjustments of 33 $\frac{1}{3}$, 45, and 78 rpm speeds by $\pm 5\%$ to match the pitch of accompanying musical instruments. Convenient push-button selection of each speed and OFF position.

7. Heavy-duty induction motor, with dynamically balanced-rotor and extremely low external hum field, designed specially for this turntable.

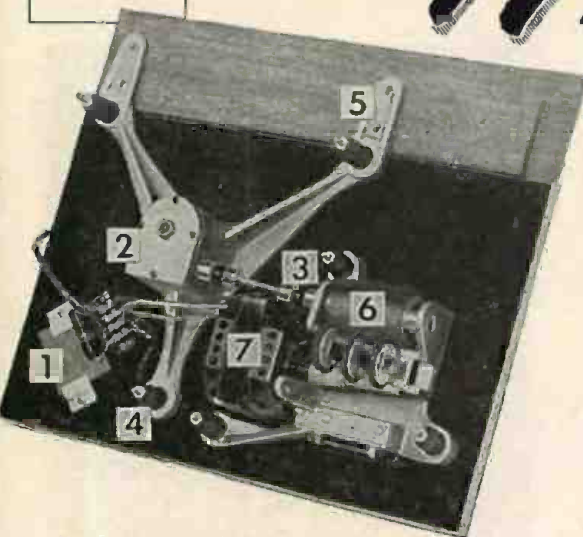

4. Dual-stage mechanical filtering between motor and turntable reduces motor rumble to more than 60 db below recording level, an outstanding engineering accomplishment.

5. Integral pickup-arm mounting board, accommodating all leading pickup arms, is rigidly connected to turntable bearings by a heavy aluminum casting. This eliminates acoustic feedback and other undesirable vibration differences between pickup arm and turntable.

Prices 710-A Turntable, finished in stainless steel with mahogany pickup-arm mounting board. \$102.00* Net.

710-X1 Hand-finished modern mahogany base for convenient, attractive installation: \$14.95* Net

*West Coast Prices: 710-A \$107.10

710-X1 \$15.70

H. H. SCOTT inc. 385 PUTNAM AVENUE, CAMBRIDGE 39, MASSACHUSETTS

LETTERS

Continued from page 22

me after the publication of "Toscanini on Records" [Dec. 1954, Jan., Feb. 1955].

There was one (and I am happy to say *only* one) slip in the dates: the *Rhine Journey* recording on LM 1157 is the 1949 version also found in LM 7020, and the 1941 recording released in M 853 was never transferred. The reason for this *faux pas* is that on my earlier machine the LM 1157 recording sounded rather unpleasant and the "shirt" reprinted the notes from the old M 853 album liner. I was thus prepared to succumb to the ambiguity in Victor's correspondence on the subject. (Usually I caught such slips in my cross-checking.) To top it off, LM 1157 and LM 6020, although the same recording, have different timings: LM 1157 being eight seconds slower than LM 6020. This clinched the argument for me, and not until after publication, and exchanges of letters with Richard Mohr of Victor and Igor Kipnis of New York (who pursued this issue in an admirable fashion) did I realize that the two recordings were the same. The mystery now is, how can the same recording time out at 10:59 (LM 1157) and 10:51 (LM 6020)? Mohr doesn't know. I attribute it to the difference in grooving (but am unconvinced), and I trust you will award some handsome prize to the chap who comes up with the answer.

As for the other letters, nice and otherwise, I can only repeat that the dates given are correct, and in the *Waldteufel* (say, on LRY 9000 what you are hearing is 1945 sound miraculously updated. Similarly, excepting the 1939 version never released in the States, there is one and only one *Leonore No. 3* and the differences between the three versions (which are not inconsiderable) are all due to fancy Victor laboratory work.

Mr. Rosenthal [March 1955] asks for a coupling for an LCT 1939 Beethoven Fourth. Easily done. The Brahms *Tragic Overture* from the 1937 BBC series, the Rossini *Silken Ladder* from 1938, and the thrilling *Italian Woman in Algiers* from the 1936 Philharmonic series. All are wonderful and unobtainable, and as far as I am concerned, Victor can go into production post haste. I agree with Mr. Miller that in every instance the composer is more important than

Continued on next page

Crestwood brings you new features...new models for 1955

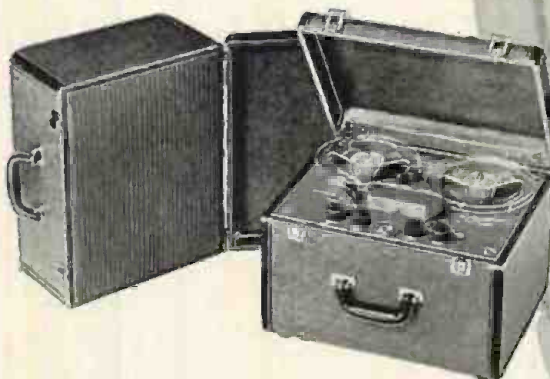

CRESTWOOD new model 404 offers high fidelity response. (30 to 15,000 cycles at $7\frac{1}{2}$ " per second tape speed.) Gives you crystal clear performance — free from wow, hum and distortion . . . combined with model 402 power amplifier and speaker makes a two-case portable package . . . fits nicely into your hi-fi system and your budget, too!

Exceptional fidelity (50 to 10,000 cycles at $7\frac{1}{2}$ " per second tape speed) is featured in the new CRESTWOOD 304. New tape transport mechanism and professional type recording heads make the 304 one of the best values ever offered in a tape recorder . . . includes internal speaker, microphone, radio and TV connection cable.



The new CRESTWOOD consoles move tape recording enjoyment into a permanent and prominent position in your living room, den or recreation room . . . instantly ready to record or reproduce. Extended range dynamic speakers — fully baffled for complete range reproduction — give you truly outstanding sound quality . . . Choice of 300 or 400 Model Series in hand rubbed cabinets.



Ask for, and insist upon, a Crestwood demonstration at your dealer's store—or write for the address of your nearest Crestwood dealer.

Crestwood[®]
BY DAYSTROM

Daystrom Electric Corp.
Dept. F-20
753 Main Street, Poughkeepsie, N. Y.

Please send me information and specification sheets on the new CRESTWOOD models.

Name _____

Street _____

Town _____ State _____

YOU ASKED FOR IT PDQ*

We took a hint from the automobile people and based our new tuner design on the results of a consumer survey. Here's what you said you wanted, PDQ*.

First, a fine tuner with a fully flexible preamp. We had the preamp, and built the Pageant around it.

Second, a compact attractive appearance. We designed a 4"x14½" package, so good-looking it begs to be left in the living room (in or out of a cabinet).

Third, specifications? Look at the Pageant, then ask your dealer or write to us for full details



PAGEANT by PEDERSEN

Sensitivity: 3 microvolts for 30 db on FM—3 microvolts on AM.

Frequency Response: AM \pm 2 db 20 cps to 7 KC. FM \pm ½ db 20 cps to 20 KC. AM whistle filter. Tape, multiplexing, cathode follower outputs. 17 tubes.



P. O. BOX 572
LAFAYETTE
CALIFORNIA

* Pedersen Denotes Quality

LETTERS

Continued from preceding page

the conductor, Toscanini agrees to that too, but Victor promotion is another matter. I suggest he buy his Toscaninis on the "La Voix de Son Maître" label, where NBC Symphony comes at first, in large caps, and below, in rather small type "direction: Arturo Toscanini." Mr. J. H. Christiansen of Dominicana, has asked about my remarks on the Brahms Fourth. I confess I was talking more of Toscanini's concept of the work as I have experienced it in a series of performances than a specific disk, although I still feel that the recording is distinguished, even though it preserves a performance that is now overrefined, and a little too brilliant and slick to get to the heart of the matter. As for my remarks on "Viennese" style, let me say that it was a *style*, not a place, or an orchestra, or a given conductor that I was talking about. I have heard good "Viennese" performances in Chicago (under Fritz Busch), and I am sure that Artur Rodzinski is capable of delivering most un-Viennese readings in Vienna.

My thanks go to all who wrote, and I am sorry that my obligations to the University of Cambridge prevented me from sending personal letters to everyone, but I have been hard pressed for time this term.

Robert Charles Marsh
Trinity College
Cambridge, England

SIR:

Very nice of you to print my letter soliciting co-operation with Francis F. Clough [Noted With Interest, April 1955], but I don't think I gave his address as "England." Denbighshire is in Wales and the proud people of that wonderful country prefer "Great Britain" on mail addressed to them from abroad—nor "England."

Albert Franck
Richmond Hill, N. Y.

SIR:

It seems to me that there is a place for someone [who can supply] technical information to your readers for a fee—not the \$100 per day kind but rather somebody who can answer questions on individual problems that are not necessarily of general interest.

The problem is this: the practice of

Continued on page 28

THE NEW PRESTO T-18 TURNTABLE

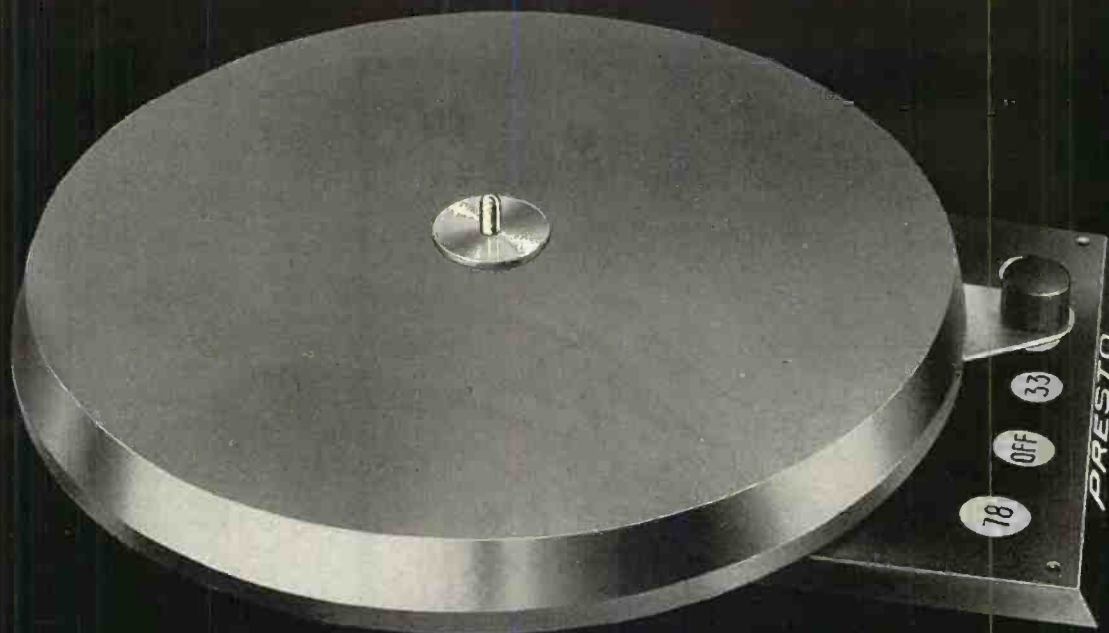

introducing **PRESTO's** exclusive flick shift

one sideway flick of the single control lever . . .

- selects 3 speeds—33 $\frac{1}{2}$, 45, 78 rpm
- engages and disengages idler wheels
- turns motor off and on

PRESTO's new streamlined T-18 surpasses even the famous PRESTO T-15 in ease of operation . . . and fully matches it in quality of performance.

The heart of PRESTO's T-18 is an exclusive 3-speed shift with 3 idlers mounted on a single movable plate. A sideway flick of the control lever automatically engages the proper idler for

the desired speed. T-18 eliminates trouble-making arms and shift cams—assures trouble-free operation indefinitely.

More advantages! Extra heavy weight, wide-bevel, cast aluminum turntable; precision deep-well bearing; center spindle with built-in adapter for 45 rpm; smart telephone black and brushed chrome finish.

Your best buy in hi-fi—only \$53.50; with hysteresis motor \$108.

Mail this coupon today

 **PRESTO** RECORDING CORPORATION

PARAMUS, NEW JERSEY

Export Division: 25 Warren St., New York 7, N. Y.
Canadian Division: Instantaneous Recording Service,
42 Lombard St., Toronto

PRESTO RECORDING CORPORATION, HIGH FIDELITY SALES DIV.
PARAMUS, NEW JERSEY

Please send me illustrative data and specifications on the new PRESTO T-18 turntable.

NAME

ADDRESS

CITY

ZONE STATE

WORLD'S LARGEST MANUFACTURER OF PRECISION RECORDING EQUIPMENT AND DISCS

"Superb Performance!"

—HIGH FIDELITY Magazine

THE 
FISHER

SERIES SEVENTY

"HIGH QUALITY results at an attractive price," says *High Fidelity Magazine*. The SERIES SEVENTY tuner and amplifier have established themselves firmly as the outstanding buy in the professional quality field. The performance of this equipment is limited only by the calibre of the phonograph pickup, turntable and loudspeaker system used in conjunction with it.

THE FISHER FM-AM Tuner • Model 70-RT

■ Features *extreme sensitivity* (1.5 mv for 20 db of quieting); works where others fail. Armstrong system, *adjustable AFC* on switch, *adjustable AM selectivity*, separate FM and AM front ends. Shielded and shock-mounted main and subchassis. Distortion below 0.04% for 1 volt output. Hum level: better than 90 db below 2 volts on radio, better than 62 db below 10 mv input on phono. 2 inputs. 2 cathode-follower outputs. Self-powered. Exceptional phono preamplifier with full equalization facilities. 15 tubes. Six controls: Bass, Treble, Volume, Channel/Phono Equalization, Tuning and Loudness Balance. Beautiful control panel. SIZE: 14 $\frac{3}{4}$ " wide, 8 $\frac{1}{2}$ " high, 9 $\frac{1}{4}$ " deep. **\$184.50**



THE FISHER 25-Watt Amplifier • Model 70-AZ

■ Offers more *clean watts* per dollar at its price than any amplifier made. The 70-AZ has *2 $\frac{1}{2}$ times the power* of 'basic' 10-watt units. **OUTSTANDING FEATURES:** High output (less than $\frac{1}{2}$ % distortion at 25 watts; 0.05% at 10 watts.) IM distortion less than 0.5% at 20 watts; 0.2% at 10 watts. Uniform response ± 0.1 db, 20-20,000 cycles; 1 db, 10-50,000 cycles. Power output constant within 1 db at 25 watts, 15-35,000 cycles. Hum and noise virtually non-measurable (better than 95 db below full output!) Includes FISHER Z-MATIC at no additional cost. SIZE: 4 $\frac{1}{8}$ " x 14 $\frac{3}{4}$ " x 6 $\frac{1}{8}$ " high. **\$99.50**



Priced Slightly Higher West of the Rockies

WRITE TODAY FOR COMPLETE SPECIFICATIONS

FISHER RADIO CORP. • 21-25 44th DRIVE • L. I. CITY 1, N. Y.

LETTERS

Continued from page 26

"planned obsolescence" brings out new features that we all wish we had. But no one can afford to keep buying the stuff as fast as every new feature—high sensitivity, current feedback, etc.—is added. They're all interesting, and many of them could be added to present equipment by the owner if he just knew how to do it . . .

Now I wish my set had better FM sensitivity so I could pick up some of Chicago's good music stations but I simply don't know if it can be done.

I would welcome an opportunity to present my problem to some sharpie who could say, "For five dollars I'll tell you how to get 3 MV sensitivity," or even say, "It can't be done." Then at least I could stop wondering how to do it and make plans to get a new tuner.

Wouldn't some college, for instance, be glad to direct this work to some deserving student? . . .

C. C. Fraser
Milwaukee, Wis.

SIR:

I take great pleasure in pointing out to J. F. I. that he "goofed" in his recent [April 1955] review of the London recording of the four Mendelssohn Overtures (LL 1048).

He erroneously stated that the *Fair Melusina* Overture, Op. 32, was not previously recorded on LP. It was recorded by both Vox (7440) and Vanguard (425) under the name *Die Schöne Melusina* Overture.

Daniel Suchman
New York, N. Y.

"My eagle eye was blinking." —
J. F. I.

SIR:

I am advised that there is an outfit in New York known as Record Collectors' Exchange, but I don't have their address. Can you steer me to this or perhaps better connections?

John C. Peterson
Barstow, Calif.

In the Manhattan Telephone Directory we find listed a Record Collectors' Shop, at 113 West 47th Street; also we have been informed of the International Audio & Record Exchange, 1101 Lexington Avenue, New York 21. The latter states its policy as follows: "Three of yours

(12-inch classical) for one record of your choice, in guaranteed mint condition, cello sealed." — Ed.

SIR:

I would like to announce the organization of the Recordist Society, a club with the purpose of exchanging tape recordings of things of music and national interest. We expect to contact members in Great Britain and France, so in time our catalogue should be of international interest.

We are a group of hi-fi enthusiasts wishing to trade copies of our best quality tapes for the same of others who have also been bitten by the recording bug. As our plans are now, the organization will have no membership fees, etc. The only requirement for membership and the receipt of items from our listing is the trade of tape recordings of interest to us.

We will have a regular system of notifying each member from time to time as to which tapes are available for exchange and the methods used in recording them. For a copy of our listing, inquiries can be addressed to me.

Robert McHaffey
71-19 67th Place
Glendale 27, N. Y.

SIR:

... Why doesn't someone start a campaign to get London Records to record at least one or two Gilbert and Sullivan's *complete* with dialogue? They should be best sellers among G & S enthusiasts. With the present fine quality coming from "ffrr," it would be just fine to recapture the whole spirit of these largely satirical operettas, rather than the spate of melodious songs that are the present offering. There is no sense of plot or continuity.

Surely they would sell as readily as some of the other truly complete recordings that have been issued, many with dialogue incomprehensible to most of us Yankees.

Leslie F. Garrett
Derry, N. H.

SIR:

I'd like to congratulate Paul Sampson on his article "Hi-Fi Oversimplified" (April 1954). On glancing through some back issues, I ventured to read this masterpiece of expository writing.

Being that I am only fourteen years old, I have run up against the problem of finding somebody of approximately

Continued on next page

"Dream Set!"

—LIFE Magazine

THE FISHER



FISHER

SERIES FIFTY

THE FISHER FM-AM Tuner • Model 50-R



■ "This tuner is among the most sensitive of all in 'fringe' areas and conjoins beautifully with the FISHER Amplifier."—*Life Magazine*. The truest index to the quality of the Model 50-R is its selection even by FM stations, *after competitive trials*, for pickup of distant programs for rebroadcast to their own communities. In town, or even in the extreme suburbs, the 50-R is unexcelled. **\$164.50**

THE FISHER Master Audio Control • Series 50-C



■ "The finest unit yet offered."—*Radio and TV News*. 25 choices of record equalization, outstanding phono preamplifier, separate bass and treble tone controls, loudness balance control, 5 inputs and 5 input level controls, cathode follower outputs. Hum and noise inaudible.

Chassis **\$89.50**
With cabinet **\$97.50**

THE FISHER 50-Watt Amplifier • Model 50-AZ



■ "Of the very best!"—*High Fidelity Magazine*. Will handle 100 watts peak. World's finest all-triode amplifier. Uniform response within 1 db from 5 to 100,000 cycles. Less than 1% distortion at 50 watts. Hum and noise content 96 db below full output—virtually non-measurable! Oversize components and quality workmanship in every detail. Includes FISHER Z-MATIC, at no additional cost. **\$159.50**

Prices Slightly Higher West of the Rockies

WRITE TODAY FOR COMPLETE SPECIFICATIONS

FISHER RADIO CORP. • 21-25 44th DRIVE • L. I. CITY 1, N. Y.

Fine Accessories

FOR THE FULLEST ENJOYMENT
OF YOUR HOME MUSIC SYSTEM

FISHER ACCESSORIES



MIXER-FADER • Model 50-M

NEW! Electronic mixing or fading of any two signal sources (such as microphone, phono, radio, etc.) No insertion loss. Extremely low hum and noise level. High impedance input; cathode follower output. 12AX7 tube. Self-powered. Beautiful plastic cabinet. **Only \$19.95**



PREAMPLIFIER-EQUALIZER • 50-PR

Professional phono equalization. Separate switches for HF roll-off and LF turn-over; 16 combinations. Handles any magnetic cartridge. Extremely low hum. Uniform response, 20 to 20,000 cycles. Two triode stages. Fully shielded. Beautiful cabinet. Self-powered. **\$22.95**



PREAMPLIFIER-EQUALIZER • 50-PR-C WITH VOLUME CONTROL

50-PR-C. This unit is identical to the 50-PR but is equipped with a volume control to eliminate the need for a separate audio control chassis. It can be connected directly to a basic power amplifier and is perfect for a high quality phonograph at the lowest possible cost. **\$23.95**



HI-LO FILTER SYSTEM • Model 50-F

Electronic, *sharp cut-off* filter system for suppression of turntable rumble, record scratch and high frequency distortion — with *absolute minimum* loss of tonal range. Independent switches for high and low frequency cut-off. Use with any tuner, amplifier, etc. **\$29.95**



PREAMPLIFIER • Model PR-5

A self-powered unit of excellent quality, yet moderate cost. Can be used with any low-level magnetic cartridge, or as a microphone preamplifier. Two triode stages. High gain. Exclusive feedback circuit permits long output leads. Fully shielded. Uniform response, 20 to 20,000 cycles. The best unit of its type available. **\$12.57**

QUALITY IS NO ACCIDENT . . .

At Fisher Radio Corporation we never take chances with quality. All materials go first to the Incoming Inspection Department and any that do not meet our rigid requirements are returned to their manufacturer. In addition, inspection occurs at many points during production — from the original, blank chassis to the final, assembled unit, assuring correct assembly and wiring. Our Test Department is staffed with a highly-trained group of technicians. Finally, equipment *already packed for shipment* is selected at random and given a complete inspection and electrical test in our Engineering Laboratories to keep Quality Control at a constant, high level.

WRITE TODAY FOR COMPLETE SPECIFICATIONS

FISHER RADIO CORP. • 21-25 44th DRIVE • L. I. CITY 1, N. Y.

LETTERS

Continued from preceding page

my age and interests. If any of your readers are in the same boat, I'd appreciate hearing from them via tape if they possibly could.

I consider myself quite fortunate in having my system. I'm running a Bogen DB-15, backed by a Pilot AF-824, a Lenco (Bogen) turntable (B-53X), etc. My latest pride and joy, a Pentron PMD-1, 'is receiving almost constant use by yours truly. It may not be super fidelity, but I call it mine.

As I have stated, anybody interested in hi-fi especially tape, *not* especially in California, that can be considered a teen ager (young-at-hearts excluded) please contact me via tape at 136 Annandale Road, Pasadena 2, Calif.

David Berkus

SIR:

[Regarding Robert Kotlowitz's review of *Marlene Dietrich at the Café de Paris*, April 1955] . . . Miss Dietrich did record "Lola" (from the *Blue Angel*) earlier, I think around 1927-8, 10-inch, old speed. "*Ich bin die Fesche Lola*," HMV EG 1802.

Eric Larrabee

New York, N. Y.

Sir:

Reviewing *Early Medieval Music* (February 1955), Mr. Grunfeld implies this music was not created in a vacuum. I disagree.

Gregorian chant is related to the rhythms of the Latin language. As Latin became understood only by the priesthood, Gregorian became a music removed from everyday living. If the average man did not clearly understand Latin how could he perform a music derived from Latin?

Perhaps, if the church had allowed its liturgy to be sung in the vulgar, we would now have a European music homophonic like Gregorian deriving its rhythms from the language of each European country.

Since the content, style, and manner of performance could not change by Church edict there was only one other modification possible, and it took five centuries for this vacuum to spring a leak — until the interval of a 4th was discovered.

But music still was in a vacuum of laws and artificial devices until it received new vitality and meaning in medieval songs.

Art Faner

Denver, Colo.

HIGH FIDELITY MAGAZINE

SIR:

I have been wondering how many other readers who have their TV sets integrated with high fidelity as I do (Craftsmen & Electro-Voice) have noted the vast differences in the audio fidelity of today's live TV programs.

It would seem that CBS has a distinct lead in this department; two shows which I find outstanding as regards really high fidelity audio are the Perry Como and Jo Stafford shows received here over WBNS-TV, Columbus, Ohio. Other shows broadcasting quality audio to a lesser degree are "Toast of the Town" and "Studio One," all originating from CBS. Being far from an expert in such matters, I can only guess that such superb sound is a result of using as nearly as possible acoustically perfect studios and careful attention to microphone placement, among other things.

By contrast, most other TV programs vary from just average down to poor in this respect. It would seem to me that a worth-while project for all program producers would be to try to emulate the Como program in respect to audio quality as a companion to their generally excellent video quality.

James L. Campbell
Lancaster, Ohio

SIR:

Nowadays the record companies are very thoughtfully printing the name of the work, artists, etc., on the outer edge of the jacket so that a person can find a record without pulling the jacket out to look at the front . . .

However . . . why don't the companies offer new jackets to replace the older ones that are still in their catalogues? They could offer these at cost as a service to many who must be in my position. It would be an invaluable service and one no one else could offer. Wouldn't there be a very interested response to such an offer? They could offer this service through the dealers instead of direct to the consumer.

R. M. Allen
Indianola, Miss.

SIR:

Do you know of anyone who makes a record container—something like a suitcase, small enough to be carried and with a capacity of, say, fifty LPs—which would help me transport my LPs personally and provide the necessary protection they require? . . . If not, could you help me find one?

Antonio Mortena, M.D.
Cincinnati, Ohio

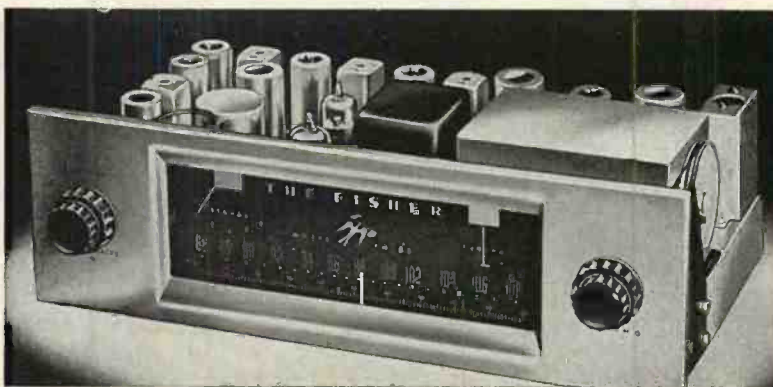

America's TOP Tuner!

THE 
FISHER

FM TUNER MODEL
FM-80

World's Best by LAB Standards

FOR almost two decades we have been producing audio equipment of outstanding quality for the connoisseur and professional user. In the cavalcade of FISHER products, some have proved to be years ahead of the industry. THE FISHER FM-80 is just such a product. Equipped with TWO meters, it will outperform any existing FM Tuner *regardless of price!* The FM-80 combines extreme sensitivity, flexibility and micro-accurate tuning. Despite its full complement of tubes and components, the FM-80 features an unusually *compact* chassis of fine design. **Only \$139.50**

Outstanding Features of THE FISHER FM-80

- TWO meters; one to indicate sensitivity, one to indicate center-of-channel for micro-accurate tuning. • Armstrong system, with two IF stages, dual limiters and a cascode RF stage. • Full limiting even on signals as weak as one microvolt. • Dual antenna inputs: 72 ohms and 300 ohms balanced (*exclusive!*) • Sensitivity: 1½ microvolts for 20 db of quieting on 72-ohm input; 3 microvolts for 20 db of quieting on 300-ohm input. • Chassis *completely* shielded and shock-mounted, including tuning condenser, to eliminate microphonics, and noise from otherwise accumulated dust. • Three controls—Variable AFC/Line-Switch, Sensitivity, and Station Selector PLUS an exclusive Output Level Control. • Two bridged outputs. Low-impedance, cathode-follower type, permitting output leads up to 200 feet. • 11 tubes. • Dipole antenna supplied. Beautiful, brushed-brass front panel. • Self-powered. • WEIGHT: 15 pounds. • SIZE: 12¾" wide, 4" high, 8¼" deep including control knobs.

Price Slightly Higher West of the Rockies

WRITE TODAY FOR COMPLETE SPECIFICATIONS

FISHER RADIO CORP. • 21-25 44th DRIVE • L. I. CITY 1, N. Y.

Perfection of the famous  high fidelity

Patrician 4-WAY SPEAKER SYSTEM

NOW YOURS TO ENJOY
THIS EASY
DO-IT-YOURSELF
WAY



STEP 1

Model 103C Package of Patrician IV 4-way Driver Components

Use this simplified way to reach the ultimate in high fidelity reproduction. Permits you to build the interior horn assemblies yourself or add the Model 115 "K" horn, for a complete 4-way system. Model 103C includes:

- 1—18WK VLF Driver \$90.00
- 2—A8419 LF Phenolic Horns } 60.00
- 2—828HF Drivers
- 1—T25A Treble Driver 57.00
- 1—8HD Diffraction Horn 21.00
- 1—T35 VHF Driver 33.00
- 1—X2635 4-way Crossover 72.00
- 1—8675 Cable Harness and 15.00
- 3—AT37 Level Controls

Total, Audiophile Net: \$348.00
Shipping wt.: 103 lb.

Components also available individually

STEP 2

Model 115 Klipsch "K" Type Basic LF Folded Horn

Add this scaled-up "K" type low-frequency driver horn to the Model 103C components and you have a complete new Patrician IV 4-way speaker system ready to operate.

Utilizes the Klipsch principle of folded-corner-horn loading with extended taper rate down to 35 cps for augmented bass reproduction. Includes integral mid-bass exponential horn bell drilled to accept E-V Model A8419 low-frequency horn sections. Black matte stain. Can be color painted by user, but will not take furniture finish. Size 57½ in. high, 37½ in. wide, 26½ in. deep. Shipping wt.: approx. 150 lb.

Audiophile Net: \$180.00

STEPS 1 AND 2

Model 103C-115 Patrician IV 4-way Utility Speaker System

All the flawless performance of the incomparable new Patrician IV is now available to music lovers in this Utility 4-way System. Every engineering advantage of multiple cross-overs, specialized driver components and intricate interior acoustic design is utilized to achieve the utmost in cleanliness, range and realism.

Frequencies up to 200 cps are handled by the largest, most highly developed low-bass folded horn driving section ever designed for a home audio system. Newly created separate mid-bass section takes over to 600 cps. Specialized treble driver and diffraction horn reproduces the "presence" range from 600 to 3500 cps. E-V Super-Sonax takes over from 3500 cps to beyond the range of audibility. Level controls provide proper balance to room acoustics.

Includes Model 103C Driver Components and Model 115 "K" Type Corner Folded Horn—ready to assemble and operate. Gives you all parts of the new Patrician IV 4-way speaker system, except the outer decorative housing. Size 57½ in. high, 37½ in. wide, 26½ in. deep. Shipping wt.: 256 lb.

Audiophile Net: \$528.00

Write for Bulletin No. 220

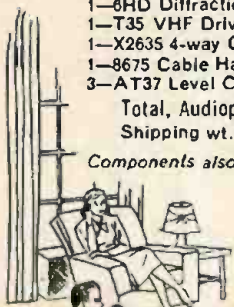

No Finer Choice Than **Electro-Voice**®

ELECTRO-VOICE, INC. BUCHANAN, MICHIGAN • Export: 13 East 40th St., New York 16, U.S.A. Cables: Ariab
HIGH FIDELITY SPEAKER SYSTEMS, AMPLIFIERS, MICROPHONES, PHONO-CARTRIDGES, AND OTHER ELECTRO-ACOUSTIC PRODUCTS

AS THE EDITORS SEE IT

SINCE APRIL we have been subjected to a gentle but incessant shower of pages torn from *Time*, *Life*, and several other large-circulation publications. These tearsheets all have had the same content: a full-page advertisement entitled "Facts and Fiction About High Fidelity." Invariably the copies of the advertisement have been accompanied by letters from our readers, urging us to "answer" it, or at least do *something* about it.

The advertisement was put forth by the Magnavox Company—a sometime advertiser in our own pages, incidentally—and it embodied, as promised, both fact and fiction, but a good deal more of the latter than of the former. In essence, it amounted to a tirade against custom home music components, the people who sell them, and the people who buy them. The public was being gulled, the ad implied, by "pseudo experts" peddling the theory that custom components represented better dollar-values than ready-made phonographs and that they delivered better sound. Behind the sinister growth of this noxious notion, according to the Magnavox copywriter, were a clique of people not interested at all in music, but only in "creating sounds that are often mechanical—noises, incidental to music, which the musical artist strives to suppress." For true musical pleasure, it was made clear, the only proper recourse was to ready-made, single-package phonographs. And, in case anyone couldn't think offhand of a manufacturer producing such treasurable items, there was a little recapitulation of Magnavox phonograph features, coyly listed under the heading: "The Facts." Among the facts relevant to Magnavox phonographs (\$99.50 and \$198.50) was this one, stated with winning modesty: "*Nothing finer is made, regardless of price.*"

We commend the loyal ire of the readers who clipped this sheet of nonsense and sent it in for our "answer." But how can we answer, to any practical effect, an advertisement that ran two months earlier in several multi-million circulation magazines? It takes six weeks—from typewriter to newsstand—for a monthly like HIGH FIDELITY to deliver itself of an editorial comment. And when it has done so, the comment reaches—whom? No millions. Just the 55,000 or so who buy and read us because they already believe the audio-doctrine we preach. It is probably significant that Magnavox stopped advertising its \$198.50 phonograph in our pages some months ago. There is ground for the suspicion that our readers were not responding—a claim that very few other advertisers can make.

We could, of course, rebut the statements in the offending advertisement point by point. A separate loudspeaker-enclosure would perhaps lessen the likelihood of acoustic feedback, especially if there is any bass reproduction beneath 60 cycles per second. Sundry engineering laboratories have worked their way to the conclusion that the ultimate

in transduction may involve more than a pair of coaxial cones in a small semi-enclosure. A precisely-machined, individually adjusted twelve-inch turntable sometimes rumbles a little less than an economy-priced record-changer. Diamond styli have been known to outlast sapphires. And so forth. But you, blessed reader, can enumerate these points as well and readily as we, so why should we remind you of them? The people who need to be apprised of what's what are those who do *not* subscribe to HIGH FIDELITY nor its worthy companion publications in the field. They can be reached, but it would cost money. Magnavox can reach them, by spending money. We know of no single maker or proponent of custom componentry likely to be able to devote comparable sums of money to the task.

In 1812 the young United States undertook a naval war against Great Britain, employing as the main part of its sea-forces private shipowners, authorized to do battle by letters of marque. There were some prodigies of valor, and some privateers made money, but the sea-war was lost. Since then the nation has relied on a professional Navy, paid for out of taxes levied on all citizens, with gratifying results. It seems to us that an industry should prepare its defenses in the same way. The staff of HIGH FIDELITY might feel very noble about buying a page in *Life* to argue with Magnavox on behalf of the components industry, but their Board of Directors ought properly to fire them if they tried it. The same thing applies to most of the member businesses of the industry, which in general are profitable but small.

On the other hand, we would very willingly indeed pay membership fees to an organization of businesses in the field, so that it—the organization—might in a case of this kind enter the publicity-arena to make the needed rebuttal. In other words, an effective high fidelity trade association, of nationwide membership, is overdue.

IF THE high fidelity components industry is ill-organized collectively, the American summer music festival business is even worse organized, festival by festival. In April, introducing a roundup of European musical events, we promised for June a kindred survey of summer music in America. We hired a capable young man to compile it—but he was not able to do so. At least four top-ranking summer music series could not furnish programs and schedules by mid-April, so we abandoned our plan. We do not complain out of editorial pique. Summer vacation plans, in many American homes, are fairly firm by May. If music festival managements cannot have publicity ready to be used then, they deserve all the empty seats they will get when summer comes. The Old World does it better.

J. M. C.

The triple life of . . .

Dr. Hermann Scherchen

by Robert Charles Marsh



HAYDN ON RECORDS



MODERNS IN CONCERT



ELECTROACOUSTICS
IN SWITZERLAND

THE EUROPEAN concert-goer is likely to think of Hermann Scherchen primarily as the sponsor of new music, recalling the many contemporary scores he has introduced and the manner in which his programs are frequently built about an enthusiastic performance of one or more fine works of this century.

The American record collector, on the other hand, may regard him as the guiding hand behind some of the finer disks of the older classics in the catalogues. For him, Scherchen may suggest Handel, Haydn, and Beethoven more than Prokofiev, Ravel, and Berg.

I first encountered Scherchen in the role of the champion of the contemporary composer. "*Selbstverständlich können Sie meinen Proben beiwohnen,*" he had written me.* The concert he was preparing with the London Symphony contained the first performance here of Humphrey Searle's *The Riverrun*, a lyric, atmospheric work set to the final pages of James Joyce's *Finnegan's Wake*, in which Miss Jean St. Clair delivered with a fine brogue the monologue of the river Liffey as it merged with the sea. The score includes a thunder machine which the percussionist played with gusto and sound fanciers might well find irresistible.

British orchestra players are friendly, marey types, accustomed to sight-reading and under-rehearsed concerts, and generally equal to whatever comes along. Several members of the LSO had toured the United States with Sir Thomas Beecham as members of the Royal Philharmonic. (There is a constant interchange of players among the five symphony orchestras in London.) In the tea breaks I heard all about it. "Do you know the Carnegie Hall bar? We had some jolly times in the Carnegie Hall bar. I'd like to go back, I would."

Like Hindemith, Scherchen is largely self-taught. His fresh appearance and apparently unlimited vitality suggest a man many years younger than sixty-four. After rehearsing the LSO six hours, until it was blue and puffing, he was equal to prolonged and vigorous conversation, and then went off to dinner with his wife with a smile and a sense of undiminished energy, as if the day had been spent quietly reading scores. He learned conducting the very best way, as a string player in the Berlin Philharmonic, and was launched on his career before the 1914-18 war: indeed, he was director of the Riga Symphony Orchestra in 1914 at the age of twenty-three and spent the war interned in Russia as an enemy alien. He took no chances of having that

sort of thing happen again, and since he had little use for the Nazis he left Germany in 1932 and assumed direction of broadcast music for the Swiss radio.

Scherchen's rehearsals are models of efficiency and quiet mastery of the situation. He is invariably polite nowadays: ("Would you gentlemen have the kindness to play that note louder? It must be heard. The music makes no sense if it is not heard."); he knows the score thoroughly and is absolutely certain of what he wants ("Would you have the kindness to take the E string of the violin down to D, as is required by Stravinsky? Please, all the time this is not done, and it is necessary. You hear? That way it sounds different."); although when required he can be forceful: ("Why do you make a crescendo there? A crescendo there makes no sense! Always it must be pianissimo not creeping up to mezzo-forte.").

He was not always so polite. Indeed, for many years he was considered one of the hardest conductors in Europe to get along with. His reformation seems to have been a family affair. Not long after the birth of the youngest Scherchen, his wife, Pia, was bathing the baby. The child splashed her. Pia laughed. Hermann (who would have blown his top) asked why she didn't get annoyed. Because the little girl didn't know what she was doing, explained smiling Pia. The lesson percolated. A couple of days later, at orchestra rehearsal, only three horn-players showed up. Nothing from Scherchen. Midway in movement one, in tiptoed Horn No. 4, and sat down. At the first break, Scherchen said to him: "I'm sorry you were detained." Nothing more. The orchestra didn't understand, but Scherchen had it all worked out. If the man weren't stupid he'd know he had to be there on time, and would have made arrangements to get there. Since he didn't—why make him miserable because he was stupid? Scherchen has held to this moderation ever since, with impressive results.

Although not one of those conductors who lectures to his men, Scherchen talks to them a great deal. Some of his remarks are quite illuminating. "Let this be, gentlemen, for one time entirely right," he said as they began work on Stravinsky's 1919 suite (he does not like the 1945 version as well) from the *Firebird*. "This is so often played, and yet so often not right. It should be fresh, like the first day it was played . . ." Again he returned to the point. "This must not be so heavy. It must be light and fine, like chamber music." The contrabass solo in the second part of Prokofiev's *Lieutenant Kijá* brought a laugh at first. Scherchen

*As a matter of course you may attend my rehearsals.

broke off. "No," he said, "it is not a joke. It is a simple man singing to his girl. He has not much of a voice, but he is singing as best he can."

Always one is aware of Scherchen's concentration in the music. He is no showman and is interested in guiding the orchestra rather than emoting to impress an audience. As one would expect from the author of a celebrated treatise on conducting, his beat is simple, clear, and functional to the exclusion of everything else. He uses no baton, but the point formed by the tips of his thumb and index finger is easy to see and gives the men all they need.

Scherchen the conductor is able to get orchestras to give him their best even in limited rehearsals, and Scherchen the musicologist knows exactly what points must be made. (His analysis of the Beethoven symphonies in *The Nature of Music*, London, 1950, is exceptionally interesting.) Thus in two rehearsals with the choir and orchestra of the Liverpool Philharmonic Society he was able to achieve a performance of the Beethoven *Ninth* that brought his series of guest appearances in that city to a brilliant conclusion. It was the finest reading of the score I had heard in concert from a European orchestra, and others said that they had never heard their Philharmonic play so well before.

One would think from this that afterward Scherchen would be pleased with his achievement, but he greeted me with: "The third movement is so difficult. It never goes right." He knew how he wanted it to be. The next time would be better.

Normally a successful conductor is happy simply being a successful conductor, but Scherchen's primary interest now is audio-research, and he would rather be at work in his studio than concertizing around Europe. Similarly it is the technical side of recording that he finds more stimulating than preparing the performance. "When I am the sound engineer," he remarks, "then it is interesting for me. I would rather make the tapes than direct the orchestra."

His sound studios at his home at Gravesano in the southern portion of Switzerland, not far from Toscanini's haunts near Lago Maggiore, are a symbol of his conviction that only in doing those things which one feels to be important can the value of life be found. From the time he first began to direct radio concerts, some twenty-five years ago, Scherchen has thought that the traditional method of seating an orchestra on a level within the six parallel surfaces formed by the walls, floor, and ceiling of the room led to a transformation and deformation of the sound of their playing. A studio designed for the electronic reproduction of sound should add nothing which it itself produced. His first objective, then, was "liberation from the room," in other words, a studio that was acoustically dead and allowed the engineer to create with related equipment continuously variable acoustical conditions so that one could place a recording or broadcast in a setting appropriate to the music to be played.

His first opportunity to work along these lines came in Palestine in 1938, but the major project in which he is now engaged had to wait until the end of the war. He moved to Gravesano in 1953, and his first construction there was a swimming pool. ("The neighbors thought I was crazy!") After that the house, a remodeled monastery of impressive vintage with twelve large rooms and solid stone walls two

feet thick was made habitable. It now echoes to the sounds produced by a trio of little Scherchens, ages one, two, and three, all of whom were born in London. His oldest child, by a previous marriage, is 35.

Doing his best to ignore the flood of advice from those who thought he should construct a "classic" studio rather than experiment with the unconventional, he put up, near the house, a building with five walls, no two of them the same length. Construction was of solid stone blocks nearly twenty inches thick ("still the best sound insulating material of all"). There are no windows, and the interior space, which is shaped roughly like a small grand piano, amounts to 500 cubic meters. The ceiling slants downward from six meters at one end to four at the other, and there are no parallel surfaces.

The acoustical insulation was designed in co-operation with Dr. Hans Joachim von Braunmühl and Professor Willy Furrer of Bern, who are responsible for the 250 sound absorbers which line the walls and ceiling. Of two sizes (12 and 20 cm. diameter), they are roughly the shape of an orchestral gong, the open side of which (made of Fiberglas) faces the wall, while the flat side (made of pavarex) faces out. Those on the ceiling are fixed, but those on the walls can be removed to alter the characteristics of the studio at will. Further variation is provided by an acoustical wall which can be erected in the studio to a maximum length of nine feet. Built up of paravanes of a Swiss composition board, it is designed to reinforce the lower frequencies.

The floors presented a problem. Scherchen wanted acoustical treatment that could be altered as he wished. "I tried a lot of things," he said, "and didn't like any of them. Finally I tried the finest Persian carpets. They are perfect! Now people come into the studio and see the sound absorbers and the fluorescent lights and all over the floor heavy carpets, and they say 'Is this a new art form?' but it is only sound insulation!"

The large studio was completed last July and served as the scene of the International Congress on Music and Electroacoustics reported in the "London Newsletter" in HIGH FIDELITY for November 1954. Since then Scherchen has continued work with his architect, Hoeschule of nearby Lugano, and put up a second studio of 250 cubic meters

"Always one is aware of Scherchen's concentration in the music. He is no showman . . . his beat is simple, clear, and functional."
R. C. MARSH



which is acoustically identical with the larger one. A third, with different characteristics, is under construction, and the Zurich radio has now built a "Scherchen studio" with six walls, but without the acoustical treatment of the Gravesano installation.

In addition to the studios there are four reverberation chambers, each of which contains sound boxes which can be opened and closed to increase reverberation or suppress it. The first of these (with a normal factor of 0.8) is intended for chamber music, the second (1.5) for orchestral music, a third (2.2) for "cathedral effects," and a fourth reinforces only the high frequencies. At present, tests are being made so that the characteristics of about 150 of the many possible acoustical combinations will be available in a convenient table form.

Ironically, certain Toscanini recordings made in RCA's Studio 8-H have been found the nearest thing available on disks to the sound of an orchestra playing in a totally dead room and are thus ideas for experimentation with the addition of resonance. (It must be noted that 8-H, like many American studios, did not have parallel walls and was heavily treated acoustically.) In a completely dead studio one may have as many musicians as one wishes, since there is no possibility of "saturation" with sound, and theoretically as many as fifty microphones can be used, each line adding a specific amount of resonance to the voice it picks up.

Scherchen's idea is combining music with the technical skill of the engineer to produce something "finer than what was played," music heard with a clarity and brilliance impossible in any concert hall. This summer Scherchen plans to record chamber music experimentally with friends. "We will be under no pressure," he says. "If we feel like working, we will work. If we feel like going swimming, we will go swimming. If we want to record at night, then is when we will record." Eventually he will make orchestral recordings as well.

"I pay for everything myself," he adds, "and then I can do as I wish." Those who buy Scherchen recordings can have the satisfaction of knowing that the royalties go to audio research rather than Cadillacs. There are three objectives in view: (1) to increase our knowledge of acoustics, (2) to gain mastery over the special electro-acoustical problems involved in sound reproduction, (3) to carry the technique of recordings, radio, television, and film music beyond their present levels into entirely new concepts of realism. The possibilities of the electrical reproduction of sound have only recently been given the attention they deserve, Scherchen feels. "This must all be explored. I write and study like the devil to keep up with it."

UNESCO is sponsoring two lecture conferences at Gravesano in July. The first is on the structure of sound, while the second is on light music, another of Scherchen's interests that goes back to his first broadcast concerts.

"About 80% of what is played on the air is light music, and it is not often well played or wisely selected," he says.

Scherchen's concept of light music is slightly unconventional. He means to include all music which is easily understood, employing themes and forms which reveal their content at once. Thus, without suggesting that they are not serious and important, he would classify such works as Rossini overtures, the four Bach suites for orchestra, the Mozart serenades and divertimentos, etc., as light music, and items such as Romberg operettas and "symphonic" treatment of popular songs he would dismiss on the grounds that there was better light music to be heard. Radio music must pay attention to the listening conditions in most homes, the hour at which a given work is to be played, and the manner in which it is presented, he feels. For instance, "The working man comes home at night. He is tired, and when he gets into the house, before he can sit down with his paper his wife says the child has been bad, and he must smack him. He does that, and then sits down to eat and the soup is not good, so he turns on the radio and hopes to find some pleasure there. In such a mood what music does he want to hear, a Serenata for Oboe and Harp or the *Walkürrenritt*?"

"Obviously the *Walkürrenritt*. Besides, it would dampen the sound of the child's crying.

"And when a symphony is announced, how is it done? We shall now play Mozart's Symphony No. 36 in C major, the "*Linz*" Symphony, Köchel Verzeichnis 425, the four movements are Adagio e allegro, and so forth. What does any of this mean to the ordinary man? The music he can understand, but this type of announcement is without meaning. It frightens him and repels him needlessly from

something he is able to appreciate and enjoy. Instead tell him that for Mozart his father was next to God, and then when he desired to marry Constanze they quarreled, so he took her to Salzburg in hope that he could patch it up, and, when it came time to leave, the breach had only widened. On the way back to Vienna they stopped in Linz, where Mozart was welcomed as if he were a prince and a concert was arranged. Since there was no symphony he wrote one with incredible speed. It begins slowly, full of all the suffering he felt, and then out bursts all the pure spiritual joy that nothing could overcome. Tell him that, and it is all true, it is nothing that has been made up, and he will be ready to listen and understand. But Köchel Verzeichnis, adagio, these he does not need.

"And after the concert, tell him, please come back at ten o'clock and we shall play you some fine modern music which you will also enjoy. That too must be something which he can understand. If we hear Caruso's high B flat we are thrilled whether the text is obscenity or the *Missa Solemnis*. On the radio we must see it is always something good.

Continued on page 128



ERICA. LONDON

Photogenic Scherchens: Mama Pia with son Herpi, daughters Manna and Piber

The day they almost got my number

A tragic tale by HERBERT KUPFERBERG



BEFORE I tell you the story of the great failure of my life, I think you should know a little about me. My name is Number Eighteen—or No. 18, as I am known most commonly throughout the record industry. You have, I am sure, often seen my modest insignia stamped in the back of record albums. “Inspected by No. 18,” it says in a little circle, indicating that my stamp of approval has been given to the album and all its contents.

Those of us in the business are very proud of our little stamps and what they signify. Number Sixteen, who works at the next bench to me (Seventeen left some years ago for a job inscribing the day of the week on milk-bottle caps, and has never been replaced) says he would rather die than lose his stamp. Poor Number Four actually took his with him, for he had his tombstone decorated with a circle engraved “Inspected by No. 4.”

Some of the newer inspectors, I am sorry to say, have not yet developed this deep respect for their calling. Number Sixty-Four, a brash young fellow near the end of the line, actually sneers at those of us who affix our insignia with pride, and says he would just as soon be inspecting animal crackers as records.

I mention these incidents not to depress you but merely to show you that our business, too, has its vexations and its tragedies. As a matter of fact, it has become more difficult than ever these last few years because of the advent of the long-playing record. I could weep when I think of those carefree, relaxed days of the 78-rpm records, when all we had to do before affixing our stamp was to count the disks in the album. I was only a young inspector then, far back in the line—Fifty-Three was my number—but well I remember what a joy it was to make certain there were four records in Beethoven’s Fifth, and that the album cover was the proper shade of brown, and call it a day.

Nowadays, with the LP records, we have much more to contend with. And lately our work has become even more strenuous, for the newest records, as you know, include not only a disk and printed material, but also a reproduction of a work of art. Ah, my friends, if you only knew how many weary hours of my own time I have been forced to spend at art museums reading about Vermeer, El Greco, Breughel, Crivelli, Miro, Dufy, and many others in order to prevent any errors about them from appearing in albums bearing the stamp “Inspected by No. 18.”

Yet in spite of my most strenuous efforts, it was the art works that led to my catastrophe. I had no inkling of what was coming, because for several weeks my work had progressed particularly smoothly. I had carefully made sure

that all the Van Goghs were included with the recording of the Bartók Violin Concerto and the Dufys with the Brahms Violin Concerto, though what difference it would have made if the two had been reversed I am sure I don’t know.

So when I was summoned to the office of the Chief, Number One, I thought it was perhaps because he had at last decided to move me up to Number Seventeen’s old spot, or even to shift me to the Cellophane Department, where I would pass on the sleekness of the outer envelopes—a point upon which the Company had lately been putting great stress.

But alas, it was to be neither of these things. The Chief was courteous, but he had a slight edge in his voice as he opened the conversation.

“Eighteen,” he said, “how long have you been with us now?”

“Forty-three years, sir,” I said respectfully. “I was here in the old hand-winder days and can well remember when a stylus was called a needle.”

“Quite so, quite so,” said the Chief, and his face softened a bit as he, too, recalled the Old Days. But not for long.

“Eighteen,” he said, “serious charges have come up against you. They involve Biedrich-Dietrich’s album of Phoenician songs. Biedrich-Dietrich himself was just up here raising the devil about it. Says he is the world’s greatest *lieder* singer and that he’s going to leave us if he’s subjected to this kind of humiliation. Now, Eighteen, I want you to think carefully and try to remember just what it was you put into that album.”

The Chief leaned back in his chair while I gathered my thoughts.

“Actually, Chief,” I said, trembling a little, “it’s not so hard to remember as you might think. I know the great pride the Company takes in Biedrich-Dietrich and in the Phoenician songs, so I was especially careful.”

The Chief nodded noncommittally.

“All right so far, Eighteen,” he said. “Go on.”

“Well, first of all, I put in the thirty-two page booklet tracing the history of the Phoenicians and their music. I knew it was the only brochure of its kind, representing the results of twelve years’ scholarship and research and worth the price of the set by itself, so I made doubly certain it was included. Then I saw to it that a strip of cardboard three-sixteenths of an inch thick was inserted as backing to prevent the album sides from being crushed. I then tested the gold lettering on the spine to make sure it was fourteen-carat. After that I checked on the translucent plastic envelope, sealed at the factory and

Continued on page 124



Melancholy music-lovers (backed by Brubeck album) suffer soulfully in Tokyo hi-fi and coffee shop.



Nipponese enthusiasts crowd around new turntables and pickups, some of familiar American appearance.



“Baha, Betofen, and Bramsu”

by Capt. George E. Posner and Robert Fink

MOSTLY as a result of reading American magazines and publications, high fidelity has swept over Japan like one of the country's seasonal typhoons. A very conservative Tokyo estimate indicates there are several dozen audiophiles in Nippon to every one in the United States. This may not be true at all, but it is certainly true that “Hi-Fi” long ago assumed the aspects of a very busy cult.

Reflections of the current enthusiasm in Japan can best be seen in the numerous high fidelity coffee shops—a phenomenon unique to Tokyo. The names are colorful, such as “Ella Vaughan,” (derived from Ella Fitzgerald and Sarah Vaughan, both of whom are popular vocalists in Japan) “Le Villon,” “L'Etude,” or “Confectionery West.” In general the atmosphere is that of a warm living room. The coffee is rich and the music is played at the proper loudness. Volume is not used for the purpose of drowning out idle chatter. It isn't necessary since the Japanese are very polite and wouldn't dream of disturbing the music while other listeners are lost in reverie.

Japanese taste in music is broad and varied. The universally beloved three “B's”—“*Baha, Betofen, and Bramsu*” rank first in popularity. “*Bramsu*” can be stretched to include Mozart, Bartók, Mendelssohn, Debussy, Schubert, Haydn, Ravel, Prokofiev, Verdi, Puccini, Berlioz, Bernstein, and the rest records put out by Capitol, RCA, Westminster, et alia, as well as nearly all the classics.

Jazz is extremely popular. There is a trend toward Dixieland, and Louis Armstrong is as well liked in Japan as he is in the United States. Brubeck, Parker, Gillespie, Bruff, Thompson, Krupa, Kenton, and nearly all the modern jazzmen have their followings among the purple beret and pony-tail set.

Of the electronic equipment sold in shops, over half is bought by amateurs with only rudimentary electronic knowledge but possessing a profound appreciation for good music. The rest of the equipment goes into commercial installations or is bought as parts by high-school and college students building installations for private sale.

Window displays along “electronics row” in Japan present the appearance of unkempt hock-shops. A helter-skelter jumble of equipment in a shop window to the true hobbyist simply suggests good bargains to be obtained. In Japan this is important since all buying is on a strictly cash basis. There is no easy-payment system in Japan. However, in the end a Japanese buyer like his American counterpart spends just a little more than he feels he should have spent.

Fi-emporium is beneath Ella Vaughan coffee-shop, both owned by audio wholesaler Maruyama Kinjiro.



Refreshment and music counter in the Ella Vaughan. Serving girls, not completely "bai sai" oriented, sometimes stealthily turn down volume at crescendi. At right: No reverential obeisance, just a close look at a do-it-yourself television receiver kit.



In Kanda-ku shop, audio and video sets are piled up to form a veritable maze.



**Photographs by
CAPT. GEORGE E. POSNER
U. S. Army Signal Corps.**



Sidewalk audio-radio-video mart seems to extend very nearly a whole city block.

No whistle while they work . . .

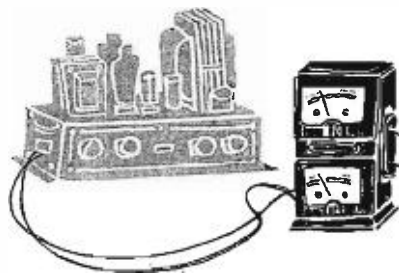

The Well-Adjusted Watt

by IRVING M. FRIED

THE job of an amplifier probably is known to everyone. By high fidelity neophyte or design engineer, more is known and appreciated about it than about any other part of the high fidelity system. Speakers will be a terrible mystery for a long time to come; cartridges are a precarious subject; tuner "sensitivity" is variable. But as for amplifiers—everyone knows that his amplifier's function is to make from a tiny, unequalized signal a large electrical jolt, enough to drive a speaker to distraction, and himself into ecstasy (or despair). And everyone knows that amplifier-ratings are generally concise, and more or less believable. Most people have at least a talking acquaintance with frequency response, "power" response, output, stability, distortion, and price. In other words, there are things one can say about an amplifier (as opposed to the descriptive material concerning speakers), which are good enough to be reported honestly by most manufacturers, and which should rather reliably predict a given amplifier's performance.

However, the interpretation of this information is not, strictly speaking, an easy matter. The writer, who daily faces a public eager to buy amplifiers for home use, finds terrible confusions the rule. For instance, he will be told by one enthusiast that 10 watts are more than enough for any home, and be assured by the next enthusiast that one "must" have at least 30 watts. In each case, the writer feels that there is a basic misunderstanding of the "facts" concerning amplifiers. These "facts" should be of interest to every home user of an amplifier, since they bear directly on the question of what kind of amplifier will meet his needs; and since they may help him keep his treasured amplifier in a good state of repair.

How many watts of output power are sufficient for an amplifier in the typical home? Many articles in technical journals have indicated that the "power" used in a living room for music reproduction is measured in thousandths or hundredths of a watt. These articles take their respective figure, talk about something mysterious called "10 db," or "20 db," or some such number, and arrive at the conclusion that the home listener will never need more than X number of watts. By some strange coincidence, the X watt value is always well below the maximum power output of that author's favorite circuit—which is invariably a low-output amplifier. Other literature (notably that from the makers

of expensive, plush amplifiers) promises the "full dynamic range of the orchestra in your living room," if you get 30 . . . 40 . . . 60 . . . 80 watts—(whatever that author owns or sells). Who is right?

Unhappily, no one is quite sure just how enormous are the power requirements in the home. Certain "facts" are known. As long ago as 1925, Bell Telephone Laboratories conducted some basic research on the nature of sound and its intensity. Certain common sounds were selected from the myriads that infest the world. These were each investigated and charted on a "profile." The "profile" is a graphical representation of the power (in acoustical, or sound watts) fluctuation during production of a single characteristic sound, from the lowest part to the "peak" (loudest requirement) of the sound. It was found, for an example, that during the production of the letter "h" by a male voice, there is a very rapid alternation from much sound to very little sound, in a definite rhythmic pattern—up and down several times. The "average" amount of power used was very little, but in some cases the "peak" power was tremendous as compared to the average. A few of the ratios are given below:

	"Average"	"Peak"
Male voice	1	40
Snare Drum	1	27
Pipe Organ	1	650

In other words, to reproduce the full dynamic range of a pipe organ, the reproducer had to go from one level to one over 600 times as great, in a very short period of time!

Bell Laboratories concluded, on the basis of 1925 standards, that a respectable reproducing system should have a dynamic range of 200-to-1. Today, it is conceivable that the range would be nearer the 600-to-1 figure.

What does this mean to you as prospective amplifier purchaser? First, this is as good a time as any to talk about "peak" power ratings as given in amplifier advertisements. You are familiar with the phrasing: "30 watts, 60 watts peak." The "peak" power of amplifier ratings is, strictly speaking, only a different method of rating the amplifier (instead of using one kind of meter to measure the output voltage, the manufacturer suddenly shifts to a meter that reads higher). If you have a 30-watt amplifier, it stays that—it will not suddenly become a 60-watter on peaks—if

you keep talking about the same kind of watts. Since the writer is not advertising, but is trying to clarify, your 30-watt amplifier, for purposes of this discussion, is never more than a 30-watter.

Therefore, if we accept the 200-to-1 power ratio of 1925, your 30-watt amplifier can average only 150 milliwatts (.15 watts) of amplifier power (30 divided by 200). And, on the same scale, a 10-watt amplifier will produce only .050 watts' average of power into your speaker.

Since speakers are far from efficient, and since you are interested in speaker efficiency over the entire audio band of 20-20,000 cycles, and since few speakers short of the \$600 full horn-loaded varieties are actually more than 2% efficient over that range, you can, taking 2% of the above figures, find that your 30-watt amplifier will give you 3/1,000 of a watt in your living room; and your 10-watter will actually deliver only 1/1,000 watt of sound!

These figures, beside being stupefying, show the truth in both of the schools—the low power and the high power. For these small fractions of a watt are still tolerable in a living room—but you do need a high powered amplifier to get .003 watts!

Conclusion: If your 10-watt amplifier is perfect, giving 10 full watts of power over the entire audio spectrum, and if it stays perfect, you will have just enough undistorted sound for a typical living (no longer than 15 or 20 feet) room. But even if your 10-watt amplifier is perfect—if your living room is a trifle bigger, or if heavily furnished, or if you have two people listening, or if you want more than just a moderate volume level at some time; your 10-watt amplifier, frankly, just isn't enough, even by standards of 1925! Certainly, under no conditions will you have enough power to reproduce realistically, and without amplifier distortion, "live" FM orchestra broadcasts; also, since modern LP records have a dynamic range of 1,000-to-1, you won't be able to play them much above whisper volume, if you want realism without substantial distortion.

The writer pointed out in an earlier article ("Time for a Check-up," July 1954) that he had never heard a reproducing system in an average living room which had what he called "listening ease," unless the amplifier used was substantially larger than 10 watts actual (let us ignore that misleading "peak" power in the ads). For a 10-watt amplifier cannot satisfy the "average" levels that most audio enthusiasts want, and also properly reproduce the crescendos. Where an amplifier ignores the "peak" requirements of musical instruments, the whole sound becomes strained; the timbre of musical instruments is changed. This is constantly being reiterated in the writer's studio—novices characterize the sound of a high-powered amplifier as contrasted to a 10-watter in perfect condition as being "clearer" or "more natural."

The other arguments for higher power in home amplifiers are summarized below. People interested in additional details are invited to write to me:

1. This matter of the "power" curve. Properly speaking,

a manufacturer's power-curve on an amplifier should represent the power available all over the frequency range at a given percent of distortion, say 1%. It is no secret in the profession that the typical "10-watt amplifier" of moderate price has no more than a very few watts of low-distortion power below 100 cycles and over 5,000 cycles—the very regions that require boost with most speakers. Many more expensive and higher powered amplifiers are almost as bad. Thus, when it was pointed out that a 10-watt amplifier could just squeak through, the writer was discussing the "perfect" 10-watt amplifier, none of which has ever existed, so far as he knows. A great many 30-watt amplifiers are actually 10-watt amplifiers at the edges of the audio spectrum.

2. Most amplifiers tend to become erratic in behavior at or near their power limits. Some become generally unstable; others can be "triggered" into "muddiness" on the bass end. If you use a larger amplifier, you are generally assured of being farther away from the "ragged edge" region.

3. Amplifier output measurements are made into "load" resistors, of fixed value. A loudspeaker, particularly one with sharp crossover networks, is a constantly shifting load. Where the "load" varies, the power delivered must be less than the rated power (attempts to equalize the power with variable impedances, ahem, then, must lead to great distortion at certain frequencies). Therefore, your 10-watt amplifier may deliver substantially varying amounts of undistorted power over the audio band.

4. Several laboratories have begun to suspect—though they don't as yet know the proper way to corroborate—that a higher powered amplifier accelerates the cones of a speaker system faster than a lower powered one, and decelerates them faster when the electrical impulse is finished—just as a bigger engine gives a car more get-away, and larger brakes faster stopping. If so, high power is justified as a means of improving what we call "transient response" to music—just as we know that larger magnets on the speaker do.

Whichever of these arguments you believe or disbelieve, the writer has on scores of occasions noted (along with fellow-listeners) that, when the 10-watter is replaced by a 30-watt amplifier, and when the 30-watt amplifier is replaced by a well designed 50- or 60-watt amplifier, the total effect is to clean up the sound, making it crisper, better defined, smoother, more pleasant, and more natural. To be brutally clear and frank, the pattern is invariable, even when the speaker involved is one of the highest quality, highest efficiency, true exponential horn design—the \$600 kind. The conclusion can only be—you "need" the amount of power for which you can either afford or are willing to pay.

How important is frequency response? All amplifiers claim 20-to-20,000 cycle response. Some talk about 100,000 cycles, and 5 cycles. For purposes of this discussion let us assume that all amplifiers are actually more or less flat from 20-to-20,000 cycles. Why do

Continued on page 124



Custom INSTALLATIONS

Since they illustrate a Canadian approach to custom high fidelity, the installations shown on this page should be of particular interest to our neighbors north of the border. Pictured below is a complete system designed and installed by Electro-Voice Sound Systems, of Toronto, Ontario. Television chassis atop speaker enclosure is swivel-mounted for convenience of restless viewers.

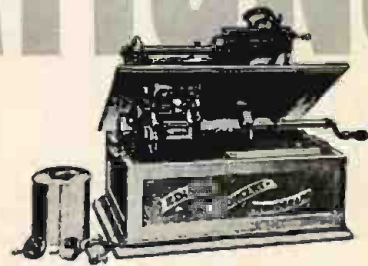

The attractively housed turntable at the right is in the home of William Doberty of North Vancouver, British Columbia. At upper right is Mr. Doberty's amplifier remote control unit (under the radio). Installation is by "Homecrafts."

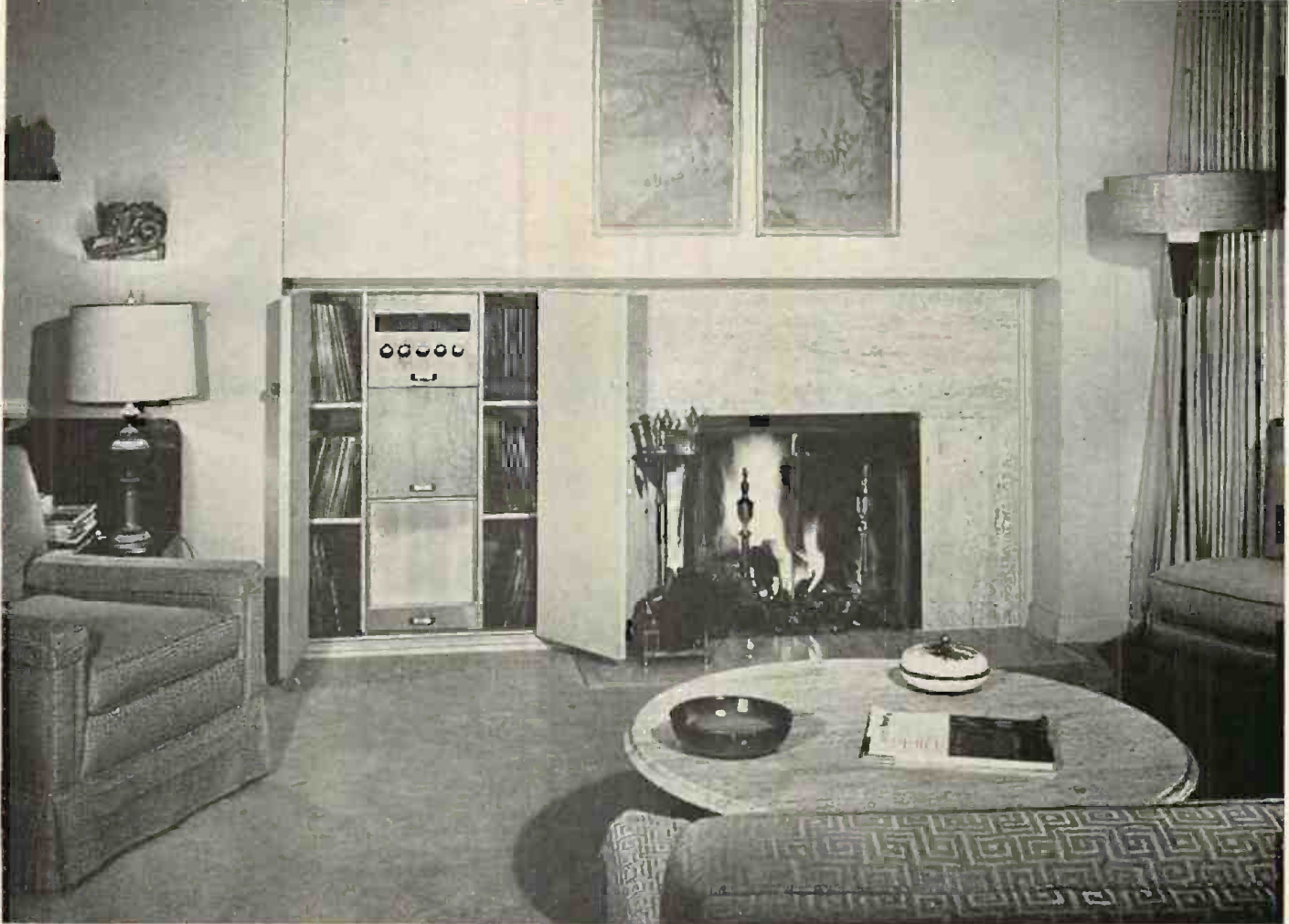

Shown above is part of an installation made recently in a Seattle, Washington, home by the Olympic Engineering Company. Seen at the left is the corner-table speaker enclosure (speaker is aimed skyward) of Donald H. Perry of Kansas City, Missouri.



The installation at right is the work of Dr. G. R. Loomis of Lexington, Kentucky. Cabinet is of cherry wood. The unit was home constructed, as was a matching speaker enclosure.

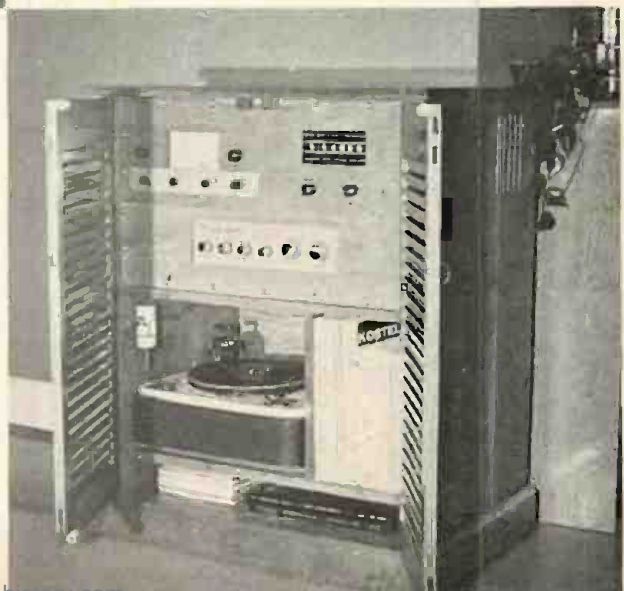

An ex-record dealer speaks . . .

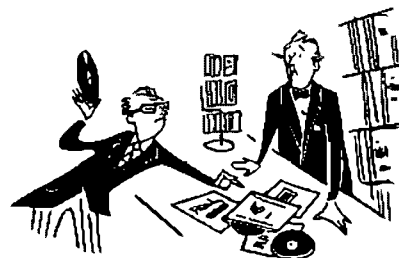

You meet the nicest people, BUT . . .

by ALBERT J. FRANCK

WHEN I FIRST consented to write on the subject of what a record dealer has to endure at the hands of his customers and his suppliers I thought I had the material for a good humorous discourse. As I went on with the writing, however, the memory of a thousand mischances experienced and impositions suffered reasserted itself, and to write about only a few of them turned out to be reliving all the bitterness and disgust which attended the original incidents. So, I write this now for the instruction of those who think, even for a moment, that they would enjoy participating in the record business.

It takes a toughness of fiber with which very few of us softies—essentially worshipers of musical beauty—are endowed. One has to be able to adjust with equanimity to despoilment by those who are stupid, incompetent, indifferent, and dishonest, and to unindemnifiable losses as, for instance, in my own experience, water damages. I have no count of the number of times floods descended upon me from floors above, never twice from the same point, and, once, a plumbing defect brought an inundation up through the shop floor. It is possible to survive such exasperations, but the psychological beating one has to take in his daily dealings with cynically indifferent suppliers, with the screwball fringe of his customers, and with the hirelings of public and private agencies of all sorts, reduce all but the very toughest of us to the mental plasticity of beaten beasts of burden.

So, if you still think you want to go into the record business, read this—and *forget it!* Believe me, if to err is human and to forgive divine, wholesalers are the humanest people and retailers the saintliest.

Being a record dealer is like being the middle man of three in a bed. One has to keep his suppliers off his neck on one side and to put up with customers who range downward from passably normal all the way to plain wacky, on the other. If I were still in business, I would have to keep all this to myself, but I am not, largely because I could not compete successfully against other concerns which, by means I can only suspect, were able to *retail* records profitably at prices less than what I had to pay my wholesale suppliers for the same lines. A babe in the woods! That's what I was, I guess.

Now, in my time as a record retailer I had cause, at one time or another, to take up arms against the record manufacturers, the record distributors, the Post Office, the Customs Service, the Railway Express, truckmen, landlords, and, once in a while, the customers, too. The truth of the

matter is, the customer is *not* always right. It must not be assumed, from all this, that I am an extraordinarily bellicose or irascible character, but there *is* a limit, and when one has had to contend with continually recurrent misfeasances, malfeasances, and nonfeasances and with perpetually recrudescient outbreaks of sabotage, the milk of human kindness tends to coagulate and turn acid. It is indeed a wonder that a good many more record dealers have not gone screaming, gibbering mad or have availed themselves of the gas pipe. Some have.

The young hopeful who has digested the contents of a few catalogues and has more nerve, and maybe money, than good sense, usually starts out to be a Record Dealer by importuning a few wholesalers to provide him with token stocks, a dash of credit, and, of course, "service." He doesn't know it, but that is, constructively, equivalent to soliciting permission to blow one's brains, if any, out! The truth of the matter is that the prime requisites for participation in the retail record business are (1) a capacity for unlimited correspondence, (2) patience beyond anything ever recorded in Holy Writ, (3) limitless concurrence with the opinions of all who harangue one interminably on the telephone, over the counter, or in the sanctuary of one's private office, and (4) a forty-hour *day* to get things *half-done* in. That will get the prospective dealer off to a start, of sorts.

So he is in business, and from there on he becomes a stranger to his friends. His wife, on those rare occasions when she gets to see him by daylight, observes, "Dear, are you *sure* you are quite well?" in that tone of voice which suggests more concern with one's mental soundness than his physical health. That is, at the beginning. Later on, one's ever-loving just looks him over as he shuffles in, bleary-eyed, haggard and bewhiskered, puts down the pamphlet on divorce law through which she has been thumbing, and observes, slightly acidly, "I imagine you haven't eaten since you went out the night before last," and adds, "or was that last week?"

You think, maybe, that I'm exaggerating? Ha!

You think you can keep your business life and your home life insulated from each other? Do justice to both? Don't you wish it! The records follow you home. So does everything else connected with the business, including the customers who get in by telephone if not by the door. The stuff is in your living room. It's in the dining room. It's piled on the piano, on the buffet, in the closets, in cartons under your bed. Even the cellarerte is not immune to in-

vasion. But do you ever get time to play records for yourself? Heh, heh.

Maybe, you think, if you hired yourself some help, you might be able to relax a little. Ah, me! Right about there is where you find out that Uncle Sam, your state, and the local authorities have a few jobs for you. Now you have to compile statistical data and fill in forms, all in accordance with gobbledygook instructions which have you tearing your hair out in handfuls. Oh, sure, your help relieve you of some of your former burdens. Now you use the time to do the paper work which comes from having help. So the help go home at closing time while you stay in the back room and scribble, *far* into the night.

Sure, you're tired, but do you sleep? What's bed for? You lie awake while your poor brain surveys all the things you will have to get under way, come morning. In mind, you go over all the problems of short shipments, wrong shipments, damaged shipments, no shipments, bad accounts, missing stuff, wrong records in the right sleeves or albums, promotional ideas. Your biggest headaches are the orders you gave this, that, and the other distributor weeks, maybe months ago. No action! Why?

That worry over back orders, by the way, is one of the things which, in the long run, lay the groundwork for apoplexy. Here is an example:

The ABC Record Distributing Corporation, let's say, handles N records, O records, and P records. You need some of each brand. You make up an order. You mail it in. The N records come. The O records are there too. No P! Oh, well, you figure, they are on back order. So you wait. The weeks go by, on leaden feet. You drop ABC a card to find out what gives. No answer. In the meantime, you see P records in other stores. You begin to check, and the facts come to light. ABC Record Distributing Corporation had ceased to carry the P record line. More exactly, the producer of P records had found ABC's representation less effective than he had expected. He had made only half-a-million in the first two weeks; so he took the line back and put it into DEF Distributing Corporation's hands. DEF handles K records, L records, and M records. Does ABC's sense of dealer-service transcend the impulse to get even with the producer of P records? A likely theory! As far as ABC is concerned no such records as P records ever existed. Interestingly, by the time you have found out that DEF handles them, the impatient producer may have turned them over to GHI Records, Inc., and so on.

Now that is not a special case. That sort of thing goes on *all* the time. It is just a specimen irritation. One of the very largest distributors in this country practically *never* replies to any dealer inquiries or complaints. He had a particularly cute routine with respect to orders for imported records. Say you wanted ten copies of a certain number. He had to pass your order on to the domestic manufacturer who had the contractual tie-in with the foreign producer of the brand you wanted. That domestic manufacturer, in turn, routed the order abroad. Then, if the records

were available and not restricted, the foreign firm forwarded them to the domestic manufacturer who broke bulk and sent the records to your wholesaler who, finally, sent them on to you. In that way, *everybody* along the line made a few pennies and the customer had to pay \$2.64 for a record he might have imported *directly* for himself from a foreign retailer at a total cost to himself of only \$1.55. What kept him from doing that, however, was Sec. 526 of the Tariff Act of 1930.

But let's get back to that order for ten records of foreign manufacture. Four, five, maybe six months have gone by. (Not unusual!) Finally, you drop your supplier a card to ask what's up. You get no answer. Another month or two. No records. You write once more. After all, the customers are beginning to needle you. Again, no answer. *Another* month or two, and you are on the point of writing one last, pleading inquiry when you hit the jackpot. You get *thirty* copies of the record you wanted only ten of—ten for the original order, ten for the first inquiry, and ten more for the second follow-up.

Or like this:

Like buying a pair of shoes in a box and when you open it at home you find both shoes are for the left foot, comes a two-record album. It should contain record No. 12345 and record No. 12346. You find two No. 12345s; no No. 12346. You negotiate for adjustment. You get, after a couple of weeks, a return authorization for one (1) No. 12345. Comes a replacement. It's another No. 12345!

All right! Scream your head off about how they are spending your money for you. See what it gets you. Do they say send the extras back? Do they give you a credit? Do they say or do *anything*? You should live so long! A successful record jobber is one who is totally deaf to complaints, protests, expostulations, and remonstrances. One cost me the sale of perhaps 20,000 records by failing to supply me while I objected for over a year to the recurrent appearance on my statement of a substantial balance I did not owe. *There is absolutely no worse evil in America's distributive system than the establishment of exclusive regional distributorships.* The arrangement confers on distributors thus established the power of economic life or death over the retail dealers, who are left without any alternative but to submit to their coercive powers, and these are absolutely enormous. In ever so many instances the dealer has only little freedom of choice. Often he is compelled to accept the clucks along with the clicks, whether he likes the idea or not.

Well, anyway —

Few businesses have ever been so liberally booby-trapped as the imported record business. In general, the leading foreign lines could be imported only through or with the consent of their affiliated houses in this country. Sec. 526, mentioned above, in effect, made the U. S. Customs Service the guardian of certain American monopolies. Whoever undertook to import records of the brands under protection of this statute

The reader is reminded that Mr. Franck is writing as a former record dealer, not as a dispassionate outside observer of the industry. We have no reason to doubt his word on abuses generated within the industry, but call to your attention that there may be rational aspects to the exclusive-distributorship system, for instance, that he does not discuss.

— The Editors.

ran the risk of having his shipment intercepted, impounded and possibly confiscated, and there was a risk of civil and criminal penalties. If such an importer managed to obtain the consent of the firm whose privileges he had violated, he could obtain the release of his consignment, but that was always an embarrassment. There might have been ninety-nine records in such a case against which no restriction might have existed, but if the hundredth record was of one of the makes under the protection of Sec. 526, the *entire* shipment was deemed to be contaminated by it and in danger of seizure. It did you no good to instruct the customs to destroy it and release the remainder. Therefore, the importing dealer who wished to avoid distressing contingencies was careful to do his importing of such brands strictly in accordance with the prescribed routines. Rugged individualism was not countenanced. And, naturally, costs (and prices) were outlandish.

Obstacles to trade in imported records, erected by American companies, were numerous. One such company argued that the more imported records they had to obtain for their dealers, the fewer of their domestic records would be sold. However, whatever the considerations that influenced their attitudes, there were great numbers of foreign records they absolutely *would not* obtain for their dealers and *would not* permit the dealers to import for themselves. Desirable items from Australia, Argentina, Brazil, Japan, and Mexico were made absolutely inaccessible to American collectors by reason of this dog-in-the-manger policy. Collectors could not even buy them abroad and bring them home as personal possessions.

Nothing was spared to make life rough for the importing dealer. It was quite the usual thing, for years, for the domestic companies to accept and execute their dealers' orders for records from abroad while they were actually engaged in preparing the identical recordings for release in domestic pressings. Consequently, the dealers often just barely got the imported pressings into their stocks at a cost *to them* of \$1.63 per record, when the American counterparts were proclaimed available at \$1.25, *retail!* The domestic companies contended that to have warned their dealers would have disclosed to their competitors their plans for forthcoming releases.

The almost quarter-century I spent as a dealer in my own right was a continual struggle to keep my clients informed about the devious ways of the record trade. I wanted them to comprehend in what ways selfish, stupid, greedy, or conniving interests were placing impediments in the way of their ready access to fine recordings of culturally valuable material from all over the earth. I endeavored to show them how the effective cartelization of the industry inflated costs needlessly. I undertook to enlist the aid of members of Congress and the appropriate Federal agencies towards terminating some of the more objectionable practices, as being "monopolistic and in restraint of trade." My appeals might as well have been addressed to institutions for blind deaf-mutes.

I alluded above to the "exclusive regional distributor" racket. I tried — in vain also — to attract the attention of government agencies to that utterly disreputable mechanism of monopoly. Under that arrangement the dealer is

without any alternative but to obtain his supplies of any given line from a single source. If his trade policies do not happen to conform to the jobber's idea of his own business interests, he may find himself subjected to myriad annoyances, impositions, deprivations, and delays. If he *attempts* to circumvent the situation by addressing his orders to a distributor in another area, he is coldly referred back to the jobber who enjoys the regional monopoly to which he is subservient. I have heard this referred to as "free enterprise."

Even when a dealer is in good *standing* with his distributor-supplier, this *arrangement* may operate to his injury. For instance, if his own supplier is out of stock on an urgently needed number, the jobber in another monopoly area who may have a good stock of it cannot or will not supply him. That would be "invasion." The dealer simply has to wait until his own jobber has the item again.

In parts of the Southwest, during the war years, record retailers who hoped to obtain any records at all from their suppliers often were required to buy supplies of needles guaranteed to last them to 1984. Had they been in any position to tell their regular jobbers to go jump in the lake, that they would get their stuff elsewhere, the standards of service to all concerned would surely have been at least *slightly* better.

As I view it, the wholesale distributor of records is an excrescence. The correct and legitimate function of jobbing is to provide wide representation for manufacturers who are individually too small or too weak to establish effective large-scale sales-organizations or to finance advertising programs by themselves. Where such small producers can realize a collective *advantage* through the use of a common distributor, the jobber's *function* is fully justified.

There is much more that might be said about relations within the trade, but much *space* has been devoted to that phase of record dealership *already*. Let us now turn our attention to the record *customer*. Without him, there would be no record business. Therefore, it behooves the record retailer to handle him with kid gloves, to cherish his goodwill and, now and then, to submit to abuses for which (so help him!) he would clip anybody else in the jaw.

YOU CAN START in the mail order department. Here is a letter. It is on rough, blue-lined, grayish-white paper, torn from a cheap notebook. The edges are yellowed and crumbly. The writing, made with a thick, soft pencil, is jerky, irregular, and *difficult* to decipher. Large and childish at the very start, it *quickly* becomes tiny and even harder to read as it descends to the bottom of the page and finally trails off into microscopic illegibility up one side and upside-down across the top. There is no signature, no return-address on either the letter or the envelope. You put it into the "pending matters" file, figuring that sooner or later the writer will *follow up* on it. He does, with some trace of acerbity. He *seems* to think less well of you than before, but again he *leaves you* in the dark as to his name or place of residence. Now and then one comes in with a complete address but no hint of the writer's name, and you feel *cheered*: the world is

Continued on page 113

COLLINS — One of the nation's foremost makers of tuners — our only business!

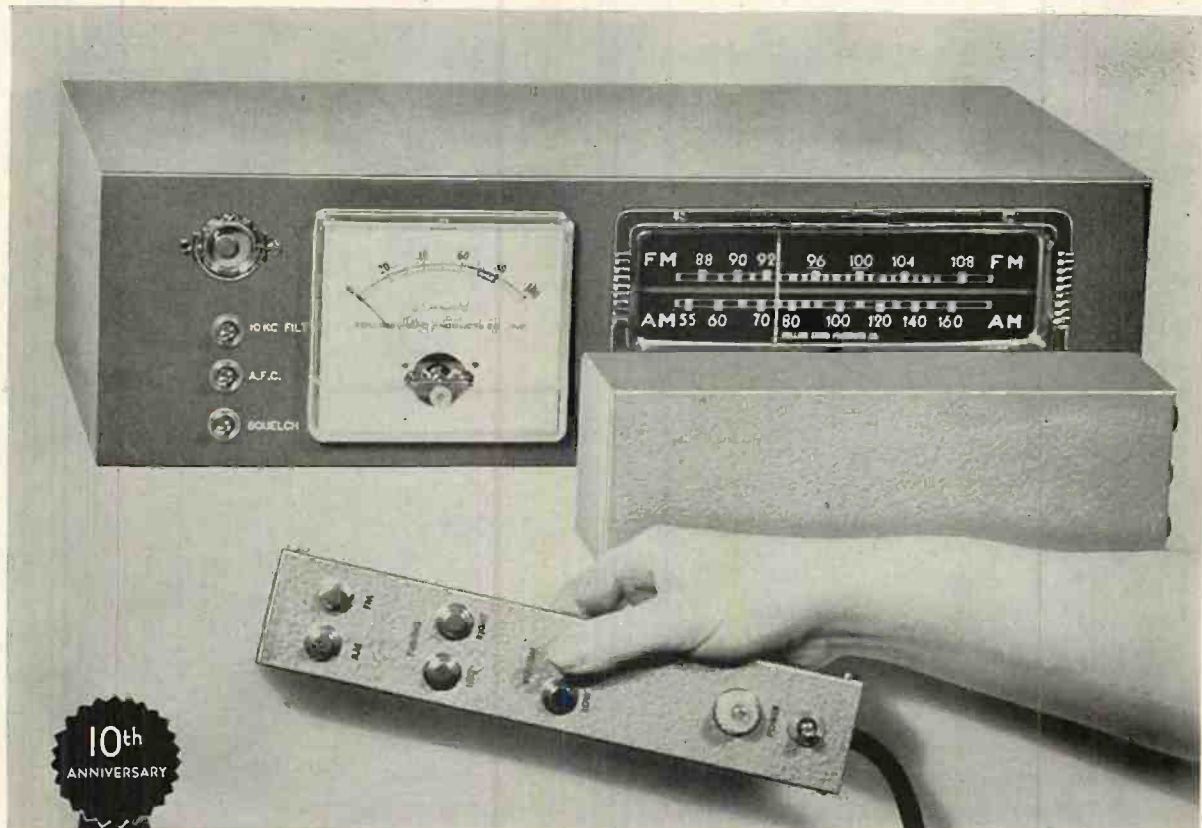

there IS something NEW IN TUNERS!

THE Collins "Custom Special" is an entirely new concept in tuner design. Here is a prestige instrument to provide the utmost in High Fidelity and ease of operation. See it at better dealers. This Collins tuner has outstanding features found in no other tuner on the market. Here are some of these exciting features:

- **Remote control attachment**
- **Cascode front-end on FM 3 mv. sens.**
- **Wide range AM — better than 11,000 cycle response**
- **Functional panel arrangement.**

REMOTE CONTROL

Collins is proud to be **FIRST** with a completely remote controlled tuner. All functions are controlled by the push buttons without getting up from your chair.



Write Dept. HF-6 for Interesting Brochure on the "Custom Special"
Dealerships Available

COLLINS AUDIO PRODUCTS CO.
WESTFIELD, NEW JERSEY

Collins Audio Products Co. Is In No Way Affiliated With Collins Radio Co.

Superior



Golden Twins by Bell

Hi-Fidelity tuner-amplifier ensemble

These twin self-cabineted units (12 watt high fidelity amplifier and AM-FM Tuner) are the ideal foundation for a superior home music system. They may be used separately, or as companion components perfectly matched, electronically and in styling.

See and hear these perfectly matched Bell high fidelity units at your dealer's salon now. Write for catalog 542 for complete details.

Those who demand the finest always choose Bell

Bell Sound Systems, Inc.

A Subsidiary of Thompson Products, Inc.

555-57 Marion Rd., Columbus 7, Ohio Export Office: 401 Broadway, New York 13, N.Y.

SPECIFICATIONS:

The Model 2256 amplifier has 5 controls (7-position equalization and selector switch, continuously variable loudness control, gain control, bass and treble cut and boost), 6 inputs, 4 outputs and response from 20 to 20,000 cps plus or minus 1/2 db. Output is 12 watts (20 watt peak) with .5% distortion. The Model 2255 AM-FM tuner covers the full AM range from 55 to 165 kc and the entire FM spectrum from 88 to 108 mg.

Controls include band selector switch, tuning knob with AFC defeat switch.





music makers

by ROLAND GELATT

NEW YORK'S MUSIC SEASON ended this spring on a note of high artistic achievement with the recital early in May of Dietrich Fischer-Dieskau, baritone, and Gerald Moore, accompanist. Unlike most Town Hall debutants, Fischer-Dieskau was greeted by a full house and the kind of rapturous applause that betokens an audience composed of the already converted. Phonograph records had obviously accomplished some impressive missionary work. Mr. F-D turned out to be tall, baby-faced, and thirtyish, with a dignified, fairly immobile platform manner, a well-controlled though not especially distinctive voice, and a sober, refined sense of musical values. Other singers have come to New York preceded by wonderful recordings, and some of them — Suzanne Danco and Ferruccio Tagliavini, to name two — did not quite live up to expectations. Happily, no illusions were shattered by the appearance of Fischer-Dieskau in the flesh. If anything, his program (devoted entirely to Schubert's *Winterreise* cycle) showed him to be a more interesting singer than his recordings would have led one to suspect....

For me, however, the real musical stimulus of the evening came from the playing of Gerald Moore, a squat, beefy man in his mid-fifties, with a ruddy complexion and a twinkling mien. This was not his New York debut: he had played in Town Hall back in 1926 as accompanist for the English tenor John Coates and had returned in October 1954 to give a lecture-recital of his own; but for many of us in the audience this was the first opportunity to hear in person a musician whose work on records has become practically legendary. It would not be accurate to say that he surpassed his records on this occasion, since there comes a point when excellence cannot be surpassed; but it was as winning a demonstration as any Moore has given on records of his rare ability to project through the piano the essence of a song's poetic

imagery. He sees subtleties in a piano accompaniment that no one else, seemingly, can; and, seeing them, he is able to realize their execution through his extraordinary command of both tone and rhythm. In the few opening measures of *Die Post* he re-creates with remarkable definition the cantering of horses and the fruity braying of a postman's horn. And in *Der Leiermann*, as Alec Robertson points out in the April *Gramophone*, he suggests by his astute timing of a rest and weighting of a chord "the pathos of the old man, with frozen fingers and worn out hurdy-gurdy, churning out his disregarded tune."

The day before the concert, I met Mr. Moore and asked him the inevitable question: how did he decide to become an accompanist? The shaping of his career, he told me, came about through the death of his piano teacher, Michael Hambourg, father of a well-known pianist (Mark) and cellist (Boris). Although English-born, Gerald Moore was raised in Toronto, and



DOUGLAS GLASS

Gerald Moore

there he became a scholarship pupil of Michael Hambourg's, with the understanding that he would repay his teacher in part from the proceeds of any forthcoming concerts. When Hambourg père died in 1916, Moore had not repaid his debt; and as an

expression of gratitude toward the family, he offered his services as accompanist to cellist Boris at a fee of \$1.00 per concert. The offer was accepted and the career of accompanist begun, though Moore still had his sights set on a solo career. A few years later he returned to England, and to earn his keep continued to play accompaniments. Sir Landon Ronald, who heard him at this juncture, advised him to concentrate on accompanying. "The world is overstocked with brilliant solo pianists," Sir Landon asserted, "but there are precious few good accompanists in the field." Moore saw the light, and began then and there to learn as much about accompanying as he could.

He has learned a great deal. And now he is putting some of that knowledge at the disposal of us all in an engaging little book entitled *Singer and Accompanist* (Macmillan, \$3.75). In it Mr. Moore writes perceptively and wittily about fifty songs he is fond of. I heartily recommend his book to anyone with a love of songs and a sense of fun.

EVEN THE MOST ERUDITE collector of musical oddments may not be able to name the famous composer who met an untimely end because of an invitation to the White House. It was Enrique Granados. He came to the United States in the midst of World War I to attend the world premiere of his opera *Goyescas* at the Metropolitan Opera House and had planned to return directly to Spain thereafter. But an invitation to play at a White House reception given by President Wilson made him postpone his departure and cancel his steamship passage to Spain. Instead he chose to sail by way of England. Midway in the English Channel his ship was torpedoed by a German submarine and Granados perished, in his fiftieth year.

At that time Granados was working on a symphony, the unfinished manuscript of which survived him and has

remained the property of his children in Barcelona. Recently the Granados family attended a concert in Barcelona's Palacia de la Música to hear a young Spanish conductor and composer, Rafael Ferrer, conduct his own orchestration of a Granados piano suite. Ferrer's rapport with the idiom of this music so impressed the heirs and musical executors of Granados that they gave him the unfinished symphony and authorized him to complete the work interrupted so tragically in 1916. Doubtless the Granados-Ferrer symphony will be recorded in due course.

THE NAME OF GRANADOS keeps recurring in a recent French book entitled *Conversations avec Pablo Casals*, published by Editions Albin Michel, in which an interlocutor draws out the cellist on his remembrances of things past and his opinions on music and musicians. Casals considers Granados the most creative composer of the modern Spanish school and believes that music sustained a severe loss because of his premature death. The news of the torpedoing reached Casals while he was on a concert tour in the United States. Soon after, he joined Paderewski and Kreisler in a joint concert at the Metropolitan Opera House for the benefit of the Granados children. Among the works played to a capacity audience was the Beethoven *Archduke* Trio. Too bad no microphone was on hand to capture this evening of music making for posterity, or to immortalize some informal chamber music sessions at the home of Eugène Ysaye when piano quintets were performed far into the night by Kreisler, Thibaud, Ysaye, Casals, and Busoni!

On the question of recordings, Casals holds some rather startling opinions. He begins by acknowledging the tremendous progress made in recording technique, but then goes on to say: "Yet I still prefer the records that dare back thirty or forty years. The sound is less brilliant but more faithful." He further states: "In general, I derive greater pleasure from hearing recorded music when the records are turning faster. As far as my recordings of the Bach suites are concerned, I feel the need of hearing them a tone and even a tone and a half higher. The changes of tonality do not dismay me at all." Casals is definitely not the man to endorse a hysteresis turntable.

BENNO MOISEWITSCH, the Russian-British pianist, shares this nostalgia for the records of yesteryear, though for a different reason. He believes that the conditions of record making in the days of 78 rpm were more likely to bring out the best in a musical performer. "The nervous strain," he concedes, "was terrible. You waited in the studio until the sound of a buzzer and the blink of a red light gave you the signal to start. Then you had to begin without a moment's delay and play right through for the duration of a side. If it didn't go right, you made the side over and over again. This kind of tension was hard on the nerves of the performer, but it produced excellent musical results. It keyed you up to a high pitch of musical concentration, and eventually you produced a four-minute side that was really good. Today, with magnetic tape, the job of making records is far easier on the performer, but I find it musically less satisfactory. There is much less tension in the recording studio now. You start and stop when you want to. You make several takes. Some are good, some not so good. The engineers tell you that they will patch together a final recording using the best portions from each take. They do, and it sounds all right. But, frankly, I don't find the results as satisfactory as they used to be, when record making was less relaxed and easygoing."

IN CELEBRATION of Giovanni Martinelli's seventieth birthday this fall, RCA plans to reissue on LP a selection of the many recordings he made for Victor during the 1920s and 1930s. This birthday tribute will appear in the \$1.98 Camden catalogue, which grows increasingly valuable as a repository of some inimitable musical performances. A few Martinelli items have already been tapped for the \$3.98 Collectors series, but there are still about forty uncommitted sides to choose from, and the Camden impresarios have decided to put the choice to a vote. Will those of you who have been yearning for a Martinelli recital please express your preferences to Frank O'Donnell, Camden Records, 630 Fifth Avenue, New York 20, N. Y. This is to be a "By Request" recital, and your vote is needed.

On the subject of Martinelli I am apt to get delirious. I was brought up on his *Radames*, *Manrico*, *Otello*, and *Canio*, and they remain for me the

quintessential embodiments of those roles. Certainly I have heard no Italian tenor of the younger generation whose musical insights or dramatic address are of like stature; and the more I listen to his records, the more I am prepared to agree with Desmond Shawe-Taylor's description of him as "one of the great stylists of the century."

By and large, Martinelli's records do him justice; however the votes fall, I shall be happy with the Camden reissue. But I shall be particularly happy if *vox populi* singles out the 1927 recording of "*No, Pagliaccio non son*," which contains one of the most thrilling moments on records as Martinelli spins out a miraculously sustained phrase to the words beginning "*E fidate credete*"—a prime example of this singer's ability to inflect music with dramatic impact and maintain at the same time a legato line. Commentators are continually remarking on morsels like this from Martinelli's recorded legacy. For Shawe-Taylor, the Martinelli recording of "*Di quella pira*" would be worth buying if only for one phrase of recitative: "*Amor, sublime amore, in tale istante ti favelli al core*." "Martinelli," he writes, "invests this simple line with such purity, such nobility and intensity of feeling, that it could well stand as a model for the vocal student." For another British critic, J. B. Richards, the "cry of real anguish" on the words "*io non sentivo sul suo corpo divin che n'innamora*," in the Martinelli-Tibbert-Jepson album of *Otello* excerpts, haunts the memory.

If all this has started opera lovers thinking about their favorite Martinelli record, it will have served its purpose. At Camden they are waiting to hear from you.

THE FOLLOWING INDICATION of Sir Leonard Bernstein's newly acquired baronetcy appears on the inner jackets of all current Columbia records:



Doubtless this information will be incorporated in the next edition of *Liebertson's Peerage*.

Records in Review

Reviewed by PAUL AFFELDER • NATHAN BRODER • C. G. BURKE • JOHN M. CONLY
 RAY ERICSON • ALFRED FRANKENSTEIN • ROLAND GELATT
 JAMES HINTON, JR. • ROY H. HOOPES, JR. • J. F. INDCOX • ROBERT KOTLOWITZ
 HOWARD LAFAY • GONZALO SEGURA, JR. • JOHN S. WILSON



Classical Music Listed by Composer	51	Folk Music	72
Advertising Index	52	The Best of Jazz	73
Recitals and Miscellany	67	The Music Between	76
Dialing Your Disks	68	The Spoken Word	76
Building Your Record Library	71	Chopin: A Discography	78

CLASSICAL

ARNOLD, MALCOLM

English Dances

The London Philharmonic Orchestra, Sir Adrian Boult, cond.
 LONDON LD 9178. 10-in. \$2.98.

A most cunningly contrived set of six dances, which though sounding like a reworking of old folk tunes are all original material from the pen of Malcolm Arnold, a young English composer and onetime trumpet player with the London Philharmonic. They get a lovely performance from Boult and his men, and the sound is faultless. J. F. I.

AUBER

Overtures: Masaniello (La Muette de Portici); The Bronze Horse; Fra Diavolo; The Crown Diamonds

Paris Conservatory Orchestra, Albert Wolff, cond.
 LONDON LL 1157. 12-in. \$3.98.

A truly great conductor is needed to lift these overtures out of the routine groove into which they are too likely to fall. Seventy-one-year-old Albert Wolff is such a conductor. He revitalizes them as Toscanini has revitalized the Rossini overtures, and the results on this disk are spectacular. P. A.

AUBERT

La Habanera — See Carpentier: *Impressions d'Italie Suite*.

BABAJANIAN, ARNO

Heroic Ballad

Arno Babajanian, piano; State Radio Orchestra, Nathan Rachlin, cond.

†Tchaikovsky: *Concert Fantasy, Op. 56*

Tatiana Nikolayeva, piano; State Orchestra of the USSR, Kiril Kondrashin, cond.
 CLASSIC CE 3007. 12-in. \$5.95.

Babajanian's symphonic variations for piano and orchestra, entitled *Heroic Ballad*, constitute twenty-one minutes of pleasant but hardly distinguished musical interplay. The piece is most remarkable for the composer's flair for writing in the style of his great Russian predecessors than for any originality of musical thought on his part. Reminiscences of Tchaikovsky, Rimsky-Korsakov, and particularly Rachmaninoff are well in evidence, with occasional whispers of Ravel and even Gershwin. The performance appears to be well managed by soloist and orchestra alike, though the recorded sound is not overbright.

Tatiana Nikolayeva gives a very fluent and persuasive performance of the Concert Fantasy, one of Tchaikovsky's most slighted works, despite its undoubted challenge to the virtuoso pianist. Her playing is beautifully relaxed in the quieter passages; however, she does not dispose of the bravura sections with quite the brilliance of Noel Mewton-Wood, whose recording (CONCERT HALL CHS 1126) is still the preferred version. J. F. I.

BACH

Cantata No. 11, Praise Our God; Cantata No. 67, Hold in Affection Jesus Christ; Jesu, Joy of Man's Desiring, from Cantata No. 147

Eva Mitchell, soprano; Kathleen Ferrier, contralto; William Herbert, tenor; William Parsons, bass; Cantata Singers and Jacques Orchestra, Reginald Jacques, cond.
 LONDON LL 845. 12-in. \$3.98.

These works were previously listed in the London catalogue on two separate ten-inch

disks. Except for the late Kathleen Ferrier's warm singing of the wonderfully poignant alto aria in No. 11 (used by Bach later in the *Agnus Dei* of the B minor Mass), the performances have little to recommend them. Elsewhere stodginess reigns. The chorus is weak and blurred, the important woodwind parts are often barely audible. The ethereal character of the lovely soprano aria of No. 11 is spoiled by the addition of an uncalled-for continuo, played on the harpsichord; to complete the damage, the aria is cut, long before the *da capo*. In the final movement of No. 67 the sound of the chorus twice fades unaccountably. This is the sole recording of No. 67, but Ferrier has only a few measures of recitative in it. No texts are supplied, possibly because the works are sung in English. N. B.

BACH

Concertos for Harpsichord and String Orchestra, in F minor and D major

Isabelle Nef, harpsichord; L'Ensemble Orchestral de L'Oiseau-Lyre, Pierre Colombo, cond.
 L'OISEAU-LYRE OL 50042. 12-in. \$4.98.

Colombo conducts these works with a rather heavy hand. Tutti chords are punched out, there is a feeling of ponderousness in other tutti passages, and the slow movement of the F minor Concerto ends with a retard from here to over yonder. The solo part is nicely played. The golden tone of Isabelle Nef's harpsichord sounds particularly charming when combined with the pizzicato strings in the Largo of the F minor. Recording is resonant and clear. N. B.

BEETHOVEN

Concerto for Piano and Orchestra, No. 3, in C minor, Op. 37
Variations in C minor, G 191
 †Mozart: *Sonata for Piano, No. 16, in B-flat, K. 570*

Emil Gilels, piano; Moscow Philharmonic Orchestra, Alexander Gauk, cond.
COLOSSUM CRLP 177. 12-in. \$3.98.

Swollen sides lasting three minutes beyond an hour, with the Cocerto side vying with the Toscanini record of the Beethoven Septet in an approach to thirty-five minutes. So much the longer to endure the macabre sonics here, the emaciated bass and skeletal creble of an orchestra made toneless by electronics. The solos are better but far from good. There is some gold in the playing, and its transmutation into zinc is a realization in reverse of the old dream of the alchemists. C. G. B.

BETHOVEN

Minuets (6), G 167
 †Dvořák: *Gavotte*

London Baroque Ensemble, Karl Haas, cond.
DRCCA DL 4096. 10-in. 13, 3 min. \$2.98.

Competent playing, no more—and perhaps no more is necessary for this kind of thing—and pleasant recording. The Dvořák, a good piece, does not belong here

Record Advertising Index

Angel Records.....	65
Beyland Engineering Co.....	77
Calex Co.....	89
Columbia Records, Inc.....	61
Cook Laboratories, Inc.....	77
Dublin's.....	89
Gene Bruck Enterprises.....	89
High Fidelity Recordings.....	87
Leslie Creations.....	89
London International.....	81, 83, 85
London Records.....	59
Mercury Records Corp.....	62, 63
Missouri National Corp.....	89
Music Box.....	88
Music Room.....	89
Nuclear Products Co.....	84
Record Index.....	86
Record Market.....	89
Telefunken Records.....	81
Vox Productions, Inc.....	73
Westminster Recording Co.....	75

where fifteen minutes of other Beethoven or Pleyel or Haydn or Boccherini would have been germane. Decca asks an inordinate reward for her lazy editing, and discophiles would be unfair to themselves and to the industry to offer it. The container is only half filled with music.
 C. G. B.

BETHOVEN

Sonatas for Piano: No. 29, in B-flat, "Hammerklavier," Op. 106; No. 30, in E, Op. 109

István Nádas.

PERIOD SPL 718. 12-in. \$4.98.

The world can provide competent pianists in any quantity required, and Messrs. Period have reached into Venezuela for this one in asylum from his native Hungary. Offering him the *Hammerklavier* as an instrument for debut was not an act of recklessness but a testimony of confidence, which a hearing reveals not to have been misdirected. In this huge sonata lavish with huge difficulties the player has achieved above all clarity and sense, foregoing the pianistic ecstasy of a hot bath in

Chapi and the Musical Spirit of Madrid 1900

AMONG THE MANY successful zarzuela composers of the last hundred years, two stand out for the beauty and expressiveness of their music: Bretón and Chapi. Curiously enough, they were born just a few months apart, in 1850 and 1851 respectively. Of the two, Chapi would probably have more of an immediate appeal to American ears both because of his own melodic style and because of the richness of his orchestrations.

Of the three Chapi zarzuelas listed below, *La Revoltosa* is probably the most popular. It is a work that breathes of the Madrid of 1900 much as *Fledermaus* breathes of the Vienna of Franz Josef—except that we Americans feel emotionally close to the latter and know nothing at all of the former. The story revolves about Mari Pepa, a girl who simply can't resist indulging in a bit of coquetry from time to time. Not unreasonably—at least for a Spaniard—her fiancé objects strenuously, but our Mari Pepa stands by her inalienable rights and proceeds to flirt openly on every occasion with all the men in the neighborhood. Naturally enough, all the corresponding wives, sweethearts, etc., resent this violently. Finally the women get together to put a stop to all this. They send a child to tell each man that Mari Pepa expects him in her room that night. Of course, Mari Pepa never intended to go that far—her virtue is indeed above reproach and she truly loves her Felipe. While she is most ably defending herself (words have sufficed so far), the women turn on the lights in the courtyard by Mari Pepa's room—and find that every man in the neighborhood has accepted what he thought was an invitation from Mari Pepa. The resulting scandal can be imagined, for none of the revengeful women expected to find her man there. Mari Pepa manages to clear herself and is finally, if grudgingly, forgiven by all—provided she and her Felipe get married soon and move to another neighborhood.

I have gone into some detail explaining the plot because I feel that, in spite of its intensely Spanish atmosphere, this is work that may well appeal to that enormous mass of the American public that enjoys Strauss, Léhar, Rodgers and Hammerstein, etc. Perhaps one of these days an enterprising Broadway producer, looking for something decidedly different and yet highly likely to succeed, will investigate the Spanish theater. I would not be at all surprised if, when the day comes, *La Revoltosa* is chosen and, with perhaps a few minor modifications, becomes the hit of the season. Incidentally, the London translation of the title, *The Lady Joker*, is most inept. Columbia did better with *The Trouble-Maker*, although a more faithful version would be *The Live Wire*. Both of these versions are well performed and recorded. The Columbia version has been cut to fit one side (the other side is given to an abbreviated version of another superb zarzuela, *Gigantes y Cabezudos*), while the London is presumably complete. It is this matter of variety versus completeness that must decide the choice.

Altogether different is *La Tempestad*—a deadly serious work for all of its including several amusing scenes. The plot itself is not very compelling; it moves toward a false accusation of murder that is finally cleared up in a rather contrived fashion. However, there is a wealth of magnificent music and some very dramatic scenes. The atmosphere of a fishing village, the storms and the sea that take the lives of its men, are all painted in vivid colors. To mention just one specific item: the great baritone aria at the end of the first side is almost worth the price of the entire two-record set, particularly when performed by an artist of the caliber of Manuel Ausensi.

The third Chapi work, *El Barquillero* (*The Water Seller* or, completely translated into American terms, *The Ice-Cream Man*), is difficult to judge. The music is still by Chapi, which means that it is absolutely

first-rate—in particular, Socorro's aria is extraordinarily beautiful—but I simply could not make out the plot, if any, and that disturbed me somewhat. Furthermore, the singing is barely acceptable, and the set lacks any artist of stature.

None of the zarzuelas that I have seen on records ever carry an English libretto. Montilla includes a Spanish libretto and a brief summary of each scene in English. Columbia has dispensed with the Spanish part and abbreviated the English summary. London includes interesting analyses of each work in both languages—but often not even a bare outline of the plot itself. However, I understand that London is now intending to prepare some line-by-line translations. Maybe this will provide the impetus needed to popularize the zarzuela in this country. GONZALO SEGURA, JR.

CHAPI

La Revoltosa

Ana María Iriarte, Inés Rivadeneyra, Pascu-cinio Rico, Mari Carmen del Río, López Roldán, Manuel Ausensi, Enrique Povedano, Julio Nadal, Antonio López, Joaquín Roda; Cantores de Madrid, Orquesta de Cámara de Madrid, Ataúlfo Argenta, cond.

LONDON INT'L TW 91014. 12-in. \$3.98.

La Tempestad

Toñy Rosado, Pilar Lorengar, Manuel Ausensi, Carlos Munguía, Gregorio Gil, Antonio Díaz Martos; Cantores de Madrid, Orquesta de Cámara de Madrid, Ataúlfo Argenta, cond.

LONDON INT'L TW 91029/91030. Two 12-in. \$7.96.

El Barquillero

Toñy Rosado, Carlos Munguía, Juan de Andía; Cantores de Madrid, Orquesta Sinfónica, Ataúlfo Argenta, cond.

LONDON INT'L W 91025. 10-in. \$2.98.



Markevitch: Borodin moves along smartly

billowing noise. The distinctness of the voices in the fugue is a triumph of abnegation. Op. 109, without the pitfalls of its mighty predecessor, has been realized with the same modesty and with the addition of a becoming lyricism.

Placing the two sonatas on one disk with a duration of more than an hour has been accomplished without apparent detriment to the sound of the piano, close and natural throughout, like a piano played at home. C. G. B.

BEETHOVEN

Symphony No. 6, in F ("Pastoral"), Op. 68

Derroit Symphony Orchestra, Paul Paray, cond.

MERCURY 50045. 12-in. \$3.98.

Beethoven gave subtitles to the movements. We may alter the first two, in this running projection, to "Soccer at Heiligenstadt" and "Prix des Drags à Auteuil," the brook being that which we would call the water-jump and the French call the *rivière des tribunes*. This athleticism in contradiction of the musing, devotional relaxation prescribed by the composing pantheist, testimony to the conductor's animal spirits, is unfortunately uninteresting. Some good sound has been wasted. This is the first time on LP that Mr. Paray has seen fit to show character in this way; his other Mercury records are accomplishments of high order. C. G. B.

BERLIOZ

Symphonie Fantastique, Op. 14

Philharmonia Orchestra, Herbert von Karajan, cond.

ANGEL 35202. 12-in. \$4.98 or \$3.48.

The *Fantastique* is not Von Karajan's dish. He treats it far too broadly and too gently, rounding off the intentionally rough edges and, in the last two movements, taking the music at far too slow a pace. This symphony requires lean, taut, brilliant treatment, none of which it receives here. In addition, the first side ends at a bad spot in the middle of the third movement. My favorite *Fantastique* remains Ormandy's on Columbia. P. A.

BIZET

Symphony in C major; Patrie, Overture
L'Orchestre de la Suisse Romande, Ernest Ansermet, cond.

LONDON LL 1186. 12-in. \$3.98.

The coupling is identical to the Angel issue conducted by Cluytens. The over-all play-

ing time of each version is reasonably close: Ansermet 27 min., 34 sec.; Cluytens 28 min., 51 sec. Cluytens is faster in the first and third movements, slower in the second and fourth. Listening closely, I do not find his slow pacing of the second movement at all objectionable; the lovely melody of the oboe, indeed, seems to improve as the conductor lingers over it, as if reluctant to let it pass. For this and other reasons I continue to prefer the Angel version.

J. F. I.

BORODIN

Prince Igor: Polovtsian Dances

†Mussorgsky: *A Night on Bald Mountain*

†Tchaikovsky: *Romeo and Juliet*

Orchestre National de la Radiodiffusion Française, Igor Markevitch, cond.

ANGEL 35144. 12-in. \$4.98 or \$3.48.

This conductor has a predilection for smartly paced readings, directed with energy and dynamic strength. Occasionally these qualities may have been misdirected, but they are surely apropos in these Russian scores. The Borodin is neat and well turned, the balance is good, the singing (the language used is French) appropriately lusty. The *diablerie* of Mussorgsky's sym-

phonic poem is well realized, the changes of pace in Tchaikovsky's fantasy-overture nicely controlled. In fact, this *Romeo and Juliet* is one of the best now in the catalogue. Orchestral playing throughout is alert and distinguished, and Angel's sound is exceptionally good, except for a moment at the end of the *Polovtsian Dances*, where some hazy notes in the bass are a little too obvious.

J. F. I.

BRUCKNER

Mass No. 2 in E minor

Choir and Orchestra of the Hamburg State Opera, Max Thurn, cond.

TELEFUNKEN LGX 66033. 12-in. \$4.98.

If one did not know that this Mass was by Bruckner, it is likely that not a single listener would identify him as its composer. Both harmonically and thematically, it is much simpler and more straightforward than any of his instrumental works; the scoring, too, is very simple. But there is no denying the deep religious devotion in its pages.

The present disk is a dubbing from 78-rpm masters (it was once available on both 78 and 33 $\frac{1}{3}$ from Capitol) and the tone quality suffers from age and distortion;

Moderns on the Louisville Label

AS EVERYONE knows by now, the Louisville Orchestra has for some years been commissioning new works from composers all over the world, performing them for its own audience and making them available on records. For a season or two these records were issued by Columbia in its regular course of business; then these disks began to appear singly under the Louisville Orchestra's own label. Not long ago the Kentucky institution received a grant of \$400,000 from the Rockefeller Foundation to step up its commissioning program, and as a result of this it has recently issued two boxed albums, each containing pockers for six twelve-inch records. Only two of these pockets have been filled so far; obviously the others are to be used for forthcoming releases in the series.

Each of the two records provided to date with the albums contains three compositions. Peter Mennin's Sixth Symphony, the *Variations for Piano and Orchestra* by Wallingford Riegger, and a *Notturmo* by Ernst Toch can be found on one; Alan Hovhaness' *Concerto for Orchestra No. 7*, Castelnuovo-Tedesco's *Overture to Much Ado About Nothing*, and Carlos Surinach's *Sinfonietta Flamenca* are on the other. All the performances, of course, are by the Louisville Orchestra under its conductor and idea-man, Robert Whitney; the piano soloist in the Riegger work is Benjamin Owen, of the University of Louisville.

The most rewarding of these six pieces are those by Mennin, Riegger, and Hovhaness. The Mennin is a beautiful example of the twentieth-century symphony—a work of great energy and propulsion in its two fast movements, with an exquisitely lyrical slow movement between. Its orchestral sonorities combine utmost clarity with the big, heroic sound that defines the symphony and distinguishes it from other genres. Riegger's *Variations* are immensely

dynamic, exciting, and ingenious; they are composed in the twelve-tone system. The Hovhaness *Concerto for Orchestra No. 7* makes a totally convincing amalgam of Oriental effects and Western forms and ends with a magnificent "Hymn to Louisville" that should give the blue grass country an altogether new picture of itself. The other pieces—the *Notturmo*, the Shakespearian comedy overture, and the short symphony on Spanish folk material—sound exactly as their titles would lead one to expect: pleasant and tuneful but not especially remarkable. Recordings throughout are very good.

Inquiries regarding these subscription records should be sent to the Louisville Philharmonic Society, 830 South Fourth Street, Louisville 3, Kentucky.

ALFRED FRANKENSTEIN



MILLER. GRAPHIC ARTS

Robert Whitney

neither the voices nor the instruments come through clearly. P. A.

CANTELOUBE (arr.)
Chants de la France

Fourteen French traditional songs, harmonized by Joseph Canteloube: *La belle est au jardin d'amour* (Picardy); *Quon you n'ero pitichounelo* (Rouergue—Spinning Song); *Y a rien de si charmant* (Savoy); *La sermo d'un paure omé* (Languedoc); *Ma douce amie* (Brittany); *Pesite Claudinette* (Savoy); *Au berdurè* (Béarn); *De bon matin je me suis levé* (Auvergne); *Som-som* (Languedoc); *L'hiver sera bientôt passé* (Dauphiny); *O ciucciarella!* (Corsica); *Sé lo voy* (Haut-Quercy); *Bon mati me llevi* (Roussillon); *Sur la montagne* (Gascony).

Lucie Daullene, soprano; Joseph Canteloube, piano.
L'OISEAU-LYRE OL 50047. 12-in. \$4.98.

As a pupil of Vincent d'Indy's and a student at the Conservatoire when J. B. Weckerlin was improving his librarianship by making the first significant modern investigations of French folk music, Joseph Canteloube was touched by the enthusiasm

that has continued to rule his life. In the first fifty years of this century he has, it seems safe to say, accomplished more than anyone before him in the work of noting down the songs that have been known to his countrymen since the days of the troubadours. Yet, as he points out in his note to this recording, songs simply noted down might as well be dead. They are flowers pressed and dried. To be brought alive they must be sung, and sung so that the countryside, the air, even the time, will be evoked for the hearer.

To this end he made arrangements—for piano and for instrumental groups and voice; and he found, in Madeleine Grey, a singer who seemed the perfect interpreter. Some day, scholars may niggle at the harmonizations. Meanwhile, what matters is that the songs are very lovely—and that in this recording there are more of them of comparable quality to the celebrated *Chants d'Auvergne*. Lucie Daullene's voice does not give the same impression of varied color that Miss Grey's does in the older, fainter recording of the Auvergne songs, but she sings with the same precision of style and with much the same kind of never-never impersonality that communi-

cates so very personally across the spaces and the years. And Canteloube himself is at the piano. The sound is actually that of a not-large room; but when the music begins, the walls melt into field and hills, the ceiling becomes sky. No texts, and sketchy notes, but very highly recommended.

J. H., Jr.

CHARPENTIER
Impressions d'Italie—Suite
†Aubert: *La Habanera*

Paris Opera Orchestra, Louis Fourestier, cond.

ANGBL 35120. 12-in. \$4.98.

Italy has inspired several musical travelogues; this particular one was composed in 1887 by the now venerable Gustave Charpentier when he was in Italy as a winner of the Prix de Rome. I found the first movement, with its numerous viola solos, and the last, a vivacious tarantella, especially appealing. Louis Aubert, another veteran French composer, has cast his little symphonic poem in the Spanish mold. It turns out to be a pleasantly atmospheric piece of no great consequence—just a nice filler for the Charpentier suite.

Both of these works herewith make their

Irving Kolodin Explores RCA Victor's Old Masters . . .

By what appears to be common disagreement, there is no such thing in the world as a perfect anthology. One may be appreciated, enjoyed, thought admirable—but not ever without reservations. This is implicit in the richness of materials that are considered worthy of being gathered and sifted and, finally, anthologized. The most the compiler can do is look to his criteria, make his choices, and go to rest with an easy conscience. For even the most voluminous and best-planned of anthologies is open to the question that can be asked of them all: If Z is included, why should X be left out?

The answer, if there is one at all, may or may not remove the question. Even the most rigidly stated criteria can be budged by taste; and tastes vary. The real point is that even though X may have a very valid claim to inclusion, may have been slighted, Z may have at least as valid a claim, and, at the very least, be worth attention on its merits. To borrow a line from Tennessee Williams, it all depends on who's driving the bus.

And this applies to RCA Victor's *Fifty Years of Great Operatic Singing*, in which Irving Kolodin, Music Editor of *The Saturday Review*, has made a personal, sometimes arguable, but always interesting decade-by-decade selection of performances from the master archives of both RCA Victor and its European affiliates—beginning early in the century, with Francesco Tamagno's famous *Di quella pira* (1902-03?), from Verdi's *Il Trovatore*, and just touching the present decade, with a 1951 recording by Risè Stevens of *Non so più*, from Mozart's *Le Nozze di Figaro*.

Not everyone will agree with his selections, to say nothing of his exclusions. Disagreements of varying violence are quite possible, both on grounds of taste and on grounds of historical imbalances. Yet, weighing all objections double, this is by

all odds the most serious and systematic and rewarding exploration to date of the art of singing as related to the art of recording, and the set will more than repay its cost—will repay it many times over, in fact—to anyone whose interest in opera or singing or recordings, or all three, is more than casual.

The quality of the sound, as well as inclusions and exclusions, is certain to stir up controversy among collectors of vocal recordings—especially collectors of acoustical disks. But some of the performances reissued here are now so extremely hard to come by in any form that it is almost impossible to imagine even the most dedicated fanciers of records that turn at (or about) 78 rpm snubbing them in LP form; and the average standard of the group is so astronomically high that to refuse to listen because the reproduction does not follow the New Orthophonic curve would be perfectly ridiculous.

As described by Roland Gelatt, three issues ago, the transfer to LP has been done with great care and skill, and the various arcane techniques of removing pops and sputters have left most bands remarkably free from any very obtrusive inherited surface noises. On direct comparison with 78 rpm originals in good condition, the advantage gained is naturally not great; and, in at least some cases, the perspective has been altered, not necessarily for the better. The commonest change in this regard is—as in Nellie Melba's *Hamlet* "Mad Scene" (1910) and Frieda Hempel's "Qui la voce" (1914), from Bellini's *I Puritani*—an apparent bringing forward of the voice, so that brilliance and immediacy seem increased, but the sense of a particular voice heard in a particular place is rather decreased. The Melba, in particular, acquires a sharpness of edge that it does not have on the 78. Somewhat similarly, the 78 of Tamagno's "*Di quella pira*"

gives—perhaps not altogether independently of foreknowledge and imagination—the illusion of a huge voice, and a very individual one, resonating freely in a room and recorded at a little distance. On LP, the same performance gives the subjective feel of a voice no less individual but of indeterminate size, recorded rather close-to. However, the operative word here is "subjective," and everyone will have to decide for himself whether character has been lost or verisimilitude sacrificed to mere closeness. No dubbing has been done so as to falsify essential quality, though, and from early to late the performances and the performers retain their integrity—and that, after all, is the main thing. All told, these seem to be the best and most basically honest transfers to LP of historic vocal recordings. They may not be all equally good, but all seem to have been done with respect and, certainly, with much more taste than certain transfers and updatings of the past.

In an anthology of this scope and pretension, it is no wonder that there are at least some X-versus-Z question marks. But it is, by the same token, a little surprising that there should be so many, and so disposed. From Tamagno onward, each decade is allotted a twelve-inch disk, the performances all together adding up to what Mr. Kolodin describes in his introduction to the album as "as representative a range of fine operatic performances as my taste can devise," that is, from the files of the issuing company and affiliates. He limits this by explaining omissions of the "most well-worn" examples of the work of famous singers, on grounds of their being sufficiently available, mostly in earlier LCT-series releases; other omissions on other grounds.

It is the omissions that are likely to give the greatest cause for debate. In the first decade, 1900-10, there are many such

initial appearance on microgroove. Resplendent orchestral coloring has been lavished on them by their respective composers, as this brilliantly conducted and recorded disk well attests. P. A.

CHUECA

Agua, Azucarillos, y Aguardiente

Toñy Rosado, Ana María Iriarte, María Teresa Berganza, María Angeles Carчена, Antonio Pérez, Juan Encabo, Manuel Ortega; Cantores de Madrid, Orquesta de Cámara de Madrid, Ataúlfo Argenta, cond. LONDON W 91016 10-in. \$2.98.

Bright tunes and sharp rhythms combine with a very clever libretto to give us this delightful little gem that has been tickling audiences since it was first produced almost sixty years ago. The plot itself is of the slightest; it is more like a series of candid shots of Spanish life, and the results are irresistible. I did not have the opportunity to make a side-by-side comparison with the Montilla recording which appeared some time ago, but if memory serves me correctly, neither is noticeably superior to the other—they are both better than just good. G. S., Jr.

DANZI

Quintets for Flute, Oboe, Clarinet, Bassoon, and Horn, Op. 56: No. 1, in B-flat; No. 2, in G minor

Jean-Pierre Rampal, Pierre Pierlot, Jacques Lancelot, Paul Hongne, Gilbert Coursier. L'OISEAU-LYRE DL 53005. 10-in. \$2.98.

Routine music of the late eighteenth century, animated clarity, the kind of thing that Haydn, Mozart, and Boccherini transfigured. Nevertheless, each of the four-movement works has one movement truly inventive, while the others are listenable if one does not listen hard. The French players are by now familiar to most discophiles, and their casual skill in this pair of quintets seems right for the music. The instruments have been recorded accurately enough, but an effect of five men playing in an empty room emanates from the disk, a little chilling to the beguilement expected from such a combination. C. G. B.

DEBUSSY

Pelléas et Mélisande

Janine Micheau (s), Mélisande; Rita Gorr (s), Geneviève; Annik Simon (s), Yniold; Camille Maurane (t), Pelléas; Michel

Roux (b), Golaud; Xavier Depraz (bs), Arkêt; Elizabeth Brasseur Choir and Orchestre des Concerts Lamoureux, Jean Fournier, cond.

EPIC SC 6003. Three 12-in. \$11.94.

Debussy's first and only opera has been eulogized and censured ever since its first performances more than fifty years ago, when the Opéra-Comique reverberated to the fervent cheering and booing of partisans and detractors. Today the fever has subsided, but *Pelléas* remains controversial. Many people would agree with Louis Untermeyer that it is "a long and lugubrious bore"; others become transfigured at the mere mention of its name and hold the opera as an article of aesthetic faith. I find myself reentering between the two camps. If I hear it in a properly crepuscular mood, I surrender completely to its mezzotinted magic and recognize it for the creative masterpiece that it is; but let me hear it in another—more impatient—humor, and *Pelléas* can seem just as tiresome as unridiculed critics depict it.

Pelléas has been recorded in its entirety three times. The eldest version—made in Paris in 1942 under Roger Désormière's direction—is superior interpretatively to

... to Illustrate a Half-Century of Operatic Singing

omissions, and a correspondingly very full dose of Sembrich and Enrico Caruso and Melba, Pol Plançon and Antonio Scotti. Mattia Battistini—the fabulous *Gloria d'Italia*, who did not sing here because the sea made him sick—is represented by the Act I aria of Renato from Verdi's *Un Ballo in Maschera*; Adelina Patri by her sixtyish Zetlina; Maurice Renaud by his *Hérodiade* dream aria; Geraldine Farrar by her *Manon* "Gavotte," and so on. But no Victor Maurel or Fernando de Lucia; no Schubmann-Heink; no Louise Homer; no Gerville-Réache. The list could be extended, but the point is clear: This, like any other anthology at all, is inescapably a very personal choice, and some collectors will not find their favorites represented.

However, in this as in later decades, although there can still be disagreement about the excerpts chosen to represent certain singers, there is so much fine singing to be heard that the best answer to objections is simply another such anthology, and another, and another, with all companies that have such materials entering the competition with the best they have in their files—and doing as good a job of engineering as RCA has done.

The five disks hold a total of 68 excerpts—far too many to list in even the most economical fashion. Among the real treasures are Plançon's *Don Carlo* soliloquy, in the French text that Verdi set; Caruso's tremendous "No! *Pagliaccio non son!*"; Edmond Clément's exquisitely phrased "*La Réve*"; Emmy Destinn's "*O patria mia*," with an incredible pianissimo at the end; Caruso's arias from *Macbeth* and *L'Africano* (not the usual); John McCormick's aria from Méhul's *Joseph*; Frieda Hempel's aria robbed of its cabaletta, from *I Puritani*; Leo Slezak's fine-spun Goldmark aria; Beniamino Gigli's *Andrea Chénier*; Giovanni Martinelli's *Guillaume Tell*; Tito Schipa's *Almaviva*; Ezio Pinza's *Don Gio-*

vanni; Lauritz Melchior's Siegmund—and so on down the years, the crop of great names thinning out, still what seem some odd omissions, yet the best no less good for being more familiar.

Relative to this best, there are some disappointments, some matters of taste on which it is not necessary to agree. Farrar's *Manon* aria is not her best singing, and Enma Calvé's *Carmen* "Habanera" not her best performance of it. Surely Margarete Matzenauer deserved better than a snippet-in-duet from the same opera, and the main claim to inclusion of a very immature (1911) Claudia Muzio recording is that it was made before she was signed by Columbia. The historic Mary Garden *Carmen* "Card Scene" only just balances Senta sung in not half-clear English by Florence Austral, and it seems a bit of a waste to have the whole last scene of Massenet's sleazy *Don Quichotte* sung in auto-duet

style and abominable French by Feodor Chaliapin, when he made better recordings by far. Sigrid Onegin's "*O don fatale*" is from a cold climate; Kirsten Flagstad was hardly known here as a Weber specialist, nor Helen Traubel as a Gluck stylist. And where are Bori and De Luca? Where is Friedrich Schorr? It is explained that Lotte Lehmann is best represented elsewhere; but so are others who are here, and how can a survey of great singing afford to leave her out, especially when criteria are set aside for a Nina Koshetz and a Tiana Lemnitz?

The final disk, 1940-50, scrapes almost embarrassingly deep and wide in the RCA barrel, with over half the performances for the microphone alone, so far as this country is concerned. Dorothy Maynor's *Louise* aria has quality, but not that of any opera house, and Maggie Teyte's Grètry ("*Vous étiez ce que vous n'êtes plus*") is very much like a self-reproach. In fact, the critical judgments in Mr. Kolodin's book come closer to cold truth than some inclusions here might indicate.

Yet however much an individual may regret the intrusion of un-favorites, the anthologist can hardly be blamed that the early years of the century had too many fine singers to admit in such a time-divided anthology—nor that neither the world nor RCA is as rich in vocal art as it once was and may come to be again. The most apposite reaction, really, is one of deepest envy of Mr. Kolodin. After all, not everyone is invited to take his pick of such a treasure-trove as that of the RCA hoard, and if some gold has been left, silver will do until the next visit. All told, very, very highly recommended. JAMES HINTON, JR.

50 YEARS OF GREAT OPERATIC SINGING

RCA VICTOR LCT 6701. Five 12-in. \$29.95.



Mary Garden sings in the "Card Scene" from *Carmen*. At left: Rosario Bourdon.

the others, but it has been deleted (temporarily at least) from the RCA Victor catalogue. Between the Swiss recording presided over by Ernest Ansermet (London LLA 11) and the Fournet version noted above, there is little to choose. Both are eminently praiseworthy; both can be heard with satisfaction; neither projects the fragile quality of Debussy's score quite as successfully as the earlier recording conducted by Désormière. Ansermet's is a more refined interpretation than Fournet's; he pays closer heed to timbre and balance, and is helped by somewhat more luminous reproduction. The singers in the two sets are about equally capable. I could wish for a younger and more innocent conception of Mélisande than Janine Micheau gives, just as I would prefer an Arkël who is more believably an aged man than Xavier Depraz, but these are both intelligent, well-schooled vocalists whose shortcomings are not vital. Michel Roux is a dramatic, sympathetic Golaud, and Camille Maurane a winningly ardent Pelléas; in fact, his is the finest interpretation of this role on records.

Although the artistic merits of the two sets are about evenly divided (with a slight tipping of the scales in favor of Ansermet), the cost of acquiring them is decidedly unequal. The London-Ansermet, on four records, comes to \$19.92 (with libretto); the Epic-Fournet, on three records, to \$11.94 (without libretto). R. G.

DEBUSSY Piano Music

Includes: *Préludes*, Books I and II; *Deux Arabesques*; *Children's Corner*; *Images*, Books I and II; *Estampes*; *Masques*; *L'Isle joyeuse*; *Six Epigraphes antiques*; *En blanc et noir*.

Robert Casadesu, piano (with Gaby Casadesu in *Six Epigraphes antiques* and *En blanc et noir*).

COLUMBIA SL 222. Three 12-in. \$14.95. (Records available singly at \$5.95 each.)

As an accomplished, intelligent, thoroughly professional artist, Robert Casadesu must have reasons for playing Debussy as he does in these records; but I must confess that I cannot fathom them. His interpretations of this sumptuously evocative music are literal, painstaking, and severely dry. Is he insensitive to its shifting, kaleidoscopic coloration, its ebb and flow of rhythmic tension, its transmutation of poetic imagery into subtle sonorities—all the qualities that Walter Gieseking has taught us to appreciate and that are captured so beautifully in his recent Angel recordings? Or was Casadesu merely in a prosaic frame of mind when he undertook to play Debussy in the recording studio? Either way, the results are not memorable. The listener has only to hear the opening measures of "*Les sons et les parfums tournent dans l'air du soir*" as played by Gieseking and Casadesu to recognize the difference between imaginative and pedestrian interpretation of Debussy.

To make matters worse, Columbia's engineering and packaging are poor. These records are woefully afflicted with pre-echo. This is an annoying phenomenon at any time, but in music of such diaphanous nature it is catastrophic; to hear the rests at the opening of *Les Collines d'Anacapri*



Debussy: the problem is one of dryness.

marred by faint anticipatory chords is simply intolerable. Columbia has also seen fit here to dispense with bands separating the sections of a long work, so that it is impossible—for instance—to pick out any one of the twenty-four preludes or any one of the six *Epigraphes antiques*. This may have been done in the interests of "economical editing," but at \$5.95 a record these are no bargains, however much has been crammed onto them. Not recommended. R. G.

DUKAS

The Sorcerer's Apprentice—See Ravel: *Bolero*; *La Valse*.

DVORAK

Gavotte—See Beethoven: *Minuets*, G. 167.

ELGAR

Concerto for Violin and Orchestra, in B minor, Opus 61

Alfredo Campoli; London Philharmonic Orchestra, Sir Adrian Boult, cond.
LONDON LL 1168. 12-in. \$3.98

Elgar's was the last of the big Romantic violin concertos—a work in the Brahmsian mold, conceived in symphonic terms, robust in utterance, and compounded of some meltingly beautiful themes. It is probably a bit too long, but then so is a lot of other music that is still very much worth our attention. Elgar was not remiss in providing his soloist with difficult acrobatics: the concerto is strewn with sequences of double stopping and rapid chromatic figurations, and in an earlier recording of it with the London Symphony under Sir Malcolm Sargent's direction (RCA Victor LM 1090) Jascha Heifetz cleared these hurdles with his customary *savoir faire*. His was a brilliantly exciting interpretation—perhaps a trifle too assured and muscular, for some of the soft-spoken sweetness and intangible Englishness of the music seemed to escape his notice. Alfredo Campoli, Italian-born but long resident in England, projects these subjective attributes more persuasively though he does not flick off the violinistic glitter with Heifetz's cool abandon. You pay your money and takes your choice. There is little to choose between Boult and Sargent or their respective orchestras, and the superiority of London's newer recording is not decisive.

If memory is to be trusted, the old set

of 78s conducted by the composer with fifteen-year-old Yehudi Menuhin as soloist was interpretatively on a higher plane than either of these LPs. Victor should earmark it for reissue. R. G.

FALLA

Nights in the Gardens of Spain—See Rodrigo: *Concierto de Aranjuez*.

FAURE

Nocturne No. 2, in E minor, Op. 107;
Barcarolle No. 4, in A-flat major, Op. 44;
Valse caprice No. 3, in G-flat major, Op. 59;
Impromptu No. 3, in A-flat major, Op. 34

†Ravel: *Prelude*; *Minuet on the Name of Haydn*; *Valses nobles et sentimentales*; *Toccata from Le Tombeau de Couperin*

Jean-Michel Damase, piano.

LONDON INTERNATIONAL TW 91035. 12-in. \$4.98.

A newcomer to records, Mr. Damase brings a precise, delicate touch and an array of muted colors to the Ravel works, a slightly richer tone to those of Fauré. He approaches the music romantically; the Ravel waltzes in particular have some excessive rubatos, though there are compensatingly fine passages filled with nostalgia and wistfulness. One senses a pervasive lack of vitality, but this could be an illusion fostered by the extremely intimate, airless recording. Still, Mr. Damase is a pianist with provocative ideas. R. E.

FURTWÄNGLER

Symphony No. 2, in E minor

Berlin Philharmonic Orchestra, Wilhelm Furtwängler, cond.

DEUTSCHE GRAMMOPHON LPM 18114-5. Two 12-in. 1 hr. 12 min. \$16.80.

Most conductors compose a symphony or two, and their creations are usually received with polite contempt: "Conductor's music—he knows how to score, but not what." This is a superior example of the creation, but the mockery is at least half true. The late Wilhelm Furtwängler knew how to score, and parts of this (of course it is much too long) his Second Symphony are undeniably effective and unique in their orchestration, the decisive and declarative colors of Richard Strauss laid over the mottled shades that cup the character of Johannes Brahms's peculiar genius. But the ideas are not pointed and are generally somber. The good ones recall someone else—César Franck, amusingly; wistfully, Franz Schubert; inevitably Richard Wagner, and Richard Strauss of course.

The formal pattern, two sonata movements enclosing an andante in the sequence of a three-part song and a scherzo, is very apparent, and it seems cruel, after listening carefully thrice to the painstaking craftsmanship of a man dead after fifty years of service in music, to praise his long, gloomy tapestry as "well made." But that is what it is, although happily it may be added that the short central movements maintain enough interest to warrant performance.

Presumably the performance on these records is definitive. Certainly the orchestra is at its darkly glowing best; and if the conductor misinterpreted anywhere, the composer had no right to reproach him.

Sonically the disks are similar to many of the Berlin Philharmonic—smooth, well-adjusted mass with a feeling of expansiveness, no insistence on detail and no dramatic timbre, but no excesses at the extremes of the frequency range either. Their four skins, on the samples received here, are almost entirely free of the blemishes we expect on LPs. If they are truly representative of standard Deutsche Grammophon production, it would be good to see and hear more of them. The well-made limp jackets are lined with soft plastic, and there are notes on the music and a brief sketch of Furtwängler's career, in German.

C. G. B.

GANNE, LOUIS *Les Saltimbanques*

Janine Micheau (s), Suzanne; G n v ie Moizan (ms), Marion; Robert Massard (t), Andr ; Raymond Amade (t), Pailasse; Michel Roux (b), Grand Pingouin; Marcel Carpentier (buffo), Malicorne; Vall  Valdy (buffo), Le Vicomte; Rivers Cadet (bs), L'Aubergiste; Claude Aray (speaking), Rigobert; "et les clowns Alex et Rhum." Orchestra and chorus, Pierre Dervaux, cond.

LONDON INTERNATIONAL TW 91044-5.
Two 12-in. \$9.96.

Louis Ganne (1862-1923) became, as a matter of choice, a popular composer rather than a serious one—a composer of marches (of which old-time 78 fanciers may recall *Le P re de la Victoire* from L on Rothier's singing of it) and operettas rather than of suites and operas. His *Les Saltimbanques* (read "tumbler," "acrobats," or something like), first given in 1899, is a sort of unsentimentalized Mignon-story, minus the unpleasantness of Philine—all about how Suzanne, a temporarily mislaid noble child, lives adventurously among circus people with hearts of gold, always being rescued from admirers who mean no good by the arrival of Andr , her tenor-lieutenant-admirer. Edited down to four sides by Max de Rieux's *r alisation*, it is a gay, bouncy, uncomplicated score, with tunes that are very ingratiating but not easy to remember an hour or so after hearing. Full spoken text is provided but only partial text for the musical numbers, some of which are cut—and no English translation at all of text or notes. J. H., Jr.

GLAZUNOV

Sonata for Piano, No. 2, in E minor—
See Saint-Sa ns: *Concerto for Piano and Orchestra, No. 2.*

GOULD, MORTON *Dance Variations*

Arthur Whittemore and Jack Lowe, duopianists; San Francisco Symphony Orchestra, Leopold Stokowski, cond.

†Menotti: *Sebastian*—*Ballet Suite*

Members of the NBC Symphony Orchestra, Leopold Stokowski, cond.
RCA VICTOR LM 1858. 12-in. \$3.98.

As program editor for the San Francisco Symphony, the writer of these lines ought to be enthusiastic about the reappearance of that orchestra on the LP lists. Unfortunately, however, the ingenious trivialities

an obvious "effective" theater-piece, barely worth listening to once. A. F.

GRANADOS *Spanish Dances*

Alicia de Larrocha, piano.
DECCA DL 9762. 12-in. \$3.98.

Alicia de Larrocha is a pianist of nimble fingers, with a keen sense of rhythm and refined musical sensitivity—in short, an ideal interpreter for these compositions. Unfortunately, my copy of this record was not only a bit off-center, but also full of hiss, clicks, and sometimes downright peculiar sound. I hope that mine was the only defective copy and that, mechanically speaking, the pressing as a whole is worthy of the wonderful music and the exciting performances of it. G. S., Jr.

HANDEL

Concerti Grossi, Op. 6: No. 1, in G; No. 2, in F; No. 6, in G minor; No. 7, in B-flat.

Vienna Symphony Orchestra, John Pritchard, cond.
EPIC LC 3097. 12-in. \$3.98.

Granted that the presentation of an arbitrary four out of twelve is faintly obnoxious, it must be granted too that these are lively and luminous statements in decided clarification of the contrived oppositions of these grand things. Perhaps majesty, in the conductor's firm grip, is less compelling than the contrasting legerity which in the same grip bubbles convincingly; but in the contest between the substantial body of strings devoted to the *ripieno* and the four instruments of the *concertino* we have the nicest delineation yet on records of how the *concerto grosso* should be. Hearty recording and a string tone bright and smooth earn commendation for the disk while we denounce the distribution of its contents. The notes by Klaus George Roy are helpful, and the provision of one cardboard jacket inside another is certainly the easiest way yet, of a hundred ways, to protect vinyl against disfigurement and dust. May the idea have imitators! C. G. B.

HANDEL *Water Music*



Hadyn's Queen's honors to Paul Sacher.

Boyd Neel String Orchestra, Boyd Neel, cond.

LONDON LL 1128. 12-in. \$3.98.

The *brío* of this fourth version is inspiring, no doubt of it: it never flags. It may pall after a time, for the slow movements have been infected by the urgency of the others, granting no relief from a din of triumphant celebration. Aside from these fast slow sections Dr. Neel has done well, insisting alone among the conductors who have recorded the *Water Music* upon that predominance of the winds essential to its gusto. (This "string orchestra" includes piccolos, flutes, oboes, bassoons, horns, and trumpets.) The forward winds risk and obtain some coarsening of tone in the very bright recording, but this is preferable to their repression. Perhaps it is fair to call this the best version of what in the score is animated, and the worst of what is contemplative, the amalgam being of perplexing value. C. G. B.

HAYDN

Symphony No 44, in E minor, "Mourning"

Symphony No 85, in B-flat, "La Reine"

Vienna Symphony Orchestra, Paul Sacher, cond.

EPIC LC 3059. 12-in. \$3.98.

The small handful of records made under the stick of this Swiss conductor are of a quality to excite surprise that he has not been used more often. The *Queen* here, infinitely the best of four on records, moves smartly with the conviction of a man versed and practiced in Haydn, whereas so many of the master's interpreters play a mere cautious apery of standard eighteenth-century mannerisms. The harder stuff of the *Mourning* Symphony is manipulated with an equivalent if different agility, and the Vienna Symphony Orchestra, subjected to more conductors these last few years than any orchestra that ever was, follow the Swiss with alacrity and ability. Bright and broad registration of high class after the treble has been attenuated. C. G. B.

HONEGGER

Pacific 231—See Ravel: *Bolero; La Valse.*

IRELAND, JOHN

Minuet—See Warlock: *Capriol Suite.*

KABALEVSKY

Concerto for Piano and Orchestra, No. 2, in G minor

Gregory Ginsburg, piano; National Philharmonic Orchestra, Dmitri Kabalevsky, cond.

†Prokofiev: *Concerto for Piano and Orchestra, No. 1, in D-flat major, Op. 10*

Sviatoslav Richter, piano; National Philharmonic Orchestra, Kiril Kondrashin, cond.

†Prokofiev: *Sonata for Piano, No. 2, in D minor, Op. 14*

Emil Gilels, piano.

COLOSSEUM CRLP 186. 12-in. \$3.98.

These three works are all relatively youthful efforts. Prokofiev was twenty when he of Gould's *Dance Variations* do not inspire much enthusiasm from this typewriter. Menotti's ballet score on the other side is

wrote his First Piano Concerto, twenty-one when he completed the Second Sonata; Kabalevsky composed his Second Piano Concerto — recorded here for the first time — at the age of thirty-two. These works contain echoes of Rachmaninoff, but all of this music is pleasing, generously melodic, and soundly conceived. Certainly, Prokofiev's professors at the St. Petersburg Conservatory and the music critics of 1912 would think much less harsh thoughts of this music were they to pass on it today.

Altogether this might have been a most attractive disk had the performances been decently reproduced. The word "decently" is used advisedly here, for Colosseum has reached a new low in recorded quality. The sound is so dreadfully distorted that it would be unfair to attempt to pass judgment on the merits of the playing. P. A.

KABALEVSKY

Taras' Family (excerpts)

B. K. Kalyada (s); S. A. Kashevarova (s); S. P. Preobazhenskaya (ms); V. G. Ulianov (t); I. A. Nechaev (t); I. Alexeyev (b); V. M. Luginin (bs-b); I. Yashugin (bs); Orchestra and Chorus of the Kirov Theatre of Opera and Ballet, Leningrad, B. E. Khalkin, cond.

CLASSIC CE 30004. Two 12-in. \$11.90.

So much has been written about the sad state of Soviet music, and the Babylonian captivity of Soviet creative artists in general, that rather special interest attaches to the first appearance on recordings easily obtainable in the West of substantial excerpts from a contemporary opera by a Soviet composer — and one of established status — in a very decently reproduced performance by the forces of one of the big government theaters.

Born in 1904, Dimitri Kabalevsky grew to maturity after the revolution. His father was a government employee, and he had to overcome family objections before being allowed to take up music as a field of study and then as a career. Brilliant as a conservatory student, he has had a very successful career in Soviet terms, and though (aside from works like the ballet *The Comedians*, from which the galop familiar to jukebox players is taken) he has tended in instrumental music to work within limits that might possibly be called "formalistic," he is both a popular composer and an officially approved one.

His postwar opera *Taras' Family* looks in synopsis almost like a parodistic spoof of a "people's art work." It deals with an old man whose sons go off to join the army and the partisans and help repel the Nazi invasion, and the plot keeps jumping back and forth from home to battleground, to the town factory in the midst of the German occupation, and back again. There are all kinds of opportunities for the unleashing of patriotic sentiments, all kinds of opportunities for spectacle — as in the big scene where the underground-youth boys blow up the village schoolhouse with the Germans (drunken, of course) inside it — and so on. In other words, it is the kind of Soviet work that is very easy to make fun of. When you think, though, that many members of its audience have actually lived through similar experiences, it may not seem quite so funny any more. Naïve?

Yes. Elemental? That, too. It can be figured as a kind of expanded contemporary Russian *verismo*, built around familiar motifs, and liberally spiced with chances to let all kinds of emotions come out in the open. It may not be great art, but I fail to see that it is either ridiculous or despicable — however strongly one may feel about the totalitarian context in which, it came into being.

Musically, it is extremely competent — a fabric of big, broad, sweeping tunes, always effectively (and sometimes quite strikingly) harmonized and scored, with everything shaped and built up in unexceptionally



HAROLD STEIN

Reel composers Ussachevsky and Luening

professional style. It is not at all a mere string of easy-to-hum folk songs and dances, and though it certainly leaves no major points unemphatically stated, neither does it really condescend. Like Shostakovich's *A Song of the Forests*, it may be propagandistic, and it may not be Beethoven, but it is most certainly a sound, strong, expert piece of craftsmanship.

The performance is quite strong orchestrally and the casting is good all the way down to the smallest roles; by all the evidence that can be heard, the Leningrad opera house is a theater with high standards and all the means of implementing them. Helpful notes by James Lyons; but only a detailed synopsis — no text in any language. Engineering: better than the average for Soviet opera recordings. Very, very special as a thing to buy, but worth while and interesting to hear. J. H., Jr.

LALO

Symphonie Espagnole — See Prokofiev: *Concerto for Violin and Orchestra, No. 1.*

LECUONA

Andalucía, Danzas Afro-Cubanas, Danzas Cubanas

Jose Echániz, piano
WESTMINSTER WL 5343. 12-in. \$5.95.

Nothing I could say could possibly add to or subtract from Lecuona's tremendous popularity — his *Malagueña* surely must be as well-known as *The Star Spangled Banner*, and there is no reason why the rest of the *Andalucía* suite should not be just as popular. The Cuban and the Afro-Cuban Dances

included in this record provide the right amount of contrast and should appeal to the enormous American public who enjoys Latin American music for dancing or listening. Jose Echániz is a fine pianist of nimble fingers, a keen sense of rhythm, and a definite feel for this sort of music. In addition, the recording is quite good, so Westminster should have little trouble disposing of a million or two copies of this record. G. S., Jr.

LISZT

Hungarian Fantasia for Piano and Orchestra; Hungarian Rhapsody No. 2

Julian von Karolyi, piano; Munich Philharmonic, Edmund Nick, cond.
DECCA DL 4084. 10-in. \$2.98.

These excellent, idiomatic performances can be safely recommended, even if they do not possess the ultimate in nuance, such as can be found in Claudio Arrau's version of the *Fantasia*. The sound is presentable, though again not the ultimate, as the orchestra is mildly clouded by too much resonance and the solidly round piano tone is wanting in brightness. R. E.

LUENING, OTTO USSACHEVSKY, VLADIMIR Tape Recorder Music

INNOVATIONS GB 1. 10-in. \$4.95.

Otto Luening and Vladimir Ussachevsky are two members of the music faculty of Columbia University who have been experimenting extensively with the creative possibilities of the tape recorder. This disk is devoted to a group of their compositions. The potentialities of the medium are infinite: tape recording can extend the timbre of any instrument into any range, high or low; it can alter timbres in countless ways; it can capture the audible overtones of inaudible fundamentals; it provides all manner of echoes, reverberations, and dimensional levels of sound; by means of it, any melody, once recorded, can be stepped up or down in pitch or speed or reversed on any of these planes; and, by means of montage, any or all of these things (and many more) can be assembled on a single tape in any desired order or to any desired extent.

Luening and Ussachevsky have entered this vast new realm with a sense of high adventure but also with a sense of responsibility. Their music, which goes into the microphone as the sounds of the flute, the piano, and human voices, is invariably fascinating as aural experiment and is frequently very moving and meaningful from a strictly musical point of view. There are five compositions on the record — *Sonic Contours*, for piano and voices, by Ussachevsky; *Fantasy in Space, Invention, and Low Speed*, all for flute and all by Luening; and *Incantation*, for voices and some unidentifiable instrument or instruments, by both composers. The names of the performers are not given. But as Luening is an excellent flutist one suspects he is his own interpreter here, and Ussachevsky is probably the pianist. A. F.

MAHLER

Symphony No. 8 in E minor

Continued on page 60

.. the names that count ..

Full frequency range recording ensures the faithful reproduction of every interpretive and tonal nuance of a performance, whether by soloist or full orchestra and chorus. Thus the reputations of the world's greatest artists are in the safest possible hands with LONDON. London can rely on the quality of their performances; they can rely on the technical quality of the records. The "NAMES THAT COUNT" are on the LONDON label. There are many of these great names; a few of the most illustrious are the artists whose new recordings are featured below.

ERNEST ANSERMET

DEBUSSY

Le Martyre de Saint Sebastien
Incidental Music

Suzanne Danco (soprano); Nancy Wough (contralto); Lise de Gontmollin (contralto) with Union Chorale de la Tour-de-Peils and L'Orchestre de la Suisse Romande. Conductor: Ernest Ansermet
LL-1061 \$3.98

BORODIN

Symphony No. 2 in B Minor
Symphony No. 3 in A Minor "Unfinished"
Prince Igor—Overture

L'Orchestre de la Suisse Romande
Conductor: Ernest Ansermet
LL-1178 \$3.98

ROUSSEL

Le Festin de l'Araignée "The Spider's Feast"
— Ballet

Petite Suite pour Orchestre
L'Orchestre de la Suisse Romande
Conductor: Ernest Ansermet
LL-1179 \$3.98

RAVEL

Shéhérazade—Song Cycle
Trois Poèmes de Stéphane Mallarmé
Deux Mélodies Hébraïques
Suzanne Danco (soprano) with L'Orchestre de la Suisse Romande. Conductor: Ernest Ansermet
LL-1196 \$3.98



Suzanne Danco



SIR ADRIAN BOULT

HOLST The Perfect Fool—Ballet Suite

BAX Tintagel

BUTTERWORTH A Shropshire Lad • The Banks of Green Willow

The London Philharmonic Orchestra • Conductor: Sir Adrian Boult

LL-1169

\$3.98



CESARE SIEPI

GOMES Salvator Rosa—Di sposo di padre le gioie serene

VERDI Simon Boccanegra—Il lacerato spirito

MEYERBEER Les Huguenots—Seigneur, rampart et seul Soutien.

Les Huguenots—Piff, Paff

Robert le Diable—Nonnes, qui reposez

HALEVY La Juive—Si la rigueur

Cesare Siepi (bass) with Orchestra of Accademia di Santa Cecilia, Rome.
Conductor: Alberto Erede

LD-9169

\$2.98

For full details of other new London ffr releases consult supplement—now at your dealer.

LONDON
RECORDS



Soloists, Combined Rotterdam Choirs, Rotterdam Philharmonic Orchestra, Eduard Flipse, cond.
EPIC SC 6004. Two 12-in. \$9.96.

Galileo proved years ago that when size increases arithmetically, problems grow geometrically. The "Symphony of a Thousand" is a case in point. It cannot be dealt with simply as a choral symphony on a larger scale; a successful performance depends on such a concatenation of factors that it seems highly unlikely that conditions would ever be altogether favorable. Mahler made it difficult for everybody. The size of his apparatus puts the acoustics of any hall to the acid test (to say nothing of its backstage facilities). Three choirs and auxiliary bands and players have not merely to be drilled, but trained in an unfamiliar, personal style; eight solo parts have to be filled with singers who have big voices and considerable cranial capacity — and where can you find a well-matched cast of first-rate artists who will consent to take roles in a

quasi-oratorio? The whole has to be stage-managed as well as conducted, distributed so that the tonal forces remain in equilibrium, and handled so that light can penetrate through successive layers of sound to the deepest stratum. After that, problems of interpretation can be considered: what were Mahler's dramatic and philosophical intentions? If you discount the emotional and intellectual content of the score, there is nothing left, the thousand notwithstanding. Lastly, a conductor has only to worry about keeping everybody together. The recording engineers can take it from there, but they, too, have their difficulties multiplied.

Mr. Flipse copes with the Eighth in admirable fashion. His reading has sweep, meaning and sensuousness. He exploits the dramatic possibilities inherent in these masses and their juxtaposition. He is inclined to be weighty, but never lapses into that laggard state which is the thief of tempo. The soloists are not identified but

they deserve to be, for on the whole, their voices are of remarkably high calibre — and far more responsive than those of the old, fuzzy Scherchen version on Columbia. Perfectionists will find spots to complain about, particularly in the closing portion of Part II, but there is little point in caviling at the Eighth: tell it to city hall. The contributing forces are well placed in the recording, and the sonics are spacious, as clear as a thousand can be when stuffed down the throat of a single loudspeaker. Philosophically, the Eighth calls for Redemption; technically its only real salvation lies in trinaural recording. All told, however, matters have come out far better than one has a right to expect.

FRED GRUNFELD

MENDELSSOHN

Elijah

Jacqueline Delman (s), Norma Proctor (c), George Maran (t), Bruce Boyce (b); London Philharmonic Choir, Hampstead Parish Church Boy's Choir, and London Philharmonic Orchestra, Josef Krips, cond.
LONDON LLA 27. Three 12-in. \$11.94.

If *Messiah* may rightly be called the king of oratorios, then Mendelssohn's fine *Elijah* may safely be cast in the role of heir apparent. This has been so since the work was first performed at Birmingham in 1846. In the intervening years much of Mendelssohn's other music has been subject to fluctuating popular esteem, but *Elijah* has always maintained its original popularity. Yet this acceptance is hardly reflected in the representation accorded *Elijah* on records, for this is only the second version to appear in the LP catalogue, against the eight currently available recordings of Handel's masterpiece.

The earlier Columbia set (SL 155), issued in 1947 (the centenary of the composer's death), offers a well-balanced, highly musical performance under the skillful direction of Sir Malcolm Sargent. It boasts some superb oratorio singing by a quartet of soloists well schooled in the field, together with choral singing by the Huddersfield Choral Society that is impressive but would have been more so had the technical facilities of that day been better able to capture the impact of such a solid mass of vocal sound. Even with this deficiency, the set is a considerable achievement for all concerned.

The new London issue is mainly notable for its exploitation of a wonderful, open, and well-extended sound, remarkable for the truth of its perspective. It is particularly imposing in the large dramatic choruses, the strongest feature of this work, which roll out with thunderous power, yet manage at the same time to be clearly defined. It is thrilling to hear the appeal of the pagans to their god, "Baal, we cry to thee," emerge from the speaker in such spine-chilling sound. Equally remarkable, both for the intensity of the singing and the beauty of the sound, is the famous passage for chorus, "Behold, God the Lord passed by," for which Mendelssohn supplied such a wonderfully pictorial orchestral accompaniment, making it the dramatic high point of the score.

When we come to the soloists, it is apparent that Krips has not been as fortunate

Continued on page 62

Rich Promise from the Promised Land

THE ISRAEL Philharmonic Orchestra is said to be embarrassed by a superfluity of concertmasters. Four string-players alternate in assuming responsibility for this function. Or so the printed publicity claims. To begin with, I was a little incredulous, but I am not, after hearing the orchestra's first records. A string-section like this is not met with frequently these days; its suavity, flexibility, and dynamic-range at once put the orchestra into the top rank of today's symphonic organizations. And the ensemble's assets do not stop there. There is in its playing, throughout, a disciplined verve that perks the attention and repays intentness. This is an orchestra to keep an eye on — or an ear bent to.

EMI obviously was aware of this. When Lawrence Collingwood was sent to make the initial Israel Philharmonic recordings, the good offices of the British Ambassador were invoked, and Israeli officials responded by detouring all traffic away from the recording auditorium. The results are felicitous. The recordings are beautiful.

In only one — of three — initial issues are efforts possibly wasted (and this is rare in today's crowded LP field). The Mahler First Symphony from Kletzki and the IPO I should have to give second rating on two important scores. Bruno Walter interprets it better in a Columbia performance just barely inferior in recorded sound; Rafael Kubelik and the London engineers just barely outpoint it sonically in a performance slightly less telling. This is, like losing to the Yankees or the Dodgers, not bad at all. And from there on, all is triumph.

Kletzki has previously proved his powers in Mendelssohn with a splendid *Midsummer Night's Dream* Suite; he does it again here with a "Scotch" Symphony that brooks no current competition at all. His interpretation is broadly Romantic, but upon its completion you do not want to try a competitive record, you want to play his again. And the last portions of the "filler," — the overture "A Calm Sea and A Prosperous Voyage," never have been recorded before with such joyous thunder.

Mahler's Ninth Symphony always has seemed to me, heretofore, too long. It's still long, but this way I can take it, and with pleasure, even if benumbed. The interpretation closely resembles that by Bruno Walter, Mahler's acolyte, in an elderly RCA Victor transcription from 78s. (Kletzki might not like this comment, but it's true.) But the dynamics and tone-color furnished by the Israelis give it a vitality hardly imaginable from the older recording. It may be that Walter and his New Yorkers will come along later and dislodge this version from its top rating, but it will not be easy, and no one else in sight need even try.

JOHN M. CONLY



HANS KAUFMAN

Collingwood and Kletzki go over a score

MAHLER: *Symphony No. 1, "Titan."*

ANGEL 35180. 12-in. Factory-sealed: \$4.98; Standard-pack: \$3.48.

MAHLER: *Symphony No. 9, with Schönberg: Verklärte Nacht.*

ANGEL 3526B. Two 12-in. Factory-sealed: \$9.96; Standard-pack: \$6.96.

MENDELSSOHN: *Symphony No. 3, "Scotch," with Overture: "Calm Sea and Prosperous Voyage."*

ANGEL 35183. 12-in. Factory-sealed: \$4.98; Standard-pack: \$3.48.

All with Israel Philharmonic Orchestra, Paul Kletzki, cond.

**RALPH
KIRKPATRICK:
SIXTY BEST
SONATAS OF
DOMENICO
SCARLATTI**

60 of Scarlatti's delightful sonatas for harpsichord are to be found on 4 new Columbia "Lp" records—brilliantly, immaculately performed by Ralph Kirkpatrick. Columbia Sound Laboratory techniques have reproduced Mr. Kirkpatrick's superb playing with highest fidelity.

Deluxe set SL 221 \$15.92



NEW ON COLUMBIA



**CASADESUS: PIANO
MUSIC OF DEBUSSY**

A combined tribute to a master of keyboard composition and to one of the great artists of our time—on the occasion of his 20th concert season in America: Columbia Records proudly presents, on 3 "Lp" records, the major portion of Debussy's works for the piano, performed by his foremost interpreter, Robert Casadesu.

INCLUDES: Preludes, Books I & II • Estampes • Masques • L'Isle Joyeuse • Images, Books I & II • Deux Arabesques • Children's Corner Suite • Six Epigraphes Antiques • En Blanc et Noir (with Gaby Casadesu)

Available as 3 single "Lp" records (ML 4977-79), at \$5.95 each or in a deluxe set with notes (SL 222) at special price of \$14.95.

**New Needle! New Sound! Change to a
Columbia needle and hear the difference.**

COLUMBIA  RECORDS

© "Columbia," "Masterworks," "Lp" T.M. Prices are suggested list.

Mercury
Living Presence
HIGH FIDELITY



PHOTO BY ANSEL ADAMS

HOWARD HANSON
conducting the
**EASTMAN-ROCHESTER
ORCHESTRA**

GRIFFES *The Pleasure Dome of Kubia Khan; The White Peacock; Clouds; Bacchanale.*
LOEFFLER *Memories of My Childhood; Poem for Orchestra.* MG 40012

PORTER *Poem and Dance;* DONOVAN *New England Chronicle;* HIVELEY *Tres Himnos ("Three Hymns").* MG 40013

other new releases
**OSLO PHILHARMONIC
ORCHESTRA**

SVENDSEN *Norwegian Rhapsodies Nos. 2 and 3; Symphony No. 2.* Oivin Fjeldstad and Odd Gruner-Hegge conducting. MG 90004

GROVEN *Ballad for Chorus and Orchestra;* EGGE *Piano Concerto No. 2* (Robert Rieffling, pianist). Hugo Kramm and Oivin Fjeldstad conducting. MG 90003

BRAEIN *Concert Overture;* OLSEN *2 Edda Songs;* JENSEN *Partita Sinfonica;* JOHANSEN *Pan, Symphonic Music;* EGGEN *Olav Liljekrans.* Odd Gruner-Hegge conducting. MG 90002

HALVORSEN *Suite Ancienne; Fossegrimen Suite.* Oivin Fjeldstad conducting; Alfred Maurstad, *hardanger fiddle.* MG 90001

**TIVOLI CONCERT
HALL ORCHESTRA**

DANCES FROM TIVOLI by Hans Christian Lumbye. Tippe Lumbye conducting. MG 90000



nate as was Sargent. The powerful baritone of Bruce Boyce is impressive enough, but there are times when he finds the tessitura of his part quite troublesome; his attacks are too tentative to be satisfying. His conception of the part, too, is on the earthy side, and as such less than convincing. In the few arias allotted to the tenor, George Maran sounds as if he might be more at home in a Sullivan operetta than in oratorio. The soprano voice of Jacqueline Delman—light, clear, but hardly weighty enough for the music—is carefully used, but her work never begins to approach the artistic level of Isobel Baillie in the Columbia set. Only Norma Proctor, the contralto, is completely satisfactory. Her rich, firm tones have the proper ring for oratorio, and her style is in the best British manner. Krips entertains a slightly brisker view of the score than Sargent, and the orchestra, responding to his incisive beat, gives a handsome performance, equally handsomely recorded. J. F. I.

MENOTTI

Sebastian—Ballet Suite—See Gould: Dance Variations

MILHAUD

La Cheminée du Roi René; Suite d'après Corrette

French Wind Quintet

LONDON DL 53002. 10-in. \$2.98.

Milhaud at his most Frenchly classical. Michel Corrette was an obscure eighteenth-century Parisian composer some of whose tuneful dances are presented here in an artful, polytonal arrangement for oboe, clarinet, and bassoon. The work on the other side has more substance. It is a suite for wind quintet in seven movements delightfully recalling the gallant, peaceful days of the fifteenth-century King René of Provence, whose habit of sitting in the sun gave the French their proverb, *Se chauffer à la cheminée du Roi René*. As these reviews have often noted, woodwinds record better than anything else. This record is no exception to that rule. A. F.

MOZART

Sonata for Piano, No. 16, in B-flat, K. 570—See Beethoven: Concerto for Piano and Orchestra, No. 3.

MOZART

Concerto for Violin and Orchestra, No. 5, in A, K. 219
Symphony No. 32, in G, K. 318

David Oistrakh, violin; National Saxon Orchestra, Dresden, Franz Konwitschny, cond. (in the concerto). Bamberg Symphony Orchestra, Fritz Lehmann, cond. (in the symphony).

DECCA DL 9766. 12-in. \$4.98.

For the first time to the knowledge of this reviewer the great Russian violinist utilizes the prerogative of great celebrity to apply extrinsic fanciness to the defacement of music. This fattening-up and slowing-down of a concerto that needs only candor from its exponent is not comely. The orchestra is large for this music, but the sound is thick and sluggish. The pleasant performance of little Symphony No. 32 is lifted from old Decca 4045: it is fair in sonics. C. G. B.

MUSSORGSKY

A Night on Bald Mountain—See Borodin: Prince Igor: Polovtsian Dances.

PAISIELLO

Il Duello

Eva de Luca (s), Bettina; Angela Vercelli (s), Clarice; Tatiana Bulgaron (s), Violetta; Vittoria Mastropalo (ms), Fortunata; Alfredo Nobile (t), Leandro; Ivo Vinco (bs), Don Policronio; Teodoro Rovetto (bs), Topo; Gino Viziano (bs), Don Simone; Chamber Orchestra of L'Instituto Fonografico Italiano, Ugo Rapalo, cond.

HAYDN SOCIETY HSL 130. 12-in. \$5.95.

The jacket notes for the Haydn Society recording of *Il Duello* (more usually called, in full, *Il Duello Comico*), put Giovanni Paisiello forward as a kind of missing link between Mozart and Rossini. Since this is the first complete Paisiello opera to be made available on LP, this conceit—for it is little more—seems particularly unfortunate. It would have been more accurate, if perhaps less piquant, to note that, as an opera composer, Paisiello was roughly contemporary with Mozart. Born in 1740, he was older than Mozart, and he lived on until 1816—the year in which Rossini's *Il Barbiere di Siviglia* made its start towards displacing his own charming opera on the same text. But Paisiello began relatively late as a stage composer, and his really significant work for the theater trailed off by 1794, only three years after the death of Mozart and only two years after the birth of Rossini.

As for *Il Duello*, it dates from 1774, when Mozart had advanced no further operatically than the relatively conventional *La Finta Giardiniera*. It bridges no Mozart-Rossini gap whatever. It is simply, and more or less purely, a good example of middling-late eighteenth-century opera buffa, in which standard post-Pergolesi usages are modified only by the composer's characteristically mild, gracious musical personality. Its closest affinities could very likely be found in the musics of Piccinni or Cimarosa. As a type and as a work, though, *Il Duello* is most surely worth hearing for the grace and charm—occasionally sweet and wistful—and purity of its music, though it does not have long stretches of recitative conversation that may seem tedious to listeners whose Italian and French are not sturdy enough to allow them to dig the fun out of the somewhat intricate bilingual farce of manners that is the libretto.

The supplied translation (apart from occasional lapses into the "golly" school of Englishing colloquially) is fair enough, but it is really not much help, for the whole story turns on the addiction of the charming but witless heroine for everything French—including French phrases and an even more witless admirer who is similarly addicted. This, quite naturally, exasperates the hero—who confines his excesses to some moderately apocopated Italian—and a duel is arranged. Through the machinations (just as in French comedies of the period) of a reliably venal servant, everything comes out bloodlessly and as it should—to the surprise of no one at all.

The performance, under the direction of Ugo Rapalo—who conducts opera at the Teatro San Carlo, in Naples, and apparently makes a hobby of Paisiello—is well

"stunning performances...incomparable reproduction..."

ANTAL DORATI

conducting the

MINNEAPOLIS SYMPHONY ORCHESTRA



BARTOK · Concerto for Orchestra, MG 50030
BEETHOVEN · Symphony No. 5 in C Minor — Egmont, Coriolan, Leonore No. 3 OVERTURES, MG 50017
BERLIDZ · Roman Carnival OVERTURE, MG 50005 — Symphonie Fantastique, MG 50034
BORODIN · Symphony No. 2 in B Minor, MG 50004
COPLAND · Symphony No. 3, MG 50018
DEBUSSY · Three Nocturnes, MG 50005 · MG 50025
GERSHWIN-BENNETT · Porgy and Bess, MG 50016
GOULD · Spirituals, MG 50016
MENDELSSOHN · Symphony No. 4 in A Major "ITALIAN", MG 50010
MOZART · Symphony No. 40 in G Minor, MG 50010
RAVEL · Pavane pour une Infante defunte — Alborada del gracioso, MG 50005
RESPIGHI · The Pines of Rome — The Fountains of Rome, MG 50011
RIMSKY-KORSAKOV · Scheherazade, MG 50009
RICHARD STRAUSS · Ein Heldenleben, MG 50012
JOHANN STRAUSS · Wiener Blut — Tales from the Vienna Woods — Wine, Women and Song — The Emperor Waltz, MG 50019
STRAVINSKY · The Firebird, BALLET SUITE, MG 50004 · MG 50025 · Le Sacre du Printemps, MG 50030
TCHAIKOVSKY · Symphony No. 5 in E Minor, MG 50008 · The Nutcracker BALLET (complete), OL-2-101

NEW RELEASES

RESPIGHI · Vetrata di Chiesa — Feste Romane, MG 50046
TCHAIKOVSKY · Swan Lake BALLET (complete), OL-3-102
BRITTEN · The Young Person's Guide to the Orchestra, MG 50047; (with DEEMS TAYLOR, narrator), MG 50055
GINASTERA · Concertantes Variaciones, MG 50047
RAVEL · Daphnis and Chloe (complete), MG 50048

ANTAL DORATI conducting the CHICAGO SYMPHONY ORCHESTRA

TCHAIKOVSKY · Romeo and Juliet OVERTURE-FANTASIA — SCHUBERT · Symphony No. 8 "UNFINISHED", MG 50037
BARTOK · The Miraculous Mandarin SUITE — KODALY · Peacock Variations, MG 50038

Mercury Living Presence High Fidelity



prepared and rather well sung by a cast that is competent and musicianly but hardly virtuosic enough to go very far in ornamenting—traditionally or otherwise—the chaste vocal outlines left by Paisiello. The sound is quite full and resonant all the way up and down, if without much theater illusion. Off the beaten track, but recommended freely. J. H., Jr.

PROKOFIEV

Concerto for Piano and Orchestra, No. 1, in D-flat major, Op. 10—See Kabalevsky: *Concerto for Piano and Orchestra, No. 2.*

PROKOFIEV

Concerto for Violin and Orchestra, No. 3
†Lalo: *Symphonie Espagnole*

Nathan Milstein, violin; St. Louis Symphony Orchestra, Vladimir Golschmann, cond.

CAPITOL P 8303. 12-in. \$3.98.

Magnificent performances and excellent recordings of two standard violin concertos which scarcely demand discussion as such. The omission of the third movement of the Lalo, however, is inexcusable in a recording, even if it is sanctioned by one of the idiotic "traditions" of the concert hall.

A. F.

PROKOFIEV

Sonata for Piano, No. 2, in D minor, Op. 14—See Kabalevsky: *Concerto for Piano and Orchestra, No. 2.*

PUCCHINI

La Rondine

Eva de Luca (s), Magda; Ornello Rovero (s), Lisette; Tatiana Bulgaron (s), Yvette; Angiola Vercelli (s), Bianca; Vittoria Mastropalo (ms), Suzy; Giacinto Prandelli (t), Ruggero; Luciano della Pergola (t), Prunier; Alfredo Nobile (t), Gobin; Vladimiro Pagano (b), Rambaldo; Teodoro Rovetta (bs), Pétrichaud, Crebillon. Antonio Guarnieri Orchestra and Chorus (Milan), Frederico del Cupolo, cond.

COLUMBIA-ENTRE EL 12. Two 12-in. \$5.96.

With the release by Columbia of *La Rondine*, on the budget Entré label, the list of Puccini operas that can be heard on LP is as nearly complete as it seems likely ever to be. The two very earliest—*La Villi* (1884) and *Edgar* (1889)—are still missing, but both of them have been so long out of mind, and stand so low in repute, that not even the coming Puccini centennial, which will be celebrated in 1958, gives them much prospect of being recorded commercially. In fact, few composers in any medium have less to offer in the way of surprise favors for the guests at their birthday parties. *La Rondine* is no rough, self-sustaining theater piece like *La Bobème*. But it is an interesting and, needless to say, highly polished score. Puccini admirers ought not to pass up hearing it but also ought not to judge it finally on the basis of this recording, which is of a per-

formance no better than fair, no better than passably engineered.

As a totality, the work seems quite uncharacteristic and yet unmistakably Puccini—in the genetic sense, a sport. Just before the war of 1914, an Austrian publisher urged on Puccini the idea of composing a sort of Viennese operetta. He agreed. Long before he had finished, though, he decided that spoken lines and set pieces were not for him, and *La Rondine* was completed as an opera, which had its premiere at Monte Carlo in 1917. It went the usual rounds in Italy, and was done at the Metropolitan in 1928 and 1936—both times for Lucezia Bori, both times with mild success, and a mild, occasional success it has remained.

The plot revolves around Magda, a girl of easy virtue who is kept in luxury by a rich man in Paris but loves to theorize and grow nostalgic about real, true love. Prunier, a part-time poet and full-time sophisticate, tells her that her talk is all very well, but that she doesn't mean it—that she will always fly back, like the swallow (the *rondine* of the title), to her true home. Almost at once, she meets young Ruggero, and they elope—like Violetta and Alfredo—to make a new life. As long as the arrangement is irregular, all goes well enough; but when Ruggero gets serious about making it legal, she parades her scarlet past, proclaims her unworthiness, and with great nobility goes back to her jeweled nest and her rich lover, leaving the boy in tears. For Puccini's purpose, she would have done better to die in Ruggero's arms. For, world-wise man though he was, Puccini was not one to sneer at true love. The music has a great deal of sparkle, and much of it is very lovely—most especially when Magda is in a sentimental vein, as in her idealistic addition to Prunier's poem, "*Il bel sogno*," the best-known excerpt from the score and one of the most grateful soprano arias in the Puccini literature. But all the waltz tunes, all the banter, even the sky-and-countryside music of the last act, cannot disguise the fact that in the end Magda is going back to live in sin with a baritone.

The Entré set, unlike others in the list, which are reissues of prewar 78s, is a new recording, apparently taken from Italian tapes of recent date. While the earlier Entré operas are first-class productions of the past, good as far as they go, this is a second or third-rate production of today, and not good by any standards. The performance, decently paced, has no positive distinctions and many flaws. Eva de Luca, American by background, sounds like any one of a hundred Italian sopranos and is none too sure musically, while Giacinto Prandelli is colorless in his reading and so constricted above E that he hardly sounds himself at all. The others are variable, at best, and the ensemble is not good when it most needs to be. The sound is squeezed and unpleasant, with an edge at the top and gumminess at the bottom, and wavering perspective. Only the surfaces are good.

J. H., Jr.

RAVEL

Bolero; La Valse

†Honegger: *Pacific 231*

†Dukas: *The Sorcerer's Apprentice*

L'Orchestre de la Société des Concerts du

Conservatoire de Paris, Ernest Ansermet, cond.

LONDON LL 1156. 12-in. \$3.98.

Capable rather than inspired performances. The Honegger musical pictorialization of a locomotive trip, dedicated to Ansermet, is impressively recorded, but the performance lacks the galvanism of the Willis Page version on Cook 1068. *La Valse*, which appears to be the same performance found on LONDON LL 956, is rather erratic in tempo and too explosive in sound, while the reverse applies to the *Bolero*, which is surprisingly mild, particularly in its final moments. The Dukas symphonic poem comes off quite well, being expertly played and beautifully recorded; however, the Toscanini version on RCA VICTOR LM 1118 is not easily displaced, even though its sound lacks the luster provided by London's engineers. J. F. I.

RAVEL

Miscellaneous Piano Music—See Fauré: *Nocturne No. 2, etc.*

RAVEL

Tzigane—See Tchaikovsky: *Concerto for Violin and Orchestra.*

RODRIGO

Concierto de Aranjuez

Narciso Yepes, guitar; Orquesta de Cámara, Ataulfo Argenta, cond.

†Falla: *Nights in the Gardens of Spain*

Gonzalo Soriano, piano; Orquesta de Cámara, Ataulfo Argenta, cond.

LONDON TW 91019. 12-in. \$4.98.

Falla's magical work is, of course, deservedly well known and needs no further mention here except to say that performance and recording are both flawless. The Rodrigo guitar concerto, however, is practically unknown in the United States, a situation that this beautiful recording should remedy. It is a work written along traditional lines, in three movements, for guitar and chamber orchestra. The first movement, fresh and charming, leads into a slow movement that can only be described as exquisitely evocative, a movement that—for all of its impressionistic garb—is essentially and satisfyingly romantic. It is here in particular that the listener becomes aware of the amazing expressive powers of the guitar—at least in the hands of a Narciso Yepes. The last movement, graceful, light, and brilliant, provides a fitting close to a minor (or maybe not so minor!) masterpiece. Careful engineering has provided a welcome balance of sound between guitar and orchestra. G. S., Jr.

SAINT-SAËNS

Concerto for Piano and Orchestra, No. 2, in G minor

†Glazunov: *Sonata for Piano, No. 2, in E minor, Op. 75*

Emil Gilels, piano; National Philharmonic, Alexander Gauk, cond.

COLOSSEUM CRLP 178. 12-in. \$3.98.

There are now three LP versions of the Saint-Saëns Second Piano Concerto by Mr. Gilels. This particular one is flawed, somewhat nervous in style, with missed notes here and there. Could it have been made

Angel Records

Creators of the Gala Factory-Sealed "Perfectionist Package"

introduces its

new, handsomely designed, practical

STANDARD PACKAGE

at the amazingly low price of

\$3.48

**The color-banded gold label front and back and the imprinted spine
make the new Angel Standard Package
attractive and easy to identify on your home record library shelf.**

The best buy in quality records!

**All 12" classical long-playing Angel Records are available in both
Gala "Perfectionist" (\$4.98) and "Standard" (\$3.48) Packages.**

**Electric & Musical Industries (U.S.) Ltd., 2 Dario Soria, President 3-38 West 48 Street, New York
A subsidiary of Electric & Musical Industries Ltd., 4 Hayes, Middlesex, England**

from a radio performance or a rejected tape? In any case, it is inferior to the splendid Vanguard performance, which is also superior sonically. Presumably the best Gilels version is on Angel, which I have not heard but which has been favorably reported on by C. G. B. This recording of the Glazunov sonata sounds identical to the version put out by Concert Hall Society. Again, Colosseum fails to qualify acoustically. R. E.

SAINT-SAENS

Symphony No. 3, in C minor, Op. 78

NBC Symphony Orchestra, Arturo Toscanini, cond.

RCA VICTOR LM 1874. 12-in. \$3.98.

Hague Philharmonic Orchestra, Willem van Otterloo, cond.

EPIC LC 3077. 12-in. \$3.98.

Because it calls for a fairly large orchestra, plus organ and piano, this massive but very attractive symphony is not performed as often as it deserves. Fortunately, it has now been recorded three times on LP, counting an earlier version by Charles Munch and the New York Philharmonic-Symphony on Columbia. Though the latter recording was made in 1947, it still stands up extremely well against the new competition; in fact, Munch gives what is still the most dramatically exciting and incisive account of the music. My second choice is Van Otterloo, who makes the work move along in fine style and who enjoys the warmest, fullest reproduction. Toscanini is somewhat more deliberate in the opening movement, though he manages to work up quite a lot of steam in the Finale, and the recording (made from an NBC broadcast of November 15, 1952) is more than acceptable, if not quite as rich in bass sonorities as Epic's. P. A.

SCHUBERT

Sonata for Piano, in A minor, Op. 42

Webster Aitken.

EMS 107. 12-in. \$5.95.

A cameo has restricted uses. So too has the neat, small piano-sound on this record. Reduced like this, its purity becomes primness, hardly beneficial to the constricting substances of the sonata. The player's sympathy and love for Schubert are both applauded and apparent, but he can no more transcend the limitations of weak reproduction than could the Kempff of the Beethoven sonatas on Decca or the Gieseck of the Mozart series for Angel. Too bad. C. G. B.

SCHUBERT

Songs

An die Leier; Der Schmetterling; Du bist

Perhaps surprisingly, during the late period of record price shifts, we have been called to account for very few erroneous price-listings:—In April and May we listed certain Vox 12-inch records as selling for \$3.98; their real price was (and still is, at the time of this writing) \$5.95. We hope that this error has spoiled no beautiful friendships between dealers and customers.

die Rub'; Geheimnis; Der Atlas; Das Rosenband; Der Musensohn; Ständchen; Horch, horch, die Lerch; Litanei; Gruppe aus dem Tartarus; Seligkeit; Nachtviolen; Abschied.

Gérard Souzay, baritone; Dalton Baldwin, piano.

LONDON LL 1148. 12-in. \$3.98.

A sympathetic voice in a natural delivery, an assured understanding of text and music, and a disinclination to act the songs he sings are the agreeable assimilable attributes of this Frenchman. He is neither the man to overlook an implication nor one to brandish one. It is possible that this calculated restraint has militated against the breadth of a repute he ought to have, since it counters an influential tenet of criticism that declares that Germans alone can sing a *lied* with the vocal signals necessary to prove that they understand it, a proof of subtlety established by its absence. This department, which favors poise perhaps too much, thinks the baritone admirable in the regretful simplicity of the *Litanei*, the thudding horror of *Gruppe aus dem Tartarus*, the lyric anthem to love called *Du bist die Rub'*, and most of the rest as well, in spite of the reliance on pure and unaffected singing. The accompaniment is competent, with some of the singer's ease of expression imitated on the keyboard. The reproduction is of a matter-of-fact realism highly commendable through a broad extent of volume.

C. G. B.

SCHUMANN

Symphony No. 3, in E-flat, "Rhenish," Op. 97

Concertgebouw Orchestra, Amsterdam, Carlo Zecchi, cond.

EPIC LC 3092. 12-in. \$3.98.

A solemnly uncertain performance by a conductor with fine forces at his disposal but diffident about sending them off freely. The first two movements are held to a parade-step not enlivened by thickened harmonies, and the air pumped into the last three comes too late. The sound has a strong orchestral sweep, and with more polish would have been worth special praise. C. G. B.

SINDING

Suite in A minor, Op. 10—See Tchaikovsky: *Concerto for Violin and Orchestra*.

STAMITZ, CARL

Concertos for Flute and Orchestra in D major and G major

Kurt Redel, flute; L'Ensemble Orchestral de L'Oiseau-Lyre, Kurt Redel, cond.

L'OISEAU-LYRE OL 50035. 12-in. \$4.98.

Two works by the son of the more important and original Johann Stamitz. In the fast movements the music jogs along pleasantly and unimpressively; the slow movements are rather dull. Nothing happens to disturb the even tenor of elegant mediocrity in this mixture of Haydn and water. Both performance and recording are unexceptionable. N. B.

STRAUSS

Don Quixote

"Warwick Symphony Orchestra" (Emanuel Feuermann, cello; Alexander Hilsberg, violin; Samuel Lifschey, viola; Philadelphia Orchestra, Eugene Ormandy, cond.).

CAMDEN CAL 202. 12-in. \$1.98.

Again Camden is pretty persuasive with Richard Strauss, although as in the recently issued *Heldenleben* the conductor has expressed himself better as a mechanic of the orchestra than as an exponent of the composer. Perhaps the quality of this orchestra, with its glowing string tone, and the eloquence of the soloists suffice. The resurrection of the old 78s will not draw sneers, for though the solo cello is too close and some of the climaxes are weak, the new sonics give good timbre to the Philadelphians, a grand soar to the strings beyond hope, and a fair effect of mass. By no means the best *Don Quixote*, but worth more than the price requested. C. G. B.

STRAVINSKY

Suite from Pulcinella

Divertimento from Le Baiser de la Fée

Orchestre National de la Radiodiffusion Française, Igor Markevitch, cond.

ANGEL 35143. 12-in. \$4.98.

Pulcinella and *Le Baiser de la Fée* derive their thematic material from the works of older composers, Pergolesi and Tchaikovsky respectively. Pergolesi-Stravinsky is a magnificent combination, and the resulting score is one of the wittiest, deftest, and liveliest in the literature. The combination of Stravinsky and Tchaikovsky seems, to this writer at least, forced and artificial, and *Le Baiser* must be accounted one of Stravinsky's least convincing efforts. Markevitch's performances of both works are excellent and the recordings are superb. In no previous recording of the *Pulcinella* suite is the chamberlike character of the orchestration so well set forth. A. F.

TARTINI

Violin Concertos in F major and A minor

Walter Schneiderhan, violin; Vienna Orchestra, F. Charles Adler, cond.

SPA 46. 12-in. \$5.95.

Schneiderhan's technique is more than adequate for this music, including the rather fancy cadenzas, but whether his style is suitable for Tartini is questionable. He indulges in a type of vibrant "expression" that would be fine for Glazunov, and in the first movement of the F major Concerto sometimes slides from one tone to another on the same string. The works themselves, edited by Gilbert Ross of the University of Michigan from a manuscript collection in Padua, contain much of interest. The main theme of the finale of the F major has the character of a Slavic folk song, and the A minor is full of good ideas expressed with unwonted intensity. The balance between soloist and orchestra is satisfactory but the basses sound rather tubby and there is some surface noise. N. B.

TCHAIKOVSKY

Concert Fantasy, Op. 56—See Babajanian: *Heroic Ballad*.

TCHAIKOVSKY

Concerto for Violin and Orchestra, in D, Op. 35

†Ravel: *Tzigane*

†Sinding: *Suite in A minor, Op. 10.*

Jascha Heifetz, violin; Philharmonia Orchestra, Walter Süsskind, cond. (in the Tchaikovsky); Los Angeles Philharmonic Orchestra, Alfred Wallenstein, cond. (in the Ravel and Sinding).

RCA VICTOR LM 1832. 12-in. \$3.98.

A reissue of the polished, showy, and glacial Heifetz performance of the Tchaikovsky, previously issued on VICTOR LM 1111. The three movements have now been compressed onto one side of this twelve-inch disk, and its 1951 sound has received some ministrations from Victor's engineers. The result is more tonally persuasive, both as to orchestra and violin sound, and the record is much preferable to the original issue.

The little Sinding suite, never before recorded, is a real charmer, and is ideally suited to display the fabulous technique of this artist. Heifetz plays it with great affection, and offers in the first movement some of the most dazzling spiccato playing to be heard on records. I am not much attracted to Ravel's *Tzigane*, though I hardly expect to hear it better played than in this expert performance. In the last two works, both newly recorded, the violin sound is of extreme brilliance, but that of the orchestra inclines to muddiness. Both would have benefited from a more equitable balance.

J. F. I.

TCHAIKOVSKY

Romeo and Juliet—See Borodin:
Prince Igor: Polovtsian Dances.

TCHAIKOVSKY

The Sleeping Beauty (excerpts)

Andre Kostelanetz and his Orchestra
COLUMBIA ML 4960. 12-in. \$3.98.

Twenty excerpts are included on this record, the most of the best, but not necessarily the best of the most, since it does not displace, in my estimation, the fine Stokowski version on RCA VICTOR LM 1010, which it so closely approximates. Yet this recording must take a fairly high place among competitive versions, if only for the beauty of Columbia's recorded sound. Artistically, the performance bears less of the Kostelanetz imprint than did the earlier *Swan Lake*. Here he exhibits fewer of his musical eccentricities and shows a closer regard than is sometimes the case for the composer's markings in matters of tempos and rhythm.

J. F. I.

VIVALDI

The Four Seasons, Op. 8

George Zazofsky, violin; Zimble Sinfonietta.

BOSTON B 400. 12-in. \$4.98.

Bird songs, a murmuring brook, thunder and lightning, a sleeping drunk, hunters cornering their quarry, chattering teeth, a stroller slipping on the ice—all this and more is depicted charmingly and in what seems today quite naïve fashion in these fine works. Yet, as in Beethoven's *Pastoral Symphony*, the literalness of the tone paint-



BETTMANN ARCHIVE

Vivaldi: only the dog's bark lacked bite.

ing does not prevent Vivaldi from achieving solid, integrated form—here the pattern of a structure that is partly concerto grosso and partly violin concerto. It is only in the fourth concerto, *Winter*, that the exigencies of the "program" prove too much for Vivaldi and result in a piece that does not hang together very well.

The performance is musical and sensitive. Soloist and ensemble play with agreeable tone. The delicate balances of this carefully orchestrated work are faithfully reproduced most of the time. In the second movement of *Spring* the dog of the sleeping goatherd might bark a little louder, and in the finale of *Summer* the violas are a bit too far back in spots. The performers seem to have used an edition that differs in some respects from that in the *Collected Works*. This is especially noticeable in the last movement of *Summer*, where an important figure in the second violins is omitted. The recording is excellent, but the surfaces of the review disk were crackly.

N. B.

VIVES

Bohemios

Toñy Rosado, Teresa Berganza, Ana María Fernández, Adela Cano, Manuel Áusensi, Carlos Manguía, Arturo Díaz Martos, Gregorio Gil; Coros Cantores de Madrid and Gran Orquesta Sinfónica, Ataulfo Argenta, cond.

LONDON TW 91038. 12-in. \$4.98.

A prolific and successful zarzuela composer, Amadeo Vives belongs to the select company that includes Bretón, Chapí, Sertano, and Moreno Torroba. While perhaps not as popular as his unforgettable *Maruxa*, *Bohemios* has held the stage for fifty years, and there is no reason why it should not continue doing so for another half century. The plot is a straightforward, romantic tale of a young composer and an opera-singer-to-be in the Paris of a hundred years ago. Naturally, it is a perfect match, leading to an inevitable love duet at the end. The music is delightful, the performance satisfactory, the recording superb.

G. S., Jr.

WARLOCK

Capriol Suite; Serenade for Frederick Delius

†Ireland: *Minuet*

Boyd Neel String Orchestra, Boyd Neel, cond.

LONDON LD 9170. 10-in. \$2.98.

Warlock's *Capriol Suite* has long been one of the gems of recorded music and it is charmingly played by the Boyd Neel group. The rich harmonies of Delius were studiously copied in Warlock's serenade to the blind composer, a short work that must have pleased Delius, as it will his admirers. Ireland's minuet is light and innocuous. Excellent string tone throughout.

J. F. I.

RECITALS AND MISCELLANY

SONGS OF THE NORTH AND SOUTH

Frank Luther and Zora Layman, with the Century Quartet.

DECCA DL 8093. 12-in. \$3.98.

This recording by Decca of the songs of the North and South in the War Between the States must be a pretty complete compilation. With eighteen songs representing the North and seventeen the South—thirty-five in all; count them—too many couldn't have been left out. And this is my chief objection. The singing is straightforward and quite good, but the very fact there are so many songs of unvarying length and style makes for monotony. I feel this could have been a ten-incher.

The recorded sound is excellent.

ROY LINDSTROM

ELIZABETHAN AND JACOBAN MUSIC

John Dowland: *Can She Excuse My Wrongs?*; *If My Complaints Could Passions Move*; *My Lady Hunsdon's Puffe* (for lute solo); *From Silent Night*. Thomas Morley: *Air* (for three viols). John Bartlett: *Of all the Birds That I Do Know*. Robert Johnson: *Alman* (set for harpsichord by Giles Farnaby). John Jenkins: *Pavan* (for four viols); *Fantasia in C* (for four viols). Robert Parsons: *Pandolpha*. Giles Farnaby: *Variations on Up Tails All* (for harpsichord).

Alfred Deller, counter-tenor; Desmond Dupré, lute; Gustav Leonhardt, harpsichord; consort of viols.

VANGUARD BG 539. 12-in. \$4.98.

However discouraged a view may be taken of the creative state of English music since Purcell, there was a time, from deep in the Middle Ages to the end of the Renaissance, when the composers of England were as brilliant as any. So, when the first Elizabeth came to the throne, in 1558, and her reign turned out to be a golden age of poetry, there were other pens ready to set the words most elegantly to music. It was a cosmopolitan time, and under Italian influence a school of English madrigalists grew up. More significant, however, and certainly more definably English, were the writers of *ayres*—strophic songs in which the voice melody was supported by other voices or by instruments, the point of interest shifting more and more surely to the marriage of words and music and away from the complex interweavings of several parts. At the same time, there was a grow-

Dialing Your Disks

Records are made with the treble range boosted to mask surface noise, and the bass range reduced in volume to conserve groove space and reduce distortion. When the records are played, therefore, treble must be

reduced and bass increased to restore the original balance. Control positions on equalizers are identified in different ways, but equivalent markings are listed at the top of each column in the table below. This table covers most of the records sold in America during the past few years, with the emphasis on LP. Some older LPs and 78s

required 800-cycle turnover; some foreign 78s are recorded with 300-cycle turnover and zero or 5-db treble boost. One-knob equalizers should be set for proper turnover, and the treble tone control used for further correction if required. In all cases, the proper settings of controls are those that sound best.

RECORD LABEL	TURNOVER			ROLLOFF AT 10KC.	
	400	500	500 (MOD.)	10.5-13.5 db	16 db
	AES (old)	AES (new)	ORIG. LP LON	AES NARTB RCA ORTHO RIAA LON	NAB(old) COL LP ORIG. LP
Allied		●		●	
Angel		●		●	
Atlantic* ¹		●			●
Amer. Rec. Soc.*		●		●	
Barrok		●			●
Blue Note Jazz*	●			●	
Bosron*			●		●
Caedmon		●		●	
Canyon*	●			●	
Capitol*	●			●	
Capitol-Cetra	●			●	
Cetra-Soria			●		●
Colosseum*			●		●
Columbia*			●		●
Concert Hall*	●			●	
Contemporary*	●			●	
Cook (SOOT) ¹		●		●	
Decca*	●		●		●
EMS*	●			●	
Elektra		●			●
Epic*			●		●
Esoteric		●		●	
Folkways (most)		●			●
Good-Time Jazz*	●			●	
Haydn Soc.*			●		●
L'Oiseau-Lyre*			●	●	
London*			●	●	
Lyrichord, new* ²		●			●
Mercury*	●			●	
MGM		●		●	
Oceanic*		●			●
Pacific Jazz		●		●	
Philharmonia*	●			●	
Polymusic* ¹		●			●
RCA Victor		●		●	
Remington*		●			●
Riverside		●		●	
Romany		●		●	
Savoy		●		●	
Tempo		●		●	
Urania, most*		●			●
Urania, some	●			●	
Vanguard*			●		●
Bach Guild*			●		●
Vox*			●		●
Walden		●		●	
Westminster		●			●

*Beginning sometime in 1954, records made from new masters require RIAA equalization for both bass and treble.

¹Binaural records produced on this label are recorded to NARTB standards on the outside band. On the inside band, NARTB is used for low frequencies but the treble is recorded flat without emphasis.

²Some older releases used the old Columbia curve, others old AES.

Continued from page 67

ing interest in music for keyboard and for combinations of instruments without voices, and in the dance pieces and fantasias of Elizabethan days and on into the first decades of the seventeenth century, England could claim a real chamber-music literature more advanced than any on the Continent.

Historicity is one thing, however, and continuing worth another. It is only through performances such as these that Dowland, Farnaby, Morley, and Campian can become more than shadowy names; only through them that it is possible to know what the songs were like that Elizabeth heard and applauded and sang to her lute. Until fairly recently, there have been disadvantages to seeking out music of this period on records. First, most of the few recorded examples have been bound up in one historical series or another. Second (with all respect to the pioneering of the Dolmetsch family), performances of musics involving obsolete instruments have dankness and dedication rather than freshness and re-creative *elan*. The performances here are not entirely free from ritual seriousness, but they are basically musical rather than simply musicological and have enough flow, enough light and shade, to keep them engaging as well as interesting.

This is by no means the first appearance on records of the British counter-tenor (or, as he would have been called before the low-voiced ladies misappropriated the title, "alto") Alfred Deller, who is one of the few remaining exemplars of the falsettist art that was until well into the 1880s the distinctive feature of English cathedral choirs. Falsettists are not supposed to last much beyond middle age, but Mr. Deller, at forty-three, has still the same even, pure scale as ever, the same free high tones that float without effort past his cavalry moustache, the same scrupulous artistry. Desmond Dupré's lute accompaniments are very fine, and so is Gustav Leonhardt's playing, both at the keyboard and in his consort of viols. The sound is clean, delicately balanced, and intimate, the surfaces excellent. Full texts, and helpful notes by Sydney Beck. Highly recommended.

J. H., Jr.

EVENINGS AT THE BALLET

Tchaikovsky: *Nutcracker Suite*; *Aurora's Wedding*. Richard Strauss: *Till Eulenspiegel's Merry Pranks*. Ravel: *La Valse*; *Daphnis and Chloe Suite No. 2*. Grétry: *Céphale et Procris*. Delibes: *Coppélia* Ballet Suite. Verdi: *Aida* Ballet Suite. Bizet: *Symphony in C*. Schumann-Glazunov: *Carnaval*. Rossini-Respighi: *La Boutique Fantasque*. Weber: *Invitation to the Dance*. Saint-Saëns: *Bacchanale from Samson and Delilah*. Bernstein: *On the Town*. Prokofiev: *Classical Symphony*. Khachaturian: *Gayane* Ballet Suite. Stravinsky: *Petrouchka*. Borodin: *Prince Igor*; *Dances of the Polovtsian Maidens*.

"Warwick," "Centennial," "World Wide," "Century," "Festival," "Stratford," "On the Town," "Schuyler" Symphony Orchestras, various conductors.
CAMDEN CFL 102. Six 12-in. \$10.98.

In this Baedeker of the ballet, Camden offers the listener a tour through the ballet repertoire from Grétry to Bernstein, using eighteen scores by sixteen different composers (Ravel and Tchaikovsky are doubly represented), played by eight well-known orchestras. The exclusion of *Les Sylphides* may seem as surprising as the inclusion of the operatic ballet excerpts from *Aida* and *Samson and Delilah*, but this is probably due to the exigencies of space. The recordings date from the late Thirties and early Forties; the sound has been, in general, successfully enhanced over that found on the original issues.

The performances are not all shining examples of conductorial art, but it should be said that a few real gems appear on these disks: Koussevitzky's fine performance of Ravel's *Daphnis and Chloe* Suite No. 2 and a good *Till* from the same source; Montoux's reading of *La Valse*; an excellent *Petrouchka* by Stokowski; and a charming performance of the ballet music from Grétry's *Céphale et Procris* by Defauw. In all, a most attractive offering of more than three hours of ballet music at a most reasonable price, but definitely not for those dazzled by the latest in hi-fi. J. F. I.

FLAMENCO AND CLASSIC SPANISH DANCES

Inesira, heels, fingers, and castanets; Juan Martinez, guitar; Pablo Miquel, piano.
PERIOD RL 1905. 12-in. \$4.98.

This is undoubtedly one of the most exciting records of popular Spanish music ever released. If the guitar and the piano as recorded here seem a trifle on the discreet side—well, it simply doesn't matter, for fiery Inesira overwhelms and takes the breath away with the sharp, intricate rhythms of her heels, her snapping fingers, and her castanets. Recommended unhesitatingly to all interested, however slightly, in Spanish dancing. G. S., Jr.

HILDE GUEDEN Memories of the Vienna Theater

Vol. 1.—Johann Strauss, Jr.: *Wiener Blut*: title waltz; *Grüss dich Gott, du liebes Nesterl*. *Die Fledermaus*: Entr'acte. Fritz Kreisler: *Sissy*: *Ich wär so gern einmal verliebt*. Emerich Kalman: *Gräfin Maritza*: introduction and chorus. Oskar Straus: *Der Tapfere Soldat*: *Komm' Held meiner Träume*. Leo Fall: *Madame Pompadour*: *Heut' könnt' einer sein Glück bei mir machen*. *Die Dollarprinzessin*: *Automobilmarsch*. Franz Lehár: *Zigeunerliebes*: *Hör ich Cymbalklänge*.

Vol. 2.—Leo Ascher: *Hobeltanz Walzer*: *Man nennt mich nur dar Lerche! von Hernals*. Carl Ziehrer: *Der Schatzmeister*: waltz-motive. Franz Lehár: *Der Tsarewitsch*: introduction and *Kosende Wellen*. *Schön ist die Welt*: introduction and *Ich bin verliebt*. Oskar Straus: *Rund um die Liebe*. Franz Lehár: *Die Lustige Witwe*: *Lippen schweigen*: waltz-motive. Oskar Straus: *Ein Walzertraum*: *Leise, ganz leise*. Johann Strauss, Jr.: *Wiener Blut*: excerpt from overture (arr. Schönherr).

Die Tänzerin Fanny Elssler: *D'rassien in Sievering* (arr. Stalla). *Wiener Blut*: introduction and title waltz (arr. Schönherr).

Hilde Gueden, soprano; Vienna State Opera Orchestra and chorus, Max Schönherr, cond.
LONDON LD 9157/9158. Two 10-in. \$2.98 each.

Disposed potpourri-fashion, without spacing bands between excerpts (which sometimes take in the whole of a number, more often stop short at one stanza, sometimes give no more than a fragment) these records may frustrate some people by jumping so readily from tune to tune and by making particular favorites so hard to find. But even more people—those whose fondness for Viennese operetta is real but not hyper-intense—will probably find themselves completely beguiled by the lilting charm of Hilde Gueden's singing and the *gemütlich* feel of the performances in sum. The reproduction is very good.

The volume numbering given above corresponds with that on the record jackets; the labels, however, show Vol. 1 as Vol. 2 and Vol. 2 as Vol. 3—possibly thus including them in a three-disk set with an earlier Gueden record (LS 680) called "This is My Vienna." However that may be, these are practically ideal casual-listening or party records for operetta enthusiasts. J. H., Jr.

MARGOT GUILLEAUME Operatic Recital

Mozart: *Le Nozze di Figaro*: *O säume länger mich* (i. e., *Deh vieni non tardar*); *Die Zauberflöte*: *Ach, ich fühls*. Flotow: *Martha*: *Die letzte Rose* (i. e., *The Last Rose of Summer*). Thomas: *Mignon*: *Kennst du das Land?* (i. e., *Connais-tu le pays*).

Margot Guilleaume, soprano; Orchestra of the Berlin Städtische Oper, Walter Lutze, cond.

TELEFUNKEN TM 68052. 10-in. \$2.98.

There may just possibly be a big rumor-stimulated market in this country for recordings by Margot Guilleaume; if so, here she is—not singing a great deal of music for the money, but singing what there is on a nice clean disk that comes in (a) an inner envelope of soft paper, (b) a heavier envelope, (c) an album box, and (d) a cellophane outer wrapping. With all this, she must surely be somebody very special. But who? On the basis of this record, she seems to be a lyric soprano with a pretty



Hilde Gueden: *gemütlichkeit galore*.

middle voice, quite undeveloped low tones, and a top that floats at *piano* but sounds a shade anxious when used *forte*. Her singing is neat, well schooled, and sweet, but rather lacking in substance and quite lacking in any sort of strong conviction. All in all: nice but pale. Accompaniments: gentle and well suited to the singer. Recording: good. J. H., Jr.

INVITATION TO THE DANCE

Weber: *Invitation to the Dance*. Enesco: *Rumanian Rhapsody*, No. 1, in A major. Prokofiev: *Wedding Suite*, Op. 126 (from the ballet *Stone Flower*).

New York Philharmonic-Symphony, Andre Kostelanetz, cond.
COLUMBIA ML 4957. 12-in. \$3.98.

Kostelanetz is completely at home in the Lisztian-inspired rhapsody by the late Georges Enesco, giving it an exceptionally good reading, with its rhythms always firm and strong. The Weber is taken at a rather fast clip; dancers would surely have trouble following this tempo, and the performance in general lacks the proper airiness. The *pièce de résistance* of this record is the lovely little five-movement suite of Prokofiev, which Kostelanetz first introduced to American audiences; frolicsome, gay music, with an abundance of melodies and witty orchestration. The men of the Philharmonic play all three works with wonderful verve, and Columbia has obliged with luscious sound. J. F. I.

THE KING OF INSTRUMENTS, VOL. IV

Hilliar at St. Mark's

Pachelbel: *Chorale and Variations on Was Gott tut, das ist wohlgeran*. Loeillet: *Air Tendre*. Bach: *Trio Sonata*, No. 4, in E minor; *Chorale Prelude, O Mensch, bewein' dein' Sünde gross*. Coupetin-le-Grand: *Offertoire sur les Grande Jeux*. Dupré: *Cortège et Litanie*. Arrc: *Flute Tune*.

Edgar Hilliar, organ.
AEOLIAN-SKINNER. 12-in. \$5.95.

Edgar Hilliar plays the instrument of St. Mark's Episcopal Church, Mount Kisco, N. Y., where he is organist. It is another example of Aeolian-Skinner's American Classic Organ, and a particularly persuasive one, with some highly individual stops and a transparent texture for the eighteenth-century scores, together with a massed tone of considerable solidity for the contemporary French piece by Dupré.

This version of the Pachelbel variations and the recent one by E. Power Biggs for Columbia make a fascinating study in opposing interpretations. Hilliar's is more varied and lively, depending for its effects on contrasts between astringently colored stops; Biggs plays more soberly, using massively brilliant registrations. The performance here of the Bach sonata is almost as good as Robert Noehren's on Allegro, but the tempos in the Bach chorale prelude, slower even than Schweitzer's, positively funereal, are really too slow to give the work cohesion. That the organist keeps the work inching forward as well as he does amounts to a *tour de force* of phrasing. Superbly recorded with lifelike tone and impeccable clarity. R. E.

ERICA MORINI RECITAL

Brahms: *Hungarian Dances*, Nos. 1, 5, 6, 7, 8, and 17. Vivaldi: Violin Sonata in D major (arr. Respighi). Wieniawski: *Capriccio-Valse*, Op. 7 (arr. Auer). Sarasate: *Faust Fantaisie*. Ravel: *Pièce en forme de habanera*.

Erica Morini, violin; Artur Balsam and Max Lanner, piano.

CAMDEN CAL 207. 12-in. \$1.98.

Erica Morini is inclined to be a trifle too mannered in the *Hungarian Dances*, where she uses too many slides from one note to the next. There is nice style and proportion, however, in the Vivaldi Sonata and particularly in the Wieniawski *Capriccio-Valse*. The other two encore-type pieces are also ably handled, as are the piano accompaniments. Reproduction is adequate.

P. A.

NEW DIRECTIONS IN MUSIC AND SOUND

Blacher: *Orchestral Variations on a Theme of Paganini*, Op. 26. Von Einem: *Capriccio for Orchestra*, Op. 2. Fortner: Symphony (fourth movement only). Hartmann: Symphony No. 4 (finale, *Adagio Appassionata*, only). Liebermann: *Furioso for Orchestra*.

RIAS Symphony Orchestra, Ferenc Fricsay, cond.

DECCA DL 9769. 12-in. \$3.98.

An anthology of five short orchestral pieces by German composers who have come to prominence since World War II: Boris Blacher's enchantingly witty and ingenious *Variations on a Theme by Paganini*; a tuneful, vivacious *Capriccio* by Gottfried von Einem; the very vigorous, slightly Hindemithian finale to a symphony by Wolfgang Fortner; a highly chromatic, rich, and broadly lyrical *Adagio Appassionato* from a symphony for strings by Karl Amadeus Hartmann; and a piece called *Furioso* by Rolf Liebermann, which is clamorous and noisy but not much more. Except for Liebermann's contribution, this selection makes an extremely eloquent case for the younger Germans. Performance and recording are both elegant.

A. F.

PIAF OF PARIS

Sous le ciel de Paris; *Avec le soleil*; *Retour*; *Mea Culpa*; *Les croix*; *L'homme au piano*; *Enfin le printemps*; *Ca ira*.

Edith Piaf; M. Murcier Chorus; orchestra, E. Chauvigny, cond.

ANGEL 64015. 10-in. \$2.98.

The most satisfying part of this very agreeable Piaf concert is the discovery that the singer is just as much at home in light, lilting Parisian songs as in those melancholy ditties of frustration with which she is more usually associated. While only two of her numbers, *Sous le ciel de Paris* and *Enfin le printemps*, are in this gayer mood, she handles them both with rare artistry and engaging verve. Five of the remainder are typical Piaf plaints; one, *L'homme au piano*, is given a rather piquant touch, as a tinny barroom piano is used as background support. The climax of this recital is Piaf's electrifying and spine-tingling chanting of the French Revolution song *Ca ira*, a performance of demoniacal fury. The orchestral support throughout is dis-

creet and tasteful, and Angel's sound is superbly clear.

J. F. I.

ROSA PONSELLE SINGS TODAY

Lully: *Amadis*: *Bois épais*. Persico: *Rosemonde*. Saint-Saëns: *Guitares et Mandolines*. Chausson: *Les Temps des Lilas*. Brahms: *Von ewiger Liebe*. Trunk: *Mir träumte von einem Königskind*. Schubert: *Erlkönig*. Beethoven: *In questa tomba oscura*. Wolf-Ferrari: *Rispetto*. Donaudy: *O del mio amato ben*. Tosti: *Aprile*. Sadero: *Amuri, amuri*; *I battitori di grano*. English, traditional: *Drink to Me Only With Thine Eyes*. Fatley: *The Nigh Wind*. Del Riego: *Homing*.

Rosa Ponselle, soprano; Igor Chicagov, piano (except in *Amuri, amuri*, in which the singer plays for herself).

RCA VICTOR LM 1889. 12-in. \$3.98.

From the very hour it began — actually even before it began — the career of Rosa Ponselle has had a legendary quality quite unlike any other. It still has. Probably it always will have. This has to do partly with its background, partly with its spectacular beginning, partly with the successes that made it up, but even more with the abruptness of its end — still more with the tantalizing emanations that have floated in the air ever since. She has not sung in public, not in the usual meaning, since 1937; but she has sung freely enough in private, at home, to keep the operatic world well supplied with up-to-date status reports and with rumors, counter-rumors, and cross-rumors of all kinds. Close onto twenty years have passed since her retirement, and scarcely one — if one — has passed without the news being passed breathlessly about, always on the best authority, that Rosa Ponselle is about to emerge from retirement and resume her place as the most splendid of operatic sopranos.

She never has, of course, and she has always denied any such intention. But the rumors have never stopped. Let someone play a Ponselle recording in a group of more than two, and at least one is sure to bring the subject up. He knows someone who knows someone who has just come back from her Baltimore home, where he heard the voice, glorious as ever. And next season . . . And so on.

In such circumstances, the Ponselle career has been told over and over: how she sang with her sister in cafés and in vaudeville; how she auditioned for Giulio Gatti-Casazza and was given her debut in the

Metropolitan premiere of *La Forza del Destino*: how triumph followed triumph; how she sang this role and that; and, finally, how she suddenly married and as suddenly retired at the age of — well, birth statistics in Meriden, Conn., would put it at forty. Then speculations: Why did she retire? Because she got married? Because her top notes were becoming less and less sure? Because singing in opera was too great a strain on her nerves? Or all three? Then, again, the word that she will return.

The fact seems to be that all the rumors down the years have had some basis, but not enough to make them come true. Rosa Ponselle certainly never stopped singing completely, and she may very well have let the idea at least of returning to opera pass through her mind — she could hardly have avoided it. But she never did return, and it seems absolutely certain now that she never will.

Until now, the closest she has come to making her at-home singing public has been a semi-private affair to help raise funds for the Baltimore Symphony. But now, with the release of *Rosa Ponselle Sings Today*, all who are interested can hear and draw their own conclusions. The recording, made at her home in October of 1954, is extremely full in surrounding resonance — almost as if the room in which it was made had echo-chamber characteristics — and it is, of course, impossible to tell the size of the voice. But the quality is basically the same as in recordings made thirty years ago, at the peak of her career — the same rich, dark middle voice, the same full low notes; and, though nothing is sung that goes beyond mezzosoprano capabilities, the attack on the highest tones is characteristically precipitate-sounding. None of the songs requires really difficult skips, and none requires fast, florid articulation; the point would seem to be implied, but perhaps not. The singing is always interesting and communicative, the phrasing broad and sweeping, even when the style is questionable, even when the enunciation, in languages other than Italian and English, is not for young singers to copy. Even in the most trivial music, the effect is that of a magnificent voice and a strong, individual personality given free play in relaxed circumstances. Excellent notes by Francis Robinson.

J.H., Jr.

PORTS OF CALL

Ravel: *Bolero*; *La Valse*; *Pavane pour une infante défunte*. Ibert: *Escapes*. Debussy-Caillet: *Clair de lune*. Chabrier: *España*.

Philadelphia Orchestra, Eugene Ormandy, cond.

COLUMBIA ML 4983. 12-in. \$4.95.

Ormandy and his Philadelphians are least engaging when they try to outdo Kostelanetz, and that seems to be the direction in which they are striving here. It is true that this kind of music thrives well in the hot-house, but there comes a point when an excess of refulgence and shimmer begins to yield diminishing returns. My patience began to grow thin by the time I got to *Escapes* and it quite ran out in the *Pavane* — a simple, muted piece of music made infinitely more poignant in the restrained in-

Continued on page 72



Lady of legend: Rosa Ponselle at home.

building your record library

number twenty-one



JOHN M. CONLY SUGGESTS TEN BASIC CONCERTO RECORDINGS

HISTORY is a great help, in a quest like this. If we do our choosing on a historical basis, you are assured of considerable variety, and there will be some significance to your concerto-shelf. Within this framework, my choices will be aimed at making your collection as nearly bombproof as possible.

Let us begin with Bach, and let us forget nonsensical notions to the effect that he was unaware of the uses of virtuosity or the possibilities of the concerto as a medium of emotional communication. To this end I'd like to recommend the Fifth Keyboard Concerto, but no current recording of it satisfies me. So try the absolutely beautiful rendition of the two Concertos for Violin by Jascha Heifetz, Alfred Wallenstein and the Los Angeles Philharmonic (RCA Victor LM 1818.).

Bach overshadows everyone who followed him in this field until we get to Haydn and Mozart, and the former treated the concerto lightly (though his Trumpet Concerto, on Vanguard 454, is very exciting listening). With Mozart we must cleave to his own instrument, the piano and, oddly, few Mozart piano-concerto records are satisfactory. One that is, however, is the combination of Concertos No. 9 and No. 15, played by Wilhelm Kempff, with Karl Münchinger conducting the Stuttgart Chamber Orchestra (London LL 998), in almost faultless performances and marvelously proportioned sound. These are middle-early Mozart, but there is depth under the grace.

It is with Beethoven that the concerto achieves its highest dramatic content, and the voices of the solo instrument and the orchestra begin pleading, singing, shouting one against the other. And here the choice is easy: one of the best recorded performances I've ever heard is that of the Fourth Piano Concerto by Clifford Curzon, with Hans Knappertsbusch leading the Vienna Philharmonic (London LL 1045). The recording actually was made in one continuous take, when the musicians played the work through for fun after two days of a routine, make-and-remake session. It's a spellbinder.

It is a pity to have had to pass up Luigi Boccherini in moving from the eighteenth to the nineteenth century, his famous cello concerto is beautifully handled by Pierre Fournier and Münchinger's Stuttgart men on London LL 1036. And now we must sin again, in skipping Niccolò Paganini and one of the great showpieces of the violin literature, his Concerto No. 1 (splendidly played by Francescatti on Columbia 4ML 4315). But we arrive at a greater, the ubiquitous Violin Concerto of Felix Mendelssohn, wherein flashing instrumental virtuosity is first put to full communicative use. Its sunny Romanticism is handsomely aired by Zino Francescatti, with Dimitri Mitropoulos conducting the New York Philharmonic-Symphony Orchestra (Columbia ML 4965). And this selection allows me to cheat, since on the reverse you get the same artists playing the Tchaikovsky Concerto in D, a later, Slavic, hair-down kind of Romanticism, much freer in form, darker in hue.

But let us get back to an earlier part of the century, and the first major exponent of piano virtuosity for its own sake (but not its own sake *alone*) — Frédéric Chopin. For my taste, Artur Schnabel is more truly Chopin's man than any of the other contenders in the two great concertos, and I like best his performance in the Concerto No. 1, assisted by Alfred Wallenstein and the Los Angeles Philharmonic (RCA Victor LM 1810). There is nothing ultimate about the recorded sound, but it isn't bad either.

Franz Liszt is popularly thought of, rightly or wrongly, as having picked up where Chopin left off in the development of the piano concerto as a vehicle for virtuosity. Certainly he proceeded to explore, probably more fully than anyone else, the technical and tonal possibilities of the instrument. And he established a sort of picture of the piano virtuoso which the public has accepted ever

since. There are numerous good performances of his two concertos. Perhaps strangely, my choice is made on grounds of reproduced sound; I pick the performances of the First and Second Concertos by Edith Farnadi and the Vienna State Opera Orchestra, Hermann Scherchen conducting (Westminster WL 5168). The sonic perspective in this is engrossing, almost uncanny, and the playing impressive too.

Now back to the main line of classical tradition — drama within disciplined form, no effects wasted, a philosophical continuity from movement to movement. Johannes Brahms's First Piano Concerto has been treated in recording just a little better than his more famous Second. So let us savor the loving firmness with which its eloquence is tempered in the performance by Wilhelm Backhaus and the Vienna Philharmonic conducted by Karl Böhm (London LL 911). This is purveyed in very fine "firr" reproduction.

Staying within the count of ten, we have skipped Schumann (a pity, when Guiomar Novaes plays his piano concerto so beautifully on Vox PL 8540), and now we will do the same for Greig (another slight to Mme. Novaes, and to Vox PL 8520) and Dvořák, whose cello concerto (as played by Pierre Fournier on London LL 1106, with Rafael Kubelik conducting the Vienna Philharmonic) deserves better treatment. Thus we come to the turn of another century, and to the last of the virtuoso pianist-composers, Sergei Rachmaninoff. His Second Piano Concerto is one of his two or three greatest works, and faces us with a choice-problem. His own performance of this work, with Leopold Stokowski and the Philadelphia Orchestra, still exists in a reprint-record (RCA Victor LCT 1014). It steals the thunder from all others, but has none of its own — the sound is old and thin. The next best performance, to my mind, is that of Julius Katchen, with Anatole Fistoulari conducting the New Symphony Orchestra (London LL 384), and the sound of this is highly adequate. Even better is that given Leonard Pennario, (Capitol P 8302), but the St. Louis Symphony, despite Vladimir Golschmann, plays a little sloppily. I'd take the Katchen. (But I already *have* the Rachmaninoff.)

Not every great composer voluntarily concerned himself with his times and their tensions. Beethoven did. Brahms did. Bela Bartók did. He went back to folk-materials, he went forward into experimentation; he tried to build a bridge. Its form stands forth well in his Viola Concerto, which is accessible without being mockingly accessible, as his Concerto for Orchestra seems to me to be. There is only one recording of the concerto, but it features the wonderful William Primrose, with the New Symphony Orchestra led by Tibor Serly, and was produced by the composer's own son Peter (Bartók Records 309), a noted sound-perfectionist.

There arises now a temptation to include the second violin concerto of Prokofiev (tellingly performed on Columbia 3ML 4648 by Francescatti) but I hold back. It is beautiful but it seems to me to aim nowhere in particular, by comparison with, say, the same composer's Fifth Symphony. And I never have been able to get worked up about the Sibelius violin concerto. So I will offer as last entry another demonstration of the encouraging theme that the old forms still can enchant and compel, when they are brightened with new content, and when the new content is musical idiom the composer really loves and wants to make yield up the folk-spirit that generated it. All this is embodied in the only recording of Virgil Thomson's Cello Concerto, in which the cellist is Luigi Silva and Werner Janssen conducts an orchestra designated simply as the "Janssen Symphony" (Columbia 3ML 4468). There is not a dead spot from beginning to end. At one point you may recognize, as themes juxtaposed, "Yes, Jesus Loves Me" and a phrase from a Beethoven sonata, but they sound as if they were meant by nature to go together.

Continued from page 70

Interpretation of André Cluytens and the Orchestre National (ANGEL 35102). R. G.

17TH AND 18TH CENTURY ITALIAN MUSIC

Vivaldi: Concerto in E for Violin and Strings (*Il Riposo*); Corelli-Geminiani: *La Follia*; Galuppi: *Concerto a quattro*, in D, No. 2; Bonporti: Concerto in D, Op. 11, No. 8.

Società Corelli.

RCA VICTOR LM 1880. 12-in. \$3.98.

The concerto by Bonporti, the oldest of the composers represented on this disk (except for Corelli) and probably the least known, is an eye-opener. It consists of two vigorous movements framing a Largo that is one long, expressive, and moving melody. Bonporti seems to have been fond of deceptive cadences, which are rather rare in the music of his time. Corelli's interesting and imaginative variations, written for violin and figured bass, are here presented in his pupil's arrangement for string orchestra. The Vivaldi work is unusual in that there is no continuo and all the strings are mured. All of these pieces are well played and cleanly recorded. N. B.

FOLK MUSIC

by Howard LaFay

SONGS OF THE HEBRIDES

Mary MaKower, alto; Franz Jelinek; harp. SPA 65. 12-in. \$5.95.

The Cockle Gatherer; An Eriskay Love Lilt; The Dowerless Maiden; Dance to Your Shadow; A Fairy's Love Song; Water Kelpie's Song; The Fairy Loom; A Wandering Shade; Milking Croon; Milking Song; The Mull Fisher's Song; The Islay Reaper; The Land of Heart's Desire; The Skua-Gulls; An Eriskay Lullaby; The Coolin of Rum; To People Who Have Gardens; The Sea Gull of the Land Under Waves; Carisone; An Island Sheilung Song; To the Cradle Lord of the Isles; The Old Crone's Lilt; The Bens of Jura; Kisbmul's Galley

Lonely, lovely songs of the far islands to the north and west of Scotland. Love songs, work songs, and lullabys — all as soft and lyric as the summer clouds above the Isle of Skye, all with the sparkling surface and hidden depths of the Sound of Barra.

Miss MaKower's rich alto imparts a full Gaelic flavor to the songs, although she sings them in English. Franz Jelinek accompanies on the harp. Both artists bring a high degree of sensitivity and intelligence to this undertaking, which is fully reflected in the end product. SPA's sound is quite satisfactory.

Recommended.

MILLIONS OF MUSICIANS

A documentary of musical expression in everyday life conceived, recorded and narrated by Tony Schwartz.

FOLKWAYS FP 60. 12-in. \$6.45.

EXCHANGE

Friendship Around the World Thru Tape Exchange by Tony Schwartz

FOLKWAYS FP 62. 12-in. \$6.45.

Tony Schwartz and his tape recorder are familiar sights around New York as he unobtrusively goes about recording the sonic life of the metropolis. His *New York 19* (FP 703), containing children's street games and songs taped entirely within Manhattan's 19th Postal Zone, was a minor masterpiece.

Now he is back with two additional Folkways releases, both more elaborate than his earlier effort, but neither quite as charming. In *Millions of Musicians*, Mr. Schwartz apparently aims to prove that the world is filled with unwitting musicians. However, his results will breed no unrest in the headquarters of the ever-vigilant James Caesar Petrillo.

A taxi driver, a pitchman, a shoe shine boy, an Italian flower hawker cause the record — and Schwartz's thesis — to flare into brilliant but fleeting life. However, too many of his examples never really get off the ground. Anyone who dotes on the sounds of New York will find ample *divertissement* here; others will find only a bit of curiosia that wears none too well.

Exchange is the product of some long distance tape-swapping between Schwartz and amateur tape enthusiasts all over the world. This record has unity and warmth, plus some excellent off-beat folk music. The listener also shares vicariously in a richly rewarding international camaraderie — something our empoisoned world could do with more of. *Exchange* is interesting, unusual, satisfying.

The accompanying booklet, while hand-

ROSALIND OPPENHEIM



Recordist Schwartz, friend to friendship.

some and thick, devotes a lot of space to Schwartz's methods of exchanging tape but precious little to the music contained on the record.

In the case of both disks, the sound quality varies. This is inevitable in field recording — particularly where tapes were made by different people, using different machines, and under different conditions. Schwartz provides the narration for both records.

CLASSICAL MUSIC OF INDIA

Nazir Ali Jairazbhoy; introduction by Richard Waterman.

FOLKWAYS FP 66. 12-in. \$6.45.

Last year the Department of Anthropology of the University of Washington offered — as part of a course in Non-Western Musics — a lecture-demonstration on Hindustani classical music by Nazir Ali Jairazbhoy. The present Folkways release is based upon that lecture-demonstration.

This record is intended for people who: (1) have a working knowledge of musical theory; (2) are interested in having the fundamentals of Hindustani music explained in Western frames of reference. Nazir's presentation is lucid and masterful. His beautifully played demonstrations on the *sitar* offer ready insights into difficult concepts.

The sound, save for a sometimes surface hiss, is better than average. The illustrated booklet that accompanies the record contains an introduction to Hindustani music by Richard Waterman that is an invaluable aid to understanding.

THE FAULSE LADYE

Andrew Rowan Summers, with dulcimer. FOLKWAYS FP 44. 10-in. \$4.75.

The Ballad of Mary Hamilton; The Faulse Lady; Willie of Hazel Green; O Waly, Waly; Billy Boy; The Two Sisters

Many a purist disapproves of Andrew Rowan Summers' delicate way with folk songs. But his light voice surrounds these ballads with a fragile aura harking back to the days of the troubadors. His dulcimer accompaniments add to the illusion.

With the exception of the lovely *Ballad of Mary Hamilton*, none of Mr. Summers selections is an exact stranger to the catalogue. In the final analysis, the desirability of this record probably hinges upon whether or not one likes the Summers approach.

The engineers acquit themselves well and Folkways supplies its usual excellent booklet containing texts and notes.

JACK OF DIAMONDS and other folk songs and blues

Brother John Sellers, folk singer; Sonny Terry, harmonica; Johnny Johns, guitar. VANGUARD VRS 7022. 10-in. \$3.95.

Jack of Diamonds; I Love You, Baby; Sally Go Round the Sunbine; Nobody Knows the Trouble I've Seen; I've Been Lonesome, I've Been Worried; Every Day I Have the Blues; When I've Been Drinking; Lonesome Road; Let Us Run; Great Day

Brother John Sellers is out of the South by way of Chicago, where he came under the influence of the great Mahalia Jackson. This influence is more manifest in *what* he sings rather than in *how* he sings it. For Sellers' way with a song is more relaxed than Mahalia's.

With this record, his debut on LP, Sellers enter a field where the competition is tough. But he is more than capable of holding his own. Witness his touching version of *Nobody Knows the Trouble I've Seen*.

Perhaps the outstanding characteristic of this disk is the accompaniment — which is really no accompaniment at all but rather a full-fledged collaboration by Sonny Terry's inspired harmonica and Johnny Johns' subtle guitar.

Engineering: excellent.

MAHALIA JACKSON: The World's Greatest Gospel Singer.

With the Falls-Jones Ensemble.
COLUMBIA CL 644. 12-in. \$3.95.

I'm Going to Live the Life I Sing About in My Song; When I Wake Up in Glory; Jesus Met the Woman at the Well; Oh Lord, is it I?; I Will Move on Up a Little Higher; When the Saints Go Marching In; Jesus; Out of the Depths; Walk Over God's Heaven; Keep Your Hand on the Plow; Didn't it Rain.

Mahalia Jackson's big, unfettered voice and emotional intensity make her just what this album title calls her — The World's Greatest Gospel Singer.

Gospel singing traces its origin back to the early negro spirituals, but structurally it has been shaped into a near-jazz style. Nothing can convey this more vividly than Mahalia's rocking rendition of *When the Saints Go Marching In*.

Like the old spirituals, today's Gospel songs are religion felt rather than celebrated; raw, naked religion crying out man's eternal desolation and his eternal hope.

The emotion of these songs is communicated immediately through Mahalia's free-swinging vocalization and burning sincerity of purpose. In fact, there is a kind of incandescence about the way she sings them.

The accompaniments of the Falls-Jones Ensemble are superb. George Avakian's album notes are literate and informative — a model of what record annotation should be, but so rarely is. Columbia's sound, equal to the best it has produced, is a worthy complement to the general excellence.

This is an outstanding release.

THE BEST OF JAZZ

by John S. Wilson

CHARLIE BARNET
Town Hall Jazz Concert

Rockin' in Rhythm; Tell Me, Tell Me, Dream Face; My Old Flame; Caravan; Andy's Boogie; Pompton Turnpike; Cherokee; Redskin Rhumba; Skyliner; East Side, West Side; Terry Tune; Things Ain't What They Used to Be; Hello Baby Blues; The Gal from Joe's; Barneology; Cornet Confab.

COLUMBIA CL 639. 12-in. \$3.95.

Charlie Barnet's bands have always had a kind of disheveled charm. They have frequently been bands of some distinction but almost invariably they have had undisciplined qualities. But even though the trumpets may have screamed at times and the reeds (particularly those operated by Barnet) may have squawked, the bands have always swung. In 1947, when this Town Hall concert was taped, Barnet had one of his best bands and this is a reasonably comprehensive summary of its work. There are numerous evidences of Barnet's fondness for Ellington; there are Barnet's own best known specialties (*Pompton Turnpike, Cherokee* and *Redskin Rhumba, Skyliner*); there is Bunny Briggs, the

dancer who has been used by Barnet for years as a vocalist; and there is the aural vaudeville that is apparently dear to Barnet's heart — the conversation between his soprano saxophone and the trumpet on *Pompton Turnpike* and the long instrumental dialogue called *Cornet Confab*. It is swinging big band jazz, played with zest, feeling, and some humor. The recording suffers somewhat from that diffuseness and variance of levels which is common to unplanned concert taping.

CHARLIE CHRISTIAN
With the Benny Goodman Sextet and Orchestra

Blues in B; Wholly Cats, Till Tom Special; Gone with "What" Wind; Breakfast Fend; Air Mail Special; Waitin' for Benny; A Smo-o-o-oth One; Seven Come Eleven; Six Appeal; Gone with What Draft; Solo Flight.

COLUMBIA CL 652. 12-in. \$3.95.

Although this disk is largely made up of reissues, it is worth special attention both because it contains at least two new selections and because of the special nature of Charlie Christian. Christian is a guitarist whose total career on the bigtime jazz scene covered less than two years (1939-41) yet in that time he established the electric guitar as a jazz instrument and laid the groundwork on which post-swing jazz has been built. Christian's two influential years were spent with Benny Goodman's orchestra and, though he had ample opportunity to show his ability in Goodman's small groups, he found them confining, an inadequate means of expression for the music he wanted to play. His most typical work was done in the relaxed atmosphere of after hours joints where he was heard by other musicians but rarely by recording equipment. Some of this playing was taken down on a portable machine and has been issued by Esoteric Records (Esoteric 1 and 4) but the recording is discouragingly poor.

On this disk, two more of these rare instances of Christian unfettered are made available. They were made in a recording studio while members of Goodman's sextet were waiting for a session to start. The musicians were warming up and, fortunately, the record of that warmup session was kept. There is nothing that could be formally called balance. Christian starts playing and as he develops ideas other musicians, who have been noodling around in the far background, move in. The section of this ad lib session which is called *Waitin' for Benny* develops a theme which provided the basis for *A Smo-o-o-oth One*, which follows on the succeeding band. The limitations against which Christian chafed in the Goodman sextet are illustrated vividly by the comparison of the stiff, formal, and rather flat performance of *A Smo-o-o-oth One* with Christian's original expression of the theme in the impromptu session. It must be assumed that this selection by the Goodman Sextet was included simply to make this point for it is the least interesting of the reissued selections. Most of the rest are recognized small group classics.

This was — and still is — satisfying and exciting jazz, made none the less so by the

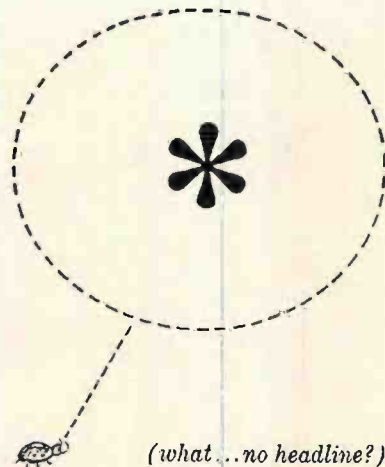

Here are two Vox De Luxe albums — rare in content, rare in form. We would no more try to tell their story in some neat little headline than we would define music or high fidelity in four words.

These albums are not for everybody...but they will be the most important additions to the collections of certain cognoscenti.

**VIVALDI:**

IL CIMENTO DELL' ARMONIA E DELL' INVENZIONE, OP. 8 (including the FOUR SEASONS) 12 VIOLIN CONCERTOS. Illustrated booklet by Dr. J. Braunstein, Music Div., N. Y. Public Library.

Reinhold Barchet, violin — Pro Musica String Orchestra, Stuttgart—Rolf Reinhardt, conductor ... 3-12" DL 173

**THIS IS HIGH FIDELITY**

(A Guide To Sound Listening) Written and produced by Tyler Turner. Lucidly narrated by Art Hannes. See HI-FI illustrated and diagrammed — read a detailed analysis — hear it demonstrated with effects that will astonish you. DL 130

for sound reasons—

VOX® Ultra High Fidelity
236 WEST 55TH ST.
NEW YORK 19, N. Y.

current realization that it is jazz of high historic significance.

KENNY CLARKE

Walter Benton, tenor saxophone; Frank Morgan, alto saxophone; Gerald Wiggins, piano; Milt Jackson, vibes; Percy Heath, bass; Kenny Clarke, drums.

Strollin'; *Sonor*; *Blues Mood*; *Skoot*.

SAVOY MG 15051. 10-in. \$3.85.

MILES DAVIS ALL STARS, VOL. 1

Miles Davis, trumpeter; Thelonious Monk, piano; Milt Jackson, vibes; Percy Heath, bass; Kenny Clarke, drums.

Bags' Groove; *Swing Spring*.

PRESTIGE LP 196. 10-in. \$3.85.

These two disks are of interest largely because they are built around three-quarters of the eminent Modern Jazz Quartet—Jackson, Heath, and Clarke. The performances are, on the whole, pleasant and unpretentious but lacking in any compelling interest. The additional associates brought along by the MJQ threesome for these recordings are of little help, except for Thelonious Monk whose curiously detached manner of playing—as though he were contemplatively flipping over the piano keys to see if there were any bugs under them—has an amusing enchantment. What there is of interest here is provided by the three core men, with Jackson in consistently good form on his solo appearances. The absence of John Lewis, fourth man in the MJQ, and the absence here of the kind of provocative originality which is usually found in the Quartet's work, suggests that the connection between that originality and Lewis is extremely close. The recording on both disks is good although there is some surface noise on the Savoy which is also atrociously short: its overall total of seventeen minutes might have been placed on a single ten-inch LP side.

BILLIE HOLIDAY

At Jazz at the Philharmonic

Billie Holiday, vocals; Joe Guy, trumpeter; Willie Smith, alto saxophone; Milt Raskin, piano; Red Callender, bass; Dave Coleman, drums.

Body and Soul; *Strange Fruit*; *Travelin' Light*; *He's Funny That Way*; *The Man I Love*; *Gee Baby Ain't I Good to You*; *All of Me*; *Billie's Blues*.

CLEF MG C-169. 10-in. \$3.98.

These numbers, recorded at a concert in 1946, are of special interest because you seldom get Billie Holiday records like this anymore. At that time she still had much of her youthful voice at her command along with the knowing wiles which she picked up along the way in a decade of singing. It was, as one might judge from these performances, the beginning of her transition period for she sings—really sings—on most of the numbers but on the occasions when the voice doesn't quite make it the wiles come into play to carry her through, as they do still. The tunes are from the top drawer of her repertoire and her execution of them, particularly the last four, are in her best tradition. Considering the date of the recording and the circumstances



WILLIAM CLAXTON

Gerry Mulligan: a case of quiet growth.

under which it was done, this is a very good job. The rather unbalanced accompaniment sounds thin and there are occasional echoes, but Miss Holiday is recorded in general with depth and reasonable range although now and then she is made unbecomingly shrill.

LONDON BROIL

Johnny Dankworth and his orchestra: *'S Wonderful*; *Younger Every Day*.

Jack Parnell and his orchestra: *April in Paris*; *Sure Thing*.

Freddy Randall and his band: *Carolina in the Morning*; *At the Jazz Band Ball*.

Kenny Baker Quartet: *Peg o' My Heart*; *Stompin' at the Savoy*.

ANGEL 60004. 10-in. \$2.98.

The subtitle on the liner is more apt than the title: "Mixed Grill." In essence, this is a British sampler. Big bands, small groups, dixie, swing, and modern are all represented and adherents of none can have much ground for complaint. Capable is the word in general with the higher reaches of capability being demonstrated by Jack Parnell's *April in Paris*, a subdued production number which achieves a particularly rich, lush tonal coloring and Freddy Randall's Dixieland group which gets a lot of lighthearted spirit into *Carolina in the Morning*. This number, incidentally, contains one of the few really good tenor saxophone solos recorded by a girl—Betty Smith. Kenny Baker's rough trumpeter tone and Johnny Dankworth's highly skilled alto are shown off to their own advantage but the material surrounding them is on another level. The recording is strikingly good and is quite consistent, a remarkable feat in view of the fact that at least four different sessions are involved.

STUART MCKAY AND HIS WOODS Reap the Wild Winds

Stuart McKay, Ernest Victor Mauro, Jerry Sanfine, Tom Mace, saxophones, bassoon, oboe, English horn, flute; Albert Richman, John Burrows, French horn, John Saunders, piano; John Porcello, guitar; Bill Halfacre,

bass; Ted Paskert, drums; Suzanne Lovell, voice.

Those That Live by the Swordfish Die by the Swordfish; *A Foggy Day*; *Ode to a Mode*; *When Your Lover Has Gone*; *Take Me Out to the Ball Game*; *Newton the Fig*; *Song of the Bayou*; *Three Speeds Forward*; *You're Just a Cucumber*; *Fagotte Gavotte*; *Aren't You Glad You Came*; *What a Way to Run a Railroad*.

VICTOR LJM 1021. 12-in. \$3.98.

Don't be thrown off by the more unfortunate titles in the listing above. These are delightfully swinging performances by a woodwind group which has, in its small group way, some of the characteristics of the Sauter-Finegan band. There is a light touch about everything McKay's group rackles and there is the constant promise of the unexpected in its approach. The voicing, of course, provides a fresh sound but this sound is used in a variety of ways—blended with Suzanne Lovell's wordless voice on *When Your Lover Has Gone* and the wonderfully swampy *Song of the Bayou*, in brisk ensemble work on *Take Me Out to the Ball Game* (which achieves what must be the highest and driest ending ever recorded) and *What a Way to Run a Railroad* and as background for McKay's virtuoso bassooning on *Fagotte Gavotte* and *Ode to a Mode*. The ensembles are easy, graceful, and propulsive and the playing is consistently clean and crisp. The group has been recorded excellently, with wide range and precise definition.

GERRY MULLIGAN

California Concerts

Gerry Mulligan, baritone saxophone and piano; Jon Eardley, trumpet; Red Mitchell, bass; Chico Hamilton, drums.

Blues Going Up; *Little Girl Blue*; *Piano Blues*; *Yardbird Suite*.

Add Zoot Sims, tenor saxophone; Bob Brookmeyer, valve trombone and piano; Larry Bunker, drums, in place of Hamilton. *Western Reunion*; *I Know, Don't You Know*; *The Red Door*.

PACIFIC JAZZ PJ 1201. 12-in. \$4.85.

Gerry Mulligan is continuing to grow as a jazz musician. His playing at the two concerts recorded on this disk (Stockton, Calif., Nov. 12, 1954, and San Diego, Dec. 15, 1954) has, on one hand, the assurance and polish that one expects of a mature musician plus the exciting creativity that is one of the hallmarks of the great jazzman. In his quiet, insinuating way (and using an instrument that is by nature neither quiet nor insinuating) he is far and away the dominant figure in both the Quartet and Sextet heard on this disk. Even when he takes to the piano, on *Piano Blues*, he doesn't fall into a stereotype of either a modern pianist or a blues pianist. His piano blues style is rugged, leavened with a sprinkling of more highly developed ideas than a blues pianist would be apt to undertake.

The quartet he uses on this occasion, one which has never been recorded before, produces the most consistently satisfying group of numbers that Mulligan has put on a single disk, despite some uncertainty on the part of Jon Eardley, the trumpeter man. When Zoot Sims and Bob Brook-

they join the ensemble, they add solo variety but dispel much of the generic Mulligan feeling. For a concert performance, this disk has a great deal of presence. The balance indicates considerable care in setting up for both audience and tape.

TURK MURPHY'S JAZZ BAND

Dancing Jazz

Turk Murphy, trombone; Everett Farey, cornet; Bob Helm, clarinet; Wally Rose, piano; Bob Short, tuba; Al Lyons, washboard; Bob Thompson, washboard. *South; Hard Hearted Hannah; Doctor Jazz; Jazzin' Babies Blues; Hula Lou; Sunset Cafe Stomp; Charleston; Red Hot Mama; See See Rider; Oriental Strut; Sadie Green, the Vamp of New Orleans; Coney Island Washboard.*

COLUMBIA CL 650. 12-in. \$3.95.

When Turk Murphy's band really gets rolling on a spirited tune, it is capable of producing delightful jazz. Murphy has found the right material in several of the numbers on this disk — *Charleston, Red Hot Mama* and *Sunset Cafe Stomp*. But he's even better this time when he broods down into the blues — *Jazzin' Babies Blues* and especially *See See Rider* are moving performances. Unlike some of his recent records, Murphy uses a cornet lead throughout this disk (he had been doing without cornet or trumpet quite often in the past). Everett Farey's well-played lead provides a focal point which the Murphy band has sometimes lacked on other occasions and fills out ensembles that are otherwise too thin or too dependent on the grotesque tone of Murphy's trombone. The vocals by Murphy and Bob Helm are still on the parlor performance level but when the blend of vocal and instrumental spirits is right, it all seems perfectly becoming. The band has been admirably recorded with a balance that is exceptional for a group of this type.

JIMMY RUSHING SINGS THE BLUES

Jimmy Rushing, vocals; Pat Jenkins, trumpet; Henderson Chambers, trombone; Buddy Tate, tenor saxophone; Ben Richardson, alto saxophone and clarinet; Sam Price, piano; Walter Page, bass; Jo Jones, drums. *How Long; Boogie Woogie; How You Want Your Lovin' Done; Goin' to Chicago; I Want a Little Girl; Leave Me; Sent for You Yesterday.*

VANGUARD VRS 8011. 10-in. \$3.95.

One side of this release, at least, is just about the best display of vocal blues put on a disk since recording equipment got modern. Jimmy Rushing's parlay of *How Long, Boogie Woogie* and *How You Want Your Lovin' Done* marks a peak in his recording career — he has scope and variety such as he was rarely permitted during his many years with Count Basie's band, he has some remarkably sensitive accompaniment and he is given better recording than he has ever had before. Rushing's voice is aging and it grows a little hoarse when he tries to push it too hard but it still has that wonderful surge that has always characterized his reading of a blues lyric. On *How Long* he gives what might be considered a definitive performance of relaxed yet potent blues shouting with the

highly effective help of Sam Price's piano. The last four numbers lack the impact of the others and there are times on them when the accompanying band pushes Rushing's voice into the background. The disk stands, and stands firmly, on the first three numbers.

TONY SCOTT SEPTET

Scott's Fling

Tony Scott, clarinet; Jimmy Nottingham, trumpet; Eddie Wasserman, tenor saxophone; Danny Bank, baritone saxophone; Billy Byers, trombone; Milt Hinton, bass; Osie Johnson, drums.

Forty-Second Street; But Not for Me; Sunday Scene; Requiem for "Lips"; Lucky to Be Me; Fingerpoppin' Blues; Abstraction No. 1: Autumn Nocturne; Three Short Dances for Solo Clarinet; Glad to Be Unhappy; Our Love Is Here to Stay; Let My Fingers Go!

VICTOR LJM 1022. 12-in. \$3.98.

Tony Scott, who has been on his way for many years, finally arrives — on records — with this disk. During these years, Scott has been evolving a personal style which often eluded him, leaving him hung between safe, known ground for the clarinet and the higher reaches for which he was aiming. He has been recorded in the past during some of these moments in limbo and he has often sounded as though he were squirming his way through some vague torture chamber.

But here, one gathers, is what he was after. It is, almost inevitably, a form of fulfilled simplicity, a rich, firm tone which spreads so shapelessly in any direction that it might be an arm without bones. His playing throughout this disk is utterly engrossing and completely unique. A good thing, too, for the other frontline men, with the exception of Danny Bank, are not overly inspired and many of the arrangements are slightly earthbound. Scott, however, is not. He brightens an otherwise drab *Forty-Second Street*, plays a touching and melodic *Requiem for "Lips"* (Hot Lips Page) and creates a beautifully soft and delicate conception of *Autumn Nocturne*. He also allows himself two unaccompanied and essentially non-jazz solos — *Abstraction No. 1* and *Three Short Dances for Solo Clarinet* — which are fascinating little exercises. The recording is polished but at times a little over bright.

KAI WINDING AND J. J. JOHNSON

Kai Winding, J. J. Johnson, trombones; Dick Katz, piano; Milt Hinton, Wendell Marshall, bass; Al Harewood, drums. *Out of This World; Thou Swell; Lover; Lope City; Stolen Bass; It's All Right with Me; Mad About the Boy; Yes Sir, That's My Baby; That's How I Feel About You; Gong Rock.*

BETHLEHEM BCP 13. 12-in. \$4.85.

This is the third LP by Winding and Johnson, all released within a couple of months, and their third label. Just as their second disk showed improvement over their first, this offering is still better. The recording in this case is also the best they have received so far, giving depth and fullness to the rich sound of their swinging

duets. Together, these two men have a strong, brash, moving quality. Their individual solos remain a matter of *chacun à son gout* — as a rule, I find their mannered pattering tedious. But when they are working within the restraints required for a joint effort, their playing takes on a completely different texture and they produce a very basic and very genuine jazz feeling. On these numbers they are helped by some especially fine piano spots by Dick Katz. Johnson arranged the selections on one side of this disk, Winding did those on the other. Winding's ideas seem the most varied. They include *It's All Right with Me*, a ruggedly swinging thing, an inventive ballad approach to *Mad About the Boy*, humor (no less) on *Yes Sir, That's My Baby* and some amusing excursions on *Gong Rock*.

THE CREATIVE TEDDY WILSON

Teddy Wilson, piano; Milt Hinton, bass; Jo Jones, drums.

Blues for the Oldest Profession; It Had to Be You; You Took Advantage of Me; Three Little Words; If I Had You; Who's Sorry Now; The Birth of the Blues; When Your Lover Has Gone; Moonlight on the Ganges; April in Paris; Hallelujah; Get Out of Town.

NORGRAN MG N-1019. 12-in. \$4.98.

Teddy Wilson's piano playing is one of the most consistent elements in jazz; yet he can, as he has lately, go through fairly long periods without recording anything that seems to be properly representative of him. On this disk, for a change, he is



FREE!

WHAT IS HI-FI?

A journey behind the scenes with Kurt List, Westminster's musical director, describes high fidelity and the making of high fidelity records. Informative, interesting, of permanent value to every record buyer. For your free copy, send a card to:

WESTMINSTER RECORDS
DEPT. HF
275 Seventh Ave., New York 1, N. Y.

quite his usual ingratiating self. His playing is intelligent, well considered and warm. He swings in that casual, effortless way he has, skirting the edges of cocktail piano yet always playing with strength and perception. These tunes are well fitted to him and so is his accompaniment, particularly bassist Hinton. The recording is good.

THE MUSIC BETWEEN

by Robert Kotlowitz

CRAZY OTTO

Glad Rag Doll; Beautiful Ohio; My Melancholy Baby; Red Sails in the Sunset; In the Mood; Smiles; Rose of Washington Square; S-b-i-n-e; Paddlin' Madelin' Home; Lights Out.

DECCA DL 8113. 12-in. \$3.98.

Crazy Otto's real name is Fritz Schulz-Reichel and under that impressive title he is known in Germany as a serious composer-pianist. As Crazy Otto, he made a few experiments with unusual sounds several years ago and came up with the "Topsy Wire Box," the instrument he plays on this record. The T. W. B., which is not much of a revelation, duplicates exactly the tinny, off-pitch quality of an ill-kept player-piano; it's been heard before under other names. Crazy Otto's playing is pretty much beer-hall oom-pa at its least attractive and it doesn't vary a jot from one tune to the next. His novelties, accompanied by a rhythm group and occasional vocal horseplay, were recorded by Deutsche Grammophon-Polydor. There are times when Crazy Otto seems to be playing smack in the middle of your living-room.

CYMBALOM MELODIES

Two Guitars; Romans and Kolo; Two Csardas; Two Dances; Rakoczy March; Lavolta Szerelme — Hüllamzo Balaton; Third Man Theme; Doina; Roses from the South; Levelem Jott a Falubol.

Lojzi Balogh, cymbalom.

PERIOD SPL 1014. 10-in. \$3.98.

The cymbalom — to risk offering some elementary information you're probably familiar with already — is an active member of the dulcimer-string family, and it is used mainly by Hungarian gypsies, who depend upon it for a great deal of their music and play it with great expressiveness. Unlike the zither, which it resembles in many other respects, the cymbalom is struck when played. It produces far more satisfying and interesting sounds than most instruments in its family. Lojzi Balogh, who is a Hungarian gypsy himself, plays the cymbalom with amazing virtuosity and can range between such disparate items as *Two Guitars*, the *Rakoczy March*, and *Roses from the South* with admirable ease. His instrument, of course, is limited both in range and appeal, but Mr. Balogh gets everything out of it he can.

HOUSE OF FLOWERS

House of Flowers; I'm Gonna Leave Off Wearing My Shoes; Waitin'; Slide, Boy, Slide; Don't Like Goodbyes; Two Ladies in De Shade of De

Banana Tree; One Man Ain't Quite Enough; I Never Has Seen Snow; What Is a Friend For?; A Sleepin' Bee; Mardi Gras Waltz; Smellin' of Vanilla.

Percy Faith and His Orchestra.

COLUMBIA CL 640. 12-in. \$3.95.

There are lovely things in Harold Arlen's score for *House of Flowers*, among them several languid and nostalgic ballads. The good things have an attractive musical character of their own, as all of Arlen's best creations have; the lesser will pass muster if they're not examined too closely. Percy Faith has got them all together in this new Columbia album and given them equal attention, regardless of quality. The orchestrations are remarkably lush, even by Mr. Faith's celebrated standards, and they tend after a while to make almost all the tunes sound alike. Columbia has provided big, resounding engineering.

LOMBARDOLAND, U. S. A.

Deep in the Heart of Texas; Poor Little Rhode Island; Give Me the Moon Over Brooklyn; Stars Fell on Alabama; Carolina Moon; Beautiful Ohio; Chicago; Tennessee Waltz; Somewhere in Old Wyoming; Florida; Way Down Yonder in New Orleans; California, Here I Come; St. Louis Blues; Moonlight on the Colorado.

Guy Lombardo and his Royal Canadians.

DECCA DL 8097. 12-in. \$3.98.

Governments crumble, stock markers crash, the whole world — as we all know — slowly goes to pot, but Guy Lombardo and his Canadians continue to play, if not the sweetest music this side of heaven, surely the squarest. The outfit opened at the Hotel Roosevelt back in 1929 and it's still there today, sounding exactly as it did at its debut. Surely no popular musical organization with less propensity for change has ever kept — and kept tight — its audience for so long. For that audience (which is enormous) *Lombardoland* offers a rich treasure in the form of a musical tour around the United States, and it's accompanied every step of the way by big, well-balanced sound.

THE SPOKEN WORD

MARIVAUX

Les Fausses Confidences

Madeleine Renaud, Araminte; Simone Valère, Marthon; Marie-Hélène Dasté, Mme. Argante; Jean-Louis Barrault, Dubois; Pierre Bertin, M. Remi; J. P. Granval, Arlequin; Jean Deshailly, Dorante; Régis Oudin, Le Comte; J. F. Calvé, Un Garçon; Jacques Galland, Un Domestique.

LONDON INTERNATIONAL TW 91042. Two 12-in. \$9.96.

Although he was born in 1688, Pierre Marivaux came to full prominence relatively well along in life; it was 1737, and Louis XV (the one whose Pompadour gets credit for having said, quite presciently, "*Après nous, le déluge*") was well settled on the throne when the *Comédiens Italiens* gave the first performance of his most famous comedy, *Les Fausses Confidences*. Both the comedy and the literary reputation of its author were too much of their own

time to stand up very well in the times that followed, and it has actually been only in the few years since Jean-Louis Barrault and his wife, Madeleine Renaud, broke away from the *Comédie* to form their own company that Marivaux has come back into the best odor. It is not too hard to see why, because, for all its charm, *Les Fausses Confidences* is not a play that would stand much inconsiderate treatment on either side of the footlights. Not a *commedia* in spite of its first auspices (although Arlequin is in and about), it is a kind of play that has no real parallel in English — an elaborately and delicately contrived comedy of sentiment and situation, with situation providing the framework, and the excuse, for everyone to analyse the sentiment in speeches as graceful and elegant and artificial as the age in which they were written. Samuel Richardson has been called, not quite rightly, the English Marivaux; the closest anyone has come to capturing Marivaux himself and binding him to an analogy has been to speak of his writing in terms of the paintings of Watteau. The world of *Les Fausses Confidences* is not a real one, but the viewpoint is so consistent that — given a performance of great style — it can charm us into believing (almost) that it is. The performance, "realized" without too much damage from the acting version given a couple of years ago in New York by the same company, is magnificent in all regards; there can be no more beautiful language than French when it is spoken with such style. Engineering: Very good. No text at all, and notes that are appreciative rather than useful. However, very highly recommended. J. H., Jr.

VICTOR BORGE

Caught in The Act

COLUMBIA CL 646. 12-in. \$3.95.

On October 2, 1953, pianist, comedian and farmer (he raises Rock Cornish pullets on his Connecticut farm) Victor Borge opened at the John Golden Theater in New York for what he announced to be a "limited engagement." As far as I know he is still there and it is beginning to look as if he will go right on until (1) someone (mentioning no names) drops an A-, H-, or C-bomb on Manhattan (2) the John Golden burns down or (3) they carry Mr. Borge off the stage in a stretcher — probably still spitting out commas and periods.

According to a lengthy profile by Geoffrey Hellman in the *New Yorker* last month, Borge's show, "Comedy in Music," has broken all records for one-man-stands. It has grossed over \$1.5 million. Alongside that kind of money, what Mr. Borge stands to make off this record is peanuts — Borge is as businesslike as he is funnylike and he will certainly not object.

"Caught in the Act," like the preceding but don't let that deter you from buying it. Borge record, is made up of a series of typical Borge skits such as *A Mozart Opera*; *Family Background*; and the usual indignant exchange with the audience over request numbers. Personally, I do not believe it is quite as funny as the first record — except for one thing: his phonetic system of punctuation which is included in "Caught in the Act." That, of course, is Borge's classic — a system of punctuation using phonetic sounds for

commas, periods, question marks, exclamation points, etc. It is worth the price of the record swiss, puppr (vertically) — a phonetic exclamation point(!) R. H. H., Jr.

L'ESPRIT DE PARIS

Pensées de Sacha Guitry et des Autres

Sacha Guitry.

LONDON LL 899. 12-in. \$3.98.

On the jacket, this record is described as being "indispensable to those interested in the French Theater and to the collector in search of a truly unique souvenir of this amazing man." The statement is rather misleading: the record, while certainly unique is not quite "indispensable"; its interest, on the other hand is not as limited as is implied. More people than just students of the French Theater and collectors of Guitryana should find it of sufficient interest to be included in their record libraries.

On side one, Sacha Guitry combines wit with philosophy to give his impressions (in French) of a number of things, among which are included the theater, Paris, women, and love. These impressions are dispensed with such grace and charm, and in such a civilized manner, that the listener, is not always in complete agreement with the sentiments expressed, is usually delighted by them. Side two of the record is not quite such an unalloyed success despite a very convincing introduction by Guitry. Entitled "*Pensées des Autres*," the second side is devoted to one-line quotations from the works of authors of such diverse talents as Montaigne, Oscar Wilde, la Rochefoucauld, Goethe, Carlyle, Mark Twain, and Voltaire. Each of these quotations taken individually is a miniature gem of literary facility: taken all together, some of the effect is lost through one's not being able to see the trees for the forest.

FRANK WRIGHT

MAURICE EVANS READS SHAKESPEARE

Hamlet — six excerpts.

Richard II — three excerpts.

COLUMBIA-ENTRE RL 3107. 12-in. \$2.98.

It was in *Hamlet* and *Richard II* that Maurice Evans established himself in the eyes of many critics as the finest Shakespearean actor since Edwin Booth. It is not surprising that the dramatic mantles of the Prince Denmark and the Second King Richard should fit well one man. They are both sensitive, poetic and tragic characters, noble but lacking the power of decisive action. These essential qualities are beautifully unfolded by Maurice Evans in nine well recorded excerpts.

The excerpts are, from *Hamlet*:

I, ii: soliloquy "O that this too solid flesh would melt."

I, v: scene with father and soliloquy "O all you host of heaven."

II, ii: soliloquy, "O what a rogue and peasant slave am I."

III, i: soliloquy, "To be, or not to be."

III, ii: Instructions to players, "Speak the speech I pray you."

IV, iv: soliloquy, "How all occasions do inform against me."

From *Richard II*:

III, i: "Landing Scene"

III, iii: "In Wales"

V, v: "In Prison"

R. H. H., Jr.

ROMEO AND JULIET

William Shakespeare

Scenes From the J. Arthur Rank Film.

EPIC LC 3126. 12-in. \$3.98.

This is an altogether unsatisfactory and annoying record. Most annoying is the fact that in order to reduce *Romeo* to one-disk size, it has been horribly truncated. Not only are many scenes omitted (included are: I, i; I, v; II, ii; II, v; II, vi; III, v; IV, iii; IV, iv; IV, v; V, i; V, iii) but the scenes themselves have been stripped to bare essentials. The result is a performance that is neither satisfactory as a sense-making story (although it can be followed by paying close attention to the jacket notes) or valuable as a dramatic study as are the customary "Excerpts From ..."

The sound is poor, even by film-track standards. The individual performers are quite good, but restricted as they are here they do little more than act out "Coming Attractions" for the J. Arthur Rank film on which the record is based and which, incidentally, won the 1954 Grand Prize at the Venice Film Festival. R. H. H., Jr.



HEAR the actual sounds of

EARTHQUAKE TREMORS*

A first recording — on LP

Shock waves of major & minor quakes from

Madagascar, Hawaii,

California, Mexico

as received by

tape-recording seismometer

*with cooperation of Dr. Hugo Benioff, CalTech Seismology Laboratory

IONOSPHERIC

swishes, whistlers,

tweaks; the dawn chorus

Unexplained audio disturbances

50 to over 7,000 miles

above the earth.

From recorded data collected & narrated by Prof. Millett Morgan, Dartmouth College

First Recording Ever Available

Provocative Listening from recent research

12" High Fidelity LP (#5012)

33-1/3 rpm only

At your dealer or

send \$4.80 to

COOK Laboratories

Y 101 Second St., Stamford, Conn.

Please send free information on "OUT OF THIS WORLD" to:

\$2.00 Boner on Henry
Last issue in our review of the new Riverside record, **HERE'S MORGAN**, we gave the price as \$5.95. The correct price is \$3.98.



PREPARE NOW FOR SUMMER MILDEW
Prevent mildew on your records during the Summer months by applying QUIET to them now!

FOR COMPLETE RECORD CARE
QUIET is a special liquid preparation for the complete care and preservation of phonograph records.

QUIET prevents static.
QUIET lubricates and protects the grooves.
QUIET retards needle wear.

CONTAINS NO SOLVENTS

QUIET is harmless to records, skin and furniture.

QUIET provides complete record care.

5 oz. plastic container of liquid QUIET, sponge applicator, applicator case, instructions, information on record care, and complete laboratory test data — \$2.00 postpaid.

Pat. pending

BEYLAND ENGINEERING CO.
YALESVILLE CONNECTICUT



Frédéric Chopin

by Harold Schonberg

AN ESSAY about Chopin and his place in music is not needed. Some remarks about Chopin-playing are more in order. Chopin has not slipped from his high position on the concert stage; his music is very much with us and shows no signs of fading. At the same time, there is no doubt that a certain tradition of Chopin-playing is disappearing. Our younger virtuosos, a hardy breed with steel fingers (and, one often suspects, souls), can spatter the notes of Prokofiev's Third Concerto with the force and fluency of raindrops from an industrious tornado. When they come to a simple Chopin mazurka they seem nonplused. In a way their difficulty is understandable. It is hard to do precision work when you wear boxing gloves.

Now, the older school of Romantic pianists, from Chopin himself on to Artur Schnabel and Guiomar Novaes of our own day, was as rugged a group of individualists as existed anywhere. There was De Pachmann, with his exquisite tracteries (and mannered eccentricity); and Anton Rubinstein, with his thunderous volleys of tone; and in between there was every conceivable shade of musical approach and philosophy.

But at least three things all these pianists had in common—a singing tone, a flowing legato, and a natural rubato. Hofmann could rear up and smite the keyboard, sometimes actually with the flat of his hand. Yet he never lost tone. And he, like all the great pianists of his day, could take a phrase and connect its individual notes so that they flowed together in a melting, logical sequence. Fingers, pedals, heart, and brain—all worked together.

The deficiency in legato playing of many of today's younger players strongly militates against their success as Chopinzees (so Huneker once described the species). Nor do they seem to be interested in experimenting with the tonal resources of the piano, its potentialities for color. Some of them seem afraid of the pedals, touching them gingerly as if a healthy charge of electricity were surging through the appendages. One wonders how they practice. It was evident, when a great Romantic pianist played Chopin, that he had spent hours upon endless hours studying not only the notes but—much more important—what was beyond the notes. He experimented with inner voices,

with accentuations, with varying finger weights, with contrasts of dynamics. It was all very personal; and yet what came out was always (well, nearly always) implicit in the music, free for all to discover.

Perhaps our present-day musical stringency is an inhibiting factor against the young pianist. He has been taught to respect the wishes of the composer. Well and good; but only too often that respect manifests itself in a cold, too-literal exposition of the notes. Accuracy is a wonderful thing; but let's make sure we are aiming at the right target. The only musical target worth shooting for is a re-creation, not a blueprint. Anyway, there never was a composer who did not expect the performer to add something of his own. What to add? That, of course, depends upon the taste of the performer and his identification with a specific style. (Listen to Landowska's Bach for a concrete example.) Some have said that our younger pianists lack identification with the Romantic school because they are children of a neurotic age and reflect that age. Perhaps there is some truth in the statement, though it seems too easy and pat. Anything, these days, can be explained away in psychiatric jargon. I myself put most of the blame on the teaching. Young recitalists, many of them from some of the most respected conservatories in the world, come before the public with appalling notions about music, and with an equally appalling lack of intellectual curiosity about it. And how seldom does one come across a young pianist who communicates any real joy in making music!

It also is very rare that one hears a convincing rubato from a young pianist; and rubato is the essence of Chopin. Much misleading nonsense has been written about the term. In some early editions of *Grove's*, Fuller-Maitland stated that rubato "is allowed in the works of all the modern Romantic masters, from Weber downwards, with the single exception of Mendelssohn . . . In the case of the older masters it is entirely and unconditionally inadmissible, and it may be doubted whether it should be introduced in Beethoven."

Fuller-Maitland could not have been more in error. Obviously he was unacquainted with the letter that Mozart wrote to his family, in which he describes the tempo rubato

and how he employed it. Even before Mozart was born, C. P. E. Bach was writing about rubato; and he also had the final word to say about it: ". . . Practice alone will not be of help here, for without a fitting sensitivity, no amount of pains will succeed in contriving a correct rubato . . . Most keyboard works contain rubato passages."

Rubato is a variation in tempo or rhythm that adds tension to a melodic line without distorting it. It should not *ever* involve actual alteration of note values (though that is what so often happens when bad taste goes to work on Chopin). Nor should it involve metrical shifts. The basic meter must always be present; it is the rhythm that may fluctuate. "Do you see those trees?" said Liszt. "The wind plays in the leaves, life unfolds and develops beneath them, but the tree remains the same. That is the Chopin rubato."

No composer, from Bach to Poulenc, wants his music played in a rigid, metronomic manner. He wants delicate shifts and adjustments, always expressed in proportional relationships. Thus, in a waltz, the second beat may be held a trifle longer, but the idea of waltz meter should never be lost. Or you can bend a measure so that it takes off at a slightly different tangent from the preceding ones, but the individual notes in that measure continue to bear the same relationship to each other. An eighth note will remain an eighth note, not turn into a dotted eighth.

Old C. P. E. Bach was right. Rubato cannot be taught. It must be felt. A calculated rubato, one that proceeds from superimposed instruction, will either be eccentric or will develop into positive musical anarchy.

Next comes the consideration of technique; and technique is a *sine qua non* of Chopin playing. Name any great Chopin pianist, and you name a great technician. For, after all, Chopin composed some of the most difficult music in the repertoire, and you can no more play it without technique to burn than you can tear down the Empire State Building with a toothpick. You may have the greatest musical instinct since Orpheus—but what good is it if you can't play the notes? If I seem to be belaboring the point, it is because the old cliché that "technique is merely a means to an end, not the end itself" is a half truth that has done considerable harm.

Of course there are additional prerequisites to great Chopin-playing—poetry, color, flexibility, spontaneity, force, and passion when needed. Chopin, though he may have worked in small forms, was a major musical thinker and innovator—a revolutionary in his days; a seminal force of the nineteenth century from whom (as Gerald Abraham points out in *Chopin's Musical Style*) most of his successors were not ashamed to borrow. Chopin, more than Liszt, more than anybody, *was* the piano, and in addition he was a genius who altered the entire musical vocabulary

of his age. He himself was a paradox—a weak, tubercular man, precious, something of a dandy, with a precise mind but a narrow frame of aesthetic reference. He knew next to nothing about the other arts and was mostly out of sympathy with the Romantic movement of his day (he disliked the music of Berlioz and Schumann; showed no liking for the paintings of his good friend, Delacroix). Yet within him was a seething rebellion that often expressed itself in outbursts of explosive force and made him one of the great Romantics, willy-nilly. "Cannon buried in flowers," said Schumann of the music of this composer.

THE FOLLOWING Chopin discography is the most comprehensive attempted since the introduction of the long-playing record. It is substantially, though not 100-percent, complete. Some disks are not worth consideration, such as the (you should pardon the expression) Liberace excursus into Chopin, or the multi-digitated work of the First Piano Quartet. A few peripheral pianists of the peripheral companies have been omitted.

For the most part the discography follows the form previously established in these pages. Some bibliographical problems have come up. The two major catalogues—Schwann and The Long Player—do not pretend to break down the Chopin recordings. Schwann lists but two of the six versions of the F minor Fantasy. The Long Player lists three versions of the Barcarolle; Schwann, two. Yet there are at least seven. When it comes to individual études, waltzes, mazurkas, nocturnes, both catalogues give up. So does this discography—up to a point. It would be impossible to attempt a breakdown, work by work, of every individual Chopin recording; he composed too many short pieces. The only feasible solution was to deal individually with major Chopin recordings, and to lump together (in their respective categories) disks that contain Chopin excerpts. Thus an LP containing, say, three waltzes, two preludes, and a nocturne, will be mentioned under Waltzes (Individual), Preludes (Individual), and Nocturnes (Individual). Some disks contain a large number of mazurkas; for these, there is an entry named Mazurkas (Collections). It would be a waste of space to list fifty-odd mazurkas individually. On the other hand, categories like the ballades and schetzos (only four each in number) can be so handled.

Reference will be found below to a Columbia disk played by Josef Hofmann. This disk is not yet available but it should be, in a few months. I have listened to the test pressings and, since they contain magnificent examples of Chopin playing (they were recorded at Hofmann's fiftieth anniversary concert, at the Metropolitan Opera House, November 28, 1937), I have included them in the discography.

ANDANTE SPIANATO AND POLONAISE,
FOR PIANO AND ORCHESTRA, OP. 22
(2 Editions)

A frequent concert-hall visitor in its solo piano form, this brilliant and effective work is seldom heard in its original scoring as a composition for piano and orchestra. The only version of the two available disks worth much consideration is the Frugoni. Vox never should have released the inept

Reinhardt performance, which bumbles along without style or sparkle. Frugoni's has more of an appropriate glitter, even if the orchestra hovers so discreetly in the background that it often hardly can be heard. Frugoni plays nimbly enough, but not very subtly; it's all pretty much one-dimensional. His disk, however, includes several rarely heard concerted pieces by Chopin, and collectors will want to investi-

gate it. Clear recording, perhaps a bit too close-up. If it's the solo version of the Andante Spianato and Polonaise in which you are interested, consult the following entry.

—Orazio Frugoni; Pro Musica Orchestra, Hans Swarowsky, cond. VOX PL 9030. 12-in. \$5.95 (with *Krakoviak; Variations on "Là ci darem la mano"; Liszt: Totentanz*).

—Rolf Reinhardt; Pro Musica Orchestra, conducted by the pianist. VOX PL 7530. 12-in. \$5.95 (with *Variations, Op. 2, 12*).

ANDANTE SPIANATO AND POLONAISE, FOR SOLO PIANO, OP. 22 (3 Editions)

Two tremendous interpretations and one transcendental one. Hofmann's is the latter. His ideas are entirely original; and yet the more one hears the performance, the more it strikes fire. Somehow he makes the competing versions sound thick. In the Andante Spianato his tempo is considerably faster than that of Rubinstein or Horowitz, and the melodic line sings in almost a disembodied inanner. His treatment of the bass, too, gives a more solid underpinning than elsewhere can be heard. Curiously his tempo in the Polonaise is slower than in the other versions. Hofmann takes "polonaise" literally as a dance form. Details come out in his playing that are missing in the more orthodox work of Messrs. Horowitz and Rubinstein. Hofmann is incomparably aristocratic. His recording is on a primitive level, but that should not deter lovers of good Chopin playing or anybody who thinks that content is more important than sound. Both of the Victor recordings are excellent examples of high-fidelity piano tone. Both, too, are splendid performances. Horowitz's is a little more tense, exceptionally brilliant, sharply outlined. Rubinstein's is broadly conceived, massive in conception, colorful in attack. You can't go wrong on either of these; but don't miss the pleasure of hearing Hofmann. It remains to be noted that the Rubinstein disk ends a half tone flat (though it is correctly pitched in its transfer as a filler in the three-disk Mazurkas set). Horowitz's performance also is available on RCA VICTOR LRM 7051 (10-in.), with the Scherzo in B minor and Nocturne in F minor. Before the price cuts it was a good bargain; now, no. The same applies to all others in the LRM series.

—Josef Hofmann. COLUMBIA ML 4929. 12-in. \$5.95 (with Chopin miscellany).

—Vladimir Horowitz. RCA VICTOR LM 1137. 12-in. \$3.98 (with Chopin miscellany).

—Artur Rubinstein. RCA VICTOR LM 152. 10-in. \$2.98 (with *Polonaise-Fantasy*).

BALLADES

4 BALLADES (COMPLETE) (6 Editions)
I am not happy about any of these. The Casadesus version, which was originally released in 1950, is probably the best. But Casadesus, a superlative technician, stands a little away from the music, refusing to get involved too strongly. Fire and passion are missing; and not all of Casadesus' elegance can compensate. Clear, rather thin recorded sound, but quite serviceable. Cor de Groot plays steadily and methodically. No errors of commission; but, then again, not much in the way of imagination. His recording has, like many Epics, a thudding bass. Gulda plays the notes with vigor; nothing small-scaled here. But nothing very poetic either. Good recording, with an occasional pre-echo. On his Concert Hall disk, Earl Wild often supplies a degree of musical excitement not apparent in the other versions. His playing does not have consistency, however. Sometimes he roars along, all jets out; at other times he

is close to a stall. His disk, like the Westminster played by Doyen, is not very attractive economically, as the other versions give extra music in addition to the Ballades. In any case, Doyen's playing is impossibly affected. This is a model of swooning adolescence. Arrau's performance I find excessively mannered and unnatural. He sounds calculated; his effects do not come off; he favors drawn-out ritards that start measures before Chopin indicated, he consistently changes the metrical pulse, and his rubato creaks. Technique he has. The recorded sound is full, clear, and not very colorful.

—Robert Casadesus. COLUMBIA ML 4798. 12-in. \$3.98 (with *Sonata in B-flat minor*).

—Cor de Groot. EPIC LC 3037. 12-in. \$3.98 (with Chopin miscellany).

—Friedrich Gulda. LONDON LD 9177. 10-in. \$2.98.

—Earl Wild. CONCERT HALL CHS 1401. 12-in. \$4.98.

—Ginette Doyen. WESTMINSTER WL 5169. 12-in. \$5.95.

—Claudio Arrau. DECCA DX 130. Two 12-in. \$11.70 (with 4 *Impromptus*; 4 *Scherzos*; *Barcarolle*).

NO. 1, IN G MINOR, OP. 23 (4 Editions)
Hofmann, easily. Again the recording is inferior, but who cares? Hofmann is heroic, lyric, delicate by turns. He has more color and authority than anybody who has attempted the work on disks, and there is a degree of imagination to the playing that vanished when Hofmann retired. In the Barere recording the piano tone is not bad, but the recording is low-level and has prominent surfaces. Barere brings a mannered quality to his reading. He tinkers around with the opening phrases, altering the note values, and in general has some arbitrary notions that do not always come off. Yet there never is any doubt that a great pianist is at work, and there are some ravishing details, including a degree of nuance and suppleness that none but Hofmann can suggest. The Horowitz is a transfer to LP of the 1948 shellac disks: dated sound, boomy bass. His performance is finicky, frequently tight and nervous, sometimes actually disconnected. One exciting and extremely effective moment: the crash in the bass in the measure preceding



the beginning of the coda. Backhaus is unconvincing and his playing is alien to the improvisatory nature of the music.

—Josef Hofmann. COLUMBIA ML 4929. 12-in. \$5.95 (with Chopin miscellany).

—Simon Barere. REMINGTON 199-17. 12-in. \$1.95 (with Chopin-Liszt miscellany).

—Vladimir Horowitz. RCA VICTOR LM 1235. 12-in. \$3.98 (with *Sonata in B-flat minor* and Liszt miscellany).

—Wilhelm Backhaus. LONDON LPS 317. 10-in. \$2.98 (with Chopin miscellany).

NO. 3, IN A-FLAT, OP. 47 (3 Editions)
None of these is successful. Katchen is

brash and immature, and all on the surface. The Horowitz pressings I played had a prominent scratch throughout. Otherwise the recorded sound is bell-like. This is a big performance that somehow fails to convince. Horowitz misses the grace and elegance of the music, and there are some odd sections involving 'detached finger weights. Nearly everything sounds too big. The Arrau disk is a transfer from a prewar shellac. Inferior recorded sound; heavy surfaces; occasional tonal shatter. But the playing has a more relaxed quality than the version in the integral set Arrau made for Decca two years ago. This is the best performance of the A-flat Ballade on LP—and the worst recorded sound.

—Claudio Arrau. DECCA DL 8517. 12-in. \$3.98 (with Chopin miscellany).

—Vladimir Horowitz. RCA VICTOR LM 1707. 12-in. \$3.98 (with Chopin miscellany).

—Julius Katchen. LONDON LS 554. 10-in. \$2.98 (with *F minor Fantasy* and *Scherzo No. 3*).

NO. 4, IN F MINOR, OP. 52 (1 Edition)
Horowitz starts with a beautiful, singing line. Then he becomes capricious. He can't leave well enough alone: he adds little crescendi and diminuendi that testify to his pianistic control rather than to his musical instincts. Withal, some driving, energetic pianism, including a thrilling coda (one of the most difficult in the repertoire). Superb recorded sound. This identical performance is also available on RCA VICTOR LRM 7018. (10-in., \$2.98).

—Vladimir Horowitz. RCA VICTOR LM 1707. 12-in. \$3.98 (with Chopin miscellany).

BARCAROLLE, OP. 60 (7 Editions)

Despite the presence of seven versions, a choice is easy to make. Lipatti takes the phrases between his hands and carefully shapes them. A masterful performance, one with nobility, passion, and tremendous control. The 1948-ish recording has a thick sound. Try the Columbia 78 equalization with reduced bass. Balogh is delicate and small-scaled; Sandor is steely and colorless. Cortot's performance is technically sloppy; some of the slips are actually embarrassing. He never should have let them release this disk. The Yves Nat interpretation is powerful but crude. Pennario's has power, too, of a brittle sort. The Arrau is impossible to recommend.

—Dinu Lipatti. COLUMBIA ML 4721. 12-in. \$4.98 (with *Sonata in B minor*, etc.).

—Erno Balogh. LYRICHORD LL 20. 12-in. \$5.95 (with Chopin miscellany).

—Yves Nat. HAYDN SOCIETY HSL 97. 12-in. \$5.95 (with *Sonata in B-flat minor* and *Fantasy in F minor*).

—Leonard Pennario. CAPITOL H 8246. 10-in. \$2.98 (with Liszt: *Mephisto Waltz*).

—Claudio Arrau. DECCA DX 130. Two 12-in. \$11.70 (with 4 *Ballades*; 4 *Impromptus*; 4 *Scherzos*).

—Alfred Cortot. RCA VICTOR LHMV 1032. 12-in. \$4.98 (with Chopin miscellany).

—Gyorgy Sandor. COLUMBIA ML 4193. 12-in. \$3.98 (with Chopin miscellany and *Beethoven: Sonata No. 15 in D*).

BERCEUSE, OP. 57 (6 Editions)
"Berceuse" means "Cradle Song." To

Novaes goes the honors for a shimmering, poetic reading. Her technique is a little rougher than one normally hears from her, but the quality of interpretation is lovely. Hofmann's ideas are strange; this is the one piece on his disk that fails to convince. The tempo is fast, and the accented A-flats toward the end sound arbitrary. De Groot is, as always, dependable, sensible, and not very imaginative. Cortot's disk, a very early electric (1926), is not one of his best records. It has its aristocratic moments, but also in evidence are some jerky hold-backs, a capricious speed-up of some sections, and a lack of steady pulse. Jonas goes about it with much too slow a tempo, and the long ritard at the end is painful. Balogh's performance neither adds much to the music nor takes anything away. One could do much worse.

—Guiomar Novaes. VOX PL 7810. 12-in. \$5.95 (with Chopin miscellany).
—Josef Hofmann. COLUMBIA ML 4929. 12-in. \$5.95 (with Chopin miscellany).
—Cor de Groot. EPIC LC 3037. 12-in. \$3.98 (with 4 *Ballades* and 2 *Waltzes*).
—Erno Balogh. LYRICHORD LL 20. 12-in. \$5.95 (with Chopin miscellany).
—Alfred Cortot. RCA VICTOR LCT 1038. 12-in. \$3.98 (with Chopin miscellany).
—Maryla Jonas. COLUMBIA ML 4476. 12-in. \$3.98 (with Chopin miscellany).

BOLERO, OP. 19 (1 Edition)

A fluffy, pianistic work that seldom turns up in concert. Minor Chopin, energetically played by Balogh. Fair recorded sound.
—Erno Balogh. LYRICHORD LL 20. 12-in. \$5.95 (with Chopin miscellany).

CONCERTOS FOR PIANO

NO. 1, IN E MINOR, OP. 11 (10 Editions)
Rubinstein remains the old master here. Despite the presence of a labored quality not normally associated with his playing, Rubinstein brings to the music more color, strength, and flexibility than any of his competitors. Beautiful recorded sound, though the balance between piano and orchestra leaves something to be desired. Brief comments about the other versions: Uninsky—strong, forthright, vigorous rather than poetic; tinny sound to the recording. Brailowsky—originally recorded in 1949, but splendid recorded sound. Methodical, routine, dynamically monotonous. Mewton-Wood—powerful; some interesting ideas; often thick and over-deliberate; misses the rhapsodic quality. Good recorded sound. Horszowski—slender, tasteful, rather innocuous; more care than spontaneity; not the strongest of technicians; fair recorded sound that is a little thick in the bass. Kilenyi—over ten years old, with consequent dated sound. Not much character to the playing; even at the disk's low price it cannot compete with the other versions. Sandor—percussive, rhythmic, lacking in charm and flexibility. Good recorded sound. Gulda—exact playing that sounds noncommittal. This young man definitely is not a Chopinist—not here, anyway. Badura-Skoda—has the virtue of both concertos on one disk. Frequently sensitive playing, but without much authority. I would not recommend it. Musulin—not a big technician (she has trouble with the nasty E major section of the first movement). This

disk, like the Westminster, contains both concertos, and the recorded sound is excellent, with an especially vibrant piano tone. Honest, not inspired, but musical performances. Of all the versions, Rubinstein's tops the list. For a cheaper version, in that both concertos are present on one disk, the Musulin is suggested.

—Artur Rubinstein; Los Angeles Philharmonic, Alfred Wallenstein, cond. RCA VICTOR LM 1810. 12-in. \$3.98.
—Branka Musulin; Sudddeutsche Rundfunk Orchestra, Karl Mueller-Kray, cond. PERIOD 574. 12-in. \$4.98 (with *Concerto No. 2*).
—Alexander Uninsky; Hague Philharmonic, Willem van Otterloo, cond. EPIC LC 3012. 12-in. \$3.98.
—Paul Badura-Skoda; Orchestra of the Vienna State Opera, Artur Rodzinski, cond. WESTMINSTER WL 5308. 12-in. \$5.95 (with *Concerto No. 2*).
—Alexander Brailowsky; Victor Symphony, William Steinberg, cond. RCA VICTOR LM 1020. 12-in. \$3.98.
—Friedrich Gulda; London Philharmonic, Sir Adrian Boult, cond. LONDON LL 1001. 12-in. \$3.98.
—Mieczyslaw Horszowski; Vienna State Philharmonia, Hans Swarowsky, cond. VOX PL 7870. 12-in. \$5.95 (with 4 *Impromptus*).
—Gyorgy Sandor; Philadelphia Orchestra, Eugene Ormandy, cond. COLUMBIA ML 4651. 12-in. \$3.98.
—Edward Kilenyi; Minneapolis Symphony, Dmitri Mitropoulos, cond. COLUMBIA ENTRE 3028. 12-in. \$2.98.
—Noel Mewton-Wood; Netherlands Philharmonic, Walter Goehr, cond. CONCERT HALL CHS 1153. 12-in. \$4.98.

NO. 2, IN F MINOR, OP. 21 (7 Editions)
Three excellent versions are available. The Rubinstein is a transfer of the 1947 shellac disks: a fine-sounding recording with only a slight surface to mark its source. Rubinstein's is the brightest, healthiest performance, large-scaled and full of vitality. Novaes is more personal, playing with her usual poetry, freedom, and instinct for just the right degree of shading. The 1951 recording is clear but rather thin. One has the feeling that Novaes and Klemperer do not always see eye to eye on essential details. Nevertheless, by virtue of some exquisite details, this is a performance to treasure. Of the two Malcuzyński versions I prefer the Columbia, a transfer from 1948 shellacs (good sound, prominent surfaces). This is a virtuoso treatment of the score; and, with a conductor to pace him, Malcuzyński is held to a steady pace. It is one of his best records, as good as some of his other Chopin playing is bad. His Angel disk contains a more mannered performance, and the eccentric interpretation of the F minor Fantasy that accompanies it is no recommendation. Badura-Skoda lacks *elan*. Was there ever a Teutonic pianist who achieved success with Chopin? Musulin is more convincing stylistically. I have heard much worse playing from pianists of much greater reputation. Her resources do not match those of Rubinstein, Novaes, or Malcuzyński; but if you insist on a version with both concertos on one disk, this is preferable to the Badura-Skoda. As for the Ellen Ballon version, it is a disgrace. The Brailowsky-

SOLD OUT *

Weill's

THE THREE PENNY OPERA

(Dreigroschenoper)

Selections by
original 1929 cast

10" LGM-65028 \$2.98

*Our first shipload of this historic recording received such an overwhelming response that it was sold out immediately.

However . . . new shipments are being made. Be sure to reserve your copy at your dealer now.

THE CRITICS ACCLAIM

Brahms: SYMPHONY No. 1 IN C MINOR, op. 68.
Berlin Philharmonic Orchestra conducted by Joseph Keilberth.

12" — LGX-66003 — \$4.98

"The mellow smoothness of its melodic flow and the orchestra's response to the majestic grandeur of the last movement make a document of distinction and tonal vitality."

—Cleveland Plain Dealer

Rossini: BARBER OF SEVILLE—Overture
Rossini: TANCREDI—Overture
L'Orchestre Symphonique
de la Radiodiffusion Nationale Belge
conducted by Franz André

10" — TM 68024 — \$2.98

" . . . The orchestra plays with an approach to perfection intonation-wise rarely heard these days. The unanimity of opinion in the strings is a joy to hear."

—Dallas Times Herald

Chabrier: ESPANA RHAPSODY
Massenet: PHEDRE—Overture
L'Orchestre Symphonique
de la Radiodiffusion Nationale Belge
conducted by Franz André

10" — TM 68016 — \$2.98

" . . . excellent recording, full of color and sumptuous string tone. Fit in rhythms and generous in its evocation of mood and atmosphere."

—The Gramophone

TELEFUNKEN



LONG PLAYING RECORDS

539 W. 25th St. • New York 1, N. Y.

Munch collaboration features routine playing, with the pianist methodically hitting the notes and the conductor hurrying along as though he were eager to get it over with. Everything is accurate enough, but the flavor of the music scarcely comes through. —Arrur Rubinstein; NBC Symphony, William Steinberg, cond. RCA VICTOR LM 1046. 12-in. \$3.98.

—Guiomar Novaes; Vienna Symphony, Otto Klemperer, cond. VOX PL 7100. 12-in. \$5.95.

—Witold Malcuzyński; Philharmonia Orchestra, Paul Kletzki, cond. COLUMBIA ML 4135. 12-in. \$3.98.

—Branka Musulin; Stuttgart Sueddeutscher Rundfunk Orchestra, Karl Mueller-Kray, cond. PERIOD 574. 12-in. \$4.98 (with *Concerto No. 1*).

—Paul Badura-Skoda; Orchestra of Vienna State Opera, Artur Rodzinski, cond. WESTMINSTER WL 5308. 12-in. \$5.95 (with *Concerto No. 1*).

—Alexander Brailowsky; Boston Symphony, Charles Munch, cond. RCA VICTOR LM 1871. 12-in. \$3.98 (with *Saint-Saëns: Concerto No. 4*).

—Witold Malcuzyński; Philharmonia Orchestra, Paul Kletzki, cond. ANGEL 35030. 12-in. \$4.98 or \$3.48 (with *Fantasy in F minor*).

—Ellen Ballou; London Symphony, Ernest Ansermet, cond. LONDON LPS 275. 10-in. \$2.98.

ECOSSAISES, OP. 72 (1 Edition)

Lightweight music, through which Dorfmann prettily tinkles her way. The recorded sound is as clear and resonant as one can get anywhere on LP.

—Ania Dorfmann. RCA VICTOR LM 1758. 12-in. \$3.98 (with *Ravel: Sonatine*, etc.).

ÉTUDES

OP. 10 AND OP. 25, COMPLETE (2 Editions)

Uninsky is preferable; but neither he nor Brailowsky exactly throws himself into the music. Nevertheless, Uninsky's regularity is to be preferred to Brailowsky's percussive attack. The latter, on two disks, also plays the three *Nouvelles Études* and Schumann's *Symphonic Études*. Uninsky does not play the *Nouvelles Études*, which have no opus number and were composed separately from the two books of twelve each. There is something essentially earthbound in Uninsky's playing here. He has a competent grasp of the notes but does little to vitalize them. And in some cases his ideas are debatable, to say the least, especially the affectations he brings to the more lyric of the études. His recording has a thin sound, and the bass is muzzy.

—Alexander Uninsky. EPIC LC 3065. 12-in. \$3.98.

—Alexander Brailowsky. RCA VICTOR LM 6000. Two 12-in. \$7.96 (with *Schumann: Symphonic Études*).

OP. 10, COMPLETE (2 Editions)

Here, and in Op. 25, Novaes is responsible for some of her strangest playing on LP. My guess is that she had not looked at some of these études for many years before whipping them into shape for the recording session. In any case, her work is erratic and often not up to par technically. I prefer Goldsand, who does not rise to

Novaes' great moments but is steadier all-around. His tempos, a trifle deliberate, suggest that he approached the music with the determination not to take any chances. As a result, we get disciplined readings that never let themselves go. Excitement is lacking; but better this than anarchy. Superb recorded sound.

However, the études as yet have to achieve a really satisfactory LP performance. Why doesn't Victor release the fine prewar Cortot performances, instead of lesser efforts that do little credit to his reputation as a great pianist?

—Robert Goldsand. CONCERT HALL CHS 1132. 12-in. \$4.98 (with *Trois Nouvelles Études*).

—Guiomar Novaes. VOX PL 9070. 12-in. \$5.95 (with *Chopin: Scherzo No. 1*).

OP. 25, COMPLETE (2 Editions)

See remarks above. Novaes is below her usual form, and the steadier Goldsand is preferred. Keep on the watch for a new version of the études. None of the current ones is really satisfactory, and the catalogue can well stand a performance that more closely approximates the brilliance, color, subtlety, and bravura that Chopin poured into these little sketches.

—Robert Goldsand. CONCERT HALL CHS 1133. 12-in. \$4.98 (with *Hérold Variations*).

—Guiomar Novaes. VOX PL 7560. 12-in. \$5.95 (with *Trois Nouvelles Études*).

ÉTUDES (Collections and Individual)

Two pianists have devoted complete disks to a miscellany of Chopin études. The largest noncomplete collection is played by David Saperton on COMMAND PERFORMANCE 1023 (12-in.). Fifteen études are present. Saperton's performances are not very imaginative or colorful, and in several cases he is downright sentimental. An example is the A-flat Etude of Op. 10, with its slow-ups, accelerandi, and constant "expression." Whatever the expressive deficiencies of the playing, it must be said that Saperton is no tyro, and he often turns a neat phrase. In view of the lack of real competition in the field of Chopin études, this disk can well be considered a legitimate entry. On COMMAND PERFORMANCE 1201/02 (two 12-in.) Saperton plays Godowsky's paraphrases on the Chopin études. These are perhaps the most fantastically difficult things ever composed for solo piano. Saperton presents Chopin's original étude, in each case, followed by Godowsky's paraphrase (on these two disks are contained the twelve études missing from COMMAND PERFORMANCE 1203). This is not the place to discuss the merits and demerits of Godowsky's work. Some circles deride the paraphrases. I have always found them among the most ingenious piano pieces in the literature, and a legitimate extension of Liszt's pioneering work. The mere fact that Saperton gets through without breaking down is in itself a remarkable feat. Each of these three disks has been recorded with exceptional

clarity, and collectors looking for something unusual should investigate the pair containing the paraphrases. One of these days they will be collectors' items.

On LONDON LS 704 (10-in.) Wilhelm Backhaus presents a miscellany of études from Op. 10 and Op. 25. These are stiff, rhythmically monotonous performances, virtually devoid of color. Technical security is always present, of course, but Chopin is not, and never was, Backhaus' cup of tea. (Not long ago I went back to his early electric set of the études; the playing is just as unconvincing.) Backhaus also has the E major Etude (Op. 10, No. 3) on his Chopin Recital disk, LONDON LS 317 (10-in.). The same étude is played with more sensitivity by Novaes on her Chopin Recital disk, VOX PL 7810 (12-in.). Still another version of this most popular of Chopin études (the composer once said it was the loveliest melody he ever wrote) is contributed by Vladimir Horowitz on RCA VICTOR LM 1707 (12-in.). He handles it in a rather mannered fashion and then whizzes through the following Etude in C-sharp minor (Op. 10, No. 4) with grand virtuosity. Josef Hofmann's brilliant performance of the *Butterfly Etude* (Op. 25, No. 9) can be heard on COLUMBIA ML 4929 (12-in.). The F minor Etude (Op. 25, No. 2) is played by Alfred Cortot on RCA VICTOR LHMV 1032 (12-in.): plenty of musical style, plenty of technical mishaps. James MacInnes offers neat and unperceptive interpretations of the *Trois Nouvelles Études* on MCINTOSH MM 104 (12-in.). The recording is clear and a little glassy in sound. On COLUMBIA ML 4476, Maryla Jonas plays the Etude in E-flat minor (Op. 10, No. 6) with restraint and poetry; and then she plays the F minor (Op. 25, No. 2) in a leisurely way, with a nonlegato touch that does not sound natural.

FANTASY IN F MINOR, OP. 49 (6 Editions)

Many specialists call this Chopin's greatest work. It has everything—a spacious design, amazingly rich harmonies, melodic content of a varied nature, variety in unity. Heading the top of the LP list are Cherkasky and Novaes. My preference is Novaes. Despite a few awkward moments, she brings to the music a typical combination of personality, color, and poetry. Cherkasky, who presents an orthodox conception, does not convey equivalent personality, and he drags the chorale-like B major section inexcusably. Novaes never lags, neither does she strain to achieve heroic flights. She presents the music in a modest framework; but within that framework she is all nuance. The recorded sound is faithful enough to convey the subtlety of her tone. Not much can be said of the other versions. Sandor's recording has dry, unresonant sound. He plays the music in a methodical manner, an absence of poetry, and a literal-mindedness that would classify Helen of Troy as just so many ounces of protoplasm, calcium, and hemoglobin. Karchen's performance is a glib collection of pianistic effects rather than a unified musical conception. Yves Nat has a big style, but his technique is not commensurate with his ideas, and he has to work much too hard over certain sections. A clangorous type of

Next issue, an Aaron Copland
discography by Arthur Berger.

recorded piano is present here. Malcuzyński's ideas I find merely eccentric. Right at the opening measures he goes his own way, ignoring Chopin's indications; and his rubato is of a type never seen or heard before.

—Guiomar Novaes. VOX PL 7810. 12-in. \$5.95 (with Chopin miscellany).

—Shura Cherkassky. RCA VICTOR LBC 1066. 12-in. \$2.98 (with *Nocturne in E minor*; *Mazurka No. 23 in D*; *Rachmaninoff: Rhapsody on a Theme by Paganini*).

—Yves Nat. HAYDN SOCIETY HSL 97. 12-in. \$5.95 (with *Sonata in B-flat minor; Barcarolle*).

—Julius Katchen. LONDON LPS 554. 10-in. \$2.98 (with *Scherzo No. 3; Ballade No. 3*).

—György Sandor. COLUMBIA ML 4193. 12-in. \$3.98 (with Chopin miscellany; *Beethoven: Sonata No. 15 in D*).

—Witold Malcuzyński. ANGEL 35030. 12-in. \$4.98 or \$3.48 (with *Concerto No. 2*).

FANTASY-IMPROMPTU, OP. 66 (See Impromptus)

3 IMPROMPTUS; FANTASY-IMPROMPTU (3 Editions)

Chopin composed four impromptus. The first three are those in A-flat (Op. 29), F-sharp major (Op. 36) and G-flat major (Op. 51). The fourth, and most popular—indeed, one of Chopin's all-time favorites, along with the *Waltz in C-sharp minor* and the *Funeral March*—is the so-called Fantasy-Impromptu (Op. 66). Chopin called it an impromptu; the "fantasy" part was tacked on by a publisher. The popularity of the Fantasy-Impromptu has obscured the others; but surely Chopin never composed a more lyrical work than the F-sharp. And the seldom-played G-flat has moments of extreme introspection and beauty. No really satisfactory LP version of the complete set exists. Balogh's is probably the best of the three available. It is neat, accurate, and tasteful. What it lacks is any degree of musical personality. Yet surely it is preferable to Arrau's sighings and intellectualized emotionalism. Arrau pulls the F-sharp Impromptu to pieces. His recording is clear and a little glassy. Balogh's, though thin, is satisfactory. Horowitz is conscientious, and that is not enough. These pieces are above all improvisatory. Horowitz's sober process of presenting the notes without commenting on them leaves an important element out. His recording has fine sound in the treble, a soggy thump in the bass.

—Erno Balogh, LYRICHORD LL 20. 12-in. \$5.95 (with Chopin miscellany).

—Mieczysław Horzewski. VOX PL 7870. 12-in. \$5.95 (with *Concerto No. 1*).

—Claudio Arrau. DECCA DX 130. Two 12-in. \$11.70 (with *4 Scherzos; 4 Ballades; Barcarolle*).

IMPROMPTUS (Individual)

Two mighty fine performances of the Fantasy-Impromptu are available. One is played by Artur Schnabel on RCA VICTOR LM 1153 (12-in.), a disk devoted to short encore pieces. Schnabel turns in the kind of singing, masculine, athletic (in the best sense of the word) interpretation that is expected of him. Halina Stefanska, on RCA VICTOR LBC 1031 (12-in.), a low-priced Bluebird disk, offers warm,

romantic playing in good technical order. All of her work on this disk is worth having, and it is a shame that Victor decided to couple her Chopin with an indifferent performance of Beethoven's *Appassionata* Sonata, played by Nicholas Medtner. By comparison to Rubinstein and Stefanska, György Sandor sounds steely in his version of the Fantasy-Impromptu on COLUMBIA ML 4193 (12-in.). Robert Goldsand once recorded the Fantasy-Impromptu on CONCERT HALL CH SPEC 52, in that company's Limited Edition series. It probably is out of print. Goldsand played the work in a deliberate, rather languishing manner. The A-flat Impromptu is played by Vladimir Horowitz on RCA VICTOR LM 1707 (12-in.): a carefully shaped performance, articulated with all of Horowitz's infernal magic. Nobody before the public today has more accurate fingers. Maryla Jonas also has the A-flat Impromptu, on COLUMBIA ML 4476 (12-in.). This is a pleasant example of piano playing, but it is not in Horowitz's class. The most beautiful of all the Impromptus, No. 2 in F-sharp major, receives the most lyric of interpretations from Guiomar Novaes on VOX PL 7810 (12-in.). The great lady is in superb form here. Another version of the F-sharp is played by Lili Kraus on DECCA DL 8517 (12-in.). Her playing is more straightforward than that of Novaes, without the latter's glints and shadings. The Kraus disk is a transfer from an old 78-rpm recording, and it shows its age.

KRAKOVIAK, OP. 14 (1 Edition)

Some of us, early in 1950, came to admire the Vox disk of the *Krakoviak* as played by one Rosl Schmid and an orchestra conducted by Alfons Dressel. It was a cut version, however, and not very lively in sound. For some time it has been discontinued from the Vox catalogue. The present replacement naturally enjoys the benefit of up-to-date recording techniques. One wonders why this attractive score has been so neglected. In general layout and feeling it resembles the finales of the two piano concertos—objective, glittering, strongly nationalistic (a *krakoviak* is a Polish dance in duple time), immensely effective. The orchestration is no better or no worse than the orchestration in the concertos (which is not as inferior as many would think). As a purist I blush to say it, but the two cuts that were adopted in the earlier recording help the work. Schmid excised two lengthy sections of empty display passages. Frugoni presents the work in its entirety. He plays competently—much better than in the "*Là ci darem*" *Variations* on the same disk. The performance sounds better rehearsed, for one thing. But this is not my idea of aristocratic Chopin playing. Frugoni seems too intent on emphasizing the surface glitter, and his tone does not seem capable of much shading. Nevertheless, as I say, the playing is competent, and those who investigate the disk will come up with an extremely charming novelty that may not be encountered in a lifetime of concert-going.

—Orazio Frugoni; Pro Musica Orchestra, Hans Swarowsky, cond. VOX PL 9030. 12-in. \$5.95 (with *Andante Spianato and Polonaise; Variations on "Là ci darem la mano"; Liszt: Totentanz*).



Spain's
foremost
conductor

ARGENTA
conducts
the best loved
ZARZUELAS
Acclaimed by the critics!

DOÑA FRANCISQUITA (Vives)

2-12" TW 91005/6—\$9.96

"... The London recording is a very plush job so far as sound, performance and atmosphere are concerned. The singers are first rate and, being Spanish, know their way around the music, lending a degree of authenticity to the proceedings that is very convincing." —*The New Records*

LAS GOLONDRINAS (Usandizaga)

3-12" TW 91031/3—\$14.94

"... 'A Spanish Pagliacci'... the performance here is most convincing." —*The Gramophone*

"This album will no doubt restore Usandizaga to his rightful place in opera's hall of fame."

—*Pittsburgh Press*

AGUA, AZUCARILLOS Y AGUARDIENTE (Chueca)

10" W-91016—\$2.98

"... most captivating... the Prelude is worthy of Johann Strauss." —*The Gramophone*

MOLINOS DE VIENTO (Luna)

12" TW 91036—\$4.98

"The performance is a very good one all around and boasts, besides, the services of Pilar Lorengar, the best Zarzuela soprano I have ever heard." —*Dallas Times Herald*

PRELUDES AND INTERMEZZI

FROM ZARZUELAS—Vol. 1

12" TW 91020—\$4.98

"Vivid, interesting music beautifully played... this is seductive music of Patrician line and detail." —*Chicago Tribune*

LONDON INTERNATIONAL

LONG PLAYING RECORDS

539 W. 25th St. • New York 1, N. Y.

MAZURKAS

COMPLETE (1 Edition)

Chopin composed over fifty of these little dances (little in size; some of them are epic in emotional scope). In prewar days, only one pianist was brave enough—and, from Victor's standpoint, popular enough—to take them on. That was Artur Rubinstein; and his three-album set, issued around 1940, was one of the glories of the prewar repertoire. The current three-disk issue on LP is not a transfer but a new recording. I can't think of a living pianist to whom the mazurkas could be more safely entrusted. As Rubinstein plays the music it emerges with all of its nostalgia, essential health, and bouncing rhythm. No affectations, no gilding the lily, no calculated superimpositions mar the work. More than any pianist, Rubinstein expresses a *joie de vivre* in his playing. Here it is captured for posterity. I could go on, in great detail. Suffice it to say that this is great Chopin, played by a great pianist at the height of his resource. The Victor engineers were most co-operative in this release, giving Rubinstein clear, undistorted recording. What results is a basic essential for any collection of Chopin. The first twelve mazurkas from the complete set have been placed on RCA VICTOR LRM 7001 (10-in.). This little disk is a good introduction for those who cannot afford to invest in the three-disk set.

—Artur Rubinstein. RCA VICTOR LM 6109. Three 12-in. \$11.94 (with *Andante Spianato and Polonaise; Polonaise-Fantasy*).

COLLECTIONS OF MAZURKAS

Five pianists have contributed disks devoted entirely or in large part to Chopin mazurkas. Here is a breakdown. Horowitz plays seven: Nos. 20, 21, 26, 32, 38, 40, and 41. Kapell plays nine: Nos. 9, 14, 24, 25, 35, 44, 45, 48, and 49. Novaes is heard in twelve: Nos. 13, 15, 17, 23, 24, 25, 26, 34, 36, 37, 39, and 51. On 10-in. COLUMBIA ML 2101, Jonas plays nine: Nos. 9, 11, 12, 13, 14, 22, 36, 41, and 45. On ML 2036 she plays an additional nine: Nos. 16, 18, 21, 27, 29, 35, 48, 50, and the posthumous G major. There is something to be said for each of these disks. Horowitz plays with a carefully turned line, with simplicity, sensitivity, and his usual remarkable control. He is heard to very good advantage here, and the delicacy of his work, plus a thorough identification with the style, makes this disk one of his great ones (the Schumann *Kinderscenen* on the reverse is also beautifully delivered). Novaes is more personal, more fragrant and scented. Many listeners do not like this disk. It has been described as wayward. All I can say is that I continue to listen to it with delight. Kapell is a little tight, but he too plays with taste and understanding. With Jonas, we come to a style that infuriates many specialists. She goes her own sweet way, changing rhythms and tempos to suit herself, simpering, acting coy, using a wild rubato. And yet through it all often comes something very attractive—a gracious quality, considerable feeling. If you like your mazurkas swaying and sentimental, try these. The two Victor recordings are clear and sparkling. Vox has given Novaes clear recording but high surfaces. The two Columbia disks are transfers from shellac, with here and there a trace of "wow" but with fairly realistic piano tone.

Since the above paragraph was written, Victor has released another disk of mazurkas played by William Kapell. Seventeen are presented—Nos. 2, 6, 11, 12, 20, 22, 26, 27, 31, 32, 36, 37, 40, 41, 43, 47, and 50. These were recorded in 1952. The performances are clear and direct, with a singing line and considerable musical flow. As in his previous disk of mazurkas, there is a suggestion that Kapell is holding himself back just a shade too strongly, but the playing is nevertheless that of an artist, and the disk is highly recommended. One slight defect: in the A-flat Mazurka (Op. 17, No. 3), there is a faulty tape snip.

—Seven Mazurkas. Vladimir Horowitz. RCA VICTOR LM 1109. 12-in. \$3.98 (with *Schumann: Kinderscenen*).

—Nine Mazurkas. William Kapell. RCA VICTOR LM 1715. 12-in. \$3.98 (with *Sonata No. 3*).

—Seventeen Mazurkas. William Kapell. RCA VICTOR LM 1865. 12-in. \$3.98.

—Twelve Mazurkas. Guiomar Novaes. VOX 7920. 12-in. \$5.95.

—Nine Mazurkas. Maryla Jonas. COLUMBIA ML 2101. 10-in. \$2.98.

—Nine Mazurkas. Maryla Jonas. COLUMBIA ML 2036. 10-in. \$2.98.

INDIVIDUAL MAZURKAS

Many pianists have recorded individual mazurkas on disks devoted to a miscellany of other music. Let's take them alphabetically. Wilhelm Backhaus plays three (B-flat minor, Op. 24, No. 4; E-flat, Op. 30,

No. 3; C, Op. 33, No. 3) in an unyielding, Germanic manner on LONDON LPS 317 (10-in.). The same three mazurkas are also on LD 9047 (10-in.). Same pianist, same performance. On COLUMBIA ML 2004 (10-in.), Maryla Jonas plays Nos. 19 (B minor, Op. 30, No. 2), 43 (G minor, Op. 67, No. 2), 49 (F minor, Op. 68, No. 4) and the posthumous B-flat, handling them in typically mannered style, yet with a peculiar affinity for the music. One of



the curiosities of the catalogue is contained on RCA VICTOR LM 1186, where Wanda Landowska plays the Mazurka in C (Op. 56, No. 2) on the harpsichord. A novel idea and, in this case, an adorable one. The great Mazurka in C-sharp minor (Op. 50, No. 3) is magnificently played by Dinu Lipatti on COLUMBIA ML 4721 (12-in.), and the entire Op. 50 set (consisting of three mazurkas) is nicely performed by Nikita Magaloff on LONDON LS 532 (10-in.). Ignace Jan Paderewski is heard in the Mazurka in C-sharp minor (Op. 63, No. 3) on RCA VICTOR LCT 1038 (12-in.). This was recorded in 1930, when the pianist was far past his prime. Buoyant, rhythmic performances of three mazurkas—B-flat (Op. 7, No. 1), C-sharp minor (Op. 6, No. 2), C (Op. 68, No. 1)—come from Halina Stefanska on RCA VICTOR LBC 1031 (12-in.). Plenty of spirit is here, plus a subtle and idiomatic turn of phrase. Stefanska sounds like a fine artist.

NOCTURNES

COMPLETE (1 Edition)

Not much can here be said that wasn't said in reference to Rubinstein's performance of the mazurkas (see above). In these nocturnes he brings an equivalent degree of strength, poetry, and technical finesse. He achieves the sentiment of the music without ever becoming sentimental, and the way he sings out the melodic content is an object lesson for all pianists. Rubinstein remains the romantic pianist *par excellence*. Superb recorded sound. —Artur Rubinstein. RCA VICTOR LM 6005. Two 12-in. \$7.70.

INDIVIDUAL NOCTURNES

Again let's take an alphabetical look at the pianists who have recorded individual nocturnes. Alfred Cortot, on RCA VICTOR LHMV 1032 (12-in.), is heard in the F major (Op. 15, No. 1), E-flat (Op. 9, No. 2) and C-sharp minor (Op. 27, No. 1). All of these are late-vintage Cortot, which will please his admirers and, unfortunately, make the younger generation ask upon what his reputation was founded. Cor de Groot has recorded the popular F-sharp Nocturne (Op. 15, No. 2) on EPIC LC 3037 (12-in.), playing carefully and steadily. Vladimir de Pachmann's curious, wistful treatment of the E minor Nocturne

Rid Your Records of Dust
always use.

STATIC masters[®]
The Best...The Dry Method

NO SPRAYING
NO WASHING
NO RUBBING

The Polonium Strip does the trick

A few circular sweeps with **STATICMASTER** on each side of the record... IT'S CLEAN.

Expensive compared with other products... but inexpensive when noise-free and longer lasting records are considered.

\$17.85

Order Your **STATICMASTER** direct—
\$17.85 sent postpaid—cash with order

NUCLEAR PRODUCTS CO.
10173 E. Rush St., El Monte, Calif.

is contained on RCA VICTOR LCT 1038 (12-in.). He was nearly eighty when he made this recording in 1927. Josef Hofmann's incomparable performances of the Nocturnes in E-flat (Op. 9, No. 2) and F-sharp (Op. 15, No. 2) can be heard on COLUMBIA ML 4929 (12-in.). Vladimir Horowitz has scattered nocturnes through several of his disks. On RCA VICTOR LM 1235 (12-in.) he offers a handsome performance of the Nocturne in F-sharp; on LM 1707 (12-in.) he is at his worst in the F minor (Op. 55, No. 1) and E minor (Op. 72, No. 1); the former is impossibly mannered. A better version of the E minor is contained in his twenty-fifth Anniversary Album, RCA VICTOR LM 6014 (two 12-in.). The same E minor is also played by Maryla Jonas on COLUMBIA ML 2004 (10-in.), along with the posthumous Nocturne in C-sharp minor. And on COLUMBIA ML 2143 (10-in.), she plays five: B-flat minor and E-flat (Op. 9, Nos. 1 and 2), G minor (Op. 15, No. 3), B major (Op. 32, No. 1—mislabelled B minor), and F minor (Op. 55, No. 1). All of these are played in a drawing-room manner—inimate, sentimental, full of holds and pauses, many changes in the rhythmic pulse. The results are not without charm, though none but Jonas could get away with it. And even she cannot get away with the dirge-like tempo in the chorale section of the G minor; and the F minor is positively weird. Eileen Joyce gives the E-flat (Op. 9, No. 2) and B major (Op. 32, No. 1) Nocturnes schoolgirlish performances on DECCA DL 8517 (12-in.). A beautiful, spun-out performance of the popular D-flat Nocturne (Op. 27, No. 2) is played by Dinu Lipatti on COLUMBIA ML 4721 (12-in.). Guiomar Novaes' poised interpretation of the F-sharp Nocturne, on VOX PL 7810 (12-in.) is very much worth owning. RCA VICTOR LRM 7015 (10-in.) contains Artur Rubinstein's mastery in the B major (Op. 9, No. 3) and G major (Op. 37, No. 2) Nocturnes. These were taken from the complete set. A fine performance of the Nocturne in C-sharp minor (Op. 27, No. 2) is played by Halina Stefanska on RCA VICTOR LBC 1031 (12-in.).

POLISH SONGS, OP. 74 (2 Editions)
Both singers use the original Polish words. There the resemblance stops. The Conrad disk, with its wavery singing and lugubrious tone, should never have been released. Kurenko uses her hard, clear voice with consistent artistry, and she has received sparkling recorded sound. The music is worth knowing. Chopin, who adored the voice and singing, composed some extraordinarily attractive songs here. One wonders why he didn't write more. The music is not only nationalistic; it is exotic, with modal turns of phrase and a permeating nostalgia. Liszt transcribed a couple of these songs.
—Maria Kurenko, soprano; Hufstader. LYRICHORD LL 23. 12-in. \$5.95.
—Doda Conrad, bass. VOX PL 8310. 12-in. \$5.95.

POLONAISES

COMPLETE (2 Editions)
Rubinstein's "complete" version is not so complete. He plays the first seven and the

Andante Spianato and Polonaise. Chopin, however, composed three early polonaises that were posthumously published as Op. 71, and there are two more polonaises, also posthumous, that have dropped from the repertoire (not that they really were ever in it). Johannesen plays all of these, though his two-disk set omits the Andante Spianato and Polonaise. Thus his version is of real value. It also is played right well, with clear articulation and plenty of rhythmic spirit. It is unfortunate that such fine playing has to buck the gigantic playing of Rubinstein. For, expertly as Johannesen plays, he cannot measure up to the fire, breadth, and virtuosity of King Artur. I have solved the dilemma by retaining both versions (which, incidentally, are very well recorded). Rubinstein's must be called the preferable version, but don't sell Johannesen short; and if you want the minor polonaises, only he can give all of them to you.

—Artur Rubinstein. RCA VICTOR LM 1205 (*Polonaises Nos. 1-6*). 12-in. \$3.98.
RCA VICTOR LM 152 (*Polonaise-Fantasy; Andante Spianato and Polonaise*). 10-in. \$2.98.

—Grant Johannesen. VOX PL 6840. Two 12-in. \$11.90.

NO. 1, IN C-SHARP MINOR, OP. 26, NO. 1 (1 Edition)

This transfer from a 78-rpm disk has acceptable sound, though some bass boom and some xylophone characteristics in the upper treble betray its age. Jonas plays with considerable flavor. She is not as affected as she sometimes can be, and her work has a gracious flow, also a rubato that here "works." Unforced lyricism prevails.

—Maryla Jonas. COLUMBIA ML 4476. 12-in. \$3.98 (with Chopin miscellany).

NO. 3, IN A, OP. 40, NO. 1 (1 Edition)

The so-called *Polonaise Militaire*. Magaloff gives a neat, sure-handed performance that never becomes overemotional. Nor does it ever become heroic. All of the notes are there, but they could have added up to a bit more. Mellow-sounding recording, with some background noise.

—Nikita Magaloff. LONDON LS 532. 10-in. \$2.98 (with Chopin miscellany).

NO. 4, IN C MINOR, OP. 40, NO. 2 (1 Edition)

See remarks directly above. Magaloff is pianistically accurate, but the brooding quality of the introduction goes along in a metronomic way that scarcely conveys what Chopin intended.

—Nikita Magaloff. LONDON LS 532. 10-in. \$2.98 (with Chopin miscellany).

NO. 6, IN A-FLAT, OP. 53 (3 Editions)

Also to be considered is the magnificent performance by Artur Rubinstein, discussed above. Horowitz' performance is on a comparable level, with mighty hammer strokes, unlimited virtuosity, and incomparable sweep. Recording to match. The Lhevinne is something you shouldn't miss. It was one of his big specialties; it was not for nothing that Lhevinne's octaves were admired wherever he played. He made this recording in 1936, and it illustrates his combination of strength and delicacy.

GRAND PRIX DU DISQUE

PURCELL COME YE SONS OF ART

Counter-Tenors*

ALFRED DELLER

JOHN WHITWORTH

Soprano

Baritone

MARGARET RITCHIE BRUCE BOYCE

with The St. Anthony Singers and
L'Ensemble Orchestral De L'Oiseau
Lyre conducted by Anthony Lewis.
10"—DL 53004—\$2.98

*In the 17th century male voices (counter-tenors) often sang the high register parts nowadays assigned to women. Over the years this delicate art has been unjustly neglected. Here it is once again in all its original beauty.

"There could be no better introduction to Purcell's music . . . than this grand work."

—The Gramophone

The critics acclaim . . .

RUGGERO GERLIN

harpsichordist

in his first two releases of authentic
keyboard music of 17th & 18th century

Vol. 1

SPANISH AND PORTUGUESE MASTERS

12"—OL 50032—\$4.98

"Gerlin is a performer of fine lightness and style . . . there are some charming discoveries in the compositions."
—Houston Post

Vol. 2

GERMAN AND ITALIAN MASTERS

12"—OL 50043—\$4.98

"Here is an intelligently planned recital of early keyboard music which has enough contrast and variety to give pleasure to the beginner as well as to the connoisseur."

—The Gramophone

Watch for future Gerlin releases to follow soon, including the complete harpsichord works of François Couperin-le-Grand.

LONDON EDITIONS DE L'OISEAU-LYRE
539 West 25 Street, New York, N. Y.

RECORD INDEX

of all
High Fidelity
RECORD REVIEWS
1951-1953

available
NOW

A complete index, alphabetical by composer or collection-title, of all the classical and semi-classical, jazz and spoken word record reviews contained in HIGH FIDELITY Magazine from 1951 through 1953. Discographies included. A "must" reference.

ONLY 50¢

Send for your copy NOW

HIGH FIDELITY Magazine Dept. RA
Publishing House
Great Barrington, Mass.

Enclosed find 50¢. Please send me a copy of the Record Index.

NAME
ADDRESS

No C.O.D.'s, please

Pennario's impetuous performance has little to commend it.
—Vladimir Horowitz. RCA VICTOR LM 1137. 12-in. \$3.98 (with Chopin miscellany).
—Josef Lhevinne. RCA VICTOR LCT 1038. 12-in. \$3.98 (with Chopin miscellany).
—Leonard Pennario. CAPITOL H 8156. 10-in. \$2.98 (with Chopin miscellany).

NO. 7, IN A-FLAT, OP. 61 (1 Edition)
This is the Polonaise-Fantasy, a low-keyed work, not often played, that is a supreme masterpiece. MacInnes is not the man for it. His approach is immature, his technique not of the unlimited kind that would enable him to deal freely with the problems. Fortunately we have the Rubinstein version on LM 152 (10-in.), discussed above in the complete edition of the polonaises.
—James MacInnes. MCINTOSH MM 104. 12-in. \$4.98 (with *Trois Nouvelles Etudes*; pieces by Mozart).

NO. 8, IN D MINOR, OP. 71, NO. 1 (1 Edition)
Despite the late opus number this is a very early work—a little charmer, lightweight, and aristocratic. Stefanska's performance is all that could be asked for. She has the notes well under control, phrases with delicacy, builds a climax with authority. Fair recording, clear on top, somewhat tubby in the bass.
—Halina Stefanska. RCA VICTOR LBC 1031. 12-in. \$2.98 (with Chopin miscellany and *Beethoven: Appassionata Sonata*, played by Nicholas Medtner).

NO. 9, IN B-FLAT, OP. 71, NO. 2 (1 Edition)
An early, relatively unimportant Chopin piece, this polonaise can stand the salon treatment that Jonas gives it. It was originally recorded on shellac. The transfer poses a few problems. I had best results on the NAB equalization, at which point the sound was not bad at all.
—Maryla Jonas. COLUMBIA ML 2004. 10-in. \$2.98.

PRELUDES, OP. 28 (7 Editions)
Although the Novaes is an early LP (1950) the sound is quite tolerable if the bass is drastically reduced. To my taste this is the best modern LP interpretation of the evanescent, magical little sketches that Chopin assembled under the title of Preludes. Examined pedantically, some of Novaes' playing might not stand up too well, but through it all shine her flexibility, her instinct for a telling phrase, and, above all, a spontaneity that is exactly apposite to the nature of the music. I have grown to think more of the Petri disk than I used to. Agree with his ideas or not, they nevertheless are the ideas of a master. What disturbs me is the lack of color and an occasional hurried feeling (as in the G-sharp minor Prelude). Petri is playing more with his brain than with his heart. The harsh-sounding recording is typical of 1940 Columbia piano reproduction. No distortion is present, however, and at its price it is a fine buy, all the more in that it is accompanied with Petri's stupendous performance of the Liszt-Busoni *Spanish Rhapsody*. Rubinstein is not in his best form here, and one hesitates to recommend a disk with so many capricious moments.

Of course, the pianist being Artur Rubinstein, there are moments of magnificence. Cor de Groot is steady, as always, playing with a maximum of musicianship and a minimum of poetry. Gulda's disk is a fine effort. His Chopin lacks flexibility, but everything is laid out in a competent manner. Nevertheless he is a long way from the inspiration of Novaes. Both Arrau and Brailowsky bring a methodical approach and a lack of emotional warmth. Of the two, Arrau is the superior technician. Neither, however, even begins to suggest the romanticism of the music.

—Guionar Novaes. VOX PL 6170. 12-in. \$5.95.
—Egon Petri. COLUMBIA ENTRE 3040. 12-in. \$2.98 (with *Liszt-Busoni: Spanish Rhapsody*).
—Artur Rubinstein. RCA VICTOR LM 1163. 12-in. \$3.98.
—Friedrich Gulda. LONDON LL 755. 12-in. \$3.98.
—Cor de Groot. EPIC LC 3017. 12-in. \$3.98.
—Alexander Brailowsky. RCA VICTOR LM 1150. 12-in. \$3.98.
—Claudio Arrau. COLUMBIA ML 4420. 12-in. \$3.98.

PRELUDES (Individual)
Over half the preludes are played by Benno Moiseiwitsch on RCA VICTOR LBC 1038 (12-in.). For some inexplicable reason, Victor chose to represent him on a Bluebird disk with Nns. 11-24 (taken from the complete set that Moiseiwitsch made in England) and three of the scherzos. The Russian-English master plays beautifully. He has slipped technically since prewar days and a few slight errors are present, but these are unimportant in view of his secure tradition. Good recording. A delightful memento of a great pianist is Moriz Rosenthal's performance of Nos. 3, 6, and 7 on RCA VICTOR LCT 1038 (12-in.). These were recorded in the Thirties. On MERCURY MG 10113, Constance Keene is heard in Nos. 3, 8, and 16—three of the most difficult in the series. She handles them with apparently unlimited virtuosity, and in the process also manages to extract the musical essence.

SCHERZOS

COMPLETE (3 Editions)
Only one of the three available versions need concern us. Rubinstein, whose prewar set of the scherzos remained unique in the catalogues, has re-recorded them with just as much insight and technical expertise. For large-scale, yet well-proportioned Chopin, he leaves all competition far behind. Next to this kind of playing, Bolet is ineffectual. No mean technician himself, Bolet is fine when his agile fingers are in motion. When he has to pause for reflection, he obviously is not certain what to do. Arrau is a masterly technician too, but he is excessively mannered. Take the B minor Scherzo, where he lets the middle section die on the vine while he strings out an interminable ritard. This kind of thing occurs too often.
—Artur Rubinstein. RCA VICTOR LM 1132. 12-in. \$3.98.
—Jorge Bolet. REMINGTON 199-161. 12-in. \$1.95.
—Claudio Arrau. DECCA DX 130. Two 12-in. \$11.70 (with Chopin miscellany).

NO. 1, IN B MINOR, OP. 20 (5 Editions)
 Rubinstein's performance is a transfer to Victor's "Concert Cameo" series of two scherzos taken from the complete set of four. Since, for an extra dollar, the complete set can be purchased, this is not too good a buy. Moiseiwitsch plays with sweep and assurance; a brilliant performance, stylistically secure, slightly muffled in sound. Novaes is quite different. She is the deftest of the pianists who have undertaken the B minor Scherzo, and her performance is light and sure-fingered. Unfortunately it is on a disk containing an indifferent interpretation of the Op. 10 Etudes. Of the two Horowitz attempts I prefer the one on LM 6014, which is somewhat slower than its companion, but which is also more carefully shaped and more natural-sounding. Rubinstein remains my first choice, in any event.
 —Artur Rubinstein. RCA VICTOR LRM 7015. 10-in. \$2.98 (with *Scherzo No. 2; Nocturnes in B and G*).
 —Benno Moiseiwitsch. RCA VICTOR LBC 1038. 12-in. \$2.98 (with *Preludes Nos. 11-24; Scherzos 3 and 4*).
 —Guiomar Novaes. VOX PL 9070. 12-in. \$5.95 (with *Etudes, Op. 10*).
 —Vladimir Horowitz. RCA VICTOR LM 6014. Two 12-in. \$7.96 (in 25th Anniversary Album).
 —Vladimir Horowitz. RCA VICTOR LM 1707. 12-in. \$3.98 (with Chopin miscellany).

NO. 2, IN B-FLAT MINOR, OP. 31 (1 Edition)
 Like the Scherzo No. 1, this version is identical with the one Rubinstein plays in his integral set. If, for some reason, you are interested only in the B-flat minor Scherzo, get this by all means. Otherwise the four scherzos on LM 1132 are the better buy.
 —Artur Rubinstein. RCA VICTOR LRM 7015. 10-in. \$2.98 (with *Scherzo No. 1; Nocturnes in B and G*).

NO. 3, IN C-SHARP MINOR, OP. 39 (6 Editions)
 Several excellent versions are available, including of course Rubinstein's, which has already been discussed above. Barere's fleet performance, is tremendously effective. He could be very elegant when he wanted to. Here the notes roll deliciously off his fingers, and in the coda he is sensational. Low-level recording, prominent surfaces. Novaes plays with her expected imagination and flair, and with utmost beauty of tone. Moiseiwitsch is stronger and fuller, and equally poetic. When in practice he is one of today's great Chopinists, and here he is in admirable fettle. The Levitzki is a collector's reissue, originally recorded in the early 1930s. The C-sharp minor Scherzo was one of this fine pianist's specialties; I must have heard him play it at least five times. He presents a well-turned job that builds to an exciting climax. Arrau's recording also was taken from shellac and is inferior in sound. His strong playing is more convincing than in the recent Decca set. Even here, however, he refuses to let the line flow naturally. Katchen does not belong in this company of giants.
 —Guiomar Novaes. VOX PL 7810. 12-in. \$5.95 (with Chopin miscellany).
 —Benno Moiseiwitsch. RCA VICTOR LBC

1038. 12-in. \$2.98 (with *Preludes 11-24; Scherzos 1 and 4*).
 —Simon Barere. REMINGTON 199-17. 12-in. \$1.95 (with *G minor Ballade* and Liszt pieces).
 —Mischa Levitzki. RCA VICTOR LCT 1038. 12-in. \$3.98 (with Chopin miscellany).
 —Claudio Arrau. DECCA DL 8517. 12-in. \$3.98 (with Chopin miscellany).
 —Julius Katchen. LONDON LS 554. 10-in. \$2.98 (with *F minor Fantasy; Ballade No. 3*).

NO. 4, IN E, OP. 54 (1 Edition)
 I can imagine a different type of performance than that which Moiseiwitsch brings to the Fourth Scherzo, but I cannot think of a better one. This is a model of controlled, glittering piano playing. The recorded sound is a little thick in the bass, like that of so many piano recordings, but is otherwise clear and well detailed.
 —Benno Moiseiwitsch. RCA VICTOR LBC 1038. 12-in. \$2.98 (with *Preludes 11-24; Scherzos 1 and 3*).

SONATA FOR CELLO AND PIANO IN G MINOR, OP. 65 (1 Edition)
 Now that the Kurtz-Balsam version has been discontinued, Piatigorsky and Berkowitz have the field to themselves. They combine for a fluent reading, one that contains the necessary Romanticism. Originally released in 1949 to commemorate the centenary of Chopin's death, the recording features the cello over the piano, which is too far in the background and poorly reproduced to boot. The music is not as bad as its neglect would lead one to

assume, and there are some remarkably imaginative touches to the writing. I have found that the work stands up very well.
 —Gregor Piatigorsky; Ralph Berkowitz. COLUMBIA ML 4215. 12-in. \$3.98 (with Schumann, Schubert, Fauré).

SONATAS FOR PIANO

NO. 1, IN C MINOR, OP. 4 (1 Edition)
 So far as I know, no other pianist since the invention of the phonograph has made a recording of the C minor-Sonata. In all truth, it is not a very interesting work, though there are some novel touches in the five-four movement; and in several places in the first movement the Chopin-to-come almost takes wing. Goldsand's performance is faithful and accurate. Excellent recorded sound.
 —Robert Goldsand. CONCERT HALL CHS 1150. 12-in. \$4.98 (with *Variations on "Là ci darem la mano"; Variations on a German Theme*).

NO. 2, IN B-FLAT MINOR, OP. 35 (12 Editions)
 Novaes, to this taste. She has the three T's—Technique, Tone, and Temperament. In the mysterious and enigmatic last movement she finds things in the way of inner voices that I have not heard since Hofmann was in his prime. Altogether, a superb achievement. Rubinstein's forceful statement of the music also is worth owning, though the recorded sound is beginning to show its age. Novaes receives much better recorded quality. The Casadesus performance I find neat, polite, and small-scaled. Unisjoy plays the notes and little more.

GEORGE WRIGHT plays the MIGHTY WURLITZER PIPE ORGAN

NEW RELEASE

available on both "HIFItape" pre-recorded tapes and "HIFirecord" long playing 12" records

George Wright is best known as Organist of the New York Paramount Theatre where for several years his artistry entertained throngs of New York theatre-goers. More recently he's doing Radio and TV work in Hollywood. The organ recorded is among the largest theatre pipe organs ever built by Wurlitzer with five manuals. Has tremendous dynamic range to show off your own "Hi Fi" equipment. An 8-in. x 10-in. photograph of both Mr. Wright and the Organ will be included with each order.

MR. WRIGHT PLAYS

Jalousie	Angela Mia	Stella by Starlight
Ebb Tide	Roller Coaster	Love for Sale
Caminito	The Boy Next Door	Dancing Tambourine
Boogie	Brazil	Stars and Stripes Forever

SEE YOUR LOCAL DEALER, OR ORDER BY MAIL

- 1. on 12-in. long playing Hifirecord \$ 4.95
- 2. on 15 I.P.S. full track Hifitape \$12.95
- 3. on 15 I.P.S. half track Hifitape \$ 8.95
- 4. on 7½ I.P.S. full track Hifitape \$ 8.95
- 5. on 7½ I.P.S. half track Hifitape \$ 6.95

above album prices include all 12 selections in 40 minutes playing time. postpaid and tax free. Dealer prices upon request.

to order
Simply enclose check or money order for correct amount with reference to above numbered High Fidelity Recording you want.

address
HIGH FIDELITY RECORDINGS, INC.
6087 Sunset Boulevard Hollywood 28, California

THESE ARE THE REASONS

why so many people are switching to THE MUSIC BOX'S unique Long Playing record mail order service:

- Every record guaranteed to be brand new, factory fresh and unplayed.
- Every record carefully inspected for visible imperfections, before mailing.
- Every record dusted, cleaned and enclosed in a polyethylene envelope . . . to lessen possible damage from dust, while in transit.
- Every record carefully packed to reach you in perfect condition.
- Orders over \$6.00 mailed to you POSTAGE FREE, anywhere in the U. S. A.
On orders below \$6.00, please add 40¢ for postage.
- Any LP record on any label. No substitutions made at any time . . . without your written approval.
- Fast, prompt and courteous service.
- The Music Box is not a regular retail store, but is devoted to mail order business exclusively. From picking to packing, all orders are handled with the greatest care, by one person only.
- Inquiries, questions or what have you on any matter pertaining to records cordially invited.
- All records sold at the manufacturers suggested list prices only. When ordering simply list records wanted (to avoid delay, list substitutes also) with your check or money order to cover. We regret we no longer will accept C.O.D. orders.
- New record prices are in operation as quickly as they are announced by the Record companies.

The Music Box

MAIN STREET
GREAT BARRINGTON, MASS.

Horowitz strives for big effects but merely manages to sound petulant. This is one of his least successful records. The veteran Yves Nat also strives for a big frame but is handicapped by lack of finger response. Backhaus is miscast here, and misses the passion of the music. His Teutonic muse strokes a lyre of a sort other than Chopin intended. I would avoid the Katcheo disk, which is glib, superficial, and in several spots actually annoying. Malcuzyński, both on Entré and Angel, I find incomprehensible. If this is good Chopin playing, then the great exponents of the past, like Hofmann and Rosenthal, were off on the wrong track. I find this playing spasmodic and intellectually unsettling. And yet Malcuzyński has temperament and the fingers of a great pianist. Too bad they don't fuse into something of greater artistic consequence. As for the Cortot version, one can only blush. The playing is a combination of anachronism and anarchism. While one is willing to pay respects to the memory of a great artist, there comes a point where a line must firmly be drawn. The Goldsand disk is mentioned here merely for the sake of completeness. It is one of Concert Hall's Limited Editions and probably will be hard to locate. The performance is not one that should spur you on to great endeavor.

—Guioamar Novaes. VOX PL 7360. 12-in. \$5.95 (with *Sonata No. 3*).

—Artur Rubinstein. RCA VICTOR LM 9008. 12-in. \$3.98 (with Debussy piano music).

—Robert Casadesu. COLUMBIA ML 4798. 12-in. \$3.98 (with 4 *Ballades*).

—Vladimir Horowitz. RCA VICTOR LM 1235. 12-in. \$3.98 (with Liszt piano music).

—Alexander Uninsky. EPIC LC 3056. 12-in. \$3.98 (with *Sonata No. 3*).

—Yves Nat. HAYDN SOCIETY HSL 97. 12-in. \$5.95 (with *F minor Fantasy; Barcarolle*).

—Wilhelm Backhaus. LONDON LLP 266. 12-in. \$3.98 (with *Beethoven: Sonata No. 30 in E*).

—Julius Katchen. LONDON LL 1163. 12-in. \$3.98 (with *Sonata No. 3*).

—Witold Malcuzyński. ANGEL 35032. 12-in. \$4.98 or \$3.48 (with *Sonata No. 3*).

—Witold Malcuzyński. COLUMBIA ENTRE 3031. 12-in. \$2.98 (with *Franck: Prelude, Chorale and Fugue*).

—Alfred Cortot. RCA VICTOR LHMV 18. 12-in. \$4.98 (with *Schumann: Carnaval*).

—Robert Goldsand. CONCERT HALL CH SPEC-52. 10-in. (with *Fantasy-Improvisu*). Limited Edition.

NO. 3, IN B MINOR, OP. 58 (7 Editions)
Three admirable versions are on the market. Novaes makes the most personal thing of the music, taking, in all truth, a good many liberties. But she has enough genius to make her own rules. The fine recorded sound does justice to her tone. Kapell here is represented by what I think is the greatest disk he ever made. This is a perfectly proportioned reading, brilliantly executed, sharply defined. What a master he would have developed into! Lipatti is the most sober of the trio. He plays the music "straight," with taste and polished execution. I find it a shade noncommittal and lacking in inner glow. The music would have grown on him had he lived. Nevertheless it is a tremendous achieve-

ment, and it's only because it's Lipatti that one automatically measures his disk against the highest of standards. The recording, British Columbia vintage 1947, lacks clarity. Try 78-rpm equalization with a highly reduced bass. Firkusny's performance is well-groomed, lacking excitement and, indeed, a sense of musical urgency. Uninsky is disappointing. He too does not seem to be able to bring the music to life. Everything is correct: nothing happens. Of the Malcuzyński and Karchen versions, see remarks in the discussion of the B-flat minor Sonata.

—Guioamar Novaes. VOX PL 7360. 12-in. \$5.95 (with *Sonata No. 2*).

—William Kapell. RCA VICTOR LM 1715. 12-in. \$3.98 (with 9 *Mazurkas*).

—Dinu Lipatti. COLUMBIA ML 4721. 12-in. \$4.98 (with Chopin miscellany).

—Rudolf Firkusny. COLUMBIA ML 2201. 10-in. \$2.98.

—Alexander Uninsky. EPIC LC 3056. 12-in. \$3.98 (with *Sonata No. 2*).

—Witold Malcuzyński. ANGEL 35032. 12-in. \$4.98 or \$3.48 (with *Sonata No. 2*).

—Julius Katchen. LONDON LL 1163. 12-in. \$3.98 (with *Sonata No. 2*).

TARANTELE, OP. 43 (1 Edition)

A rather charming work, minor Chopin, that here needs a slightly faster tempo and more sparkling finger work. Some of Balogh's attack sounds flurried. Good recorded sound.

—Erno Balogh. LYRICHORD LL 20. 12-in. \$5.95 (with Chopin miscellany).

TRIO FOR PIANO AND STRINGS, IN G MINOR, OP. 8 (1 Edition)

In effect, this work is a baby piano concerto with the piano getting the lion's share of the work and the most interesting figurations. The last movement, in Chopin's nationalistic vein, is quite charming. The trio seldom turns up in concert, and one is glad to have it on records. At the same time, one could wish for a superior performance. The polish of the writing scarcely comes through the determined playing of the Trio di Bolzano, nor is the tone of the violinist an adornment to contemporary fiddle playing. Keep your eye out for an eventual replacement.

—Trio di Bolzano. VOX PL 8480. 12-in. \$5.95 (with *Schumann: Trio in F*).

VARIATIONS FOR PIANO

ON "LA CI DAREM LA MANO," OP. 2 (3 Editions)

This is the work which introduced Chopin to the excited Robert Schumann, with the resultant famous "Hats off, gentlemen, a genius!" It was originally scored for piano and orchestra, and is thus played by Frugoni and Reinhardt. Goldsand plays the solo version, which once in a while turns up in concert, and I find his playing preferable. He gets more nuance and flexibility than Frugoni (the Reinhardt is an aberration that never should have been released). Goldsand takes a sizable cut in the introduction. Frugoni is complete, but his pianism has little charm, while some of the variations, such as the third, are almost a scramble. The supporting orchestra sounds thin. There is room for a version of the score in its concerted form, but this does not fill the bill.

—Robert Goldsand. CONCERT HALL CHS 1150. 12-in. \$4.98 (with *Sonata No. 1* and *Variations on a German Theme*).

—Orazio Frugoni; Pro Musica Orchestra, Hans Swarowsky, cond. VOX PL 9030. 12-in. \$5.95 (with *Krakowiak; Andante Spianato and Polonaise; Liszt: Totentanz*).

—Rolf Reinhardt; Pro Musica Orchestra conducted by the pianist. VOX PL 7530. 12-in. \$5.95 (with *Andante Spianato and Polonaise; Variations, Op. 12*).

ON A GERMAN THEME (1 Edition)

Chopin composed this in 1824, at the age of 14. No opus number attaches to this youthful effort, and the work is of mainly historical interest. The composer based his variations on a German song named *Der Schweizerbub* ("The Swiss Boy"), a naïve melody with yodel-like characteristics. Goldsand plays conscientiously. Excellent recorded sound.

—Robert Goldsand. CONCERT HALL CHS 1150. 12-in. \$4.98 (with *Sonata No. 1; "Là ci darem" Variations*).

ON AN AIR BY HEROLD, OP. 12 (2 Editions)

The air is *Je vends des scapulaires* from Hérold's *Ludovic*. Hérold was a very successful opera composer of the day. Goldsand plays neatly but with a singular lack of tension. Granted that the music is no heavyweight; but there is more to it than Goldsand conveys. At that his performance takes precedence over Reinhardt's heavy fumbling.

—Robert Goldsand. CONCERT HALL CHS 1133. 12-in. \$4.98 (with *Etudes, Op. 25*).

—Rolf Reinhardt. VOX PL 7530. 12-in. \$5.95 (with *Andante Spianato and Polonaise; "Là ci darem" Variations*).

WALTZES

COMPLETE (5 Editions)

Several highly contrasting pianists, several highly contrasting views of the waltzes. Novaes achieves the most swinging and gracious quality, using plenty of rubato, sounding entirely relaxed, bringing a highly personal quality to her playing. Lipatti is much more strict. He takes very few liberties, and, while his playing is to be admired for its clarity and straightforward rhythm, he does not fully capture the spontaneity of the music. Dorfmann receives admirable recorded sound—the best of all the versions under consideration—and offers lyric, tasteful interpretations. Her low-priced disk is hard to ignore. Is the Novaes disk worth twice as much? I wouldn't think so, much as I admire the performance. To my taste, neither Brailowsky nor Pennario can compete. Both are stiff and uninteresting, and both hit the piano in a percussive manner.

—Guiomar Novaes. VOX PL 8170. 12-in. \$5.95.

—Ania Dorfmann. RCA VICTOR LBC 1050. 12-in. \$2.98.

—Dinu Lipatti. COLUMBIA ML 4522. 12-in. \$3.98.

—Alexander Brailowsky. RCA VICTOR LM 1082. 12-in. \$3.98.

—Leonard Pennario. CAPITOL P 8172. 12-in. \$4.98.

INDIVIDUAL WALTZES

A large grouping of Chopin waltzes is

contained on RCA VICTOR LHMV 1032 (12-in.), played by Alfred Cortot—A minor (Op. 34, No. 2), D-flat (*Minute*, Op. 64, No. 1), C-sharp minor (Op. 64, No. 2), A-flat (Op. 69, No. 1), G-flat (Op. 70, No. 1), and F minor (Op. 70, No. 2). These are leisurely, scented performances, with many mannerisms and false notes unique to pianists of Cortot's generation. The recorded sound is not very good. The greatest single performance I have ever heard of a Chopin waltz is played by Josef Hofmann on COLUMBIA ML 4929 (12-in.)—the A-flat Waltz (Op. 42); and he also plays the *Minute* Waltz deliciously. Cor de Groot also has a *Minute* Waltz, soberly played, on EPIC LC 3037 (12-in.), along with the popular C-sharp minor. Still another *Minute* is played with obvious relish by Novaes on VOX PL 7810 (12-in.). And one more *Minute*—that played by Nikita Magaloff on LONDON LS 532 (10-in.) in a thoroughly competent manner. Magaloff, on this disk, also is heard in the C-sharp minor and the A-flat (Op. 64, No. 3). In addition to the above C-sharp minors, there are the following to consider: Horowitz on RCA VICTOR LM 1137 (12-in.), Rachmaninoff on RCA VICTOR LCT 1038 (12-in.), and Jonas on COLUMBIA ML 4476 (12-in.). Rachmaninoff is lyric, Horowitz severely lyric, Jonas sentimentally lyric. On her disk Jonas also plays the B minor Waltz (Op. 69, No. 2). And on COLUMBIA ML 2004 (10-in.) she plays the Waltzes in G-flat (Op. 70, No. 1) and D-flat (Op. 70, No. 3). Plenty of style is present if you can accept her eccentric ideas.

Breaking the Sound Barrier in Music!

Tape Recorder Music

by
Luening • Ussachevsky

Sonic ranges extended by using the tape recorder as a musical instrument! First time on disc!

Illustrated Brochure • Deluxe Package
1-10" longplay record \$4.75

INNOVATIONS

gene bruck enterprises
853 ninth ave., new york 19, n.y.



THE 10/12 LP FILER

Keeps 24 of your favorite LP's handy. Completely portable. Albums individually suspend and index.

\$2.50 ea. plus 35c for postage, handling.
MISSOURI NATIONAL CORPORATION Dept. 1-H
P.O. Box 1974, Meremac Station, St. Louis 18, Mo.
(Filer for '45's also available at \$2.25 Post Paid)

Record Market

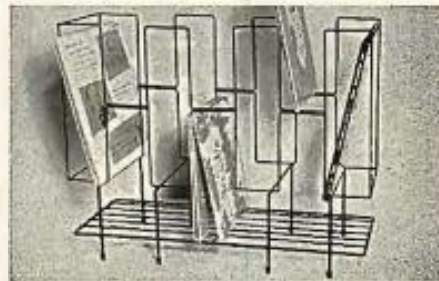

WROUGHT IRON RECORD RACK

Holds 200 12" or 10" long-playing records. Also accommodates 70 RPM albums. Black finish with rubber tips to protect your furniture. Size 21 1/2" high, 25" long, 9 1/2" deep. Sturdy construction. Ten separate sections allow for ideal storage of music by style, composer, artist, or label. Please remit with order. Satisfaction Guaranteed or Money Refunded. Shipped Express Collect. **\$9.95**

JOHN LESLIE, JR., 2116 Robbins St. Dept. 289 Phila. 49 Pa.

CHICAGO'S

Hi-Fi Record
Headquarters

101 labels—featuring
Audiophile and Cook

DUBLIN'S

203 W. Wacker Dr., Chicago 6, Ill.

Protect
Your HI-FI
Records
Against
DIRT,
DAMPNESS,
DUST . . .



• with Polyethylene, Protective
• PLASTIC COVERS

• Keep your valuable records free from dust, scratches, finger marks, spilled liquids, etc.
• PLASTIC COVERS are transparent, durable, slip over records and inside jackets

• Twelve 12" size OR Eighteen 10" size
• ONLY \$1.00. 10% discount with \$5 orders.

Dealer Inquiries Invited

CALEX CO. 4215 Troost Ave., Dept. F6,
No. Hollywood, California

"THE STORY OF JAZZ"

A New FOLKWAYS Records Release

"TOPS" High-Fidelity Mag.,
Downbeat, N. Y. Times
Narrated by Langston Hughes

with Documentary Recordings, Text.

1-10" longplay FP712 (\$4.25 list)

write for complete catalog

The MUSIC ROOM

129 West 44th St., New York 36, N.Y.

FM Antenna Installation

Questions and Answers

by L. F. B. CARINI

Mr. Carini, Director of Research for LaPointe Electronics, Inc., is possibly the only antenna engineer extant having a Jaguar, a 16-speaker music system, and a wife who knows (and cares) as much about hi-fi sound as he does. As if all this weren't enough, he can write with clarity on technical subjects; he answers here several reader's questions concerning FM antenna installations.

Q. 1: When listening to FM, I am conscious of an annoying "frying" noise which is very aggravating because it is audible in the background. I am told that this may be interference radiated by a power line that passes a short distance from my home. However, the noise seems to be present only in dry weather and disappears whenever it is wet or raining. Will stacking two Yagis sufficiently increase the signal strength to overcome the interference?

Ans.: Considering the observations noted, the interference is undoubtedly to be attributed to leakage in a high voltage power line. An electrostatic or corona discharge would necessarily occur in dry weather only because it is effectively damped out whenever it is raining. Usually this kind of trouble will be caused by a loose tie wire at the insulator which supports the line in suspension.

The problem is one that can only be corrected by the utility company and, of course, unless formal complaints are registered, the condition may otherwise escape notice and continue to radiate interference to the annoyance of many unsuspecting listeners. Because it is possible for a high voltage line to radiate this noise for many miles, enquiries made of others in the neighborhood will help to establish such suspicions. Invariably, the power company when so informed will make a co-operative effort to track down the source of trouble and take necessary measures to correct the situation.

Background noises that sound like "frying" may also be caused by the normal operation of heating pads, fluorescent lights, electric blankets, and other appliances. This annoyance can be suppressed by attaching small "interference eliminators" which provide a ground return circuit to bypass the noise component in the AC line.

Q. 2: I have found that both tubular and open wire line are difficult to work with in the home. Is there a special knack of handling it that will simplify installation indoors?

Ans.: Where the lead-in is brought into the home for a

considerable distance, several methods may be used to facilitate its distribution. The rigid line may be terminated at the lightning arrestor mounted on the window sill. A length of flat ribbon line is then attached as the continuing lead-in into the house and to the tuner. The most important requirement is to make certain that correct impedance matching is maintained.

Also, there are wall feed-through tubes available that are made especially for the purpose of conveying the line through a wall or partition.

Q. 3: What should I use for a mast for stacking BBFMs and how high above the roof top should the lower antenna be located?

Ans.: While aluminum, steel, and magnesium are all used, the preferred mast is one made of drawn aluminum tubing. Magnesium is subject to oxidation and is especially vulnerable to rapid deterioration when employed in a saline atmosphere. Steel tubing or conduit imposes an additional weight factor and, because it is usually painted or plated, will eventually rust.

Use a seamless aluminum tube having at least a 1/16-inch wall and a 1 1/4-inch diameter and of sufficient height to provide support for the antennas when spaced according to the manufacturer's directions. FM Yagis are usually spaced 5-ft. apart when stacked. Allow 2 ft. at least, preferably more, between the lower antenna and the roof top.

Q. 4: Some months ago I obtained a ten-element Yagi for my FM. I notice that a number of stations come in better on the side and the back than on the front. Could it be that its efficiency is impaired because the two driven elements are not properly linked together?

Ans.: The efficiency of an antenna is not necessarily determined by the number of elements that are employed. A well-designed antenna utilizes only the minimum number of elements necessary to yield optimum performance. For example, an eight-ele-

Continued on page 92

Revere's exclusive

Balanced Tone

makes the difference

in the brilliant high fidelity of

Revere TAPE RECORDERS

The incomparable high fidelity and rich tonal quality of Revere Tape Recorders is the direct result of a Revere exclusive, patented feature. "Balanced-Tone" is the control that coordinates amplifier and acoustic system response to emphasize both high and low tones, giving strikingly realistic HIGH FIDELITY sound reproduction, even on low volume. Compare and you'll choose REVERE!

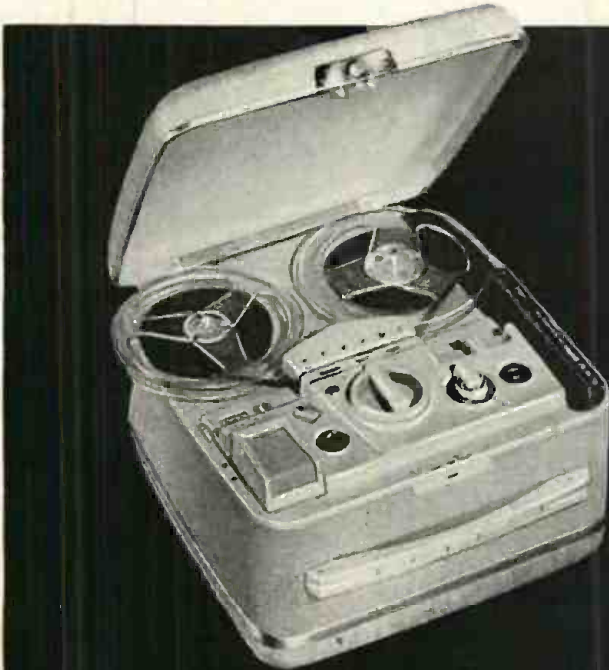

T-1100 DUAL-SPEED CONTEMPORARY. Single knob control, 3-hour play, two matched speakers, 360° sound distribution. FREQUENCY RESPONSE: 3.75 i.p.s. 85-7,000 ± 3DB; 7.5 i.p.s. 75-12,000 ± 3DB. WOW 0.3% Max. With microphone, radio attach. cord, tape, reels, \$159.50



T-700-D DUAL-SPEED DELUXE. Records up to 3 hours with long-play tape. Automatic keyboard controls; index counter. FREQ. RESPONSE: 3.75 i.p.s.—40-7,500 ± 3DB; 7.5 i.p.s. 40-14,500 ± 3DB. WOW 0.3% Max. With microphone, radio attach. cord, tape, reels, \$212.50



Announcing REVERE T-11 CUSTOM RECORDER

For professional use and custom home installation. Accurate 7.5 i.p.s. tape speed. Solenoid operated keyboard push-button control. Revere patented automatic head demagnetization. Two-level recording indicator. Index counter. Accepts 3, 5, 7 and 10 1/2-inch reels. Monitor amplifier with 2 1/2 watt output; cathode follower output, 2200 ohms at 1 volt. With reel adapters and plugs \$264.50

FREQ. RESP. 40-16,000 ± 3DB
WOW AND FLUTTER less than 0.2%

REVERE CAMERA COMPANY • CHICAGO 16, ILLINOIS

*The preference for Revere
by artists of renown is your
guide to recorder selection.*



ARTUR RUBINSTEIN
noted pianist



MARIAN ANDERSON
famed soprano



ANDRES SEGOVIA
foremost guitarist



ZINO FRANCESCATTI
brilliant violinist



ROBERT CASADESUS
piano virtuoso



LAURITZ MELCHIOR
great Wagnerian tenor

FM ANTENNA INSTALLATION

Continued from page 90

ment Yagi (such as the BBFM) may easily outperform a ten-element Yagi by virtue of its better design. Because of the number of director elements used, a ten-element Yagi necessarily has but 10 percent spacing between them, whereas much better gain is achieved in an antenna that has only eight elements but employs 20 percent spacing. Likewise the number and placement of directors in relation to the overall design also influences the front-to-back ratio (discrimination between station pick-up from the front to that at the rear) so that a poorly designed antenna may not provide adequate rejection effectively to eliminate station pick-up from the sides and the back. In other variations, an incorrectly linked coupling harness interconnecting the two driven elements will introduce a phase error and reduce the overall efficiency of the antenna.

Q. 5: How far apart should an FM antenna be separated from a TV antenna when both are to be mounted upon the same mast?

Ans.: It is generally safe to allow at least 2 ft. of space between the antennas. Impaired reception would result from antennas that are operated too close together. Sufficient space should therefore be allowed to prevent interaction between bays. Also, avoid running the lead-in lines close together, try to keep them as far apart as possible when attaching stand-off insulators to the mast.

Q. 6: To what particular advantage may I use a rotator with my FM antenna?

Ans.: A rotator is not recommended for use with either an omni-directional antenna or one that is specifically cut to the exact frequency of a given station.

However, depending upon your receiving location, the FM stations within your range of reception, as well as the type of antenna that is employed, a rotator may prove of indispensable aid in solving difficult interference. The most prevalent form of interference is that experienced when two stations cannot be separated despite careful tuning. It is essential in this case to use a uni-directional antenna. Such an antenna is the Yagi, whose narrow forward lobe can selectively "spot" the desired station by a sense of direction and frequency. By analogy, this selectivity may be compared to a spotlight whose narrow beam of light is easily focused and concentrated upon one particular object to the complete exclusion of all others. By "searching," or moving the beam, different objects may be brought into focus. In like manner, a Yagi antenna operated and made maneuverable by a rotator can be turned about to discriminate between one station and another.

Q. 7: I have a built-in cabinet housing both an FM tuner and TV, the latter capable of receiving UHF stations as well. We now have a UHF station which I would like to pick up. However, as this will re-

quire another antenna, can you suggest a solution that will not entail cluttering up my house roof with a maze of antennas?

Ans.: There have recently become available very efficient all-channel VHF UHF antennas, such as the VEE-D-X Super Chief, which was designed especially for situations of that sort. The antennas employ a single lead-in, are compact enough to give a neat appearance, and are actually capable of top performance on all TV channels from 2 through 83.

For FM, the broadband Yagi is unsurpassed and should be employed in addition to the TV antenna. Both antennas may be mounted on one mast provided that they are at least 24 inches apart (see Q. 5).

Q. 8: My problem lies in the fact that I am getting much local interference from the electrical apparatus of a nearby hospital. Do you think that a shielded cable would be of any value in reducing this interference?

Ans.: Most electro-medical hospital equipment causes serious interference to radio and TV reception, often worse than that produced by large industrial plants. It is a form of interference that is noticed throughout an entire neighborhood; it is particularly difficult to suppress because it can only be corrected at the source.

Unless it is possible to locate the antenna outside the noise zone, no significant benefit is to be gained from the use of a shielded lead-in. This type of lead-in is commonly employed in cities for apartment installations where the antenna is erected high above the building, at which location there is relatively little or no noise. A shielded lead-in will then prevent noise inducements into the line (as generated by electrical equipment within the building) as it passes down to the tuner. A great disadvantage of this type of line is the large insertion loss (due to capacity effect) that results in an attenuation of the signal strength. It is permissible in large cities for apartment installations because the stations are usually nearby and there exists a very strong signal which readily overcomes this loss.

Q. 9: If the antenna is already grounded, why should a lightning arrestor also be attached to the lead-in?

Ans.: The antenna is separately grounded as protection against lightning which may strike the antenna during an electrical storm just as it does a lightning rod on a chimney stack. The lightning arrestor (this is a misnomer) is attached to the lead-in to dissipate the accumulating static charges that build up on the antenna. It serves as a high resistance path to ground and by-passes the potential by neutralization with the earth. This averts damage to the tuner components but does not affect the passage of the FM signals carrying the program.

To protect the security of both lives and property (and your hi-fi equipment, too) make certain that the antenna is properly grounded and that a good lightning arrestor is attached to the lead-in line. The lightning arrestor, of course, must also be provided with a ground connection.

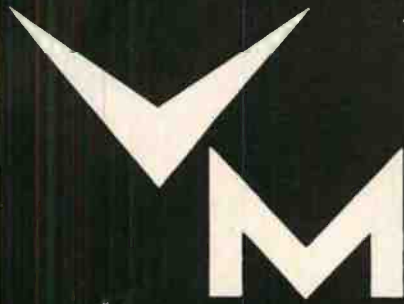

An Authentic High in Musical Pleasure



the Voice  of Music
Model 1200

- at a Down-to-Earth PRICE!

Your finest records will sound unbelievably life-like as they are played with *authentic* high fidelity on the new V-M 1200. See this outstanding new model, the *first* high fidelity changer ever offered at such a *low cost*! V-M Model 1200 features numerous Voice of Music exclusives too!

- New 4-speed direct drive mechanism
- Easy-Lift support arm for front-loading convenience
- All-weather ceramic*, two-needle cartridge
- Rumble-free . . . minimum wow . . . constant speed performance
- and many, many more!

Available on matching base pan as Model 1225.

* GE variable reluctance cartridge available.

The 1200 must be auditioned to fully appreciate its true value. Then you will realize it can bring complete, lasting pleasure—at a "why-pay-more" price!

V-M CORPORATION • BENTON HARBOR 1, MICHIGAN



WORLD'S LARGEST MANUFACTURER OF PHONOGRAPHS AND RECORD CHANGERS

He was there too...

Only he didn't buy a seat. He can hear the same music anytime in its fullest quality from his easy chair at home with his new Concertone 20/20 Stereo-monaural Recorder, Model STW-4.

Aside from giving music lovers and sound enthusiasts an unsurpassed engineering achievement in the reproduction of sound, the new Concertone 20/20 Stereo-monaural Recorder offers UNMATCHED VERSATILITY IN THE RECORDER FIELD. By using a combination of four heads and two amplifier units, this machine acts as two independent recorders using a common reel of tape with the two channels capable of being operated separately or in conjunction with each other. Its list of functions, both the ordinary and extraordinary, include:

- Stereo-binaural recording ("stacked" heads)
- Recording on channel 1 only • Recording on channel 2 only
- Recording two different signals simultaneously
- Dual track recording (one track in each direction)
- Single track recording (identical signals on both channels)
- Playing back single, dual track or binaural recorded tapes
- "Sound-on-sound" recording (Previously recorded tracks are not erased when new signal is added, so mistakes do not necessitate starting over. Particularly valuable for those who practice with recorded accompaniment)

Hear it at your nearest dealer or write for brochure 4MY.

MORE THAN EVER... "JUST LIKE BEING THERE."

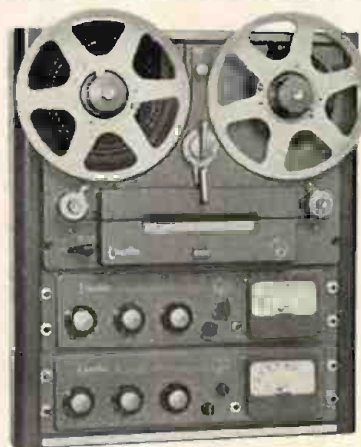

\$695 IS THE USER'S NET FAIR TRADED PRICE.

Berlant  *Concertone*

4917 West Jefferson Blvd., Los Angeles, California
Audio division of American Electronics, Inc.
Manufacturers of Berlant studio recorders
and accessories.

TESTED IN THE HOME



These reports may not be quoted or reproduced, in part or in whole, in any form whatsoever, without written permission from the publisher. Because of space limitations we normally attempt to report only on products of wide general interest. Thus, omission does not, per se, signify condemnation, although reports are seldom made on equipment that is obviously not reasonably high in fidelity. — Each report is sent to the manufacturer before publication; he is free to correct the specifications paragraph, to add a comment at the end, or to request that the report be deferred (pending changes in his product) or not published at all. He is not permitted, however, to amend or alter the report.

Scott 210-C Amplifier

SPECIFICATIONS (furnished by manufacturer): a compact 23-watt amplifier with preamp-equalizer and control sections in same case. **Inputs:** one equalized channel for phono cartridges, with input jacks for magnetic and constant-amplitude types; three high-level inputs marked for tuner, tape, and TV. Monitor input direct to power amplifier section. **Controls:** combined selector switch and variable record compensator, with eight equalization positions for phono channel; Dynaural noise suppressor control; noise suppressor and filter switch (Range); Bass (± 15 db, 50 cycles); Treble ($+15$ to $-17\frac{1}{2}$ db, 10,000 cycles); Loudness (or volume); loudness compensation on-off switch; AC power on-off switch. Hum and tube balance adjustment at back of chassis; pickup level adjustment for Dynaural noise suppressor under chassis. **Outputs:** 2, 4, 8, or 16 ohms to speaker; low-impedance output to tape recorder, unaffected by noise suppressor, tone and volume controls; high-impedance output to tape recorder, affected by noise suppressor and tone controls but not volume control. **Power output:** 20 watts long-time continuous; 23 watts short-time continuous on music; 46 watts peak instantaneous. **Distortion:** less than 0.5% harmonic at full power; less than 0.1% first-order difference tone IM. **Noise:** better than 80 db below full output. **Tubes:** 3-12AU7, 3-12AX7, 6AL5, 2-6L6G, 5V4. **Dimensions:** $14\frac{1}{2}$ in. wide by 4 high by 13 deep. **Price:** \$172.50. **Manufacturer:** H. H. Scott, Inc., 385 Putnam Avenue, Cambridge, Mass.

The 210-C Dynaural amplifier combines a good 23-watt amplifier with what is probably the most elaborate pre-amplifier-control setup ever offered in this form. In many ways, the 210-C's front end is even more versatile than Scott's super equalizer-preamp, the 121-A, and is very little larger.

There is still only one phono channel, to be sure, and three high-level channels rather than five. These will be enough for all but unusual installations. The selector switch has eight positions for the phono channel; in three are furnished curves particularly suitable for 78-rpm records, marked European, RCA-London, and Columbia. Five curves are furnished for microgroove records: Special (has RIAA turnover and very little rolloff), London, Old AES, RIAA-NARTB-Ortho, and Original Columbia. This is certainly a wide and well-considered selection. Incidentally, there is a difference in gain between the 78 and microgroove positions so as to compensate for the difference in pickup output levels — a clever idea, and a practical one. A comprehensive table of record labels and recommended equalization curves is given in the instruction book.

Dynaural noise suppressor and filter circuits are effective on all input channels. These are the same controls

and circuits described in the recent (November 1954, page 93) report on the Scott 121-A. Properly operated, they can be used to good advantage in eliminating radio interference and tape noises, as well as record pops and scratch. Bass and treble tone controls can be called normal except that they provide for perfectly flat response in their zero settings; they are then effectively not in the circuit at all. Most standard tone controls balance the boost circuit against the attenuation circuit in the middle position, which often results in a response peak or dip. As in the 121-A, these controls do not cause ringing on transients.

Loudness compensation, which can be switched in or out by a front-panel control, is less drastic than called for by Fletcher-Munson curves; to our ear, it is much more pleasant than full compensation.

The 210-C is out in front in the matter of facilities for operation with a tape recorder. There are two signal takeoffs for feed to a recorder; one, of low impedance, is ahead of noise suppressor, tone and volume controls. A flat signal can be fed the recorder in this way, while the rest of the amplifier is used to drive a monitor speaker, and the settings of these controls will not disturb the recorder's signal. But if you want to dub some old records to tape you'll want to use the noise suppressor and possibly the tone controls. Very well, there's another output jack that is connected just ahead of the volume control — the signal at that point is affected by the NS and tone controls, and you can use that to feed a recorder. Now, suppose you have a three-head recorder from which you can monitor instantaneously the signal that's going on the tape. Connect a lead from the monitor or output jack on the recorder to the pin-jack receptacle on the 210-C that is marked "Monitor" and you plug into

The Scott 210-C — flexible and capable, powerful but compact.

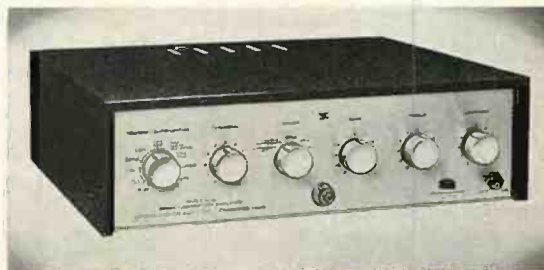

the power amplifier section directly; the connection from the 210-C's preamp-control section to the power amplifier section is broken automatically. Neat! You are then using the front end to handle one signal and the amplifier for another (you needn't plug the monitor signal from the recorder into that connection if you don't want to — you could, of course, dub records while listening to something else, by plugging the audio from a tuner into the Monitor jack). The instruction book shows several possibilities for using these connections to keep a recorder permanently hooked into the system.

With flexibility such as this, and a powerful, clean, and capable amplifier to boot, the 210-C is quite a package. It is designed so that it can be used out in the open; the metal case is perfectly presentable. A panel-mounting escutcheon is available too, if you want to enclose the unit. That \$172.50 price tag, which looms large when you get a first glance at it, seems like a bargain after closer examination. Scott has reason to be proud of this amplifier. — R. A.

V-M Model 700 Tape Recorder

SPECIFICATIONS (furnished by manufacturer): Tape-O-Matic model 700 is a portable self-contained recorder with built-in playback amplifier and speakers. Twin track, $7\frac{1}{2}$ and $3\frac{3}{4}$ ips, handles up to 7-in. reels. **Inputs:** one for microphone, radio, high-level phono and TV; one for magnetic phono. **Outputs:** normal output goes to internal speaker system (5 by 7-in. woofer and $3\frac{1}{2}$ -in. tweeter); also two external speaker jacks, one of which disconnects internal speakers. **Noise level:** better than 45 db below signal level. **Accessories:** one 7-in. reel of tape; one empty 7-in. reel; microphone (60 to 10,000 cycles, ± 5 db); adaptor plug for high-level inputs. **Controls:** described in text. **Dimensions:** $9\frac{1}{2}$ in. high by 16 wide by $11\frac{1}{2}$ deep. **Weight:** 30 lb. **Tubes:** 5879, 12AX7, 2-6V6, 5Y3GT. **Price:** \$179.95, list. **Manufacturer:** V-M Corporation, Benton Harbor, Mich.

The V-M 700 recorder appears to be well made and is designed for easy, foolproof operation; it has several convenience features unusual at its price. Sound is fair to good, about what you'd expect in a competitive package recorder. It would appear, accordingly, to be an excellent buy for anyone whose primary interest is not high fidelity sound as such, but who wants a dependable portable unit for miscellaneous recording.

Main operational controls are of the mechanical push-button type. From left to right, below the head shield, they are labeled Rewind, Record, Stop, Play, and Forward. We found the Forward (fast wind) time on our test unit to be 2 min. for a 1,200-ft. reel; Rewind time was 1 min. 45 sec. These push-buttons are not interlocked. You can go directly from Rewind to Forward or vice versa, and from Play or Record to Forward or Rewind without pushing the Stop button first. On our unit we couldn't make the tape break by doing any of these things, which is good; we don't know whether or not this is true of all production units. In any case, it's always safer to push the Stop button before changing tape motion or speed. In the Stop position, incidentally, the drive mechanism is disconnected; the Stop button should be depressed whenever the machine is not being used. The cover cannot be closed unless the Stop button is down; good feature.

Just to the left of the push-button bank is the record safety lever, which must be deflected before the Record push-button can be operated. This is to prevent unintentional erasure of recorded material, which might occur if it were possible to push the Record button accidentally. The safety lever and the Record button can be operated simultaneously, if necessary, with one hand. To the right of the push-button bank is the recording indicator, consisting of two neon lights. One light goes on when the Record button is pushed down, serving as a warning that the erase oscillator is activated. The other light flashes whenever the recording level is high enough to cause distortion. Next to the indicator, logically, is the volume level control. And just above that is a control which, when pushed up, stops tape motion momentarily or permanently — it can be locked in the upper position by pushing it to the right also. This permits proper setting of recording level before actually recording: you lock the Pause button in its upper position, depress the Record button, and set the volume control to the point at which the distortion indicator just blinks on the loudest peaks of sound. Then, when you're ready to record, push the Pause button to the left and release it. The tape starts and you're recording. You can skip anything you don't want to record (such as a commercial in a radio broadcast) by pushing the Pause button again. A handy button.

The speed change knob is on the head shield. It's relatively hard to turn, so that you can't do it accidentally, but it has a slot large enough so that you can use a coin to turn it to $3\frac{3}{4}$ or $7\frac{1}{2}$ ips.

There's a timer index to the left of the push-button group, and a chart is furnished to translate the timer readings to minutes of recording. Farther on the left are concentric bass and treble controls; they are in the circuit on playback only, and have maximum boosts (relative to their counterclockwise positions) of 10 db at 50 cycles and 6 db at 8,000 cycles. The AC power switch for the recorder is combined with the treble control. Concealed controls, for use if you know what you're about technically, are furnished for hum null, bass boost limit, and distort-light sensitivity.

On the right side of the machine are two phone-jack inputs. One is for a magnetic phono cartridge, and is properly equalized for that purpose. The other is for a micro-

Continued on page 98



The V-M 700 — not quite hi-fi, but a good buy nevertheless.

HERE'S the all NEW HORIZON *Criterion* AM-FM TUNER



NEW

Calibrated
FM and AM
logging
scales



THE exciting NEW Criterion AM-FM tuner advances the art of receiver design to a NEW frontier in radio reception. Its Criterion predecessor began a revolution in the design of AM-FM tuners which is now brought to a rich fulfillment of perfection. Only a company with National's more than 40 years' reputation for technical excellence in receiver design and performance could accomplish such rapid strides in bringing you an improvement on the best.

For the *cleanest* sound and appearance, for the *greatest* in sensitivity, for the *finest* in performance, the NEW Criterion AM-FM tuner can be your *only* answer.

Compare these features combined in the NEW Criterion and found together in no other AM-FM tuner—

- Flush mounting
- Binaural or simultaneous AM-FM tuning and reception
- Drift free reception
- Mutamatic tuning
- Flexibility—the same unit is available with or without plug-in preamp
- Greatest sensitivity of any receiver
- .8 capture ratio—makes sensitivity usable for fringe area reception . . . areas formerly inaccessible to FM can now receive quality FM signals
- FM multiplex output
- Handsome styling and cabinetry
- Simple assembly of completely integrated units

NEW

- “Lock-in” tuning—broad & non-critical. When you hear program the station is perfectly tuned—without meters, eyes or other complicated tuning indicators—the only non-critical tuning unit on the market.
- Wide range—adjustable Mutamatic*
*An exclusive National feature that eliminates all hiss and noise when tuning between stations. Music leaps out of velvety silence and stays locked in.
- Incomparable AM & FM selectivity—complete adjacent channel rejection.
- Superb stability both long and short term.
- Completely Hi-Fi AM reception—distortionless and burble free—
- The greatest sensitivity of any AM-FM tuner . . . plus
- .8 capture ratio—rejects all interfering signals up to 80% as strong as the desired signal—making signals “ghost” or “reflection” free.

†Pictured with plug in pre amplifier

tuned to tomorrow

National

NATIONAL COMPANY, INC.
61 SHERMAN ST., MALDEN 48, MASSACHUSETTS

TESTED IN THE HOME

Continued from page 96

phone; inserting a plug in this jack opens the magnetic phono channel automatically. An adaptor input plug (supplied) permits use of the microphone input for any high-level source such as a radio or TV tuner. There are two similar jacks on the left side of the recorder; these are for connection of external speakers. Plugging the lead from an external speaker into one of the jacks disconnects the internal speaker system and replaces it with the external one. This jack, therefore, is affected by the speaker on-off (Monitor) switch, above the treble and bass controls, just as the internal speakers are. The other jack is connected directly to the amplifier output, bypassing the switch, and when it is used the internal speakers are not disconnected.

Among other good points are a pilot light on the front of the case that can be seen across a room; an automatic shutoff switch that operates if the tape should break or become fully wound on one reel; and the utility of the amplifier circuits and speaker system apart from the recorder mechanism (they can be used as a PA system, for example). As we said at the beginning, we like the mechanical design and convenience features of this unit, and consider the electrical performance adequate at the price. If better heads, an output jack for playback through a high fidelity system, and more refined circuitry were used—adding, say, another \$50 to the price—V-M might lose its mass market, but would make a lot of friends in the hi-fi field. It would then be an excellent recorder, offering competition to present units selling for 50 to 100% more. How about a hi-fi model, V-M? —R. A.

Sonotone IP Cartridges

SPECIFICATIONS (furnished by manufacturer): ceramic phono pickup cartridges available with 1 or 3-mil sapphire or diamond stylus. No preamplifier needed; self-equalized to RIAA curve within ± 3 db, 30 to 15,000 cycles. **Output:** 1 volt on microgroove record. **Load impedance:** 1 to 10 megohms; 2 to 4 megohms recommended. **Compliance:** 1×10^{-6} cm per dyne. **Stylus force:** 9 grams. **List prices:** 1P-1S and 1P-3S (1 and 3-mil sapphire), \$8.50; 1P-1D and 1P-3D (1 and 3-mil diamond), \$30.00. **Manufacturer:** Sonotone Corporation, Elmsford, N. Y.

Ceramic phono cartridges can be made so as to have even response over the useful audio range; they can be made with high compliance and low distortion. They are inherently self-equalizing to a constant-amplitude record and can be made to match just about any equalization curve, including RIAA; they have relatively high electrical output, so that a preamplifier is not required with them. They are substantially insensitive to abnormal heat and humidity. They are less expensive by far than most magnetic cartridges that do require preamplifiers and equalizers, and are probably less delicate mechanically. In short, good ceramic cartridges "measure" as well or better than magnetics and have important economic advantages. Why aren't they used exclusively, then?

The answer may be partly prejudice: they are similar in appearance and operating principle to crystals, and most

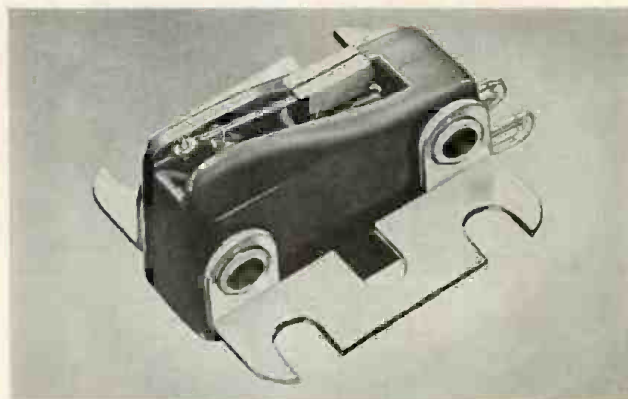

Sonotone cartridge combines low distortion with high output.

crystals a few years ago were pretty poor (some were pretty good, too, although delicate). Magnetic cartridges in general were obviously superior to crystals, and this was one of the first things a hi-fi tyro learned. Even so, this superiority could then be demonstrated by laboratory tests, and it can't be now. Nonetheless, most critical listeners seem still to prefer magnetic cartridges; we do also, but find it difficult to say exactly why. Perhaps that over-worked word "definition" is best suited to describe the difference. Individual elements of a complex sound appear to us to stand out more cleanly with a good magnetic cartridge; this is so even though that property is supposed to be determined by the amount of intermodulation distortion present, and fine ceramic cartridges have no more IM than magnetics.

It should be made clear that the difference in sound is not great. The better ceramics should be ranked among true high fidelity cartridges, and the Sonotone is as good as (possibly better than) any we've heard so far, on a subjective basis. It certainly seems logical to recommend them as replacements for standard cartridges, as the first step in bringing a lo-fi record-playing system up to hi-fi status gradually. They cost very little more in themselves than the original cartridge, and require no changes or additions to existing circuits. And if you're considering the purchase of a complete system, and don't own already a magnetic cartridge with its preamplifier-equalizer, you may be able to save some money by listening comparatively to a magnetic and the Sonotone ceramic. You may very well prefer the ceramic. —R. A.

Browning FM Tuner

SPECIFICATIONS (furnished by manufacturer): A compact, FM-only tuner. **Sensitivity:** 3.5 mV for 20 db quieting. **Output:** cathode follower; extra output connection for tape recorder, etc. **Controls:** tuning and volume. **Size:** 9 in. wide by 4 7/8 high and 8 in. deep. **Price:** \$87.50. **Address:** Browning Laboratories, Inc., Winchester, Mass.

This tuner is excellent all around: compactly built, simple to install, sensitivity comparable to that obtained with much more expensive units, no unnecessary accessories. It is intended for use with control units which provide tone and other controls, but it can be used with a straight power amplifier for an utterly-simple installation since a

Continued on page 100

PSE*

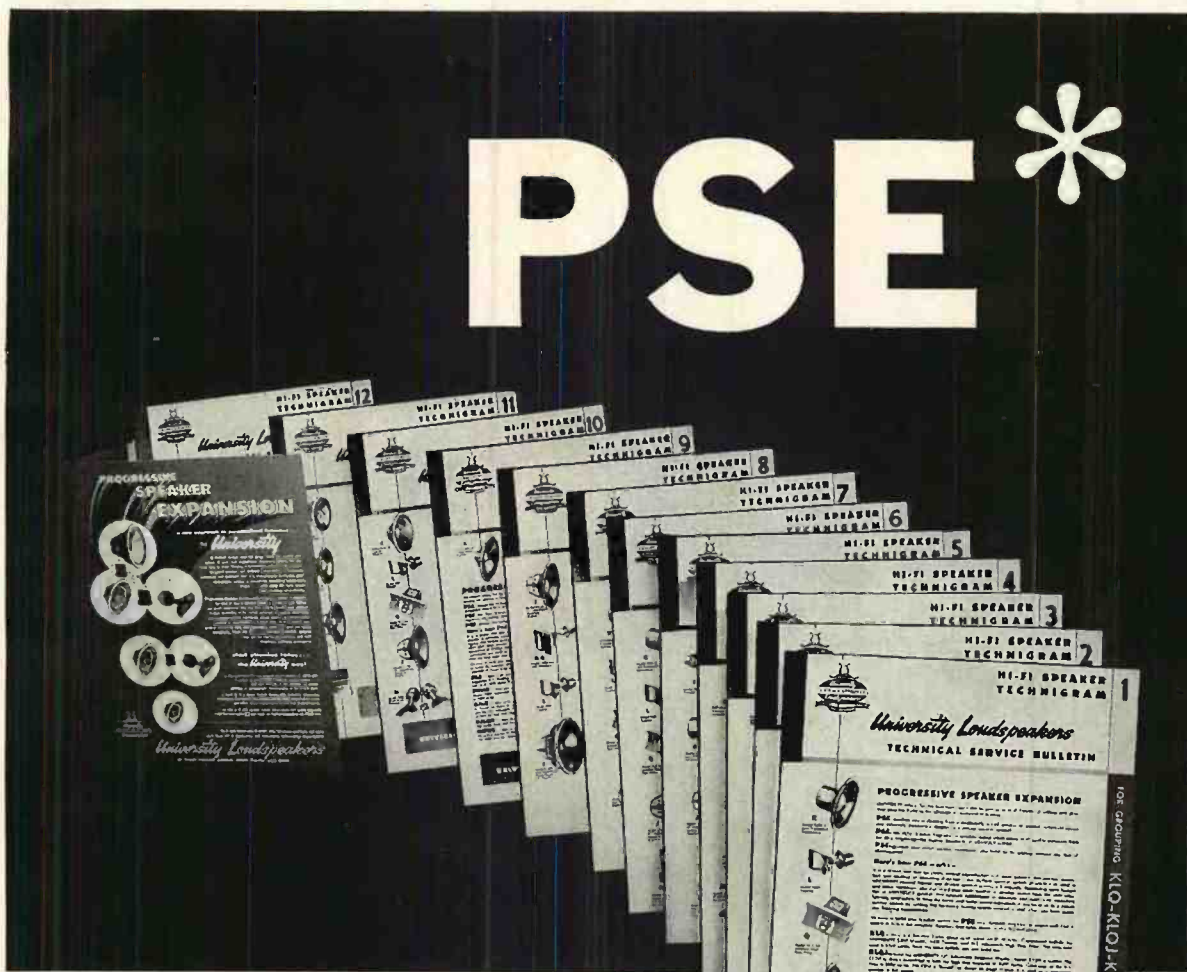

12 Pictorial Assembly Plans for Better Listening...

Now—for every high fidelity enthusiast—12 “Do-it-yourself” booklets, called Technigrams, which cover every one of the 36 different speaker systems featured in the original University PROGRESSIVE SPEAKER EXPANSION chart. These Technigrams contain all of the essential information, in words and pictures, required to assemble and install the speaker system of your choice. Even baffle board layout diagrams are included. All of this is available to help you to plan your listening the PSE way...to develop your speaker system in successive, relatively inexpensive stages...with no fear of obsoles-

cence, until what you have meets your listening tastes. With vacations and long summer days upon us, the time is ideal for building that high fidelity system which will give so much listening enjoyment on the colder Fall and Winter evenings ahead. Take advantage now of extra leisure hours... and take pleasure in leisurely listening later. See your UNIVERSITY HI-FI distributor today... and ask for the free Technigram that features the University speaker system of your choice. If you haven't seen the original University descriptive folder on the PSE Plan, mail this coupon immediately for your copy.

* Progressive Speaker Expansion

—the plan that makes it possible to buy a speaker today in terms of the system you want tomorrow.



University Loudspeakers inc.

80 South Kensico Ave., White Plains, New York

University Loudspeakers, Inc., Desk 83
80 South Kensico Avenue, White Plains, N. Y.

Please send me my free copy of “Progressive Speaker Expansion.”

Name _____

Address _____

City _____ State _____

79N32

TESTED IN THE HOME

Continued from page 98

front-of-panel volume control is provided. Automatic frequency control, which cannot be defeated, is incorporated. No tuning eye is provided; this is not a must when AFC is used.

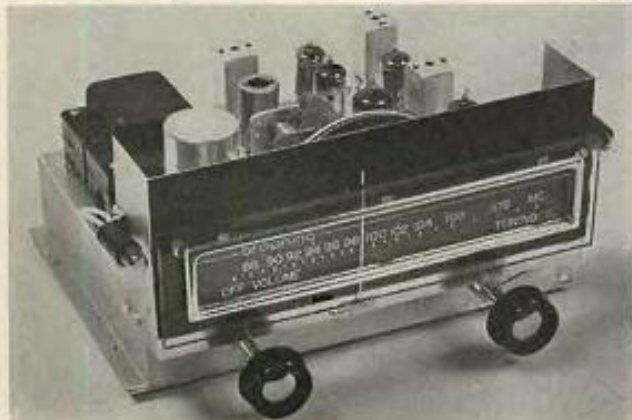

No expensive accessories on the Brownie basic FM tuner.

Output is of cathode follower design, so the tuner can be separated from the amplifier or control unit by a considerable distance without loss of high frequencies. A second output is furnished for connection to a tape recorder; this output, as well as the regular one, is affected by the volume control. An AC outlet is on the back apron of the chassis; it's controlled by the front-panel switch.

Very nice job, all around — and at a good price, too. (Incidentally, cabinets are available; our sample came in an attractive mahogany case which measured $5\frac{3}{4}$ high, 11 wide, and 9 in. deep including knobs.) — C. F.

MANUFACTURER'S COMMENT: The Brownie is just the beginning of a whole series of new hi-fi products and accessories. Cabinets are of either blonde or mahogany and, with the cathode follower output, can be remotely located at your favorite easy chair. From there you can control both tuning and volume. Clock-timer cabinets are available which can be preset so as not to miss your favorite program.

Quiet

SPECIFICATIONS (furnished by manufacturer): a liquid preparation for treatment of phonograph records. Includes 5-oz. container of Quiet, sponge applicator and applicator case, stylus brush, instructions, and text data. Harmless to records, humans, and furniture. Price: \$2.00 postpaid. Manufacturer: Beyland Engineering Company, Yalesville, Conn.

In addition to the usual de-staticizing properties, which are important enough in themselves, a number of other virtues are claimed for Quiet. It is said to "clean the record surface and remove noise-producing groove debris," to lubricate the grooves, and to retard needle wear.

We can affirm that it is a good de-staticizer — that is, it prevents build-up of static charges on the record while it is being played, so that it doesn't attract dust from the air and from the turntable mat. The effect appears to be long-lasting; we have records treated two months ago which retain the anti-static condition.

Prescribed method of treatment involves wiping the record before each play with a sponge dipped in the liquid

and then pressed on the case grilles until it (the sponge) is not excessively wet. Quiet has a fatty base, so that it does furnish lubrication while being played. But the record also becomes tacky to the touch within a very short time after being sponged; you can visualize groove dirt being gripped by this tacky film. When the record is played this film peels out of the groove, carrying dirt with it, and the mess is accumulated on the stylus. It brushes off readily, however; that's what the little brush is for. The effect is less noticeable the next time you play the record, and after three or four plays only an insignificant grayish deposit can be seen.

How much stylus and record wear is reduced because of the lubrication may be debatable, but it is certainly true that clean records wear less, and wear the stylus less, because of the absence of dirt. Moreover, clean records are quiet. We should say, then, that Quiet fulfills all its important claims. This is certainly worth while, and you get 5 ounces of Quiet for \$2, enough to treat both sides of 150 twelve-inch records. — R. A.

MANUFACTURER'S COMMENT: We advocate the application of Quiet to the record before each play because our experience and test work has shown us that dirt and dry surfaces are the primary cause of record and stylus wear and surface noises. . . The sponge is affixed to a plastic holder so that Quiet can be applied to the record without coming in contact with the fingers.

Lang 15W Speaker System

SPECIFICATIONS (furnished by manufacturer): a medium sized three-way speaker system. Size: 23 in. by 25 by 16 deep. Speakers: 12-in. woofer, 8-in. mid-range cone, single cone tweeter. Cross-overs: 200 and 5,000 cycles. Response: 25 to 17,000 cycles. Power rating: 10 watts continuous; 15 watts integrated. Impedance: 4 ohms. Finishes: mahogany or blonde. Price: \$119.95. Manufacturer: Lang & Taylor, Inc., 100 Felton Street, Waltham, Mass.

As speaker systems go now, this would have to be put in the middle-size category; a few years ago it would have been considered a small system. Even now it is in the low-price range. But its performance must be considered good against any standard, and for its size and price it is truly remarkable.



This speaker system is good by any standards.

Because it uses cone speakers throughout, the middles and highs are not of the brilliant type given by most horn-loaded tweeters for these ranges. They have a sweeter, more transparent quality that I happen to like — though many will not agree. There is no lack of highs: response extends as far out as anyone can use and, in a small room, a level control might be useful to cut down the middles and highs.

Continued on page 102

Even the walls have ears...for Bogen

NEW BOGEN DB110(G) 12 WATT AMPLIFIER. An exclusive Bogen circuit makes possible "luxury" performance in this economy amplifier. 0.65% distortion at full output; ± 0.5 db response from 15 to 50,000 cps; infinite damping. Four separate controls for gain, bass, treble and 4 inputs and 3 record equalization positions. DB110 (chassis); \$59.95. In gold-finished cage; \$64.50. (See "Tested in the Home", April *High Fidelity*.)

NEW B50 SERIES RECORD PLAYER. An unusual value. Operates manually to play any disc up to 16", at any speed from 29 to 86 rpm. (This includes, of course, 78, 45, and 33 1/4 rpm.) "Wow", "Hum" and "Rumble" are minimal. Stylus pressure is adjustable for minimum record wear. Arm is equipped with plug-in head for simple interchange. B50-4LC (with one head, you-pick-your-cartridge); \$40.40. Attractive wooden base; \$4.80.

Bogen
HIGH FIDELITY
BECAUSE IT SOUNDS BETTER

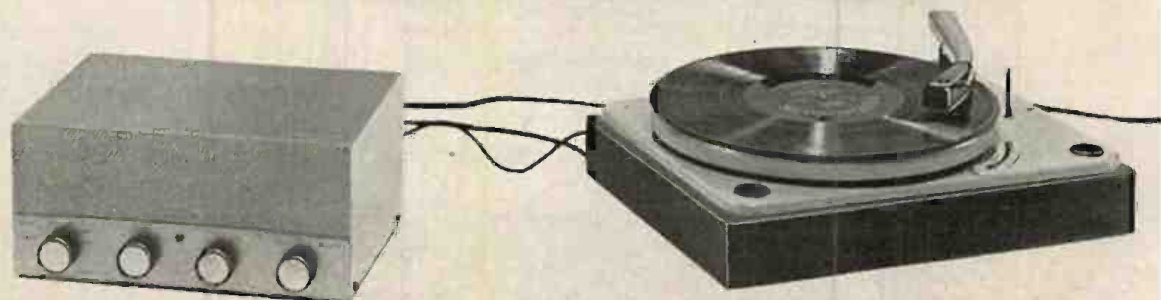
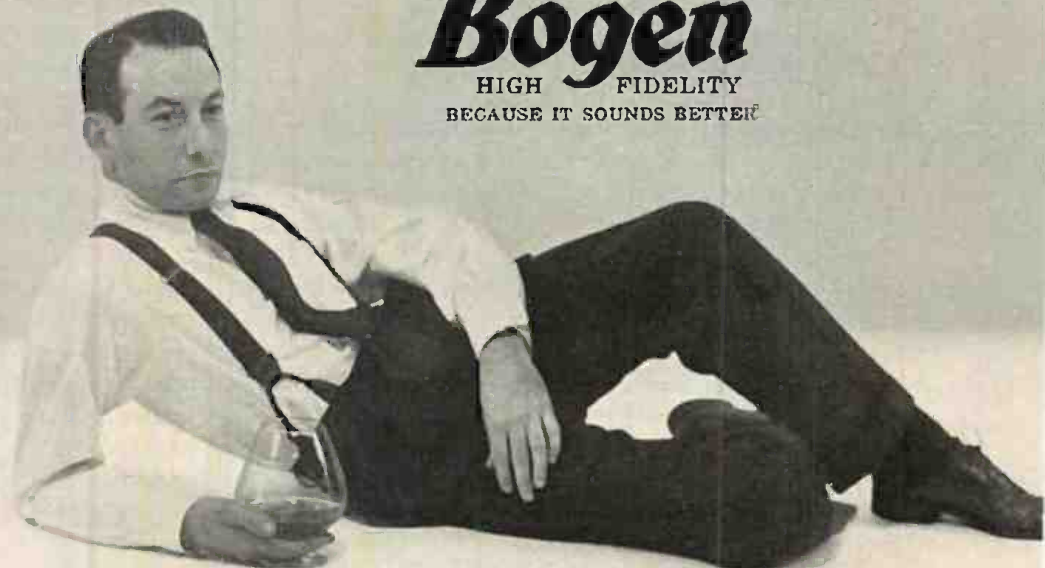

Send 25¢ for 56-page book, "Understanding High Fidelity", to Dept. WF David Bogen Co., Inc., 29 Ninth Avenue, New York City 14, New York

TESTED IN THE HOME

Continued from page 100

The most impressive feature of this system, however, is its low-frequency performance. Bass is very clean; not thumping or breath-taking, but quite even and (to my ear) flat down to 55 or 60 cycles. Contrary to what might be expected from the usual advertising claims, this is an accomplishment (in a system of such size) that deserves congratulations for its designer. Furthermore — and perhaps more important — it is resistant to doubling. If you feed 40 cycles into the system, you get out 40 cycles. It is diminished in volume, to be sure, but that is a lot better than getting 80 cycles out. And you can use amplifier bass boost which will compensate to a large extent for the volume diminution.

There is a slightly larger version of this system, the 30W, which has twice the speaker complement of the 15W and twice the power-handling ability. It sells for \$199.95. We haven't heard it, but if it's twice as good as this one it must be very good indeed. — R. A.

Pyramid Symphonette Player

SPECIFICATIONS (furnished by manufacturer): a portable table-model record player with built-in amplifier and speaker. Utilizes Collaro model 3/544 three-speed record player (manual) with Ronette TO-284-OV turnover cartridge; modified Grommes LJ-3 amplifier; 8-in. speaker (with or without separate tweeter) in case designed to act as enclosure. **Dimensions:** 13 3/8 in. deep by 15 1/8 wide by 12 1/2 high overall. **Controls:** turntable speed

control on turntable base; volume, treble, AC power on-off and bass control on side of case; phono-external input switch (optional) on back of case. **AMPLIFIER** — **Outputs:** 4, 8, and 16 ohms to external speaker; switched AC power outlet. **Response:** ±1 db, 20 to 20,000 cycles. **Rated power:** 10 watts; 18 watts peak. **Distortion:** 2% harmonic, 3% IM at 10 watts. **Noise:** 80 db below full output. **Tubes:** 12AX7, 2-6V6GT, 5Y3GT. **Prices:** standard model, \$89.95; with switched auxiliary input channel and internal speaker on-off switch, \$94.95. Cone tweeter, \$10.00 extra. **Manufacturer:** Pyramid Enterprises, 3815 Trimble Road, Nashville, Tenn.

This portable record player was designed specifically for school music departments, as a compact, inexpensive unit that would furnish acceptable fidelity in itself and, with a good external speaker system, highly realistic sound. The Symphonette meets these requirements, and it is certainly desirable that such a unit be made available to schools. But we are so pleased with its performance and price that we think it should be brought to the attention of all HIGH FIDELITY readers; it would make an ideal auxiliary record-playing assembly, portable enough to bring along on vacations, and merits serious consideration as the initial element of a low-cost, expandable primary system.

The turntable is a standard Collaro three-speed manual player, a hi-fi standard unit. Only visible controls are the speed-change lever, the cartridge turnover lever, and the weight adjustment lever on the tone arm (which increases stylus force slightly for playing 78s). A spring clip holds the arm to its rest; release the clip, lift the arm and move it to the right, and the turntable starts; set the arm down on the record, and when the record is finished the motor shuts

Continued on page 104

TESTED IN THE POCKET:

The Regency Radio

Not long ago we had a day at The Publishing House which was considerably more frantic than usual; everyone was under severe pressure. It was last-minute deadline . . . and printing schedules are made to be made, not broken!

During the course of the afternoon, it seemed as if the strain had really become too great; several members of the staff reported that they were hearing very soft music from time to time. Now, music is seldom if ever heard around the HIGH FIDELITY offices; we reserve that for our homes. So this was an unusual phenomenon. Roy Lindstrom left his drawing board to explore the office next door; refreshed by this interruption to the grind, he heard no more music when he returned. Warren Syer, talking to an equipment salesman, was positive that he heard music (and not from the salesman, either); that it faded in and out, and was very faint; the salesman — ears attuned only to the jingling of a cash register — did not hear it at all. Roy Allison suspected that the comings and goings of the Publisher had some correlation but was uncertain how the music could come and go when the Publisher was in the room all the time.

The Publisher, not able to keep his face straight any longer, told all . . . and let his imagination wander to the

local movie theatre — or most anyplace else, for that matter — where, with a confederate, the show could be stopped in no time at all. Soft music (not from the screen!) would be heard in one part of the theater. When the usher, supported by the manager, was on the verge of evicting bodily a suspected but unproven culprit, the music would cease . . . and soon whisper forth again from a different part of the theater, from a different culprit. You can let your imagination carry this happy scene to its conclusion; you can also conjure up many another practical joke *par excellence*: the Regency Radio slips into a man's trouser pocket with ease. Its tiny built-in antenna is (in fringe areas, at least) moderately directional so that a twist of the body will silence a station, if the volume isn't turned up too loud and, even in the daytime, you can get quite a selection of stations.

You can also let your imagination wander over the practical uses for this ultra-compact, transistor radio — the first one, as far as we know, to utilize transistors (four) for commercial, broadcast receivers. Since transistors are still expensive, and the Regency quite a marvel of compactness, the receiver is expensive — \$49.95 — and of course, it makes no claim to being hi-fi. It's a lot of fun, and also a useful accessory; it operates from a single 22½-volt battery (which is said to last for 20 hours) so you can take it with you wherever you go. Hats off to Regency! — C. F.



Now...record the whole performance...
without a break!

Got a favorite concert or opera program you'd like to preserve on tape? Symphony or dramatic production? Now, *record it all* using new "Scotch" Brand Extra Play Magnetic Tape. With 50% more tape wound on each reel, Extra Play Tape gives you as much recording time as 1½ reels of standard tape, plus strength to spare. This means annoying interruptions for reel change are sharply reduced to offer more perfect recording results.

You'll notice a crisper tone and higher fidelity, too—the result of "Scotch" Brand's exclusive oxide dispersion process. By packing minute, fine-grain oxide particles into a neater, thinner pattern, "Scotch" Brand has been able to produce a super-sensitive, high-potency magnetic recording surface. Hear the difference yourself. Try new "Scotch" Brand Extra Play Tape on your own machine.

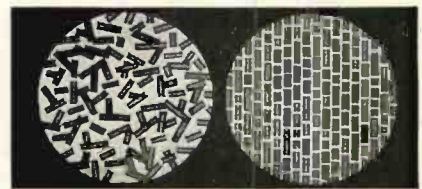

Electron Photo Microscope Shows the Difference!

At left, artist's conception of magnified view of old-fashioned oxide coating still used by most ordinary long play tapes. At right, "Scotch" Brand's new dispersion method lays fine-grain particles in an orderly pattern to give a super-sensitive recording surface that contains as much oxide as conventional tapes, yet is 50% thinner.

New! REG. U. S. PAT. OFF.
SCOTCH
 BRAND
Extra Play Magnetic Tape 190



The term "SCOTCH" and the plaid design are registered trademarks for Magnetic Tape made in U.S.A. by MINNESOTA MINING AND MFG. CO., St. Paul 6, Minn. Export Sales Office: 99 Park Avenue, New York 16, N.Y. In Canada: Minnesota Mining and Manufacturing Co. of Canada, Ltd., P.O. Box 757, London, Ontario.



TESTED IN THE HOME

Continued on page 102

off and the drive mechanism disengages. The cartridge is the turnover Ronette TO-284-OV, one of the best crystals — and very good it is, too.

Incorporated in the Symphonette is a push-pull 10-watt amplifier of quite unusual quality for a portable. It is, essentially, the Grommes LJ-3 and is installed in a separate aluminized and screened compartment at the back. Controls project through the side; there are three of them. At the bottom is the AC power switch combined with the bass control, which gives a flat response in its counterclockwise



The Symphonette player offers exceptional performance at an even more exceptional price. Very good.

position and increasing bass boost as it is turned clockwise (up to 15 db). Above it is the treble control, with flat response when turned all the way to the left and high-frequency cut increasing to 18 db when turned fully clockwise. At the top is the volume control. It should be explained, incidentally, that some treble rolloff will be needed when playing records (about 6 db at 10,000 cycles for the RIAA curve, according to our checks).

External speaker terminals at 4, 8, and 16 ohms impedance are furnished on the amplifier chassis at the rear. An auxiliary high-level input and a phono-auxiliary switch, when these are supplied, are mounted also on the amplifier chassis. This option includes an internal speaker on-off switch, which is installed in the record player compartment. There is also a switched AC power outlet at the back.

The standard speaker supplied is treated with Geon, which softens the cone suspension and lowers the cone resonance frequency. This is particularly important in a small enclosure. With the cover down the sound is full-bodied and quite listenable, with better bass than might be expected. We believe that the optional tweeter would be well worth while if the built-in speaker were to be used extensively. With a larger external speaker system, of course, the sound is improved quite noticeably; it can be labeled truthfully "high fidelity."

The case is of plywood covered with a fiber-like paint; it can easily be repainted as desired. There is a sturdy, comfortable carrying handle. Altogether, it appears to be well-designed and strongly built, offering exceptional performance at an even more exceptional price. — R. A.



Collaro RC-54 Changer

SPECIFICATIONS (furnished by manufacturer): a three-speed record changer that will play 7, 10, and 12-in. records intermixed, of the same speed. **Motor:** 4-pole, with integral 3-speed drive mechanism. **Change cycle:** consumes 7 sec. regardless of record speed. **Controls:** two; speed selector and on-off reject knob. **Dimensions:** 12 by 13 $\frac{1}{4}$ in. **Price:** \$48.75. **Distributor:** Rockbar Corporation, 215 East 37th Street, New York 16, N. Y.

The new Collaro model RC-54 is relatively simple in operation and is smaller than its predecessor, the 3/532. Furthermore, it is more versatile — it will intermix 7-in. records with 10s and 12s. Finally, the price has been reduced without sacrificing performance one whit (judging by our test unit). This adds up to an important release for hi-fiers, who know the Collaro as one of the finer changers.

Several of the noteworthy features have been retained. Plug-in cartridge shells are supplied; the surprisingly quiet motor and turntable are quieter than ever; the new changer shuts itself off and disengages the drive mechanism after the last record is played, as did the old one; a muting switch still silences the pickup during the change cycle; retained also is the lever on the tone arm that changes stylus pressure according to whether you're playing 78s or microgroove records.

But now you can stack 7, 10, and 12-in. records on the changer at the same time. The record "feeler" in the base post is more sensitive; a 7-in. record misses it entirely and the arm sets down at the proper place. A 10-in. record pushes the feeler down half-way, and the arm ser-down radius changes accordingly. But a 12-in. record pushes the feeler all the way down as it drops, and again the arm adjusts itself to hit the right spot. A record balancing arm keeps the stack from wobbling as records are dropped, and signals the mechanism to shut off after the last record.



Smoothly working versatility in the Collaro RC-54 changer.

Everything seems to work smoothly in the RC-54, and very fast. No sooner do you push the on-off reject knob to Reject, for example, than the tone arm lifts and in five or six seconds another record is being played. The speed-change knob moves easily and clicks into place. Each speed was very close to exactly right on our trial changer. We like the rubber turntable mat better than flocking or composition mats; in fact, we like just about everything on this changer, including the price. Only complaint: there's a popping noise in the loudspeaker when the motor shuts off. It should really have a built-in condenser. — R. A.

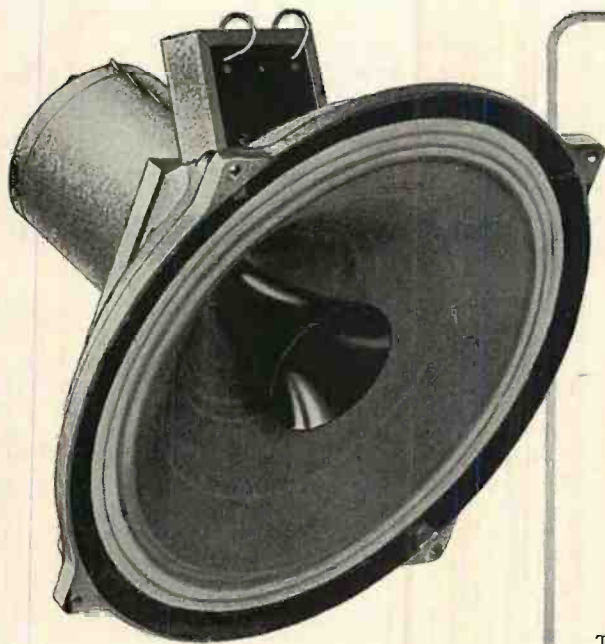

"Well worth careful consideration"
—HIGH FIDELITY TITH REPORT

Regardless
of
Price Class...

BEAM

STENTORIANS

Stand Alone

The superb, British made Stentorian line of High Fidelity Loudspeakers provides types and sizes to fit every audio purpose. Whether you select full range coaxial speakers or extended wide range direct radiators, tweeters or woofers you'll find a Stentorian to suit you perfectly. All models feature the revolutionary patented Stentorian cambric cones and suspension; Sizes 8 inches and up feature non-resonant die-cast chassis. Stentorians are unmatched in performance, craftsmanship and value. Hear Beam Stentorians — the Sound that "stands alone" — for yourself and be convinced.

12" Duplex (twin concentric) \$99.50

Response, 20 to 20,000 cps; bass resonance, 35 cps; built-in crossover; 15 watts; gross weight, 16¼ lbs. Series Alcomax magnet system; net weight, 11½ lbs.; 31,000 Gauss; two 1½" voice coils.

12" Extended Range Direct Radiator \$42.50

Response, 25-14,000 cps; bass resonance, 39 cps; 15 watts; gross weight, 10 lbs.; Alcomax magnet, 5½ lbs., 14,000 Gauss; 1½" V/C.

10" Duplex (twin concentric) \$44.50

Response, 30 to 16,000 cps; 10 watts; gross weight, 6½ lbs.; 3 lb. 9 oz. Alcomax series magnet system; 25,000 Gauss; two 1" V/C.

New 3 way variable impedance DIRECT RADIATORS
4 - 8 - 15 Ohms

You select the perfect impedance match for your system!

HF 1012 U-10"	\$15.95
HF 912 U-9"	12.55
HF 812 U-8"	11.95

Extended Range Response, 30 to 14,000 cps; bass resonance, 35 cps. 10 watts. These models also available with 15 ohms V/C only. All have 12,000 Gauss, 2 lb. 1 oz. Alcomax Magnets.



QUALITY without Compromise

BEAM
QUAD
AMPLIFIERS

"Should Satisfy the Most Critical"
—Audio Equipment Report

Quad II Amplifier.....	\$130.00
Q.C. II Control Unit.....	\$120.00
System Complete.....	\$237.50

The Beam QUAD is a truly superior audio instrument, providing uncompromising quality plus unparalleled flexibility of control. Its scarcely traceable distortion is inaudible at any volume. Add high efficiency harmonic filtering, push-button equalization and channel selection, plug-in pickup matching, balanced feedback throughout, 13 section output transformer, superb British craftsmanship, and the most functional styling in high fidelity today — and you can see why QUAD is the recognized world leader in high quality audio reproduction. Hear it at your earliest opportunity.

- Response, 10-60,000 cps; 0.5 db
- 20-20,000 cps level at full 15 watts
- Total Distortion, at 700 cps, less than 0.1 %
- Max. Intermod. Distortion less than 0.4 %
- 3 position Filter Slope Control; Level to 50 db/octave

Send for literature and detailed specifications on the Beam Products described above, and on Stentorian Speakers from 5" to 12" sizes, 5 and 15 watt pressure horn tweeters, matching crossovers, the Stentorian 18" woofer and Beam enclosures.

Charter Member: Institute of High Fidelity Manufacturers, Inc.

BEAM INSTRUMENTS CORPORATION
350 Fifth Avenue, New York, N. Y.



TELEFUNKEN

The Telefunken products shown on the opposite page are sold at leading dealers throughout the country. Below is a partial listing:

- | | |
|---|---|
| Phoenix, Ariz.
Minthorne Music Co. | Ashland, N. Y.
Ashland Radio & Supply Co. |
| Beverly Hills, Calif.
Minthorne Music Co. | Bronxville, N. Y.
Ferris Radio |
| Bridgeport, Conn.
Barney's Radio & TV | Brooklyn, N. Y.
Brooklyn Camera Exchange |
| Greenwich, Conn.
Craig-Greenwich Electric Co. | Garden City, L.I., N.Y.
Garden City Music |
| Hartford, Conn.
The Record Shop | Glen Cove, L.I., N.Y.
N. Lawres TV |
| New Haven, Conn.
Loomis Temple of Music | Great Neck, L.I., N.Y.
Vernon Shop |
| Stamford, Conn.
Atlantic Electric Co. | Woodmere, L.I., N.Y.
Long Island Radio |
| Waterbury, Conn.
Mattatuck Music | New York City, N.Y.
Abercrombie & Fitch
G. Schirmer & Co.
Gimbels Dept. Store
Harvey Radio
Haynes-Griffin
Henry Mielke
Liberty Music |
| Wilmington, Del.
Wilmington Electrical Specialty Co., Inc. | Canton, Ohio
Burroughs Radio |
| Washington, D. C.
Campbell Music | Cleveland, Ohio
Edelmuth Co. |
| Miami, Fla.
Flagler Radio Co. | Columbus, Ohio
Thompson Radio |
| Atlanta, Ga.
Baker Communications | Dayton, Ohio
Stotts Freedman Co. |
| Chicago, Ill
Voice & Vision
von Lengerke & Antoine | Lima, Ohio
Lima Radio Co. |
| New Orleans, La
A. B. Denny Radio Co. | Allentown, Pa.
Baker Communications |
| Boston, Mass.
Boston Music Co.
The Listening Post | Harrisburg, Pa.
The Music Box |
| Brookline, Mass.
Smith & Hazen | Philadelphia, Pa.
Bailey, Banks and Biddle
Witte Radio TV Co. |
| Lexington, Mass.
Pete's Music & Appliances Co. | Pittsburgh, Pa.
Superior Distributing Co. |
| Detroit, Mich.
Crandall Wholesale Co. | Reading, Pa.
Radar Fosig, Inc. |
| Kansas City, Mo.
David Beatty | Providence, R. I.
Axelrod Music |
| Englewood, N. J.
Music Manor | Greenville, S. C.
Belk Simpson |
| Haddonfield, N. J.
The Music Box | |



LISTENER'S

by R. D. Darrell

BOOKSHELF

OUT of my spectacularly technicolored, stentorianly stereophonic, Walter Mittyish dream life, the wraith-recollections of one recurring episode often haunt my waking mind. In them I am transformed into an omnipotent and omnipresent researcher conducting a country-wide home-to-home canvass in search of data for a monumental Darrell Report on the Love-Life of Music Lovers.

It will shake the world when it appears. And only one annoying minor detail holds it up: although my nocturnal polls have covered thousands of listeners, each of whom responded freely and fully to my long list of searching questions—I just can't remember, awake, a single answer!

Some bright morning, perhaps, I'll find all my dream memories miraculously preserved, or my imaginary questionnaires actually piled up on my desk, filled out in other than invisible ink. Meanwhile, the tantalizing lack of this precious information remains not only the most grievous handicap under which I and every other writer on music, audio, and records must labor, but a crippling burden on the whole sound art and industry.

Think what it would mean if we could know in what proportions musical experience is derived from disks, tapes, broadcasts, "live" concerts, and personal music-making . . . the exact number and nature of home sound systems (and their operating condition) . . . the contents of every home record collection (and the bases on which new additions are selected) . . . the precise amount of technical knowledge commanded (or desired) by every hi-fi fan . . . which pertinent magazines and books are read, why they are chosen, and just what materials and authors are found to be most provocative, instructive, and illuminating . . . !

Now I'm sure that the rewards, in both entertainment and education, of visual aids to aural experience are well enough realized—in theory, if not in practice—in by most listeners. But

among the faithful subscribers to this and other journals devored to music and audio, how many boast collections of music books that compare even remotely in size, cost, and use with their record libraries and magazine files? Not long ago James Hinton, Jr., made an admirably cogent plea in these very pages for the case of books on music and musicians, and succinctly surveyed the outstanding general and reference works (HIGH FIDELITY, October 1954) and biographies and autobiographies (December 1954 issue). I don't imagine that many of you skipped his articles or read them without a mental resolution to look into at least some of the books he discussed. But how many (if any) volumes did you actually buy, or even draw out of your local public library?

From disheartening experience, I've lost all optimistic illusions that any general music-book propaganda, however persuasive, can bring about substantial or permanent changes in the currently pervading climate—if not of opinion—at least of habitual inaction. I fully agree it's a lamentable state of affairs; indeed as a writer myself I have the liveliest personal concern (not to say financial incentive) in its betterment. But while I'd love to think that my colleagues and I have an incalculably valuable message which the public fails to appreciate out of sheer, obtuseness, laziness, or niggardliness, I reluctantly have to assign such wishful thinking to my alter ego's Mittyish dreams. The hard daylight fact is that, while many things well may be wrong with the potential reading public, the basic troubles lie elsewhere. This is the age of a "new illiteracy": the climate of our times is unfavorable to all kinds of books and no one—writer, publisher, or non-reader—knows what to do about it.

I certainly haven't any solution to this problem. My best guess (and it is only a guess) is that the right answer, if it exists at all, will somehow involve

Continued on page 108

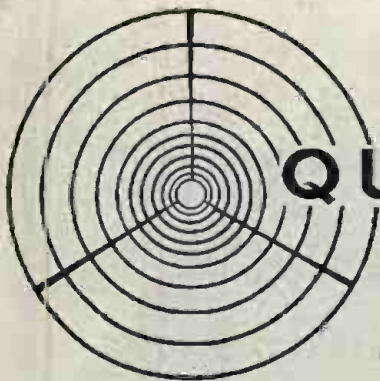

QUALITY SPEAKS..

TELEFUNKEN

Moderately Priced High Fidelity Radios...

With great pride, the manufacturers of the world famous TELEFUNKEN Microphones present their latest engineering triumphs. Never before have you heard such unbelievably perfect sound from table model radios. Actually, these fine sets are more than just radios, they are complete high fidelity audio systems incorporating superb FM-AM-Short Wave tuners. There are inputs for your turntable or recorder, and your tape recorder as well as outputs for additional speakers or the recorder. The hand finished solid French walnut cabinets are truly masterpieces of design and craftsmanship.

2 SPEAKERS
50 TO 15,000 CYCLES
FREQUENCY
RESPONSE

An amazing value-priced unit. Built-in FM dipole antenna. Armstrong FM circuitry. Cabinet dimensions: 18 3/4" x 13 1/4" x 7 3/4".

GAVOTTE



3 SPEAKERS
30 TO 18,000 CYCLES
FREQUENCY
RESPONSE

Approximately 5 watts output. Armstrong FM circuitry. Both a built-in FM dipole antenna and a rotating ferrite antenna for standard band. Cabinet dimensions 23 1/4" x 15 1/2" x 10 7/8".

RONDO



those who seek QUALITY find TELEFUNKEN

A partial list of dealers will be found on the opposite page.

Write for free literature and technical data on this and other TELEFUNKEN products.



Products of
Free Western Germany
Imported and distributed
exclusively by.



AMERICAN
ELITE, INC.

DEPT. H - 7 PARK AVENUE - NEW YORK 16, N. Y.

*Unexcelled
Perfection*



NEWCOMB

Classic 2500R

**LABORATORY STANDARD
REMOTE CONTROLLED
AMPLIFIER**

Here is the product of perfectionists, for the perfectionist in hi-fi. Designed as a laboratory standard by one of America's foremost amplifier specialists since 1937. Remote control unit less than four inches high and deep, only nine inches wide, can be placed up to 100 feet from equipment center. Response inherently excellent to 100,000 cycles... distortion less than $\frac{1}{100}\%$ up to 10 watts... less than $\frac{3}{10}\%$ at 20 watts... full 25 watt output... "Audi-Balance" distortion control gives you lifetime freedom from distortion, and only Newcomb has it... 6-position bass crossover and treble rolloff controls give 36 recording curves. Write for complete details.



NEWCOMB
SINCE 1937...THE FINEST

NEW! HI-FI Guidebook

"Hi-Fi Is For Everybody" explains how to select and install your system. Thoroughly illustrated. Not a catalog.

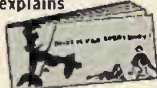

NEWCOMB, Dept. W-6
6824 Lexington Ave., Hollywood 38, Calif.

- Here's 25¢ for new book, "Hi-Fi Is For Everybody"
 Please send free information on the Newcomb Classic Series 2500 Amplifiers

Name _____
Address _____
City _____ State _____

LISTENER'S BOOKSHELF

Continued from page 106

the formation — or re-establishment — of *reading habits*, which less than a century ago were the rule among music lovers, but which in the present generation of listeners are sadly exceptional.

I doubt whether book costs are any great handicap: they're higher than they once were, but they're still not prohibitive, nor far out of line with the prices of records and audio equipment — which do sell vigorously today. The current demands on time and energy probably are more to blame — but where do so many people find the time and energy to pursue other, non-reading hobbies? Book distribution and promotion methods surely bear a heavier load of responsibility — but, even so, the whole high fidelity movement got its start and made its most sensational progress at a time when it took an international spymaster's training to track down wide-range components and when audio advertising and criticism (inside as well as outside professional technical circles) was pitifully skimpy in quantity and chaotically contradictory in quality.

No. Any satisfactory explanations must be sought elsewhere: in some realm involving more strictly "human" values. The characteristic psychology, or psychologies, of listeners have yet to be explored in any depth, but even by the fragmentary insight we command so far it seems to me that the significant reasons for the present failure of popular support for music and audio books will prove to include two vital deficiencies: 1) a lack of *infectiously communicable enthusiasm* (not merely in writers' attitudes towards their materials and their audiences, but also in reviewers' and readers' responses); and 2) a lack of *larger perspective* (again both in writers' and publishers' tactical compromises between specialization and comprehensiveness, and in reviewers' and readers' capacities for distinguishing ephemeral and lasting values).

Of course I can't fairly expect that any such notions as these, still amorphous, will impress you any more than they do me. But let us see how much they can help us in appraising some currently pertinent publications — always remembering that the natural first questions of any prospective reader are sure to be: "Is this a book I'll

Continued on page 110

TRANSCRIPT

of Silence

the

MIRACORD

XA-100

record changer

The superb craftsmanship of the Miracord XA-100 permits *only* the recording, not the surface noise of the record, to reach your ear!

AVAILABLE

at all leading distributors throughout the United States.

If you are interested in high fidelity you owe it to yourself to see and hear this remarkable instrument.



The Miracord XA-100 comes equipped with the "Magic Wand" spindle that preserves the life of your precious records.

Plus ALL THESE FEATURES

- No Wow.
- No rumble.
- Intermixes 10" and 12" records.
- Interchangeable plug-in heads.
- Ball-bearing-suspended turntable and tone arm.
- Adjustments without tools.
- Push button operation.
- Pausamatic — the user's choice of time lapse between records from 5 seconds to 5 minutes.
- Shipped complete with leads and plugs, ready to play.

AUDIOGERSH CORPORATION
23 Park Place
New York 7, N. Y.



Only recorder that surrounds you with sound

NEW 2+1 SPEAKER SYSTEM

"Roving" speaker adds new dimension to sound

Full beauty of the original performance is yours through Pentron's unique 3-speaker placement. All the brilliance and sparkle of the live performance are perfectly balanced at any listening level. An LC crossover network system separates high notes (over 1000 cps) and feeds them to the roving tweeter mounted in the lid. This speaker can be placed anywhere in the room. It supplements the 2 internal matched speakers which give life and beauty to middle and base range.

- 2-speed high fidelity recording
- Compact—portable
- Speaker in removable lid has its own volume control
- Dramatic new styling

model HT-225 complete with microphone and tape

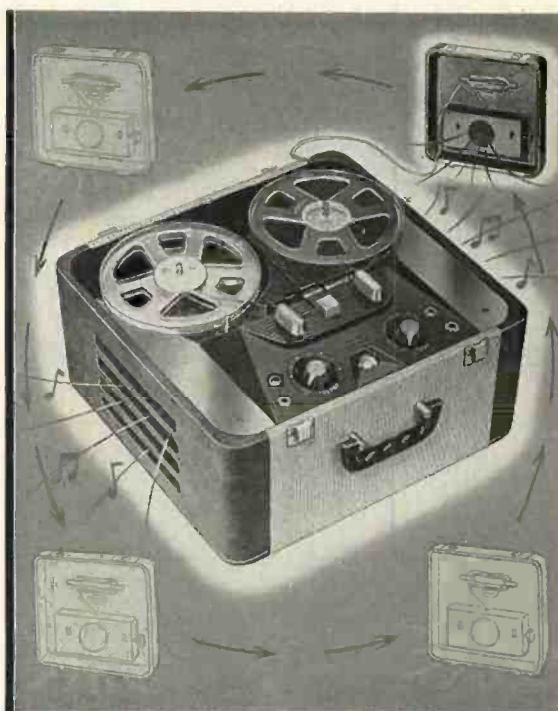

PENTRON Tape Recorders

SEE AND HEAR THE COMPLETE PENTRON LINE PRICED FROM \$99.50 to \$225 AT THESE LEADING AUDIO SPECIALISTS



2-Speed Portable with exclusive

MONOMATIC® CONTROL

New easy low-cost way to record any sound, any time, anywhere

Quickly capture every sound with a flick of your finger. Record radio or TV programs—keep them or erase tape and record new favorites. Pentron Monomatic is so simple to operate even youngsters can share in the fun of making and playing recordings. Monomatic Control gives you instant selection of record or play . . . fast forward and rewind. Easiest to operate, lowest in cost.

model CT-1 complete with microphone and tape

FOR DETAILED LITERATURE WRITE

THE PENTRON CORPORATION



786 S. Tripp Ave., Chicago 24, Ill.

Austin, Texas
High Fidelity, Inc.
3004 Guadalupe St.
Only Exclusive Outlet in Central Texas

Boston, Mass.
Radio Shack Corp.
187 Washington St.
& 230 Crown St.
New Haven, Conn.

Buffalo, N. Y.
Frontier Electronics, Inc.
1503 Main St.
Western N. Y.'s
Finest Audio Studios

Chicago, Ill.
Allied Radio Corp.
100 N. Western Ave.
Everything in Electronics

Carl Fisher, Inc.
306 S. Wabash Ave.
Service in Music Since 1872
Newark Electric Co.
223 W. Madison St.
Visit Our 5000' Hi-Fi Display

Hollywood, Calif.
Hollywood Radio Supply, Inc.
5006 Hollywood Blvd.
Buy Hi-Fi from a Qualified Source

Indianapolis, Ind.
Graham Electronics Supply, Inc.
102 S. Pennsylvania
Everything in Electronics

Los Angeles, Calif.
Electronic Sales
1433 West Pico Blvd.
Tape Recorder Specialists

Los Angeles, Calif.
Figart's Sound Un-Ltd.
6320 Commodore Sloat Dr.
Specialists in Hi-Fi Installations

Henry Radio
11240 W. Olympic Blvd.
Mail Orders Welcomed. Easy Terms
Kieruff Sound Corp.
820-830 W. Olympic Blvd.
Pentron's In Stock! Immediate Delivery!

Marion, Penna.
Hi-Fidelity Sound Corp.
368 Montgomery Ave.
Serving Philadelphia Metropolitan Area

Miami, Fla.
Electronic Supply
61 N. E. 9th St.
The Name to Know in Audio

Milwaukee, Wis.
Steffan Electro Art Co.
318 E. Norwich Ave.
Specialists in Recorders & Supplies

Minneapolis, Minn.
Hi-Fi Sound
69 So. 12th St.
Hi-Fi—Intercoms—Recorders

New Jersey
Parts Unlimited, Inc.
Stores throughout N. J. Consul: Local Phone Directory

New York, N. Y.
Arrow Electronics, Inc.
65 Cortlandt St.
Always an Audio Fair!

New York, N. Y.
Federated Purchases
Los Angeles, Calif. Mountainside
Newark, N. J. Easton-Allentown Pa.

Midway Radio & Television Corp.
60 W. 45 St.
You're Always First at Midway
G. Schirmer
3 East 43rd St.
New York's Largest Music Store

Pasadena, Calif.
Daw Radio, Inc.
1759 E. Colorado St.
Our 25th Year in Pasadena

Paterson, N. J.
Magnetic Recording Co.
344 Main St.
Recorder Hdqrs. Request Free Brochure

Philadelphia, Penna.
Magnetic Recorder & Reproducer Corp.
1533-35 Cherry St.
America's Pioneer Recorder Specialists

Seattle, Wash.
Sound & High Fidelity Center
2121 Second Ave
Northwest Tape & High Fidelity Hdqrs.

Smoketown, Penna.
Glick's Audio Sales
Phone: LA 3-7242
Recorders • Tape Sound Equip. • Record Changers

White Plains, N. Y.
Westchester Electronic Supply Co.
610 Mamaroneck Ave.



**unprecedented
FM and AM
reception
at a sensible price.**



the **Rauland**

Golden Gate
HI-FI AM-FM TUNER
MODEL HF155

**custom quality in a
perfect package 4" high**

Here is the tuner that offers you more for your money in every way: extraordinary high fidelity tone, exceptional selectivity and sensitivity, more gain and high output, beautiful "space-saver" design.

The RAULAND "GOLDEN GATE" brings you a revelation in FM enjoyment, a new experience in AM listening.

with every desirable feature . . .

FM response, $\pm .5$ db, 20 to 20,000 cycles; AM, ± 3 db, 20 to 5,000 cycles.

Sensitivity: FM—5 microvolts for 30 db of quieting; AM—5 microvolts for 1.5 volts output. Separate RF stage on both FM and AM;

discriminator with dual limiters; Cathode follower with 2 outputs; AFC; flywheel tuning; FM di-pole antenna, etc.



"space-saver" design

Only 4" high—fits anywhere. Beautiful charcoal black marbled finish with brass control escutcheons. Also easily mountable behind any custom panel. Tuner may be used up to 200 feet from amplifier.

Hear the
RAULAND
"Golden Gate" Tuner
at your Hi-Fi dealer,
or write for details



RAULAND-BORG CORPORATION
3515 W. Addison St., Dept. F, Chicago 18, Ill.

LISTENER'S BOOKSHELF

Continued from page 108

enjoy?" "Has it got information I need or can use and, if so, is it presented so I can grasp it without the benefits of a bachelor's degree in music or engineering, or both?" And finally, "If I do want to read it, either for fun or enlightenment, will it be enough worth re-reading or frequent reference to warrant the cost of owning a permanent home-bookshelf copy?"

Audio-Baedeckers for the Layman

The problems of contemporary audiophiles, anxious to get into the hi-fi swim, but not as high as their necks, still remain to be sensationalized in book form (probably because so many magazine articles and audio-show demonstrations have taken care of that job in other ways). But they continue to hypnotize publishers and writers with the golden delusion of mass sales to the most gullible specialized market available today. Or is it as gullible as it appears—at least to verbal rather than sonal titillation? Maybe. I'll suspect so if many listeners actually fall for all the enticing lures displayed in the ads for William R. Wellman's High Fidelity Home Music Systems (Van Nostrand, \$3.95) and William J. Kendall's Hi-Fi Handbook (Crowell, \$2.95).

That isn't to say that (duly discounting the blurbs) either book is impossibly bad, or not worth its cost to a completely naïve audio neophyte. But not only are the title-adjectives misnomers (unless you're willing to grant a serious writer and publisher the same Lastex leeway you tacitly concede to the advertising copy-writer for \$29.95 "high fidelity" phonographs): there's nothing here that hasn't been written better and more fully elsewhere. Wellman is an instructor in a vocational high school and his elementary descriptions of system principles and components are laboriously scaled down to the presumed mentalities of his students. If you want detailed, properly primerish instructions for constructing simple speaker enclosures in your home workshop, or connecting an RCA-type plug to a single-conductor shielded cable, Wellman's your man—but build his suggested "wide-range" (no feedback) amplifier and zero-bias pre-amps at your own risk!

Kendall, apparently a pro engineering writer if not engineer, is animated by at least a modicum of enthusiasm,



**Hi-Fi
at
low
cost!**

**Guaranteed
to answer all your
questions—or
your money back.**

NEW HIGH FIDELITY HANDBOOK

By Irving Greene & James Rodcliffe

SEND NO MONEY, unless this book proves its value to you within 10 days. Order from CROWN PUBLISHERS, Dept. A52, 418 4th Ave., N. Y. 16. If not delighted, return book and pay nothing. Otherwise pay only \$4.95 plus few cents postage. Save postage by remitting now (Same refund privilege).

This encyclopedic volume by Hi-Fi experts shows you how to get the best and most for your money.

It tells and shows everything you need to know! How to make equipment sound better. How to test, buy, install, and use Cartridges, Turntables, Changers, Amplifiers, Compensators, Speakers. How to choose the components that sound best together. How to avoid costly mistakes. How to design and build your own Hi-Fi cabinet. Where to place your set for best performance. Every new Hi-Fi development—straight from the lab! Special sections on Tape Recorders, Hi-Fi TV, and Money-Saving Home Hi-Fi Repairs! Over 300 photos and diagrams make everything clear—even to the most unscientific music-lover. List of recommended dealers and manufacturers. There's no book like it, and you can't lose with this no-risk, money-back offer!

208 pages, 8" x 11", \$4.95

Noted
for

EXCELLENCE

One-Third
Actual Size



Always at the head of its class, with honors in professional studio service, this Stephens condenser microphone is the natural choice of the home user who knows the difference . . . designed for the single microphone system, because it is engineered to pick up not only *all* the lows and highs you've come to expect in fine high fidelity recording, but the full *dynamic* range of sound as well, from a low throaty whisper to full Wagnerian brass.

Sensitive, of course, but rugged enough to withstand shock. This is an expensive microphone, but the proven results indicate its value.

STEPHENS
TRU-SONIC

Speakers
•
Microphones

Stephens Manufacturing Corp.
8538 Warner Drive
Culver City, California

another
Frazier-May
classic

FIRST TRUE
EXPONENTIAL
HORN in a
CORNER
MODEL

It's another first for Frazier-May... an amazingly true exponential corner horn utilizing the same amazing and exclusive damping formula in the now-famous Twin 70. The low end extends down to 32 cycles; will reproduce with exciting brilliance all the notes of a pipe organ. In addition, it will handle sounds of percussive nature with amazing trueness. Two 90 in. 32 cycle air columns. Tweeter horn: 250 cycle rate of taper. Cross over at 600 cycles.



UTILITY MODEL **\$297**
FURNITURE MODEL **\$375**

Size: 33 inches high, 46 in. wide, 29 in. from corner. Mahogany, honey brown mahogany, ebony, tobacco finish birch, or limed oak. Other finishes available on special order.

International
Electronics
Corporation

159 HOWELL ST., DALLAS, TEXAS

JUNE 1955

but he is neither persuasive enough to convert doubting audio Thomases nor authoritative enough to impress the faithful.

On a comparable (the reader's probably a dope, anyway) level, there's far more useful information in the Fawcett paperback *Hi-Fi Manual*, which you can get at your newsstand or supermarket for 75 cents. But, in larger perspective, if you're anxious to get a little easy-to-take technical grounding in sound-reproduction principles, you still can't do better than with Weiler's *High Fidelity Simplified* (Rider, 1952).

Edward Tarnell Canby, the spryer-than-ever grandpappy (42) of all evangelist-mentors for the audio layman, has just brought out a revised edition of his *Home Music Systems — How to Build and Enjoy Them* (Harper's, \$3.95), which retains all the best features and eliminates most of the poor ones in his original version. It still may be a bit too colloquial and "of-course-I'm-no-engineer-but" in style for some tastes (e. g., mine), but it bubbles over with irresistibly infectious gusto: here is a born tinkerer and musician who finds tremendous unprofessional delight in audio and knows just how to convince others that they too can find — and relish — the same fun. He covers all the basic points of the orthodox system-manual "formula," but far transcends it by prodigally adding diverting extras, including perhaps most notably an invaluable layman's introduction to the notion of "geometric progression" and — in this edition — a fine new chapter on current and prospective developments.

As before, the most striking attraction of the book is Canby's uncanny ability to anticipate (and answer satisfactorily) almost every question the bewildered audiophile-novice is likely to ask, plus many that probably won't occur to him until he's emerging from his apprenticeship. And while there still is cause for complaint that Canby fails to set his hi-fi standards high enough to suit fanatical purists like myself, either I've become more tolerant in the last couple of years (which is unlikely), or he makes a more effective case for the practicable "relatively best for a moderate price" versus the costly absolute "best." Anyway, I'm now completely convinced that this is a well-nigh ideal, certainly an indispensable, guidebook for the average non-fanatical potential or actual audiophile. You can't afford to pass this by.

Now...easier
more versatile
operation for...

THORENS CD-43

THE ONLY HI-FI CHANGER



New...

**SIMPLIFIED
SPEED CONTROL**

Dial-selection of any of three speeds plus a fine-tuning knob to permit exact pitch adjustments above and below all standard speeds.



New...

**CONTROL FOR
MANUAL OPERATION**

Allows you to disengage the automatic trip mechanism to enjoy flexible operation.

Plus an improved direct-drive motor with separate gear for each speed... for absolute speed constancy and silence.



\$93.75 net

See Your Dealer or... for more about new improved Thorens Record Changers, Players and Turntables write:



MORE **Terminal** SOUND VALUES!

NOW AT AMAZING LOW COST ENJOY BIG SCREEN TV WITH BUILT-IN 10 WATT HIGH FIDELITY AUDIO AMPLIFIER
PILOT Remote Controlled TELEVISION
 Receives All VHF and UHF Channels — Uses Giant 24" or 27" Picture Tube

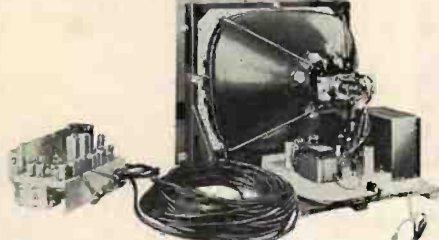

This complete 2 chassis Television system incorporates true high fidelity in both sight and sound. Features full remote control operation up to 100 ft. Tuning range VHF Channels 2 to 13—UHF Channels 14 to 83. Dual Knob controls. Slide rule dial for UHF Tuning. Will receive compatible color and color transmissions with color picture tube unit. Features the latest advances in UHF and VHF Tuner . . . designed to provide maximum in picture

quality for all channels. Has high sensitivity for fringe areas.

Supplied complete with Mask, Safety Glass, Front Panel, Base, 20 ft. remote control cable, all Tubes except picture tube, Hardware and Instructions. All for the amazing **\$169.50** less speaker

low price of only **\$169.50** less speaker

FULL PARTS GUARANTEE

BRAND NEW RCA, GE, SYLVANIA OR CBS Picture Tubes for PILOT TV — fully guaranteed:
 24" — \$50.25
 27" — 82.50

Wood Cabinet for PILOT TV Remote Control Tuner only \$20.00

AT HOME OR AWAY, ENJOY HIGH FIDELITY MUSIC TAKE A **GRANCO** "Music Hall" WITH YOU!



Model 720 AM-FM RECEIVER

Ultra compact, self-contained, no installation, AM-FM Receiver for complete radio entertainment • powerful 7-tube chassis for finest performance even in fringe areas. Features Granco's famous coaxial tuner, exceptional sensitivity, selectivity, simplicity. Remarkable tone quality, 1 1/2 watt audio. Extended range ALNICO V 6" oval speaker. Built-in AM and FM antenna. Beautiful Paragrid-styled plastic cabinet fits anywhere and in any decor. Just plug in to play. In ebony—only **\$39.95**

Model T 160 FM TUNER

Including built-in antenna. Installation is nothing more than connecting this tuner with any amplifier and speaker whether separate units or included in existing radio, TV or phonograph. Can be attached to above Pilot TV for FM reception. Has all the fine Granco features and compares favorably with FM tuners costing many times as much. In simulated grained walnut plastic cabinet, Paragrid-styled, only **\$34.95**

Model 610 FM RECEIVER

Beautiful 6 tube chassis for high sensitivity and drift-free performance. Only table radio in its price class with a big oval 6" speaker. In ebony—only **\$29.95**

The World's First Battery Operated, POCKET SIZE TAPE RECORDER

THE MOHAWK MIDGETAPE



It fits into your pocket or briefcase; is so small and so light you can take it ANYWHERE. Record with it and play it back. The Midgetape makes recordings of phone conversations, meetings, lectures, in the office, when travelling or on vacation. Like a movie camera, the Midgetape records the sound picture of memorable moments. Recordings can be kept as long as desired or erase old material as you record the new.

Cartridge loaded • Simple to operate • only 3 controls • records and plays for ONE HOUR • visual battery life indicator • battery life over 45 hours. Dimensions: 8 1/2" long x 3 3/4" wide x 1 1/4" deep. Weight: 3 lbs. Complete with hour-long cartridge of recording **\$29.50** tape, crystal microphone, ear phone and batteries.

Leather carrying case with shoulder strap — **\$14.75**

Extra loaded tape cartridge — **\$11.50**

SUMMER SPECIAL!



Model 922

TERMATONE FM-AM RADIO

Incorporates latest features. RF stage on FM for high sensitivity. FM circuit is temperature compensated for minimum drift. Built-in pre-amplifier to permit use of high-fidelity MAGNETIC phono cartridges, and a 3-position equalizer for accurate record playback assure high quality phono reproduction. Tone control • Hum adjustment to balance out residual line-frequency hum • 3.5 watt beam power amplifier delivers excellent audio. Audio Response from 60-13,000 cps. Terminals on rear for any 3.2 or 8 ohm FM speaker. Efficient built-in antennas for AM and FM; Ferrite loopstick plus conventional loop for AM and folded dipole for FM; Terminals for outdoor antennas.

Input: Magnetic phonograph. Controls: Off-on-Tone, Volume, Equalizer (L.P, AES and European) Function Selector, and Tuning. Handsome gray panel. Easy-to-read, edge-illuminated slide-rule dial. Tubes: 2—6BA6, 6BE6, 6AU6, 6AL5, 12AT7, 6AV6, 12AX7, 6V6GT, 5Y3GT Rectifier. Size: 7 1/4" x 13 1/2" x 10" deep. Auxiliary AC outlet for record player, etc. For operation from 105-125 volts, 50-60 cycles AC. Less Speaker. Shipping wt., 18 lbs. Net **\$49.50**



SPECIAL HIGH FIDELITY **UTAH 12"** LOUDSPEAKER only **\$9.95**

Has Special CURVELINER Molded Cone with 8 ohm Voice coil impedance.

6.8 Alnico V Magnet with extremely small voice coil gap gives high sensitivity and handles 12 watts of audio continuously. Clear tone frequency. Response is exceedingly flat and smooth from 40 to 12,000 cps and is down only 5 dB at 15,000 cps. Many customers, visiting our Audio Dept., thought they were listening to a \$50.00 unit when they heard this amazing speaker. Buy now at \$9.95.

Use them in pairs.....2 for only \$17.95
 Special quantity prices available for HiFi and PA Dealers. Write for quotations.

CABINART Unfinished 12" BASS REFLEX CABINET



Model 7112 SPEAKER CABINET pre-cut for 12" speaker, 5 1/2" thick select white pine, baffle volume — 6 cu. ft. Acoustically designed, easy to finish, ideal for Utah Loudspeaker. Net **\$24.00**

Model 8112 SPEAKER CABINET as above in knock down KIT Form only **\$18.00**

TERMATAPE SPECIAL!

Highest Quality RECORDING TAPE

Red oxide — plastic base — full 1200 ft. reels. Individually boxed, fully guaranteed. A scoop value! 3 reels for only **\$4.98**



Visit our Sound Studios ORDER BY MAIL

Send full remittance or 25% on account, balance C.O.D. All prices are FOB our store.

Terminal Radio CORP.

85 CORTLANDT STREET, NEW YORK 7, N. Y. • Worth 4-3311

Your BEST BUYS

Are

Permoflux
Hi-Fi Speakers
and
Components

THE WORLD FAMOUS *Royal 8*



The popular Royal 8—your best value in a hi-fi speaker. Outperforms many larger speakers. Features a slotted, treated, blue cone; high-flux, slug-type magnet; clean reproduction of audio range.

Royal 8, Model 8T-8-1 8" Speaker.
NET\$13.50

ROYAL 12, MODEL 12UP-8-1. 12" version of Royal 8, above. Use with 32KTR-C Kit, below, for coaxial performance at low cost. NET.....\$21.00

New 32KTR-C Coaxial Tweeter Mounting Kit



NOW—mount the 32KTR Tweeter coaxially on your present 12" speaker, or the Royal 12 described above. Consists of 32KTR Tweeter, arms, hi-pass filter, hdwe., instructions. Easy to install—no soldering.
NET\$12.60

32KTR SUPER TWEETER ONLY. Provides true-to-life highs; uses paper cone—same cone material used in woofers. Crossover range, 2000-6000 cps.
NET\$9.45

NK-60 6000-CYCLE CROSSOVER NETWORK. Ideal for use with 32KTR-C Coax Kit, or 32KTR Tweeter and any good woofer. Provides complete separation of lows and highs. NET.....\$9.00

Permoflux CORPORATION

Dept. F, 4916 Grand Ave., Chicago 39, Ill.
4101 San Fernando Rd. • Glendale 4, Calif.
Canadian Licensee: Campbell Mfg. Co., Ltd.

THE NICEST PEOPLE

Continued from page 46

getting better and better all the time.

The number of people who will break the news to a dealer that they are interested in *all* the records ever made by, say, Mischa Q. McMonagle, the dean of tin-whistle virtuosos, and will the dealer please send a *complete* list of *all* the records ever made by that nonpareil artist, is *very* much larger than one might suspect. That particular problem child is quite unconcerned that McMonagle did his stuff for umpteen companies here and abroad over a space of thirty-three years, eight months, and two days. He wants that *complete* list! So the dealer, being a compassionate soul and somewhat soft in the head, accedes to this demand. He works through stacks of catalogues and circulars for a couple of days, and compiles it. What follows? Does he get an order? Does he get thanks or any acknowledgment at all? As a rule, he gets nothing or, at best, word that the collector already has all of those listed, and merely wanted to be certain he had missed none. Well, such is the sucker's recompense.

Again, one encounters collectors of "cut-outs," who harbor the notion that asking the record merchant to run down a particular discontinued disk is equivalent almost to having it in their hot little hands. Actually, the serious tracking-down of cut-outs is a major project, time-consuming and *costly*. The percentage of success is small. Frequently, when a desired cut-out has been located, the party who had wanted it has lost interest, obtained it elsewhere, cries murder at the price, or disclaims ever having asked for it.

In ever so many ways the conscientious dealer is at a perpetual disadvantage. Not only is he the victim of countless impositions, but he feels obliged to guard the interests of his customers against unscrupulous producers and distributors, too, even when the customers seem to be hell-bent upon getting themselves fleeced. One thing is certain, and that is that if anything is advertised with sufficient flamboyance and the copy is liberally larded with pseudo-scientific poppycock, the job of guiding the public back to the paths of common sense is so formidable as to verge upon utter impossibility. One record producer of unimpeachable integrity put it thus:

Continued on next page

For Best RESULTS

Use

Permoflux
Hi-Fi Accessories
with Your
Tape Recorder

Diminnette Speaker System



Popular 2-way Hi-Fi Speaker System. For wide-range tape playback. Ultra compact. Uses 2 Royal 6 inch speakers, 32KTR Super tweeter and hi-pass filter. Response: 50 to 16,000 cycles. Size: 23½" W x 11½" H x 12" D. In Korina Blonde or Mahogany ¾ inch veneers.
NET\$49.50

High-Fidelity Headphones



Ideal for monitoring tape recordings . . . assure professional results. Perfect for every hi-fi listening application . . . use with the Permoflux Maestro. (See below.) Impedance: 8 ohms. (Plug-in transformers for other impedances available.) Model HD-1.
NET\$27.90
Deluxe Model. HD-100.
NET\$45.00

Maestro Speaker-Headset Control Box

For connecting Hi-Fi headphones (or extension speaker) to tape recorder or amplifier. With volume control. Distinctive styling. Mahogany-finish cabinet; gold-finish raised front panel. Size: 5" H x 10¼" W x 6¾" D.
NET\$10.50

M-53A Telephone Pickup



For recording both sides of telephone conversation on tape with crisp, clean response. Fits any type of phone. Plugs into mike jack of recorder. Complete with 6 feet of shielded cable.
NET\$10.50

Permoflux CORPORATION

Dept. C, 4916 Grand Ave., Chicago 39, Ill.
4101 San Fernando Rd. • Glendale 4, Calif.
Canadian Licensee: Campbell Mfg. Co., Ltd.

Novelty in Speakers

Among the ill-founded ideas one encounters so often from High Fidelity enthusiasts with little know-how is that results are directly proportionate to complexity of equipment.

Yet the finest audio amplifiers in the world are remarkable for their lack of complexity! Their excellence springs from careful design and the use of top grade components.

When one comes to the Loudspeaker — inevitably the weakest link in the chain — the idea that a complex unit is necessarily the best, is even less logical. For it must be remembered that the object of the Loudspeaker designer is to achieve accuracy of reproduction and naturalness, not novelty. This is work for the experienced engineer who concerns himself with precision.

The finest Speakers in the world like the finest Amplifiers are simple in conception but built to the precision standards of fine instruments.

Such a Speaker is the Tannoy Dual Concentric, which looks like many other speakers (outside the novelty class) but is so often described by High Fidelity enthusiasts with 'know-how' as the Rolls-Royce of them all.

SPECIFICATION

Frequency response 30-20,000 c.p.s. \pm or -3dB
Polar Distribution for 60° inc. angle -4dB
at 10,000 c.p.s.

Intermodulation Products less than 2%.



<p>TANNOY (America) Ltd., 38 Pearl Street, New York 4, N. Y., U. S. A.</p>	<p>TANNOY (Canada) Ltd., 36, Wellington St. East, Toronto 1, Ontario, Canada.</p>
---	--

THE NICEST PEOPLE

Continued from preceding page

"Sometimes it is difficult to give the public an improved piece of merchandise far in advance of the field. We shall now conform to the regular commercial patterns." The concern had begun offering records made of damage-resistant, vinyl-styrene compound, but could not get acceptance of them because the surfaces were *slightly* less silent than those of the easily damaged and less durable saponified vinyls. It is my understanding that the Czechoslovak record trust had to withdraw its entire original catalogue of LPs for this reason.

Every record dealer is victimized regularly by thieves who are ingenious in the extreme. The balmacaan type of overcoat with a huge pocket sewn inside the lower back panel has served to spirit even 12-inch albums out and into the night! The side pockets take 7-inch records beautifully. In the acoustic days the soundboxes or reproducers had to be wired or soldered on to the machines in the listening booths. The switch-racket, whereby a beat-up record was left with the dealer in place of his factory-fresh stock number, is as old as the disk record business itself. Bad credit and bad checks occur as in any other commercial area, but it is a real thrill when a check for *one* dollar bounces back, ragged "Insufficient funds"!

For a brief period in the earliest days of wire and tape recording there was a rash of rejections of records based upon the most tenuous of considerations. There was good reason to believe that some of the early birds were making their own wire or tape dubbings and then returning the records they had ordered for the purpose to the dealers.

The nut fringe, distinguished for vehemence, intemperance, and intolerance, are perennially on hand. Saturated with opinions, they not only can tell the dealer how to run his business, but they are red-hot for or against this or that composer, this or that artist, this or that record company, and this or that apparatus for sound reproduction. There are the lads to whom anything antedating the day after tomorrow is obsolete, disreputable, and utterly unworthy of notice or mention. It stuns them to learn that amplification and reproduction of the full range of audible sound, today's "hi-fi," was "old hat" circa 1930; that good electro-

Exciting High Fidelity Firsts!

In these superb matched instruments—enjoy the foremost advances in High-Fidelity—startling realism—lowest distortion—precision craftsmanship—gleaming polished chromium chassis.

INTERELECTRONICS

Coronation 400
40 WATT
AMPLIFIER



\$99.50

Greatest amplifier buy today! COMPLETELY NEW, NON-RINGING NEGATIVE FEEDBACK CIRCUITRY—over 50 DB feedback. CUSTOM CRAFTED—sealed transformers, encapsulated networks, finest molded components on Bakelite terminal board. DISTORTION-FREE—less than 0.05% at 30 watts. POWER RESPONSE \pm 0.1 DB 16 to 35,000 cycles at 30 watts. Surpasses FCC requirements for FM broadcasting. 5 to 200,000 cycle response. 40 WATT WIDE-RANGE OUTPUT TRANSFORMER, sealed multiple section windings, thin strip core. FOOL-PROOF DAMPING CONTROL for startling speaker performance. BUILT-IN POWER for preamplifiers and newest electrostatic tweeters.

INTERELECTRONICS

Coronation 90
CONSOLETTA PREAMPLIFIER-
EQUALIZER



\$89.50

Incomparable companion to the "CORONATION 400". EXCLUSIVE NEGATIVE FEEDBACK CIRCUITRY. Over 50 DB—virtually eliminates distortion. Surpasses FCC requirements for FM Broadcasting. 5 to 200,000 cycle response. CUSTOM CRAFTED—polished chromium chassis, satin gold front panel. Encapsulated precision networks, molded components on Bakelite panel. EXCLUSIVE PRESENCE and LOUDNESS CONTROL, continuously variable. Rumble and Scratch Filter positions. FIVE INPUT SELECTIONS, 25 PRECISION PLAYBACK CURVES, FULL 20 DB DISTORTION-FREE Bass and Treble compensation. Phenomenal lowest noise Z-729 input tube HUM INAUDIBLE with all controls on full. Highest gain. Built-in power for motion picture photocells, FM phono cartridges, condenser microphones. Ultra compact, easy front mounting.

Now at your local dealer!

INTERELECTRONICS

2432 Grand Concourse
New York 58, New York

Do you know
you can own

A *Stan White*

SPEAKER

for only \$49.50



LePettite

"the little speaker with the big voice"

You won't believe it, but

Audio Response—55 to 16,000 cps.
Speaker Components—8 inch bass driver in 36 inch exponential horn, 3½ inch tweeter and specially designed crossover network. Impedance: 8 ohms.

Construction—Korina veneers finished in Blonde, Walnut, Mahogany or Ebony hand rubbed lacquer. Wrought iron legs.

Unique Features—Curled, not folded, exponential horn (1% of formula). Multiple flare formula (patent applied for). Passive phasing chambers. 24db/octave acoustical crossover. Distributed throat characteristic (not found elsewhere).

Size—19 x 12 x 9 inches.

Other Stan White Cabinet Speakers

LeSabre—24" x 15" x 12", Frequency Response: 40 to 16,000 cycles.....79.50
Esquire—30" x 24" x 16", Frequency Response: 30 to 16,000 cycles.....194.00
Hi-Fi—4' x 30" x 20", Frequency Response: 20 to 16,000 cycles.....645.00
4-D—5' x 3' x 2', Frequency Response: 15 to 16,000 cycles.....994.00

See your high fidelity distributor or write

Stan White INC.

Dept. H-6, 727 S. LaSalle St.
Chicago 5, Illinois

A Division of Eddie Bracken Enterprises

static speakers were in limited use almost as long ago, and that the low-speed, long-playing record goes back three decades. Featherweight pickups and records playing up to an hour on a side were laboratory items nearly twenty years ago, too. That does not mean, of course, that the years since have been barren of progress, but that progress has been mostly in the direction of achieving the results desired with greater certainty, with much more compact facilities, and at prices not so fantastically out of reach as in those early days. The eight-hundred-pound amplifier, for instance, has passed into history along with the high-wheeled bicycle. But what was called "auditory perspective" in those long-gone decades now goes by the name of "binaural" or "stereophonic" sound!

A more recent gag, born in this era of if-you-don't-like-it-for-any-reason-return-it, is the widespread practice of unloading LPs on dealers, other than the concerns from which they were obtained, for credit or exchange.

To return to the nut fringe—we have to consider the numerous ecstatically impatient souls who, upon receiving parcels of records, do not take the time to ascertain how they may be opened with a minimum of effort, but, instead, rear at them in maniac frenzy or virtually blast them open, and then denounce the mails and the dealers for the debris they uncover. In passing, breakages almost always seemed to occur among the records comprised in sets; rarely among singles. Replacing parts of sets has always been one of the most frustrating, frequently futile obligations of record dealership. The gradual disappearance of shellac is the happiest development of the era, from the retailer's standpoint.

The record merchant who has never had to serve a Johnny-one-note character does not exist. He drops in and proclaims, "I - wanna - getta - reccud - it - goes - like - this - but - I - don't - know - the - name - of - it", and then begins to whistle, "tweet-a-tweet-tweet-tweet, tweet-a-tweet," all on practically the same note. Once in a while, the rhythm supplies the clue. Or one experiences a visitation from the sad soul who wants a record of the "tune that goes like 'Mickey'," which turns out to be "The Sweetest Story Ever Told." Again, he "heard it on the radio and the composer's name was 'Josef Waldo'." It took time, but the selection was by Gesualdo, the uxori-

Continued on next page

the world
is
your oyster

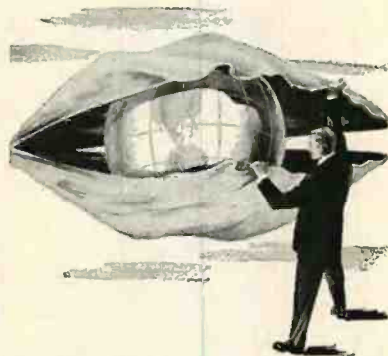

Here's a new delicacy to satisfy the taste of the audiophile — the entire world. Famous European music festivals, outstanding foreign symphony orchestras, quaint folk music or news from the capitols of the world are yours at the flip of a switch.

THE "BROWNIIE"

AM-Shortwave tuner (Model L-500) adds a new dimension to your hi-fi system. The shortwave reception is equal to that of a professional communications receiver, and the AM is of the highest quality. It's the first tuner of its kind — designed principally for your hi-fi system.

Price **\$8750**

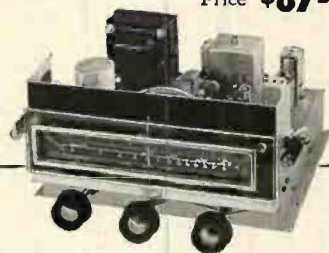

- Sensitivity 1 to 2 microvolts.
- IF amplifier for broad and sharp bandwidth
- 10 kc whistle filter.
- High gain RF stage.
- Covers complete broadcast band.
- Tape recorder output.
- International shortwave band — 17 meters through 49 meters.
- Built-in high gain ferrite antenna.
- Three controls — output level control with ON-OFF switch; 3-position selector switch, AM broad, AM sharp, shortwave control; and velvet tuning control.
- Self contained power supply.
- Cathode follower output for remote location.

browning

LABORATORIES, INC.

750 Main Street, Winchester, Mass.

Export Div., 25 Warren St., New York, N. Y., U. S. A.

CABLE: SIMONTRICE

Hi . . . Mr. Hi Fi

This is It . . .

The BRADFORD Perfect BAFFLE*



Radically new idea in loudspeaker enclosures. Not a bass reflex or folded horn.

The primary purpose of a loudspeaker enclosure is to prevent destructive sound cancellation that takes place at low frequencies, when the front and rear waves, emanating from both sides of the speaker cone, merge.

It is obvious that no rear waves can escape through a totally enclosed cabinet, and it would be the perfect baffle, except for one reason. The air pressure within the cabinet acts as a cushion upon, and therefore restricts, cone movement. This causes loss of life and color.

The BRADFORD Perfect BAFFLE is totally enclosed, yet it relieves cone pressure by an ingenious device that operates in unison with cone movement.

Since this action conforms to an ultimate scientific principle, the BRADFORD Perfect BAFFLE is the only enclosure that can give you the utmost in sound reproduction.

And that, specifically, is . . .

ALL THE BASS. Full, rich, clean bass, clearly distinguishing each contributing instrument, down to the lowest speaker frequency.

NO BOOM. Absolutely no boom. Boom, or "one note" bass, is not high fidelity.

NO FALSE PEAKS. Does not "augment" bass by false peaks that are really distortions.

ANY SPEAKER. Accommodates any speaker . . . any size, weight, shape or make.

NO TUNING. No part turning or speaker matching.

ANY POSITION. Operates in any room position.

NO RESONANCES. No false cabinet or air resonances.

COMPACT. 20" w x 20" h x 15" d for 12s & 15s . . . @ \$9.50. Unfinished birch . . . @ \$49.50. 12" w x 12" h x 10" d for 8s, 9 1/2s & 10s . . . @ \$39.50. Unfinished birch . . . @ \$34.50.

REAL HARDWOODS. In all popular finishes . . . mahogany, blond, ebony, walnut, red.

INCOMPARABLE CONSTRUCTION. Hand made, hand finished . . . by master craftsman. All walls 3/4" thick.

GUARANTEED. Unconditionally guaranteed to out-perform any other enclosure now available regardless of size, weight or price.

If you want the very best speaker enclosure, and will not be misled as to real performance by deceptive size or price, see your audio dealer at once. A demonstration will convince you. Or write for literature.

Prices slightly higher West of Rockies.

* Patent pending.

BRADFORD

Perfect

BAFFLE

BRADFORD & COMPANY,
315 East 6th Street NEW YORK, N. Y.

THE NICEST PEOPLE

Continued from preceding page

cide. Always, too, there are the embryo Carusos who take records into the listening booths, practice singing in unison with them for an hour, more or less, and then walk out. No sale and no thanks.

Among the most disastrous of the innumerable mistakes a dealer can make is to lend out a catalogue of which he has only a solitary copy for his own use. The would-be borrower of catalogues is the most earnest and persuasive pleader and the most effusive promiser the world has ever known, and for tenacity the leech is a weakling in comparison. His promises are worthless. Compared to the catalogue-borrower, Ananias was a paragon of punctilious rectitude. Catalogues never come back!

There are other kinds of borrowers. One besieged me for months. He wanted to borrow a rare Telefunken record from my private collection to have it dubbed. He was big stuff in the silk business; had a gaudy residence on Long Island, too. I capitulated when he promised me enough fine silk for a fancy gown for my wife.



Great dykes

that bring you great music

From the land where engineering skills equal the force of the mighty sea, the Duotone Company brings you Norelco Sound Equipment. High fidelity equipment that holds back the mighty force of mechanical interference in your listening as the great dykes of Holland stand stwart against every destructive trickle of the sea.

A genius peculiarly Dutch, this meticulous attention to every minute detail. That allows no weakness anywhere. That insists on orderliness in everything they do. That trusts nothing less than perfection. The kind of perfection in sound equipment, manufactured in Holland by Philips and brought to you by the Duotone Company. Consummate perfection in high fidelity. Great dykes that hold back every trickle of interference in your listening. Great dykes that bring you great music!

Model # 9750M-8"

Audio response 35 to 20,000 cycles. 6 Watts. Flux density 13,000. Magnetic flux 58,300. 10% efficiency at 4000 c/s. Impedance at 1000 c/s - 8 ohms. Resonance frequency 60 cycles. List \$36.95 subject to regular audiophile discount.

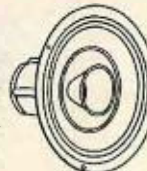

Information on other Norelco models from
THE DUOTONE COMPANY, INC.
KEYPORT, N. J.
Supplier & Manufacturer of Duotone Needles

TRADER'S MARKETPLACE

Here's the place to buy, swap, or sell audio equipment. Rates are only 30¢ a word (including address) and your advertisement will reach 50,000 to 100,000 music listeners. Remittance must accompany and insertion instructions.

WANTED: USED HOLT'S Italian Language set. Erskine Carter, Box 1500, Albany, Georgia.

HIGH FIDELITY SPEAKERS REPAIRED. Amprite Speaker Service, 70 Vesey St., New York 7, N. Y.

HAVE GOOD RECORD with tracking defects? Can repair, \$1.25. Mail to Willard Brinegar, 1200 W. Cedar, Cherokee, Iowa.

SALES — SWAP — SERVICE
ON ALL TYPES OF NEW AND USED AUDIO EQUIPMENT.
ARGUS SERVICE COMPANY
235 LYONS AVENUE
NEWARK, N. J. WAVERLY 3-3025

TAPE RECORDERS. Tape, Accessories, unusual values. Dressner, Box 66K, Peter Stuyvesant Station, N. Y. 9.

6 ELEMENT broad band FM antennas. All seamless aluminum. \$10.95 ppd. Wholesale Supply Co., Lunenburg, Mass.

TAPE RECORDER SPECIALISTS! Ask for quotations on HI-FI Components also. Bottom Prices! Get details. Boynton Studio, 10H Pennsylvania, Tuckahoe, N. Y.



COMPONENTS

Professional TURNTABLE

- Rumble—70 db. Speed, 0.25%
- 25 lb. Cast Steel Turntable
- Wow and Flutter less than 0.05%

Users coast to coast acclaim the beautiful silence of the Components Professional Turntable. Flawlessly smooth, unerringly stable, "you think you're hearing tape," owners say. The reasons are few and simple: Superior design; superior engineering. The Components sets an entirely new standard of turntable performance, regardless of price. Hear it and be convinced! User's net \$99.50. Slight additional charge for matching skirt.

WRITE FOR VITAL TURNTABLE FACTS

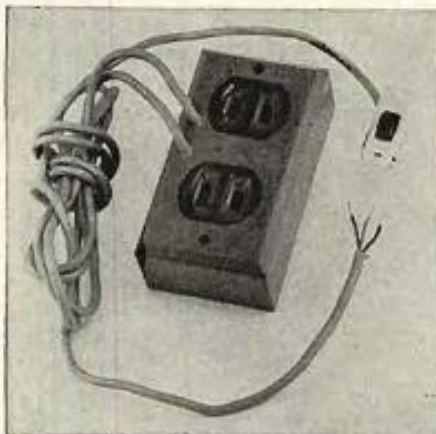

Now! For Hi-Fi and Phonograph Systems
 Automatic Shut-Off of ENTIRE
 SYSTEM at End of Last Record!

"SLUMBER SWITCH"

No more worry or bother about "remembering" to shut off power after last record plays. SLUMBER SWITCH remembers for you! Shuts off entire system automatically!

USE IT with any phonograph that shuts off itself at end of last record • To restore ordinary operation at any time, simply flick defeat switch • Foolproof! No moving parts, nothing to wear or burn out • Easy installation. Just 3 simple connections. 3' Cables to permit convenient placement • Pop-filter lessens speaker-pop, when motor shuts off • No hum or magnetic fields. Use with ANY cartridge!

Money-back Guarantee. Sent Postpaid (No C.O.D.) **\$7.95**

The HI-FI CENTER, Inc. Dept. H6
 2630 N. Downer Ave., Milwaukee 11, Wis.

Mirabile dictu! I got the record back, but, after all these years, *no silk!*

Well, those are typés. The unreasonable ones include those who, having bought a certain record any length of time back, order the same number a second time and then berate the dealer for duplicating! They also include those who order the same number from half a dozen dealers at the same time, accept it from the first one who manages to deliver it, and do not notify the other dealers from whom they ordered it that it has arrived. They just let them send and, upon arrival, refuse it. The experienced dealer soon learns to beware of the Big Order Brotherhood. So often the dealer stocks up on their account, only to find out that all they ever acquire is a catalogue-collection. They are the breed who denounce the recording companies because of the "shameful neglect" of some virtually unheard-of composer or opus, make a great noise over the matter, and when the thing finally shows up on disks and they are apprised of the fact, become singularly silent. They don't *buy* it!

The fact is, the dealer who specializes in records of culturally respectable material renders a peculiarly personal, almost intimate service to those who patronize him. With the exception of the eccentric characters described above, this is a distinctly above-average public. Because of that fact, the communications which pass between such a dealer and his customers are usually on a plane of frank friendliness quite outside the experience of most other businesses. In any number of instances a lively and exceptionally instructive exchange of views ensues, and the narration of personal experiences is particularly free. Sometimes the letters which come in impose upon the dealer the responsibility of becoming confidante, counsellor, comforter, and guide to those who wrote them. If he accepts this as a privilege and gives of himself accordingly, he may not become the world's largest record dealer, but he will attach to himself a host of the finest friends anyone ever could hope for. And *that* is the pay-off which alone makes it all worth while. Because, I must admit, it is.

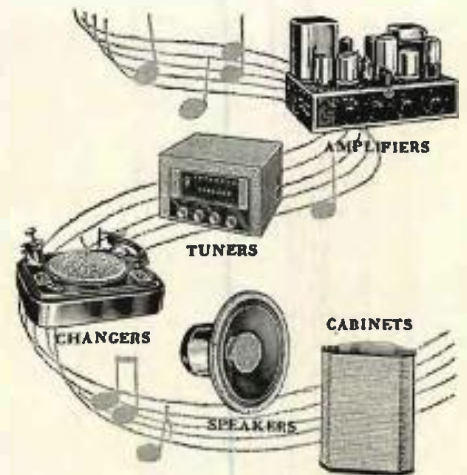

Choose from the line
 that's most complete
 and most versatile . . .

STROMBERG-CARLSON
"Custom 400"
 Matched High Fidelity



When your dealer suggests "Custom 400" equipment, he's backing his recommendation with knowledge that no other Hi-Fi line so completely meets your needs.

Stromberg-Carlson launched this equipment in 1952, but our experience in audio goes back more than 60 years! Our record is star-studded with many "firsts" which have become industry standards—like the coaxial speaker, the Acoustical Labyrinth® and the first FM receivers.

"Custom 400" is complete—and every component is perfectly *matched* to every other. "Custom 400" is versatile—your installation can be as *tailored* as your clothes! And whatever standard of "How high is Hi-Fi" you use, we'll guarantee to meet and exceed it!

Test that claim! See your Stromberg-Carlson "Custom 400" specialist for a demonstration—or send the coupon below for literature and his name.

Stromberg-Carlson®

Sound Equipment Division

1222 Clifford Avenue, Rochester 21, N. Y.

Please send me your Hi-Fi literature and the name of my nearest dealer.

NAME

ADDRESS

COMPARE this performance!



**FAIRCHILD
220
DIAMOND
CARTRIDGE**
\$37.50

Fairchild's 220 Series cartridge guarantees this distortion-free reproduction in the entire audible range!

Just look at these frequency response curves of the Fairchild 220 and two other leading cartridges. See how Fairchild alone gives smooth, even reproduction — completely uniform to 17,000 cycles with only slow roll-off beyond. This means no unnatural harshness, no distorted sound! With Fairchild, you have only the sound you were meant to hear!

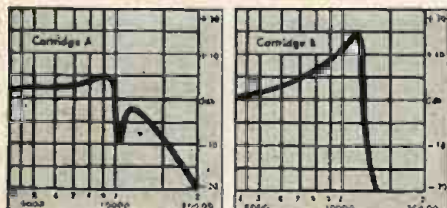
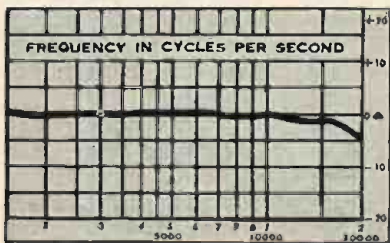

And, a
perfect mate...



**280 Series
Transcription
Arm**

Match your cartridge to the finest arm! Low-mass and resonance-free, Fairchild's 280 Transcription Arm allows the cartridge alone to lift all the tone color from your recordings. Superb precision balance and engineering assure perfect mid-groove tracking, always. And, any standard cartridge plugs in easily—performs better—with this versatile Fairchild 280!

\$29.50

FAIRCHILD RECORDING EQUIPMENT
10th AVE. & 154th ST., WHITESTONE, NEW YORK

AUDIO FORUM

SIR:

I am presently in the process of extending my music system to encompass binaural recordings and the binaural broadcasts of WQXR. I am trying to do this as economically as possible, which eliminates the outlay of \$150 or more for a binaural amplifier. Actually, this shouldn't be necessary, for I already possess two excellent amplifiers in good working condition. As each has a complete set of controls, I cannot see any justification for buying a binaural preamp, either, because this too would duplicate most of the controls I already have.

For playing binaural records I have all that is necessary, almost! It is that "almost" that spoils the whole thing. No true audiophile can ever find real happiness knowing that his rig is deficient, even if only in a minor detail. The minor detail is the controls which are available on all binaural amplifiers and preamps, but not obtainable elsewhere, that do three things: focus, reverse, and feed monaural signals to both circuits. These are all very handy little items to have if you plan to do much binaural listening.

I can assure you that it isn't as easy as it seems to get a perfect balance

between speakers and yet keep the overall volume at a proper level when you are fiddling with two volume controls. And suppose you find that you've got the orchestra backwards! It is a nuisance to pull the leads out from behind both amplifiers and reverse them by hand. But even more important than both is that switch that permits a single source to be fed to both circuits. Obviously, one does a great deal more monaural listening than binaural at the present time, and it takes a strong man to be able to sit there with two speaker systems and two amplifiers and actually use only one of each. Besides, I've heard many monaural sources made to sound binaural by leaning one amplifier toward the treble and the other towards the bass. There are many more reasons why it would be advantageous to feed a single source into both systems. The point is, how do we do it?

On the enclosed sheet is my visualization of what this might look like. For some reason, no manufacturer presently features such an item. Therefore, I would have to make it myself. I know how to use a soldering iron and

Continued on page 120

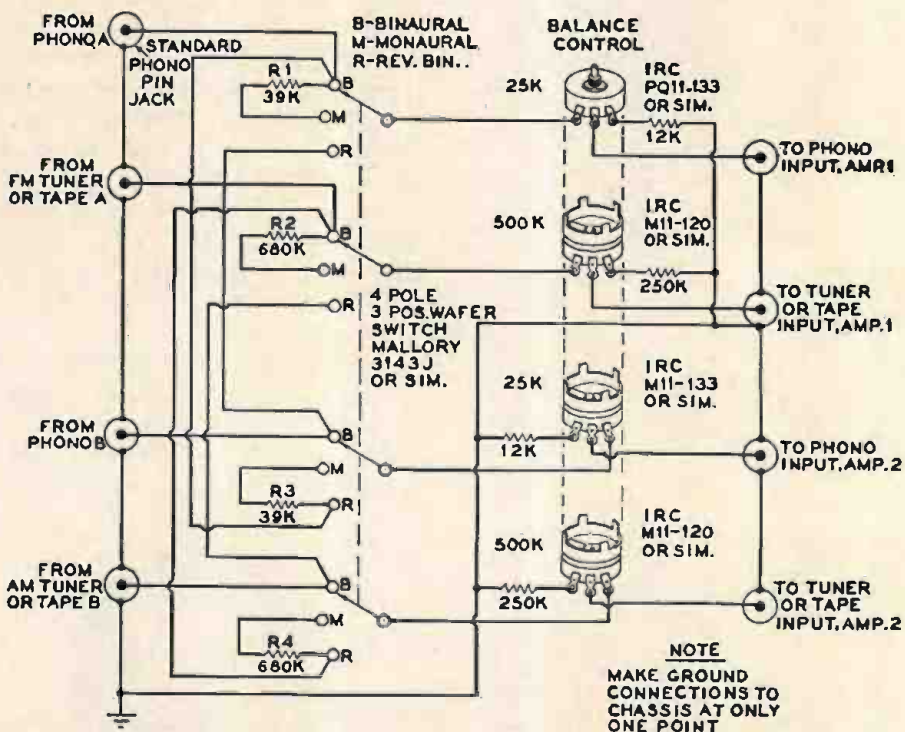

Suggested binaural control unit for use with two external preamp-equalizer-amplifiers.

Photograph is by Irvin Kershner of 17th or 18th century Colascione in the Erich Lachmann Collection of Historical Stringed Musical Instruments reproduced through the courtesy of the Allan Hancock Foundation and the University of Southern California. Printed reproductions of four of the photographs used in this series are available for one dollar. Send remittance to James B. Lansing Sound, Inc. Be sure to print your name and address clearly.



labor of love

The skilled Italian hands which fashioned this seventeenth century colascione were alive with delight. The elegance with which they inlaid the engraved mother-of-pearl in the straight-grained spruce table suggests a vision of courtly singers and noble ladies. The Jim Lansing craftsman carries in his mind another vision while he forms and assembles Signature Speak-

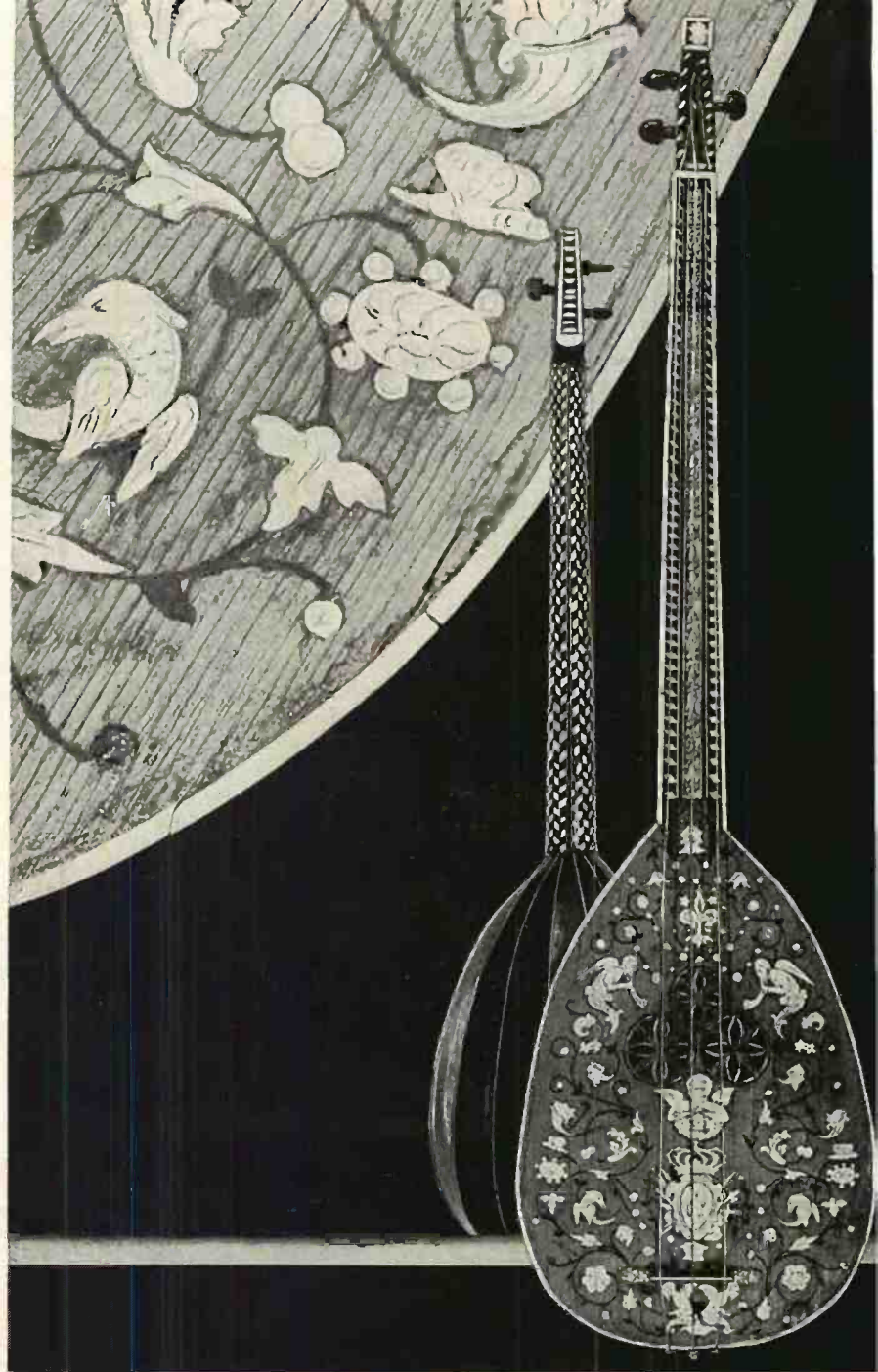

ers and Enclosures. He works to please, through his meticulous labors, the finely attuned ear which is able to perceive and appreciate today's closest approach to perfection — the verbatim reproduction of loudspeakers by Jim Lansing.



Only Jim Lansing 15" and 12" General Purpose Speakers are made with four-inch voice coils... for crisp, clean bass... for smooth, extended highs.

JAMES B. LANSING SOUND, INC. • 2439 Fletcher Drive, Los Angeles 39, California

PERSPECTIVES FOR ELECTRONIC ENGINEERS

FOCUS ON
Westinghouse

AIR ARM + ELECTRONICS DIVISION

FOR
FUTURE ★ INCOME
PROFESSIONAL
RECOGNITION

**OPENINGS EXIST
IN THE FIELDS OF:**

- ★ COMMUNICATIONS
- ★ FIRE CONTROL
 - ★ RADAR
- ★ TECHNICAL WRITING
 - ★ COMPUTERS
- ★ BOMBER DEFENSE
- ★ MISSILE GUIDANCE
- ★ FIELD ENGINEERING

TO APPLY

send letter outlining education and experience to:

Employment Supervisor
Dept. 154
Westinghouse Electric Corp.
2519 Wilkens Avenue
Baltimore 3, Maryland

AUDIO FORUM

Continued from page 118

I am sure I can follow simple instructions if they are complete enough. I am hoping that you can figure out what parts should be used in this gadget and how it should be wired.

Martin L. Borish, O.D.
81 East Main Street
Freehold, N. J.

One possible reason why no manufacturer offers a binaural switching and control system such as you desire may have to do with the fact that it would have to accommodate provisions for phonograph binaural reproduction. Unless tubes were used, it is quite possible that the hum problem would be very difficult to overcome. Nevertheless, if you would like to try it, we have attached a schematic diagram of as simple a switching system as seems practical. As you can see, we have combined the monaural-binaural and reverse binaural switches. The single switch now has three positions: monaural, binaural, and reverse binaural. In the monaural position, either the radio or phono input from channel A is split and goes to both channel outputs. This switch can be a simple 4-pole triple-throw wafer type.

**ORDER NOW!
LOWEST PRICES!**

**DIAMOND
NEEDLES \$10***

*Our skilled diamond craftsmen convert your present needle to a genuine, unconditionally guaranteed diamond-tipped needle! Send or bring your replaceable needle, check or money order for \$10. Specify either 33 or 78 rpm. If desired, new shaft supplied, \$2.75 additional.



DIAMOND STYLUS CO.

DEPT. HFM
31 WEST 47 STREET
N. Y. 36, N. Y.

the
Audio Console
control preamplifier-equalizer



Quality Designed by
marantz

Owners of the Marantz Audio Console invariably comment on the immediate improvement in sound quality of their systems. Such a fine instrument cannot be produced by the thousands, but only through careful assembly and thorough testing of each unit.

Naturally, its components are uncompromisingly chosen for superior quality. This and the character of its workmanship makes it the obvious choice for those who wish to improve their present installations. Chassis suitable for installation \$142.50, with cabinet \$155.00.

Write For Complete Details: **s. b. marantz** 44-15 Vernon Blvd., L.I.C., New York

You Save . . . when you
select Hi-Fi's Best
craftsmen

The NEW *Solitaire*



20 watt power amplifier, a preamplifier and an exclusive noise filter all in one attractive cabinet. Simply add record changer and speaker for a professional home music system.
Price was \$113.50.
NOW ONLY \$86.50
F.O.B. Chicago. Send check or M.O.

Send for New Brochure

See the new low prices on Tuners, Amplifiers, Preamplifiers.

- One year factory warrantee.
- 15 Day Home Trial—you must be satisfied—if not, return equipment for refund of purchase price.

The Radio Craftsmen Inc.
Dept. R5, 4403 N. Ravenswood Ave.
Chicago 40, Illinois

The focus control varies the output on both sets of channels, increasing that of one pair of channels as it decreases that of the other group. You would still need to use the selector switches in both amplifiers to switch between radio and phono channels, and you'd have to set the amplifiers' equalization controls properly for binaural phono sources. Low-noise resistors should be used in the phono channels of your switching box. The entire circuit should be well shielded. As was explained, this is offered with no guarantee; we haven't actually built one of these.

SIR:

In the March 1955 issue, on pages 120 and 122, there is a letter by Paul A. Alter regarding "play-through" or "pre-echo."

I would like to suggest that Mr. Alter's analysis of his problem is more accurate than he realizes, and also that he was not referring to needle talk. Pre and post-echo on microgroove records can be caused by a combination of a worn stylus whose assembly has poor or low compliance (stiffness) mounted in a tone arm with either tracking error or too high a pressure.

Continued on page 122

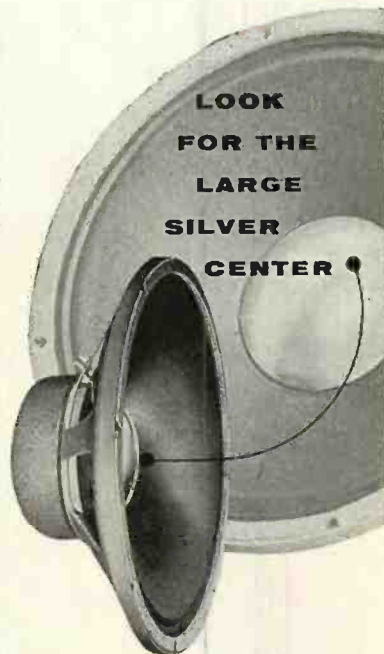

In your audio dealer's demonstration room where loudspeakers are lined up all in a military row . . . look for the speaker with the large, silvery dural dome in the center. Ear-test it with special care. This is the Jim Lansing Signature D130—the 15" Extended Range Speaker with 4" voice coil of edge-wound aluminum ribbon. The coil is attached directly to the 4" dural dome. Together they give the piston assembly exceptional rigidity. This is one reason why bass tones sound so crisp and clean . . . why the highs so smooth . . . the mid-range so well-defined. You will find the D130 to be as distinguished to your ear as it is to your eye.

THE SIGNATURE D130 (shown above) IS YOUR BASIC SPEAKER

Use it alone when you first begin your high fidelity system. Perfectly balanced with other Signature units, it later serves as a low frequency unit in your divided network system.

Additional Signature Precision Transducers with large domes and voice coils:



SIGNATURE D131 . . .
the finest 12" speaker made
O.D.—12 1/4"
4" voice coil of edge-wound aluminum ribbon
Depth—5"
Power input—20 watts
Impedance—16 ohms



SIGNATURE D123 . . .
an innovation in speaker design
Depth—only 3 3/4"
O.D.—12 1/4"
3" voice coil of edge-wound aluminum ribbon
Power input—20 watts
Impedance—16 ohms



SIGNATURE D208 . . .
an 8" precision transducer
O.D.—8 1/4"
2" voice coil of edge-wound aluminum ribbon
Power input—12 watts
Impedance—D208—8 ohms
D216—16 ohms

See your audio dealer for complete catalog

precision that  speaks for itself
JIM LANSING *Signature*

JAMES B. LANSING SOUND, INC.
2439 Fletcher Drive • Los Angeles 39, Calif.



The highest overtones of the piccolo

C2-100
Net price. \$4.50



Centralab's
Senior **COMPENTROL**[®]
lets you hear
the **full range**
of the
orchestral
score

The deepest tones of the bass tuba



Centralab

Senior Compentrol—with special Printed Electronic Circuit*—is no ordinary compensated control. There's nothing else like it, for improving the tone performance of hi-fi amplifiers or pre-amplifiers! *Level-set* lets you control compensation to suit yourself. Ask your Centralab distributor — or service man. Write Centralab, Dept. 928F, Milwaukee 1, Wisconsin for Compentrol booklet. *Trademark



Doctors' orders

- ▶ Physicians are increasingly enthusiastic about the faithful reproduction of music. The doctor's dilemma is often whether to purchase an ordinary tuner, with its fanciful claims, or insist upon the pace-setting PRECEDENT.
- ▶ This problem, which may be also yours, can be resolved by: 1) writing to REL for a free copy of the interesting, informative brochure, FM AT ITS FINEST; 2) speaking to a PRECEDENT owner; or best yet, 3) actual listening to a PRECEDENT—preferably on high quality, live FM.
- ▶ That's why more and more doctors' orders are for PRECEDENT: a prescription without equal for every music lover.

RADIO ENGINEERING LABORATORIES • INC.
36-40 Thirty-seventh Street • Long Island City 1, N. Y.



AUDIO FORUM

Continued from page 121

In earlier LPs the recording levels were often too high to be retained within groove walls. With a worn and stiff stylus combination these walls could be broken down sufficiently to carry modulation over into either the previous or subsequent groove. The walls were literally pushed over by the stylus into the next groove. The condition was particularly noticeable in sudden changes of dynamic range—for instance, from a solo instrument to full orchestral sound.

Since the advent of "variable margin technique" in record making, it is now possible to widen the margin between grooves a couple of revolutions before high modulation occurs, thus eliminating any possibility of pre or post-echo. Unfortunately, variable margin technique is neither industry-wide nor consistent on a given disk: cf., Columbia ML 4467, Berlioz' *Symphonie Fantastique*, one side of which is fixed margin technique and the other side variable margin.

I venture to guess that Mr. Alter is using a record changer with inadequate tone arm, cartridge, and stylus. Therefore, the echo can be due to his system, and his question, "Can it be a source of damage to the records?" should be answered, "Yes." The records on which he hears the pre-echo are already damaged. He can prove this fact by playing them on a friend's transcription turntable and arm combination in comparison with new copies of the same records.

I would be interested in hearing the opinions of your "experts" on all of the above.

William C. Bohn
Bohn Music Systems Co.
550 Fifth Ave.
New York 36, N. Y.

From the complete text of the letters referred to by Mr. Bohn, and from previous correspondence with Mr. Alter, we knew that he had excellent record-playing equipment (Rek-O-Kut turntable, Audax cartridge and arm) and, more important, that he kept it in good condition. Our reply was, therefore, the only reasonable one we could give under the circumstances.

We have done some more careful listening since receiving Mr. Bohn's letter. We find that it is a rare record indeed that, having a wide dynamic range, does not also have pre or post-echo to some extent. The amount

FITTING PROTECTION for your HI-FI DISCS!

Popular WALCO DISCOVERS

PROTECTIVE POLYETHYLENE SLEEVES FOR RECORDS



with EXCLUSIVE CONTOURED BOTTOM!

- Protects Records from Dust, Scratches, Finger Marks
- Slips Inside Original Jacket
- "Dresses Up" Discs

Because good hi-fi sound begins with a clean record Walco—famous for phonograph needles and STATI-CLEAN Anti-Static Record Spray—has developed the new DISCOVER protective sleeve for records. Made of soft, tear-resistant, pliable polyethylene with an exclusive, neat contoured bottom, DISCOVERS are "fitting protection" in more ways than one! Thousands of users agree, all your hi-fi records deserve this deluxe, low-cost protection.

BY THE MAKERS OF THESE OTHER FAMOUS RECORD PRODUCTS



WALCO STATI-CLEAN
Anti-Static RECORD SPRAY



WALCO REPLACEMENT NEEDLES
for all cartridges and players

FREE

Write for free sample DISCOVER, plus free \$1 book on record care, indexing, etc. Enclose 25c to cover postage and handling.

Walco

At Leading Dealers
60-F Franklin St.,
East Orange, N. J.

varies widely; on some records it is so apparent as to be startling, and on many it is easily audible if you listen for it. On most, of course, it is low enough in level as to be insignificant but detectable. This is corroborated by other staff members.

Nevertheless, Mr. Bohn has made a good point—one that all seriously interested in records should take to heart. For a comprehensive discussion of compliance and its effect on records, see the article beginning on page 38 of HIGH FIDELITY for April 1955.

SIR: When you home-tested the FM-AM tuner, you mentioned the fact that it would accommodate 72-ohm coaxial cable, and that you liked coax. However, you did *not* state why. You did refer to an article one issue earlier which mentioned coax, it is true, but dismissed it quickly.

Now the interesting thing about coax to me is that _____ claims twice the sensitivity for 72 ohms that they do for 300!

So, will you please tell me if this sensitivity can be put to use; what antenna to use; and what the disadvantages of coax may be. The lead for the antenna will not be over forty feet.

Charles V. Thayer
Breezy Hill Road
Springfield, Vt.

Coaxial cable's only advantages for a home system are that it sometimes does help to reduce ignition interference, and it may be more durable than 300-ohm twin lead. However, it has a far greater attenuation than standard twin lead, and therefore it should not be used on long runs between the antenna and the receiver if it is possible to avoid doing so. Furthermore, most FM tuners and antennas are now set up for a 300-ohm impedance, corresponding to the twin lead. If the antenna is of 300 ohms impedance you should use a matching transformer between it and the 72-ohm cable; another transformer should be used if the tuner has only a 300-ohm input.

A 72-ohm antenna will deliver to the tuner, if all impedances are matched, exactly half the voltage that a 300-ohm antenna will. So it makes no practical difference, insofar as sensitivity is concerned, whether you use a 300-ohm antenna and 300-ohm twin lead connected to the 300-ohm terminals of the tuner, or whether an all 72-ohm setup is used.



PRECISION
that speaks for itself!

Precision construction throughout! This is the reason why Jim Lansing Signature High Frequency Units "speak" with unequaled fidelity. Diaphragms are made of aluminum, hydraulically-formed for complete uniformity and homogeneity of grain structure. Phasing plugs are machined to micrometric dimensions from solid billets of absolutely pure iron. Exponential horns are machined from aluminum castings. Koustical Lenses are cut, formed and assembled to optical tolerances. The greatly superior reproduction... the ease with which transients are handled... which result from this detailed precision are immediately apparent to your ear. You hear a complete, flat, smooth high end free from disturbing dips and startling peaks.

**SIGNATURE 175DLH
PRECISION HIGH FREQUENCY TRANSDUCER**

Pictured above, the 175DLH is the first assembly ever placed on the high fidelity market to incorporate a true acoustic lens. With 14 separate elements, the lens distributes sound smoothly over a 90° solid angle. Index of refraction 1.3. Designed for 1200 cycle crossover. 16 ohms impedance. 25 watts power input above 1200 c.p.s.

**SIGNATURE 375
PRECISION HIGH FREQUENCY TRANSDUCER**

This driver, alone, weighs 31 pounds! With a 4" voice coil and diaphragm it is unquestionably the largest and most capable high frequency unit manufactured. Designed for theater systems; used in The Hartsfield. Low crossover—500 c.p.s.—is the secret of the impressive illusion of presence it creates. Power input—60 watts above 300 c.p.s. Impedance—16 ohms. Flux density—over 20,000 gauss.



**SIGNATURE 537-500
HORN-LENS ASSEMBLY**

This is a round exponential horn and lens for use with the 375 Signature Driver. Lens composed of 19 separate elements for smooth distribution of highs. Diameter, 13 1/2".



**SIGNATURE 537-509
HORN-LENS ASSEMBLY**

Consisting of a rectangular exponential horn and serpentine Koustical Lens (as used in The Hartsfield), this assembly provides wide horizontal and narrow vertical coverage in order to minimize ceiling and floor reflections. Use with the 375 Driver. Lens is 20" wide.



precision transducers for verbatim reproduction

JIM LANSING *signature*

JAMES B. LANSING SOUND, INC.
2439 Fletcher Drive • Los Angeles 39, Calif.

PROFESSIONAL DIRECTORY

• CALIFORNIA •

High-Fidelity House

Most complete stock of
audio components in the West

Phone RY 1-8171
536 S. Fair Oaks, Pasadena 1, Calif.

no finer choice than . . .
ElectroVoice
high-fidelity components
IN LOS ANGELES



Sound Un-Ltd.

6230 COMMODORE SLAT DRIVE
(opposite carthay circle theatre)
LOS ANGELES 48, CALIF. Phone WE 6-6218

WEINGARTEN
ELECTRONIC
LABORATORIES
INC.

7556 Melrose Avenue, Los Angeles 46, California
WEBster 5-5405 YORk 3872

The ultimate in High Fidelity
at net prices.

• ILLINOIS •

ALLIED RADIO

America's Hi-Fi Center

WORLD'S LARGEST STOCKS OF
HI-FI SYSTEMS AND COMPONENTS

VISIT OUR SOUND STUDIOS

100 N. WESTERN AVE., CHICAGO 80
MAYmarket 1-6800

SEND FOR FREE HI-FI CATALOG

THE HI-FI CENTER

complete demonstration facilities
components • custom installation

DISTRIBUTORS OF EVERYTHING IN ELECTRONICS
PreRecorded Tape and Records

ROgers Park 4-8640

2909 WEST DEVON AVE. • CHICAGO 45

Electronic Expeditors

• MASSACHUSETTS •

CUSTOM INSTALLATIONS

High Fidelity Center

Components Professional Servicing
Acoustic Consultants
Cabinet Design

LOWE ASSOCIATES

now at our new studios

65 Kent St., Brookline 46, Mass.

• NEW YORK •

WHY EXPERIMENT?

CONSULT A SPECIALIST IN
CUSTOM HIGH FIDELITY
IN THE NEW YORK CITY AREA.

Hear a typical home installation.

BOHN MUSIC SYSTEMS CO.

PL 7-8569 550 Fifth Ave., N. Y. 36

In Westchester it's



for high fidelity

CONSULTATIONS COMPONENTS
SERVICE CUSTOM INSTALLATIONS

2475 Central Avenue Yonkers, N. Y.
Spencer 9-6400

• PENNSYLVANIA •

HI-FI DO IT YOURSELF

In spare time, Mon., Wed., and Fri.
eves. Ample parking. Use our
workshop, tools, expert supervision.
Assemble and compare leading
makes; tuners, amplifiers, changers,
Tape Recorders, speakers, Cab-
inets, kits, etc. at low net prices.

Trade-ins • Records • Tapes

SHRYOCK RADIO AND TELEVISION CO. EST 1926
317 W. LANCASTER AVE., ARDMORE, PA. Midway 2-1928

PHILADELPHIANS:

Preview the advanced products—
electrostatic speakers, exclusive
British and European components.
Consult nationally recognized
authorities. Why buy last year's
high fidelity? Visit us.

ELECTRONICS

City Line Center GREENwood 7-9535

In PITTSBURGH and the
TRI-STATE AREA

Everything in Hi-Fi

WOLK'S HIGH FIDELITY CENTER

right next to Wolk's Kamera Exchange
306 Diamond Street Pittsburgh (22), Pa.
Express 1-0220

• CANADA •

**CANADA'S FIRST
HIGH-FIDELITY**

RADIO, PHONOGRAPH, RECORD AND
TELEVISION CENTRE

Stromberg-Carlson "Custom 400"
Brociner — Freed-Eisemann — Bogen
Fisher Radio — Concertone Tape Recorders
All Makes of High-Fidelity Records

Custom Sound and Vision Ltd.

390 EGLINTON WEST TORONTO, ONT.
Phone HUdson 9-2117

WELL-ADJUSTED WATT

Continued from page 41

others actually intimate that 100,000 cycles is a desirable reproducing area? The writer has summarized the arguments:

1. Unless the amplifier is substantially flat beyond supposedly audible limits, the response will start to roll off within the audible limits, with detriment to the sound.

2. A properly designed, stable amplifier with a good "power-curve" (cf. the explanation above) must be flat in frequency far outside audio limits.

3. For laboratory use, the response must be extremely wide.

Between complete amplifiers and preamplifiers which are actually "flat" over extreme ranges, and those which are not, there is an interesting listening difference. The proponents of limited response argue that a home amplifier, intended for playing records, on turntables, with cartridges, and with loudspeakers—all of which are not laboratory-perfect devices—sounds better on most material if it is *limited* in response. Filters of all sorts are obviously designed by this school. Frankly, the writer, an admitted perfectionist, prefers the "flat" amplifier, with suitable controls to limit the response when necessary (it is ever less necessary as program-material and associated equipment improve).

The interested purchaser should listen carefully to at least one amplifier from each "school" of design, using the kind of program-material he will use at home, with the projected associated equipment, before he decides. (Editor's Note—A typographical error on page 41 described 20-to-2,000 cps as a common frequency-range claim. It should, of course, have been 20-to-20,000.)

An article next issue will discuss the relationship between power and distortion in audio-amplifier performance.

ALMOST GOT MY NUMBER

Continued from page 37

openable only by main force, to demonstrate that the record had not been touched or even breathed upon since leaving the stamper. Finally, I inserted the specially-executed painting, suitable for framing, by Tequila, the celebrated Mexican artist."

"You remember the painting?" interrupted the Chief.

"Indeed I do, sir," I replied. "It was of a jellyfish, symbolizing the basic.

B-J TANGENTIAL TRACKING ARM

"MAKES ALL OTHERS OBSOLETE"

Works on any turntable except automatics. Accommodates most standard pick up cartridges.

\$2250



WHAT A DIFFERENCE!

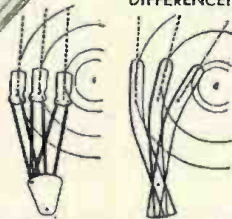

The head of the B-J is ALWAYS TANGENTIAL to record groove.

All conventional tone arms have tracking error.

New B-J is the ONLY tone arm that holds the needle TANGENTIAL TO THE GROOVE from the beginning to the end of the record. NO TRACKING DISTORTION. LESS RECORD WEAR—LESS STYLUS WEAR—LESS SURFACE NOISE

World Patent Applications

If unobtainable from your local dealer order direct from DEPT. "HF" HI-FIDELITY INC., 420 Madison Ave., N. Y. 17

DEALERS CONTACT: HI-FI AUDIO DIV. OF BRITISH ELECTRONICS SALES CO., 23-03 45th Rd., L. I. City

TRUE HI-FI...

THE D&R DR-12A TURN TABLE



Check these D&R features:

- Outside Idler Drive.
- Floating Idler—Assuring utmost freedom of mechanical vibration.
- Signal-to-Noise Ratio 60 DB.
- Non-Magnetic Turntable.
- Mercury Switch.
- Dynamically Balanced Motor.
- Constant Speeds—33.33, 45, 78.26 with high starting torque.

THE DR-12A Turntable only, with standard panel mounting

\$87.00*

*Mahogany box mounting extra

See your dealer or write to...
**AUDIO EQUIPMENT
DIVISION D&R LTD.**
402 E. Gutierrez Street
Santa Barbara, Calif.



elemental nature of the Phoenician songs. The brochure carried an explanation of it on the back page."

The Chief sighed.

"Eighteen," he said softly, "can't you remember anything else you put into that album before you stamped it 'Inspected by No. 18?'"

"No, sir, I can't," I said, paling. "I'm sure that with the painting, the brochure, the plastic envelope, the cardboard backing, the picture window and the outer wrapping, there wasn't room for anything else."

"That's just it," thundered the Chief. "Eighteen, you left out the record!"

I must have fainted then, for when I opened my eyes my face was moist and the Chief was standing over me with an empty flower vase. After making sure that I had recovered, he returned to his side of the desk and gloomily resumed his seat.

"Eighteen," he said, "we don't mind it so much when you fellows slip the wrong record into an envelope, or when you get the labels switched, or when you omit the translation of the original text. That's all part of the luck of the game, and record-buyers have to take their chances same as anybody else. But to leave out the record altogether isn't quite cricket."

"But, Chief," I cried hoarsely, "I swear there wasn't room for it."

"I know, I know," said the Chief. "It's not really your fault. The Company operates on the principle that the record proper is only a minor component of the record album. Just between us, Eighteen, you might well have got away with it, if Biedrich-Dietrich himself hadn't been in town and wanted to hear the thing. Imagine! Not to look at the art masterpiece, not to read the brochure—just to play the record. These singers are simply incredible."

He paused while I awaited his pronouncement.

"Eighteen," he said at last, "you've been with us a long time, but now that a fuss has been raised over this thing I'm afraid I shall have to make an example of you. I'm not asking you to turn in your stamp. But you won't have much use for it any more. I am transferring you to the Zipper Department."

"The Zipper Department?"

"Yes, Eighteen. From now on, all our records are going to be encased in plastic cases fastened with a zipper. Do you know why we are doing this?"

Continued on page 128

9356 Santa Monica Blvd., Beverly Hills, Calif.
161 Sixth Avenue, New York 13, N. Y.

Dept. 4-H



10,000 MOTION PICTURE THEATRES
USE ALTEC SPEAKERS AND AMPLIFIERS...

ANNOUNCING...
an automatic switch
to protect your
High Fidelity
investment



\$6.45 net

AUTOMATICALLY...

- will turn your equipment off after last record plays
- will protect your High Fidelity equipment from running all night when you forget

See your Hi Fi Dealer or write for further information

A Product of
HARWIL ELECTRONICS CO.
8413 Beverly Blvd.
Los Angeles 48, Cal.

(Advertisement)

PICK-UP FACTS

by Maximilian Weil

" . . . There is universal agreement on the superiority of a well designed magnetic (moving-iron) pickup over other types. No one, however, has ever come forth with the reasons for this. . . ." (from a letter)

The functions of the microphone and the phono pickup are the same — both have to deliver a modulated signal to the amplifier. The task of the pickup, however, is immensely more difficult. The pickup stylus must actually connect (mechanically) with the record-groove and the contact must be solid and unbroken, throughout its zig-zag course. Obviously, so long as the generating element — the part that transforms the recorded vibrations to electrical waves — is located within the cartridge, at a distance from the stylus, some form of linkage (metal shafts, etc.) between the two must be used. Unfortunately, a mechanical transmission line (linkage) with its own mode of vibrations, always produces intermodulation and other forms of distortion.

In all pickups, regardless of type, the generating element is still located inside the cartridge, at a distance from the stylus. . . . Recently, however, the quarter-century dream of those skilled in this art has, at last, been realized in the POLYPHASE type cartridge. In this magnetic cartridge the transformation of the mechanical vibrations to electrical pulses takes place directly at the stylus. This entirely eliminates the transmission line and explains the total freedom of this cartridge from phase-lag and intermodulation distortion.

This is one of the major factors that spell the great difference for the well designed magnetic cartridge.

FREE—"Electronic-Phono-Facts", a \$1.00, 18-page reference guide has been prepared to answer your many questions. It is highly interesting and informative. You may have one FREE by writing me at 500 — 5TH AVENUE, NEW YORK.

LISTENING QUALITY

is everything!

Today, all pickups, good, bad or indifferent, have wide frequency range, yet one will perform smoothly, the other harsh, shrill, etc. The NEW high output — HI-Q7 has BALANCE, SMOOTHNESS, LISTENING QUALITY, not equalled by any other pickup. . . . BUT —

all the flowery specifications in the world, cannot change the fact that ONLY you can tell what sounds best to you. Hear and compare the HI-Q7 with any other pickup known and — you be the judge. . . .

Plays all speeds. Equipped with Chromatic DIAMOND and a sapphire — both replaceable at home. . . . (available for use on Record Changers.)



NEW COMPASS-PIVOTED-ARM

Universally acknowledged as the most efficient arm — barring none • No restraint • No frontal oscillations • No springs • No fatigue • Highest tracing efficiency • Equipped for stylus-pressure adjustment.

This superb AUDAX arm is now also available for use with other cartridges.

STYLUS-BALANCE

75% of the cartridges in use, work with incorrect stylus-pressure. This means stylus and record destruction. With the scales and gauges available heretofore, it has been impossible to check stylus-pressure closer than 2 or 3 grams — one way or the other. That is 50% off-correct. This means deformation of groove-walls, and explains much of the echoes, ghosts and other distortion. —Stroboscope-like, STYLUS-BALANCE accurately indicates correctness or incorrectness of stylus-pressure.



STYLUS-BALANCE works with any cartridge and arm NET \$4.80 Plus 25¢ if shipped from N. Y.

"It's easy to use and without doubt is potentially the most accurate gauge available for home use. . . ." *High Fidelity Magazine.*

At better dealers, or write us

AUDAK COMPANY

500 Fifth Avenue Dept. H New York 36, N. Y.

Creators of Fine Audio-Electronic Apparatus for over 30 years

ADVERTISING INDEX

Allied Radio Corp.	9, 124	Klipsch Associates	18
Altec Lansing Corp.	125	Lansing, James B., Sound, Inc.	119, 121, 123
American Elite, Inc.	106, 107	lectronics	124
Ampex Corp.	23	Leslie Creations	Indexed on 52
Angel Records	Indexed on 52	London International	Indexed on 52
Audak Company	126	London Records	Indexed on 52
Audio Devices	Inside Front Cover	Low Associates	124
Audio Exchange	127		
Audiogerth Corp.	108		
Beam Instrument Corp.	105	Marantz, S. B.	120
Bell Sound Systems, Inc.	48	McIntosh Laboratory, Inc.	6, 7
Beyland Engineering Co.	Indexed on 52	Mercury Records Corp.	Indexed on 52
Bogen, David, Co., Inc.	101	Minnesota Mining & Mfg. Co.	103
Bohn Music Systems Co.	124	Missouri National Corp.	Indexed on 52
Book-of-the-Month Club, Inc.	Back Cover	Music Box	Indexed on 52
Bozak, R. T., Co.	22	Music Room, The	Indexed on 52
Bradford & Company	116		
British Industries Corp.	15	National Company	97
Browning Laboratories, Inc.	115	Newcomb Audio Products Co.	108
		Nuclear Products Co.	Indexed on 52
Calex Co.	Indexed on 52	Pedersen Electronics	26
Centralab	121	Pentron Corp.	109
Collaro	Inside Back Cover	Pormoflux Corp.	113
Collins Audio Products Co.	47	Pickering & Co., Inc.	2
Columbia Records, Inc.	4, Indexed on 52	Pilot Radio Corp.	128
Components Corp.	117	Presto Recording Corp.	27
Concertone Recorders, Berlant Associates	94	Professional Directory	124
Conrac, Inc.	10, 11		
Cook Laboratories, Inc.	Indexed on 52	Radio Craftsmen, Inc.	121
Crestwood Recorder Division	25	Radio Engineering Labs., Inc.	122
Crown Publishers	110	Rauland-Borg Corp.	110
Custom Sound & Vision, Ltd.	16, 124	Record Index	Indexed on 52
		Record Market	Indexed on 52
		Reeves Soundcraft Corp.	21
D & R, Ltd.	125	Regency	19
Daystrom Electric Corp.	25	Rok-o-Kut Co.	13
Diamond Stylus Co.	120	Revere Camera Co.	91
Dublin's	Indexed on 52	Rockbar Corp.	8, Inside Back Cover
Duo-tone, Inc.	116		
		Scott, Harmon Hosmer, Inc.	24
Electra-Voice, Inc.	32	Shryock Radio and TV Co.	124
Electronic Expeditors	124	Sound Unlimited	124
		Stephens Mfg. Corp.	5, 110
		Sirromberg-Carlson	117
FM Station Directory	128	Tannoy, Ltd.	114
Fairchild Recording & Eqpt. Corp.	12, 118	Tech-Master Corp.	16
Federal Mfg. & Engineering Corp.	128	Telefunken	106, 107
Fisher Radio Corp.	28, 29, 30, 31	Terminal Radio Corp.	112
Fleetwood Television (Conrac, Inc.)	10, 11	Thorens Co.	111
		Trader's Marketplace	116
Gene Bruck Enterprises	Indexed on 52	University Loudspeakers, Inc.	99
Goodmans Loudspeakers	8		
Harvey Radio Co., Inc.	17	V-M Corp.	93
Harwil Electronics Co.	125	Vox Productions, Inc.	Indexed on 52
Heath Co.	20		
Hi-Fi Center, Inc.	117	WWRL	128
High-Fidelity House	124	Walco (Electrovox Co., Inc.)	123
Hi-Fidelity, Inc.	125	Weathers Industries	14
High Fidelity Recordings	Indexed on 52	Weingarten Electronic Laboratories	124
		Westinghouse Electric Corp.	120
		Westlab	124
		Westminster Recording Co.	Indexed on 52
Interelectronics Corp.	114	White, Stan, Inc.	115
International Electronics Corp.	111	Wolk's Kamera Exchange	124
Jensen Mfg. Co.	7		

TRADE IN
YOUR PRESENT AMPLIFIER
AND PRE-AMP FOR THE NEWEST
FAIRCHILD



No. 240
Balanced Bar Pre-Amp
\$98.50

UNCOMPLICATED CONTROL ...
WITH FINEST RESULTS



No. 260
Amplifier — \$149.50

UNSURPASSED PERFORMANCE
UNSURPASSED STABILITY

KNOWN AS THE MANUFACTURER
OF HIGHEST QUALITY
PROFESSIONAL
EQUIPMENT

Write Dept. HF6 For Trading Information

the
audio
exchange

THE TRADING ORGANIZATION
OF THE HI-FI FIELD

159-19 Hillside Avenue
Jamaica 32, N.Y.

Phone: OLYMPIA 8-0445

WRITE DEPT. H6 FOR
FREE CATALOG OF
USED EQUIPMENT

FREE PARKING
NEAR SUBWAY



the audio exchange exchanges audio

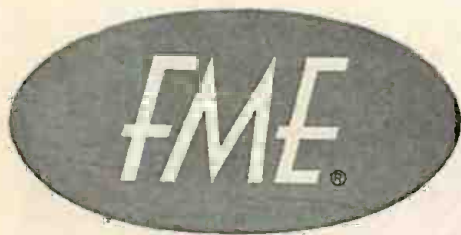

America's Greatest Tape Recorder Values

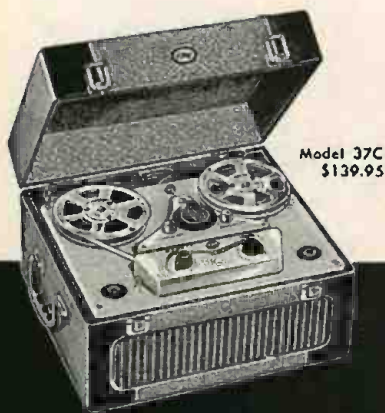

Model 37C
\$139.95

Low-Priced, Two-Speed
Dual-Track



Model 47A
\$159.50

Only in FME Tape Recorders do you get so many desirable features at such reasonable prices. Extraordinary tone quality, precision construction, and dependable performance make FME Tape Recorders unrivaled values in the low-priced field. Made and guaranteed by the makers of world-renowned Federal Photo Enlargers. Write for descriptive circulars with specifications.

Simplified Controls
50 - 12000 CPS
Editing Accessories

L-44

FEDERAL MANUFACTURING
AND ENGINEERING CORP.
215 Steuben Street, Brooklyn 5, N. Y.
EXPORT DIVISION: 25 Warren St., N. Y. 7, N. Y.
Cables SIMONTRICE NEW YORK all codes

ALMOST GOT MY NUMBER

Continued from page 125

"Is it to give added protection to the priceless art, literature, and music contained in the albums, and to prove that the outer packaging, as well as the inner contents, has been factory-sealed?"

"Right, Eighteen," snapped the Chief. "I'm glad to see that your error hasn't clouded your insight."

"One more thing," he said as I rose to leave. "Eighteen, I'm going to let you in on a secret. A month from now, a mistake like yours will be impossible, or at least impossible to detect. Our engineers are working right now on a solution to the basic problem—the bulky, unaesthetic disk that balks all our packaging dreams. What we're going to have, Eighteen, is a disk which is *absolutely invisible and takes up no room at all!*"

Now I zip and seal all day long. It isn't like stamping, but progress requires sacrifices. And now I can skip that night-course in Spanish. I really felt sorry for poor Sixteen last night, seeing him go home with those zarzuela scores under his arm. Twenty-two of them this week, I think he said.

SCHERCHEN

Continued from page 38

"Oh, to be back at Gravesano," he sighed. "I left December 31, and so far fifteen concerts. From London I go to Frankfurt, February 21."

That was an average of better than two concerts a week, and rarely were they in the same place. From Liverpool we had both come down on the night train, and at ten on the morning following the *Ninth*, here he was with the LSO in the Royal Festival Hall. "What I need tonight," he remarked, "is to see a really funny British film. Have you seen *Mad About Men*? It's about a Yorkshire mermaid who becomes a woman for fourteen days. It is very good."

And then his thoughts went back to music.

In NEW YORK CITY
FOR QUALITY MUSIC
NIGHTLY

6 P.M. to 12 Midnight
dial

WWRL-FM --- 105.1 Mc

HIGH FIDELITY



AF-860 AM-FM PILOTUNER
The Ultimate in engineering skill and sensitivity — symbolic of the complete line of superb Pilotuners.

PILOTUNERS



AA-904 PILOTONE AMPLIFIER
World famous Ultra-linear Williamsan circuit — an electronic triumph characteristic of the wide range of Pilotone Amplifiers.

PILOTONE AMPLIFIERS



PA-913 PILOTROL
Professional Preamplifier-Equalizer, an innovation in audio control — and other fine products, including the portable Encore; reflect the Pilot "Standard of Excellence."

FOR TECHNICAL DATA AND
BROCHURE, WRITE TO:

Pilot
RADIO CORPORATION

37-06 36th Street
Long Island City, N. Y.



Overwhelming

THE
Collaro
RC-54



*The Automatic Record Changer
That First Introduced . . .*

JPF
Just Plain Fidelity



Overwhelming is the word — because that's just what the reaction has been to the new Collaro RC-54. In the past 4 months, more RC-54s have been sold than in any other similar period. And it looks like this record is well on its way to being broken.

Of course, we knew all along that the RC-54 was worthy of such popularity, but we didn't quite realize that you would recognize this fact so soon. It appears then that what you have been really looking for are

the very features offered you by the Collaro RC-54: smooth, quiet operation — inter-mixing of all size records at all speeds without presetting—3-speed operation: 33 $\frac{1}{3}$, 45 and 78 rpm — fast (7 seconds) change cycle regardless of record speed — minimum rumble, wow and flutter — gentle handling of records — jam-proof operation—smaller mounting deck, and all the other convenient advantages of the RC-54. **But above all, it appears that what you want in home music reproduction is fidelity . . . Just Plain Fidelity**

Sold by Leading Sound Dealers.

Write for complete specifications to Dept. VF-2

MADE IN ENGLAND

\$48⁷⁵
Net
Slightly higher
West of Rockies

ROCKBAR CORPORATION • 215 East 37th Street, New York 16, N.Y.

TO DEMONSTRATE . . . A SENSIBLE WAY TO HELP YOU UNDERSTAND MUSIC BETTER AND ENJOY IT MORE

Will you accept without charge **ANY ONE** of these high-fidelity **MUSIC-APPRECIATION RECORDS**

 <p>Debussy's LA MER THE PHILHARMONIA ORCHESTRA OF LONDON Herbert von Karajan, Conductor</p>	 <p>Wagner's OVERTURES TO TANNHÄUSER and DIE MEISTERSINGER LONDON SYMPHONY ORCHESTRA - Norman Del Mar, Conductor</p>
 <p>J.S. Bach's SUITE FOR ORCHESTRA NO. 3 IN D MAJOR MUSIC APPRECIATION SYMPHONY ORCHESTRA George Szell, Conductor</p>	 <p>Mendelssohn's VIOLIN CONCERTO IN E MINOR THE STADIUM CONCERTS SYMPHONY ORCHESTRA Alexander Smallens, Conductor • Fredell Lack, Violinist</p>
 <p>Schumann's PIANO CONCERTO IN A MINOR THE LITTLE ORCHESTRA SOCIETY Thomas Scherman, Conductor • Eileen Flessler, Pianist</p>	 <p>Beethoven's FIFTH SYMPHONY LONDON SYMPHONY ORCHESTRA Norman Del Mar, Conductor</p>



ON ONE SIDE there is a full performance of a great musical work. The records feature orchestras and soloists of recognized distinction in this country and abroad. You listen to this performance first, or afterward, as you desire, and then . . .



ON THE OTHER SIDE is an illuminating analysis of the music, with the themes and other main features of the work played separately with running explanatory comment, so that you can learn *what to listen for* in order to appreciate the work fully.



YOU WILL RECEIVE SEPARATELY A GLOSSARY OF MUSICAL TERMS

THIS NEW IDEA, sponsored by the Book-of-the-Month Club, is designed for those who enjoy good music but who are aware, too often, that they do not listen to it with complete understanding and appreciation. There is no doubt about the reason: most of us are not primed about *what to listen for*. Music-APPRECIATION RECORDS meet this need—for a fuller understanding of music—better than any means ever devised. This enjoyable form of self-education can be as thorough as the Music Appreciation courses given in many universities.

YOU SUBSCRIBE BUT TAKE ONLY THE RECORDS YOU WANT . . . A new Music-APPRECIATION RECORD will be issued—for subscribers only—every month. Ultimately all the great masterpieces of music will be included. The announcement about each forthcoming record will be written by the noted composer and music commentator Deems Taylor. After reading this descriptive essay you may take the record or not. *You are not obligated to take any specified number of records.* And you may stop the subscription at any time you please!

TWO TYPES OF RECORDS AT A RELATIVELY LOW COST . . . All Music-APPRECIATION RECORDS are high-fidelity long-playing records of the highest quality— $3\frac{3}{4}$ R.P.M. on Vinylite. They are of two kinds: first, a so-called Standard Record—a *twelve-inch* disc—which presents the performance on one side, the analysis on the other. This is sold at \$3.60, to subscribers only. The other is an Analysis-Only Record—a *ten-inch* disc—priced at \$2.40. The latter is made available each month for any subscriber who may already have a satisfactory long-playing record of the work being presented. (A small charge is added to the prices above to cover postage and handling.)

TRY A ONE-MONTH SUBSCRIPTION—WITH NO OBLIGATION TO CONTINUE . . . Why not make a simple trial, to see if these records are as pleasurable and as enlightening as you may anticipate? The record you choose will be sent to you at once—at no charge. You may end the subscription immediately after hearing this record, or you may cancel any time thereafter.

PLEASE RETURN ONLY IF YOU HAVE A $3\frac{3}{4}$ R.P.M. RECORD PLAYER

<p>MUSIC-APPRECIATION RECORDS R10-6 c/o Book-of-the-Month Club, Inc. 345 Hudson Street, New York 14, N. Y.</p>	<p>AS MY FREE DEMONSTRATION RECORD PLEASE SEND ME:</p>
<p>Please send me at once, without charge, the Music-APPRECIATION RECORD checked at the right and enter my name in a Trial Subscription to Music-APPRECIATION RECORDS, under the conditions stated above. It is understood that, as a subscriber, I am not obligated to buy any specified number of records, but may take only those I want. Also, I may cancel my subscription after hearing this first record, or any time thereafter at my pleasure, but the introductory record is free in any case.</p>	<p><input type="checkbox"/> Bach's Suite for Orchestra <input type="checkbox"/> Debussy's La Mer <input type="checkbox"/> Beethoven's Fifth Symphony <input type="checkbox"/> Schumann's Concerto <input type="checkbox"/> Mendelssohn's Concerto <input type="checkbox"/> Wagner's Overtures</p> <p>Mr. <input type="checkbox"/> _____ Mrs. <input type="checkbox"/> _____ Star <input type="checkbox"/> _____ (Please Print)</p> <p>ADDRESS: _____ CITY: _____ ZONE: _____ STATE: _____</p> <p style="text-align: right;">MAR 18</p>