

AUDIO ENGINEERING

OCTOBER
1949
35c

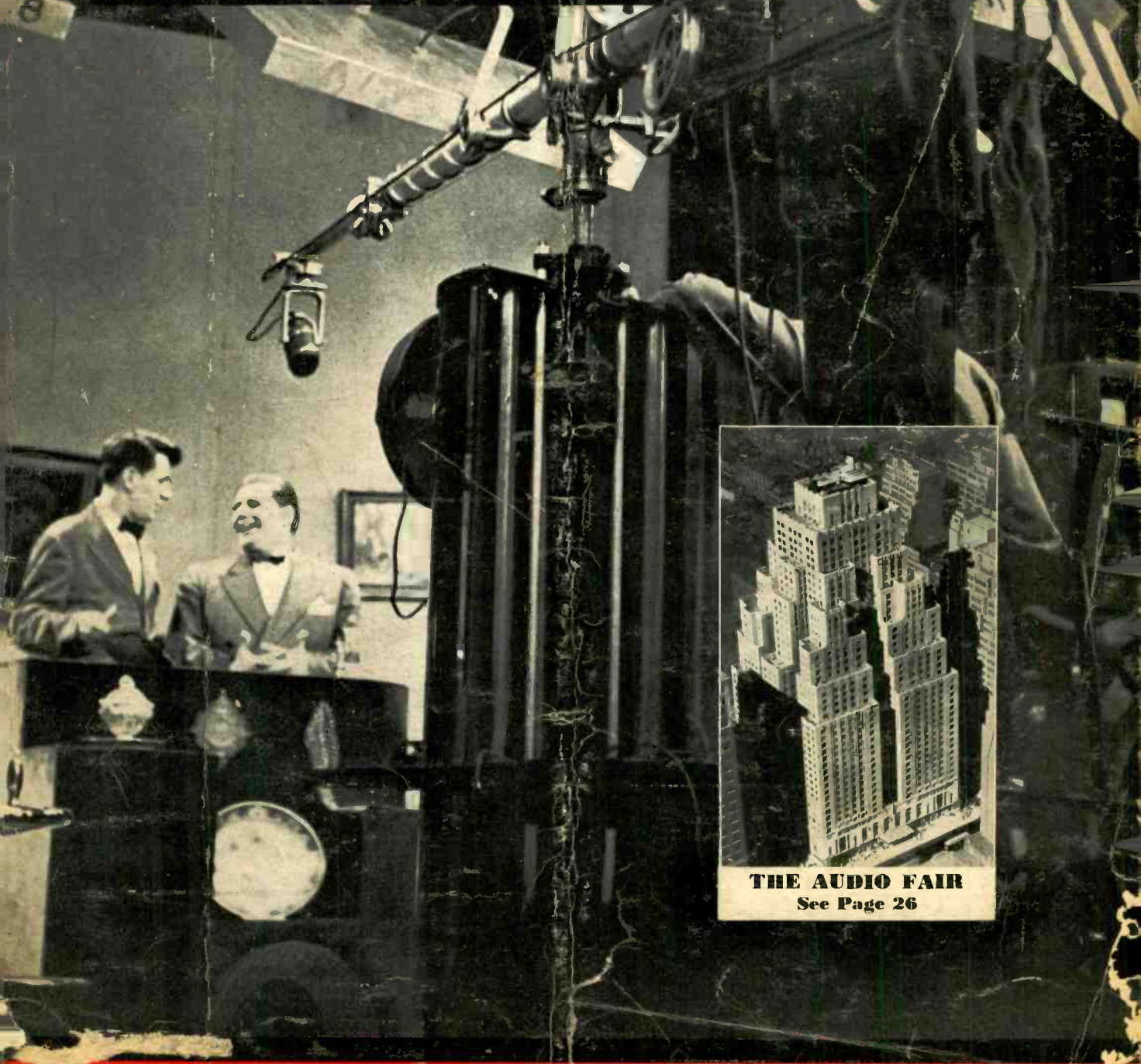

THE AUDIO FAIR
See Page 26

DON'T LET THE SUMMER'S HUMIDITY HAUNT YOU THIS FALL!

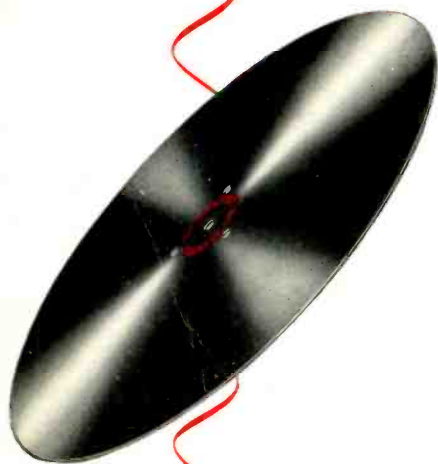

Left-over moisture is no problem when you record on humidity-resistant

audioidiscs*

The worst of the summer months have passed—but the humidity lingers on. And its after-effects may actually be felt far into the fall and winter. For an ordinary lacquer recording disc absorbs moisture much more readily than it will give it up. And “left-over moisture,” absorbed during the summer, can spoil many a recording months after the humidity has fallen below the danger point. So why risk “grey rings” and high noise level, when you can be sure of faultless recording with *humidity-resistant* Audioidiscs?

In Audioidiscs, the moisture problem has been solved *permanently* by the addition of a special moisture resisting agent—without any change in the basic lacquer formulation. As this development was perfected in 1947, we have had plenty of field experience to back up our own laboratory tests. During the summers of 1948 and 1949, for example, none of our customers has reported any humidity trouble.

So—for truly fine recording and reproduction all year around—be sure to ask your dealer for Audioidiscs!

TAPE RECORDISTS—Send for your Free Samples of the NEW audiotape*



Now, after 2½ years of research and development, Audio Devices offers you a complete line of highest quality magnetic recording tape—designed for *matched performance* in any tape recorder.

Two different types of paper-base Audiotape are now available—one with a high coercive-force black oxide, and the other with a medium coercive-force red oxide. This choice of charac-

teristics enables you to select the tape that best matches the bias of your machine—for maximum quality of recording and reproduction.

Plastic-base Audiotape, with the same choice of oxides, will be available shortly.

We'd like you to test this new Audiotape, in your own machine. The coupon at the left, or a request on your company letterhead, will bring you a 200-foot sample of each type without cost or obligation.

AUDIO DEVICES, INC.

444 Madison Ave., New York 22, N. Y.

Gentlemen:

Please send me, free of charge, two, 200-foot samples of paper-base Audiotape—one with high coercive-force oxide, and the other with medium coercive-force oxide.

NAME _____

COMPANY _____

ADDRESS _____

CITY _____ STATE _____



*Trade Mark

AUDIO DEVICES, INC.

444 MADISON AVE., NEW YORK 22, N. Y.

Export Dept.: ROCKE INTERNATIONAL, 13 East 40th St., New York 16, N. Y.

Audioidiscs are manufactured in the U. S. A. under exclusive license from PYRAL, S. A. R. L., Paris

ADOPTED

by these outstanding television set makers..

Admiral



*Andrea
Automatic
Radio*

*Bendix
Radio*

CROSLEY

DEWALD

*Emerson
Radio*

**FADA
Radio**

Farnsworth

GARDNER RADIO

hallicrafters

Hoffman

Magnavox



Motorola
NATIONAL

Olympic

Packard Bell

PHILCO



Regal

Sentinel Radio

Silvertone

Spartan

**STROMBERG
CARLSON**

Tele-tone



TRAV-LER

Westinghouse



Sylvania's outstanding television picture tubes

When 32 nationally known television set makers specify Sylvania television tubes for their sets, you have a sure indication of their excellent quality.

If you wish full information about the entire line of Sylvania Cathode Ray Tubes, made by the manufacturers of highest quality radio tubes for many years, write Sylvania Electric Products Inc., Cathode Ray Division, Emporium, Pa.

SYLVANIA ELECTRIC

CATHODE RAY TUBES; RADIO TUBES; ELECTRONIC DEVICES; FLUORESCENT LAMPS, FIXTURES, WIRING DEVICES; ELECTRIC LIGHT BULBS; PHOTOLAMPS

LOW DISTORTION SIGNAL SOURCE FOR BROADCAST MEASUREMENTS

-hp- 201B AUDIO OSCILLATOR



**EASY TO USE
INEXPENSIVE
HIGH OUTPUT
LOW DISTORTION**

SPECIFICATIONS

Frequency Range: 20 cps to 20 kc, in 3 bands
X1—20 to 200 cps

X10—200 to 2,000 cps

X100—2,000 to 20,000 cps.

Frequency Calibration: Direct in cps for lowest band. Effective scale length for 3 bands is 47 inches.

Stability: Better than $\pm 2\%$, including warm-up drift.

Output: 3 watts or 42.5 volts into 600 ohm load.

Frequency Response: Within ± 1 db over entire frequency range.

Distortion: Less than 1% at 3 watts output. Less than 0.5% at 1 watt output, at frequencies above 50 cps.

Hum Level: Less than 0.03% of maximum amplifier output voltage.

Data subject to change without notice.

Broadcast stations across the country find this high-fidelity *-hp-* 201B Audio Oscillator an ideal signal source for broadcast measurements, including new station performance data now required by the F. C. C. It meets every FM or AM requirement for speed, ease of operation, accuracy and purity of wave form. It enables you to quickly, easily and accurately make such measurements as high fidelity amplifier tests, overall station frequency response, overall station distortion, studio-transmitter line characteristics, etc.

3 WATTS OUTPUT

The *-hp-* 201B provides 3 watts of output power into a 600 ohm resistive load, sufficient to drive almost any kind of broadcast, laboratory or production equipment. Distortion may be limited to less than 0.5% at power of 1 watt or less. Hum level and output level can be attenuated together, and hum level is held 70 db under signal level for accuracy in working with small test signals.

Effective scale length is about 47" and the no-parallax tuning dial has 95 calibration points occupying 300 degrees of the scale. The entire instrument is rigidly constructed for long service; sturdy, light weight and easy to handle. It is completely powered from any 115 volt ac power source.

Get complete details. See your nearest *-hp-* representative or write direct.

20 TO 20,000 CPS

The instrument has a frequency range of 20 to 20,000 cps, covered in 3 bands. Frequencies can be tuned directly or by a 6:1 vernier control.

HEWLETT-PACKARD CO.

1878L Page Mill Road, Palo Alto, Calif.

Export: FRAZAR & HANSEN, LTD.
301 Cloy Street, San Francisco, California, U.S.A.
Offices: New York, N. Y.; Los Angeles, Calif.

FREE

**HOW-TO-DO-IT MANUAL
FOR F. C. C. MEASUREMENTS**



Broadcast Engineers: Write for new, 37-page manual. Detailed instructions for making F. C. C. station performance measurements. Recommended circuits, step-by-step procedures, charts for calculating data, recommended forms for characteristic curves. Limited quantity. Write on station letterhead—today!

Recommended circuits, step-by-step procedures, charts for calculating data, recommended forms for characteristic curves. Limited quantity. Write on station letterhead—today!

hp laboratory instruments
FOR SPEED AND ACCURACY

AUDIO ENGINEERING



Successor to **RADIO**

C. G. McProud, Editor **D. S. Potts, Publisher**
 Luci Turner, Edit. Prod. Mgr. S. L. Cahn, Adv. Director
 David Saltman, Production Manager H. N. Reizes, Adv. Mgr.
 E. E. Newman, Circulation Manager L. B. Devine, Asst. Circ. Mgr.

Editorial Advisory Board

Howard A. Chinn
 John D. Colvin
 C. J. LeBel
 J. P. Maxfield
 George M. Nixon
 Winston Wells
 S. Young White

Representatives

Sanford R. Cowan, Mid-West Sales
 342 Madison Ave., New York 17, N. Y.
 James C. Galloway, Pacific Coast Sales
 816 W. 5th St., Los Angeles 13, Calif.
 Dale International Publications, Ltd.
 106 Bolsover St., London W. 1, England
 Technical Book & Magazine Co.
 297 Swanston St., Melbourne, C. I.
 Victoria, Australia

Established 1917

CONTENTS

OCTOBER, 1949

Vol. 33, No. 10

Editor's Report	6
Letters	8
Audio Frequency Measurements— <i>W. L. Black and H. H. Scott</i>	13
Construction Details of a Continuously Variable Loudness Control— <i>J. W. Turner</i>	17
Ground Loudspeaker— <i>David Scott</i>	18
New 15-Inch Duo-Cone Loudspeaker— <i>Harry F. Olson, John Preston</i> and <i>D. H. Cunningham</i>	20
Problems in Audio Engineering— <i>Lewis S. Goodfriend</i>	23
Audio Engineering Society Section	26
Improved Audio Quality from Standard TV Receivers— <i>C. G. McProud</i>	28
Book Review	30
Record Revue— <i>Edward Tatnall Canby</i>	32
New Products	34
Techni-Briefs	36
New Literature	54
Advertising Index	56

COVER

Proper manipulation of the microphone boom required for TV broadcasting operations presents a new responsibility to the audio technician whose past experience has been limited to aural broadcasting. The photo—a view in a CBS studio—will indicate the relatively complex, heavy construction of a TV mike boom as compared to the simple units used for sound broadcasting.

AUDIO ENGINEERING (title registered U. S. Pat. Off.) is published monthly at New York, N. Y., by Radio Magazines, Inc., D. S. Potts, President; Lawrence LeKashman, Vice Pres. Executive and Editorial Offices at 342 Madison Avenue, New York 17, N. Y. Subscription rates—United States, U. S. Possessions and Canada, \$3.00 for 1 year, \$5.00 for 2 years; elsewhere \$4.00 per year. Single copies 35c. Printed in U. S. A. All rights reserved. Entire contents copyright 1949 by Radio Magazines, Inc. Entered as Second Class Matter July 29, 1948 at the Post Office, New York, N. Y., under the Act of March 3, 1879.

-5 DECIBELS +5

OVERALL FREQUENCY RESPONSE
AT TAPE SPEED OF 15 IN./ SEC.

20

100

FREQUENCY IN CYCLES PER SECOND

3 RCA PROFESSIONAL

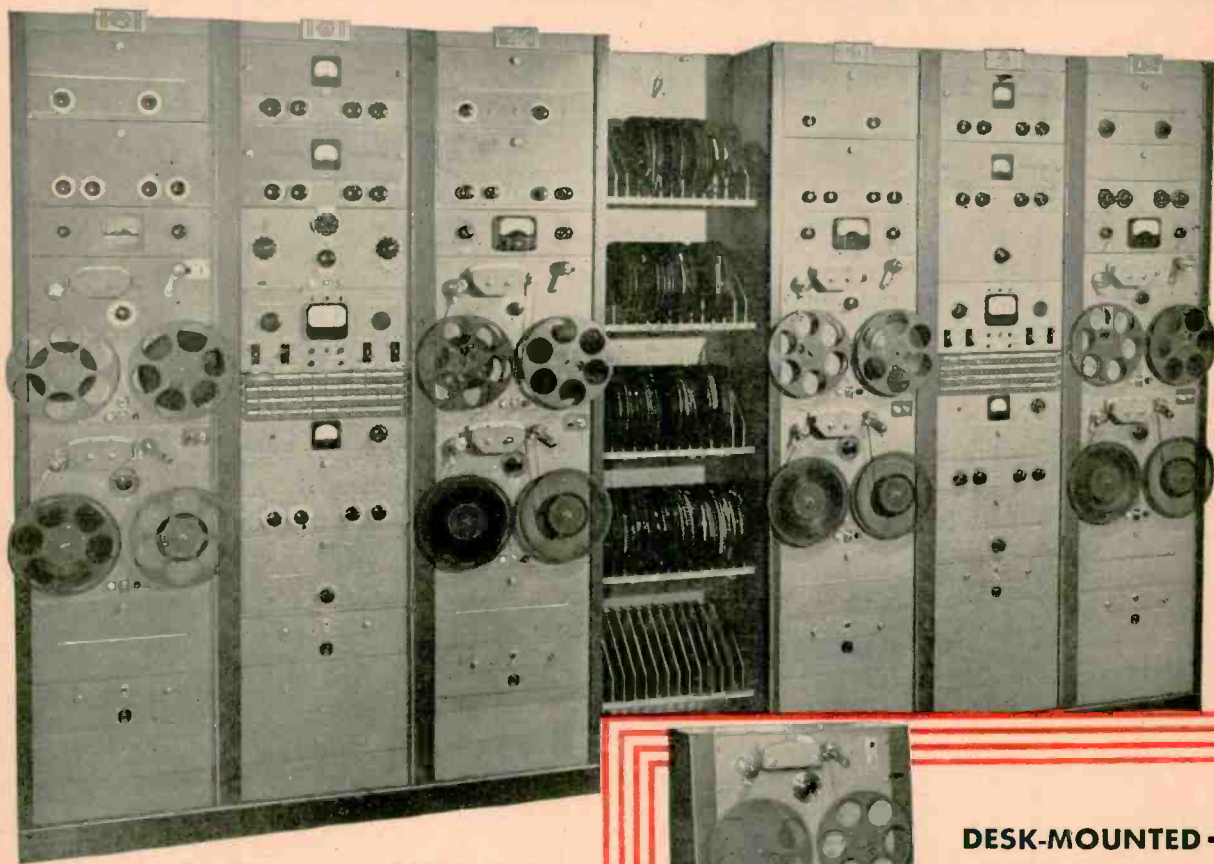

Rack-mounted RCA Tape Recorders in action at NBC, Chicago

Rack-mounted RCA Tape Recorders (Type RT-5) are well-suited for control rooms and recording laboratories—lend themselves well to system layouts where more elaborate recording jobs are required. You load the tape and cue at the rack. You start the recorder by a switch at the control desk.



FREE—new booklet about RCA's revolutionary new Tape Recorder. Curves, illustrations—complete descriptions of recorder set-ups. Write Dept. 7J, RCA Engineering Products, Camden, New Jersey.

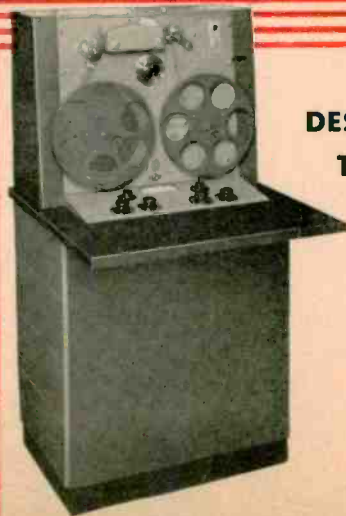

DESK-MOUNTED — Type RT-4A

The RCA Tape Recorder in desk-type console. Recorder and amplifier are "built-in" for maximum operating convenience. Plenty of desk-top space. Extra room below for additional amplifiers. A handsome and thoroughly dependable control-room recorder to install beside your studio console or turntables.

1000

10,000

20,000

TAPE RECORDERS!

THREE OF THE finest heavy-duty tape recorders in broadcasting—at prices under any comparable type in the high-fidelity class!

Taking only three or four seconds to thread . . . and requiring no complex over-and-under threading or "doubling back" of the tape . . . RCA recorders are so simple to operate that anybody can run one. Vertical reel-mounting makes them easy to handle without bending or leaning over the instrument. Sturdy, two-sided reels reduce danger from unreeling the tape or snarling. There is only one driving motor—and only one 3-unit head, that plugs in and out without need for tools.

At the flip of a switch, you can run off high-fidelity recording or playback for 33 minutes—with response at 15 kc. Or 66 minutes of it with response at 7.5 kc,

whichever you choose. Frequency compensation is automatic for either tape speed position. Tape tension is held so carefully that front-panel "speed-change" switching from *fast-forward* to *fast-reverse* is done instantly . . . without damage to the tape. Feather-weight tape tension also insures playback timing to ± 0.2 per cent at both speeds (you can edit recordings precisely—with minimum tape stretch). Automatic tape "lift-off" eliminates head wear during rewinds. A separate recording and playback amplifier enables you to monitor the tape and record programs simultaneously—your assurance that important programs are actually on the tape.

Designed by men who live with the business, these RCA units meet the needs for a foolproof instrument capable of recording true-to-life shows in the field

and in the control room. Frequency response is essentially flat from 30 to 15,000 cps—at a tape speed of 15 inches per second. Signal-to-noise ratio is 55 db on the console and rack models—and 50 db on the portable model. "Wow" and flutter is less than 0.2 per cent at 15 inches per second—and less than 0.3 per cent at 7½ inches per second. With the standard VU meter (large-size) you can read recording and output levels, plate currents, bias, and erase voltages—*directly*.

More than a hundred of the new RCA Professional Tape Recorders are already in commercial service. Ask any network, independent station, or transcription studio how they like them. Your RCA Broadcast Sales Engineer has the facts. Call him. Or write Dept. 7J, RCA Engineering Products, Camden, N. J.



BROADCAST EQUIPMENT
RADIO CORPORATION of AMERICA
 ENGINEERING PRODUCTS DEPARTMENT, CAMDEN, N. J.

In Canada: RCA VICTOR Company Limited, Montreal

PORTABLE—Type RT-3A

The ideal recorder for high-quality "remotes," studios, or control rooms. The recorder is carried in one case. The amplifier is carried in another case. Amplifier input is arranged for standard microphone (cannon receptacle provided), or bridging of 600-ohm line (terminals). Playback amplifier is designed to feed standard 600-ohm lines and headphone jack.



EDITOR'S REPORT

FURNITURE CABINETS NEEDED

THE SOLUTION to any problem is usually simplified greatly by the complete statement of that problem. With the hope that this may be the case in this instance, it seems desirable that a few words be set down on behalf of the home experimenter—as we choose to call him—the audio hobbyist.

Such a hobbyist pursues what appears to be unattainable—since he is continually at it—and that is perfect reproduction. This “perfect reproduction” may differ appreciably from one installation to another, but who is to tell anyone just what he should consider perfection? One person may demand complete studio realism, while another may want “mellow” music. Let it suffice, though, that each person is entitled to judge whether or not his particular installation satisfies his desires. The steps toward this satisfaction—considering the equipment alone—are relatively straightforward. Components of practically all types, sizes, and styles may be had at the parts jobbers’. But when it comes to the cabinet to house this equipment, the road is not so easy.

Currently there are entirely too few furniture manufacturers who include cabinets in their lines which are suitable for housing a high-quality residence radio installation. If the hobbyist owns his own home, it is often quite simple to install the amplifier equipment in a basement or in an unused closet or under a stairway as suggested by a leading manufacturer of home music systems. The apartment dweller is confronted with many more difficulties. Even if he does have sufficient closets—a rarity in most apartments—they are likely to be full of clothes and boxes, as witness the hall closet made famous by Fibber and Molly.

The cost of having a custom cabinet made to order is usually prohibitive; the skills of the average individual do not usually include the type of craftsmanship necessary to construct suitable furniture cabinets which would be acceptable to the “interior decorator in charge.” While most furniture manufacturers do make cabinets of various types, these are rarely adaptable to the requirements of residence radio systems. One radio components manufacturer provides a line of sectional cabinets which may be combined to make almost any desired arrangement, but these are all modern and may not fit into the decoration scheme.

What is needed, then, is a line consisting of about four cabinets in each of two designs—period and modern—that are styled to harmonize with standard furniture, and which will provide space for record changers or turntables, tuners, and amplifiers, and with at least one model large enough to include a tape or wire recorder. The addition of record storage space would be desirable in the larger models. These cabinets need not necessarily include

space for speakers, for most serious hobbyists do not subscribe to the idea of having the speaker in the same cabinet with the remainder of the equipment. It is generally recognized that the volume required for good speaker performance must be of the order of six to ten cubic feet, and thus hardly suitable to be combined with another four to eight cubic feet of cabinet designed to hold the electronic equipment.

One of the reasons for the absence of suitable cabinetry in existing lines is undoubtedly the fact that manufacturers have overlooked this market. It is firmly believed, however, that from five to ten thousand cabinets could be sold every year to music lovers and audio hobbyists who have been made aware of the advantages of specialized equipment in the search for optimum quality.

Many readers have already found a cabinet arrangement which answers their requirements completely; others are still groping. In an effort to get these two groups together, we would like to see photographs and simple sketches of satisfactory units. A number of the outstanding cabinet designs submitted will be described and shown in an early issue. May we have your ideas?

COLLEGE OF AUDIO ENGINEERING

Further proof of the growing recognition being given to the field of audio engineering as separate and distinct from other branches of electronics and radio is evident from the recent chartering by the State of California of the new University of Hollywood. The Hollywood Sound Institute, long outstanding as one of the better schools for professional training in our field, will be merged with the University, and will hereafter be known as the College of Audio Engineering. The University offers an eighteen-month major resident course in Sound and Audio Engineering, leading to the degree of Bachelor of Science in Audio Engineering. Other courses will include magnetic and film recording engineering, drama, music, radio, and television.

Dr. B. M. Klekner, president, and Howard M. Tremaine, vice president and educational director, are to be congratulated on their efforts toward the establishment of the new University, and our best wishes are extended to them.

AUDIANA

Elsewhere in this issue are a number of excerpts from your letters seconding the plea of Mr. Schwartz as presented in the Letters column of the September issue. The response was surprising, both as to the number of letters and the promptness with which they were forthcoming, and it appears that such a series of articles would be read with some interest. The first of the series is now being prepared, and is scheduled for the December issue.

BRITAIN'S BEST AUDIO AMPLIFIER

DISTORTION : 0.1%

Investigate its quality of reproduction and workmanship at

ROOM 650, THE AUDIO FAIR

H. J. Leak M. Brit. I. R. E., will be in attendance to discuss technicalities and to settle distribution rights. He will be at The Hotel New Yorker from Oct. 20—Nov. 6.

LEAK "POINT ONE" AMPLIFIERS



**REMOTE CONTROL
PRE-AMPLIFIER RC/PA**

**TL/12 12W. TRIPLE LOOP
POWER AMPLIFIER**

Standard U.S. tubes used.

An original feedback tone-control circuit.

No resonant circuits employed.

- Distortion: Less than 0.05%.
- Switching for Pick-up, Microphone and Radio, with automatic alteration of tone-control characteristics.
- High sensitivities. Will operate from any moving-coil, moving iron or crystal P.-U.; from any moving coil microphone; from any radio unit.
- Controls: Input Selector; Bass Gain and Loss; Treble Gain and Loss; Volume.

Output Impedance: 0-30,000 ω at 20 kc.p.s.

The unit will mount on motor-board through a cut-out of 10 $\frac{1}{8}$ in. x 3 $\frac{1}{8}$ in., or it can be bolted to the power amplifier, when, with a top cover, the whole assembly becomes portable.

For use only with LEAK amplifiers.

A Leak triple loop feedback circuit, the main loop giving 26 db feedback over 3 stages and the output transformer.

- Push-pull triode output stage. 400 V. on anodes.
- No H.T. electrolytic smoothing or decoupling condensers.
- Impregnated transformers; tropically finished components.
- H.T. and L.T. supplies for pre-amp. and radio units.
- Distortion: at 1,000 c/s and 10 W. output, 0.1%; at 60 c/s and 10 W. output, 0.19%; at 40 c/s and 10 W. output 0.21%.
- Hum and Noise: -72 to -80 db on 10 W.
- Frequency response: ± 0.1 db, 20 c/s-20 kc/s.
- Sensitivity: 160 mV.
- Damping Factor: 20. Input impedance: 1 Meg.

Output impedances: 2 ω ; 7-9 ω ; 15-20 ω ; 28-36 ω .
Phase margin 20° \pm 10°; Gain margin 10 db + 6 db.

25 W. model available.

The TL/12 Specification is bettered by check of the National Physical Laboratory (equivalent National Bureau of Standards) and their certificate will be on view.

Write for 16 page brochure "A".

We will be demonstrating with Leak Dynamic Pick Up & "550" Loudspeaker.

H. J. LEAK & CO. LTD. Westway Factory Estate, LONDON, W. 3.

AUDIO ENGINEERING ● OCTOBER, 1949

— Letters —

Driver Figure-of-Merit Sir:

Audio men who prefer the triode as a power output tube generally find the driver stage a bit of a problem because of the relatively high driving signal required by most low- μ power triodes. This is particularly true of the interesting 6AS7G.

In selecting a suitable driver, one might take a page out of the pulse amplifier man's notebook. Pulse men use a "figure of merit" to rate tubes for wide-band pulse-amplifier duty by comparing the product of the mutual conductance and the electrode capacitances. Similarly, the audio man might rate drivers according to a "driver figure of merit" by comparing the product of the grid-bias and amplification factor. Obviously, gain alone is of little consequence in a driver if the grid bias is low since the low permissible grid signal limits the plate signal output. On the other hand, a high grid bias will be nullified by too low a μ since again the plate output will be low.

On this basis, the old 27 looks surprisingly good with a "figure of merit" of 21 times 9, or 189, as compared to the 76 or 6P5 with 186.3, and to the 6SN7GT or 6J5 with 160. The old 6N7 has a very high figure of merit of 210, but its high μ of 35 means higher odd-order harmonics, and harsh intermodulation distortion. The 27 tends to be a bit non-linear at 250 volts on the plate and -21 volts on the grid.

For a time, the writer contemplated trying out the video pentodes 6AG7 and 6AC7 as triodes for driver duty. However, just recently one manufacturer has come out with a new 9-pin miniature twin-triode, the 5687, which appears to be the answer to the triode man's prayer. At 250 volts, it takes a grid bias of -12.5, and has an amplification factor of 16.5, giving it a driver figure of merit of 206.25. This is nearly as high as that of the rather high- μ 6N7.

By using two of these tubes in push-pull-parallel, one could get quite a walloping driver signal since conductance is doubled and plate loading can be cut down. This increases gain and provides better impedance matching looking into the power triode grid circuit. Of course, the electrode capacitances and Miller effect are more or less doubled, and circuit design must be carried out so as to hold down high frequency cutoff.

Admittedly, this simple method of rating driver tubes is a bit oversimplified, but is particularly effective where an "all-other-factors-are-the-same" condition exists. A table set up for various triodes shows a more less consistent decrease in grid bias with increase in amplification factor, indicating the general fact that medium- μ tubes are most effective as power-triode drivers, as a rule.

Ted Powell
5719 69th Lane,
Maspeth, N. Y.

LP Echoes Sir:

... We have found that the most serious cause of echo in playing LP records is a worn reproducing stylus. This is probably due to a greater effect of the echo near the surface of the record where the grooves are closest, and the compliance of the medium is highest. In cases of severe needle wear, the shoulder formed on the tip may contact the "horns" which surround the adjacent groove.

Howard A. Chinn
Chief Audio-Video Engineer,

Schwartz's Responses

Sir:

Mr. Schwartz is definitely not alone in his wish for articles in good basic audio design. Please start such a series, and the sooner the better.

Kenneth A. Wahrenbrock,
1785 N. Hunter,
Stockton, California

Sir:

I heartily agree with Mr. Schwartz' plea. Such articles as commercial sound systems and the like that may be found in manufacturers' literature are a waste of space in your magazine.

Frank A. Peters,
Smithtown Branch,
L. I., N. Y.

When seconds count
YOU'RE THERE WITH...

**SAVES UP TO 500%
ON HANDLING TIME**

Handle up to 400 feet of mike cord with short cord ease

Here's one of the handiest tools ever made for the Radio-Audio Engineer—for either in studio or outside use. Rugged... light weight... Saves time... gets the job done easier... faster... with less confusion... fewer jangled nerves. A must for every special events and remote crew.

MAKES CORD LAST 5 TIMES AS LONG!

PORT-O-REEL pays for itself in cord saved. Cord size governs capacity. Some stations and networks use over 400-ft. of 2-wire shielded mike lead, other units equip for 120-volt power transmission. Unwind cord needed... set brake.

Reel turns with operator as cord is drawn off. Non-slipping... non-tipping. Re-wind 400 ft. of cord in only 40 seconds!

- Weighs only 9-lbs. without cord... Low, level-wind cord guide prevents kinks and knots.
- Available without cord or equipped with any standard cable and plugs to your specifications.
- Handy screw binding posts permit quick attachment or change of cord on unit.
- Available with receptacle in frame for plug-in of feeder cord or for attachment of feeder cord to screw binding posts.
- Moisture-proof running constant collector ring... reel out or wind while broadcasting... no audible sound through transmitter.

Patents and Patent Pending

Send for literature, prices and name of nearby distributor.

INDUSTRIAL ELECTRICAL WORKS, 1505 CHICAGO ST., OMAHA 2, NEBR.

PORT O REEL
CORD SAVER

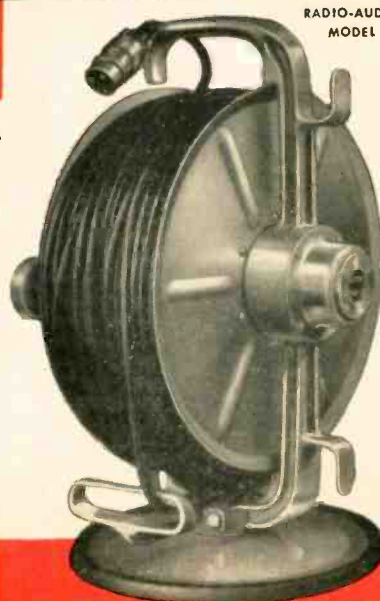

**TV Engineers:
Ask about the
3-phase
Heavy Duty
POWEREL**

Now you can work with
REMALLOY

Permanent Magnet Material

(Manufactured under license from Western Electric Company)

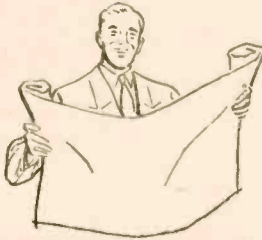

*It's fully available
for the first time*

*How you
can
get it!*

ARNOLD can supply **REMALLOY**
in the form of **BARS** and **CASTINGS**
or **SINTERED TO SPECIAL SHAPES**

*How you
can
use it!*

REMALLOY generally may be used
instead of **36-41% Cobalt Permanent
Magnet Steel**—replacing it without
design changes, and at a cost saving.

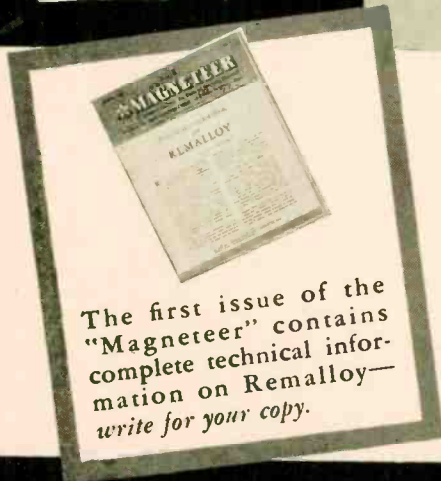

The first issue of the
"Magneteeer" contains
complete technical infor-
mation on Remalloy—
write for your copy.

In addition to our customary production of all types of ALNICO and other permanent magnet materials, we now produce REMALLOY. The various forms in which it is available—bars, castings or sintered shapes—are all produced under the Arnold methods of 100% quality control; and can be supplied to you either in rough or semi-finished condition, or as completely finished units ready for assembly. • Let us help you secure the cost-saving advantages of REMALLOY in your designs. Call or write for further data, or for engineering assistance.

THE ARNOLD ENGINEERING COMPANY

SUBSIDIARY OF ALLEGHENY LUDLUM STEEL CORPORATION
147 EAST ONTARIO STREET, CHICAGO 11, ILLINOIS



ARNOLD SPECIALISTS AND LEADERS IN THE DESIGN, ENGINEERING AND MANUFACTURE OF
PERMANENT MAGNETS

**FOR PERFECT
PROCESSING**

PRESTO IS YOUR DISC

When the processing plant reports
they can't plate your master (usu-
ally for reasons unknown) . . .

DON'T LET IT RUIN YOUR DAY . . .

*Switch to
Presto Discs*

Every disc bearing the Presto label
will plate well — either silver or
gold — any time, everywhere.

PRESTO
RECORDING CORPORATION

PARAMUS, NEW JERSEY

Mailing Address:

P. O. Box 500, Hackensack, N. J.

*In Canada: Walter P. Dowis, Ltd.,
Dominion Sq. Bldg., Montreal*

World's Largest Manufacturer of Instantaneous Sound Recording Equipment and Discs

Sir:

I approve heartily of the suggestion put forward by Mr. Schwartz. Most of us indicate by subscribing to this publication that we expect something on a higher plane than is found in the strictly popular magazines. At the same time, we are too busy to comb through a mountain of literature trying to arrive at best practices and so on.

Woodrow J. Radle,
Box 336,
Vandalia, Ohio

Sir:

Count me as seconding Mr. Schwartz' motion. . .

L. Jacobson
1535 Shattuck Ave.,
Berkeley 9, California

Sir:

Bravo for Mr. Schwartz' proposal. I approach audio purely from a music-lover's viewpoint, and must confess that I am partly baffled by a full 50 per cent of the articles—which however does not keep me from plowing through them all with no little pleasure or profit.

. . . The few of us benighted characters who can haltingly grope through a schematic would, once it was given us, find the series indispensable.

James H. Day
1201 E. Seneca Ave.,
McAlester, Okla.

Sir:

I read with enthusiasm Mr. Schwartz' letter. . . One suggestion: In planning the articles, have in mind their subsequent publication as a book.

A. D. Battey,
5757 Blackstone Ave.,
Chicago 37, Ill.

Sir:

Mr. Schwartz is not alone . . .

Such a series would help to allay a certain degree of disappointment which is inevitable on the arrival of an issue such as September, 1949.

Charles M. Waldo,
51 Jackson Road,
Wellesley Hills, Mass.

Sir:

I agree enthusiastically with the suggestion offered by Mr. Schwartz. Those of us interested as hobbyists and semi-professionals would welcome a series on fundamentals—design, placement, and practical suggestions on audio practices which are routine with the professional but are picked up the hard way by the hobbyist. Most of us have stumbled on these elements of audio engineering but at great cost of time and cash. Errors of "cut and try" could be somewhat eliminated for us. The cost of the output transformer I drilled a hole in the other day would buy another three-year subscription to A.E.

Name withheld
Seattle 5, Washington

Sir:

I agree substantially with the ideas of Mr. Schwartz. Here's hoping they will be carried out.

Donald J. Ketchum
Ketchum Sound Recording
Laboratory
South Pasadena, Calif.

[Continued on page 55]



*music
comes to
life!*

with New

Jensen Genuine *Wide Range* Loudspeakers

16 COMPLETELY NEW MODELS

3 15-inch Coaxials, 1 12-inch Coaxial

11 5-inch to 15-inch Single Radiator models

Now music can come to life for everyone—for in the new Jensen Genuine Wide Range Loudspeaker series, there is a choice of cast, size and degree-of-performance to meet every requirement for thrilling, realistic reproduction. Whether it be a 5" loudspeaker at \$8 list . . . a 12" Coaxial at \$33.40 list . . . or a 15" Coaxial with the new Jensen Wide-Angle Acoustic Lens listing at \$135 . . . you will find totally new concepts of performance, way ahead of conventional speaker reproduction, brilliantly engineered and painstakingly constructed into these new products.

Write now for Data Sheet No. 152 describing all the new loudspeakers in the Jensen Genuine Wide-Range series, and booklet "Let Music Come to Life!"

NEW — WIDE ANGLE ACOUSTIC LENS

Typical of Jensen leadership in loudspeaker engineering is the acoustic diverging lens used on the H-510 Coaxial illustrated above. Adapting optical principles to acoustics, this lens acts in conjunction with the h-f horn to distribute h-f radiation uniformly over a wide angle . . . insures constant balance and high quality reproduction throughout the whole room.

This trademark identifies an advanced design loudspeaker . . . with performance to meet today's exacting requirements for faithful music reproduction . . . achieved through the most modern applications of acoustics.

JENSEN MFG. CO. CHICAGO
Jensen **MADE IN U.S.A.**
WIDE RANGE
 Division of the Muter Company
 6633 SOUTH LARAMIE AVENUE • CHICAGO 38, ILLINOIS
 In Canada: Copper Wire Products, Ltd., 351 Corlaw Avenue, Toronto

For audio facilities that give
you the *most* for your *money*...

Look into this Western Electric line!

25B Speech Input Console

The 25B provides highest quality studio control for AM, FM and TV audio. It more than meets FM performance requirements for audio equipment—wide frequency range, high signal-to-noise ratio and exceptionally low distortion. It's flexible—handles two programs simultaneously without interference. It's easy to install—supplied complete with junction boxes and plug-in connectors.



22E Portable Speech Input Equipment

This equipment provides complete high quality amplifying and control facilities in two compact, easily portable units—Amplifier-Control unit (upper illustration), and separate carrying case with space for rectifier, batteries and cords (lower illustration). Order now and be adequately equipped for the fall sports programs.



23C Speech Input Equipment

The 23C is a complete, compact amplifier and control assembly combining the advantages of high quality and minimum cost. It will serve either one or two studio layouts in AM or FM stations—and because of its low cost, it's ideal for semi-permanent remote pick-up installations.



639 Type Microphones

These Western Electric Cardioids, well known for quality performance in AM and FM, are serving equally well as TV mikes. They provide excellent front-to-back discrimination, wide frequency response, high signal-to-noise ratio. The 639A provides a choice of three pick-up patterns, the 639B a choice of six.



THE above items are available for immediate delivery. For further information or prices get in touch with your nearest Graybar Broadcast Representative. Or write Graybar Electric Company, 420 Lexington Avenue, New York 17, N. Y.

— QUALITY COUNTS —



Western Electric

DISTRIBUTORS: IN THE U. S. A. —
Graybar Electric Co. IN CANADA
—Northern Electric Co., Ltd.

Audio Frequency Measurements

W. L. BLACK* and H. H. SCOTT**

Part I: Design, development, and maintenance all depend on the measuring procedures employed. The author discusses these methods thoroughly, and presents reasons for every step.

DURING THE LAST SEVERAL YEARS the Radio Manufacturers Association has given considerable attention to codifying minimum standards of performance for the major components of radio broadcasting systems. The engineering aspects of this subject have been considered by committees in the Transmitter Section of the Engineering Department of the Association.

Definitions and minimum standards for the audio facilities of a radio broadcasting system considered primarily as a complete electrical system have been issued as an RMA standard.¹ As defined in this standard, audio facilities comprise "all audio facilities from the input terminals of the microphone pre-amplifier to the input terminals of the main transmitter, excluding the studio-transmitter link which may be either wire line or radio. No pre-emphasis is included in the audio facilities."

Subsequently work was undertaken to outline methods of measurement of audio facilities. In this connection, it is necessary to specify conditions for testing to insure that measurements made at different times and on different apparatus will be comparable. Furthermore, it is desirable to indicate the instrumentation necessary for practical results. The measuring equipment should be such as to insure adequate and duplicable results in the light of the requirements of the standards involved, while at the same time avoiding the imposition of an undue burden on instrument manufacturers.

In the consideration of audio frequency measuring equipment it was early apparent that, while the subject is not new, there is a great dearth of correlated published material. In view of this situation, it is the purpose of this paper to summarize the technical background which is the basis for the

This paper was originally presented at the joint IRE-RMA Meeting at Syracuse, New York, on April 28, 1948 and is presented in its entirety in AUDIO ENGINEERING by authorization of Radio Engineers.

RMA standardization activity, to indicate the philosophy leading to the formulation of the standards proposals as issued, and to outline possible pitfalls in making measurements on complex high-gain audio systems.

The measuring techniques which are discussed may be applied with equal validity to component parts of systems, such as an amplifier having a transmission gain or a network having a transmission loss, or to overall systems. However, emphasis is placed on system measurements because a complex high-gain system ordinarily presents more of a measurement problem than do system components.

As a practical matter, the important characteristics of audio systems for radio broadcasting which have been agreed upon for RMA standardization are: gain, frequency response (relative gain over a frequency range), single-frequency harmonic distortion, and noise (in the sense of noise being extraneous sound or corresponding electrical energy tending to interfere with the proper and easy perception of desired sounds or their equivalent electrical waves).

Gain Measurements

Gain for the determination of performance characteristics is measured between resistances equal to the rated source and load impedances. The term

"insertion gain" may be defined² as the ratio, expressed in decibels, of the powers at a given frequency, which are delivered to that part of a transmission system beyond the point of insertion after and before the insertion of apparatus in the system. However, to take into account differences between source and load impedances, the Committee on Audio Facilities has defined insertion gain¹ as the ratio, expressed in db, of the power delivered to the load to the power which would be delivered to the same load if the amplifier or system were replaced by an ideal transformer which matches the load and source impedances.* For the purpose

*This latter definition, based upon the power delivered to a resistance load by the system being measured and the optimum power transfer from the generator, is that generally implied in connection with amplifier gains (Ref. 3, pp. 48-50; ref. 4, pp. 226-227; ref. 5). However, it has not been uniquely named or defined in the literature. At the present time the term "transducer loss" and the cognate term "transducer gain" are understood to be under consideration. As they are being considered, both include the concept of an "ideal transducer" for the determination of reference power. The term "gain" in this paper is used in this latter sense.

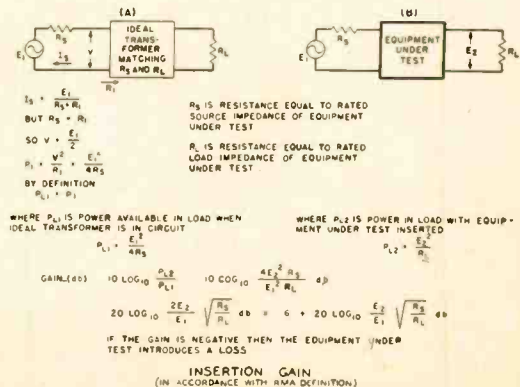

Figure 1

*Bell Telephone Laboratories, Murray Hill, N. J.
**Herman Hosmer Scott, Inc., 385 Putnam Ave., Cambridge 39, Mass.

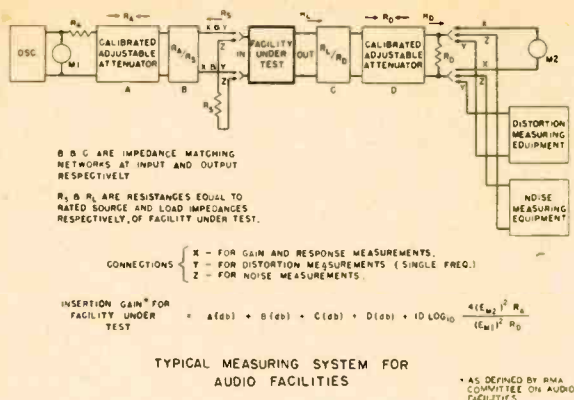

Figure 2

of measuring insertion gain (or loss) on this basis the arrangement shown in Fig. 1 is used. In this figure, A shows an ideal transformer matching the load impedance to the internal generator impedance. By definition such a transformer has no dissipation loss. Under this condition, the power in the load may be stated in terms of the equivalent internal resistance of a generator and the open circuit voltage delivered by that generator. In B the power dissipated in the same load after insertion of the equipment to be measured is defined in terms of the voltage across the load and the resistance of the load. Then by definition the gain is the ratio of the power in the load with the equipment under test in the circuit to the power delivered to the same load without the equipment under test.

It is obvious that any further discussion of gain will refer with equal validity to frequency response, as the latter is relative gain over the specified frequency range. However, the determination of absolute gain requires more precise refinements in the measuring system than does the determination of relative gain (frequency response) as discussed in more detail later.

Measurements using resistance terminations for the measurement of the component parts of a system may not agree in total with the results of overall measurement of the system between resistances. Ordinarily the disagreement is, however, of relatively small magnitude when the interrelations of the impedances of the components have been considered in conjunction with the system design. For large variations from rated impedances, distortion of gain - versus - frequency characteristics may be sufficient to require consideration of the coupling factors⁶ involved and may indicate corrective equalization.

Practical Test Circuit

For practical tests, particularly where large amounts of gain or loss are being measured, the simple circuit of Fig. 1 is not adequate because of the limitations in the voltage ranges of the meters which may be available for indicating the input and output voltages. In order to obtain suitable voltage levels, calibrated attenuators are used in conjunction with the input and output meters. Since the attenuators may not always have the desired impedance for matching the equipment under test, impedance-matching networks or pads will be required in some instances. Figure 2 presents an essentially complete diagram showing all circuit elements which would ordinarily be required for audio-frequency measurements. In many cases several of the units may be combined in one

physical instrument. Separate consideration of each of the various elements follows.

Oscillator

The source of power for gain testing is generally an audio frequency oscillator. This oscillator should cover the range of frequencies involved in the tests. Ordinarily absolute frequency accuracy and stability with time are not practical limitations. Thus absolute stability of the order of two per cent maximum, which is fairly readily achieved, is adequate. However, in the measurement of frequency selective devices such as filters and in the use of some types of distortion measuring instruments containing sharply tuned rejection circuits the accuracy of frequency may be a governing factor in accuracy of results. Another practical consideration is freedom from drift of output voltage with time and with variation in oscillator power supply voltage.

In addition, for gain measurements the spurious components, such as harmonic distortion and noise in the oscillator output, should not represent more than ten per cent rms of the output voltage. However, when distortion measurements are made, as discussed later, it is important that distortion and noise components in the oscillator output wave be appreciably below this value to avoid affecting the accuracy of the distortion measurement. Low distortion from the oscillator is also important if the equipment under test includes filters having sharp cut-off characteristics. It may be necessary to

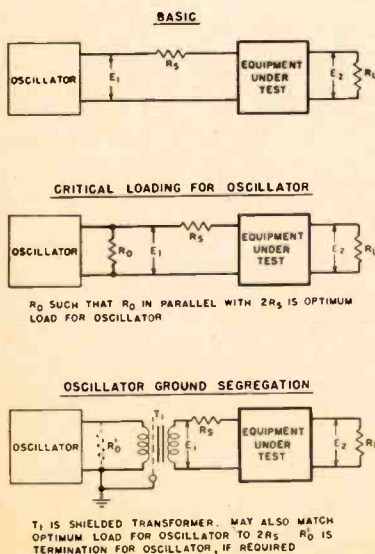

OSCILLATOR CONNECTIONS
Figure 3

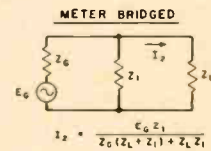
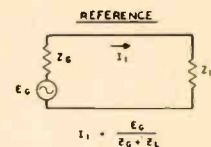

LOSS DUE TO Z_L

$$LOSS (db) = 20 \text{ LOG}_{10} \frac{I_1}{I_2} = 20 \text{ LOG}_{10} \frac{Z_G(Z_L + Z_1) + Z_L Z_1}{Z_L(Z_G + Z_L)}$$

LOSS DUE TO VOLUME INDICATOR IF IMPEDANCES ARE SUBSTANTIALLY RESISTIVE AND Z_G = Z_L = 600 OHMS; Z₁ = 7500 OHMS

$$LOSS = 20 \text{ LOG}_{10} 1.04 = 0.34 \text{ db}$$

LOSS DUE TO BRIDGED METER
Figure 4

take special precautions to obtain satisfactorily low distortion from the oscillator. For example, with some oscillators the distortion is a function of output power. With such an oscillator the output level obviously should not be above that determined to be objectionable. Harmonic suppression filters may be necessary following the oscillator. Means for checking the oscillator distortion are described later.

Some oscillators may be critical as to load impedance, in which case it may be necessary to take special precautions in the output circuit, such as those shown in Fig. 3. Although this figure shows such load impedance correction as shunt resistance it is equally feasible to use a series resistance if the optimum load required for the oscillator is higher than that offered by the measuring circuit. The principal difficulty usually experienced with oscillators critical to load impedance is an increase in harmonic content with departure from optimum loading. It will often be necessary to include a transformer having an interwinding electrostatic shield between the oscillator output and the input of the testing circuit to control ground connections and parasitic coupling between the oscillator and the remainder of the testing system. This is discussed in more detail later.

In any event, with the input voltage to the test circuit measured at the location shown in Fig. 3, once the cir-

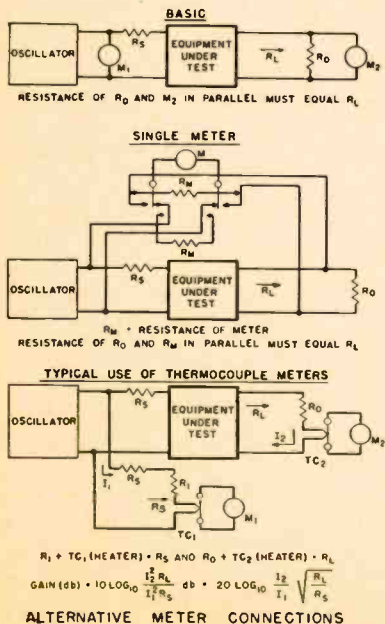
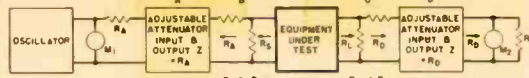

Figure 5



B AND C ARE MINIMUM LOSS "L" PADS MATCHING R_A TO R_S AND R_L TO R_D RESPECTIVELY
IF Z IS LARGER AND Z IS SMALLER OF TWO IMPEDANCES BEING MATCHED BY EACH MATCHING PAD, THEN

$$\text{LOSS (db)} = 20 \log_{10} \left(\sqrt{\frac{Z}{Z_1}} + \sqrt{\frac{Z_1}{Z}} \right)$$

MATCHING PADS

Figure 6

cuit at the output of the oscillator has been determined and the oscillator output voltage is stabilized, the output circuit does not affect the measurements of gain or of response as a constant output voltage is maintained, and the oscillator is then the equivalent of a zero internal impedance generator.

Terminations and Meters

The desired objective of comparable results indicates the use of pure resistances for terminations. Such terminations include that for the output of the equipment under test as well as any used for input termination, including that used for equivalent generator internal impedance. If the impedance of a resistor used for such termination is within five percent of the desired resistance value over the frequency range from 0 to 50,000 cps, the inaccuracy of results due to such variation will be less than 0.01 decibel.

There are other factors regarding precision of terminating resistors which warrant consideration. These include the absolute value of output terminating resistors and the stability of such resistors with temperature, particularly when the output distortion of a power amplifier is being measured. Also included is the comparative accuracy of a pair of resistors when an arrangement such as Fig. 9 is employed.

The input voltmeter may be of the vacuum tube, rectifier, or thermocouple type, or may be a standard volume indicator. This meter may be rms, average or peak reading except as noted in specific instances later. The stability of this meter must be such that its readings are not influenced by extraneous factors, such as power supply to a vacuum tube.

If a rectifier meter is used, its possible introduction of extraneous modulation products, particularly when making distortion measurements, as well as its possible variation in impedance with change in input are limiting factors. The loss introduced in the transmission circuit by the ordinary meters of this type (of which the "standard volume indicator" is a special form) must be taken into account, particularly

if the meter is alternately connected and disconnected during a test. This effect can be reduced to negligible practical proportions if a resistance equal to the impedance of the meter is substituted when the meter is disconnected. In the recommended good engineering practice section of the American Standards Association material on the "standard volume indicator" it is recommended that the value of its impedance be not less than 7500 ohms for use as a bridging instrument on a 600-ohm circuit. A volume indicator having such an impedance would introduce a 0.34 db loss as shown in Fig. 4, assuming all impedances are substantially resistive.

A thermocouple meter may be used provided it is appropriately connected to the circuit so that its internal resistance is taken into account. Suitable thermocouples will have a heater resistance of the order of 600 ohms or less for the sensitivity desired. Suitably calibrated thermocouple meters have good scale spread, practical freedom from frequency discrimination at audio frequencies, freedom from modulation, and adequate accuracy. The disadvantages are relatively slow speed of operation and danger of damage from excessive current.

In this general connection, the indication of a rectifier type meter, typified by one using a copper oxide rectifier, approximates the average value of a sine wave, while a thermocouple meter indicates the effective or rms value. However, if the former is cali-

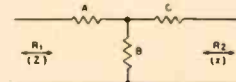

IF $Z > Z_1$ THEN $R_1 > R_2$
AND $X = \log_{10} \frac{db}{20}$ = CURRENT OR VOLTAGE RATIO
WHERE db IS LOSS DUE TO PAD IN DECIBELS
THEN

GENERAL SOLUTION

$$A = \frac{R_1(X^2 + 1) - 2X\sqrt{R_1 R_2}}{X^2 - 1}$$

$$B = \frac{2X\sqrt{R_1 R_2}}{X^2 - 1}$$

$$C = \frac{R_2(X^2 + 1) - 2X\sqrt{R_1 R_2}}{X^2 - 1}$$

WHEN $R_1 = R_2 = R$

$$A = C = R \left(\frac{X-1}{X+1} \right)$$

$$B = 2R \frac{X}{X^2 - 1}$$

FOR C = 0 (MINIMUM LOSS PAD)

$$A = \sqrt{R_1(R_1 - R_2)}$$

$$B = R_2 \sqrt{\frac{R_1}{R_1 - R_2}}$$

FOR BALANCED PADS DIVIDE A AND C EACH BY 2 FOR VALUE FOR EACH SIDE OF CIRCUIT.

FOR CENTER TAP GROUND DIVIDE B BY 2 AND GROUND COMMON POINT BETWEEN TWO HALVES

RESISTANCE PADS

Figure 7

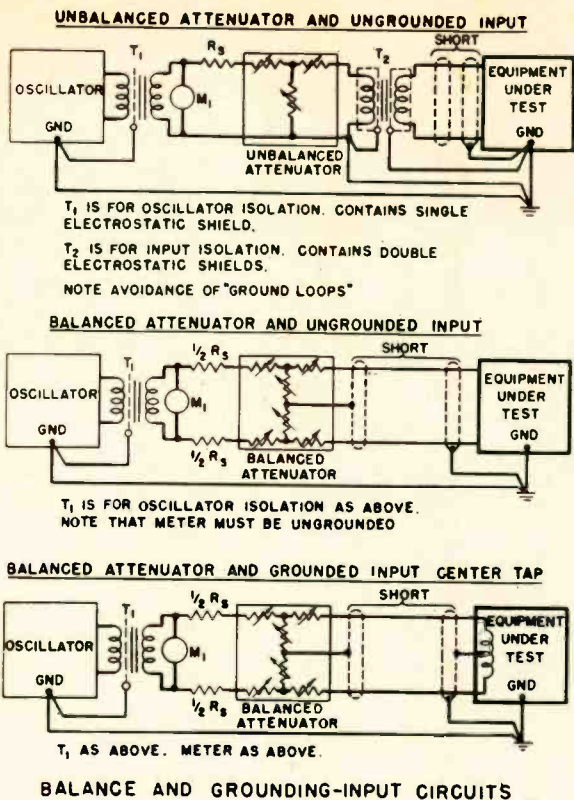

Figure 8

brated in terms of rms values, no practical difficulty will be experienced on this score in making gain (and frequency response) measurements, even though one type is used at the input and the other type at the output, provided that the testing frequency has a sine wave form within the limits already discussed. In the determination of harmonic distortion, wave-form errors due to the type of meter used may limit the accuracy of measurement.⁸

The output meter may be similar to

the input meter or may actually be the same meter alternately connected at the input and at the output. If the other components of the measuring system are so arranged that the input and output voltages are the same, the measurements are expedited with this arrangement, and errors due to absolute calibration of the meter and to its variation in indication with frequency are eliminated in making response measurements. However, convenient switching on this basis involves bring-

ing wires from the input and the output of the system in close proximity and may cause undesirable coupling, particularly when a high-gain system is being measured. This may cause an error in absolute gain indication or an error changing with frequency during response measurements, or both. This procedure is, of course, impractical if the input and output of the equipment under test are not in approximately the same vicinity. For example, the input of the system being tested might be in a studio control booth and its output in a master control room.

Any meter or meters used should have either flat frequency response for the range of frequencies involved in the measurements or must be calibrated for deviation with frequency to obtain accurate indication of absolute gain over the frequency range of interest. In addition, the instrument scale spread and pointer structure must be such that deviations are discernible on the instrument with changes in gain of the equipment under test to an accuracy corresponding to at least the order of accuracy desired for the value of absolute gain. Furthermore, the sensitivity of the output meter may require consideration in the case of loss measurements. Finally, the factors such as pivot friction and uniformity of magnetic field ordinarily affecting the accuracy of electrical instruments should be considered in conjunction with the absolute accuracy desired.

Figure 5 shows some possible variations in circuit arrangement for varying meter connections.

Adjustable Attenuators

As a practical matter, greatest convenience of measurement is achieved if the meters used are held at constant readings and the variations in gain are determined by calibrated adjustable attenuators at the input and at the out-

(Continued on page 38)

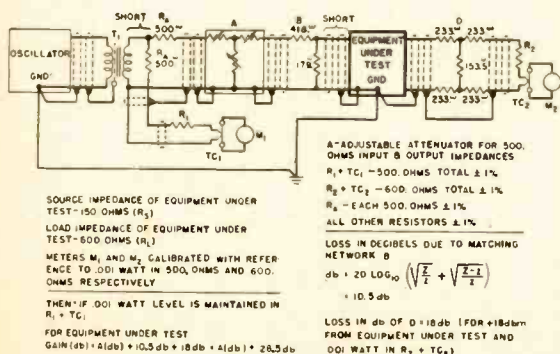

Figure 9

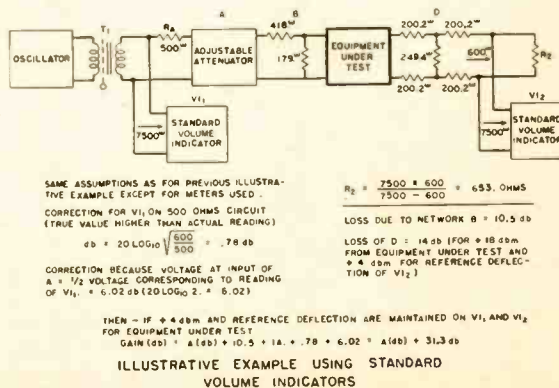

Figure 10



Construction Details of a Continuously Variable Loudness Control

J. W. TURNER*

The popularity of this type of control provides the incentive to construct a simpler form than the original.

SEVERAL MONTHS AGO the writer constructed a loudness control according to the information set forth in David Bomberger's article in an earlier issue.¹ The improvement in balance at all levels, and particularly at average living room level and below, is just another one of those things which can only be appreciated through actual experience. No amount of description can replace one minute of listening to a system incorporating fully compensated control of this kind. Without exception, its excellence has been admitted by all who have heard it, and no one could fail to be impressed by its value after hearing the difference between a selection played at a low level using the loudness control and the same selection played at the same level but with the amplifier gain reduced by the usual methods.

After doffing the hat to Mr. Bomberger in the above fashion, it is necessary to point out that the control had one serious drawback to which the writer could not accustom himself. This lay in the fact that a switching arrangement was used, whereas nearly everyone is thoroughly accustomed to the smoothly variable nature of the standard volume control. The result of using a switch was a poor psychological situation in which it seemed that no matter which position of the eleven

point switch was in use, another one might be better. It did not seem that a greater number of positions, as suggested by Winslow², was the right answer apart from the increased number of components, so some means of making the control continuously variable seemed indicated.

A survey of the catalogues failed

² "Full Range Loudness Control," AUDIO ENGINEERING, Feb. 1949.

to turn up a potentiometer which met the requirements with respect to number and location of taps, so it was decided to attempt the modification of a standard unit. An Ohmite 250K linear pot was chosen, chiefly because of the fact that the resistance element in this type is mechanically secure as compared to some types in which the carbon strip is fastened down only at the ends, permitting the strip to move

[Continued on page 44]

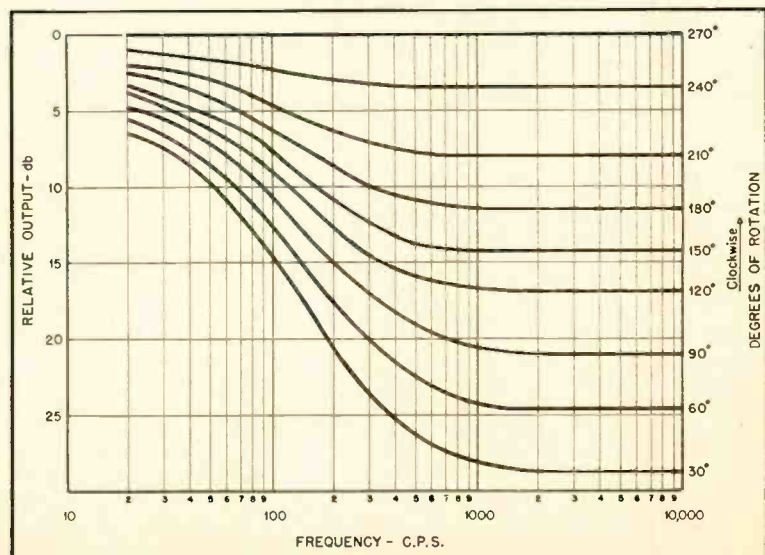

Fig. 1. Measured response curves for various settings of the loudness control.

* 440 Rockaway St., Boonton, N. J.

¹ "Loudness Control for Reproducing Systems" AUDIO ENGINEERING, May 1948.



Fig. 1. Ground loudspeaker with protective cover in place, and showing access plate which permits easy removal of driver unit for maintenance.

Ground Loudspeakers

DAVID SCOTT*

A unique loudspeaker arrangement which is ideally suited for airports or large athletic fields such as the one for which it was designed.

DESIGNING a practical loudspeaker installation for use in a large outdoor arena has been a running problem for Czech engineers for a number of years. The unusual requirements which had to be met brought forth several different proposals and designs. However, none of these has been completely satisfactory until now.

The problem was a public address system for the Strahov stadium in Prague. This is one of the largest stadia in the world, the arena measuring 1000 by 650 feet, and the stands having a capacity of 280,000 spectators. It is used primarily for exhibitions of mass calisthenics and exercises in which up to 26,000 participants perform simultaneously. These are normally held

*Praha XVI, Zaverka 2460, Czechoslovakia

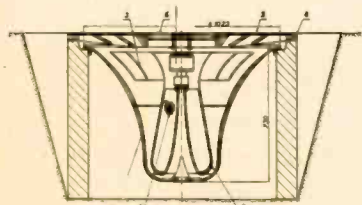

Fig. 2. Cross section of ground loudspeaker. Dimensions shown are in millimeters, with overall diameter of bell being 40 inches and depth of bell being 28.5 inches.

- | | |
|--------------------------------|--|
| 1 Bell | 5 Perforated main cover |
| 2 Horn center section ("bomb") | 6 Removable center section of main cover |
| 3 Deflectors | 7 Matching transformer |
| 4 Ribbed cover support | |

at six-year intervals by the Sokol physical training organization which has been in existence in Czechoslovakia since 1862.

Since one of the features of these performances is synchronized movements of all the gymnasts, it is necessary that coordinating music reach each participant with a negligible delay. When loudspeakers were placed on the stands along one side of the field, the dimensions of the area are such that there was a time-lag of 0.6 seconds between the first and last rows of the performers. This resulted in a wave-like movement of the mass. Loudspeakers mounted along all four sides of the field would reduce this lag, but at the same time would introduce acoustical distortion.

For practical and aesthetic reasons loudspeakers could not be mounted on poles throughout the field, so experiments were made with loudspeakers placed in the ground. Early models of this type were either excessively complicated or were not waterproof or impervious to humidity, and therefore had to be removed and stored in a dry place between performances.

The most recently developed ground loudspeaker, described in this article, was first used during the Sokol exercises in 1948, and the results were satisfactory in every respect. The PM driver unit is completely waterproof, and during tests has been operated under water for as long as 24 hours with no harmful effects and with only a negligible change in its reproduction characteristics.

Fifty 15-watt loudspeakers are installed flush with the surface of the ground 115 feet apart in a regular pattern, so that no participant can be further than 80 feet from a speaker. The maximum time-lag is therefore .07 seconds. The construction of the steel grill covering each buried installation is capable of supporting a weight of 6.5 tons, permitting loaded sprinklers or other heavy vehicles to drive over them.

A cross-section drawing of a complete assembly is shown in Fig. 2. The concentric, exponential horn is composed of two sections, the bell (1) and center-section (2). The inside of the cross-section casting forms the neck of the horn, while its outside is the internal surface of the wide end and

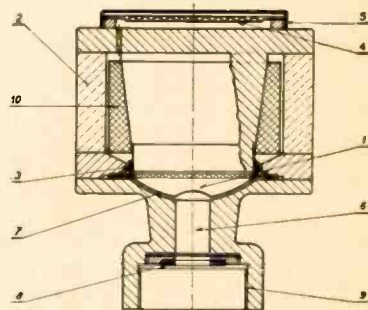

Fig. 3. Cross section of driver unit to show internal construction.

- | | |
|--------------------------|--|
| 1 Plastic diaphragm | 7 Pressure chamber |
| 2 Alnico magnet | 8 Contact ring |
| 3 Voice coil | 9 Internal threads for mounting and electrical contact |
| 4 Compensation diaphragm | |
| 5 Protective cover | |
| 6 Throat | |

mouth. The small cone is part of the center-section, and acoustically covers the two-inch drainage hole in the base of the bell, but is undercut to permit water to flow underneath it.

The PM driver unit is screwed onto the throat of the center-section, as shown in Fig. 1, while its matching transformer (7) is mounted in the "dead area".

The circular deflectors (3) are held in position by wire supports, and the innermost section forms the inside surface of the horn mouth as well as acting as a dust cover for the PM unit. The ribbed cover-support (4) has additional deflecting fins which also strengthen it structurally. The perforated main cover (5) is bolted to the cover-support, but the cover center-section (6) can be removed easily to give access to the PM unit.

PM Driver Unit

Removal of the PM driver unit is accomplished as shown in Fig. 1. The dust-cover pulls off and the unit unscrews. In the cross-section drawing, Fig. 3, its construction may be seen in detail.

The flange on the plastic diaphragm (1) provides a water-tight seal, and the voice-coil (3) is placed in the air gap between the two poles of the concentric, Alnico V magnet. The voice-coil leads on the outer surface of the diaphragm pass through holes in the brass neck of the unit where they are connected to a small terminal strip and thence to the contact rings.

A wooden ring (10) is placed inside the magnet to make the sealed volume of air as small as possible so that the effect of temperature changes will be reduced to a minimum. The thin aluminum compensation diaphragm (4) with protective cover (5) on the top of the unit equalizes the internal and external pressure differences caused by

Fig. 4. Strahov stadium, Prague, viewed from the air. 17,000 men engaged in mass gymnastics before crowd of approximately 280,000 spectators in July 1948.



heating and resultant expansion of the air. This type of construction completely seals the voice-coil and magnet.

The throat of the unit (6), with a diameter of 2 cm., and the pressure chamber (7), form an acoustic transformer. At the face of the throat is an insulated contact ring (8), while the internal threads of the mounting collar provide the second electrical contact. When the unit is screwed down tightly on the neck of the horn, perfect electrical and acoustical connections are automatically made. The contact surfaces of the horn are connected to the matching transformer, and from there wires are carried out through rubber grommets in the sides of the horn center-section and of the bell.

This type of ground loudspeaker was designed by Dr. Josef Merhaut and manufactured by the Tesla National Corporation, the center of the Czechoslovak electronics industry. In addition to tests of prolonged submersion in water, the PM driver unit has been subjected to extreme mechanical and electrical overloads. One test consisted of applying a low-frequency square-

wave voltage of three times the normal rated input. This was maintained for a period of 72 hours without any noticeable harmful effects.

During the Sokol exhibitions last year torrential rains flooded the stadium on several occasions, yet the entire installation functioned quite unaffected. The success of these ground loudspeakers has prompted their use at airfields and other places requiring unobstructed movement and vision.

TECHNICAL DATA:

- Area of the diaphragm: $A_d = 38.5 \text{ cm}^2$
- Moving mass of the diaphragm: 3.6 gms.
- Throat of the horn: $A_0 = 3.14 \text{ cm}^2$
- Radiation resistance of the diaphragm: $c_p \times A_0 (A_d/A_0)^2 = 41.5 \times 3.14 \times 12.2^2 = 2 \times 10^4 \text{ (cgs) (or g/sec}^{-1}\text{)}$
- Length of the horn: $L = 130 \text{ cm.}$
- Cross section of the horn is given by the equation:
- $A = A_0 e^{\gamma x}$ where the exponent γ at the start is $= 0.0784 \text{ cm}^{-1}$ and changes continuously to the value of $\gamma = 0.046 \text{ cm}^{-1}$.
- Low-frequency cut-off: 200 cps
- Rated input: 15 watts at a nominal voltage of 100 V_{rms}.
- Saturation in the Alnico magnet gap: 17,000 gauss.

Fig. 5 (left). Perforated main cover removed to show ribbed support. Fig. 6 (right). Sound deflectors are visible when ribbed support is removed.

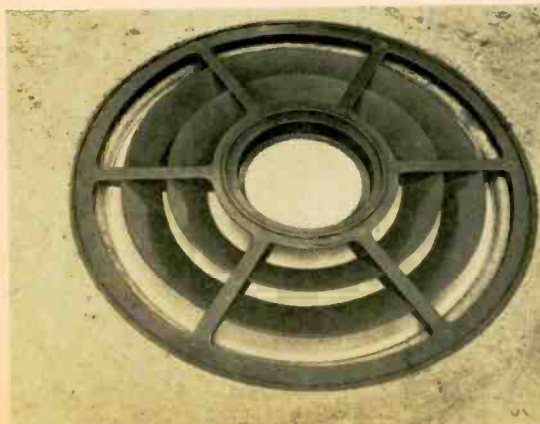



Fig. 1 (above), and Fig. 2 (below). Front and back views of new RCA 51551 duo-cone loudspeaker.

New 15-Inch Duo-Cone Loudspeaker

HARRY F. OLSON* and JOHN PRESTON*
and
D. H. CUNNINGHAM**



Modifications made on the well-known LC1A result in a speaker which can be manufactured in mass quantities at lower cost.

THE ALMOST UNIVERSAL USE of the direct-radiator loudspeaker is due to its simplicity of construction and the relatively uniform response-vs-frequency characteristic. Uniform response over a moderate frequency band may be obtained with any simple direct-radiator speaker. However, reproduction over a wide frequency range is restricted by practical limitations. The portion of the speech-frequency range required for intelligibility falls in the mid-audio-frequency band. The range of the fundamental frequencies of most horn, reed, and string musical instruments also falls within this band. This is rather fortunate, because it is a simple task to build a direct-radiator dynamic speaker to cover this mid-frequency band. The two extreme ends of the audio-frequency band are the most

difficult to reproduce with an efficiency comparable to that of the mid-frequency range. Inefficiency at the low frequencies is due primarily to low radiation resistance. Inefficiency at the high frequencies is due primarily to large mass reactance.

Volume range is another factor. An increase in volume and frequency ranges of a speaker multiplies the problems connected with obtaining low nonlinear distortion and broad directivity patterns. When the high-frequency range is increased, the directivity pattern becomes quite narrow, and some means must be devised for obtaining a broad directivity pattern. The problem of nonlinear distortion also is increased when the frequency range is increased. From the foregoing it is quite evident that there are many problems to be considered in the development and production of a high-quality wide-range

speaker.

Wide-frequency-range, low distortion speakers are required for monitoring in radio and television broadcasting, phonograph and motion picture recording, high-quality sound systems, and custom sound-reproducing systems. The demand for a reasonably priced high-quality speaker by connoisseurs of high-quality reproduction is rapidly increasing. The direct-radiator speaker is particularly suited for these applications because the acoustical power required is relatively low and the space requirements comparatively small.

Some time ago a duo-cone speaker was developed, manufactured, and sold by RCA as the LC1A. It has now been

¹"Wide Range Loud Speaker Developments," H. F. Olson and J. Preston. *RCA Review*, Vol. VII, No. 2, June 1946.

²Olson. *Elements of Acoustical Engineering*, 2nd Edition, D. Van Nostrand Company, New York, N. Y. 1947.

*RCA Laboratories Division, Princeton, N. J.
**RCA Victor Division, Camden, N. J.

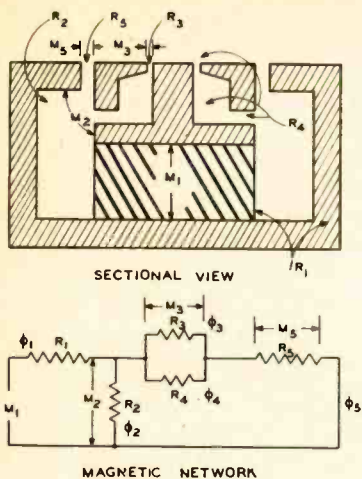

Fig. 3. Schematic sectional view and the magnetic network of the magnetic structure. M_1 , the magnetomotive force developed by the permanent magnet. M_2 , the magnetomotive force drop across the two air gaps. M_3 , the magnetomotive force drop across the small air gap. M_5 , the magnetomotive force drop across the large air gap. R_1 , the reluctance of the iron. R_2 , the reluctance of the leakage gap. R_3 , the reluctance of the small air gap. R_4 , the reluctance of the added gap and leakage. R_5 , the reluctance of the large gap. ϕ_1 , the total flux. ϕ_2 , the leakage flux. ϕ_3 , the flux in the small gap. ϕ_4 , the leakage flux and the flux through the added gap. ϕ_5 , the flux in the large gap.

in the field for almost two years. The design principles embodied in this device have been found to be fundamentally sound and highly desirable. The LC1A duo-cone speaker^{1,2} still remains the "de luxe" item, and particular pains are taken in its manufacture to maintain the high performance characteristics with no compromise in quality. The problem of incorporating the desirable features of the LC1A speaker into a simplified and lower-cost mechanism with certain compromises was considered and, as a result, a simplified version (Type 515S1) has been developed, designed, and commercialized. It is the purpose of this report to describe this speaker mechanism.

Magnetic Structure

In the duo-cone speaker Type 515S1 two separate cones driven by separate voice coils are used. Furthermore, the coaxial and congruent arrangement of the cones is maintained essentially the same as in the duo-cone LC1A. This type of vibrating system required two separate air gaps.

A fundamental study of two-air-gap magnetic structures was carried out. As a result, a magnetic bridge system with two air gaps supplied by a single magnet was developed. A schematic view and the magnetic network of this air gap are shown in Fig. 3. From a consideration of the magnetic network it can be seen that practically any ratio of flux densities in the two air gaps may be obtained by suitable selection of parameters. The magnitude of the flux density in the air gaps is governed by the magnetomotive force developed by the permanent magnet. The magnetic efficiency of this combination structure is higher than that of two separate magnetic structures in spite of the fact that the flux in the gap R_4 is lost. This higher magnetic efficiency is due to the smaller percentage of leakage in this structure as compared to that of two separate magnetic structures.

Vibrating System

A sectional view and the mechanical network of the vibrating system of the duo-cone speaker are shown in Fig. 4. The vibrating system consists of a large voice coil for the reproduction of the low-frequency range and a small cone driven by a small voice coil for the reproduction of the high-frequency range. The outside suspension of the

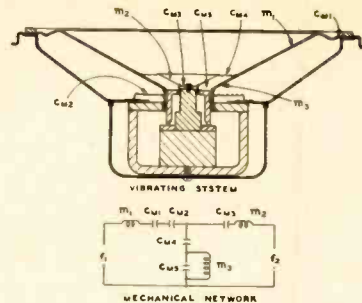

Fig. 4. Sectional view and mechanical network of the RCA 15-inch duo-cone speaker. In the mechanical network: f_1 , the driving force in the low-frequency voice coil. m_1 , the mass of the low-frequency cone and coil. C_{M1} , the compliance of the outer suspension system of the low-frequency cone. C_{M2} , the compliance of the centering suspension of the low-frequency cone. f_2 , the driving force in the high-frequency voice coil. m_2 , the mass of the high-frequency cone and coil. C_{M3} , the compliance of the centering suspension of the high-frequency cone. C_{M4} , the compliance of the outer suspension of the high-frequency cone. C_{M5} , the compliance of the cavity between the low- and high-frequency cones. m_3 , the mass of air in the vent holes in the low-frequency cone.

small cone is fastened to the large cone. This construction eliminates the need for a "dishpan" or other outside support for the small cone. It also makes it possible to place the small cone very close to the large cone so that as far as acoustical radiation phenomena are concerned the two cones are congruent. In this construction, certain precautions must be taken to keep the vibrations of the large cone from being transmitted to the small cone. Referring to the mechanical network of Fig. 4, this objective can be attained by making the compliance C_{M3} of the center suspension of the small cone very small compared to the compliance C_{M4} of the outer suspension of the small cone. In general, in a speaker covering the high-frequency range it is desirable to make the effective compliance of the vibrating system of a high-frequency radiator small regardless of the manner in

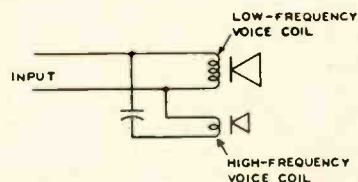

Fig. 6. The electrical crossover network of the duo-cone speaker.

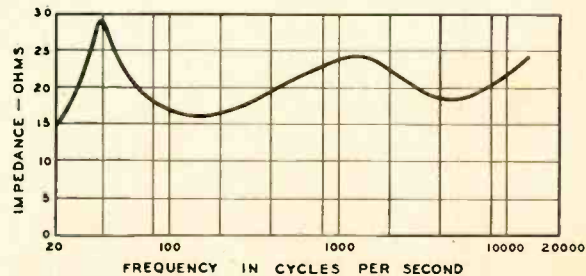
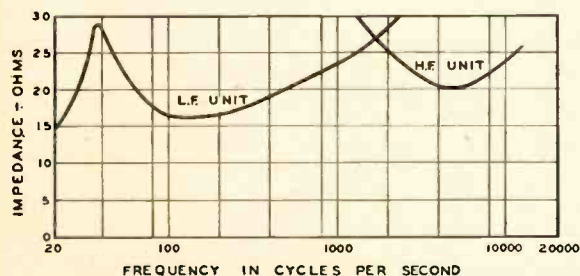

Fig. 5 (left). The electrical impedance-vs-frequency characteristics of the low- and high-frequency voice coils of the duo-cone speakers. Fig. 7 (right). The overall electrical impedance characteristic of the duo-cone speaker using the crossover network of Fig. 6.

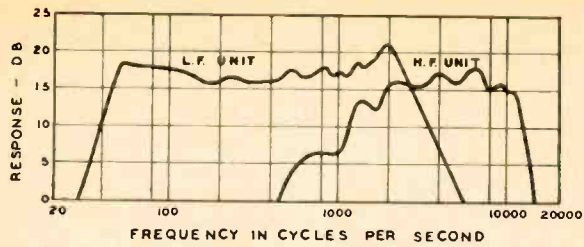

Fig. 9 (left). Response-vs-frequency characteristics of the high and low-frequency units of the duo-cone speaker in the cabinet of Fig. 8 with the port closed.

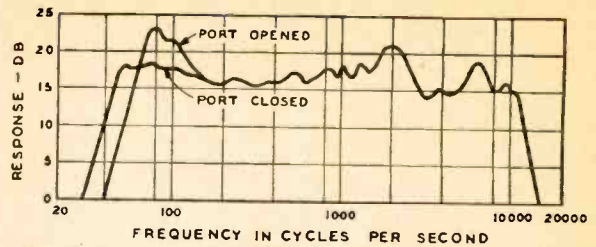

Fig. 10 (right). The overall response-vs-frequency characteristics of the duo-cone speaker in the cabinet of Fig. 8 with the port open and closed.

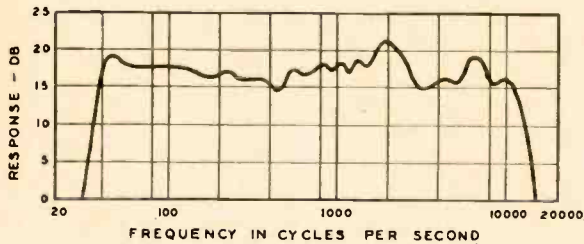

Fig. 11 (left). The overall response-vs-frequency characteristic using a flat baffle about 5 feet across.

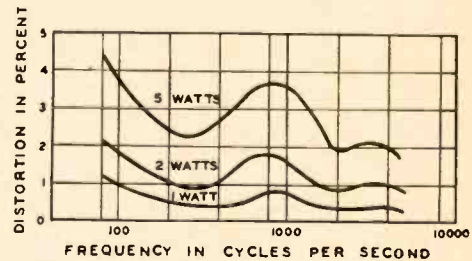

Fig. 13 (right). The total nonlinear distortion-vs-frequency characteristics of the duo-cone speaker for inputs of 1, 2, and 5 watts.

which it is used. In order to prevent coupling between the two cones through the compliance C_{M5} , it is necessary to vent the space behind the small cone. Under these conditions, the compliance C_{M5} of the cavity will be ineffective because the effective mass of the air in the vent holes shunts the compliance of the air cavity. If the cavity were not vented, the compliance C_{M5} would serve as a coupling means between the cones. By these expedients the motion transmitted to the small cone by the vibration of the large cone is negligible. The vibrating system of Fig. 4 retains the advantages of two separately driven, coaxial congruent cones.

Mechanical Design and Manufacturing Assembly

In any dynamic speaker, in order to assure good operation for a long life period under all conditions of humidity and temperature changes, it is important to have a good mechanical assem-

bly of the moving parts relative to the stationary parts. The slightest interference with the movement of the voice coil and cone creates a noise disturbance too severe to be acceptable to the listener. This problem is greater on the duo-cone speaker because two sets of voice coils, cones, and air gaps must be properly aligned in their assembly. The solution to this problem was provided by designing the parts so as to give them full lateral freedom during assembly. This method allows the parts to be assembled accurately in a coaxial arrangement, which does not produce stresses resulting in off-center parts when the assembly fixtures are removed. The steel pole-piece members and the magnet are firmly bonded to one another and to the yoke with solder over their entire contacting areas. This type of junction is capable of resisting any movement due to shock or other disturbing forces. The magnet is made

of Alnico V and weighs two pounds.

Ample clearances are provided between the voice coils and the pole-piece members to prevent any interference with the movement of the voice coils.

The cones, voice coils, and suspensions are all anchored to one another and to the metal speaker frame with cement. This cement is of a thermal-setting type especially developed for good adhesion to paper, metal, and cloth, and is resistant to loosening or deterioration caused by temperature, humidity, and aging.

Electrical Network

The cross-over network is an important consideration in a direct radiator speaker. In the design of a two-unit speaker in which there is a considerable path length between the two units, a cross-over network with relatively sharp cutoffs is required in order to prevent interference in the cross-over-frequency

[Continued on page 46]

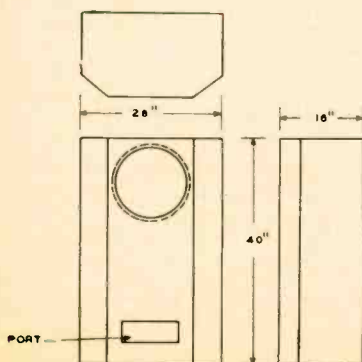

Fig. 8 (left). One type of cabinet which may be used with the duo-cone speaker. Wood $\frac{3}{4}$ " thick is used.

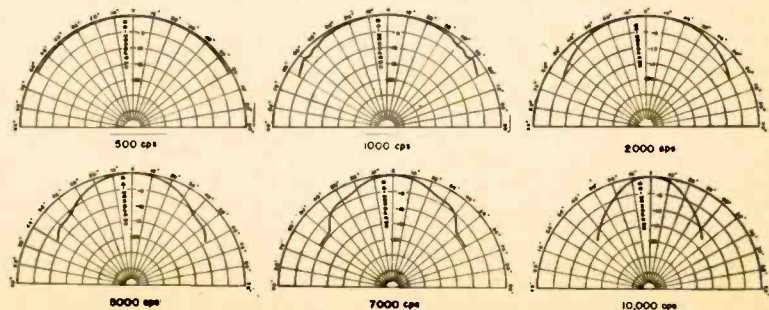

Fig. 12 (below). Directional characteristic of the duo-cone speaker at various frequencies.

Problems in Audio Engineering

L. S. GOODFRIEND*

In this concluding article, the author describes musical instruments and the human speech organs as sound generators.

AS POINTED OUT in the previous article, musical instruments and the organs of speech constitute a special group of sound generators. This article will discuss at length the manner in which various instruments produce musical sounds and will tabulate the more common musical instruments with their method of sound production and reinforcement or amplification.

Sounds generated by strings, reeds, or edges in air streams produce not only the fundamental and harmonics, but also generate inharmonic partials. These generators usually do not produce loud tones, but must have some form of amplification before they are clearly audible as instruments in a concert hall. The method by which this amplification takes place is usually the forced vibration of an air column, as in the case of reed and edge-tone instruments, or the forced vibration of a sounding board, as in the string instruments. In the first case the standing waves set up in an air column selectively reinforce the desired resonant frequency to which the column is tuned. In the case of the string instruments, the strings are coupled to an air chamber which has a particular resonant frequency, and to a sounding plate or membrane. In a piano there is a large wood sounding board which acts to couple the string to the air. This occurs because the string sets the sounding board in motion, and while the displacement of the board may be small, it moves a large volume of air. This is in contrast to instruments that require an air column resonator. For example, when resonance in the true sense (as shown by the simple mechanical system described last month) takes place in the string instruments, it causes a selective amplification which is greatest at one frequency. In the violin this is the so-called "wolf note," a loud unpleasant note, and one not easily controlled by the player. In the wind instruments and brasses additional coupling of the air column to the surrounding air is

accomplished through the use of end bells which, like exponential horns on some types of loud speakers, couple the end of the pipe to the atmosphere with an action similar to a transformer coupling two lines of different impedance. The classification of the various types of instruments is shown in Table I.

It is not the purpose of this series to deal with the aesthetic and musical factors involved with bowing violins or tonguing wind instruments. The manner in which strings produce tones has been discussed earlier. A brief glance at the generation of tones by sharp edges placed in an air stream and by blown reeds, however, is in order.

Air Stream Generators

If a jet of air from a slit is aimed at a sharp edge, as in Fig. 1, the stream will divide and flow past the edge. As the air stream leaves the edge it forms little whirlpools, or vortices, alternately on each side of the edge. In other words, the stream tends to oscillate back and forth across the edge. The frequency at which these oscillations occur is generally within the range of audibility for

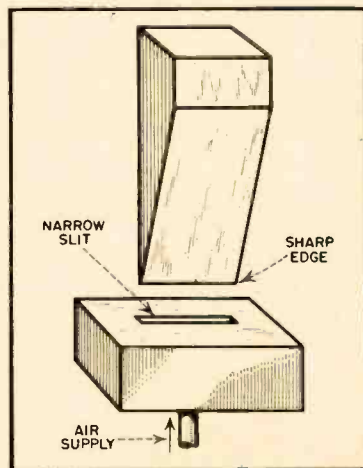

Fig. 1. Basic apparatus for producing edge tones. Narrow stream of air is "split" by sharp edge, which might be that of an organ pipe.

most constructions, and is dependent on the velocity of air across the edge and on the distance from the slit to the edge. The tones produced by this method are not very loud and have a large number of overtones present. However, by placing the edge and slit at one end of a pipe whose fundamental is the same as the edge tone or one of the overtones, the fundamental will be reinforced and clearly heard. This is the method used to produce tones in the modern flue-pipe organ. The flute is also an edge-tone instrument, with the lips used as the slit, and the mouthpiece forming the edge.

Reed instruments, on the other hand, depend on the motion of air about an obstacle. When we consider that sound consists of alternate compressions and rarefactions of the air, it is obvious that we can generate a sound wave by alternately turning a stream of air on and off. When a strip of metal or bamboo is placed at the end of a pipe, the reed will tend to vibrate at the frequency to which the pipe is tuned. When the reed and pipe are tuned to the same frequency, large amounts of power may be generated, and in the woodwind instruments this usually produces the squeaky sound associated with the playing of beginners.

Reed Instrument Construction

There are several types of reed structures used to produce sound in musical instruments. These are shown in Fig. 2. The clarinet and saxophone reeds operate against the opening of the mouthpiece, completely stopping the flow of air when it is against the opening. On instruments of the oboe family there are two reeds which vibrate against each other, alternately opening and closing. When they are open they form a tube through which the air passes. Other instruments that use this double reed construction are the English horn and the bassoon. The reeds on the instruments named are of the striking reed type as shown in (A) of Fig. 3; that is, they close the aperture through which the air passes by striking against an opening or against another reed. There is another type of

*Rangertone, Inc., 73 Winthrop St., Newark 4 N. J.

reed construction in which the reed stops the flow of air by moving back and forth through a slot in a plate as in (B) of Fig. 3, and as the reed passes through the plate it effectively cuts off the air. The brass instruments, including the trumpet, trombone, and French horn, are really reed instruments in which the player's mouth acts as a vibrating double reed, and the piping, of which the horn is made, acts as a resonator for the tones thus produced.

Although it might appear from the descriptions so far that each of the instruments described produces tones at the fundamental, this is not altogether true. In the brass instruments, in particular, the ratio of the width of the pipe to its length causes the second and higher harmonics to be resonated with greater ease than the fundamental, and it is only in the trombone that the fundamental is more prominent than the overtones. Pictures and charts of the structure of musical tones produced by the various instruments are so common in the contemporary literature that they will not be presented here.

Since it is possible to force a generator of edge or reed tones to generate sound having the pitch to which the resonating pipe is tuned, it is only necessary to change the length of the pipe to change the pitch. (The term pitch is used here because the tones produced by musical instruments are not simple, and do not have the characteristics of pure tones). In the woodwinds the length of the pipe is varied by opening and closing holes spaced along the length of the instrument. In the simpler instruments this is done by placing fingers over the holes, while in the more complex ones, the holes are covered by pads which are controlled through lever, key, and cam assemblies. In the brasses the length of the pipe can be changed through the use of valves which bypass the sound through longer or shorter lengths of pipe. One exception to this method is the slide trombone. In this case the length of the pipe itself is increased or decreased.

Two notable characteristics of woodwinds should be mentioned here. In the clarinet the bore of the pipe is straight, while in the oboe and saxophone it is conical. This difference causes the clarinet's harmonic structure to contain only the odd harmonics in its overtones, which is the structure normally associated with a closed pipe. The conical bore of the oboe permits it to produce even harmonics and an overtone structure that contains the complete series of harmonics. In addition to varying the pipe length, it is possible to overblow an edge or reed tone, causing some higher harmonics to become pre-

dominant. This also occurs in the brasses, and it is only through overblowing that the higher octaves may be produced in wood and brass wind instruments. If the reader would like to study this phenomenon without purchasing an instrument, it is only necessary to take a cola bottle and first blow the fundamental. Then, if the lips are

pressed together to form a narrower slit, harder blowing should produce one or more of the overtones quite clearly, without the fundamental.

Percussion Instruments

The percussion instruments—drums, cymbals and xylophones—incorporate membranes, plates and bars. The mechanism of sound production of the

TABLE I

INSTRUMENT	GENERATOR	RESONATOR	CLASS
Piano	String	Sounding board	Percussion-string
Violin		Air chamber & plates	String
Violoncello		Air chamber, plates & floor	
Double Bass			
Harp			
Mandolin		Air chamber & plates	
Guitar			
Banjo		Air chamber & Membranes	
Flute	Edge tone, lips (used to form slit)	Cylindrical bore pipe	Woodwind
Piccolo			
Clarinet	Striking reed	Conical bore pipe	
Saxophone			
Oboe	Double reed		
English horn			
Bassoon			
Trumpet	Lips	Cylindrical valved pipe	Brass
Cornet			
Bugle			
French horn			
Trombone		Cylindrical pipe sliding section varies in length	
Tuba		Valves	
Tympanum	Membrane	Air chamber	Percussion
Drums			
Xylophone	Bars	None	
Chimes	Bars (Hollow cylinders)	Air column	
Triangle	Rod	None	
Celesta	Plate		
Glockenspiel			
Cymbals			
Gong			
Bell chimes	Bell		Bell

first two types has been covered in an earlier article, and the relation of the bar to the string is analogous to the relation of the plate to the membrane. It is the use of the bar with which we shall concern ourselves here. If a series of bars are supported at the point where there is no motion in their standing wave pattern, and the bars are of increasing length, they may be struck in succession to produce a series of rising tones. It is possible to select a set of these bars having tones corresponding to the musical scale; thus a xylophone is the result if the bars are of wood, or a hollow chime, if the bars are hollow metal cylinders. The triangle and the tuning fork, are bent or split rods. The plate is used in the celesta, cymbal and gong.

Bells are often considered as special cases of plates and are extremely complex in theory. They are used musically as chimes, carillons and single bells.

Speech

The study of speech has been the concern of three separate groups: teachers of speech and English, medical groups, and audio and acoustical engineers. Since better transmission of speech is the primary aim of a large group of the audio engineering profession, it is important to understand its production and characteristics. Speech is characterized by two distinct types of sound—buzz or hum tones, and the hiss sound. The vowels and their associated diphthongs, semi-vowels and transitionals, are of the buzz tone type; while the unvoiced fricative consonants, *f* and *s* are hiss sounds.

Buzz energy in the speech sounds is produced by a pair of muscularly controlled membranes in the larynx.

Fig. 2. Woodwind reeds differ in construction. The clarinet uses the single reed shown at the left, while the oboe and bassoon reeds at the right are actually two reeds placed back to back and wrapped at the stem to hold them in proper position.

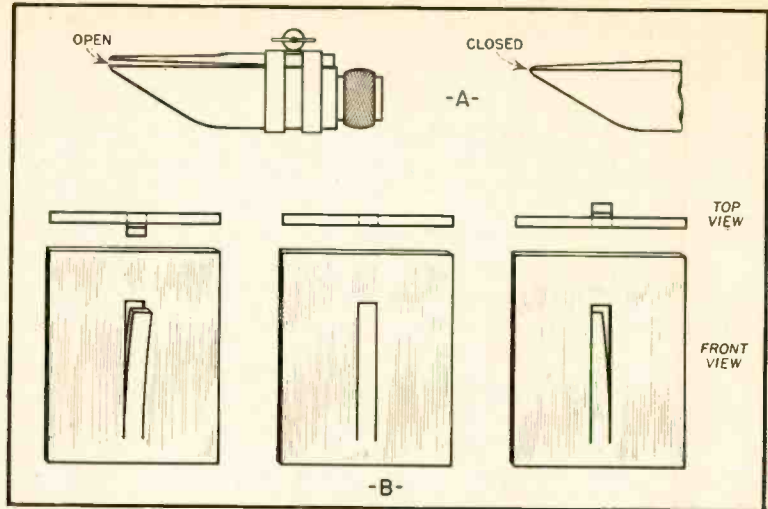
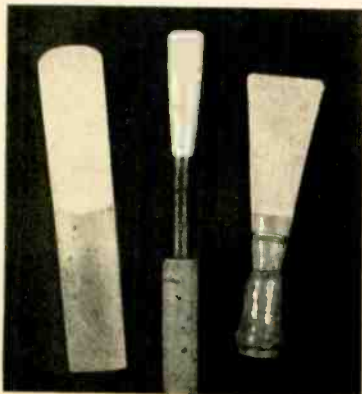

Fig. 3. (A) Side view of clarinet reed. (B) Metal reeds of the type employed in reed organs and harmonicas.

These membranes interrupt the flow of air from the lungs at a periodic rate, and the tone thus produced is resonated in the mouth and nasal cavities. Hiss energy is produced by the flow of air through slits or past sharp edges in the oral cavity. Speech sounds are, in gen-

eral, a combination of the two types of energy. cal cords that determine the frequency and not the resonator. These cords force air in the oral cavities into vibration, and by changing the manner in which energy is released through the mouth by movement of the lips and tongue we may combine the two forms of speech sounds to produce the full range of speech sounds or words. The similarity of the vocal cords to the reeds used in musical instruments should be apparent, and the overtone structures of each bears out the likeness. The sounds from reeds and vocal cords are in pulses which, since they are not purely sinusoidal, contain many harmonics and have distinctive qualities, depending on the phase and amplitude of their harmonics.

It is not difficult to see that all sound generators involve principles which are of a physical nature, and to recognize the importance of including physics as an element of the background for audio engineering. These same physical principles also form the basis for electronics and for architectural acoustics, which too many audio engineers consider as separate fields unrelated to the other fields of audio work.

TABLE II

1. Pure Vowels (11)
Long: ū (tool), ō (tone), ó (talk), a (far), ā (tape), ē (team).
Short: u (took), o (ton), á (tap), e (ten), i (tip).
2. Diphthongs (4)
i, ou, oi, ew.
3. Transitionals (3)
w, v, h.
4. Semi-vowels (5)
l, r, m, n, ng.
5. Fricative Consonants (8)
Voiced: v, z, th (thien), zh (azure).
Unvoiced: f, s, th (thin), sh.
6. Stop Consonants (8)
Voiced: b, d, j, g.
Unvoiced: p, t, ch, k.

eral, a combination of the two types of energy.

The names used to tag particular combinations of sounds are the subject of a continual discussion among the various learned groups investigating speech phenomena. Table II shows an arrangement of speech sounds as worked out by Dr. Harvey Fletcher. The table is in order from buzz sounds to hiss sounds.

In contrast to musical instruments, which have hard walls and well defined smooth shapes, the oral and nasal cavities, which act to resonate speech sounds, have compliant, poorly defined, varying shapes. It is, therefore, the vo-

REFERENCES

- Acoustics—Alexander Wood. Interscience Publishers, Inc., New York, 1941; pp 348-355.
- Acoustics of Music—W. T. Bartholomew. Prentice-Hall, Inc., New York, 1942.
- Elements of Acoustical Engineering—H. F. Olson. D. Van Nostrand Co. Inc., New York, 1947; pp. 459-467, 477-483.
- The Science of Musical Sounds—D. C. Miller. The MacMillan Company, New York, 1916.
- Speech and Hearing—Harvey Fletcher. D. Van Nostrand Co. Inc., New York, 1929; pp. 1-107.



AUDIO engineering society

Containing the Activities and Papers of the Society, and published monthly as a part of AUDIO ENGINEERING Magazine

OFFICERS

C. J. LeBel, President

Audio Engineering Society,
Box F, Oceanside, N. Y.

C. A. Rackey.....Executive Vice-Pres. John T. Mullin.....Western Vice-Pres.
Norman C. Pickering.....Secretary Ralph A. Schlegel.....Treasurer

Convention Program

Thursday, Oct. 27th

1:30 to 2:30 p.m. Business Meeting—Installation of officers

2:30 to 5:00 p.m. Magnetic Recording Session

- | | |
|--|----------------------------|
| Chairman | Dr. D. G. C. Hare |
| 1. Operating Problems & Experiences | R. H. Barnaby—NBC |
| 2. Standards—Present Status | R. M. Morris—ABC |
| 3. Technical Problems of Standardization | E. W. Franck—Audio Devices |
| 4. Distortion Measurements | G. L. Dimunick—RCA |
| 5. Speed Regulation Problems | P. Brubaker—Rangertone |

Friday, October 28th

9:30 a.m. to 12 Noon Papers

- | | |
|--|--------------------------|
| 1. Automatic Audio Gain Control & Limiting | J. L. Hathaway—NBC |
| 2. A New Development in Directional Microphones | Dr. Harry F. Olson—RCA |
| 3. Microphone Placement in AM & TV | H. M. Gurin—NBC |
| 4. Longitudinal Interference | B. W. Augustadt—BTL |
| 5. Control of Sound in the Theatre | Dr. Harold Burriss-Meyer |
| 6. Logic in Relay Switching Circuits, with an
Introduction to Boolean Algebra | W. Keister—BTL |

1:30 to 5:00 p.m. Papers

- | | |
|--|---|
| 1. A New Coupling Circuit for Audio Amplifiers | F. M. McIntosh |
| 2. Standards—A General Discussion | Cyril Ainsworth—ASA |
| 3. Audio Techniques in TV Broadcasting | S. Patremio—DuMont |
| 4. Audio Consoles for TV | R. W. Byloff—NBC |
| 5. Sound Reinforcing System | A. W. Schneider—Commercial
Radio-Sound, Inc. |

6:30 p.m. Audio Engineering Society Banquet
Presentation of awards—loudspeaker demonstrations.

Saturday, October 29th

9:30 to 12 Noon Audio Measurements Session

- | | |
|------------------------------|---|
| Chairman | W. L. Black—BTL |
| 1. The General Problem | W. L. Black—BTL |
| 2. Intermodulation | Dr. Pederson—General Radio;
E. Roys—RCA; J. K. Hilliard—Altec-Lansing; N. C. Pickering—Pickering Co. |
| 3. Transient Methods | |
| 4. Operating Problems | J. D. Colvin—ABC |

THE FIRST annual convention of the Audio Engineering Society opens its first session at Hotel New Yorker (shown in the inset on the cover) at 1:30 p.m. on Thursday, October 27, 1949, with an anticipated attendance of a majority of the 800 members of the Society throughout the three-day meeting.

For a relatively young organization, an imposing array of technical sessions has been scheduled—rather more papers on audio than have heretofore been presented at all other conventions taking place within a year's time. To ensure the greatest interest in the technical sessions, the papers have been grouped to attract specialists in the audio field

to specific mornings or afternoons where their particular interests lie.

The first session begins at 1:30 p.m. on Thursday with a Business Meeting of the national organization, at which time the newly elected officers will be installed. This will be followed by the Magnetic Recording Session under the chairmanship of Dr. D. G. C. Hare, and presenting papers covering operating, standardization, and measurements.

The Friday sessions will be devoted to a variety of papers, principally on equipment and operating techniques. These will be followed by the banquet to be held in the East Ballroom during the evening. Unique in professional society banquets, this one is limited to

a minimum of speeches. The Society's annual awards will be presented at the banquet, however, and some enlightening entertainment is promised in the comparative loudspeaker demonstration.

The Saturday Morning session is devoted to Audio Measurements, under the chairmanship of W. L. Black, of Bell Telephone Laboratories. Considerable interest is being shown in the papers on Intermodulation, which are being presented by four different engineers, and which may lead to a more thorough understanding and standardization of this relatively new method of rating distortion.

All technical sessions of the Convention are open to members at no charge, while nonmembers may register for any or all sessions for a single nominal fee of \$1.50.

The Audio Fair, being held simultaneously with the convention, consists of a number of exhibits arranged so that the manufacturers can demonstrate their products aurally as well as show them visually. The exhibits, which will cover practically the entire sixth floor of the Hotel New Yorker, will open at 11:00 a.m. on Thursday and remain open until 10:00 p.m. On Friday they will be open from 10:00 a.m. to 6:00 p.m., closing to permit members to attend the banquet. The exhibits will be open on Saturday from 10:00 a.m. to 4:00 p.m., at which time the Convention and The Audio Fair will come to a close.

Designed to give the exhibitor the opportunity of displaying his products in the manner in which they are designed to be shown—aurally—The Audio Fair will bring amplifiers, loudspeakers, phonograph pickups, microphones, turntables, measuring instruments, and accessories before the audio men in attendance, along with the latest developments in film, magnetic, and disc recorders and in equipment for broadcasting and TV as well as for the hobbyist. Anyone interested in any phase will find something to his particular liking.

The Audio Fair is open to both members and nonmembers alike, and there is no charge for admission.

PARTIAL LIST OF FAIR EXHIBITORS

Although last-minute requests are still coming in for exhibit space at The Audio Fair, the following exhibitors have already completed their plans for participation. As will be seen from a study of this list, most of the major manufacturers of sound and broadcast audio equipment will have their products on display, and all who attend will be able to hear as well as see the new developments in this field.

Altec Lansing Corp.
Ampex Electric Corp.
Audak Company
Audio and Video Products Corp.
Audio Development Company
Audio Devices, Inc.
Audio Facilities Corp.
Audio Instrument Company
Ballentine Laboratories, Inc.
Brociner Sound Laboratories
Brush Development Co.
Burlingame Associates
Frank L. Capps, Inc.
Clough-Brengle
Cook Laboratories
The Daven Co.
Allen B. DuMont Laboratories, Inc.
Electric Indicator Co.
Electronic Workshop, Inc.
Electro-Voice, Inc.
Fairchild Recording Equipment Corp.
General Electric Company
Gawlor-Knoop Co.
Hewlett-Packard Co.
James B. Lansing Sound, Ind.
H. J. Leak & Co., Ltd.
Livingston Electronic Corp.
Magnecord, Inc.
McIntosh Engineering Laboratories
J. A. Maurer, Inc.
Minnesota Electronic Corp.
Panoramic Radio Products, Inc.
Peerless Electrical Products Division
Perminflux Corporation
Pickering and Co., Inc.
Presto Recording Corp.
Prestoseal Manufacturing Corp.
Proctor Soundex Corp.
Racon Electric Co., Inc.
Radio Corporation of America
Rangertone, Inc.
Recogram Recorders Co.
Rek-O-Kut Company, Inc.
Sonar Radio Corporation
Somerset Laboratories, Inc.
Stancil-Hoffman Corp.
Stephens Manufacturing Corporation
Sun Radio & Electronics Co., Inc.
Tech Laboratories, Inc.
Tektronix, Inc.
University Loudspeakers, Inc.
U. S. Recording Co.

San Francisco Section Starts Audio Course

AUDIO ENGINEERS in the San Francisco area have begun a ten-lecture course on audio engineering which is being presented as a fall educational program by the Society Section. This series, which began Monday, September 26, is being held at the Redding School, Pine and Larkin Streets, San Francisco, at 8:00 p.m., and will continue on Monday evenings through December 12.

Nationally recognized authorities in the various fields covered have prepared subject matter which is being presented and interpreted by engineers active in the corresponding specialties with companies and educational institutions throughout the Bay area. The lecture series covers essentially the same subject matter as that of the New York section in its Spring Educational Series, and the original papers are the basis for this new series.

The Educational Committee of the San Francisco Section is composed of Walter T. Selsted, Pacific Broadcasting Co., chairman; Bob Hugh Smith, Dept. of Elec. Engrg., Univ. of California; Myron C. Stolaroff and Frank Lennert, Ampex Electric Corp.; Al Eisberg, KRON and KRON-TV; and Ross H. Snyder, KJBS and KJBS-FM.

Individual lectures or the entire series are open to members and non-members of the Society on payment of the established fees. Mr. Selsted, chairman, may be contacted at 363 Oakview, San Carlos, Calif.

Southern Michigan Section Starts Fall Season

The first program of the 1949-1950 season was held on Tuesday, September 20, at Kalamazoo, Michigan, with a paper on "Magnetic Tape Recording" presented by Mr. Tinkham, President of Magnecord, Inc., and Mr. Leroy W. Beier, of the Leroy W. Beier Co. In addition to the talk, the program offered a demonstration of a high-quality audio system consisting of the professional magnetic tape recorder manufactured by Magnecord, Inc., with an audio range of 30 to 15,000 cps; the new fifty-watt McIntosh amplifier; and the Stephens Coaxial two-way speaker and cabinet. This equipment is of broadcast quality, and does full justice to the program material used.

Student Chapter News

The first Student Chapter of the Audio Engineering Society at the RCA Institutes, Inc., N. Y., has completed a highly successful first semester. Active membership totals over fifty students, and interesting and informa-

Employment Register

Positions open and available personnel may be listed here at no charge to industry, or to members of the Society. For insertion in this column, brief announcements should be in the hands of the AES Editor before the tenth of the month preceding the date of issue. Address replies to AES Editor, Audio Engineering, 342 Madison Ave., New York 17, N. Y.

• **Technical Public Relations** man, with wide experience in publicity, brochure production, press relations, etc., especially in audio work. College graduate, 30, married, presently employed. Will consider part-time employment. Box 91.

• **Audio Engineer**, with manufacturing, design, development experience in disc, film, and magnetic recording and reproduction and in sales engineering for recording equipment desires to change present position, held 10 years. Age 33, married, university graduate in engineering. Prefer New York area, but willing to travel. Box 92.

• **Audio Engineer**, BSEE 1936. Section head at govt lab; 8 years applied research, analysis, and development in electronics, electro-acoustics, sound recording and reproduction. Desire position in private industry in audio or electronics, northeast preferred. Age 33, married. Box 93.

• **Music Engineer**. Grad. RCA Institutes; MA in Music (Harvard). Excellent background in audio and music. Seeking position requiring coordination of technical and musical considerations. Highest references. Available Sept. 6. Box 94.

• **Engineering Student Graduate**. Trained in audio amplifier and circuit design. Interested in audio-video amplifier and test equipment design. Box 95.

• **Engineering Trainee**. RCA Institutes graduate, Age 25. Recording, amplifier, and transducer interests. Machine shop experience. Box 96.

• **Recording Engineer**. 10 years exp. recording, maintenance, disc and tape. Good mixer, excellent knowledge of classical music. Available after 2 p.m. daily, all day Sat. and Sun. Box 97.

• **Audio Technician**. 12 yrs laboratory, mfg, and field experience. 1st phone, competent trouble-shooter and constructor with design background. Pleasing, effective personality. Desire responsible position with BC station or equipment manufacturer. Box 101.

• **Research and Development Engineer**. Ph. D., specialized in electronics, circuit design, electro-mechanical devices, acoustics, precision-mechanics, nuclear physics equipment. Would like to be your consultant or part-time adviser. Box 102.

• **Electrical Engineer**, over 20 yrs electronic, acoustic, dynamic audio devices, systems. Accomplishments in development, design, manufacture, for commercial, marine, govt equipment. Exp. supervision, planning, estimating. Early radio background. Residence NY area. Box 103.

• **RCA Institute** graduate wishes position with audio company or recording studio. Box 104.

tive programs have formed a major part of the monthly meeting. Such well-known men in the audio engineering field as Norman Pickering, and Clyde R. Keith have been guest speakers. An equally active program is planned for the coming school year.

Improved Audio Quality from Standard TV Receiver

C. G. McPROUD

A few simple modifications to the famous RCA 630TS will give better low- and high-frequency response with less distortion.

AUDIO QUALITY IN TV receivers has been the subject of several comments in these pages from time to time, but so far nothing constructive has been offered. In an endeavor to prove just how much of the poor quality which has been attributed to TV was due in fact to the receiver itself, some experiments were made and the final conclusions are that TV program transmission is considerably better than common receivers are able to reproduce.

This is reasonably understandable because in a high-priced item such as the average TV receiver, economies must be practiced to keep the selling price within reason. It has been, to date, far more important to provide a good picture than to provide good sound reproduction. To reduce costs, therefore, the audio channel is skimmed in many receivers, although the picture quality has been held to high standards.

The factors which contribute to poor quality are obvious from a study of the circuit schematics. Considering one of the most popular receivers on the market—the RCA 630TS, either in original factory-built form or as a kit such as the Tech-Master—it will be observed that the audio channel consists of a high- μ triode with contact-potential bias as the first stage, and a pentode output stage without feedback. Add to this the use of an output transformer which has a $\frac{1}{2}$ x $\frac{1}{2}$ -inch core and a small speaker with inadequate baffling, and it is no wonder that the quality is somewhat short of ideal. It will be noted from the schematic of the audio portion of this chas-

sis (Fig. 1) that the coupling capacitors are smaller than optimum for good low-frequency response.

A few relatively simple changes will give this receiver a new voice—one

plate circuit provides the de-emphasis, and the bias for V_{109} is obtained from the power supply. The output circuit is fairly conventional.

Using a pentode for the first audio stage so that feedback may be applied readily without overall loss of gain, it becomes necessary to obtain the de-emphasis by another means, since the capacitor C_{207} would be inside the feedback loop. This may be done by replacing R_{236} with a 56,000-ohm resistor, and connecting a 120- μ f capacitor C_1 from the junction of R_{236} and C_{205} . This gives a de-emphasis of 67 μ sec, which appears to be adequate.

Measured response of the audio system indicates a droop of 13 db at 10,000 cps, which is within 1 db of the nominal value. To improve the low-frequency response, C_{205} and C_{208} are both increased in value; C_{207} and C_{209} are eliminated. The arm of the volume control is connected directly to the grid of V_{108} , eliminating C_{206} . The circuit which formerly connected to the diodes of V_{108} is connected to ground through a 1N34 germanium crystal diode, thus maintaining the normal operating characteristics of the picture control circuit.

The bias required by the 6V6 in the output stage is somewhat less than that for the 6K6. Therefore, the two resistors R_3 and R_4 are employed in the grid circuit as a voltage divider, giving a bias of approximately 13 volts.

Physical Changes

Using a speaker separate from the chassis will eliminate the use of the present speaker field as a filter choke. A new choke coil having a resistance

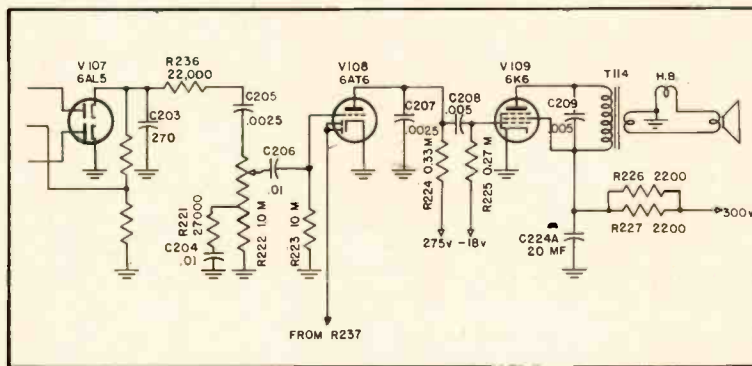

Fig. 1. Audio section schematic of RCA 630TS receiver chassis.

which will compare with any good FM receiver—provided the output is fed to a larger speaker of recognized quality. These changes are not difficult to make, and aside from the physical aspects of mounting the output transformer, should be completed in an hour's time.

Recommended Changes

The most important change is the replacement of the output transformer. The new unit may be mounted on the chassis directly, or upon the speaker mounting bracket—the latter being somewhat simpler but restricting the size of the transformer used. Two different circuit arrangements have been used in the experimental changes, with comparable results from either method.

Referring again to Fig. 1, it will be noted that the output of the discriminator feeds the volume control through R_{236} and C_{205} . The capacitor C_{206} isolates the volume control from the grid of V_{108} , permitting the use of a 10-meg grid resistor across which the contact potential bias is developed. C_{207} in the

**Response ± 2.5 db, 40 cps to 15 kc.,
Output -46 db.**

**Broadcast Engineers Helped Design it!
Network Shows Use it!**

Now Compare it with Any in Your Studios!

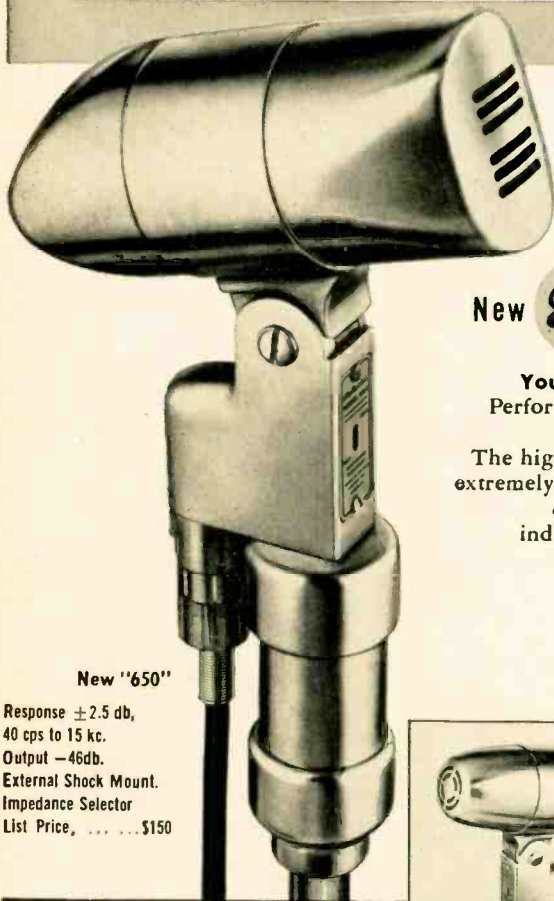

New **E-V** High Fidelity Broadcast Dynamic

You've wanted microphones like these!
Performance meets the highest FM and AM broadcast standards. The bass end is smooth and flat. The highs are particularly clean and peak-free. Construction is extremely rugged and shock-resistant. Has E-V Acoustalloy diaphragm. Omni-directional. Each microphone individually laboratory calibrated and certified. Try one. Compare it with any mike in your own studios.

Write for full facts today!

Electro-Voice

ELECTRO-VOICE, INC., BUCHANAN, MICHIGAN
Export: 13 E. 40th St., New York 16, U. S. A. Cables: Arlab

New "650"
Response ± 2.5 db,
40 cps to 15 kc.
Output -46db.
External Shock Mount.
Impedance Selector
List Price, \$150

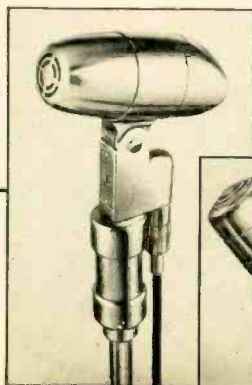

New "645"
Response ± 2.5 db,
40 cps to 15 kc.
Output -50 db.
External Shock Mount.
Impedance Selector.
List Price \$100



The "635"
Response ± 2.5 db,
60 cps to 13 kc.
Output -53 db.
Impedance Selector.
For Hand or Stand.
List Price \$60

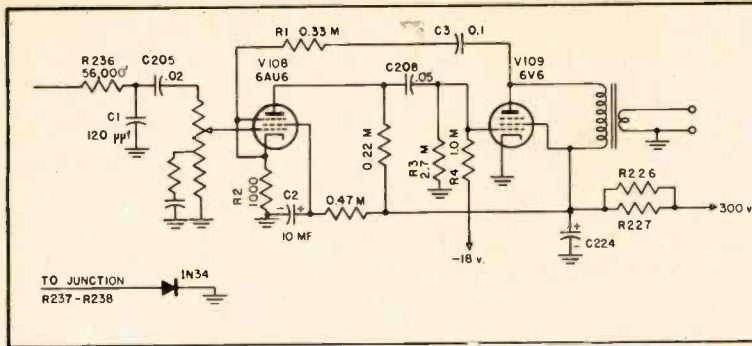

Fig. 2. Recommended changes, using feedback from plate of output stage.

of the order of 60 ohms should be mounted on the left apron of the chassis, approximately under the 1B3/8016 rectifier tube. The leads from this choke should be connected directly to the two terminals on the filter capacitor (C_{221} in the complete schematic) and permitting the removal of the leads to the tie point located adjacent to V_{109} . This leaves two connection points for the components in the feedback circuit used in Fig. 2, as well as for the additional filter capacitor C_2 in the screen circuit of V_{108} . All the connections should be removed from V_{108} except the leads to terminals 3 and 4. Connect a 1000-ohm resistor R_2 from terminal 7 to ground, and strap terminals 2 and 7 together. The plate and screen resistors should be connected to terminals 5 and 6 respectively, with the other end being connected to terminal 4 of V_{109} . An extra lead is run from the screen (terminal 6) to the tie point, and a 10- μ f, 450-volt electrolytic capacitor C_2 is then connected between this lead and ground.

Using the circuit of Fig. 2, C_3 is connected from the plate of V_{109} to the remaining tie point, and the 0.33 meg resistor R_1 from this point to terminal 2 of V_{108} . The capacitor C_{208} is connected directly between the sockets, and the 2.7-meg resistor R_3 runs from terminal 5 of V_{109} to ground. The 1.0-meg resistor R_4 goes in place of the old R_{225} (0.27 meg).

The Fig. 3 arrangement is somewhat better when the output transformer is not of top quality, since the transformer is included in the feedback loop. It will require some care to make sure of selecting the correct polarity, however. Make a temporary ground connection to one side of the transformer secondary, and with a signal passing through the set, momentarily connect the feedback resistor R_5 to the other output lead. If the output is reduced, correct polarity is indicated and the connections may be made permanent. If not, reverse the connections to the trans-

former secondary. The values specified for the feedback resistor will give approximately 17 db of feedback, which will ensure a signal output of essentially the same value as in the original circuit.

The output transformers chosen for the two tests were both intended for a 5000-ohm plate load, and both had a number of output impedances. In one instance, a cased transformer was used, and it was mounted directly on the chassis with the terminals up. A shielded pair was used for the plate and B+ leads. To mount the transformer on the chassis in this fashion—assuming that the set is in finished form—the r-f unit must be removed. This is an operation which must be performed with care, and in general is not recommended. If the set is being assembled from a kit, the mounting of the transformer may be made before the r-f unit is installed, and a more workmanlike job is ensured. For the complete receiver, however, it is simpler and safer to mount the new transformer on the speaker bracket.

One additional change is recommended to provide more filtering for the output stage, desirable because of the improved low-frequency response. This involves removing the resistors

R_{226} and R_{227} from their present connection to C_{220} , and reconnecting them to the lug marked with a square on C_{225} , directly below C_{224} when the chassis is in the normal position.

With these simple changes, the set is comparable to any good FM receiver with respect to quality of reproduction, and increased entertainment pleasure is sure to be had. The 630—already recognized as a reliable picture receiver—takes its place with the most expensive TV console. The 8TS30 is nearly identical, and has the filter choke already installed, since this chassis employed a PM speaker. Obviously, similar changes may be made on any table model TV receiver with the assurance that the inherent quality of FM transmission is there—and that an improved audio channel is all that is necessary.

Book Review

Radio Components Handbook. Cloth bound, 6 x 9, 211 pages. Technical Advertising Associates, Cheltenham, Pa. \$2.50.

A new type of handbook which, while intended primarily for the radio receiver designer, is full of much useful data that should be familiar to anyone interested in radio and audio design. The general problems of commercial design are treated in a way not common to the usual engineering handbook, but with the point of view of the engineer working for a radio manufacturer. Thus the book does not provide the exact design procedure for circuits and equipment, but will serve to introduce the reader to another aspect of the radio field.

This handbook covers general design, transformers (both audio and power) r-f transformers, capacitors of various types, resistors, insulating materials, speakers, switches, and tubes and metallic rectifiers. Among the interesting treatments will be found the methods of choosing the correct component for a specific application, what specifications are important and why, how to design circuits for minimum cost, and numerous other design data.

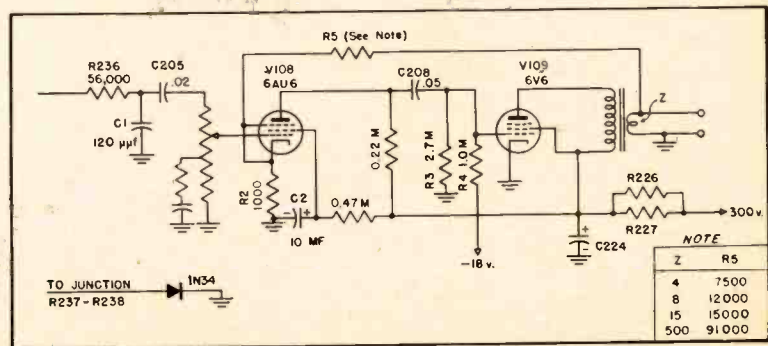

Fig. 3. Circuit used when it is desired to include the output transformer in the feedback loop.

REEVES
Soundcraft
10 EAST 52nd STREET • NEW YORK 22
RECORDING DISCS

"The Standard of the Broadcasting and Sound Recording Industry"



"If it's an ELECTRICAL TRANSCRIPTION
... Chances are it's a SOUNDCRAFT DISC *"*

RECORD REVUE

Hindemith, *Nobilissima Visione* (St. Francis).
1937.

Philadelphia Orchestra, Ormandy.

Columbia MM 847 (3)

Hindemith, *Symphonic Metamorphosis* on
Themes of Carl Maria von Weber. 1943.
Cleveland Orchestra. Szell.

(No 78-rpm album yet)

Both of above: Columbia LP: ML 4177

• This department has already spent a lot of space explaining why musicians use fancy names for simple things—perhaps it had better be admitted right now that one reason is simply that they *like* fancy names: i.e., they're only human. Witness the sage Mr. Hindemith, who has practically guaranteed a negative reaction to his two big orchestral works, above, by giving them such fabulous handles!

For, if you can get yourself past those forbidding monickers, you're likely to find a good deal of pleasure in listening to these works, if you are even the slightest bit attuned to music of Today, including, of course, jazz and what-not. The *Nobilissima Visione*, the *Most Noble Vision*, comes from the score of a ballet concerning St. Francis, and it is not unlike the quite popular "Mathis der Maler" ("Matthias the Painter") score of Hindemith, similarly put together in 1934 from the score of an opera. In "Mathis," now available in two different recordings and on All-Three Speeds, the final movement is the *Temptation of St. Anthony*, and here too is a similarity of theme, a different Saint. This is big, dignified music, dissonant but not noisy and harsh by any means; it has plenty of orchestral color and expression for the ear trained in Tchaikowsky and Brahms. Recording is up to the usual Philadelphia standard; the orchestra sounds huge and in that large sound a good deal is lost or blurred. Perhaps that's as it should be.

As to the *Symphonic Metamorphosis* on Themes of Carl Maria von Weber (Phew!), you are likely to find the surprise of the month, and perhaps the best All-Around Recording, too. Maybe Carl Maria was the most German of all early 19th century German Romantics. Maybe Hindemith did use his themes—and Hindemith, too, is noted for his Germanity, so to speak. The program notes on the record don't give you any other idea than the title itself—that here is a very German, very scholarly (or why so much Latin?) exposition and development, probably full of fugues and what-not.

It is. The second movement (2nd cut) is a fugue—with a fine jazz theme in a very low-down trumpet, plus as snazzy a percussion section as you'll find in any local dive. It's that kind of fugue. It's that kind of piece, most of the way through, Weber or no Weber. American as all get-out.

My own private explanation for this is simple. Hindemith, in 1943, simply went

*279 W. 4th St., New York 14, N.Y.

EDWARD TATNALL CANBY*

American—after all, he was in this country and still is. The "Metamorphosis" title would seem to me to be an ingenious screen of pseudo-long-hairedness, behind which Mr. H. proceeded to show what he had learned about the U.S.A. and its music! This score is utterly unlike anything else I've ever heard of H., and if you think you know your Hindemith you had jolly well better try it out. Moreover, not only does it have a highly colorful orchestration of brass, percussion, everything a hi-fi fan likes, but the recording itself is out of this world, considerably better than that of the Philadelphia in the "Nobilissima Visione." And this is one of those quite rare LP's where almost everything is undistorted, only a few of the loudest squawks being on the fuzzy side. Try it.

Vaughan Williams, *Symphony #6* in E minor.
New York Philharmonic, Stokowski.

Columbia MM 838 (4)

• While we're at it, here's another important contemporary piece that will be very easy listening for most. V.W. is England's elder statesman of music. He never was what you might call a "modernist" and his music today is conservative; but what counts in music is not radical or conservative tendencies (so many of us think that), but content. Music, we sometimes forget to remember, has laws of construction and logic that are as reasonable, when you get into them, as those of drama or the novel or the mystery story. The stuff has to fall together in a shape to be consistent; there must be no irrelevant material, however luscious and tempting it may be on its own, however descriptive or atmospheric or stirring. Vaughan Williams, while inclined towards the "Gone with the Wind" category in the way of size, writes good, consistent music. This symphony, conservative in tone, was written during the recent war, and the agony of emotion which it expresses is likely to hit you at once. Behind that agony, though, is the excellent craftsmanship that puts Vaughan Williams (that's his *last* name—his first is Ralph) in a class well above some of our other symphonists who also can muster a wicked orchestra and paint some pretty gory war scenes with it. There's no wise cracking in this music, little humor, no jazz at all. But some pretty fine stuff, of the serious sort.

Respighi, *The Pines of Rome*. 1924.

Cincinnati Symphony, Goossens.

RCA Victor DM, WDM 1309 (2)

• While the shouting continues over 33 vs. 45, don't overlook some good things in the way of music that may slip past you in

the excitement—for example, this album from RCA. It is technically, I suppose, "contemporary" music but you won't think of it as that when you hear it. Respighi was, at least in 1924, a real old-fashioned neo-Impressionist (though he later had a change of heart and managed to write some pretty dissonant stuff before he died). The "Pines" is highly colored descriptive music, comparable to the better known "Fountains of Rome" in the same series of tone poems. Its biggest claim to notoriety, however, was and is the inclusion of the actual song of a live nightingale, recorded, as part of the score. Since the music dates from 1924 we can at this point wonder what the original nightingale on wax sounded like—probably there was a nice old-fashioned morning glory acoustic machine stuck in the middle of the orchestra! Judging from the scoring of the music at this famous passage, it must have been a pretty feeble sound—Respighi writes a kind of faint, shimmering background of strings and a pluck or two from the harp, against which a bullfrog or even a katydid would sound like thunder, let alone a nightingale! In this new recording the nightingale has quite obviously been refurbished. Sounds like a wide-range one to me. Might come straight from one of those tricky water whistles; or maybe from a clever vaudeville-style technician, one of those people who can imitate twenty birdcalls simultaneously. (After all, how about Baby Snooks?) But then, I'm no birdologist—ornithologist, if you will. Maybe it *is* a nightingale, mike-happy. Sounds good anyhow. The rest of the music makes a lot of fine noise, but it leaves me definitely bored.

Rimsky-Korsakov, "Antar" (*Symphonic Suite*).

The Cleveland Orchestra, Leinsdorf

Columbia LP: ML 2044 (1 10")

• This is music for those who have been playing that LP of the "Scheherazade" Suite until it's worn out. Same type of stuff, with the special difference that this is unfamiliar, whereas "Scheherazade" is hardly that. The recording, on LP, is good but, on my equipment at least, it tends to that buzziness in the loud parts which is so often found in the Columbia product as played on magnetic pickups, wide-range. Nevertheless, an interesting comparison, musically and technically, with the earlier disc. (Incidentally, I have met the man who made the recording—Scheherazade just mentioned—with the barking dog in the final measures of side 2. It was a dog. He even knows what dog. But that's about all I could get out of him. Hush-hush. It was a French poodle, that much I did get.)

Mozart, *Symphony #35* ("Haffner").

Pittsburgh Symphony, Reiner.

Columbia MM 836 (3)

LP: ML 4156 (1/2)

• The most often heard version of this

[Continued on page 49]

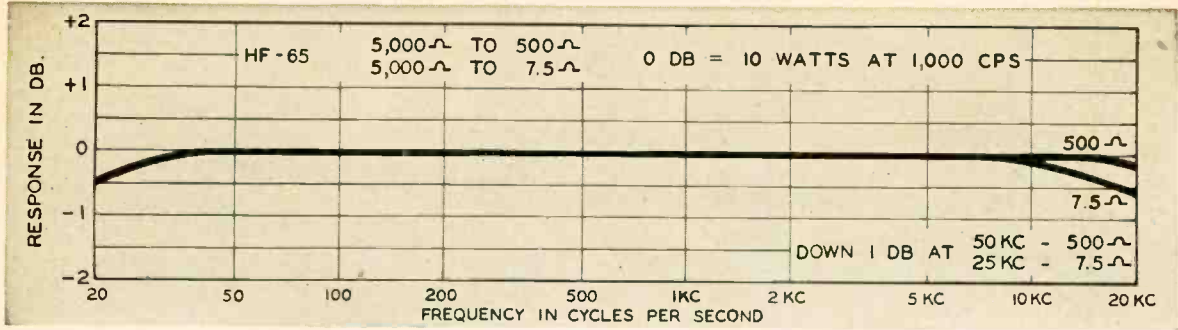

For Critical Audio Requirements...

STANCOR "HF" SERIES TRANSFORMERS



STANCOR "HF" series high fidelity transformers are premium quality components, designed to satisfy the most exacting demands of audio engineers and service technicians. Their advanced design enhances the performance of the finest amplifier circuits, speakers, microphones and pickups.

CHECK THESE "HF" QUALITY FEATURES

- ✓ Guaranteed response, within ± 1 db, from 20 to 20,000 cps.
- ✓ High permeability shielding for minimum inductive pickup.
- ✓ Balanced multiple line matching available.
- ✓ Special coil design for low leakage inductance and distributed capacity.
- ✓ Precision hum-bucking construction on low level units.

Part Number	Application	Primary Impedance in Ohms	Secondary Impedance in Ohms	Response ± 1 DB From	Max. Pri. DC Unbalance	Max. Level	*Hum-Pickup Reduction
LOW IMPEDANCE TO GRID							
HF-20	Low Impedance Microphone, Pickup or Multiple Line to Grid	50, 125/150, 200, 250, 333, 500/600	60,000 ohms overall, in two sections	20 to 20,000 cps	0.5 ma	15 db	-74 db
HF-20X	Low Impedance Microphone, Pickup or Multiple Line to Grid	50, 125/150, 200, 250, 333, 500/600	50,000 ohms	20 to 20,000 cps	0.5 ma	14 db	-92 db†
HF-22	Low Impedance Microphone, Pickup or Line to P.P. Grids	50, 125/150, 200, 250, 333, 500/600	120,000 ohms overall, in two sections	20 to 20,000 cps	0.5 ma	15 db	-74 db
HF-22X	Low Impedance Microphone, Pickup or Line to P.P. Grids	50, 125/150, 200, 250, 333, 500/600	80,000 ohms overall, in two sections	20 to 20,000 cps	0.5 ma	14 db	-92db†
INTERSTAGE							
HF-29	Single Plate to P.P. Grids—2A3, 6A3, 6L6, etc.	15,000 ohms	95,000 overall 1.25:1 each side	20 to 20,000 cps	.0 ma	17 db	-50 db
HF-31	Single Plate to P.P. Grids, Split primary and secondary	15,000 ohms	135,000. Turns ratio 3:1 overall	20 to 20,000 cps	.0 ma	14 db	-74 db
HF-32	P.P. Plates to P.P. Grids, Split primary and secondary	30,000 Plate to Plate	80,000 Turns ratio 1.6:1 overall	20 to 20,000 cps	0.25 ma	26 db	-50 db
MIXING							
HF-40	Low Impedance Mixer, Microphone, Pickup or Line to Line	50, 125/150, 200, 250, 333, 500/600	50, 125/150, 200, 250, 333, 500/600	20 to 20,000 cps	0.5 ma	17 db	-74 db
OUTPUT							
HF-65	P.P. 2A3, 6L6, etc. to Line or Voice Coil	3,000 to 5,000 Plate to Plate	1.2, 2.5, 5, 7.5, 10, 15, 20, 30, 50, 125, 200, 250, 333 or 500	25 to 20,000 cps	5.0 ma	20 watts
HF-67	P.P. 2A3's, 6A5-G's, 300A's, 275A's, etc. to Voice Coil	3,000 or 5,000 Plate to Plate	30, 20, 15, 10, 7.5, 5, 2.5, 1.2	25 to 20,000 cps	5.0 ma	20 watts
HF-68	P.P. Par. 2A3's, 6A5-G's, 300A's, 6A3's to Line or Voice Coil	1,500 or 2,500 Plate to Plate	500, 333, 250, 200, 125, 50, 30, 20, 15, 10, 7.5, 5, 2.5, 1.2	25 to 20,000 cps	5.0 ma	40 watts

*As compared to standard uncased units. †Quadruple alloy magnetic shield.

WE WELCOME COMPARISON, under identical test conditions, of Stancor "HF" units with equivalent types of any other brand of high fidelity transformer, regardless of published claims. Frequency response curve charts sent on request.



For complete information on the Stancor "HF" series and the smaller "WF" units, see your Stancor radio parts dealer or write for the 1949 Stancor catalog A, listing over 400 transformers and related components for sound, radio and television.

STANDARD TRANSFORMER CORPORATION
ELSTON, KEDZIE & ADDISON, CHICAGO 18, ILLINOIS

NEW PRODUCTS

• **Tube testing** is a necessity for any user of vacuum tubes, and for both laboratory and service applications the recognized optimum test method is that of the dynamic mutual conductance of the tubes operated under test voltages approximating those encountered in normal use. A new lightweight portable tester, Model 600, is offered by Hickok under the classification of "technicians" model. This instrument, with self-contained power supply, provides direct reading mutual conductance measurements with ranges of 3000, 6000, and 15,000 micromhos. For complete information, write H. D. Johnson, The Hickok Electrical Instrument Co., 10617 Dupont Ave., Cleveland 8, Ohio.

• **Sound effects consoles** are usually the results of a combination of apparatus which is added from time to time as the occasion arises. Not so the unit recently announced by Gray Research and Development Co., Inc., 16 Arbor Street, Hartford 1, Conn. This console is a complete instrument with all the necessary features already added.

The new Type 352C unit is especially useful for television work, since the sound effects engineer is playing an increasingly more important role, and his equipment must be extremely versatile. Three turntables, each continuously variable from 10 to 130 rpm, are mounted on the console, with four tone arms so arranged that the two center arms may be used on either of the two adjacent tables. Each arm is equipped with a "grain-of-wheat" lamp to permit exact placement of

the exposed stylus. Necessary amplifiers, filters, equalizers, and controls are mounted in an easily accessible position, the amplifiers being of the plug-in-type for easy replacement and maintenance. A transparent script rack does not obstruct a view to the stage, and a roll top protects the unit from dust and from dial-twiddlers. Complete information and block schematics may be obtained from the manufacturer.

• **Magnetic recording**, like every other new art, brings with it the need for a number of accessories. Among them are splicers, and a simple unit for making the desirable diagonal butt joint is now available from Magneccessories, Box 6960, Washington 20, D. C. This unit was designed especially for the amateur, but is also satisfactory for the professional where the simplest possible device is desired. It is provided with mounting holes to permit attachment to the recorder near the tape channel.

Also available from the same source is a solution called Visi-Mag, which will deposit finely divided iron on magnetic recording tapes to make the recording visible for checking alignment of heads and for determining defects in head-to-tape contact.

• **Small parts storage** is somewhat of a nuisance to the hobbyist or the occasional constructor, because he is not usually equipped to handle parts of the type employed in radio work—resistors, capacitors, machine screws, lock washers, nuts, soldering lugs, and many others too numerous to mention. Bulletin 520, available from Andrew Technical Service, 4747 N. Damen Avenue, Chicago 25, Ill., describes two different sizes of trays, both 11 $\frac{3}{8}$ " in length and 2 $\frac{3}{4}$ " deep, with widths of 2" and 3 $\frac{3}{4}$ " respectively, which may be combined in a number of forms to provide adequate storage for small parts. These trays are constructed of transparent Polystyrene, with molded index-card slot and a finger pull at the front of each. Four removable partitions make it possible to adjust the trays for parts of varying sizes, and the height and width of the trays is such that they stack in standard metal shelving used in industrial plants.

• A "Dynaaural" system, based upon the famous H. H. Scott Dynamic Noise Suppressor, has recently been introduced as a device in which the band-width is automatically and continuously adjusted to conform to the requirements of the music, thus combining maximum fidelity with minimum noise level. The first unit available is the Type 111-A Dynaural Converter, intended for use with standard amplifiers, phonographs, and combinations, and offered at the lowest price in history for a dynamic noise suppressor.

Operating up to a maximum frequency of 14,000 cps, the device minimizes needle scratch as well as the pops and crackles on plastic records and the rumble from turntable motors. Connections are made quite simply, and a single remote control may be mounted on the panel of the phonograph or on the radio panel, as desired. Further information may be obtained from Hermon Hosmer Scott, Inc., 385 Putnam Ave., Cambridge 39, Mass.

• **Static will again become** an annoyance to record enthusiasts with the winter months. A new product introduced by Walco Products, Inc., 60 Franklin St., East Orange, N. J., is a liquid which, when applied to



Magneccessories



Andrew Technical Service



Hermon Hosmer Scott, Inc.

record surfaces, creates a condition in the record which causes it to discharge any inherent static electricity so that it will no longer attract dust particles. Walco Static Eliminator is applied by spreading a few drops on a soft cloth which is then rubbed over the surface of both sides of a record. Then a follow-up rub with a dry cloth will further spread out an invisible, microscopically thin film (of a thickness of one to 10 molecules) over the entire record surface, which is then immune to static electricity, so that dust may be brushed off easily. Records may be played from 50 to 100 times before another application of the Eliminator is required.

Samples are available from the manufacturer when requested on the letterhead of broadcast stations and large commercial users of phonograph records.

• **Synthetic rubber**—neoprene—is now being used for Sealnuts, a combination mounting and sealing device for toggle switches and control shafts, with the result that greater flexibility is obtained at low temperatures, and greater resistance is offered to sunlight, weathering, and other aging factors.

These devices are used extensively on military, naval, and commercial equipment
[Continued on page 51]



Hickok Electrical Instr. Co.



Gray Research and Dev. Co.

New Polyphase Reproducer System *

Incorporating principles which provide a simple and logical solution of today's problem of high quality reproduction of different types of records and transcriptions—at incredibly low cost.

DESIRE FOR MUSIC springs from the pleasure it can afford. However, one could hardly expect much pleasure from a record that can be played only after changing and shifting of apparatus, back and forth.

To enjoy today's discs (micro, 78 rpm, etc.) requires a single pickup unit capable of delivering such quality performance as would be delivered by two or more separate high grade magnetic reproducers—each designed expressly for a given type of recording.

The new AUDAX Reproducer,—pre-

sented herewith,—*will do just that.*

This new AUDAX is perhaps the most important and revolutionary advance since the advent of the electronic pickup itself,—back in 1926. Yet,—remember,—its cost to you is *less than the cost of ordinary pickups.*

Your admiration will be aroused when you see and hear the way this remarkable instrument works.

You will know,—this new AUDAX performs important functions that no other unit does,

You will know,—this new AUDAX

is the very type of instrument you so long wanted, but thought impossible of development.

You will know,—this new AUDAX constitutes the complete answer to your reproducer problem.

You will know,—this is the logical instrument for YOU—whether you play one type or several types of discs.

When you learn that, with all its unprecedented accomplishments, this new AUDAX costs less than ordinary pickups,—you too will say:

"Yes, this is IT!"

Wide range performance with any type disc • Point pressure about 7 grams • Genuine sapphire styli (or diamonds if desired), replaceable individually by the user himself • Output about 30. m.v. • High or low impedance • Needle radiation very, very low • Ear quality *par excellence*

Write for complimentary **EDITORIAL REPRINT** describing polyphase principles

There is an AUDAX model to suit every purpose

Also available for Radio Stations:—

*This is the answer for which you waited so long. This remarkable reproducer—
—one single unit—will play ALL your discs—superbly!*

There is no substitute for experience. When you are buying a motor car, washing machine or refrigerator, almost instinctively you evaluate the experience of the manufacturer behind the product. Has he the all-important KNOW-HOW to justify your implicit confidence? In no other field is this KNOW-HOW more important than in the field of Electronic Sound Apparatus, where AUDAX has set the pace for more than twenty-five years.

* Pat. Pend.

Visit us at the N. Y. Audio Fair, Oct. 27-28-29

AUDAK COMPANY

500 Fifth Avenue

New York 18, N. Y.

"Creators of Fine Electro-Acoustical Apparatus Since 1915"

Techni-Briefs

Measuring High-Resistance Values

UNTIL RECENTLY, the average audio engineer has not had much contact with resistors of the order of more than ten megohms in the general run of his work. However, with the re-entrance of the condenser microphone and the attendant high input resistance of that device, resistors of the order of 100

megohms are finding their way into the audio facilities of the up-to-date sound installation.

Then too, ambitious scientists are branching into nuclear work, if not as a vocation, at least as an avocation. Here the needed resistors are best expressed as a higher power of tens of

megohms, and it is not unusual to find resistor values of 5×10^{11} ohms in such installations.

A suitable method of measuring these components with a degree of accuracy of better than ± 5 per cent is needed, and is indeed simple to accomplish by the method to be described. All that is necessary is a source of comparatively high voltage and a vacuum-tube voltmeter, such as the RCA VoltOhmyst, Model 195-A, or its equivalent. A word of caution should be inserted here—this is a decidedly dangerous procedure, and is to be undertaken only with due caution, commensurate with the high voltages employed. Such a system can produce a lethal shock, if not treated with proper caution and respect.

Figure 1 shows the general procedure for making the tests. E_s represents a source of high-voltage direct

Unique Audio Instruments

Our work is concentrated in fields involving new methods or unusual techniques.

These have been used to give improved performance at reduced cost.

THE BRIDGER

MODEL 100: For bridging measuring instruments across any part of an audio circuit through shielded cable without appreciable loading. Cable capacitance almost completely balanced out by use of improved cathode follower and special double-shielded cable. Input impedance is 100 megohms in parallel with 6 mmf at end of 3-foot shielded cable.

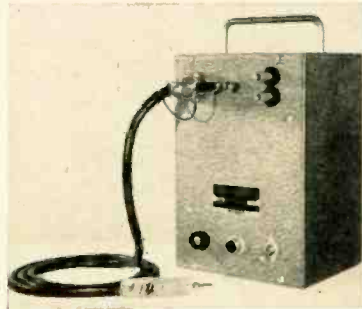

MODEL 121 LOGGER

Logarithmic voltmeter with 50 db linear meter scale; output may be used to feed direct writing recorder (via a suitable amplifier) for acoustical reverberation tests. Input impedance—50,000 ohms; output impedance—1000 ohms.



MODEL 140 DISC-NOISE METER

Overload-proof amplifier voltmeter for quality control of lacquers, phonograph records, transcriptions. New stable logarithmic element. 20-db linear meter scale. Minimum reading 75 db below 7 cm/sec. velocity with pickup cartridge supplied.



Miniature Preamplifiers for use with 640AA Condenser Microphone

MODEL 12: High gain, operates VTVM directly at normal room sound levels. Output: —40 dbm for 1 dyne/cm². Output Z: 250 ohms, balanced. Size: 10" long x 1 1/4" diameter. Lower power drain. Available with insert calibrating resistor on special order.

MODEL 14: Medium gain for general broadcast and recording use, also to operate VTVM directly at sound pressures used in receiver testing. Output: —55 dbm for 1 dyne/cm². Output Z: 250 ohms, balanced. Size: 6 1/2" long x 1 1/4" diameter. Low power drain. Available with insert calibrating resistor on special order.

Both models also available with nose piece dimensions modified to fit Kellogg Miniature Condenser Microphone.

Write for further information and prices. Our complete catalog of audio instruments is now ready.

AUDIO INSTRUMENT COMPANY

1947 Broadway

New York 23, N. Y.

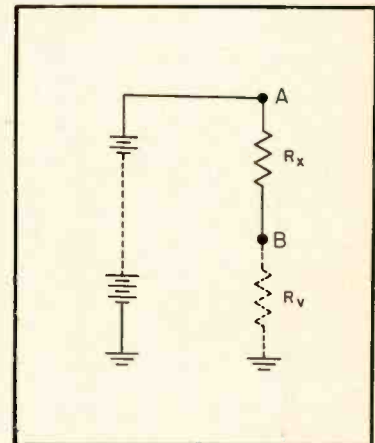

current, a suitable value for which can be chosen from the suggested values in Table I for the approximate value of the resistor under test. R_x is the un-

TABLE I

Resistance to be measured	Power Supply Voltage
100 megohms	100 volts
10,000 "	500 "
50,000 "	2,000 "
100,000 "	5,000 "
500,000 "	10,000 "

known resistor, and R_v is the input resistance of the particular v-t voltmeter, including both the resistance of the probe and that of the instrument itself as a lumped figure.

Proceed as follows: Measure the

voltage of the power supply at point *A*, taking the necessary precaution to use a sufficiently large probe resistor so as not to exceed the rating of the voltmeter. Then measure the voltage at point *B*—that is, with the unknown resistor in series with the present probe. Then, calling the two voltages *E_a* and *E_b* respectively, the value of the unknown resistance *R_x* is given by the formula

$$R_x = \frac{E_a - E_b}{E_b} R_r$$

where *R_x* and *R_r* are both expressed in megohms.

In the absence of a high-resistance probe for making measurements of the high voltages required for these tests, it is not too difficult to make such a needed adjunct to a v-t voltmeter. A probe suitable for adapting the RCA 195-A to measure with a full-scale value of 5000 volts needs only a 41-megohm resistor, which may be had to an accuracy of ±1 per cent, which is more accurate than that claimed for the instrument itself.

The formula used to determine the resistance required for a high-voltage probe can be expressed as follows:

$$R_p = (N - 1) R_r + r_p$$

where *R_p* = the resistance of the new probe;

N = the number of times the maximum voltage range is to be increased;

R_r = the input resistance of the v-t voltmeter including the normal probe; and

r_p = the resistance of the normal probe supplied with the instrument.

All resistance values are expressed in megohms.

With these simple directions, it will not prove difficult for the most uninitiated to measure the highest useable resistance. The same technique can be used, of course, to measure insulation resistance of cables, winding-to-winding and core-to-winding resistance of transformers, and for similar high-resistance measurements. Such measurements can be considered to be better than ±5 per cent, since they do not depend on the accuracy of the v-t voltmeter itself because the readings are purely comparative and are made by the same instrument and usually on the same scale. It is necessary that the readings be taken with reasonable accuracy, and that the power source is at least that indicated in the Table I.

Llewellyn Bates Keim
Consulting Radio Physicist
20 E. 74th Street
New York 21, N. Y.

WHY CHOOSE FAIRCHILD FOR TOP PERFORMANCE

Each month you read equipment specifications in the advertising pages of your favorite magazines. Specifications are fine things, but often difficult to interpret in terms of *what the equipment will do for you*. For example, suppose we say that Fairchild Disk Recorders and Transcription Turntables have a time accuracy of 1 part in 4.6×10^6 at 33 $\frac{1}{3}$ rpm; an instantaneous speed deviation of .075%; a noise level of such and such decibels below some stylus velocity at so many cps. Impressive? Sure. And factual, too. But what you want to know is . . . what effect do these specs have on your operations. What is the performance, after the specifications are paid for? Here are the data on Fairchild Recording and Playback equipment, in facts and effects.

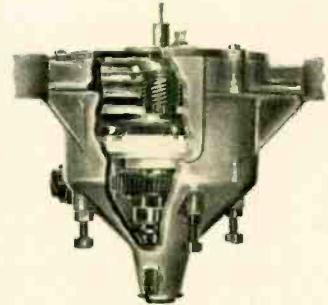

Precision Turntable Drive.
Used in all Fairchild Disk Equipment.

FEATURE	FAIRCHILD EQUIPMENT	OTHER DESIGNS
Type of Drive and Resultant Speed Regulation	Direct to center—gear. Absolute synchronism for use with sound-on-film and on the nose programming. Accurate within .00026 seconds in 20 minute play period at 33 $\frac{1}{3}$ rpm.	Rim drive—puck or pulley. Usual accuracy—6 seconds in 20 minute play period (.5% speed regulation). Does not permit rigid synchronization nor on the nose programming.
Possible time error—record and playback (20 minute disk)	± .00052 seconds	± 12 seconds (based on above)
Instantaneous speed deviation and Effect on audible signal	less than .075% None	approximately .125% <i>Wow</i> usually evident at this figure
Noise and Rumble	Experienced users of Fairchild Equipment claim dynamic range of 62 db.	Dynamic range limited by noise and rumble when wide tolerances are permitted in machining.
Control of cutting pitch (lines per inch)	Studio model: turn knob for <i>continuous</i> and <i>instantaneous</i> pitch change from 80 to over 900 lines per inch. Can be varied at will during the recording. Portable model: insert small gear—no disassembly required—only one feed screw for all pitches.	Portable and Studio models: disassemble lathe mechanism—change feed screw—reassemble lathe mechanism. Or, change pulley ratios.
Overhead cutter assembly	Secured as integral part of turntable deck. Always in positive alignment.	Lift or swing into position. Possibility of cutter misalignment—causing varying depth of cut and incorrect groove shape.
Portable model	Actually a console model in a portable case. Same performance on location as in the studio.	Sacrifices in mechanical design to gain portability further exaggerate inferior performance.
Maintenance	Periodic lubrication of drive mechanism. Always at peak performance—no headache for the owner and operator.	Lubrication, and frequent replacement of puck and pulleys. Continued adjustment necessary to keep speed of turntable up to specifications.

Fairchild specializes in LIP SYNCHRONOUS recording and playback equipment for SOUND-ON-FILM, TV PRODUCTIONS, and all such installations requiring laboratory standard performance. Write for full details.



Fairchild
RECORDING EQUIPMENT CORPORATION

WE'RE
AT THE
AUDIO
FAIR
ROOM 653

154TH ST. AND 7TH AVE. WHITESTONE, L. I., N. Y.

Floating Action!

for all TV Cameras

"BALANCED" TV TRIPOD

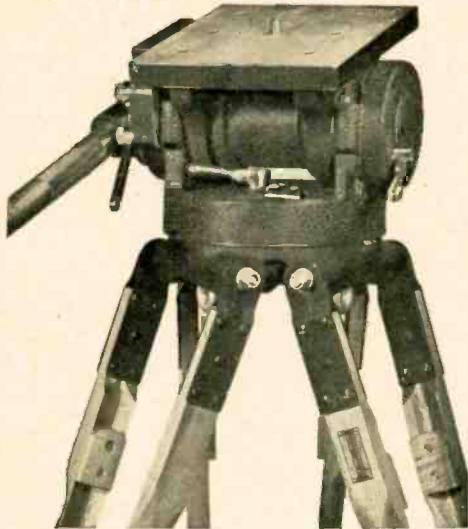

Pat. Pending

This tripod was engineered and designed expressly to meet all video camera requirements.

Previous concepts of gyro and friction type design have been discarded to achieve absolute balance, effortless operation, super-smooth tilt and pan action, dependability, ruggedness & efficiency.

Below:

3 wheel portable dolly with balanced TV Tripod mounted.

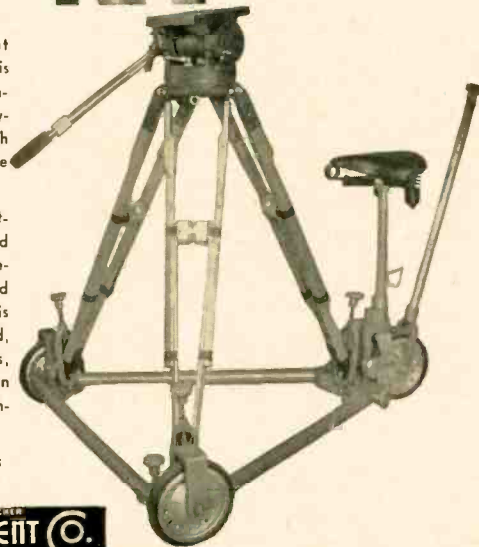

Complete 360° pan without ragged or jerky movement is accomplished with effortless control. It is impossible to get anything but perfectly smooth pan and tilt action with the "BALANCED" TV Tripod.

Quick-release pan handle adjustment locks into position desired by operator with no "play" between pan handle and tripod head. Tripod head mechanism is rustproof, completely enclosed, never requires adjustments, cleaning or lubrication. Built-in spirit level. Telescoping extension pan handle.

Write for further particulars

CAMERA EQUIPMENT CO.
FRANK L. ZUCKER
1600 BROADWAY NEW YORK CITY

AUDIO FREQUENCY MEASUREMENTS

[from page 16]

put of the equipment under test as shown in Fig 2. This method has several advantages. The meter scale range, absolute sensitivity, and possible variation in accuracy with indication are not factors in the choice of meters used. Possible observational errors due to the use of meter-range switches are eliminated. The amount of calculation to obtain the desired result from observed readings is minimized. Further, this arrangement has the merit that known input and output levels over a wide range of values can readily be provided. This is of particular practical importance if the same testing equipment is to be used to measure a wide range of gains and losses and various power levels.

The increments of attenuation available and the accuracy of their calibration together with the scale sensitivity and accuracy of the meters used governs the accuracy with which absolute gain can be determined. Response (relative gain) measurements require absolute accuracy so that relative gains are indicated within the desired limits of precision. A total measuring error of ± 0.2 db from all causes is the order of precision required for frequency response (relative gain) measurements on equipment for broadcasting transmission. This limit includes frequency response errors in the attenuators. These may ordinarily be avoided by careful attenuator design. Failing this, recourse to calibration is possible. In some instances, particularly in attenuator network arms of low resistance values, contact resistance in switches may introduce errors. Careful design and proper maintenance of the switches will minimize this difficulty. The adjustable attenuators should preferably be mounted in a shielded enclosure. This precaution minimizes the possibility of errors due to parasitic capacitances to external surroundings, which become increasingly troublesome with increasing frequency.

Impedance Matching Networks

The calibrated adjustable attenuators will have fixed input impedances determined during design. If the impedances from and into which it is desired to measure the equipment under test are other than those of the attenuators, it is necessary to add impedance matching networks. These ordinarily can be fixed pads. The addition of such pads to the testing circuit is shown in Fig. 6. The determination of the values of such pads is well

NEED BACK ISSUES?

Only a few are available and
the supply is limited

- | | | |
|---|--------------------------------------|-------------|
| <input type="checkbox"/> August 1948 | <input type="checkbox"/> March 1949 | 1948 issues |
| <input type="checkbox"/> September 1948 | <input type="checkbox"/> May 1949 | 50c |
| <input type="checkbox"/> November 1948 | <input type="checkbox"/> June 1949 | 1949 issues |
| <input type="checkbox"/> December 1948 | <input type="checkbox"/> August 1949 | 35c |

Payment should accompany order.

Circulation Dept., Audio Engineering, 342 Madison Ave., New York 17, N. Y.

covered in extant literature.^{9 10} However, Fig. 7 is included to summarize information for determining such pads as well as "equality impedance" fixed pads, which may be useful to supplement the adjustable attenuators. It should be noted that the "zero resistance" arm of the minimum loss matching pad is always toward the smaller of the two terminating impedances and that there is only one possible value of loss for such pads if both input and output are matched.

The power handling capacity of the resistors used in pads may also require consideration on occasion. For example, when measurements are made on an amplifier for a high-powered sound system, an output pad might well be used to reduce the power to normal measuring level, and the difference between the power out of the amplifier and that in the meter circuit would be dissipated in the pad.

Ordinarily one per cent accuracy will be adequate for the values of the resistors used for pads. However, the required accuracy (or alternative calibration of actual loss) will be governed by the accuracy desired in absolute gain indication. In addition, freedom from change of attenuation with frequency or calibration for such change of loss is also a necessary consideration.

In connection with the use of both adjustable attenuators and fixed pads, whether for impedance matching or to supplement limited range adjustable attenuators, it should be noted that Thevinin's Theory may be applied to reduce the input and the output networks to the equivalent of a generator in series with a resistance.

Balance and Grounding

For measured results comparable to actual performance conditions, the equipment under test should be grounded in the same way for measurement as it is in actual use. In particular, the grounding or freedom from grounding of the input or output or both should be maintained. Among the practical problems which this introduces are, first, the balance of attenuators (both fixed and adjustable), and second, the control of oscillator grounding.

The attenuators, including those for impedance matching, should be of the unbalanced type for connection to a grounded circuit and of the balanced type for connection to circuits intended for ungrounded operation or with a "center-tap" ground. When using an unbalanced measuring circuit one side should always be grounded. The term "ground" is used here as meaning that zero potential plane is used for reference. The impedance to ground for all points on the grounded side should



A DYNAMO AMONG DYNAMIC MICROPHONES

Here is *the* microphone in its class—a high-output moving-coil dynamic that was designed to outperform... outsmart... outlast even higher priced microphones. The "Sonodyne" features a multi-impedance switch for low, medium, or high impedance—plus a high output of 52 db below 1 volt per dyne per sq. cm. It has a wide range frequency response (up to 10,000 c. p. s.) and semi-directional pickup. Mounted on swivel at rear, can be pointed 90° for non-directional pickup.

The "Sonodyne" is ideal for all general purpose use, including public address, communications, recording, and similar applications.



Multi-Impedance
Switch for
**LOW, MEDIUM,
or HIGH**
Impedance

HIGH OUTPUT
(-52 db)



**WIDE RANGE
FREQUENCY
RESPONSE**
(up to 10,000 c. p. s.)

Shure Patents Pending

SHURE

MODEL "51"

CODE: RUMON

LIST PRICE . . . **\$39.75**

SHURE BROTHERS, INC.

Microphones & Acoustic Devices

225 W. HURON ST., CHICAGO 10, ILL. • CABLE ADDRESS: SHUREMICRO

STEPHENS TRU-SONIC

Model 409 Separate 2-way Speaker System — 800 Cycle Crossover

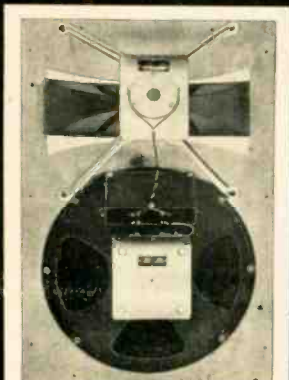

Rear View: Components sold mounted on properly designed baffle for 6 cu. ft. enclosure.



Front View: Showing manner in which HF horn exhausts through base port to conserve space.

For the custom builder who has the space required for a higher fidelity speaker installation, the Model 409 2-Way Components present the opportunity for smoother, extended response than that which is available from conventional and coaxial speakers. The price is comparable, your price being only

\$120⁰⁰

Specifications

Crossover frequency with Model 800X-2 Dividing Network, 800 cps; Cone resonance in free space, 41 cps; Uses Model P-52LX Low Frequency Driver, 4½ pounds Alnico V magnet; Model P-15 High Frequency Driver. Frequency Response of System is ± 5 db to 14,000 cps; Input impedance 10-20 ohms; Input power 20 watts. Size: 18" w. x 27" h. x 14½" d. Weight, 40 pounds.

STEPHENS

Manufacturing Corporation

TRU SONIC

8538 Warner Dr., Culver City, Calif.

GRAY

BETTER REPRODUCTION FOR BROADCASTING —

GRAY TRANSCRIPTION TURNTABLE 304T with exclusive RECORD LIFT

The Gray Transcription Turntable 304T assures you virtually perfect reproduction with 78 rpm or 33 ½ rpm transcriptions. It features . . .

- Absolute synchronism at 78 and 33 ½ r.p.m.
- Instant speed change
- Single control for starting and speed change
- Filters building vibrations
- Record Lift lever-operated
- No record slipping, flutter, wow
- Record Lift guarantees exact timing
- Maximum simplicity and SPEED of operation

Mounted in all metal cabinet 27" square. Price **\$450** f.o.b. Hartford (Pickup, Equalizer, casters extra)

GRAY STYLUS FORCE GAUGE 901

Preserve your record library. Check stylus force with this new gauge. Accurate to grams. As simple as it is important to use!

Please ask for descriptive bulletins.

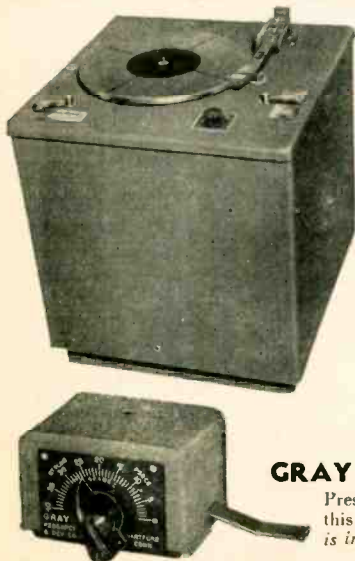

THE GRAY RESEARCH & DEVELOPMENT COMPANY, Inc.
16 ARBOR STREET • HARTFORD, CONN.

be as low as possible, the interconnecting leads should be as short as possible, and no series resistors included in the ground circuit. For example, the generalized pads of Fig. 7 should have their series resistors in the ungrounded side of the circuit. A properly balanced attenuator requires both resistance balance between the two sides of the attenuator and capacitance balance to ground on the two sides. The latter is ordinarily provided by the proper design of the calibrated adjustable attenuator switches. A ground at the center point of the shunt resistance element of the attenuator is usually necessary to insure balance in actual use. Tests to determine the adequacy of the balance (assuming freedom from parasitic coupling) may be made by reversing the connections either to the input or to the output of the attenuator in question and observing whether the output is affected due to such reversal, particularly at the higher audio frequencies. An alternative arrangement to the use of balanced attenuators is the use of an electrostatically shielded and balanced transformer between the attenuators and the equipment under test as shown in Fig. 8. This necessitates taking into account the loss introduced by such a coil, or coils, and the possible change in loss with frequency-response measurements.

One practical check of the stability of the measuring circuit is to make a known change in the output level from the oscillator with a corresponding change in the input attenuator setting. For example a 10-db increase in test signal level and a 10-db increase in the input attenuator should result in the same input level to the equipment under test and consequently no change in observed output level. This check should preferably be made at a frequency in the higher range of the frequencies to be used for testing.

The oscillator output circuit may be grounded, or even though not grounded may have sufficient capacitance to ground to introduce errors (the usual practical case). Therefore, this circuit must also be considered in conjunction with the input ground. This condition can often be provided for by the use of an electrostatically shielded transformer at the oscillator output as shown in Fig. 3. As the reference input voltage is measured beyond this coil, its frequency-response characteristic does not affect frequency-response measurements. However, it should be borne in mind that such a coil may contribute undue harmonic distortion unless it is chosen to handle the desired oscillator output power adequately. This is of particular importance in making single-frequency har-

monic measurements. The efficacy of an electrostatically shielded transformer is a function of the reduction of effective interwinding capacitance brought about by the shield, which is a function of the transformer design. Effective interwinding capacitance of the order of 15 to 20 μmf is feasible with such a coil having a single electrostatic shield and capable of operating at approximately ten milliwatts power level. This is ordinarily adequate. However, a coil having an electrically separate electrostatic shield around each of the two windings may have an effective interwinding capacitance of less than 4 μmf .

In addition to the transmission circuit grounds, the shields ordinarily required on the interconnecting wiring must be grounded. Such leads, particularly those at the input of the equipment under test, should be as short as possible. In grounding these shields precautions should be taken to make the grounding leads as short as possible and to avoid ground loops. Each shield should be connected at one end only and so grounded that a "radial ground" system results.* This is illustrated in Figs. 8 and 9.

Bridging Gain

A special condition of gain measurement occurs when it is desired to determine bridging gain which has been defined previously as "the ratio, expressed in db, of the power delivered to the bridging amplifier load to the power in the load across which the input of the amplifier is bridged." For this measurement the output of the input attenuator is terminated by a resistance equal to the reference load, and the input of the equipment under test is connected in parallel with this load. Equipment intended for bridging operation will ordinarily have an input impedance which is high relative to that of the circuit on which it is bridged. However, it will still be necessary to take into account the reduction in power in the reference load due to the bridged input for accurate results. Otherwise, the measurement technique does not differ from that previously discussed.

A specific arrangement for measuring the insertion gain and frequency response of a hypothetical system is shown in Fig. 9. For purposes of illustration, it is assumed that the measurements are to be made at a constant output power level of 18 db above .001 watt, the input is grounded on one side and the output operates into an ungrounded circuit. It is further assumed

* While such a ground system will ordinarily be adequate, in certain cases other arrangements may be better as determined by trial or by analysis of the particular case.

Choice of 626 Tubular Resistor Values

IN STOCK

Hundreds of other Stock Types, sizes and values!



**the Variety! . . . the Range! . . . the Quantity!
Ready to Meet Your Needs Quickly!**

More Ward Leonard wire-wound resistors have been produced and used over more years than any other make. And records show that quite often a stock unit as the perfect answer to many an industrial need . . . for application, for performance, for economy, for quick delivery. For example: there are 626 Vitrohm tubular stock values in fixed and adjustable types . . . and many others . . . promptly available! It pays to check into them . . . for your requirements.

Contact your local Ward Leonard
Authorized Industrial Distributor.
Send now for handy

Stock-Unit Catalog D-130

Radio and Electronic Distributor Division

WARD LEONARD ELECTRIC CO.

53-R West Jackson Blvd., Chicago 4, U. S. A.



The sign of a
Ward Leonard
Authorized
Industrial
Distributor

WARD LEONARD

RESISTORS • RHEOSTATS • RELAYS • CONTROL DEVICES

WHERE BASIC DESIGNS ARE RESULT-ENGINEERED FOR YOU

THESE THREE NEW DEVELOPMENTS ARE KEEPING ASTATIC OUT IN FRONT IN THE MANUFACTURE OF PICKUP CARTRIDGES

GC CERAMIC CARTRIDGE



FIRST MAJOR engineering stride in phonograph pickup cartridges employing ceramic elements since Astatic pioneered in this type unit last year. The GC is the first cartridge of its kind with replaceable needle. Takes the special new Astatic Type G² needle—with either one or three-mil tip radius, precious metal or sapphire—which slips from its rubber chuck with a quarter turn sideways. Resistance of the ceramic element to high temperatures and humidity is not the only additional advantage of this new development. Output has been increased over that of any ceramic cartridge available. Its light weight and low minimum needle pressure make it ideal for a great variety of modern applications.

CQ CRYSTAL CARTRIDGE



AN ENTIRELY new Astatic design, featuring miniature size and five-gram weight. Model CQ-1 fits standard 1/2" mounting and RCA 45 RPM record changers. Model CQ-11 fits RMA No. 2 Specifications for top mounting .453" mounting centers. Needle pressure five grams. Output 0.7 volts at 1,000 c.p.s. Employs one-mil tip radius, Q-33 needle. Cast aluminum housing.

LQD DOUBLE-NEEDLE CRYSTAL CARTRIDGE



THE LQD CARTRIDGE—for 45, 33-1/3 and 78 RPM Records—quickly became the first choice of many of the nation's largest users, on the basis of comparative listening tests, and is today the PROVED TOP PERFORMER for turnover type pickups. Outstanding for excellence of frequency response, particularly at low frequencies. A gentle pry with penknife removes ONE "Q" needle for replacement... without disturbing the other needle, without removing cartridge from tone arm. Gentle pressure snaps new needle into place. Stamped aluminum housing. Model LQD-11, illustrated, has needle guards and front bracket for turnover knob. LQD-1 not equipped with needle guard or front bracket.

Astatic Crystal Devices manufactured under Brush Development Co. patents



NEW Economy-Portability-Fidelity

WITH THE MAGNECORDER PT6-JA

PROFESSIONAL, MAGNETIC TAPE RECORDER



Radio and recording studios, schools, and industry acclaim the professional reproduction quality of this new, low priced Magne recorder. It offers a frequency response of 50 to 15,000 cps, ± 2 db with less than 2% harmonic distortion at full modulation, conforming to NAB specifications. For unmatched portability and flexibility, amplifier and recorder are in separate 25 lb. cases and may be operated individually with other Magne recorder equipment. PT6-JA complete \$499.50

Amplifier includes single low impedance mike input with gain control, high level input, monitor speaker, zero level output terminal, VU type meter, and 10-watt monitor amplifier and associate jack for use with an external speaker.

Recorder unit features easily interchangeable capstans making possible either 7 1/2" or 15" tape speeds. Three-position switch selects erase, record, playback, or public address operation.

SEE US AT THE AUDIO FAIR

For detailed specifications and name of your nearest dealer write:

Magne recorder, INC., CHICAGO 1, ILL.
360 N. MICHIGAN AVENUE

World's Largest and Oldest Manufacturers of Professional Magnetic Recorders

that a single 500-ohm adjustable "T" attenuator is available and that thermocouple meters are to be used. The necessary fixed pad values are shown in this figure.

In connection with the meters in this figure, it should be noted that when both are indicating .001 watt no meter correction need be added. Further, both can be held to this indication, provided the oscillator output level adjustment is sufficiently fine, the steps on the adjustable attenuator are of the same order of magnitude as the desired gain indication, and the output power is to be held constant. If the input level were to be held constant for the frequency-response measurement, the setting of the adjustable attenuator and the reading of M_1 would be held constant at the reference frequency, for example, 100 cps. Then, as no output adjustable attenuator is available, the variation of gain with frequency could be indicated on M_2 . If the power reading on this meter at reference is termed P_R and is .001 watt, the correction in decibels is obtained for other frequencies by observing the power indicated by M_2 and determining the number of decibels corresponding to that indication referred to P_R . If this power is greater than P_R , then the number of decibels difference must be added to the gain determined for the reference frequency, or, if less, subtracted. It is probable that greater accuracy of indication can be obtained by reading small variations on the thermocouple meter scale than by the use of 0.1-db steps on attenuators.

In this same connection, if the desired input level is equivalent to -50 dbm (2.45 millivolts, rms, in series with 150 ohms), this level is achieved in the illustrative example with .001 watt indicated by M_1 and 39.5 db in the adjustable attenuator. This 39.5 db plus the 10.5 db of the matching network provides the desired equivalent of -50 db referred to .001 watt.

For further illustration, there is shown in Fig. 10 an arrangement using standard volume indicators as the input and output meters. This figure also indicates the necessary corrections because of the use of such meters. In particular it should be noted that the resistance of the output volume indicator in parallel with the terminating resistor must be taken into account for proper output termination.

The illustrative examples of both Figs. 9 and 10 are essentially similar to the general basic circuit of Fig. 2. However, it will be noted that the arrangement of the input meter circuit of Fig. 9 is such that the same input voltage appears across the input terminals of the input adjustable attenuator as that indicated by M_1 , thus

avoiding the 6 db correction required in the case in Fig. 10. With the arrangement of Fig. 9 the relative values of the series input resistances are, of course, factors in the accuracy of measurement.

(To be concluded)

REFERENCES

- 1 Radio Manufacturers Association—Standard TR-105A "RMA Standard—Audio Facilities for Radio Broadcasting Systems." May 1948.
- 2 "American Standard Definitions of Electrical Terms"—American Standards Association C42-1941, 65.11.035 and 65.11.045.
- 3 T. E. Shea—Transmission Circuits for Telephone Communication. D. Van Nostrand Co., 1925.
- 4 Motion Picture Sound Engineering—Research Council of the Academy of Motion Picture Arts and Sciences. D. Van Nostrand Co., 1938.
- 5 S. J. Haefner—Amplifier Gain Formulas and Measurements. *Proc. IRE*, April 1931. Vol. 19, No. 4.
- 6 F. F. Romanow and M. S. Hawley—Rating Microphone and Loudspeakers for Systems Use. *Proc. IRE*, September 1947. Vol. 33, No. 9.
- 7 "American Recommended Practice for Volume Measurements of Electrical Speech and Program Waves"—American Standards Association C16.5, 1942.
- 8 L. Wolff—Alternating-Current Measuring Instruments as Discriminators Against Harmonics. *Proc. IRE*, April 1931. Vol. 19, No. 4.
- 9 A. E. Thiessen—Impedance Matching Networks. *Electronics*, March 1931.
- 10 P. K. McElroy—Designing Resistive Attenuating Networks. *Proc. IRE*, March 1935. Vol. 23, No. 3.

BIBLIOGRAPHY

- K. S. Johnson—Transmission Circuits for Telephone Communication. D. Van Nostrand Co., 1925.
- W. L. Everitt—Communication Engineering. McGraw-Hill Book Co., 1932.
- Electrical Engineers' Handbook—Electric Communications and Electronics. Ed. by H. Pender and K. Mellwain. John Wiley & Sons, 3rd edition 1936.
- Radio Engineers' Handbook—F. E. Terman. McGraw-Hill Book Co. 1943.
- N. B. Fowler—Measurements in Communications. *Electrical Engineering*, February 1947. Vol 66, pp. 135-140.
- H. H. Scott—The Measurement of Audio Distortion. *Communications*, April, 1946, and Engineering Handbook of National Association of Broadcasters.

Selenium Rectifier Booklet

A booklet just made available describes Westinghouse selenium rectifiers for power supplies and electronic circuits, with efficiency curves for both the standard (type M) and the high-voltage (Type H) cells together with discussions of efficiency, aging, life, back leakage, and forward and reverse resistance. Life characteristics are plotted graphically for both types of cells under various overload conditions and for high ambient temperatures. Also included are formulas for calculating rectifier performance, cell ratings for a wide range of applications, and a tabular presentation of schematic diagrams.

For a copy of this booklet, write Westinghouse Electric Corporation, P. O. Box 868, Pittsburgh 30, Pennsylvania.

For the first time

studio quality reproduction in an automatic record changer for all types of records: RCA Victor 7" 45 RPM, Columbia 7" LP, Columbia 10" and 12" LP 33 1/3 RPM, Standard 78 RPM 10" and 12" records—all played automatically.

NEW

design plug-in pick-up heads permit use for the first time of highest quality pickups as used by many broadcasters.

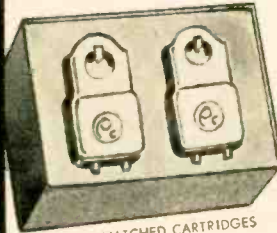

PICKERING MATCHED CARTRIDGES

Controls are marked for simple selection, according to type of records to be played. Records may also be played manually. Quiet jam-proof mechanism. Webster Chicago 356-27PS supplied with special matched pair type W Pickering cartridges balanced to give only 17 grams stylus pressure on standard records and 6-7 grams on LP microgroove records. Special Pickering cartridges have built-in precision sapphire styli for standard and microgroove records. Price with cartridges, all hardware and instructions.....

52²¹ NET

Webster Chicago 356-27 PD same as above with special matched pair type W Pickering cartridges equipped with laboratory ground diamond styli for years of finest reproduction with minimum record and stylus wear.....

88²¹ NET

356-27 G.E., same as above, with pair of General Electric variable reluctance cartridges equipped with sapphire styli.....

38⁹⁵

Above changers operate on 105-120 volts 60 cycles AC.

Dimensions: Base plate 14" x 14". Height above main plate 5 3/8", below main plate 3 3/8". Note mounting size is same as older models 56, 156 and 256.

THE NEW SOMERSET NOISE-SUPPRESSOR
Tone-Corrected Preamplifier

NOW

you can have a minimum of unwanted record noise with a maximum frequency range.

A new design giving a high degree of noise suppression with a frequency range of 40 to 15,000 cycles.

The degree of noise suppression is controlled by a calibrated indicator. The built-in equalized preamplifier with equalization control insures finest tone quality with cartridges like Pickering wide range magnetic, G.E. or other variable reluctance type cartridges.



Input also provides for use with crystal pickups and radio tuners.

The Somerset noise suppressor preamplifier has a self-contained power supply and is easily connected to any AC operated amplifier system or radio. Tubes: 2—6SL7GT, 1—6SK7GT, 1—6SJ7GT, 1—5Y3GT. Chassis size 7 x 9 x 5 1/2"

Price complete with tubes and instructions. **59⁵⁰** NET

Same as above, but with controls on 4 ft. extensions. **62⁵⁰** NET

FREE! WRITE FOR YOUR COPY OF OUR NEW 1949 CATALOG OF HIGH QUALITY SOUND EQUIPMENT

TERMINAL
RADIO CORPORATION

Distributors of Radio & Electronic Equipment

85 CORTLANDT ST.—NEW YORK 7, N. Y. • Phone—WO 4-3311 • Cable—TERMRADIO

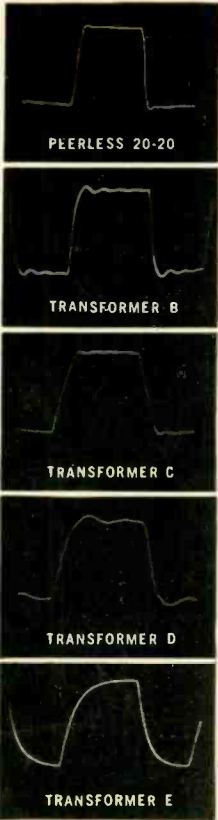

AGAIN! PEERLESS DEMONSTRATES SUPERIORITY OF ITS TRANSFORMERS BY SQUARE WAVE TEST AT WCEMA SHOW AND WEST COAST I.R.E. CONVENTION IN SAN FRANCISCO

*Photos show square wave response with
11,000 cycle fundamental frequency*

Square waves provide the most rigorous test of an audio system and give indisputable evidence on transformer performance. These square wave tests were made under conditions simulating actual transformer operation, that is, square waves were fed from a balanced generator through resistors equivalent to the plate load of the tubes. A non-inductive resistance load was used on the secondary. All transformers were demonstrated under identical conditions. No compensation of any kind was used. A switching mechanism was arranged to give an A-B comparison between any of the transformers. All competitive transformers (as well as the Peerless transformer used) were selected from jobber stock items of leading transformer manufacturers. Only the highest priced "high quality" transformer of each manufacturer was chosen. Equally decisive comparative results were obtained at all other frequencies from 20,000 down to 20 cycles. Let Peerless figure on all of YOUR transformer requirements.

PEERLESS ELECTRICAL PRODUCTS DIVISION



1161 N. Vine St., Hollywood 38, Cal.
161 Sixth Avenue, New York 13, N. Y.

Frazar & Hansen Ltd., 301 Clay St., San Francisco 11, Cal.
Exclusive Export Agent

World-Wide Popularity

Since the inception of **AUDIO ENGINEERING** in May 1947, engineers and audio hobbyists have subscribed in ever-increasing numbers, not only in the 48 states and in all of the major foreign countries but in such places as Tasmania, Transvaal and Trinidad.

Each month **AUDIO ENGINEERING** covers the latest developments and practices in recording, reproduction and instrumentation for the entire audio field.

Subscribe Now—Don't Miss an Issue! Back numbers are hard to get!

AUDIO ENGINEERING
342 Madison Avenue, New York 17, N. Y.

Sirs: Here is my check (or money order) for \$..... Enter my subscription order to **AUDIO ENGINEERING** for the next..... issues. Subscription Price: In U.S.A., Canada and Pan American Union—12 issues \$3—24 issues \$5. All others \$4.00 per year. Please check one: New Subscription Renewal

Name (please print).....

Address..... City..... Zone..... State.....

Occupation (give title and department).....

Firm Name.....

LOUDNESS CONTROL

[from page 17]

in a vertical direction as the shaft is rotated. There are undoubtedly other controls which could be used, but this type seems nearly ideal.

Construction

The installation of the extra taps was accomplished in the following manner: The cover was removed from the control and an ohmmeter connected between the center and one side of the pot. The control was then rotated to give readings of 50K, 100K, 150K, and 200K. At each of these settings a scratch mark was placed adjacent to the rotor contact, beginning at the edge of the resistance element and extending to the outer edge of the bakelite. Holes are drilled and tapped for 2-56 screws into the edge of the bakelite opposite each of these marks. The drilling and tapping must be done carefully because of the brittle nature of the material, which tends to crumble.

Next, four lugs are installed, the sketch in Fig. 2 showing how this was done. Other variations will occur to the individual, but this method proved to be satisfactory.

The major problem, that of making a good electrical contact to the resistance element at the proper intervals, was considered from many angles, including pressure contact, etc., but was solved in simple fashion by making use of conductive paint. In the writer's case this was an air-drying silver paint, but there are no doubt many other possible materials, notably aqua-dag. In any case, the material is applied with a fine pen to the edge of the resistance element at each of the pre-

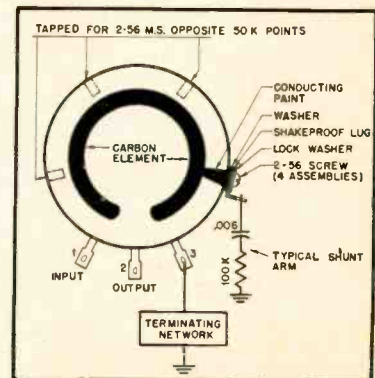

Fig. 2. Physical modifications to standard type of volume control to convert to loudness-control operation.

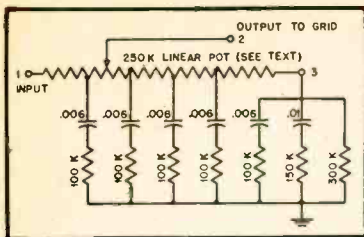

Fig. 3. Electrical circuit of continuous loudness control.

viously located 50K-ohm points, care being taken not to encroach upon the area of contact of the rotor. The paint is carried out over the edge of the bakelite and to the tap, being applied liberally once away from the resistance element.

Once the paint has dried the shunt arms may be added, either directly upon the control, as was done in this case, or externally upon a terminal board.

The schematic of the complete control is shown in Fig. 3. Two other points should be considered: first, the fact that in removing the original dust cover in the type of pot we have also removed the stop, making 360 deg. rotation possible, which is highly undesirable because rotating the shaft too far in the direction of minimum gain will bring the control to the point of maximum gain in a very abrupt manner; and second, the fact that it would be wise to enclose the unit in a shield to prevent the collection of dust on the exposed resistance element, as well as to reduce the possibility of hum pickup.

The first problem can be solved in a variety of ways; the use of pins or a block placed on the panel in such a way as to prohibit the travel of a pointer-type knob beyond the proper limits seems perhaps the simplest method and the one which was used in the present case.

As for shielding, a 2½ in. diameter shield can was cut down to the length of 2¼ in. and a ⅜ in. hole was drilled in the center of the closed end. The control was then mounted inside the can with the shaft protruding through the hole, the input, output and ground leads having first been attached. A cover for the open end of the shield can was made from a flat piece of aluminum and attached to the shield by means of screw lugs riveted to the can. Holes are provided in the cover for bringing out the leads.

Response

It will be noted that although these controls have a nominal effective rotation of approximately 310 deg., curves are shown only from 30 deg. to 270

CLARKSTAN
CORPORATION

MANUFACTURERS OF
FINE ELECTRONICS & INDUSTRIAL EQUIP.

THE CARTRIDGE WITH EASILY REMOVABLE STYLUS

A STYLUS FOR EVERY PURPOSE

Here's the wide range variable reluctance pickup you have been waiting for. It features a removable and replaceable stylus to permit use of the cartridge with all types of recordings, LP microgroove records and commercial pressings. Change the size of the sapphire ball point as desired without altering the fine quality performance of this pickup. The cartridge has standard holes for mounting on tone arm. A high fidelity pickup offering flat response (meets FM specifications), low distortion and feather-weight needle force. Response is velocity responsive to above 12000 cps. Needles available with .0010" ball point radius for microgroove records, or .0015", .0022", .0025", .0030" for conventional recordings and pressings. See it at your jobber or write for Bulletin #141B.

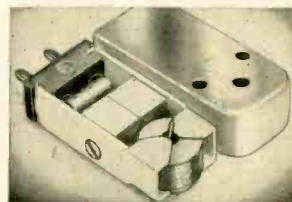

The cartridge has standard holes for mounting on tone arm. A high fidelity pickup offering flat response (meets FM specifications), low distortion and feather-weight needle force. Response is velocity responsive to above 12000 cps. Needles available with .0010" ball point radius for microgroove records, or .0015", .0022", .0025", .0030" for conventional recordings and pressings. See it at your jobber or write for Bulletin #141B.



CLARKSTAN EQUALIZER

Designed to work with the Clarkstan RV Pickup and other high impedance variable reluctance cartridges, this low cost equalizer includes the four most useful curves for broadcasters and owners of fine high-quality equipment. It offers playback equalization for all modern records including LP microgroove. Has a four position selector switch for standard curves. Mounts on panel with a ⅜" diameter center hole, for a neat installation. See your jobber or write for Bulletin #165B.



ARM WITH SLIDE-IN CARTRIDGE HOLDER

Ballbearing Record Arms with the new Slide-In Cartridge holder, which requires no soldering. Quick acting weight adjustment for all types cartridge and records, standard and L.P. made in two sizes for records up to 12" and 17". See your jobber or write for Bulletin #172B.



CLARKSTAN PICK UP-TO-LINE TRANSFORMER

A high quality transformer to be used wherever the signal is to be introduced to 30/50, 200/250, 500/600 ohm lines. May also be used as a line-to-grid transformer. Complete information available at your jobber or write for Bulletin #162B.

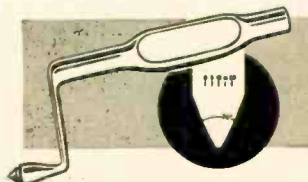

FINEST QUALITY STYLII

Clarkstan finer quality stylii are the result of expert craftsmanship and repeated checking for close tolerances after each cutting and polishing operation. Only highest quality sapphire rod is used. Entire cone is polished and tip is super-polished. Only Clarkstan offers a wide selection of tip radii accurate to .0001". Our diamond points are made from only the finest entire small diamonds available. See your jobber or write for Bulletin #170B.

SEE
YOUR
JOBBER
TODAY

CLARKSTAN

CORPORATION
11927 W. Pico Blvd.
Los Angeles 34, Cal.

SEE
YOUR
JOBBER
TODAY

Send today for . . .

the only book that covers
the entire field of recording

ELEMENTS OF SOUND RECORDING

By John G. Frayne, Supervisor of Development Engineering; and Halley Wolfe, Development Engineer, both of Electrical Research Products Division, Western Electric Company.

Here is a comprehensive, practical reference volume on basic sound problems for the designer, operating engineer or technician.

The authors discuss in detail those subjects that belong to the restricted field of sound recording and reproduction, and which are not discussed in books devoted to the allied fields of electronics, radio engineering, etc. However, since those interested in studying sound recording have widely different kinds of training and experience, some closely related subjects such as electromechanical analogies, acoustics, vacuum tubes, and audio amplifiers are discussed.

The book includes . . .

A large number of numerical examples to make the design procedure perfectly clear to the reader.

More than 480 diagrams and photographs illustrating every step of the text material.

Contents: Nature of Sound, Sound Waves and their Perception, Electrical, Acoustical, and Mechanical Circuits, Microphones and Their Uses, Vacuum Tubes, Audio Amplifiers, Network Theory, Attenuators, Filters, Equalizers, Compression and Limiting, Recording Systems, Electrical Measurements, Principles of Disk Recording, Disk Records and Their Processing, Fundamental Principles of Variable-Density Recording, The Light Valve, Variable-Intensity Modulators, Principles of Variable-Area Recording, Variable-Area Modulators, Noise-Reduction Methods, Intermodulation Test Methods, Flutter and Its Measurement, Film and Disk Drive Mechanisms, Motor Drive Systems, Film Laboratory Processes, Recording, 35-mm Motion-Picture Recording Systems, 16-mm Sound Film Systems, Magnetic Recording, Loudspeaker Systems, Acoustics of Stages and Theatres, Stereophonic Recording.

May 1949

686 pages

483 illus.

\$8.50

10-DAY
EXAMINATION



ON APPROVAL COUPON

JOHN WILEY & SONS, INC.

440 Fourth Ave., New York 16, N. Y.

Please send me, on 10 days' approval, a copy of Frayne and Wolfe's ELEMENTS OF SOUND RECORDING. If I decide to keep the book, I will remit \$8.50 plus postage; otherwise I will return the book postpaid.

Name.....

Address.....

City..... State.....

Employed by.....

(Offer not valid outside U.S.) AE-10-49

deg., an effective rotation of only 240 deg. This is accounted for by the fact that linear potentiometers, though specified as such, actually have a slow rate of change of resistance at both ends of their range. The unit for which curves are shown was ineffectual over a range of about 30 deg. at each end.

The maximum control range of only 30 db, as indicated by the response curve of Fig. 1, may be deemed insufficient by some, but has been found to be adequate. This type of control has radically changed the writer's listening habits so that it is no longer considered necessary to shake the house. With the control set at the position of minimum output, the amplifier gain was adjusted to give a level in the room which might be described as "conversational background". The output at the maximum setting of the control is then more than adequate for normal listening.

The entire construction of the unit described required little more than an hour of working time. The improvement from the standpoint of operation has had the effect of greatly enhancing the value of the loudness control in the ear of this listener, whose hat is now permanently off to Mr. Bomberger.

DUO-CONE LOUDSPEAKER

[from page 22]

range. Since the large cone is effectively a continuation of the small cone, the cross-over between the low- and high-frequency cones in the duo-cone speaker need not be confined to a narrow frequency band, because the two cones vibrate as a single cone in this region. Thus it is possible to use a very simple cross-over network. The electrical impedance-vs-frequency characteristics of the low- and high-frequency voice coils are shown in Fig. 5. It can be seen that the electrical impedance of the low-frequency unit increases rapidly above 1000 cps. As a consequence, it is not necessary to use an inductance in series with the low-frequency coil to reduce the current in this coil in the high-frequency region. The only external element required for the cross-over network is a capacitor in series with the high-frequency unit which limits the current through the high-frequency unit at the low frequencies. The voice-coil circuits and cross-over networks are shown in Fig. 6. The electrical impedance-vs-frequency characteristic with the cross-over network and normal operation of the mechanism is shown in Fig. 7. The cross-over frequency in this system extends well over an octave. However, as

PROFESSIONAL DIRECTORY

C. J. LeBEL
AUDIO CONSULTANT

Sound Recording • Instrumentation

370 RIVERSIDE DRIVE
NEW YORK 25, N. Y.

Winston Wells

Designer and Consultant

Acoustical, Electronic and Nuclear
Research

307 East 44th St.

MU 4-3487

New York 17, N. Y.

Custom-Built Equipment

U. S. Recording Co.

1121 Vermont Ave., Washington 5, D. C.

Sterling 3626

Consultation • Design • Fabrication

Audio Facilities Corporation

608 Fifth Avenue

New York 20, N. Y.

RATES FOR
PROFESSIONAL CARDS
IN THIS DIRECTORY

\$10 Per Month.
Orders Are Accepted
for 12 Insertions Only

HERMAN LEWIS GORDON

Registered Patent Attorney

Patent Investigations and Opinions

Warner Building
Washington 4, D. C.
National 2497

100 Normandy Drive
Silver Spring, Md.
Shepherd 2433

pointed out, this spread is not objectionable, because in the overlap region the two cones vibrate as a single unit.

Cabinets

For most applications the direct-radiator speaker is housed in some type of cabinet. One design of cabinet which has been found to be suitable for the duo-cone speaker is shown in Fig. 8. The speaker mechanism is designed to be flush-mounted on the front face of the cabinet. The cabinet is completely lined with one-inch Ozite. This lining absorbs standing-wave systems and reduces the amplitude of the fundamental resonance. The cabinet is equipped with a port which may be used to accentuate the low-frequency response if this type of response-vs-frequency characteristic is desired. The cabinet dimensions for the duo-cone mechanism are not critical. Satisfactory operation can be obtained with any well-designed cabinet having a cubical content of approximately 5 to 7 cubic feet. The mechanism may also be used in a flat baffle.

The measured response-vs-frequency characteristics of the duo-cone speaker mechanism mounted in the cabinet of Fig. 8 are shown in Figs. 9 and 10. These characteristics show the effect of the port opening in the cabinet upon the low-frequency response. The response with the port closed is relatively uniform from 50 to 11,000 cps. These characteristics also show that the response is uniform in the overlap frequency range of the low- and high-frequency units.

The response-vs-frequency characteristic of the duo-cone speaker mechanism mounted in a flat baffle is shown in Fig. 11.

Directional Characteristics

The directional patterns of a high-quality speaker should be substantially independent of frequency over a broad angle. The directional characteristics of a cone speaker are a function of the frequency. At the low frequencies, where the dimensions are small compared to the wavelength, the system is nondirectional. When the dimensions of the cone become comparable to the wavelength, the system becomes directional. At higher frequencies, the directional pattern becomes progressively sharper with increase in frequency. A uniform pattern may be obtained by decreasing the size of the radiator with frequency. This decrease is approximated by the use of two cones—a large cone for the low-frequency range and a small cone for the high-frequency range. The directional pattern of a cone is also a function of the cone angle because of the finite velocity of sound transmission in the cone. When the angle of the cone is increased, the direc-

Announcement

PICKERING'S NEW LINE OF FINE AUDIO EQUIPMENT

Will be shown for the first time at the Audio Fair, October 27, 28, 29, Room 624, Hotel New Yorker, 34th St., and 8th Ave., New York City

PICKERING CARTRIDGES AND AUDIO EQUIPMENT ARE AVAILABLE THROUGH LEADING JOBBERS AND DISTRIBUTORS EVERYWHERE.

PICKERING
A COMPANY, INCORPORATED
OCEANSIDE, NEW YORK

3 SPEED TURNTABLE Using *Instantaneous* Speed Selector

MODEL LP-743

\$49⁹⁵
NET

HOW IT WORKS!

3 SIMPLE OPERATIONS!

1. **78 r. p. m.**
slide shift-lever to left
2. **45 r. p. m.**
slide shift-lever to right
3. **33¹/₃ r. p. m.**
press selector button down,
slide shift-lever to right



Selector Button

Noise Level: —30 db minimum
Motor: 4 pole, induction
Turntable: Cast aluminum
Speeds: Adjustable stops to set all 3 speeds
Dimensions: L. 15"; W. 12"

See Our Line at the Audio Fair,
Room 52, Hotel New Yorker.



REK-O-KUT COMPANY, INC.

38-01 QUEENS BOULEVARD, LONG ISLAND CITY 1, N.Y.

This Phenomenal FM Tuner

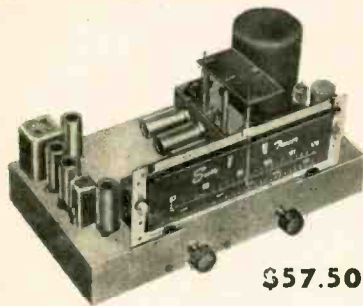

\$57.50

Has 2-Microvolts Sensitivity!

Plus Automatic Frequency Control and much, much, more

Here's FM at its best and at mighty low cost, too. Highly compact, newly designed, the Sun FM Tuner is built to our own specifications and has a combination of features never before available at any price: Full Armstrong circuit, 2-microvolt guaranteed sensitivity, AFC, no drift after two-minute warmup period, 1F bandwidth 200 KC at 6 db down, patented permeability tuning head for high Q selective RF circuits, 13 1/2" long x 7 1/4" wide x 5 1/2" height overall, 10 high-gain miniature tubes: 6AK5 RF, 6BE6 converter, 3-6AK5 IF's, 2-9001 cascade limiters, 6AL5 Foster-Seeley discriminator, 6X4 rectifier, 6J6 AFC. Complete, ready to use, not a kit. All for only \$57.50, FOB.

Order today by mail direct from Sun. Send check or money order for full amount or 25% with COD's.

Complete specifications for this tuner (model AFC-10) are available on request. But please don't ask for the circuit—we guard it rather jealously. Can you blame us?

Write for Descriptions

We also have complete descriptive literature on our famous all-triode, high-fidelity, 10 watt amplifier kit (engineered by us from design published by Consumers' Research of Washington, New Jersey), and on our complete "219" top quality home music system. This literature is yours for the asking. We're preparing a handy, new high-fidelity booklet-catalog, too. So better get on our mailing list now.

Visit Us at the "Audio Fair"

See us at the "Audio Fair" at the Hotel New Yorker, room 640, on October 27, 28, and 29. You'll be thrilled by our exhibits of new ideas, new products, new perfection in high-fidelity reproducing equipment. See and hear our interesting collection of Edison and other cylinder-type antique phonographs. We'll be looking for you, so be sure to drop in. Remember, it's room 640, the Hotel New Yorker, October 27, 28, and 29.

SUN RADIO

AND ELECTRONICS COMPANY, INC.
122-124 DUANE STREET
New York 7, N. Y. Barclay 7-1840
2 BLOCKS NORTH OF CHAMBERS ST.

STORE HOURS: Open Daily 9 to 6.
Saturdays 9 to 4.

tional patterns become broader at the higher frequencies. Relatively wide-angle cones were used in the duo-cone speaker in order to obtain broad directional patterns in the high-frequency range.

The directional characteristics of the duo-cone speaker for the frequencies 500, 1000, 2000, 5000, 7000, and 10,000 cps are shown in Fig. 12. A consideration of these characteristics shows that a broad directivity pattern is maintained over the entire response range.

Nonlinear Distortion

The nonlinear distortion-vs-frequency characteristic depicts the spurious harmonics which are generated by a loudspeaker. There are many possible sources of distortion in a direct radiator dynamic speaker. A few of the most common sources of distortion are: the suspension system, lack of rigidity in the cone, inhomogeneity of the air-gap flux, and inadequate flux density in the air gap. The expedients for reducing or eliminating these distortions have been considered at length in the literature and will not be repeated here. Every effort was made to develop a system in which these distortions would be as low as possible without adding unduly to the complexity of construction, the sensitivity, or the cost. The total distortion-vs-frequency characteristics of the duo-cone speaker for inputs of 1, 2, and 5 watts are shown in Fig. 13. The average input to this speaker for a level of 75 db in the average living room is about 0.1 watt. The distortion under these conditions is negligible. Even at an input of 5 watts the distortion is quite low.

ERRATUM

Through an error arising somewhere between manuscript and final printing, the name of the Principal of Archbishop Stepinac High School was shown incorrectly in the caption of Fig. 6, page 13, of the September issue. Father Joseph C. Krug has been Principal of the school since its opening.

RACON TWEETER

Highest Music Quality
At Low Cost!



Clean
Output to
15,000 Cycles!
Wide Distribution Pattern!

MODEL
CHU-2
\$37.50
List Price

Add the Racon tweeter to your radio or phono amplifier to s-t-r-e-t-c-h the range of your 12-15" cone speaker to the upper limits of today's wide range music. For the first time, enjoy the rich brilliance and life-like realism of concert hall music!

Smooth, clean response to 12,000 cycles, with usable output to 15,000 cycles. High frequency horn logarithmically expanded as two horns for wide, uniform distribution pattern. Satisfactory match assured with amplifier output impedances from 4-15 ohms. When used with crossover network, will handle amplifiers rated to 25-30 watts.

Cast aluminum throughout. Easy flush mounting. Cutout template provided with free wiring diagram and instructions to build your own 1,000-cycle crossover network.

Listen to the Racon tweeter at your nearest distributor, or write for free Catalog A

Racon LC Crossover Network, Model CON-20 List Price \$22.50
All Racon products are guaranteed for 18 months.

ACOUSTICAL EXCELLENCE

Racon Electric Co., Inc.

52 East 19th Street, New York 3, N. Y.

The answer...
IN 16 MM PRODUCTION!

MAGNAGRAM

SYNCHRONOUS

16MM Magnetic FILM RECORDER

RECOGRAM RECORDERS CO.

11338 BURBANK BLVD., NORTH HOLLYWOOD, CALIF.

P. O. BOX 405

RECORD REVUE

[from page 32]

symphony is that recorded before the war by the great Sir Thomas. Beecham has a special way with Mozart, and his big rep among Mozart fans has plenty of basis, notably the wonderful accuracy of phrasing and of detail on which he always insists. But there are those who wonder sometimes just how far Sir T. can carry certain Mozartian eccentricities and maintain his hold on the cognoscenti. The Beecham "Haffner" (it is Columbia MM 399) is characteristic—a beautifully precise and finished performance. Yet a single hearing of this new Reiner edition is enough to show how different the same music can sound, and it would seem to me, legitimately so. There is no one interpretation of a work like this. There are aspects of it, things in it that may be overlooked, or put in their place, brought out, even exaggerated. An interpretation is the sum total of hundreds of such considerations. Speaking generally (for this can be no essay on Mozart), the Beecham version makes the symphony a beauty but a rather amiable affair, without much in the way of tension. It pauses, almost, to polish off every entrancing detail; there is humor and ease in it. The Reiner version, strikingly different, is tense, serious, taut. The music has drive, as that of the G minor symphony, number 40. It is almost harsh. And hearing it thus, one realizes that these tensions *are* in the music, to be brought out or to be smoothed down, according to conductorial taste. So are the glittering and precise beauties that Beecham brings out. And who can say what Mozart's own conception of the balance of these forces might have been?

Beethoven, "Triple" Concerto in C, Opus 56. John Corigliano, violin; Leonard Rose, cello; Walter Hendl, piano; New York Philharmonic, Bruno Walter.

Columbia MM 842 (4)
LP: ML 2059 (1 10")

• Here is an epochal record, because it is one more in the dual series of definitive recordings this conductor has been making for Columbia, the Beethoven and the Mahler series; also because here is a recording of a big, important Beethoven piece that would be well known to all of us were it not for its unorthodox form—a concerto with not one but three soloists. In these days our concert planners prefer to let well enough alone and stick to the single-solo concertos. Three is definitely a crowd! Thus the "Triple" is virtually never heard and more the pity. It takes a man like Walter to put it through and, better, to make his three soloists perform as a team so perfectly that one hears no concatenation of rival virtuosi striving against the common rival, the orchestra, but instead a unified and smooth-flowing exposition of pure Beethoven. That's something.

Recording balance is unusually clever—this was a knotty problem, to set up three differing soloists so as to register all of them clearly, yet keep them in balance with a full orchestra. The trick was one of live-ness. The soloists are close-to, much closer

AMPERITE

Studio Microphones at P.A. Prices

Ideal for BROADCASTING
• RECORDING
• PUBLIC ADDRESS

"The ultimate in microphone quality," says Evan Rushing, sound engineer of the Hotel New Yorker.

- Shout right into the new Amperite Microphone—or stand 2 feet away—reproduction is always perfect.
- The only type microphone that is not affected by any climatic conditions.
- Guaranteed to withstand more "knock-around" than any other type mike.

Special Offer: Write for Special Introductory Offer, and 4-page illustrated folder.

AMPERITE Company, Inc.
561 BROADWAY • NEW YORK 12, N. Y.

In Canada: Atlas Radio Corp., Ltd., 560 King St. W., Toronto



Models
RBLG—200 ohms
RBLG—Hi-imp.
List \$42.00



"Kontakt" Mikes
Model SKH, list \$12.00
Model KKH, list \$18.00



SOMERSET DYNAMIC NOISE SUPPRESSOR Pre-amplifier

This unit having its own power supply includes:

1. A pre-amplifier essential for high quality pickups.
2. A Dynamic Noise Suppressor in which the signal volume in the middle frequency range automatically and continuously regulates the high frequency response to give the highest attainable signal to surface noise ratio without impairing highest quality reproduction.

A NEW Somerset 12 watt High Fidelity Amplifier is now in production and will be on exhibit at the Audio Fair, Hotel New Yorker, October 27, 28 and 29th.

Beam power tetrodes are used in a unique multiple feedback circuit which greatly reduces output impedance. This produces extraordinarily effective loud speaker damping resulting in exceptional bass tone response without distortion or intermodulation.

The SOMERSET Dynamic Noise Suppressor Pre-amplifier—the Last Link in High Fidelity Reproduction—which so effectively controls high frequency surface noise is incorporated into the unit.

This combination gives the finest in High Fidelity Reproduction.

SOMERSET LABORATORIES, INC.

1701 Palisade Avenue

Union City, New Jersey



7 x 11 x 8 hi

WT. 17½ LBS.

FULL POWER ALL the way with the new MODEL 2 AMPLIFIER

POWER: Rated 20 watts actual power measured 19.6 watts @ ½% total harmonic distortion from 30 cycles thru 15 kc.
FEEDBACK: over 20 db

SPECIFICATIONS:

RESPONSE: Flat within one db 15 cycles to 100 kc.
INPUT: 1 volt level
OUTPUT: 8 to 20 ohms

\$60
users
net

audio pacific co. 30 w. colorado st.
pasadena 1, calif.



SCIENCE STOPS DUST

*Polonium Eliminates Surface
Attraction for Dust and Lint

Your discs will be completely free of dust and lint with the STATICMASTER. Mounted on the ferrule of this brush, a shielded strip of *Polonium neutralizes static electricity when passed over the surfaces of the disc. Freed of static charge, the tiniest particles are easily brushed away.

Reduces Surface Noise Pick-Up

As the sensitivity of your equipment is increased, fractional sounds affect the reproduction. Dust in disc grooves has an audible abrasive action from needle pressure. Only the complete elimination of this dust will give minimum surface noise pick-up...STATICMASTER does this job.

Longer Disc Life

The same abrasive action of needle on dust also reduces the effective life of your disc. Minute particles grate on the sensitive cut...only complete removal of every particle will prevent your disc from greying rapidly. Use a STATICMASTER!

For informative brochure write

NUCLEAR PRODUCTS CO.

424 So. Broadway

Los Angeles 13, Calif.

You Are Invited To Attend The First Annual

AUDIO FAIR

Hotel New Yorker, New York City, October 27, 28, 29



An event of utmost importance to Broadcast Engineers, Recordists, Sound-on-Film Men, Public Address Men, Audio Hobbyists and Distributors and Dealers.

Presenting for the first time, under one roof, an industry-wide display of audio equipment, components and accessories.

Sponsored by the **AUDIO ENGINEERING SOCIETY**

than the orchestra, but *not* louder, an ingenious mike trick that is used more and more these days as engineers realize that mere volume counts for almost nothing, perspective and apparent distance everything. For those interested in problems of separation of this sort (and they crop up in popular music all the time), this recording is a good one for study. The LP edition that I heard is not, I'm sorry to say, as perfect as the last Walter Beethoven, the First Symphony, which is about the finest LP I've ever heard, musically as well as technically. Here we have the same slight buzzings in the loudest passages that seem to be plaguing me lately in so many LP's. You can quickly eliminate the distortion with a cut-off at 8000—but this is torture to a hardened hi-fi man!

Don Cossack Concert.

Don Cossack Chorus, Serge Jaroff.

Columbia MM 844 (4)

• The Don Cossacks go on and on, and presumably get older and older. Though I haven't all of the past recordings with me to prove it, I have a feeling they also get throatier and throatier, with a bigger tremolo content each album. Nevertheless, this is still very fine singing—in fact there is no competition at all to it in the Russian music sphere. Main trouble nowadays (and for some time back) with the Dons is that a good percentage of their ingenious choral arrangements is so much hogwash. Were it not for those fabulous Cossackian tones, the swells and the dyings-away, the high falsettos and the sub-basement basses, the sense of utterly controlled hysteria—were it not for the legitimate spell of the chorus itself and its extraordinary technique, the stuff would show up for what it is, cheap salon music. By far the best of the album is in the true religious music, here by Tchaikowsky himself, written in the great 19th century Russian tradition.

Superb recording, better than ever. (Or maybe I have better equipment now than I did for the last album!)

Meyerbeer, Coronation March; Chabrier,

Joyous March.

Minneapolis Symphony, Mitropoulos

Columbia 3.201 (1 7")

19013-D (1 10")

• For the summer's dizziest, try this one, in the 7-inch size or its ten-inch 78 counterpart. The two marches are quite respectable, or have been until now—in this superduper high fidelity recording under the great Greek conductor's hypnotic touch they are turned into hysterical rat races. Nobody on earth could march at such a tempo, nor with such explosive assistance! Gives just a wee bit that familiar effect you've heard when a 33-rpm record is played 78—but this time it's bona fide. Rather fun to listen to, though, and as a *tour de force* of orchestral playing it can't be matched. Nor is any other conductor likely to try.

Mr. Canby's column is shortened this month due to illness which has prevented him from preparing his usual entertaining discussion of some aspect of music or musical reproduction. His comments will be resumed with the November issue. Ed.

NEW PRODUCTS

{from page 34}



to prevent dirt, water, or gas from entering panels around switches and control shafts. There are also numerous applications for the Sealnut in portable and emergency equipment which is subjected to exposure.

Sealnuts are a product of Radio Frequency Laboratories, Inc., Boonton, N. J., from which may be obtained complete information as to size and styles.

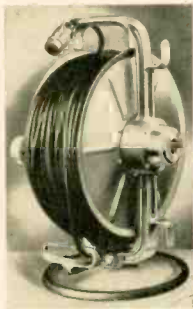

- **Reeling and handling** of portable cables is a difficult operation unless the user is provided with an efficient reel mechanism designed just for the particular application. Any type of reel will hold a cable, but it is inconvenient if it is necessary to unwind the entire reel just to get at the plugs at the start end. With the inside end of the cord terminated by a plug to which access may be had from the outside of the reel, it is only necessary to unroll the required amount of cable and connect a jumper to the plug on the side of the reel. In addition to saving time, this method is also saving of wear on the cable itself, since only that part which is in use is exposed. Thus cables should last almost indefinitely.

Such a reel has recently been introduced by Industrial Electrical Works, Omaha 2, Nebr., and prices and further information may be obtained from them.

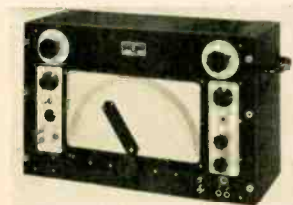

- **Sweep frequency generators** are rare in the audio field, but unquestionably they are useful items where a number of measurements must be made on equipment, particularly in the development stage. Routine maintenance of equipment is also simplified by the use of instruments of this type.

**AUDIO ENGINEERING SUPPLIES • KEYS
PANELS • PLUGS • POWER SUPPLIES
GAIN SETS • TRANSFORMERS
EQUALIZERS • KNOBS • DIALS
• VU METERS
DB METERS
TRANSMISSION LINE • TERMINAL BLOCKS
AMPLIFIERS • PATCH CORDS • FILTERS**

**WRITE FOR
FREE
1950 CATALOG**

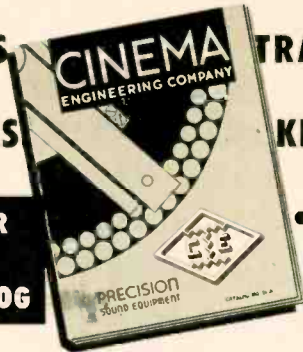



CINEMA ENGINEERING COMPANY
1510. WEST VERDUGO AVENUE, BURBANK, CALIFORNIA

Export Agents: Frost & Hansen, Ltd. • 301 Clay Street • San Francisco, Calif., U. S. A.

IN THE PROFESSION, AN HONORED NAME

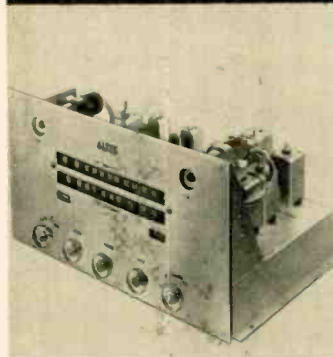

ALTEC
LANSING CORPORATION

*Right—The Altec Lansing
A-323C Amplifier*

*Left—The Altec Lansing
ALC-101 FM-AM Tuner*

**ENGINEERED FOR THE HIGHEST POSSIBLE
PERFORMANCE REGARDLESS OF COST**

This superb two-unit Altec Lansing combination was designed in accordance with a single directive: "They are to be the finest. No component, no circuit, is to be chosen with price in mind. They must be able to realize the full resources of the finest AM and FM programs; they must be capable of receiving and delivering these resources undisturbed to the finest loudspeaker in the world,

the Altec Lansing 604B Duplex." The AM section is an improved tuned radio frequency circuit recognized as the best for high quality reception. The distortion-free circuits of the FM section re-create all of the life-like reproduction possible with FM. The A-323C Amplifier transmits to the loudspeaker the signal delivered by the tuner, changed only in power level. This two-unit com-

bination is available with special accessories to permit rack mounting for professional monitoring. Phonograph and television inputs and required switching are provided.

Technical folder describing ALC-101 Tuner and A-323C Amplifier sent on request. Write Altec Lansing Corporation, 1161 North Vine Street, Hollywood 38, Calif., 161 Sixth Avenue, New York 13, N. Y.

At last —

*A complete coverage
of the entire field*

ACOUSTIC MEASUREMENTS

By LEO L. BERANEK

*Technical Director of the Acoustics
Laboratory, The Massachusetts Institute
of Technology*

Here, brought together for the first time in one book, is much of the material which was previously scattered throughout engineering literature. In addition, considerable previously unpublished data is also included.

From History to Theory and Practice

Beginning with a brief history of the field, the author points out old and new techniques that need revision. He considers the basic facts underlying practically all types of acoustic measurement techniques. The fundamental types of acoustic measuring apparatus are described in detail. Relative advantages and disadvantages of alternate methods for accomplishing electro-acoustic measurements are discussed. The theory of many electro-acoustic phenomena is also presented.

Contents include: Disturbances of Plane Sound Waves by Obstacles and by Finite Baffles. Primary Techniques for the Measurement of Sound Pressure and Particle Velocity and for the Absolute Calibration of Microphones. Measurement of Frequency. Measurement of Acoustic Impedance. The Audiometer. Characteristics of Random Noise. Analysis of Sound Waves Basic Tests for Communication Systems. Tests for Laboratory and Studio Microphones. Tests of Loudspeakers. Testing of Communication System Components. Measurement of the Acoustic Properties of Rooms, Studios, and Auditoriums.

October 1949 914 pages \$7.00



EXAMINE
BOOK
FOR
10 DAYS

ON APPROVAL COUPON

JOHN WILEY & SONS, INC.
440 Fourth Ave., New York 16, N. Y.

Please send me, on 10 days' approval, a copy of Beranek's ACOUSTIC MEASUREMENTS. If I decide to keep the book, I will remit \$7.00 plus postage; otherwise I will return the book postpaid.

Name.....

Address.....

City..... Zone..... State.....

Employed by.....
(Offer not valid outside U.S.) AE-10-49

The Automatic Audio Sweep Generator recently announced by Clough Brengle Co., 6014 Broadway, Chicago 40, Ill., covers a continuous range from 25 to 32,000 cps, and the sweep may be adjusted to any spread from 500 to 10,000 cps within that range or the instrument may be operated manually. Distortion is held to less than 0.5 per cent, and the sweep calibration is linear. The repetition rate may be adjusted over the range from 2 to 10 sweeps per second. Complete construction and operational data is given in Bulletin 14A, available from the manufacturer.



• **Stylus Pressure Gages** are important to the engineer and experimenter alike to make sure that a phonograph pickup is operating under optimum conditions. Quite a number have been brought out during the last decade, but none has been so useful to the audio man as that recently offered by Livingston Electronic Corp., Livingston, N. J. This device is molded plastic, and contains a unique spring indicator which provides two scale spreads without any adjustments or manual operations. The entire scale covers a distance of about one inch, with half of that amount covering the range from 0 to 10 grams, while the remaining half of the scale covers the range from 10 to 30 grams, the two most useful ranges for phonograph pickup work.



• **Loudspeakers**— always an interesting subject among audio engineers — are appearing in a variety of new types, one of the more recent being the Integral Space Transducer. This unit incorporates some unique features which provide excellent distribution of sound throughout the room as a result of the internal construction of the corner unit, which combines horn loading with a multiplicity of features which make for an attractive speaker for home use. Further information on the unit may be obtained from Audio Research Laboratories, 5531 John Avenue, Superior, Wis.

HIGH "Q" DECADE-INDUCTORS

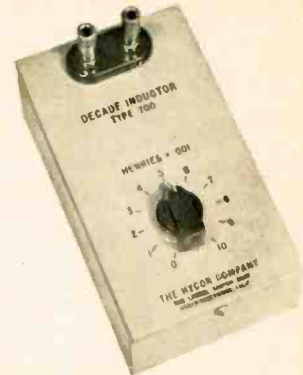

HYCOR DECADE — Inductor units are indispensable for design and experimentation work on audio filters.

The units are available in four ranges up to 10 henries. Units may be used individually or all four may be connected in series to obtain 11.11 henries in 1 millihenry steps.

Toroid coils are used to obtain high "Q", stability and low pickup from external fields. Inductance accuracy is 2%.

The units are economically priced to bring them within the reach of all audio experimenters. Send for Bulletin D.

Jobbers Inquiries Invited.

THE HYCOR COMPANY
7116 LAUREL CANYON BLVD.,
NORTH HOLLYWOOD, CALIF.

Ready NOW ULTRASONIC FUNDAMENTALS

By S. YOUNG WHITE

The rapid increase in the use of ultrasonics during the last few years makes it natural that the well-informed sound engineer should want to learn something of the applications and potentialities of this amazing new field. But interest in ultrasonics is not confined to the sound engineer—it is of still greater importance to the industrial engineer for he is the one who will visualize its uses in his own processes.

Elementary in character, **ULTRASONIC FUNDAMENTALS** was written originally as a series of magazine articles just for the purpose of acquainting the novice in this field with the enormous possibilities of a new tool for industry. It serves the double purpose of introducing ultrasonics to both sound and industrial engineers. The list of chapter headings will indicate how it can help you.

CHAPTER HEADLINES

Too Much Audio. Opportunities in Ultrasonics. Elements of Ultrasonics. Experimental Ultrasonics. Coupling Ultrasonic Energy to a Load. Ultrasonics in Liquids. Ultrasonics in Solids. Testing by Ultrasonics. High-Power Ultrasonics. Notes on Using High-Power Ultrasonics. Applications of Ultrasonics to Biology. Economics of Industrial Ultrasonics.

The applications of ultrasonics have already extended to many industries, and as its possibilities are explored they will increase a hundredfold. To keep abreast of its growth, engineers in all fields must know what they may expect from ultrasonics, how it is used, how the energy is generated, and the techniques of applying ultrasonic treatment to many processes.

ULTRASONIC FUNDAMENTALS is not a big book—it does not cover the entire field of ultrasonics with hundreds of pages of dull reading. But in the three hours it will take you to read it, you will get a down-to-earth glimpse into the far-reaching possibilities of a new art.

ULTRASONIC FUNDAMENTALS

By S. YOUNG WHITE
36 pages, 40 illustrations. 8 1/2 x 11,
paper cover. \$1.75
Book Division, Dept. A
RADIO MAGAZINES, INC.
342 Madison Avenue
New York 17, N. Y.

Scientific Tests Show How To PRESERVE YOUR RECORDS And Get Superb Reproduction

DIAMOND STYLI

maintain a polished, rounded tip which minimizes wear on record grooves

**AFTER 1000 PLAYS ON
STANDARD-GROOVE RECORDS**



Osmium Sapphire Diamond

**AFTER 15 PLAYS ON
MICRO-GROOVE RECORDS**



Osmium Sapphire Diamond

The above photomicrographs (greatly enlarged) show the results of wear on stylus tips. Note the smooth, round, unchanged contours on the diamond styli. Compare them with the sharp chisel points worn on the sapphire and osmium tips. These sharp edges cut groove walls and destroy response.

**Scientists find that diamond is
90 TIMES MORE RESISTANT TO WEAR
AND 4-10 TIMES STRONGER
than sapphire—the next-hardest
material**

Why subject the records you treasure to the ruinous grinding action of worn styli? You can preserve your collection—and save money too—by using a diamond stylus. It would cost at least \$100 in sapphire stylus replacements to equal the durability and efficiency of one diamond stylus.

SPECIAL OFFER SAVES YOU MONEY

Remember that in many cases a stylus becomes worn—and causes damage—long before the defect is audible. It is far cheaper to replace your present stylus with a diamond than to have to replace or bear the loss of fine records. And you can now obtain a genuine diamond stylus—for standard or micro-groove records—at the **LOWEST PRICE EVER OFFERED!**

These are the finest styli available. The same styli are used by radio stations.

**REPLACEMENTS CAN BE MADE ON
NEARLY EVERY TYPE OF CARTRIDGE**

ATTENTION G. E. CARTRIDGE OWNERS:
Don't throw away your old model variable reluctance cartridge. The worn stylus can be replaced with diamond by our experts.

Here's how to get your diamond stylus replacement, which will pay for itself over and over. Just fill out the coupon below and mail it today. We will send you a special mailer in which you mail your cartridge or stylus assembly to us; we will replace with a new diamond stylus and return to you within a few days. If not completely satisfied after a 10 day trial, your money will be refunded.

Please Print

ANDREW'S RADIO COMPANY
44 1/2 Warburton Ave., Yonkers 2, N. Y.

Enclosed is check money order for \$14.95 for one diamond stylus replacement.
Make and model of cartridge.....
Stylus required for standard groove
 for micro-groove
Special radius sizes on request; no extra charge.
state size.....
Name.....
Street.....
City.....Zone...State.....



• **Noise generation** is considerably simplified by the use of a new miniature noise generating diode recently made available by Sylvania Electric Products, Inc., 500 Fifth Ave., New York 18. This tube, type 5722, is designed for standard laboratory noise measurement, and is operated with 150 volts on the plate and with filament voltages ranging from 2.0 to 5.5 volts, depending on the desired plate current or noise output. In intermittent service, the maximum plate dissipation is five watts, and the noise spectrum extends up to 500 megacycles/second.



• **The Corner Horn principle**, now widely accepted as highly efficient, is utilized in a new model of the Brociner-Klipsch Dual-Horn Reproducer which is now offered in attractively styled cabinets for use in the home, both period and modern. The new models feature improved performance. Driver units of higher efficiency afford cleaner reproduction of the extreme bass, a better balance in the middle range, and exceptionally smooth and flat frequency response to 15,000 cps. The basic features of the original Klipsch system are retained, and fundamental tones from 30 to 15,000 cps are reproduced cleanly and distributed throughout the listening area with uniformity. Horn loading permits bass reproduction without hangover, resulting in remarkable definition, and individual bass instruments are clearly recognized because there is no resonant frequency to be excited by all notes in its vicinity.

Details of the new models may be obtained from Brociner Electronics Laboratory, 1546 Second Ave., New York 28, N. Y.

MERIT NEWS

MERIT TRANSFORMERS Lead Again for Sound Equipment! with NEW OUTDOOR TYPE

Universal Line Transformers. To couple various line impedances to voice coil. Universal mounting bracket.

Designed specifically for maximum service in the outdoor sound field.

Features: Universal mounting (may be bolted or clamped to speaker bracket); Weather-sealed at moderate cost to withstand outdoor conditions; Encased in one piece drawn metal can; Potted to resist moisture absorption; Terminal board mounted inside can.

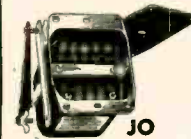

Mounting JO

MTR. Center Case

2 3/4 x 3 3/8

Dimensions

W D

4 1/4 4-7/16 3-9/16

TYPE NO.	LIST PRICE	OHMS IMPEDANCE PRIMARY	SEC. WATTS
A-4040	\$ 8.75	250-500-1000-1500-2000	4-8-16 8
A-4041	9.75	250-500-1000-1500-2000	4-8-16 12
A-4042	13.75	250-500-1000-1500-2000	4-8-16 25
A-4043	9.75	45-50	4-8 12

HEAVY DUTY OUTPUT TRANSFORMERS

High Level Type to Couple Line to Speaker

Sec. Impedances: 4:8:15:250-500 Ohms

OPEN MOUNTING D

TYPE NO.	LIST PRICE	TUBE	PR. IMPEDANCE	PR. P.P.	PAR. 6LA	P.P. 807	3300 c.t.	PR. M.A.	MAX. PER SIDE WATTS
A-3133	\$11.50							240	55
A-3131	7.00	6A3, 6B4, 45, 6P6N7, 46						80	30
A-3128	8.00	6P6V6, 6F6						50	14
*SEALED IN MOUNTING H									
A-4033	16.50							240	55
A-4030	13.00							80	34
A-4028	12.00							50	14

*Weatherproofed, potted for outdoor use at 100%, over list price.



For information on other transformers see the complete MERIT line in Sam's Red Book or ask for New MERIT Catalog No. 4911 H



EQUIP WITH MERIT OUTDOOR TYPE TRANSFORMERS TODAY



MERIT

COIL & TRANSFORMER CORP.

4415 NORTH CLARK ST., Chicago 40, Ill.

for service
with the speed
of sound...



for everything in sound, electronics,
radio and television equipment
at DEALER LOW PRICES!

WHAT DO YOU NEED?

The most complete stock of equipment
from the most minute part to the largest
installation... ready for instant delivery
from our THREE HUGE STORES AND
WAREHOUSES!

GET IT WHEN YOU WANT IT!

Newark gives 24-hour service on mail orders
... works even faster on wire or phone
requests!

COME!

Visit our elaborate sound studios in New
York and Chicago. SEE all the outstanding
high-fidelity instruments of leading manufac-
turers. HEAR and judge their performance
instantly.

COMPARE

Newark's values... the finest equipment in
the field at dealer-low prices!



FREE!

A 1c POSTCARD WITH
YOUR NAME & ADDRESS
to Dept. AE will bring
you NEWARK'S great new
1950 SOUND CATALOG
supplement!

MAIL, WIRE & PHONE
ORDERS FILLED AT
ONCE! NEW LOW CREDIT

TERMS: 10% DOWN... UP TO A YEAR TO PAY

... only 6% carrying charge - no more!

3 GREAT STORES! Uptown at 115 W. 45th St.
Downtown at 212 Fulton St. in NEW YORK
323 W. Madison St. in the heart of CHICAGO

NEWARK
FOR
RADIO & TELEVISION

MAIL NOW!

NEWARK ELECTRIC CO., INC. Dept. AE
NEWARK ELEC. CO., 242 W. 55th St., N. Y. C.
Please send FREE 1949 Newark Catalog to:

Name _____
Address _____
City _____ State _____

NEW LITERATURE

- **Co-axial Transmission Lines.** What amounts to a complete reference library on co-axial transmission lines is available to broadcast and TV engineers, and to others in high-frequency electronic fields from Andrew Corporation, 363 E. 75th St., Chicago 19, Ill. This material is essentially a catalog, but contains many reprints of magazine articles on this subject.

- **Sun Mailer.** The Sun Radio Monthly Mailer, designed to bring news, descriptions, and prices of new or unusual items available from this distributor. Free to anyone in the industrial electronics field. Write on your letterhead—Sun Radio & Electronics Co. Inc., 122 Duane St., New York, 7, N. Y.

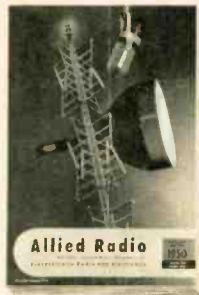

- **New jobber catalog**—with 196 pages of "everything in radio and electronics"—is offered free by Allied Radio Corp., 833 W. Jackson Blvd., Chicago, Ill.

- **Tube data book**, the seventh edition of this useful manual, has just been brought out by Sylvania Electric Products, Inc., Emporium, Pa. Includes data on 637 types of receiving tubes, together with characteristic curves of types in common use, resistance-coupled amplifier data, interchangeable tube charts, dictionary of terms, and instruction on the use of characteristic curves. Available from jobbers at a nominal charge.

- **High-speed rectangular coordinate recorder** is described in a brochure available from Airborne Instruments Laboratory, Inc., Mineola, N. Y. This instrument plots voltage or the log of voltage as a function of time or of the displacement angle of a measured element.

- **Die-less duplicating** is described fully in a 40-page catalog just published by manufacturers of Di-Aero equipment, O'Neil-Irwin Mfg., Lake City, Minn.

- **Television Components Replacement Guide** is the title of the third edition of a useful 4-page reference available from Standard Transformer Corporation, 3580 Elston Ave., Chicago 18, Ill. Ask for bulletin DD338B.

- **Varnished Insulation**—extremely important to the electrical engineering industry—is the subject of an interesting booklet just published by the Varnished Fabric and Paper Section of the National Electrical Manufacturers Association. The book covers the nature, purpose, origin, development, and use of varnished insulations. A copy may be obtained free from the NEMA, 155 E. 44th St., New York 17, N. Y.

NEED RECORDING TAPE IN A HURRY?

For emergency use, we will rush-ship (by Air if outside N. Y. area) up to 20 reels from our New York stock at prices listed for such quantities.

CALL OR WRITE

today for complete Recording Tape price list and a Free supply of Program Identification Labels.

AUDIO & VIDEO PRODUCTS CORP.
1650 BROADWAY, N. Y. 19, N. Y.

AUDIO ENGINEERING SCHOOL

A practical AUDIO engineering course in Sound fundamentals: DISC, FILM, and MAGNETIC recording; Monitoring and Mixing; AUDIO Frequency measurements. Studies assimilating Broadcast, Motion Picture, Television and Commercial Recording. Approved for Veterans.

HOLLYWOOD SOUND INSTITUTE, Inc.
1040-A North Kenmore, Hollywood 27, Calif.

Correspondence courses available

VISIBLE MAGNETIC TRACKS

MAGNETIC RECORDING USERS: See what you are recording on your tape. A solution, **Visi-Mag**, is now available in which the tape may be dipped to make the recorded signal visible. Shows irregularities in head to tape contact. Especially valuable for aligning heads on dual-track recorders. **BOOKLET** also available on how to adjust and align the heads on a popular reversible dual-track recorder. A **CARSON TAPE SPLICER** is really a big help in those editing jobs. Every tape recordist should have one. Inexpensive. Write for information.

Magnecessories, Box 6960, Washington 20, D. C.

To be sure your
calculations are
RIGHT, use

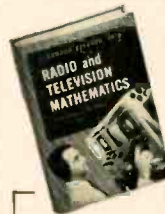

Fischer's

RADIO & TELEVISION MATHEMATICS

Over 400 sample problems, completely worked out. All the calculations commonly required in the design, operation or servicing of radio, television and modern industrial electronics are included, arranged under electronic headings where they can be easily found. All formulas, mathematical tables, and a math review are included. A highly useful handbook for anyone working in radio or television and for all those preparing for FCC license exams. \$6.00

SEE IT FREE

The Macmillan Co., 60 Fifth Ave., New York 11
Please send me a copy of Radio & Television Mathematics on 10 days' approval. I will either remit in full or return the book.

Signed _____

Address _____



NEW YORK: 100 Sixth Ave. & 542 E. Fordham Rd.
 CHICAGO: 901 West Jackson Boulevard
 BOSTON: 110 Federal Street
 NEWARK: 24 Central Avenue
 ATLANTA: 265 Peachtree Street

LAFAYETTE HI-FI SELECTOR RACK

Makes It Easy To

**LISTEN . . .
 COMPARE . . .
 CHOOSE**

Laid end to end, the components we have for your comparison would stretch more than a city block. Yet we've condensed them into one rack in one sound-proof room. Practically every known component is hooked up in this special Lafayette hi-fi rack. From it you make your choice of tuner, amplifier, speaker, baffle, record changers, etc. Test them in any combination. Compare them side-by-side! In this rack you'll find the makings of your radio-phonograph combination that has no equal in the commercial market. You'll also find single units to improve existing sound systems or receivers. And everything for LESS than you'd pay elsewhere.

AMONG THE FAMOUS MAKES FEATURED ARE:

Altec-Lansing, Bell, Bogen, Browning, Cinaudagraph, Collins, Espey, Fisher, Garrard, General Electric, Goodall, Hallierafters, Howard, Jensen, Lafayette, Meissner, National, Pickering, Radio Craftsmen, Scott, Stephens, Stromberg-Carlson, Thordarson, University, U.T.C., Webster, and many other nationally known values.

COME IN FOR A
 DEMONSTRATION

Send for NEW FREE CATALOG

LAFAYETTE RADIO

Dept. AJ-9
 100 Sixth Ave., New York, or
 901 W. Jackson Blvd., Chicago

LETTERS

[from page 10]

Sir:

I read Mr. Schwartz's letter with much interest. I would like to add my name to the list of your readers also interested in such a series.

Paul M. Kersten, M. D.
 826 Watson Ave.,
 Topeka, Kansas

Sir:

I am in complete accord . . . Not only is the available literature quite widely scattered, but the treatment varies from too elementary a presentation to one which is highly theoretical. Such a series can very well cover the "great in-between" and be a boon to the technically minded layman and audio hobbyist.

George W. Sioles,
 36 E. Montauk Highway,
 Lindenhurst, N. Y.

Exactly expresses my need . . . a boon to those of us who are not *bona fide* audio men from way back . . . There must be others like myself who would appreciate articles, not "written down" in the accepted sense, but perhaps couched in more elementary terms—projects which could be attempted with reasonable assurance of ultimate success without necessity of investing in expensive test apparatus . . . Chalk up one vote—would fill the great gaps in my own as well as in many others' audio educations. . . and on and on.

(Your response has been remarkable, and it also shows what we have not been giving our readers. The series requested by Mr. Schwartz will be inaugurated with the December issue. Ed.)

Address Changes . . .

Subscribers to AUDIO ENGINEERING should notify our Circulation Dept. at least 3 weeks in advance regarding any change in address. The Post Office Dept. does not forward magazines sent to a wrong address unless you pay additional postage. We cannot duplicate copies of AUDIO ENGINEERING sent to your old residence. Old and new addresses MUST be given.

Circulation Dept.

AUDIO ENGINEERING

Radio Magazines, Inc.

342 Madison Ave.

New York 17, N. Y.

For the First Time . . . "ON STAGE" REALISM OF BOTH HIGHS AND LOWS Speakers by **BOZAK**

New tone values, never before available to the critical listener, are now distributed over the entire area of music's most useful frequency range. From robust basses to clear, non-piercing highs, *richness* is the keynote of loudspeakers by Bozak—the gratifying result of over 10 years' skilled development.



WOOFER:
 Model B-199

Twelve-inch unit specially developed for low resonance. Not only are low frequency tones distinctly audible, but they have the rich fullness of true orchestral bass. Unique Bozak cone eliminates "drumhead" characteristic common to many woofers. Response: 40-3500 cycles; Rating: 12 watts; 22 oz. Alnico V permanent magnet using special low carbon cast pole pieces. \$52.50 list.

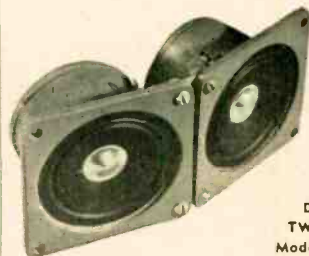

DUAL
 TWEETER:
 Model B-200

High tones, brought out with new degree of realism, now made acceptable to the ear by Bozak system of rubber damping. Direct radiated highs dispersed over wide angle. Clean, smooth response makes high frequency listening a pleasure. No shrill "piercing". Response: 1500—beyond 13,000; Cones: 2 1/2" dia. with aluminum alloy apex; Coverage: 120 deg. at 10 kc.; 100 deg. at 18 kc.; Rating: 5 watts; 7 oz. Alnico V permanent magnets. \$27.50 list. (Patents pending).

These speakers require only 1/2 mfd. capacitor for crossover.

See your distributor or write

R. T. BOZAK
 DESIGNER & MANUFACTURER

90 Montrose Ave.

Buffalo 14, N. Y.

Some
Prefer a
Portable



Others
Prefer a
Standard

But ALL Prefer
TWIN-TRAX^{*}
"The Tape Recorder
the Engineers are Buying"

When it comes to high fidelity sound equipment, it's the specifications that count with engineers. And that's why they're buying Twin-Trax—the popular-priced tape recorder with professional specifications. Extended frequency response, wide dynamic range, low hum level, easy operation, trouble-free performance! And two tracks means twice the playing time on standard tape reels, with tape costs cut in half—a saving you don't have to be an engineer to appreciate.

Write today for technical literature and professional factory discounts.

^{*}Trademark

AMPLIFIER CORP. OF AMERICA

398-4 Broadway • New York 13, N. Y.

DOLLAR DEFICITS.

We heartily endorse Mr. Paul Hoffman's statement that the only way to overcome a deficit of dollars is to earn them. In an article in the London Daily Express of July 29th, H. A. Hartley said, apropos of earning dollars, "It cannot be done by State planners who consider the people of North America a collection of suckers who will buy anything so long as it is marked 'Made in Britain'. I find Canada and U.S.A. anxious to do business with me, not because a high-powered, high-salaried hawk has called on them with sales ballyhoo, but because we offer them something they cannot buy at home and the price is right."

In seven short months Hartley-Turner reproduction has brought new pleasure to many American music-lovers, and you can experience this pleasure too at an absurdly low cost. In spending dollars on Hartley-Turner you may be helping international economics but the thing that matters is that you have got something you couldn't get anywhere else at any price!

The Hartley-Turner 215 Speaker . . . \$50.00

High-grade output transformer . . . 14.00

Complete Kit of parts for
Bottle Cabinet 32.00

These prices include freight, packing and insurance. Import duty 15% which you pay to the postman.

Send a dollar bill today for the complete guide to high-fidelity "New Notes In Radio", including a service of technical data sheets dealing with every aspect of the subject. Literature is free for the asking.

H. A. HARTLEY Co., Ltd.
152, HAMMERSMITH ROAD,
LONDON, W. 6, ENGLAND

ADVERTISING INDEX

Allied Radio Corp.	56
Altec Lansing Corp.	51
Amperite Co., Inc.	49
Ampex Electric Corp.	Cover 3
Amplifier Corp. of America	56
Andrew's Radio Company	53
Arnold Engineering Co.	9
Astatic Corporation, The	42
Audak Company	35
Audio Devices, Inc.	Cover 2
Audio Engineering Society	50
Audio Facilities Corp.	46
Audio Instrument Co.	36
Audio Pacific Co.	50
Audio & Video Products Corp.	54
Bozak, R. T.	55
Camera Equipment Co.	38
Cinema Engineering Co.	51
Clarkstan Corp.	45
Electro-Voice, Inc.	29
Fairchild Recording Equip. Corp.	37
Gordon, Herman Lewis	46
Gray Research & Dev. Co.	40
Hartley, H. A. Co., Ltd.	56
Hewlett-Packard Co.	2
Hollywood Sound Institute	54
Hycor Mfg. Co.	52
Industrial Electrical Works	8
Jensen Manufacturing Company	11
Lafayette Radio	55
Leak, H. J. & Co., Ltd.	7
LeBel, C. J.	46
Livingston Electronic Corp.	56
MacMillan Co., The	54
Magnecories	54
Magnecord, Inc.	42
Merit Coil & Transformer Corp.	53
Newark Electric Co., Inc.	54
Nuclear Products Co.	50
Peerless Elec. Products	44
Pickering & Co., Inc.	47
Presto Recording Corp.	10
Professional Directory	46
Racon Electric Co., Inc.	48
Radio Corp. of America {Broadcast Equip. Div.}	4, 5
Recogram Recorders Co.	48
Reeves Soundcraft Corp.	31
Rek-O-Kut Company, Inc.	47
Shure Brothers, Inc.	39
Somerset Laboratories, Inc.	49
Standard Transformer Corp.	33
Stephens Manufacturing Co.	40
Sun Radio & Electronics Co., Inc.	48
Sylvania Electric Products, Inc.	1
Terminal Radio Corp.	43
United Transformer Corp.	Cover 4
U. S. Recording Co.	46
Ward Leonard Electric Co.	41
Wells, Winston	46
Western Electric Company	12
Wiley, John & Sons, Inc.	46, 52

Another Audio Addition
by
LIVINGSTON



The Pocket Stylus Pressure Gage—with expanded 0-10 gram range and full range at 30 grams, is an economical yet accurate solution to the problem of stylus pressure determination.

Compact, sturdy, and attractive, this gage really "does the job." Selling for \$1.50 net, it's another member of the Line "by Livingston."



The MB Loudness Control is now available at most jobbers, and is the instantaneous hit we had hoped it would be.

Write us direct, if you care to, for the address of your nearest jobber.

Livingston Electronic Corp.
Livingston, New Jersey

FREE! Send for it NOW!

**ALLIED'S NEW
1950 CATALOG!**

**196 PAGES—
Everything in
Radio and
Electronics**



**GET RADIO'S
LEADING BUYING GUIDE**

Service Technicians and Engineers: ALLIED'S 1950 Buying Guide brings you all the new releases and money-saving values—from the world's largest stocks of test instruments, amplifiers, P.A. systems and equipment, tubes, parts, tools, books and accessories—ready for instant expert shipment. Send today for your FREE new 196-page ALLIED Catalog.

ALLIED RADIO CORP., DEPT. 17-K-9
833 W. Jackson Blvd., Chicago 7, Ill.

Send FREE New ALLIED Catalog.

FREE

Name.....

Address.....

ALLIED RADIO

Listen for the words "Transcribed by AMPEX" after the great shows in radio

Here's why.....

the new series 300

AMPEX

MAGNETIC TAPE RECORDER
answers industry need!



*Designed by engineers
who had your engineering
needs in mind!*

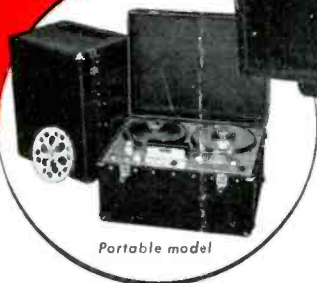

Portable model

Console Model 300* \$1,573.75
Portable Model 300 \$1,594.41
Rack Mounted \$1,491.75

* Meter panel extra

F. O. B. Factory, San Carlos, Calif.

★ **Original program quality preserved**

Use of independent reproduction facilities allows instantaneous monitoring and makes possible the most stringent comparisons between recordings and originals.

★ **Tape and playback noise non-existent**

Use of special record and bias circuits has eliminated tape noise.* Extreme care has been exercised to eliminate hum pick-up.

★ **Editing made easy**

With Ampex editing is almost instantaneous. Single letters have been actually cut off the end of words. Scissors and scotch tape are all the tools needed.

★ **You can depend on Ampex**

Read what Frank Marx, Vice President in charge of Engineering, American Broadcasting Company, says: "For the past two years A.B.C. has successfully used magnetic tape for rebroadcast purposes... A.B.C. recorded on AMPEX in Chicago... 17 hours per day. For 2618 hours of playback time, the air time lost was less than 3 minutes: a truly remarkable record."

SPECIFICATIONS

FREQUENCY RESPONSE:

At 15" ± 2 db. 50-15,000 cycles
At 7.5" ± 2 db. 50- 7,500 cycles

***SIGNAL-TO-NOISE RATIO:** The overall unweighted system noise is 70 db. below tape saturation, and over 60 db. below 3% total harmonic distortion at 400 cycles.

STARTING TIME: Instantaneous. (When starting in the Normal Play mode of operation, the tape is up to full speed in less than .1 second.)

FLUTTER AND WOW: At 15 inches per second, well under 0.1% r.m.s., measuring all flutter components from 0 to 300 cycles, using a tone of 3000 cycles. At 7.5 inches, under .2%.

Manufactured by Ampex Electric Corporation, San Carlos, Calif.

DISTRIBUTED BY

BING CROSBY ENTERPRISES

9028 Sunset Blvd., Hollywood 46, Calif.

**AUDIO & VIDEO
PRODUCTS CORPORATION**

1650 Broadway, New York, New York

GRAYBAR ELECTRIC CO. INC.

420 Lexington Ave., New York 17, N. Y.



FOR COMPACT HIGH FIDELITY EQUIPMENT

Ultra compact, lightweight, these UTC audio units are ideal for remote control amplifier and similar small equipment. New design methods provide high fidelity in all individual units, the frequency response being ± 2 DB from 30 to 20,000 cycles. There is no need to resonate one unit in an amplifier to compensate for the drop of another unit. All units, except those carrying DC in Primary, employ a true hum balancing coil structure which, combined with a high conductivity outer case, effects good inductive shielding. Maximum operating level $+ 10$ DB. Weight—8 ounces. Dimensions— $1\frac{1}{2}$ " wide x $1\frac{1}{2}$ " deep x 2" high.

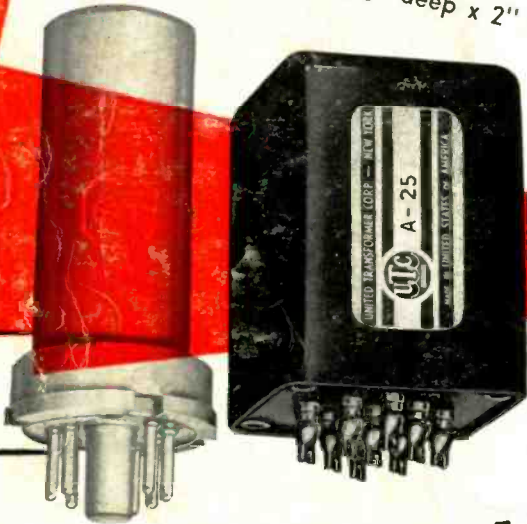

Unit shown is actual size. 6V6 tube shown for comparison only.

HERMETICALLY SEALED

On special order, we can supply any of the Ultra Compacts hermetically sealed per Jan T-27 Grade 1 Class A in our RC 50 case as illustrated. Dimensions: Height $2\frac{1}{4}$ ", Base $1\frac{9}{16}$ " x $1\frac{9}{16}$ ".



ULTRA COMPACT HIGH FIDELITY AUDIO UNITS

Type No.	Application	Primary Impedance	Secondary Impedance	± 2 DB from	List Price
A-10	Low impedance mike, pickup, or multiple line to grid	50, 125/150, 200/250, 333, 500/600 ohms	50,000 ohms	30-20,000	\$15.00
A-11	Low impedance mike, pickup, or line to 1 or 2 grids.	50, 200, 500 ohms Multiple alloy shielded for	50,000 ohms extremely low hum pickup	50-10,000	16.00
A-12	Low impedance mike, pickup, or multiple line to push pull grids	50, 125/150, 200/250, 333, 500/600 ohms	80,000 ohms overall in two sections	30-20,000	15.00
A-18	Single plate to two grids Split primary	8,000 to 15,000 ohms	80,000 ohms overall, 2.3:1 turn ratio overall	30-20,000	14.00
A-19	Single plate to two grids 8 MA unbalanced D.C.	15,000 ohms	80,000 ohms overall, 2.3:1 turn ratio overall	50-20,000	18.00
A-24	Single plate to multiple line	8,000 to 15,000 ohms	50, 125/150, 200/250, 333, 500/600 ohms	30-20,000	15.00
A-25	Single plate to multiple line 8 MA unbalanced D.C.	8,000 to 15,000 ohms	50, 125/150, 200/250, 333, 500/600 ohms	50-12,000	14.00
A-26	Push pull low level plates to multiple line	8,000 to 15,000 ohms each side	50, 125/150, 200/250, 333, 500/600 ohms	50-20,000	15.00
A-30	Audio choke, 300 henrys with no D.C. 450 henrys	8,000 to 15,000 ohms each side	50, 125/150, 200/250, 333, 500/600 ohms	50-20,000	10.00

The above listing includes only a few of the many Ultra Compact Audio Units available. Write for our new catalog.

United Transformer Co.

NEW YORK 13, N. Y.
150 VARICK STREET
EXPORT DIVISION 13 EAST 40th STREET, NEW YORK 16, N. Y. CABLES: "ARLAB"