

db

THE SOUND ENGINEERING MAGAZINE

October 1970 75c

Compressors and Limiters –
Forum and Compendium

A Four-Channel Stereo Broadcast

The London Professional Audio Exhibition

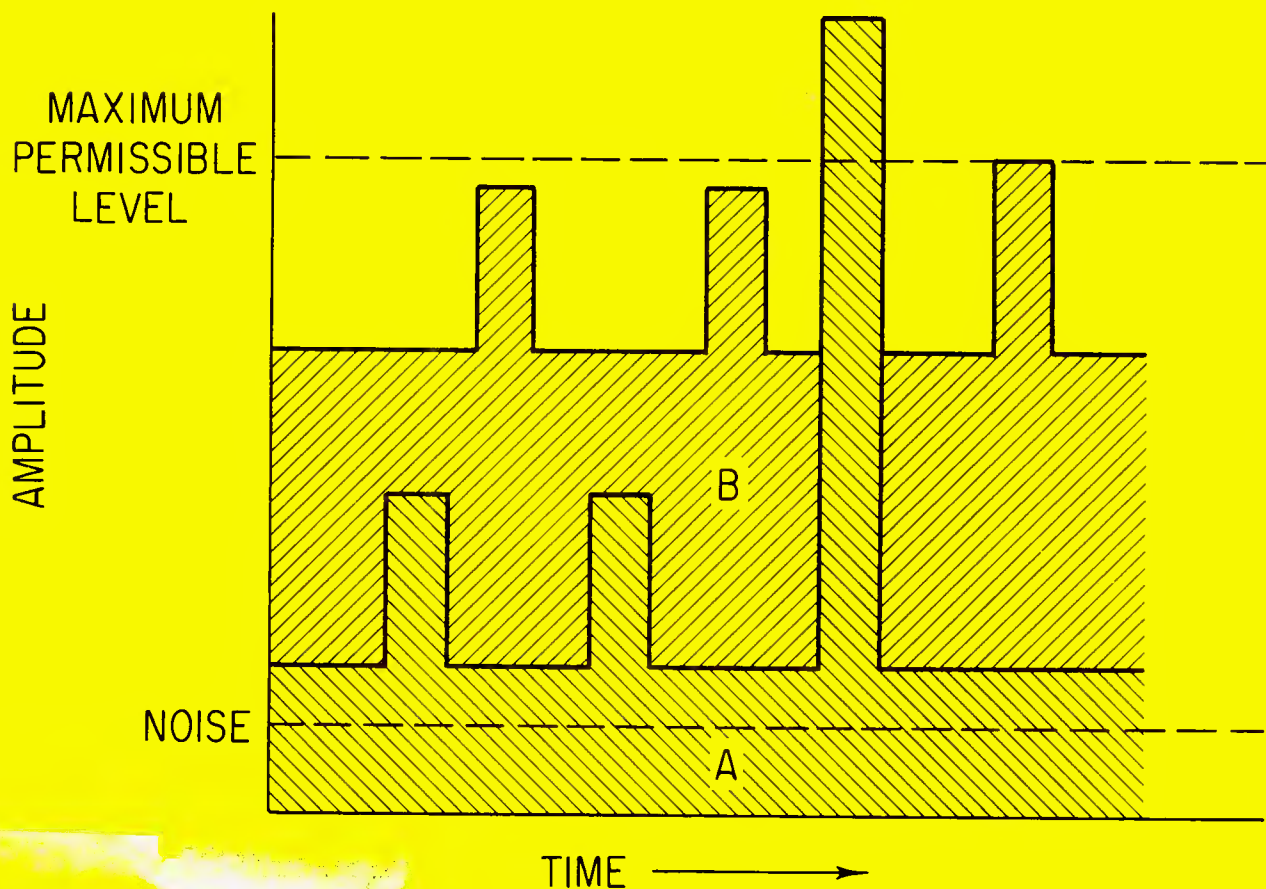

BUILT FROM SCRATCH for mirror-perfect sound

The Gauss 1400 Professional Studio Master Recorder is the *first* audio transport designed for 2" tape. It is assembled on a massive, precision-machined casting which stabilizes azimuth and tape tracking adjustments. Look at these features:

- Complete flexibility in overdub and sync modes.
- Automatic monitor transfer to line from sync/record.
- Monitor preview between line and sync/record.
- Instantaneous record/reproduce punch-in/punch-out with no pops or ticks.
- Preset level control for both record and reproduce.
- Simultaneous local or remote control, all functions.
- Illuminates status indicators, local and remote.
- Two high level outputs: 1) Sync monitor; 2) Permanent reproduce output (exclusive with Gauss).
- No relays.
- Full edit capability without tape creep.
- Internal variable stabilized capstan speed control obviates external power amplifier and oscillator.
- 3 forward/reverse wind speeds.
- All controls and adjustments for operation and service are front-accessible.

Equipment that good has to be built from scratch . . .
by Gauss!



Gauss Electrophysics
An MCA Tech. Division
11822 W. Olympic Blvd.
Los Angeles, California 90064
(213) 478-0261

Circle 10 on Reader Service Card

Coming Next Month

●Next month a special issue devoted to the sophisticated business of mass duplication of tapes. Norman H. Crowhurst has researched and delved to come up with the total picture and equipment at the present state of the art. Included, will be a directory of equipment manufacturers.

Martin Dickstein went behind the scenes at a new audio/visual exhibit at New York's Burlington Mills Building. The exhibit is called the Mill and it is in every way a miniature world's fair of display, using giant visuals, multiple slide-projection techniques, special audio effects, and a moving viewing platform.

We will have a picture gallery report on the latest equipment shown at the New York Audio Engineering Society Convention.

And there will be our regular monthly columnists, George Alexandrovich, Norman H. Crowhurst, Martin Dickstein, Arnold Schwartz, and John Woram. Coming in *db*, The Sound Engineering Magazine.

About the Cover

●This art work is an illustration from John Woram's THE SYNC TRACK column which begins our special section on compressors and limiters. It starts on page 25 and goes to page 35.

db

THE SOUND ENGINEERING MAGAZINE

OCTOBER 1970 • Volume 4, Number 10

Table of Contents

FEATURE ARTICLES

- A Forum on Compressors and Limiters 31
- Compressor and Limiter Directory 33
- A Four-Channel Stereo Broadcast
Richard Alan Rogers 36
- London Professional Audio Exhibition
John Borwick 40

MONTHLY DEPARTMENTS

- Letters 2
- The Audio Engineer's Handbook
George Alexandrovich 4
- The Feedback Loop
omitted this month
Arnold Schwartz
- Theory and Practice
Norman H. Crowhurst 10
- Sound with Images
Martin Dickstein 16
- New Products and Services 21
- The Sync Track
John Woram 25
- The *db* Bookcase 44
- Classified 45
- People, Places, Happenings 46

db is listed in **Current Contents: Engineering and Technology**

EDITORIAL BOARD OF REVIEW

George Alexandrovich
Sherman Fairchild
Norman Anderson
Prof. Latif Jiji
Daniel R. von Recklinghausen
William L. Robinson
Paul Weathers
John H. McConnell

db, the Sound Engineering Magazine is published monthly by Sagamore Publishing Company, Inc. Entire contents copyright ©1970 by Sagamore Publishing Co., Inc., 980 Old Country Road, Plainview, L.I., N.Y. 11803. Telephone (516) 433-6530. *db* is published for those individuals and firms in professional audio—recording, broadcast, audio-visual, sound reinforcement, consultants, video recording, film sound, etc. Application should be made on the subscription form in the rear of each issue. Subscriptions are \$6.00 per year (\$7.00 per year outside U. S. Possessions, Canada, and Mexico) in U. S. funds. Single copies are 75c each. Controlled Circulation postage paid at Easton, Pa. 18042. Editorial, Publishing, and Sales Offices: 980 Old Country Road, Plainview, New York 11803. Postmaster: Form 3579 should be sent to above address.

ADVERTISERS INDEX

Reader Number	Advertiser	Page
11	Allison Research	Cover III
12	Ampex	Cover IV
35	Audio Designs	29, 30
28	Automated Processes	16
19	Bang & Olfson	6
16	CCA—QRK	4
15	Dolby Labs	3
37	Duncan Electronics	27
26	Electrodyne	23
41, 14	Fairchild Sound	14, 18
25	Gately Electronics	9
10	Gauss Electrophysics	Cover II
30	Gotham Audio	26
31	Infonics	18
24	Koss	11
38	MCI	41
17	Maxell	7
32	Mincom (3M)	17
33	Neve	25
29	Orban Parasound	19
36	Pentagon Industries	38
21	ReVox	8, 10, 12
27	Spectra Sonics	20
23	Suburban Sound	13
18	Superscope	5
22	Teac	15
20	Timekeeper	14
40	UREI	43
39	URL	39
34	Westrex	26

Letters

The Editor:

Mr. Silver's article on SYNCHRONOUS RECORDING TECHNIQUES, July 1970, dismisses, with a mere seven lines of mention, a system which is employed extensively by some of the world's largest motion-picture studios. Furthermore, his statement is that it does not fulfill professional requirements.

I refer to employment of two-track tape recorders in which one track is employed for dialog or music and the other for the 60Hz synchronizing signal.

We have been making such machines for several years. Among the studios that use them exclusively for on-the-set dialog recording are Universal, 20th Century Fox, and CBS Studio City (formerly Republic Studios).

Signal-to-noise performance has never been a problem nor has there ever been need to be concerned with cross talk from the sync signal since these are in no way physically intermingled. As far as inability to playback such tapes on a full-track quarter-inch machine is concerned, Mr. Silver must surely recognize that such machines are, in general, fast fading from the professional audio scene. They continue to be found in use primarily in applications where they are essential to maintain minimum 60 Hz cross talk in sync systems containing cross oriented or push pull sync tracks. Furthermore, introduction of the synchronizing signal anywhere on top of the signal track takes its toll in degradation of signal-to-noise because of the modulation noise it causes.

*John T. Mullin
Research Specialist
Professional Audio Products
3M Company
Camarillo, California*

Robert Bach
PUBLISHER

Larry Zide
EDITOR

Bob Laurie
ART DIRECTOR

Marilyn Gold
COPY EDITOR

Richard L. Lerner
ASSISTANT EDITOR

A. F. Gordon
CIRCULATION MANAGER

Eloise Beach
ASST. CIRCULATION MGR.

SALES OFFICES

New York
980 Old Country Road
Plainview, N.Y. 11803
516-433-6530

Chicago
Jim Summers & Associates
35 E. Wacker Drive
Chicago, Ill. 60601
312-263-1154

Denver
Roy McDonald Associates, Inc.
846 Lincoln Street
Denver, Colorado 80203
303-825-3325

Houston
Roy McDonald Associates, Inc.
3130 Southwest Freeway
Houston, Texas 77006
713-529-6711

Dallas
Roy McDonald Associates, Inc.
Semmons Tower West
Suite 714
Dallas, Texas 75207
214-637-2444

San Francisco
Roy McDonald Associates, Inc.
625 Market Street
San Francisco, California 94105
415-397-5377

Los Angeles
Roy McDonald Associates, Inc.
1313 West 8th Street
Los Angeles, California 90018
213-483-1304

Portland
Roy McDonald Associates, Inc.
2305 S. W. 58th Avenue
Portland, Oregon 97221
503-292-8521

Japan
TECHNOSERVICES, LTD.
31-16 Akazutsumi 1-Chome
Setagaya-Ku
Tokyo 156, Japan



DOLBY AND MULTITRACK IN LONDON

With the increasing sophistication of pop and rock recording, quality conscious London studios are finding the DOLBY SYSTEM essential in preventing the noise problems which are otherwise inherent in multi track recording. In London's rapidly expanding network of 16-track studios, 19 of the 20 recorders currently in use are fully equipped with Dolby noise reduction units

Robin Cable at Trident Studios
23 Dolby A301 units,
including 16 on two 16-track recorders

Mike Claydon at I.B.C. Recording Studios
fully Dolby equipped 16-track installation

Frank Owen at Island Studios
30 Dolby A301 units,
including 24 on three 16-track recorders

top right:
One of the Dolby installations at Olympic Studios
London's first multi-track studio to use
noise reduction throughout

DOLBY LABORATORIES INC

333 Avenue of the Americas New York NY 10014
telephone (212) 243-2525 cables Dolylabs New York

UK and international:
346 Clapham Road London SW9 England
telephone 01-720 1111 telex 919109 cables Dolbylabs London



Circle 15 on Reader Service Card

Q R K

Announces a
Break Thru!!

RUMBLE?



NOT WITH THE

Q R K

QRK is now producing turntables with rumble figures far better than NAB specifications!!

QRK rumble, -39db NAB, -35db
QRK weighted rumble -62db

Instant start; reliable; unequalled service; attractively priced; and now . . . rumble free performance!!

QRK ELECTRONIC PRODUCTS, INC.
1568 NORTH SIERRA VISTA, FRESNO, CALIFORNIA 93703 • Phone: 209 251-4213

Subsidiary of

CCA ELECTRONICS CORP.
716 JERSEY AVENUE, GLOUCESTER CITY, NEW JERSEY 08030 • Phone: 609 456-1716

The Audio Engineer's Handbook

GEORGE ALEXANDROVICH

INPUT IMPEDANCE AND FREQUENCY RESPONSE

• Every once in a while when extreme accuracy in measuring frequency response is needed, audio engineers and technicians fall into an invisible trap and come up with erroneous results. See if you can recall an occasion when you have been measuring frequency response of a system or device and every time you changed the frequency you readjusted the output of the signal generator because the meter connected across its output terminals showed a change of level. Have you ever stopped to think if this touching up of the generator output was improving the accuracy of your readings, or throwing you off course.

Let's analyze it together. First, we should recall some properties of the signal generator output. Most generators in use for audio measurements have a 600-ohm source impedance. Some models have selectable pads providing variety of output impedances. Some models have very low output impedances so almost any load is bridging.

What is bridging and what is matching? The term *bridging* means that load impedance is at least ten times larger than source impedance and very small percentage of power available from the source is being drawn. Matching load draws maximum available power from the source and its impedance equals that of the source. Bridging load is used when only voltage of the source is being sensed for further amplification in equipment which follows.

To verify that the load is matching you should observe a 6 dB voltage drop as the load is connected to the signal generator terminals. If the impedance of the load is varied so will the voltage. Basically this phenomenon is the theme of this month's discussion. It may seem to be simple and straightforward but it has fooled many

people I know. Well, back to our discussion about signal generators. If the signal generator has a source impedance of several ohms any load used in practical application would not affect the output of the generator. It also means that if the load impedance is varied the output voltage will remain constant. This is sort of an ideal condition which can be found in many systems today, which use amplifiers having very low output impedance and very high input impedance. This way no source is ever overloaded, or affected by the multiple loading of several bridging loads.

The majority of system components in use require matching of inputs and outputs. Most of the transformer isolated devices require matching of impedances.

When we test a certain piece of equipment for frequency response what are we trying to find out? We want to know how much deviation in frequency response we are to expect when the signal generator is substituted by the microphone or other source of audio signal in actual use. We want to be sure that the signal generator is a precise replica of our audio source, impedance-wise, in order to assure accurate readings. If we are substituting a source which is a 600-ohm line, then our signal generator should have a 600-ohm source impedance, if the source is 50 ohms then we have to adjust the output impedance of the generator to be 50 ohms. Since most equipment inter-connections are made by means of transformers, we should take a hard look at the transformers in general.

It is a well-known fact that the impedance of a transformer varies with frequency. And no wonder. Resistance of the wire, inductance of the coils as determined by the quality of the metal laminations, and the interwinding capacitances make a transformer the most non-linear device we use as far as impedance is concerned.

Depending on the loading and termin-

Circle 16 on Reader Service Card

Circle 18 on Reader Service Card →



Sony professional at work.

You're looking at Sony's new ECM-50 Tie-Tac/Lapel Electret Condenser Microphone. It's one of the new line of Sony Professionals—products specifically designed for special applications.

For example, TV announcers long burdened by the cumbersome lavalier version of the standard dynamic microphone, will welcome the miniaturized Sony ECM-50 Tie-Tac/Lapel condenser microphone. Employing the electret principle, it is so small it literally cannot be seen on camera. Yet its condenser performance with tailored frequency response and high sensitivity is vastly superior to any dynamic lavalier microphone.

The Sony ECM-50 is an excellent example of the new line of Sony/Superscope special application products that have a unique ability to solve difficult problems in modern communications.

The ECM-50 is available at select Sony/Superscope dealers. For their names, as well as complete details and specifications, please write Special Application Products Division, Sony/Superscope, 8150 Vineland Ave., Sun Valley, CA 91352.

SONY **SUPERSCOPE**

Frequency/Phase Response Test Record

- RIAA-Equalized 1 kHz Square Wave
- Low-Distortion 1 kHz Sine Wave
- Silent Grooves of 50 dB Weighted
- 3 kHz Signal for Flutter Test

\$6.95

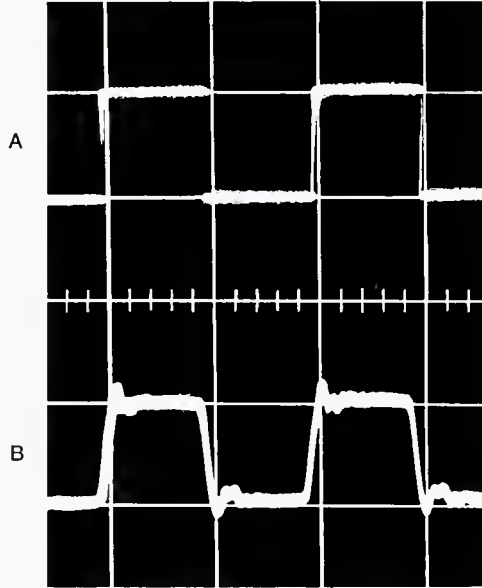

A — INPUT TO RECORDING AMPLIFIER
B — REPLAY FROM DISC

Here is a single record designed to provide a precise and rapid evaluation of disc playback equipment. It is a seven-inch, 45 r.p.m. disc of highest quality. All cuts are recorded to the RIAA characteristic, no other equalization is required to interpret the square waves.

Broadcast/recording standards are used throughout in the disc's production. The 1 kHz square wave has a tilt of less than 1% and is recorded at an RMS velocity of 7 cm./sec. (equivalent to a sinusoidal form). Overshoot and ringing have been found to be purely a function of replay.

The 1 kHz sine wave will be found useful for level and distortion measurements. Recorded velocity is 7 cm./sec. Typical distortion measurements (using a 500 Hz high-pass filter) are less than 2%.

Silent grooves are provided for rumble evaluations. Accurate measurements with signal-to-noise measurements of better than 50 dB are possible.

Finally, a 3 kHz signal is recorded for use with standard flutter meters. When played on a high-quality turntable, measurements well below the NAB standard may be made.

The recording is produced in Australia by Ranger Recordings, exclusively for TIMEKEEPER.

TO: TIMEKEEPER

P. O. Box 762
Mincola, N. Y. 11501

Enclosed is a check for \$..... Please send copies of the Ranger Frequency/Phase Response Test Record at \$6.95 each. Shipping costs: add 50c regardless of quantity.

Name Company

Address

City State Zip

(New York State residents must add 5% sales tax)

ation, a transformer can attenuate, resonate, shift phase, and distort. Transformers are designed for specific application, utter care should be used if high-quality performance is desired.

Transformers are used extensively on the input of almost all systems for isolation. Designers of the equipment try to devise circuits and transformers which would keep the input impedance constant, but even the best designs are not perfect. Inevitably, at some frequencies transformers will show variation in impedance. Generally, it drops at the low frequencies and increases at the extreme high frequencies. Capacitive loading of the secondary winding may produce resonance so that transformer may look like a tank circuit with usually fairly low Q.

And now we are ready to measure frequency response of the system. Let's assume that we have a piece of gear with an input impedance of 600 ohms, transformer isolated. We connect the generator with 600 ohm output impedance. Across the input terminals we connect a vtvm. We select the reference frequency in the middle of the band and adjust for convenient output level. A second vtvm is connected at the output of the system. We adjust the gain of the system to have correspondingly convenient indication on the second vtvm. Now we start changing frequency. As we reach the lowest design frequencies of the unit, we may note that the output of the system has dropped let us say 1 dB. But, you also notice that the voltage across the input terminals has also dropped 1 dB. Would you re-adjust the output of the generator raising it 1 dB while the output indication reaches reference level? Would you declare the response of the system flat at the low end, or would you say it is down 1 dB?

Definitely the last. Although the voltage gain of the system remained the same, loading of the input transformer on the generator output produced a level drop of 1 dB. This showed up at the output of the system as a drop in level. The reason you can't readjust the generator output is simply because under actual working conditions the generator will be substituted by a source with the fixed output adjusted to produce flat frequency response into an ideal load—most likely a vtvm with resistive load.

If, instead of a 600-ohm generator we had an extremely low-impedance source (of several ohms) then this frequency rolloff would have never showed up. In actual operation, if the source would have been 600 ohms then low-frequency rolloff would exist.

Circle 19 on Reader Service Card



The only thing you'll ever get from a bent horn is a sour note.

Unless you're using the best in tape, you can expect a lot of sour notes among the sweet.

One way to tell which is best is to look at the guarantee. The best goes the limit. Ours is guaranteed, unconditionally. Maxell tapes must perform to your standards or we'll replace them, pronto, with no questions asked.

That's just one of the reasons more and more record and dupe makers specify the advanced Maxell F-20 magnetic tape. It's the one for high frequencies, capturing every note on the scale, 25 to 18,000 Hz, 10% greater tensile strength than conventional tapes. Plus an exclusive, our closely-guarded Hush-Hush process that practically wipes out hiss, permits fullest, truest fidelity for mono or stereo, recording and playback.

Maxell F-20. The bulk tape made specifically for duplicating and recording cassettes. For the sweetest sounds you ever heard.

- For general recording purposes, Maxell bulk tapes for C-60, C-90 and C-120 cassettes.

For details on all Maxell professional tapes, write

maxell® Maxell Corp. of America
Dept. DB-1, 501 Fifth Avenue, New York, N. Y. 10017



THE PROFESSIONAL CAPABILITY FACTOR

In an area where versatility and performance often tend to be nothing more than a set of written specifications, one tape recorder stands apart from all the rest, Revox.

Revox is built to such exacting standards that Julian Hirsch writing in Stereo Review was moved to comment, "We have never seen a recorder that could match the performance of the Revox A77 in all respects, and very few that even come close."

But performance is only part of the story. When you've produced a truly professional quality machine you should be prepared to go all the way and provide complete professional capability. That's why Revox is the only machine in its price class (or anywhere near it) that's built to handle NARTB professional 10½" tape reels.

A 10½" reel offers twice the recording time of the standard 7" reel found on most tape recorders. And while much has been made of slower playing speeds and double-play tapes, the fact remains that frequency response, signal-to-noise ratio, dynamic range and a number of other important recording characteristics are adversely affected by slower speeds and thinner tapes.

Certainly smaller reels, slower speeds and thinner tapes have their place in home tape recording and Revox provides for them, but they have nothing to do with professional performance standards.

If you want fully professional performance and capability and you're not prepared to settle for anything less, the answer is Revox.

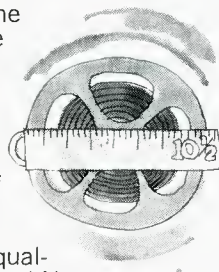

REVOX DELIVERS WHAT ALL THE REST ONLY PROMISE.

Revox Corporation
212 Mineola Avenue,
Roslyn Heights,
N.Y. 11577

1721 N. Highland Ave., Hollywood, Calif. 90028
In Canada: Tri-Tel Associates, Ltd., Toronto, Canada

Circle 21 on Reader Service Card

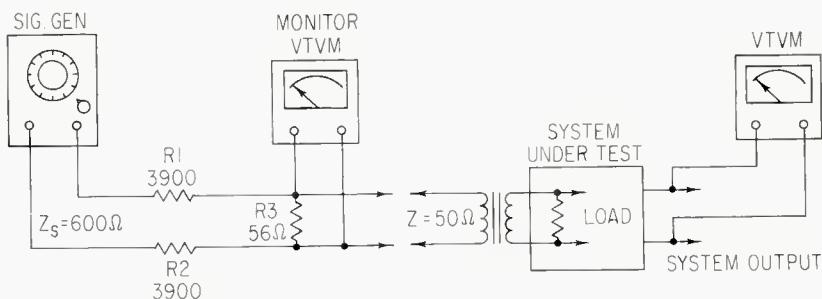

Figure 1. A balanced resistive pad for low-impedance, low-level loads.

Another case involving the same test set-up, but where deviations of input level do not affect the output of the complete system, is where the system compensates for the variations in the input impedance. There is another example where readjustment of the input level is wrong. If the input transformer is properly terminated minor variations in the impedance of the primary may be neglected, providing over-all results are satisfactory. But there may exist a condition when two loads are connected to the same source—one load is matching and the other is bridging. This happens often when outputs of the console are bridged off for monitoring while main feed is connected to a matching line.

In this case impedance variation of the matching line will adversely influence the monitoring circuit. Standard procedure to minimize this interaction is to use isolation pads between the console output and the matching load. However, thanks to the modern technology of bridging loads and low impedance sources, if the output amplifier of the console happens to be of low output impedance, no isolation pad is required and no interaction between loads will occur. This is because the matching load is no longer matching, but bridging.

Since we are on the subject of matching loads and measurements of frequency response it would be appropriate to consider one more situation found in daily practice. This is the matching of signal-generator impedance as well as its level to the mic input circuit. In practice there are only few studios or maintenance shops equipped with costly audio test generators. Most likely you can put your hand on a generator with 600-ohm impedance and on output level of several volts. How would you go about deriving the signal from such unit at a mic level of -60 dBm or matching the impedance of the unit to the 50-ohm load?

Another word of caution. Before attempting to turn that level-control knob down in order to achieve levels of -50 or -60 dB make sure that

the generator produces signal with low noise and distortion content. The best approach is to build an external balanced resistive pad which can accomplish impedance matching and level reduction at the same time.

Since most of mic inputs are balanced, you would have to build a balanced resistive pad. From FIGURE 1, you will note that resistor R3 determines the source impedance for the load. Let us use a 56-ohm resistor for R3, then the extra 6 ohms will represent the d.-c. resistance of the mic line. For all practical purposes it will be close enough. Next, you want to find the values of R1 and R2 which would reduce the level 50-60 dB. In order to reduce voltage 44 dB, the pad ratio should be 160/1. From this it follows that 50 ohms x 160 = 8000 ohms. Since the pad is balanced, R1 and R2 are only half of this value: 4000 ohms each. Using standard resistance values of 3900 ohms we obtain voltage across R3 about 43 dB below the output of the generator output. Now when we connect the 50-ohm load, level across R3 should drop another 6 dB adding to a total of 49 dB reduction in generator output level. However, if we aim to get dBm or power reading across the 50-ohm source then we should reduce voltage across it another 11 dB in order to maintain the same power as it would be across the 600 ohms. In other words, the lower the impedance—the less voltage it takes to develop the same power across it. It is shown by the power formula:

$$P = \frac{V^2}{R} \quad \text{where } P \text{ is in watts} \\ \qquad \qquad \qquad V \text{ in volts} \\ \qquad \qquad \qquad R \text{ in ohms}$$

$$\text{Also} \\ 0 \text{ dBm} = 1 \text{ mW in } 600 \text{ ohms} = 0.775 \text{ volts} \\ \qquad \qquad \qquad \text{or} \\ 0 \text{ dBm} = 1 \text{ mW in } 50 \text{ ohms} = 0.223 \text{ volts}$$

To summarize, any time you have to perform some measurements, stop, think, and analyze the circuit for a minute. This minute will be well spent since it might save you hours of retesting and trying to figure out what went wrong. ■

Excellence

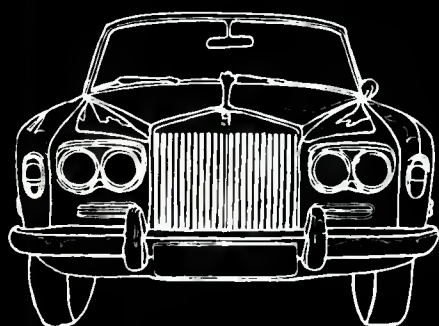

**Excellence
you can
afford**

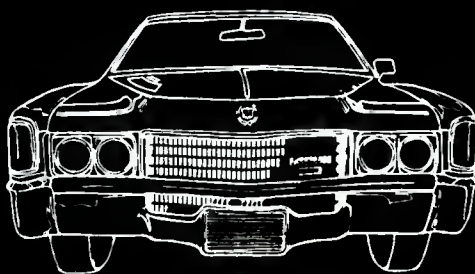

**Excellence
—economy
size**

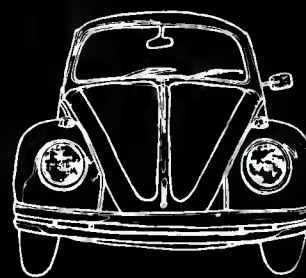

If it's more than you can use...you don't need it!

In automobiles—as in almost everything—excellence is seldom limited to the most prestigious, or the most expensive. Excellence comes in many sizes.

At Gately we believed that most “name” audio systems were overfeatured—at Rolls prices—for the majority of studios. So Gately research went to work and developed the “Cadillac” class of audio equipment—our Series Eight BUILDING BLOCK module system.

The Building Block system allows a studio to buy for today's needs with an eye on tomorrow. When you want to increase the capability of your Series Eight System, just add one or more affordable Building Block modules. Wiring connections are elementary and may be done by the average studio engineer—at additional cost savings up to

75%! Today your needs may dictate an 8-input, 2-output console, for instance. This can affordably be expanded to 24 inputs for 8- or 16-track work merely by adding the appropriate building blocks.

For those studios requiring excellence in economy size we offer the Gately Series Seven—4- or 8-channel mixer-equalizer capabilities at really low prices . . . with no sacrifice in quality or performance.

So before you pay Rolls prices for features you may never use, check with Gately. You'll be greatly impressed with our systems, our prices, our individual attention to your requirements. Let Gately Electronics, or one of our dealers, put you in the driver's seat—the one that fits you best!



GATELY ELECTRONICS

57 WEST HILLCREST AVENUE, HAVERTOWN, PENNSYLVANIA 19083 • (215)HI 6-1415

... have you checked Gately lately?

Circle 25 on Reader Service Card

THE GOLD-PLATED RELIABILITY FACTOR.

In this age of planned obsolescence, unreliable performance and shoddy workmanship are almost taken for granted. But there are still a few exceptional products that are built to last and one of them is the Revox tape recorder.

Revox dependability is a combination of many factors, but perhaps the most important of them is advanced engineering. Borrowing from space age technology, Revox gold-plates all of the electrical contacts on its plug-in circuit boards, relays and rotary switches. The result: every one of these movable contacts, the ones that usually cause most of the problems, can be depended upon to perform well for the life of the machine. Obviously, gold plating is considerably more expensive than conventional tinning, but Revox thinks it's worth it.

Because Revox engineers demand margins of performance and reliability that far exceed ordinary production standards, you can own a tape recorder that will work perfectly the first time you use it and for years to come.

And that's why Revox is the only one to back its machines with a lifetime guarantee.

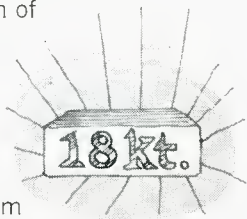

REVOX DELIVERS WHAT ALL THE REST ONLY PROMISE.

Revox Corporation
212 Mineola Avenue
Roslyn Heights, N.Y. 11577
1721 N. Highland Ave.
Hollywood, Calif. 90028

Circle 21 on Reader Service Card

Theory and Practice

NORMAN H. CROWHURST

●We have seen already that different environmental situations call for different treatment—that there is no universal ideal. Now we come back to some more esoteric aspects related to electronics. We left the matter with a choice of whether or not to use crossovers, and then, if we use crossovers, of whether to put them before or after power amplification (FIGURE 1).

The approach that gets away from crossovers altogether, by using a fairly large number of small, wide-range units, has some merit. Putting a large number of small units in a common enclosure, so their diaphragms are all driven in phase, changes the characteristics of each speaker, due to the influence of all the others working with it. This fact is often overlooked in making a theoretical comparison.

A small unit will have poor bass response below its rather high resonance frequency. But putting a number of them into a common enclosure, all connected in phase, lowers the resonance and enables the combination to respond to lower frequencies than an individual unit can, even mounted singly in the same size enclosure. And all the units retain their high-frequency capabilities.

This is not all. Small units are normally not too efficient, mainly because they cannot couple well to the air medium in which they radiate. But putting a number of them in the same enclosure improves the individual efficiency.

A single unit working in a baffle has to move a lot of air to make a lot of sound. When it is working with others around it, it has to move only the air immediately in front of it, because other units are moving adjoining air in a precisely similar way. And it can move this smaller quantity of air more efficiently, because it is better coupled to it.

You may have noticed that such an assembly produces a relatively high level of sound, but that when you examine the diaphragm movement, each unit seems to be moving very little. The first time I noticed this effect, I found it incredible that the assembly was actually producing all

the sound I could hear, by comparison with earlier experience using single unit multi-way speakers operated with crossovers.

Without arguing, at this point, the relative merits of these multi-unit systems, as compared with conventional multi-way units, let us now turn to the question as to where to put the crossovers in such systems.

First comes the question of steepness of crossover, introduced last month. Choice on this basis depends on the extent to which the units chosen for adjacent frequency ranges can overlap or should be kept separate. If each unit has a sensibly flat response beyond the frequency chosen for crossover, a relatively slow transition is good.

If the units either cannot handle frequencies appreciably below their nominal range (as is usually the case with horns) or become erratic in response appreciably above their designated range, then steeper slopes may be advisable. We will leave this part

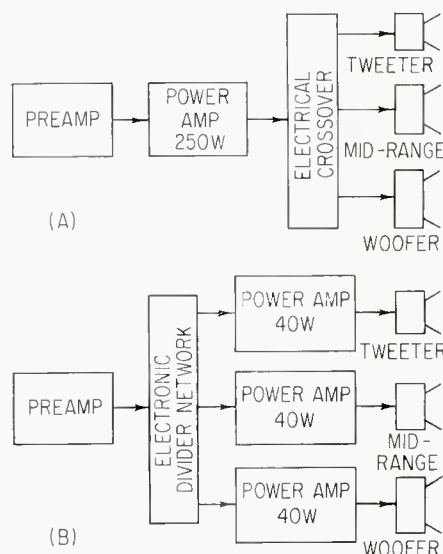
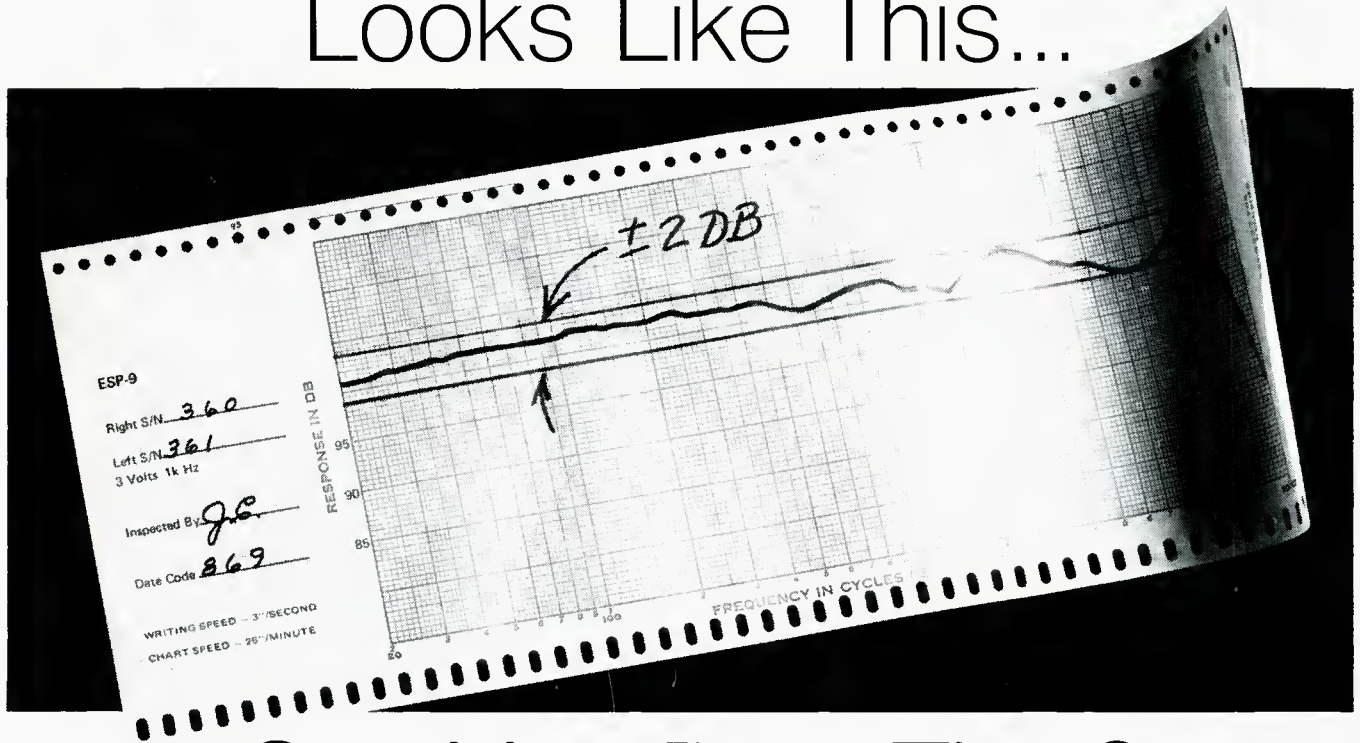

Figure 1. The choice between systems using crossover frequencies: (A) the conventional electrical system, where the crossover divides frequency distribution after power amplification, as energy is fed to the speaker units; (B) electronic frequency division, before power amplification.

The Sound Of KOSS Looks Like This...



Can You Beat That?

To guarantee performance to specifications, this individual machine-run response curve comes with every ESP-9 Studio Monitor Headset. You get, for the first time, flat ± 2 db monitoring over the entire audible spectrum because the ESP-9 is a breakthrough electro-acoustical development achieved by exploiting electrostatic principles. Only Koss electrostatics give push-pull balanced acoustical circuitry, cancelling all second harmonic distortion to provide fatigue-free listening through long recording sessions. Now you hear what the program material *really* sounds like, uncolored by monitor room reflections. Exceeding the range and cleanliness of any speaker system, the ESP-9 gives the measure of separation and accurately positions the soloist. 40 db isolation through comfortable, fluid-filled cushions relieves the noisy distraction caused by producers, A and R men, time-killing artists, and other visitors in the control room. The ESP-9 eliminates the masking effect of blowers, breath sounds, clothes rustling and other control room ambients. So now you have a running check on low-level system noise. You monitor the sounds you only saw before on the VU meter, like the "whoosh" of a stage door closing, ventilator rumbles and music stand rattles — because speakers simply don't have the super-wide-range you need to hear them.

The ESP-9 has a signal handling capacity of 10 volts at 30 Hz with good wave form versus 6 volts for the integrated ESP-6 introduced last year. This is made possible by increasing the size of the coupling transformers by a factor of 4 and mounting them in the E-9 Energizer external to the cup.

The E-9 Energizer offers the option of self-energizing for the bias supply, or energizing through the ac line; choice is made with a selector switch on the front panel. When energized through the ac line, very precise level measurements can be made. Thus the unit is ideal for audiometry, and for evaluating the spectral character of very low level noise in tape mastering machines and recording consoles.

SPECIFICATIONS

Frequency Response Range, Typical: 15-15,000 Hz ± 2 db (10 octaves) 10-19,000 Hz ± 5 db. An individual, machine-run calibration curve accompanies each headset. Sensitivity: 90 db SPL at 1kHz ± 1 db referred to 0.0002 dynes/cm² with 1 volt at the input. Total Harmonic Distortion: Less than 1/5 of 1% at 110 db SPL. Isolation From External Noise: 40 db average through fluid-filled cushions provided as an integral part of the headset. Power Handling Capability: Maximum continuous program material should not exceed 10 volts (12 watts) as read by an ac VTVM; provides for transient peaks 14 db beyond the continuous level of 10 volts. Source Impedance: Designed to work from 4-16 ohm amplifier outputs. External Power Requirements: None, except when used for precise low level signal measurement, when external ac line can be selected by a front panel switch on the E-9 Energizer.

See your dealer today or write for free technical paper, "An Adventure in Headphone Design" and ESP Catalog 108.



**KOSS
MODEL ESP-9
ELECTROSTATIC
STEREOPHONES
WITH
E-9 ENERGIZER
\$150.00**



KOSS

KOSS ELECTRONICS INC.
2227 North 31st Street
Milwaukee, Wisconsin 53208
KOSS ELECTRONICS S. r. l.
Via Valtorta 21/20127 Milan, Italia



Circle 24 on Reader Service Card

THE ABSOLUTELY UNVARYING CONSTANT SPEED FACTOR

Of all the parameters affecting tape recorder performance, few are as important as constant speed.

Considering the havoc even comparatively small speed variations play with recorded sound, it's rather surprising that most tape recorder manufacturers seem to give short shrift to this vital, performance affecting feature. On the other hand, the manufacturers of professional recording equipment go to great lengths and expense to insure both short and long term speed stability and constancy. And so do the people who make the Revox A77.

The Revox A77 is the only machine in its price class that incorporates a servo-controlled capstan motor that automatically adjusts and corrects itself so as to guarantee a maximum speed deviation of less than .2%.

According to Audio Magazine, "The electronic speed control held the speed exactly 'on the nose' at all input voltages from 135 down to 92... and at all frequencies from 40 to 70 Hz". Stated simply, this means the Revox is unaffected by those all too common fluctuations that occur in both line voltage and frequency.

When you consider the uncompromising design philosophy, meticulous craftsmanship and outstanding performance built into every Revox, you begin to understand why we say...

REVOX DELIVERS WHAT ALL THE REST ONLY PROMISE.

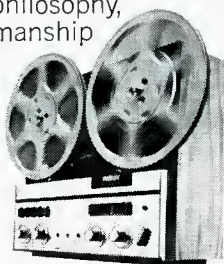

Revox Corporation
212 Mineola Avenue,
Roslyn Heights,
N.Y. 11577

1721 N. Highland Ave., Hollywood, Calif. 90028
In Canada: Tri-Tel Associates, Ltd., Toronto, Canada

Circle 21 on Reader Service Card

of the discussion with this generality, because individual decisions will involve examining the whole situation and probably running some tests, too.

So we assume we have decided on a suitable crossover frequency and rates of transition or crossover. The choice is whether to use an electrical crossover directly with the units, employing one large power amplifier for each complete speaker system, or whether to use frequency division before power amplification, so each unit in the speaker system must have its own power amplifier (FIGURE 1).

If an electrical dividing network is correctly designed, to have amplitude and phase response identical with the electrical crossover it replaces, the over-all frequency response and integration of sound emanating from the various units in the system will be identical.

However, for slopes of more than the simplest 6 dB/octave, the electrical dividing networks need to be of active form, to accentuate the turnover point. A succession of r-c networks, however coupled, will add at least 3 dB of loss for each stage, so there will be a dip in over-all response at crossover frequency, unless the responses are moved together, in which case they do not perform at their nominal slopes, until far beyond crossover (FIGURES 2 and 3).

Figure 2. A fallacy of using multi-stage crossovers as frequency dividers that do not possess interaction or active feedback. The solid curves show the result of cascading the shown number of identical roll-off networks, while the dashed line curves show the required response.

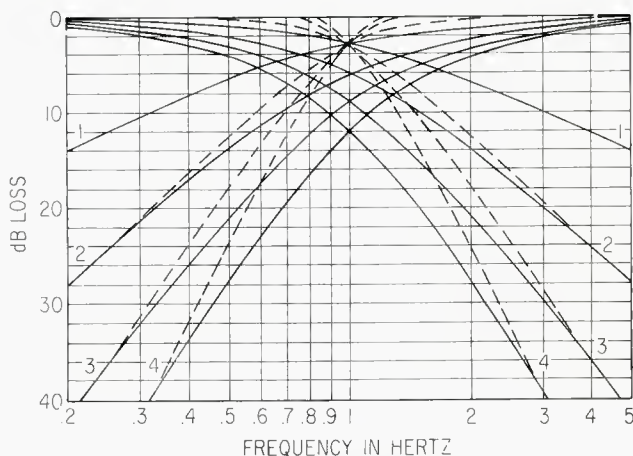
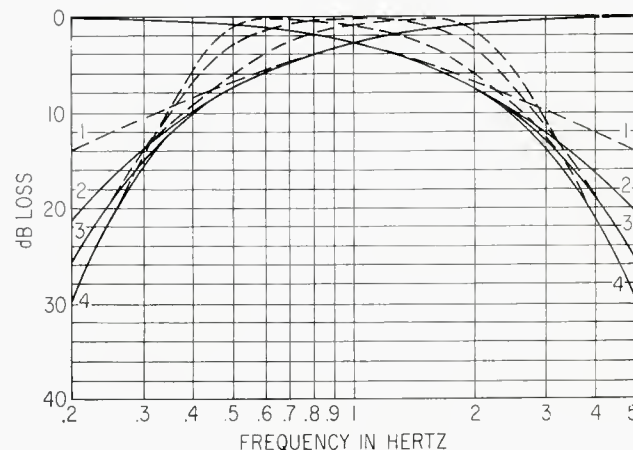

Figure 3. By changing the frequencies of curves for two or more networks, the 3-dB point can be corrected, as shown here (solid curves). But the result does not differ appreciably from a single network, until about an octave beyond crossover. The dashed line curves show the true responses similarly frequency-shifted.



Only by applying feedback over the dividing network, or otherwise inducing interaction, can the true response form be achieved. When it is, the amplitude and phase relationship will follow the minimum-phase network laws, and thus behave just like the prototype electrical crossovers.

Having settled that, we come to the question of relative merits, assuming each method is followed correctly. This depends on how the system is to be used. If the system will handle only one frequency at a time, as in taking frequency runs of microphones (and this does require a rather special speaker system) then the electrical system is most economical, because the amplifier can handle all frequencies equally well, and the electrical network will deliver each frequency to the appropriate unit(s).

But most speaker systems reproduce composite program, made up of many component frequencies at the same time. And the constitution of this composite may differ, from voice only, to various forms of music. For voice only, the electrical network may still be quite adequate and the best economic choice. But for musical reproduction, a different situation may prevail.

To illustrate this, assume we want to reproduce a 50-piece orchestra. Even groups of instruments nominally

The Expanding Sound

Is SSI! It's expanding in the sense that more and more studios are switching to or installing ultra-reliable professional audio products from SSI. It's expanding in the sense that systems from SSI embody the ultimate in sophisticated state-of-the-art design—from a single channel speech unit to a 16-channel professional system for full orchestration. And, it's expanding in the sense that we've designed-in a modular building block approach that lets any user custom-tailor or expand a system to meet his own particular requirements...now and in the future.

For existing installations, complete functional upgrading is easily achieved on an as-you-need-it basis—switching, signal transfer, mixing, level correction, impedance matching, added channels, echo send, cueing, etc. Each of SSI's "interface modules" are completely compatible and easily installed; and they always will be! If you require a special purpose, multiple-channel control system, SSI engineers will custom design it to meet your specific audio and physical needs.

If your requirements are expanding, investigate the full range of moderately priced audio control systems and components from SSI. Since our only business is audio expansion, let's grow together. It could be a sound investment.



A division of
A&R Recording, Inc.

Dept B
4956 Wyaconda Road
Rockville, Md 20853
Phone: (301) 933-7788

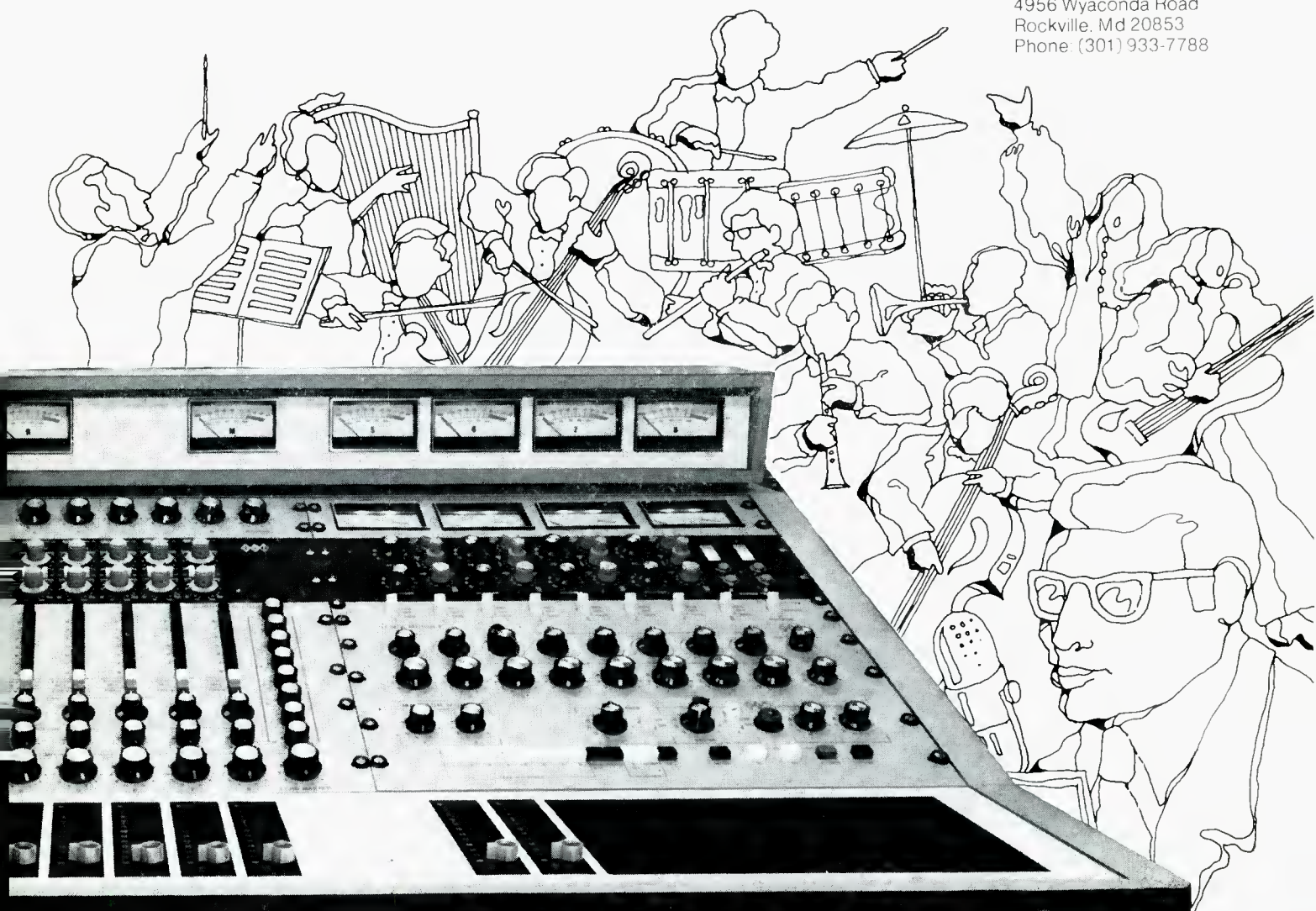

Circle 23 on Reader Service Card

stop watches

These are Switzerland's finest quality stop-watches manufactured by Heuer-Leonidas S.A. Heuer has been the leading manufacturer of quality stopwatches for over 100 years. Their reliability and design leadership are well known throughout the world.

All are fully guaranteed for one year with service available in 90 countries. Isn't it time you had one of these new models?

If you are seeking a stopwatch for a special application please let us know. Heuer stopwatches are available for sports, aircraft, automotive, industrial, scientific and many other uses.

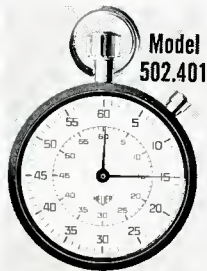

Model 502.401

1/5 second recorder, central 0-60 minute register. 2 crown functions with time-out and locked return. 7 jewels, shock-protected. \$39.00

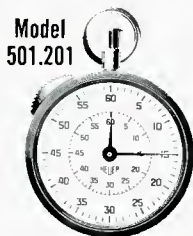

Model 501.201

1/5 second recorder, central 0-60 minute register. 1 crown function with side-slide. 7 jewels, shock-protected. \$34.00

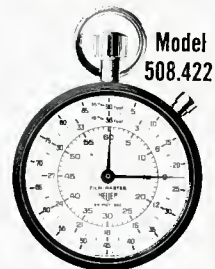

Model 508.422

FILM-MASTER. 60 second recorder, central 0-60 minute register. Records on outside scale consumed 35 mm film from 1-90 feet, on intermediate scale consumed 16 mm film from 1-36 feet. Framespeed 24 pictures/second. 2 crown functions with time-out and fly-back return. 7 jewels, shockprotected. \$39.00



Model 502.050

WRIST TIMER for program directors in radio, TV and film. 1/5 second recorder, central 0-60 minute register. Dial reading indicates elapsed time; remaining time can be read on 60 minute turning bezel. 2 crown functions with time-out and locked return button with safety bolt. 7 jewels, shockprotected. \$49.00

Add \$1.00 shipping to indicated prices

GUARANTEE

100% absolute satisfaction or your money returned within 10 days without question. To order send check directly to:

TIMEKEEPER

P.O. Box 762, Mineola, N.Y. 11501
N. Y. State residents add 5% sales tax

playing the same note or musical part, such as a clarinet section, will not be in perfect unison. So there will be moments when all their waveforms add, while the average power will be the sum of the individual powers.

This is even more definitely true of the various groups of instruments playing different musical parts. Assuming, for simplification, that each instrument produces equal peak level and equal average power: suppose each produces 1-volt peak level, which corresponds with 100 milliwatts of signal.

Then a 50-piece orchestra will produce an average power of 5 watts (50 times 100 milliwatts). But at times—such as a few times every second—all the voltages will add, to produce close to 50 volts momentary peak. Now, if 1 volt peak corresponds with 100 milliwatts signal, then 50 volts peak will correspond with 50 squared, or 2500 times 100 milliwatts signal, which is 250 watts. This is the size amplifier needed to handle the orchestral 5 watts, all at once!

Now suppose the speaker system is 3-way, with crossovers chosen so about equal peak power is needed in each range—say 20 volts peak, to allow a margin. This corresponds with a power rating of only 400 times 100 milliwatts, or 40 watts for each amplifier.

Assume each speaker unit is designed to handle the power fed to it within its frequency range, thus allowing a peak movement that would correspond with 40 watts power, but at a peak dissipative power around 2 watts (or even more, for safety margin against blow-out). Such a system, driven by a divider network and three 40-watt amplifiers would serve fine.

But what could happen if a 250-watt amplifier were fed to a speaker system using the same units with an electrical crossover? If all the musical energy should momentarily be in one unit's range, then the power fed to that unit could be turned up to 250 watts, with possibly 100 watts of dissipative power during that momentary interval. That could easily destroy the unit in question.

Using separate power amplifiers thus also provides a safety factor, as well as an economy. In fact, the economy may be questionable, as power in amplifiers does not come at a flat rate of so much per watt.

A 250-watt amplifier is unlikely to be more than six times as expensive as a 40-watt amplifier, which the ratio of wattage ratings would suggest, assuming flat rate with equal degree of sophistication in both sizes. However, the 250-watt amplifier could well be more than three times as costly as a 40-watt unit.

How does all this relate to the multiple-unit speaker system, discussed at the beginning? Obviously, since all the units handle all the frequencies, such frequency division is not possible. What this really says, when you think the matter out, is that the relative merit between this choice of systems, will depend on program type to be played.

For full-orchestra reproduction, a multi-way unit is undoubtedly the better proposition, because of the tremendous inherent ratio between peak and average power (quite apart from the large dynamic ranges that can be involved, or the transient peaks that can occur). The multiple-unit system is obviously at a disadvantage for this purpose.

However, for a great deal of the more popular type program reproduction, using fewer musical instruments in a group, or perhaps principally human voice, the multiple-unit type has advantages: low cost, good efficiency, no phase problems (other than seeing they are all in phase) etc.

Which once more comes back to a matter we have stressed before: that, in audio at least, every kind of unit or system has its valid uses. There is no universal best, for every purpose, even assuming we may want to disregard cost as a factor in choice.

Proven Performance Power Amplifiers from Fairchild!

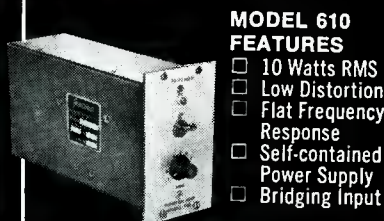

MODEL 610 FEATURES

- 10 Watts RMS
- Low Distortion
- Flat Frequency Response
- Self-contained Power Supply
- Bridging Input

MODEL 870 FEATURES

- 70 Watts RMS
- Low Distortion
- Plug-in Driver Circuit
- High Damping Factor

For complete details write today to:

FAIRCHILD

Sound Equipment Corporation
10-40 45th Ave., L.I.C., N. Y. 11101

When you know what it takes to make a TEAC, you know why professional people wax lyrical about our A-7030.

This is a no-nonsense pro-quality tape deck, with unrivalled sound reproduction at 15 or 7½ ips. A streamlined solenoid control system for effortless operation. A system that makes cueing as easy as pushing a button. Automatic rewind and shutoff for built-in convenience.

The A-7030 is the sum of many systems, and the sum of our savvy in producing them. It's the head of our whole fine family of tape decks.

So if somebody wants to write a sonnet on it, we've got a great line for them.



SOUNDS LIKE POETRY TO THE PROS.



A-7030

- Dual-speed hysteresis-synchronous motor for capstan drive
- Two heavy duty 6-pole capacitor-start induction motors for reel drive
- Tape tension adjustment
- Massive inertial flywheel, over 1½ pounds
- Instant off-the-tape monitoring without interruption of recording
- Sound-on-sound and echo with simple external connections
- Built-in mike-line mixer
- Stainless steel panel reinforced with 13/64" aluminum base plate for assured stable performance

TEAC

TEAC Corporation of America
2000 Colorado Avenue
Santa Monica, California 90404

Sound with Images

MARTIN DICKSTEIN

THE AMA EXPOSITION

• Last month, we tried to impart some of the flavor of a meeting that took place in July in Washington, D. C., at which some of the latest in audio-visual equipment was displayed and demonstrated.

A second conference and exhibition was held in the first week of August in New York City with its emphasis also on application of audio-visuals to the educational and training field. This latter one was the 6th Education and Training Equipment Exposition held by the American Management Association.

For those not familiar with the Association, the AMA is a non-profit, educational, membership organization whose function lies in developing and sharing better methods of management to keep executives up-to-date on the latest in training and management trends and procedures. A continuing

program of courses, seminars, conferences, and publication services aids executives to exchange views on common problems or procedures. An in-depth training program in many facets of management is also part of the service provided by the AMA. The 47-year old Association, which now has more than 60,000 members, has its headquarters in N.Y.C.

The exposition, which ran for 4 days, presented many individual sessions on Education and Training and several joint sessions at which subjects common to both fields were discussed. Among the joint meetings, there were workshops demonstrating multi-media instructional systems for education and training. Topics included *The Creative Use of Film in Education and Training*, *Media Selection and Application* and *Educational Technology for Tomorrow*. At the *Media Selection* session, discussion included guides and criteria for deter-

ERRATA

Back in the August issue, during the discussion on evaluation of projection systems, an example was given to indicate the use of the factors to be considered as a guide toward judging the capabilities of the system. If you wondered why the math did not check out, it's our fault. The value for the non-image light on screen given in the example should be 0.25 FtL. We regret leaving out the decimal point.

mining proper media for particular educational needs and the utilization of these media most effectively. An evaluation of the latest in video recording systems was also included. At the technology workshop, discussion included new breakthroughs in multiplex color TV and audio-visual technology for application in the instructional and training fields. Many of the top executives associated with training and management education in the largest industrial concerns in the nation as well as educators from the finest universities in the country and many top engineers and system designers took part in the sessions.

In the display area, more than 160 exhibitors showed the latest in hardware, software and services and also demonstrated the latest in techniques for disseminating knowledge and information, in order to inform the industrial and academic experts of the most recent advancements in technological solutions to education and training problems. Displays ranged from computers and their programming capabilities to audio-visual hardware such as CCTV cameras, projectors, audio and video recorders, and accessory items; through language

YOU-SHAPED SOUND...

with Automated Processes Quadrasonic Stereo Panner Model 480

Precise, finger-tip, 360° control of a sound source into 4-channels is yours with the Model 480 Quadrasonic Stereo Panner. It lets you create any type of motion pattern: sequeways between stereo programs; reverb sound combinations; or static positioning (if that's all you want).

The single-knob "joystick" provides infinite resolution... stepless movement, noiseless and accurate. It also acts as a visual indicator for the phantom sound source.

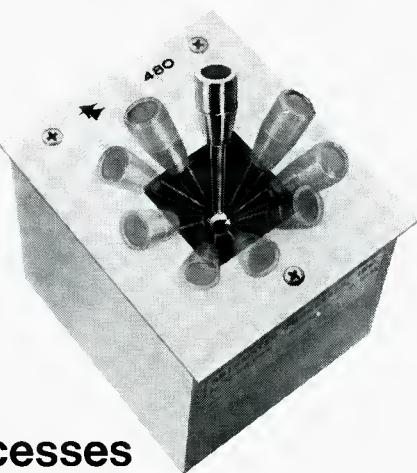

We designed the Model 480 to meet the demanding requirements of 4-channel sound positioning... low noise conductive plastic elements, precious metal contacts, connections for splitting 1 channel into 4, or simultaneous 2 into 2.

No power supply required. Occupies only 3" x 3 1/2" of panel space, 3 3/8" deep.

To put "you" in the 4-channel driver's seat, contact us at once for technical literature.

 **AUTOMATED PROCESSES, INC.**
35 CENTRAL DRIVE, FARMINGDALE, NEW YORK 11735-516-694-9212

Circle 28 on Reader Service Card

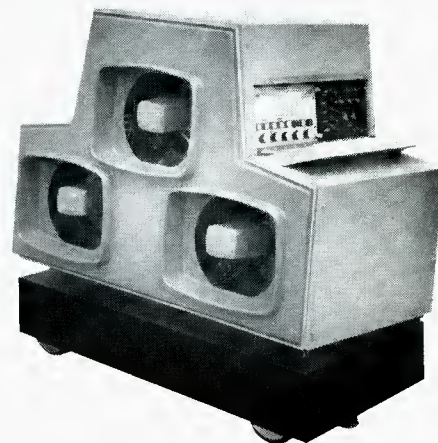

Figure 1. Amphicon's three-section large-screen color projector, model Amphicolor 1000. Note the easily-accessible controls.



THROUGH THIS DOOR

PASSES THE INDUSTRY'S MOST COMPACT 16 TRACK RECORDER WITH LOTS OF ROOM TO SPARE, AND LOTS MORE TO OFFER!

The 3M Brand 16 Track Recorder is unexcelled in the familiar studio game of squeezing the most out of floor space. Overall base dimensions are 27 inches wide by 22.5 inches deep. (In square feet that's only 4.2.)

But compactness is only a small part of the story.

Added to this space economy, studios continue to enjoy the top performance that has made 3M's professional audio recorder a new standard in the recording industry. In the last three years, playback pre-amp and overdub noise has been improved by

10 db. Mincom's exclusive Isoloop® tape drive utilizing a differential capstan maintains constant tape tension in just 3½" of unsupported tape. This results in the lowest wow, flutter and scrape in the industry. Erasure has been improved by 10 db.

Plus: DC transport and dynamic braking, advanced electronics, unequalled no-stretch no-snap tape handling, stable and rugged 1.5-inch cast top plate—and *Remote Sync Control, 7" x 7" x 4"*, included at no extra cost.

Write for details and specifications.

Mincom Division **3M**
COMPANY

3M Center • St. Paul, Minnesota 55101
300 South Lewis Road • Camarillo, California 93010

Circle 32 on Reader Service Card

profit from cassette & cartridge duplication



Produce 1,400 to 30,000 C-30 cassettes per 3-shift workday on the new Infonics Super Cassette Duplicator. It offers professional-quality 12,000 Hz frequency response... only \$3795
Produce 3 eight-track 150-foot cartridge tapes per minute at 30 ips on the professional Infonics D-8 Duplicator. The single-pass D-8 gives 12,000 Hz response and puts you in the high-profit 8-track business for only..... \$6495
Send for free color brochure today.

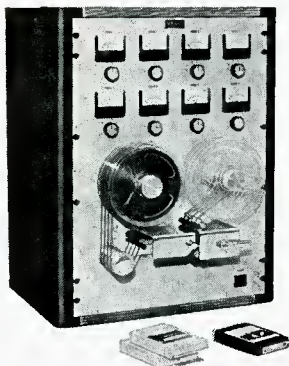

@ infonics

1724 Cloverfield Boulevard
Santa Monica, California 90404
(213) 828-6471 • Cable: Infonics

laboratories, textbooks, testing and demonstration materials, to training and production services. It is estimated that close to 10,000 visitors attended the exposition.

Exhibitors ran the gamut from A to X and, in some cases, duplicated the presentations made at the Washington NAVA meeting several weeks earlier. Here again, to try to describe the numerous devices (or even to mention them) would be quite an undertaking. Instead, here is another quick look at some of the equipment shown without including those items described last month from the NAVA exhibit. It should be noted that the equipment chosen for mention here does not constitute, in any way, a preference for these devices over the many that may be similar. The selection was made purely to indicate the range covered in the displays and to provide a brief glimpse at the variety of equipment available to the audio-visual designer and dealer.

To begin in the A's, Ampex presented a complete TV production center for CCTV videotaping or for CATV telecasting. The AC-125, in a unit less than 2 feet in any dimension, and weighing only 90 lbs., includes 3 monochrome five-inch monitors (each with four picture controls); a

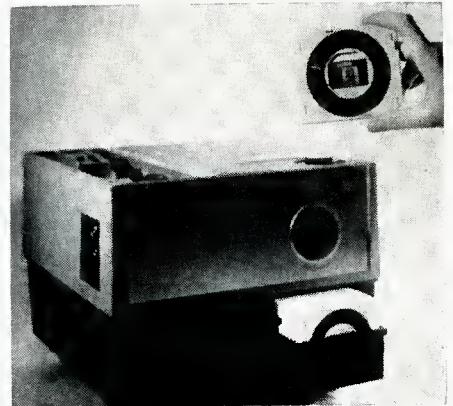

Figure. 2 The 3M sound-slide projector. It uses a standard 2 x 2 slide ringed by the sound track.

video control center which has a fader and special effects generator, a six-input vertical interval program switcher, a four-input preview switcher, a sync. generator for 2:1 interlace, intercom with cameras, tally light switching, dual camera remote controls of gain and pedestal and a waveform sampler; and a four-input audio mixer. Video inputs are provided for three cameras (including one from a film chain) and a vtr. Two of the three monitors observe the two main cameras while the third is used for previewing or line monitoring. Resolution of the unit is given as 500 lines horizontal and 350 lines vertical.

Amphicon Systems, Inc., Moonachie, N. J., showed their Amphicolor 1000 unit (FIGURE 1). The projector is capable of providing large screen color images from three inputs and can be used in large auditoria for entertainments. Other large screen projectors were also on display and all literature and informational data are available from the manufacturer.

CBS demonstrated its EVR color unit, just one year after it presented its monochrome EVR at last year's AMA exhibit. This year, the Motorola manufactured color/monochrome unit was connected to color TV sets so that viewers on all sides of the exhibit would be sure to see the demonstration.

The system, about which a great deal has been written, provides TV programs for the standard home receiver by a single lead from the EVR unit to the antenna input. The cartridge, 7 inches in diameter and 2/3 of an inch thick, provides 50 minutes of black-and-white material (using both available channels) or 25 minutes of color program material (using the second channel for color information to supplement the picture information on the other track). Sound is from a magnetic track running parallel to the visual information. The unit is 20 x 18 x 8 inches and weighs about 35

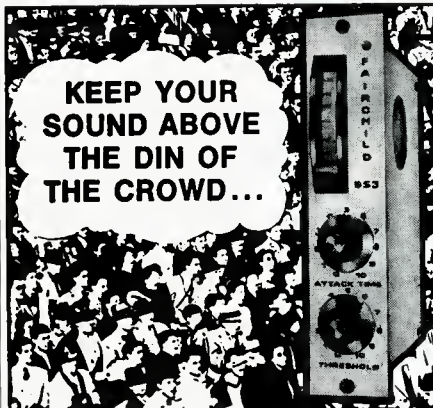

**KEEP YOUR
SOUND ABOVE
THE DIN OF
THE CROWD...**

AUTOMATICALLY with the ... FAIRCHILD AMBICON

For over 5 years the FAIRCHILD AMBICON has been faithfully increasing or decreasing levels of sound systems in accordance with the ambient noise present in the reproduction area.

Easily integrated into your existing sound system it is ideal for air, rail-and bus terminals, stadiums and arenas, convention halls, theaters, factories and schools.

The compact (1 1/2" x 7") solid-state FAIRCHILD AMBICON is your silent gain control device which automatically controls background noise that can adversely affect intelligibility.

To keep your sound above the din of the crowd write today.

FAIRCHILD
Sound Equipment Corporation
10-40 45th Ave., L.I.C., N. Y. 11101



Figure 3. Technicolor's super-8 cartridge player. It is completely self-contained including capability to feed out audio.

lbs. The cartridge contains 750 feet of sprocketless film with 90,000 frames in each channel. Speed of travel of the film is 6 inches per second. Rewind time is 1 minute for a full reel. Film is 8.75mm wide. Video performance is better than 500 lines horizontally; scanning is 525 lines, 60 frames; audio response is 100 Hz to 10 kHz plus or minus 3 dB. Synchronization is by means of an optical mark on the film. The unit lists for \$795.00 and the cartridges range from a cost of \$6.00 each for 50 with 5 minutes of material to \$23.10 for 50 minutes in quantities of 2,000. The EVR is capable of slow motion, stop motion, and single frame motion.

Roberts, division of Rheem Manufacturing Co., L. A., Calif., showed a 1/4-inch tape video-recorder, model 1050AV. This unit is completely battery operated, weighs 20 lbs. with batteries, camera and 3-inch monitor. Resolution is better than 200 lines. The machine has 2 rotating video heads, has a tape speed of 11.25 in./sec. for 20 minutes of recording on a 5-inch reel, an audio response of 100-10,000 Hz and is 10 x 10 3/8 x 4 3/8 inches. It weighs only 10 lbs. The camera, with microphone right on it, comes with a 4:1 zoom f/1.8 lens, weighs 4 lbs, and has a through-the-lens reflex viewfinder. The monitor is detachable from the playback unit. The battery takes about 4 hrs. to recharge and can be recharged more than 500 times.

The 3M Sound-on-Slide system was presented with emphasis on its application to training with the new 3M Self Study Unit. The sound/slide projector (FIGURE 2) uses push-in trays containing up to 16 slides, each with its own sound tape capable of up to 35 seconds of audio material. The self-study unit, listing for \$499.00, is for playback only. The recordings must be made on the 3M sound-on-slide unit. This unit measures 12 x 12 x 10

inches and weighs 32 lbs. A tray with 16 mounting frames lists for \$46.50. Each holder can have the slides changed, the audio recorded or erased and re-recorded, each separately, or both at the same time.

Technicolor was represented with a demonstration of its new portable super-8 cartridge optical sound projector. Model 1300 (FIGURE 3) projects the image on a self-contained rear screen but can be converted to project normal front screen images by removal of the rear screen. Technicolor (Costa Mesa, Calif.) based the design of this unit on its previous Model 1000. The new unit, which folds into an attache case, is 8 1/4 x

21 5/8 x 15 inches and has a 7 x 9 1/2 inch rear screen. Cartridges come in the 10 or 29 minute size and provide for automatic shut-off at the completion of the program.

Other equipment shown included multi-track programmers, learning devices with light pencils, cassette duplicating systems, hand-held 8-mm playback projectors and projectors with automatic stop on desired frames and with stop-action projection and no loss of brilliance of image.

There is no end to a-v equipment development for various applications. Exhibits like this one make catching up with the latest devices interesting and educational. ■



**ORBAN PARASOUND
MIXDOWN
MATRIX**

- Provides True Mono/Stereo Compatibility
- Increases Ambience and Clarity
- Eliminates Center-Channel Build-Up

**LET
YOUR MUSIC
SPRING TO
LIFE**



ORBAN PARASOUND REVERBERATION

- Lowest noise and distortion
- Usual spring reverb colorations substantially reduced
- Exclusive envelope risetime limiter eliminates popping and sproing sounds on transients
- Only usable spring reverb for drums, electric base, guitar, etc.
- Available in console or 1 3/4" rack mount

PARASOUND, INC.
 SAN FRANCISCO: 580 BEACH ST., SUITE 495, SAN FRANCISCO, CA 94109 (415) 776-2808
 LOS ANGELES: 2825 HYANS STREET, LOS ANGELES, CALIFORNIA 90026 (213) 462-3311

Circle 29 on Reader Service Card

beyond the state of the art



SPECTRA SONICS announces a rack-mounting limiter/compressor so new—in both concept and performance—that it requires a new name: COMPLIMITER™*. It performs the functions of peak-limiting and volume-compression, either independently or simultaneously, as a direct function of the type of program input and amount of compression desired with performance that is unequaled by most linear amplifiers! As the fastest of all peak-limiting devices (100 nanosec. to 2 microsec.), peak-limiting can be employed with no audible distortion of any kind, thus allowing undistorted recordings (typically less than 5/100ths of 1%, 30 Hz to 20 kHz) at significantly higher than conventional "0" VU (+4 dBm). Available only on the Model 610 COMPLIMITER™: visual lamp indication for essentially instantaneous peak-limiting and also for system overload; continuously variable compression ratio from 1.1:1 to over 100:1. For the smoothest inaudible protection available, order your Model 610 COMPLIMITER™. Now!

Contact your distributor, write or telephone:

SPECTRA SONICS

LEADER IN ADVANCED TECHNOLOGY

770 Wall Ave.

Ogden, Utah 84404

801-392-7531



New Products and Services

AMPEX TAPE SYSTEM

• Ampex recently unveiled a new system for video recording featuring automatic cartridge loading and designed both for closed-circuit television and home recording and playback markets. Dubbed "Instavision" the recorder/player uses standard half-inch video tape enclosed in a small plastic cartridge. The cartridge enclosed tape is accessible and may also be played on any Type 1 standard reel machine. Operation of the recorder/player is accomplished by inserting the cartridge and pressing the record or play buttons. The machines will be available in mid-1971 and will cost approximately \$1000 for a color recorder/player. The unit will operate from standard batteries, permit slow motion and stop action recording and some elementary editing. Two independent audio channels are provided. An accessory unit permits operation from automobile cigar lighters. A standard included item is a power pack that houses an a.c. converter, a battery recharger, and optional electronic circuitry for color record or playback. The recorder plugs into the pack.

A companion monochrome camera will be available for about \$400 including a zoom lens and electronic viewfinder. The entire system has been designed by Ampex Educational and Industrial Products Division in Elk Grove Village, Illinois.

Actual manufacture of the equipment is by TOAMCO, Ampex's joint venture with Toshiba in Japan. Toshiba will market the system in Japan, and Ampex elsewhere in the world.

Professionals will be interested in the fact that picture quality is 300 lines for monochrome and color resolution is compatible with standard color television receivers. S/n is 42 dB. A standard NTSC color output signal is provided

← Circle 27 on Reader Service Card

The Instavision system. Shown are the recorder player, camera, tape cartridge (which will record up to an hour and be priced under \$13), and a video monitor. The entire system, less monitor, is expected to sell for under \$1500.



The Instavision recorder player showing a tape cartridge being inserted. The cartridge holds up to 30 minutes at the Type 1 standard, or 60 minutes in an extended play mode. Ampex engineers told us that the quality differences between Type 1 and extended play are virtually undetectable—and we can state that video and audio seemed good to us.



CONVERSION KITS

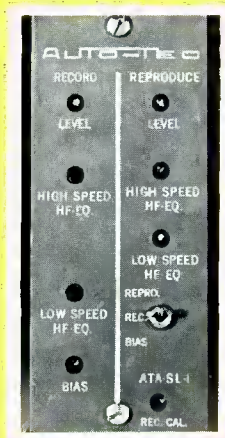

● This Auto-Tec conversion kit for the Ampex model 300 offers advantages such as using the original heads, using the original meter panel of the 300, all plugs and jacks match those on the Ampex tape transport, it is solid state, low noise, offers smooth frequency response, and record level calibrate and bias test switching. All units are pre-aligned on a typical Ampex with typical Ampex heads. Other versions are available for the 350-351 models.

Mfr: United Research Laboratory Corp.

Prices Mono 300—\$595.00, mono 350-351—\$695.00

Circle 50 on Reader Service Card

SLIDE SYNC CASSETTE RECORDER



● The cassette transport is a heavy-duty a.c. powered cassette recorder/player. Narration and sync signals are recorded either independently or simultaneously. The sync signals are designed to trigger slide projectors. The model 2550 uses a 60-Hz signal to activate the tripping mechanism. However, the recorder will reliably sense slide-change signals from 50 to 2000 Hz where the sync signal pulses and audio program are recorded on two separate tracks.

Mfr: \$299.95

Circle 54 on Reader Service Card

QUAD PAN POT

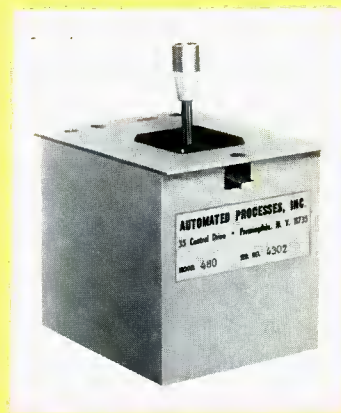

● A new four channel sound control is being offered. Designated model 480, the quadrasonic stereo panner uses a joy stick operation to create motional effects. The position of the stick is also a visual indication of the phantom location of the sound source. Effects range from a 360° sound in motion to simple static positioning. Resolution is infinite. The unit splits a signal into four separate outputs. Action is noiseless and accurate. Tracking accuracy is ± 0.5 dB, or 5° of indicated position. Insertion loss of this passive device is 1 dB. The unit measures 3-inches wide by 3½-inches high and 3⅞-inches deep.

Mfr: Automated Processes, Inc. Circle 60 on Reader Service Card



The Philips plant stands in a deep suburban setting among trees and a stream. Though near an exit to the Garden State Parkway, it is pleasantly isolated.

db VISITS PHILIPS

● Philips Broadcast recently held an open house at their beautiful plant in Montvale, New Jersey. The plant is used as a warehouse and distribution point for professional audio products, though it also functions as a manufacturing plant for a number of Norelco professional video products. The open house was for the audio fraternity and their various products were on display, and in some cases was operational. Our peripatetic camera was there and we present some views.

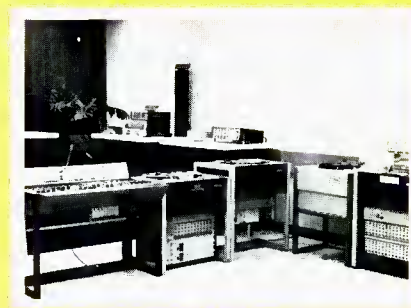

A look at part of the room. Included are a mixing desk, ¼-inch recorders, a turntable, and a new 8-channel recorder.



The new Pro 72 uses one-inch tape and records 8-track. There is sel-sync and plug-in modules.

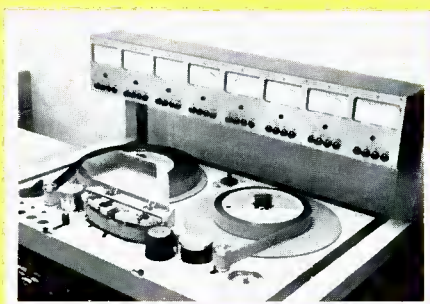

A closer view of the Pro 72, showing the tape path and head assembly section. Note that a tape timer is built in.



For the cassette tape industry, Norelco has this duplicating slave system, as well as master recorders.

CONSOLE YOURSELF (and your pocketbook)

ELECTRODYNE'S NEW MODEL ACC-1608C AUDIO CONTROL CONSOLE STILL COSTS LESS WHETHER YOU BUY THE BASIC UNIT ALONE OR WITH DESIRED OPTIONS

OPTIONS: 2-4 Gang Masters • Stereo Mixing • Mono-Overdub • Preview Monitor System • Patch Panel • Additional input modules with channel select switches

With over 150 consoles in use throughout the world, the name ELECTRODYNE is synonymous with proven acceptance, profitable experience, company and product reliability. The first Electrodyne ACC-1608 was an innovation in its day. The ACC-1608B brought it up to date. Now, Electrodyne's unsurpassed ACC-1608C IS the state of the art. Compare these features: Wired for 20 inputs, supplied with 12. Eight-frequency equalization with reciprocal curves on all inputs.

Individual submasters, all 8 buses. 4 gang master controls, complete mono overdub bus with VU meter and master control optional. Pan pots on 2 channel mixdown for program and individual pan pots on echo send for all 8 buses. Same reverb on tape playback as on bus when recording dry, but monitoring with reverb with "Preview" monitor option. Separate echo switching. And many, many more.

Compare prices too. Check the competition. Especially their table top console. It hasn't a leg to stand on. Your authorized Electrodyne Distributor has the facts. Contact him, or us.

**ELECTRODYNE
CORPORATION**

An MCA Tech. Company, 7315 Greenbush Ave.
North Hollywood, Calif. 91605 • Phone 213/875-1900



Circle 26 on Reader Service Card

STEREO POWER AMPLIFIER



• The Citation Twelve is a stereo power amplifier for use where highest quality, stability, and reliability of performance are important. Careful attention has been given in the design to conservative rating of componentry and fully adequate protection against abuse is provided for the output devices. The two channels, though mechanically linked on a common chassis, are separate even to the use of individual power transformers and supplies. Important specifications include: 60 watts continuous per channel at less than 0.2 per cent t.h.d. at any frequency between 20-20,000 Hz, with both channels driven simultaneously into 8 ohms. Power bandwidth is stated to be 5 Hz to 5 kHz at 0.2 per cent thd, and i.m. is less than 0.15 per cent at all power levels. Input impedance is 30 kohms.

Mfr: Harman-Kardon, Inc.

Price: Factory assembled—\$295.00, kit—\$225.00

Circle 59 on Reader Service Card

PROGRAM EQUALIZER

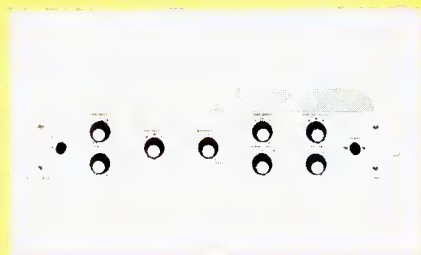

• The PE-1a is a self-contained unit for mounting in standard racks. Two controls provide shelf boost or cut functions in the low-frequency range, while variable bandwidth high-frequency peak boost is at seven discrete frequencies from 700 Hz to 12 kHz. A three-position high-frequency shelf attenuate control covers 5, 10, and 15 kHz. The input is balanced high impedance and the output will deliver a maximum of +30 dBm. A separate push button permits the preset equalization to be inserted on cue.

Mfr: Tempo Audio Industries Ltd. (Canada)

Circle 61 on Reader Service Card

ATTENUATOR

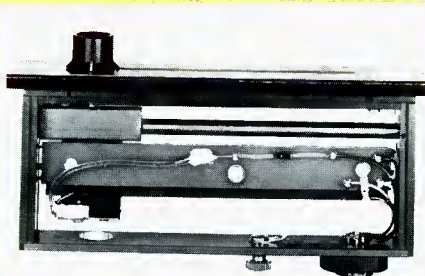

• A low-impedance straight-line ladder attenuator offers a smooth mechanical slide system. A set screw adjusts the exact tension to give a light feel. The resistive elements and related wiper mechanics are designed to eliminate contact bounce and to increase contact pressure to allow wiping through the usual atmospheric coating without making the movement stiff. The Gliss 7011 is available as a retrofit for most existing straight-line mixers.

Mfr: Quad-Eight Electronics

Price: \$75.00

Circle 53 on Reader Service Card

EDITING BLOCK

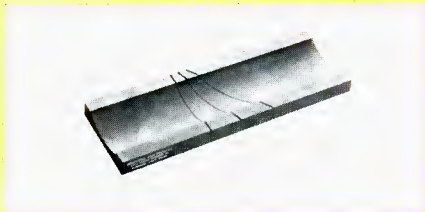

• This editing block is designed to handle two-inch tape and provide either straight or angular cuts. It holds the tape securely, yet is as simple to use as conventional 1/4-inch tape blocks. It is hard anodized aluminum with a satin finish. Length is 7 3/4 inches and the height is 1/2 inch. Delivery is immediate.

Mfr: Stephens Electronics

Price: \$55.00

Circle 58 on Reader Service Card

15-INCH TRANSDUCER

• Model 2150 is a complete two-way system made up of a controlled-excursion 15-inch low-frequency unit and separate high-power high-frequency radiator. Both are acoustically integrated and mounted on a single chassis. It is ideally suited for high-level distributed systems requiring full dynamic range and uniform coverage. The speaker can produce a spl greater than 100 dB at a distance of 30 feet. It will handle 60 watts of continuous program material.

Mfr: JBL

Circle 52 on Reader Service Card

REPEATING CASSETTE



• An automatic repeating cassette is now marketed that will work with any cassette machine. The tape has been formulated to work in this cassette and it is stated that there is no appreciable difference in quality to be noted after thousands of plays. The cassettes are available with one minute to twenty minutes of recording time. *Mfr: Automated Learning, Inc.* *Circle 57 on Reader Service Card*

DIGITAL METRONOME



• Model 963 is a digital metronome that provides the musical director with 320 different precise tempo beats to aid in producing live music scores for motion pictures. The beats are selectable from 1 to 40 frames per beat in 1/8 frame steps, based on the standard speed of 24 f.p.s. The beats may be synced with other equipment by using an externally generated start signal, or can be started and stopped manually from front-panel buttons. The unit has no noise-producing elements, so it can be used on a sound stage. The output is a sharp, uniform, audio click without distracting background noise.

Mfr: UREI

Circle 56 on Reader Service Card



The Sync Track

JOHN M. WORAM

LIMITERS, COMPRESSORS, AND A FEW GRAPHS

• Not too long ago, limiters and compressors were fairly straightforward devices. Generally, they had two knobs, labelled *gain reduction*, and *amplitude*. The first would control the amount of limiting (or compression) and the second, the output amplitude of the device. That was all there was to it. Such little niceties as attack time, release time, and compression ratio were fixed by the manufacturer, and

Figure 1. Idealized graphs of compressor and limiter functions.

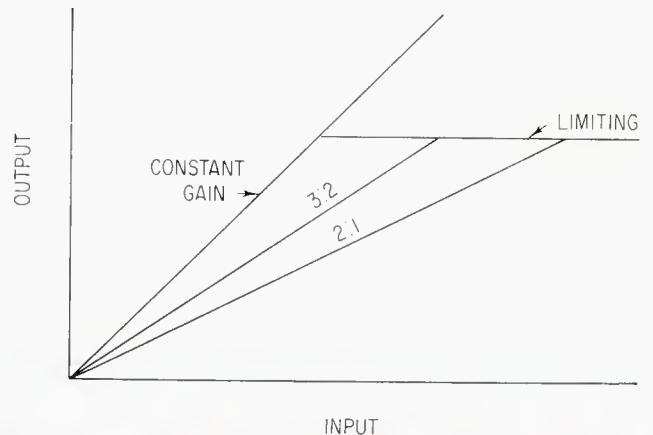

Neve SOUND CONTROL EQUIPMENT

styled to
the needs of
modern
studios

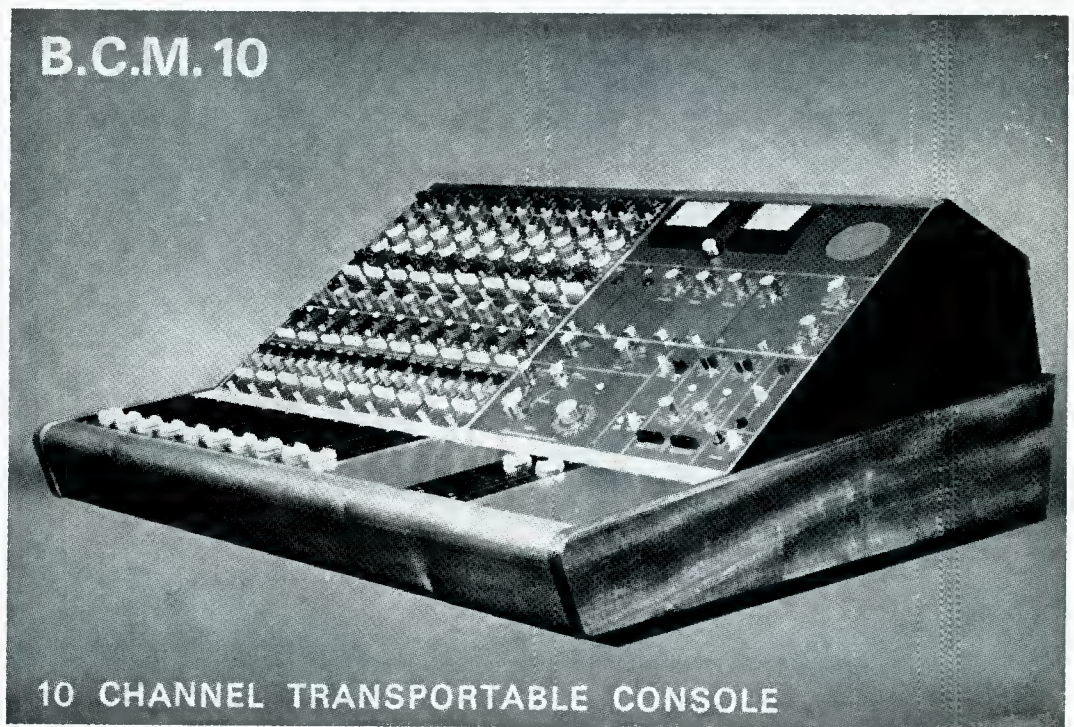

The Neve BCM 10/2 marks a new departure into the field of sophisticated audio control. It embodies ten full mixing input channels and two output groups and is conveniently transportable. Facilities are included for echo, studio foldback and talkback communication, stereo monitoring, cueing and D.J. "combo" working. All signal inputs and outputs are on 1R connectors at the rear. Thus the BCM 10/2 provides for every possible requirements within its class. It is competitively priced and available for quick delivery. Full specifications will be sent gladly on request.

Telephone 076 386 776 (Ten lines) Telex 81381

Rupert Neve & Co. Ltd. Cambridge House, Melbourn, Royston, Herts.

Circle 33 on Reader Service Card

IMPROVED WESTREX StereoDisk RECORDER

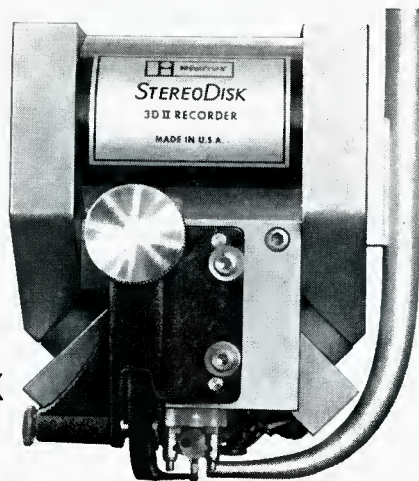

Since the introduction of the 3D StereoDisk Recorder, Westrex has followed a program of continuing improvement. There are now enough significant improvements to merit a change of name. The 3D II, to point out just a few of the changes, has better sensitivity in the difficult frequencies. It has exact balance between channels. Its crosstalk is lower and its over-all performance has been greatly improved. Write for complete details.



DIVISION OF LITTON INDUSTRIES

1136 North Las Palmas Avenue
Hollywood, Calif. 90038
Phone: (213) 466-7795

Circle 34 on Reader Service Card

The new Stellavox Sp7 will become a giant in the recording industry.

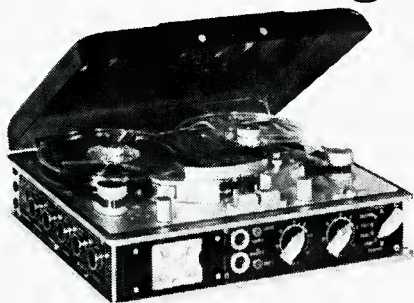

All 8 lbs. of it.

Up till now, perfect stereo location recording meant lugging unportable portables.

So we've come up with a rugged precision instrument, the Swiss-made Sp7. It's small—8"x10"x3". It's light—only 8 lbs. with batteries. And, despite its size, Sp7's features measure up to any portable you're now using..

Plus giving you several advantages you'll get nowhere else, regardless of size.

Like four standard tape speeds. 3¾, 7½, 15 and 30 ips. It is also continuously variable from 0-30 ips.

Another exclusive: Our many tape head assemblies with up to four heads. They plug in. Are quickly exchanged in the field. And each one contains the components to equalize the electronics precisely for a particular tape speed, track configuration and tape oxide. With Neo-pilot for mono

and "Synchronone" for stereo sync recording!

Then there's our 10½" real adapter. It gives you more recording time than any portable ever.

Plus: hands-off automatic stereo level control, dual peak indicating meters, internal powering for two condenser mikes, external AC supply and battery charger, and an internal quartz generator.

We expect this tiny Stellavox Sp7 to live up to the highest hopes of the industry. Because you don't have to be big to be a giant.

Stellavox

exclusively by

GOTHAM
AUDIO CORPORATION

2 West 46th Street, New York, NY 10036 (212) 265-4111
1710 N. LaBrea Avenue, Hollywood, CA 90046 (213) 874-4444

Circle 30 on Reader Service Card

confusion, the two words are often interchanged, and some manufacturers call their units limiters, when they appear to function as both limiters and compressors.

To simply define, and illustrate;

Compressor: a device whose output is proportional, and less than, its input.

Limiter: a device whose output is constant, regardless of its input (once the input exceeds a certain level).

Idealized graphs of both functions are shown in FIGURE 1. The compression curves are for ratios of 3:2 and 2:1—that is, for every 3 dB in, you get 2 dB out, or, for every 2 dB in, you get 1 dB out.

It's easy enough to determine (on paper) the correct settings. Presumably, you already know your maximum allowable output level before tape saturation, disc overcutting, or a little note from the FCC. Just set the compression ratio so that your maximum input level gives you an output equal to, or below your maximum allowable output level. As long as you stay on this compression curve, your output is proportional to your input, and everything sounds fine. *Right?*

Wrong. If that's all there was to it, all you'd need is a volume control, set so as not to exceed a certain level. The trouble with this approach is that you are restricting the entire program level in order that a few high-level peaks do not cause trouble. The net result is that your program sounds quiet (it is), and the lower-level portions are a lot closer to the residual noise level. A more satisfactory arrangement would not lessen the apparent loudness, yet would remain within the limits prescribed by the medium. In addition, the lower-level program would not be buried in the noise.

Fortunately, the demands of the ear are not quite similar to those of recording or broadcasting devices, and so we may create an apparently loud program, yet remain within our imposed limits. In evaluating loudness, the ear averages the sound level over a period of time. Thus a low-level program with occasional high-level peaks will not sound as loud as an average level program with no high-level peaks. FIGURE 2 illustrates this. Program B will sound a lot louder than A, despite A's higher peaks, since its average level is obviously much higher. If the peak(s) in program A were limited, the entire program level could be brought up to the B level, resulting in a louder sounding, yet electrically safe, program.

From this example, it may appear that limiting is preferable to compression, and it may well be, but only up

to a point. Since the ideal limiter's output is not proportional to its input (see definition above), it may be said that it yields a distorted output. The question is, how much of this type of distortion will the listener accept? There's no stock answer to this. A fender bass might be severely limited without sounding objectionable. A much smaller amount of limiting on a violin would be completely unacceptable. Once again, mathematical or electrical values yield to taste and discretion. Usually, the best results may be obtained with a careful combination of limiting and compression. A suitable compression ratio is chosen, and at some predetermined point, the limiting function takes over to prevent overload.

CHOOSING A COMPRESSION RATIO

Generally, a compression ratio should be chosen to give the desired proportion of constant gain, compression, and limiting over the operating range of your input signal. (see FIGURE 3).

There are different methods of designating compression ratios, and if a graph is not supplied by the manufacturer, it is usually worth your time to prepare one to better visualize the method of operation. You might want to cool it with the graph routine during an actual session, as some producers have been known to get up tight when the engineer shows up with a drawing board and T-square. It's probably better to work it out before you buy the limiter/compressor, and not while you're trying to get it to work in the studio.

One popular unit has four compression ratios available, each of which begins operating at a different threshold. (*Threshold*—the point at which the device changes from constant gain to compression.)

Two of the compression ratios are shown in FIGURE 4. Notice that the output is dependant on the compression ratio *and* the point of threshold. It is important that you know both values in order to predict the action of the device.

Another type of unit may list several compression ratios, all of which reduce to 2:1. For example, the *Audio Cyclopedia* describes compression ratios of 32:16, 20:10, and 8:4. All of these ratios should be referred to a reference output level, say, +6 dB. The thresholds are, respectively 16, 10, and 4 dB below +6 dB on the constant-gain plot. From each threshold a 2:1 curve may be drawn, as in FIGURE 5.

So far, we've been describing idealized straight line "curves". In practice, the curves would probably look

Live longer, feel better.

Now, Duncan Electronics is *the* source for high-precision slide actuated potentiometers ("faders"). Duncan 2-3/4" linear travel KP200 series combines infinite resolution with long life — and at low cost. The design features "touch-sensitivity," enabling the operator to feel the action without disturbing the smoothness of motion. The KP200 series are used widely in audio control consoles for the recording and broadcast industries, as well as commercial sound systems. In combination with SCRs, these slide pots are also employed as "dimmers" in studio, stage and auditorium lighting controls. Key features include: single or dual resistance elements, linear or audio tapers, standard tap positions, all metal housing and complete electrostatic shielding.

**WRITE FOR
NEW FADER
CATALOG!**

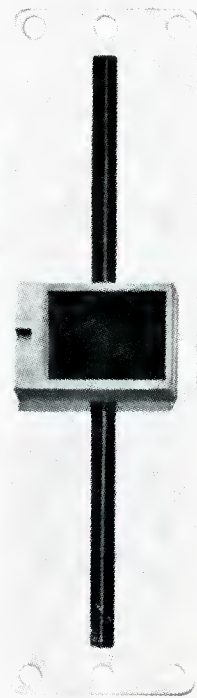
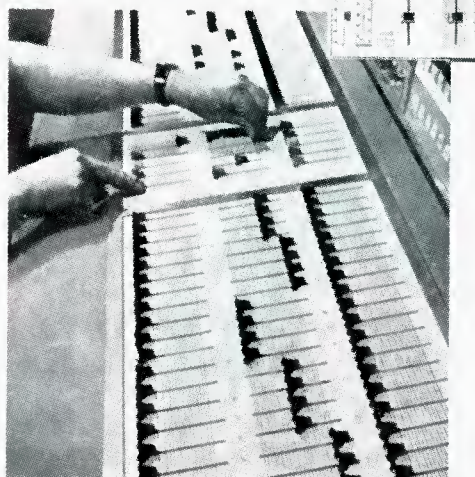

DUNCAN ELECTRONICS
SUBSIDIARY

SYSTRON  **+ DONNER**

2865 FAIRVIEW ROAD □ COSTA MESA, CALIFORNIA 92626 □ PHONE: (714) 545-8261

Circle 37 on Reader Service Card

Our Blood and Sweat:

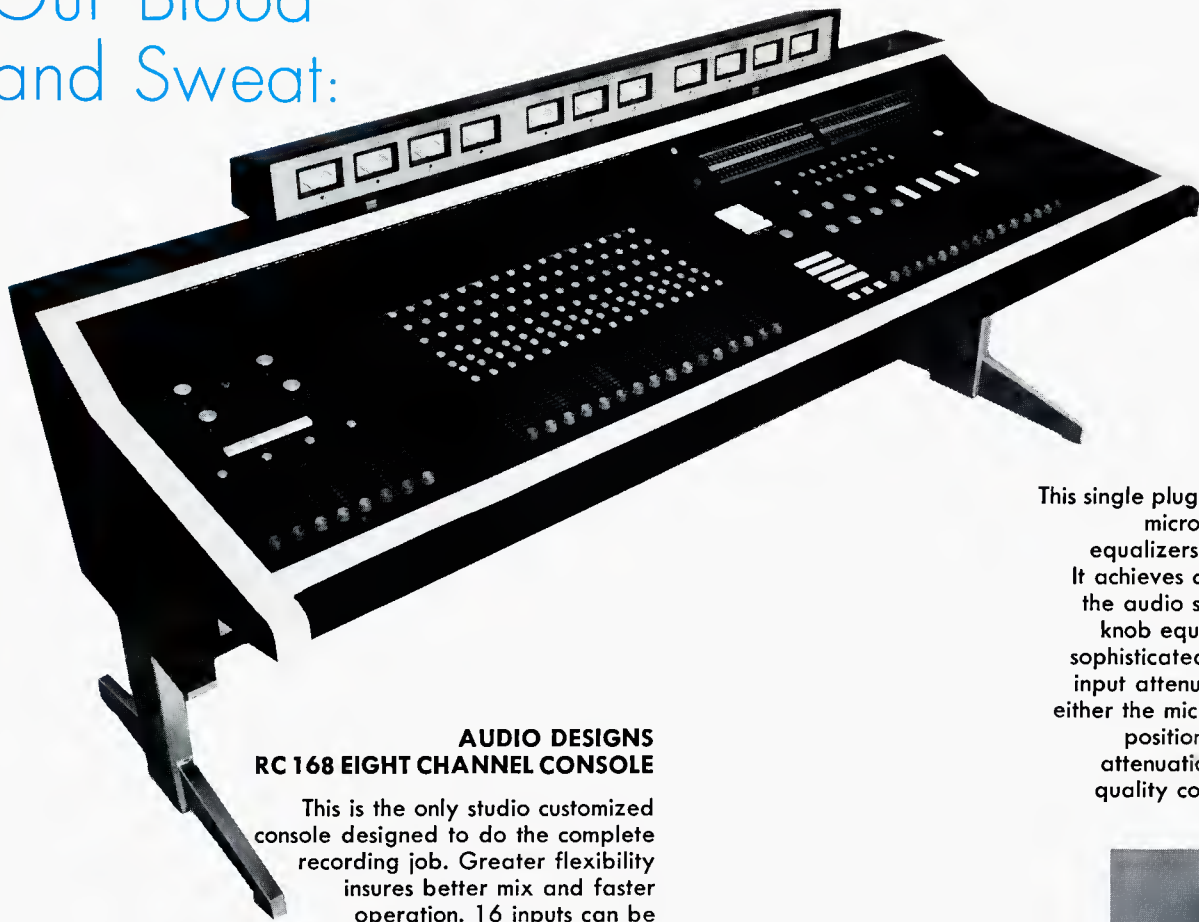

AUDIO DESIGNS RC 168 EIGHT CHANNEL CONSOLE

This is the only studio customized console designed to do the complete recording job. Greater flexibility insures better mix and faster operation. 16 inputs can be assigned simultaneously to any of 8 program channels, plus 4 echo channels using our unique Audex switching system. This console is also available with both 20 input positions (RC 208) and 24 input positions (RC 248).



AUDIO DESIGNS FILM FOOTAGE COUNTER (ADM 163)

This counter achieves a high noise immunity through the state of the art circuitry, which insures accuracy and repeatability, while eliminating erroneous counting. This model counts both 16 mm and 35 mm with equal ease of operation. The ADM 163 uses integrated circuits, and is capable of both forward and reverse counting. Readouts are large, easy to read.

AUDIO DESIGNS ADM 700 SERIES

This single plug-in module integrates microphone preamplifiers, equalizers, and line amplifiers. It achieves complete control over the audio spectrum with a three knob equalizer, adding highly sophisticated flexibility. The step input attenuator may be used in either the microphone or line level position with up to 30db of attenuation in 10db steps. 23 quality components to fill your input requirements.

AUDIO DESIGNS AUDEX

New, compact audio switchers solve the complexity of buss assignment and matrixing of multichannel consoles. Simplifies your console programming, by replacing up to 640 buttons.

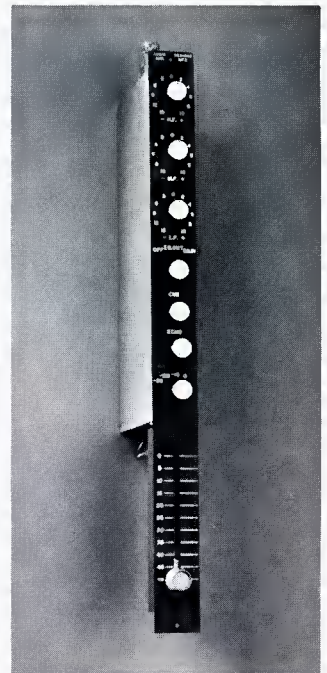
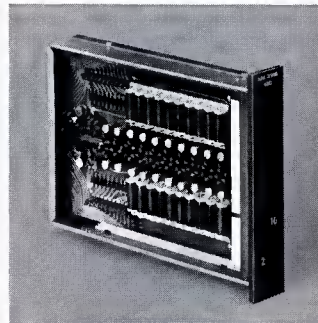

AUDIO DESIGNS
and Manufacturing, Inc.
15645 Sturgeon
Roseville (Detroit)
Michigan 48066

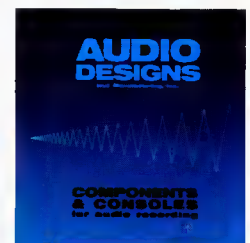

If you're interested, Call Us Collect-(313) 778-8400... **NO SWEAT!**

Compressors and Limiters

A Forum

Compressors and limiters, their uses and functions have created a host of misunderstandings and confusions. Here are authorities to dispel them.

ASK AN AUDIO ENGINEER who uses these products just what he wants and has in the way of compression and limiting equipment, and you will get as many answers as you have asked engineers. Yet the modern requirements of broadcast and recording require the use of these components. And as we strive to improve the sophistication of the final product—broadcast or record—the need for more versatile componentry is required. Thus, the spiral of better equipment and greater confusion moves on.

We asked four authorities on the subject to discuss the many questions that are asked about these components. They are all manufacturers or distributors as well, so their knowledge of their products and the requirements for them are great. They are:

George Alexandrovich, vice president and general manager of Fairchild Sound Equipment Corp. of Long Island City, N. Y.

William G. Dilley, president of Spectra Sonics of Ogden, Utah.

Edward J. Gately, Jr. of Gately Electronics of Haver-town, Pa.

Stephen F. Temmer, president of Gotham Audio Corp. of New York City.

The logical beginning for these discussions was an attempt at definition of compressor and limiter.

Temmer: A compressor is an amplitude dependent variable gain amplifier whose function it is to raise low-level program material by a predetermined amount, while maintaining peak program material virtually unchanged.

Gately: A compressor is an electronic device whose gain decreases above a given signal input level. Normally above the threshold of gain change, the new gain is between $\frac{1}{2}$ and $\frac{1}{5}$ of the value below the threshold. A limiter, on the other hand is identical to a compressor *except* that above the threshold the new gain is $\frac{1}{10}$ or less of the value below the threshold. Many people think that a limiter operates as a clipper. That is, clipping off any signal which exceeds a given value. This is exactly what a limiter is intended to prevent. A good limiter in essence rides gain to prevent clipping or other distortion.

Temmer: A limiter is an amplitude dependent variable gain amplifier (just as I said about a compressor) whose

function is to prevent input levels which exceed a predetermined point or threshold from reaching the output.

The differences between a compressor and limiter can also be described this way: The control function for a limiter is based on the program's peak energy content, while a compressor uses the average program level for control.

Dilley: With the limitations of space and time that exist, I won't presume to develop and recommend useful definitions in the space allotted for this discussion—and complete derivation is, indeed, required for proper understanding, acceptance, and usage—and since the question as asked is framed around conventional definitions and do not apply to the concept of operation of our company's designs and equipment, some discussion is prerequisite.

All of the existing definitions assume that the only way to limit peaks is by changing the *average* gain, and further, that if the average gain is lowered, it must be slowly restored to prevent unacceptable level changes. Without elaboration at this time let me say that it is possible to limit typical program material peak voltage excursions without any audible change to the average program. Such an action truly limits peaks only, with no level change, no frequency discrimination, no audible distortion, and audible dynamic range is unchanged. Utilizing this explanation for a basis of concept, the following terms apply in my mind.

A limiter provides amplitude (peak voltage) limiting only independent of average signals.

A compressor provides average (volume) power compression only.

Should compressors and limiters differ in their compression characteristic and not in their reaction or attack time?

Alexandrovich: Compressors should not react to every transient peak but rather to a series of strong signals requiring attack time to be somewhere between 1 and 10 m/sec. and the compression characteristic to have from 2/1 to 4/1 compression ratio. That is, an input signal level increase of 2 dB will produce a 1 dB increase in output level.

The limiter should sense every peak exceeding the threshold and, therefore, should have extremely fast attack or reaction time. In order to sense a single peak of a

10 kHz signal, the limiter should have an attack time preferably faster but not slower than 25 μ sec. Limiters usually have attack times of few μ sec. The limiting characteristic should have a compression ratio of 10/1 or better. This also means that the gain of the audio chain will drop accordingly for the duration of the limiting.

Do you consider limiting or compression of separate parts of the audio spectrum superior to wide-band limiting?

Gately: For most applications, I feel that wide-band limiting is superior. However, for specialized applications where the overload of the transmission system is frequency dependent, such as FM broadcasting, then compression/limiting on parts of the frequency spectrum can be very valuable. Also selected frequency band compression or limiting can be valuable in sophisticated noise-reduction systems.

Dilley: I don't consider any concept or philosophy by itself to guarantee either the success or failure in a given application. Individual philosophies possess merit in the technical world only when supported or implemented by operating equipment that is tangibly superior to that previously existent.

Temmer: If the requirement for limiting is objective, that is required to prevent overmodulation of a transmitter, then minimum attack time and a frequency spectrum identical to that of the transmitter must be used (the pre-emphasis for FM). In all other applications, it is a matter of personal taste.

Are compressors or limiters of benefit in sound-reinforcement systems?

Alexandrovich summed up the thinking of the four: Compressors and limiters are very useful in public-address systems providing they are adjusted properly. The gain of the system should be set with limiting or compression turned off. Limiting or compression in this case is used only to achieve equalization of levels and protect against overload but not to get higher levels.

Gately, however, added: We find that rock groups we work with have little understanding and therefore a reluctance to spend on, the value of limiting.

What frequencies requiring limiting do you find most troublesome?

Alexandrovich: Higher frequencies usually require limiting action and are most troublesome. Short duration pulses produced by percussion instruments and pops and clicks to be controlled require fast reaction time of the controlling device.

Gately: Low frequencies because of the inherent distortion that develops because of slow release times.

Dilley: With limiters none exist in a natural environment (a function purely of attack time). In compression, only the lowest reproducible frequency.

What is the most inconspicuous release time of a limiter?

Dilley: The most inconspicuous release time of a limiter for both circuit interaction and lack of audible degradation is simply stated as the-fastest-time-possible.

Alexandrovich: One would think the most inconspicuous release time after limiting would be instantaneous. But this creates problems of producing harmonic distortion. In order to preserve the quality of the sound, dynamic balance and low distortion, the release time is varied between half a second to several seconds depending on the amount of limiting action. The more severe the

limiting, the longer the release time should be.

Temmer: Program dependent release time is most practical but if such is not available I would prefer instant release time equal to attack.

Gately: This is a loaded question. Classical music requires longer release times than rock. The history of the amount of limiting being accomplished enters into the answer also. If the previous amount of limiting has been slight then rapid release is acceptable. If the limiting has been very great—say 10 or 20 dB—than a slower release time is required.

Should there be separate limiting action on positive and negative peaks?

Everyone seemed to agree on this question differing only perhaps in the reason for their agreement. It was summarized in one sentence by *Temmer:* There shouldn't be for pure audio use, though this is sometimes useful in AM radio transmitting.

How much low-frequency distortion is permissible by a good limiter or compressor—at sustained levels and at the time limiting starts and stops?

Here again there was general agreement, though some differences on percentages were noted. Again, *Temmer* served to summarize most succinctly: Distortion requirements ought to be the same as is permissible for all linear systems. Why anything else?

As limiting or compression stops, noise level increases. What is your feeling on expander-type circuits that would tend to keep the level of noise constant?

Gately: First off, when limiting stops, the noise level increases because the gain of the system is at maximum. The observed increase of the noise is not caused by the limiter per se, but because of the high system gain. Attention to reducing noise throughout the system will do much to reduce this apparent noise increase. An expander circuit will only add to the problem as it will increase both the signal and the system inherent noise.

In AM broadcasting where out-shouting your competitors is the name of the game, limiter/expander devices may have great value in keeping the average modulation at a very high value.

Temmer: In properly designed limiters, noise will not increase when limiting stops. This is only a problem with compression—and for such compressors an expander is absolutely necessary.

Alexandrovich: The Dolby system has demonstrated how effectively expansion and compression can reduce noise. The expander working on a threshold lower than the compressor or limiter produces background noise reduction. The amount of expansion and release times of the expander and compressor should be identical for a most inconspicuous effect.

Is the operation of compressor, expander, and limiter action in combination advantageous in an audio chain?

Alexandrovich: Compressors and limiters complement each other in the chain of equipment and can be used effectively in almost any type of work providing they are used with discretion. While compressors work at levels as low as 40 dB below average level, the limiter can cover the part of the dynamizer range not covered by the compressor; that is, above the average output level, setting the ceiling on all excessively high-amplitude signals which would normally drive output into clipping.

Gately: Combination operation has value in systems

having limited dynamic range where a signal having wide dynamic range must be accommodated. Tape cartridges for automobile use or AM radio are examples where limiting of high level signals and expansion of low-level signals would be desirable. Noise-reduction techniques also successfully rely on complimentary limiter/expansion techniques.

Dilley: The final objective of any compressor or limiter is any one, any combination, or all of the following—re-

strict peak amplitude excursions; restrict and/or compress average power excursions; reduce peak to average ratio. Obviously such devices can be used to startling advantage if the individual and accumulated performance of the device does not compromise or degrade the audio quality, and thus the rest of the chain, to the point that their very use defeats the purpose of their insertion—to improve the audio chain.

Temmer: In answer to the question—yes! ■

Compressor/Limiter Guide

What follows is a basic guide to available compression and limiting devices that has been derived from information supplied by the respective manufacturers. We have tried to be as complete in this listing as possible but some manufacturers simply did not supply information.

Each manufacturer listed has a reader service number attached. Simply circle this number on the reader service card and you should receive information in detail directly from the manufacturer concerned.

ALTEC LANSING

Model 436C Compressor Amplifier. A self-powered unit that features variable compression ratio with a maximum of 4:1, attack time of 50 milliseconds and release times adjustable from 0.3 to 1.3 seconds. A front-panel meter indicates compression in dB. Dimensions are 19 x 3½ x 6 inches deep. The price is not given.

Model 1591A is an all solid-state self-powered compressor designed for mixing high- and low-level inputs. A front panel meter indicates compression in dB. Maximum compression ratio is 10:1 and release times are selectable at 0.5 or 1.5 seconds. Dimensions are 3½ x 19 x 5¼ inches deep. The price is not given.

Model 9473A is a limiter amplifier with a 10 µsec attack time and a release time of 0.4 sec above 250 Hz and 3.6 sec. below. The two bands may be combined at either release speed. Dual front-panel meters indicate compression in dB and compression ratios up to 20:1 may be selected. *Circle 79 on Reader Service Card.*

AUTOMATED PROCESSES

Model 25 is a combined compressor/limiter of modular design for insertion into consoles. Attack time is 15 µsec and release times of 0.1, 0.5, 2, and 2.5 sec. are provided. Compression up to 20:1, de-essing by reciprocal voice energy curve, and a gain-reduction meter are provided. The connector is a 30-pin pc unit. Power requirements are ±15V bipolar d.c., 60 mA max. Dimensions are 1½ wide x 5¼ high x 6 inches deep. Price is \$325. *Circle 80 on Reader Service Card.*

BOGEN

Model CMP-1 is a compressor designed for sound-reinforcement systems. It mounts on the chassis of Bogen amplifiers and provides a maximum compression of 30 dB, an attack time of 30 msec. and a fixed release time of 300 msec. The only control is for threshold. Power of 20 to 40 V at 15 mA is taken from the amplifier. List price is \$100.00. *Circle 81 on Reader Service Card.*

CBS LABS

Model 4440 Audimax is a slim-line automatic-level controller of all solid-state design. It provides automatic gain riding by monitoring the incoming signal and comparing it with its memory of the average program content over a preceding period of time. In standby conditions, the unit waits 10 seconds before changing the gain from the last setting and reducing it slowly to normal. The unit fits a standard 19-inch rack, is 1¾-inches high and 16-inches deep. It is self powered. Price is \$725 mono and \$1295 stereo with mono units later convertible to stereo.

Model 4000 Volumax is an automatic peak controller of slim-line solid-state design. It provides automatic control of speech asymmetry, silent polarity switching, and microsecond regulation. Attack time is less than 1 µsec. or 2 msec. depending on program waveform. Dimensions are 19-inch wide x 1¾-inch high x 14½-inch deep. The unit is self powered. Price is \$725.00. *Circle 82 on Reader Service Card.*

CREATRONICS

Model CL400-2 is a limiting amplifier of all solid-state design. The model actually consists of two CL400 series limiters to provide attack times that are so fast that they are claimed unmeasurable (less than 1 µsec.).

Release times are adjustable from 50 msec. to 1.6. seconds. The unit is self powered and has dual front panel meters. Price for this model is \$50.00, a single limiter for console mounting is \$220.00 and comes without meters, but with meter drive amplifier for external connection to a VU. *Circle 83 on Reader Service Card.*

EMT (GOTHAM AUDIO)

Model 156 is a compressor/limiter which can also function as an expander. The limiter portion has attack times up to 100 μ sec., and the compressor has internal adjustment but a factory setting at 2 msec. Compression and expansion ratios of 1 1.5. and 2.5:1 can be selected. Switches select manual or automatic (program content) operation and a front-panel meter is provided. A light guide on the front also indicates the function at work. Dimensions are a standard 19-inches wide, and 5½ high x 14-inches deep. Price is \$2990. *Circle 84 on Reader Service Card.*

ELECTRODYNE

Model CA-700 is a compressor/limiter with both VU and compression meter. It can limit peaks with or without level compression. Ratios of compression are 30:1, 40:20, 30:15, and 20:10. Design is all solid-state using fets and i-c amplifiers. Attack times are less than 20 μ sec and release time is self-powered. There is a de-essing control. It fits a standard 19-inch rack and is 3½-inches high. A model CA-702 is electrically similar but is not self powered and is designed for inclusion as a console module. Prices are \$575 and \$350 respectively. *Circle 85 on Reader Service Card.*

FAIRCHILD SOUND

Model 663 Integra I is a compressor for console mounting. It features all solid-state design and adjustable release time of 300 msec to 7 seconds. Attack time is 3 msec. A front panel meter indicates compression. Power requirements are 6.3V a.c. or 9V d.c. at 70 mA. All vital circuits appear on a barrier strip at the back of the unit. Dimensions are 1½ x 7 x 4½ inches. Price is \$165.

Model 692AGC Integra II is a remote controllable compressor that is available as a console module with a separate plug-in card. It has been designed to provide compression with no distortion and no loss of gain. Attack time is 3 msec. and release time is adjustable from 300 msec. to 5 seconds. 24V d.c. are required at 110 mA. Price is \$145 with the remote operating control.

Model 670 is a limiting amplifier of solid-state design with full limiting available in 5 μ sec. Release time is variable up to 25 seconds or may be set for automatic operation by the program content. The unit can also be used as a compressor and thus function as a peak limiter with a 30:1 ratio (or down to 2:1). This model is designed for stereo operation as it is actually two limiters that can act independently. The unit comes in a rack mount and occupies 14 inches of panel and is 11 inches deep. Price is \$1795. *Circle 86 on Reader Service Card.*

GATELY

Model 1880 is a compact limiter of solid-state design for installation in consoles. Extremely fast attack times of 1 μ sec are provided and release times may be adjusted to 5 seconds from 100 msec. The front panel, regardless of small size has gain and limiting controls and an indicating meter. Power required is +45 V d.c. at 120 mA maximum. Size is 1½ inches wide x 5¼-inches high, 7-inches deep. Connectors are at the rear. Price is \$299.00. *Circle 87 on Reader Service Card.*

GATES RADIO

The Solid Statesman FM Limiter is designed to provide fast, medium, or slow selectable recovery times (200 msec., 2 sec., 10 sec.). Attack times are 40 μ sec maximum. Front panel controls are concealed and are screw-driver set with only a meter indicating limiting action showing. The self-powered unit takes 3½-inches of standard rack space. Price is \$730.00. *Circle 85 on Reader Service Card.*

Peak Limiting Amplifier is designed for either AM or FM use due to a choice of asymmetrical or symmetrical limiting. With asymmetrical limiting there is automatic phase reversal. Attack times are less than 10 μ sec. with release times gated to program content using a three-position screw-driver switch for individual preferences in release times. The unit is self-powered, fits a standard rack, takes 5½ inches of vertical space. Cost is \$675.00.

Automatic Gain Control Amplifier is a compression and expansion system that may be used either way. Compression attack times can be selected at 100 μ sec., 1-2 msec., and 30 msec. Recovery times are dependent on attack times and run from 12 sec. to 53 sec. Expansion is similarly adjustable for both attack and release times. Two units may be synced together for stereo with a simple jumper cable. 3½ inches of standard rack space are used. Price is \$695.00. *Circle 88 on Reader Service Card.*

LANGVIN

Model AM7A is a compressor/limiter that functions as a high ratio fast attack limiter or a low-ratio compressor. Attack times as fast as 5 μ sec. are available ranging to 2 msec. (switch selected). Release times are also selectable from 50 msec. to 2 seconds. A meter indicates the degree of gain reduction. De-

essing control is included. The unit fits a standard rack and occupies 3½ inches of height. It is self powered. Price is given as approximately \$600.00 *Circle 89 on Reader Service Card.*

McMARTIN

The model LR-1004A is a solid-state compressor/limiter designed for the commercial-sound market. It offers 2-5 millisecond (adjustable) attack time and release times of 1-5 seconds (also adjustable). Inputs and outputs may be either balanced or unbalanced. The front panel has an input level control, compressor in/out switch, limiting-indicating meter, meter switch, and power on-off. The system is self powered and fits a standard rack, occupying 1¾ inches of vertical space. Price is \$204.00 suggested list. *Circle 90 on Reader Service Card.*

MELCOR

Model CL-20 is a compressor/limiter of solid-state design for use as a console module. The front panel provides threshold and degree of compression/limiting, output, and an indicating meter. The attack time constant is 10 µsec., and release times are automatically variable to provide instantaneous peak limiting. Melcor operational amplifiers are used. Dimensions are 4⅞-inches high x 1 9/16-inches wide x 5-inches deep. A 14-pin mating connector is supplied. Power requirements are ±15V at 55 mA. Price is \$248.00 *Circle 91 on Reader Service Card.*

NORELCO

Types 5752 and 5753 are compression units designed for broadcast studio and transmitter compression functions. Attack times are less than 0.2 msec., in the compression mode and 1 msec. functioning as a limiter. Front panel controls are provided along with an indicating meter. Among these functions are switchable release times ranging from 100 msec. to 3.2 seconds. Dimensions are not given. Price as a self-powered unit is \$650.00 *Circle 92 on Reader Service Card.*

SPECTRA SONICS

Model 610 is called a Complimiter as it provides both compression and limiting functions. It claims to give the fastest of all peak-limiting speeds (100 nanoseconds to 2 µsec.). It is all solid-state in design, has compression ratios that are continuously variable from 1.1:1 to 100:1. Compressor attack times range from 100 nanoseconds to 1.2 msec., release times are less than 90 nanoseconds as a limiter and variable from 50 msec. to 10 seconds as a compressor. The unit is self powered. It fits standard racks and occupies 3½ inches of height. Price is \$585.00.

Model 601 compressor/limiter is a solid-state circuit card that provides the same level of performance as model 610 above. It requires 24V d.c. at approximately 40 mA, and is 2½ x 5¾ inches. Price is \$111.60. *Circle 93 on Reader Service Card.*

TELETRONIX (UREI)

Model 1176LN is the successor model to the 1176 limiter. Front panel controls include ratio selection, input and output, attack, release, and meter. Attack times are variable from less than 20 µsec. to 800 µsec. Release times are adjustable to a 50 msec. minimum and a 1.1 second maximum. Compression ratio settings range from 20:1 to 4:1. The unit is self powered. It fits a standard rack and is 3½ inches high. Price is \$489.00.

Model LA-3A is a solid-state leveling amplifier that functions as limiter. Attack times of 250 µsec. to 0.5 msec. are front panel adjustable as are 500 msec. to 5 second release times. A front-panel meter is provided. With an accessory kit the unit will rack mount. Dimensions without the kit are 8½ wide x 3½-inches high, with a depth of 9¼ inches. Price is \$375.00. *Circle 94 on Reader Service Card.*

PARASOUND

The Orban/Parasound program-controlled amplifier is a compressor/limiter of solid-state design and features overload protection. Attack times of 100-500 µsec. are typical and are dependent on the degree of overload and pre-existing level of gain reduction. The unit may be used for asymmetrical peak limiting of AM broadcasts due to separate adjustments for positive and negative thresholds. A standard vu meter indicates gain reduction. Compression release is adjustable. Prices are \$650 for a self powered unit, \$750 for a stereo correlated version and \$395 for a card-only version (without power supply, meter, and cabinet). *Circle 95 on Reader Service Card.*

QUAD-EIGHT

This new product is a compressor card for inclusion in consoles as a gain-reduction section. It has attack times of approximately 1 msec., release times adjustable from 0.5 to several seconds, a de-essing option, and remote-control operation. The power supply can be either a bipolar 28 V d.c. or a single 24 V d.c. supply. The price with a remote control panel and connectors is \$190.00. *Circle 96 on Reader Service Card.*

A Four-Channel Stereo Broadcast

RICHARD ALAN ROGERS

Sophisticated techniques brought together audio and video technologies to present to west-coast viewers a color television show with four-channel stereo sound, yet with a measure of compatibility for non-stereo viewers.

AT MIDNIGHT, July 11, 1970, history's first quadriphonic simulcast was aired to more than one million viewer/listeners throughout the San Francisco Bay Area. KPIX (Channel 5), a Westinghouse-owned television station, aired a videotaped rock concert while simultaneously the audio portion was being broadcast in four-track stereo from two local FM radio stations. KPIX teamed with stereo radio stations K101-FM and KCBS-FM to present *Celebration*, a 90-minute presentation featuring the Chambers Brothers, Boz Scaggs and Linda Ronstadt. The stereo rock concert was presented in color to a light show. It marked the first time television has offered viewer/listeners a video presentation with 4-channel sound.

"Television," said William Jackson, KPIX program manager, "is primarily a visual medium. It has depended almost solely on picture presentation for its existence and has largely neglected audio output. Our objective with *Celebration* was to give viewer/listeners a demonstration of the best audio/visuals radio and television technology can offer."

A color television set and two FM-stereo receivers were necessary to receive the full impact of the show. Viewer/listeners were encouraged to have stereo parties to make up for any lack of receiving equipment. Audience response and appreciation resulted in KPIX receiving more than 1,500 letters and phone calls, according to Jackson.

"We are very satisfied with audience response," said Jackson, "and feel the show was a tremendous success."

However, doing the show at all meant solving technical problems for which no precedents served as guidelines. KPIX technical supervisor John Gates headed a team

of Don Lincoln, KPIX assistant chief engineer, Don Geis, audio mixing expert from McCune Sound Service in San Francisco and KPIX technical aides.

"The main obstacle which we foresaw at the onset of the project," said Gates, "was how to synchronize the audio and video segments of the presentation from two different tape systems. The use of recording machines operating from a.-c. power sources made problems of speed variation a pressing reality. Editing and splicing, usually a minor procedure in videotaped productions, became a time consuming and complex obstacle because we had to synchronize the four-track audio tape with the video portion."

The major equipment included an Ampex VR-2000 color broadcast videotape recorder, an Ampex MM-1000 16-track professional audio recorder, a Hewlett-Packard 206B oscillator used as a variable 60-Hz a.-c. power source and a surplus Ampex motor-drive amplifier from a VR-



Figure 1. Engineers huddle around audio-mix specialist Don Geis as he feeds the 16-track MM-1000 for the audio/video show.

Richard Alan Rogers (known to everyone as Rick) is employed in the public relations department of Ampex Corporation in Redwood City, California.

1000. The VR-2000 performed its usual task of recording video along with one track of monophonic audio for the television broadcast. However, this track was not used on the air. The 16 tracks of the MM-1000 were used for recording, in master studio fashion, from several microphones and were mixed down to the four-track stereo which was subsequently broadcast by the two FM-stereo radio stations. It also provided a special control track for syncing information which was derived from the video machine. The oscillator and the Ampex motor-drive amplifier were used to drive the MM-1000 capstan motor and maintain synchronous operation of both video and audio machines during the broadcast playback.

At noon, on the day of taping, audio expert Don Geis and two technical aides set up the MM-1000 in a small studio adjacent to the larger studio used by the performers. They positioned microphones, checked record levels on the MM-1000 and made certain that closed-circuit television monitors were operable. The two monitors provided a view of the performers and microphones.

The performers arrived at 3 p.m. and rehearsed until midnight. Final taping ended four hours later and marked the beginning of technical headaches. Geis achieved proper sound balance and mix on the MM-1000 during the live performance. He used up to 20 microphones with four

inputs on eight tracks for the quadriphonic portion of the presentation. "Actually," said Geis, "six or eight tracks would have been enough, but we felt we needed duplicates in case grave audio splicing or editing errors were made later.

"In future applications," added Geis, "one track should be used for the television mono; one track for the control track signal which will be taken from the video recorder's reference speed; and four tracks for the quadriphonic portion."

Geis followed general master recording studio procedures in operating the MM-1000 with one exception — tape speed was run at 7½ in./sec. instead of 15.

Operating the MM-1000 at 7½ in./sec. allowed Geis to record the complete show on one reel of tape. This prevented additional syncing problems which would have occurred if it was necessary to change reels during broadcast or operate two audio tape machines.

"We achieved a beautiful balance and mix during the live performance," said Geis, "and no dubbing or adding of sound effects, except applause, was necessary." Thus, audiences heard the original audio tape with no sound gimmickry.

John Geis explained the exact use of the 16 tracks of the MM-1000 recorder thusly:

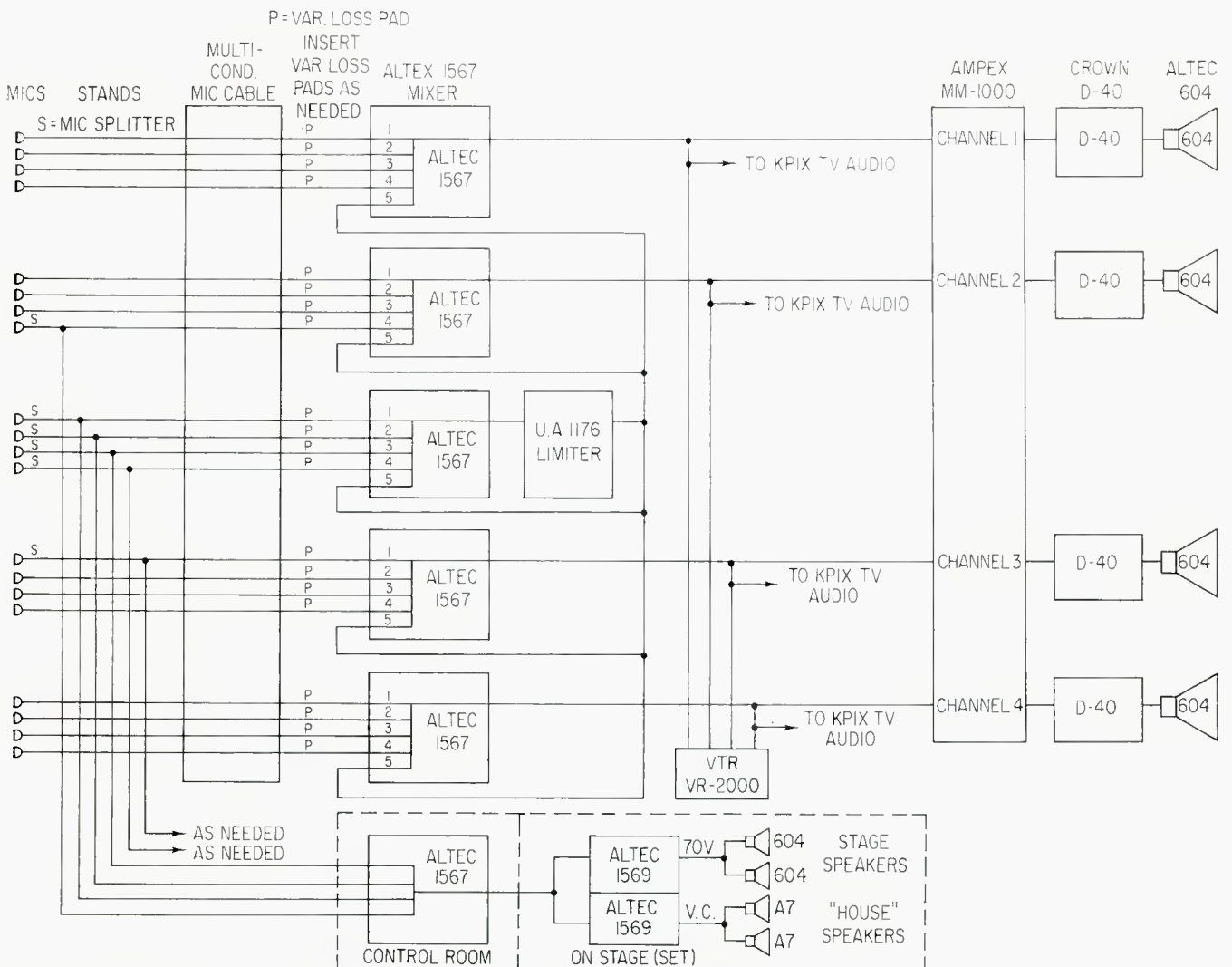

Figure 2. This is the way the audio signals went to get to the correct stations in the correct way.

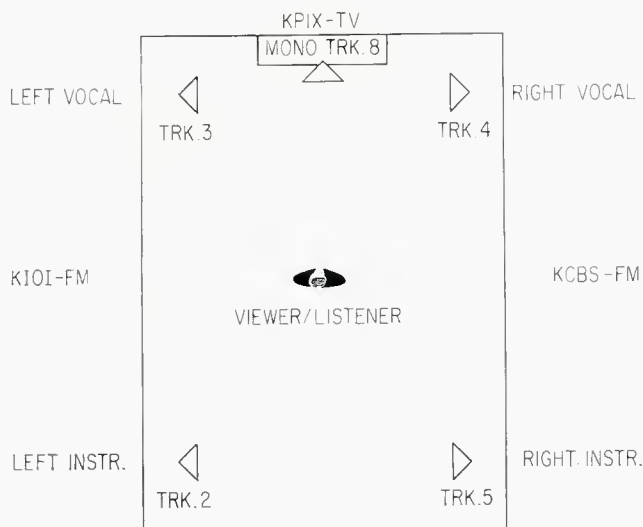

Figure 3. This listening/viewing setup was necessary to achieve full benefit of the transmission described.

TRACK USE

- 1 Blank in the case of tape curl which would occur on the inner and outer tracks of the tape and might distort audio information.
- 2, 3, 4, 5 Quad tracks fed four separate signals from 16 microphones on stage and mixed during the performance. The vocal information was split and sent to the fronta tracks (3, 4) which were used by the FM-stereo radio sta-

- 6 Blank.
- 7 Used to record a mono track for KPIX (obtained by mixing the quad tracks). This track was also recorded on the video machine.
- 8 Used to remix the mono track after it was learned that one track of Geis' mixed signal to Gates was out of phase. This necessitated cancelling the mono track on track 7 and on the VR-2000 and recording the original four stereo tracks in selective synchronization onto track 8.
- 9 Blank
- 10 Contained the control signal used for synchronizing the audio and video recorders. This track contained the 240-Hz sine wave sync signal derived from the VR-2000. This signal later proved invaluable in maintaining lip-sync after splicing and editing the audio and videotapes.
- 11 Blank
- 12, 13, 14, 15 Used for duplication of tracks 2, 3, 4, 5. These tracks would provide protection in the event of irreparable errors on the first set of stereo tracks.
- 16 Station identification track. This was recorded during post-production and then transferred from this track to the proper individual tracks.

DISCOVER PENTAGON

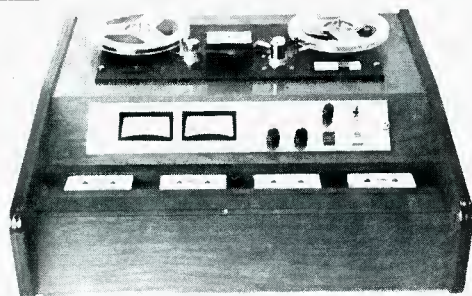

CASSETTE TAPE DUPLICATORS

High Speed. 4 One Hour Cassettes Recorded Both Sides in Less Than 4 Minutes. Master Reel to Reel Deck 3 Direct Drive Motors (60 i.p.s. or 30 i.p.s.) Specially Designed Cassette Decks, Heavy Fly Wheels, Two Motors Per Cassette, Precision Ground Capstans. Solid State, Plug-In Circuit Boards, Frequency Response 20-12,000 HZ, Individual or Simultaneous Recording of Tracks. All Components U.S. Manufactured. Excellent Dealer Service.

A Model to Suit Your Need. For Detailed Literature Write Today:

Pentagon Industries, Inc. DEPT. DB
P. O. BOX 48277
CHICAGO, ILLINOIS 60648

EDITING AND SPLICING

Gates and crew edited the videotape, made cut-a-ways of wild shots (recorded from an isolated camera on a second VR-2000), pieced out commercial breaks and dubbed the videotape to leave the proper amount of commercial time between segments.

"When the videotape was processed to the satisfaction of the producer and director," said Gates, "we then took up the task of splicing the audio tape to coincide in length and information with the video portion. It required two full days to achieve a satisfactory synchronization."

At one point, 29 seconds of video information was edited out and the amount of time and effort required to lip-sync audio with video at this point, was extensive. "We developed a method of lip-syncing," continued Gates, "which proved most accurate. We had our floor manager (from one to 40) during commercials. The timing cadence

which he set, usually to a stop watch, provided the video and audio recorder operators with a reference for synchronizing their machines in perfect lip-sync during the commercial breaks."

Synchronization was maintained between the VR-2000 and the MM-1000 during programming segments by comparing on a Tektronix oscilloscope the 240-Hz signal recorded on the MM-1000 (track 10) with 240-Hz signal derived in the servo of the VR-2000. As the oscilloscope trace would drift, a correction was made to the frequency of the Hewlett-Packard oscillator, which was amplified in the surplus Ampex motor drive amplifier. This supplied synchronized power for the MM-1000 capstan motor. This operation was necessary due to splicing that was done on the audio tape and to a slight amount of tape slippage in the MM-1000. However, comparing these two signals and correcting the error kept both machines in perfect synchronization. (Note: Ampex Corporation is now providing electronic equipment designed for splicing and editing on broadcast audio and video machines in perfect synchronization with no manual operation.)

Said Gates, "We had a man matching reference signals with the oscilloscope during the entire 90-minute presentation."

Post production included recording an audio cartridge onto the MM-1000 16-track recorder. The information included was station identification for KPIX, K101-FM and KCBS-FM. The information was dubbed onto the MM-1000 (track 16) and from track 16 onto each separate audio track (track 3 for KCBS, track 4 for K101 and track 8 for KPIX) in a manner which would identify only the station to which the audience was listening. In the case of viewer/listeners who received the complete presentation, the announcement "brought to you by KPIX, K101 and KCBS-FM came in succession from three different speaker positions. This satisfied FCC identification requirements. (Television speaker, speaker 3 and speaker 4) Refer to Figure 2.

The use of basic 4-track stereo format provides the concert-hall effect of surrounding the listener with sound. The receiving speakers of viewer/listeners are placed in the four corners of the living room, the front speakers providing all vocals including announcements, station identification and singing. The two rear speakers provide audience applause and instrumental separation of bass guitars, drums and organ. Since the first two tracks provided a separation of lead vocal and background singing, listeners who only received on FM-stereo radio station often received only lead vocals and instruments or background vocals and instruments.

Interstation linking was achieved with the use of a direct feed line (telco) provided by the local telephone company. The direct line linked the two FM-stereo station transmitters with KPIX. Each FM-stereo station received its designated signal and broadcasted to its respective audience.

No miking of the approximately 75-100 person studio audience was done. Applause response was dubbed onto tracks 2, 5 and 8 of the master tape.

Plans to air *Celebration* on four other Westinghouse-owned television stations throughout the country are currently in progress. A similar presentation designed to include representation of a wider range of music is being scheduled for about the time you read this. ■

UNITED RESEARCH LABORATORY

PRESENTS

AuTo-Tec L16 — 16 TRACKS



\$19,995⁰⁰ F.O.B. NYC

AUTO-TEC
RECORDERS

MONO TO 16 TRACKS

BOOTH #46



United Research Laboratory Corp.

681 FIFTH AVENUE • NEW YORK, N. Y. 10022 • (212) 751-4663

DEVELOPMENT DIVISION OF UNITED RECORDING LABS. INC.

London Professional Audio Exhibition

JOHN BORWICK

This past summer, British audio professionals came to London to view this annual exhibition of equipment designed for their craft. The author details some of the more interesting highlights that were shown.

THE HUNDREDS of studio engineers, broadcasters and record producers who braved a scorching London heat-wave to visit the Waldorf Hotel on the 12th and 13th of June found what was possibly one of the most comprehensive exhibitions of professional recording equipment ever staged anywhere.

APRS 70 was the third such annual show organized by the Association of Professional Recording Studios and it attracted no less than 34 exhibitors embracing practically every European manufacturer as well as a goodly turnout of United States products. The closest parallel to this Show was the US Audio Engineering Society Exhibition in support of the 38th Convention in Los Angeles on May 4-7. The list of APRS 70 Exhibitors given here contains a considerable overlap with the AES Show (reported earlier in **db** particularly if you make such transatlantic conversions as Gotham Audio for F.W.O. Bauch (the respective agencies for the German Studer recorders) and so on.

John Borwick is contributing a series of articles from Europe. A resident of Surrey, he is deeply involved in both professional and consumer audio—both as a writer and editor. As secretary of the APRS, he organized the show he describes.

WHAT'S NEW?

Even though the two shows were only about one month apart, so that Ray Dolby and his charming wife Dagmar told me they had quite a dash back to London, there were several completely new items at APRS 70.

Mr. Kudelski, the world-famous Swiss designer of Nagra professional portable recorders, turned up with a real surprise item. This is the Nagra SN miniature recorder. It measures only 5¾ x 4 x 1 inches and weighs 1 lb. 3 oz. and so can easily be carried in a coat pocket. Performance is up to professional standards, with frequency response at 60-16,000 Hz ±2dB. Wow and flutter from the open reel transport (using 0.15 inch wide cassette-type tape) is ±0.1 per cent (DIN) and speeds are 1⅞ and 3¾ in./sec. Cost in the UK is about £360 (\$690). The standard Mark IV Nagra is used all over the world and is now available with radio-controlled camera synch.

A close competitor to the Nagra, and having the advantage of being available in stereo, is the Stellavox SP7. This too is built like a (midget) battleship and rivals studio machines in performance, with four speeds up to 30 in./sec. It now has an adaptor kit to allow the use of 10½-inch NAB spools. The British agents for Stellavox also handle Sennheiser microphones. Amongst their new



Figure 1. Mr. Kudelski, the designer of Nagra recorders shows his new miniature recorder.

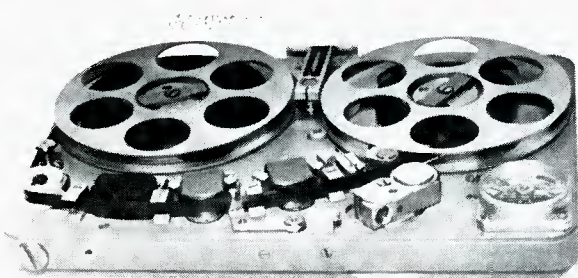

Figure 2. The new Nagra SN miniature tape recorder.

range of condenser microphones is a mini-gun model 415. This is the little brother of the well-known MKH 805, so often seen in TV relays usually in its "zeppelin" windshield, but is only about 10-inches long compared with the earlier model's 22 inches. A strengthened version of the 805, the MKH 815 was also released.

The Viennese firm AKG is best known for such classic condenser microphones as the C12, C28 and C451 but they are so refining their dynamic (moving-coil) designs as to produce real magnetic-versus-capacitor competition. The D224 is a two-way cardioid, keeps within ± 2 dB over the whole audio range and even *looks* like a condenser mic. Shure Electronics (for Shure Bros.) were attracting attention with a new shock-proof collar attachment which silences impact noises anywhere near the mic stand.

It's MCI's new total-logic JH10.

The logic is so total, not even a power failure (much less an engineer failure) can break or spill the tape.

"Sudden" is the most accurate word we can find for JH10's acceleration from "Stop" to any commanded tape function.

And for its conversion time from one- to two-inch, and vice versa.

Practically everything is plug-in for fantastically simplified maintenance and expansion from, say, 8 to 24 tracks.

Constant, electronic (not mechanical) tension control sensing reduces head wear, wow, flutter and speed variations.

Prices start at \$3,500.

Write: MCI, 1140 North Flagler Dr., Ft. Lauderdale, Fla. 33304

MCI

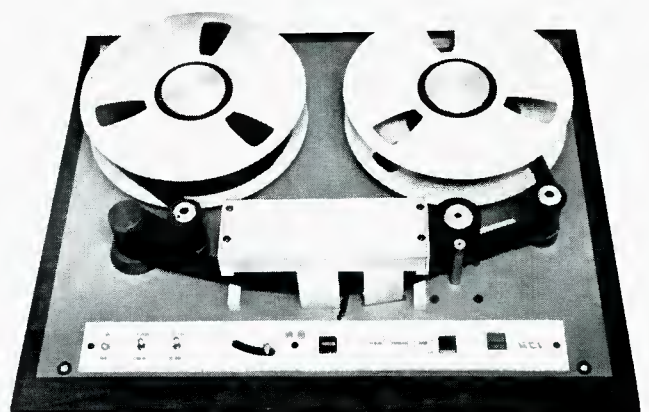

Circle 38 on Reader Service Card

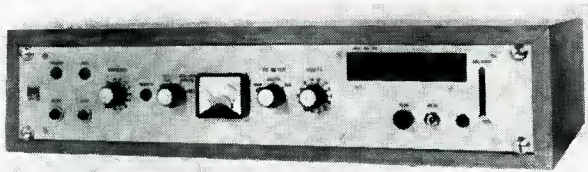

Figure 3. Sure to be the vanguard of a new generation of broadcast products, this is the Appel cassette recorder/reproducer, model 316.



Figure 6. Crowds formed around demonstrations (as they have done in the U.S.) of the Neumann computer-controlled disc mastering lathe, model VMS 66.

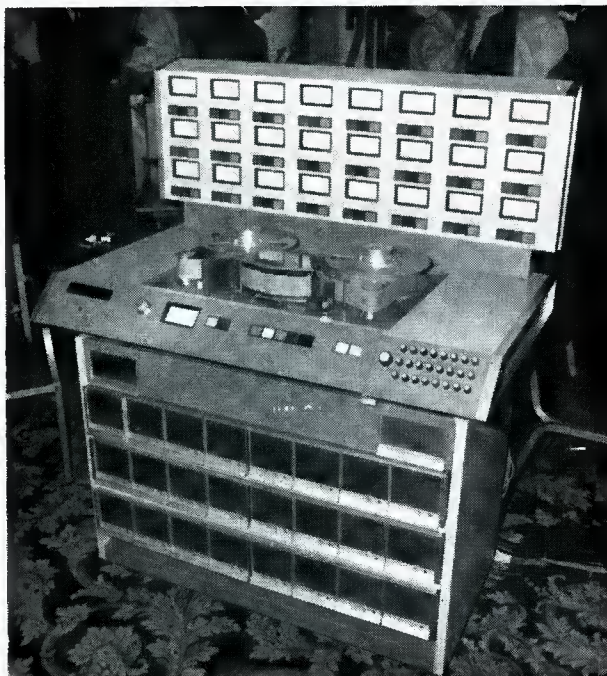

Figure 4. The Unitrack Equipment Ltd. 24-track recorder.

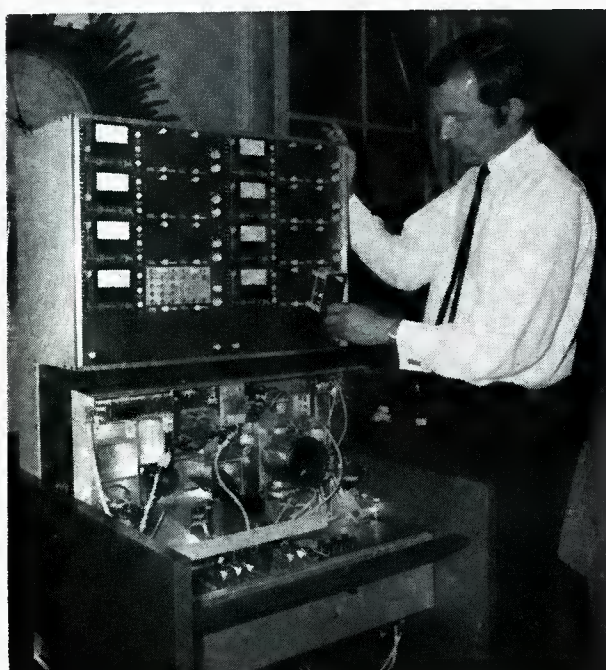

Figure 5. Michael Bauch demonstrates the new Studer 8-track machine.

A new name to me was Appel of Italy who unveiled a professional cassette machine. The Model 316/SS takes endless loop cassettes and will record cue signals simultaneously with program to give fully automatic sequential playback and switching of other associated reproducers. A big market is foreseen in local broadcasting and unattended transmitting stations. (Editor's note: similar products will soon hit the U.S. market.)

TWO, FOUR, SIX, EIGHT.

Multi-track recording is now an accepted feature of professional studios and nowhere more so than in England. The high technical standards and brilliant session musicians in English studios, plus the relatively low costs, have persuaded many foreign producers to do their mastering in and around London.

From four tracks to eight, sixteen and now even twenty-four, the complexity of tape machines has snowballed. Far from diminishing, the present boom in new and re-equipped sound studios seems about to escalate further. And they all want multi-track recorders.

In alphabetical order, the Exhibition was proudly displaying eight track (or bigger) machines from Ampex (the new MM-1000 servo-controlled 16-track) Studer (the A80 8-track), Scully (said to be the best seller in the UK), Leavers-Rich (8-track), 3M Company (the Mincom 16-track with compact remote control unit), Unitrack (the Uni-16 16-track).

Control consoles and their associated electronics have always tended to get bigger and more versatile each year and of course multi-track tape recording has done nothing to reverse this trend. Several British companies specialise in building these desks, using a modular style to adapt to customers' needs. Among the best known of these at the show were Rupert Neve, Audio Developments, Helios Electronics, Pye TVT (Philips Sound Division) and J. Richardson Electronics.

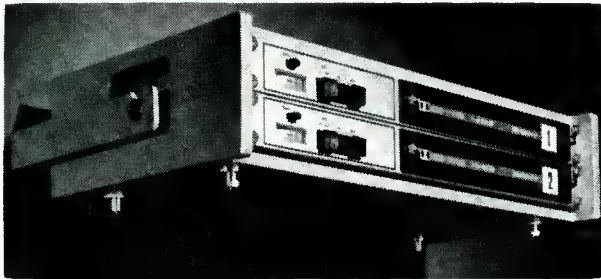

Figure 7. In less space than that occupied by an A301, a pair of Dolby 360 units nestles.

SOPHISTICATED NOVELTIES

The Moog Synthesizer was on display and acted as a magnet to every visitor who sees himself as a latent composer of electronic music. Prices of the alternative versions ranged from about £2,250 to £4,050 (\$4,305 to \$7,985).

The standard A301 Dolby noise-reduction system was joined by a new 360 Series which is very compact and should ideally suit multi-track operators and mobile assignments. It is fully compatible with the A301 and was shown in a variety of cases and mounting as well as pre-stacked on a four-track Scully recorder. (Scully and Ampex both offer versions of their electronics stacks with spaces for the Dolby 360 Series built in.) The noise reduction printed board module itself can be bought separately, as a stand-by or for building into other equipment and both the KLH and Advent B-type (consumer)

models were on exhibit.

Set up and working on the F.W.O. Bauch Stand was a complete Neumann VMS66 computer-controlled disc-cutting lathe system. On the expensive side, this sophisticated machine could only be looked at with envy by all except the very largest disc producing companies but this first-ever in the UK demonstration was a highlight of the show. So too was a new Studer transportable mixer console which the brothers Michael and John Bauch told me they had chartered a special plane to fly in after it had been wrongly off-loaded at Zurich airport.

Among a plethora of fascinating test gear, I was intrigued by the new Crown International i-m distortion analyser which gives fast i-m readings over a wide range of signal levels. European test equipment and limiter/compressors and so on have always enjoyed a high reputation and there were good examples from Audio Design (Recording), Audio Engineering, Audix B.B., EMT, Leever-Rich, Cadac (London), Spectra-Sonic, WaveForms, U-Tech, Miniflux, and Philips.

To sum up: this annual show, just as the industry and the equipment it represents, seems to go from strength to strength each year. It remains to be seen whether a new and larger venue will be required next year and whether any of the big changes in recording media, of which rumors-a-plenty were being bandied about, will materialize in 1971. One thing is certain, gramophone records, cassettes, cartridges, videotapes, videodiscs, EVRs—whatever the final customer product, the basic mastering equipment shown at *APRS 70* will still be the mainstay of the world's studios. ■

We're No. 1 (twice)

Here are the **TWO No. 1** gain reduction amplifiers in the industry...!
Take your pick, they're **No. 1** in performance and **No. 1** in popularity.

THE UNIVERSAL AUDIO

1176LN LIMITER AMPLIFIER

The Industry leader has F.E.T. Gain reduction ahead of first stage; Ultra-fast attack time; Pushbutton selection of compression ratios for every program requirement; and adjustable attack and release times.

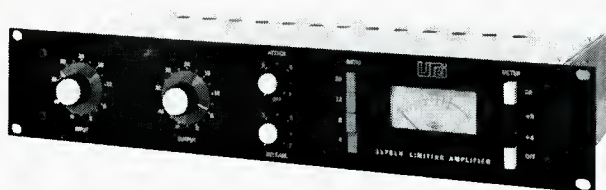

Urei

Send for complete specifications, today!

11922 Valerio Street, North Hollywood, Calif. 91605 (213) 764-1500
Exclusive export agent: Gotham Audio Development Corp., New York, N.Y.

THE TELETRONIX

LA-3A LEVELING AMPLIFIER

This popular, solid-state limiter/compressor has a unique electro-optical attenuator; +25 dBm output power; low noise (over 80 dB s/n at threshold); half-rack size, 3½" high.



The db Bookcase

As a service to our readers we are pleased to offer these books from prominent technical publishers. All prices listed are the publishers' net. Shipping charges are included.

Use the coupon at the bottom of the page or give the complete title, author and coupon number. Be sure to indicate quantity on the special instructions line if more than one copy of a title is wanted. Full payment must accompany your order. We cannot ship c.o.d. Checks or money orders should be made payable to Sagamore Publishing Company, Inc. Because of the time required to process orders, allow several weeks for the receipt of books.

Broadcasting

RADIO BROADCASTING

edited by Robert L. Hilliard. Each of the five chapters has been written by a prominent educator with an extensive background of practical experience in commercial and educational broadcasting. 190 pages; 6¼ x 9½; indexed; clothbound.

\$6.95

Circle 2 on Coupon Below

RADIO TRANSMITTERS

Gray and Graham. Provides, in a logical, easy-to-understand manner, a working knowledge of radio transmitters for quick solution of problems in operation and maintenance.

1961. 462 pp. \$16.00

Circle 40 on Coupon Below

ELECTRONIC AND RADIO ENGINEERING, 4th Ed.

Terman. A thorough coverage, in easy-to-understand terms, of those principles and techniques which are the basic tools of the electronic and radio engineer.

1955. 1,078 pp. \$19.50

Circle 39 on Coupon Below

HANDBOOK OF BROADCASTING, 4th Ed.

Abbott and Rider. This non-technical handbook sets forth clearly and thoroughly the fundamentals of radio and television broadcasting. Over 100 illustrations amplify the text.

1957. 531 pp. \$9.50

Circle 38 on Coupon Below

TELEVISION BROADCASTING

Chinn. A practical, compact technical guide to the equipment, systems, facilities, good engineering practices, and operating techniques of television broadcasting.

1953. 695 pp. \$17.00

Circle 37 on Coupon Below

RADIO ENGINEERING HANDBOOK, 5th Ed.

Henney. Prepared by a staff of specialists, this working manual of radio science provides information on each of the branches of radio engineering, with emphasis on working practice, final working formulas, dimensions, and actual useable circuits.

1959. 1,800 pp. \$28.75

Circle 36 on Coupon Below

AN ALPHABETICAL GUIDE TO MOTION PICTURE, TELEVISION, AND VIDEOTAPE PRODUCTION

Levitin. This all-inclusive, authoritative, and profusely illustrated encyclopedia is a practical source of information about techniques of all kinds used for making and processing film and TV presentations. Gives full technical information on materials and equipment, processes and techniques, lighting, color balance, special effects, animation procedures, lenses and filters, high-speed photography, and much more.

1970. 480 pp. \$24.50

Circle 35 on Coupon Below

Electronic Music

ELECTRONIC MUSICAL INSTRUMENTS

by Richard H. Dorf. Now in its third edition and sixth printing since its first appearance in 1954, this is considered the authority on electronic organs. 393 pages; 239 diagrams and photographs.

\$10.00

Circle 19 on Coupon Below

Test and Maintenance

INTERMODULATION AND HARMONIC DISTORTION HANDBOOK

by Howard M. Tremaine. A complete reference guidebook on audio signal intermodulation and harmonic distortion. 172 pages; 5½ x 8½; softbound.

\$4.25

Circle 9 on Coupon Below

ACOUSTICAL TESTS AND MEASUREMENTS

by Don Davis. Provide; a solid understanding of the entire subject of acoustical measurements; based on actual field test work, using commercial equipment. 192 pages; 5½ x 8½; hardbound.

\$6.95

Circle 7 on Coupon Below

How To

PRACTICAL PA GUIDEBOOK: HOW TO INSTALL, OPERATE AND SERVICE PUBLIC ADDRESS SYSTEMS

by Norman H. Crowhurst. 1967. This book gives all the basics needed to become a successful PA operator, in any situation where the reinforcement, relay, or distribution of sound can provide a service. 136 pages; 6 x 9; illus; softbound.

\$4.50

Circle 15 on Coupon Below

Reference

HANDBOOK OF ELECTRONIC TABLES & FORMULAS, (3rd EDITION)

A one-stop source for all charts, tables, formulas, laws, symbols, and standards used in electronics. Includes an 8-page, full-color fold-out chart showing latest FCC allocations for the entire frequency spectrum. 232 pages; 5½ x 8½; hardbound.

\$5.50

Circle 8 on Coupon Below

BASIC BIBLIOGRAPHY OF SCIENCE AND TECHNOLOGY

McGraw-Hill. Important to the researcher, librarian, or student, this reference book lists and describes over 8,000 outstanding books in every scientific and technical field. A topical index organizes all subject headings into about 100 general categories enabling the reader to locate quickly the listings which pertain to his field of interest.

1966. 738 pp. \$19.50

Circle 34 on Coupon Below

NOISE REDUCTION

Beranek. Designed for the engineer with no special training in acoustics, this practical text on noise control treats the nature of sound and its measurement, fundamentals of noise control, criteria, and case histories. Covers advanced topics in the field.

1960. 752 pp. \$19.50

Circle 33 on Coupon Below

THE AUDIO CYCLOPEDIA (2nd EDITION)

by Dr. Howard M. Tremaine. New and updated, here is the complete audio reference library in a single volume. It provides the most comprehensive information on every aspect of the audio art. This new edition includes the latest audio developments including the most recent solid-state systems and integrated circuits. It covers all subjects in the fields of acoustics, recording, and reproduction with more than 3400 related topics. Each topic can be instantly located by a unique index and reference system. More than 1600 illustrations and schematics help make complicated topics masterpieces of clarity. 1760 pages; 6½ x 9-3/8; hardbound.

\$29.95

Circle 20 on Coupon Below

General Audio

ACOUSTICS—ROOM DESIGN AND NOISE CONTROL

by Michael Rettinger. 1968. The enormous problems and hazards presented by noise are dealt within an orderly and practical manner. With many charts, graphs, and practical examples, the text covers the physics of sound, room acoustics, and design, noise and noise reduction. 392 pages; hardbound.

\$17.50

Circle 21 on Coupon Below

Sagamore Publishing Company, Inc.

980 Old Country Road, Plainview, N. Y. 11803

Please send me the books I have circled below. My full remittance in the amount of \$..... is enclosed. N.Y. State residents add 5% sales tax.

1 2 3 4 5 6 7 8 9 10 11 12 13 14 15 16 17 18 19 20 21 22
23 24 25 26 27 28 29 30 31 32 33 34 35 36 37 38 39 40

Name.....

Street Address.....

City..... State..... Zip.....

Special Instructions.....

Canada and foreign: Add \$1.00 per book

THE TECHNIQUE OF THE SOUND STUDIO

NEW EDITION

by Alec Nisbett. This is a handbook on radio and recording techniques, but the principles described are equally applicable to film and television sound. 264 pages; 60 diagrams; glossary; indexed; 5½ x 8½; clothbound.

\$13.50

Circle 1 on Coupon Below

PASSIVE AUDIO NETWORK DESIGN

by Howard M. Tremaine. A complete and comprehensive guide to the design, construction, and testing of all types of attenuators, equalizers, and wave filters for the practicing audio technician or engineer. 288 pages; 5½ x 8½; softbound.

\$5.50

Circle 5 on Coupon Below

Circuitry and Components

TRANSISTORS FOR AUDIO FREQUENCY (AUDIO-FREQUENCY AMPLIFICATION)

by Guy Fontaine. 1967. This systematic and detailed treatment of the application of transistors in audio-frequency amplifiers shows how the published transistor characteristics are related to the principles of design. An ideal textbook or reference on the subject for engineers and advanced technicians. 384 pages; 5½ x 8; illus.; clothbound.

\$7.95

Circle 12 on Coupon Below

CLOSED-CIRCUIT TELEVISION HANDBOOK

by Leon Wortman. Gives comprehensive detailed information about the field in an easy-to-understand presentation, suited to those who plan to use, install, and service cctv. 288 pages; 5½ x 8½; clothbound.

\$5.95

Circle 18 on Coupon Below

CIRCUIT DESIGN FOR AUDIO, AM/FM, AND TV

Texas Instruments. Texas Instruments Electronics Series. Discusses the latest advances in electronic design and application which represent the results of several years research and development by TI communications applications engineers. Emphasizes time- and cost-saving procedures throughout.

1967. 352 pp. \$14.50

Circle 32 on Coupon Below

SOLID-STATE ELECTRONICS

Hibberd. A Basic Course for Engineers and Technicians. An extremely practical reference book for anyone who wants to acquire a good but general understanding of semiconductor principles. Features questions to answer, problems to solve.

1968. 169 pp. \$9.95

Circle 31 on Coupon Below

INTEGRATED CIRCUITS

Motorola. This complete, authoritative volume of design and construction techniques for modern integrated circuits covers theory, thin-film techniques, diodes, transistors, thermal design, and other vital aspects.

1965. 373 pp. \$13.75

Circle 30 on Coupon Below

PRINCIPLES OF UNDERWATER SOUND FOR ENGINEERS

Urlick. Discusses problems entailed in underwater sound transmission and their practical solutions; describes causes, effects, and underwater sound phenomena; and offers numerous references to unclassified literature in the field.

1967. 342 pp. \$17.50

Circle 29 on Coupon Below

Classified

Closing date is the fifteenth of the second month preceding the date of issue. Send copy to:

Classified Ad Dept.

db

THE SOUND ENGINEERING MAGAZINE
980 Old Country Road
Plainview, New York 11803

Rates are 50c a word for commercial advertisements. Non-commercial and employment offered or wanted placements are accepted at 25c per word.

FOR SALE

SCULLY TAPE RECORDERS — one to twenty-four track and model 270 auto players, many models in stock for immediate delivery. SCULLY LATHES — Previously owned and rebuilt. Variable or automatic pitch. Complete cutting systems with Westrex heads. MIXING CONSOLES — Custom designed using Wiegand Audio Lab modules. From \$7,000.00. Wiegand Audio Laboratories, 3402 Windsor Road, Wall, New Jersey 07719. Phone: 201 681-6443.

SOLID-STATE AUDIO PLUG-IN OCTAL (1" Dia x 2" H) modules. Mic preamps, disc & tape preamp-equalizers, tape bias osc. & record ampl., power amps & power supplies. Send for free catalog and audio applications. Opamp Labs., 172 So. Alta Vista Blvd., Los Angeles, California 90036.

MODULES FOR ALL TYPES of applications. Discrete to thick film IC devices, Pre-amplifiers to power amplifiers. New Catalog with schematics, \$1.00. PM Electronics, Inc., Box 46204, Seattle, Washington 98146.

1 INCH SCOTCH (1 ROB-10 1/2M) empty NAB reels and boxes. New, unopened, cartons of 5; \$3.20 per reel. Cash, money order, check. Minimum order 10 reels prepaid. Sample, prepaid: \$4.20. Picture free on request. Helffrich Recording Labs., R.D. #2, Allentown, Pa. 18103.

BRAND NEW AMPEX AG/500 f.t.—including remote control, portable case, fourth stereo head, microphone preamp, transformers, etc. \$950.00. Telephone: (215) CH 7-4268

SCULLY 282-4 four-track recorder. Brand new, in portable cases, remote control, etc. \$3,750.00 or best offer. (313) 563-8097.

AMPEX 354 \$800.00. 7 new Langevin EQ251A program equalizers, never used; \$160.00 each. Department H1, db Magazine, 980 Old Country Road, Plainview, N. Y. 11803.

TV MONITORS and amps 7-in.; Presto 8DG lathe; kinescope; Gestentner 360 and Gestefax Jr. Printer. Dept. 101, db Magazine, 980 Old Country Road, Plainview, N.Y. 11803.

4 FAIRCHILD 663 N.L. compressors—\$125.00; 8 Fairchild 664 NL equalizers—\$125.00; 1 Fairchild 675 de esser—\$125.00; New and repaired Ampex 351 and 300 recording equipment for sale. Accurate Sound, Box 3505, San Angelo, Texas, 76901.

EMPLOYMENT

PROFESSIONAL RECORDING PERSONNEL SPECIALISTS. A service for employers and job seekers. Call today! Smith's Personnel Service, 1457 Broadway, N.Y.C. 10036. Alayne Spertell 212 WI 7-3806.

TRANSFORMER DESIGN ENGINEER. Leading manufacturer in the professional audio industry is seeking a man highly qualified to direct our transformer effort including design and production. Located in California. Please send resume and salary requirements to Box 9B, db Magazine, 980 Old Country Road, Plainview, N.Y. 11803.

People, Places, Happenings

● **John Eargle**, chief engineer of **Mercury Records** recently announced that **Chuck Irwin** has re-joined Mercury as a staff engineer. Mr. Irwin had worked for Mercury in the past and left to head a remote-recording outfit. Previous to his first stay with Mercury he had been with **A & R Recording** in New York.



● With the realignment of positions at **Allied Radio/Radio Shack** divisions of **Tandy Corporation**, **George W. Steeves** has been named president of **Allied Electronics**, the industrial subsidiary of Allied Radio. Mr. Steeves comes to Allied from the Radio Shack division where he was eastern regional manager. He has been with Radio Shack since 1948 except for a year (1968-69) with **Sterling Electronics**.



● **Charles N. Houser** has been appointed as an account representative of the Michigan electronics representative firm, **J. Malcolm Flora, Inc.** Mr. Houser has been the manager of the **Sony/Superscope** factory branch in Michigan and has over twenty years experience in electronics.

● The **CBS EVR** system continues to move forward. **Nicholas J. La Bate** has been appointed mastering supervisor for EVR cartridge film processing. In this new position, he will be responsible for customer materials, film, or videotape, from arrival at the EVR processing facility in Rockleigh, New Jersey, to transfer to EVR master negatives. Mr. La Bate has been with CBS for four and a half years in engineering positions both in New York and Hollywood.

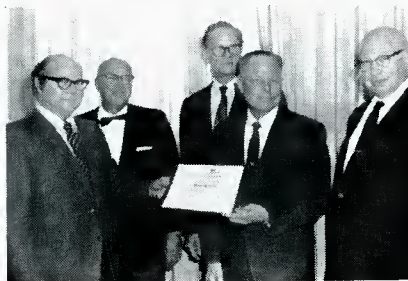

● **James J. Noble**, **Altec Lansing** vice president of engineering is shown receiving a certificate naming him a Fellow of the **AES**. Presenting it is **Hugh Allen**, western vice president of the Society. Shown above, left to right, are **Allen**; **William H. Johnson**, marketing v-p of Altec Lansing; **H.S. Morris**, president of Altec Lansing; **Noble**; and **Arthur C. Davis**, vice president of Altec Audio Controls.

● An announcement by **Larry Grossberg**, general sales manager of **Sonocraft** tells that the New York professional Audio/visual distributor has moved to new premises at 29 West 36th Street, in New York City. The new move quadruples facilities, and centralizes all operations, including warehousing under one roof. The new facilities include a fully-operational closed-circuit television studio for demonstration of both color and b & w. Sonocraft distributes professional recording and broadcast equipment from such manufacturers as **Ampex**, **Fairchild**, **Gateway**, **Pultec**, **Scully**, **Shure**, **Telemation**, and also products from **KLH**, **Kodak** (educational division), **Norelco**, **Rheam**, **Sony**, and **Tandberg**—as well as many others, all of which are carried in stock.



● **Raymond Cooke**, managing director of **KEF Electronics**, Maidstone, England is shown receiving the Queen's Award to Industry from **Lord Cornwallis**, Lord Lieutenant for the County of Kent. The Queen's Award is given for export successes. KEF produces both high-fidelity speaker products and professional monitoring loud-speaker systems. KEF now exports to 44 countries and is expanding its plant for greater production.

● **David L. Klepper** of the firm **Bolt Beranek and Newman** has been relocated from his Downers Grove, Illinois office to the New York City office of **BBN**. Here he is now serving as a supervisory consultant in architectural acoustics, sound isolation, and electro-acoustics. Hopefully, his new position will not keep him too busy to continue to contribute occasionally to **db**.

● **David J. Knorr** has joined the engineering staff of **Fairchild Sound Equipment Corp.** of Long Island City, N. Y. His experiences lie in the design and manufacture of broadcast and audio systems, and he is presently actively participating in the rapid expansion of Fairchild's professional custom service to the audio industry. Formerly with **Gates Radio**, Mr. Knorr is an EE graduate of Tristate College of Angolo, Indiana. He is also a railroad enthusiast and is currently restoring an old-fashioned caboose he owns to be someday used as a museum piece. Perhaps he can give some pointers to the **Long Island Railroad!**

A hearing aid for good ears.



KEPEX™

keyable program expander



7120 SUNSET BOULEVARD
HOLLYWOOD, CAL. 90046

BOOTHS 67-68

Circle 11 on Reader Service Card

Onstage were Dick Schory and his Percussion Pops Orchestra. Over 200 percussion instruments. Plus soloists Gary Burton, Paul Horn, and Joe Morello.

Backstage was an Ampex MM-1000 recording the total concert—live—on 16 channels all at once!

Result—some of the cleanest big band sound ever recorded in live concert, soon to be released in a sparkling new album.

Dick Schory and his engineers chose the MM-1000 for one reason: proven dependability. It's the machine that started the multichannel revolution, and has led it ever since. Providing more flexibility

and creative accessories than any other.

The multichannel revolution is here—now. And the MM-1000 is recording more hit records than all other 16's combined. If you're planning some recording breakthroughs of your own, you'll want an MM-1000. It's the one machine you'll be able to keep up-to-date—by adding on the latest multichannel innovations as they're developed for you by Ampex. Lease/Option and pay-as-you-use plans are readily available. Call (415) 367-4400. Or write Ampex Corporation, Professional Audio Products Division, M.S.7-13, Redwood City, California 94063.

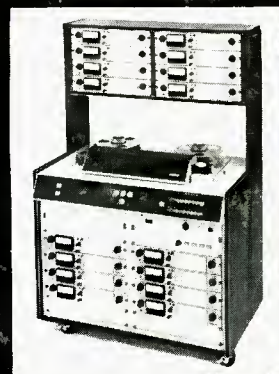

AMPEX



APRIL 7, 1970

The debut of 16-channel live concert recording: Ampex MM-1000 at Carnegie Hall.

Visit us at the AES Technical Meeting, Booth 74-77, October 12-15
Circle 12 on Reader Service Card