

Hi-Fi Phono Preamp Design - See Page 19

AUDIO

ENGINEERING

APRIL
1953
35c



THE WORLD OF SOUND

here are the
30 BEST SELLING RECORDS
OF 1952*

29 of them used
audiodiscs[®]
 for the master recording

... and over 43% used
audiotape[†] for the original sound!

Like Audiodiscs and Audiotape, this record speaks for itself.

Of the thirty top hit records of the year, all but one were made from Audiodisc masters! And that one — a London Record — was made abroad.

It is significant, too, that the original recordings for over 43 per cent of these records were first made on Audiotape, then transferred to the master discs. This marks a growing trend toward the use of Audiotape for the original sound in the manufacture of fine phonograph records.

Yes — Audiodiscs and Audiotape are truly a record-making combination — in a field where there can be no compromise with Quality!

†Trade Mark

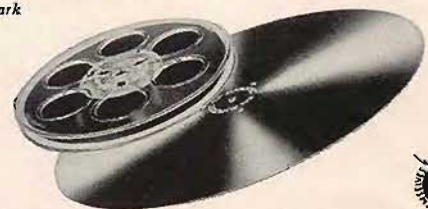

AUDIO DEVICES, INC.

444 MADISON AVE., NEW YORK 22, N. Y.
 Export Dept.: 13 East 40th St., New York 16, N. Y., Cables "ARLAB"

Record, Artist & Label	Made from Audiodisc Master
BLUE TANGO (Leroy Anderson—Decca).....	✓
WHEEL OF FORTUNE (Kay Starr—Capitol).....	✓
CRY (Johnnie Ray—Okeh).....	✓
YOU BELONG TO ME (Jo Stafford—Columbia).....	✓
AUF WIEDERSEH'N, SWEETHEART (Vera Lynn—London)...	✓
I WENT TO YOUR WEDDING (Patti Page—Mercury).....	✓
HALF AS MUCH (Rosemary Clooney—Columbia).....	✓
WISH YOU WERE HERE (Eddie Fisher—Hugo Winterhalter—Victor).....	✓
HERE IN MY HEART (Al Martino—BBS).....	✓
DELICADO (Percy Faith—Columbia).....	✓
KISS OF FIRE (Georgia Gibbs—Mercury).....	✓
ANY TIME (Eddie Fisher—Hugo Winterhalter—Victor).....	✓
TELL ME WHY (Four Aces—Decca).....	✓
BLACKSMITH BLUES (Ella Mae Morse—Capitol).....	✓
JAMBALAYA (Jo Stafford—Columbia).....	✓
BOYCH-A-ME (Rosemary Clooney—Columbia).....	✓
GUY IS A GUY (Doris Day—Columbia).....	✓
LITTLE WHITE CLOUD THAT CRIED (Johnnie Ray—Okeh).....	✓
HIGH NOON (Frankie Laine—Columbia).....	✓
I'M YOURS (Eddie Fisher—Hugo Winterhalter—Victor).....	✓
GLOW WORM (Mills Brothers—Decca).....	✓
IT'S IN THE BOOK (Johnny Standley—Capitol).....	✓
SLOW POKE (Pee Wee King—Victor).....	✓
WALKIN' MY BABY BACK HOME (Johnnie Ray—Columbia).....	✓
MEET MR. CALLAGHAN (Les Paul—Capitol).....	✓
I'M YOURS (Don Cornell—Coral).....	✓
I'LL WALK ALONE (Don Cornell—Coral).....	✓
TELL ME WHY (Eddie Fisher—Hugo Winterhalter—Victor).....	✓
TRYING (Hilltoppers—Dot).....	✓
PLEASE, MR. SUN (Johnnie Ray—Columbia).....	✓

*According to Retail Sales, as listed in THE BILLBOARD.

audiodiscs • audiotape • audiofilm • audiopoints

Audiodiscs are manufactured in the U.S.A. under exclusive license from PYRAL, S.A.R.L., Paris

SPECIALIZATION MAKES THE DIFFERENCE

Specialization may be defined as the concentration of all effort to a special or specific course of action

Even a mechanical device concerned with the function of record reproduction should possess all the advantages of such specialization.

Most units undertake to do much more. They change records, mix records, flip records, reject records, and assume a multitude of other functions. This is 'generalization' as distinguished from 'specialization'.

The REK-O-KUT turntable, on the other hand, is devoted entirely to playing records. And every design feature, every fragment of engineering know-how has been devoted and restricted to the all-important job of playing records... to provide the constant, steady, unwavering record motion necessary for the faithful reproduction of records free of mechanical distortion.

Specialization makes that difference. And all of the efforts and facilities of the manufacturer shall continue to be intensively devoted to that one objective... that one aim: *To make the finest turntables in the world.*

There is a REK-O-KUT Turntable for your specific discriminating requirement. Seven models are available at prices ranging from \$54.95. Sold through leading Dealers and Parts Distributors.

Write for Descriptive Literature



REK-O-KUT TURNTABLES

REK-O-KUT COMPANY, 38-03M Queens Boulevard, Long Island City 1, New York
Export Division: 458 Broadway, New York 13, U. S. A. Cables—Morhanex
In Canada: Atlas Radio Corp., Ltd., 560 King Street, W., Toronto 2B

the **AUDIO "BUGS"** know best



they're using

CHICAGO

for quality



Audio Amplifier with "Presence"
Described in Radio News, Nov. 1951. Heart of the amplifier is the CHICAGO full-frequency BO-6 output unit, with other "Sealed-in-Steel" transformers incorporated in the separate power supply chassis for top audio results.



An Unusual P.A. Amplifier
An unusually compact 20-watt P.A. amplifier of exceptional audio fidelity. CHICAGO full-frequency range transformers are used exclusively for exceptional audio quality coupled with small size and light weight.



Audio Modulator
Described in Radio News, June 1951. An efficient audio testing instrument suitable for precise lab analysis or for subjective quality tests. CHICAGO "Sealed-in-Steel" input, output and power transformers are incorporated.

Wherever audio quality is a "must"—the experts specify and use
CHICAGO "Sealed-in-Steel" Transformers



talk about full frequency—
CHICAGO Output Transformers
really deliver for you...

.2 db 30-20,000 CPS

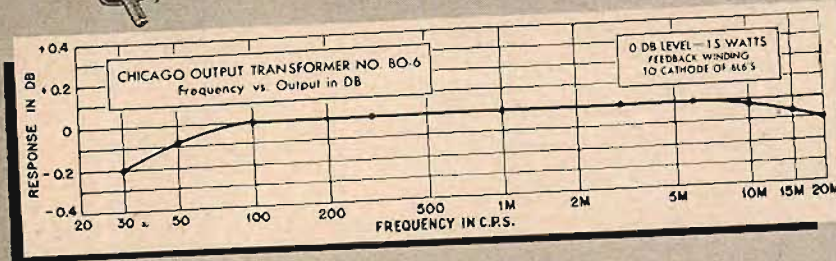

No. BO-6

For use in high fidelity amplifiers. Couples push-pull 6L6's (7500 ohms, C-T) to 6/8 or 16/20-ohm voice coil. Center-tapped tertiary winding provides 15% inverse feed-back to reduce harmonic distortion to a minimum. In drawn steel case, 4 1/4" x 3 3/8" x 3 1/8", with mounting studs and convenient pin-type terminals.

No. BO-7

For matching 600 or 150-ohm line to a 6/8 or 16/20-ohm voice coil. Frequency response within plus or minus 1 db. at full rated output—maximum power level, 30 watts. Mounted in compound-filled drawn steel case, 4 1/4" x 3 3/8" x 3 1/8". Mounting studs and pin-type terminals same as No. BO-6 illustrated above.

There's a **CHICAGO**
Transformer for Every
Audio Application

CHICAGO "Sealed-in-Steel" Transformers (the world's toughest) are available in 3 complete ranges for every type of audio requirement: Full Frequency, Public Address, and Communications. Whatever the application, it's wise to choose CHICAGO audio transformers for that extra margin of dependability under all operating conditions.

Free "New Equipment" Catalog

Get the full details on CHICAGO's New Equipment Line—including "Sealed-in-Steel" transformers designed for every modern audio application. Write for your Free copy of this important catalog today, or get it from your electronic parts distributor.



CHICAGO TRANSFORMER

DIVISION OF ESSEX WIRE CORPORATION

3501 ADDISON STREET • CHICAGO 18, ILLINOIS



corded, the square wave at A. The first half-cycle modulates the oscillator associated with track 1, the oscillator frequency swinging downward and back as at B. The second half-cycle has no effect on oscillator 1 but modulates only oscillator 2, on the second track, swinging its frequency down and back as in C. Thus each track carries information about odd half cycles. On the playback the oscillators are demodulated, then the recovered half-cycles of audio combined to reproduce the original modulation.

One circuit capable of doing the job is shown in Fig. 2. The signal goes into the primary of a transformer. The center-tapped secondary and rectifiers cause only odd half-cycles to affect the reactance tube in each circuit. A playback circuit is shown in Fig. 3. Outputs of the two playback heads are fed to suitable volume limiters, thence through frequency-slope networks to detector rectifiers. The transformer recombines the two signals into the original one. The slope networks are simple FM discriminators which operate in the same way as a slope detector for r.f. FM transmissions. In ordinary receivers FM is sometimes (not often these days, fortunately) detected by ordinary AM circuits by tuning the carrier to one side of the i.f. response curve and relying on the skirt slope to change the signal amplitude over each modulation cycle. The slope detector shown here is usable because the slope can be made quite linear, which is not true of receivers using tuned circuits.

Stabilized D.C. Amplifier

D.c. amplifiers rarely find justification for use in pure audio work today except for special purposes, but they are essential for many types of instrumentation. When they are used—particularly for amplifying direct current—they are plagued by output variations traceable to drift in power-supply voltages.

Robert P. Nelson has designed a simple compensation circuit for d.c. voltage amplifiers; it is diagrammed in Fig. 4. The patent, No. 2,620,406, is assigned to Philco.

The amplifier itself has two stages, the two halves of a 12AX7, V_1 and V_2 in the diagram. The circuit is fairly conventional. The positive voltage at the plate of V_1 , which would appear at the grid of V_2 , is balanced out by a suitable tap on the voltage divider R_1 - R_2 - R_3 between B-plus and C-minus. Output for the amplifier is taken from the plate of V_2 . It is this output d.c. which is to be stabilized.

Initially R_1 is set for the desired gain and d.c. balance (correct voltage on the grid of V_2 for bias). R_1 may have to be readjusted later.

Next R_2 is adjusted. R_2 is part of another voltage divider used to bias the grid of V_1 , which is a compensation tube. It has a

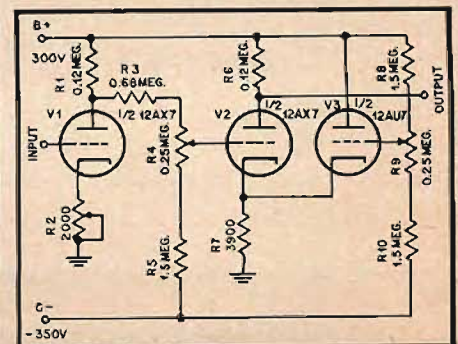
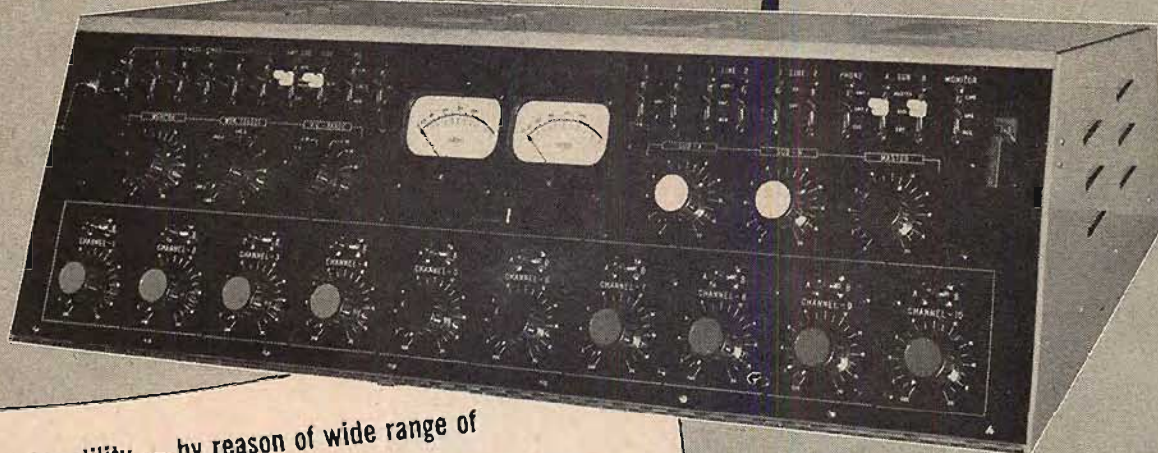

Fig. 4

BEST LONG-TERM INVESTMENT IN TV STUDIO SPEECH CONSOLES

the New **GATES CC-1** "Program Master"



- Versatility — by reason of wide range of plug-in amplifiers
- Accommodates 14 plug-in units, 10 pre-amplifiers, 2 line amplifiers, 1 monitoring amplifier, 1 power supply
- Buy this GATES Console with the number of amplifiers needed — add later for expansion

Here is a TV speech console that can grow with your station. Meets ALL large studio demands for TV (and AM too) yet is flexible enough for any station requirement.

It features NEW GATES PLUG-IN amplifiers throughout. There's room for 14 — but you buy only what you need and add later as you need them.

The NEW GATES CC-1 was designed following months of study covering all phases of TV programming and production. It fully meets every requirement for complex or simplified production techniques.

The NEW GATES CC-1 Speech Console is beautifully constructed, providing a new high in rigid performance standards — both electrical and mechanical.

Before you invest, investigate the newest and latest in speech input equipment — the GATES CC-1 "PROGRAM MASTER".

Outstanding Features

- Ten mixing channels
- Provision for ten or lesser number of pre-amplifiers
- Provision for single or duplicate line amplifiers
- Choice of 8 or 16 watt monitoring amplifier
- Complete remote line, cueing, over-ride and auxiliary switching facilities
- Provision for patch panel termination of all major circuits
- Duplicate VU meters
- Group control of any number of mixing positions provided by two SUB and one MASTER gain controls
- Color coded control facilities

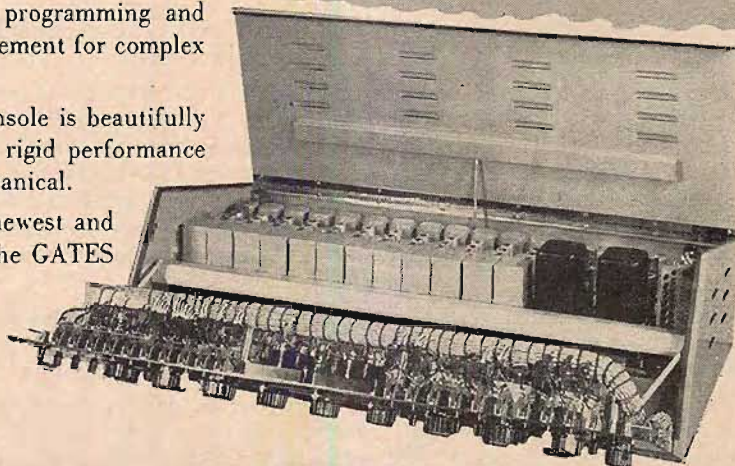

GATES

GATES RADIO COMPANY, QUINCY, ILLINOIS, U. S. A.

MANUFACTURING ENGINEERS SINCE 1922

2700 Polk Avenue, Houston, Texas • Warner Building, Washington, D. C. • International Division, 13 E. 40th St., New York City
Canadian Marconi Company, Montreal, Quebec



Meet the Redheads... tops for tape recording

See how the latest additions to the Brush family of magnetic recording components can improve your tape recorders!

The BK-1090 record-reproduce head has the standard track width designed for dual track recording on 1/4 inch tape. It provides unusually high resolution and uniformity over an extended frequency range. Cast resin construction assures dimensional stability, minimizes moisture absorption, and affords freedom from microphonics. Its balanced magnetic construction, precision lapped gap, Mu-metal housing, and single-hole mounting provide important design advantages.

The BK-1110 erase head has the same basic construction as the companion record-reproduce unit. Its outstanding feature is its efficient erasing at low power consumption—less than 1/2 voltampere.

Investigate these new "Redheads" for your magnetic recording. Your inquiries will receive the attention of capable engineers. Write Brush Electronics Company, Department ZZ-4, 3405 Perkins Avenue, Cleveland 14, Ohio.

BRUSH ELECTRONICS

INDUSTRIAL AND RESEARCH INSTRUMENTS
PIEZOELECTRIC MATERIALS • ACOUSTIC DEVICES
MAGNETIC RECORDING EQUIPMENT
ULTRASONIC EQUIPMENT



COMPANY

formerly
The Brush Development Co.
Brush Electronics Company
is an operating unit of
Clevite Corporation.

much lower plate resistance than V_2 and therefore draws several times as much current. Its cathode is paralleled with that of V_2 . Since most of the current drawn through R_2 is due to V_2 , setting R_2 substantially determines the cathode voltage of V_2 .

If the negative supply voltage becomes somewhat less negative, so does the grid of V_2 . This increases its cathode current, making the cathode of V_2 more positive. With R_2 set correctly, the increase in positive cathode voltage is the same as the resulting positive change in the V_2 grid voltage. In this way the compensating tube keeps the V_2 plate-ground voltage the same, stabilizing it against C-minus supply changes.

R_2 stabilizes the amplifier against changes in B-plus voltage. The amount of positive voltage presented to the voltage divider $R_1-R_2-R_3$ is determined principally by the plate current of V_1 , which is controllable by the setting of R_2 . When the B-supply goes positive, the output voltage (plate of V_2) also goes positive. When R_2 is adjusted correctly, the grid voltage of V_2 goes just enough positive to cause additional V_2 plate current to flow and swing the plate in the negative direction, back to its original voltage. R_2 and the stabilization tube V_2 also have an effect on output when the positive supply varies, but that is offset by the action described in the beginning of this paragraph.

A copy of any patent specification may be obtained from The Commissioner of Patents, Washington 25, D. C., by sending 25¢ along with the patent number.



Employment Register

POSITIONS OPEN and AVAILABLE PERSONNEL may be listed here at no charge to industry or to members of the Society. For insertion in this column, brief announcements should be in the hands of the Secretary, Audio Engineering Society, P. O. Box 12, Old Chelsea Station, N. Y. 11, N. Y., before the fifth of the month preceding the date of issue.

★ Positions Open • Positions Wanted

★ Chief Engineer, for two recording studios in Westchester County, N. Y. Prefer draft exempt. Thoroughly experienced, heavy emphasis on maintenance. State salary required. Box 401, Audio Engineering.

● Electrical Engineering Student with experience in commercial radio and recording desires summer job in New York—Westchester area in either field. Joseph W. Schmitt, 124 Witherspoon Hall, Princeton University, Princeton, N. J.

IF YOU ARE MOVING

Please notify our Circulation Department at least 5 weeks in advance. The Post Office does not forward magazines sent to wrong destinations unless you pay additional postage, and we can NOT duplicate copies sent to you once. To save yourself, us, and the Post Office a headache, won't you please cooperate? When notifying us, please give your old address and your new address.

Circulation Department
RADIO MAGAZINES, INC.
P. O. Box 629 Mineola, N. Y.



Coffee
 may revive you...
 but what about the
sound you have
 just recorded?

New life is what it needs! Liven up that sound with emphasis that sells. Punctuate and dramatize your sound with "effects" to bring it above the commonplace average.

Tonal balance is a static thing . . . *instantaneous* control is the answer. Yes, and you'll find the answer in Cinema's 4031-B Program Equalizer and 6517-D Variable Sound Effects Filter. Include these items in your purchase plans today!

**THE CINEMA 4031-B
 PROGRAM EQUALIZER**



Used in all types of speech input equipment. The 4031-B corrective equalization saves on recording retakes; improves tonal quality; provides emphasis when needed during the program. Widely used in Motion Pictures, T-V, Recording and Military Communications.

YOUR
 AUDIO
 IS
 ENTITLED
 TO THE
 BEST

**THE CINEMA 6517-D
 VARIABLE LOW AND HIGH FREQUENCY FILTER**



Cut off characteristics ideal for shortening frequency range; providing sound effects, such as telephone, whispering, spooks, etc. Clickless control allows insertion upon cue. Used in Motion Pictures, T-V, and Scientific Laboratories.

Write for descriptive literature.

IN NEW YORK: Audio & Video Products Corp. • 730 Fifth Ave. • Plaza 7-3091



CINEMA ENGINEERING COMPANY
 1510 WEST VERDUGO AVENUE, BURBANK, CALIFORNIA

EXPORT AGENTS: Frazar & Hansen, Ltd. • 301 Cloy Street • San Francisco, California, U.S.A.

LETTERS

Binaural vs. Stereophonic—Again

SIR:

On semantic grounds, the suggested definitions of binaural and stereophonic reproduction seem to leave something wanting. If monaural refers to a single-channel sound source (the word is not used to mean listening with one ear), then binaural logically means listening to two channels. Since stereophonic listening also can consist of listening to two channels (or three or more), it too should logically qualify as a form of binaural reproduction. Semantically, therefore, binaural and stereophonic reproduction should not in all cases be two different things.

Conforming to the suggested definitions, however, methods of listening to musical reproduction can be classed as follows:

I. Single Channel

- A. "Point Source"—single speaker (or one earphone).
- B. "Diffused Source"—several speakers spaced apart (or two earphones) on one channel.
- C. "Source-Free"—one or more speakers on one channel heard with *one ear only*.

II. Multichannel

- D. "Stereophonic"—multiple speakers spaced apart, each on a separate sound channel. The respective channels originate from microphones spaced in a manner similar to the loudspeakers.
- E. "Binaural"—two earphones on separate sound channels. The respective channels originate from microphones spaced a head's distance apart.

A and B are the conventional methods commonly referred to as monaural. Methods D and E are the present subject of lively discussion as improved means of reproduction. Method C, although an old trick, seems to have been overlooked.

Multichannel listening endeavors to restore to reproduced music its original spaciousness, detail, and arrangement of instruments. More, it tries to free the music from its connection with a box against the wall—it tries to restore presence. One wants to feel surrounded by the music, as happens at a good seat in a good hall.

Perhaps some readers would like to experiment with listening to orchestral reproduction with one ear *completely* stopped up. My own reaction is quite favorable. While one does not hear violins on the left and horns on the right, yet the music does seem to acquire more detail and free itself from association with a speaker at the other end of the room. It also becomes more spacious.

Among friends, reactions have been mixed. At worst, some experienced a loss of highs and/or bass. One complained of fuzziness. On the other hand, a musically trained couple who have a fine hi-fi system said about as follows: "The music had much more detail. Individual instruments were easier to pick out. We felt as though we were in the middle of the music and in fact had to turn the volume down a bit."

HERMAN BURSTEIN,
280 Twin Lane E.,
Wantagh, L. I., N. Y.

Confusion

SIR:

Last summer Antal Dorati conducted the Minneapolis Symphony orchestra in a series of recordings at the University of Minnesota for Mercury. Getting glowing reports from our critic, I hastened to purchase "Scheherazade."

[Continued on page 57]

NEW
magnecord
Voyager
one-case Portable tape recorder

Now a professional portable recorder and amplifier in a single case, light in weight, yet ruggedly constructed to take the most difficult remotes.

Tested and Proved—Thoroughly field tested, the outstanding performance of the Voyager has brought enthusiastic approval of networks to this newest member of the Magnecord family.

Professional Quality—Frequency response up to ± 2 db from 50 to 15,000 cycles per second. The amplifier has bridging input and one low impedance mike input. 600 ohm balanced output and two speed (7½" and 15") equalization and headphone monitor jack on front. Tape lifter optional.

Successfully Used by Advertising Agencies—Permits unlimited uses—air checks, development of spot announcements, program development, and with an amplifier and speaker, auditions and client presentations. The full sound spectrum is flawlessly reproduced.

For demonstration, see your Telephone Directory under "Recorders," or write

Magnecord INC.
Dept. AE-4 • 225 West Ohio Street
Chicago 10, Illinois

CLASSIFIED TELEPHONE DIRECTORY

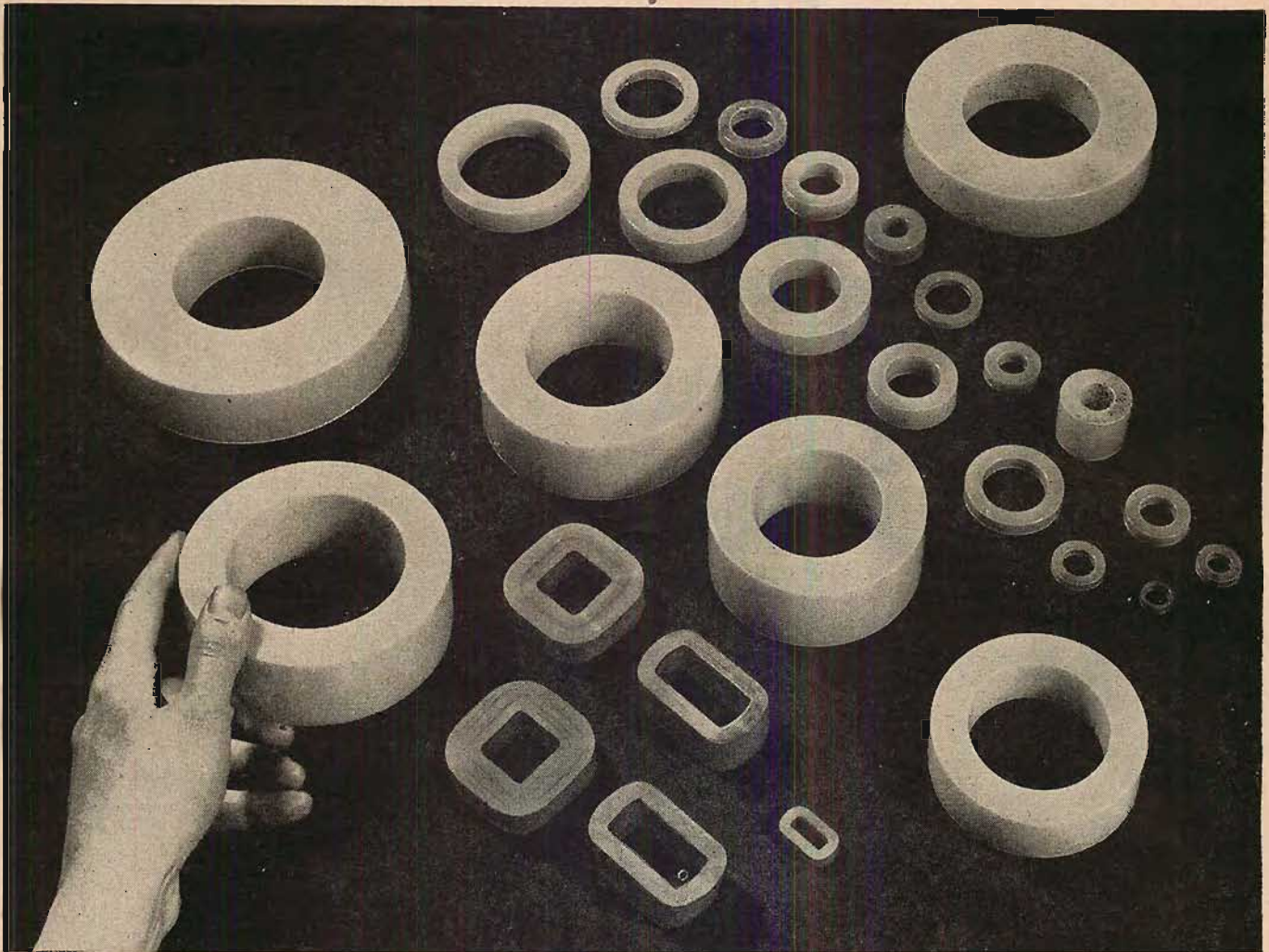

IN **TAPE-WOUND CORES** JUST NAME YOUR REQUIREMENTS!

RANGE OF MATERIALS

Depending upon the specific properties required by the application, Arnold Tape-Wound Cores are available made of DELTAMAX . . . 4-79 MO-PERMALLOY . . . SUPERMALLOY . . . MUMETAL . . . 4750 ELECTRICAL METAL . . . or SILECTRON (grain-oriented silicon steel).

RANGE OF SIZES

Practically any size Tape-Wound Core can be supplied, from a fraction of a gram to several hundred pounds in weight. Toroidal cores are made in twenty-two standard sizes with protective nylon cases. Special sizes of toroidal cores—and all cut cores, square or rectangular

cores—are manufactured to meet your individual requirements.

RANGE OF TYPES

In each of the magnetic materials named, Arnold Tape-Wound Cores are produced in the following standard tape thicknesses: .012", .008", .004", .002", .001", .0005", or .00025", as required.

Applications

Let us help with your problems of cores for Magnetic Amplifiers, Pulse Transformers, Current Transformers, Wide-Band Transformers, Non-Linear Retard Coils, Peaking Strips, Reactors, etc.

Address: ENG. DEPT. A

W4D 4613

THE ARNOLD ENGINEERING COMPANY

SUBSIDIARY OF ALLEGHENY LUDLUM STEEL CORPORATION

General Office & Plant: Marengo, Illinois

DISTRICT SALES OFFICES

New York: Empire State Bldg.

Los Angeles: 3450 Wilshire Blvd.



**PERFECT PRODUCTION
REQUIRES**

Precision Prints

**TRACK PRINTS
OF TOP QUALITY**

All tracks printed independently on Maurer 1-to-1 optical track printer, exclusive with PRECISION. Highly refined optical system eliminates "contact shifts," gives complete flexibility in printing from "A- or B-wind" originals. Sensitometric sound control.

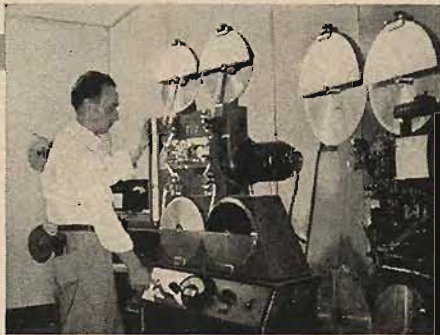

YOUR ASSURANCE OF BETTER 16mm PRINTS

15 Years Research and Specialization in every phase of 16mm processing, visual and aural. So organized and equipped that all Precision jobs are of the highest quality.

Individual Attention is given each film, each reel, each scene, each frame — through every phase of the complex business of processing — assuring you of the very best results.

Our Advanced Methods and our constant checking and adoption of up-to-the-minute techniques, plus new engineering principles and special machinery

Precision Film Laboratories — a division of J. A. Maurer, Inc., has 14 years of specialization in the 16mm field, consistently meets the latest demands for higher quality and speed.

enable us to offer service unequalled anywhere!

Newest Facilities in the 16mm field are available to customers of Precision, including the most modern applications of electronics, chemistry, physics, optics, sensitometry and densitometry—including exclusive Maurer-designed equipment—your guarantee that only the *best* is yours at Precision!

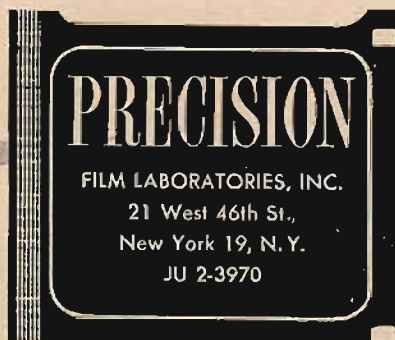

NEW LITERATURE

• **Allen-Bradley Company**, Milwaukee, Wis. is offering a new 26-page bulletin featuring multi-unit control centers. Contained in the bulletin is a complete description which covers all aspects of design and construction. Included also are unit dimensions and ratings, as well as typical applications. An informative feature of the bulletin is titled "Pattern for Planning a Control Center," which includes typical layout charts and floor arrangements.

• **Allied Radio Corporation**, 333 W. Jackson Blvd., Chicago 7, Ill. is releasing the first issue of the "Allied High-Fidelity Auditor," a 4-page quarterly publication which contains information about new audio products and developments, especially in the field of high fidelity. One of the publication's interesting features is the "Hi-Fi Clinic," which includes questions and answers about typical problems encountered with home music systems. Available free to audio technicians, experimenters, and hobbyists. To be placed on the mailing list, address your request to High-Fidelity Auditor, Allied Radio Corporation at above address.

• **General Electric Company**, Schenectady 5, N. Y. announces the 1953 edition of the GE Instrument Buyer's Guide. Fully illustrated, the 102-page book contains ratings, ASA accuracy classifications, and prices of all GE indoor and outdoor potential and current transformers. Listings of ratio and phase-angle tests, together with tables covering the mechanical and thermal limits of current transformers, are included. Request Publication GEA-4626F.

• **The Gray Manufacturing Company**, Hartford 1, Conn. recently issued an unusual employee-recruiting booklet titled "Careers at Gray" to interest experienced radio and electronic engineers in joining the company's staff. Pocket-sized, the publication contains 32 pages describing the employment opportunities existing at Gray, also the firm's facilities for designing and building reproduction apparatus, radar equipment, and other advanced electronic devices. In addition, the booklet describes in detail the advantages of living in Hartford, carefully delineated as "The Hometown of Happy Families." Truly an exceptional little book—if you are a competent engineer with a weather eye out for a better job in a delightful community, write for it by all means.

• **Hudson Radio & Television Corp.**, 48 W. 45th St., New York 36, N. Y. announces a new 196-page catalog of electronic equipment. In addition to being a worthwhile buying guide, the book is so prepared that it can also serve as a reference manual for users of electronic components of virtually every type. Included is a cross-reference and guide to JAN equipment of most leading manufacturers. Emphasizing the importance of Audio in the over-all electronic picture, the first section of the catalog is devoted to sound equipment for home and professional use. Will be mailed on request by mail.

• **Radio Shack Corporation**, 167 Washington St., Boston 8, Mass. will mail free on request a new 8-page rotogravure sales bulletin which has been published as a part of the company's 30th anniversary celebration. Featured in the bulletin are the first commercially available junction-type transistors, and the sale-priced high-fidelity tuner and amplifier inventory of Approved Electronics Company, which Radio Shack bought out in its entirety.

• **Sanborn Company**, 38A Osborn St., Cambridge, Mass. is now releasing a 6-page illustrated bulletin which explains the scope of application of Sanborn equipment for the recording of a wide variety of electrical and mechanical phenomena. Included in the bulletin is a chart of various phenomena which can be recorded with Sanborn direct-writing recorders, together with transducer data. Also included are complete performance data and specifications of Sanborn equipment. Titled "Applicability of Sanborn Direct Writing Recording Systems," the bulletin will be mailed free on request.

Be Sure of Your Installations . . . Use

Aptitude-Tested MULTIPLE CONDUCTOR

CABLE

• You know what you are doing when you use Belden Multiple Conductor Cables — they're aptitude rated. They are designed to provide desirable electrical characteristics, and rigid control assures constant quality.

Specify Belden Radio Wires.

Belden Manufacturing Co., 4689-R W. Van Buren St., Chicago 44, Ill.

To You, Belden's Golden

Anniversary Means

—product performance that can come only from a "know-how" that has grown through actual service since the inception of Radio.

—an ability to co-operate in pioneering new wires to meet or anticipate industry's growing needs.

In the years that follow

This Belden Program Is—

— TO BE CONTINUED

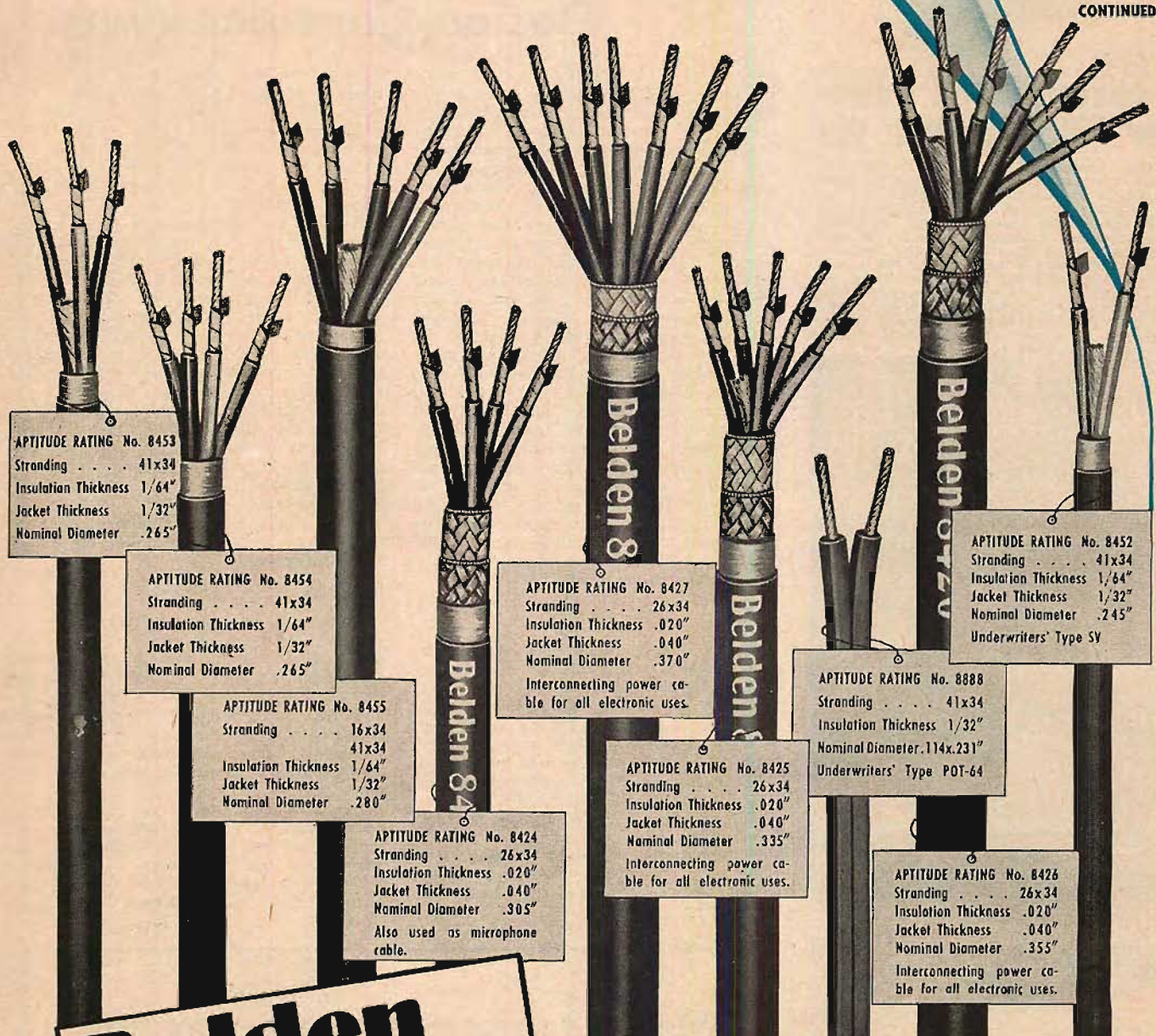

APTITUDE RATING No. 8453
Stranding 41x34
Insulation Thickness 1/64"
Jacket Thickness 1/32"
Nominal Diameter .265"

APTITUDE RATING No. 8454
Stranding 41x34
Insulation Thickness 1/64"
Jacket Thickness 1/32"
Nominal Diameter .265"

APTITUDE RATING No. 8455
Stranding 16x34
 41x34
Insulation Thickness 1/64"
Jacket Thickness 1/32"
Nominal Diameter .280"

APTITUDE RATING No. 8424
Stranding 26x34
Insulation Thickness .020"
Jacket Thickness .040"
Nominal Diameter .305"
Also used as microphone cable.

APTITUDE RATING No. 8427
Stranding 26x34
Insulation Thickness .020"
Jacket Thickness .040"
Nominal Diameter .370"
Interconnecting power cable for all electronic uses.

APTITUDE RATING No. 8425
Stranding 26x34
Insulation Thickness .020"
Jacket Thickness .040"
Nominal Diameter .335"
Interconnecting power cable for all electronic uses.

APTITUDE RATING No. 8888
Stranding 41x34
Insulation Thickness 1/32"
Nominal Diameter .114x.231"
Underwriters' Type POT-64

APTITUDE RATING No. 8426
Stranding 26x34
Insulation Thickness .020"
Jacket Thickness .040"
Nominal Diameter .355"
Interconnecting power cable for all electronic uses.

APTITUDE RATING No. 8452
Stranding 41x34
Insulation Thickness 1/64"
Jacket Thickness 1/32"
Nominal Diameter .245"
Underwriters' Type SY

Belden
Radio WIRE

The
Aptitude-Tested LINE

The NEW

Custom
DC-AC CONVERTER
 by **Carter**



Delivers MORE Power for PROFESSIONAL Use

These latest-of-all Carter DC to AC Converters are specially engineered for professional and commercial applications requiring a high capacity source of 60 cycles AC from a DC power supply. Operates from storage batteries or from DC line voltage. Three "Custom" models, delivering 300, 400, or 500 watts 115 or 220 V. AC. Wide range of input voltage, 12, 24, 32, 64, 110 or 230 V. DC. Unequaled capacity for operating professional recording, sound movie equipment and large screen TV receivers. Available with or without manual frequency control feature.



HOW LEADING NETWORKS USE CARTER CONVERTERS

Photo shows Tommy Bartlett, star of NBC "Welcome Travellers" program, aboard N.Y.C. R.R. "Twilight Limited." His Carter "Custom" Converter makes recording possible on board the train, from regular train current converted to 110 V. AC. Radio networks, stations, program producers use Carter Converters for all sorts of on-the-spot recording.

MAIL COUPON FOR CATALOG

Carter MOTOR CO.
 2648 N. Maplewood Ave.
 Chicago 47

Carter Motor Co.
 2648 N. Maplewood Ave., Chicago 47
 Please send new catalogs containing complete information on Carter "Custom" Converters and other Rotary Power Supplies.

Name _____
 Address _____
 City _____ State _____

audiology

W. R. AYRES*

Output Transformer Design Considerations

SUCCESSFUL DEVELOPMENT of an audio power amplifier depends greatly upon output transformer characteristics, whether the principal equipment objective be economy or quality. While some pertinent features may be specified readily in simple numerical form, other characteristics, important to high-fidelity equipment, are of such involved nature that simultaneous development of circuit and transformer is almost essential. However, experience and analysis demonstrate several principles upon which important choices are based, and form a basis for judgment applicable to either design or purchase.

Basic purposes of the output transformer are coupling tubes to the load with d.c. isolation, and transformation of the load impedance to a value suitable for efficient tube operation. To avoid adversely affecting amplifier performance, the transformer preferably would be highly efficient over the desired band, and would not cause objectionable distortion at low frequencies. Apparently then, refinements characterizing high-quality output transformers simply permit good circuit performance, rather than cause it to be good.

Response

The frequency range over which relatively uniform transformation may be had is controlled largely by the source and terminating impedances, the shunt winding inductance, and the leakage inductance. With fixed source and load impedances, the ratio of these inductances sets the ratio of limiting high and low frequencies; ratio values range from less than 200 for lowest cost equipment, to 10,000 or more in costly idealizations. Chief determining factors are the core material, prevailing d.c. magnetization, and the winding configuration. To the extent that capacitances and changes in

core permeability may be neglected, coil turns do not influence the bandwidth in octaves, since both self inductance and leakage inductance vary as the square of the number of turns. While not affecting the response-curve shape, the number of turns sets the position of the curve in the frequency spectrum.

Assume a certain ratio of these inductances, and no other reactances of importance, and let g equal the ratio of source impedance to load impedance. The ratio of high and low frequencies at which the response is down 3 db is then proportional to the factor $(g+1)^2/g$, which has minimum value when $g=1$. Thus, equal source and load impedances is the least desirable combination if wide-range response is a principal object. Core distortion considerations indicate that g should be made low rather than high; that is, the source impedance would preferably be very low compared with the load impedance. Most significant reduction of g is accomplished with negative feedback in the amplifier, which in turn causes additional complication in the transformer design.

Distortion

Low-frequency waveform distortion in iron-core transformers occurs because the shunt winding inductance is not constant throughout the signal cycle. Relatively little quantitative material has been published, and there is considerable variation among core materials of otherwise similar character. General trends of the data have been analyzed, however, and are reviewed briefly here.

Let X/R equal the ratio of the open-circuit reactance of the transformer primary winding to the parallel combination of source and load resistances. X may vary widely with frequency, flux density, and changes in d.c. magnetization. With X/R

* 311 W. Oakland Ave., Oaklyn 6, N. J.

[Continued on page 69]

This is the first of a series of short articles covering various aspects of audio engineering on a not-so-technical level, yet with information which can be relied upon. During the next few months, Mr. Ayres will discuss resistance-coupled amplifier charts, the effect of feedback upon tube characteristics, feedback from the output transformer primary, from the secondary, and from a tertiary winding. *Æ* would welcome readers' comments, as well as suggestions for further subjects to be covered in the future. Ed.

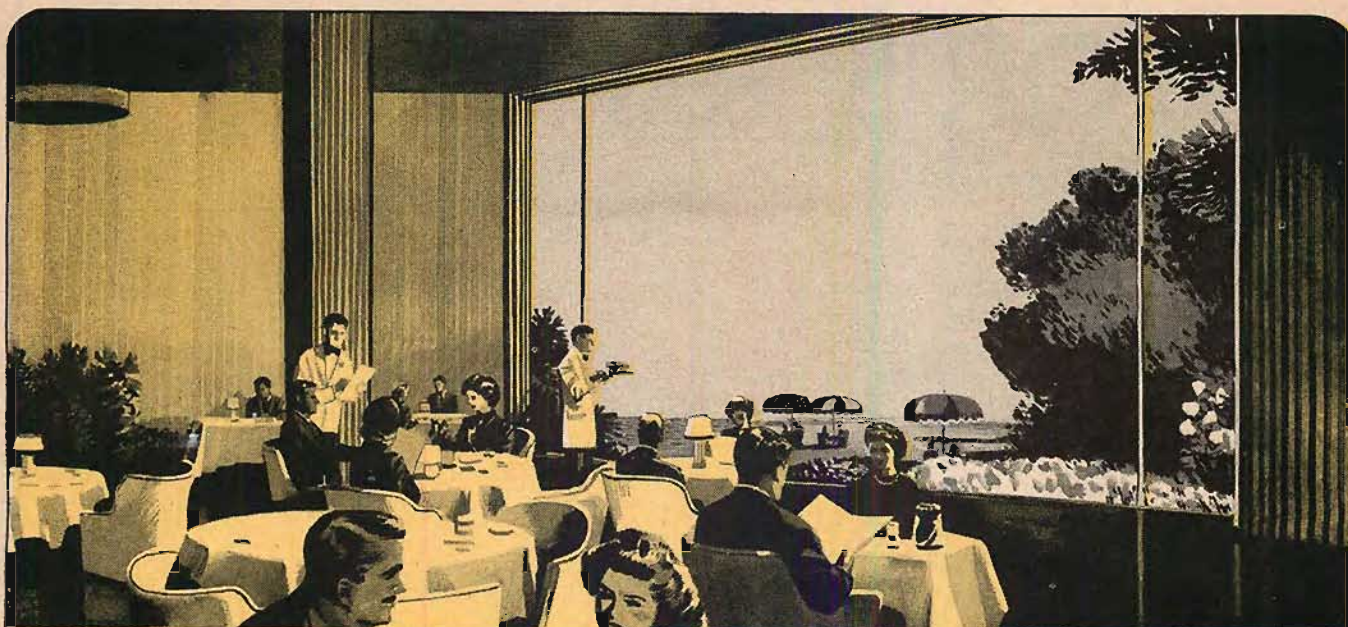

Have you heard *the latest...*
IN BACKGROUND MUSIC?



An atmosphere to relax and enjoy—or the stimulation to work, to think, to play or buy—these are the benefits of background music. And background music is now practical *anywhere*, even beyond the reach of present wired services.

With the announcement of the new AMPEX 450, magnetic tape, musical wonder of a coming era, has become the ideal medium for background music. Hourly cost drops to a new low; quality rises to an all-time high. A wide variety of music for every purpose is now available on pre-recorded tape (see your Ampex distributor). Tape recordings eliminate needle scratch and their fidelity is permanent. They last for any conceivable number of plays.

On the AMPEX 450, up to eight hours of unrepeatd music is available from one 14-inch reel of tape, and fully automatic repetition is available. The troubles and complexities of record changers are eliminated. And the AMPEX requires no standby attention from an operator.

AMPEX background music has a place in your business.

For further information, write to Dept. B

AMPEX

MAGNETIC RECORDERS

THE NEW AMPEX 450

- 8 hours of uninterrupted music (rest periods as desired)
- Usable on land, sea or air
- No standby operator required
- Lowest cost per hour

AMPEX ELECTRIC CORPORATION
 934 CHARTER STREET • REDWOOD CITY, CALIF.

EDITOR'S REPORT

AUDIO ENGINEERING AWARDS

WITH THIS ISSUE, *Æ* rounds out its sixth year of publication, and simultaneously takes pleasure in making its initial public announcement of the first annual AUDIO ENGINEERING Awards for technical excellence. These awards—to be made in three fields involving audio—will be announced in the May issue, together with the all of the details of the judging. Announcement of the winners will be made at the same time to the public prints, to the end that many more converts to better audio may be enrolled.

Of the three fields in which awards will be given, there are two which involve audio in a form which is far from being hi-fi, as we know it, but which depend entirely upon audio for the existence. Until next month, they shall remain unidentified.

The third field will be of greatest interest to most of *Æ*'s readers since it involves what is, by and large, the largest source of music for reproduction in the home. By now this field must be recognized as Phonograph Records, and correctly so.

Since there are many thousands of phonograph records made annually, and since there are only so many weeks in a year, some means of screening had to be found. Who better than the individual manufacturer is able to select the best single record put out by his own efforts? No one. And if this is the case, the small manufacturer who turns out one super-excellent record has as much opportunity to win an award as the massive organizations who make thousands of titles; which is, after all, a very fair arrangement.

To this end, therefore, we set up the following criteria: every manufacturer we could locate was invited to submit his best record in each of eleven categories—judged from both musical and technical excellence—to *Æ*'s judging committees. The limitations were few—only those records placed on the market in 1952 were to be allowed, and only one record was to be submitted in each category.

In the Classical Section, five categories were established—symphonic, chamber or small instrumental group, solo instrument, vocal (including chorals, duets, trios, quartets, quintets, and so on), and operatic—either complete opera or selections. In the Popular Section, six categories were established—dance, jazz, vocal, musical comedy, novelty, and folk. Regrettably, many of the finer jazz discs have been created by small companies, oftentimes impossible to trace. Where possible, these have been obtained by outright purchase from retail sources. Preliminary screening—from the technical standpoint—was applied to the popular group, and final judging was done on those records which were considered passable technically. All classical records submitted were passed to the judging committee without preliminary screening.

Going back to the original premise—the list of records submitted by the manufacturers naturally represented the top single product in each of the categories, from the viewpoint of the manufacturers' authorities,

and consequently makes a very imposing list of records in itself—without the need for any further judging. But it is still a large list, and careful consideration was necessary to determine which single record in each of the eleven categories is *really* the best—in the judges' opinion—both musically and technically.

Obviously, engineers are rarely qualified to judge how well a musical selection is performed; and by the same token, musicians are all too likely to become so enthralled by the virtuosity of the performer that they overlook technical imperfections. Therefore, the judging committees are composed of two types of people—musical, and technical.

Frankly, this is an experiment. We believe that when a small manufacturer turns out an exceptionally fine product, he should be commended, just as the large manufacturer should. However, in the record columns the small producer is hidden by the sheer mass of records made and released each month, yet he *should* get a fair shake. We hold no brief for either the large or the small manufacturer over the other, but aim only for fairness.

We believe, therefore, that the method chosen to reduce entries to a number which it is feasible for a group of judges to study thoroughly has some merit. It gives the judges a high level of product to work with, and best of all, it gives all of us a fine list of records.

As for ourselves, we look forward to a number of interesting sessions—all of which will be over by the time this is being read. But *Read All About It* in the May issue.

LOOKING FORWARD

Don't be too dismayed at the prospect of a May issue filled with ballyhoo about the awards—we still have some interesting articles on technical matters. One of the best of these is Bob Moyer's paper on "The Evolution of a Recording Characteristic" which tells the whys and hows of this elusive curve—and gives the official Word on the proper playing characteristic for RCA Victor records from 'way back. We believe you'll like this article. Julius Postal entertains educationally—or vice versa—with the first of a two-part article which we titled "Simplified Push-Pull Theory"; his title, "Push-Pull Without Tears," somehow didn't seem to be sufficiently dignified for *Æ*'s austere pages.

The June issue holds up with a few good numbers, too. Our choice for the lead article is "The Lateral Mechanical Impedance of Phonograph Pickups," which is not nearly so deadly as its title might indicate. Actually, this paper shows the importance of lightweight moving elements in a pickup, and how various factors affect performance. It takes two issues for this paper, so it will conclude in July, which, being well into the summer, will carry an article on the use of our regular high-quality music system in out-of-door surroundings. Incidentally, in June we expect to have a first-hand, ear-witness report on British and French audio—since we are spending most of April in those parts as a "vacation."

PICKERING

PROFESSIONAL AUDIO EQUIPMENT

BALANCED COMPONENTS / MAXIMIZE PLAYBACK PERFORMANCE

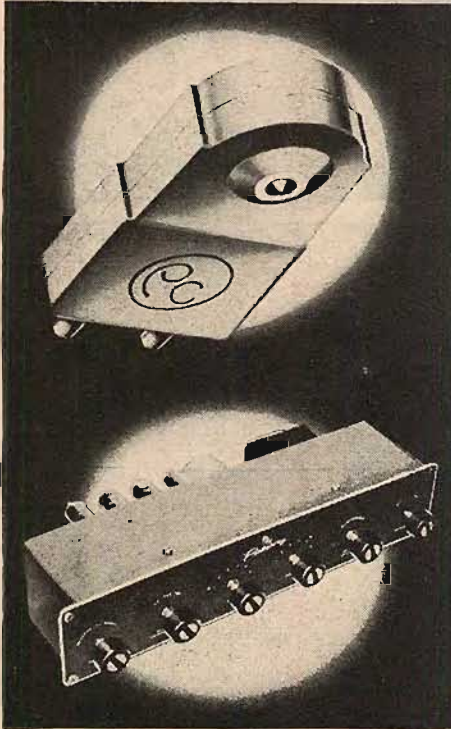

PICKERING CARTRIDGES . . .

are the choice of audio engineers throughout the world. They are universally acclaimed because of their high output, wide range performance and low distortion. They are used wherever a fine cartridge is required in radio stations, recording studios and for purposes of quality control by leading record manufacturers.

MODEL 410 AUDIO INPUT SYSTEM . . .

is designed to provide a complete audio control center. Model 410 may be used in any high quality playback system. Three input channels are provided—one for magnetic cartridges and 2 "flat" channels for other audio circuits. A 3-position equalizer network is built into the magnetic cartridge channel and provides accurate equalization for LP, AES and 78 rpm recording characteristics. Separate bass and treble controls are also provided. These are of the step-type and permit bass and treble adjustments in 2 db increments. The tone control circuits are intended to compensate for record characteristics and for listener-environment acoustical conditions. They are not intended to compensate for amplifier and/or loudspeaker deficiencies. Model 410 is intended for use with the highest quality professional type playback equipment. The output of the Model 410 is fed from a cathode-follower circuit and will work into any high quality audio or line amplifier having a high impedance input. It may also be used with a transformer for the purpose of feeding a 500 ohm line. Because of its flexibility, low noise and low distortion level, it is ideally suited for bridging and monitoring purposes and for critical listening applications.



THE MODEL 190 ARM . . .

is designed primarily for use with microgroove records. Its design has been recognized by leading audio engineers as that which incorporates all of the desirable tracking characteristics. Analysis has shown that for maximum performance with LP records the vertical mass of the moving arm element must be held to a minimum and further, that the arm must be counterbalanced about the vertical axis. This permits minimum stylus or tracking force and provides maximum record life. The Model 190 Arm embodies these all important features necessary for proper microgroove record playback.

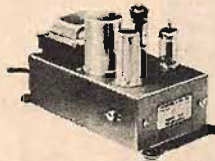

MODEL 230H EQUALIZER-PREAMPLIFIER . . .

is unique in its accuracy of equalization and frequency response. The intermodulation distortion is .2 per cent at normal output level. It is intended for use with high quality amplifiers having gain and tone controls. When used with the Pickering Model 132E Record Compensator the 230H is ideal for radio station and recording studio use and for applications requiring accurate low noise and distortion free playback.

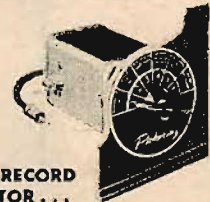

MODEL 132E RECORD COMPENSATOR . . .

is designed to be used in conjunction with a magnetic cartridge preamplifier such as the Pickering 230H or any preamplifier which provides 6 db per octave bass boost. Six playback positions are incorporated:

- 1—European 78 rpm Records
- 2—Victor 45 rpm and Decca 78 rpm Records
- 3—No high frequency roll-off, 500 cycle turnover
- 4—All Capitol Records, new Victor 33 1/2, Audio Engineering Society Curve
- 5—Columbia, London and most LP Records
- 6—To remove the hiss from old noisy records

Precision elements are used in its construction to give accurate compensation. The 132E is inherently a low distortion R-C device.

PICKERING PROFESSIONAL AUDIO EQUIPMENT

"For those who can hear the difference"

... Demonstrated and sold by Leading Radio Parts Distributors everywhere.
For the one nearest you and for detailed literature, write Dept. A-2.



PICKERING and company incorporated • Oceanside, L. I., New York

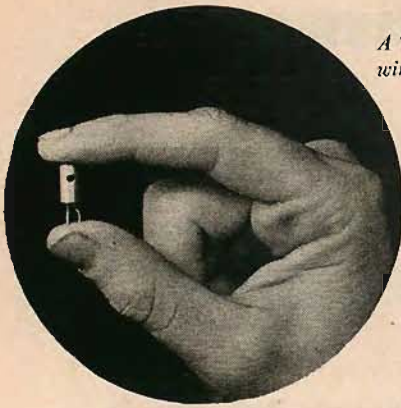

A Transistor of point-contact type. Two hair-thin wires control current flow in germanium metal.

It's helping to win the Battle of the Watts



Laboratories engineer examines Transistor oscillator. It is used in Englewood, New Jersey, where 10,000 subscribers can personally dial distant cities. Transistors generate the signals which carry the dialed numbers to other towns and cities. Other uses are in prospect.

When you keep down the power needed to send voices by telephone you keep down the special equipment needed to supply that power. A great new power saver for telephony is the **Transistor**, invented at Bell Telephone Laboratories, and now entering telephone service for the first time.

Tiny, simple and rugged, the **Transistor** can do many of the things the vacuum tube can do, but it is not a vacuum tube. It works on an entirely new principle and uses much less power than even the smallest tubes. This will mean smaller and cheaper power equipment, and the use of **Transistors** at many points in the telephone system where other equipment has not been able to do the job as economically.

It's another example of how Bell Telephone Laboratories makes basic discoveries, then applies them to improve telephone service while helping to keep its cost down.

TRANSISTOR FACTS

Created by Bell scientists. First announced in 1948.

Has no glass bulb, requires no filament current or warm-up period. Operates instantly when called upon. Uses no energy when idle.



BELL TELEPHONE LABORATORIES

Improving telephone service for America provides careers for creative men in scientific and technical fields.

Hi-Fidelity Phonograph Preamplifier Design

R. H. BROWN*

A comprehensive discussion of the principles of determining component values to provide the compensation required, combined with practical pointers on construction.

SEVERAL EXCELLENT phonograph pre-amplifier circuits have appeared in the literature but it is difficult for the individual who is not a full-fledged audio engineer to find the information he may need for designing a high-quality preamplifier to meet his individual preferences, or to make desirable changes intelligently in equipment already on hand. This article aims to set forth in a summary fashion basic material which a technically minded audio hobbyist or an amateur engineer would need in the design or revision of quality preamplifying and compensating equipment. Rather than attempt a comprehensive survey of the problems and theory of preamplifier and compensation circuit design, attention will be confined to straightforward basic circuits.

Basic Amplifier With Degenerative Bass Boost

Figure 1 shows the basic circuit around which most high-quality phonograph preamplifiers are designed. Resistor R_2 provides degenerative feedback to set the amplifier gain to the desired value for high frequencies, reduce amplifier distortion in the high-frequency range, and extend the high-frequency range beyond that which could be obtained from the basic amplifier without feedback. R_2 provides degenerative feedback to set the maximum value of bass boost, reduce amplifier distortion at the extreme low frequencies, and extend the low-frequency range below that which could be obtained from the basic amplifier without feedback. R_2 may be omitted (made infinite) when compensation is desired down to a frequency requiring the full gain of the basic amplifier. C_1 provides 6-db-per-octave bass boost as figured from the turnover frequency for which C_1 is selected.

The first step in the design of a pre-amplifier is to design a basic amplifier which has sufficient gain to provide down to the lowest frequency of interest compensation for the highest turnover frequency to be used. Information on electrically correct turnover frequencies may be found in the literature, and it will be observed that there are combinations of listening conditions, listener preference, and recording characteristics which may require turnover fre-

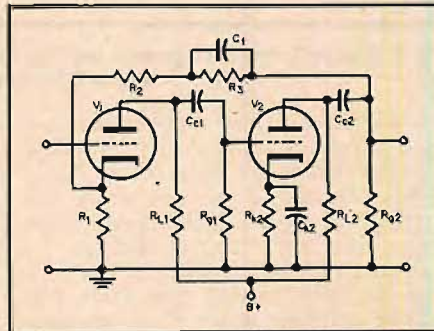

Fig. 1. Basic degenerative-bass-boost amplifier circuit. V_1 and V_2 and associated components, excluding feedback elements R_2 , R_3 , and C_1 comprise the basic amplifier. Triodes are shown for simplicity.

quencies as high as 900 cps. As a 900-cps turnover requires approximately 29 db boost at 30 cps, the preamplifier gain at 30 cps must be the antilog of 29/20 or 28.2 times as great as in the high-frequency range if bass compensation is to be provided down to 30 cps for a 900-cps turnover. Since due to the action of C_1 the gain only approaches the full basic amplifier gain as the frequency is reduced, in order to obtain good compensation down to a given frequency it is necessary to design for a frequency one octave lower. Thus for good compensation down to 30 cps for a 900-cps turnover one must have a basic amplifier with a gain at least 56 times greater than that required in the high-frequency range.

A preamplifier designed for use with a "Williamson" type power amplifier and a G.E. magnetic cartridge should provide between one and two volts output for a 10-millivolt input at 1000 cps. If this preamplifier is to provide good compensation down to 30 cps for turnovers up to 900 cps it must have a basic amplifier gain of between 5600 and 11,200, with R_2 selected to obtain a gain of between 100 and 200 in the high-frequency range. If no turnovers above 500 cps are to be used, good compensation to 30 cps may be secured with a basic amplifier gain of between 3100 and 6300. High-level cartridges, such as Clarkstan and Pickering, require minimum preamplifier gains approximately only one-sixth as great.

The selection of V_1 , V_2 , and associated components is best made from reference to the resistance-coupled amplifier data supplied by tube manufacturers. Because of the unbypassed cathode resistor the

gain provided by V_1 will be

$$A_1 = \left[\frac{A_1'}{1 + \left(\frac{R_2}{R_{k1}} \right) A_1'} \right], \quad (1)$$

where A_1' is the gain provided by V_1 with a completely bypassed cathode. C_{c1} , C_{c2} , C_{k2} , and screen bypass capacitors if pentodes are used, must be selected to provide essentially uniform gain down to the lowest frequency f_L for which full compensation is desired. To accomplish this it is desirable to choose the value of C_c (in farads) so that the product $f_L C_c R_g$ is between one and two, and to choose C_{k2} so that the product $f_L C_{k2}$ is between one and two times the mutual conductance of V_2 . In many cases adequate gain may be obtained without use of C_{k2} . Data required for the selection of a pentode screen bypass capacitor is ordinarily not available, but one can usually make a satisfactory choice by requiring that the product of the bypass capacitance (in farads), the lowest frequency of interest, and the plate resistance of the tube when triode connected have a value between one and two. If it is not convenient to use capacitances as large as those required by the foregoing conditions, the situation may be relieved by providing around 10 db of feedback through R_2 .

Once the basic amplifier has been designed to provide adequate gain for the maximum bass boost desired, the next step is to select R_2 so that the amplifier will give the right amount of gain for the high frequencies. At high frequencies (5000 to 10,000 cps) the gain is given by

$$A_{HF} = \left[\frac{A_{HF}'}{1 + \frac{R_2 A_{HF}'}{R_1 + R_2}} \right], \quad (2)$$

where A_{HF}' is the gain of the basic amplifier when a resistance equal to $R_1 + R_2$ is placed in parallel with R_{k2} . The gain provided by V_2 under these circumstances is equal to the mutual conductance of V_2 , multiplied by a resistance equal to the parallel combination of the plate resistance of V_2 , $R_1 + R_2$, R_{k2} , and R_{g2} . To obtain accurate 6-db-per-octave bass boost it is necessary for A_{HF}' to be large enough to make negligible the unity in the denominator of Eq. (2)—i.e., for A_{HF}' to be greater than $10R_2/(R_1 + R_2)$. When this

*Walla Walla College, College Place, Wash.

condition is satisfied Eq. (2) becomes

$$A_{HF} = \frac{R_1 + R_2}{R_1} \quad (3)$$

Since R_1 will usually be chosen from resistance-coupled amplifier data for proper biasing of V_1 , one may write the following equation for R_2 ,

$$R_2 = R_1(A_{HF} - 1), \quad (4)$$

where A_{HF} is now the required high-frequency gain—i.e., the gain without bass boost. If the loading effect of $R_1 + R_2$ keeps A_{HF} from being large enough to render insignificant the unity in the denominator of Eq. (2), the situation may be remedied by connecting R_2 and C_1 to an unbypassed cathode of a stage following V_2 (possibly a cathode follower output for the preamplifier).

The maximum gain available from the amplifier may be designated A_{LF} and is given by

$$A_{LF} = \left[\frac{A'}{1 + \frac{R_1 A'}{R_1 + R_2 + R_3}} \right], \quad (5)$$

where A' refers to the normal gain of the basic amplifier without feedback. In practice the coupling and bypass capacitors often prevent realization of the full value of A_{LF} .

From the fact that a simple resistance-capacitance arrangement which will provide 6-db-per-octave boost computed from a turnover frequency f_t must give a 3 db boost at f_t ,¹ one obtains the following relation for the selection of C_1 .

$$C_1 = \frac{1}{2\pi f_t (R_1 + R_2)}, \quad (6)$$

¹ The boost will be very close to 1 db at $2f_t$, 3 db at f_t , 7 db at $\frac{1}{2}f_t$, and 12 db at $\frac{1}{4}f_t$.

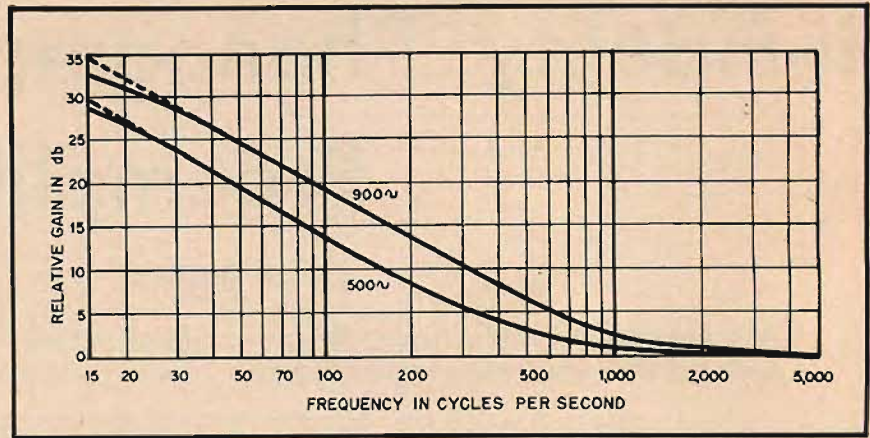

Fig. 2. Bass performance of pentode amplifier example discussed in text. Dotted lines indicate idealized 6-db-per-octave slope.

It will now be instructive to see how these principles are applied in selecting the components for a practical high-fidelity preamplifier for use with a GE cartridge and a "Williamson" type power amplifier. On consulting the resistance-coupled amplifier charts in a receiving tube manual one finds that a basic amplifier gain A' of approximately 18,000 may be obtained by using for V_1 a 6SJ7 with 180-v. E_{bb} , 0.5-meg. R_{L1} , 2.4-meg. screen resistor, 2.0-meg. R_{g1} , and 2410-ohm R_1 to obtain a gain of 95; and for V_2 a 6SJ7 with 180-v. E_{bb} , 0.5-meg. R_{L2} , 2.2-meg. screen resistor, 1.0-meg. R_{g2} , and 2180-ohm R_{k2} to obtain a gain of 192.

For 10-db minimum feedback $A_{LF} = 1800 / (\text{antilog } 10/20)$ which is 5700. From Eq. (5) one finds that this requires 20 megs. for R_2 , $R_1 + R_2$ being negligible in comparison with R_2 . For $A_{HF} = 100$, Eq. (4) requires a value of

0.241 meg. for R_1 . This provides at high frequencies a 45 db feedback in addition to the 6.8 db of current feedback on V_1 due to its unbypassed cathode resistor. For 900 and 500 cps turnovers Eq. (6) requires values for C_1 of 740 and 1310 μf respectively.

The actual performance of this preamplifier is shown in Fig. 2. The value chosen for A_{LF} was 35.1 db above that chosen for A_{HF} , an amount just equal to the boost required at 15 cps by a 900 cps turnover. The necessity for designing to a frequency one octave below the lowest frequency to which full compensation is desired is illustrated by the 900 cps turnover curve in Fig. 2.

In a preamplifier designed for use with a high-level magnetic cartridge, a value of but 15 for A_{HF} would be adequate. One could use the basic 6SJ7 amplifier discussed above with 33,700

(Continued on page 65)

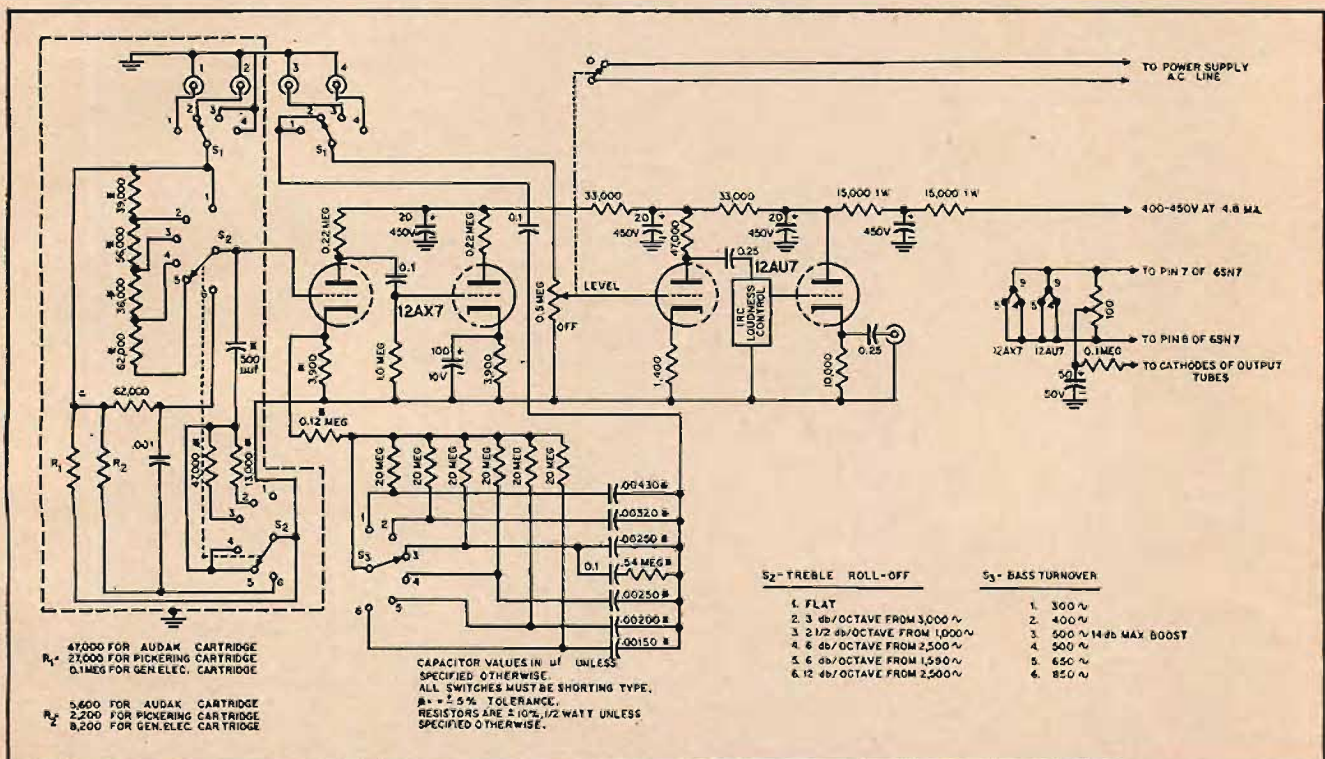

Fig. 3. Complete schematic of author's preamplifier with six bass turnover conditions and six roll-off positions.

High Fidelity —

An Essay on Scale Distortion

JOE DICKEY*

Although the essay—as a form—is a rarity in technical literature, the ideas presented herein are of sufficient value to provoke considerable thought in the minds of music lovers and audio hobbyists.

ONE OF THE NICER things about audio is its universal appeal. Across the nation there is a growing thirst for “high fidelity.” It is particularly heart warming to the sound engineer to see the base of interest in his field being broadened. At the same time many hobbyists are fascinated by work in a tangible field, the bulk of which is within their means and understanding. In short, it appears that we are enjoying a renaissance in sound to the delight and good of all.

It is important to note, however, that every musician or music lover who may be attracted to better audio does not retain his initial enthusiasm. It is surely true that some lack basic interest. In addition it must be assumed that an important segment of the artistically progressive and technically curious simply experience a measure of disappointment which no amount of “changing output transformers” can gloss over. Emphasis on the material side of the problem appears as so much planned frustration and only widens the gulf between the objective and the result. The search for high fidelity finds only its enigma, “high futility.”

The situation calls for an examination of the concept of reproduced music. In order to simplify the inquiry, the “little black box” idea may be applied to the “electronics” of high fidelity. In other words, it is a basic consideration of this study that all limitations stemming from the electronic portion of the system (including the loudspeaker and its enclosure), have been overcome. In order to complete the background, it is desired to introduce the definition of scale distortion as follows: “the reproduction of sound at a level which differs from that at which it was originally made.”

At the outset we need to note that it is unlikely that the conditions, setting, and environment of any particular event of importance could be recreated for the reproduction of the sound associated with the event. Nor may we assume that we would wish it so. Reproduced sound, by its very nature, means a separation in space, as well as in time, between performer and audience. Our desire is

to call forth musical, or other events for our pleasure under conditions of our choice. It is not at all unusual to enjoy a “symphony concert” in the subdued quiet of a small living room or to delight in the spectacle of a teen-age daughter studying Latin to the accompaniment of the “Hit Parade.” The point is that in most cases music is reproduced in the home under conditions which differ greatly from those usually associated with the program and it is therefore neither possible nor desirable to eliminate scale distortion. One might say that the treatment of scale distortion is a personal matter and represents the adaptation of the available to the needs or the general to the specific. Everyone knows that volume controls correct for inequalities in station signal strength, and tone controls give “more bass.” But is it appreciated that the volume control represents the privilege of introducing, or partially correcting for, scale distortion? Is it fully understood that the true role of the tone control is to effect second order, (but still not complete), correction of scale distortion?

Before running head-on into the subject, some review is needed in order to establish a proper point of departure for our qualitative analysis. In particular we need to note a few pertinent points concerning the human ear and room acoustics. With respect to the ear, the more important points are: the varia-

tions in loudness with changes in frequency (the familiar Fletcher-Munson effect);¹ variations in pitch with changes in intensity;² the non-linear response of the ear which causes amplitude distortion to be generated at the higher listening levels;³ and masking effects which cause certain normally perceivable sounds not to be heard in the presence of other sounds.⁴ With respect to room acoustics, the more significant points are: the variations in the effectiveness of sound absorbing material with changes in frequency;⁵ variations in transmission efficiency with changes in frequency;⁶ reverberation time;⁷ and ambient noise levels.⁸ Each of these items has been treated quite objectively as may be seen by a reference to the notes.

With an understanding of these several separate effects we may turn our attention to the subject itself. The mathematical work required to correlate the above factors in a comprehensive treatment of scale distortion is a prodigious task. Fortunately for us, an understanding appropriate to our inquiry can be had for a reasonable expenditure of effort. A particularly attractive scheme is to study a typical situation.

The Listening Pattern

The selection of a typical family listening pattern is probably our most difficult choice. Careful observation of our



“Sure it’s tough on plaster, but you should hear the bass!”

¹ Edgar M. Villchur, “Handbook of sound reproduction, Chapter 6,” *AUDIO ENGINEERING*, Nov., 1952.

² *Loc. Cit.*

³ *Loc. Cit.*

⁴ *Frequency Range and Power Considerations in Music Reproduction*, Technical Monograph No. 3, Jensen Radio Mfg. Co., Chicago, Ill., 1944.

⁵ *Sound Absorption Coefficients of Architectural Acoustic Materials*, Bulletin IX, Acoustical Materials Association, Chicago, Ill., 1947.

⁶ Harry F. Olson, *Elements of Acoustical Engineering*, page 429, New York, D. Van Nostrand Co., 1947.

⁷ *Ibid.*, page 399.

⁸ Jensen Technical Monograph No. 3, *Op. Cit.*

*75 *Roseneath, Newport, R. I.*

own listening habits, as well as those of our friends, will most likely reveal that music, regardless of type, generally forms a background for some other activity. These activities may include housework, dining, or the evening paper. They may range from a high level (noise, that is) cocktail party to the serene joy of the children sleeping. It seems clear enough that our choice of listening conditions has the greatest of all influences upon the requirements we set for our sound system. It can hardly be overemphasized that subjective considerations determine these choices. The first determinant is volume and the second is tone. It is not until these two basic selections are made—the first usually introduces scale distortion and the second partially corrects for the undesirable effects of the first—that the other forms of distortion which plague reproduced music are even noticed, much less considered. Thus in providing the music we want it is not enough that the sound system simply transmit melody, harmony, and rhythm. Nor is it sufficient that the system transmit tones over a wide band with negligible distortion, although it should be stated that an electronic system which is free of the more usual forms of distortion is a basic requirement. In this connection, today's quality equipment is a revelation to those who remember the early "high-fidelity" systems that would have failed completely but for the bass (high cut) tone control.

Objective measurements will show that a lot of listening is done at a level of about 55 db above the usual reference of 10^{-16} watts per square centimeter. This is true regardless of the type of program material; i.e. the listening level is determined more by the situation than it is by the substance of the program. In order to see the extent of the problem we need only note that even a string quartet is unrealistic at 55 db and certainly a symphony orchestra just doesn't show up in one's living room without considerable adjustment. For our purpose the symphony provides the better example, although the same parameters exist in the problem of reproducing any other type of program.

A 70-piece orchestra has an average power output of about 0.1 watt with $\frac{1}{2}$ sec. interval peaks of 70 watts. The lower limit to the dynamic range is, say a soft violin with a power of 7 microwatts. This represents dynamic peaks of about 30 db, with a total dynamic range of 70 db. Let us now turn to the acoustical setting in which the music, not the orchestra, finds itself. If background measurements were made in the living room of a typical home, the readings would likely indicate a total noise level of 40 db on a cool night, with the windows closed. Spectral distribution of the energy might not be known but could be assumed to be such as to provide an average, or normal, masking level contour.⁹ This is a valid assumption pro-

⁹ Jensen Technical Monograph No. 3, *Op. Cit.*

vided there are no unusual disturbances such as resonance effects in heating ducts, noisy fluorescent lighting fixtures, etc. By applying the masking level contour to the absolute hearing response curve, one obtains the effective hearing contour for an average listener in the room being studied. For a frequency of 1000 cps and a total room noise of 40 db, the masking intensity is 22 db. When listening to the full orchestra with a 70-db dynamic range the softest passages fall some 40 db below the average level. Now, if the listening level has been set at a level of about 85 db, which is close to the loudness experienced by a person occupying a choice seat at a concert, we see at once that the softest passages—which are 40 db below the 85-db average—will be reproduced at 45 db, which is 23 db above the noise mask and will be heard. But suppose the listening level has been set arbitrarily at 55 db for reasons of choice. The softest passages will then be reproduced at 15 db, which is 7 db below the noise mask and thus not perceivable. A complete analysis would require measurements and determinations throughout the audible range, but the point seems clear enough. The failure of perception as outlined above is artificial in that we have created the problem by our listening habits. Since it does not appear likely that the solution to this problem will come about by changing our outlook on music in the home, we must look to other means for a solution. It is obvious that increased quieting of the room by eliminating the sources of noise would reduce the masking effects. Though desirable, this change is impractical for the average home due to architectural difficulties. The simple expedient of adding acoustic material tends to deaden a room by absorbing the sound as well as the noise and thus reduces the reverberation time which is already too low, as will be shown later. There is no entirely correct solution to this problem, but there are considerations which tend to lessen the undesirable effects.

The Program Source

Suppose we examine the program source and see what the situation is insofar as standards are concerned. The full 70-db dynamic range is not transmitted on current AM radio because of two factors: an average modulation 30 db below 100 per cent would reduce the geographic coverage to the extent that the station could not operate in competition; and average wire lines carrying program material cannot handle a range of 70 db by reason of noise level. In the case of recordings, the full 70-db dynamic range is seldom recorded because the louder passages would cause excessive displacement of the stylus and uneconomical usage of recording space on the one hand, and a bad situation with respect to surface noise on the other. The net result of these limitations is a reduction of the dynamic range of programs to a value consistent with

wire lines, modulation capabilities, and recording media. It should be noted and appreciated that compression of the dynamic range is a distinct help in minimizing the loss of perception due to the combination of scale distortion and ambient room noise. By and large it was because of these underlying reasons that the attempt in the early thirties to apply volume expansion to AM radio and the phonograph was doomed to failure. With the advent of wide range (dynamic) programs on FM, better record materials, and a better choice of the recording characteristic it is even conceivable that some compression will be introduced in home systems in order to prevent loss of perception when listening at low volume levels.

Considering the volume control, if taste were as simple as figuratively walking toward, or away from, the orchestra, then a simple potentiometer-type control would satisfy all needs. Furthermore, tone controls, once set to account for peculiar conditions of the system, could be left untouched. This approach to the problem, though psychologically proper, is not very popular and for good reason. As noted earlier, home listening is generally characterized by a depressed level. With most individuals, the loss of low and high frequencies that attends the use of an uncompensated-voltage-divider type of control is disconcerting to say the least. For the critical listener, the necessity for restoring tonal balance is great enough to mother the invention of the tone control, had it not been chanced upon early in the game by those who simply "liked their music the way they liked it." In order to simplify the operation of sound systems and lessen the chance of an incorrect setting of the tone control, loudness controls have been incorporated into many systems.¹⁰ Insofar as our analysis is concerned, these two methods of improving the situation that results from scale distortion are one and the same.

If microphone placement is such that the sound level is about 85 db average in reasonably strong passages, and one desires to listen at a level of 55 db, then 20 db of bass compensation is required to correct for scale distortion at 50 cps. The additional gain could easily be built into the system, but the problem is not that simple. When dynamic peaks raise the level to 85 db the compensation should be zero, but the 20 db of compensation is still present. The situation that occurs during soft passages is even worse for then 30 to 40 db of compensation is required, depending upon studio technique. Under this condition the 20 db of compensation provided for an average level of 55 db falls short and the bass is absent. There is only one practical solution to this problem and that is

(Continued on page 68)

¹⁰ David Bomberger, "Loudness control for reproducing systems," *AUDIO ENGINEERING*, May 1948.

Feedback—Degenerative and Regenerative

RUDOLPH L. KUEHN*

An analysis of the various forms of feedback, with particular attention to conditions which cause oscillation, and a mathematical presentation of the condition which must be present to cause oscillation.

ONE MIGHT SAY that feedback is as common as the measles. By the brief analysis presented here it is hoped that a clearer understanding is developed of the electronic phenomena.

In general, the block diagram for feedback is given in Fig. 1. If a voltage proportional to the output current or voltage of an amplifier is fed back in series with the input voltage so as to decrease the amplification the method is called negative, inverse, or degenerative feedback. The resulting amplifier has certain properties which may be desired despite a loss in amplification.

For simplicity, a sinusoidal input voltage E_i and an absence of harmonics due to nonlinearity in the tube and related circuits are assumed. The input to the amplifier proper is the vectorial sum of E_i and the feedback voltage, thus $E_t = E_i + E_{fb}$. The complex voltage gain of

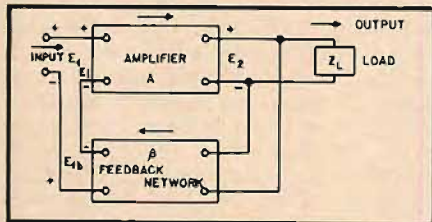

Fig. 1. General feedback configuration as applied to an amplifier.

the amplifier is given as $A \equiv E_o/E_i$, and the feedback ratio is $\beta = E_{fb}/E_o$. It is seen, then, that $E_{fb} = \beta E_o = \beta A E_i$, and $E_t = E_i/(1 - \beta A)$, and $E_o = A E_i/(1 - \beta A)$. From the last expression the following is obtained:

$$\frac{E_o}{E_i} = \frac{A}{1 - \beta A} = A'$$

which is the over-all complex voltage gain with feedback.

Now it follows that if βA is real and negative, then $A' < A$ and the amplifier is degenerative. If βA is real, positive, and less than unity, then $A' > A$ and the amplifier is regenerative. The voltage gain approaches infinity if βA is real and approaches 1. If $\beta A = 1$ the amplifier is unstable and begins to oscillate. This latter condition is the Barkhausen criterion for sustained self-excited oscillation of a single tube circuit under the initial assumptions above. Generally speaking, the magnitude of the voltage

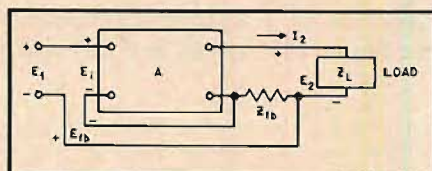

Fig. 2. Block schematic of connection for current feedback.

gain depends on the absolute quantity $|1 - \beta A|$. For very large values of negative feedback the expression $|1 - \beta A|$ is very nearly $-\beta A$ and $E_o \approx A E_i / -\beta A$ so that $E_o/E_i = A' \approx -1/\beta$. To an arbitrary degree the voltage gain may be made independent of supply voltage changes, tube parameters, and characteristic curves by a high value of inverse feedback. Without considering the involvements of the theory, it is enough to state here that feedback reduces the nonlinear distortion produced in an amplifier for a given output by the ratio $1/(1 - \beta A)$.

For any resistance-capacitance coupled amplifier the amplification remains constant for a certain large range of frequencies, but falls on either side of this range. This so-called mid-band range usually extends from below 100 cps to above 5000 cps. In the mid-band frequency range the output voltage is 180 deg. out of phase with the input voltage. The angle of phase shift of the output voltage relative to its mid-band phase is given as

$$\gamma = \text{arc tan } \omega r_p C_L$$

where C_L is the parallel load capacitance and r_p is the effective output impedance of the stage (defined as the impedance that the plate circuit offers to an external voltage applied between the plate and the cathode).

If the voltage to be fed back is such as to make β independent of the value of the load impedance (which can be had by a simple voltage-divider across the load), then the condition is known as voltage feedback. If, however, the circuitry is as represented in Fig. 2, then the ratio of E_{fb} to the output current, I_o , is made constant by the feedback impedance Z_{fb} . This is known as current feedback. In the case of voltage inverse feedback, E_o decreases as Z_L is decreased and E_{fb} also decreases; but the decrease in E_{fb} tends to increase the output voltage and to maintain it constant. With current inverse feedback I_o increases as Z_L decreases, and E_{fb} increases; but the increase in E_{fb} tends to decrease the

output current and to maintain it constant. Therefore, with voltage negative feedback the effective internal series impedance is made smaller by the feedback; whereas, with current inverse feedback the effective internal series impedance of the amplifier is made larger by the feedback. Thus it can be seen that at constant input voltage E_i the former approaches the behavior of a constant-voltage source, while the latter approaches that of a constant-current source. In multistage amplifiers or in any situation where the amplifier must be terminated for power transfer it is necessary to know the effective internal impedance for optimum matching.

Cathode-Follower Analysis

The cathode-follower is a form of inverse feedback amplifier (see Fig. 3). This arrangement has two major advantages over the conventional ampli-

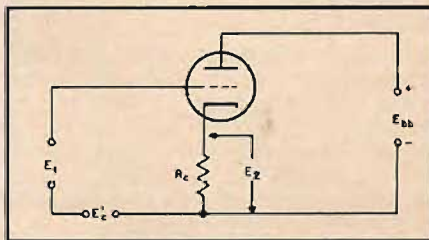

Fig. 3. Typical arrangement of a cathode follower.

fiers which place the load impedance in the plate circuit:

1. One of the load terminals may be grounded.

2. The impedance presented by the tube to the load is small enough that it can be easily matched to a transmission line.

The voltage developed across the load R_c opposes the applied signal voltage so that the circuit exhibits negative feedback characteristics. If the equivalent impedance and the transconductance are not too low, the voltage developed across the load will be almost equal to the applied signal voltage but never larger. The equivalent impedance is formed by the load in parallel with the term $r_p/(1 + \mu)$, where μ and r_p have their customary significance.

Oscillators

It was shown earlier that the general requirement for oscillation is $\beta A = 1$. Consider the simple feedback circuit of Fig. 4. In the general case the following is true:

(Continued on page 58)

* 437 Broad Ave., Palisades Park, N. J.

Theater Sound in a Small Package

THOMAS R. HUGHES*

Part 3. Concluding the description of a unique loudspeaker housing with details of the dividing network and the methods of testing and adjusting for optimum performance.

IN THE TWO preceding articles the theories and construction of this loudspeaker system have been developed. This concluding article covers the electrical system and controls for providing complete satisfaction.

As previously stated, the tweeter may be any good make of horn tweeter, with a horn that cuts off well below 1000 cps. Some manufacturers have versions that are inexpensive (\$17 to \$35) and suitable for our purpose. As stated earlier, we are not so concerned with the angle of spread of sound from the tweeter, where it is to be used in the corner of a living room. The rated impedance is most desirable at 12 or 15 ohms but it may be 8 ohms. In any case, it is simpler if it has the same impedance as the woofer used.

Within the woofer's operating range, its voice coil impedance does not range much above its d.c. resistance value, while the impedance of the tweeter varies over a larger range, in relation to the frequencies it is generating. So we can design the components of the dividing network for the impedance of the woofer and forget about the tweeter, as long as it is not over 100 per cent from that of the woofer, and we can match impedances by using additional resistors, if desired.

Many good articles in the literature have covered the details of designing and constructing dividing networks. These articles give charts for estimating the number of turns of wire to wind on each coil and the dimensions of the coil spools, etc. So we will not take up space with such details here.

For winding coils, remnants of No. 16, 17, or 18 magnet wire can be obtained from motor winding shops and can be spliced together with a thin copper sleeve, sweated over butted ends. Thin "spaghetti" can be slid over the sleeve, after soldering, for insulation. The voltage is so low that insulation is not a critical item in these coils.

Surplus capacitors can generally be used by paralleling different sizes to get the right capacitance. These can be the oil-filled paper type with working voltages at 25 or 50 volts, if obtainable. If the higher voltage types have to be used they will be much larger in size

and higher in cost. There are some electrolytics for sale in "bathtub" cases, so beware of them. The regular oil-filled paper types have no polarity marking of terminals but the electrolytics either have a positive and negative mark or the terminals have different colored insulators. And, of course, the electrolytic is much smaller.

We used the series-filter system for our dividing network, since authorities seem to agree that it is the most desirable. It requires coils and capacitors of different sizes for the two legs or circuits. The coils may be bolted to the sides of the speaker cabinet—in the upper compartment allotted to the tweeter. Place them several inches apart on adjoining sides, so that their axes are at right angles, and use brass or aluminum bolts.

Preliminary Listening Tests

Connect the two coils and two capacitors together in proper relation with joints soldered in a temporary manner for testing. Then place the tweeter about 8 or 10 feet away from the main cabinet for the first hour or two of listening. By this means you can tell what you are getting from the different components. It is much easier to judge, if you have an audio oscillator, but a frequency test record can be played on your record player to check the response at crossover between the two speakers. Using an output meter across the speaker terminals or a microphone placed in front of the speakers is of little avail because of the vast difference in the character of the two speakers and differing spread of sound dispersion.

If this is your first experience of trying out two speakers and a dividing network, you may be highly confused at first. Things do not happen like you expected and you wonder if you are a complete flop. But just be patient and make no decisions until you have grown accustomed to listening to them for several hours. If you are getting response from each speaker you know that there is nothing open-circuited and it is going to take time to appraise the balance.

If this is your first experience of listening critically to two horn-loaded speakers, you not only have the surprises of where the sound is going to hit you from but your ear will have to

get used to richer notes packed with harmonics you were missing before. So, even the playing of your most familiar records can be disconcerting. Thus we repeat: your first decisions are going to waver back and forth and you had better not make any.

In the end, the thing you will have to decide (maybe with the help of others) is whether you have a satisfactory balance in volume levels between the two drivers. We mentioned, in an earlier issue, that a University 4408 tweeter so closely balances the output of our horn-loaded woofer that they are just connected directly to each leg of the dividing network. If one of your drivers overbalances the other it can be fed from a potentiometer connected across its leg of the network, as described in articles on dividing networks. This may be a 10-watt wirewound resistor with a sliding clamp contact for takeoff adjustment. Its resistance may be from 100 to 200 per cent of the voice coil impedance rating of that driver in ohms. It's a good idea to measure the d.c. resistance of voice coil and resistor with an ohmmeter, as an approximate check.

Means of Comparing Speakers

You are going to find that it is no easy matter to decide whether you should be satisfied with the balance or not. You play an album of records and then you change it one way. Later on you play some other records and decide it still isn't right. But remember that in recording you have differing characteristics in microphones and their placing, not to mention difference in recording equipment and operators.

Since your main concern is with the region that the crossover falls in, it is a big help to compare your balance with the output from any single cone speaker of fair quality. This is just one of the reasons you are going to need the control hookup we use. Another good use for this hookup is to prove to the family and friends that you aren't going slowly off your nut, when you try to explain the purpose of this new system and what is different about it.

When a real music lover comes to visit you and listens to a good over-all system for a while, he will soon make comments or ask questions about the means of obtaining this realism. As the

* 3721 Hillcrest Dr., Los Angeles 16, Calif.

reader doubtless knows by now, it is fruitless to start an explanation of speaker systems. But it is a simple matter to demonstrate all aspects by flipping the switches in our control hookup.

All that is needed to complete the hookup of these controls and the dividing network (as shown in Fig. 10) are four DPDT toggle switches, a phone plug jack, and an L or T pad. The pad may be 12 or 16 ohms, assuming the impedance of the drivers is in that region. All of the equipment shown in Fig. 10 is installed in the upper compartment with the tweeter and we have switch handles protruding into one of the side openings of the bass horn, next to the wall, where curious hands are not likely to discover them. The jack also opens into this passage as does the handle of the T pad.

Switches 1 and 4 are used most so they were placed on the ends of the line of switches, so their handles are easily found by feel. Switch 2 is thrown to the position which inserts the pad only when another speaker is to be plugged into the jack. Most of the time the pad is out of the circuit. But the pad must be used to attenuate the response through the dividing network, when comparing our horn-loaded speakers with ordinary box-mounted cones.

To check the balance between woofer and tweeter (after the connections of Fig. 10 have been made and an attenuating potentiometer for adjusting the tweeter-woofer balance has been inserted) a normal cone speaker, around 10 or 12 inch diameter, is plugged in. Then adjust the pad while operating switch 1 back and forth until the volume is the same in either position. Now play several orchestra or choral records through the new system and at points where you doubt your judgment switch to the other speaker and see if there is any great difference.

We want to emphasize that the balancing is to be done on the passages around the crossover region. Do not try to judge the system on solo flute or violin music, for example. The comparison speaker will be of little use two octaves away from the crossover.

Confidence in Appraisal

Listening at all the different horn mouths of the new speaker system will show you that all kinds of thin squeaky noises come from the tweeter and choked squawks come from the lower horn in some alternate passages. These things happen when the dividing network cuts the broad band of harmonics of a note (in the crossover range) into shreds and you were listening to the narrowest of the shreds. Several feet back, this is not apparent, but if you really want to hear it you can flip either switch 3 or switch 4 and sample it readily. Then, if you think it shouldn't sound that way, plug in the comparison speaker. Then when you flip the switch, the sound will come out of the comparison speaker and you can see how it sounds there. If you have to use the T

pad to attenuate the tweeter or woofer response for comparison, it will be necessary to flip switch 2 back and forth with the other switch. By this means you insert the T pad with its attenuation, for the horn-loaded speaker, and drop it out for a straight through run to the comparison speaker, with its poorer efficiency.

This arrangement provides a versatile sampling hookup. The quality or response of over-all systems can be compared or either treble or bass response can be sorted out for comparison with that of another speaker. If you are trying to explain to someone that a cello or Ezio Pinza excite a broad band of harmonics, you can cut out either driver and show that there is still a considerable complement of harmonics issuing from the other. On the other hand, you can show that a lyric soprano has no lower harmonics while a mezzo-soprano has to have woofer response for rounded notes. It is uncanny what can be done with it.

Les Paul started the novelty of recording several sound tracks on one tape with different modes of playing the same steel guitar. With his record of "Little Rock Getaway" you can completely erase the highest or the lowest sound tracks with switches 3 or 4, because there are no stray harmonics of these tracks on the other side of the crossover. We can take certain records of Lily Pons and erase Pons and leave the orchestra still playing along fairly effectively.

When we are trying to point out to untrained ears how the efficient response of the little woofer will etch the sharp intensity into cello or English horn passages, their attention is likely to be distracted by the sharp excursions of some flute or violin. So we can cut off the tweeter and focus their attention on the feature we are trying to demonstrate.

Then there is the fellow who thinks his pet speaker is just as good as yours and he has infinite faith in his hearing and memory. Tell him to bring his own speaker and his pet records over and you can really give him a comparison. When he hears his own records he cannot claim any fakery in the line up, if his speaker is shown up.

Hold That Distortion

All of the foregoing discussions of the

virtues of this speaker system are predicated on the assumption that high-quality music signal is being fed into the dividing network. There is the old argument between technical experts—whether one should improve the speaker system or the other sound equipment first. We believe that the speaker is the end to start on because you can do a lot of see-sawing around in the feeding equipment without being fully conscious of results unless you have a sensitive speaker system.

It is about like the old tale of the man who found a horseshoe and bought a horse to put it on. Our new speaker system will mercilessly display the defects in records and equipment. The first thing you have to do to soothe it is get rid of record surface noise with a magnetic pickup and a new changer—one of the better modern changers, with only a few grams needle force and a ball-bearing arm swivel, so it is free from the different forms of distortion contributed by drag of arm on groove walls.

If you have not done this already, you have no idea how different the records can sound. Fifty per cent of the surface noise and distortion from inexpensive pickups is from vertical vibrations and is mostly eliminated by change to a modern magnetic or variable reluctance pickup. The reason being that they produce practically no response from vertical vibrations. The other fifty per cent still remains from lateral distortion of stylus movement caused by a heavy arm with stiff swivel joints, working against the whip of eccentric or warped records.

After the man got a horse he had to get a stable and a riding habit. So a preamp stage ahead of the amplifier will be necessary, unless it already has one. Then we start in on equalization—because the speaker system shows that up. There are almost as many ideas for attacking this problem there are ideas for speaker enclosures but we have not experimented with these to the same extent. Success in the matter is not difficult, however.

The amplifier is the oldest member of the team, having started its career before the loudspeaker. So there are no secrets about amplifiers and plenty of satisfactory performers can be had

(Continued on page 70)

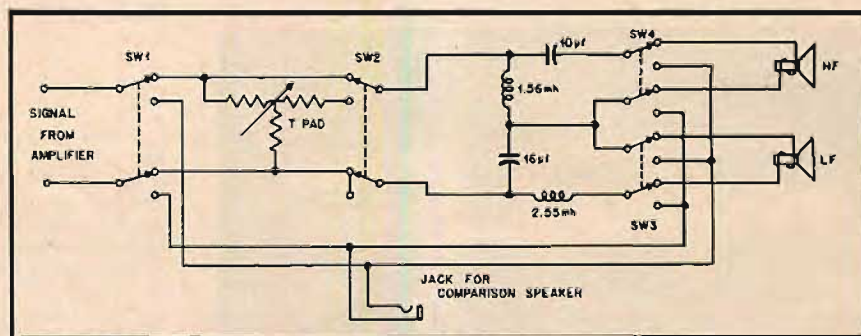

Fig. 10. Schematic of the dividing network to show the four switches used in making comparisons between the over-all system and other speakers, and for checking performance of the individual components.

An Auxiliary Mixer for TV Studios

GEORGE A. SINGER*

A description of a commercial unit which combines good engineering with a practical consideration of the requirements of modern studio operation.

PRODUCTION TECHNIQUES of the more elaborate television shows require an extensive and flexible audio system. In particular, a much larger number of microphone inputs are needed in television than are required for a similar radio show. There are two basic reasons for the use of more microphones in a television production. First, the microphone has to be kept in close proximity to the actor to reduce noise pick-up from the audience or changes of props. As the scene shifts, the microphone has to follow the action or when this is not practical—as is frequently the case—other microphones, distributed at strategic locations, have to be used to pick up the sound.

Unlike radio it is not usually possible for the actor to step up to the microphone to deliver his lines, then to step aside to make room for the next actor, thus reducing the number of microphones required.

The second reason for the need of additional microphone input facilities in television is the fact that frequently more than one set or staging area is used in a single studio. Each area requires its own complement of microphones. However, usually only one area is in use at a time, and it is therefore possible by providing suitable input selector switches to reduce the number of microphone mixer channels needed.

Many of the television stations which have been on the air for some time are faced with the need of expanding their audio facilities. Similarly, the many new stations which are now springing up all over the country will require or are at least planning for more microphone inputs than the standard broadcast studio console affords.

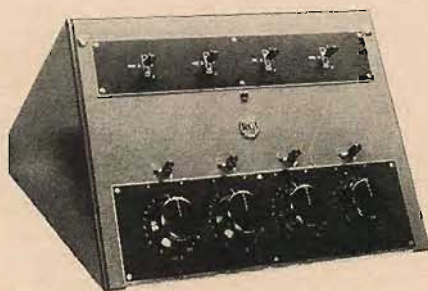

Fig. 1. Over-all view of the BCM-1A Auxiliary Mixer which may be used to extend the number of microphone inputs of a conventional studio console.

Auxiliary Unit Needed

There is, therefore, a definite need for a unit which may be added to a studio console to provide additional microphone switching, amplifying, and mixing channels. Such a unit should of course not only match in styling the other studio equipment but also be convenient to use and easy to install.

With these considerations in mind, the BCM-1A Auxiliary Mixer was designed to supplement the facilities of the type BC-2B Studio Console.¹ The new unit is shown alone in Fig. 1, and in its normal operating position alongside the console in Fig. 2.

As shown in the block diagram of Fig. 3, the Auxiliary Mixer provides four mixing channels. The input selector switches S_1 to S_4 permit a selection of any one of three microphone inputs for each of the four preamplifiers, making available a total of twelve microphone inputs.

The preamplifiers employ two stages of amplification with inverse feedback to reduce distortion and stabilize gain. Low-noise tubes are used to obtain a high signal-to-noise ratio. The ampli-

fier chassis are secured by vibration mounts to eliminate microphonics.

Following the preamplifiers are the ladder type attenuators AT_1 to AT_4 . These attenuators have 20 steps of 2 db each except for the last three steps which taper to infinity. The lever key switches S_5 to S_8 connect the output of the mixer attenuators to either the program bus or the audition bus.

To make convenient external connections for special applications, the inputs and outputs of the selector switches and amplifiers have been brought out to terminals on the audio terminal block, as shown at the top of

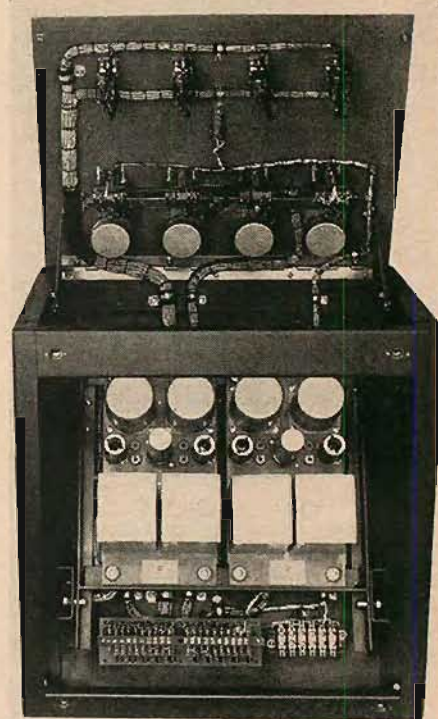

Fig. 3. Removing the top and tilting the front panel forward provides easy access to the interior for maintenance. The bottom of the amplifier chassis is accessible simply by raising a hinged framework.

Fig. 4, which shows the internal appearance of the mixer with the top removed and the front panel tilted forward.

Flexible Mixer Circuit

The mixing circuit itself was designed so that the mixer busses of the auxiliary mixer can be paralleled with the mixing busses of the console. This was accomplished by making the output impedance of the auxiliary mixer the same as the resistance of the load resistors in the mixing circuit of the console. These load resistors are removed when

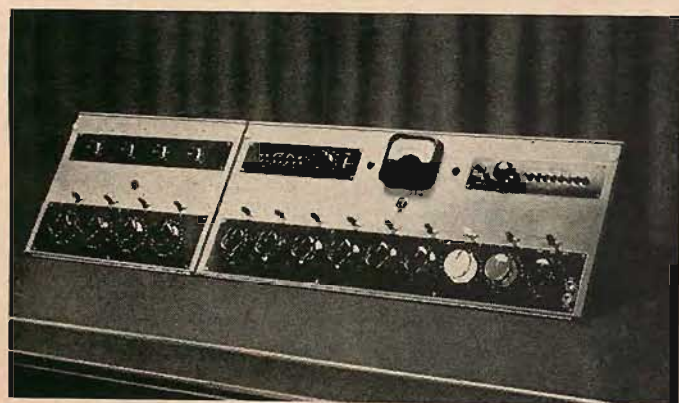

Fig. 2. The Auxiliary Mixer as set up for use with the BC-2B Console—which it matches in finish and design—for side-by-side operation in the studio.

* Engineering Products Department, RCA Victor Division, Camden, N. J.

¹ P. W. Wildow and G. A. Singer, "New AM-FM-TV studio console," AUDIO ENGINEERING, September, 1951.

the two units are connected together. In addition, the auxiliary mixer circuit was designed so that its proper load impedance would be that of the mixing circuit of the consolette.

The imposition of these conditions resulted in an output impedance of 370 ohms and a load impedance of 255 ohms. It is therefore necessary to use a matching pad when the output of the auxiliary mixer is fed into a 150 or 250 microphone input of either the consolette or another amplifier.

The program-audition switches are also equipped with contacts for interlocking circuits which activate the speaker muting and studio warning light relays of the consolette.

Thus there are two ways in which the auxiliary mixer can be connected to the consolette:

1. *Paralleling of the mixer busses.*

The program and audition busses of the auxiliary mixer are connected directly to the corresponding mixer busses of the consolette. Eight connections are required between the interlocking circuits of the two units. This type of installation results in 12 mixing channels—8 of which are microphone mixing channels—and a total of 18 possible microphone inputs.

2. *Using the Mic 1 mixer of the consolette as a sub-master gain control.*

In this type of connection, the program bus of the auxiliary mixer is connected through a matching pad to the Mic 1 input of the consolette. The audition bus of the auxiliary mixer may be connected through a matching pad to an external monitor amplifier if so de-

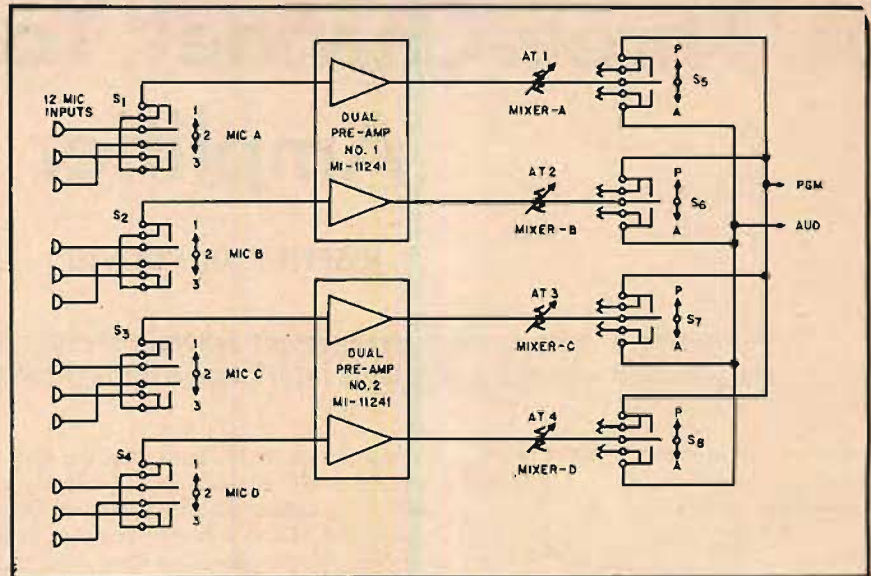

Fig. 4. Block diagram of the Auxiliary Mixer.

sired. No interlocking connections are required for this case since the program-audition switch of the Mic 1 channel in the consolette controls the speaker muting and warning light relays. The Mic 1 mixer attenuator of the consolette may be used as a "sub-master" gain control for the auxiliary mixer. This type of installation reduces the number of possible microphone mixing channels by one. The added feature of a sub-master gain control, however, simplifies operation as it makes possible to fade four channels in and out simultaneously.

Typical Application in Studio

The audio facilities of a typical TV studio are illustrated in Fig. 5. The studio is divided into three staging areas. Each of these areas contains four microphone inputs to the auxiliary mixer. In the main staging area #2, are an additional three or four microphone inputs leading directly to the consolette. (The microphone 1 input is shown dotted because it cannot be used if the output of the auxiliary mixer is fed to the Mic 1 input of the consolette.)

(Continued on page 61)

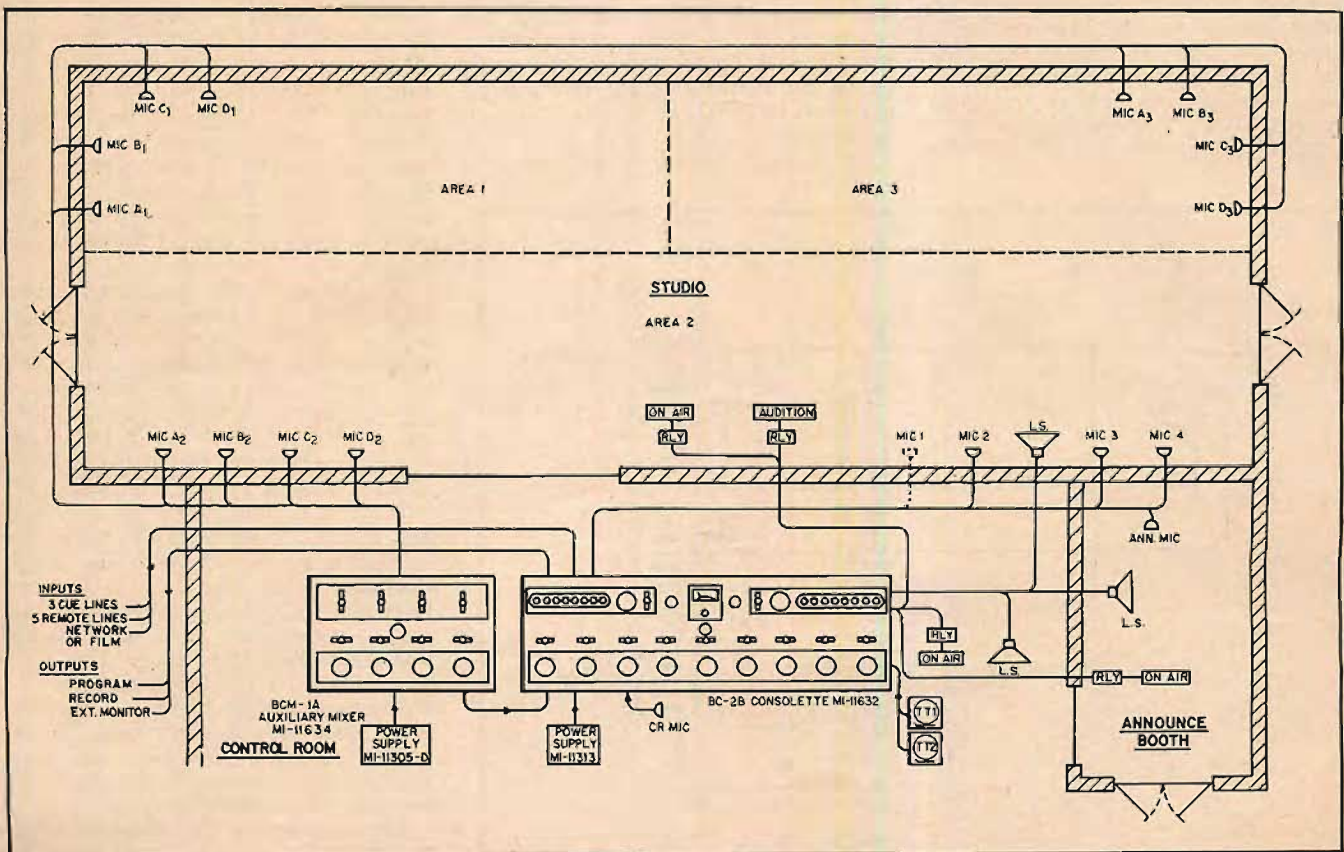

Fig. 5. Typical studio layout which employs the capabilities of the Auxiliary Mixer to augment the number of microphone inputs available for instant use.

A Three-Channel Tone-Control Amplifier

JOSEPH F. DUNDOVIC*

Presenting a tone-control arrangement wherein steeper low- and high-boost curves are provided without appreciable interference throughout the mid-range frequencies.

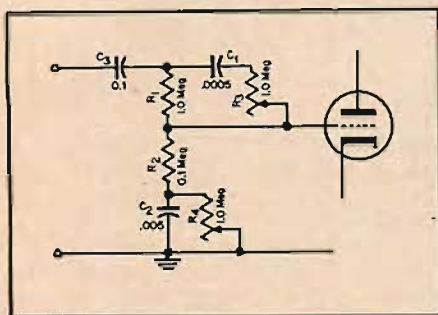

Fig. 1. Simple tone-control circuit commonly used to provide boost of both low and high frequencies.

THE TONE CONTROL to be described here may be considered somewhat elaborate, but it does produce results which cannot be duplicated by any of the more conventional circuits. It is the final result of extended experimentation to obtain the desired effect in the simplest possible manner.

Most tone control circuits use some type of R-C network to attenuate or boost either or both ends of the audio

* 4119 Irving Avenue North, Minneapolis 12, Minn.

frequency spectrum. However, the problem in audio equipment is generally a deficiency rather than an excess of lows and highs. Two of the responsible factors are the limitations of the equipment, and the need for compensation for the Fletcher-Munson effect at low volume levels. Hence this article will deal only with the "boost" type of control.

A circuit which is representative of many of the common tone controls is shown in Fig. 1. Briefly, the voltage divider, consisting of the resistors R_1 and R_2 , attenuates the signal applied to the grid of the amplifier tube. The capacitor C_1 shunts R_1 for the high frequencies, and the amount of shunting action is controlled by varying the resistance of the series potentiometer R_3 , resulting in a variable high-frequency boost. For the bass boost, C_2 is introduced in series with the lower leg of the voltage divider by increasing the resistance of its shunt potentiometer R_1 . Since C_2 has a greater impedance at the low frequencies, the effective attenuation at that end of the spectrum is reduced.

The main drawback of the tone con-

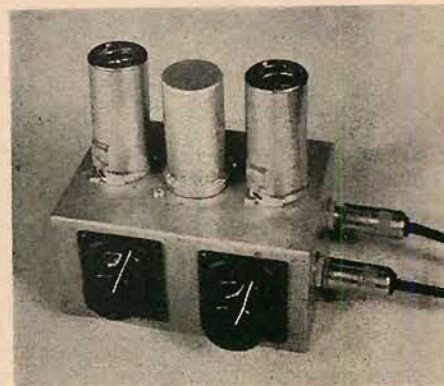

Fig. 2. The author's tone-control amplifier mounted on a small chassis for use with other equipment.

trol of Fig. 1 is the shallow slope of the attenuation curves. For example, in order to obtain an appreciable boost such as 20 db at the frequencies around 20 cps, frequencies well into the middle range of 500 to 1000 cps are also boosted. The result is the familiar "boomy" effect generally associated with juke boxes. Likewise, when the high-frequency boost extends into the middle range, a pronounced distortion of the original tonal balance is observed.

A more desirable characteristic may be obtained by a tone control which reinforces only the very ends of the audio range, below 100 cps and above 3000 cps. In these regions the limitations of the loudspeakers and other auxiliary equipment between the listener and original performance combine to cause a sharp drop in output.

A three-channel tone control amplifier which accomplishes the above aim is shown in Fig. 2, with the circuit diagrammed in Fig. 3. It is designed to be inserted between a tuner or phonograph preamplifier and the average audio amplifier input stage. The insertion gain is 6 db, corresponding to a voltage-gain factor of two. Thus, with both boost controls fully retarded, the middle-frequency amplifier tube section V_{2A} has a gain of 6 db, and is flat over the entire audio range.

The tube section V_{1A} serves as a pre-amplifier for the low- and high-fre-

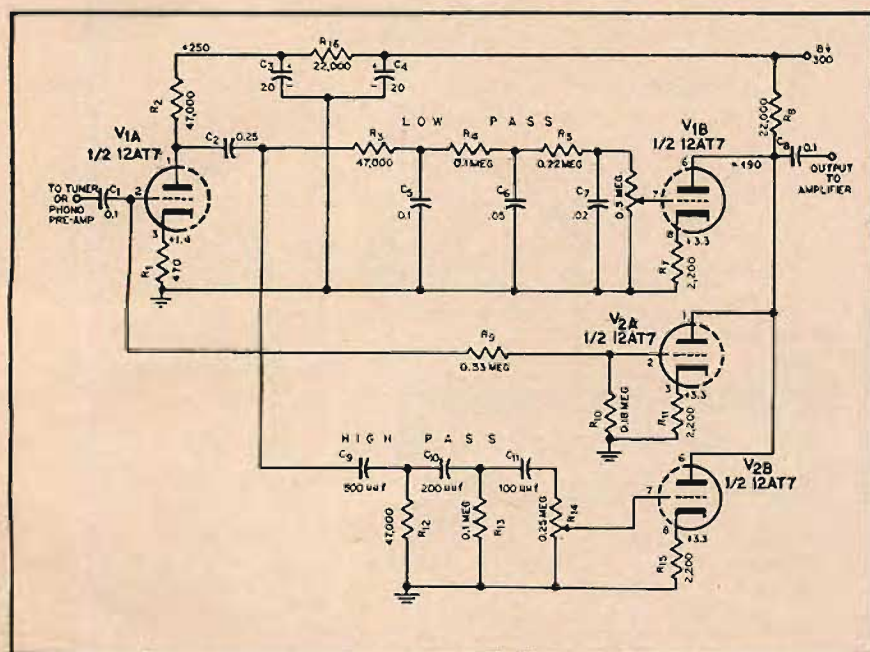

Fig. 3. Schematic of tone-control amplifier of Fig. 2.

(Continued on page 60)

Handbook of Sound Reproduction

EDGAR M. VILLCHUR*

Chapter 10—Part 2. Loudspeakers.

Continuing the discussion of the basic principles of one of the most important elements of a sound system, with a few hints on optimum conditions for speaker operation.

Harmonic Distortion

Non-linearity in loudspeakers is normally much greater than that of any other component in the reproducing chain. While amplifier advertisements vie with one another in comparing fractional distortion percentages at rated output, the best commercial speakers available cannot even approach such excellence. The manufacturer's published distortion *vs.* frequency and output curves of a speaker in the 150 dollar class is shown in *Fig. 10-7*. This speaker is probably one of the top quality units available, but if its distortion curve were presented as a performance index of the most humble of amplifiers, that amplifier would undoubtedly be scorned by the audio market.

A major source of harmonic distortion is the non-linearity of the cone and voice-coil suspensions, particularly at large excursions. As these suspensions are stretched their restraining forces increase instead of remaining constant.—beyond a certain point the suspensions will not give at all without tearing—and cone displacement ceases to be proportional to the magnetomotive force.

Harmonic distortion is also produced if the excursion of the voice coil takes it into a region where the total magnetic flux through which it moves is reduced. The instantaneous voice coil displacement no longer follows the signal because the magnetomotive force at the extreme positions is reduced.

These mechanical sources of distortion generally affect both halves of the cycle equally and the generated harmonics are therefore of odd orders, predominantly the third. Any method for reducing voice-coil excursion without decreasing output will reduce harmonic distortion. The more efficient the coupling to the air the less will be the displacement required of the voice coil for a given radiated acoustical power; the type of speaker mounting used is thus extremely important relative to distortion.

Both of the above types of non-linearity are most prominent in the bass fre-

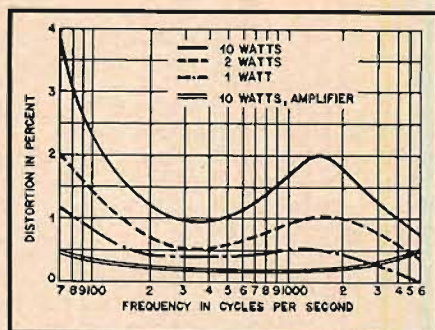

Fig. 10-7. Harmonic distortion of a high quality coaxial speaker, compared to that of an equivalent-quality amplifier.

quencies due to the increased excursion. Voice-coil displacement for the same signal amplitude increases as the frequency is lowered, and below the frequency of ultimate air load resistance displacement increases inversely as the *square* of the frequency. At a given frequency distortion increases with signal amplitude, also because of the increased excursion.

Subharmonic Distortion

Figure 10-8 illustrates how flexing of the cone in response to voice-coil motion may produce subharmonics. When the voice coil moves forward,

a stiff rim suspension may cause the cone to bend in either direction. When the voice coil moves forward a second time, however, the cone is already in transverse motion, returning from its first position of flexure, and the resulting momentum added to the flexing force causes it to bend the opposite way. The cone thus completes one cycle of motion during the time required for the voice coil to complete two. The frequency of flexure of the cone is one half that of the frequency of vibration of the voice coil.

Subharmonic formation is relatively minor in loudspeaker performance, and is discouraged by a highly compliant rim suspension and by cone design which discourages flexure.

Intermodulation

The fact that amplitude distortion is produced by a loudspeaker means that intermodulation will also exist, providing that the different frequencies involved are passed through the same distorting system. In the case of the speaker this intermodulation may be illustrated physically. When the voice coil is driven by a low-frequency note into a position where the suspensions exercise more than normal restraint on motion, or where the magnetic field is

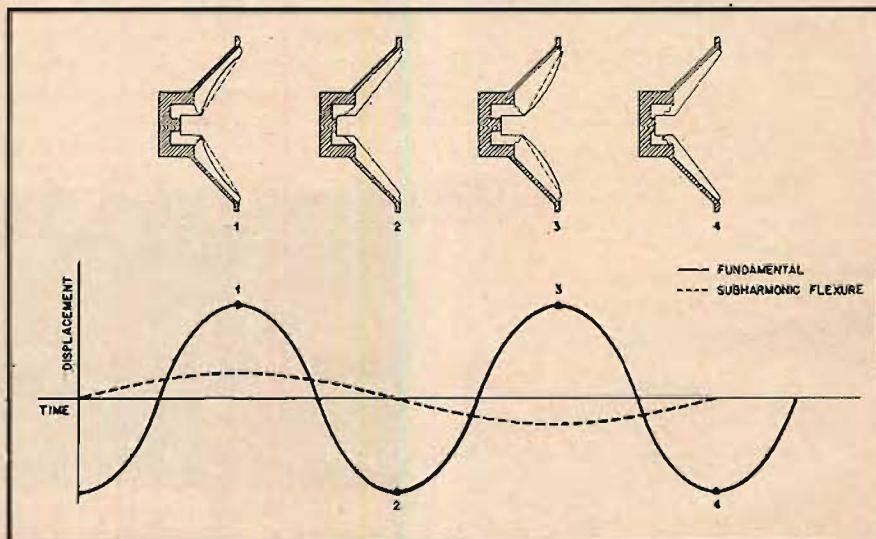

Fig. 10-8. Formation of loudspeaker subharmonics.

* Contributing Editor, AUDIO ENGINEERING.

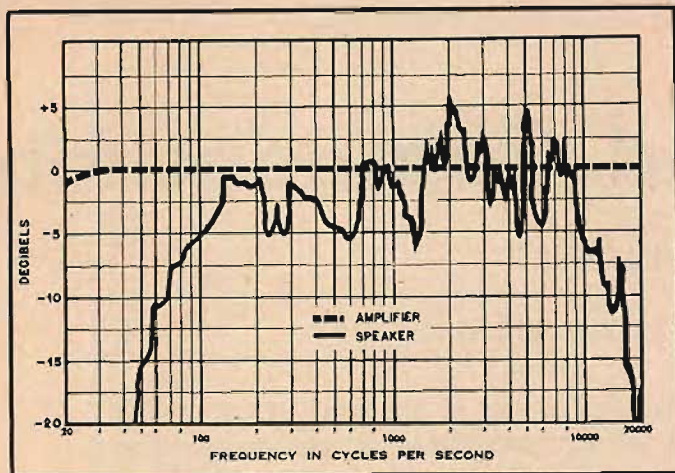

Fig. 10—9. Manufacturer's published on-axis frequency response curve for a high-quality speaker, compared to curve for equivalent-quality amplifier.

weaker, the peaks of the low-frequency signal will be flattened. But the restraint of the suspensions will also limit the excursion of high-frequency vibrations at this moment, and any high-frequency signals will be reproduced with less amplitude during the peaks of the low-frequency signal. Since the peaks are usually flattened during both halves of the cycle, the higher-frequency signal will be amplitude modulated at twice the low-frequency rate. The sidebands, or sum and difference frequencies associated with such modulation, may be expected to be at frequencies equal to that of the higher frequency plus and minus twice the lower frequency.

A second type of intermodulation that occurs in speakers is caused by the Doppler effect. If the cone is stimulated by a low-frequency signal it will at times be approaching and at other times receding from the listener. A high-frequency note superimposed on this slowly oscillating cone will have its pitch, relative to the listener, alternately raised and lowered. This constitutes frequency modulation of the high note by the lower frequency, creating sidebands. The Doppler type of intermodulation will be greatest when a cone with large excursion in the bass is simultaneously used to reproduce the upper treble. The effect, however, is much less serious than that of amplitude modulation, and like the latter it is alleviated by reduced voice-coil excursion.

Speaker systems which assign different portions of the sound-frequency spectrum to separate voice coil and cones discriminate against intermodulation between the distorted signals of each portion.

Frequency Response

The frequency-response curve of a speaker is commonly plotted as sound pressure created by the speaker (in dynes/cm² converted to db) vs. the frequency of a constant-amplitude signal input. It is a very difficult measurement to make, since it involves the acoustical conditions of the space into which the speaker radiates. Speaker frequency-response curves are often more indicative of general trends than exact performance, and can only expect to be dupli-

cated under the same acoustical and electrical conditions that existed when the curve was made.

The frequency response of the best speakers is, as might be expected, far more erratic than the response of electronic amplifiers. Figure 10—9 is the manufacturer's published on-axis frequency-response curve for a typical high-quality speaker, compared to the curve for an equivalent-quality commercial amplifier. It is common practice for speaker frequency response to be described numerically, as the upper and lower frequency limits which the speaker reproduces. Variation within these limits is sometimes as much as plus or minus 10 db or more.

From the point of view of listening, more variation in the tonal color of reproduction may be expected in changing from one make or type of speaker system to another than in changing any of the other audio components. In speakers of the same general price range this is usually not so much a function of the range of frequencies reproduced as it is dependent upon the emphasis and deficiencies at different points on the response curve. The greatest evils of this erratic response are associated with bass resonance, tending to produce boominess, and cone break-up resonances in the low highs, tending to produce shrillness. At its worst, accentuated resonant response creates a situation where signals anywhere near resonance set the speaker to sounding its lone, prolonged note in chorus. Low-fre-

quency signals may become loud thumps or roars whose pitch is difficult to distinguish.

For the speaker to radiate low frequencies efficiently, large masses of air must be moved. The excursion of the cone has a limited range, and so systems designed for good low-frequency performance generally take full advantage of what motion there is by having a large cone area in contact with the air. (Several twelve- or fifteen-inch speakers in parallel may even be used for extreme low-frequency reproduction.) A large cone and extended travel calls for a large voice coil. The voice coil must be long enough to utilize efficiently the entire magnetic field over the extended path, and of sufficient radius for rigid coupling to the cone. Thus the mass of the moving system, when designed from the viewpoint of low-frequency reproduction, will be comparatively high. This is not particularly disadvantageous in the low range.

For high-frequency reproduction it is especially important that the mass of the moving system be low. Small, rigid cones or diaphragms and small, light voice coils are therefore suitable. The excursion of the voice coil will be greatly reduced, because of the inverse relationship between frequency and displacement, and also because of the fact that typical program material has somewhat less energy content in the high-frequency range. The magnetic field can therefore be concentrated over a smaller area, and the required size of the magnet structure is less.

The contradictory requirements of low- and high-frequency reproduction may be compromised in a single speaker unit, or two or three speakers can be used, each designed for optimum performance within its frequency range. Horn loading is often used for the high range because of the reduction in size and weight of the vibrating diaphragm made possible by the more efficient coupling to the air, and because the size of the required horn is conveniently small.

Transient Response

The accuracy with which a speaker can follow sudden starts, stops, and changes of the electrical signal is directly proportional to the damping and to the evenness of the frequency response.

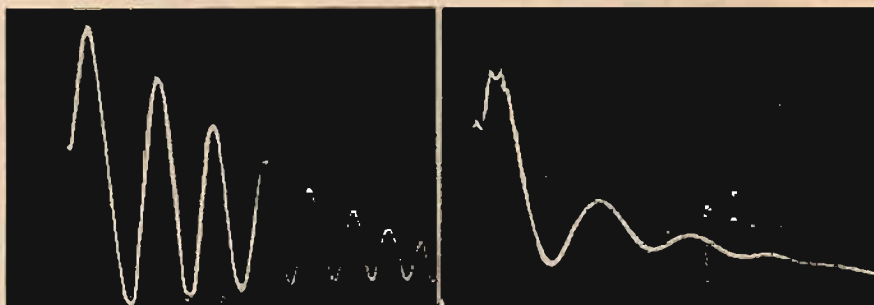

Fig. 10—10 (A) left. Impedance and damping characteristics of undamped speaker (8-inch). The oscillogram represents back e.m.f. produced by the voice coil for instantaneous d.c. stimulation, removed after the first quarter-cycle. (B) right. Same as (A), using edge-damped loudspeaker (12-inch W. E. 728B).

High-frequency transients will, of course, require good high-frequency response, though the transient may be associated with lower frequencies.

A type of transient distortion commonly associated with loudspeakers is hangover, the tendency of the speaker cone to continue to vibrate after the signal has stopped. Hangover is especially likely to occur at a signal frequency to which some part of the mechanical or acoustical system of the speaker and enclosure exhibit sympathetic resonance, and where, as a result, there is a peak in the frequency-response curve. The effect is that of smearing one note onto the next, destroying the clarity and distinctness of the various voices of the program material.

Mechanical, acoustical, and electrical damping all reduce hangover. *Figure 10—10* illustrates the effect of internal speaker damping, achieved by coating the rim suspension with a viscous material. (Mechanical friction changes with velocity, while the viscous friction of the coating tends to be independent of velocity, as pure electrical resistance is independent of current.) Acoustical and electrical damping, upon which most speaker systems primarily rely, involve characteristics of the associated mounting device and amplifier as well as of the speaker itself. Low amplifier output impedance presents a heavy electrical load to the speaker as a generator, quickly bringing unauthorized motion to a halt. High magnetic flux in the voice coil gap, which produces a strong back e.m.f., aids this damping action.

Power Capability

Speakers are rated as to their ability to handle steady power within given distortion percentages, and also as to their power capacity for peaks of short duration. These ratings refer only to input electrical power and not to output acoustical power. If the input power is quite a bit less than the maximum power rating of the speaker, distortion is less, indicating that the use of a speaker system over-rated as to power is advantageous. When several speaker units are connected together in a properly matched multispeaker system the power capacities of each unit are added together for the total power rating.

Speaker Efficiency

The efficiency of a speaker is defined as the output acoustical power divided by the input electrical power. Direct-radiator loudspeakers have efficiencies ranging from about 2 to 7 per cent. For an input of 10 electrical watts a 3-per-cent efficient speaker will radiate 0.3 acoustical watts, while a 6-per-cent efficient speaker will require only 5 watts of electrical input to produce the same acoustical output. It is evident that the power-rating of the speaker must be considered in terms of speaker efficiency; an efficient 10-watt speaker may be able to handle more acoustical power than an inefficient 20-watt unit.

Important determinants of speaker efficiency are the strength of the mag-

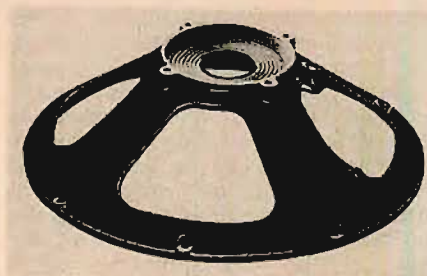

Fig. 10—11. Typical speaker frame and voice-coil suspension. (Courtesy Stephens Mfg. Corp.)

netic field in the gap relative to the mechanical impedance of the moving system, and the length of wire in the voice coil. Speaker efficiency is also highly dependent upon the acoustical coupler—horn couplers may increase efficiency to from 25 to 50 per cent. A common "intuitive" fallacy is the assumption that large speakers require more electrical driving power than small ones for the same acoustical output. The opposite is usually true.

Although speaker efficiency has no direct bearing on performance (especially when internal viscous damping is used) the same construction features that make for high electro-mechanical efficiency create good electrical damping. An efficient speaker system also allows the amplifier to operate at a lower electrical power level for the same sound power. Good mechanico-acoustical efficiency is always advantageous, as a given amount of acoustical energy can be radiated with less voice-coil excursion and therefore less distortion.

Speaker efficiency may be simulated by an apparent loudness created by resonances and distortion in the mid-frequency range.

Radiation Pattern

The radiation pattern of a vibrating loudspeaker cone is determined by the combination of effects of the circular ring elements composing this cone. (See Chapter 3.) A given point in space will



Fig. 10—12. Voice coil and seamless molded cone for use in woofer. (Courtesy Stephens Mfg. Corp.)

be subject to sound radiation from all of the adjacent vibrating ring sources. The additive or cancelling effects of the sound from these sources will be affected not only by the relative position of each ring, but also by the time delay involved in the travel along the cone from the voice coil to the ring element.

The smaller a speaker cone is in relation to the wave length being radiated the less cancellation will result from radiation from different points on the ring elements, and the broader the radiation pattern will be. A large speaker, therefore, has a very directive radiation pattern concentrated around the axis at the high frequencies. The use of small treble speakers, or of separate small cones or diaphragms for treble reproduction, broadens the high-frequency radiation pattern.

High-frequency sound radiated from the center ring elements of the cone travels along two paths, that of the air and that along the sides of the cone itself. The velocity of travel in the paper cone is on the order of two times the velocity in air, and so the phase of sound from the outer rings—relative to that from the center—is affected by both the angle of the cone and the velocity of sound in the particular cone material. Factors which tend to delay radiation from the rim relative to that from the center broaden the radiation pattern. Shallow cones therefore have a broader pattern than deep ones of the same diameter. The flared cone, due to increased rigidity, has a sharper pattern than that of the conical cone. The use of corrugations and of relatively soft cone material, both of which slow up sound propagation, broaden the angle of sound radiation.

Special procedures and devices to broaden high-frequency radiation are often employed. More than one high-frequency speaker may be used, and the units arranged in an arc. A second method of diffusion is to load the high frequency radiator acoustically with a multicellular horn whose individual mouths are fanned out. Whatever method is used, the results are stated most rigorously by a polar graph which relates angle of radiation, frequency, and the sound intensity level.

LOUDSPEAKER CONSTRUCTION

The Speaker Frame

The main requirement of a good speaker frame is rigidity and absence of resonant behavior. To these ends it is heavy and sometimes made of cast metal. A typical commercial speaker frame (with voice coil suspension in place) appears in *Fig. 10—11*.

Rim Suspensions

The most common type of rim suspension is that employing a corrugation in the one-piece cone, as in *Fig. 10—12*. Another effective but expensive method makes use of a separate rim of kidskin, cloth, or soft leather.

Voice-Coil Suspensions

The type of centering suspension in current general use is the corrugated disc illustrated in Fig. 10-11. Formerly the most popular type was the slotted disc, whose appearance gave the voice coil suspension the name of "spider."

Cones

Although cheaper cones are sometimes made by rolling and gluing a paper development of the cone form, the best type is moulded in one unbroken section. (See Fig. 10-12.) A mixture of pulp and water is drawn through a master screen in the shape of the cone, leaving a deposit of pulp which is removed when dry. Hard, springy cone material may create an impression of greater volume due to more accentuated break-up resonances and increased distortion.

Voice Coils

The design of voice coils is concerned with factors of mass, resistance, and efficient and linear use of the narrow air gap.

Low resistance is most important in low-frequency speakers, for reasons of efficiency and electrical damping (the d.c. resistance of the wire appears in series with the source impedance of the amplifier), and copper wire is therefore commonly used. The added mass is not an important consideration in woofers. Speakers which must also reproduce high frequencies, however, require as light a voice coil as possible, and therefore often make use of higher resistance aluminum wire for their voice coils.

The most efficient use of the air gap is made by square wire or by edgewise wound ribbon wire. The dividend of additional use of the available space may

be taken in lower resistance or in reduced thickness for the same resistance.

The excursion of the voice coil must not take it into a region where the magnetic flux through which it moves is reduced. If the voice coil is made longer than the gap length the average field strength affecting the voice coil will be the same, because as one end of the coil moves into a weaker part of the field the other end is moving into a stronger field area. Uniformity of gap flux may also be maintained by a system which makes the voice coil shorter than the length of gap. If the excursions of the voice coil are small it will remain within the strong uniform section of the field at all times.

The system which uses the smaller voice coil is more appropriate for high-frequency reproduction, and the one with the larger voice coil is suited for low frequencies. These two systems, contradictory to one another in a speaker with a single voice coil, may both be used in a dual or multiple unit.

Multispeaker Circuits

Speakers may be connected in series, parallel, or series-parallel, and the total nominal impedance is calculated by the same method that is used for simple resistive networks. For example, two 8-ohm speakers in series must be fed from the 16-ohm amplifier tap, and a second such 16-ohm speaker combination, connected in parallel with the first, brings the total impedance down to 8 ohms again.

Where remote speakers are used it is occasionally desirable to furnish separate volume controls for the individual speakers. This may be accomplished by an L-type level control, illustrated in

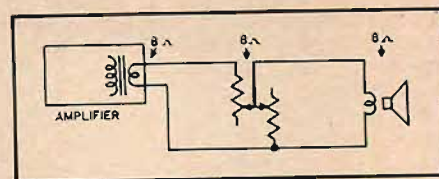

Fig. 10-13. L-type level control for attenuating volume at speaker.

Fig. 10-13, in which the two sections are tapered in such a way that the impedance presented to the speaker source remains relatively constant. Attenuation is accomplished by wasting power in the control, and its power rating should be as great as that of the amplifier. A simple heavy-duty potentiometer, with a resistance several times the nominal impedance of the speaker, may also be used, but at the expense of impedance mismatching.

Bass-treble combinations, poetically referred to as "woofer-tweeter" systems, require some sort of dividing network to separate the different portions of the frequency spectrum. The simplest of these networks is shown at (A) in Fig. 10-14. The tweeter is protected from damage by low-frequency signals, but treble signals are fed to both woofer and tweeter. Cone break-up and intermodulation in the woofer is thus discouraged only to the extent that part of the treble signal is by-passed through the tweeter.

The more complicated but more effective inductance-capacitance networks of (B) and (C) in Fig. 10-14 produce a much greater separation between bass and treble. Here a roll-off is introduced at the top of the woofer range and at the bottom of the tweeter range, at the rate of 6 db per octave (in terms of power) for the single capacitor-inductor network, and 12 db per octave for the double element network. The crossover frequency is that frequency at which the value of the various elements, including the speakers themselves, cause the input power to divide equally between the two speakers. Since the power to each speaker is halved at this point, the attenuation in both treble and woofer circuits is 3 db.

The equations for calculating the values of L and C for given crossover frequencies appear below the diagrams. The equation for the R-C network is a mathematical statement of the fact that the impedance of the capacitor is equal to that of the speaker at crossover. The impedance of the combination is treated as the impedance of the woofer.

The equations for the single element L-C network are derived from expressions which state that the impedance of the capacitor is equal to that of the tweeter at crossover, and that the impedance of the inductor is equal to that of the woofer at crossover:

$$\frac{1}{2\pi f C} = Z_{\text{tweeter}} \quad 2\pi f L = Z_{\text{woofer}}$$

The impedance of the combination is treated as the impedance of one speaker, if woofer and tweeter have the same value, or as the average between woofer and tweeter impedances if these differ.

(Continued on page 63)

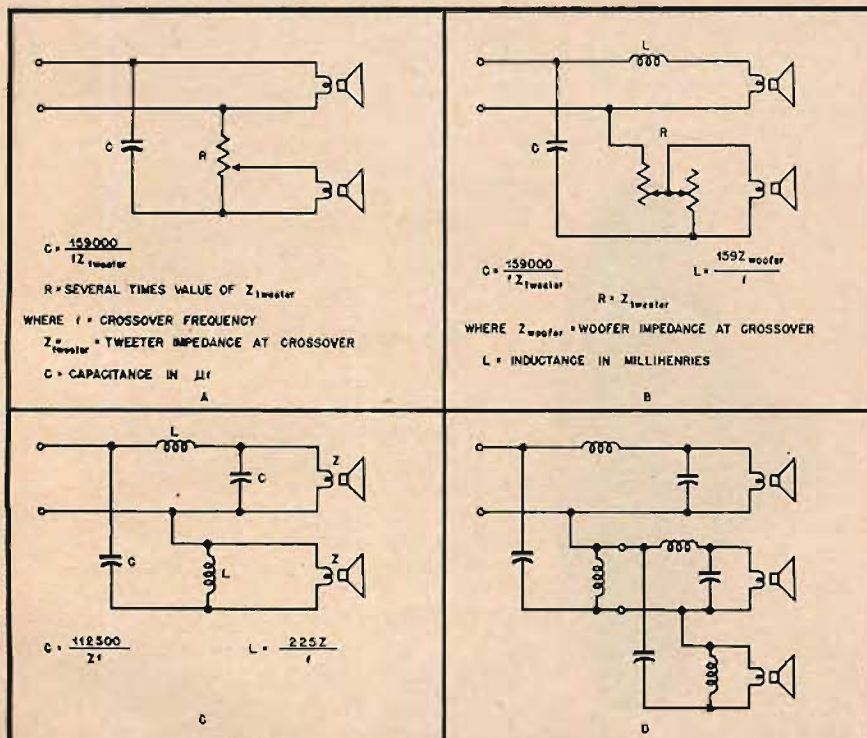

Fig. 10-14. Dividing networks for two- and three-way speaker systems.

IT MAKES Good Sound... AND Good Sense, too

You buy good records so you can enjoy good sound. You fondle these records, and handle them ever so gently, because you know that once the surfaces are marred, the quality will be gone to you forever.

You must realize then, that your record changer becomes an all-important factor in the matter of record quality. It must treat with your records even more gently than you could yourself, and it must contribute nothing which might impair the quality of the sound. Its tone arm must track at

light stylus pressures and with free lateral compliance to protect the groove walls from wear.

Its speed must be constant for correctness of pitch, and to avoid 'wow'. It must be free from rumble, and from audible resonances. It must retain and reproduce all of the quality in the record, protect it for future plays, and it must contribute no distortions of its own.

In the light of these requirements, examine the features of the COLLARO, and see if they don't meet all the exacting specifications that make this

The High Fidelity Record Changer for High Fidelity Reproduction

Model 3/522—Fully Automatic Intermix Model
List Price.....\$65.00
Model 3/521—Fully Automatic Non-Intermix Model
List Price.....\$54.50



ONLY THE Collaro INTERMIX 3/522 HAS ALL THESE HIGH FIDELITY FEATURES:

- | | |
|---|--|
| Intermixes 10 and 12 inch Records at All Speeds. | Stylus Pressure Adjustment—Tracks at as little as 3 grams. |
| Steady, Constant Speeds—No Rumble or Wow. | Absolutely Jam-proof Operation. |
| Weighted, Rubber-matted, Rim-driven Turntable. | Ball-bearing Mounted Turntable and Tone Arm. |
| Four Pole Motor with Self-aligning Oilite Bearings. | Automatic Shut-off after Last Record. |
| No Hum Pickup. | Tone Arm Clamp for Portable Applications. |
| Molded Rubber Drives—No Belts to Slip or Replace. | Base Dimensions: 14 3/4" x 12 1/4" |
| Automatic Muting Switch. | Depth Below Base: 2 1/2" |

Complete Service and Replacement Facilities Maintained for your Convenience.



Record Player
3-Speed Model 3/514
List Price \$33.60

Model 3/522

Collaro

Fully Automatic INTERMIX

3-SPEED RECORD CHANGER

FOR 7, 10, AND 12 INCH RECORDS

At Leading Distributors, or Write for Literature.

ROCKBAR CORPORATION
211 EAST 37th STREET • NEW YORK 16, N. Y.

Feedback and Loudspeaker Damping

JOHN A. MULVEY*

The author proposes a solution to the problem of obtaining a feedback signal which is equivalent to the movement-generated e.m.f. of a speaker voice coil.

THE RELATIVELY RECENT articles on positive current feedback used to improve loudspeaker damping have, to this reader, been most engrossing. In spite of studies made of the articles and arguments on this subject he has, until quite recently, felt much in the dark when it came to feeling able to claim much of an opinion of his own on the relative merits of such a system. It seemed that such a subject should be resolved into simpler contradictions than any presented so far in order to make one feel he has made a wise choice of one opinion or another.

This need has led to this attempt to reduce the subject into simpler terms by digging into the fundamental aspects of the subject. The author feels that the analysis which is here presented can show some things not apparent in foregoing discussions, and finally may offer amends to those who think they disagree, as well as to make some proposals that the engineers more actively engaged may find promising.

According to Lenz's law, the voltage induced in a coil due to its passage through a magnetic field is always of a polarity such as to produce a current which would oppose the motion. In other words, an e.m.f. due to coil motion in a field tends to stop the motion. This presumes, however, a closed circuit at the coil ends, for this e.m.f. can only act if it can act to cause or influence current through the coil. When such a coil is a voice-coil there is always such a closed circuit existing. The path is around through the windings of the output transformer secondary. This closed

circuit can nearly constitute a short-circuit for the coil, permitting much current to flow with just a small movement-generated coil e.m.f. The more current which flows as a result of this e.m.f. the better will be the dynamic braking of the movement, that is, the quicker will the movement cease. But even with a short-circuited coil moving in a magnetic field the current through it is definitely limited. It is limited by the resistance of the coil itself. A method to overcome this limitation and further enhance the dynamic braking action is most desirable. Such a method, to be successful, would have to permit a greater current flow than a short-circuited arrangement would allow. At first any such method might seem impossible for it would seem that nothing could allow more current than a short circuit. But on second thought it should be realized that a second source of voltage in series with the voice-coil could be provided to increase the current above what simply a short-circuited voice-coil would allow. This suggests a circuit employing as a second source of voltage one greater but proportional to the movement-generated e.m.f. and in phase with it having also a lower source impedance, as in Fig. 1. So far we have spoken only of movement-generated voltages. In the case of a loudspeaker, where it is voice-coil current which causes the motion in the first place, movement-generated e.m.f. is still present and acts to oppose the voice-coil current. In this way it influences the actual current and always acts to stop the motion the same as if some physical force was causing the motion. However, generally under these circumstances the movement-generated

e.m.f. itself causes no current to flow. It only acts to influence the voice-coil current which is moving the voice-coil, by subtracting from the voltage causing it. This is true all the time except during "hangover" periods. During these periods the physical forces of inertia or suspension compliance cause the movement-generated e.m.f. to exceed the driving voltage and so cause its own reverse current to flow. Notice here that this is a "reverse current," one of opposite polarity to that originally causing the motion. This reverse current then will act on its own and damp the motion and so limit the hangover effect. Since positive feedback—whether voltage feedback or current feedback—tends to increase the output signal, at this time if positive current feedback were introduced it would increase the current limiting the hangover effect so as to squelch it quicker.

From this the main point may be apparent but it is simply that positive current feedback does not oppose voice-coil movement until the movement-generated e.m.f. exceeds the driving voltage and produces a reverse current. At this time there is a phase reversal which, in effect, changes positive feedback to negative feedback. If this point is not made clear there is yet much room for controversy. It should be noted that the comparison was said to be only an effect similar to inverse feedback. The e.m.f. generated by a coil moving in a magnetic field is inverse feedback. Any voltage which aids that voltage is, with regards to it, a positive feedback voltage, but with regards to the total effect it is a negative feedback voltage. There is a good comparison in the rather familiar circuit of an amplifier using a positive feedback loop connected to the cathode end of an unbypassed cathode resistor. The feedback voltage is definitely positive with respect to the signal voltage appearing across the cathode resistor, but just as definitely negative with respect to the over-all effect.

But the story doesn't end here. To some, the advantage of improved damping during hangover periods will be thought to be too highly paid for by the inherent disadvantages existing the rest of the time, since the rest of the time the in-phase feedback is regenerative.

[Continued on page 62]

* 3080 S. W. Spring Garden Road, Portland 19, Ore.

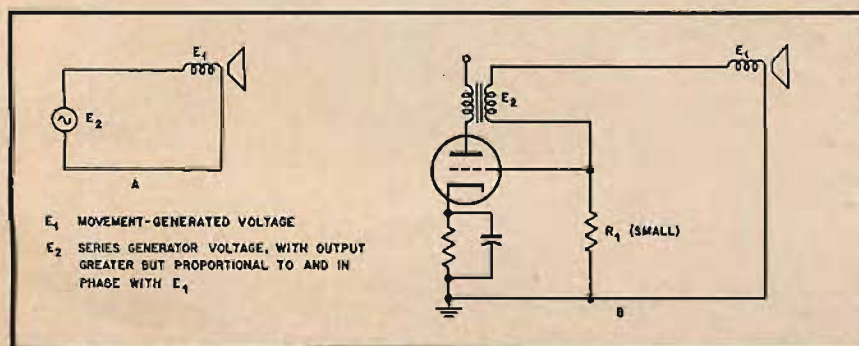

Fig. 1. (A) Theoretical circuit, and (B) practical circuit of feedback obtained from current in a voice-coil.

How Come?

PILOT

*runs an ad for Hi-Fidelity
Pilotuners and Amplifiers
without listing features!*

Yes, — listing of features on hi-fi equipment IS important. But — it would take a good four pages of fine type to list all the outstanding features of these superb PILOT instruments.

So may we suggest, — send in the coupon below for our beautifully illustrated, completely descriptive color folder. Read it in comfort, at your leisure. Compare PILOTUNERS and AMPLIFIERS, feature for feature, with any others on the market. See PILOT's superiority for yourself. You'll be glad you did!



PILOTUNER AF-821 A
\$99.95



PILOTUNER AF-723
\$79.95



PILOTONE AMPLIFIER AA-901
\$99.50



PILOTONE AMPLIFIER AA-902
\$46.95



PRE-AMPLIFIER PA-912
\$49.95

Write in today
PILOT RADIO CORP.
 Dept. AE-3, 37-06 36th St., Long Island City, N. Y.
 Please send me your free folder describing
 PILOTUNERS and Amplifiers.

NAME.....
 ADDRESS.....
 CITY.....STATE.....

FAMOUS PILOT "FIRST!"

1927...
First home
short-wave receiver



FAMOUS PILOT "FIRST!"

1937...
First truly portable
battery receiver



FAMOUS PILOT "FIRST!"

1928... First
Government licensed
TV station, W2XCL



PILOT RADIO CORP., "The Standard of Excellence," LONG ISLAND CITY, N. Y.

8 db more

with no increase in noise

It's the new

REG. U.S. PAT. OFF.
SCOTCH
BRAND

Magnetic Tape

High  *Output*
TRADE MARK

- **NEW, IMPROVED COATING!**
"Scotch" Brand *High-Output* Magnetic Tape is coated with a revolutionary new magnetic material that offers unparalleled sensitivity.
- **UNEQUALLED OUTPUT LEVEL!**
Actually produces 8 db and up to 12 db more output than any conventional magnetic tape with no increase in harmonic distortion.
- **SPECIAL NEW COLOR!**
This new tape is colored a distinctive grey-green for easy recognition.

"Scotch" Brand No. 120A *High-Output* Magnetic Tape gives the recording engineer a new and potent tool for the production of truly high fidelity recordings. The 8 db minimum added output of *High-Output* Magnetic Tape increases significantly the available signal to noise ratio, making possible for the first time low background noise recordings of orchestral works having wide dynamic range. Besides offering unparalleled output at all audio frequencies (see graphs), this new tape retains all the physical and magnetic properties that have made "Scotch" Brand No. 111A the recognized standard of the recording industry: high tensile strength, freedom from elongation, stable anchorage, low noise level, excellent uniformity, ease of eraseability.

Freedom from squealing, cupping and curling is assured thanks to exclusive "Dry Lubrication" feature. *High-Output* tape is guaranteed 100% splice-free (up to 2400-foot reels)

The term "SCOTCH" and the plaid design are registered trademarks for Sound Recording Tape made in U.S.A. by MINNESOTA MINING & MFG. CO., St. Paul 6, Minn.—also makers of "Scotch" Brand Pressure-Sensitive Tapes, "Underseal" Rubberized Coating, "Scotchlite" Reflective Sheeting, "Safety-Walk" Non-slip Surfacing, "3M" Abrasives, "3M" Adhesives. General Export: 122 E. 42nd St., New York 17, N. Y. In Canada: London, Ont., Can.



output

or harmonic distortion!

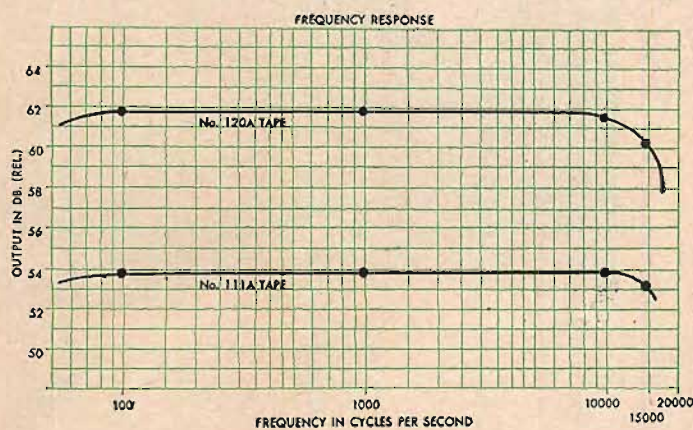

The frequency response characteristics of both No. 120A and No. 111A tapes are virtually identical at 15 ips tape speed. These curves were made with each tape set at optimum bias and an input level 15 db below 1% 3rd harmonic distortion.

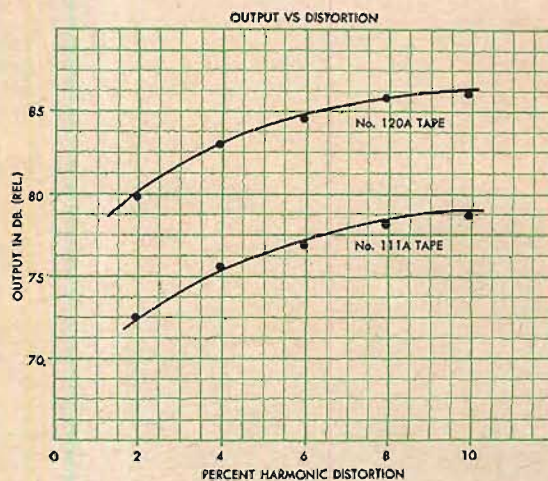

This graph shows the 8 db increase in output of *High-Output* Magnetic Tape No. 120A over No. 111A at any given distortion level. When compared with other brands of magnetic tape, the difference in output is as much as 12 db!

FREE BOOKLET tells the full story of the tremendous technical possibilities of *High-Output* Magnetic Tape. Address Dept. AE44, Minnesota Mining & Mfg. Co., St. Paul 6, Minn., and a copy will be sent promptly.

Available now on: 120-AP 1200-foot Professional Reel
120-A 2400-foot on NARTB hub or reel

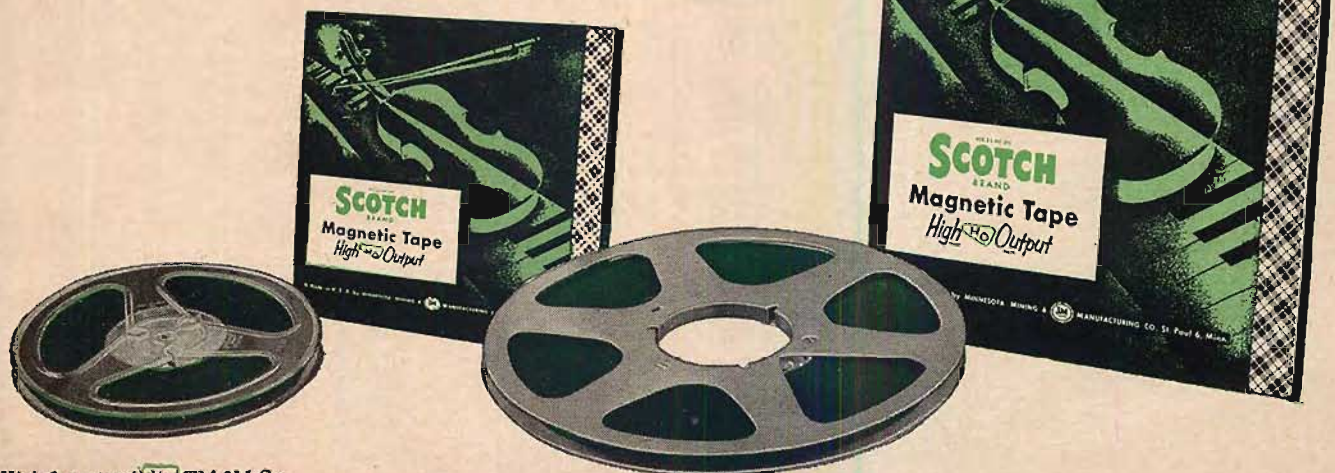

High-Output and TM 3M Co.

Canadian House of Commons Sound Installation by Tannoy

Low-level sound system provides exceptionally good distribution of sound to all members with a minimum of un-naturalness often encountered in high-level systems.

IN RECENT YEARS there has been noticeable a growing tendency toward the use of so-called "low-level" sound reinforcement systems, in which a large number of speakers are situated strategically throughout the area to be covered, and operated at moderate volume, as opposed to the "high-level" system in which all sound emanates from a single speaker or group of speakers more-or-less centrally located. An outstanding example of this new trend in the United States is the sound system installed in New York City's new Port of Authority bus terminal—which



Fig. 1. Control panel and main equipment of Tannoy low-level sound reinforcement system in Canadian House of Commons.

Fig. 2. Guy R. Fountain, founder and chairman of Tannoy, Ltd., discusses remote control panel with son Michael Fountain

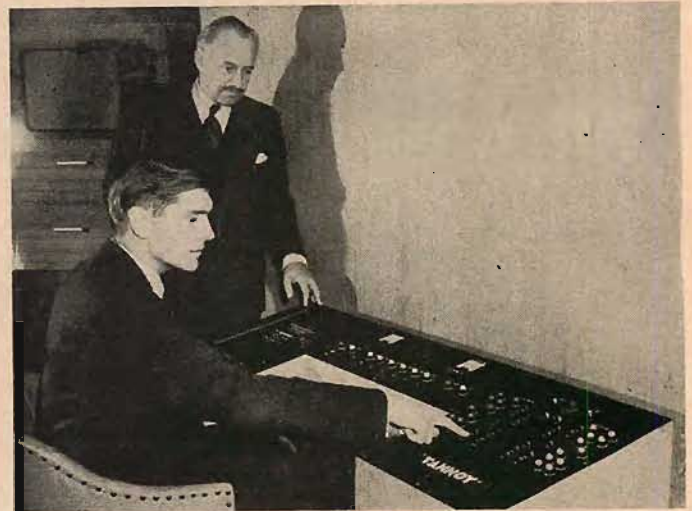

will be described in its entirety in a future issue of *Æ*.

Also closely adhering to this advanced approach toward realism in sound reinforcement is a system recently designed, manufactured, and installed in the Canadian House of Commons by Tannoy Products, Ltd., London, England. Similar in principle to the systems Tannoy created for the Houses of Parliament in London, the equipment permits any member of the House to speak and be heard by all other members as though he was but a foot or so away, without any intervening disturbance.

This effect is achieved by dividing the chamber into 23 separate zones, with each zone having its individual micro-

phone, as well as control over reproducers in the immediate vicinity. Over 500 high-quality miniature speakers are installed throughout the chamber.

Those for the members are housed in attractive oak recesses on the individual desks, while the galleries are supplied with small metal-enclosed units mounted between theatre-type seats.

The entire system is controlled by a single operator seated at a master control desk so situated that the entire House may be observed. Upon observing a member indicate a desire to speak, the operator has only to press a key controlling the zone in which the member is located. This action connects the desired microphone to the system, and at the same time reduces the output level of the speakers in the immediate vicinity to avoid feedback howl. Volume output of the remaining speakers throughout the chamber is unaffected.

When another member of the House rises to speak, the operator depresses a switch button controlling this new zone, and thereby cancels out all of the previous connections while simultaneously re-setting for the new zone of transmission.

Main equipment for the system is housed in a special room adjacent to the assembly chamber, with all functions operated by remote control. In the event of equipment failure, provision is made for automatic substitution of any unit, so that operation remains continuous and uninterrupted.

In the paragraphs which follow are described some of the installation's tech-

[Continued on page 59]

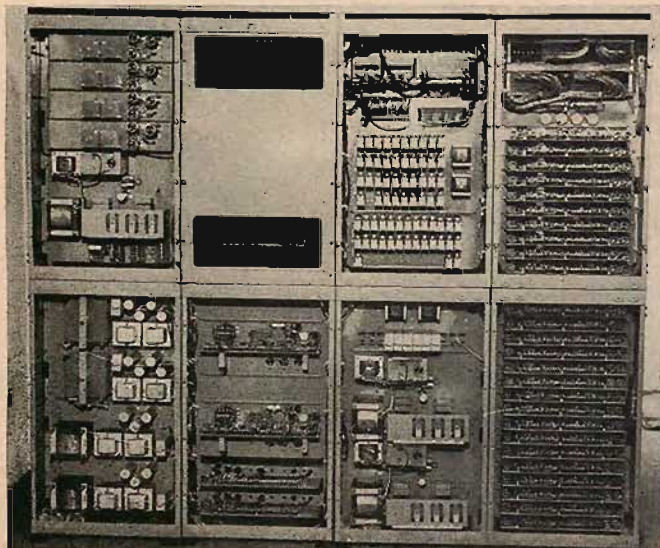
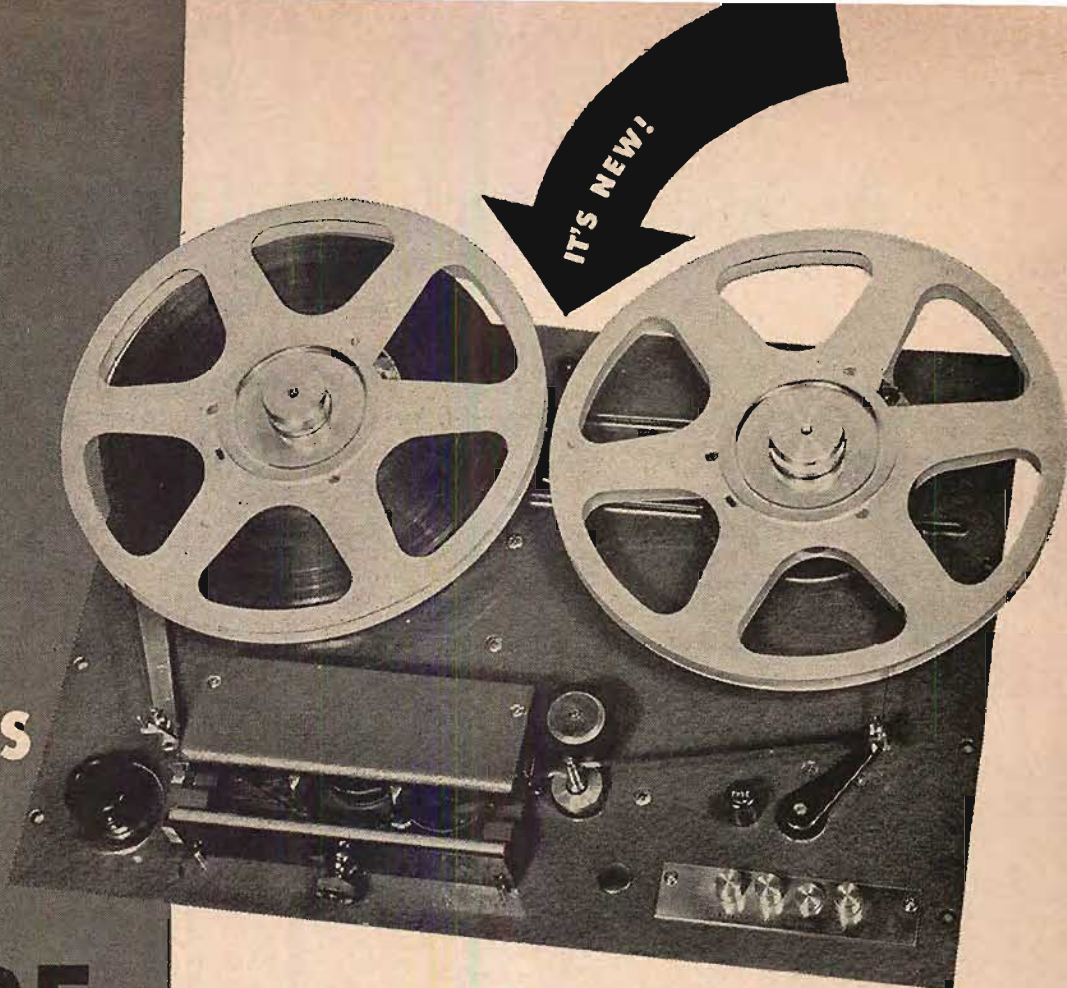

Fig. 3. Rear view of low-gain amplifying equipment in Canadian House of Commons.

puts
other
tape
recorders
in the

SHADE... the PRESTO RC-11



PRESTO introduces a precision-engineered tape recorder with a radical new type of construction!

Featuring a self-contained capstan drive unit, the PRESTO RC-11 provides durability, flexibility and rapid maintenance heretofore unheard of in tape equipment. Motor, fly wheel, capstan shaft, pressure pulley and solenoid are all pre-mounted on a cast aluminum sub-assembly . . . a complete working unit quickly removable for service or replacement.

A heavy, ribbed, cast aluminum panel designed for rack or case mounting supports all other components. Overall durable construction gives additional reinforcement and protection during shipping and adds years to the life of the machine.

In terms of performance and operational ease, the RC-11 also steps out front. This new recorder, with complete push button operation, automatic microswitch in case of tape breakage and a reel capacity of 10½ inches, is an engineer's delight.

The combination of advanced design and engineering in the RC-11 puts ordinary tape recorders in the shade . . . makes this instrument an *investment*, not an expenditure. Ask your PRESTO distributor for full information on this important development in tape recorder design . . . the *all new* RC-11.

The "unitized" construction of the Presto RC-11

. . . allows a complete flexibility in the manufacture of various types of instruments. By the simple rearrangement of components the RC-11 becomes a high fidelity recorder, a dual track, bi-directional recorder or reproducer or a long-playing reproducer with automatic tape reversal.

PRESTO RECORDING CORPORATION
PARAMUS, NEW JERSEY

Export Division:
Canadian Division:

25 Warren Street, New York 7, N. Y.
Walter P. Downs, Ltd., Dominion Square Bldg., Montreal

WORLD'S LARGEST MANUFACTURER OF PRECISION RECORDING EQUIPMENT AND DISCS

A Note on Volume Controls

CHARLES P. BOEGLI*

The author shows that it is not always satisfactory to place a high-resistance potentiometer just anywhere in an amplifier circuit if specified performance is to be obtained.

An audio amplifier is generally made up of several stages arranged in cascade so that the input signal is fed through one after the other, being amplified on the way, finally appearing as an output voltage at the loudspeaker terminals. Somewhere in this unit, it is usually necessary to provide a control over the gain of the entire amplifier, so that input signals of the given voltages can be made to yield output voltages of the desired magnitudes. This is most often accomplished in high-impedance locations, by means of a simple potentiometer; the output from the plate of one stage is connected to the top of the potentiometer, the other end of which is grounded, and the grid of the following stage is fed from the slider. The purpose of this note is to mention some considerations that appear to be generally overlooked in providing a "volume" control of this type.

Since hum and noise are most apt to assume noticeable proportions in the input stages of the amplifier where signal voltages are quite low, the volume control should generally be located after the first few stages. In this manner, the signal is maintained at the maximum value compared to the noise through these critical stages and becomes attenuated only when it has reached a value quite large in comparison to noise voltages. On the other hand, should the volume control be located too near the output tubes, the possibility is increased that the signal will attain sufficient magnitude before reaching the control to cause unnecessary distortion in previous stages. Placement of the control at a point where the maximum signal level is from 2 to 4 volts will usually lead to a fairly satisfactory design, suffering neither from distortion nor excessive noise. It goes without saying that the control must not be placed inside the feedback loop, if any are employed in the circuit.

The only disadvantage to locating the control otherwise than at the input to

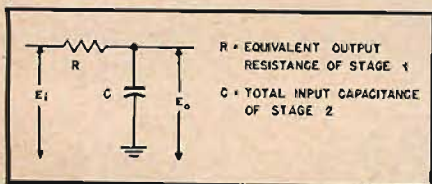

Fig. 1. Low-pass filter existing between two stages of an audio amplifier.

* Cincinnati Research Company, 6431 Montgomery Road, Cincinnati 13, Ohio.

the amplifier is that the voltages of the signal sources used with the amplifier must—to a degree, at least—be controlled. Thus, with the volume control at the input we need concern ourselves only with the minimum input required for full output, but if the control is situated later, the *maximum* input also becomes important. An input stage handling a minimum of 0.5 volt may well be designed to carry a maximum of the order of 1.5 volts; obviously, if a tuner supplying 6 volts is connected to such an input, overloading will result. The best arrangement would therefore seem to be one in which the volume control is placed near enough to the output stages to maximize the signal-to-noise ratio and close enough to the input stages to prevent serious distortion, and in which individual pads are used on the various signal sources to bring their outputs to approximately a uniform level, preferably slightly over the minimum required to drive the amplifier fully.

Effect on High-Frequency Response

The high-frequency response of an amplifier (utilizing a good output transformer) is largely determined by the cutoff frequencies of the series of low-pass filters incorporated into it and made up of the output resistance of one stage and the input capacitance of the next, as indicated in Fig. 1. When one stage feeds directly into the next the problem of attaining good high-frequency response is fairly well defined, and the solution consists simply in keeping the output resistance of each stage as low as possible. Low- μ triodes with plate resistances of the order of 10,000 ohms are excellent in this respect and may be used with plate-load resistances of almost any size without adversely affecting high-frequency response. With high- μ triodes and pentodes the plate-load resistors, as well as the grid resistors of the following stages, must be kept small in order to realize good high-frequency response. But what occurs upon the introduction of a volume control?

Obviously, when the slider is at the top of the control, the situation is the same as if no control were present. When the slider is near the bottom, also, the following stage is fed from a very low impedance so that the high-frequency response is even better than when the slider is at the top. In less extreme positions, however, if the volume control resistance is quite high, there

may be a substantial loss of high frequencies—and it is precisely these positions that are most important.

Reference to Fig. 2 will make this clear. R_2 is the output resistance of the preceding stage and R_1 is the volume-control resistance. The symbol a represents the position of the slider and measures the fraction of the voltage appearing at the top of the control that is applied to the following grid. Now R_0 , the resistance into which the following grid looks is aR_1 in parallel with $R_2 + (1-a)R_1$, which is found to be

$$R_0 = \frac{aR_1R_2 + (a-a^2)R_1^2}{R_2 + R_1} \quad (1)$$

We are interested in the manner in which R_0 varies with a . Hence, differentiation of the above expression with respect to a yields

$$\frac{dR_0}{da} = \frac{R_1R_2 + R_1^2 - 2aR_1^2}{R_2 + R_1} \quad (2)$$

The resistance R_0 is a maximum at the value of a found by setting the right side of Eq. (2) equal to zero and solving for a :

$$R_1R_2 + R_1^2 - 2aR_1^2 = 0$$

$$a = \frac{R_2 + R_1}{2R_1} \quad (3)$$

When a assumes this value, the maximum output resistance

$$R_{0m} = \frac{R_2 + R_1}{4} \quad (4)$$

For example, if we had a low- μ triode stage with an output resistance of 10,000 ohms connected to the top of a 1-meg. volume control, there would be some point at which the next stage would look back into as much as

$$\frac{10,000 + 1,000,000}{4} = 252,500 \text{ ohms}$$

and if the input capacitance of the following stage were sufficient to cause a

[Continued on page 60]

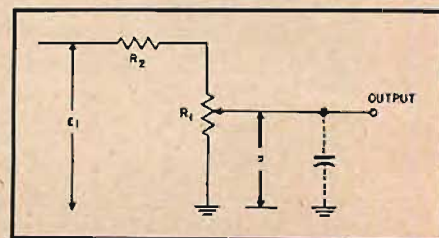

Fig. 2. Equivalent circuit of a stage followed by a volume control.



**Of course he's using Soundcraft Recording Tape
...it's **micro-polished*****

Perfect reproduction — that's the reason why more and more engineers today demand Soundcraft Professional Recording Tape.

Soundcraft is the only professional tape that is Micro-Polished. The only tape that is polished, buffed and re-polished by a special process to produce a surface that is mirror-smooth, completely free of even the most minute irregularity. The results of Micro-Polishing are apparent to any sound engineer:

- Lower distortion
- Uniformity of output
- Improved high frequency response
- Better head contact
- Less friction, longer head life

Soundcraft Professional Recording Tape incorporates all the features developed by Soundcraft research engineers during the last two years: **pre-coating** to insure better adhesion, prevent curling and cupping — **dry lubrication** to eliminate squeals. The 7" reel has the 2 $\frac{3}{4}$ " hub, eliminating torque problems and resulting in better timing. All this, plus a splice-free guarantee on all 1200' and 2500' reels.

Why settle for less than the best? Next time, insist on Soundcraft Professional Recording Tape. It's Micro-Polished!



REEVES

SOUNDCRAFT CORP.

* PATENT APPLIED FOR

WRITE FOR FREE INFORMATION—DEPT. B

10 East 52nd Street, N. Y. 22, N. Y.

Equipment Report

THE COLLARO 3RC522 RECORD CHANGER

A review of the details of construction and operation of a modern automatic record changer relatively new to the American market.

EVERY TIME this reviewer sees a new type of automatic record changer, his first reaction is that it couldn't possibly work—yet all of them seem to, and quite efficiently. The Collaro—one of the latest makes to reach the U. S. market in any quantity—is no exception. It is available in four different types, and can be supplied for any frequency from 40 to 60 cps. and for a.c. voltages of 100/125 or 200/250. The accommodation for different frequencies is accomplished by a change of motor pulley. Both mixing and non-mixing types in both one- and three-speed versions are available.

The principal questions concerning the performance of automatic record changers are those about rumble, hum pickup, and speed constancy. The secondary questions about simplicity of operation, minimization of roughness in handling records, ease of changing from one type of record to another or from one speed to another, and other considerations are also worthy of attention. Since the changers are equipped with adapters to permit the use of any of the standard phono pickups, no problem is encountered in this direction, since reasonable flexibility of adjustment is provided to permit accommodation to various weights of pickup.

Test Observations

The instrument submitted for test was a three-speed "mixing" model designed for 33 1/3, 45, and 78 r.p.m. and for 7-, 10-, and 12-inch records. The intermixing feature applies only to the latter sizes, since a separate lever located at the right side of the top panel must be actuated to cause the pickup to set down at the 7-inch diameter. With the intermixing models, the pickup set-down position is determined by the size of the record just lowered to the turntable—the 12-inch discs tripping a lever at the

rear as they drop into the playing position. The operating control knob is also located at the right side of the panel, and is used for starting, stopping, and rejecting. As soon as the last record on the stack is played, the pickup arm lifts and motor power is cut off automatically. If it is desired to replay the last record, the operating knob is moved to START and the changer completes its cycle, plays the record, and again stops.

Record handling is quite gentle, with the drop being occasioned by a small lever within the center spindle. When all of the records in a stack have been played, they may be removed by swinging the balancing arm out of engagement with the spindle and simply lifting them up and off. Cycling time is approximately 12 seconds for LP's, 10 for 45's and 5 for 78's. The cycling action is completely disengaged from the mechanism except during a change cycle, being actuated by a rubber pulley which is moved so as to contact the inside rim of the turntable, from which it receives its power. All of the rubber-tired pulleys in the drive mechanism are automatically retracted when the changer is switched off, thus avoiding the tendency to form flat spots which might cause wow or flutter. The pickup leads are shorted by a muting switch during the change cycle or when the unit is switched off.

For users who employ different pickup cartridges for microgroove and standard records, a small lever on the pickup arm changes the needle force—allowing heavier force for the 78's and reducing it for the LP's and 45's. Further adjustment inside the arm permits setting the force to the optimum value for each pickup. The pickup arm may be clamped to the rest when the instrument is being moved—thus making it acceptable for portable use without any

additional modifications. The instructions specify that the arm should be clamped whenever the cartridge is being changed, in order to eliminate the possibility of damage to the arm mechanism.

Once the change cycle is completed, the pickup arm may be operated by hand as freely as on a single-play turntable, except for the inner half-inch of playing surface. If the arm should happen to be moved sideways too far by hand, no damage is incurred because of the manner in which the arm is attached to the mechanism—a pair of spring-loaded rollers engage slots in the actuating lever. When the arm is moved too far, the rollers simply slip out of the slots. They can be restored to normal position, however, by moving the arm inward to the spindle, then back to the arm rest.

Mechanically, the changer is well constructed, easy of access, and relatively simple. The motor is equipped with self-oiling bearings, and is built with die-cast end bells which minimize acoustic noise. The instructions accompanying the unit are sufficiently lucid that any reasonably handy user could effect any necessary adjustments. The minimum size of the mounting board is 12½ by 15 inches, not less than ½ inch in thickness. Minimum clearances above and below the board are 4½ and 2½ inches, respectively. Six springs are used on the three mounting bolts—the lighter ones being placed below the board. When transporting the unit, it is recommended that the screws be tightened to prevent damage.

The turntable rides on a ball thrust bearing, and is exceptionally steady. Tests with piano recordings at all three speeds showed no noticeable wow, though no absolute measurements were made. Tests with recordings of solo violin, string groups, and soprano vocalists—considered best material to check flutter—indicated "clear as a bell" performance. Warped records played satisfactorily when placed directly on the rubber covered turntable, but not when combined with other records.

For 45's, die-cut fibre spiders are used, being inserted in the large center hole and left in place permanently. Small extrusions on the spiders provide engagement between discs so that there is no slipping throughout an entire stack of records.

Hum pickup was no greater than with the single-play broadcast-type turntable with which the unit was compared, and while the rumble was audibly satisfactory, it measured 4 db higher than with the comparison turntable. These tests covered a total of about 30 hours of normal playing with all three types of records, and without any failures of operation whatever during that period.





America's Finest

HOME MUSIC AMPLIFIERS



The star of these amazing amplifiers is the Classic 25, fidelity sans pareil, 25 watt with complete remote control.

8 COMPLETELY NEW HOME MUSIC MODELS *4 Feature Remote Control*

There is absolutely nothing to compare with the brilliant, full-bodied, "live" tones of the Classic 25 by Newcomb, its unique "Audi-balance" feature or its beautifully finished complete remote control with the "Adjusta-panel" to extend shafts for easy cabinet mounting. All eight models have this exclusive "Adjusta-panel" feature. A crossover selector simplifies attainment of correct playback response, includes foreign and domestic frequencies as well as the A.E.S. recommended curve. The A.E.S. standard is provided on all eight models. "Fletcher-Munson" compensated volume control maintains perfect aural balance on all eight models. The tremendous range of the Classic 25 power amplifier extends from below 10 to over 100,000 cycles, a by product of perfection through-out the audible range from 20 to 20,000 cycles. Response is flat from below 10 to above 30,000. All eight models feature frequency response ± 1 db from 20 through 20,000 cycles or better. All models but one include a built in, compensated pre-amplifier to meet needs of wide variety of magnetic and crystal pickups.

Substantial installation savings

Exclusive Newcomb features make all eight of these new amplifiers easier to install and make possible savings in cabinetry and labor often greater than the cost of the amplifier itself. Investigate all the many advantages of these superb new custom home amplifiers. Send for detailed information and installation diagrams in catalog of all 8 models priced from \$39.50 to \$269.50 audiophile net.



Newcomb
15 years of quality leadership

Dept. T, 6824 Lexington Avenue • Hollywood 38, California

EXCLUSIVE
"ADJUSTA-PANEL"
ON EVERY MODEL

CROSSOVER CONTROLS

A. E. S.
ON EVERY MODEL

"FLETCHER-MUNSON"
COMPENSATED BASS & TREBLE
ON EVERY MODEL

± 1 DB 20-20,000
OR BETTER

COMPENSATED
BUILT IN PRE-AMP

The Best British Records of 1952

A compilation of the author's preferred selections from the catalogs of English record manufacturers, chosen for good performance and technical excellence.

H. A. HARTLEY*

FOR THIS YEAR'S review your correspondent has had a very tough assignment.

The shortness of the list is no indication of the amount of work involved, for indeed the work has been heavier than ever. The list is short because it seems the time has come to delete all 78's unless of exceptional interest or merit. This year only a few appear; next year there will be none. This doesn't mean that the 78 is dead in Britain, but it is fighting a losing battle.

The year was notable for the fact that in October the E.M.I. combine entered the LP market, with the Decca Company two years ahead. In the six months' period between E.M.I.'s announcement and their actual production of LP's, the Decca Company really got busy, and new recordings and dubbings of old poured off the presses. The amount of new stuff made available to us was truly fantastic, and made your reviewer's life far from easy. As might be expected, this colossal burst of activity was not without effect on the records themselves, and a large proportion did not come up to the standards laid down for these annual lists. Whether these faults were due to hurried recording or hurried processing is not known, but that the faults are there is undeniable. On the other hand the year produced some notable discs, and the characteristic firm string tone, which is not favored by many of us, seems to be on the wane. Hurried production resulted in a large proportion of records being pressed too thin and coming out conical. These could be spun on the table like a top, and when put on a record-changer, literally nothing happened at all. Reviewing was done on a normal simple turntable and several records were unplayable. These may have good music on them, but there was no means of extracting it with a lightweight pickup.

When the E.M.I. LP's arrived it was seen that the processing had been well done. The records were flat, clean, and provided with the nice tapering rim which is the hall-mark of a well-made record, although with few exceptions the quality of recording was far from satisfactory. A check-up on the source of the performances soon revealed that these LP's were simply dubbings from 78's, sometimes of pre-war vintage. Some of the old 78's were masterpieces in their day, but time and technique marches on, and the shortcomings were painfully obvious to anyone with good equipment and a critical ear. Some, of course, were dubbings from quite recent 78 recordings, but this did not ensure satisfactory results. A few LP's were somewhat better than the original 78's, but in general something was lost in the transfer to LP.

At any rate, many of these records could not go into your list, and many hours of listening to E.M.I. LP's have resulted in

* 152 Hammersmith Road, London, W. 6, England.

ORCHESTRAL

Beethoven	 Creatures of Prometheus. L.P.O. (van Beinum)	Lon. LL577
Berlioz	Symphonic Fantastique. Concertgebouw O. (van Beinum)	Lon. LLP489
	Harold in Italy. R.P.O. (Beecham)	Col. ML4542
	(78) Overture: Le Corsaire. Philharmonia O. (Kletzski)	Br. Col. LX1533
Debussy	La Mer. Suisse Romande O. (Ansermet)	Lon. LLP388
	Nocturnes. Suisse Romande O. (Ansermet)	Lon. LLP530
	L'Apres-midi d'un Faune. Suisse Romande O. (Ansermet)	Lon. LS503
Delius	(78) Eventyr. R.P.O. (Beecham)	Br. Col. LX8931/2
Dvorak	Symphony No. 4. Concertgebouw O. (Szell)	Lon. LLP488
Gounod	Faust, Ballet music. Paris Conserv. O. (Fistoulari)	Lon. LLP180
Handel	Concerti Grossi, Op. 6. Nos. 5 & 6. Boyd Neel O. (Neel)	Lon. LPS396
Haydn	Symphony No. 49. London Mozart Players	Lon. LL586
Massenet	Le Cid, Ballet music. L.S.O. (Irving)	Lon. LL651
Meyerbeer	Les Patineurs, Ballet music. L.S.O. (Irving)	Lon. LL651
Mozart	Divertimento No. 2. K. 131. London Mozart Players	Lon. LL586
	Symphonies Nos. 31 & 39. L.S.O. (Krips)	Lon. LL542
Ponchielli	Gioconda, Dance of the Hours. Paris Conserv. O. (Fistoulari)	Lon. LLP180
Ravel	Bolero. Paris Conserv. O. (Münch)	Lon. LLP446
	Rapsodie Espagnole. Suisse Romande O. (Ansermet)	Lon. LL530
	Alborado del Gracioso. Suisse Romande O. (Ansermet)	Lon. LS503
Rossini	Overtures: Semiramis, Scala di Seta, Gazza Ladra and William Tell. Concertgebouw O. (van Beinum)	Lon. LL358
Schubert	Symphony No. 7 (or 9). Concertgebouw O. (Krips)	Lon. LL619
Strauss, R.	Symphonia Domestica. Vienna P.O. (Krauss)	Lon. LLP483
Tchaikovsky	Swan Lake (complete). L.S.O. (Fistoulari)	Lon. LL565/8
	Overtures: Hamlet and 1812. L.P.O. (Boult)	Lon. LL582
Vaughan-Williams	A London Symphony. L.P.O. (Boult)	Lon. LL569
	Fantasia on a theme by Tallis. New S.O. (Collins)	Lon. LL583

CONCERTI

Piano

Beethoven	Concerto No. 1 in C. Gulda and Vienna P.O. (Böhm)	Lon. LLP421
	Concerto No. 4 in G. Backhaus and Vienna P.O. (Krauss)	Lon. LLP417
Rachmaninov	Concerto No. 3. Lympny and New S.O. (Collins)	Lon. LL617

Violin

Beethoven	Concerto in D. Campoli and L.S.O. (Krips)	Lon. LL560
	Concerto in D. Ricci and L.P.O. (Boult)	Lon. LL562
	(Two quite different interpretations. You pay your money and takes your choice. Both good recordings).	

Oboe

Marcello	Concerto in C mi. Reversy and Suisse Romande O. (Ansermet)	Lon. LS591
-----------------	---	------------

Bassoon

Vivaldi	Concerto in D mi. Helaerts and Suisse Romande O. (Ansermet)	Lon. LS591
----------------	--	------------

**Here is the first basic advance
in tone arm design in
many decades!**



The GRAY "Viscous-Damped" 108-B Tone Arm

Gives you perfect contact and tracking on all records at lowest stylus pressure—virtually eliminates tone arm resonances—cannot damage record if accidentally dropped.



The entirely new suspension principle of the Gray 108-B makes it *hug the grooves* . . . prevents stylus skidding on worn records—overcomes groove-jumping caused by floor vibrations. Its "viscous-damped" design provides perfect tracking, virtually eliminates tone arm resonances, and prevents any possibility of record damage if the arm is dropped.

The 108-B satisfies every requirement of high fidelity reproduction. A plug-in feature permits instant change from 78-rpm to 33 $\frac{1}{3}$ -rpm or 45-rpm, *with automatic adjustment to the correct stylus pressure*. See and try this "viscous-damped" arm soon—solve all your transcription problems with this revolutionary, versatile arm!

GRAY RESEARCH

AND DEVELOPMENT CO., INC., HILLIARD STREET, MANCHESTER, CONN.
Division of The GRAY MANUFACTURING COMPANY—Originators of the
Gray Telephone Pay Station and the Gray Audograph and PhonAudograph



Gray Research & Development Co., Inc.
Hilliard Street, Manchester, Conn.

Please send me your Bulletin RF-4 on the new Gray
"Viscous-Damped" 108-B Tone Arm.

NAME _____

ADDRESS _____

CITY _____

STATE _____

only two being listed for you. As they are obtainable under your Columbia label, American Columbia numbers are given. It is possible, of course, that many records originally recorded in England, or under British auspices, already appear as LP's in either the Columbia or RCA-Victor lists, but the task of ferreting these out is too gigantic to contemplate. Such must have happened during the past few years, for there is the celebrated case of the Berlioz Requiem recorded in Paris under Columbia auspices which came out in your country and has never appeared in Britain in any form at all; on the other hand, the Ravel "L'Enfant et les Sortilèges," again recorded in Paris, appeared as an LP with you and on 78's here. The 78's were good, and they were listed in an earlier article, but the LP is far better. Yet both were taken from the same tape.

As a contrast, the Columbia tape recording of the complete Meistersinger appeared in Britain on thirty-four 78's and sounded beastly. You can judge the American LP version for yourselves. Here all the professional reviewers loudly praised the Decca version as superb recording. Your correspondent found himself in a minority of one, and he still thinks it far from good.

The celebrated Mercury recording of "Pictures at an Exhibition" was transferred to a ten-inch H.M.V. LP (losing something in the process). One of our more learned record magazines came out with this in the review of the H.M.V. version: "This recording is the answer to criticisms of shallowness of tone on LP attributed to narrowness of the groove (the italics are mine). I do not think there has ever been before such realistic reproduction as we hear of timpani and big drum . . . in fact the recording makes one sit bolt upright with amazement from the first trumpet notes. . . Sensational recording. . . I am eager to know what this system of recording will yield in less picturesque music." That reviewer was unaware that the H.M.V. company were not responsible for what is undoubtedly a fine piece of technical effort. So the list that has been prepared for you was put together the hard way—by getting the records themselves, playing them on good equipment, and listening. The result, as you can see for yourselves, is meagre.

Every record originating in America has been omitted because you can get them at first hand. The list is intended to show which records originating in Britain are worth getting as real high-fidelity discs. The few 78's that are included have been

INSTRUMENTAL Chamber Music

Beethoven	Archduke Trio. Trieste Trio.	Lon. LL599
Brahms	Piano Quintet in F mi. Quintetti Chigiano.	Lon. LL501
Schubert	Quartet No. 13 in A mi. Op. 29. Vegh Quartet.	Lon. LL587

Piano

Beethoven	Sonatas Nos. 14 and 31. Gulda.	Lon. LLP150
	Sonata No. 29. Gulda.	Lon. LLP422
	(78) Sonata No. 22. Solomon.	H.M.V. C4159
Handel	Sonata No. 5 in E. Gieseking.	Br. Col. LX1532
Moussorgsky	Pictures at an Exhibition. Katchen.	Lon. LLP530
Scarlati	Longos Nos. 10, 142, 223, 292, 294, 325, 382. Long.	Lon. LS524
Schumann	Carnaval. Nikita Magaloff.	Lon. LS528

Violin

Bach, J. S.	Sonata No. 1 in G. mi. Renardy.	Lon. LPS423
--------------------	--	-------------

Piano & Violin

Bach, J. S.	(78) Sonata No. 3 in E. Menuhin & Kentner.	H.M.V. DB21435/7
--------------------	---	------------------

Organ

Haydn	(78) Eight little pieces for mechanical clocks. Jones.	H.M.V. C4177
--------------	---	--------------

OPERATIC

Debussy	Pelleas & Melisande (complete). Mollet, Danco etc. Suisse Romande O. (Ansermet)	Lon. LL592/5
Delibes	Lakme (complete). Opera Comique, Paris.	Lon. LLA-12
Mozart	Le Nozze di Figaro (complete). Schwarzkopf, London, Kunz, etc. Vienna State Opera and Phil. O. (Karajan)	Col. SL114
Puccini	La Boheme (complete). Rome Acadamia di Sta. Cecilia.	Lon. LLP462/3
	Madame Butterfly (complete). Tebaldi and Rome Acadamia.	Lon. LLP4-8
	La Tosca (complete). Tebaldi and Rome Acadamia.	Lon. LL660/1
Strauss, J.	The Gipsy Baron (complete) Vienna State Opera & P.O. (Krauss)	Lon. LLP418/9
Wagner	Parsifal (complete) Bayreuth Festival (Knap-pertsbusch)	Lon. LLP4-10

put there because they seem to your compiler to have intrinsic merits which should not be overlooked, but individual arias from operas are not now included since the LP opera makes the collection of them unnecessary, or so it seems to the writer. Much thought was given to the problem of whether to include "recital" records or not. Some people like these, some do not, and a private census of the people who might buy such records showed that the majority don't, so out they went.

Perhaps before this time next year this scheme may have to be substantially modified or perhaps even abandoned altogether. There seems no prospect whatever of individual small recording companies spring-

ing up as they do in your country—possibly the market here isn't big enough. Whatever may be the cause, what remains is that occasionally a few independent 78's come out, usually of very poor technical quality.

The following abbreviations are used: O simply means "orchestra". L.S.O. is London Symphony Orchestra. L.P.O. is London Philharmonic Orchestra. R.P.O. is Royal Philharmonic Orchestra. Lon. is London (i.e. British Decca). Col. is American Columbia. Br. Col. is British Columbia. H.M.V. is His Master's Voice. The conductor's name is given in brackets after the name of the orchestra.

All records are LP's except where otherwise specified.

COMING EVENTS

April 28-May 1—Seventh Annual NATIONAL ASSOCIATION OF RADIO AND TELEVISION BROADCASTERS' convention and 1953 BROADCAST ENGINEERING CONFERENCE. Burdette Hall, Philharmonic Auditorium, Los Angeles.

April 28-May 1—1953 ELECTRONIC COMPONENTS SYMPOSIUM. Presented through

cooperation of AIEE, IRE, RTMA, and WCEMA. Shakespeare Club, Pasadena, California.

May 7-9—Forty-fifth Meeting of the ACOUSTICAL SOCIETY OF AMERICA. Warwick Hotel, Philadelphia, Penna. Featured subject: Sound Reproduction. Side trip to RCA Laboratories, Princeton, N. J., on May 8.

May 18-21—1953 ELECTRONIC PARTS SHOW. Conrad Hilton Hotel, Chicago.

May 20-22—SOCIETY OF PHOTOGRAPHIC ENGINEERS' Third Annual Conference, Hotel Thayer, West Point, N. Y.

August 19-21—WESTERN ELECTRONIC SHOW AND CONVENTION, sponsored jointly by WCEMA and Western Sections of IRE. Municipal Auditorium, San Francisco, California.

September 1-3—INTERNATIONAL SIGHT AND SOUND EXPOSITION, combined with the CHICAGO AUDIO FAIR. Palmer House, Chicago, Ill.

October 14-17—Fifth Annual Convention of the AUDIO ENGINEERING SOCIETY, and THE AUDIO FAIR. Hotel New Yorker, New York City.

HARVEY the House of Audio



The ORIGINAL WILLIAMSON HR-15 Amplifier Kit

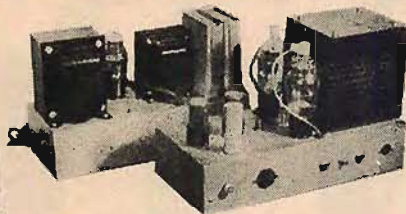

The famous, original Williamson HR-15 . . . still acclaimed the leader . . . in kit form, with the Partridge Output Transformer specified by Williamson in his original design. Assemble this kit, and in 3 hours or less, enjoy the finest sound you ever heard. Operates from a tuner, phono-preamp, crystal pick-up, or other signal source. Absolute gain is 70.8 db with 20 db of feedback. Frequency response: ± 5 db, from 10 to 100,000 cps. Output impedances to match all speakers from 1.7 to 109 ohms. Kit is complete with 5 tubes: 1-5V4, 2-6SN7, and 2-5881 (or 807 if requested), 2-Punched Chassis, 2-Resistor Mounting Strips, Sockets, Partridge WWFB Output Transformer, Assembly Instructions, and All Other Necessary Parts for Amplifier and Power Supply **\$76.50**

PARTRIDGE OUTPUT TRANSFORMER WWFB — Available Separately **\$26.50**

HR-15T Williamson Kit — Furnished as above, with TRIAD Transformers and Chokes **\$69.50**

NOTE: HR-15 and HR-15T Kits may be had with British KT-66 Output tubes for \$3.00 additional.



R-J SPEAKER ENCLOSURES BOOKSHELF MODELS

The new famous R-J cabinet developed to new dimensions. Small enough to permit it to be inconspicuously mounted on a bookcase shelf. Reproduces amazingly clean, smooth, bass fundamentals while permitting direct radiation of high frequencies. An ideal system

where space is at a premium or as an extension reproducer in an extra room. May be finished to match the decor.

- Model S-8-U for 8 inch speakers (11" high x 10" deep x 23 1/2" long) **\$24.50**
- Model S-12-U for 12-inch speakers (24" high x 10" deep x 21" long) **29.50**

WESTERN ELECTRIC 755-A SPEAKER (8" PM)

A remarkable value, ideal for use with the R-J Model S-8-U. Provides full frequency range coverage and wide angle high-frequency distribution. **SPECIAL \$24.60**

The NEW McINTOSH LOUDSPEAKER SYSTEM



Housed in an attractive enclosure for either flat-wall or corner location. Provides a response ± 3 db. from 40 to 10,000 cycles/sec., and a useful response from 30 to 20,000 cycles/sec. Four 12" speakers are used for low frequencies, an 8" speaker for the mid range and four tweeters for high frequencies. Nearly 4 square feet of diaphragm area are thus provided for more efficient acoustical coupling, more closely approaching linearity in excursions, thereby reducing low frequency distortion to a minimum. Over-all width of the enclosure is 43 inches, and the height is 30 inches. Front width is 22 1/2 inches. Power Rating: 30 watts continuous operation. Impedance: 8 ohms.

- Model F100 (blond finish) **\$394.50**
- Model F100A (Mahogany finish) **394.50**

Visit the HARVEY AUDIOTorium

If you want to See and Hear the finest . . . the widest selection of high fidelity equipment . . . be sure to visit the HARVEY AUDIOTorium. It will thrill you.

NOTE: Prices Net, F.O.B., N.Y.C. Subject to change without notice.

The NEW MINIFON Miniature, Portable WIRE RECORDER



Measuring only 1 3/8 x 4 3/8 x 6 3/8, and weighing only 2 lbs. 7 ozs., the Minifon is just about the world's smallest sound recording instrument. Records, rewinds, erases, and plays back through either a pair of stethoscope type earphones or an external amplifier. Capacity 2 1/2 hours uninterrupted recording. Powered by 1 1/2 v. A battery, standard 30 v. B battery, and 7 Mallory RM-4Z mercury batteries. An ideal tool for executives, engineers, doctors, and wherever there is need for recording notes, interviews, and other data.

Complete with microphone, stethoscope type earphones, 1 hour spool of wire, tubes, batteries, and instructions. **\$289.50**

Morocco Leather Zipper Case **\$10.00**
Transformer-rectifier Unit for operation of motor from 117 v. AC line **\$20.00**

RECORDING WIRE

On spools, in dust-proof plastic containers, suitable for mailing.

1/4 hour	\$5.00	1 hour	\$9.00
1/2 hour	7.00	2 hour	17.00
		2 1/2 hour	21.50

The BOGEN MODEL DB10-1 Audio Amplifier

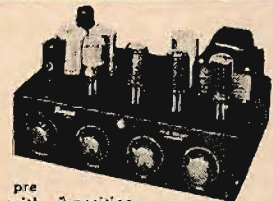

Affording high quality at moderate cost, the Bogen DB 10-1 is ideal for home installations. Has a built-in pre amplifier for magnetic cartridges with 3-position selector switch. Three additional knobs serve as controls for bass and treble boost and attenuations, and for volume. Frequency response is flat from 30 to 18000 cps within 1 db. Power output is 10 watts (Peak 15 watts) with 3% total harmonic distortion. Output impedances: 4, 8 and 16 ohms.

Dimensions: 11" wide x 7" deep x 7-5/16" high. **\$54.45**
Complete with tubes.

You Owe It To Yourself . . . to See and Hear The MAGNECORDETTE and other MAGNECORDER TAPE RECORDING EQUIPMENT

Always in Stock . . . Always on Demonstration
at the HARVEY AUDIOTorium



The New PILOT FM-AM TUNER—Model AF-723

Designed for high quality reception of both FM and AM broadcasts. Slide-rule dial has individually illuminated scales indicating band in use. Provided with cathode-follower output (900 ohms) permitting up to 100 feet connecting cable to main amplifier. Has two inputs for through-channeling of phono and TV audio signals. Five knobs provide the following controls: 'on/off' switch and volume . . . continuous treble attenuation from flat to -24db at 20Kc . . . selector switch for AM, FM, phono and TV . . . tuning . . . AFC 'on/off' switch. Has built-in Loop-Slick AM antenna, and built-in FM antenna, plus 300-ohm input for external FM antenna. Power supply is built-in.

Dimensions: 14" wide, 7 1/4" high, and 8 1/2" deep. **\$79.95**
Complete with tubes and panel escutcheon.



HARVEY RADIO COMPANY, INC.

103 W. 43rd Street, New York 36, N. Y. • LUXemburg 2-1500

RECORD REVUE

EDWARD TATNALL CANBY*

BINAURAL MARCHES ON and I have some more to say on the subject—perhaps revising some earlier ideas expressed here. As said many a time before, this department reserves the right to climb onto limbs, speculatively, and the further right to climb delicately off again if need be, to “*changer d’avis*”, as the French so elegantly put it.

My last, in the December issue, was written the day I arrived in St. Louis for, among other things, an extended look into the details of the two-channel process, at Washington University where I’m currently attached to the Music Department. Those indefatigable pioneers in the binaural tape field, the Magnecorder people, had followed up their initial interest with the loan of a recorder without which, needless to say, investigation would be slightly theoretical. Now, a good many very uncommercial tapes and a number of months later, I’m feeling an awful lot clearer about the whole business though my efforts have not, alas, been of the sort that could pay Magnecorder back as handsomely as deserved in terms of gorgeous binaural recordings!

Eavesdropping

Indeed, as some old readers will guess, my approach to the recording problems was deliberately informal. I wanted to be able to fuss around with a minimum of trouble. I figured that the college band, sight-reading for their coming basket-ball session, would be as good a test audio source as, perhaps the St. Louis Symphony. It was, if one forgets about music. An amateur trombone, out of tune and a measure late, is as good a binaural point-source as Harry James or Yehudi Menuhin in person! I picked up the band and a Hindemith Clarinet Sonata and the college organ (*that* one is a wow of a recording) and a woodwind quintet playing for fun and a tea party—to catch voices talking in a general scramble—and ended up my first session working with the cast of a college play, as adaptable a source of sound as I’ve ever had.

And all of this was played back on speakers and via phones in a great variety of places and to many people. Direct com-

parisons were made constantly between two-channel and one-channel reproduction (one track through two speakers or both phones of a set) at every phase of the experiments—which was certainly the best check we could have as to what was going on. Especially the speaker comparison, between two speakers on the same channel and on two channels. That comparison, strangely enough, I had never been able to hear before and it is a vital one that every one of us who is interested in two-channel work (or 3- or 5-channel) should make constantly. Most revealing.

Brain Twisting

That was, shall we say, the physical exercise part of the job (Magnecorder did more for my muscles than Charles Atlas ever could, begging their pardon. Suffice it to say that my office was on the third floor, no elevator. . . .) But alongside of the tape pattering, I began sounding out People Who Ought to Know in the University—which has a raft of them. Physics department, Electrical Engineering. We would listen, then go out for three-hour lunch and cover all the menus with how-does-it-work binaural doodles.

Most important contact, however, was in the Institute for the Deaf, a fabulous place where binaural hearing was practically invented. Those people were not aware that there was any great problem, in the dim-distant audio world, as to how to get a binaural effect, but they certainly knew a great deal about how two ears work better than one. The Lord had worked out the two-eared process quite some time before binaural tape. Science had got to the bottom of a good deal of the Lord’s intentions quite a while back, too. They referred me to the Literature, which I haven’t absorbed and probably never will—it’s tough stuff. The one thing that is dreadfully clear was that from the ear men’s viewpoint there just isn’t any argument. It’s all very, very simple, relatively speaking.

There came a memorable day when I finally saw a blinding flash of light or something. I haven’t recovered since. I think I catch on now, as I say, and maybe, Literature or no, I can give you non-

Literature readers some useful hints in plain ordinary Amurrican.

Bistereonauralphonic

Yep—it has to do with Binaural versus stereophonic. It seems, as you probably are well aware by now, that we have two quite distinct kinds of hearing involved in the present two-channel developments. Whether they overlap at all is still somewhat of a question. It seems to me a good guess, among conflicting opinions now raging, that they don’t. There are those who feel that two loudspeakers can give a partial true-binaural effect—one sound to each ear. I certainly had thought so. I’m still not clear on the point. But I can only say two things. First, the Higher Scientists gave me to understand in most emphatic terms that *there can be no binaural effect at all worth mentioning via two loudspeakers*. I repeat, no effect. The observed phenomenon are accounted for purely as stereophonic—which I will get to in a moment. I’m not quoting this directly, but that is what my two attentive ears and one brain took in. Dr. Ira Hirsch, one of the top hearing experts, who has done extensive work in this field (including construction of as nearly perfect a binaural “head” as could be devised, with mikes imbedded in ear-like channels) was the main source for this deduction on my part.

Secondly, I can give you, too, my own private evidence, to supplement what I seem to have understood from the experts; i.e., my observations of the phenomena of two-speaker reproduction are accountable very nicely in stereophonic terms without necessarily any binaural effect. Moreover, there are what I might call “anti-binaural” observations which indicate to me that the loudspeaker effect, such as it may be and however good it may be, is specifically *not* true binaural.

True Binaural

There is no argument about the “binaurality” of headphone reproduction, with two mikes, say, not over fifteen inches apart (the ears are flexible) and the usual complete dual system. Perhaps not literal, especially as to accurate direction, since standard mikes are not really very much

* 780 Greenwich St., New York 14, N. Y.

coast to coast

In Music, Listening Quality is everything . . .

At the recent Audio Fair—Los Angeles, (as in New York) hundreds waited in line before each Audax CHROMATIC performance (every 20 minutes) best described by the following excerpt from the Audio Fair Review in AUDIO ENGINEERING.

"If we had to name the most popular display of the recent N. Y. Audio Fair, the top honors would most certainly go to the Audax Company. Maximilian Weil, AUDAX president, long known for his virtuosity in the creation of fine Electronic Music reproducers . . . had the violinist David Sarsar, (Toscanini's NBC Symphony), and the cellist, Sebe Sarsar (New York City Opera Co.) in person, play for the AUDAX audience. Intermittently, they would put down their bows and the performance was then carried on by the new AUDAX CHROMATIC pickup, playing a disc-recording of the same composition.

So startlingly realistic was the reproduction by the new AUDAX CHROMATIC reproducer that, invariably, the audience broke into spontaneous applause. Adding to the demonstrations dramatic proportions, was the fact that the musical instruments used by the artists were Stradivari, valued at well over a hundred thousand dollars. Strictly big-time . . ."

Only You can decide what sounds most pleasing. See and Hear the Audax CHROMATIC and—You be the judge . . . Yest Audax costs no more than ordinary pickups.

Only AUDAX has *individually* replaceable Sapphire or Diamond styli.

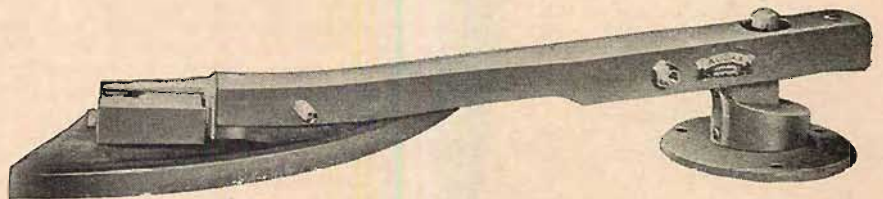

Available with the new Compass-Pivoted Audax arms and to fit the high quality record changers

*No H. P. (hidden pull) see
*1953 ELECTRONIC PHONO FACTS now
available from your favorite store*

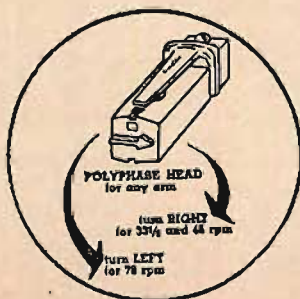

One single magnetic pickup plays all home records

AUDAX COMPANY

500 Fifth Avenue New York 36

Creators of Fine Audio-Electronic apparatus for over 25 years

"The Standard by Which Others Are Judged and Valued"

New! BINAURAL

On your tape recorder
Now...



with
MAGNETRONICS
DYNAMU TRIO *

Broadcast Quality Recording Heads

These Revolutionary New Miniature 3 WAY Recording Heads provide a superlative high fidelity system with results comparable to highest priced professional equipment.

For new equipment or direct replacement for modernizing older tape recorders. Range: 20 to 15,000 cycles at 7.5" speed. Mountings available for most recorders.

WORKS 3 WAYS

Now, for the first time, at the flip of a switch, you can...

1. Record & Play two channel BINAURAL 3 Dimensional Sound on your own recorder tape mechanism.
2. Record & Play half track as usual.
3. Play & Record opposite half of tape without stopping or changing reels.

MT-3 DYNAMU TRIO BINAURAL 3 DIMENSION erase and record/playback Heads complete with leads and mounting nuts... 49.00
MM-3D Microfocus Azimuth Alignment Kit (optional)... 5.95
Complete circuit diagrams and home construction data for Model H3D Binaural pre-amplifier etc. (optional)..... 3.00

New! DUAL CHANNEL

PROFESSIONAL Binaural

3 dimension recording amplifier and playback pre-amplifier with supersonic bias oscillator. 20 to 15,000 cycle response at 7.5" tape speed when used with MT-3 heads..... 99.00

*Trademark Registered Patents Pending

See your distributor or write to

MAGNETRONICS CORPORATION



4312 N. Kedvale Ave.,
Chicago 41, Illinois

like standard ears-in-heads. But the twoness of the reception is enough to give us the undeniable binaural effect, not unlike the undeniable 3-dimensional effect of a stereo photograph via a viewer.

The big argument comes with speakers. Binaural effects depend strictly upon the selective reception by the two ears of different signals. With earphones, as in normal hearing, the separation is 100 per cent or so. But is there (a) no separation or (b) some separation with loudspeakers? That is a very big question, and it is the basic clue as to whether there is any truly binaural effect at all with loudspeakers.

The answer is pretty technical. All I can say is that I heard much about sound pressure being substantially equal on both sides of a head for most significant frequencies regardless of direction; therefore two loudspeakers, to right and to left and equidistant, will be heard equally loud at significant frequencies by both ears—hence no separation. Both ears hear both speakers. Like two eyes looking at a pair of stereo photos without a viewer. True? Not true? I'm not sure—but it is a point that is vital, if we are to explain two-loudspeaker "binaural" scientifically. I say, again, that my St. Louis experts gave me to understand that there is no significant separation of the right and left sounds with speakers off in room, to right and left. (If they were six inches or even two feet from each ear there might be separation—but this is not what we are considering.)

Stereophonic

Suppose, for the argument, that we accept the idea that there is no binaural action at all when two speakers reproduce two channels. What else is there involved? A lot.

The stereophonic principle, involving the hearing of sound by two ears together, can account by itself for the well known observable effects when we have two-speaker reproduction at its best. The way I see it, stereophonic reproduction via speakers is a sampling of the "curtain of sound" in front of you—or the mikes, as picked up. If we could set up a thousand-odd mikes in parallel rows and feed them through a soundproof curtain to a thousand-odd correspondingly placed speakers, we would have a sort of "half tone" reproduction of the total sound, spaced out neatly according to its multiple source. The multitude of tiny dots in a printed picture are in a way similar to this. Sample the light intensity in terms of black and white at many points and reproduce the same—and you "see" the original picture.

Moreover, even though the picture dots be large, crude and few in number, we can still reconstruct the sense of a photo. The coarser the dots, the harder it is to see the picture and the more indistinct is the detail.

Our ears are a lot more easily satisfied, in this sampling process, than our eyes. We use more imagination with our ears, even if we are in the long run less accurate as to shapes and directions. Sample a "sound-picture", the area of sound-source in front of you, with as few as a half dozen mikes, six points, and the reproduction via loudspeakers in the same relation will be (distortion allowing) very nearly perfect.

Even with as few as three points, middle and the two sides, we can pick up and reproduce a sound-picture that is remarkably accurate in its directionality. We can mentally spread out a whole orchestra and hear the first violins on the left, the heavy brass at right rear. We scarcely miss the lack of an up-and-down dimension. The well

known three-track stereophonic demonstrations, via wire and film recording, of the Philadelphia orchestra illustrated this most effectively back in the early thirties.

Two-point Sampling

What then, if we sample space at only two points? (Remember that the ordinary one-point sampling of the usual record or broadcast still gives us a vast number of clues as to space and distance, even though we have actually only one perceivable dimension—front-and-back.) Two-point sampling falls somewhere between the accuracy and clarity of direction that three-point sampling gives us, and the pleasant but indefinite illusion of space heard via the one-point system. It clearly can be an improvement, technically, over the one-point sound.

If we get as much as we do, with one mike and one speaker, then two points, nicely spaced, should, we can easily deduce, add in addition a somewhat greater sense of side-to-side "shape" in the whole, round picture. (Not all the instruments of an orchestra will be inches from one mike or the other; many will be in between.) Not too accurate—for there is the vast complexity of reverberation to count in; sounds reaching the two mikes are reflected, in most good musical situations, from all sorts of directions in addition to the direct beam. When this side-to-side clarity is added, we can more accurately imagine the actual shape and position of the sound source, around and between the points of sampling. We fill in the details via imagination.

This means that reproduction of two sound pickups via two speakers can allow us to "place" the music distinctly better than we can when (for fair comparison) two speakers reproduce only one track, together. And that, in turn means a greater sense of presence, realism, and an improvement in musical clarity, in separation of the various sounds as they come from vaguely different spots, instead of all from the one source.

Moderate Improvement

Now, I suggest you read that last bit carefully and ask yourself—*is not this exactly what we experience in actuality when we hear a so-called "binaural" reproduction via two loudspeakers? Is not this fully sufficient to account for the observed phenomena?*

If you have made the fair test between one-channel and two-channel sound via two speakers—using two speakers in both cases—you will, I am sure, agree. The effect may be better or worse according to circumstance, but substantially it fits this description, in character and in degree. There is, at best, a notable but still a moderate improvement. The improvement over equivalent one-channel reproduction (same music, same speakers) is not a thing you can put in percentages; it depends on your subjective feeling. But, with constant experience, constant demonstrations of both ways, AB tested, I think you'll find it satisfying, exciting, but still—moderate. Three-channel reproduction—or 5-channel, as in Cinerama—would do a great deal more for you via loudspeakers.

That is stereophonic reproduction, the sampling-of-space system. Ideally, N channels, optimally, perhaps five channels, minimally for rough accuracy of spacing, three channels. Absolute minimum, for moderate general improvement in presence and a vague general sense of direction—two chan-

nels. Two points of space sampling, to give cues to the entire space-picture.

I find no good reason to think that the binaural, *sound-separation* effect is involved here at all. Here we have always *both* ears hearing *both* (all) points. That's why Cinerama (and Fantasia) don't involve ear-phones.

Liveness—a Big Clue

But—editor permitting—I can't quite stop here. There are anti-binaural indications to me, in this two-loudspeaker sound. I've been listening hard.

What are the essentials of the real, two-eared binaural hearing, as differing from the one-eared "broadcast" and recorded sound? (Also the one-track sound of the hearing aid.)

Briefly, in speech and everyday noise, the two-ear separation and the directional clarity it affords us allow us to sort out sounds, as we can sort out colors with our eyes. That sorting ability gives us a far better grip on the mass of sound and we can relegate that which we do not want into our subconscious. In a crowded cocktail-party or a dinner-table multiple conversation, we can be attentive to the sounds we want, put the others into the background of our minds. Without the directional ability to sort out sounds and separate them, we are far less able to do this—and the result is confusion, a general blur, inability to understand one speaking person against the competition of others. The difference between binaural and monaural hearing is sensational in this sorting-out respect. (We can also compare this to the stereoscopic effect of, say, a tree with millions of leaves; on a flat picture they blend and merge, but in perspective—with two-eyed separation—they stand out in their individuality.)

And music? The same basic sense for sorting, for reducing confusion, for eliminating unwanted interference, makes binaural hearing of music vastly more clear than the same music heard via one channel. *Liveness*, the general blur of delayed echo coming from all directions, is much more apparent with the non-sorting, monaural sound. We most go out of our way to reduce it—via close-up mikes, dead studios, etc. A voice at ten feet in a "bright" room sounds entirely normal via two ears, but recorded monaurally, it is dismally off-mike. Too far away—too much room confusion added to the direct sound.

Now for the pay-off, as I've found it. Even though directional effects are not entirely accurate via binaural headphone reproduction, the 100 per cent separation of the two sound pickups definitely gives these same binaural effects. Confused, mixed voices are startlingly more clear, more easily understood via binaural phones than via monaural phones or speaker reproduction. I tried that, with a tape of muddled, mixed party conversation. Via speaker, I got only a few words from the confusion. Via binaural phones I could follow almost every conversation verbatim and could concentrate on any one of them, at will.

I also recorded speaking voices ten and fifteen feet from the mikes in live halls. Via monaural speakers or via monaural phones they sounded typically off-mike. Too far away. But via binaural phones the same voices were entirely natural, with no sense of too-great distance. I've done this over and over again, to complete satisfaction. Voices recorded close, sounding just right monaurally, as for standard radio, are much too near via binaural phones. Unpleasantly close.

**LISTENERS AND
CRITICS ALIKE
APPLAUD THE**

**UNPARALLELED
PRESENCE**

OF
TANNOY
Dual Concentric
LOUDSPEAKER SYSTEMS
A WORLD RENOWNED NAME SINCE 1926

Now experience the amazing listenability of wide range response in *perfect balance*. Hear the world famous Tannoy Dual Concentric Loudspeaker System, providing *optimum fidelity* at any level from the audibility threshold up to full room volume. Features of the Tannoy system include:

Uniform response from 35 to 20,000 cycles per second. Integrated concentric sources for both high and low frequency components eliminate crossover interference. H.F. horn formed by machined center pole and L.F. diaphragm; these combined with a special throat and electrical network insure perfect acoustical balance. Intermodulation product less than two per cent.

Hear it to appreciate it! Write for free brochure and name of nearest distributor today. 12" and 15" types, handling 15, 25 watts.

Dual Concentric 15" LSU/H.F. 15/L Net \$159.00 complete
Dual Concentric 12" LSU/H.F. 12/L Net \$130.00 complete

THE SPEAKER WITH

International Prestige

**TYPICAL OF TANNOY HIGH FIDELITY
INSTALLATIONS ARE THE FOLLOWING:**

- House of Commons, London
- House of Lords, London
- Church House, London
- House of Parliament, Ottawa
- United Nations, New York and Paris
- Houses of Parliament, New Delhi, etc.

A Few Distributorships Still Available to
Selected Audio Dealers in U. S. A. and Canada

TANNOY

BEAM INSTRUMENTS CORPORATION
Department AA, 350 FIFTH AVE., NEW YORK 1, N. Y.



Illustration
15" Model LSU/H.F. 15/L
and Crossover Unit

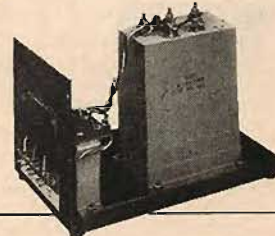

New **TANNOY**
Bass Reflex Enclosures

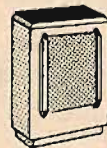

Engineered by Tannoy to provide the optimum in natural wide range acoustical reproduction.

Tannoy enclosures provide the perfect complement for Tannoy full range loudspeakers. Beautifully designed and magnificently executed by master craftsmen, they are handsome additions to traditional or modern decor. See and hear them at your Tannoy dealer's.

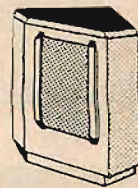

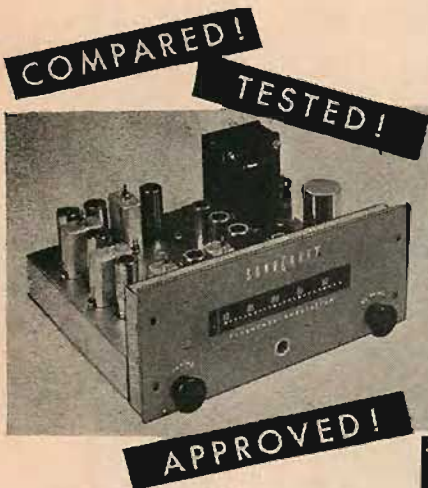

COMPARED!

TESTED!

APPROVED!

SONOCRAFT FM TUNER

America's Most Advanced Tuner

COMPARED . . . by engineers and critical music-lovers for audio-quality, and technical advancements. Consensus of comment: "Amazing tonal quality" . . . "True fidelity of reproduction" . . . "Live programs really sound live!"

TESTED . . . and found consistently effective for fringe-area reception at distances from 40 to 80 miles from New York City . . . New, super-sensitive circuit assures perfect signal pick up with sufficient quieting for excellent reception even in remote locations. Automatic Frequency Control (AFC) prevents station drift.

APPROVED . . . because of its superior performance, its compact dimensions for easy mounting into almost any enclosure, its new type tuning indicator (simpler to use) and many other exclusive features . . .

★ ★ ★

SPECIFICATIONS: New black-out tuning indicator; 3 gang inductive tuning; dual limiter; all coils slug-tuned; 5 microvolt sensitivity for 20db quieting; 200 KC bandwidth at 6db down; adjacent channel down 60db; eleven miniature tubes plus neon-tuning indicator; AFC with disable switch; compact size: 10" w., 4" h., 8" d.; new design for simplified installation.

SONOCRAFT FM TUNER \$89.95

Visit the remarkable new Asco Studios—America's finest demonstration facilities—for the best in sound equipment . . .



Gift:
Come in and pick up or write for your free copy of "Sound Advice" written for Music Lovers, by Irving Greene. 124 pages of vital information in high fidelity.

ASCO SOUND **ALS**
CORPORATION **C**

113 WEST 45th STREET, 3rd FLOOR
NEW YORK 36, N. Y.

The same principles apply in music. Binaural phones allow you to move your mikes very much further away than for a proper one-channel standard set-up. Good standard recording mike placement is in most case far too close via binaural. Too close for two ears.

In other words, the binaural effect is consistently and accurately present via binaural phones, in terms of liveness, clarity, separation of wanted and unwanted sounds. Even such noises as that of passing busses, very distracting and painfully obvious in monaural pickup, are easily relegated to the background via binaural. I have watched a woman listening via phones to a speech where a bus roared past outside. Via the single monitoring speaker on the Magne-corder (one channel only) the speaking voice was almost drowned out. Yet the lady behind the phones was not even consciously aware of it. She lived right there and merely put that bus where she always put it *binaurally*—out of mind.

Do these true binaural effects occur when two loudspeakers are used? That is an acid test.

I have tried and tried and tried, comparing one-channel and two-channel sound via speakers. The answer, in my experience, is a dramatic NO.

Off-mike voices remain off-mike when reproduced via two channels on speakers—though the source of the voices can definitely be heard in space between the speakers. That is the stereophonic reconstruction of the sound-picture by your ear and mind. The liveness, however, does *not* change.

Confused recorded conversation is *just as confused* via two-track sound as via one-track—though the placement in space and the realism is heightened.

Music recorded off-mike—that is, too far away for good monaural sound—remains too far away via two-channel, though, again, the placement of the sound source may be dramatically improved. The liveness *does not* change.

Therefore, I deduce, there can be no appreciable binaural effect, via loudspeakers. The specific binaural phenomena are missing.

Space Placement

But what of the wonderful sense of placement in space that two-speaker reproduction via two channels can give? What of the magical effect when a grand piano—or a speaking voice or an orchestra—suddenly seems to "appear" *in the space between the two loudspeakers*—or around and behind them? That effect has been taken by many as proof that the music is binaural. I thought so, too. If you can place the sound in space between the loudspeakers, you *must* be getting a directional effect from the two tracks, via some degree of sound separation from the two speakers, to their respective right and left ears. So I thought.

I believe you will find that this is not the case. The space placement is thoroughly and adequately accounted for by the stereophonic space sampling of your ears—they gather enough sound clues from the two points of sampling to reconstruct the actual aspect of the sound-space as picked up. That is the entire explanation. It fully covers all the aspects of "binaural" sound you have heard of, with one minor qualification, to follow.

If, then, the more specific binaural effects of liveness—which are so dramatic via ear-phones and natural hearing—are not found, by direct comparison, in the two-speaker

set-up, then we must conclude that the ear is not concerned at all with binaurality. If there is some percentage of actual separation of the two sounds to the two ears, then it cannot be much, nor very effective. And that is that.

Dual Point-Source

One final note. I made a boner in my last on this subject. There is a third effect of a sort, the literal substitution of a point-source speaker for a point-source sound. I called that "stereophonic"; it is not, strictly.

Record two actors three feet from two mikes, at thirty or forty feet separation. In effect, each voice is on one track only. Doesn't carry to the other. Then play these tracks back through two speakers. Wherever you put them—there will be the voices. Point-source two-channel recording. But never will you hear either voice in space *between* the two speakers. Each voice is "inside" its own speaker box.

This point-source effect, has figured quite a bit in "binaural" sound recently. A table tennis game for instance. A piano at one mike and a singer close to the other. There may be some sound merging, and thus the stereophonic "in-between" effect gradually may be introduced, as well.

Emory Cook's "Mosque" two-channel organ records, termed binaural, are essentially point-source dual recordings, I'd say. The two parts of the organ were in two corners of the huge hall and mikes were placed fairly close to each, maybe 30 feet, and perhaps 90 feet or more apart. (So I hear) That, I'd suggest, is neither stereophonic *nor* binaural! But the effect, mind you, is gorgeous via speakers. Each speaker reproduces its own organ and they blend externally, as they did in the original hall, more or less.

All these effects may be put to excellent use. It's just a matter of getting them straight. And to point up that big difference between binaural and stereophonic. I only suggest, for your edification, that if the Lord had figured we needed more than two ears, given *complete* sound separation, he'd have given us more. He didn't figure on sound reproduction, I guess. We can use his way—true binaural. Or we can fake up that "curtain of sound" in front of our listening ears, via sampling at various points. To match the good Lord's system we then need N points, and economy gives us "only" two. We ought to have at least three.

But we'll never, *never* need three ears.

SPECTACULARS

Strauss: Ein Heldenleben.
♯^{db} (A) Minneapolis Symphony, Dorati.
† Mercury MG 50012
♯ (B) Vienna Philharmonic, Krauss
London LL 659

It takes a long time to listen to these two mammoths and make a comparison! A lot of music. For excellence in the recorded medium I'll choose the Mercury-Dorati version, but not without comment. I underline, above, intentionally. Do we want concert-hall realism or phonograph realism?

Mercury's version is done via the now well established one-mike technique, with a Telefunken. That technique is fairly straight-forward in theory; one finds, in a good hall, that point in space where the direct over-all sound, from the source, nicely balances the liveness, the reverberation. Sometimes that point is quite critical—too far away and you're off-mike, too close and the instruments are solos instead of ensemble. They don't blend.

This record has hit the over-all sound to perfection. But the balance among the instruments—which must be adjusted to the single mike—is, shall I say, phonographically effective but

musically slightly cockeyed. Brass and percussion are very loud, sharp, close, and clear, overriding the strings as is seldom the case in a concert hall hearing.

Wrong? Not at all—in this case. The sharp brass sounds and the equally clear drum sounds are wonderful—via good reproducing equipment. Moreover, these sounds are musically very important in the score itself and their technical exaggeration, though perhaps a concert musician's ear would not approve, on the whole does the music much good. We must adjust our music to the new medium. This is a real "hi-fi record".

The London version, probably done with more than one mike, has a more conventional brass balance of tone, though paradoxically, here the strings (as in many Londons) sound unnaturally close. An excellent ensemble—but less transparent, the bass more tubby than the Mercury. Inner grooves do not hold up quite as well, either. Credit that to Mercury's Margin Control, I'd guess.

Standards are high these days! Ten years ago either of these discs would have been miracles unbelievable.

KEY

- * Outstanding record of its type
- † AES playback curve specified on record
- †† NARTB (NAB) curve specified on record
- ^b Big Bass; European-type low (300) turnover; adjust accordingly
- ^{bb} Bass and cymbals
- ^{dd} Distortion in loud passages only
- ^e Extra treble pre-emphasis—use more roll-off
- ^f Flatter-than-average high end—use less roll-off
- ^g Unusually good musical performance
- ^o From older 78 discs

*^{dd} **Respighi: Fountains of Rome; Pines of Rome.** Vienna State Opera Orch., Quadri. †† Westminster WL 5167

A competing version of this has not yet reached me—but this offers enough for comment, as the first in Westminster's new "—" technique (\$1000 to you if you can find a name for it)—the company's bid for notice in the developing spectacular field, once pretty much monopolized by London.

It's a fine recording, no doubt, and truly more "naturally balanced" in detail than either of the Strauss records above, from the musician's viewpoint. Excellent big liveness, with good sharpness in the detail. But I have one serious complaint—too much pre-emphasis of the highs.

Compared directly to the Mercury and London offerings above, this Westminster is noticeably shriller and louder in the highs. A change in equalization is definitely needed. (The album calls for NAB roll-off for best results on high-fidelity equipment.) Even with proper equalization, this steep high boost, combined with high-level groove cutting, is bound to cause some distortion trouble in many a home system. I found a noticeably increased distortion in the loud parts as compared with the other two discs, above. (Mercury, you'll note, calls for AES on its album cover.) Before Westminster settles on a name and throws out that One Grand, I'd strongly suggest it reconsider its high end, and settle on something less steep—say the AES curve.

Musico-ornithological note: the famous recorded nightingale who sings in the "Pines" is expertly inserted here, to any ornithologist's delight. How? The bird, immersed in shimmering strings, is so faint that you can just hear it—and thus is startlingly realistic! First time, I thought it was outside my window. That's the way we normally hear birds: at a distance, not "close-up" as in most bird song records. Natural balance! This is what I call enlightened recording technique.

*^e **Chopin: Les Sylphides.** Tchaikowsky: Princess Aurora. Ballet Theatre Orch., Levine. Capitol P 8193

A lot to be learned from this disc as to what makes hi-fi sound. Same recording, we assume,

on both sides, but the Chopin is no hi-fi record, the Tchaikowsky is—so much so that you might be tempted to say it is "better recorded." I suspect the difference is all in the music. The Chopin is quiet, mostly strings; the loud parts are heavily stringed—and loud strings, with their multiplicity of violent LM effects, are extremely hard to record clean (and get clean onto a disc). Thus the Chopin occasionally sounds shrill and a bit distorted. But, on the reverse, Tchaikowsky's clean, varied orchestration, full of fine brass and percussion, makes a superb sound.

Musically a most sympathetic and warm playing of both pieces, by an orchestra that knows its ballet, even if its ensemble is not as perfect as in some of the fancier orchestras.

* **Dvorak: The Golden Spinning Wheel; The Midday Witch; †† Waltzes, op 54, #1 and #4.** Czech Philharmonic, Prague Soloists Orchs., Talich.

Urania URLP 7073

Two rare bits of Dvorak and no less attractive (as we might expect) for the mere fact that the

first is seldom heard, the second just about unknown, until now. That is, to U. S. concert audiences. (The two dances are familiar and lovely.)

The fat, resonant big-orchestra sound of these is one that we don't seem to get in this country. Our big ensembles are more pretentious in tone; our littler groups can't achieve the tonal mass. Acoustics count heavily in the gorgeous old halls that abound in Europe. This record (the two tone poems) is very live, with a strange "double" echo, about a half-second late, that is quite pleasing; the sound has fine presence, big bass and good highs, and the music, while rambling, lives up to the usual Dvorak reputation for lyric charm and warm, colorful harmony. Some exotic effects in the "Witch."

The two fill-in waltzes are in closer acoustics; recording distorted in loud parts. Inner groove trouble, perhaps.

* **Mendelssohn: Midsummer Night's Dream; incidental music.** Robin Hood Dell Orch., Reiner.

NEW Metal Speaker Enclosures

BUD SILVER SONANCE LINE

Here, at last is a line of metal speaker enclosures that are outstanding in design and performance. They are handsomely finished in silver grey hammertone, provide lifetime durability and are acoustically perfect.

These metal speaker enclosures are ideal for many locations such as hospitals, auditoriums, stadiums, schools, restaurants, factories, department stores, railroad stations, airports, out-door theatres and any other place where a speaker is used.



CS-2240

LOOK AT ALL THESE ADVANTAGES

- **ACOUSTICALLY PERFECT** because they are treated with a special sound-deadening compound to eliminate metallic resonant sounds.
- **ALL DIRECTIONAL MOUNTING** permits adjustability of speaker in any vertical or horizontal position. Can be attached to wall or ceiling.
- **LIFETIME DURABILITY** since there is no danger of warping, cracking or splitting which are hazards of wood speaker baffles.
- **2-WAY SOUND** arises from bi-lateral feature which permits sound to come from both the front and back of the enclosure.
- **FULL SIZE RANGE**—enclosures available to accommodate 4", 5", 5½", 6", 8", 10" and 12" speakers.
- **ECONOMY** assured by our large scale manufacturing operation. Prices are relatively low in comparison with advantages provided.

RECESSED CEILING AND WALL ENCLOSURE

This metal speaker enclosure is designed for recessing in the wall or ceiling where a projecting speaker would be liable to damage or where an unbroken wall or ceiling surface is desirable. The same quality features and advantages are found in this model as are prevalent in CS-2240. Its size will accommodate an 8" speaker. The grille plate is finished in silver grey hammertone or with a primer coat that can be painted to match the surrounding decorations.

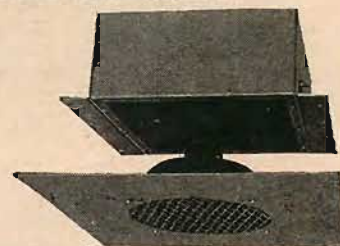

CS-2244

Write today for descriptive literature and prices.

BUD RADIO, INC.

2118 East 55th Street

Dept. AE-4

Cleveland 3, Ohio



FREE!!
COMPLETE VOLUME CONTROL
and ATTENUATOR
CATALOG SECTION

as reprinted from Radio's Master

- Potentiometers • Volume Controls
- Attenuators • Rheostats

Send coupon today!

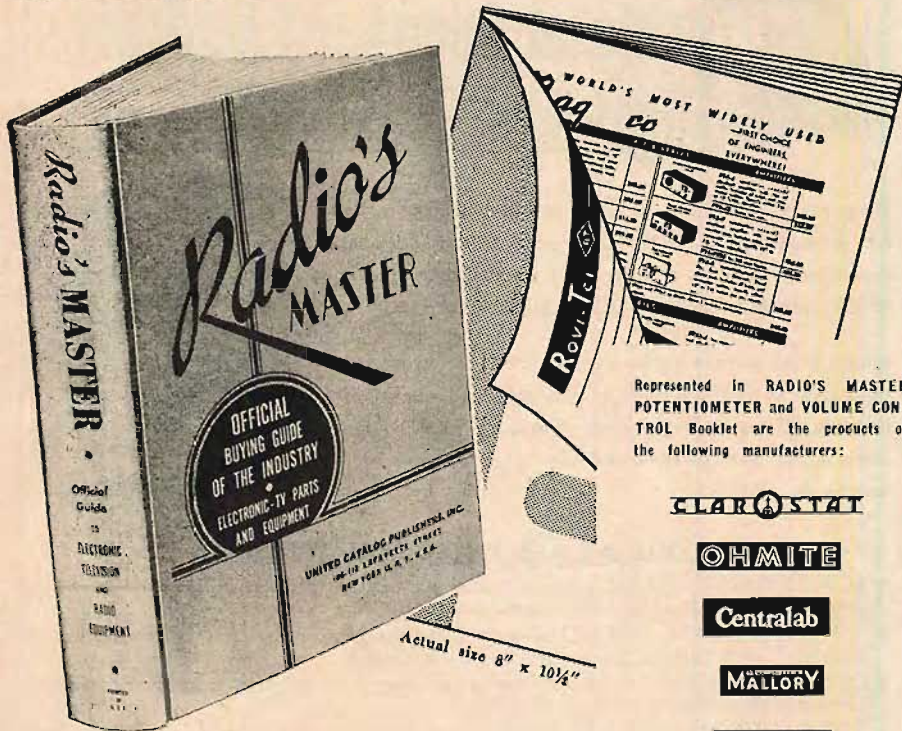

Represented in RADIO'S MASTER POTENTIOMETER and VOLUME CONTROL Booklet are the products of the following manufacturers:

CLAROSTAT

OHMITE

Centralab

MALLORY

SMALLCROSS

IRC

Summary of Contents

- Controls
- Control Kits
- Exact Factory Replacements
- Audio Attenuators
- Rheostats
- Potentiometers

MAIL TODAY

This offer is made possible by a special arrangement between Audio Engineering and the publishers of **RADIO'S MASTER**.

AUDIO ENGINEERING

P. O. BOX 629, Mineola, N. Y.

Please send me, without cost or obligation, the **VOLUME CONTROL** and **ATTENUATOR** Booklet reprinted from Radio's Master.

Name

Address

City

Debussy: Petite Suite. Ravel: Le Tombeau de Couperin. NBC Symphony, Reiner. RCA Victor LM 1724

RCA's "new orthophonic" sound surely makes up for certain oit-mentioned deficiencies of the dim, distant past (a few years ago)—there were never such clean, sharp highs as these, and no tonal "ceiling"; I came close to putting a small "b" beside this item, too—"heavy bass; use 300-eps turnover"—believe it or not. The days of thin bass seem over, as well.

The Midsummer Night recording omits the lovely choral parts, seems to me a lot less melodious and fresh than the sturdy Fricasay LP from Decca (DL 8516) though this one probably has better quality. (If you don't like these two, you have no less than ten LP versions of some or all of this music to choose from. Don't ask me to compare them—I've only got one lifetime . . . !) The Wedding March, however, is tremendous. Fast, loud and brassy, with all the interludes.

The French music is acoustically more on the small-studio side, which is quite correct. Again, not as warm as the old Mitropoulos version, from discs, of the Ravel (Col. ML 2032) and Urania has a nice Petite Suite. Neither one of those has the new orthophonic sound, alas.

Strauss: Le Bourgeois Gentilhomme (Der Bürger als Edelmann). Vienna Philharmonic, Krauss. London LL 684

This really delightful bit of period music, semi-chamber style (small orchestra of soloists) with a fine whiff of the 17th century, of Moliere's play and Lully's music—rewritten by Strauss—is given a good Viennese performance here but in spite of Krauss' supposed reputation for humor (see album notes) this strikes me as not as rich an exploitation of the Straussian satire as that by Reiner on the earlier Columbia LP, (ML-2062) which I think comes from disc originals.

Contradiction—after my objections to Reiner's Mendelssohn, above? Not quite. Mendelssohn and Strauss are worlds apart; Strauss was a rapier composer, sharp, brilliant; Reiner is a conductor to match. Mendelssohn needs a sweeter, warmer treatment—Fricasay's.

An excellent disc from the standpoint of quality, which is good enough reason for considering it.

45 EXTENDED PLAY

The 45 longish-play disc discussed in these columns not so far back has been spreading rapidly. Most of that spread has been in the expected and conventional semi-pops and light collection area—witness in particular RCA's own Extended-Play catalogue. I'm not the one to quarrel with the economics of this. 45 probably scoops in the cash in this form and, I'll admit, it is bringing some astonishing sounds to the nation's juke boxes—enough to stop any long-hair musician in the midst of his dog-wagon cup of coffee. (You can get a whole Beethoven sonata in the original—not jazzed—for two nickels!)

But, semi-pops or no, fact remains that 45-ext. opens up an attractive area in the so-called classical field. Urania seems to be the most alert, right now, to this interesting opportunity and the Urania 45 series, nicely packaged with full album notes, is an intelligent culling from the existing catalogue, removing one-sided LP works to independent existence, excerpting salient items from longer pieces, etc.

In common with other Uranias, a lot of these are of so-so quality (they come, I hear, from earlier German radio tapes) with considerable distortion in the louder parts. Here are the better ones from the first list. All are worth a try:

- De Falla: Three-Cornered Hat Dance. 45 UREP 11**
- Strauss: Wiener Blut; Overture, Waltz and Duet. 45 UREP 5**
- *Wagner: Tannhauser; Elizabeth's Greeting, Evening Star. 45 UREP 13**
- Prokofieff: Love for Three Oranges Suite. 45 UREP 7**
- Berlioz: Roman Carnival Overture. 45 UREP 9**
- Beethoven: Piano Music (Polonaise, Vars. on Turkish March.) Steurer. 45 UREP 15**

ODDIANA

Early Italian Music. Leopold Stokowsky & His Symphony Orchestra, Brass Choir, Chorus. RCA Victor LM 1721

"Freely transcribed by Leopold Stokowsky"—how that takes us back to the pre-war days of Bach-Stokowsky and the rest of those hyphenated horrors! Not that Stoky didn't spread a taste for the old masters, and it must be admitted that he represented, in a backwards sort of way, a budding interest in "our great musical heritage" on the part of the larger musical audience.

In reasserting, here, his old self as classical popularizer, Stoky mainly shows us how tastes have changed—a bit. Same old pompous, heavy-weight ultra-slow style of playing, with the well-remembered swellings and dyings-away, calculated to flutter the naive musical heart. (Evidently, in his mind, nobody played anything fast until After Bach.) But here we have new appeal—instead of the old-time full symphony orchestra we have chorus, organ, brass, approximating more nearly the original forces. A big concession to our recent feeling that music ought to be heard as intended, un-doctored. Well . . . only a little doctored.

Best item (and only one I can listen to without getting the creeps) is the Gabrieli "In Ecclesiis", with large organ, mixed chorus, boys' chorus, brass choirs.—Stoky gets over the feeling of ultra-magnificence of sound that undeniably was intended in this display music for St. Mark's cathedral in Venice.

dd Scarlatti (A.); Cantata "Sulle Sponde del Tebro". Mozart: Marcia #2; Recitativo and Rondo "Mia Speranza", K. 416. Teresa Stich-Randall, Scarlatti Orch. of Naples, Baumgartner.

Colosseum CLPS 1035

Here's another approach to the old music—typically Italian. The Italians have their own peculiar way of "modernizing" as far as I can see, which involves instead of the slow-as-molasses treatment, a kind of breathless exaggeration, with much gusty sighing and carrying-on, at the proper tempi more or less; the instruments are often technically correct for the music, as here in the Scarlatti, but the performance is something else again.

This album is labelled LIVE MUSIC— a new twist on the old practice of taking down a public concert for issue on records! It reflects, I think, the unfortunate aspects of that easy practice. Not only subdued coughs, which are unimportant. More significant is the division of interest which brings us in America a soprano who may have had local interest for the Italian audience but is not at all suited to the music, either Scarlatti or Mozart—the latter being wholly beyond her vocal powers. Moreover, she is the type who suddenly sings very loud, then as suddenly dies away; concert conditions made an impossible situation for the recording engineer, who took what came his way: result is poor balance, much sudden blasting, acute aural indigestion for the record listener.

And yet—these are worthwhile pieces, decidedly. The Mozart is a stunning Italian-style aria of great virtuosity, the Scarlatti, by the early pioneer of opera-oratorio in the 17th century, is an equally fine work, dulled by the singer's gusty vocal treatment, in spite of good instrumental playing.

We've had enough of this tantalizing half-baked music on LP. Let's stick to more careful work, with the recording as the primary consideration, not a mere incidental.

The old truth remains, in spite of LP—the recorded listening medium is unlike that of the live concert, and it is basically unsuited to the preserving of publicly heard music in concert form. The psychological difference between once-only, on-the-spot listening and listening via records (with repeats ad infinitum) is permanently immense. A good recorded concert is a freak of luck, and every performing musician knows it. Better not to tempt fate, for a little cash saving.

Cavalli: Il Guidizio Universale ("Universal Justice"). Chorus, soloists, orch. of "Societa del Quartetto".

Colosseum CLPS 1032

This, a Vatican Radio production, is also labelled LIVE PERFORMANCE—but, to do

Colosseum justice, it is an excellent recording. The answer, aside from more competent performers, is I'd say in that this is a radio performance, not a public concert. Audience or no, a performance set up primarily for radio runs a lot better chance of becoming a good record than a public concert.

Cavalli, another 17th century Italian experimenter, writes a really dramatic oratorio, with all the elements that went later into the great Handel works and the like. A serious lack here—there is no text and we are in the dark as to what's happening. An excellent performance, with good singers, chorus, solos, plenty of life and a minimum of fancy affectation. The music, under these circumstances, tells its own story most effectively.

Sorry, Wrong Number. by Lucille Fletcher, Agnes Moorehead, supporting cast.

Decca DL 6022

A concentrated bit of horror for you if you feel inclined to witness murder. Pussonally, I'd call it pretty far-fetched and definitely morbid—don't let the kids get it. But this was a famous radio thriller and with reason. Lady, in bed with her telephone, gets a knife in her, after two LP sides of hysterics.

From Barrelhouse to Bob. Piano stylings by John Mehegan, with narration. C. Mingus, bassist.

Perspective PR 1

This young gent tells about the big men of ragtime, blues, etc. while strumming soft piano, then plays in their style, one by one. A bit confosin'—I thought at first these were historical recordings. He does 'em all himself. Improvisations, "after" the original. He writes a good script, but he can't read it—sounds like junior high school stuff. Diction lessons—or somebody else's voice—is in the answer. An interesting use of the LP medium.

Schubert: Quartettsatz (movement from a quartet) in C minor. Wolf, Italian Serenade. Koeckert Quartet.

Decca DL 4044

This is as strikingly fine playing of Schubert as you'll likely hear—and the piece is an unforgettable one, full of Schubert melody and that strange eerie tension, midnight witchery, that was so much in style at the time, early 19th century. An ideal quartet sound, too—full, rich, not too sharp yet plenty clear. The Wolf work is good too, though not up to the Schubert. If you want just one sample of quartet playing, try this, by all means.

Music of the Arab People. Toraria Orch. of Tangiers.

Esoteric ES 2002

Another of Jerry Newman's peripatetic recordings, with Telefunken and Ampex 401-A. Authentic enough, this—the Arab version of local cafe music, sung in odd Eastern ways and played on traditional instruments. A Western "beat", steady and pounding, but otherwise very Eastern. The relationship of this to Spanish gypsy music is clear enough to any ear. Super hi-fi, but take it in small doses!

of A Tribute to Lotte Lehman (Songs of Schubert, Mozart, Brahms, Schumann, Franz, with piano).

RCA Victor LCT 1108

No amount of hi-fi could have made Lotte Lehmann more intelligible than she is, in her own way, in these wonderful reissues of 78's from 1935 to 1940. Lehmann flatted plenty of notes and she wobbled on more. Outwardly, her middle-aged voice was nothing much. But—if you can break through the language barrier, so to speak, get the sense of the tunes, the harmony, the words, you may discover for yourself why this lady has been one of the greatest conveyers of musical emotion in our time. Nobody else can touch her, especially in the Schubert.

Play this disc with flat highs—no roll-off at all; otherwise they'll sound strictly sofa-pillow. The originals were probably flat in the high end and for some reason RCA has got them onto LP disc in the same way.

Always in Stock
at **ALLIED**

world's largest
selections of Professional
and Home Quality
Audio Components



get and use
the 236-page
buying guide

- complete music systems
- all famous-make amplifiers
- speakers & enclosures unlimited
- widest selection of tuners
- all phono components
- tape and disc recorders
- everything in microphones

IF IT'S ANYTHING
IN AUDIO, IT'S
IN STOCK AT
ALLIED

ALLIED RADIO

833 W. Jackson Blvd., Dept. 17-D-3, Chicago 7, Ill.



NEW PRODUCTS

• **Step-Type Frequency Oscillator.** Choice of seventeen fixed frequencies is obtainable at the turn of a single knob with the new oscillator manufactured by Pulse Techniques, Inc., 1411 Pallsade Ave., West Englewood, N. J. Although it weighs only 7 lbs., the instrument offers a standard of accuracy, stability, and low distortion which is well within accepted require-

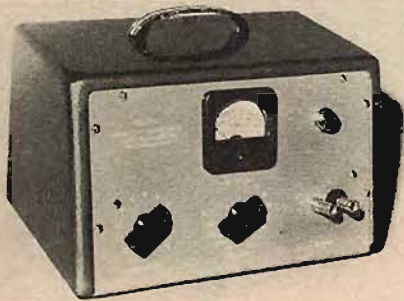

ments for laboratory and production line testing of amplifiers, filters, recorders, and similar devices. Portability makes it ideal for field maintenance and testing. A unique gain-stabilizing circuit holds amplitude variation within 0.2 db over the entire frequency range. Use of toroidal coils assures frequency stability well within 1 per cent. Signal-to-hum ratio of 60 db prevails at all output levels, and known resistive output impedance is provided through use of a "T"-pad attenuator. Distortion is less than 0.7 per cent. Frequencies provided on standard model cover the audio range, although other frequencies are available and any 17 will be provided on request.

• **Recording Head Demagnetizer.** Excessive noise level in tape recordings caused by accumulation of permanent magnetism in the recording heads can be prevented through use of an a.c. magnet assembly now available from Audio Devices, Inc.,

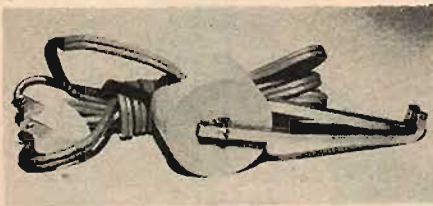

444 Madison Ave., New York 22, N. Y. Designed to remove any residual magnetism from recording heads of tape recorders, the Demagnetizer has extended pole pieces to fit the contours of all heads currently available. Use of the device requires only a few seconds. It is supplied complete with cord and plug for connection to standard a.c. outlet. Since high noise level may be caused by factors other than residual head magnetism, the unit is sold with the provision that it can be returned for credit if results are not satisfactory.

• **Tiny Mercury Batteries.** Rapidly expanding use of junction-type transistors in hearing aids and other miniature electronic equipment has resulted in the introduction of a new line of low-voltage, miniaturized mercury cells and batteries by P. R. Mallory & Co. Inc., Battery Division, North Tarrytown, N. Y. Known respectively as "Energy Capsules" and Power-Pak batteries, the new units are designed to meet the specific requirements and characteristics of transistor operation, including increased energy per unit volume, long service life, constant discharge characteristics, and extended shelf life. Batteries are coated with a "shrink-on" plastic to provide a tight, leakproof seal between cells. They maintain a substantially constant voltage and current output level over wide temperature ranges at drains ranging from 10 microamperes to 10 ma.

• **Sound System Control Console.** Complete control of an extensive sound system is afforded by the new RCA Type MI-14937 control console. Designed for use in schools, hospitals, hotels, and industrial plants, the unit is designed to provide recorded programs, radio programs, or live material of local origin to selected areas or to all areas reached by the sound sys-



tem with which it is used. Up to 20 rooms or areas are served by the console in its standard form, but it can be expanded to handle up to 60 circuits if required. Provision is made for adaptation of the program channel for intercom use when desired. The console may be mounted on a standard desk or table, or on any of several RCA cabinet bases to form a complete program control center. Full information will be supplied by Engineering Products Department of the RCA Victor Division, Radio Corporation of America, Camden, N. J.

• **Matched Hi-Fi Radio-Phono System.** Tuner, three-speed record changer, amplifier, speaker, and magnetic cartridge are all included in the new packaged home music system recently announced by Meissner, Mt. Carmel, Ill. All units are matched in attractive gold-finish styling. In addition to major components, the system is supplied complete with all



mounting hardware, matched knobs and escutcheons, shock mounts, and cabling, plugs and jacks for interconnection. Changer is equipped with muting switch for silencing the system during changing cycle. Tuner features high-gain front end, with frequency response flat within ± 2 db from 50 to 15,000 cps. Ten-watt amplifier has separate bass and treble controls providing both boost and attenuation. Amplifier frequency response is flat within ± 1 db from 20 to 20,000 cps. Speaker is rated at 20 watts and uses two coaxially-mounted cones driven by a single voice coil. The new system will be merchandised through radio parts distributors. A brochure, describing the system in detail, is available from the manufacturer.

• **Attenuation Network.** A direct-reading precision attenuation network designed for operation over the 0-to-1-mc range, the new Daven Type 790 is particularly useful in gain and loss measurements on filters, transformers, and amplifiers. Non-inductively wound, the 790 is mounted in series on an alumilited panel and housed in an attractive metal case. Each decade dial



provides 10 steps of attenuation. Each individual decade is shielded in a brass housing, and all decades are grounded to the front panel. Among the 790's outstanding features are: extreme accuracy over a range extending into the low r-f spectrum; wide range of attenuation in small db steps; stops and detents are positive and prevent over-travel. Both balanced "H" and "T" networks are available, as are networks for various impedance requirements. Full technical information may be obtained by writing direct to The Daven Company, Dept. AT, 191 Central Ave., Newark 4, N. J.

• **Mixer-Preamplifier.** The new Masco Type EMM-8 mixer greatly expands the usefulness of tape recorders and other single-input devices, by permitting the simultaneous use of up to four microphones, plus radio tuner and phonograph.



The amplification provided on all six inputs, of which four are mixing channels, plus a cathode-follower output, allows placement of the unit up to 400 feet from the amplifier or recorder it is feeding. Output is 1.0 volt r.m.s. Harmonic distortion is less than 0.75 per cent. Response is 50 to 15,000 cps ± 2 db. Three 12AX7 tubes are used, plus selenium rectifier. Mark Simpson Mfg. Co., 32-28 49th St., Long Island City 3, N. Y.

• **Magnetic Record-Reproduce Heads.** Improved uniformity, wider frequency response, and extended life are features of a new line of magnetic heads now being produced by Stancil-Hoffman Corporation, 921 Highland Ave., Hollywood 38, Calif.



The new heads have the same physical appearance as the Model TD-704, formerly

manufactured by Indiana Steel Products Company. Stancil-Hoffman has taken over all of this company's magnetic head activity. The excellent qualities of the new heads result from improved production procedures which have been originated by Stancil-Hoffman. Standard heads record a track 0.2 in. wide. Full technical particulars will be supplied on written request.

• **Smallest Transformer.** Designed primarily for use with transistors, a new line of iron-core ultra-miniature transformers recently introduced by Standard Transformer Corporation, 3580 Elston Ave., Chicago 18, Ill., are described as the

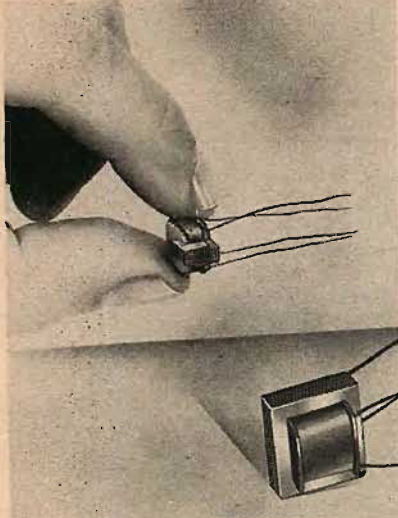

world's smallest of their type. Weighing less than one-tenth of an ounce, the new Stancor units measure as little as $\frac{1}{4} \times \frac{1}{2} \times \frac{1}{8}$ in. and are no larger than the transistors they are designed to power. While they are intended essentially for transistor audio applications, they can be used wherever low power is involved. Useful below 1 mw power level, they are wound on molded nylon bobbins, with special nickel alloy steel laminations. Various types are available for input, interstage, and output or matching applications.

LETTERS

(Continued from page 10)

"Now," I mumbled, looking over my amplifier controls built on the pattern of a B-29 control panel, "what compensation do I use for this?" Something induced me to read the back of the record case, and there it all was: the family trees of everyone concerned with the recording, a plain statement—in English—that it took the AES curve, everything excepting barometric pressure and temperature at the time.

Wouldn't it be marvelous if every recording company could be induced to publish this information on the sheath—or even better, on the record? There are so many companies recording, and many of the records are from abroad.

Pouring the first signal into a new amplifier with a pair of 3C33's in push-pull-parallel (*country home, no doubt.* Ed.) and getting a sine wave that looks like a Japanese pagoda struck by lightning is a blow from which one can recover, with patience. Having a record with an unknown compensation curve is definitely not a joy forever. I hope we can enlist ETC in such a campaign, for he impresses one as a person who won't believe things even after he has proved them.

You don't have to be nuts to be a 101 per cent audiomaniac, but it helps immensely.

DWIGHT B. JONES
Night Managing Editor,
The Pioneer Press,
St. Paul, Minnesota.

Hear It BETTER Now!



PEDERSON PRT-1 PREAMP TONE CONTROL \$99.50 net

A precision built all-triode equalizer preamp, the PRT-1 is ideal for use with any power amplifier. All equalization and tone controls are of the preferred step type. Low distortion and wide band operation are made possible through an entirely new circuitry utilizing a cathode coupled, grounded grid dual triodes in each isolated tone control stage. Treble control: 10 positions; Bass control: 11 positions; Low frequency phono equalizer: 6 crossover positions; High frequency equalizer: 5 roll off positions; Tubes: 5 12AXT's, 1 6X4; Size: $15\frac{1}{2}'' \times 9\frac{1}{4}'' \times 5\frac{3}{4}''$; Weight: 13 lbs. Cabinet in blond or mahogany, \$12 net.

PEDERSON W-15 WILLIAMSON AMPLIFIER \$129.00 net

Featuring a new high in performance, the W-15 gives you the exact circuitry laid down by Williamson PLUS every laboratory technique developed in the Pederson Laboratories. Power output: 15 watts; Frequency response: ± 0.1 db, 10 cps to 35 KC; ± 2 db, 5 cps to 150 KC; Hum & noise level: 90 db below; Sensitivity: 1.5 volts; Power consumption: 105-125 volts, 60 cps, 130 watts; Tubes: one 6J5, two 6SN7GT, two KT66, one 5V4G. All coupling condensers are oil impregnated, plastic cased, molded paper type. All transformers are specially built to specifications by Triad. Size $13\text{-}7\frac{7}{8}'' \times 7\frac{1}{2}'' \times 7\frac{3}{4}''$; Weight: 33 lbs.



GARRARD RC-80 3 SPEED CHANGER \$41.45 net

The world-famous Garrard has been acclaimed by music lovers everywhere. Plays all speeds and all sizes automatically . . . including switch-off at end of last record. Complete with automatic 45 RPM spindle and 2 empty cartridge shells.

BOZAK B-199 WOOFER \$38.72 net

Offering a new sense of orchestral fullness, the B-199 gives you true pitch and unmuffled tone. Output: 12 watts, peaks to 18; Impedance: 8 ohms; Frequency response: 40-4500 cps; size: $12\frac{3}{4}'' \times 5\text{-}7\frac{7}{8}''$; Weight: 8 lbs.



BOZAK B-200X DUAL TWEETERS \$22.72 net

Here is listening pleasure entirely free of the usual shrill tones. A unique system of rubber damping gives you an amazing degree of smoothness. Power output: 5-8 watts; Frequency response: 1500-13,000 cps; Impedance: 16 ohms; Weight: 4 lbs.



Write for Free Hi Fidelity Booklet, Music of the Masters



LEONARD-RADIO-INC.

69 CORTLANDT ST., NEW YORK 7, N. Y.

Audio Mart

CORTLANDT 7-0315

Dept. A 43

The House Built on Service

New Portable Battery-Operated Spring-Motor Tape Recorder



The Magnemite*

For all field recording without AC power! Smaller and lighter than a portable typewriter, the Magnemite* actually makes field recordings that can be played on any studio console equipment. Completely self-powered, the Magnemite* goes away with bulky and cumbersome generators, storage batteries and rechargers.

Just check these unusual features:

- Noiseless and vibrationless governor-controlled spring-motor assures constant tape speed.
- 100 operating hours per set of inexpensive flashlight-type dry cell batteries.
- Earphone monitoring while recording, and earphone playback for immediate quality check.
- Operates in any position, and is unaffected by movement or vibration during operation.
- Warning indicator tells when to rewind, and shows when amplifier is on.
- Broadcast models weigh 15 pounds. Slow-speed models weigh only 10 pounds.
- Requires no more desk space than a letter-head, measuring only 11 x 8½ x 5½ inches.

There's a choice of 5 different models for any recording need. High fidelity units, meeting primary and secondary NARTB standards, which record and play back frequencies up to 15,000 cycles, are available for broadcast stations, critical music lovers, and scientific research. For investigation, missionaries, reporters, and general dictation while traveling, there are units which play up to 2 hours per reel of tape.

Write to Dept. A today for complete descriptive literature and direct factory prices.



**AMPLIFIER CORP.
of AMERICA**

398 Broadway, N. Y. 13, N. Y.

*Trade Mark Reg

FEEDBACK

(from page 23)

$$E_p = -\mu E_g \frac{Z}{r_p + Z}$$

$$A = -\mu \frac{Z}{r_p + Z}$$

$$\beta = \frac{I}{A} = -\left(\frac{1}{\mu} + \frac{r_p}{\mu Z}\right) = -\left(\frac{1}{\mu} + \frac{1}{g_m Z}\right)$$

which is simply applying the normal tube and circuit parameters to the Barkhausen criterion. In this particular case

$$E_{fb} = E_g$$

$$\beta = \frac{E_g}{E_p} = -\frac{j\omega M I_s}{(R + j\omega L) I_s} = \frac{-j\omega M}{R + j\omega L}$$

Also,

$$Z = \frac{(R + j\omega L)(1/j\omega C)}{R + j\left(\omega L - \frac{1}{\omega C}\right)}$$

Now substitute β and Z into the Barkhausen criterion:

$$\frac{-j\omega M}{R + j\omega L} = -\left[\frac{1}{\mu} + \frac{1}{g_m} \cdot \frac{R + \left(\omega L + \frac{1}{\omega C}\right)j}{(R + j\omega L) \frac{1}{j\omega C}}\right]$$

$$j\omega M = \frac{R}{\mu} + \frac{j\omega L}{\mu} + \frac{R + \left(\omega L - \frac{1}{\omega C}\right)j}{g_m (1/j\omega C)}$$

$$\frac{1}{\mu} + \frac{1}{g_m} \cdot \frac{j\left(\omega L_p + \omega L_g - \frac{1}{\omega} \cdot \frac{1}{C_p + C_g + C_{gp}}\right)}{j^2\left(\omega L_p - \frac{1}{\omega C_p}\right)\left(\omega L_g - \frac{1}{\omega} \cdot \frac{1}{C_g + C_{gp}}\right)} - \frac{j\left(\omega L_g - \frac{1}{\omega C_g}\right)}{j\left(\omega L_g - \frac{1}{\omega} \cdot \frac{1}{C_g + C_{gp}}\right)} = 0$$

$$\frac{1}{\mu} - \frac{1}{g_m} \cdot \frac{j\left(\omega L_p + \omega L_g - \frac{1}{\omega C_o}\right)}{\left(\omega L_p - \frac{1}{\omega C_p}\right)\left(\omega L_g - \frac{1}{\omega} \cdot \frac{1}{C_g + C_{gp}}\right)} - \frac{\omega L_g - \frac{1}{\omega C_g}}{\omega L_g - \frac{1}{\omega} \cdot \frac{1}{C_g + C_{gp}}} = 0$$

where

$$C_o = C_p + C_g + C_{gp}$$

and:

$$\frac{1}{\mu} + \frac{1}{\omega L_g - \frac{1}{\omega} \cdot \frac{1}{C_g + C_{gp}}} \left[-\frac{1}{g_m} \cdot j \frac{\omega L_p + \omega L_g - \frac{1}{\omega C_o}}{\omega L_p - \frac{1}{\omega C_p}} - \omega L_g + \frac{1}{\omega C_g} \right] = 0$$

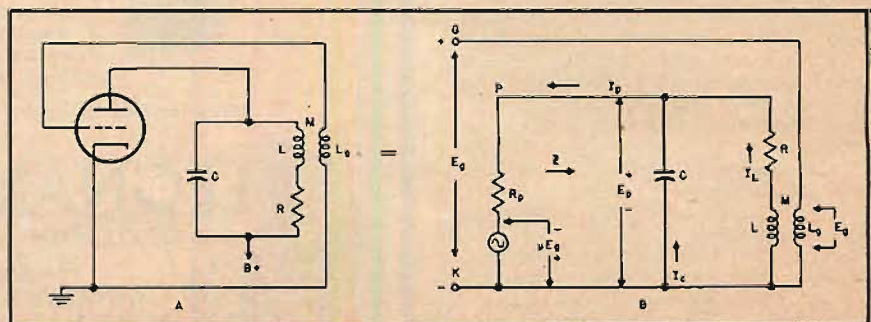

Fig. 4. (A) A simple feedback amplifier, and (B), its equivalent.

$$\frac{R}{\mu j\omega C} + \frac{L}{\mu C} + \frac{R}{g_m} + \frac{j\left(\omega L - \frac{1}{\omega C}\right)}{g_m} - \frac{M}{C} = 0.$$

This is the circuit requirement for oscillation.

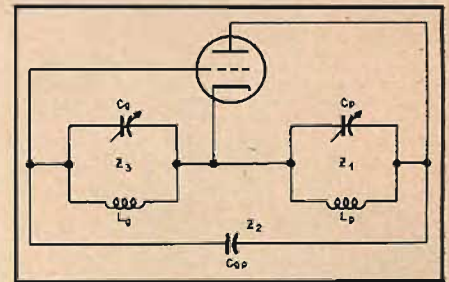

Fig. 5. A simple, tuned-grid, tuned-plate oscillator.

Similar analysis may be performed for any configuration. One other is here given as illustrated in Fig. 5. This becomes at once evident as a tuned-grid, tuned-plate oscillator.

$$Z_1 = j\left(\omega L_p - \frac{1}{\omega C_p}\right)$$

$$Z_2 = -\frac{j}{\omega C_{gp}}$$

$$Z_3 = j\left(\omega L_g - \frac{1}{\omega C_g}\right)$$

Completing the general Barkhausen criterion, we have:

The generalized criterion used above depends on the assumption of circuit linearity and inductances of zero resistance for simplicity. It can be shown that

$$\frac{1}{\mu} + \frac{1}{g_m} \cdot \frac{Z_1 + Z_2 + Z_3}{Z_1(Z_2 + Z_3)} - \frac{Z_3}{Z_2 + Z_3} = 0$$

is required for oscillation.

HOUSE OF COMMONS

[from page 38]

nical features which are considered of unique interest.

The system contains 23 microphones, all being of the single-element unidirectional type. Each has its own preamplifier. Three spare preamps are provided as standbys. Both inputs and outputs can be connected as desired by remote control, the outputs being fed to relays which are interlocked with the speaker muting circuits. The same relays also operate indicator lamps, showing the state of the equipment at any time.

Output of the selected preamplifier is fed to a buffer amplifier through the main control panel. The buffer incorporates frequency correction circuits, and also acts as a driver for the power amplifiers.

Output of the power amplifiers is connected to 19 speaker groups comprising a total of 550 speakers. The speakers are fed through the muting panel which provides level adjustments for the various groups, dependant upon the microphone in use. Also included in the output circuit are volume indicators showing power being delivered to the loudspeakers.

Full monitoring facilities are provided at the control panel, while the main equipment room contains, in addition, a comprehensive test unit permitting all aspects of the system's performance to be checked without interrupting operation.

Individual level controls are provided for each microphone in addition to a conventional master volume control.

Although the entire system was designed with superb audio performance as its chief objective, primary consideration was also accorded the need for esthetic value in appearance, and the fact that it must not interfere in any manner with normal parliamentary procedure.

How effectively these objectives have been achieved is well proved by the large number of engineers, sound technicians, and architects who have inspected the installation with the thought that it may influence their own future activities.

The Connoisseur of Sound

SELECTS

DIACOUSTIC DEPENDABLE

DIAMONDS*

for

R. C. A. - G. E. and other Reproducers

Standard or Microgroove

Diacoustic Revolving Resharpen Service for

Sapphire^s Cutting Stylⁱ

Custom Made and Guaranteed Under Capps Patents

Literature and Prices on Request

Diacoustic Laboratory

Since 1928

P. O. Box "P" Phone STate 4-0881

Encino, California

^sSynthetic

*Genuine

A New Development!

WHITE SOUND

WITH THE

New Revolutionary Amplifier Circuit

WHITE SOUND AMPLIFIERS

White Sound's new circuit has established a New High in the realistic reproduction of music. The finest electronic components, precision engineering and White's new design combine to give you Ultra High Fidelity.

- Cross-Coupled Amplifier Circuitry
- Balanced Drive • Tapped Screen Output
- Balanced Impedance Phase Inverter

Exclusive! Non-resonant Cross-Over Circuit
• Cross-Over (24db./ Octave) at the Input of Dual Channel Amplifier.

Model 1010, 10 watts. Model 1020, 20 watts
Model 2010, Dual Channel Amplifier with the Model C-101, Cross-Over Network.

WHITE CABINET SPEAKERS

- A True Exponential Horn (within 1%) ... Coupled to Speaker through a New Unique Phasing Device and Sound Trap • Nine foot Horn compactly Curled into Non-Resonant Cabinet • Response: 15-18,000 cps • White Cabinet Speakers offered in 4 Sizes ... 3 Finishes ... 5 Prices.

For Complete Information, see your Distributor
or Write to Department H-3

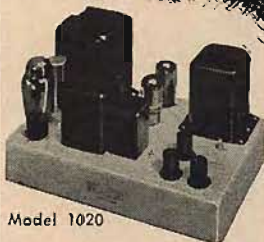

Model 1020

Ultra High Fidelity



Model 3422
15-18,000 cps.

105 W. MADISON ST. **WHITE SOUND, INC.** CHICAGO 2, ILLINOIS



Plug-in Broadcast PROGRAM/MONITOR AMPLIFIER

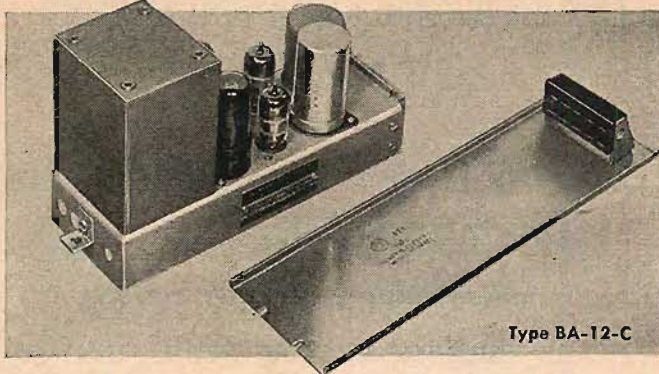

- **PLUG-IN DESIGN**—simplifies maintenance.
- **VERSATILE**—Fulfills all medium and high-level audio system requirements. Up to 8-watt output when used as a Monitor Amplifier.
- **EXCELLENT FREQUENCY RESPONSE**—Features low distortion and noise level.
- **COMPACT...YET HIGHLY ACCESSIBLE.**

The G-E Plug-in Broadcast Audio line includes:
 BA-1-F BA-12-C BP-10-B
 PRE-AMP PGM/MON AMP POWER SUPPLY
 For information write: General Electric Company,
 Section 4443, Electronics Park, Syracuse, New York

GENERAL ELECTRIC

VOLUME CONTROLS

(from page 40)

3-db drop at 1000 kc without the volume control, there would actually be a drop of 3 db at about 4000 cps at this position of the volume control.

We find, consequently, that the resistance of the volume control is rather stringently limited by the capacitance into which it must work. As an example, suppose we had a 12AY7 stage with an output resistance of 20,000 ohms working into a 6SL7GT with an input capacitance of 100 μ f. At best, there will be a drop of 3 db at 80 kc. Suppose further that we cannot tolerate a drop of more than 3 db at 50 kc in this particular stage. Then the maximum output resistance at any position of the control must be 32,000 ohms. To find the maximum permissible volume control resistance we use Eq. (4) with 20,000 ohms for R_1 , 32,000 for R_{om} , and solving for R_2 we obtain $R_2 = 108,000$ ohms, and a 100,000-ohm control would be used.

Suppose we are more exacting and state that the high-frequency response with the volume control must never be any poorer than without it. This is the same as saying that R_{om} in Eq. (4) must be the same as R_2 :

$$\frac{R_1 + R_2}{4} = R_2$$

$$R_1 = 3R_2 \quad (5)$$

To realize this performance in the case just described we should have to utilize a 60,000-ohm control. That these values are much lower than those commonly in use will readily be recognized.

The installation of a volume control thus appears to be somewhat more involved than simply inserting a 1-meg. potentiometer at the amplifier input. In particular, the use of relatively low values is indicated in cases where the control is working into appreciable capacitance.

THREE CHANNEL

(from page 28)

quency channels. Its output feeds a low-pass R-C filter network in the grid circuit of V_{1b} , and a high-pass filter in the grid circuit of V_{2b} . The multiple sections of these filters produce the desired steep attenuation slope. Potentiometer R_2 controls the level of the low-frequency signals fed to V_{1b} , the low-frequency amplifier channel. Likewise, R_{11} is the high-boost control feeding the high-frequency amplifier, V_{2b} . The plates of the three tube sections are tied together and are fed from a common plate resistor, thereby mixing and adding the signals from the three channels. Capacitor C_2 serves to couple the resulting output signal to the master gain control of the following audio amplifier.

WHARFEDALE

SUPER 12 CS/AL

A single extended range speaker that outperforms many multi-speaker combinations!

A complete range of speakers is available for every application... all built by Wharfedale Wireless Works under the personal direction of G. A. Briggs, world-renowned audio engineer

Aluminum voice coil... extended range without "peaking"

Cloth suspension... reduced resonance — improved transients

Bakelized cone apex... amazingly clear "highs"

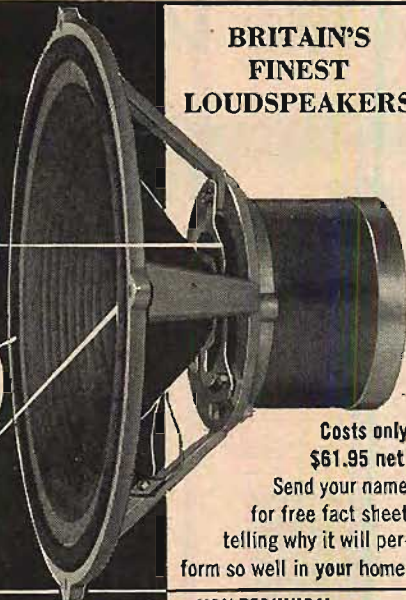

BRITAIN'S
FINEST
LOUDSPEAKERS

Costs only
\$61.95 net

Send your name for free fact sheet telling why it will perform so well in your home.

Loudspeaker \$1.60 Amplifiers \$2.95 Piano, Pianists, Sonics \$2.50



Loudspeakers
Speakers—Baffles
Acoustics—Frequency response, etc.

Amplifiers
Phase Splitters—Push Pull—Negative Feedback—Tone Compensation—Circuits, etc.

Piano, Pianists, Sonics
Touch and tone—Tuning—Toning—Oscillograms of sounds, etc.

**NON-TECHNICAL
SIMPLE LANGUAGE**
Practical Informative
Only books of their kind written expressly for the layman. Simple, easy-to-understand language. Many illustrations and diagrams. At your jobber or send check or money order.

Dept. AE 4
BRITISH INDUSTRIES CORP.,
164 Duane St., N.Y. 13, N. Y.

SOUND HANDBOOK

(from page 32)

The equations for the dual element L-C network are derived from expressions which state that the impedance of each capacitor and each inductor is equal to the impedance of each voice coil at crossover, multiplied by the square root of two:

$$\frac{1}{2\pi f C} = \sqrt{2} Z \quad 2\pi f L = \sqrt{2} Z$$

The impedance of the combination is treated as the impedance of one speaker.

When the woofer and tweeter voice coils have different values, and the circuit of (C) in Fig. 10-14 is used, the values of L and C associated with each speaker must be calculated independently. In such a case the rated input impedance of the whole network, as in the case of the single-element network, is treated as the average between the rated impedances of the two speakers.

Where the upper range is again divided up between speakers the network of (D) in Fig. 10-14 is used. This circuit is derived from that of Fig. 10-15 (C); the input leads to the latter's tweeter are treated as the source for the new two-way system of middle and high range speakers. Using the same equations as for the original two-way system the values for the sub-network may be calculated independently, on the basis of the new crossover. The total impedance is still the average.

The value of speaker impedance used for all of the above calculations will probably be fairly close to the nominal impedance, depending on the crossover frequency used; the value for Z at particular frequencies may be estimated, requested from the speaker manufacturer, or measured as in Fig. 10-15. The variable resistor in this test set-up is adjusted until the voltmeter indications are the same in both positions.

The crossover frequency is selected on the basis of the characteristics of each speaker. The advantages of a low crossover frequency are that intermodulatory products between the bass signals of probable greatest distortion, and the higher-frequency signals are avoided, the woofer can operate over the frequency range in which it moves rigidly, without break-up, and the radiation pattern of higher frequencies is not restricted by the large diameter woofer. The disadvantages are that the crossover network becomes bulkier and more expensive, and that the responsibilities placed upon the tweeter become much greater. Crossover points from several hundred to several thousand cps have been used successfully. When the crossover point occurs at a frequency region in which the output of one or both of the speakers is significantly accentuated (a common situation where the woofer is used for low treble signals) this condition may be relieved by a suitable shift of the roll-off of that speaker away from the crossover point. This is achieved simply by calculating L and C of the affected branch on the basis of the shifted crossover. Similarly, a

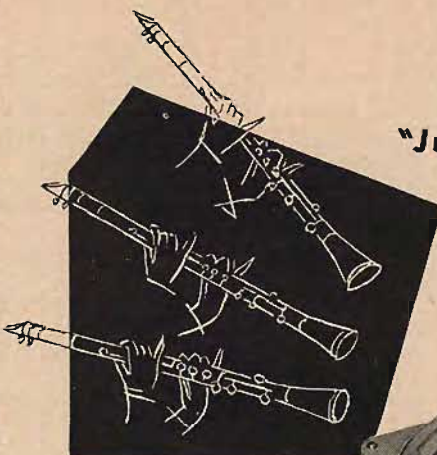

Concertone

"Just like being there"

The Clarinet, basic instrument of the woodwind section, has a fundamental response from 80 to 9000 c.p.s.; an overtone range extending to 15,000 c.p.s.

To faithfully capture and reproduce on tape the pure, round tones of the clarinet in its complete range requires the finest recording equipment.

The Concertone 1501 is the only tape recorder under \$1000 combining distortion-free full frequency response with all the tape handling facilities of professional equipment.

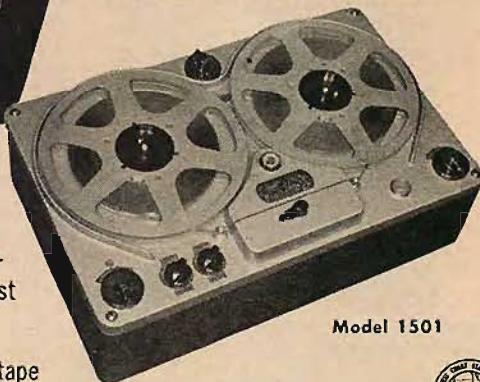

Model 1501

Write for Bulletin 200

Manufactured by

Berlant Associates

4917 W. Jefferson Blvd., Los Angeles 16, Calif.

NEW WILLIAMSON TYPE

Heathkit AMPLIFIER KIT

FEATURES

- Practically distortionless. Harmonic and intermodulation distortion both less than one half of 1% at 5 watts.
- Frequency response ± 1 db from 10 cycles to 100 kilocycles.
- Altec Lansing PEERLESS or ACROSOUND transformers available.
- First Williamson type Amplifier supplied with matching preamplifier.

When selecting an amplifier for the heart of a fine high-fidelity audio system, investigate the outstanding advantages offered by the Heathkit Williamson type Amplifier. Here is an amplifier that meets every high-fidelity audio requirement and makes listening to recorded music a thrilling new experience through naturally clear, lifelike reproduction of sound at all tonal levels. Wide acceptance of the Heathkit Williamson type Amplifier by the most critical purchasers clearly demonstrates that high-fidelity can be coupled with low cost. For factual information regarding the Heathkit Williamson type Amplifier, consult "CONSUMERS RESEARCH ANNUAL CUMULATIVE BULLETIN 1952-53."

This outstanding amplifier is offered with the optional choice of the ACROSOUND output transformer or the PEERLESS output transformer. ACROSOUND features ULTRA-LINEAR circuitry, which is the exclusive development of the Acro Products Company and provides a greater margin of reserve power efficiency and increases power output. PEERLESS features additional primary taps to permit the optional choice of either the extended power circuitry, now enjoying current popularity, or all of the advantages of the original Williamson type circuit.

The construction manual has been simplified to the point where even the complete novice can successfully construct the amplifier without difficulty. Write for a free catalogue containing complete specifications and schematics of the Heathkit Williamson type Amplifier.



PRICES OF VARIOUS COMBINATIONS

- W-2 Amplifier Kit (Incl. Main Amplifier with Peerless Output Transformer, Power Supply and WA-P1 Preamplifier Kit) Shipping Weight 39 lbs. Shipped express only. **\$69.50**
- W-2M Amplifier Kit (Incl. Main Amplifier with Peerless Output Transformer and Power Supply) Shipping Weight 28 lbs. Shipped express only. **\$49.75**
- W-3 Amplifier Kit (Incl. Main Amplifier with Acrosound Output Transformer, Power Supply and WA-P1 Preamplifier Kit) Shipping Weight 39 lbs. Shipped express only. **\$69.50**
- W-3M Amplifier Kit (Incl. Main Amplifier with Acrosound Output Transformer and Power Supply) Shipping Weight 28 lbs. Shipped express only. **\$49.75**
- WA-P1 Preamplifier Kit only. Shipping Weight 7 lbs. Shipped express or parcel post. **\$19.75**

HEATH COMPANY
BENTON HARBOR 25, MICH.

BLACK MAGIC!



found only in
PermoFlux

ROYAL BLUE SPEAKERS

T. S. C.* an exclusive PermoFlux development and the result of many years of laboratory research—truly a touch of "Black Magic"—increases cone compliance, adds octaves of frequency response, and gives startling realism to reproduction.

Royal Blue Speakers will bring you undreamed of fidelity—the Royal Eight comparable to any 12-inch speaker and the Royal Twelve superior to larger reproducers. Hear them both at your nearest Sound demonstration room. Look for the Blue cone—the emblem of high fidelity.

*Treated, Slotted Cone with permanently soft plastic impregnant.

Folded-Horn Enclosures



Home-level reproduction at its finest is achieved by Royal Blue Speakers in Folded-Horn corner enclosures. Two sizes are available: Model CH-8 for a single Royal Eight speaker and Model CH-16 for two Royal Eights or one Royal Twelve. Both sizes are offered in mahogany or blonde to suit your taste and your room decor.

See your PermoFlux Distributor or ask us for literature.

PERMOFLUX®

"SOUND IN DESIGN"

PERMOFLUX CORPORATION

4902 W. GRAND AVE., CHICAGO 39, U.S.A.
236 SO. VERDUGO RD., GLENDALE 5, CALIF.

Canadian licensee
Campbell Mfg. Co., Toronto, Canada

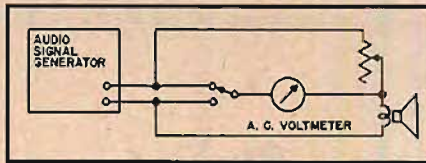

Fig. 10—15. Method of measuring unknown speaker impedance at a given frequency. The speaker impedance is numerically equal to the value of the resistance when the voltage drops across each are equal.

significant "hole" in the response curve may be filled in by a corresponding shift in the opposite direction.

An array of speakers assigned to different portions of the frequency spectrum may produce an unbalanced tonal structure due to varying efficiency from one unit to the other. Horn-loaded tweeters used alongside direct-radiator woofers, for example, normally require provision for attenuating the treble signal, and a horn loaded woofer should be given a correspondingly efficient tweeter. An L-type level control between the speaker (normally the tweeter) and the network feeding it [See (B) in Fig. 10—14] accomplishes this result without affecting operation otherwise.

The coils of the dividing network must have high power-handling capacity, and must not introduce non-linearity into the circuit. Non-metallic cores, which avoid the non-linear and power dissipating effects of core saturation and eddy currents, are suited to such requirements, and are made possible by the low values of inductance called for. Winding data appears at (A) and (B) in Fig. 10—16.

The capacitors must be non-polarized since they are in an a.c. circuit, and should have a working voltage rating of about 50 volts for safety. Although non-polarized electrolytic capacitors (two electrolytics connected "back-to-back") have been used in dividing networks, this practice is not recommended because of the lower reliability of electrolytics from the point of view of accuracy of rated value, changes of value with time, and failure in service. Good-quality paper or oil-filled capacitors are suitable.

Experimental Trends in Speaker Design

The logical extension of the use of negative feedback in amplifiers is to include the speaker moving system within the feedback loop. If the source of feedback voltage is an independent generating coil in the loudspeaker, inaccuracies in voice-coil motion as well as electrical inaccuracies in the amplifier will be corrected. Such a design was patented as long ago as 1925,² but has not, to date, been brought to commercial practicability. A successful feedback loudspeaker would go far in bringing instantaneous voice-coil velocity to a closer relationship with the electric signal. (The feedback principle has already been applied, with great success, to disc recording heads.) Paradoxically,

² J. P. Maxfield, et al., U. S. Patent No. 1,535,538.

however, the acoustic output of a voice coil with constant-velocity response would exhibit bass losses, due to the progressive drop of air-load resistance at lower frequencies. The shape of the acoustic frequency-response curve at the low end, corresponding to that of the graph of air-load resistance vs. frequency, would require that compensatory bass boost be introduced, and that the amplifier have a power capability sufficient to handle this extra boost.

A revolutionary principle of speaker design has recently been introduced in France. The "ionic" loudspeaker is a direct electro-acoustic device that bypasses the usual electro-mechanical stage. Agitation of the air molecules is produced by an electrostatic field rather than by the mechanical pushing and pulling of an intermediary cone or diaphragm, and since no mechanical moving parts are necessary the entire suspension system—the weakest link in loudspeaker design—may be eliminated.

The molecules which are controlled electrostatically are in an acoustical chamber which contains the stimulating electrodes. Since air molecules in their normal, uncharged state are unsusceptible to the influence of electric fields, the particles in the chamber are first ionized, or given a positive charge. This is done by heating the chamber, increasing random molecular movements and inducing collisions which knock off orbital electrons from some of the molecules. Once there are a few charged particles, an alternating field of super-sonic frequency is able to complete the ionization process by more of these electrically created collisions.

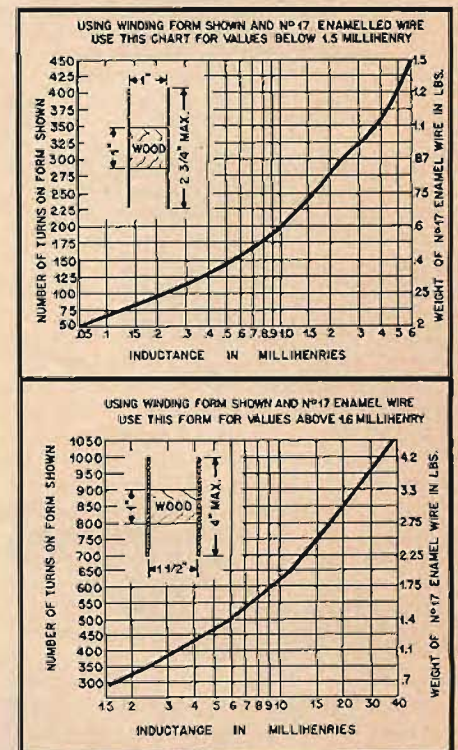

Fig. 10—16. Winding data for dividing network coils. Brass screws are used for the coil form. (From "Crossover Networks for Speaker Systems," Courtesy University Loudspeakers, Inc.)

The signal to be reproduced is applied as an amplitude-modulating voltage to the supersonic field, and the acoustical vibrations are coupled to the room through a horn. The field is of radio frequency, a fact which introduces an interesting feature. The output of an AM radio receiver requires only sufficient r.f. amplification before it is applied to the speaker, dispensing with the need for a detector and audio amplification stages.

REFERENCES

John G. Frayne, and H. Wolfe, *Elements of Sound Recording*, Chapter 30.
 Jensen Mfg. Co., *Impedance Matching and Power Distribution in Loudspeaker Systems*, Technical Monograph No. 2.
 H. F. Olson, *Elements of Acoustical Engineering*, Chapter 6.

PREAMPLIFIER DESIGN

(from page 20)

ohms for R_2 and 4 megs. for R_3 to obtain good compensation down to 20 cps for a 900-cps turnover. Actually the 6SJ7 is a poor choice for V_1 , for unless d.c. is used on the heaters one is likely to experience hum difficulties. The 6J7 would be more suitable in this respect, even though it will not provide quite as much gain. The high-level cartridge makes possible good bass compensation with a simple preamplifier using a twin triode such as the 12AX7, 6SL7, or 7F7. Triodes may be used in a preamplifier designed for use with a low level cartridge by following the basic amplifier with an additional stage of amplification as shown in Fig. 3. With a high-level cartridge the amplifier noise and hum level will be about 16 db lower with respect to the signal level than would be the case with the same amplifier and a low-level cartridge.

If the preamplifier is to provide for switching between various turnovers,

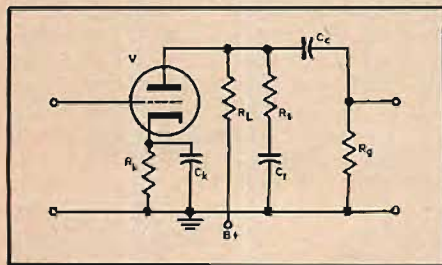

Fig. 4. Basic variable-load-impedance bass-boost amplifier circuit. Triode shown for simplicity.

the selector switch must be of the shorting type to avoid serious switching transients high-quality capacitors should be used for C_t , and a 10- to 20-meg. resistor must be placed in parallel with the selector switch for each switch position. These precautions are required because of the d.c. potential difference across C_t . The value of the switch-shunting resistors is not critical, but the combined resistance of all of them in parallel should be no less than about 40 times R_s .

"Compact Little Marvel of Tone"

THE NEW BOGEN DB10-1 HIGH FIDELITY AMPLIFIER



- 10 WATTS OUTPUT
- RESPONSE FLAT FROM 30 to 18,000 CYCLES
- SHOCK MOUNTED PREAMPLIFIER
- INDIVIDUAL BASS & TREBLE CONTROLS
- VIRTUALLY HUMLESS
- UL APPROVED



CALL OR WRITE FOR LITERATURE ON BOGEN HIGH FIDELITY EQUIPMENT



C. G. BURKE, WRITING IN THE SATURDAY REVIEW HOME BOOK OF RECORDED MUSIC HAS STATED:

"The Bogen DB-10 is a compact little marvel of tone . . . resourceful enough to compete over most of its range with amplifiers costing three times as much . . . It employs six tubes and is rated at ten watts . . . It has three input channels—one for strong-impulse magnetic pickups like the Pickering, one for weak impulse magnetic pickups like the GE, and one for tuner or crystal pickup . . . The tone controls—separate for bass and treble—are continuously variable providing both increase and diminuation, and are capable of surprisingly efficient rectification of the idiosyncrasies of records . . ."



DAVID BOGEN CO., INC. 29 NINTH AVE., NEW YORK 14, N. Y.

A Quarter Century of Electronic Equipment Specialization

MEASURE YOUR PHONOGRAPH'S PERFORMANCE

(no test instruments required)

PHONO-TEST D-100 is the first of a series of test records offered by THE DUBBINGS CO.... Basically a Re-recording Service, we have always believed that a need exists for a reliable test disc. This new 12" long playing record is the result of our intensive research...

(look for this cover)

HIT OF THE '52 AUDIO FAIR!
 Now you can check:

TRACKING • WOW • RUMBLE with confidence in the signal source. Added feature: 13 bands of frequency response, 30-12,000 cps.



WRITE US FOR THE NAME OF YOUR LOCAL DEALER or mail this coupon to:

THE DUBBINGS CO. • DEPT. AE-43 41-10 45TH STREET, LONG ISLAND CITY 4, N. Y.

ENCLOSED CHECK M. O. IS FOR: PHONO-TEST D-100 @ \$3.50, add \$.50 postage FREE Information on Re-recording Services

NAME..... ADDRESS..... ZONE (please print)

LOUDSPEAKER DAMPING

(from page 34)

The basic problem is one of separating the movement-generated voltage from the driving voltage so that only and at all times will the feedback signal resemble the actual cone movement, in-phase current feedback succeeds in doing this part of the time only. True it serves best during those critical periods of hangover, but hangover is only part of realism. It follows usually in the wake of transients which themselves would be much improved if motional feedback could be put to work on a full-time job.

Source of Feedback Signal

It is not difficult to produce separate and independent movement-generated voltages. Every microphone does it. A separate winding on the voice-coil former suggests itself but this is only a partial answer for it will have some mutual inductance with the voice-coil

Fig. 2. Typical circuit employed a movement-generated feedback voltage. The use of resistor R_1 is optional, since the feedback could be applied in any of a number of ways.

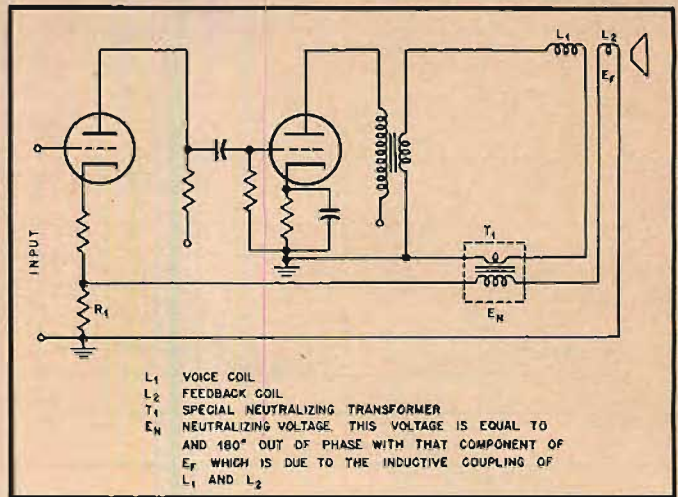

that will mean voltage will be induced in it other than that due to motion. The apparent solution is to shield the windings from each other magnetically. This seems a difficult problem since the pick-up windings should be as close as possi-

ble to the voice-coil from the standpoint of minimizing time lag between driving voltage and pick-up voltage. Such a time lag is due, of course, to sound traveling at a rather slow speed even through a solid. If it were not kept at a minimum serious phase shifts would occur at the higher frequencies and would limit the introduction and effectiveness of feedback. Another approach suggests itself and this is likely the simplest solution: use of neutralizing voltage. Feedback windings wound over a voice-coil, or near one end would be the same as a transformer; current through the voice-coil would induce a voltage in them. If another simple transformer of special design were used in series with the voice-coil to allow the same voice-coil current to produce a secondary voltage equal to that induced in the feedback windings it could be used to cancel the voltage so induced. This transformer could have a low-impedance primary since the secondary can consist of many turns to produce the right voltage. By this device then, it should be possible and feasible to use motional feedback with all the advantages that the principle implies. Figure 2 shows a suggested circuit.

Although the author has believed for some time now that a feedback signal due to voice-coil movement would be considerably better to use than any signal existing within an amplifier itself, this positive feedback discussion has helped to stimulate and crystallize thinking on the subject. It can be seen that theoretically the resulting improvements of using an independent feedback signal as described would not be limited to improved damping. It would act to make the voice-coil and cone follow more exactly whatever voltage wave-shape was applied, and at all times.

It is felt that much credit belongs to Warner Clements who seems to have stirred up this thing in the first place and to Ulric Childs who gave him some good arguments.

Authoritative and Enlightening...



Acknowledged the Leading Publication in the Field of Sound Reproduction

If you are novice, hobbyist, experimenter, or engineer... if you are a lover of music... and in pursuit of sound, undistorted... Audio Engineering will be your faithful, reliable companion all the way. You will find no more pleasureable and stimulating reading than there is in AE; absorbingly interesting material, valuable and authentic data, workable detailed instructions... all comprehensively and yet practically presented.

"What to Do" and "How to Do" will guide your every move through this thrilling experience we call Audio.

Each new issue brings New Ideas, New Slants, and Latest Developments... month in and month out... twelve times a year.

BE SURE to get your copies REGULARLY.

MAIL this Coupon NOW

AUDIO ENGINEERING

P. O. Box 629, Mineola, N. Y.

Enclosed is Check Money Order for \$_____ Please send a copy of each new issue of Audio Engineering for the next 12 months; 24 months to:

Please Print

Name _____

Address _____

City _____ Zone _____ State _____

Subscription Price: U.S.A., Canada and Pan American Union: 1 year... \$3.00 2 years... \$5.00. Other countries: 1 year... \$4.00 2 years... \$7.00.

Altec — Brook — Bell — Jensen

TEXAS-TV

"Southwest Sound Hq."

A corner of one of the Texas-TV air-conditioned Hi-Fi demonstration rooms in which all major lines of sound and recording equipment can be demonstrated at the "flick of a switch."

Electro-Voice Regency
handsome speaker enclosures for 15-inch single, double or 3-way systems. Kilpsch-licensed folded horn, low-boy style, in Korina blonde, \$120, rich mahogany. **\$114.00**

Altec 604C Loudspeaker
the ultimate in high-fidelity reproduction. 15-inch coaxial with cross-over net, GUARANTEED response from 30-22,000. **\$156.00**

Altec 601A Loudspeaker
12-inch duplex, little brother to 604C. Response GUARANTEED 30-22,000. World's best buy for the money! Includes cross-over. **\$89.00**

for prompt personal attention, write Jeff Smith at

TEXAS-TV
506 W. Hildebrand Avenue
San Antonio 12, Texas

Clarkstan — University — Ampex — Cabinart

GROMMES AMPLIFIERS

Model 50 PG
A high fidelity single unit amplifier with unusual performance. Power output, 10 watts, 20 watts peak. Distortion at 10 watts, 1% harmonic and 2% intermodulation. Frequency response ± 1 dB, 30 to 20,000 CPS at 10 watt level. **\$55.00**

Model 210 PA PRE-AMPLIFIER
Completely variable feedback equalization for reproducing records exactly. Response 6 to 100,000 CPS. IM distortion less than 1%. Calibrated step type controls. **\$99.50**

WRITE FOR CATALOG

PRECISION ELECTRONICS, Inc.
9101 King Avenue, Franklin Park, Ill.

The Columbia long-playing recording characteristic requires a 500-cps turnover with a maximum bass boost of about 14 db. For this compensation the capacitor used for C_t should have shunting it a resistor of such value as to provide in parallel with the resistor used for R_s an effective resistance for the R_s term in Eq. (5) that will give a value for A_{eff} which is five times the value of A_{av} for the amplifier. To avoid serious switching transients a blocking capacitor should be placed in series with this resistor. This blocking capacitor should be chosen so that the product of its capacitance (in farads) and the lowest frequency of interest is at least equal to the reciprocal of three times the resistance of the shunting resistor in series with it.

Variable-Load-Impedance Bass Boost

A simple, commonly-used type of bass boost circuit is shown in Fig. 4. R_k , R_t , and R_θ may be selected from resistance-coupled amplifier data to provide the maximum gain desired at the lowest frequency of interest. The requirements on C_o and C_k are the same as discussed for the basic amplifier in the degenerative-bass-boost circuit. The high-frequency gain is given by the product of the mutual conductance of the tube and a resistance equal to the parallel combination of the plate resistance of the tube, R_s , and R_θ . The required value for C_t may be computed from Eq. (6) by substituting R_s for $R_t + R_s$. The maximum gain should be at least 6 db above, or two times greater than, that required for the greatest bass boost desired, if a 6 db per octave slope is to be followed to the lowest frequency of interest. A 6SJ7 operated to obtain a maximum gain of 200—46 db—will provide for a high-frequency gain of about three and

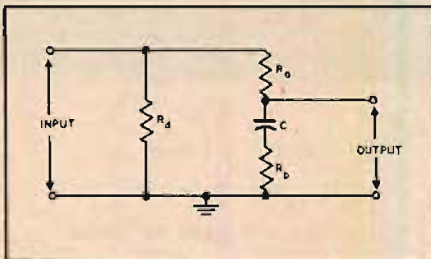

Fig. 5. Treble roll-off circuit. R_A selected for cartridge damping and/or to obtain roll-off rates between 6 and 12 db per octave. R_b selected to obtain roll-off rates less than 6 db per octave.

full bass compensation down to 30 cps for a 900-cps turnover when used in this simple circuit. There will be, of course, no degenerative feedback to provide for low distortion obtainable with the previously discussed system. For a 500-cps turnover compensation may be carried about one octave lower, or about 6 db more gain may be provided for the high frequencies.

By following a degenerative-bass-boost amplifier with a stage of amplification containing variable load imped-

ance bass boost with a very low turnover frequency—50 cps, for example—extra boost for the low bass may be obtained if desired.

Treble Compensation

For a 6 db per octave roll-off, the simplest treble compensation is obtained by selection of the resistance shunting the magnetic reproducer cartridge.² Neglecting the effects of cartridge internal capacitance (usually negligible in the audio range), 6-db-per-octave attenuation will be obtained as figured from a frequency equal to 6.28 times the cartridge inductance in henries divided into the sum of the internal resistance of the cartridge and the effective external resistance shunting it. One can select the roll-off frequency by adjustment of the preamplifier input resistance with either a fixed position switching arrangement or a continuously adjustable potentiometer control.

A more flexible treble roll-off circuit

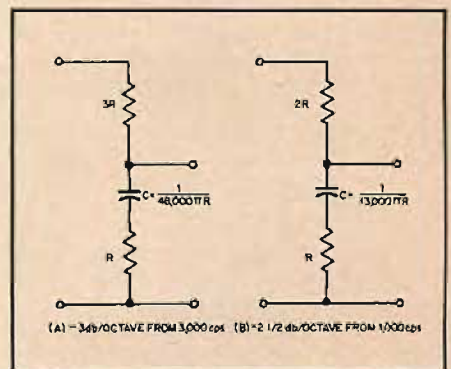

Fig. 6. Circuits for commonly used roll-off less than 6 db per octave. (A) is accurate within $\pm 1/4$ db to 15,000 cps. (B) is accurate within $\pm 1/4$ db to 10,000 cps and gives 1 db less than ideal attenuation at 15,000 cps.

is shown in Fig. 5. R_A is usually selected for cartridge damping in accordance with the recommendations of the cartridge manufacturer. If R_b is zero, an attenuation at 6 db per octave will be obtained as figured from a frequency equal to the reciprocal of the quantity 6.28 times the product of R_o in ohms and C in farads. R_o should be large enough so that its parallel combination with R_A acting in connection with the cartridge inductance will not cause appreciable additional high-frequency attenuation, unless a roll-off rate greater than 6 db per octave is desired. To accomplish this the resistance of R_o and R_A in parallel should be at least 125,000 times the cartridge inductance in henries. Figure 6 gives data for selection of components for treble roll-off at less than 6 db per octave as required by some RCA Victor and some British 78 rpm recordings.

Noise and Hum Reduction

If the preamplifier is laid out and wired carefully, hum and noise may be reduced to a negligible level by simple

² Norman Pickering, "Effect of load impedance on magnetic pickup response." *AUDIO ENGINEERING*, Mar. 1953.

SAVE
33 1/3%



This is our

GROUP SUBSCRIPTION PLAN

You and your friends and co-workers can now save up to \$1.00 on each subscription to AUDIO ENGINEERING. The more men in a Group, the more each saves. If you send 6 or more subscriptions for the U.S.A. and Canada, they will cost each subscriber \$2.00, 1/3 less than the price of a regular 1-year subscription. Present subscriptions may be renewed or extended as part of a Group.

AUDIO ENGINEERING is still

- The only publication devoted entirely to Audio—
- Recording
- Broadcasting equipment
- Acoustics
- Home reproduction systems
- PA systems
- Psychoacoustics

(Please print)

Name

Address

Position Company

Name

Address

Position Company

Name

Address

Position Company

Name

Address

Position Company

Name

Address

Position Company

Name

Address

Position Company

Add \$.50 to each Foreign subscription ordered

RADIO MAGAZINES, INC.
P. O. Box 629, Mineola, N. Y.

is that the source material is more likely to contain the stronger high frequencies and less compensation is needed in the system proper. This is most fortunate, for even the slightest trace of harmonic distortion will be raised in percentage by a gain characteristic that rises with increasing frequency. This is known as selective distortion. Where compensation is deemed necessary, an attractive scheme is to lessen the de-emphasis. This is feasible in FM reception and in the playback of modern records.

The Listening Room

When one undertakes the determination of quantitative data on which to base the design of tone or loudness controls, it is soon learned that there are other factors to be considered besides the response of the ear to various intensity levels. For example, few living rooms are arranged or furnished with real consideration for the reproduction of music. It is a matter of slight misfortune that a room we would consider as comfortable for living, is "too soft" for best music enjoyment. With the battle lines so clearly drawn, it is easy to see whose point of view will prevail. Even so, it is important to know something of the room acoustics. A typical living room and dining room combination may have a volume of 3000 cubic feet, and yet contain sufficient furniture, rugs, drapes, doors opening into other rooms, etc., to reduce the reverberation time to 0.6 seconds. The optimum reverberation time (for music) for a room of this size is closer to 0.9 seconds, some 50 per cent above the actual value. This departure from the ideal, though undesirable, is not severe. It must be remembered though, that these optimum characteristics are for live performance, and for reproduction there is an unavoidable deviation from the ideal caused by the characteristics of the studio wherein the performance is actually accomplished. The quality of program in the home can

¹¹ Olson, *Op. Cit.*, page 399.

¹² The relation between tonal compensation and reverberation time may be derived from the approximate formula for acoustic power required to maintain a given intensity in a room:

$$\text{POWER (in watts)} = 11.6 \times V \times \frac{I}{T}$$

where V = volume in cubic feet,
 T = reverberation time in seconds,
and

I = intensity in watts/square cm.,

If T_f is the reverberation time at some extreme frequency, and T_o is the time at mid-frequency, then the compensation that can be obtained from an increase in reverberation time is:

$$\text{COMPENSATION (in db)} = 10 \log T_f/T_o$$

This method for accomplishing tonal compensation is not recommended for home use for the following reasons: difficulty in obtaining a sufficient amount; inflexibility, in that changes are difficult to make; and the danger of creating an acoustical absurdity in which eerie high-frequency echo effects may become manifest, or strong modes of vibration may be set up in a small room to upset seriously the pattern of low-frequency tones.

be enhanced by control of studio reverberation time, best microphone placement, and a more objective approach on the part of performing artists. All of these factors are receiving consideration today.

It is generally much easier to calculate reverberation time than to measure it.¹¹ The coefficients normally used in computing reverberation time are average, and therefore the calculated time is probably too high for high frequencies and is surely too low for very low frequencies. This deviation at the lower spectrum limit is in the correct direction, however, for optimum reverberation time at, say 50 cps, may be greater than that at 1000 cps by an amount consistent with the bass compensation needed.¹² Conditions at the upper end of the spectrum are not so favorable. Here the requirement for optimum reverberation time at 15,000 cps is equal to, or greater than, that for 1000 cps and the actual time is below the calculated value to the extent that average absorption coefficients are used and all factors are not considered. Reverberation time is influenced by absorption in transmission as well as upon reflection, and, at average room conditions of 70° F. and 50 per cent relative humidity, the transmission of a 15,000 cps sound wave may be down by a factor as great as 30 when compared to the transmission of a 1000 cps wave. The necessary power gain at 15,000 cps can be had in the amplifier to correct this deficiency, but its inclusion is questionable because of the increase in selective distortion and the psychological effect of the high-frequency tones coming from the "box" instead of being a part of the sound pattern existing in the room.

There are a few other items which should be mentioned in order to complete our view of the matter of scale distortion. We know, for instance, that the ear is non-linear and different intensity levels produce varying percentages of amplitude distortion and combination tones. Thus a performance may be "distortionless," or at least tolerable, as played but when the level is raised by even a perfect fidelity system, the total distortion produced in the ear may be noticeable and even objectionable. The human ear is sensitive to pitch rather than frequency, and the pitch of a constant-frequency tone varies with amplitude. The artist will perform so as to produce the correct pitch initially, but when the level is changed upon reproduction (the frequency remaining constant), there is a change in pitch and discords may result. These two points may seem somewhat academic because our listening experience with scale distortion is generally confined to lowering the average level of the entire program, rather than raising the level, particularly the selective amplification of a solo part. It may well be that some of the underlying reasons for the chronic troubles associated with the application of sound reinforcing systems to top-quality musical performances is to be

means. Resistor noise will ordinarily be unnoticeable; the ultra-perfectionist may practically eliminate it by using wire wound resistors in the plate circuit and any unbypassed portion of the cathode circuit of the first stage. Most of the hiss noise from an amplifier usually comes from the first tube. Tube noise varies greatly between tube types, and between individual specimens of a given type. Unless a selected low-noise tube is used, tube noise will usually be less in a preamplifier employing a triode in the first stage than in one using a pentode. If the first stage is to use a pentode it is well worth while to use the 1620 or the 5879 for their low microphonism, hiss, and hum. Where a low-noise triode is desired one can use the 12AY7 or a triode-connected 5879.

The most obvious and straightforward way of eliminating hum arising in the cathode circuits is to use direct current heater power. D.c. for heaters may be obtained from a full-wave dry disc bridge rectifier with a simple capacitance filter of between 1000 and 5000 microfarads. The rectifier will require an r.m.s. input voltage about 50 per cent greater than the required filament voltage. One should provide a variable series resistance between the rectifier and the capacitor so that the filament voltage may be adjusted to the proper value. With this arrangement a standard 12.5-volt transformer may be conveniently used for a 6.3-volt d.c. heater supply.

If one is not so unfortunate as to get a poor tube in the input stage, hum due

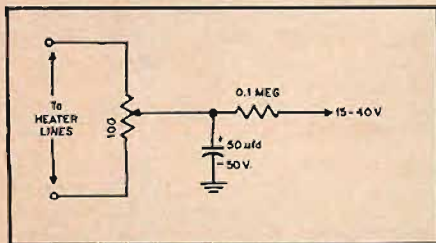

Fig. 7. Hum reduction circuit. Neither of the heater lines may be grounded, and a center tap on the transformer should not be used. Potentiometer is adjusted for minimum hum.

to a.c. heater operation may usually be eliminated by the simple arrangement of Fig. 7. The value of the bypass capacitance is not critical (values less than

1.0 μ f have been used successfully). Satisfactory hum reduction may often be accomplished by eliminating the balancing potentiometer and connecting the positive bias to the center tap of the filament transformer. When the balancing potentiometer is used it is well to locate it and the associated bypass capacitor near the first stage of the preamplifier, as it takes the place of the usual grounding of one side of the heater line.

Illustrative Preamplifier Circuit

As an illustration of the principles discussed in this article, Fig. 3 gives the schematic of an easily constructed preamplifier designed for use with the author's Ultra-Linear Williamson power amplifier. This preamplifier has ample gain for use with a low-level GE reluctance cartridge and carries compensation fully down to 30 cps for the highest turnover frequency. At maximum gain settings approximately one-third volt input on the high-level inputs 3 and 4 will drive the power amplifier to full output. The author's unit is completely contained within a $10 \times 4 \times 2\frac{1}{2}$ inch aluminum box. In constructing the preamplifier it is important to keep to a minimum the stray capacitances in the treble compensation circuits and in the input connection to the 12AX7. If the preamplifier is to be used only with a Pickering cartridge, or any other make of similarly low inductance, it would be well to double the compensation capacitor connected to the first 12AX7 grid to 1000 μ f and reduce to one-half the values given for all the compensation resistors connected to the treble switch points 2, 3, 4, and 5, thus reducing stray and input capacitance problems.

In the author's opinion, any adjustment of the system frequency response beyond the simplest that will compensate for the recording characteristics of the disc being played will deteriorate the transient response. As a concession to situations in which simulated live program loudness is undesirable or unpermissible, the circuit of Fig. 3 has been designed to incorporate an IRC loudness control. For this control to function properly the level control must be set to give simulated live program loudness with the loudness control at its maximum setting. Much of the criticism of loudness controls has come from failure to do this.

HIGH FUTILITY (from page 22)

bass is absent. There is only one practical solution to this problem and that is to set the compensation for the average level so as to obtain a minimum of scale distortion. While this solution is a compromise, it is not so bad as may appear at first. If our listening habits are reasonably firm, the scale-distortion peaks will vary about the compensated characteristic just as the dynamic peaks vary about the average level, and the peak excursions of scale distortion will be reduced over what would be true were there no compensation. Further-

more, some compression is almost sure to be present, and this will be a further aid.

The situation that obtains for the high frequencies is very similar to that just discussed for the low, and, once again, compensation is needed in order to insure the high frequencies not being lost at depressed listening levels. In this case there is a mitigating circumstance in the characteristic shape of the Fletcher-Munson curves in that they more nearly maintain their spacing while rising. The significance of this

Now ready--

IMMEDIATE
DELIVERY

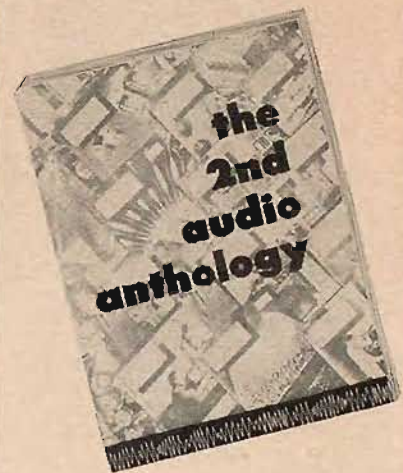

No bigger, no better than the original Audio Anthology—in fact it's just the same size and it's a perfect companion for the most authoritative book you now have on the subject of home music systems. However, the 2nd Audio Anthology contains all new material—reprints of over forty of the valuable articles which have most interested *AE*'s readers during the past two and a half years.

FEATURES

- Amplifiers
- Preamplifiers
- Tone Controls
- Phono Equipment
- Loudspeakers
- Speaker Enclosures
- Tape Amplifiers

Plus--

Details of the modified Universal Tape Recorder amplifier first described in *AE* in May-June-July, 1952. This material has not appeared in the magazines, and presents improvements which simplify construction and better performance.

Board Cover . . \$3.00

Paper Cover . . \$2.00

Customary Discounts to Distributors

The first Audio Anthology is still available—order both at once.

AA-1 and AA-2, paper cover
\$4.00

RADIO MAGAZINES, INC.
P. O. Box 629 Mineola, N. Y.

Miller
 BUILDERS OF QUALITY RADIO INDUCTANCES SINCE 1924
**THE SENSATIONAL
 NEW MILLER BAND-PASS TRF
 TUNER USING A GERMANIUM DIODE
 DETECTOR**

**HIGH
 FIDELITY**

- NO TUBES!
- NO POWER SUPPLY! • NO HUM!
- A SIMPLE 2 TUNED CIRCUIT NEGATIVE MUTUAL COUPLED BAND PASS TUNER
- EASY TO ASSEMBLE & WIRE!

In spite of its simplicity, low cost; #585 kit is not a toy — it is a carefully designed High Fidelity Broadcast band tuner. Use it with your amplifier and speaker system for truly high quality reception.

The audio output of the tuner is proportional to the input signal and will vary from .05V to .5V for stations within a 20-25 mile radius when used with a good antenna of from 75 to 100 feet in length. A good antenna is absolutely essential to the proper operation of the #585 tuner.

The net price of the Miller #585 TRF tuner kit, including chassis, dial, and tuning condenser, is only \$11.40. The additional parts required make it possible to build the complete tuner at a net cost of less than \$15.00.

Order yours now — ask for the new MILLER — Cat. No. 585 Crystal Detector Tuner — Not \$11.40



SEE YOUR LOCAL RADIO PARTS SUPPLIER FOR THE MILLER #585 KIT AND OTHER MILLER PRODUCTS

J. W. MILLER COMPANY
 5917 S. MAIN ST. LOS ANGELES, CALIF.

IF YOU ARE MOVING

Please notify our Circulation Department at least 5 weeks in advance. The Post Office does not forward magazines sent to wrong destinations unless you pay additional postage, and we can NOT duplicate copies sent to you once. To save yourself, us, and the Post Office a headache, won't you please cooperate? When notifying us, please give your old address and your new address.

Circulation Department
RADIO MAGAZINES, INC.
 P. O. Box 629 Mineola, N. Y.

**HI-FI WILLIAMSON TYPE
 AMPLIFIER
 KIT**



Using Stancor transformers. Easy-to-assemble amplifier kit. Comes with schematic and instruction sheet based on famous Williamson circuit. Frequency response 1 db. from 20-50,000 kc at 8 watts. Intermodulation distortion is only 3% at 8 watts output. Total harmonic distortion at 1000 cycles is non-existent below 10 watt power level.

WITH CBS HYTRON TUBES	2-6L807 2-6SN7GT 1-5U4G	SPECIAL PRICE PER KIT \$44.95 Less Tubes	TOTAL PRICE: \$52.75
-----------------------	-------------------------------	---	--------------------------------



IRISH PLASTIC RECORDING TAPE
 BRAND NEW! NOT SURPLUS. This First Grade recording tape is 3/4 in. wide. Frequency response: 50 to 8,000 cy. Plastic reel included with each.
 600 FT. \$1.35 1,200 FT. \$2.10

FOR YOUR HI-FIDELITY REQUIREMENTS VISIT OUR NEW SOUND STUDIO.

All orders F.O.B. Los Angeles. Minimum order \$5.00. 25% deposit required with order.

OLYMPIC ELECTRONICS SUPPLY
 1440 W. Olympic Blvd., Los Angeles 15, Calif.

Thus one frequently finds that superior power-amplifier designs have been based upon simultaneous development of circuit and output transformer, with each adapted to accommodate the other.

Manufacture may then consist of duplicating the model declared optimum for the particular circuit, with just enough tests along the way to assure the required closeness of duplication. To the manufacturer, this is an obviously workable plan. To the casual amplifier construction enthusiast who wants top quality at moderate power, the implication is that best results, for effort expended, may probably be had by purchase of an output transformer of published overall characteristics. There is often a strong element of buying on faith, and likelihood of satisfaction is improved through buying from one of the now numerous manufacturers who specify the circuits with or for which their transformers were developed.

THEATRE SOUND

(from page 23)

at moderate prices. But, here again, modern tubes, circuits, and output transformers will probably make a better showing in reproduction of the exquisite detail in later recordings, as displayed by the new speaker system.

In the writer's opinion, simplicity is the watchword—from the diamond stylus right through all stages to the dividing network. Simplest tubes with self-biasing, no interstage transformers, simplest power supply with oversize components, and no special circuits in the regular line up.

It is hoped that this description may have been sufficiently full of detail that any interested hobbyist who wants speaker performance which, in the writer's opinion, is well above the average, will be able to duplicate the enclosure type with a minimum of effort. The pleasure given by a speaker of this type is usually well worth the trouble taken to build one—a fact which is attested by a number of the writer's acquaintances who are using the same type of speaker housing.

IT'S NOT TOO LATE



CLASSIFIED

Rates: 10c per word per insertion for noncommercial advertisements; 25c per word for commercial advertisements. Rates are net, and no discounts will be allowed. Copy must be accompanied by remittance in full, and must reach the New York office by the first of the month preceding the date of issue.

THE AUDIO EXCHANGE, INC. buys and sells quality high-fidelity sound systems and components. Guaranteed used and new equipment. Catalogue. Dept. AE, 159-19 Hillside Ave., Jamaica 32, N. Y. Telephone OL 8-0445.

WANTED: Used disc recorder with overhead lathe not driven from turntable center. Box CA-1, AUDIO ENGINEERING.

AUDIOPHILES WANTED for part or full time work. Technical or secretarial experience desirable. Location: North Suburban Philadelphia. Send resume of education and experience to Box CA-2, AUDIO ENGINEERING.

WANTED: Old-fashioned ear trumpet—the type used before electric or electronic hearing aids. Please state asking price. Reply to Box CA-3, AUDIO ENGINEERING.

Radio Craftsmen tuner, 500 amplifier, Garrard changer, E-V SP-12B speaker; reasonable. Stearns, 307 N. Adams, Mason City, Iowa.

Send for tape library catalog. Over 61 half-hour programs available. Empire Recording Company, 3221 S. Acoma, Denver, Colo.

15% DISCOUNT on cartridges. High-fidelity transformers perfect for Fairchild's—bargain. Oil-filled capacitors, filter and coupling, matched pairs. E. Garr, Box 101, Riverdale Station 71, New York, N. Y.

The ULTIMATE in Williamson-type amplifiers, \$129.50. Send for facts. Nicely Associates, Kenton, Ohio.

30% DISCOUNT on factory-fresh, guaranteed LP records! Send for free catalog and literature. SOUTHWEST RECORD SALES, Dept. AE-2, 4710 Caroline, Houston 4, Texas.

FOR SALE: Collins Custom Deluxe AM-FM tuner. Perfect condition, highest quality. Charles Garland, 505 Edgewood, Columbia, Missouri.

SPECIAL PACKAGE PURCHASE: Ampex portable recorder, 400-A series, 50-watt McIntosh amplifier, Electro-Voice 650 microphone with stand, two 15-in. Lausung speakers, Permoflux headphones—all for \$1200. Mr. J. Ross, HY 7-5397 (Brooklyn, N. Y.) between 9:30 a.m. and 5:30 p.m.

50-WATT PRESTO 92-A Recording Amplifier \$200. 10 magnification microscope, Bausch & Lomb lenses, mount on any disc recorder, \$100. Brush 3-hour wire recorder, original cost \$800, only \$185. Reco-Art Company, 1305 Market Street, Philadelphia 7, Pa.

AUDIO RESISTORS, LOW-NOISE, 1%, DEPOSITED-CARBON TYPE. Beautiful appearance, ideal for preamps, phase inverters, improve existing equipment. Williamson Kit: 1-47K 1w, 2-20K 1w, 2-47 meg 1/2w, 2-50K 2w, 2-100K 1/2w \$5.00. Single resistors: 1/2w 43¢, 1w 63¢, 2w 88¢. Shipping charge 15¢. Edwin Behr, Dayton Pike, Chattanooga 5, Tennessee.

FOR SALE: W. E. 72S-B Speaker \$21. Thordarson T-32W10 Amplifier \$21. Charles Leigh, 162 Passaic St., Trenton, N. J.

SELL: Atlee 603B speaker, perfect condition, best offer. W. Tannenbaum, Tompkins 7-1698 (N. Y. C.)

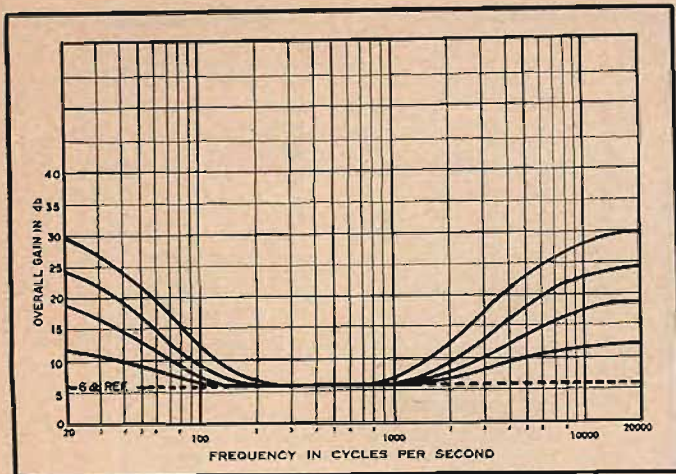

Fig. 4. Response curves obtained with three-channel tone-control amplifier of Figs. 2 and 3.

A question might be raised regarding the problem of the additional phase shift of 180 deg. in the high- and low-frequency channels, since they both have one more stage of amplification than the center channel. It is conceivable that a condition could arise wherein the low- and high-frequency components of the broad band passed by V_{14} would cancel the signals of the other two channels. This does not occur, however, because of the additional compensating phase shift introduced by the low- and high-pass R-C filters.

The response curves of Fig. 4 illustrate the measured results obtained from various settings of the low- and high-boost controls. Boosts ranging from 6 db to 24 db at the 20- and 20,000-cps. spectrum extremes are shown. Note that practically no increase occurs in the middle-frequency range between 200 and 1000 cps, even at maximum settings.

Construction of the tone control amplifier is not difficult. It may be incorporated directly into an existing or proposed amplifier, or else built up as an accessory on a small subchassis similar to that used for magnetic pickup pre-amplifiers.

The author has used variations of this type of tone control for over ten years, and the results have been very satisfactory. Although it will not work miracles for a poor audio system, the degree of depth and crispness imparted to music and speech is remarkable.

PARTS LIST

C_1, C_5, C_8	0.1 μ f, 400 v. paper
C_2	0.25 μ f, 400 v. paper
C_3, C_4	20-20 μ f, 450 v. electrolytic
C_6	.05 μ f, 400 v. paper
C_7	.02 μ f, 400 v. paper
C_9	500 μ f, 500 v. mica
C_{10}	200 μ f, 500 v. mica
C_{11}	100 μ f, 500 v. mica
R_1	470 ohms, 1/2 watt
R_2	47,000 ohms, 1 watt
R_3, R_{12}	47,000 ohms, 1/2 watt
R_4, R_{13}	0.1 meg, 1/2 watt
R_5	0.22 meg, 1/2 watt
R_6	0.5-meg potentiometer, audio taper
R_7, R_{14}, R_{15}	2200 ohms, 1/2 watt
R_8, R_{10}	22,000 ohms, 1 watt
R_9	0.33 meg, 1/2 watt
R_{11}	0.18 meg, 1/2 watt
R_{14}	0.25-meg potentiometer, audio taper
V_1, V_2	12AT7 dual triodes

AUXILIARY MIXER for TV (from page 27)

The control room and announce booth microphones, turntable, cue, remote line, network, and film inputs are handled in the usual manner.

This is only one of many possible arrangements, but it shows the flexibility of the auxiliary mixer. The microphone inputs can also be divided between two studios which may be used simultaneously—one for program, the other for audition purposes.

The BCM-1A auxiliary mixer should be installed adjacent to and to the left of the console. Both units are identical in cross-section and similar in styling. The auxiliary mixer is 16 3/4 in. in length, and the combined length of the two units is only 49 3/4 inches. All controls are therefore within convenient reach. The front panel of the auxiliary mixer is hinged and tilts forward as

shown in Fig. 3 to provide access to the attenuators and switches for inspection, cleaning and service. The sloping top cover is removable to expose the tubes and tube test jacks. The amplifier wiring becomes accessible by raising the pivoted amplifier mounting frame. Power for operating the speaker muting and warning light relays is supplied through the console. Only an external plate and heater supply is required for the operation of the auxiliary mixer.

The BCM-1A auxiliary mixer is another example of the building-block type of broadcast equipment which may be placed in operation at the initial installation or may be added later to existing equipment as the need for greater facilities becomes apparent.

can you Hear these charts?

You can't listen to a radio tuner on a magazine page. But one glance at the charts above will tell your audiophile eye—here's high-fidelity!

You're looking at the visual delineation of frequency characteristics of Stromberg-Carlson's newest equipment. If a sensitive electronic instrument records such wide-range fidelity, imagine how pleasant it will sound to your ear!



You can hear for yourself by asking your dealer for a demonstration of the

Stromberg-Carlson

"CUSTOM FOUR HUNDRED"
SR-401 AM-FM TUNER

one of the component parts of the "Custom Four Hundred" high-fidelity series which carries the recommendation of Leopold Stokowski.

For the name of your nearest dealer or for more complete technical data, write

STROMBERG-CARLSON
Sound Division

1219 Clifford Ave. Rochester 3, N. Y.

found in these two factors. At least we are on firm ground in drawing the conclusion that a symphony orchestra is not likely to be composed of one violin, one flute, one horn, etc., each with a public address system.

Conclusion

In summary, the following factors are generally bearing upon high-fidelity reproduction in the home: listening level depends primarily upon acoustic environment, concurrent activities in the case of incidental listening, and taste; within the home the listening level is generally depressed and scale distortion is therefore present; the more pronounced effects of this distortion are alterations in tonal balance and failure of perception at the lower limits of the dynamic range; compression of the dynamic range, although detrimental to true fidelity, is a strong factor in minimizing the effects of scale distortion; a lower ambient noise level will permit wider dynamic range under the conditions of intentional scale distortion; and tone, or loudness, controls offer the only simple means for partially correcting the adverse effects of scale distortions involved in recognized high-fidelity the recognition of a problem coupled with failure to understand its nature

leads invariably into "high futility." For that reason this paper has attempted to point out some of the basic considerations involved in recognized high-fidelity problems with the hope of fostering a better understanding of some of the non-electronic problems.

Perhaps it shall ever remain that a ticket to the symphony or opera is the privilege of true entertainment. In a sense, the audience and the performers comprise a team and under these circumstances a concert can neither be rehearsed nor duplicated (a playback is an attempt at duplication). While the technique of recorded sound is no real match—nor competitor—for the live performance, it is still a wonderful scheme for broadening the base of music appreciation and enjoyment. In the process of capturing, holding and calling forth at will our musical choices, some restraint must be used. If the restraining forces are applied intelligently and gently the changes in dimensions which we find upon freeing the imprisoned sound may well leave a pattern and texture that is subjectively pleasing. If we are to reach the goal of having the re-created seem as the original, the listener alone can supply that final measure of understanding which must take over where techniques fail.

AUDIOLOGY (from page 14)

as the independent variable,

1. Distortion at a given flux density varies roughly inversely as X/R for values of this ratio above about unity.
2. Distortion variation with flux density for constant X/R is of the general form $y = a + b \cdot x^n$ (a straight line on log-log paper) in the flux density ranges of approximately 200 to 8000 gauss for silicon steel, and 300 to 3000 gauss for the more common nickel alloys.
3. Distortion falls only very slowly as the flux density is reduced below about 200 gauss.
4. Direct-current magnetization results in even as well as odd harmonics, and may increase the total distortion materially.

For minimum transformer distortion, the a.c. flux density and d.c. magnetization would be minimized, and the ratio X/R made as large as practicably possible. But there is no useful object in making distortion due to transformer nonlinearity much lower than that due to other causes at the low frequency in question.

Efficiency

Losses at mid-frequencies are usually considered to be due to winding resistances only. Aply named "copper efficiency" is easily estimated in design, and may be tested by simple resistance measurements. Notion of the error at low frequencies may be gained from consideration of a transformer with a 2-lb. core of high-silicon steel, operating at 10 watts output with a flux density of 5000 gauss at 60 cps. Total core loss would be about 0.4 watt. Were the copper efficiency (say) 92 per cent, the true efficiency would be more like 88 per cent.

While heating is ordinarily not the problem in output transformers that it is in power transformers, the cost per watt-hour

is much higher. But from the designer's standpoint, increased over-all value of an equipment development through improvement of output transformer efficiency is often small compared with the increased component cost. Almost any successful design, whether commercial or laboratory, is a wisely chosen set of compromises, and choice of operating efficiency is no exception.

When necessary reduction in physical size warrants added cost, significant miniaturization of low-level audio transformers is possible through the use of nickel-steel cores. But if transformer requirements dictate maximum operating flux densities as high as several thousand gauss or more at the lowest intended frequency of operation, nickel-steel core material is generally inferior to high-silicon steel. Of the latter, the grain oriented variety is a preferred type, and is available in woundloops and as punched laminations, with neither form always having advantage over the other. Additional output-transformer miniaturization is possible by improved utilization of the core window area, or by selection of a more favorable core shape.

Assuming such improvements have already been incorporated, further size reduction (for a given specification on response and distortion) can be had only with reduced efficiency. The extent to which one may exploit this possibility depends largely upon the associated circuit, and over-all equipment considerations of size, cost, and practicability of manufacture.

Particularly for wideband arrangements in which extensive negative feedback is employed, there are important transformer details "not shown in the circuit diagram." These are complex coupling and capacitance structures resulting from interleaving of the various windings, and are not readily subject to design calculation or adequate description in simple specification form.

Air-Tone

HEADQUARTERS FOR SOUND EQUIPMENT

INDUSTRIAL SOUND

for any and all installations. Continuous music or business message up to 8 hours.

Illustrated: MAGNECORD Units PT6J, PT6AH, 814, with automatic switching equipment, custom built by Air-Tone Sound & Recording Co.

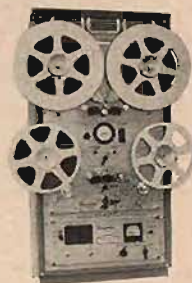

Air-Tone

SOUND AND RECORDING CO.
1527 CHESTNUT ST.
PHILA. 2, PA. • RI-6-8388

AMPERITE

Studio Microphones at P.A. Prices

Ideal for
BROADCASTING
RECORDING
PUBLIC ADDRESS

"The ultimate in microphone quality," says Evan Rushing, sound engineer of the Hotel New Yorker.

- Shout right into the new Amperite Microphone—or stand 2 feet away—reproduction is always perfect.
- Not affected by any climatic conditions.
- Guaranteed to withstand severe "knocking around."



Models
RBLG—200 ohms
RBHG—Hi-imp.
List \$42.00



"Kontak" Mikes
Model SKH, list \$12.00
Model KKH, list \$18.00

Special Offer: Write for Special Introductory Offer and 4-page illustrated folder.

AMPERITE Company, Inc.

561 BROADWAY • NEW YORK 12, N. Y.
Canada: Atlas Radio Corp., Ltd., 560 King St. W., Toronto

PROFESSIONAL DIRECTORY

Custom-Built Equipment

U. S. Recording Co.

1121 Vermont Ave., Washington 5, D. C.
Lincoln 3-2705

"EVERYTHING IN HIGH FIDELITY"

From Primary Components
to Completed Custom Audio Equipment

KIERULFF

Sound Corp.

820 West Olympic Blvd. • Los Angeles 15, Calif.
Richmond 7-0271 ZEnith 0271

In Southern California it's HOLLYWOOD ELECTRONICS

(in The Audio Mile)

Distributors of Hi Fidelity
Components Exclusively
Webster 3-8208

7460 Melrose Ave. Hollywood 46, Calif.

Two ways you can protect your family against CANCER

... a check ... a check-up

Cancer strikes in one of every two families. Each year more than 60,000 American children under the age of eighteen lose a parent to cancer.

Yet many cancers can be cured, if discovered in time.

Every man should have a complete physical examination once a year. Women over thirty-five should have a complete physical examination twice a year. Patients are being saved today who could not have been saved even a few years ago.

The American Cancer Society asks your help.

How soon we find cancer's cause and cure depends on how soon and how much help comes from people like you.

Send contribution to Cancer,
c/o your local Post Office.

Cancer strikes One in Five
STRIKE BACK...

Give to Conquer Cancer!

Industry Notes—

Fred Cantor, well-known sales executive in high fidelity circles, is newest addition to list of New York manufacturers' reps—among first accounts are Bozak speakers and Sound Workshop radio-phonos . . .

John Bose, long-time associate of Maj. E. H. Armstrong and president of the Radio Club of America, on the receiving end of industry congratulations for performing major developmental work on new FM-multiplex system—permits transmission of up to three programs on single FM channel . . . "Life" magazine is latest major consumer publication to plan article on Audio—piece will be written by Herb Brenz . . .

Bob Catherwood, broadcast pioneer, is newest team mate of Ira Hirschman, owner of Manhattan's FM station WABF—intends to establish the station as the country's pace setter in stimulating and satisfying listeners' desire for fine music on the air . . . Robert M. Mitchell has been appointed to executive sales position by Sonotone Corporation—appointment represents part of Sonotone's expansion program—in addition to hearing aids, company is now engaged in volume production of miniature tubes, pickup cartridges, electron guns for TV picture tubes, and special purpose batteries . . . New v. p. of corporate affairs for Westinghouse Electric Corporation is E. V. Huggins, formerly Assistant Secretary, USAF—also elected president of Westinghouse Radio Stations, Inc. . . .

John Silver, formerly general manager of Communications and Electronics division of Motorola, Inc., has been elevated to vice-presidency . . . Karl E. Hoffman, whose radio-TV days date from 1921 (in '27 he worked under Dr. Alexanderson in designing first GE TV transmitter), has been elected vice-president of WGR Broadcasting Corporation, Buffalo, N. Y. . . . Joseph M. Benjamin, formerly manager of government contract department, has been named vice-president of Pilot Radio Corporation . . . Max Baume, sales manager, Brook Electronics, Inc., has altered company policy to include factory reps in selected areas—first appointments are George Davis Sales Company and E. W. Brandt Company covering Southern and Northern California, respectively. . . .

Frank J. Donnola, audio expert for Liberty Music Shops, New York, has assembled truly fine custom-built audio systems for installation in cabinetry to customer specifications—included are Craftsman tuner, and Brook amplifier . . . Joe Martin, director of public relations for Association of Record Manufacturers, reports that the classics are accounting for increasing percentage of total sales . . . Jerry B. Minter, chief engineer, Measurements Corporation, Inc., Boonton, N. J. spending evenings at home working on a gadget which may well have revolutionary effect on the science of disc recording . . . Sam Girard, head of New York's Sun Radio & Electronics Company, taking pride in country's first triple-demonstration-studio sound department at firm's new midtown headquarters . . . Harry Miller, eastern factory representative for McIntosh, Magnecord, and James B. Lansing, has expanded sales force to meet demands of increased business. . . .

ERRATUM

Inadvertently the trade name of Reeves Soundcraft Corporation's Magna-Stripe sound-on-film process was misspelled in the caption describing the cover of AUDIO ENGINEERING's March issue. At least, it was correct on the cover—but they furnished the cover art work in complete form.

Yours... FREE!



TERMINAL'S
New, Illustrated, 130-page

AUDIO CATALOG

Your complete guide to the
Finest in Audio Equipment!

Write or come in for your
FREE Complimentary Copy!

Visit our Audio Dept.
Open Thurs. eves. till 9 P. M.
Ample Parking Space after 6 P. M.

Terminal Radio Corp.
85 Cortlandt St., New York 7

Compo EASY-HANDLING MAGNETIC TAPE REELS

Precision manufactured in accordance
with the exacting standards set by the
N.A.B.

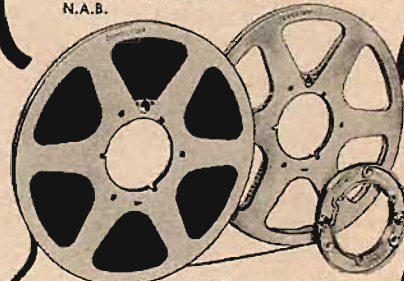

- Easy to handle because:
1. Burrs and sharp edges are smoothed away.
 2. Components assemble quickly, easily.
 3. Aluminum flanges stay flat. Eliminate tape rubbing.
 4. Hubs are die-cast to close tolerance.
 5. Grey, "write-on" finish available for editing notes.

TAPE REELS, STORAGE CANS, AND SHIPPING
CASES FOR EVERY PROFESSIONAL REQUIRE-
MENT ALWAYS IN STOCK

Write for descriptive literature and price list

COMPO CORPORATION
Manufacturers of fine products for the Audio-
Visual Industry.

2251 W. St. Paul Ave. Chicago 47, Illinois



HERE IS THE SPRING BULLETIN OF HARTLEY AUDIO ADVERTISED AND PERFORMING WITHOUT DISTORTION

In our March ad we said "For the finest possible results, regardless of expense, we introduce the double Baffle, which, with the two 215's wired in simple series, will give you for \$200 a performance not to be equalled by any speaker ensemble offered elsewhere at prices up to more than \$1,000." You might say that this is just some more advertising guff that doesn't mean what it says.

Well, when we wrote that copy the Los Angeles Audio Fair had not started. Our Los Angeles agent, acting entirely on his own initiative, decided he was going to prove it to one and all, and the double Baffle with 215's "wired in simple series" was duly demonstrated.

It would not be fair to say who, but eminent audio experts, known to you all, wrote and told us that McShane had produced the hit of the Fair, and people were queuing up to hear this terrific outfit. It was, we were told, a wonderful performance, and at the price it was miraculous. So, honestly, we mean what we say in our ads, and what we say in our ads is endorsed by our customers.

The 215, the Baffle, the Hartley amplifiers, are now in stock at headquarters in the U.S.A. and in the hands of various agents. These are the basic units for a non-distorting reproducer, but we are now getting around to completing the whole picture. The first of the newcomers is a record-changer better than you have ever met. This changer has been most rigorously tested in London and we guarantee that it meets our fastidious requirements in freedom from rumble, wow, and vibration. It handles mixed 10" and 12" records, operates 45's automatically, and is so free from "top hamper" that it can be used delightfully as a plain turntable unit for single L.P.'s. Just slip the record on and slip it off, and the changer will gently lower the pickup on to the proper groove of a ten or twelve-inch disc.

Coming with this is a new really high-fidelity turnover crystal pickup with diamond stylus. For long we have tended to believe that high-fidelity and crystals were not in sympathy, but we are always learning, and this new pickup is astonishing. But, as we believe in freedom of opinion, we shall also be able to supply interchangeable plug-in adaptors fitted with Audak or Fairchild cartridges.

Supplies will be available shortly and we expect the price will be very favorable.

We hope all our mailing list subscribers will have had their new information by the time this ad appears, but if you are not on our mailing list, a postcard to our New York address is all that is necessary. There has been some delay in replying to many enquiries for literature, but this has been due to the vast amount of work resulting from setting up our new headquarters in New York.

Meanwhile we draw your attention to three demonstration centers, where you will be entertained intelligently and artistically. New England music-lovers should visit us in New York, where we are open all day Saturday for your convenience.

McSHANE AND COMPANY, 6903 MELROSE AVENUE, LOS ANGELES, CALIFORNIA, are our sole agents for Los Angeles, but will welcome all enthusiasts from southern California.

THE DIXIE HARTLEY CO., P. O. BOX 1622, CHATTANOOGA, TENNESSEE will be glad to arrange demonstrations in any of the following places:
Knoxville, Atlanta, Birmingham, Nashville, Chattanooga, and the Southeast.

H. A. HARTLEY CO. INC.

521 East 162nd St., New York 56, N. Y. LU 5-4239

H. A. HARTLEY CO. LTD.

152 Hammersmith Road, London W.6, Eng.

ADVERTISING INDEX

Air Tone Sound & Recording Co...	69
Allied Radio Corp.	55
Amperite Co., Inc.	69
Ampex Electric Corp.	15
Amplifier Corp. of America	58
Arnold Engineering Co.	11
Asco Sound Corp.	52
Audak Co.	49
Audio Devices, Inc.	Cover 2
Beam Instruments Corp.	51
Belden Mfg. Co.	13
Bell Telephone Laboratories	18
Bogen, David Co., Inc.	65
British Industries Corp.	60
Brush Development Co.	8
Bud Radio, Inc.	53
Carter Motor Co.	14
Chicago Transformer Co.	6
Cinema Engineering Co.	9
Classified	70
Compco Corp.	71
Concertone Recorders	63
Daven Co.	Cover 3
Diacoustic Laboratory	59
Dubbings Co.	65
Gates Radio Co.	7
General Electric Co.	60
Gray Research & Dev. Co., Inc. ...	45
Hartley, H. A. Co., Ltd.	72
Harvey Radio Co., Inc.	47
Heath Co.	63
Hughes Research & Dev. Co.	1
Leonard Radio, Inc.	57
Magnecord, Inc.	10
Magnetronics Corp.	50
Miller, J. W. Co.	70
Minnesota Mining & Mfg. Co. 36,	37
Newcomb Audio Products Co. ...	43
Olympic Electronics Supply Co. ...	70
Permoflux Corp.	64
Pickering & Co., Inc.	17
Pilot Radio Corp.	35
Precision Electronics, Inc.	66
Precision Film Laboratories	12
Presto Recording Corp.	39
Professional Directory	71
Radio Corp. of America	4, 5
Radio's Master	54
Reeves Soundcraft Corp.	41
Rek-O-Kut Co.	3
Rockbar Corp.	33
Stromberg Carlsson Sound Div. ...	61
Terminal Radio Corp.	71
Texas TV Stores	66
Triad Transformer Mfg. Co.	2
United Transformer Co. ...	Cover 4
White Sound, Inc.	59



for MINIATURIZED COMPONENTS

The constant miniaturization of military and portable civilian gear has required audio components of smaller and smaller dimension. This is particularly exaggerated in the case of transformers for use in transistor circuits. The "H" series of miniature and sub-miniature units described below are hermetic military types to cover virtually all audio applications. For even smaller structures our ultra-miniature types are available against quantity orders.

from STOCK

MINIATURE AUDIO UNITS...RCOF CASE

Type No.	Application	MIL Type	Pri. Imp. Ohms	Sec. Imp. Ohms	DC in Pri., MA	Response \pm 2db. (Cyc.)	Max. level dbm	List Price	
H-1	Mike, pickup, line to grid	TF1A10YY	50,200 CT, 500 CT*	50,000	0	50-10,000	+ 5	\$16.50	
H-2	Mike to grid	TF1A11YY	82	135,000	50	250-8,000	+21	16.00	
H-3	Single plate to single grid	TF1A15YY	15,000	60,000	0	50-10,000	+ 6	13.50	
H-4	Single plate to single grid, DC in Pri.	TF1A15YY	15,000	60,000	4	200-10,000	+14	13.50	
H-5	Single plate to P.P. grids	TF1A15YY	15,000	95,000 CT	0	50-10,000	+ 5	15.50	
H-6	Single plate to P.P. grids, DC in Pri.	TF1A15YY	15,000	95,000 split	4	200-10,000	+11	16.00	
H-7	Single or P.P. plates to line	TF1A13YY	20,000 CT	150/600	4	200-10,000	+21	16.50	
H-8	Mixing and matching	TF1A16YY	150/600	600 CT	0	50-10,000	+ 8	15.50	
H-9	82/41:1 input to grid	TF1A10YY	150/600	1 meg.	0	200-3,000 (4db.)	+10	16.50	
H-10	10:1 single plate to single grid	TF1A15YY	10,000	1 meg.	0	200-3,000 (4db.)	+10	15.00	
H-11	Reactor	TF1A20YY	300 Henries-0 DC, 50 Henries-3 Ma. DC, 6,000 Ohms.						12.00



RCOF CASE

Length1 25/64
 Width61/64
 Height1 13/32
 Mounting1 1/8
 Screws4-40 FIL.
 Cutout7/8 Dia.
 Unit Weight1.5 oz.



SM CASE

Length11/16
 Width1/2
 Height29/32
 Screw4-40 FIL.
 Unit Weight8 oz.

SUBMINIATURE AUDIO UNITS...SM CASE

Type No.	Application	MIL Type	Pri. Imp. Ohms	Sec. Imp. Ohms	DC in Pri., MA	Response \pm 2db. (Cyc.)	Max. level dbm	List Price	
H-30	Input to grid	TF1A10YY	50**	62,500	0	150-10,000	+13	\$13.00	
H-31	Single plate to single grid, 3:1	TF1A15YY	10,000	90,000	0	300-10,000	+13	13.00	
H-32	Single plate to line	TF1A13YY	10,000***	200	3	300-10,000	+13	13.00	
H-33	Single plate to low impedance	TF1A13YY	30,000	50	1	300-10,000	+15	13.00	
H-34	Single plate to low impedance	TF1A13YY	100,000	60	5	300-10,000	+ 6	13.00	
H-35	Reactor	TF1A20YY	100 Henries-0 DC, 50 Henries-1 Ma. DC, 4,400 ohms.						11.00

SPECIAL

ULTRA-MINIATURE UNITS TO SPECIFICATIONS ONLY

UTC ultra-miniature units are uncased types of extremely small size. They are made to customers' specifications only, and represent the smallest production transformers in the world. The overall dimensions are $\frac{1}{2} \times \frac{1}{2} \times \frac{1}{16}$ " ... Weight approximately .2 ounces. Typical special units of this size are noted below:

- Type K-16949 100,000 ohms to 100 ohms ... 6 MW ... 100 to 5,000 cycles.
- Type M-14878 20,000 ohms (1 Ma. DC) to 35 ohms ... 6 MW ... 300 to 5,000 cycles.
- Type M-14879 6 ohms to 10,000 ohms ... 6 MW ... 300 to 5,000 cycles.
- Type M-14880 30,000 ohms (1 Ma. DC) to 3,000 ohms ... 6 MW ... 300 to 5,000 cycles.
- Type M-14881 25,000 ohms (.5 Ma. DC) to 1,000 ohms ... 6 MW ... 300 to 5,000 cycles.

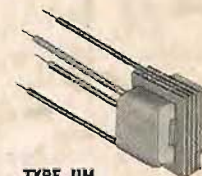

TYPE UM

* 200 ohm termination can be used for 150 ohms or 250 ohms, 500 ohm termination can be used for 600 ohms.
 ** can be used with higher source impedances, with corresponding reduction in frequency range. With 200 ohm source, secondary impedance becomes 250,000 ohms ... loaded response is -4 db. at 300 cycles.
 *** can be used for 500 ohm load ... 25,000 ohm primary impedance ... 1.5 Ma. DC.

United Transformer Co.
 150 VARICK STREET NEW YORK 13, N. Y.
 EXPORT DIVISION: 13 EAST 40th STREET, NEW YORK 16, N. Y. CABLES: "ARLAB"

Shocking News About Super Davohm Resistors



Since Daven originated the first pie-type wire wound resistor more than a generation ago, it has pioneered many innovations in the production of resistors.

Today, *only Daven* uses a stranded lead wire to connect the resistance wire to the solder terminal of the Super Davohm Precision Wire Wound Resistor.

As a result, no matter how much strain, stress, heat or pressure is applied to the solder terminal, no accompanying shock is put upon the fine resistance wire itself, but is absorbed by the heavy lead wire without adversely affecting the resistor in any way.

Therefore, Super Davohm Resistors are substantially more rugged than conventional resistors and are able to withstand unusual vibration, rough treatment and abnormal shocks.

This exclusive Daven feature, plus the many other quality aspects of Super Davohm Precision Wire Wound Resistors, makes Daven the leader in the resistor field.

The Super Davohm line includes resistors made in accordance with MIL-R-93A specifications, as well as sub-miniature units to give you the most complete selection of resistors available anywhere. Deliveries can be made to meet your requirements.

Write for assistance with your problems, and ask for a copy of Daven's complete, new brochure on Super Davohm Precision Wire Wound Resistors.

THE **DAVEN** CO.

185 CENTRAL AVENUE, NEWARK 4, N. J.