

the authoritative magazine about high fidelity

ENGINEERING LIBRARY *Eng.*

# AUDIO

ON SALE  
FEBRUARY  
1968  
60¢

Benny  
Goodman  
Rides  
Again

Electronic  
Crossover  
Improves Speaker  
Performance

Report  
On New  
Low-Noise  
Tape

UNIVERSITY OF CALIFORNIA  
INSTITUTE OF

MAR 3 - 1971

TECHNOLOGY

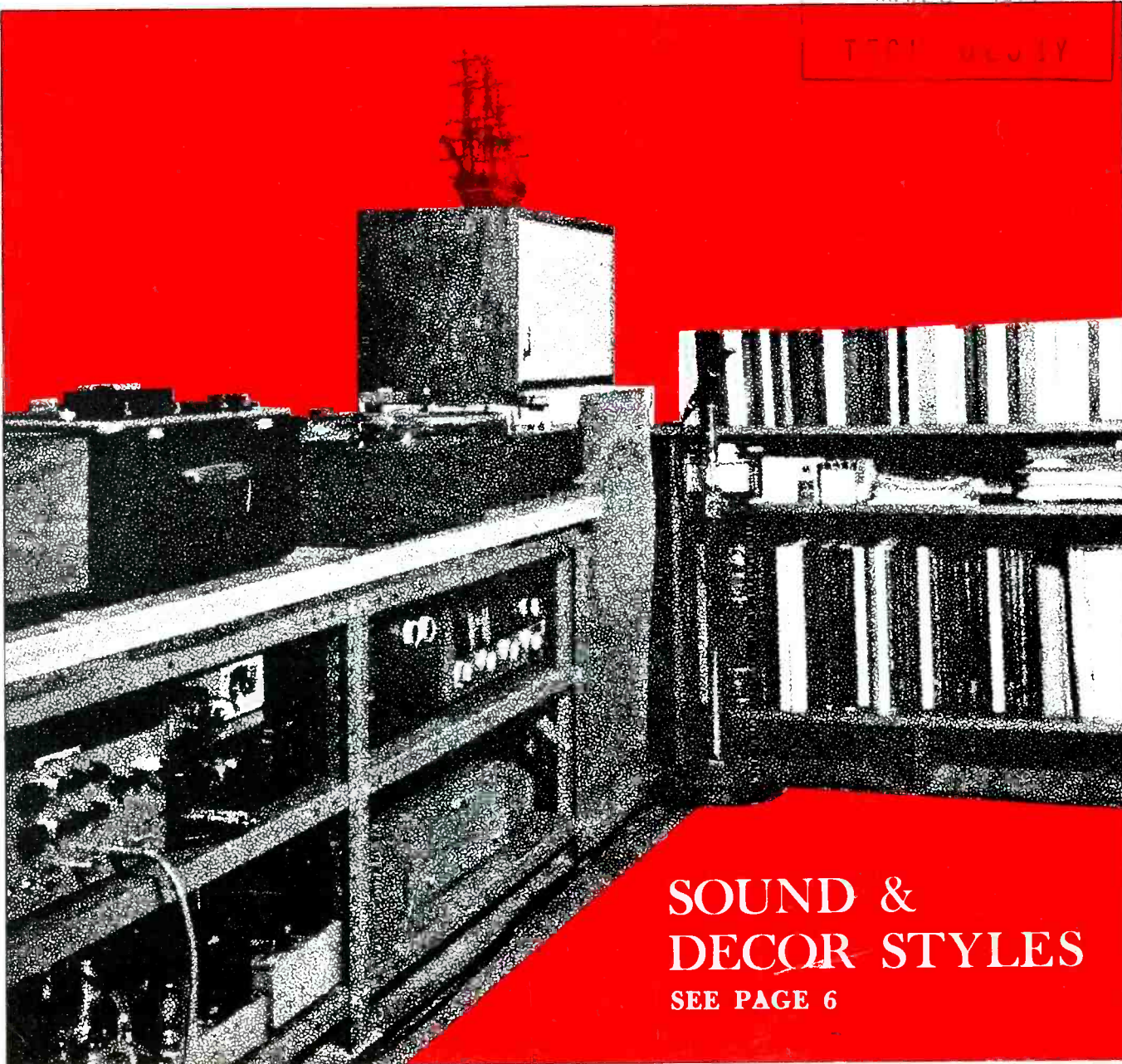

SOUND &  
DECOR STYLES  
SEE PAGE 6

# If you're still listening to 1963 stereo, update with Scott (THERE'S A SOUND REASON)

How long have you had your present amplifier or tuner . . . five years? Maybe eight or ten? A lot has happened since you bought it . . . new developments like Field Effect Transistors, Integrated Circuitry, direct coupled all-silicon output. And the performance you *are* getting just isn't the performance you *could* be getting. Don't miss out . . . check out these two new Scott advanced components:

**Scott 260B 120-Watt Stereo Amplifier** — This solid-state powerhouse includes a tone-control by-pass switch for laboratory-flat response, plus dual microphone inputs and headphone jack conveniently mounted on the front panel. Professional control complement includes dual speaker selector switches, rumble and noise filter controls, loudness compensation, and tape monitoring facilities. This is truly the audiophile's dream amplifier!

**260B Specifications:** Music power rating at 0.8% harmonic distortion, 120 W @ 4 ohms, 100 W @ 8 ohms; Frequency response, 15-30 kHz  $\pm$  1 dB; Power bandwidth, 20-20 kHz; Hum and noise,  $-55$  dB; Price \$294.95.

**Scott 312D FM Stereo Broadcast Monitor Tuner** — 3-Field Effect Transistor front end and Integrated Circuit IF bring the 312D's performance close to the theoretical limits of sensitivity, selectivity, and interference rejection. 3-way meter provides for signal strength, center tuning, and multipath correction. Levels of both phone and amplifier outputs may be independently varied by special front panel controls.

**312D Specifications:** Usable sensitivity, 1.7  $\mu$ V; Capture ratio, 1.9 dB; Cross modulation rejection, 90 dB; Stereo separation, 40 dB; Selectivity, 46 dB; Signal/noise ratio, 65 dB; Price \$319.95.

Write for complete information and specifications on Scott stereo components.

Scott where innovation is a tradition

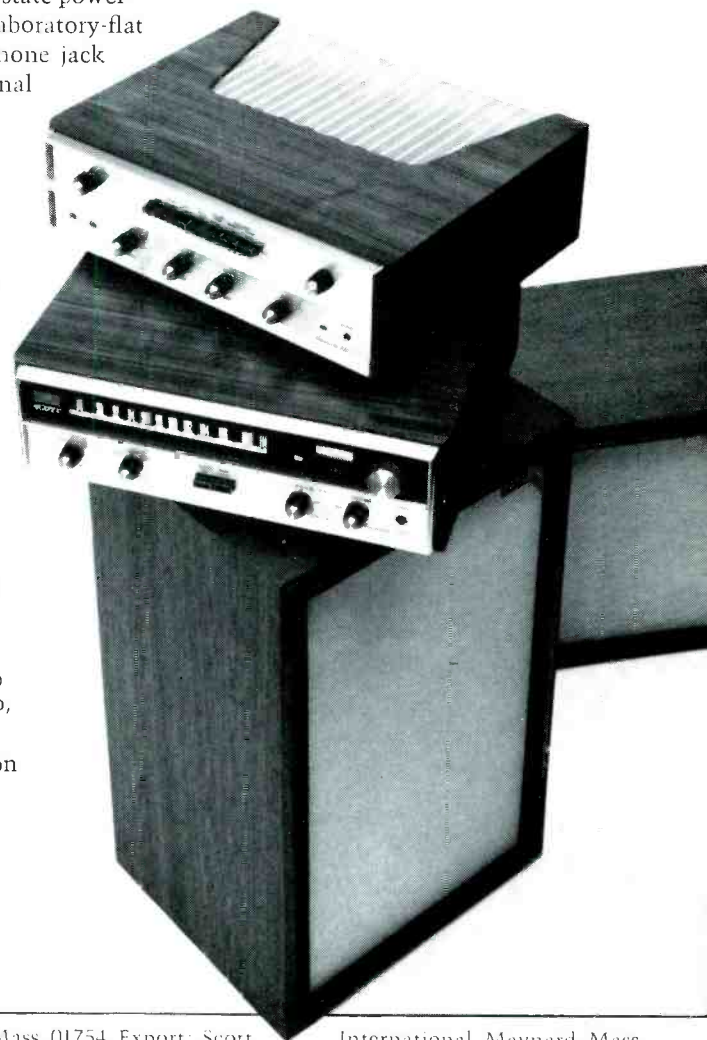

© 1967, H.H. Scott, Inc.

H.H. Scott, Inc., Dept. 35-02, 111 Powdermill Road, Maynard, Mass. 01754, Export: Scott

International, Maynard, Mass.

Check No. 100 on Reader Service Card

[www.americanradiohistory.com](http://www.americanradiohistory.com)

# AUDIO

Successor to **RADIO**, Est. 1917

ARTHUR P. SALSBERG, *Editor*

EDWARD TATNALL CANBY  
*Associate Editor*

PETER RENICH  
*Art Director*

*Contributing Editors*

HERMAN BURSTEIN  
LEONARD FELDMAN

JOSEPH GIOVANELLI  
ALEXANDER ROSNER

BERTRAM STANLEIGH

C. G. MCPROUD, *Publisher*

SANFORD L. CAHN

*Marketing Director*

R. KENNETH BAXTER

*Production Manager*

MARY CLAFFEY

*Subscription Manager*

## FEATURE ARTICLES

- |   |    |                            |
|---|----|----------------------------|
| Sound and Decor Styles                                      | 6  |                            |
| Report on New Low-Speed Tape                                | 12 | <i>Edward T. Canby</i>     |
| How to Build a Three-Channel Electronic Crossover           | 19 | <i>C. G. McProud</i>       |
| The Recorded "Works"  | 24 | <i>Edward T. Canby</i>     |
| Microphones for Sound Reinforcement Systems, Part III       | 26 | <i>Don Davis</i>           |
| A Doctor in the Movie House                                 | 34 | <i>Robert Sherman</i>      |
| Benny Goodman Rides Again                                   | 36 | <i>Bertram Stanleigh</i>   |
| How Negative Feedback Affects Amplifier Performance, Part I | 38 | <i>Norman H. Crowhurst</i> |

## MUSIC REVIEWS

- |                 |        |  |
|-----------------|--------|--|
| Classical       | 56     | <i>Edward T. Canby</i>                   |
| Light Listening | 34, 58 | <i>Chester Santon and Robert Sherman</i> |
| Jazz and Blues  | 36, 60 | <i>Bertram Stanleigh</i>                 |

## EQUIPMENT PROFILES

- |                                   |    |                    |
|-----------------------------------|----|--------------------|
| Shure Stereo Cartridge            | 44 | <i>M75E</i>        |
| Telex Stereo Headphone/Amplifiers | 46 | <i>Amplitwin</i>   |
| Telex Stereo Headphone            | 48 | <i>Serenata II</i> |
| Switchcraft Portable Mixer        | 50 | <i>307TR</i>       |

## AUDIO IN GENERAL

- |                     |    |                          |
|---------------------|----|--------------------------|
| Audioclinic         | 2  | <i>Joseph Giovanelli</i> |
| What's New in Audio | 4  |                          |
| Letters             | 10 |                          |
| Editor's Review     | 16 |                          |
| ABZs of FM          | 52 | <i>Leonard Feldman</i>   |
| Tape Guide          | 54 | <i>Herman Burstein</i>   |
| Audio News          | 71 |                          |
| Classified          | 72 |                          |
| Advertising Index   | 74 |                          |



AUDIO (title registered U. S. Pat. Off.) is published monthly by North American Publishing Co., I. J. Borowsky, President; Frank Nemeyer, C. G. McProud, and Arthur Sitner, Vice Presidents. Subscription rates—U. S. Possessions, Canada, and Mexico, \$5.00 for one year; \$9.00 for two years; all other countries, \$6.00 per year. Printed in U.S.A. at Philadelphia, Pa. All rights reserved. Entire contents copyrighted 1967 by North American Publishing Co. Second class postage paid at Philadelphia, Pa.

REGIONAL SALES OFFICES: Sanford L. Cahn, 663 Fifth Ave., New York, N. Y. 10022; (212) 753-8824. Louis Weber, 2927 W. Touhy Ave., Chicago, Ill. 60645; (312) 743-1206. Jay Martin, 9350 Wilshire Blvd., Beverly Hills, Calif.; (213) 273-1495.

REPRESENTATIVE: Warren Birkenhead, Inc., No. 25, 2-chome, Shiba Hamamatsu-cho, Minato-ku, Tokyo, Japan.

AUDIO Editorial and Publishing Offices, 134 N. 13th St., Philadelphia, Pa. 19107

Postmaster: Send Form 3579 to the above address.

Number 53 in a series of discussions  
by Electro-Voice engineers



## BUILD A BRIDGE WITH AIR

ROBERT JACKSON  
Project Engineer,  
Microphones

If you closely examine a modern microphone, you'll often find some bits of cloth, fiberglass wool, felt, or sintered metal employed in the air stream. These porous materials are usually included to add an acoustic resistance to the design, either to control frequency response by damping the diaphragm, to control polar pattern by shifting phase, or both.

Despite the ubiquitous presence of these materials, they are difficult to control precisely. The relative porosity of cloth, felt, or other "loose" materials can vary widely, even in a single bolt of material. Unless the actual acoustic resistance of a given piece of material is known, it may be impossible to accurately predict the performance of a microphone.

Measurement of acoustic resistance is not normally an easy task. The conventional approach is to measure the air flow rate through a sample of the material under test, using a source of constant air pressure. But the flow rate is dependent on both resistance and air pressure (thus a measurement made at high pressure may bear no useful relationship to the behavior of the same material at low pressure). In addition, absolutely constant air pressure is difficult to achieve and maintain.

Indeed, it is rare that an absolute measure of acoustic resistance is needed. More often it is desired to compare a new microphone assembly with a "standard" either for lab development or quality control. And so a technique has been developed to provide comparative measurements with ease and accuracy.

In essence, the new instrument developed is the pneumatic equivalent of a Wheatstone bridge. A source of air pressure is connected to two tubes with equal, fixed acoustic resistance. Joining these tubes is a differential pressure meter (designed to prohibit air flow through the meter). The "standard" microphone and the unit under test form the other two legs of the bridge. Air passing through these microphones is exhausted into the atmosphere to provide the return path. Accuracy is unaffected by variations in air pressure (although sensitivity increases with higher pressure).

This new measurement technique offers several significant advantages to E-V engineers. Materials can be tested as installed in their acoustic environment (including the case and internal structures). More accurate adjustment of resistance permits mass assembly of more sophisticated designs. Closer control of production quality can also be achieved for higher product uniformity. In addition, time spent in trial and error can be reduced when developing new designs.

For technical data on any E-V product, write:  
ELECTRO-VOICE, INC., Dept. 283A  
602 Cecil St., Buchanan, Michigan 49107

**Electro-Voice**  
SETTING NEW STANDARDS IN SOUND

Check No. 101 on Reader Service Card

# Coming in March

## SPECIAL SPEAKER SYSTEM ISSUE

### Including:

#### Roundup of Speaker Systems

—Specifications and details of the latest hi-fi speaker systems.

**Speaker System Buying Guideposts** — What the specs mean; how to evaluate speaker performance.

**A Deluxe Stereo Sound System for Church**—James Ferguson, who authored "Concrete Monster" in AUDIO Magazine 14 years ago, describes the innards of a stereo sound system in a new church. Special emphasis is given to its concrete horn-loaded speaker systems, built by the author on a grander scale than his earlier effort in 1954.

... and more.

### Also:

#### EQUIPMENT PROFILES:

**H. H. Scott** 2504 and 2505 compact stereo music systems.

**Ampex "Micro 85"** cassette stereo player/recorder system.

**Plus:** Record reviews, ABZs of FM, Audioclinic, Tape Guide, and other regular monthly departments.

**ABOUT THE COVER:** February's cover illustrates a stereo hi-fi installation where most of the owner's investment went into components, least into cabinetry. In contrast, another installation (see page 7), in a Shawnee Mission, Kansas home, utilizes a handsome antique French cabinet and attractive wall cabinets to house equipment. To each his own, we say. See these installations in full color, starting on page 6.

## AUDIOCLINIC

### JOSEPH GIOVANELLI

If you have a problem or question on audio, write to Mr. Joseph Giovanelli at AUDIO, 134 North Thirteenth Street, Philadelphia, Pa. 19107. All letters are answered. Please enclose a stamped, self-addressed envelope.

### Orchestral phonograph record dynamics

*Q. What is the dynamic range of a standard symphony orchestra? What dynamic range may be realized on a phonograph record? If the answer to the second question is smaller in terms of dB than the first, how does one explain several record companies' explicit claims to reproduce the entire dynamic range? I have at hand, as an example, a recording (Mercury SR90272) of Schubert's "Great C Major Symphony," which contains on its liner the statement: "Three omnidirectional microphones are used for the stereo version. . . . There is no limiting or compression at any time during the session or in later processing or cutting."*

*... I was under the impression that an orchestra produced approximately 80 dB dynamic variation, while records are capable of only 40 dB. What gives?*—Don De George, Murfreesboro, Tenn.

A. It is true that under some circumstances a symphony orchestra will have an 80-90 dB dynamic range. However, this is not always the case, as witness "The Great C Major Symphony" of Schubert. I doubt that this Schubert symphony requires more than a 40 dB dynamic range. Such a range does represent the limits of most phonograph record/playback systems.

I will really wonder if I see an advertisement for a record which claims to encompass the entire dynamic range of either the "1812 Overture" or Stravinsky's "Firebird." These works require virtually the entire dynamic spectrum of a symphony orchestra.

### Powering an FM phonograph transmitter

*Q. My problem is a frustrating one. I have an automatic turntable in my living room, often used in conjunction with an FM radio in my bedroom. Be-*

*cause of the inconvenience of running long cables from turntable to radio, I have been using an FM wireless phono transmitter. This transmitter uses a 9-volt transistor radio battery as a power source. This lash-up has given me fairly good results. However, in order to eliminate the nuisance and expense of constantly replacing batteries, I have tried using a transistor radio, 9-volt a.c. adaptor. The result is a loud hum in my FM radio. How can I eliminate this annoying hum problem?—Louis Weidner, Kew Gardens, N. Y.*

A. The hum is probably being generated in your a.c. adaptor because of a lack of filtering. When this adaptor is powering a transistor radio, this problem does not arise because the radio itself contains some filtering. Also, the small speaker used in such radios cannot reproduce much in the way of hum.

You will need more filtering. Unfortunately, there is insufficient room inside the adaptor. You must, therefore, put the filters on the outside. A capacitor having a value of perhaps 2,000  $\mu$ F, 15 VDC, will be sufficient for this application.

An alternate method is the use of a larger, 9-volt battery. This may be the simplest solution to your problem. Such a battery costs more than your presently-used, typical transistor radio battery. However, it will last so much longer in proportion to its increased cost.

### Mounting large electrolytic capacitors

*Q. I am assembling the parts to build a transistor amplifier. Two of these parts are Mallory 4500  $\mu$ F 50 V capacitors. They are simply large aluminum tubes without mounting hardware, and are covered with plastic.*

*Can you tell me how I am to mount these on top of the chassis? Am I supposed to remove the plastic?—James Cleveland, El Paso, Texas.*

A. I am not sure from your description just how your capacitor is constructed. However, I would gather that it is designed to be mounted on a printed circuit board, and that it is to be held by its leads.

However, if the terminals on the bottom of the capacitor are screw terminals, it can be mounted directly to the chassis, using these screws.

First, drill the holes in the chassis large enough to accept a grommet or fiber washer. (I prefer the grommet.) To mount the capacitor, slip the screws through the grommet or fiber washer

(Continued on page 64)

# Singer... Critic



*Ordinarily, we do not use testimonial advertising in the high fidelity magazines, our reason being that we believe the readers of these publications prefer to base their evaluation of products upon features and specific capabilities. A meaningful new development such as the Synchrono-Lab Motor, which provides absolutely constant synchronous speed, is certainly a more cogent reason to prefer a Garrard SL 95 than the fact that any particular person uses it. However, you will see this painting of Frank Sinatra in our general magazine advertisements, for a very special reason. Frank Sinatra is not only a brilliant performer and producer of records—he is also a perfectionist. His extremely critical judgment applies to the reproduction as well as to the performance. He has been using Garrard equipment for years, and today owns a Garrard SL 95. He does so for only one reason—its performance—which he considers worthy of the artistic effort that goes into the making of any fine record.*

**Garrard**<sup>®</sup>  
WORLD'S FINEST

pretty  
clever...  
those  
fellows at  
Superex

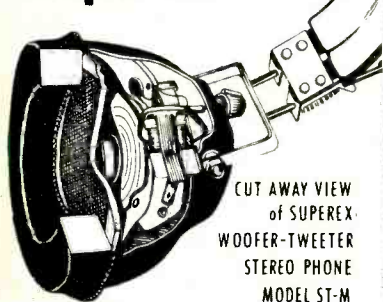

CUT AWAY VIEW  
of SUPEREX  
WOOFER-TWEETER  
STEREO PHONE  
MODEL ST-M

First they put a woofer/tweeter in their stereo headphones to provide a full range of response without distortion. They also added a complete crossover network right in the earpiece... for an authentically fine speaker system in miniature. Just what the true stereo buff ordered!

Then they extended their line in depth for the Hi-Fi enthusiast and for Education, Broadcast, Aviation, Marine and Communications use.

Now, they've developed a great new model, the ST-PRO-B... just about the last word in a professional quality headphone.

Pretty clever, those fellows at Superex. All they do is give you the edge in quality, value and forward-looking audio engineering. Ask your dealer for a demonstration.

Write for complete catalog.

**SUPEREX ELECTRONICS**  
1 Radford Place, Yonkers, N.Y.



## WHAT'S NEW IN AUDIO

### It's a tape cassette world

Seems that every time we turn around, another tape cassette machine is being introduced. Clearly, manufacturers have sensed the excellent prospects for reaching a mass audience with easy-to-use cassette (and cartridge) tape machines. But not all the cassette tape units are mere duplicates of each other (though the cartridge mechanism itself is). There are different twists, each geared to fill a particular niche.

For example, Sony Superscope has just introduced to the public a mini cassette unit, its new Easy-matic Pocket Cassette-corder, model TC-50. It's hardly bigger than the cassette itself. This put-it-in-your-jacket-pocket machine incorporates a built-in microphone and speaker, push-button rewind and fast-forward, and automatic record control to provide hands-off balanced recording levels. The TC-50 has a battery-level and recording-modulation meter, too.

The unit, powered by four type "AA" batteries, is priced under \$125 with a leather carrying case and one

60-minute tape cassette. (For more information, check 6 on Reader Service Card.)

Harman-Kardon has a home music system which incorporates a tape cassette recorder/player. The new SC-2520 compact, which includes a Garrard 3000 record changer with a Grado B stereo cartridge, an FM stereo tuner, and two speaker systems, features pushbutton control of the built-in cassette machine, including automatic lifting and ejecting of the tape cartridge. With the built-in tape machine, you can listen to an FM broadcast or play a disc and record the material at the same time.

Features include a defeatable contour control, automatic shut-off at the end of the last record, stereo headphone receptacle, bass and treble tone controls, speaker selector switch, automatic switching from mono to stereo FM and vice versa, center of channel tuning meter, and a stereo indicator light.

Power output is 30 watts (IHF) at 8 ohms; frequency response, 20 to 30 kHz  $\pm 1.5$  dB at 1 watt; harmonic distortion, less than 1%; FM sensitivity, 2.9 microvolts (IHF). Speaker systems each consist of air-loaded, high compliance 8-in. woofer, network, and 3-in. wide-dispersion tweeter. The center section measures 17 $\frac{7}{8}$ -in. D by 18 $\frac{1}{4}$ -in. W by 8 $\frac{1}{2}$ -in. H. Weight is 28 lbs. The system is priced at \$479. The center unit alone, that is, without the speaker systems, is available at \$399.50. (For more information, check 7 on Reader Service Card.)



### Mobile TV/FM antennas

If you're really on the go, in trailers and mobile homes, the Finney Company has two antenna kits to solve reception problems. The model TTR-1 is an all-channel FM-VHF-UHF antenna mounted on a telescoping mast and rotator mechanism. This allows the antenna to be rotated from inside the vehicle through a full 360-deg. When

traveling, the antenna can be folded down, closed up and locked in a position below the vehicle roof top without disconnecting the transmission line or disassembling the unit. List is \$54.95.

The second model, Finco's TTW-1, mounts to the vehicle on a wall mount. The antenna and top mast section can be removed for storage by simply snapping closed the preassembled antenna elements. \$29.95. (For more information, check 12 on Reader Service Card.)



# The AM4A mixes everything

Sermons, choirs, congregations and background music: musicians, soloists, audience and sound tracks. Wagnerian sopranos or folk-rock singers; wherever you have a requirement for sound mixing, that's where you need an AM4A.

A single AM4A with 4 output channels, can mix and match the inputs from up to 20 microphones, controlling HF and LF, equalize, reverb and mix... mono or stereo. You can even solo any given microphone.

Prices start at less than \$3500, and most important, you buy only the channels you need. Each channel is a pre-wired plug-in module. Just unpack the AM4A, connect your input and output lines, drop in the modules and you're ready to go.

But don't take our word for it. If you are a qualified customer you can try an AM4A on a free 30-day trial. That's how confident we are that once you have it in operation, you'll never let it go.

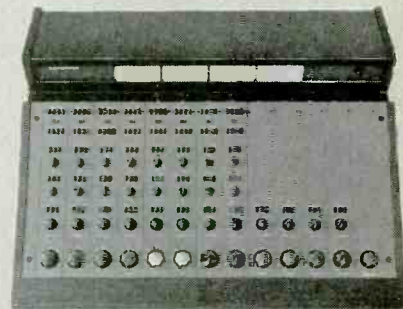

# Langevin

1801 EAST CARNEGIE AVENUE, SANTA ANA, CALIFORNIA 92702 (714) 546-8830

## SOUND & DECOR STYLES

AUDIO INVITES YOU TO SEND IN PHOTOS AND DETAILS ON YOUR HI-FI SYSTEM. PAYMENT WILL BE MADE FOR ALL PUBLISHED MATERIAL.

### INSTALLATION No. 1—

Here is an eye-appealing conversion of an antique French chest into an equipment cabinet. Custom-installed by David Beatty Hi-Fi, a Kansas City, Mo., dealer, equipment includes: Dual 1019 automatic turntable, Stanton 481 stereo cartridge, Marantz 7 stereo preamplifier, McIntosh MR67 stereo FM tuner, and a Marantz 8B 70 watt stereo amplifier hidden behind the color TV set. Speaker systems are disguised behind cabinet doors. Each one consists of a JBL 15-in. D130 woofer and LE175DLH high-frequency horn and driver with acoustic lens.







## INSTALLATION No. 2—

**Alan J. Werner, Jr., Rochester, N. Y.** Mr. Werner's hi-fi equipment philosophy is to make a maximum initial investment in top-quality components, acquiring one by one as funds permit. On the other hand, he follows a minimum initial investment program in cabinetry, aiming for flexibility and ruggedness. As pressures for investment in component equipment decrease, however, he plans to replace cabinets with more elegant units.

This audio buff's equipment "cabinet" is made up of two sections of industrial steel shelving with a  $\frac{3}{4}$ -in. layer of polyurethane foam on top of the shelves. A plain, cut-down door is used across the cabinet top, placed on top of foam.

Equipment shown here includes: **Tape Machines**—Viking model 75 mono (PB70 playback amplifier, RA72 record amplifier, 75 deck); Ampex 4460 tape recorder, Ampex PR10-2 tape recorder, Ampex 934 deck. **Record Playing**—Gray 33H manual turntable; Grado tone arm and Lab cartridge. **Tuners**—McIntosh MR71 stereo FM tuner; Heathkit FM3A FM tuner; Heathkit BC-1 AM tuner. **Microphones**—AKG D19E (3). **Preamplifiers**—Dynakit PAS-2; solid state, home design and construction. **Power Amplifiers**—Dynakit Stereo 70; Mullard 520 design (home built); separate amplifier and power supply (own design and home construction). **Speaker Systems**—JBL Lancer 33 (2); Stromberg RF483 woofer, JBL LE20 tweeter and crossover in Stromberg LK 490 acoustical labyrinth cabinet (2).

Not shown in the photographs are a Tandberg model 6 tape recorder, two Ampex model 2012 speaker-amplifiers (one, in an adjoining room, fed from the center channel of the home-built preamp, the other in a bedroom, fed from the mono tape output of the home-built preamp), one AKG D19# microphone, and AKG K60 stereo headphone.

(Continued on next page)



## JBL SA600: Superlative sound in all respects—any way you measure it

The JBL SA600 may be the most perfect inanimate object you will ever bring into your dwelling. It is a complete 80 watt stereophonic amplifier-preamplifier that has no peer. Without exception, all who have worked with it, tested it, and lived with it agree that the SA600 is the finest unit of its kind ever made.

**Cleanest Sound Ever**—Distortion is so low that it becomes next to impossible to measure; it is masked by the distortion inherent in the finest test instruments available. The SA600 must be driven to overload before meaningful distortion figures can be derived.

**"Lowest Noise ever measured on an integrated amplifier,"** one testing laboratory reported. With the finest program material available—low noise records or tapes, even masters—the only audible noise and distortion will be in the program material itself, not the amplifier.

**Design Philosophy**—The SA600 began with the premise that an amplifier should be as good as the state of the art permits, with wide bandwidth and low distortion,

before inverse feedback is introduced. This is exactly what you find in the SA600. Without feedback it meets NAB specifications. Negative feedback is used to eliminate relatively minor aberrations rather than to buck out gross imperfections. The feedback loop in the SA600 power amplifier section extends all the way from the output back to the input terminals; no stage or any part of one is left out.

**The JBL T-Circuit**—The power amplifier section of the SA600 incorporates the JBL T-circuit, on which a patent is pending. It is an operational DC amplifier, the type used in analog computers. Performance is phenomenal.

Technically speaking, the output circuit consists of three cascaded complementary-symmetry emitter-follower stages. It is stable even under overload conditions and recovers instantly from transient overloads at any frequency. Dynamic loudspeaker systems with almost any impedance rating can be connected without degradation in signal quality. All stages are direct coupled, and the loudspeakers are connected directly to the output transistors, maintaining control all the way down to DC.

**Power to Spare**—The T-circuit provides 80 watts (40 watts per channel) of continuous sine-wave power into 8-ohm loads

with both channels operating simultaneously, with power-line voltages as low as 110 volts, with less than 0.2% harmonic distortion at any frequency from 20 to 20,000 Hz. With 4-ohm loads the SA600 can put out 65 watts per channel for brief periods of time.

**Perfect Taste**—The SA600 looks every bit as good as it sounds. Knobs fit your fingers. Controls are as smooth-acting as the pots on a studio mixing console. The SA600 has a clean, professional air, yet with its warm satin-gold finish and optional walnut side panels is readily assimilated into domestic decor.

**Guaranteed**—A two year guarantee covers the SA600 for both parts and labor. JBL knows its product. The SA600 was designed by JBL's vice president in charge of engineering. It is manufactured in JBL's own electronics facility. Production is not simply spot checked. Each SA600 is thoroughly tested and life cycled for 25 hours before it is released for sale.

Specifications are extremely conservative, and actual performance of any given unit will fall well within these figures.

The priceless performance of the SA600 is yours for \$429. Make a date with your Franchised JBL Audio Specialist for an in-depth demonstration.

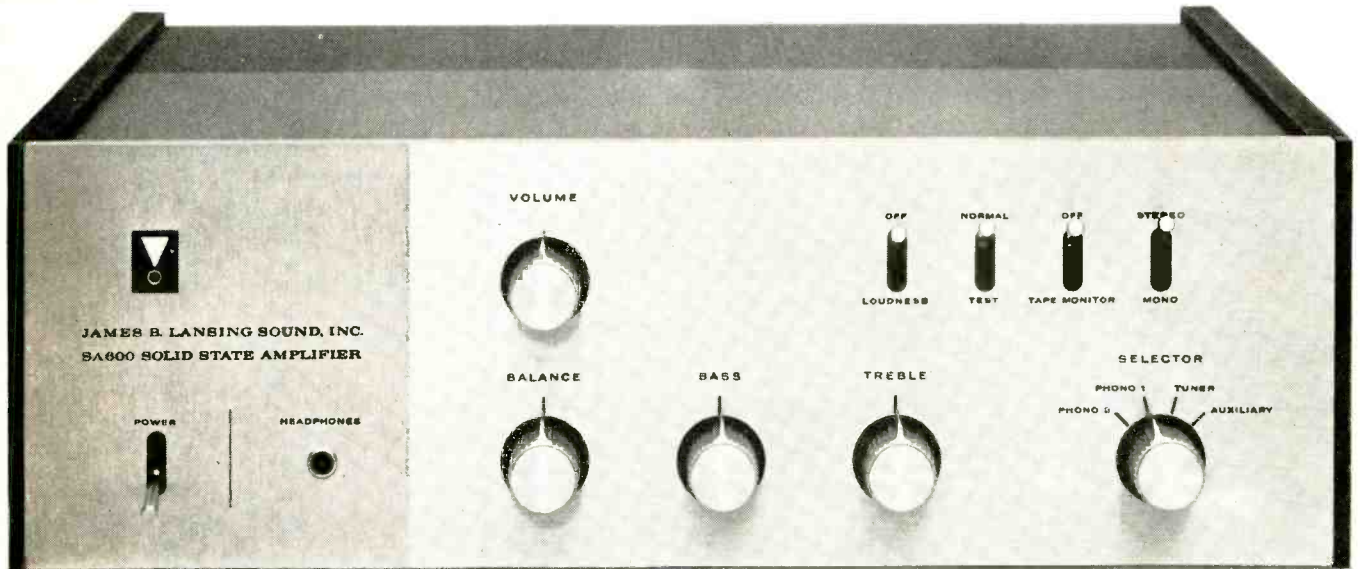

# Consensus: the finest audio amplifier you can buy



JBL, 3249 Casitas Avenue, Los Angeles, California 90039

Check No. 8 on Reader Service Card



## Specifications for the SA600

**Power Output** 80 watts continuous RMS power, 40 watts per channel, at any frequency from 10 cps to 30,000 cps.

**Frequency Response**  $\pm 0.75$  db 20 to 20,000 cps  $+ 1.5$  db 10 to 130,000 cps.

**Harmonic Distortion** Less than 0.2% from 20 to 20,000 cps at 80 watts or any level less than 80 watts, 0.1% from 20 to 20,000 cps at one watt.

**Intermodulation Distortion** Less than 0.2% at 80 watts or any level less than 80 watts, 0.07% at one watt.

**Signal required for rated output** Phono input at 1,000 cps reference—4 millivolts, 8 millivolts, or 16 millivolts into 47,000 ohms, switch selected. High level inputs—0.25 volts into 30,000 ohms.

**Maximum Phono Signal** 250 millivolts at 1,000 cps with less than 0.1% harmonic distortion.

**Hum and Noise** Low level inputs (1,000 ohm termination)—72 db below rated output, equivalent to one microvolt at input terminals or 80 db below 10 millivolts.

These specifications are measured with the phono switch set at LOW, giving rated output with 4 millivolts signal. With switch set at MED or HIGH noise is further reduced to 75 db or 78 db below rated output, respectively. High level inputs—85 db below rated output.

**Transient Response** Rise time measured at high level inputs is 2.5 microseconds from 10% to 90% of square wave signal at 160 watts peak power or any lower power level.

**Overload Recovery** Less than 1/10 of one cycle to recover from 100% single cycle overload at any frequency from 20 to 20,000 cps.

**Output Impedance** 8 ohms rated impedance, 4 to 16 ohms nominal impedance. When driving a 16-ohm load, the SA600 meets all published specifications except that power output is reduced to 64 watts. When driving a 4-ohm load, the SA600 produces 130 watts of undistorted power for brief periods of time. Prolonged operation at more than 40 watts per channel however will trigger the built-in automatic overload devices.

**Stability** The SA600 is completely stable when connected to any loudspeaker system or even to a capacitive load. AC line surges do not affect the stability of the circuit.

**Short Circuit Protection** Absolute. The SA600 cannot be damaged by short or open circuit at the output terminals, or by any degree of impedance mismatch.

**Transistors** 36 silicon transistors plus 19 silicon diodes.

**Special Features** Built-in JBL Aural Null Stereo balancing system for simple, exact balancing of stereo installation. Three-position phono switch for best possible signal-to-noise ratio. Tape monitor switch for direct comparison of program source with recorded signal while recording. Front panel stereo headphone jack.



## INSTALLATION No. 3—

**William J. Miller, Madison, Wis.** This hi-fi enthusiast has combined two hobbies, mating sound recording and reproducing equipment with three aquariums (at least as far as physical location is concerned).

His cabinet—11-ft. long by 33-in. high by 16-in. deep—is made of birch wood, stained walnut. The unit was built in three sections, each of which has hidden casters so that they can be rolled about easily.

Located across the top are the following hi-fi components: Garrard Lab 80 automatic turntable with a Shure M44-5 stereo cartridge and a spare Pickering V15AT2 stereo cartridge, a Rek-O-Kut B12H manual turntable with a G.E. tone arm and an Empire stereo cartridge, Roberts 770 tape

recorder, Dynaco PAS-3 preamplifier (built from kit), Eico AM tuner (built from kit), Shure 545S dynamic microphone (cardioid), and color organs (above right- and left-hand speakers). Each speaker system incorporates an Electro-Voice SP12 woofer, Utah D8LA mid-range, and University "Sphericon" tweeter. Two Electro-Voice SP-8 speakers with dual stereo volume controls bring music into the bedroom.

Removing the front-face center panel, you can see a Dynaco Stereo 70 power amplifier mounted under the center tank. Rounding out the front panel are four drawers to hold equipment and source material (which includes about 500 LP records and 36 reels of 7-in. magnetic tape).

# WORTH WAITING FOR!



# DYNACO STEREO 120

3 years of intensive development give you all the virtues of transistorized amplifiers with none of the harsh "transistor sound."

The combined distortion of the Stereo 120 and the PAS-3X perfectionist's preamplifier does not exceed 1/10 of 1% from 20 to 20,000 cycles at most useable power levels.

60 watts continuous power per channel; fully regulated power supply; complete electronic protection (no fuses or thermal cutouts) against open or short circuits; impeccable specifications; modular design for easy kit building.

Specifications available

**DYNACO INC.**

3060 Jefferson St., Phila., Pa. 19121  
IN EUROPE WRITE:  
DYNACO A/S, HUMLUM, STRUER, DENMARK

## Letters from Readers

### Measurement correction

• The December **AUDIO** carries an Equipment Profile on the Dynaco PAT-4 preamplifier. However, one set of figures, those for channel separation, do not conform to ours. I believe that this is because of a slight error in the method of measurement used by the reviewer.

We normally test for channel separation by injecting a signal in one channel and reading the output on the other channel, with the input of the unused channel terminated in a "normal" source impedance. This simulates the cross-feeding which can occur in normal use. Our figures, obtained in this measurement, are more than 20 decibels better than those obtained by the reviewer. The reviewer apparently made his tests with the unused channel *open*. The relatively high impedance of the open input leads to higher cross-feed and consequent lower channel separation.

The method which we use conforms with that recommended by the IHF. It also conforms with the simulation of actual use conditions, so we feel that it is the logical and appropriate rating method.

DAVID HAFNER  
Dynaco, Inc.  
Philadelphia, Pa.

### Pro-AM

• The article, "ABZ's of FM" in your August issue contained some errors.

To quote FCC paragraph 73.2, "The term 'standard broadcast band' means the band of frequencies extending from 535 to 1605 kHz." This compares with from 540 to 1640 kHz stated in one place, and from 640 to 1640 kHz in another place in the article. According to FCC paragraph 73.3, there are 107 carrier frequencies assigned to the standard broadcast band, not 100 as mentioned in the article.

An AM broadcast station with an FCC-imposed upper limit of 5 kHz on its modulating frequencies is the exception rather than the rule. A modulating frequency of 7,500 Hz is included in the FCC-required AM proof-of-performance measurements and most modern AM standard broadcast trans-

mitters will modulate to 10 or 12 kHz. Our 17-year-old AM transmitter, at WGKA, for example, which I measure often, has response to 16 kHz within 3 dB of the 1 kHz level.

LEWIS A. EDGE, JR.  
Atlanta, Ga.

• There are some inaccuracies in "ABZ's of FM" in your August and September 1967 issues:

(1) AM broadcasting uses frequencies from 535 to 1605 kHz, according to Sec. 2.106 of FCC Rules and Regulations (not 540 to 1640 kHz, as stated).

(2) The FCC sets no hard-and-fast limits on AM audio bandwidth, such as 5 kHz. The Rules only state that "... emissions outside of the authorized channel do not cause harmful interference to the reception of other radio stations. (Sec. 73.46(c) of FCC Rules.) Audio-frequency response and harmonic-distortion measurements are required to be made out to 7500 Hz on AM transmitters (Sec. 73.47) and even down to 30 Hz (which is lower than FM).

Nearly every AM broadcast transmitter is capable of AF response to 10,000 Hz. Examples:

AEL AM-1 KA	30-12,000 Hz $\pm$ 2.5 dB
Bauer 707	30-12,000 Hz $\pm$ 1.5 dB
CCA AM-1000DK	30-12,000 Hz $\pm$ 1.5 dB
Collins 820E/F-1	50-10,000 Hz $\pm$ 1.5 dB
Gates Vanguard II	1.0 dB, 20-16,000 Hz $\pm$ 1.0 dB
ITA AM-1000A	3.0 dB, 30-12,000 Hz $\pm$ 3.0 dB
RCA BTA-5T	1.5 dB, 30-10,000 Hz $\pm$ 1.5 dB
Visual AM-1K-A	1.5 dB, 30-10,000 Hz $\pm$ 1.5 dB

As a matter of fact, WLW in Cincinnati, Ohio, has a home-built transmitter which is flat out to 20,000 Hz.

(3) The theoretical limit of stations in any one locality is 107 (not 100, as stated). AM carrier frequencies are 10 kHz apart from 540 to 1600 kHz (not 640 to 1640 kHz, as stated).

Separation between stations in a community is never as little as 20 kHz, as stated. Separation depends not on the city of license or allocation, but on the measured field intensity of the station. The 25 mV/m field-intensity contours of two stations 30 kHz apart may

(Continued on page 62)



There's Music in the Air!

## Tape it with a Sony Solid-State Stereo 560

There's a world of beautiful music waiting for you and it's yours for the taping. Let Sony-superb 4-track stereo capture every note faithfully while you relax in your easy chair. Simply connect your stereo tuner to the Sony Solid-State 560, "Stereo Compact Portable," and tape your favorites off the air. Here is the nucleus of a complete stereo sound system with an ESP automatic reversing stereo tape recorder as its main component. The Sony-unique Stereo Control Center permits four separate stereo components to be connected to its stereo preamplifier and 20-watt music power amplifier. Push buttons select your component source for listening or recording. Individual input level controls balance output whenever you switch between components. Sony's revolutionary ESP Reverse electronic brain constantly scans and automatically senses the voice of music modulations on your recorded tapes. When these modulations stop, the ESP (Electronic Sensory Perceptor) automatically reverses the tape direction in 10 seconds. The Sony Solid-State 560 incorporates the most advanced electronic developments for sound-quality control. The Sony-exclusive Servo-Control Motor provides, among other things, the flexibility of AC/DC operation and variable musical pitch tuning. Non-Magnetizing Heads eliminate the most common cause of tape hiss. The exclusive Scrape Flutter Filter eliminates tape modulation distortion providing the purest recordings ever. An exclusive Noise Suppressor Switch eliminates any undesirable hiss that may exist on older recorded tape without affecting the sound quality. All of this is yours, with two Sony F-98 cardioid dynamic microphones for less than \$499.50! Check these Sony-exclusive features for luxury listening: ■ ESP Automatic Tape Reverse ■ Stereo Control Center ■ Scrape Flutter Filter ■ Servo Control Motor ■ Noise Suppressor Switch ■ Non-magnetizing Heads.



SONY'S PROOF OF QUALITY — A FULL ONE YEAR WARRANTY  
**SONY** **SUPERSCOPE** *The Tapeway to Stereo*  
 8142 VINELAND AVENUE • SUN VALLEY, CALIFORNIA • 91352

**Sony Solid-State 560D ESP Automatic Reverse Stereo Tape Deck Recorder.** If you already have components or a package stereo system, simply connect the Sony Solid-State 560D Stereo Tape Deck Recorder and add the incomparable advantage of stereo tape to your present stereo sound system. Here is the same superb ESP Reverse stereo tape deck that is the main component of the Sony 560. You will find every feature and the same advanced electronic developments for sound-quality control less the Stereo Control Center and speakers. Yet, mounted in its own handsome, low-profile walnut cabinet with recording amplifiers and playback preamplifiers, the Sony 560D sells for less than \$349.50!

# AUDIO, ETC.

EDWARD TATNALL CANBY

## New Low-Noise Tape

A MONTH AFTER I wrote in this space about a dramatic new kind of magnetic tape based on a chromium dioxide compound, the august Dupont company gave an informal demonstration of the new product, which they call *Crolyn*, before a potent and intensely interested group of audio engineers at a meeting of the New York section of the Audio Engineering Society (AES). This slightly inquisitive non-engineer (who had been foresighted enough to become a charter member of the Audio Engineering Society many long years ago) hastened to the scene to listen in, and hopefully to sniff the winds of change.

They blew all right. They fairly whistled around the slightly antique New York hotel ballroom that Bob Fine has converted into a very un-antique recording studio. This was one of those Major Occasions. Or so I felt. A great deal more than just another new and better tape was involved here.

It was a peculiar meeting in a way. Great Commercial Empires have a distinctive style of presentation for their new products, as those of us who have attended press reviews, seminars, technical convention presentations and the like have long since discovered. It might be called the cryptic underplay, or the super-soft sell. The larger the Commercial Empire, the slicker is the presentation—and the more utterly off-hand are the “claims.” Indeed, the air of genial informality can get so intense you can slice it with a knife! You have to be on the spot to appreciate the phenomenon. Sometimes you can get more info from mere tones of voice, from fleeting smiles or frowns, from very expressive deadpans, than you can from the actual words.

After all, it is a huge responsibility for a man to stand up before a professional audience and represent, in his person, perhaps a cool billion dollars of sheer corporate entity. And to talk about a new potential that also may involve enormous investment sums. If you were acting as Mr. Dupont, personified, wouldn't you play it cool?

And so I give my full admiration to the two Dupont gents (I'll leave them

their anonymity) who so engagingly and offhandedly described Dupont's new tape for us. They were surprisingly straightforward, I thought, and remarkably unevasive. Only once or twice did I get that certain feeling that maybe, behind a deadpan answer to a probing question, there just might be a bit more involved than was being said in so many words. The net result added up to a very impressive presentation—under-play or no. That is, that this chrome tape is going to be as big a thing in our audio field, I would guess, as it already promises in the large first-priority areas of computer and instrumentation where it is now in limited commercial production.

## Family of tapes

A few basics. First—we must understand that to develop a “family” of tapes from a single new magnetic compound of this sort involves a long period of research and experiment. There is no single tape for all purposes, and desirable characteristics vary greatly. They even vary within our relatively simple audio field. It seems wholly reasonable for Dupont to have turned first to the pressing needs of the non-audio tape areas, formulating its new tape first in those special terms. Audio inevitably comes further down on the priority list—we are a bit smaller than we think, you know. But, *unless* there are fundamental problems, basic faults or disadvantages, the audio demands will inevitably be investigated and audio tapes will be formulated to fit our special requirements. Business is business, and nowhere more so than *chez* Dupont. They'll admit it cheerfully.

Chromium dioxide, the basic new material, is a synthetic that does not exist in nature. It is derived from chromium trioxide at high temperatures (above 375° C) and a pressure of 3000 atmospheres of oxygen. You won't be synthesizing it in your kitchen sink. (Presumably the stuff could occur at the pressures and temperatures found near the earth's center. But we aren't likely to be mining around down there

Fig. 1—An electron microphotograph of chromium dioxide crystals at 50,000 time magnification shows the uniform, needle-like particles which are said to permit better orientation.



in the near future.) Dupont was the first to synthesize it and when the rather extraordinary magnetic properties of this material became apparent, they inevitably went into the preliminary developments that would lead to a new tape.

The dioxide comes in needle-like crystals (roughly 10:1 in configuration, length to width), as Dupont puts it, “acicular, single domain particles which can be varied in length from 4 to 400 microinches” and with a coercivity that “can be varied from 25 to over 700 oersteds.” The saturation flux density is 6100 gauss and the Curie point is 126° C. This oxide has “a higher magnetic moment per unit of volume than gamma iron oxide typically used in conventional magnetic tape”; and this over-all characteristic “leads to many practical advantages in the various industries which rely on magnetic tape for information recording.” That may be the understatement of the year. In the Canby lingo, the stuff just has more umph per inch—a lot more. And—so far—very few serious problems, actual or anticipated.

It is especially significant, if I read the photomicrographs I saw correctly, that chromium dioxide forms a marvelously even and smooth coating for tape, the particles much more uniformly dispersed and much smaller than even the best iron oxide in present high-grade low-noise tape. This, you see, slants the spotlight straight in the direction of our most vital area of present development in audio: slow-speed, narrow-track tape recording. And, as we shall see, so do other factors.

There are some lovely Dupont diagrams to illustrate the umph of this chromium dioxide. Its basic hysteresis loop is fantastic—superimposed on that of top-quality iron oxide tape, it starts lower, goes up much taller, and has longer, straighter slanting sides. The signal-to-noise ratio, necessarily somewhat variable from one type of formulation to another, is claimed *from 3 to 8 dB better* than comparable iron oxide tapes. You get both a higher signal *and* a lower noise, for the same input, though—at least on the instrumentation tape now being made—the maximum advantage seems to be well above 100 kHz. Even with my limited savvy in these technical areas, I still get the strong impression that similar S/N advantages will show up when the basic material is adapted specifically to audio needs.

## Slow video

Videotape is the big second-string market coming up for chrome tape, after the computers and the instrumen-

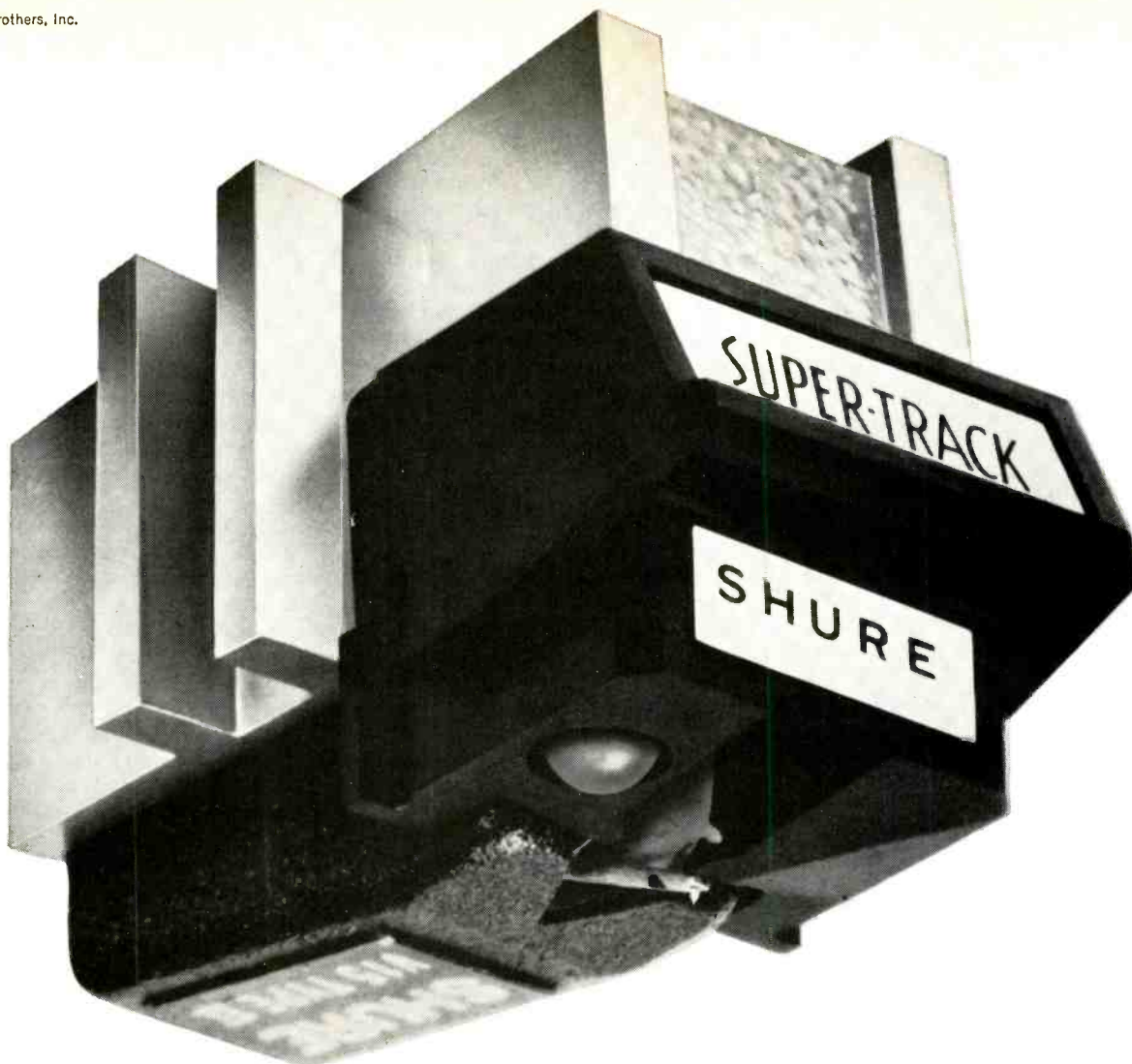

**SINGULAR!**  
in no other way can  
\$67.50 create such a  
hearable sound improvement

The Shure V-15 Type II costs about \$30.00 more than "second-echelon" (good) cartridges. This same \$30.00 would barely pay for a different finish in loudspeakers; or provide minimal convenience-type improvements in a good quality turntable; and would have virtually no noticeable sound difference if invested in a better amplifier. With the V-15 Type II, you will *HEAR* a difference, always.

World-wide, critics say that all of your recordings will sound better and last longer when played with the revolutionary Shure V-15 Type II Super-Trackability phono cartridge.

Independent testing organizations say it is alone in its ability to track passages which have been cut at a sufficiently high recording velocity to insure precise and definitive intonation, full dynamic range, and optimum signal-to-noise ratio . . . at one gram (or less) force!

**WRITE FOR COMPLETE LITERATURE**, or send \$3.95 for the definitive Shure trackability test record "An Audio Obstacle Course". (Record is free with a V-15 Type II.) Shure Brothers, Inc., 222 Hartrey Ave., Evanston, Illinois 60204.

tation needs are satisfied. Videotape gets much closer to our audio characteristics; for the same basic problem exists there as in present audio cassette recording—how to get more signal on less tape. We were given a beautiful endless-loop video demonstration on a pair of Sony machines, one of them adapted to run at half-speed,  $3\frac{3}{4}$  ips. Each loop was made up half of standard tape, half chromium and the picture thus jumped, AB-style, from one tape directly to the other. (Because bias requirements are quite different, a higher bias being needed for chrome, the bias was manually switched as the tape patches went by.)

This dual demo proved an important point which applies directly to audio. At  $7\frac{1}{2}$  ips, the standard Sony tape speed, there was only a slight difference in picture quality between chrome and iron oxide tape. Explanation: *Other factors than the tape itself* were the limiting ones. The same thing will be true, generally, in terms of chromium tape used in higher speed audio recordings, though there are still, so to speak, residual advantages.

However, when the half-speed videotape loop was played at  $3\frac{3}{4}$  ips, the difference in picture quality was striking—chalky highlights, ragged details, grainy snow, from the standard oxide tape; a startlingly smooth, clear picture from the chrome. Slow-speed reso-

Fig. 2—The top photo shows iron oxide tape which was recorded and played back at half speed ( $3\frac{3}{4}$ -in. per second), while the bottom photo shows the "Crolyn" magnetic tape played back under the same conditions.

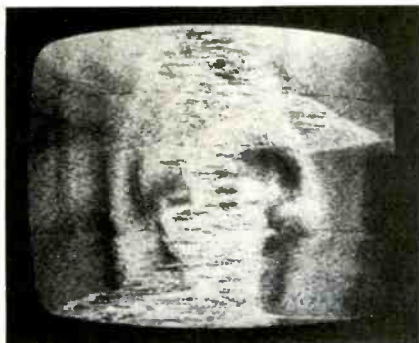

lution! In fact, and this is the basic improvement factor at speeds where the tape itself is now often at fault, the ratio of quality was approximately 2 to 1. That is, at  $3\frac{3}{4}$  ips, chrome tape on the Sony gives as good a picture as iron oxide tape at  $7\frac{1}{2}$ . Momentous, yes?

Once again, the maximum and most significant advantage of chrome occurs at the critical slow speeds (or, more precisely, short wave-lengths on the tape) where iron oxide itself, even the best, has now become a basic limiting factor. It is in this critical area, the area of the slow-speed cassette for us, where the full 2:1 advantage will apply. And in unexpected other ways, too.

For example: cassette tape requires a thin oxide coating, as well as a thin base. At the *same* speed, a chromium coating *half as thick* as an iron oxide coating on polyester material will give the *same* response. And the slower the speed, the more microscopic the actual recorded wave-shapes, the greater is the chrome advantage.

In this specific connection, I must quote Dupont in respect to its present instrumentation chrome tape. The significant performance factors here have to do with such things as information integrity at high bit rates per inch (bpi), flux changes per inch, etc. (where the same general doubling of performance is shown); but the following seems just as likely to apply to our own audio field, if and when:

"At the shortest recorded wave lengths—60 micro-inches on 2 MHz recorders—the superiority of Crolyn is most pronounced. [And] the performance advantage of Crolyn tapes over high-quality iron oxide tapes *appears to widen at still shorter recorded wave lengths*, based on results from experimental and laboratory recording equipment." (Italics mine.)

### Any questions?

In the question period after Dupont's New York presentation, someone asked about prospective frequency response under audio conditions at very slow speeds. With the utmost casualness, as though it really weren't very important, the Dupont man said (and I quote, more or less verbatim), "Oh, I'd say with optimum heads and so on, 20 kHz at  $1\frac{7}{8}$  ips."

20 kHz! Twenty thousand cycles—if I may use the old terminology! Natch, this was only in the rough, this answer, without associated figures. But no matter. If I read it correctly, what he meant was simply that the particle size and uniformity of distribution, plus the inherent magnetic quality of this chrome material, should make possible

this superb frequency range at the new and ultra-important cassette speed. Wow! Some tape. I want it.

Is there a catch? Are there many catches? Well, the questioning was lively, but Dupont was pretty quick. Not until question #14 (I counted them) did someone ask what seemed to me a clincher—how about abrasion? Well, they said, that is largely a matter of the formulation of the binder, rather than the basic oxide itself, and there are, of course, many binder formulations. When pressed further, the Dupont man said flatly that the chromium dioxide crystals themselves are *not* more abrasive than those of iron oxide. He said it. I wrote it down. But—and here is the advantage of being present in person—I thought that I detected just the merest whiff of an understandable evasion in this interchange. Yet, after all, Dupont is still in the midst of developing this wholly new tape, and has not even (at this writing) made a start in the audio direction. Moreover, if the instrumentation tape is already in commercial use (via Honeywell equipment designed especially for it), then there are surely answers, if indeed there is any serious problem of abrasion. We've had such problems before.

Print through? On present instrumentation chrome tape, *7 dB better* than equivalent low-noise iron oxide tape. That's what they say. Bias and erase? No unusual problems, though some machines will require higher bias levels than now available. Stability? Only limited by the tape base. That is, they have not yet been able to destroy a recording without destroying the base itself. Storage? "No problems"—this after several years' experience to date. Changes needed in equipment? According to normal practice, only in recording—not in playback. Any trouble in binding to base? None. Dupont says it knows all about those things, and didn't really expect any problems, other than the normal ones with tape.

Somebody wanted to know what advantage there would be in using chrome tape for higher-speed mastering, since the most immediate advantage seems to be at very slow speeds. The answer to this I missed in part, and so got down only a dangling comparative. "... 3 dB more, at 3-per cent harmonic-distortion output; also on up to saturation." Sort of incomplete, that statement, but it sounds hopeful.

How about film striping? How about magnetic discs? Haven't even thought about them. Later, later, later. How much will it cost? Here the Dupont

(Continued on page 64)



# Liberator.

New EMI DLS 629  
the speaker that  
frees your amplifier  
to do a better job



Some of today's most popular speakers are of low-efficiency design. This simply means they take more power from your amplifier to produce the same level of sound in your living-room.

That's the problem. These speakers may sound fine, but what about your 20-watt-per-channel amplifier, forced to hover around its maximum output every time you listen to *Night on Bald Mountain*? It's generating far more distortion than it would if it had to put out only about 5 watts for the loudest sounds, which would also give you a 6-db margin for peaks before the amplifier overloads.

So that's why we say the new EMI DLS 629 is "the speaker that frees your amplifier to do a better job." Among all its other virtues, it's also a more efficient transducer than most. It converts electrical power from your amplifier into sound power with less waste. Your amplifier doesn't need to work as hard, no matter how little or how much power it has.

If you're acquainted with our model 529 (the well-regarded "dangerous" loudspeaker) you'll be pleased to know that the EMI 629 has an 8-ohm nominal impedance instead of the 529's 4 ohms. This makes it especially desirable for use with modern, solid-state amplifiers.

In addition, we fitted the 629 woofer with a larger voice coil, increased the gap, and doubled the size of

the magnet — greatly increasing power-handling capacity. But we retained the unique elliptical woofer construction, with its rigid aluminum center cone and molded PVC (polyvinyl chloride) edge suspension, which contribute so much to the low frequency performance of EMI speakers.

Two damped 3 1/2-inch cone tweeters provide smooth highs to the limits of audibility. A 3-position brilliance switch lets you tailor the response to the acoustics of your listening room. The crossover network is an inductance/capacitance type with 12-db-per-octave slope. Tweeter and woofer have been electrically and acoustically matched to provide smooth integrated performance over the entire sound spectrum.

All this adds up to an efficient system that offers presence unmatched by any speaker in its price class. Sound is free, natural; does not have the constricted effect that some low-efficiency speakers exhibit in the mid-range. The handsome oil finish walnut cabinet 24 1/2h x 13 1/2w x 12 1/4d, has braced 3/4-inch walls. All of this for \$164.50.

Visit your hi fi dealer and hear the new 629 and other fine EMI speaker systems starting at \$79.50. Ask for the "volume-control" test, it will prove our point about high-efficiency speakers. For brochure, write: Benjamin Electronic Sound, Farmingdale, New York 11735.

**EMI**

the natural sound

[www.americanradiohistory.com](http://www.americanradiohistory.com)

## EDITOR'S REVIEW

### Pity the poor consumer

The record merchandising picture has changed drastically over the years. Remember back in the 78 rpm days when you could step into a record retailer's store and sample the contents of records almost to your heart's content? Why, some stores even had enclosed listening booths.

Peter Goldmark's (Columbia) 33 $\frac{1}{3}$  rpm long-playing record brought this practice to a halt. Record manufacturers made it easy for a record dealer to refuse a customer's plea for a quick listening preview by sealing record jackets in cellophane ("How can I sell it as 'new' if the seal is broken?"). So recorded music lovers sought guidance from record dealers who learned about their music predilections, record reviews, and by listening to disc jockeys' offerings over the air.

The point of purchase pattern has changed again these past few years. Seems that the mass merchandising concerns are rapidly displacing independent record stores. Norman Racusin, RCA Victor vice-president, told a trade paper (*Home Furnishings Daily*) recently that he estimates 50 per cent of records are sold through record racks in mass merchandising outlets. He notes that the major change in the record business is the wide variety of popular music created and listened to today, in contrast to the few pop styles in evidence some years ago. Coupled with the public's great demand for music entertainment, a flood of companies entered the record business. Now there are

some 2,000 record labels around which poured out over 3,000 LPs and more than 7,000 singles in 1966.

That's a lot of recorded material to choose from. So be kind to your friendly record dealer (if you are fortunate enough to have a knowledgeable one). It is expected that he will join the corner candy store as a vanishing breed, leaving you to the mercy of supermarket-style record racks and disinterested clerks.

"Progress" has its price.

### June is busting out . . .

Two electronic industry trade shows are scheduled for the month of June, both in New York City. The 1968 NEW Electronics Show is scheduled for June 14 to June 16; the 1968 Consumer Electronics Show will be held June 23 to June 26.

### Snapshots with sound

When Kodak was in the magnetic sound tape business they produced a public relations piece that compared picture-taking film and processes to sound-taking tape and processes, twisting and turning to illustrate how one resembles the other.

Far fetched? We thought so, too, until the art of acoustical holography came to our attention. Though the process of taking three-dimensional pictures with sound is entirely different than that of either conventional photography or magnetic tape recording, it does combine light and sound energy.

In a recent experiment in acoustical holography, Douglas Aircraft placed an object to be "photographed" between a high-frequency sound source and a scanning microphone. The sound energy picked up by the scanning microphone was converted to light energy by connecting it to a cathode ray tube similar to one in an ordinary TV set. The pattern on the screen was then photographed with a special Polaroid camera, subsequently "developed" with coordinated laser light.

Coming next? *Color* acoustical holograms, of course.

A.P.S.

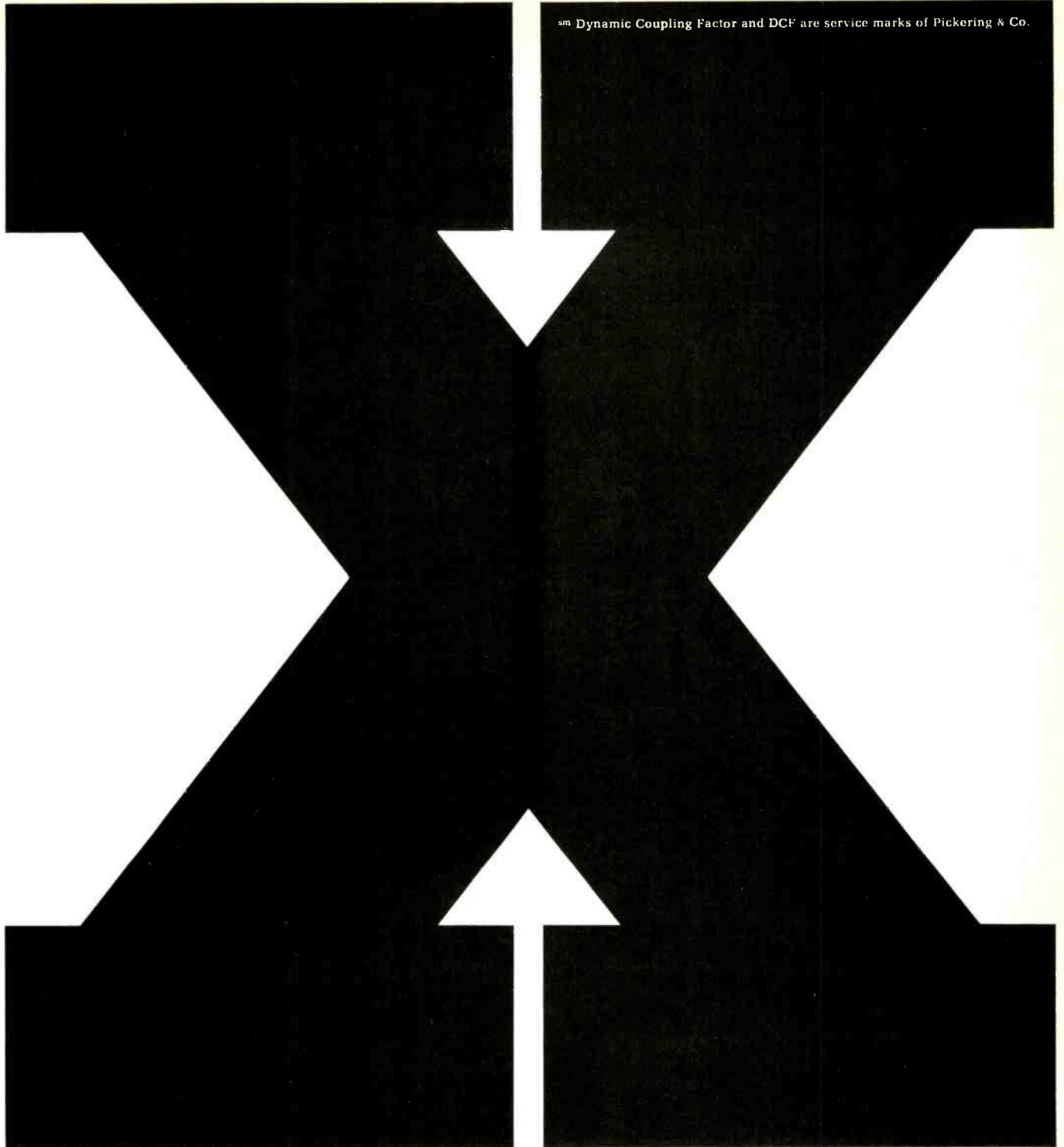

## The X factor in the new Pickering XV-15.

The X in the new Pickering XV-15 stands for the numerical solution for correct "Engineered Application." We call it the Dynamic Coupling Factor (DCF).<sup>sm</sup>

DCF is an index of maximum stylus performance when a cartridge is related to a particular type of playback equipment. This resultant number is derived from a Dimensional Analysis of all the parameters involved.

For an ordinary record changer, the DCF is 100. For a transcription quality tonearm the DCF is 400. Like other complex engineering problems, such as

the egg, the end result can be presented quite simply. So can the superior performance of the XV-15 series. Its linear response assures 100% music power at all frequencies.

Lab measurements aside, this means all your favorite records, not just test records, will sound much cleaner and more open than ever before.

All five DCF-rated XV-15 models include the patented V-Guard stylus assembly and the Dustamatic brush.

For free literature, write to Pickering & Co., Plainview, L.I., N.Y.

# new problem-solving receivers from Sherwood!

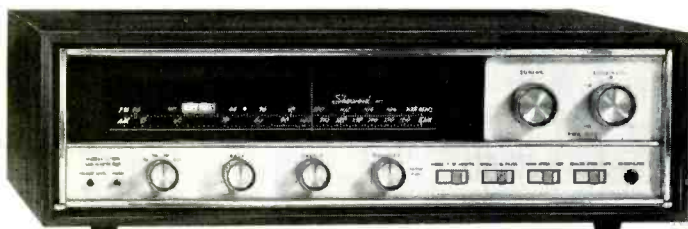

Model S-7800 140-Watt *All-Silicon* FM-AM Stereo Receiver. Features: *Synchro-phase* FM limiter/detector, Field-effect transistors in RF and Mixer stages, separate monophonic speaker terminals, DC coupled *All-Silicon* power amplifiers, instant overload protection, main and/or remote speaker switching, 140 watts @ 4 ohms. Front panel controls: Source selection, Bass, Treble, Balance, Loudness, Stereo/Mono, Tuning, Pre-Amp Sensitivity, and Hush Level. Rocker-action switches for Tape Monitor, Hi Filter, Main Speakers, Remote Speakers.

Custom-mount chassis . . . . . \$419.50  
In walnut leatherette case . . . . . 428.50  
In oiled-walnut cabinet . . . . . 447.50



Model S-8600 80-Watt *All-Silicon* FM Stereo Receiver. Features: *Synchro-phase* FM limiter/detector, Field-effect transistors in RF and Mixer stages, separate monophonic speaker terminals, DC coupled *All-Silicon* power amplifiers, main and/or remote speaker switching, 80 watts @ 4 ohms. Front panel controls: Bass, Treble, Loudness, Stereo/Mono, Tuning, and Hush Level. Rocker-action switches for Tape Monitor, Phono/Tuner, Main Speakers, and Remote Speakers. Rear-panel preamp sensitivity control.

Custom mounted chassis . . . . . \$299.50  
In walnut leatherette case . . . . . 308.50  
In oiled-walnut cabinet . . . . . 327.50

PROBLEM-SOLVING  
FEATURES  
FOR PROBLEM  
INSTALLATIONS

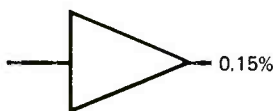

**SYNCHRO-PHASE FM LIMITER/DETECTOR**-Silicon monolithic microcircuits are used in Sherwood's symmetrical-differential limiters for improved noise rejection and reception under difficult multipath signal conditions.

Specifications: 0.15% distortion @ 100% modulation.  
2.0 db capture ratio.  
55 db AM rejection.



**FIELD-EFFECT TRANSISTOR CIRCUITRY** - In urban strong-signal locations, the reception of distant weaker FM stations is not disturbed with interference of spurious images of stronger, local stations.

Specifications: -95 db crossmodulation rejection.  
1.8  $\mu$ v (IHF) FM sensitivity.

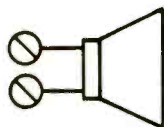

**SEPARATE MONO SPEAKER TERMINALS** - Independent of main and remote stereo speaker terminals, they offer new convenience in installations requiring powered monophonic center-channel or extension speakers.



*Sherwood* ELECTRONIC LABORATORIES, INC., 4300 North California Avenue, Chicago, Illinois 60618 Dept. A-2

# How to Build a Three-Channel Electronic Crossover

C. G. McPROUD

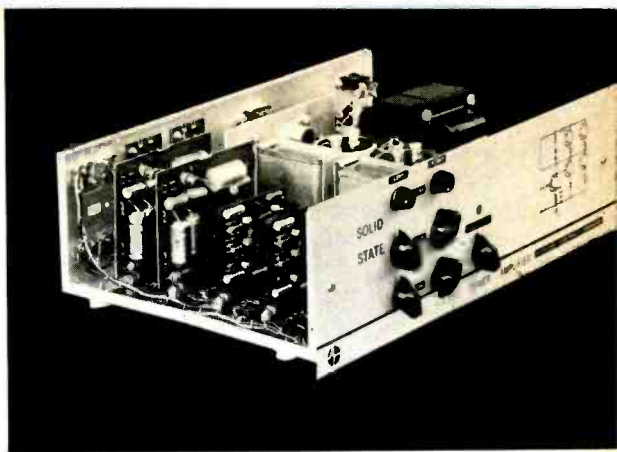

Fig. 1—Completed three-channel electronic crossover unit for stereo three-way multi-speaker systems.

## Electronic crossover networks can improve fidelity of multi-speaker systems

AS READERS KNOW, using multiple speakers—each one designed to handle a certain part of the sound spectrum—instead of one wide-range speaker can have its reward in a speaker system that exhibits better fidelity. But each speaker must be balanced against the others' output to present realistic bass, presence, and brilliance (from a woofer, mid-range speaker, and tweeter, respectively, in the case of a three-speaker system).

Further, each speaker must be fed the selected band of frequencies for which it has been designed. This funneling job is given to a crossover network, a circuit designed to pass certain frequencies, reject others. There is an overlap, of course, as can be seen in Fig. 2.

About a year and a half ago the writer embarked on a project which involved two three-way speaker systems to be built in a basement recreation room. The plan was to employ 15-in. woofers in a horn-loaded structure similar in design to the Altec A7-500, supported by a mid-range horn and a "super-tweeter." It was originally intended to operate with conventional crossover networks—circuit arrangements with capacitors, resistors, and inductors—in the speaker lines.

Then we were privileged to hear some first-class reproduction involving three separate speaker systems, three separate power amplifiers, and a three-way *electronic* crossover system. That was the beginning of the project to be described.

It is well known that there are some disadvantages in the conventional dividing network. These have been covered in a number of articles in past issues<sup>1,2</sup> which indicates that there is some doubt as to the degree of perfection obtainable with dividing networks.

And while dividing networks succeeded in providing the required separation of frequency ranges successfully when used with vacuum-tube amplifiers, they severely limit the advantages of solid-state amplifiers by the introduction of a finite value of impedance between the amplifier, usually a very low source impedance, and the speaker load.

Some of these disadvantages have been noted by

manufacturers. Some years ago Marantz produced an electronic crossover unit which enjoyed considerable popularity, although apparently not enough to warrant keeping the product in the line. In spite of that, we still see classified ads occasionally in which some purist wants to buy one of them. Sony has an electronic crossover unit available, an elaborate device which provides a variety of crossover frequencies and slopes, and separate adjustment of the various channels. Kenwood has shown an amplifier which actually comprises six separate power amplifiers in one cabinet—a pair for bass, a pair for the mid-range, and a pair for the tweeters. During the AES Convention, Pioneer showed a new system involving two amplifiers in a speaker cabinet, one for each speaker spectrum—low and high. All of these systems show considerable promise, not only theoretically, but also in performance. But theory or no, our experience with the Sony 3-way system convinced us that we would do without the conventional dividing network in our new system.

We studied the Mitchell article, worked our way through the Crowhurst one, and then encountered another one by the redoubtable Norman<sup>3</sup>. This one we

<sup>3</sup> Norman H. Crowhurst, "Electronic crossover design." *AUDIO*, Sept. 1960, p. 19.

Fig. 2—Outputs of each of the three sections illustrates overlapping.

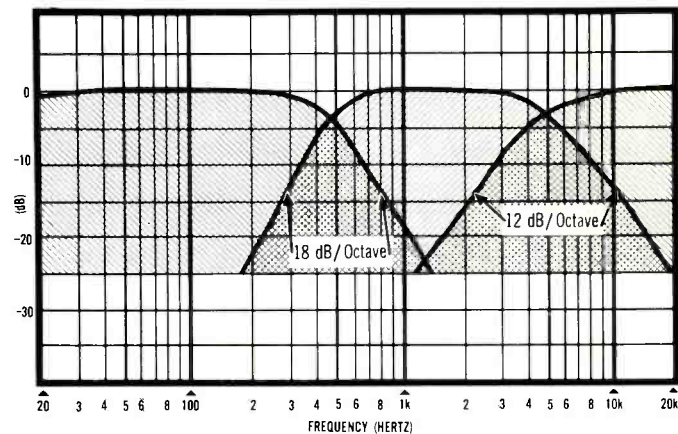

<sup>1</sup> N. H. Crowhurst, "The RC crossover compromise." *AUDIO*, July 1957, p. 17.  
<sup>2</sup> Robert M. Mitchell, "Transient performance of loudspeaker dividing networks." *AUDIO*, Jan. 1964, p. 24.

perused, studied, and considered, since it described how to design an electronic crossover system. Then we came across the instruction book for the Sony stereo power amplifier, model TA-3120. There, all laid out in schematic form, was an electronic crossover system which was almost ideal. We say almost, since the crossovers suggested were 318 and 5300 Hz, whereas we needed a crossover at approximately 500 Hz for the transition between the woofer and the mid-range horn, and we could go along with the 5300-Hz crossover to the tweeter. While Sony's idea in offering this circuit was undoubtedly to sell some more TA-3120's, we decided to revise it for our own requirements—with crossovers at roughly 500 and 5300 Hz.

We had available a TA-1120, which is a single stereo amplifier that is equipped with a pair of phono jacks in each channel so that the output of the preamplifier/control section is available to be "patched" to some other circuit before feeding the power amplifier section. Hence we would use the TA-1120 as a control amplifier, take its

preamp output and feed it to the electronic crossover circuitry, and then feed the output of the mid-range section back to the TA-1120 to drive the mid-range speaker system. Needless to say, we had available a few stereo power amplifiers, so we chose a Citation B for the low-frequency driver, and an Acoustech XI for the high-frequency unit. This latter choice was not dictated by any particular reason other than its adaptability to provide a mounting for the crossover units, as well as for a source of power for the crossovers, which require about 25 volts at something like 16 mA total for the two channels. Any other solid-state power amplifier should be equally suitable.

One further attraction of the Acoustech XI is the fact the chassis is already punched for the addition of the P/M—Preamplifier Module—to convert the XI power amplifier to a complete integrated amplifier. The driver amplifiers of the XI are two circuit boards, which plug into two 15-connector sockets, and when the conversion is added, the preamp/control sections also plug into two more such sockets. Thus the chassis is punched to accommodate the preamp-board sockets, as well as for an additional filter capacitor and a few other components. Different views of the completed project are shown in Fig. 1 and Figs. 3 through 5.

Therefore it seemed logical to lay out the crossover circuit on an etched panel—one for each channel—and arrange to plug them into two more 15-terminal sockets. Basically, the power amplifier was to serve as the driver amplifier for the tweeter section, using two other amplifiers for the other two channels. And it was necessary to provide an input, three volume controls per stereo channel, and two low-level (1.0 V.) outputs for each stereo channel.

Starting from the basic Sony circuit—which differs from its commercial version of the electronic crossover in that the frequencies are not variable, nor is the slope away from crossover, we planned a construction project.

The first step, therefore, was to recalculate the components for our choice of the crossover frequency between the low and mid-range sections. Sony suggested 318 Hz, which simplifies the component values, but we wanted a crossover closer to 500 Hz to accommodate the mid-range horn. The changes were minor, and affected only the woofer and mid-range sections. We left the crossover between mid-range and tweeter at the suggested 5300 Hz, although in the final result the frequency was closer to 5000 Hz.

Figure 6 shows the circuit of the entire system as mounted in the Acoustech XI chassis. All of the crossover components are accommodated on the circuit boards—one channel on each. We used Acoustech's shorting-type phono jacks for input, with the second one having the shorting contact left unconnected so that if the input were removed the input to the circuit board would be shorted, yet the second jack could serve as a multiple jack if it were needed for testing. The AUX and TUNER jacks were wired to serve as the output to the woofer amplifier, while the third pair of jacks—tape recorder feed and monitor input—served as the mid-range output. Figure 8 shows the layout of the circuit board, and since it is exactly the same size as the finished circuit board, it can be used as a pattern for making the board, of which more later.

Figs. 3, 4, 5—Various views of the completed dual three-channel electronic crossover network—front, back and top—are shown here.

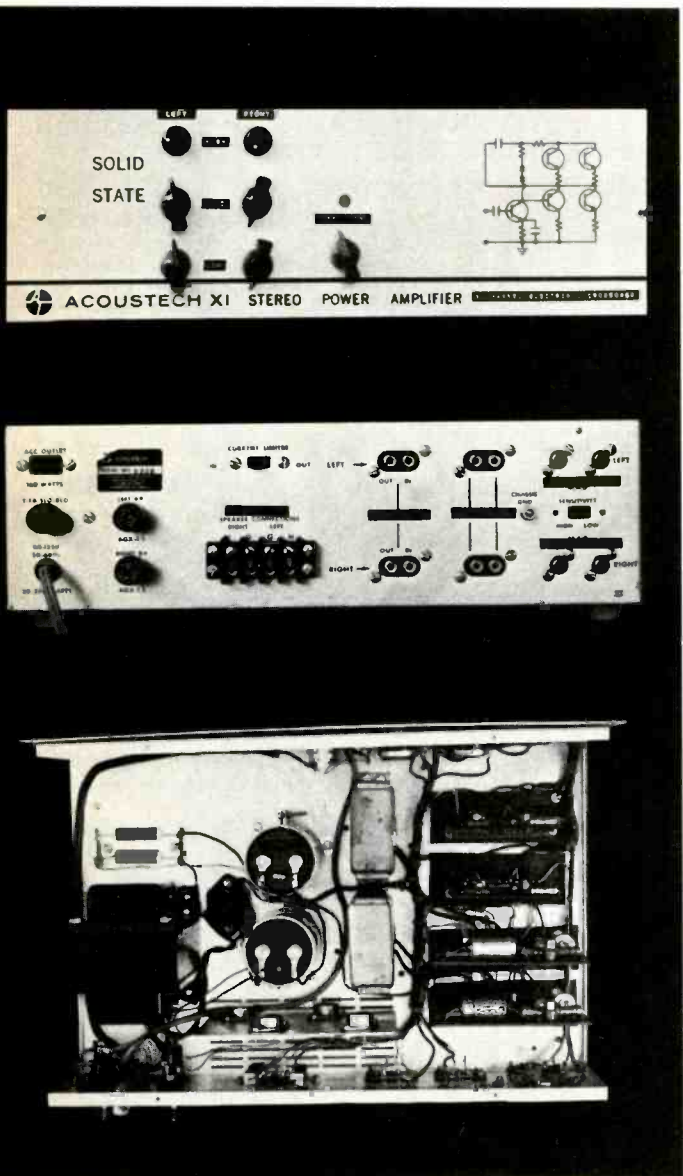

# Cross Over to ALL THE MUSIC

The unique Bozak "building block" principle is a speaker system growth that helps you cross over, in easy stages, to truly full sound. Grow to the Concert Grand — the optimum in home music enjoyment. You can begin with as few as three speakers — a bass and a tweeter pair. Then, when you decide, add another bass and another tweeter pair. It's just like adding violins to your orchestra! Step three — add a midrange and a crossover network. You now have a truly big system. Improve upon it, when you want to, by completing the array with two more bass speakers, two more tweeter pairs, and a second midrange — fourteen speakers in all. This is sound quality you have to hear to believe! Listen to it at your nearest Bozak dealer's — or to other Bozak models. If you don't know your dealer's name, ask us. Then, go hear "ALL the music at its big sound best."

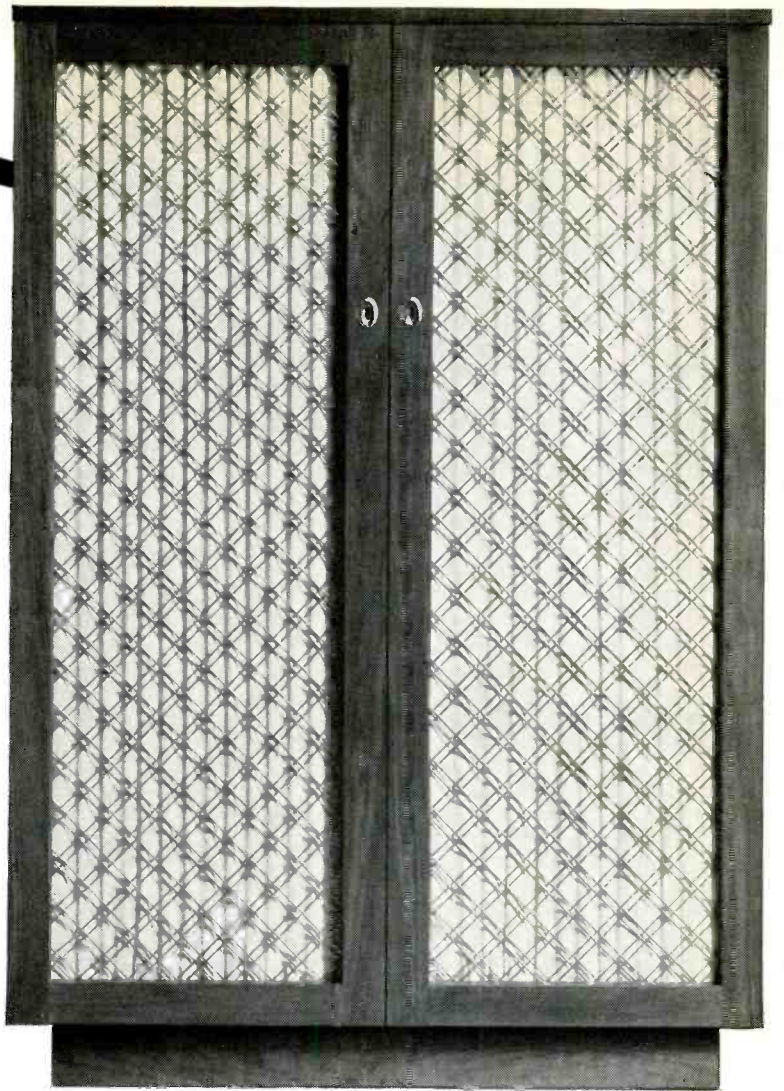

P.O. BOX 1166 • DARIEN  
CONNECTICUT 06820

CONCERT GRAND  
CLASSIC ENCLOSURE

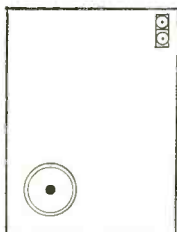

Begin with B-199A  
Bass and  
B-200Y Treble Pair

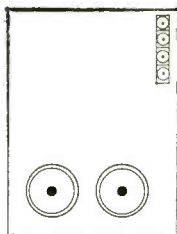

Add Second B-199A  
and Second B-200Y

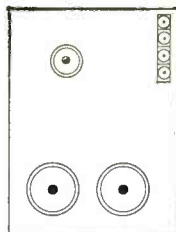

Add B-209B Midrange  
and N-10102A  
Crossover

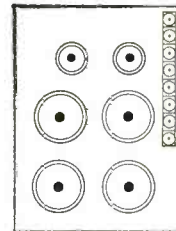

Add Two B-199A's,  
a Second B-209B  
and Two B-200Y's

EXPORT: Elpa Marketing Industries, Inc., New Hyde Park, N.Y. 11040

# ELECTRONIC CROSSOVER

(Continued from page 20)

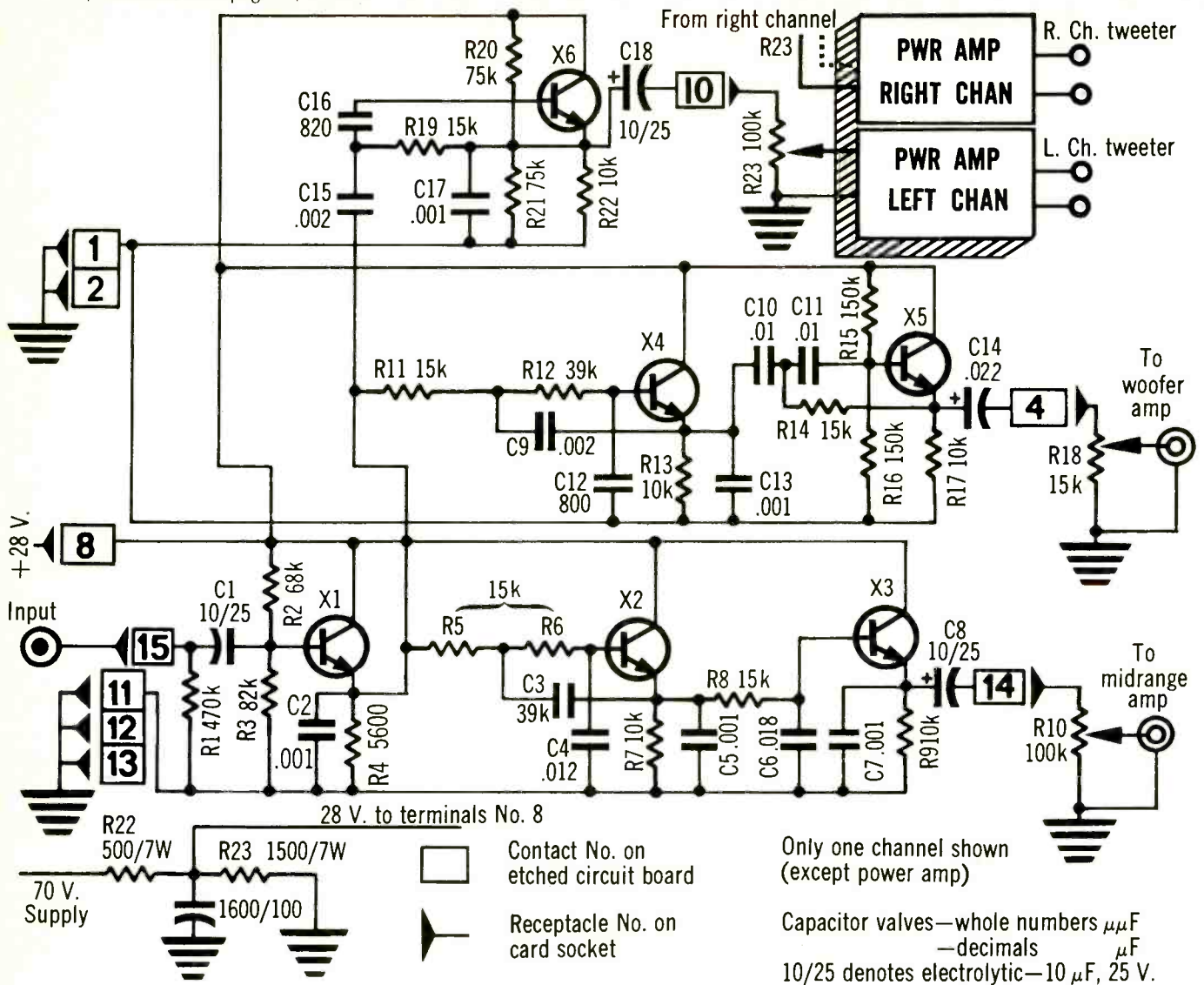

Fig. 6—Three-channel Electronic Crossover Circuit.

## PARTS LIST

(per channel—2 of each required)

C <sub>1</sub> , C <sub>8</sub> , C <sub>18</sub>	10 μF, 25V. Sprague TE-1204	R <sub>3</sub>	82 k ohms, 1/2-watt, 5%
C <sub>2</sub> , C <sub>5</sub> , C <sub>7</sub> , C <sub>13</sub> , C <sub>17</sub>	.001 μF, Sprague 192P10292	R <sub>4</sub>	5600 ohms, 1/2-watt, 5%
C <sub>3</sub>	.039 μF, Sprague 192P39392	R <sub>5</sub> , R <sub>6</sub> , R <sub>8</sub> , R <sub>11</sub> , R <sub>14</sub> , R <sub>19</sub>	15 k ohms, 1/2-watt, 5%
C <sub>4</sub>	.012 μF, Sprague 192P12392	R <sub>7</sub> , R <sub>9</sub> , R <sub>13</sub> , R <sub>17</sub> , R <sub>22</sub>	10 k ohms, 1/2-watt, 5%
C <sub>6</sub>	.018 μF, Sprague 192P18392	R <sub>10</sub> , R <sub>23</sub>	100 k-ohm pot, Ohmite CU 1041
C <sub>9</sub> , C <sub>15</sub>	.0022 μF, Sprague 192P22292	R <sub>12</sub>	39 k ohms, 1/2-watt, 5%
C <sub>10</sub> , C <sub>11</sub>	.01 μF, Sprague 192P10392	R <sub>15</sub> , R <sub>16</sub>	150 k ohms, 1/2-watt, 5%
C <sub>12</sub> , C <sub>16</sub>	820 μF, Sprague 192P82192	R <sub>18</sub>	15 k-ohm pot, Ohmite CU 1531
C <sub>14</sub>	.022 μF, Sprague 192P22392	R <sub>20</sub> , R <sub>21</sub>	75 k ohms, 1/2-watt, 5%
C <sub>19</sub> , C <sub>20</sub>	6 μF, 100 V, oil filled	R <sub>24</sub>	500 ohms, 7-watt
C <sub>21</sub>	1600 μF, 100 V.	R <sub>25</sub>	1500 ohms, 7-watt
	Mallory CG1651U100K1	X <sub>1</sub> -X <sub>6</sub>	RCA 40232 transistors
R <sub>1</sub>	470 k ohms, 1/2-watt, 5%		Printed board socket
R <sub>2</sub>	68 k ohms, 1/2-watt, 5%	1	(Two each of the above parts are required for a stereo system except for C <sub>21</sub> , R <sub>22</sub> and R <sub>23</sub> , for which only one each is required.)
		7	
			Rotary a.c. line switch
			Knobs
			Phono jacks, hardware, wire, solder

(Article continues on page 66)



## WHAT A GREAT IDEA!

At last BSR has done something to take the confusion out of your shopping for a quality automatic turntable. We've completely pre-assembled the Total Turntable unit for you . . . cartridge and all . . . in these superb new BSR McDonald models.

Each is precision engineered in Great Britain with features you'll find only on the most expensive professional equipment.

An anti-skate control, a resiliently mounted coarse and fine vernier adjustable counterweight, a micrometer stylus pressure adjustment from 0 to 6 grams, a cueing and pause control lever and an automatic locking rest to secure the tone arm in the "off" position. These are just a few of the very many features of BSR McDonald turntables.

Ask your dealer to demonstrate the many features or send for a free detailed brochure and name of your nearest dealer.



PRECISION CRAFTED IN GREAT BRITAIN  
BSR (USA) LTD., BLAUVELT, N.Y. 10913

The BSR McDonald 400/808



The BSR McDonald 500A/M44-7



The BSR McDonald 600/M44-E



# TOTAL TURNTABLES

Complete with cartridge, wood base and dust cover...ready to plug into the hi-fi system...and play beautifully!

# The Recorded "Works"

EDWARD T. CANBY

THERE IS SOMETHING FASCINATING to all of us about complete collections — whether the complete works of Shakespeare or Edgar Guest, the complete sonatas of Beethoven or the Nine Symphonies, or the works of Edgar Allan Poe, every last horror story; the Complete Garden Book (every last flower?)—or the "complete" Stravinsky.

I got to know this "completeness" urge very early. My Father used to collect gorgeous sets of books, fifty or a hundred identically bound volumes, all the works of this or that famed author. What you find immediately is that there are always too many works—but never mind. Nobody could possibly read them all, or listen to them all on records. Who cares, just so the collection is complete. I used to browse in the complete H. G. Wells, concentrating on the science fiction stuff—must have gone through six or seven volumes out of a yard or so of Wells on our living room bookshelf. Then there was O. Henry. Dozens of O. Henrys, hundreds of his short stories. I sampled almost every big set we had, but never got much beyond Vol. 2. Or maybe Vol. 79, if I started at the other end.

The completeness urge sprang up bravely in recording when the 78 record went electric and at last we could record almost anything, any place. Enormous volumes of ten or a dozen shellacs came out, almost too heavy to lift, tackling a whole act of an opera. Or the total Beyreuth Festival, taken down in interminable four-minute segments. Societies were set up to record complete rarities: the Beethoven Piano Sonatas played by Arthur Schnabel. Unsatisfied, some phono fanatics published elaborate lists of unrelated single discs

which could be patched and overlapped — different soloists, different orchestras — to give a zany semblance of "completeness" to some large work. Only when the LP arrived did this sort of inspired nonsense give way to practicality, with "complete" recordings that most of us would be glad to buy.

But don't think the basic proposition has changed! The old idea still persists—completeness for itself, as a kind of aesthetic design. Who wants an album of eight of the nine Beethoven symphonies, even with a perfectly good recording of the remaining work already on the home shelf? Plain fact is, it's good to have things sewed up and final. Complete.

Doesn't always work out. Death, taxes, obsolescence, the profit motive (and the loss motive), all take their toll. Some "complete" LP editions are in effect open-ended—they just go on and on and never will make it to the end. Or they stop, tired out with much too much of a muchness. Modesty of aim is not typical of such enterprises.

Last I remember, Westminster's Scarlatti harpsichord sonatas were somewhere beyond the 20th LP, and scarcely off the ground. Well over 500 sonatas! Buxtehude's complete organ works go onward, too, if not always upward. Max Goberman died with the complete Vivaldi and all the Haydn symphonies (104-plus) en route—a project that seemed good for 50 years at least.

But the idea is good, nevertheless, especially on a smaller scale. Ruggerio Ricci, one of the most marvelously accurate violinists going, has just launched his Vol. 1 of the Complete Sonatas and Partitas of Bach for unaccompanied violin via the Decca label (*DL 710142 stereo*).

The music is tough, but there are only six works, and two are on the first disc. That'll be three LPs and Mr. Ricci will surely make it. He should. There has seldom been such a superbly communicative playing of the music which, if the listener is to make sense of it, requires an absolutely perfect player's ear for the implied harmonies that are merely sketched out by the solo instrument.

A bigger Bach project is Vol. 1 of the Complete Organ Music on Epic, played by Lionel Rogg (*BC36 166 stereo*). Curiously, the organ itself is anonymous, and Mr. Rogg might as well be too, for all Epic has to say about him. But he's good. The somewhat straightforward interpretation of a batch of Toccatas, Fantasias, Passacaglias and their fugues are very solidly phrased and shaped. He ought to make it, too.

The most celebrated "complete" series on records is Columbia's continuing parade of Stravinsky performed under the composer's direction. Astonishing how many odds and ends, little and very big, are still flooding forth from the elderly master. Using tape to the full, Columbia often rearranges this material in new LP combinations of older and new recordings. The latest, "Recent Stravinsky Conducted by the Composer" (*MS 7054 stereo*), has three major works and a half-dozen tiny ones, all from 1953 through 1966, and it is hard to say that the little ones are least important. All the music is astonishingly up to date, profoundly mathematical (don't read the notes first — listen first!) and yet unflinchingly communicative, from the tiny "Fanfare for Two Trumpets," seconds long, to the cantata-like "A Sermon, A Narrative and a Prayer" of 1961, in three movements with solos, chorus, speaker and orchestra. The latest and most charming bit, from 1966, is something called "The Owl and the Pussycat" for soprano and piano, out of Edward Lear's nonsense rhyhmes. Delightful, but not yet the final "complete" item, we can hope.

And on the subject of "complete" works, let us not dismiss Vox's recent outpouring of record sets: "the complete piano and chamber music everything by every composer that matters without breaking the bank" [Sic].

Æ

# Watt for Watt Spec for Spec Dollar for Dollar Sansui offers you more...



This is the new Sansuifidelity 2000. 100 watts (IHF) of music power... 36 watts/channel RMS... harmonic distortion of less than 0.8% at *all* rated outputs... FET Front End... 1.8 $\mu$ V (IHF) FM Sensitivity... frequency response from 15-40,000 Hz. If you are an expert in audio equipment you will know what these specifications mean; if you are not, ask any sound engineer; he will tell you. He will also tell you that specifications alone do not make a great receiver. There is the perfection of every component, the most exacting quality control, the integrity and pride of the manufacturer, and that extra care and extra imagination that make a truly great product.

Your Franchised Sansui Sound Specialist invites you to see and listen to the Sansuifidelity 2000. Watch the exclusive Sansui blackout dial light up when you listen to AM or FM broadcasting and change when you switch the selector to phono or tape or auxiliary; notice the ease with which the controls let you choose exactly the blend of music you want to suit you and your personal taste. All this and much more at the unbelievable price of **\$299.95**.

## Sansui

Sansui Electronics Corporation • 34-43 56th Street • Woodside, N.Y. 11377 • Telephone 446-6300  
Sansui Electric Company, Ltd., Tokyo, Japan • Electronic Distributors (Canada), British Columbia



Fig. 1—Omnidirectional condenser microphones and high-directional multicellular speaker horns combine here to realize very high acoustic gain in an outdoor reinforcement situation.

THE PRINCIPLE OF A condenser cardioid microphone is illustrated in Fig. 2. The sound field acts on both sides of the stretched diaphragm. To achieve the cardioid characteristic, sound pressure on the back side of the diaphragm is delayed by an acoustic network consisting of an acoustic resistance,  $R_1$ , and an acoustic compliance,  $C_1$ . Therefore, between the sound entrance on the front and the sound entrance on the rear of the microphone, there will exist a pressure difference proportional to the effective sound path between front and rear (which also will be dependent on frequency).

Figure 2 also shows the equivalent circuit for this cardioid microphone. Since the sound pressure difference, which constitutes the driving force for the diaphragm, increases with increasing frequency, and the output

voltage of the microphone is proportional to the amplitude of the diaphragm, the diaphragm's movement has to be resistance controlled if the output of the microphone is independent of the frequency of the sound field. This resistance, "R," is formed by the thin air film between diaphragm and back plate.

In the graph of Fig. 3 (top), the sound pressure is plotted as a function of distance for a certain instant of time. "D" designates the effective sound path from the front to the rear sound entrance of the microphone. As can be seen, the pressure difference is, at first approximation, proportional to the distance, "D." It will increase with increasing frequency.

The sound wave coming from the rear will first hit the rear sound entrance of the microphone, acting on

the back side of the diaphragm with a certain delay, "T," caused by the acoustic resistance,  $R_1$ , and the acoustic compliance,  $C_1$ . (See Fig. 3, bottom.) If this delay is equal to the time it takes the sound pressure to reach the front side of the diaphragm, both pressures will cancel each other, and the microphone will not be sensitive for this sound wave. Sound coming from the front side will first act on the front side of the diaphragm, then, after being delayed by the sound path between front and rear and by the acoustic network, it will act on the back side of the diaphragm. There will be a considerable difference between these two sound pressures. Accordingly, the microphone will be sensitive in this direction.

The arrangement discussed so far works satisfactorily only for micro-

Fig. 2—Principle of a condenser cardioid microphone and its equivalent circuit.

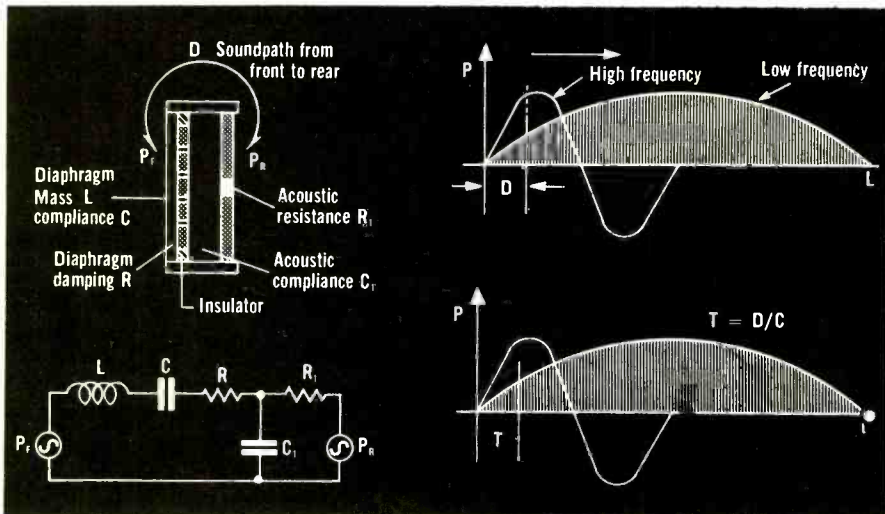

Fig. 3—Sound pressure for the microphone in Fig. 2. See text.

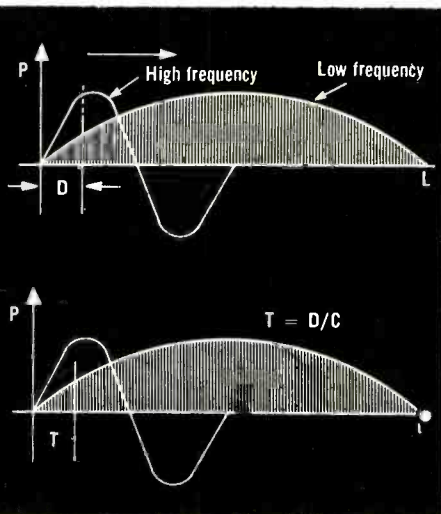
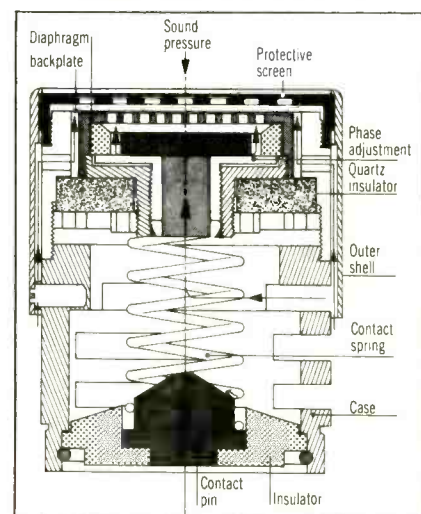

Fig. 4—Schematic cross section of a condenser cardioid microphone.



# we've "humanized" headphones

Now, for the first time—AKG has developed stereo headphones which recreate the *you-are-there* realism of an original performance.

Impossible you say?

Many thought so, but we investigated and carefully measured the characteristics of human hearing when coupled to headphones. We discovered significant differences between listening to loudspeakers in rooms, and the sound from headphones close to your ears.

AKG K-20 and K-60 headphones are **humanized** with the first scientifically designed driver units specially suited for headphone listening.\* They look like headphones, but sound entirely different—accurate bass, superb transient response, transparent highs and intimate sound. Hear them at your AKG Headphone dealer.

**It's an original listening experience  
you'll take home!**

*\*Send for a copy of this original research report.*



**MICROPHONES • HEADPHONES**

DISTRIBUTED BY  
NORTH AMERICAN PHILIPS COMPANY, INC.  
100 EAST 42nd STREET, NEW YORK, NEW YORK 10017



7-67

Check No. 27 on Reader Service Card

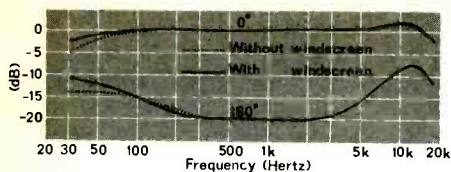

Fig. 5—Frequency response for 0-deg. and 180-deg. sound incidence.

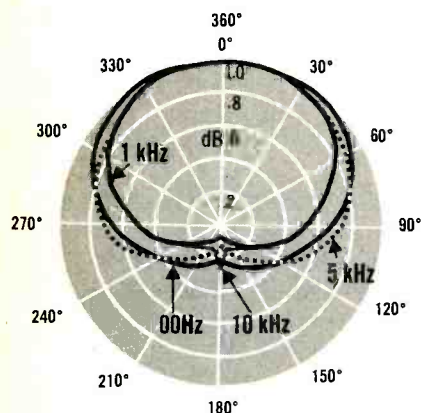

Fig. 6—Polar pattern of microphone used for plotting in Fig. 5.

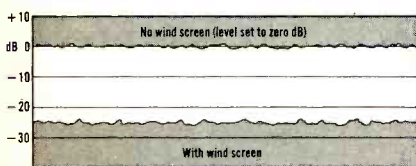
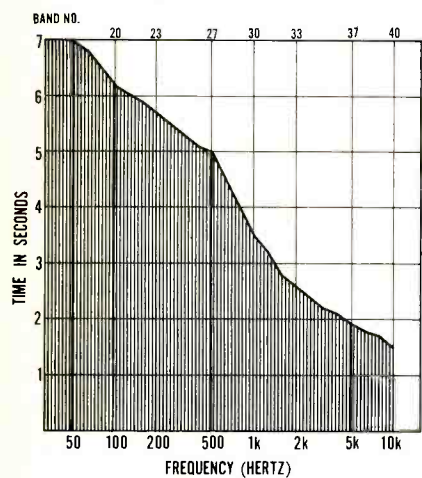

Fig. 7—Wind-noise reduction from a wind screen.

Fig. 8—Reverberation time vs. frequency in a large Catholic church.



phones of large diameter (1½ to 2-in.) which have an inherently long sound passage between front and rear, and which at high frequency provide directivity due to their size. Cardioid microphones of smaller size require much more complicated acoustic networks to achieve flat frequency response and good front-to-back discrimination over a wide frequency range.

Figure 4 shows a schematic cross-section of a cardioid microphone of this type. The maximum diameter is only ¾-in. and the total length, ⅞-in.

In this microphone, the sound pressure, which acts on the back side of the diaphragm, has to pass through several phase-delaying acoustic networks. One network consists of a narrow ring passage formed between the outer shell and the case of the microphone. This narrow passage decreases the propagation velocity, thereby providing the necessary time delay for the sound pressure. Another network consists of a narrow passage between two adjustable discs (phase adjustment and a cavity forming a R-C network similar to that discussed above.) The combination of these two networks can be adjusted so that the microphone has high sensitivity, flat frequency response, and good discrimination.

Figure 5 shows a frequency response for 0° and 180° sound incidence. The excellent low-frequency response and good discrimination at low frequencies are especially noteworthy. Since the diaphragm movement is resistance controlled and the diaphragm resonance frequency is in the mid-range, the microphone is comparatively sensitive to wind blasts. In many cases it is therefore advisable to use a wind-screen. A special wind-screen which has practically negligible influence on the

frequency response (and even improves the discrimination at the low end) is available. The dashed curves in Fig. 5 show the response with wind-screen.

It is interesting to note the polar pattern of such a microphone for various frequencies (See Fig. 6). The pattern is nearly a perfect cardioid over most of the frequency range, and only slight deviations occur at the very low and very high frequencies. Figure 7 indicates the degree of wind-noise reduction available from the wind-screen.

### Random notes for using microphones

The major technical points covered by this article are summarized in Chart I. The remainder of this exploration of microphones for sound reinforcement consists of a series of practical notes that have served the authors as a good mental checklist when "all is not going according to the book."

It is always helpful to remember that when a system is in a state of acoustical feedback, you are attempting to solve one of two problems: either the feedback is in-phase with the input and the gain has exceeded unity, or the phase,  $\phi$ , of the system equal  $2N\pi$  radians. In other words, you either have a big bump in overall house response or you have some slope in the response that creates a detrimental phase relationship. Acoustic measurements can point the way to pull additional dBs of acoustic gain by the dozens out of the hat if the bumps and slopes measured are equalized. The excellent discussion by Richard V. Waterhouse and the series of articles by Dr. C. P. Boner covers this subject, feedback, in great detail. (See bibliography.)

Fig. 9—Four-way test of effective use of a cardioid-pattern microphone tested as an omnidirectional unit.

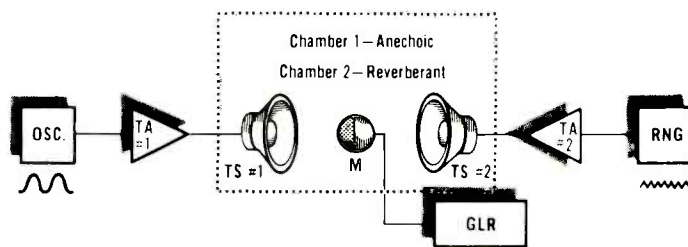

## When Stanton engineers get together, they draw the line.

The frequency response curve of the new Stanton 681 Calibration Standard is virtually a straight line from 10-20,000 Hz.

That's a guarantee.

In addition, channel separation must be 35 dB or greater at 1,000 Hz. Output must be 0.8 mv/cm/sec minimum.

If a 681 doesn't match these specifications when first tested, it's meticulously adjusted until it does.

Each 681 includes hand-entered specifications that verify that your 681 matches the original laboratory standard in every respect.

Nothing less would meet the needs of the professional studio engineers who use Stanton cartridges as their ref-

erence to approve test pressings. They must hear exactly what has been cut into the grooves. No more. No less.

But you don't have to be a professional to hear the difference a Stanton 681 Calibration Standard will make, especially with the "Longhair" brush which provides the clean grooves so essential for clear reproduction. The improvement in performance is immediately audible, even to the unpracticed ear.

The 681 is completely new, from its slim-line configuration to the incredibly low-mass moving system. The 681A with conical stylus is \$55.00, the 681EE with elliptical stylus, \$60.00.

For free literature, write to Stanton Magnetics, Inc., Plainview, L. I., N. Y.

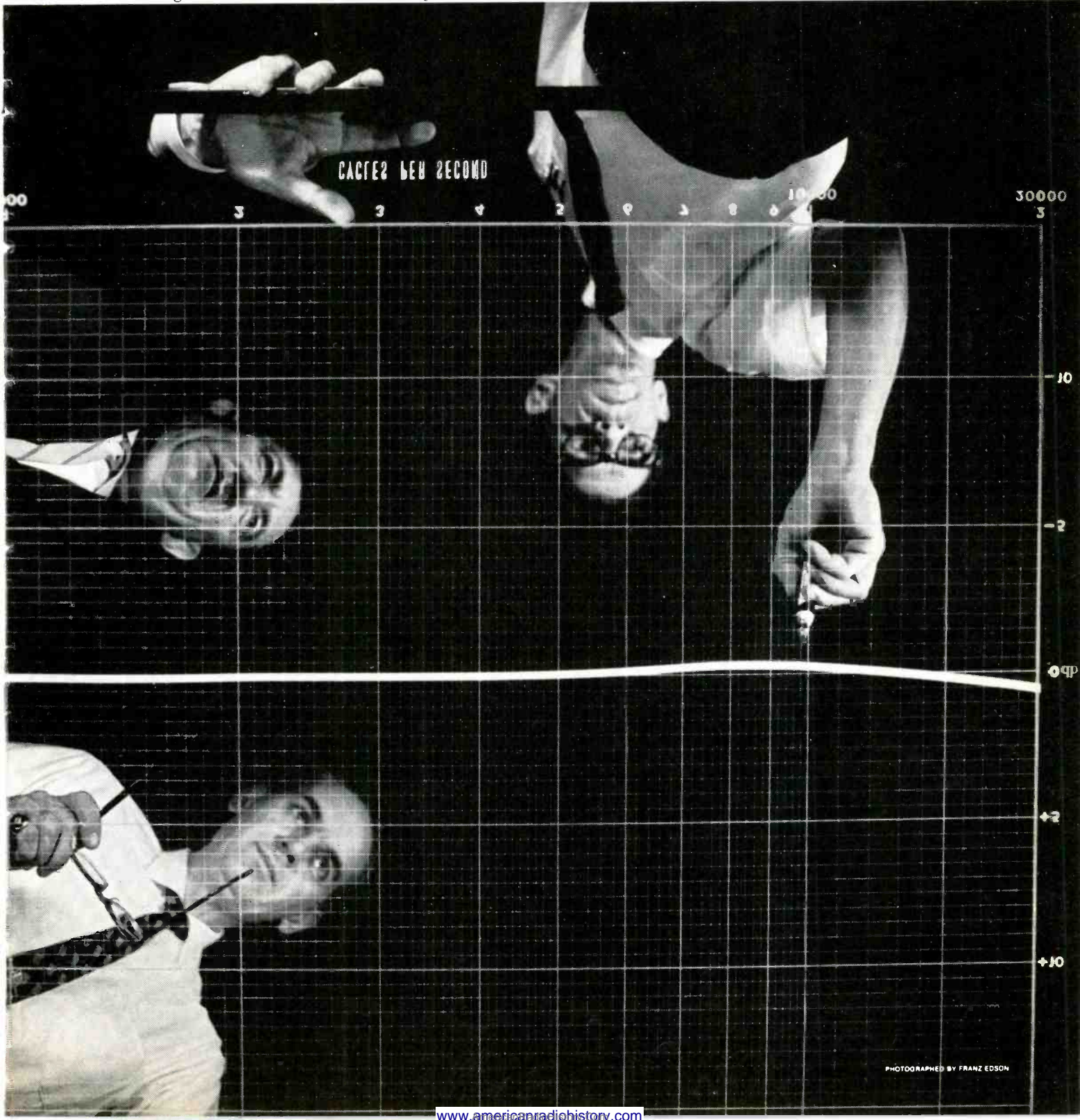

PHOTOGRAPHED BY FRANZ EDSON

*Directional microphones in reverberant rooms.* Experience has shown that bi-directional and unidirectional microphones are of far less use in a reverberant space than often claimed.

In examining this, let us assume that the correct loudspeakers, electronics, time relationship, and sound distribution basics have been reasonably satisfied. (Usually, the choice of an inadequately or improperly chosen microphone is a manifesta-

tion of faulty equipment elsewhere in the system, as well.) One very common mistake today is to use super-directional line-source microphone types. These are designed for two special cases: (1) very absorbent surroundings (outdoors, heavily-treated rooms); (2) for recording or broadcast use. (Frequency response is sometimes so irregular here that it assures severe feedback problems in a reinforcement system.)

Still another problem is the com-

mon occurrence of reverberation time rising at lower frequencies in the reverberant space. Figure 8 shows a typical reverberation time vs. frequency plotting for a large Catholic church. This indicates that the absorption of the room is not the same at all frequencies. Some front-to-back discrimination can be expected at high frequencies, but as the frequency is lowered ever-increasing energy is being uniformly diffused in the room, negating the effectiveness

Chart I—Microphone Principles

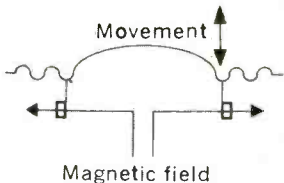
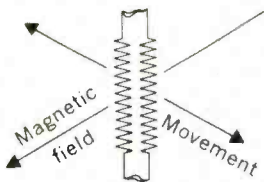
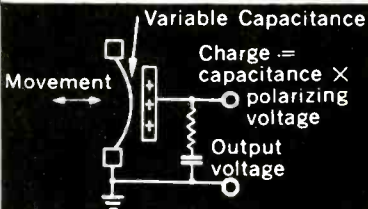
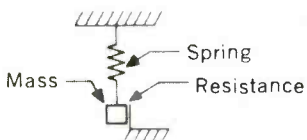
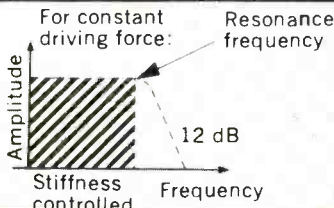
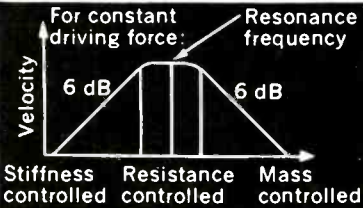
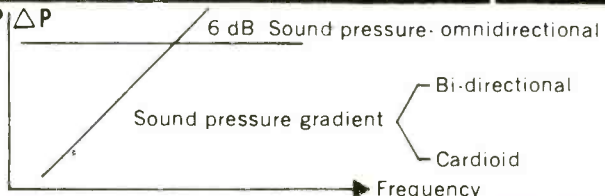
MICROPHONE TYPES	DYNAMIC MICROPHONES				CONDENSER MICROPHONES	
	MOVING COIL		RIBBON			
OPERATING PRINCIPLES						
OUTPUT VOLTAGE	VOLTAGE PROPORTIONAL TO VELOCITY				VOLTAGE PROPORTIONAL TO DISPLACEMENT	
PRINCIPAL MECHANICAL SYSTEM						
DIRECTIVITY	OMNI-DIRECTIONAL PRESSURE	CARDIOID PRESSURE GRADIENT	BI-DIRECTIONAL P. GRADIENT	CARDIOID P. GRADIENT	OMNI-DIRECTIONAL PRESSURE	CARDIOID P. GRADIENT
DIRECTIONAL EFFICIENCY	0 dB	5 dB	5 dB	5 dB	0 dB	5 dB
ACCESSORIES REQUIRED	None				Power supply	Power supply
IMPEDANCE	Low				Very high Preamp close to microphone	
FREQUENCY RESPONSE	Good	Fair	Good	Good	Very good	Very good
MECHANICAL RUGGEDNESS	Very good	Good	Good	Good	Very good	Good
RESISTANCE TO ENVIRONMENT	Good	Good	Good	Good	Good	Good
FORCES IN A PLANE WAVE SOUND FIELD	For constant sound intensity: Far field plane wave					



# !!! a Marantz receiver

Now everyone may enjoy the eloquent sound of Marantz components, combined in a single completely solid-state system — the Marantz Model 18 Stereo Receiver. Here is the incomparable quality of Marantz stereo components — tuner, preamplifier and power amplifiers — combined on a single chassis. Designed to the unequivocal standards which have made Marantz a legend in stereo high fidelity, the Model 18 achieves the level of performance of the most expensive components in a moderately priced compact receiver. Here is the total performance you would expect from Marantz. Finer sound than you have heard from most quality component systems and it is priced at less than half the cost of the fine Marantz components which inspired its design — only \$695.00

**Features:** Out of intensive research comes the Marantz "passive RF section" a revolutionary new development which advances the state of art and eliminates the overloading problems commonly encountered in strong signal areas . . . Four I.F. stages assure maximum phase linearity and maximum separation . . . an integral Oscilloscope, a Marantz hallmark, provides absolute tuning accuracy and permits elimination of multipath . . . Gyrotouch tuning provides a new experience in quick, silky-smooth station selection and precise tuning. **Amplifiers:** Solid-state throughout with a massive power output of 40 watts continuous rms per channel, from 20 Hz to 20k Hz, nearly three times the output of many receivers rated at 60 "music power" watts . . . Direct coupled design for instantaneous recovery from overload . . . Automatic protector circuits for amplifier and speaker systems eliminate program interruptions . . . Total distortion from antenna input to speaker output is less than 0.2 per cent at rated output . . . and substantially less at listening level. Flawless performance was the design objective. Flawless performance has been achieved.

**Specifications:** **Tuner Section:** Signal-to-Noise Ratio — 70 DB; Harmonic Distortion at 400 Hz, 100% modulation — 0.15%; Frequency Response, 75 microsecond de-emphasis — ±0.5 DB; Multiplex Separation, 20 Hz — 43 DB, 1000 Hz — 45 DB, 10k Hz — 35 DB, 15k Hz — 30 DB. **Amplifier Section:** Power, 40 rms watts per channel at 4 and 8 ohms, 20 Hz to 20k Hz; Distortion, 0.2% THD; Frequency Response, 15 Hz to 30k Hz, ±0.5 DB. **Dimensions:** 18¼" wide x 16" deep x 6" high.

**marantz**®

37-04 57TH STREET, WOODSIDE, NEW YORK, 11377



MARANTZ MODEL EIGHTEEN STEREOPHONIC RECEIVER

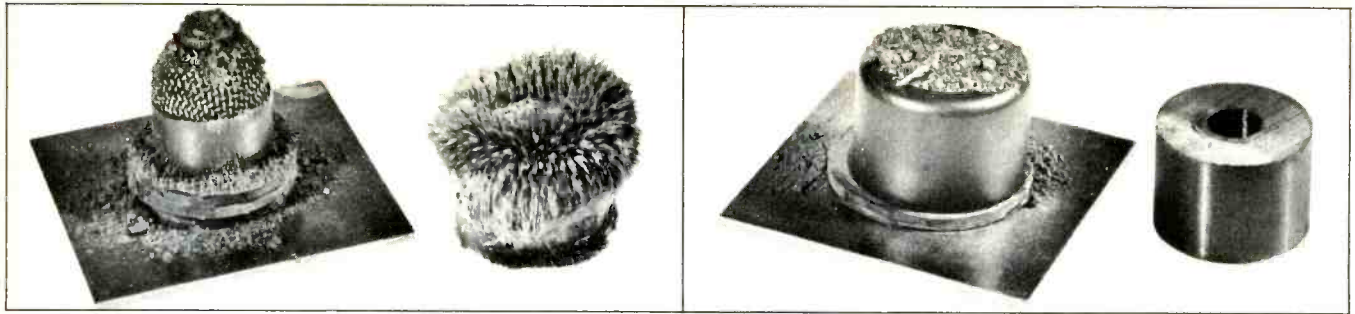

**Fig. 10**—Microphones should be protected against environmental hazards. Metallic filings at left, for example, can reach the inner mechanism of a microphone with inadequate protection. In con-

trast, a properly-protected microphone at right does not allow foreign objects to damage delicate mechanism.

of the unidirectional response. In practical terms, it means that unidirectional microphone output from a signal in a reverberant space becomes bass accentuated.

Unidirectional microphones work best in anechoic chambers, not in reverberant chambers. Figure 9 details a four-way test of the effective use of a cardioid-pattern microphone (M), tested as an omnidirectional unit.

Two signals adjusted to equal level at (M) are put into the chamber. One is an oscillator sine-wave signal

**Fig. 11**—Plotting in I and II, using test setup of Fig. 9, are made in an anechoic chamber. Plot I shows test as an omnidirectional unit; plot II as a unidirectional unit. Plots III and IV are done in a reverberant chamber.

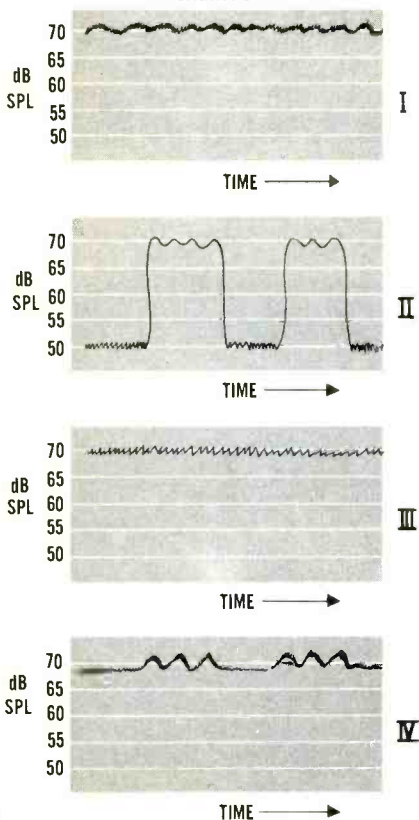

fed through a test amplifier to test speaker #1, aimed at the zero axis of the microphone and turned on and off. The other is a random noise generator feeding noise through a test amplifier to test speaker #2, aimed at the 180° axis of the microphone. The output of the microphone is connected to the input of a graphic level recorder. This is done twice, each in a different environment: an anechoic chamber and a reverberant chamber. Plotting (I) in Fig. 11 illustrates the type of response that occurs: The sine wave and the random noise appear equally mixed in the microphone's output. Next, (M) is changed to a cardioid-type microphone and the test is run again. This time, as Plot II in Fig. 11 reveals, the rear discrimination of the cardioid pattern very effectively performs its work when the sine-wave signal is switched on.

Now let's look at the results from the same test setup in a reverberant chamber. Plot (III) in Fig. 11 shows the omnidirectional microphone response of both signals. (The overall level is adjusted to the same level as that of the anechoic chamber. It would appear higher if the settings were left the same due to the useful reflections now also arriving at the diaphragm.) Plot (IV) in Fig. 11

reveals that little, if any benefit, is realized by the cardioid microphone in a reverberant chamber.

At this point it is well to remember that cardioids have, type for type, rougher random frequency response than omnidirectional units, and this roughness will result in reduced acoustical gain due to the peaks present. If a cardioid is desired, either the condenser unit or a specially selected and calibrated moving-coil cardioid should be used. A response chart of the specific microphone accompanies each calibrated unit.

*Shock-mounted and environmental protection.* All microphones should be shock mounted without exception. Just a few experiences in acoustic measurements shed much light on sympathetic resonances wreaking havoc on rigidly-mounted microphones. Microphones should also be protected against environmental hazards to avoid costly damage. See Fig. 10.

*Use of multiple microphones.* In reinforcement systems, each additional microphone brought up in gain reduces the maximum gain available from anyone of them by approximately 3 dB. Even worse, if the space is reverberant, it results in the

(Continued on page 65)

**Fig. 12**—A graphic equalizer can be used to smooth frequency response, achieving maximum acoustic gain.

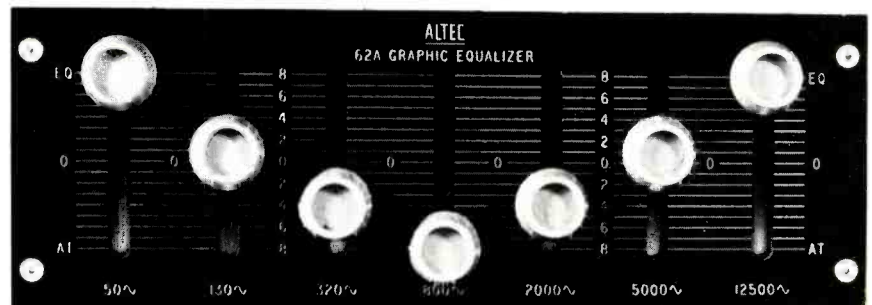

# Our microphones are now transistorized.



## And that's not the only good news.

Now, it's easier than ever for you to own the world's finest microphone. Because we've reduced the price of the entire line—by as much as 30%.

Of course, Neumann FET condenser microphones give you several other advantages. Long-life DC battery operation, for example.

The flexibility of central compatible power.

And a two-year guarantee.

Performance? Identical to their tube predecessors. And that's the most exciting news of all.

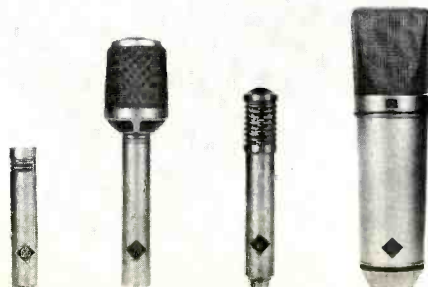

**Gotham**  
Audio Corporation

2 West 46th St., N.Y., N.Y. 10036 In Canada: J-Mar Electronics Ltd.



Photo courtesy of 20th Century-Fox

# A DOCTOR IN THE MOVIE HOUSE

ROBERT SHERMAN

ORIGINAL MOVIE MUSICALS, which used to come tumbling out of Hollywood as fast as MGM could feed its lion, are all but extinct nowadays. There have been lots of remakes of Broadway hits, but the last major original production I can think of was Walt Disney's "Mary Poppins," and before that we'd probably have to go all the way back to 1958, and "Gigi." ("Thoroughly Modern Millie" had a few new songs, but most of the score is derived from music of the '20s). If only on general principles then, 20th Century Fox deserves a loud huzzah for contributing to the birth of a full score by one of our more gifted theatrical talents, Leslie Bricusse. He wrote words, music and the screenplay, too; is probably known best for his stage collaborations with Anthony Newley: "Stop the World, I Want to Get Off" and the equally long-titled "The Roar of the Greasepaint, the Smell of the Crowd." Working on his own, he impresses as a more genial composer, less concerned with "special effects," and with a decided penchant for writing tuneful songs.

I wouldn't call "Doctor Dolittle" a memorable score, nor is it especially original in concept or execution, but it is consistently charming. There are some gentle, affecting ballads (*Where Are the Words* and *Beautiful Things*, for instance), and

some bouncy novelty numbers too, the best being the Doctor's reluctant credo as *The Vegetarian* and the effective title tune.

Only four of the singers from the large screen cast turn up more than incidentally on the soundtrack recording: Rex Harrison, Samantha Eggar (if indeed it is she singing, and not a dubbed-in voice), Richard Attenborough and Anthony Newley. Harrison is great, the only problem being that he is great within a previously established style. His clipped tones, his semi-talked singing, his supremely confident manner sometimes make it difficult to remember that he is involved with Doctor, rather than Eliza Dolittle. The soft Irish brogue that Newley brings to his first song evaporates in the excitement of subsequent numbers, but he is generally warm and winning as the Doctor's steadfast travelling companion. Attenborough has a brief, spirited stint as an incredulous circus manager, and only Miss Eggar (or stand-in) saunters through her part in a disappointingly pale, uneventful manner.

Like so many albums recorded directly from a film soundtrack, this one has rather dry, unresonant sonics, albeit well within the bounds of acceptability.

It's no surprise when solo performers latch onto an already successful movie score, but it certainly

is unusual to encounter such advance confidence as "Doctor Dolittle" engendered—no less than five non-soundtrack albums appeared *before* the film premiered in December. Easily the most dashing of these is the one by Sammy Davis, Jr. Never having been one of Davis' more ardent admirers due to the cavalier way in which he frequently distorts a song to fit his own style, he comes through here, singing reasonably "straight." The result is a dynamism that has always been a Davis trademark, making the tunes bubble with spirit.

I was less impressed by a similar set of Dolittle songs from Bobby Darin. Somehow the numbers resist conversion into pop ballads. Darin's crooning, quite acceptable in its own metier, seems out of place here. Even more pointless (though more idiomatic) is a solo album by Anthony Newley. As already noted, Newley is in the film, and he sings on about half-a-dozen cuts of the soundtrack version, which makes this second recording superfluous, if nothing else. The singing is properly ebullient, and the recorded sound is crystal clear (this holds for the Darin disc, too), but there are no other compelling reasons to rank it over the original cast edition.

It's reasonably appropriate for kids to be singing about the adventures of Doctor Dolittle; the Do-Re-

We believe that the Nocturne Five-Thirty delivers a degree of excellence never before attainable at such a modest price.

That's what we said when we introduced the Five-Thirty stereo receiver.

We said other things too.

Like it's the best receiver we have ever made. And that its sound will please the most critical ear; its styling the most critical eye.

We must have been very convincing.

Within a relatively short time, the Five-Thirty has become one of the best selling stereo receivers on the market.

The Five-Thirty is a complete, solid state control center with a powerful 70-watt

stereo amplifier and an AM/FM, FM stereo tuner that delivers astonishingly clear broadcast reception. The most advanced integrated micro-circuits are employed for absolute reliability and unsurpassed performance. Ultra-wide frequency response, well beyond the range of hearing, coupled with very low distortion, guarantees flawless sound quality with extraordinary clarity and spaciousness.

The AM section of the Five-Thirty employs a MOSFET front-end and separate AM board with its own I.F. strip. The result is a radically new sound in AM—an AM radio that serious music listeners can take seriously.

If AM radio isn't your cup of tea, we

make an FM/FM stereo receiver called the Five-Twenty. It's identical to the Five-Thirty in every way, minus the AM section.

Whether you choose the Five-Thirty or the Five-Twenty, we guarantee you'll be buying a receiver that delivers a degree of excellence never before available at such a modest price.

Now where have we heard that before?

For more information write Harman-Kardon, Inc., Box A-2, Plainview, New York 11803.

**harman kardon**

A subsidiary of Jervis Corporation

“...excellence never before attainable at such a modest price.”

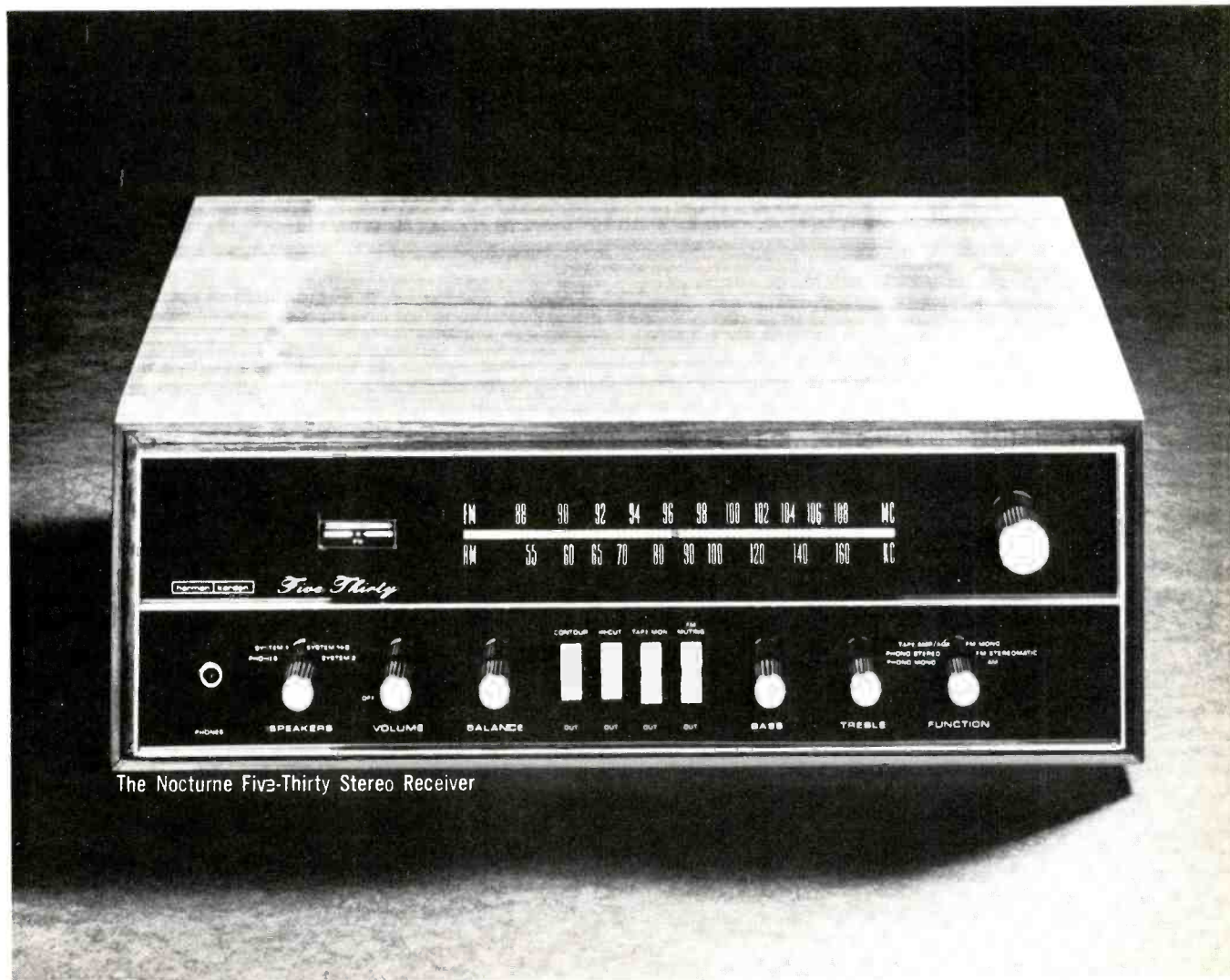

The Nocturne Five-Thirty Stereo Receiver

Mi Children's Chorus has a go at it, with only moderately appealing results. The arrangements by Marty Gold are bouncy and bright, but lack inventive, imaginative touches. While the youngsters perform with spirit, their unvarying dynamic levels and lack of musical subtlety tend to make the whole affair sound like a poor man's (or boy's) sing-along-with-Mitch.

One of the tastiest Dolittle albums of all, London's presents most of the score as songs without words. The settings are big and brassy, and the Phase-4 stereo sound is dazzling. Frank Chacksfield and the Orchestra are old pros at making you forget the need for lyrics, but there are

some vocal assists as well: Jackie Lee does a nifty solo on *I Think I Like You*, and an unidentified, but cheery children's chorus helps out with three or four other tunes as well.

**Doctor Dolittle:** Original Motion Picture Soundtrack.  
20th Century Fox stereo DTCS 5101, \$4.79 or Ampex C 5101 (4-track stereo tape)

**Performance:** A                      **Sound:** B

Sammy Davis, Jr. Sing the Entire Set of Hits from Dr. Dolittle.  
Reprise stereo RS 6264, \$5.98

**Performance:** A                      **Sound:** A

Bobby Darin Sings Doctor Dolittle  
Atlantic stereo SD 8154, \$4.79

**Performance:** B                      **Sound:** A

Anthony Newley sings the songs from Dr Dolittle  
RCA Victor stereo LPS 3839, \$5.79

**Performance:** B                      **Sound:** A

The Do-Re-Mi Children's Chorus and the Wonderful World of Dr. Dolittle  
Kapp mono KL 1540, \$4.79

**Performance:** C                      **Sound:** B

Frank Chacksfield plays Music from Dr. Dolittle  
London stereo SP 44102, \$5.79

**Performance:** B+                      **Sound:** A+

## Benny Goodman Rides Again

BERTRAM STANLEIGH

BENNY GOODMAN HAS BEEN making records since 1928. Among his best efforts have been some of his platters with small combinations. The trio and quartet performances with Teddy Wilson, Lionel Hampton, and Gene Krupa are, of course, the ones we think of first, but there have been many other Goodman combos of varying size with outstanding performers over the years. They had one thing in common—a marvelous group spirit that produced a kind of music that was generally better than any of the individual participants. It's a funny thing, but when you listen to Goodman, you realize that even though he's a superb technician, there's something stiff and formal about his playing. Yet, after the music is over, when you think about the performance, only the excitement, the pacing, the polished style, and the mood of the music remain in the mind. He is the rare performer who produces a special aura, and rarer still, he can shed that special aura over an entire group.

He's done it again! After forty years of recording, the old magic is still there. And in this latest Command recording there's a kind of technical magic that's not only missing from the earlier Goodman platters, it's missing from most discs being made today. This is one of those super-duper productions that

Command sometimes releases. The original masters were recorded on 35mm magnetic film, and the disc was cut with "a revolutionary new audio noise reduction system," which I take to be engineer Bob Fine's version of the Dolby system.

Command sound is generally excellent, but this new release has set a new standard against which to measure all future jazz recordings.

All of the six musicians heard here with Benny have been associated with him in recent years, either on his well-publicized tours for our State Department or in the group with which he recently appeared in Radio City's Rainbow Grill: Joe Newman, trumpet; Urbie Green, trombone; Bernie Leighton, piano; Attila Zoller, guitar; George Duvivier, bass; and Joe Marshall, drums. Their performances are freely improvised, but are based on the kind of familiar collaboration that only comes with long and sympathetic association.

The music is all familiar, but Goodman has never recorded any of it before. The cohesive theme of the set is Paris, and each of the dozen tunes either originated in the city of lights or has that center of romance as its subject. Included are *How Ya Gonna Keep 'Em Down on the Farm (after they've seen Patee)*, *Autumn Leaves*, *I Love Paris*, *April in Paris*,

*A Man and a Woman*, *C'Est Magnifique*, *Petite Fleur*, *I Wish You Love*, *Mimi*, *C'Est Si Bon*, *Under Paris Skies*, and *I Will Wait for You*.

One of Goodman's many virtues has always been the way he builds his performance around the essential character of the music he's playing. If a tune is a bouncing bit of ragtime like *How Ya Gonna Keep 'Em Down on the Farm*, Benny's response is pure dixieland with some fine tailgate trombone from Urbie Green. For *Autumn Leaves*, the change of pace and performance style is total. A tender duet for clarinet and guitar is followed by an extended guitar solo followed by one for clarinet; trumpet and trombone take this one out. The same quiet treatment is accorded Vernon Duke's *April in Paris* and *A Man and a Woman*, from the film of the same title.

Very close mike placement sometimes picks up minor transients from the keys of Benny's instrument, as well as a bit of heavy breathing, but the sound is thrillingly bright, warm, and undistorted. George Duvivier's bass has never sounded so great on a record, and I'm sure that I have never heard him so clearly in a live performance. This is a thoroughly exciting record—one I expect to wear out!

**Benny Goodman & Paris:** Listen to the Magic  
Command Stereo RS 921 SD, \$5.79

**Performance:** A                      **Sound:** A

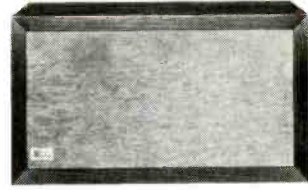

# AR-3a

## ***Acoustic Research announces a new speaker system.***

In 1959, our first advertisement for the AR-3 stated, "it has the most musically natural sound that we were able to create in a speaker, without compromise." This judgment was supported by distinguished writers in both the musical and engineering fields. Hirsch-Houck Laboratories, for example, agreed that "the sounds produced by this speaker are probably more true to the original program than those of any other commercially manufactured speaker system we have heard." For nearly nine years the AR-3 has been the best speaker we could make.

However, technical development at Acoustic Research, as at many companies in the high fidelity industry, is a never-ending search for improvement. After much effort we have found a way to better the performance of the AR-3. The new speaker system, the AR-3a, has even less distortion, more uniform dispersion of sound and still greater power handling capability. The improvement can be heard readily by most listeners; it has been brought about by the use of newly designed mid-range and high-frequency units, and a new crossover network. Only the woofer and the cabinet of the AR-3 are retained in the new system. The AR-3a is priced from \$225 to \$250, depending on cabinet finish, and is covered by AR's standard five-year speaker guarantee.

Detailed information on conversion of an AR-3 to an AR-3a is available from  
**ACOUSTIC RESEARCH, INC., 24 Thorndike St., Cambridge, Mass. 02141**

# How Negative Feedback Affects Amplifier Performance

NORMAN H. CROWHURST

## PART 1

Exploring traditional methods of analyzing negative feedback

BASICALLY, THIS ARTICLE WILL take up where earlier ones left off. In May 1953, *AUDIO* published my "New Approach to Negative Feedback Design," which introduced some short cuts to conventional design methods. In October and November, 1956, this was followed by "The Interaction Concept in Feedback Design," which aimed to make the work both easier to do and easier to understand.

Then in January 1962, there was "Feedback, Head Cook and Bottle Washer!" which tried to show some of the limitations of the conventional approach. But it did not really give answers about how to analyze feedback performance where the traditional method breaks down. So that's where this series of articles is directed.

First we should review a little, to refresh memories of long-time *AUDIO* readers and for the benefit of newer readers.

### Phase relationships

The essential thing about negative feedback is that the signal fed back, for whatever purpose (we'll come to that later), must be negative: in opposite phase to the input at the point to which it is fed back. The conventional diagram illustrates this (Fig. 1). Provided the feedback signal is negative, it can be many times the original input signal

(after combination), thus reducing the overall gain by the feedback factor  $(1 + AB)$ . The bigger this factor, the more gain is *reduced* by adding the feedback it represents.

Feedback theory first directed its attention to the phase shifts that all amplifiers inevitably introduce. Because of these phase shifts, although the feedback signal is negative over the major frequency range, the phase swings round at extreme frequencies so that the feedback becomes *positive*. To see what this means, the first step is to analyze response round the loop, in terms of magnitude and phase (Fig. 2).

By "round the loop" we mean from the input point, starting as a resultant signal (external input with feedback added) going through the gain part of the amplifier and back through the feedback to the starting point. Every reactive element in the amplifier produces phase shift at either lower or higher frequencies. To keep the loop stable it's a question of whether magnitude can be dropped before phase shift produces reversal at either extreme.

Coupling capacitors or inductors produce a negative phase shift (advance) at low frequencies. Direct-coupled stages have no phase shift

Fig. 1—Conventional diagram illustrates basic feedback theory.

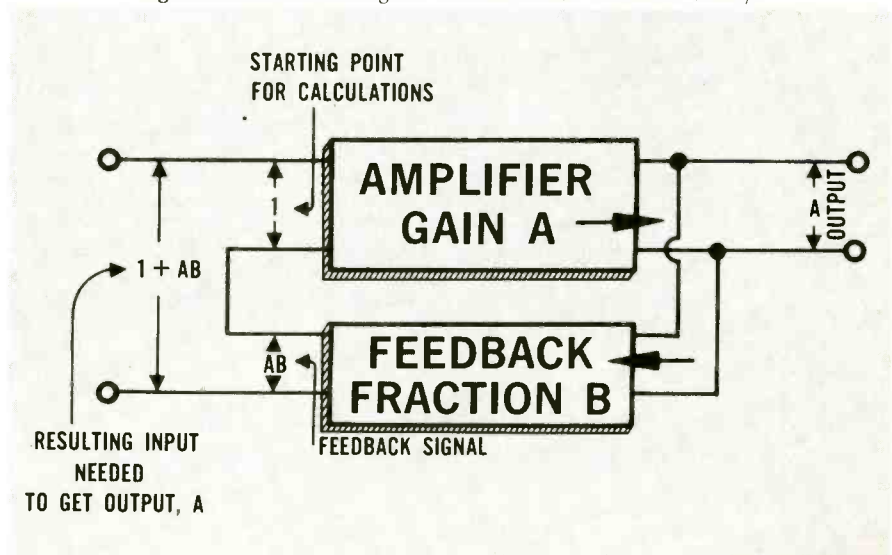



# AN ASTOUNDING NEW AUDIO NOISE REDUCTION SYSTEM WHICH IS MAKING BACKGROUND NOISE YESTERDAY'S PROBLEM.

The Dolby System gives

- A 10dB increase in usable dynamic range
- A 10-15dB hiss reduction
- A 10dB print-through and cross-talk reduction
- A 10dB hum reduction

**PLUS** generally cleaner, more transparent recordings—with unaltered frequency response and signal dynamics.

The basic principle of the system is simple. Low-level signals are amplified in four independent frequency bands during recording and attenuated in a complementary way during playback—recording noises being reduced in the process. High-level signals are unaffected by this procedure (no distortion or overshooting), and the symmetrical design of the circuitry ensures that the signal is restored *exactly* in all details—high-level *and* low-level, amplitudes *and* phases. The result is a noise reduction system with ideal characteristics—perfect signal handling capability which can pass any line-in, line-out A-B test, and a genuine 10dB noise reduction.

In short, the Dolby system offers an entirely new area of sound for the recording engineer. Get to know more about it fast by writing directly to Dolby Laboratories or contacting your nearest agent.

## DOLBY ANNOUNCE THE OPENING OF NEW OFFICES IN THE U.S.A.

Dolby Laboratories Inc. proudly announces the opening of its New York office at 333 Sixth Avenue, on January 1st, 1968. Dolby products are now *here*—at lower prices (Audio Noise Reduction System A301—\$1950 F O B New York). Full sales and service facilities—plus expert technical advice on use of the Dolby noise reduction system—are now available in the U.S.A.

## DOLBY, LABORATORIES INC.

333 SIXTH AVENUE · NEW YORK · N.Y. 10014  
Telephone: (212) 243-2525 · Cables: Dolbylabs New York

# TAKE 10 WITH THE DOLBY

**U.K.:** Dolby Laboratories, 590 Wandsworth Road, London, S.W.8. **Europe and the Middle East:** Impetus SA, 2 Via Berna, Lugano, Switzerland. **Australia:** General Electronic Services Pty. Ltd., 5 Ridge Street, North Sydney. **Japan:** Sakata Shokai Ltd., No. 10, 2-Chome, Kandakaji-Cho, Chiyoda-Ku, Tokyo. **South Africa:** Vitaphone Pty. Ltd., Cape York, Jeppe & Nugget Sts., Johannesburg.

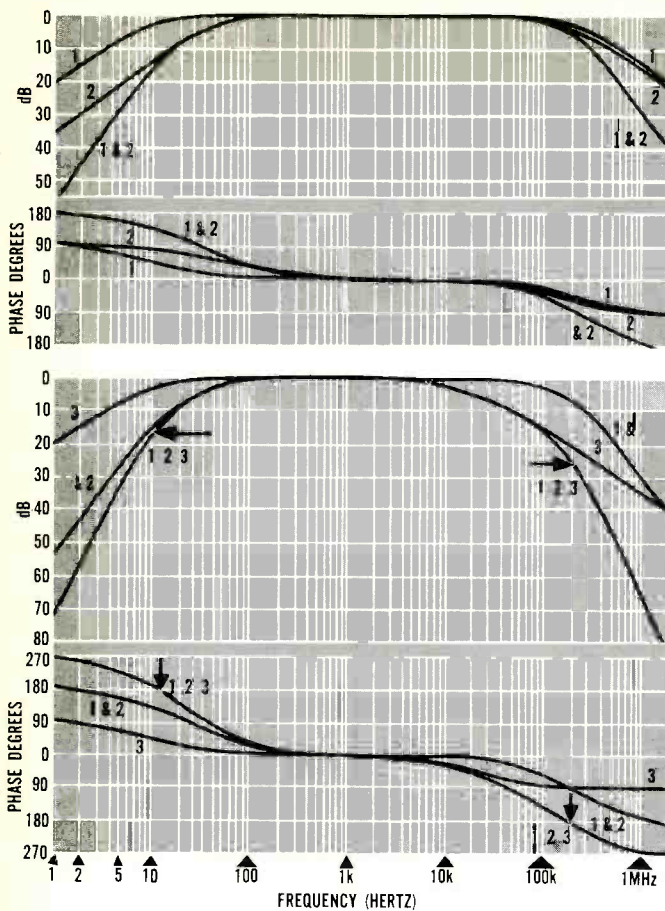
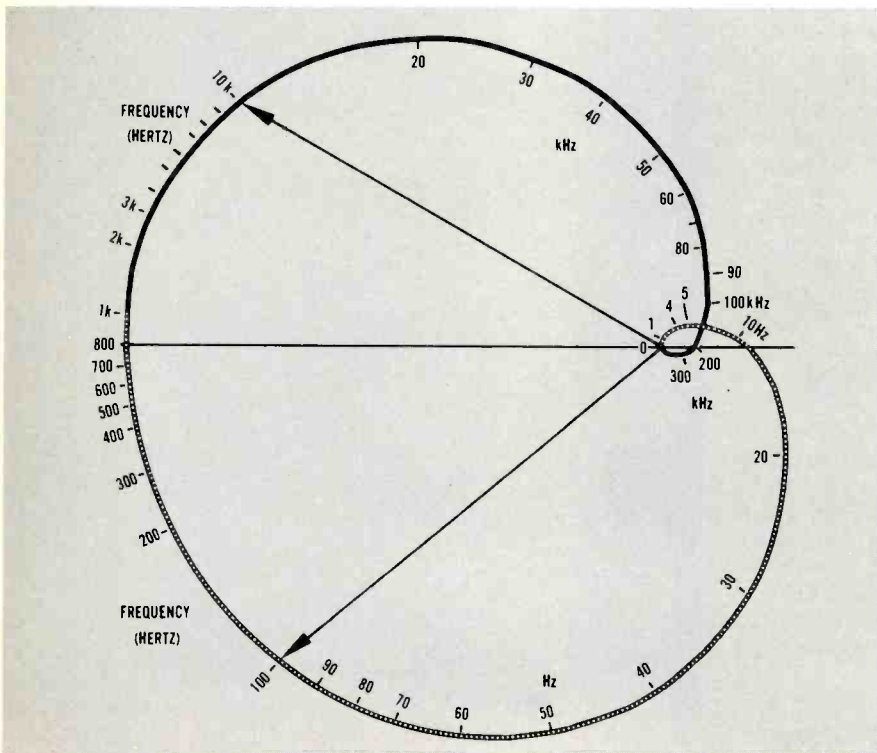

Fig. 2 — Developing the magnitude and phase responses 'round a feedback loop. At the top are the responses, 1 and 2, of the first two stages of coupling, together with their combined response in dB and phase. Below the third stage, 3 is added to obtain the complete loop response, 123. Note the points on the 123 response where phase passes 180 deg. each way, and the corresponding attenuation in dB.

Fig. 3—A Nyquist diagram or plot of the same response developed in Fig. 2. Vectors are drawn for 100 and 10,000 Hz to show where the quantity AB is represented.



at these lower frequencies. And stray capacitances across stage impedances cause positive phase shift (delay) at high frequencies.

Each reactive element produces a maximum of 90 degrees phase shift (advance) at low frequencies. Direct-coupled stages have no phase shift at these lower frequencies. And stray capacitances across stage impedances cause positive phase shift (delay) at high frequencies.

Each reactive element produces a maximum of 90 degrees phase shift in its appropriate direction, which cannot cause instability by itself. Even a system having two elements active at each extreme cannot become unstable, because attenuation of magnitude is then theoretically infinite by the time phase shift reverses to 180 degrees.

But three elements acting to roll off the same end of the frequency response, whether this involves three stages or less, and more than three elements, can cause instability unless care is taken in the design to see that attenuation exceeds gain by the time phase reaches 180 degrees. Greater care can allow more feedback to be applied.

### Nyquist diagrams

This whole problem was first made easier to visualize by Nyquist, whose name is given to the diagram he originated. Instead of plotting magnitude and phase of the feedback signal, his method uses a polar plot (Fig. 3). The condition of stability is easier to spot with such a diagram.

If the feedback becomes positive and at least equal to the input signal, oscillation will start up. On the Nyquist diagram, this condition is shown by the curve enclosing the point representing phase reversal (180 degrees) and unit gain. The polar plot represents the quantity AB, gain multiplied by feedback fraction. Where there is no phase shift, this quantity usually has a value greater than 1. For example if it is 9, there is 20 dB feedback because  $(1 + AB)$  is then 10.

But where the phase shift gets round to 180 degrees, the curve must

# Disney's Magic World of Sound... from Altec.

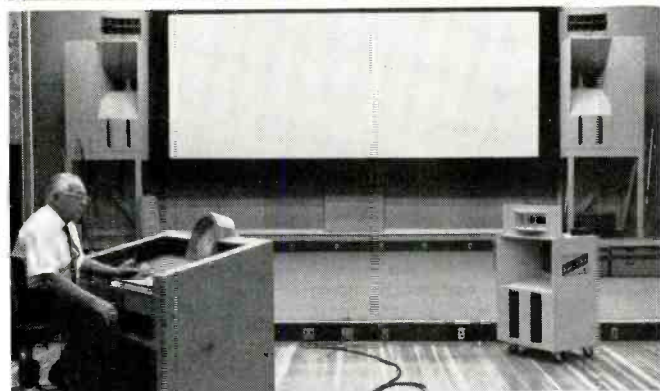

The magic that is Disney is not just a pat formula. It is a form of perfectionism that pervades everything which carries the Disney name. Certainly, there's a Disney look. But just as certainly there's a Disney sound. And that's where we come in.

For example, the new control console at the Disney Studio's orchestra stage is made up of 29 Altec slide-wire attenuators, 7 rotaries, and one 4-gang master. The works are powered by rack-mounted banks of Altec amplifiers. Monitoring in the control room is done in a big way—with three giant Altec A4 "Voice of the Theatre"<sup>®</sup> systems butted together in a single plane of the most powerful, pure sound you can get.

The stage itself uses three more A4's for monitoring, re-recording, and playback. (That's one good way to keep the musicians happy.) Eight caster-mounted A7 "Voice of the Theatre"<sup>®</sup> systems are mobile, may be moved where and as needed.

And that's not all. On the back lot Altec PA equipment provides the paging. Dialog stages at the Studios also use A4's, with Altec's space-saving 844A Monitor Speaker Systems in the compact transfer room. The list could go on, but the point is made.

So who listens when Altec Lansing sounds off at Disney? Everybody, that's who. And if you understand the remarkable expertise of Disney sound engineers, perhaps you should listen too. Let's hear from you.

ALTEC LANSING, A Division of  
LTV Ling Altec, Inc., Anaheim,  
California 92803 Dept. A-2



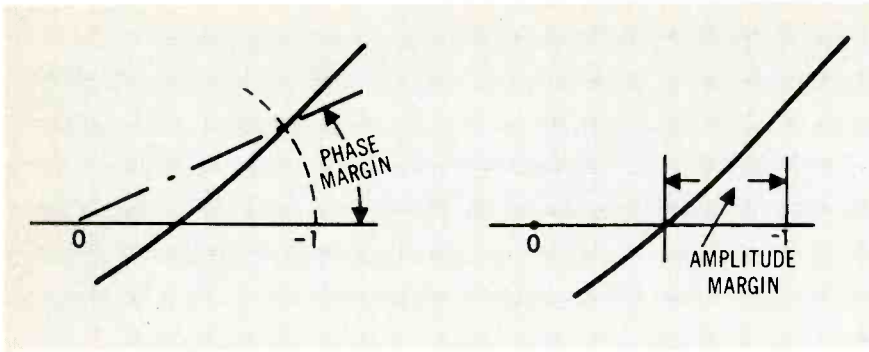

Fig. 4—Showing the meaning of phase and gain margin, relative to the Nyquist diagram. The point marked “-1” represents phase reversal at unity gain, which will maintain oscillation and thus make the system unstable.

Fig. 5—Conditions of stability as represented on a Nyquist diagram: (a) stable; (b) unstable; (c) conditionally stable; (d) shows gain of (c) reduced (the curve is proportionately smaller) to the point where it is unstable.

have dropped below 1 (or the radius representing that magnitude) or oscillation can occur. The Nyquist plot enables this to be clearly shown. It can also show margin of stability in either of two forms: phase margin, the phase by which shift falls short of 180 degrees when gain falls to unity; or amplitude margin, the amount by which gain is less than unity when phase reaches 180 degrees (Fig. 4).

Nyquist draws attention to a third possibility, in addition to stable and unstable (Fig. 5), which he calls conditional stability. In theory, provided the curve does not enclose the point -1, the system is stable. So it is possible for the curve to go around the -1 point without enclosing it by use of some rather complicated circuit design.

This condition means that, if the system is set up, and the loop is already closed without oscillation occurring, the system will remain stable. But some disturbance can change this state from stable to unstable, in which case it will continue oscillating until it is either switched off or the loop is opened.

For example, the system may go unstable when the amplifier is switched on because the gain goes through a lower value, at which it is unstable, and continues to oscillate, holding the gain down to the unstable region (which means it must be oscillating pretty hard).

Even closing the loop can initiate instability, if the potentials across the connection are not zero at the moment it is closed, by momentarily

blocking the system. At this point it will again pass through the unstable gain condition as it recovers. Such a system is very easily triggered into its unstable condition, and may in fact be difficult to persuade to operate at all in its stable condition.

The Nyquist diagram has a useful feature that can be exploited by some extra rulings on the paper. The graph is a polar presentation of the loop gain product,  $AB$ : the forward gain,  $A$ , is multiplied by the feedback fraction,  $B$ . The gain is usually a large number, while the feedback fraction is small, less than one, but such that the product obtained by multiplying  $A$  by  $B$  is usually larger than 1.

For example,  $A$  might be 10,000 (80 dB), with  $B$  at  $1/526$  so that  $AB$  would be  $10,000/526$  or about 19. Adding 1 to make the feedback factor  $(1 + AB)$  will make this 20, which represents 26 dB feedback.

But the product  $AB$  is not quite as simple as that. It is not a simple number, but possesses variation of magnitude and phase with frequency, as shown on the Nyquist diagram, which plots it as a complex quantity. The feedback factor  $(1 + AB)$ , which is the amount by which gain is reduced by closing the feedback loop, is also complex. As the distance between the origin of the polar graph for  $AB$  and the -1, 180 degree point, is simply 1. The third side of the triangle represents the feedback factor  $(1 + AB)$  as a complex quantity in magnitude and phase (Fig. 6).

(Continued on page 70)

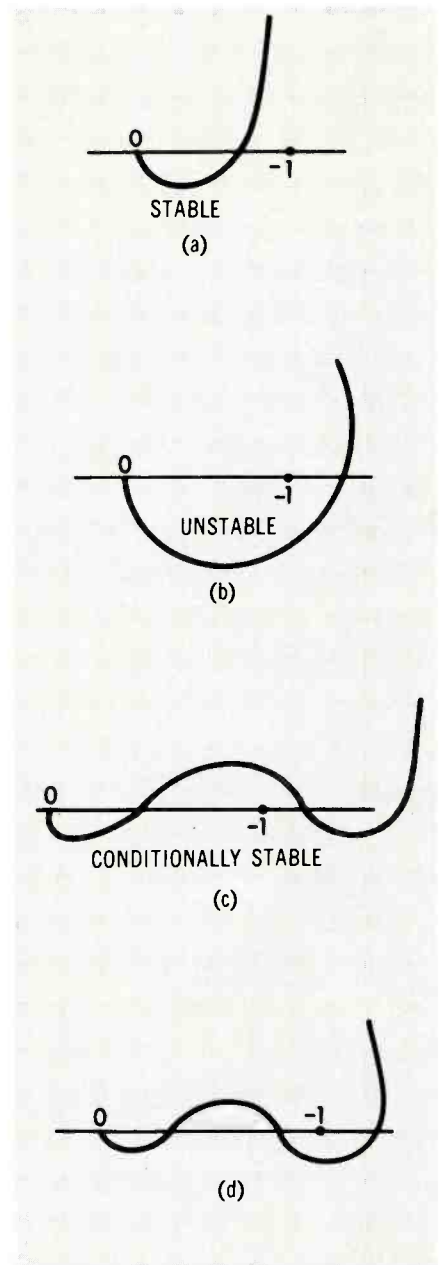

# If you can trust your ears... you can trust Pioneer.

The ultimate test of any high fidelity equipment is its ability to reproduce sound with the same characteristics as live music (i.e.—smooth linear reproduction with no one section of the audio spectrum magnified).

We therefore cordially invite you to hear the latest Pioneer trustworthy hi-fi components . . . truly worthy companions to their Pioneering predecessors.

## The SX-700T FM-AM Stereo Receiver

Designed along the lines of the acclaimed SX-1000TA, the SX-700T is a perfect solution when the desire for performance and the desire for economy are in conflict. With 2.0  $\mu$ v of sensitivity, and a separation figure of 35 db, the SX-700T is ideal for suburban areas, brings in distant FM with concert-hall clarity. Its 60 watts (IHF-4 ohms) of power will easily drive any speaker system. Price: \$249.95.

## The CS-63 Bookshelf-type, 4-way Speaker System

If you're looking for perfection, consider the CS-63, a rarity with its classic 15-inch woofer. Hi-fi technology has developed substitutes for the huge woofer, but there are no equivalents for it. Midrange is a 6½-inch cone type speaker, and the upper frequencies are delivered by a horn-type tweeter and a 2½-inch super tweeter. Response is flat from 25 to 20,000 Hz. Price: \$245.00 each.

## The CS-88 Bookshelf Speaker System

If budget or space are limitations, a pair of CS-88's mate beautifully with any receiver, or any decor. Their genuine wooden latticed grilles put their construction and appearance in a class by themselves. Each enclosure is a three-way system featuring a 12-inch, massive magnet woofer, a 4-inch midrange radiator, and three tweeters. One of the tweeters is a horn type; the other two are cone units. Price: \$175.00 each.

Pioneer builds for music lovers because music lovers built Pioneer. Listen to Pioneer's superb components — then trust your ears. The Pioneer line is at fine dealers everywhere. Or write for more detailed literature. Please specify the items in which you are interested.

## PIONEER'S NEWEST MODELS ARE HERE TO HEAR!

### The SE-30 Headphones

- If you want to keep it to yourself,
- the SE-30 headphones deliver the full
- brilliance and strength of the finest
- speaker systems — yet even the head
- on the adjoining pillow will not hear
- a sound. The SE-30 headphones come
- beautifully boxed in a permanent
- case of Scotch grain vinyl fully lined.
- Ideal for gift giving and for
- permanent storage. Price: \$29.95



SX-700T

CS-63

CS-88



PIONEER ELECTRONICS U.S.A. CORP. 140 Smith St., Farmingdale, L.I., N.Y. 11735 • (516) 694-7720  
Manufacturers of Quality Audio Components • Receivers • Turntables • Speaker Systems • Loudspeakers • Headsets

Check No. 43 on Reader Service Card

# EQUIPMENT PROFILES

## SHURE MODEL M75E STEREO CARTRIDGE

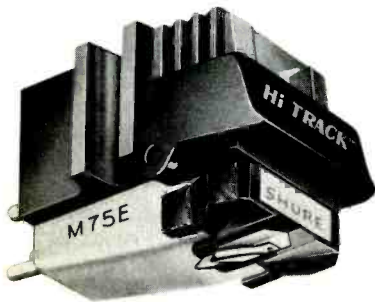

**MANUFACTURER'S SPECIFICATIONS—**  
 Frequency Response: 20-20,000 Hz. Channel Separation: More than 25 dB at 1,000 Hz. Recommended Load Impedance: 47,000 ohms per channel. Inductance: 720 millihenries. D.C. Resistance: 630 ohms. Mounting: Standard 1/2" (12.7 mm) mounting centers. Weight: 6 grams. Terminals: 4. Trackability with 1 gram at 400 Hz, 18 cm/sec; at 1000 Hz, 25 cm/sec; at 10,000 Hz, 14 cm/sec. Recommended tracking force: 3/4 to 1 1/2 grams. Output Voltage (1000 Hz at 5 cm/sec): 5.7 mV. Elliptical Stylus with Side Contact Radius: .0002-in. Frontal Radius: .0007-in. Price: \$39.50.

The Shure M75E cartridge is the top of the M75 series of cartridges. It is the elliptical successor to the M75-6 and is similar in design to the V15 Type II "Supertrack" cartridge. The M75E has a replaceable stylus assembly that is interchangeable with that of the V15 Type II, as well as others in the M75 series. It, too, incorporates a convenient swing-away stylus guard.

For tests, the M75E was mounted in a Garrard Model SL95 automatic turntable, with tracking force set to

1.3 grams. Frequency response and crosstalk, as measured using CBS Labs.' STR100 test record, is shown in Fig. 2. The frequency response is smooth, with a minor dip at 7 kHz and a 3 dB peak at 14 kHz. Separation is good, being in excess of 20 dB throughout most of the spectrum, and exceeds 25 dB at 1 kHz, as specified.

In the tracking department, a Shure forte, the M75E sailed flawlessly through the 12 dB band of CBS Labs.' STR111, which is cut at about as high a velocity as any commercially available record. This assures that the M75E will probably track anything you've got. It tracked everything we've got!

Sensitivity measured 7 mV and 7.4 mV for left and right channels, respectively, referred to 3.54 cm/sec rms, 45 deg. velocity at 1 kHz. Hum was way down at -59 dB through a wide-band RIAA preamplifier; the vertical tracking angle was measured to be

about 16. IM distortion was below average for the popular moving-iron design. Square-wave tracking tests, as shown in Fig. 3, substantiated the cartridge's excellent frequency response and tracking ability. The damped oscillation shown at the leading edge of the square waves is caused by the small 14 kHz peak. Without it, the leading edge would not have been as steep and the cartridge would have probably missed the mark just a bit in the transient response department. The slight rounding at the top of the wave is caused by the M75E's elevated bass response.

The final test of a cartridge's "metal" is always listen, listen, listen to it playing back a variety of recorded material. And after this is done, listen again. There are some particularly fine records for this purpose; everyone has a favorite or two. A superb one used here was Benjamin Britten's *Cantata Misericordium* with the London Symphony

Fig. 2—Frequency and crosstalk response of Shure M75E stereo cartridge (mounted in a Garrard SL95 automatic turntable).

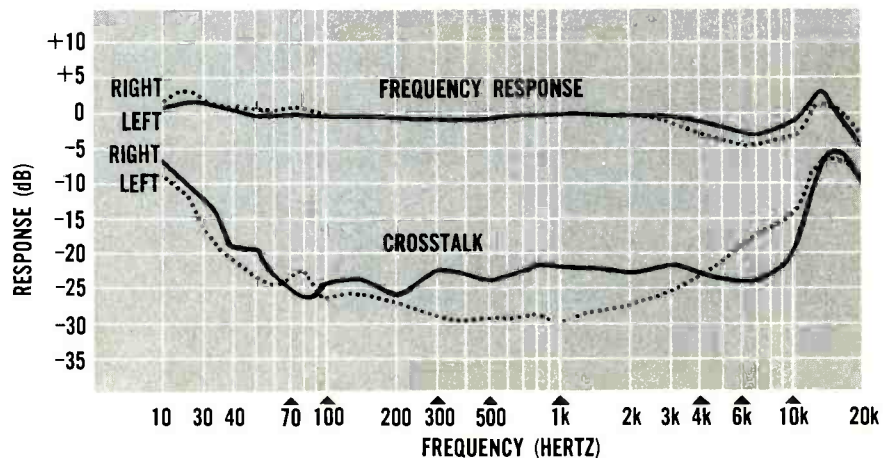

This suggestion is made only to those who have top-flight integrated amplifiers with an electrically separate preamp and power amplifier, or individual preamp and power amplifier components. It involves your present equipment and three Sony components: the TA-4300 electronic crossover and two TA-3120 stereo power amplifiers. It's for those venturesome enough to break away from conventional approaches to sound reproduction. If we've described you, then these Sony components can bring you just that one iota closer to realism in home music.

Here's why.

The electronic crossover goes between the preamplifier and the power-amplifier portions of your present stereo amplifier. It

divides the audio-frequency spectrum into three ranges, and sends each range to a separate amplifier: your existing power amplifier, plus the two Sony TA-3120's. Each amplifier feeds a speaker expressly designed to handle that particular part of the audio spectrum. By not forcing a single amplifier to handle the full range of frequencies, IM distortion is reduced. By eliminating the inductor-capacitor-resistor crossover networks built into ordinary speaker systems, speaker damping is not disturbed. The speakers' motions are always fully controlled by the amplifiers. Speaker impedance variations have less effect on the amplifiers.

Also, you can select crossover frequencies to suit the speakers of your choice, or experi-

ment to discover the audible effects of varying crossover points. The points provided are 150, 250, 400 or 600 Hz between woofer and mid-range, and 3, 4, 5, or 6.5 kHz between mid-range and tweeter. A bass turn-over control fits the system's response to the characteristics of the woofer, and a bass-boost control lets you experiment with extending the woofer's bass response.

The Sony TA-4300 solid-state electronic crossover costs \$199.50; the two TA-3120 solid-state amplifiers \$249.50 each. Sound extravagant? Maybe just a bit. But so are the results. Interested? Write for literature on how to upgrade your system. Sony Corporation of America, 47-47 Van Dam St., Long Island City, N.Y. 11101.

## Get drunk with power

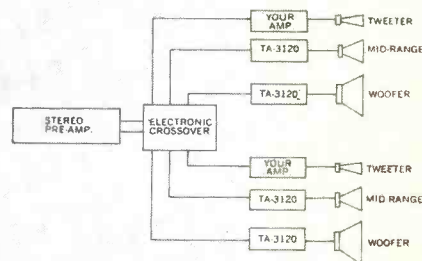

**SONY**®

Orchestra and chorus, Britten conducting; Pears and Fischer-Dieskau, vocal (the other side is equally fine: *Symphonia da Requiem, Op. 20*). This modern music, on London stereo disc 25937, is recorded clear as a bell, and it has plenty of percussion and brass to titillate listeners. So it was one of a number used to put the M75E through its paces.

The M75E sounded clean, much like the excellent, higher-priced Shure V15 Type II. Its sound is on the neutral

Fig. 3—M75E's responses to square waves from a CBS STR111 test record. (A) left channel, lateral 5 cm/sec velocity; (B) right channel, vertical 5 cm/sec; (C) left channel, left 3.54 cm/sec; (D) right channel right 3.54 cm/sec.

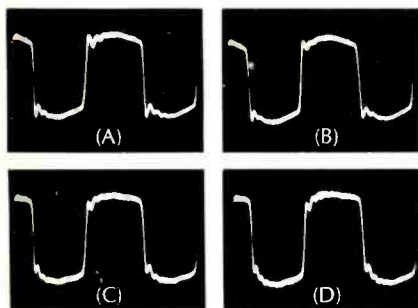

side, neither obviously bright nor dull. Only on super highly-modulated source material could a difference between it and the V15 Type II be noticed, in which case the V15 Type II tracked a smidge better and had better separation.

We'd call the M75E a "poor man's V15 Type II" if we had to characterize it. True, it does not offer the *n*th degree in silky, transparent reproduction, but, generally, this performance pinnacle is limited to cartridges costing much more than the \$39.50 M75E. Except for the most critical listening demands, it will do its job well in any modern tone arm. It is an appropriate mate for any of the better automatic turntables available today, especially when budget considerations do not allow one to grab for that extra wisp of realism with a higher-priced cartridge.

Check 44 on Reader Service Card.

## TWO TELEX HEADSETS— THE AMPLITWIN and SERENATA II

**MANUFACTURER'S SPECIFICATIONS—**  
**AMPLITWIN**—Acoustic response: 16 to 15,000 Hz. Distortion: Less than 1% at 1000 Hz with 25 mW output. Current drain: 3 mA, no signal. Signal-to-Noise ratio: -50 dB. Batteries: Two 9-volt transistor radio type. Headset impedance: 45 ohms at 1000 Hz each channel. Speaker sensitivity: 1 mW (0.22 V. across 45 ohms) produces 95 dB SPL in both cups. Max Input: 1 W. Weight: 26 oz. (with cords). Price: \$79.50 (excluding batteries).

Want a pair of headphones for normal applications? Want a pair of headphones with which you can hear records played by a magnetic pickup, ceramic pickup, or tape deck *without an external amplifier*? Then you probably want a Telex "Amplitwin." This headphone pair consists of the usual small loudspeakers in a suitable housing, together with a four-transistor amplifier with volume controls. The integrated amplifier has suitable gain and equalization to bring the signals from a magnetic phono cartridge up to the same level you would normally use for listening with the usual type of phones when plugged into the phone jack of an amplifier. Cables (two sets), terminated with RCA pin-type plugs, are detachable.

In appearance, the Amplitwin phone resembles most any headphone except for a compartment on the back which accommodates a 9-volt transistor radio battery. The battery is accessible by removing an aluminum cover plate, which can be done without tools. Internally, the amplifier is assembled on a glass epoxy etched circuit board which circles the 2½ x 3½-in. cone. The housing is also fitted with a miniature slide switch, a volume control, and two phono jacks labeled "HI" and "LO." Two 9-ft. phono-tipped connecting cables are supplied. For conventional use, connections are made to the HI jacks, and the switch is left in the off

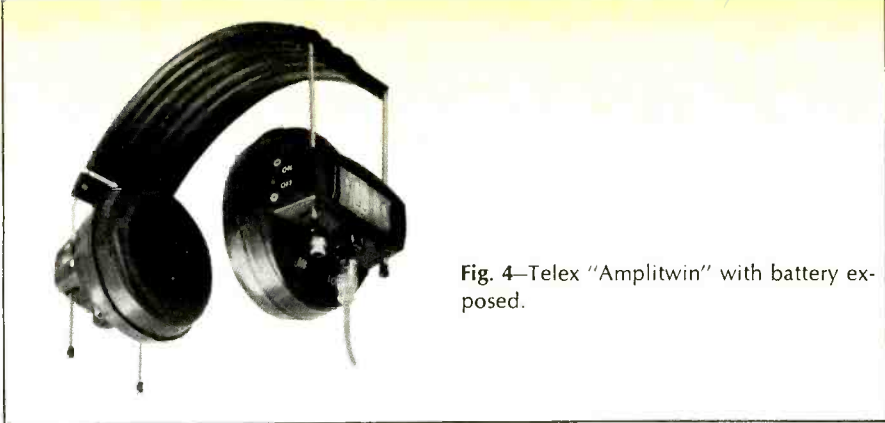

Fig. 4—Telex "Amplitwin" with battery exposed.

position. In this use, the connections are made directly from the external amplifier source to the speaker cones. To listen to the output of a tuner or a ceramic cartridge, leave the connections in the HI jacks and simply turn on the switches. These actuate the amplifiers and switch the speaker cones from the jacks to the output of the amplifiers. The connection from the HI jack to the top of the volume control is through a 620k ohm resistor which is bypassed by a small capacitor to decompensate for the equalization in the built-in amplifier.

To listen to the output of a magnetic cartridge or to a tape head, the cables are moved to the LO input jacks and the amplifiers turned on. This provides the same acoustic output—a SPL of 95 dB—from a 5-mV signal as is obtained from a 220-mV signal in the HI jacks without amplification. In any case, there is ample volume for satisfactory listening in any of the three modes.

Obviously, considerable "human engineering" has gone into the design of this pair of phones. The two units are not identical, which, of course, makes for a more expensive construction. They are mirror images of each other, so that the LO input jacks are toward the front in both phones, the HI jacks toward the rear. The switches are on the back side of the cups when on the user's head. The volume controls, which are between the input jacks, both increase volume as the knob is rolled forward, and the switches are "on" when in the raised position, being in the logical position to be reached by the forefinger of each hand.

The cups are molded plastic, with the plastic molded grille in front of the speakers having the letters L and R molded in as a part of the design. The phones are supported by two spring steel wires which pass through the cups under a spring tension, and tipped with plastic knobs. These wires are held apart by two plastic clamps—one at each end of the soft plastic headband, which is nearly 3-in. wide. The cups are cushioned by removable liquid-filled pads.





*Crown Leadership presents the*



**MODEL CX 822**

For the studio where flexibility means creative productions.



**MODEL CI 844**

Four channel recorder for perfect mastering.

# NEW

## Computer Logic Control Pro 800 Transport

In the league of nimble-fingered tape-handlers there exists a recurrent problem. It has been demonstrated time and again that anyone can ruin a valuable tape by absentmindedly outsmarting the interlock system of an otherwise safe tape recorder.

In answer to this problem and similar problems arising in automated and remote control applications, the *CROWN Pro 800* was designed. This recorder has a computer logic system using IC's which prohibit all such destructive operations.

The *CROWN* computer stores the last command given it in its memory (forgetting all previous commands) and by a continuous knowledge of the operating state of the machine (motion and direction), it takes all the necessary measures and executes the command. This is all done *without* time-wasting delay mechanisms.

Computer logic control brings to you rapid error-free tape handling. It is actually impossible to accidentally break a tape. Call your *CROWN* dealer NOW!

**MOST PERFECT REPRODUCTION**

- 👑 Performance as yet unequalled
- 👑 Four years proven Solid State circuitry
- 👑 Extremely low noise electronics

**FINEST TAPE HANDLING**

- 👑 Computer smooth operation
- 👑 True straight line threading
- 👑 Patented Electro-Magnetic brakes never need adjusting

**THE HALLMARK OF CROWN — QUALITY CRAFTSMANSHIP THROUGHOUT**

**MADE  
ONLY  
IN  
AMERICA**



**BOX 1000, ELKHART, INDIANA 46514 • PHONE (219) 523-4919**

Current drain from the batteries under no-signal conditions is only 3 mA, which augurs for a long battery life under normal listening conditions of about 40 hours with carbon/zinc batteries. Mercury batteries are recommended for longer life.

## Performance

As with all transducers, headphones leave much to subjective appraisal. This is all the more difficult since so much depends on the "fit" of phones over the ears and how an individual reacts to an alien listening sensation. And topping this, standard measurement practices have not been adopted by manufacturers so that one set of measurements can be correlated against another set. Frequency response was measured here with a condenser microphone through a simulated 2-cm<sup>3</sup> coupler. Response of the Amplitwin was approximately  $\pm 5$  dB from 100 Hz to 14 kHz using this method. While there was a noticeable drop off below 100 Hz, this was not apparent in listening tests. On the magnetic pickup input, the same general characteristic appeared, measured from a pickup on a test record (CBS STR-100). Thus the equalization is well designed, although in direct comparison with the same signal played through an external amplifier, it appeared to be slightly dull—about 3 to 5 dB down at 10 kHz, we would judge.

Comfort with a capital C is an important criterion in evaluating headphones. In this respect it is not surprising that the Amplitwin cannot match sophisticated amplifier-less headphones. After all, its amplifiers and batteries add weight to it—about 10 oz. more than the company's Serenata II (see following profile). This is enough to cause some discomfort from its easy-to-clean, fairly hard rubber headband over long periods of listening; especially if you're thin on top.

On the whole, however, and in full consideration of the multiplicity of services available from the Amplitwin, we would certainly choose it if we wanted a hi-fi system without amplifiers and loudspeakers in the usual sense. One needs only a turntable and cartridge or a tape deck to have a complete hi-fi system, albeit that it is not hi-fi for the *cognoscenti*. So one gives up some comfort for its versatility. The truth is, we have found the Amplitwin so useful that we employ it in our own office to audition records before shipping them out to our reviewers. Can't beat its convenience. (And don't overlook this point for use with electric guitars.) \$79.50 with padded vinyl carrying case.

Check 46 on Reader Service Card.

**MANUFACTURER'S SPECIFICATIONS—SERENATA II—Frequency Response:** 20-20,000 Hz, subjectively flat. **Distortion at Normal Listening Level:** 0.5%. **Impedance:** 50 ohms, for use with 4- to 16-ohm outputs. (500-ohm version available.) **Sensitivity:** 1 V input at 1000 Hz produces a 100-dB sound pressure. **Maximum Continuous Input:** 2 W. **Weight:** 16 oz. (with cord). **Price:** \$44.95.

The Serenata II is a more conventional phone—no amplifiers, batteries, nor switches. The 8-ft. cord terminates in a standard stereo phone plug, both of a handsome dark brown which matches the color of the liquid-filled ear pads. The unit itself is similar to a number of other makes, being totally enclosed in plastic (except for the side adjacent to the ear). The opening in front of the unit is covered by a round foam disc of fairly coarse texture, and this in turn is covered by a larger and finer foam oval, which is in turn covered by an attractive silver and beige "grille cloth." The molded housings are beige plastic, and are shaped to provide space for that "disappearing headband." This band is a shaped spring-steel strip  $\frac{1}{2}$  in. wide which is held in the cups by a plastic strip that applies pressure to the band. Instead of extending below the cups, the band simply remains within the cup housing, yet allows a 1-in. movement on each phone. A 2 x 5-in. headband cushion is faced with a foam for comfort. The plastic housing for the headband cushion has one other unique feature: A large knurled disc permits the user to increase or decrease the pressure to the desired amount. The nameplate on each phone indicates which ear it should be worn over, and the single cord extends from the left phone.

While normally wired to the plug to use a common ground terminal—the

sleeve of the plug—the cable itself consists of two shielded leads, with insulation between the shields. Thus, in case the phones are to be used with some of the older transistorized amplifiers in which the two "common" terminals cannot be connected together, the plug may be removed and two separate single-circuit plugs substituted may be connected, one for each channel, therefore keeping the two channels isolated. Alternatively, spare terminals could be attached to the cables, in case a pair of headphone jacks is not provided. In any instance, the important thing about this pair of phones is that the two circuits are electrically isolated.

A number of useful accessories are available for use with the Serenata II headphones. These include a protective network, PN-III, which includes a 3-circuit jack mounted on a plate and equipped with a resistor network for protection against excessive power for use with amplifiers not fitted with phone jacks. A 10-ft. extension cord fitted with a 3-circuit jack on one end and a plug on the other permits use at greater distances from the amplifier than the 8-ft. cord will allow. An STC-1 Stereo Control provides on-off control of either phones or speakers as well as individual adjustment of volume in the two earphones. The prices of these three accessories are \$2.95, \$4.50, and \$10.50, respectively.

## Performance

The frequency response of the Serenata is fairly smooth, ranging  $\pm 3$  dB from 50 Hz to 16,000 Hz, measured through a simulated 2-cm<sup>3</sup> coupler, as was the Amplitwin. Distortion at 1000 Hz measured less than 1 per cent at a SPL of 95 dB.

Sound was pleasingly bright, with real solid bass response. The clarity of sound due to the absence of room reso-



Fig. 5—Telex "Serenata II."

# LOOK WHAT'S NEW FROM HEATH

**NEW! Exclusive Heath Hi-Fi Furniture... Fully Assembled And Finished**

## Contemporary Walnut Stereo/Hi-Fi Cabinet Ensemble Complements Modern Furnishings

Masterfully crafted of fine veneers and solids with walnut finish. Statuary Bronze handles. Equipment cabinet features adjustable shelves to accommodate all makes of hi-fi components, record storage or tape recorder compartment, turntable compartment. Speaker cabinet features special Tubular-Duct Reflex design for matching 8" or 12" speakers, plus slot for a horn tweeter.

**Model AE-37**, equipment cabinet... no money dn., \$12 mo. .... **\$125.00**  
**Model AEA-37-1**, speaker cabinet... no money dn., \$6 mo. .... each **\$59.50**

Complete Ensemble  
**\$244<sup>00</sup>**



## Early American Stereo/Hi-Fi Cabinet Ensemble

Early American richness with modern component layout. Constructed of specially-selected solids and veneers finished in popular Salem-Maple. Statuary Bronze handles. Equipment cabinet has adjustable shelves to accommodate any make hi-fi component, record storage or tape recorder compartment, turntable compartment. Speaker cabinet can be matched to any 8" or 12" speaker... has slot for horn tweeter.

**Model AE-47**, equipment cabinet... no money dn., \$13 mo. .... **\$135.00**  
**Model AEA-47-1**, speaker cabinet... no money dn., \$7 mo. .... each **\$64.50**

Complete Ensemble  
**\$264<sup>00</sup>**



## Mediterranean Stereo/Hi-Fi Cabinet Ensemble

Beautifully constructed of fine furniture solids and veneers with Pecan finish. Statuary Bronze handles. Equipment cabinet has adjustable shelves to house any make hi-fi component, record storage or tape recorder compartment, turntable compartment. Speaker cabinet can be matched to any 8" or 12" speaker... has slot for horn tweeter.

**Model AE-57**, equipment cabinet... no money dn., \$14 mo. .... **\$150.00**  
**Model AEA-57-1**, speaker cabinet... no money dn., \$8 mo. .... each **\$74.50**

Complete Ensemble  
**\$299<sup>00</sup>**



## NEW! Lowest Cost Solid-State Stereo Receiver

Kit AR-17  
**\$72.95**  
 (less cabinet)  
 \$8 mo.



Features wide 18-60,000 Hz response @ ±1 db at full 5 watts RMS power per channel... 14 watts music power... inputs for phono and auxiliary... automatic stereo indicator... outputs for 4 thru 16 ohm speakers... adjustable phase for best stereo... flywheel tuning... and compact 9 3/4" D. x 2 7/8" H. x 11 1/4" W. size. 12 lbs. Optional factory assembled cabinets (walnut \$7.95, beige metal \$3.50).

**Kit AR-17**, (less cab.) 12 lbs. ... no money dn., \$8 mo. .... **\$72.95**  
**Kit AR-27**, 7-Watt FM Mono Only Receiver (less cab.) 9 lbs. ... no money dn., \$5 mo. .... **\$49.95**



Kit AR-15  
**\$329.95**  
 (less cabinet)  
 \$28 mo.

Assembled  
**ARW-15 \$499.50**  
 (less cabinet) \$43 mo.

## World's Most Advanced Stereo Receiver

Acclaimed by owners & experts for features like integrated circuits & crystal filters in IF amplifier; FET FM tuner; 150 watts music power; AM/FM and FM stereo; positive circuit protection; all-silicon transistors; "black magic" panel lighting; and more. Wrap-around walnut cabinet \$19.95

**Kit AR-15** (less cab.), 34 lbs. ... \$33 dn., \$28 mo. .... **\$329.95**  
**Assembled ARW-15**, (less cab.), 34 lbs. ... \$50 dn., \$43 mo. .... **\$499.50**



**NEW**  
**FREE 1968**  
**CATALOG!**

Now with more kits, more color. Fully describes these along with over 300 kits for stereo/hi-fi, color TV, electronic organs, electric guitar & amplifier, amateur radio, marine, educational, CB, home & hobby. Mail coupon or write Heath Company, Benton Harbor, Michigan 49022.

HEATH COMPANY, Dept. 41-2  
 Benton Harbor, Michigan 49022  
 In Canada, Daystrom Ltd.

Enclosed is \$ \_\_\_\_\_, including shipping.

Please send model (s) \_\_\_\_\_

Please send FREE Heathkit Catalog.

Please send Credit Application.

Name \_\_\_\_\_

Address \_\_\_\_\_

City \_\_\_\_\_

State \_\_\_\_\_

Zip \_\_\_\_\_

Prices & specifications subject to change without notice.

HF-212

nances was very evident on these fine headphones. Phones present a different listening sensation than do speaker systems, of course. With stereo, a listener feels as if he's in the middle of a concert hall, so to speak, with sound surrounding him. Changing to a mono mode moves the sound somewhere up near the head's temple. In any event, it's an extraordinary experience for those who have not tried this listening format.

The Serenata II, which is a lower-priced version of the Serenata (I?)—\$44.95 compared to \$59.95—caused no discomfort after wearing them for one-half hour. Cutting volume from one channel by adjusting a preamp's balance control, it felt as if one ear was sort of clogged. And that is as it should be with a good seal between ear cushions and ear.

Check 48 on Reader Service Card.

## SWITCHCRAFT MODEL 307TR STUDIO MIXMASTER

**MANUFACTURER'S SPECIFICATIONS—**Low-level inputs: four. Voltage gain: 60 dB (for low- or high-impedance microphones). Magnetic phono inputs: Two. Voltage gain: 40 dB at 1000 Hz. Auxiliary inputs: Four. Voltage gain: 20 dB. Recommended load: 50k ohms or greater. Frequency response:  $\pm 0.5$  dB, 20 Hz to 20 kHz. Power requirements: Two size "D" batteries, 3.0-V. d.c. at 150 mA.

Mixers for use in recording applications are no longer unique—there are several on the market, and the latest to be encountered is the Switchcraft

Model 307TR Studio Mixmaster—the newest in a fairly long line of transistorized mixers by this long-established company. This model is one which combines suitable facilities, excellent performance, and an attractive "professional" appearance which should appeal to the recordist. Measuring only 3½ in. high, 7½ in. deep, and 12 in. wide, it is undeniably compact. It accommodates four mike channels, two of which can be switched to serve as phono inputs. All of them are available for use as a mono mixer, or they may be split into pairs and serve as two mixers per channel for stereo. In addition, an AUX high-level input can be plugged into any of the four mixers, so that sufficient flexibility is provided for most any application that the non-professional recordist has inputs or microphones for. A master is provided, which controls both channels if the unit is working in stereo, or which controls all four inputs if working in mono.

The front panel, Fig. 6, shows five large skirted knobs and a single slide switch on an anodized aluminum panel, the master being in the center position. The rear panel illustrates four pairs of inputs, two outputs, two slide switches which convert inputs #2 and #3 from microphone preamps to equalized phono preamps, and one more slide switch which parallels the two outputs for mono operation.

Each input operates with a separate amplifier, using two transistors for the low-level inputs, while the AUX inputs feed into the circuit between the transistors. AUX inputs are provided with phono jacks, while the low-level inputs use phone jacks. Thus when it is desir-

able to use inputs #2 and #3 for phono inputs, an adapter would probably be required. Dual volume controls are used in all inputs as well as the master so as to insure low noise level.

In addition to two transistors in each input channel, three more are used to provide a 20 V collector supply for the amplifiers. These make it possible to operate the entire mixer with only two "D" cells while still providing a sufficiently high collector voltage to insure a low distortion level. Since the unit is designed to operate an output level of 1.0 V, it must therefore have sufficient gain to operate with a 1-mV microphone input, which means a voltage gain of approximately 60 dB. All four channels measured within 1 dB of this value, with frequency response measuring within  $\pm 0.5$  dB from 20 Hz to 20 kHz. Distortion measured less than 0.3% throughout.

On the phono inputs, the gain at 20 Hz measured approximately 60 dB, dropping to 47 dB  $\pm 0.5$  dB at 1000 Hz. High-frequency rolloff was slightly greater than the standard value of 13.75 dB at 10,000 Hz, being 15.5 dB on one channel and 16.1 dB on the other. However, from 5000 Hz down, the response was within  $\pm 0.5$  dB of the standard RIAA value. The AUX inputs measured 20 dB  $\pm 0.5$  dB in all four positions, indicating that a signal of 0.1 V would provide the standard 1.0-V output.

Inputs of as much as 10 volts can be handled without excessive distortion provided the output signal does not exceed approximately 1 volt. Similarly, phono inputs of as much as 300 mV can also be handled without undue distortion. The maximum signal-to-noise ratio was measured at 77 dB on one channel, while the worst channel measured 73 dB. This measurement was made by setting the gain control to provide a 1-volt output from a 10 mV-input, and then removing the input signal.

What more could one ask from a mixer accessory? It is attractive, effective, and provides most any accommodation that the average recordist could want. In particular, its battery power supply could be a boon to recordists who require a portable mixer for in-the-field use. Furthermore, it uses a battery supply which is readily replaceable at practically any store—supermarket, candy store, five-and-10, or an automobile service station. And when you need a replacement battery quickly, that is an important consideration. List price is \$145.00.

Check 50 on Reader Service Card.



Fig. 6—Front and rear views of Switchcraft model 307TR transistorized mixer.



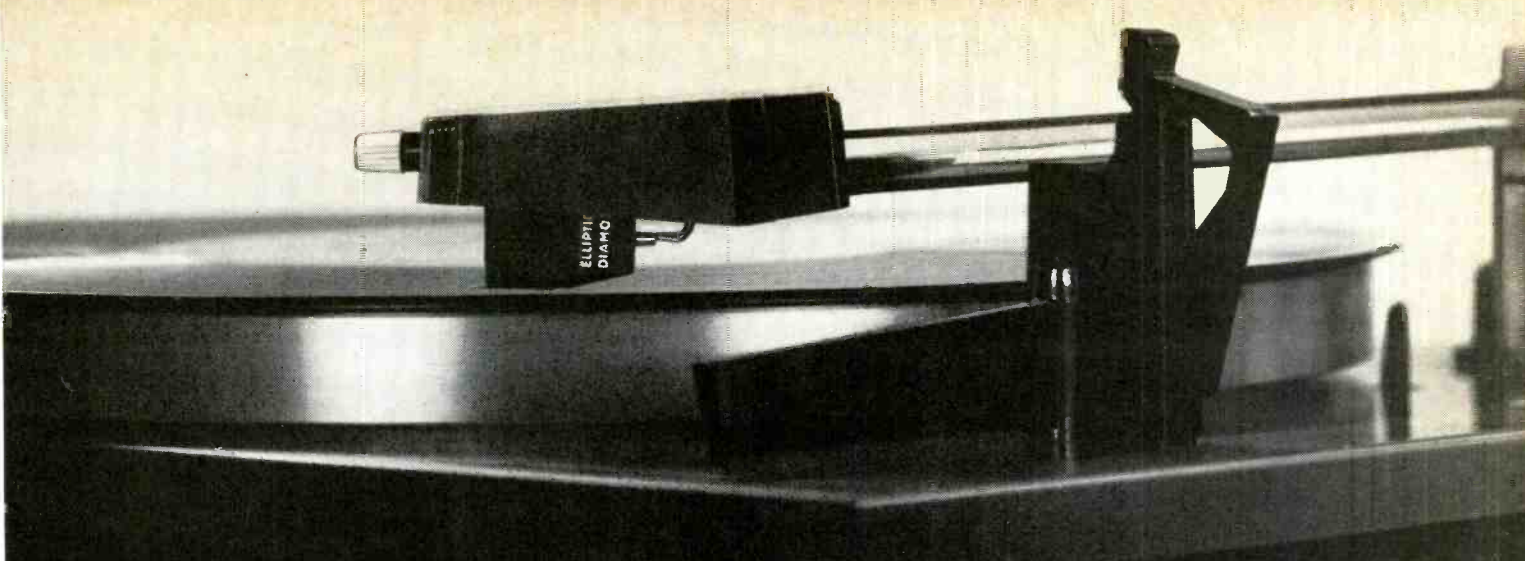

Your records are cut at a 15° vertical tracking angle for minimum distortion.

Shouldn't they be played that way?  
Elpa thinks so.

The better high fidelity records of today were meant to be played with the stylus mounted at a 15° vertical tracking angle.

Any recording engineer will tell you that.

But until now the only way you could be sure a record tracked perfectly was on a single play transcription turntable—with the stylus angle always at a precise 15°.

Now that's OK for a disc jockey. He just sits there and plays one record at a time anyway. *But what about the rest of us?* What about the man who wants transcription quality in his turntable but doesn't care to get up and change each and every record?

For him, Perpetuum-Ebner and Elpa invented the PE-2020.

It's the only turntable in the world that tracks like a manual, acts like an automatic and works like a charm.

Every record in the stack is tracked for minimum distortion. And minimum record wear. Either in multiple or in single play.

The PE-2020 has a lot of other things going for it, too. Like an automatic anti-skating device. A single lever command center to start, stop, repeat, cue, pause and lift. An automatic retrace scanner. A four-speed setting control with pitch control.

And we could go on. But what's the sense of that when you can just as easily see and play the PE-2020 for yourself at your Elpa dealer.

If you don't know who or where he is in your neighborhood and wish further information, just drop us a line. The PE-2020 — \$129.95 less base.

ELPA MARKETING INDUSTRIES, INC.,  
NEW HYDE PARK, N.Y. 11040.



the Elpa PE-2020

# ABZ's of FM

LEONARD FELDMAN

## Adjacent Channel Interference

As we noted last month, FM frequencies are assigned 200 kHz apart, but the FCC usually assigns stations at least two channels apart (400 kHz) in any given locality. The fact that interference can still occur arises from two factors. First, the selectivity characteristic of a given receiver may permit this form of interference. Secondly, extreme sidebands caused by certain instantaneous modulations of two adjacent stations may interact to form audible frequencies at the output of the receiver. The region of possible sideband interaction between two adjacent channels is shown in Fig. 1.

Fig. 1—Under conditions of extreme (but legal) modulation, some interaction of high-frequency sidebands may take place between adjacent channels on the FM band. For this reason, the FCC assigns channels 400 kHz apart in any one geographical area.

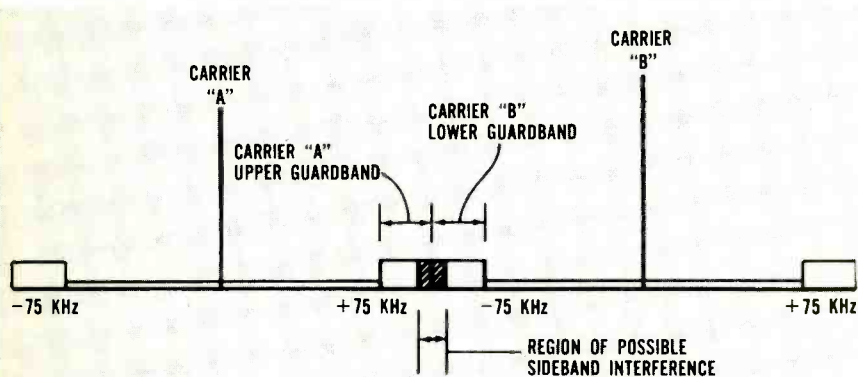

Fig. 2—Under actual conditions described in the text, fully 25 kHz of sideband interaction will take place between the two adjacent channels shown here.

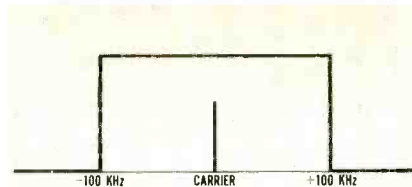
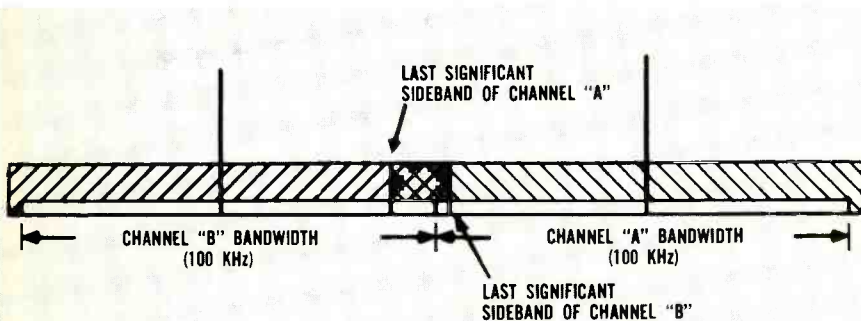

Fig. 3—Idealized response curve of tunable portion of an FM receiver. If this response could be achieved in practice, adjacent channel problems would not exist.

of sideband interaction possible under these conditions, as shown in Fig. 2.

The selectivity characteristics of a given receiver also play an important part in this adjacent channel form of interference. Ideally, the perfect response characteristic for the combined r.f. and i.f. portions of an FM receiver would be that represented in Fig. 3. Interestingly, some very late models perfected in the last year or so by one or two manufacturers actually come very close to this type of response curve. Crystal filters combined with integrated circuits, as well as multi-section, carefully-calculated band-pass filters (as opposed to the usual tuned-primary, tuned-secondary "i.f. transformers"), are finally beginning to come upon the FM tuner scene.

More often than not, however, a typical response curve of the tuned circuits of an FM receiver would be that shown in Fig. 4. Clearly, the bandwidth of such a receiver does extend beyond the ideal  $\pm 100$  kHz, however attenuated the response at the extreme is. With such a response, it is quite possible to receive sidebands emanating from adjacent channel stations.

As a practical matter, the situation is still much better in this regard for FM than it is for AM. For one thing, the FCC has been careful in its assignment of station carrier frequencies. The use of 25 kHz guardbands further decreases the possibility of adjacent bands interfering with each other. Too, the higher frequencies used in FM are limited essentially to line-of-sight transmission as opposed to the lower AM frequencies where long distance reception often occurs, particularly at night. Finally, the inherent characteristic of FM, wherein all that is required is a two-to-one signal advantage for practical elimination of interference, renders this form of reception far less susceptible to interference as compared with AM, where dominance of a strong signal does not really occur until the stronger signal is at least 100 times more powerful than the weaker one.

(Continued on following page)

Are you getting the most  
or simply paying the most?

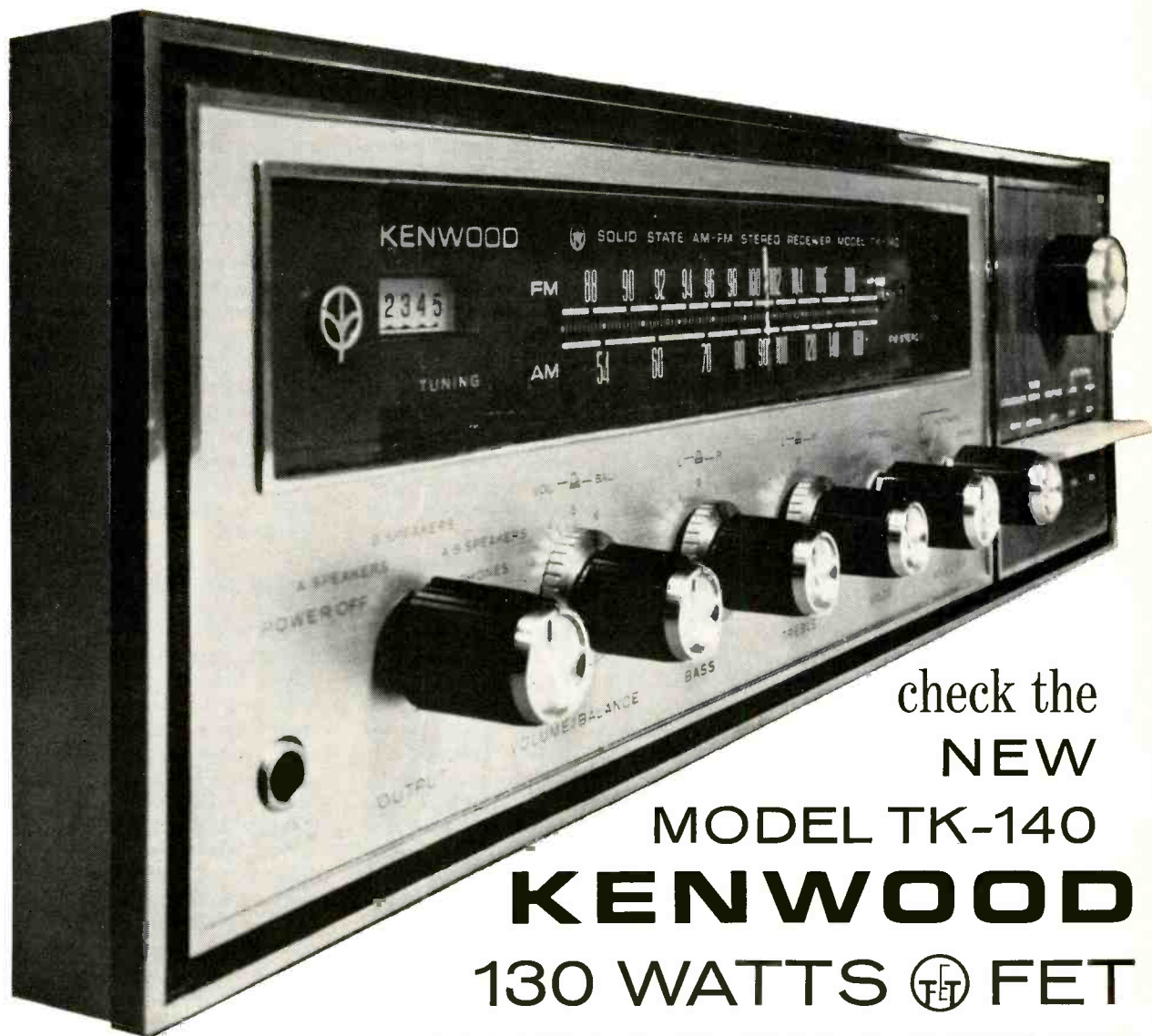

check the  
**NEW**  
**MODEL TK-140**  
**KENWOOD**  
**130 WATTS**  **FET**  
**AM/FM STEREO RECEIVER**  
**\$339.95**

- **F.E.T. (Field Effect Transistor) 4 Gang tuning Condenser front-end** for superior sensitivity and image rejection, cross modulation ratio
- **5 IF Stages with 4 limiters and wideband ratio detector** have been incorporated to provide 45 dB alternate channel selectivity and freedom from noise and interference
- **130 watts of total music power** – enough to drive even low efficiency Hi-Fi speakers
  - All silicon transistor amplifier for wide 20 to 30,000 Hz power bandwidth
  - Exclusive blow-out proof automatic circuit breaker protects power transistors
- **4 sets of speaker terminals** (2 sets stereo speakers) and front panel speaker selector switch (A speakers, B speakers, A + B speakers, phones)
- Price includes handsome walnut simulated finish cabinet
- 2 year warranty

*the sound approach to quality*



**KENWOOD**

69-41 Calamus Avenue, Woodside, New York 11377  
3700 South Broadway Place, Los Angeles, Calif. 90007

## ABZ's of FM

(Continued from preceding page)

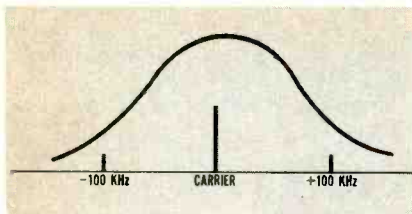

Fig. 4—Practical response curve achieved by most commercial receivers. Note that there is still significant response to signals well beyond the 200-kHz channel bandwidth assigned to any given station.

## TAPE GUIDE

HERMAN BURSTEIN

Reader W. A. Kernaghan, 1752 Kilohi St., Honolulu, Hawaii submits the following useful information:

"In reading your column for May, the correspondence on the Sony 263D versus the 262D attracted my attention. I've owned both of these and still have the instruction manuals, from which I'll extract some information. For playback of the 263D, connect the playback head output terminals to the respective tape head inputs of any stereo pre-amp/amplifier combination. . . . The SRA-3 recording amplifier can be used with either the 263D or 262D tape transport since it can be adjusted for either. The 263D has a low impedance record/playback head. Both transports should 'see' an impedance of 100K to 250K ohms in the playback mode."

### Cross-field tape heads

*Q. I recently acquired a tape deck with a cross-field head (in which recording bias is applied opposite the record head through the base of the tape). I taped some music broadcasts, using 1 mil and 1/2 mil mylar tape, and the results were superb. I then switched to a 1 1/2 mil "high output" tape, and the results were terrible, including a fantastic reduction of the signal recorded on the tape. At first I attributed this to under-biasing, as the machine is biased for "standard" oxides. I then remembered that I had recorded this tape under severely under-biased conditions with another recorder, and had obtained satisfactory results.*

### Static Interference

The last form of interference which we shall consider for the present is "static"—a form of interference so familiar to the AM listener, especially during a summer thunderstorm. Studies have shown that while "static" contains many, many bands of frequencies, the greatest concentration of electrical energy is in the lower frequency region. Thus, with FM we not only have the advantage of the "dominance of the stronger signal" effect (not to mention the use of amplitude limiters which strip away much of the

static interference), but the additional advantage of the high-frequency bands allocated for FM use. Finally, more distant thunderstorms and the like seldom cause any interference because they are beyond the "line-of-sight" limitations of FM reception. All of these factors work in the right direction to make FM the noise-free, static-free, interference-free listening medium that it has proved to be.

Let us conclude that FM receivers are *entirely* noise free, we shall devote a future article to a study of noise in FM and what is done to eliminate it or reduce it to an irreducible minimum.

*I then reasoned: Since the manufacturer of the tape machine had stated the machine to be biased and adjusted for Scotch 150, the THICKNESS OF THE TAPE was the culprit (using a cross-field head). I set up the following experiment. Using 1 mil "standard" tape, I obtained excellent results. Using 1 mil "low noise" tape, I obtained excellent results. Using 1 1/2 mil "low noise" tape, I obtained poor results—a very substantial drop in output.*

*Based on the above, I have the following questions: If bias fed to the cross-field head is increased, would this solve my problem when using thicker (1 1/2 mil) tape? If the bias current is increased, what effect would this have on the frequency response characteristics of various 1 1/2-mil tapes; and of 1-mil and 1/2-mil tapes? Does all this mean that I must make a decision to stick solely either to 1 1/2-mil tape or to thin tape (1 mil or 1/2 mil), and that any adjustment permitting me to use both thick and thin tapes would be a poor compromise? — J. Hart Walters, Jr., Washington, D. C.*

A. Frankly, my experience with cross-field machines is too limited for me to give you more than a partial answer to your questions. To supplement my comments, I strongly suggest that you direct your problem to the manufacturer of your tape machine and to manufacturers of tape. Using one of the cross-field machines with 1-mil tape and with 1 1/2-mil tape, I found the recorded signal level was about the same with both tapes; that is, it was not "terribly" different, as you found it. On the other hand, with both tapes the recorded signal level (for a given amount of harmonic distortion) was several dB less than when using a similar machine, but with bias applied in the customary manner via the record head. If you were to increase the bias current, this would produce a drop in treble response of any tape used.

Whether the effect would differ according to type and base of the tape, I do not know. It does appear that in your case it would be difficult to find a compromise bias giving satisfactory results for both thick and thin tapes.

It is my hope that readers of this column — manufacturers of cross-field machines and of tapes, and users—can shed more light on your problem. If they do, this column will relay their comments.

### 4-track mono conversion

*Q. I have a Panasonic RQ-705 mono two-track tape machine. Where can I buy a conversion kit for this type of recorder? I would like to have four-track mono, not stereo, and I need more recording time per reel. I can add a switch from the tape head to the amplifier. Do you think it will work?— Allen S. Johnson, El Cajon, California.*

A. I take it that you wish to replace the present half-track head in your tape machine with a quarter-track one, and to switch between the two sections of head in feeding signals from the amplifier to the tape head or from the tape head to the amplifier. I think you can easily work out the switching requirements. Preferably use a make-before-break switch to avoid loud pops. Keep all leads as short as possible, and route them carefully to avoid hum pickup. Of course, use shielded leads. With respect to head replacement, I suggest that you write to The Nortronics Co., Inc., 8101 10th Ave. N., Minneapolis, Minnesota.

To obtain more recording time per reel you can also do either or both of the following: Use a slower speed, such as 3.75 ips instead of 7.5 ips. Use thinner tape, such as 1 mil instead of 1 1/2 mil. These measures, together with adoption of 4-track in place of 2-track mono recording, should greatly augment your recording time per reel. Æ



## Meet the "Copy Cat"

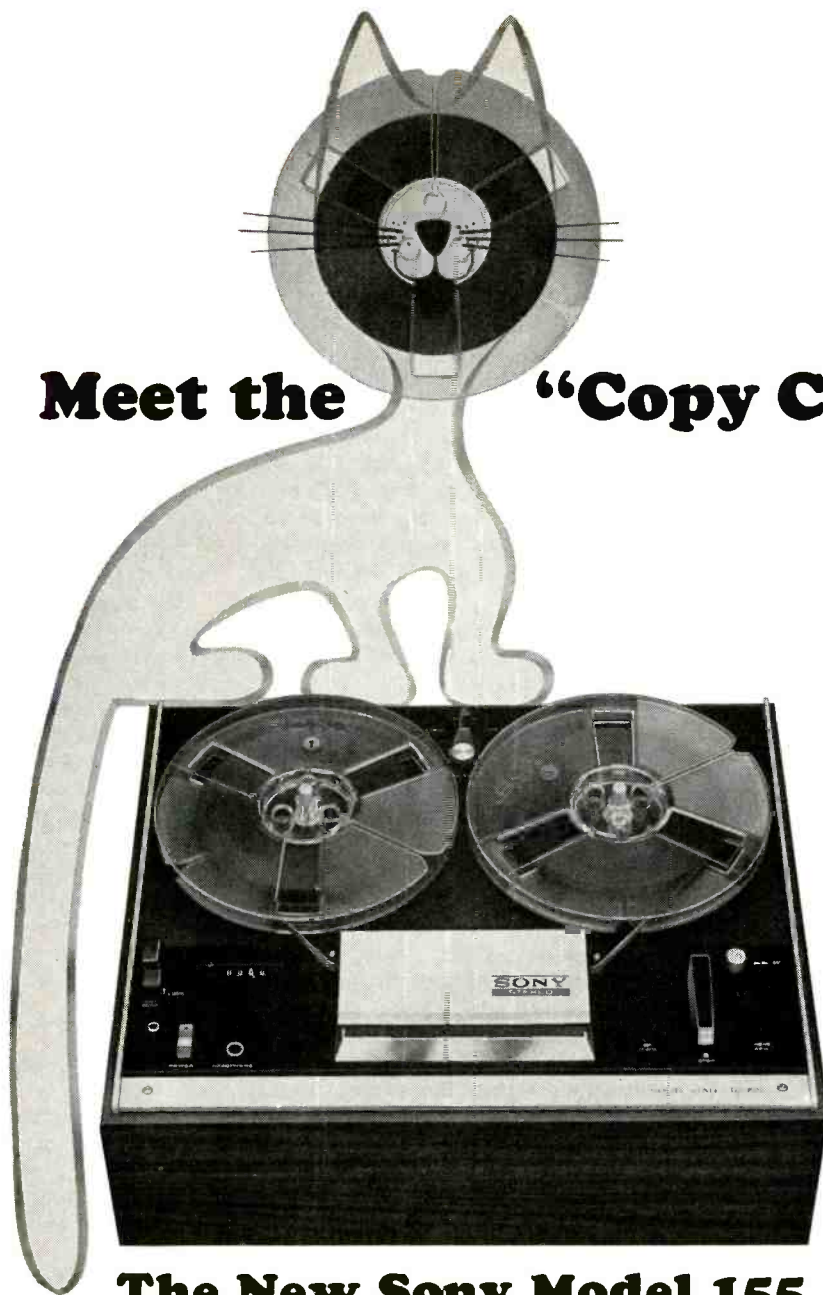

### The New Sony Model 155 Playback/Dubbing Stereo Tape Deck!

If you now own a stereo tape recorder, you can become a "copy cat" for only **\$99.50** For the cost of about fifteen pre-recorded tapes, you can own your own complete 4-track stereo tape duplicating system and build a fabulous stereo tape library at a fraction of the cost of pre-recorded tapes! The Sony Model 155 is a complete stereo transport deck *with solid-state playback pre-amplifiers specifically designed to be used together with your present stereo tape recorder for dubbing!*

■ The Model 155 has features and performance never before heard of at under \$100.00! For example . . . Three speeds . . . Special filter for virtually flutterless performance . . . Retractable pinch roller to permit tape threading with one hand ease . . . Stereo headphone jack for private listening, and . . . the flexibility of vertical or horizontal operation! These are all features normally found on only much higher priced equipment. ■ The Model 155 can also be used just for stereo tape playback through your existing components or package stereo music system. Imagine . . . Sony quality true-fidelity stereo tape playback for under \$100.00! Complete with handsome walnut finish, low-profile base and optional dust cover. Let the Model 155 Playback/Dubbing Stereo Tape Deck make a "copy cat" out of you! And, as always . . . you can count upon the extraordinary "Sound of Sony"!

AMERICA'S FIRST CHOICE IN TAPE RECORDERS

**SONY** **SUPERSCOPE** *The Tapeway to Stereo*

© SUPERSCOPE, INC. 1967 8146 VINELAND AVENUE • SUN VALLEY, CALIFORNIA • 91352

# CLASSICAL RECORDS

EDWARD T. CANBY

## Beethoven symphonies

**Beethoven: Symphonies Nos. 1 and 2; 4 and 5; 8 and 9.** Various performers (see below).

**Audio Fidelity FCS 50,021, 30-026;  
FCS 21 (2) stereo (\$2.50 ea.)**

These Beethoven symphonies sport the familiar and handsome AF "first component" label (the other three symphonies are on three more, already released), but the price is the new low-level \$2.50 list and the recordings are imports from European originals, like so many others at this price. This, then, is part of a new AF series and, if I am right, from a new management.

A knowing record collector, noting the orchestras and conductors featured—and even listening to the sound—will perhaps figure that the records come from that ubiquitous Josefowitz record empire, operated from Geneva, that once launched our first American record clubs, Concert Hall and Musical Masterpiece Society, and now blankets the whole world with records, books and just about everything else via literally dozens of subsidiary companies. The familiar musical sound of the Josefowitz recordings has been appearing of late on other U. S. local labels. It is musically well worth anybody's notice, too, though in terms of hi-fi the sound is not exactly outstanding.

David Josefowitz, the musician brother, is responsible for the high musical standards involved and the intelligent choice of performers. Also, alas, for the sometimes gimmicky sound—too much directorial enthusiasm at the controls! He himself conducts Symphony No. 5 here.

In general, the Beethoven series is highly recommended for those who love Beethoven and want him well-played in an inexpensive format. But the hi-fi demo man will need to look elsewhere. These records are entirely satisfactory for the musical listener but they aren't as super-clean as a demo disc ought to be.

In particular, four of the symphonies are played by the excellent Vienna State Opera Orchestra under Michael Gielen, Nos. 2 and (also 3 and 7, earlier

release). Three are from Frankfurt, with Walter Goehr conducting Nos. 1, 4 and 9. You will find the Gielen-Vienna symphonies precisely played but a trace nervous, the tempi rather fast, or slow, the music a bit mannered with fussy details. Not bad—far from it. Walter Goehr is a more able and traditional conductor; his somewhat low-voltage Beethoven is rock-sure in style and tempo, though the Frankfurt musicians aren't as precise as the men at Vienna.

No. 5 is a loner, the Hamburg Symphony with David Josefowitz. I found it so-so, the music restless and uneven, the tempo a too-fast Americanized sort, not very effective with these players. (But who else makes this symphony sing? It's a tough one.) An earlier release, No. 6, from Vienna too, was conducted by Hans Swarowsky, another excellent veteran. It should be excellent.

You get two orchestras and two conductors on each of these discs. So much the better for variety. E.T.C.

---

*Performance: B*                      *Sound: B—*

---

**Arturo Toscanini—Beethoven Symphonies Nos. 1, 4 and 6 ("Pastorale").** B.B.C. Symphony.

**Seraphim IC 6015 (3) mono (\$7.47)**

If you thought that all Toscanini broadcasts were via NBC and all his recordings from RCA Victor, you are hereby reminded that he operated elsewhere.

These performances originated as broadcasts, though I am not clear as to whether these are the actual broadcasts themselves or subsequent recordings for disc. (In those tapeless days, the only serious difference was the four-minute 78 side—here avoided via the use of two disc cutters, overlapping in coverage. The uncomfortable breaks on the 78's are removed via tape editing.)

Three main sources of Toscanini material were available on records. His pre-war European recordings, such as these, his pre-NBC American recordings with the New York Philharmonic and, of course, the NBC Symphony recordings and broadcasts. Many of us have long thought that the earlier material was musically superior to the over-tense NBC performances, with all their attendant hoopla. Now you may try for yourself. Sampling through these, I find them characteristically Toscanini, always incandescent, wonderfully phrased and ultra-accurate, always a bit faster than you expect to hear the music. But there is none of the cranked-up near-hysteria that one

hears in the last recordings and broadcasts. Toscanini was merely a superb conductor then, not yet an awesome saint on wheels whose very glance caused aspiring musicians (and everybody else) to quake with fear and adoration.

It isn't easy to be critical of an LP transfer job such as this, which must have been very difficult; but I can't help feeling uneasy about Angel-Seraphim's choice of correctives. Again, this sound has an unpleasant metallic ring in the mid-highs which, my ear says, comes from a sharp-cutoff type of filtering, presumably to remove noise and distortion. Frankly, I'd rather hear more of the original sound and less of this unpleasantness. In addition, the bass seems unduly attenuated, for an over-all shallow, pinched sort of tone. (Yet 78's generally had very full bass, even if it was seldom then reproduced.)

It's a matter of opinion and, as always, the state of the crucial inner grooves in each 78 side no doubt determined the over-all corrections that were found necessary. ("Fade in" the filtering by degrees as the side progresses? Impossible. What about the beginning of the next side, now blended inaudibly into a continuous flow?)

Don't let me discourage you—these are very listenable and very exciting historical documents for those with ears to hear the music. E.T.C.

---

*Performance: B*  
*Recording: B— (C+)*

---

## Zinks, Piffaros, Etc.

**Monteverdi: Vespro della Beata Vergine (1610).** Soloists; Vienna Singing Boys; Monteverdi-Chor Hamburg; Concentus Musicus, Vienna; dir. Jurgen Jurgens.

**Telefunken SAWT 9501/02 stereo**  
\$11.58

Here is one of the biggest Monteverdi works, at last in a performance that is both "authentic" and highly listenable. In a word, it makes sense, where in earlier "modernized" and generally hoked up recordings it was jargon for the ear.

The Vespers (its shortened English title) is made up of a vast number of segments, like a Mass or a Magnificat, the final order of which is (or was) in some doubt, since a number of its parts are really separate pieces. No matter—you can take this version as *it*. What does matter is that the astonishing impact the original, monstrously big work must have made back in 1610 is realized here via an immense collection of old instruments—viols, recorders, zinks, piffaros, dulcian, lute, cornetto

# Take a poke at your favorite FM station

If you're a well-versed music lover there have probably been times when you felt like strangling the dial on your FM receiver. Tuning back to

Bach, forward to Beethoven, losing one station while searching for another, is all behind you now. ADC is introducing electronic tuning in its new 100 watt FM stereo receiver. This Dio-Matic push button tuning section allows you to pre-set any five FM stations and have music as you like it with one little poke or push of a finger. Instantly. Effortlessly. (Naturally, there's a smooth gliding manual tuner for dialing all the other stations.)

And what's more, the ADC 1000 is all professional. It represents the heart of a total music center for your home, enabling you to get maximum enjoyment from your entire music system. And, the complete unit has been engineered with your comfort in mind. All function controls are positive smooth-action push buttons.

We've even added selector push buttons for two individual sets of speakers, for sound here there or everywhere.

There are full tape facilities including a tape head input and, of course, a headphone socket for your own private world of entertainment.

Indicative of its solid performance is its solid state modular construction including an FET front end and integrated circuits.

(Suffice to say, it permits perfect FM tuning, free from cross modulation, station drift and any inherent noises...

especially in urban areas.)

All in all, the ADC 1000 is a powerful 100 watt (IHF) unit, carefully designed to perform at an extremely low distortion (less than 0.3%). The result is a more superior sound.

Crisp. Alive. Brilliant. Absolute!

This week, drop in at your local ADC dealer and take a poke at your favorite FM station. We'll bet you'll want to lay both hands on the ADC 1000 after that.

Oh yes, one more thing. A two year guarantee. That's so you won't want to take a poke at us. Price: \$379.95. Walnut case optional.



## The ADC 1000 Push Button Stereo Receiver

Audio Dynamics Corp., New Milford, Connecticut 06776

(wooden trumpet), organ, harpsichord and more—all of them played with virtuoso musicality, plus several combined choirs, the superb Monteverdi Chorus of Hamburg and the well-known Singing Boys of Vienna. Also, a separate Gregorian chant choir of men's voices from Munich.

Finally, the solo singers, two sopranos, two tenors and basses, are admirable. Somehow, these singers have learned to sing the strange, elaborate, almost oriental-sounding melodies of Monteverdi's music, including the weird "ha-ha-ha-ha-ha-ha" cadences that end the musical paragraphs, where most modern pro vocalists sound like people gargling Listerine. No exaggeration! Not these people. The old vocal techniques are being re-learned today by many European singers, just so this kind of music may be performed intelligibly.

No, it's not a familiar sort of piece. If you don't already know Monteverdi you'll have to listen awhile before sense comes through, especially in the above-mentioned vocal solo parts. But the grand, big ensemble numbers, with their hundreds (so it seems) of participants, are brilliant beyond belief and recorded in a vast, clean, impressive stereo sound. Definitely a collector's item for those who want something memorable. E.T.C.

*Performance: A      Sound quality: A*

## Browsing Department Winners

**Beethoven: Symphonies Nos. 3, 5, 7.**

Vienna Philharmonic, Wilhelm Furtwangler.

**Seraphim IC 6018**

**The Virtuoso Harmonica** (Sonatas by Loeillet, Marcello, Veracini, Vivaldi). Adalberto Borioli; Mirna Miglioranza, harpsichord.

**Everest 3172 stereo**

**Tchaikowsky: Nine Choruses** (a cappella).

The Sveshnikov Chorus.

**Melodyia-Angel SR-40039 stereo**

**Offenbach: Orpheus in the Underworld.**

Soloists, Paris Philharmonic Orch. & Cho., Leibowitz.

**Everest S 438 (3) stereo**

**Bartok: Two Violin Concertos; Two Rhapsodies for Violin and Orch.** Andre Gertler; Czech Philh., Brno State Philh.

**Crossroads 22 26 0012 stereo**

**Symphonies of the Eighteenth Century** (Kraus, Filtz, S. C. Bach). Vienna Radio Orch., Otvos.

**Westminster WST 17128 stereo**

# LIGHT LISTENING

CHESTER SANTON  
ROBERT SHERMAN

## Sound Tracks

**Casino Royale** (Original Sound Track Recording)

**Colgems CoSO (Stereo) \$4.79**

This is the first Colgems soundtrack recording I've heard since RCA Victor became involved in the manufacture and distribution of this label's material taken direct from movies produced by Columbia Pictures. *Casino Royale* should have a certain importance to today's movie goers. It is the first James Bond film to be offered without Sean Connery in the title role.

Five directors, including the well-known John Huston, were used by producer Charles K. Feldman to ride herd on the wild antics of this spoof of preceding spoofs of Bond films. An enormous starring cast enlivens the film but makes no appearance during the sections of the sound track Colgems has packaged in this album. Most of the score will make sense only to those who have already seen the picture but that, of course, can be said about nine-tenths of the movie tracks. The main interest of record buyers will be drawn to the sections of this album offering the talents of vocalist Dusty Springfield and Herb Alpert's Tijuana Brass.

The first item of the Burt Bacharach score heard on the disc is the main title, *Casino Royale Theme*, with a slightly augmented Tijuana Brass bouncing its way through a tune that certainly was written with the group in mind. The stereo is wide spread, but the sound quality is rather thin and nasal compared to the discs Herb Alpert produces on his A & M label. Dusty Springfield is heard in a torchy trifle called *The Look of Love*. She sounds about two inches away from the mike. Somewhere in the background are to be found piano, percussion and rhythm with a solitary saxophone coming in toward the end of the piece. Oddly enough, the best sound on the record is to be found in the instrumental version of this pale little ditty. c. s.

*Performance: B      Sound: B—*

**A Countess from Hong Kong:** Music from the film soundtrack, composed by Charles Chaplin, arranged and conducted by Lambert Williamson.  
**Decca DL 71501 stereo (\$5.79)**

There's something curiously refreshing (to borrow a drinking man's phrase) about Chaplin's film music for *A Countess from Hong Kong*. It's so old-fashioned, so naive, so sentimental, so totally of another era, that it comes as something of a welcome antidote to the current crop of hard-driving, super-sophisticated soundtrack scores. The themes are melodious, in a simple, straightforward fashion, and the soaring violins, lush harmonies and easy-going nostalgia add up to a highly listenable album, with a musical comfort quotient equivalent to that of the proverbial old shoe. R. S.

*Performance: B      Sound: B*

## Folk Singer Goes Pop

**Tommy Makem Sings Tommy Makem**  
**Columbia stereo CS 9545 \$4.79**

Whenever a folk singer—particularly a first rate folk singer—ventures into the pop field, he takes the chance that his old fans will write him off as another Hero Gone Wrong. Tommy Makem has avoided this pitfall by the simple expedient of being great in his solo debut as composer-singer of what he calls "a wedding of folk and country-and-western, with a liberal splicing of the blues." Only one of the songs here is typical of Makem's usual material (an Irish rebellion ballad called *Freedom's Sons*); for the rest, he sings of love and rambling, of greetings and farewells, in a style that is quite his own, in a voice that seems to have shed much of its Irish accent.

The accompaniments, by a small, bustling instrumental combo are sometimes a little too obviously Nashville oriented (even to the inclusion of a tinkling piano in several numbers), but the warmth and spontaneous lilt that Makem has shown in his previous doings with the Clancy clan, come through in full measure, and make the album a thorough delight. *No More Good Times* could well have the makings of a folk-pop classic, while two gentle, tender ballads, *Seven Shades of Sunday* and *Ever the Winds* are lovely too. The sound is close-to, adding to the intimacy of the softer songs, but spacious enough to let Makem soar out with full power when he has a mind to. R. S.

*Performance: A      Sound: A*

THE WORLD'S ONLY  
**CERTIFIED\***  
 RECEIVER

*“Superlative...  
 ...Performance”*

NOW  
**VERIFIED**  
 BY AUDIO MAGAZINE

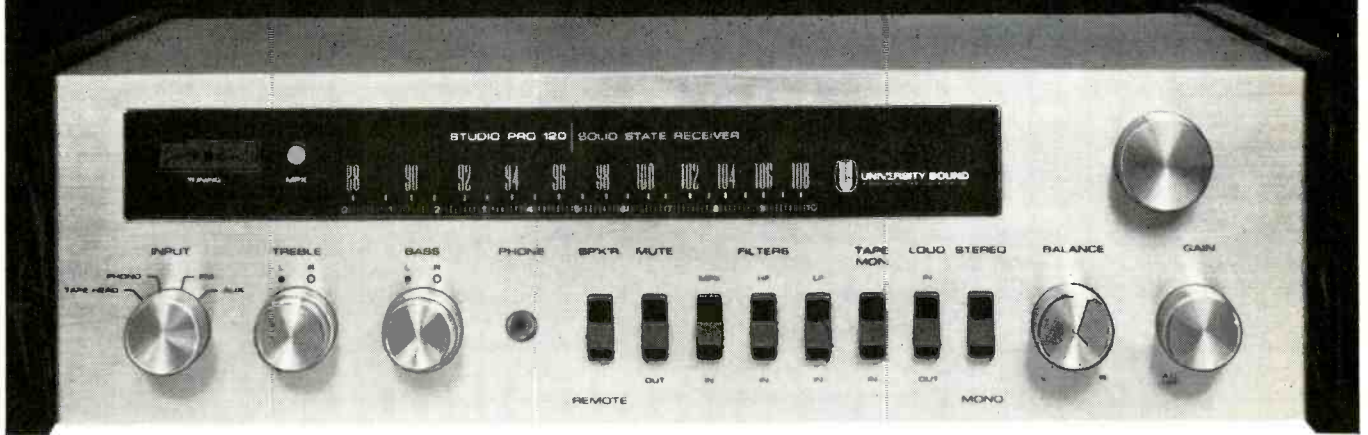

UNIVERSITY STUDIO PRO 120 SOLID STATE FM/STEREO RECEIVER

When a receiver is so remarkable that it achieves immediate recognition, setting it above and beyond its competition, how can it be better described than “Superlative Performance.”

The following quotations are taken from a report on the Studio Pro 120 January, 1968 issue of AUDIO MAGAZINE.

“The Studio Pro receiver exceeded its published specifications, often by a wide margin”

“the Studio Pro 120 reproduced sound with matchless clarity . . . beautiful to hear: crisp, sharp, absolutely clean, no muddiness — take your choices of adjectives.”

“There is no doubt that this receiver has a superlative audio amplifier. In fact, it’s the peer of many separate amplifiers in performance.”

“deviation never exceeded .2 dB, the ‘curves’ appeared as a straight line!”

“pulled in 38 perfectly listenable FM stations in the New York City area . . . on a simple dipole antenna tossed casually behind the receiver.”

“. . . there was no difficulty in isolating one station from the next, nor was there the slightest audible evidence of co-channel interference.”

“receiver limiting is achieved at an incredibly low input of only 0.55  $\mu$ V!”

“extremely accurate equalization and gain between channels.”

“stable at all conditions of loading from open circuit to a 0.1 mfd capacitor across speaker output terminals.”

“includes a position-acting FM Stereo indicator light (which during all tests, instrument and listening, was never triggered by inter-station noise or any other non-stereo interference).”

“Phono hum and noise was less than that specified . . . AUX hum and noise measured 90 dB below full output, a parameter normally associated with separate power amplifiers rather than all-in-one receivers.”

“The Studio Pro certainly lives up to its name.”

\*The University Sound Studio Pro 120 solid-state, FM/stereo, receiver, is certified to meet or exceed the manufacturers published specifications by Nationwide Consumer Testing Institute, Inc., a division of United States Testing Company, Inc.

Write Dept. B-83

*Listen . . . University Sounds Better!*



**UNIVERSITY<sup>®</sup> SOUND**

A DIVISION OF LTV LING ALTEC, INC.  
 9500 W. Reno Oklahoma City, Oklahoma

# JAZZ & BLUES

BERTRAM STANLEIGH

## Latin Touch

**Cal Tjader:** Along Comes Cal  
Verve Stereo V6-8671 (\$5.98)

The Tjader vibes are ably abetted by a set of Latin-flavored arrangements from the pen of Chico O'Farill in a brilliantly recorded stereo set that provides Latin percussion and lyrics from a variety of pin-pointed positions between two speakers.

Performance: A Sound: A

**Bola Sete at the Monterey Jazz Festival**  
Verve Stereo V6-8689 (\$5.98)

Recording for the first time with his new group—Sebastian Neto, bass, and Paulino, drums—Bola Sete sounds even better than he did with Vince Guaraldi. The Brazilian guitarist is in perfect company as he plays Bossa Nova favorites by Bonfá and Jobim and two of his own compositions.

Performance: A Sound: A

## The Blues

**Joe Turner:** Singing the Blues  
BluesWay Stereo BLS-6006 (\$4.79)

The veteran Kansas City singer reveals that he still has ample voice and is a supreme master of the blues idiom. *Piney Brown Blues*, *Roll 'Em Pete*, and *Cherry Red* are given fine new performances that brings to mind the great 1938 versions Turner recorded with Pete Johnson.

Performance: A Sound: A

**Big Mama Thornton and the Chicago Blues Band**  
Arhoolie Mono F 1032 (\$4.98)

A poised, stylish shouter in the grand manner, Big Mama Thornton has the assistance of a great blues group headed by Otis Spann. Poor engineering keeps this disc from winning top honors, but a lot of fine music making can still be heard. Big Mama may not be Bessie Smith, but she can be mentioned in the same breath.

Performance: A Sound: C

**Eddie "Cleanhead" Vinson:** Cherry Red  
BluesWay Mono BL-6007 (\$4.79)

A big-voiced Texas blues singer heard with one of the best blues accompaniments in one of the most spectacularly engineered blues discs available. Mike Bloomfield, on guitar, deserves equal billing.

Performance: A Sound: A

## Count and Duke

**Count Basie:** Basie's Beat  
Verve Stereo V6-8687 (\$5.98)

This is traditional Basie; no novelties, no gimmicks of any kind, and rather a bit more piano than usual. *Only a Paper Moon*, *Squeeze Me*, *St. Louis Blues*, *I Got Rhythm*, and *Frankie and Johnny* are heard in the finest big band sound imaginable, and trombonist Richard Boone makes a promising debut as a vocalist.

Performance: A Sound: A

**Duke Ellington:** Far East Suite  
RCA Victor Stereo LSP-3782 (\$4.79)

The ideas for this collection of pseudo-orientalia were supposed to have been collected by the Duke during State Department tours to the Middle East and Japan in 1963 and 1964. In fact, these impressions all bear a close thematic resemblance to *Hindustan* and the *Sheik of Araby*. Considering the amount of rehearsing and performing required of the band during its tours, there's mighty little chance that Ellington had any opportunity to hear any of the music of the exotic lands in which he performed, but even if he had, it is doubtful that he would change his style at this late date.

As a result, Ellington's Eastern music bears the same relationship to Asia as his African music does to that continent. But if it doesn't stem from authentic folk sources, it nevertheless stems from one of the most fertile and creative jazz personalities of all time. And in spite of its title, suggestive of some of the ponderous and portentous large scale efforts with which the Duke has been associated over the years, the present set emerges as a bright, light, atmospheric-tinged collection of nine bits of deft Ellingtonia.

Particular attention should be called to the alto solos by Johnny Hodges on *Isfahan* and *Blue Pepper* and to Harry Carney's mood-evoking statement in *Agra*. The band hasn't sounded so bright, alert, and flexible in a long time, and it's also been quite a while since

we've heard Ellington play a two-and-a-half minute improvisatory solo. The recording is full, clean, and well-balanced. You won't want to pass this one by.

Performance: A Sound: A

## Sax Time

**Stan Getz Quartet:** Sweet Rain  
Verve Stereo V6-8693 (\$5.98)

With Ron Carter, bass; Grady Tate, drums; and Chick Corea, piano; Stan Getz plies his tenor in some of his most relaxed and eloquent music making. Jobim's *O Grande Amor* and Gillespie's *Con Alma* are not to be missed.

Performance: A Sound: A

**Sil Austin Plays Pretty for the People Again**  
Mercury Stereo SR 61126 (\$5.98)

A fine set of ballads played in clean, straightforward style by a tenor saxophonist who worked with Cootie Williams in the 50's. An accompaniment on vibes, piano and drums is very much in the background, but the recording is stunningly bright, clean and close up.

Performance: B Sound: A+

**Steve Lacy Quartet:** The Forest and the Zoo  
ESP Compatible Stereo ESP 1060

Recorded in Buenos Aires, Lacy is joined by Enrico Rava, trumpet; Johnny Dyani, bass; and Louis Moholo, drums; in two side-long compositions. Lacy's deeply probing, strongly unsettling performances brand him as the most creative soprano saxophonist working today. His unfamiliar collaborators are well matched in sensitivity. Separation is excellent on this compatible stereo disc.

Performance: A Sound: B+

## Folk

**Been in the Storm So Long**  
Folkways Mono FS 3842

Guy Carawan, one of the veteran collectors of folk music of the southern Negro, recorded this set on Johns Island off the coast of South Carolina. It offers a fascinating group of spirituals and shouts, children's games, songs, and folk tales from a region that has preserved much of the culture of the slave days.

Performance: A Sound: B

**Several interesting facts about the design of the new Dual 1015:  
after you read them, you may wonder why other automatic turntables aren't made this way.**

You've probably noticed that many of the new automatic turntables, in several price ranges, offer features like anti-skating devices, levers for raising and lowering the tonearm (cueing devices), interesting motors of one kind or another, plus some pretty fancy designs for overall appearance.

Well, the new Dual 1015 has these things too. Even the fancy design for overall appearance.

But our features are different. Different because we don't offer them just to offer them. They are there to perform a real function. With precision and accuracy.

Take our anti-skating control.

It's there because, quite simply, our low-mass tonearm skates. No, that isn't something to be ashamed of. In fact, it indicates bearing friction so low (less than 40 milligrams, always) that there's no internal resistance to skating. Even at 1/2-gram. (You'll note that other arms offering anti-skating devices don't mention bearing friction. It's understandable. If bearing friction is high, skating never occurs in the first place.)

And that's not all.

Our anti-skating control is continuously variable and dead-accurate. It doesn't under-compensate or over-compensate. This means the stylus will track with equal force on both walls of the stereo groove. Also, our anti-skating control applies force internally, at the pivot, keeping the force constant throughout the record. You can't do this by applying

a dead weight to the outside of the arm.

Okay, now for our cueing control.

The purpose of cueing is to lower a stylus to a predetermined spot on a record. Accurately and gently. If it does neither, or just one of these things, it's not cueing. It's simply doing what you could do by hand (that includes damaging a high-compliance stylus).

Dual's cue-control is accurate and gentle. Rate of descent is .5cm/second and is controlled by silicon damping and piston action (which also prevent side-thrust from anti-skating). And the cue-control works on automatic as well as manual start.

Here are a few more things that should interest you:

Our hi-torque motor is a constant speed motor. It's quieter and more powerful than a synchronous motor, and turns the record accurately. Not just itself. (It maintains record speed within 0.1% even if voltage varies  $\pm 10\%$ .) Our counterbalance has practically no overhang (for compactness), and locks in position to prevent accidental shifting.

By the way, about that fancy design for overall appearance:

We know that a lot of you wouldn't even consider a top, precision product if it didn't look good.

With all that precision, and a price of only \$89.50, the Dual 1015 gets better looking all the time.

United Audio Products, Inc., 535 Madison Ave., New York, N.Y. 10022. **Dual 1015**

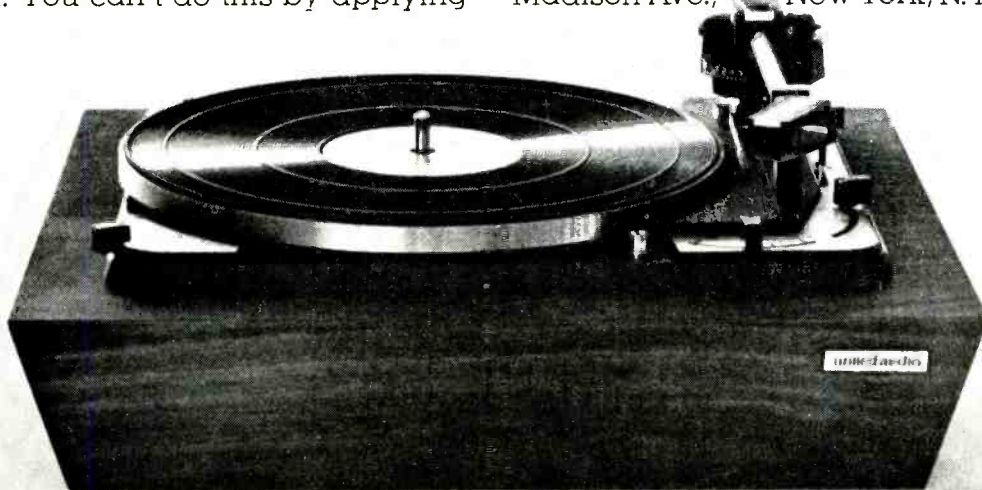

# QUAD

for the closest approach  
to the original sound



## QUAD 303 POWER AMPLIFIER

A two channel power amplifier of unique design capable of a standard of quality\* limited solely by the capabilities of the accessories with which it is used.

*\*Distortion: harmonic, intermodulation, amplitude, steady state or modulated and however weighted, several times lower than any other amplifier known to us.*

## QUAD 33 CONTROL UNIT

A self powered control unit to select, match, correct and amplify for the closest approach to the original sound inherent in the programme.

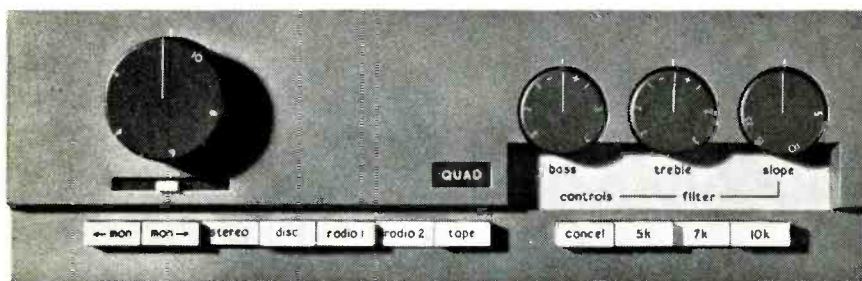

For further details  
see your Hi-Fi dealer  
or write direct to:—

# QUAD

ACOUSTICAL MANUFACTURING CO. LTD.  
HUNTINGDON, ENGLAND.

## LETTERS

(Continued from page 10)

not overlap, no matter where they may be, licensed or located. (This is the practical limit for two stations licensed to the same market area.) For stations spaced 20 kHz apart, the 2 and the 25 kHz contours may not overlap. (Sec. 73.37 of FCC Rules and Regulations.)

Thus, for all practical purposes, the most stations which could be licensed in a given community is 107 divided by 3, or 35. Because of nearby stations, this number is reduced in practice. Not even New York City or Los Angeles has 35 stations (AM).

(4) It is stated that the FCC "... seldom assigns stations closer than 400 kHz apart in an immediate geographical area." The FCC will never even assign FM stations 400 kHz apart in an immediate geographical area, let alone closer.

As with AM, stations are assigned on the basis of transmitter mileage separation, not city of license. Class C FM stations (high power) separated only 600 kHz are required to be 65 miles apart. Class B stations (also high power) must be 40 miles apart. Class A stations (low power) must be at least 15 miles apart. (Sec. 73.207, FCC Rules)

As a practical matter, the FCC Table of Assignments for FM stations (Sec. 73.202) never allocates FM stations closer than 800 kHz in the same city of license. That is the standard spacing—800 kHz.

(5) There is no 5 kHz audio-frequency bandwidth limit imposed on AM broadcast stations, as stated. Each case is decided on its own merits, depending on the interference situation. See reference #2.

(6) Public Frequencies—AM should read 540-1600 kHz (not 640-1640 kHz, as stated).

PAUL NORMAN  
New York, N. Y.

## Author replies

• While the AM broadcast band is defined by the FCC as extending from 535 kHz to 1605 kHz, it is a well known, almost standard practice in the industry to manufacture AM radios with a frequency capability of from 530 or 540 kHz to 1620 to 1640 kHz. In fact, upper calibration is often made at a frequency of 1620 kHz to insure total coverage of the band.

Although the FCC does not specifically exclude frequencies above 5,000 Hz in the modulating information for AM, the truth is that not all stations actually transmit audio informa-



tion above the 5 kHz upper limit implied in my article. Thus, the mere capability of a transmitter to transmit frequencies above 5 kHz does not insure that they *are* being transmitted.

Finally, general comments regarding AM were certainly not intended to depreciate the senior, useful medium but merely to define it as the type of communications medium that it is—definitely NOT high fidelity. This was further confirmed not long ago by the FCC in its refusal to even consider proposals for broadcasting AM Stereo. In denying consideration of the many AM Stereo proposals, the FCC stated that stereo, being an adjunct of high fidelity sound reproduction, did not rightly belong in the “AM world.”

The above covers comments #1 and #2 of Mr. Norman's letter. Other answers are as follows:

(3) I accept the theoretical maximum of AM stations as 107 not 100. I question the 35 maximum in any locality because, obviously, how do you define locality? I know that at night I get one station crowding right up against another on the AM band, even though they may be a couple of hundred miles apart.

(4) A listing from *CUE Magazine* of local stations (FM) refutes the 800 kHz separation claimed. With today's sensitive receivers every one of these stations is “readable,” and many are only 400 kHz apart.

(5) There is not a definite 5 kHz limit, it's just that that's the way it usually works out in practice.

(6) This is a typographical error. It should read 540-1600, not 640-1640.

LEONARD FELDMAN  
Great Neck, N. Y.

## The missing Canby

Here is the half of Ed Canby lopped off in “The Audio Pro's at Show Time,” *AUDIO*, January 1968.



get the turntable a studio needs  
...and rek-o-kut durability, too!



*There's hardly an engineer in the broadcast field that hasn't used a Rek-O-Kut turntable in his career. Rek-O-Kut has been building studio turntables for over a quarter century. So you are assured of buying top quality sound reproduction along with the ruggedness and durability that broadcast and commercial installations demand. The rim drive Rek-O-Kut B-12H by Koss Electronics permits slip cueing without sacrificing fidelity. And your Koss/Rek-O-Kut will last and last and last with a minimum of maintenance and repair. Write for complete details on the popular Model B-12H or the 16" studio B-16H today.*

## specifications:

*SPEEDS: 33 $\frac{1}{3}$ , 45, 78 rpm. NOISE LEVEL: — 59db below 5 cm/sec average recorded level. MOTOR: custom-built computer type heavy duty hysteresis synchronous motor. 45 RPM HUB: instantaneously removable by hand. PILOT LIGHT: neon light acts as an “on/off” indicator. FINISH: grey and aluminum. DECK DIMENSIONS: 14 x 15 $\frac{1}{16}$ ". Minimum Dimensions: (for cabinet installation) 17 $\frac{3}{4}$ " w. x 16" d. x 3" above deck x 6 $\frac{1}{4}$ " below. PRICE: B-12H Turntable \$165. S-320 Tonearm \$34.95. Optional BH Base for audition room \$18.95.*



Rek-O-Kut Turntables by

**KOSS**

Koss Electronics Inc., 2227 N. 31st St., Milwaukee, Wis. 53208  
Export Cable. STEREOFONE • Koss-Impetus/2 Via Berna/Lugano, Switzerland

## AUDIO ETC.

(Continued from page 14)

men waxed very cryptic—and who could blame them? A whole industry depends on it. But they did opine that in the video-computer areas their chrome tape would cost from 20 per cent to 50 per cent more than, presumably, standard high-quality iron oxide tapes.

Considering that you can use only half as much tape for the same quality of resolution—and the same will be generally true in audio—this would make the stuff reasonably cheap. I'd say. But at mastering speeds, which probably will not be reduced for the new tape, the cost factor will revolve around the improvements to be had without speed changes. And in effect the same is true of slow-speed tape in cassette and similar form.

\* \* \*

So there you have it. Most of it, anyhow. I must say again that, having been in the actual presence of the Dupont representatives and having seen and heard their demo material, I am reasonably convinced that no major, glaring deficiencies in chrome tape were being glossed over or even mini-

mized, at least as of its present stage of development. I speak only for me, not for Dupont—I am no part of their Big Commercial Empire! (Though my Daddy used to horse around with the Dupont boys back in the old days in Wilmington, he didn't acquire any stock, alas.) I'm just an intensely interested outside audio observer—and so are you, I'll bet.

Two BIG questions just had to be answered before we all left that AES meeting if we were to sleep tight and feel right. One of them was forthcoming—number 16. WHEN???. I am still not quite sure I could have heard right; but what Dupont said, I *think*, was "We certainly hope to have something concrete (in audio tape) to tell you, to sell you, in 1968."

Now if I'm getting those Dupont boys into trouble, I am truly sorry. It just might have been 1969, they said. Or meant. Anyhow—without much doubt we'll be seeing and hearing this stuff in the near future, formulated precisely and specifically for audio use.

The other question? Oddly, nobody asked it. Will anybody ELSE be able to make chromium dioxide tape and sell it competitively? Like, say, pardon the expression: 3M? You ask Dupont. I didn't. Æ

## AUDIOCLINIC

(Continued from page 2)

from the underside of the chassis. Align the capacitor so that it will accept these screws. The capacitor will not be shorted out because of the insulation provided by the frommet or fiber washers. Of course, lugs must be secured to these screws to allow for connection of the leads.

When a capacitor of this size is equipped with leads for mounting it to a printed circuit board, you can have a real problem. However, you can fashion a clamp from aluminum scrap which will secure the capacitor in an upright position. This clamp is designed to wrap around the bottom of the capacitor. Two "ears" would project from the clamp and be bent so they can be screwed down to the chassis. These leads would be run to the PC board.

In some circuits, the can (or negative connection) of the capacitor is at a different electrical potential than the equipment chassis. If the potential difference is great enough, touching the can and the chassis at the same time will represent a shock hazzard. Therefore, the can is sheathed in plastic.

# People who built their own Schober Organs wrote this ad

Here's what they say about the pleasure of assembling the Schober Electronic Organ from kits . . . and enjoying the magnificent sound of an instrument they've created in their spare time.

### Building was fun

"Building it was at least as much fun as playing it!"

Mr. Lester F. Schwartz,  
Somerset, N. J.

### So proud I could pop

"I've done over 90 per cent of the work on this organ myself—and I'm so proud I could about pop!"

Mrs. V. P. Allbert,  
Topeka, Kansas

### Nothing as fine under \$5,000

"... I could not find any organ that sounded as fine as the Schober under \$5,000."

Mr. Jerome J. Fraenkel,  
Franklin Square, N. Y.

### Proud to own

"I am proud to own such a valuable instrument."

Mr. Jean J. Juteau,  
Montreal, Canada



The NEW Schober THEATRE ORGAN—  
one of four models available

### Most cherished possession

"My spinet has become the most cherished possession in our home—fabulous, indeed."

Mr. Frank J. Marion,  
North Bergen, N. J.

### Tremendous sound

"The sound is conservatively, tremendous."

Mr. Paul DeForest Wren,  
Westbrook, Conn.

### Unbelievably easy to build

"When we ran out of instruction, the organ was finished... To me it was unbelievable!"

Mr. Ted Sowinski,  
Chicago, Illinois

Thousands of music lovers in every walk of life—from teen-agers to grandmothers, from people who are "all thumbs" to electronic engineers—have enjoyed the pleasure of assembling, playing and hearing the magnificent sound of the Schober organ. Whether you favor Bach or Bop, there is a Schober organ that gives you full range of expressional and tonal quality—so like a fine pipe organ that many listeners can't tell the difference. You can build a Schober organ for as little as \$645. And—even if you've never played a note before—Schober's self-teaching courses give you immediate musical results.

Over 50% of Schober Organ owners never handled an electronic job before and didn't play a note, yet assembled some of the best organs ever designed and get a daily thrill from making their own music. Isn't it time for you to take this cost-saving road to greater musical

pleasure—and enjoy the satisfaction of doing it yourself?

**Free Information and Demonstration Recording**  
Send today for your free copy of Schober's 16-page, full color booklet, plus 7" free recording.

The Schober Organ Corp., Dept. AE-23  
43 West 61st Street, New York, N. Y. 10023

Please send me Schober Organ Catalog and free 7-inch "sample" record.

Enclosed please find \$1.00 for 12-inch L.P. record of Schober Organ music.

NAME \_\_\_\_\_

ADDRESS \_\_\_\_\_

CITY \_\_\_\_\_ STATE \_\_\_\_\_ ZIP \_\_\_\_\_

Check No. 64 on Reader Service Card

## your own reference library CLOTH BOUND BINDERS



**\$4.95**

post paid

**HOLDS**

**12**

**ISSUES**

**OF**

**AUDIO**

The valuable information in this publication will continue to serve you, month after month, year after year, when you file each issue in this easy-to-use, stiff-cover binder. Keep your copies safe from damage, safe from dust and discoloration, yet instantly available. Binding mechanism makes it simple to insert new issues, yet holds 12 copies firmly.. Attractively finished in green cloth, with the publication title stamped in gold. Check must accompany order.

Order from **AUDIO**  
134 North Thirteenth Street  
Philadelphia, Pa. 19107

# problem solving micro-phones

by

**SHURE**



**PROBLEM:**  
"Pop" & Feedback  
**SOLUTION:**  
Unisphere I®  
Microphone

Provides superb feedback control and uniform pickup pattern for solving difficult public address problems—plus the added problem-solving ability afforded by spherical filter assemblies that effectively control explosive breath sounds ("POP") and wind noise in outdoor locations. They are particularly recommended for close-talking applications and permit superior utilization of space on small stages or studios. And, they control echoing in partially filled halls ("BOOM"). For hand or stand.

**UNISPHERE I—Model 565.**  
Dual-impedance, small size for maximum handability. List Price: \$95.00

## budget a problem, too?



**SHURE**  
Unisphere A

Budget priced version of UNISPHERE I for use in low-budget systems. Unidirectional, "pop" suppressing. Model 585 SA High Impedance; 585 SB Low Impedance. List Prices: Model 585 SA \$65.00; Model 585 SB \$58.00.

Write for Data Sheet:

**SHURE BROTHERS, INC.**  
222 HARTREY AVENUE  
EVANSTON, ILL. 60204

U.S. Patents 3,132,713 and 3,240,883  
Check No. 65 on Reader Service Card

## MICROPHONES FOR SOUND REINFORCEMENT

(Continued from page 32)

reverberation being picked up and re-amplified by each additional microphone. Provisions for a skilled operator, or at the very least, interlocking relays activated by floor mats near the microphones, are much better answers than trying to turn all of them up at the same time. In some situations, all may need to be on. When this is the case, narrow-band equalization can perform wonders.

**Broadband equalization.** If a quality microphone(s), electronics, and speaker system have been selected and installed in correct relationship to each other, a graphic equalizer, such as one shown in Fig. 12, can be used to "smooth" the overall acoustic response for maximum acoustic gain. This is the very minimum that should be done in the way of equalization. Use of a 1/3-octave filter set with a random noise generator as source and walking the audience area with a sound level meter will allow surprisingly smooth response curves via the graphic equalizer. Once you have heard this simple equalization accomplished *you will never fail to do it for every subsequent sound reinforcement system with which you may be involved.*

**Narrowband equalization.** "Miracles" are being accomplished today under extremely trying acoustical conditions by following the overall smoothing of the acoustic response with specific narrowband filtering of individual feedback modes. (This subject has been treated extensively elsewhere, and the reader is referred to the bibliography.) Suffice it to say that narrowband equalization is a very specialized business and only the best professional help should be engaged if it is contemplated. An enormous amount of time can be wasted trying to "hunt and peck" at this technique, with much money squandered without any results to show for it. When professionally done, the improvements can range from very good to startling.

In sum, microphones are more complex than the average sound engineer often realizes. We have barely nicked the surface of a vast collection of data. It is hoped that by

(Continued on page 67)

# problem solving micro-phones

by

**SHURE**



**PROBLEM:**  
overload & "pop"  
**SOLUTION:**  
adjustable-volume  
Unisphere® A

### MODEL 585SAV

One of the most ingenious microphones ever designed. The volume control is right on the microphone case. Enables the user to reduce output if audio-break-up due to overload occurs. Also, enables a speaker or singer to control his own volume for dramatic effects. Ideal where amplifier controls are inaccessible. Model 585SAV \$72.50 list.

## vibration a problem?



SHOCK-MOUNTED  
**SHURE**  
UNISPHERE® I  
Model 566

All the superb feedback and pop-control characteristics of the famed Unisphere I, plus built-in vibration isolation shock-mount which prevents pickup of mechanical vibrations and handling noise. Model 566 \$140.00 list.

write for data sheets:

**SHURE BROTHERS, INC.**  
222 Hartrey Ave.  
Evanston, Ill. 60204

Check No. 66 on Reader Service Card

© 1967 Shure Brothers, Inc.

# ELECTRONIC CROSSOVER

(Continued from page 22)

We made two modifications with the Acoustech power amplifier. We added a 1000- $\mu$ F capacitor and two resistors,  $R_{24}$  and  $R_{25}$ , to drop the 70-V supply to the desired 25-30-V range for the crossover boards, each of which draws about 8 mA. Photographs here show the placement of these added components, as well as the locations of the level controls for the three outputs. Dymo tapes provided the designations for both the front and rear panels. Figure 7 shows the front and back views of the circuit boards. These are quite compact, and are designed to use Sprague 192P capacitors, which are small and are of 10% tolerance. The two electrolytics on each board are subminiature types. All resistors on the circuit boards are 1/2-watt, 5% types, so that the two boards would be as similar as possible.

While the curves of Fig. 2 show the measured outputs of the three sections, they represent only one channel. However, actual measurements showed that there was less than 0.5 dB difference between the channels throughout the entire spectrum. The woofer and mid-range responses were measured at the output jacks, and the tweeter response was measured at the speaker terminals, thus including the power amplifier. As a further protection for the tweeter voice coils, the 1000- $\mu$ F output cou-

pling capacitors of the original Acoustech XI were replaced by 6- $\mu$ F oil-filled capacitors rated at 100 V. This was done for two reasons—it served as additional protection for the tweeters and it freed the two high-capacitance units for other applications.

The circuit schematic shows a series of numbered rectangles which indicate the socket terminals to which these portions of the circuit board connect. The transistor symbols are not etched on the circuit board because of space limitations, but are shown to aid in assembling the boards. All other components are indicated for ease in assembly.

## The circuit

The crossover consists entirely of emitter followers, so there is no gain to the system. However, there is only a small loss, with an input signal of 1 volt resulting in an output in each section of approximately 0.9 volts. Since all of the transistors function as emitter followers, there is little opportunity for any distortion to creep in, and actual measurements show that distortion, measured in each section separately (at 800, 2000, and 8000 Hz), is less than 0.1%. The tweeter section, measured through the power amplifier, showed .08% distortion at 8000 Hz, and response was down less than 2 dB at 100 kHz, being flat to 60 kHz.

The circuit proper consists of the input emitter follower,  $X_1$ , which drives the three sections. In the woofer section, which consists of two more transistors,  $X_2$  and  $X_3$ , all that is needed is a high-pass filter. This is composed of three RC filters, with design frequencies of 1/2 the crossover, twice the crossover, and the crossover frequency, respectively. This arrangement is standard practice when a sharp cutoff is desired, and offers a rolloff of approximately 18 dB/octave.

The mid-range section must provide both low-pass and high-pass actions. The former consists of  $R_{11}$  and  $C_9$ , which centers around 5000 Hz, together with  $R_{12}$  and  $C_{12}$ , also centering around 5000 Hz. With both sections at the same frequency, the rolloff is only 12 dB/octave. The high-pass section consists of  $C_{10}$  and  $R_{14}$  centering at twice the crossover frequency,  $C_{11}$  and the parallel resistance of  $R_{15}$  and  $R_{16}$  which centers at 1/2 the crossover, and  $C_{14}$  and  $R_{18}$  which centers at the crossover frequency. Together, these networks provide a rolloff of 18 dB/octave, matching the low-pass rolloff of the woofer section. In the tweeter section, the high-pass action is provided by  $C_{15}$  and  $R_{19}$  together with  $C_{16}$  and the parallel resistance of  $R_{20}$  and  $R_{21}$ . Both of these combinations center at 5000 Hz and provide a rolloff of 12 dB/octave. The effect of the 6- $\mu$ F capacitor in the output circuit when working with a 16-ohm super-tweeter is to reduce the level by 3 dB at 2000 Hz, where the response from the network is already down some 15 dB, so the only effect is to provide some further protection for the voice coil.

## Making the circuit boards

There are several ways in which the etched circuit boards may be made. Our preference is to make a same-size negative of the layout of Fig. 8. Etched-circuit kit

(Continued on page 68)

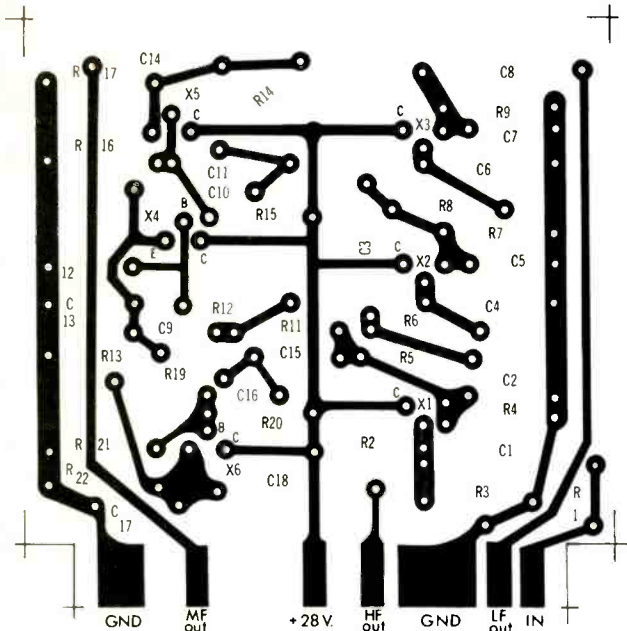
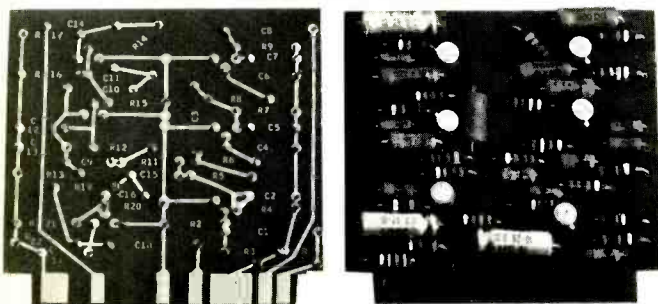

Fig. 7—Same-size circuit board layout.

Fig. 8—Front and back views of the small etched circuits used to construct the electronic crossover unit.



## MICROPHONES FOR SOUND REINFORCEMENT

(Continued from page 65)

pointing out, in a non-mathematical way, a few of the broad concepts that hint at underlying complexities, that some of you will be encouraged to dig deeper and enjoy the multi-dimensional mathematical inter-relationships as well. The bibliography was compiled to allow the reader to trace the thinking presented here, as well as to encourage him to venture further. Æ

### BIBLIOGRAPHY

- Alexis Badmaieff, "Techniques of Microphone Calibration," *Audio*, December 1956.
- Alexis Badmaieff, "The Use of Polyester Films in Microphone Designs," *Journal of the AES*, Vol. 9, No. 3, July 1961.
- Leo L. Beranek, *Acoustic Measurements*, John Wiley & Sons, 1949.
- Leo L. Beranek, *Acoustics*, McGraw-Hill, 1954.
- C. P. Boner and C. R. Boner, "Minimizing Feedback in Sound Systems and Room Ring Modes with Passive Networks," *Journal of the Acoustical Society of America*, Vol. 37, No. 1, January 1965.
- C. P. Boner and C. R. Boner, "A Procedure for Controlling Room Ring Modes and Feedback Modes in Sound Systems with Narrow Band Filters," *Journal of the AES*, Vol. 13, No. 4, October 1965.
- C. P. Boner and C. R. Boner, "Behavior of Sound System Response Immediately Below Feedback," *Journal of the AES*, Vol. 14, July 1966.
- R. J. Carrington, "Miniature Capacitor Microphone Omnidirectional at All Frequencies," *Electrical Manufacturing*, October 1959.
- Don Davis, "Custom Equalization Enhances P.A. Sound," *Radio Electronics*, November 1966.
- William L. Hayes, "Two Papers on Microphones," Technical Letter No. 148 issued by Altec Lansing, 1964.
- Keith Henney, *Radio Engineering Handbook*, Chapter 21, Carl G. Dietsch "Broadcasting," McGraw-Hill, 1959.
- John K. Hilliard and Walter T. Fiala, "Condenser Microphones for Measurement of High Sound Pressures," *Journal of the Acoustical Society of America*, Vol. 29, February 1957.
- Lawrence E. Kinsler and Austin R. Frey, *Fundamentals of Acoustics*, John Wiley and Sons, 1962.
- Frank Massa, *Acoustic Design Charts*, The Blakiston Co., Philadelphia, 1942.
- James J. Noble, "High Quality High Reliability Amplifiers for Speech Input Systems," *Journal of the AES*, Vol. 9, April 1961.
- Harry F. Olson and Frank Massa, *Applied Acoustics*, P. Blakiston, Son & Co., Philadelphia, 1934.
- Harry F. Olson, *Acoustical Engineering*, D. Van Nostrand Co., New York, 1957.
- J. W. S. Rayleigh, *The Theory of Sound* (2 vol.), Dover Publications, New York, 1945.
- Michael Rettinger, *Practical Electroacoustics*, Chemical Publishing Co., New York, 1955.
- E. G. Richardson, *Technical Aspects of Sound*, Elsevier Publishing Co., 1953.
- Howard W. Tremaine, *The Audio Cyclopaedia*, Howard W. Sams & Co., Indianapolis, 1959.
- A. Prose Walker, Editor, *N.A.B. Engineering Handbook*, McGraw-Hill Book Co., New York, 1960, 5th edition. (Chapter 6, especially, by J. P. Maxfield, starting on page 643.)
- Richard V. Waterhouse, "Theory of Howback in Reverberant Rooms," a Letter to the Editors, *Journal of the Acoustical Society of America*, May 1965.
- American Standards Association, "American Standard Method for the Calibration of Microphones," March 14, 1966.

# A Sound Investment

The 711B FM Receiver. For real music to your ears. Every touch of sound from FM, tape or record player, arrives with distortion-free reproduction whether it's the softest whisper of a muted guitar or the rolling crescendos of tympani.

100 watt power rating (IHF) with frequency response of  $\pm 1$ dB, 15 to 30,000 Hz, the 711B is fully silicon transistorized, has the latest FET front end, integrated circuits, automatic reset circuit breakers. Between-station noise is completely eliminated by Altec's new muting circuit.

The professional look. Certainly the professional touch. (Professional sound engineers have installed Altec quality in broadcast and recording studios for over three decades.) That's why it's the very sound buy at \$399.50. See your Altec dealer. Or send for our 1968 Hi-Fi Catalog.



A division of LTV Ling Altec, Inc., 1515 S. Manchester Ave., Anaheim, Calif. 92803

## ELECTRONIC CROSSOVER

(Continued from page 66)

materials are made by Kepro, and are readily obtainable from some jobbers or by mail order from Allied Radio Corp. Since each board is 3 x 3 in., procure one package (5 pcs.) of S1-335 sensitized phenolic laminate, 1 pt. D-1PT developing solution, and 1 pt. E-1PT etching solution. Place the negative in contact with the sensitized surface and hold in place with two glass plates clamped together. Expose for about 6 minutes to a #2 photoflood lamp at a distance of 18 in. Then place the laminate in a glass dish and pour the developing solution over it in sufficient quantity to cover the surface, and leave for one minute. Remove from the developer and allow to dry, being careful not to touch the surface of the laminate. Then place the laminate in a clean glass (preferably Pyrex) dish and cover with the etching solution. The etching action is speeded up if the solution is heated slightly on the kitchen range. The etching is completed in about 20 to 30 minutes, and after thorough washing is ready for drilling. A No. 55 drill is recommended for the holes.

A second method is simpler, but does not produce as neat a result as the first. This method is simply to "paint" the pattern on a piece of unsensitized laminate, using a paint resist or even nail polish. This is the method used to make repairs to a pattern produced by the photographic method when it does not show up correctly after development. However, the entire pattern can be

"painted" on the laminate, after which the board is etched as in the first method. This works just as effectively, but it is quite difficult to produce a small complicated pattern by this technique.

There are several other ways in which an etched circuit board can be made, but the first suggested method is recommended for this particular application since it is small, the "work" of making the layout has already been done, and the results checked out. It is suggested that the transistor designations on the board be scratched off before soldering the components in place, since there is barely enough room for suitable soldering as it is.

After all the components are soldered into the circuit boards, they may be inserted into their sockets. It is assumed that the remainder of the wiring from the input jacks to the board sockets has already been completed, as well as the wiring to the level controls, and from the level controls to the output jacks. Then, after connecting the input from the control amplifier to the input, and connecting the woofer and mid-range outputs to their respective power amplifiers, and the loudspeakers to their respective driver amplifiers, you are ready to apply power to the system.

### Adjusting levels

As with any multi-speaker system, it will be necessary to balance the various levels. If a microphone and an amplifier with an output meter is available, it will simplify the work and provide an optimum balance.

**BEND AN EAR...**  
*toward the newest shape in sound*



**Possibly some one has been bending your ear about the newest shape in sound. It's called CELESTA! This speaker has a cast chassis, functionally-formed under extremely high pressure for lasting precision. A baked-on lacquer finish and slim profile (8" model is only 3 3/8" total depth) are distinguishing features of all SIX CELESTA models. Vibration-free, rugged CELESTA frames assure added years of listening pleasure. So go on . . . bend some one else's ear about the newest shape in sound . . . CELESTA. Incidentally, free cabinet plans included with speaker.**

**See your dealer, or write UTAH for complete information**



**HUNTINGTON, INDIANA**

Place the microphone five feet in front of the mid-range speaker of one channel. Apply a signal of the crossover frequency—in this case, 500 Hz—to the input. Disconnect the woofer output from the crossover unit, and adjust the output from the mid-range to a fairly good level, say about 80 dB SPL, using the control  $R_{18}$ . Then without changing  $R_{18}$ , disconnect the mid-range output and connect the woofer output and adjust  $R_{10}$  for the same output. With a microphone, this is a simple procedure; with ears it is slightly more difficult. Then change the input frequency to the crossover frequency between mid-range and tweeter and repeat the procedure, adjusting the tweeter output to be exactly equal to the mid-range output at this new frequency. Note that only one speaker unit is operating at a time while making these adjustments. After completing the level adjustments, apply the lower crossover frequency again with both mid-range and woofer operating. Then move the mid-range unit backward and forward to get the maximum output. This is where the microphone and amplifier with the output meter is especially valuable.

If the mid-range and woofer are more than a foot apart in the position of maximum volume, reverse the leads to one of the speakers and recheck the positioning. For a 500-Hz crossover frequency, the reversal of the leads should move the maximum point about 13½ in. so that the two units may be nearer the same plane in the final positioning.

Then change the input signal to the frequency of the upper crossover — 5000 Hz, approximately — and repeat

the measurement and adjustment for the mid-range and tweeter units, this time moving only the tweeter. This will not be as critical as the adjustment for the 500-Hz crossover, but still should be performed if the optimum result is desired.

After completing one channel, repeat the same adjustments on the other one. When properly done, this should result in the finest speaker system you have ever heard, presuming each component of your speaker system is of high quality.

### Hints

For wiring between the amplifier outputs and the speakers themselves, we found a suitable cable to be 3-wire #14 A.W.G. house wiring lead. We recommend the use of the ground wire (usually green, and probably about #18) for the tweeter feed, white for common, black for woofer, and red for mid-range. This makes for a neat installation, and if standardized will save you some time if you ever have to make any changes.

If you use three 60-watt amplifiers to drive the three speaker units, you *may* have to replace the speakers occasionally. So our concluding suggestion is that you set your levels on the safe side so that the maximum level from the source can never cause too much signal to be fed to the speakers. If this precaution is taken, you may be sure that the saving in speakers may well pay for the cost of the crossover network, even if the listening is not sufficient of itself to make the whole project worthwhile.

Æ

## Some of the Soundest Ideas come from England



THE HAMMOND M-100  
CONDENSER  
MICROPHONE  
IS ONE OF THEM

- Flat Frequency Response
- Extended Frequency Range
- Nuvistor Preamplifier
- 60 ohms source impedance
- Stabilized AC power unit
- Miniature size
- Unique extended warranty



The price of this sound idea:

Stereo Model: \$229.50

Mono Model: \$149.50

May we send you a brochure?

The Microsound Company

Box 4591 G

Colorado Springs, Colo. 80909

Check No. 69 on Reader Service Card

# If you want the answers to questions like:

How are wow and flutter measured . . . what is compliance . . . how should I keep my records clean . . . why is a tone arm manufactured three years ago obsolete today . . . why don't broadcast stations ever use 'automatic turntables' . . . how do I talk intelligently to hi-fi salesmen?

**A.** Send for Elpa's FREE informative "Record Omnibook"



# If you know the answers... you're probably an Elpa customer already!

Elpa markets through its selected franchised dealers a line of turntables and record playback equipment of the highest quality. And Elpa stands between consumer and manufacturer as a guarantee of the highest quality control. Some of our endorsed products are:

**THORENS** The unchallenged world leader in superb transcription turntables and tone arms.

**Ortofon** The ultimate in fine cartridges, matching tone arms for getting the most out of any recording.  
**CECIL E. WATTS, Inc.** — Producer of the finest products for record care and cleaning.

LOOK FOR THE ELPA ENDORSEMENT ON EVERY COMPONENT YOU SELECT; IT WILL CONFIRM YOUR JUDGMENT OF SUPERIOR QUALITY.



**Elpa Marketing Industries, Inc.**  
 New Hyde Park, New York 11040

Dear Sirs:  
 Please send me the "Record Omnibook" and put me on your mailing list for future mailings.

Name \_\_\_\_\_

Address \_\_\_\_\_

City/State \_\_\_\_\_ Zip Code \_\_\_\_\_

## NEGATIVE FEEDBACK

(Continued from page 42)

This means that the ratio between the loop gain,  $AB$ , and the feedback factor,  $(1 + AB)$ , gives the gain with feedback multiplied by the feedback fraction,  $B$ . If the feedback fraction,  $B$ , is a simple fraction, possessing no phase or amplitude characteristic of its own, then the relative response of the ratio,  $AB/(1 + AB)$  in magnitude and phase will be the same as that of the gain characteristic of the system as an amplifier from input to output, with the feedback loop closed, which is  $A/(1 + AB)$ .

Even if the feedback fraction  $B$ , does have an amplitude and phase characteristic, this ratio is a useful step toward solution. The overall response is then obtained by subtracting (in dB and phase) the charac-

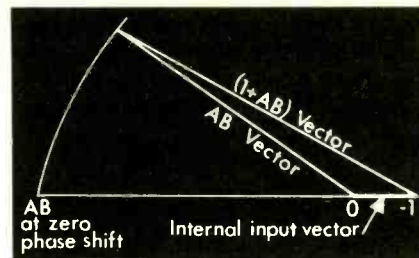

Fig. 6—The geometry of the Nyquist diagram, showing the various vector quantities for one point on the curve.

teristic of the feedback fraction from the characteristic of  $AB/(1 + AB)$  thus obtained.

To aid in reading off this  $AB/(1 + AB)$  characteristic, the Nyquist plot for  $AB$  should be made on a chart with background rulings consisting of a series of circles that represent dB and phase of the  $AB/(1 + AB)$  characteristic (Fig. 7).

(Continued next month)

Fig. 7—Scales for  $AB/(1 + AB)$  in dB and phase, to aid in reading off performance from the Nyquist plot. The point marked indicates a frequency on a possible curve where the overall response would be  $-2$  dB with  $50^\circ$  phase shift.

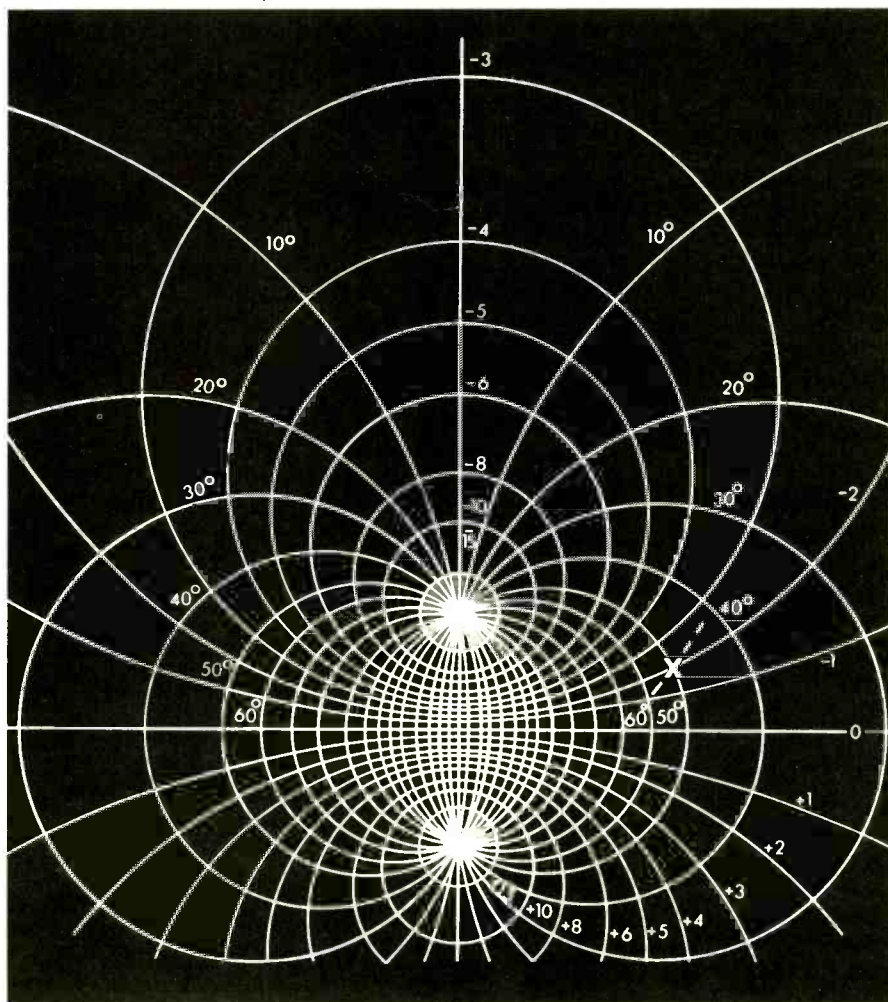



# AUDIO NEWS

## Tape News

Herb Alpert and the Tijuana Brass picked up yet another award recently—the 1967 “Artistry in Sound” award, based on a poll conducted through Ampex Stereo Tape dealers. Last year’s winner was Mantovani. . . . Audio Devices presented 1,250,000 feet of low-noise “Audiotape” on a 1½-mil Mylar base to the Rodgers and Hammerstein Archives of Recorded Sound of the New York Public Library. Original material in the collection of 145,000 recordings dating back to the 1890s—early Metropolitan Opera performances, classical and American music, voices of Sarah Bernhardt, John Barrymore, George Bernard Shaw, and others—will be transferred from Edison cylinders, wire recordings, and wax and acetate discs to the modern sound medium.

## Joint Ventures

Columbia Broadcasting System and the Sony Corporation have requested Japanese government approval of a joint organization in that country, CBS/SONY Records Corp. The repertoire of the CBS Records Div. and the CBS International Div. will be available to the new company. . . . Bell & Howell and International Video have agreed to exchange technical information and patents which will lead to marketing of a line of color video tape recorders and cameras under the Bell & Howell banner.

## Ampex offers video course

The Ampex Corporation has established the *Ampex Video Institute* in Elk Grove Village, Illinois, to teach VTR owners and operators the rudiments of video tape recording. The CCTV Workshop (a Service Training School course is also offered) shows students how to use video tape as an effective visual communications tool, as well as lighting, camera, and sound track techniques. Tuition for the five-day resident course is \$100 to purchasers of an Ampex VTR, \$150 to non-owners. Fees include bus transportation from motel to institute, all text materials, and one meal per day.

*New Transistorized,  
Portable Impedance Tester*

by **SENNHEISER**



**Solves  
Matching  
Problems in  
Audio Circuits**

Now audio repairmen can check the impedance of capacitors, inductors and transformers right on a service call with the battery operated, Sennheiser Model ZP2 Impedance Tester. Features direct reading in ohms at frequencies of 250, 1000 and 4000 Hz. (Accuracy is ±5% at 1000 Hz.)



WRITE TODAY FOR LITERATURE:

**SENNHEISER ELECTRONIC CORPORATION (N. Y.)**  
500 FIFTH AVENUE, NEW YORK, N. Y. 10036 · PHONE: 212 564-0433  
PLANT: BISSENDORF/HANNOVER, WEST GERMANY

Consumer net price  
**\$175<sup>00</sup>**

Check No. 70 on Reader Service Card

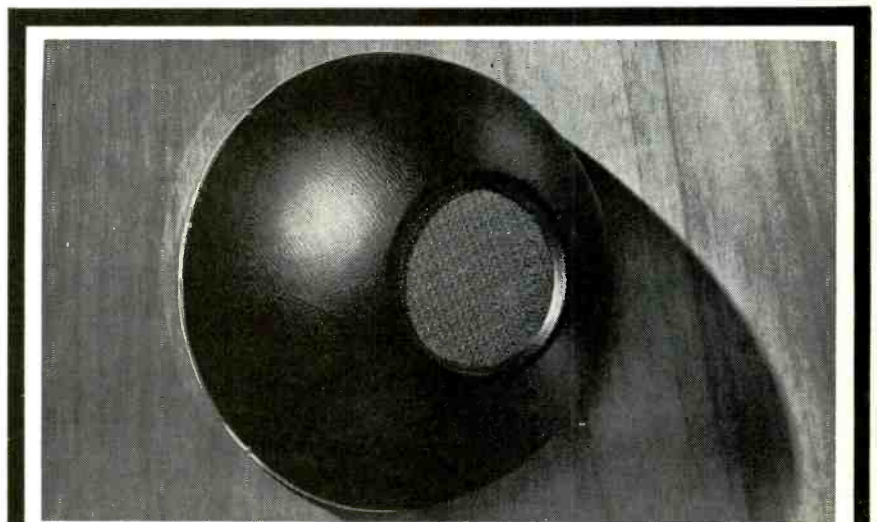

THE FIRST **NEW** IDEA IN A  
**SPEAKER ENCLOSURE  
COMBINATION** IN 20 YEARS

- OUTPERFORMS LARGER UNITS
- COMPLETELY WEATHERPROOF
- EASY, FAST INSTALLATION

Ask your dealer or write for  
Brochure #673.

**OAKTRON INDUSTRIES, INC.**  
Monroe, Wisconsin 53566



Check No. 71 on Reader Service Card

# NAGRA

WORLD'S MOST ACCEPTED  
1/4" TAPE SYNCHRONOUS  
SOUND RECORDER



- ★ Lightweight-Portable-Rugged
- ★ Fully Transistorized
- ★ Two microphone input circuit
- ★ Closed-Loop servo-drive for lowest available flutter and wow.
- ★ Electronic Speed Control by accurately tuned resonant circuits.
- ★ Neopilot synchronizing system with high frequency bias.
- ★ Self-Contained line-up oscillator provides a level index for matching prints and reprints.
- ★ Accepts 1200' - 7" reels with lid open.

Send for FREE Brochure

DISTRIBUTION-SERVICE-SALES

**NAGRA MAGNETIC RECORDERS, INC.**

565 Fifth Avenue, New York, New York 10017  
Telephone (212) 661-8066

Check No. 72 on Reader Service Card

# FREE!

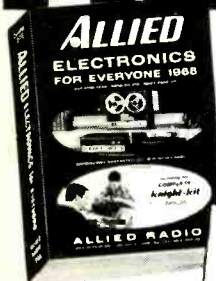

**ALLIED  
NEW 1968  
CATALOG**

**518  
PAGES**

**SAVE ON:**

- Famous Knight-Kits®
- Stereo Hi-Fi
- Tape Recorders, Tape
- CB 2-Way Radios
- Walkie-Talkies
- FM-AM & AM Radios
- Shortwave Receivers
- Portable TV
- Phonographs
- Amateur Gear
- Intercoms & PA
- Automotive Electronics
- Test Instruments
- TV Antennas & Tubes
- Power Tools, Hardware
- Tubes, Transistors
- Parts, Batteries, Books

**TOP SAVINGS ON  
THE BEST IN  
ELECTRONICS  
FOR EVERYONE**

Shop by mail and save at Allied, world's largest electronics headquarters. Hundreds of money-saving values. **NO MONEY DOWN.** Up to 2 years to pay!

**MAIL COUPON  
BELOW**

**ALLIED RADIO, Dept. 118  
P.O. Box 4398, Chicago, Ill. 60680**

NAME (Please Print) \_\_\_\_\_

ADDRESS \_\_\_\_\_

CITY \_\_\_\_\_

STATE \_\_\_\_\_

ZIP \_\_\_\_\_

Check No. 73 on Reader Service Card

## CLASSIFIED

Rates: 25¢ per word per insertion for noncommercial advertisements; 50¢ per word for commercial advertisements. Frequency discounts as follows: 2 times, less 15%; 6 times, less 20%; 12 times, less 30%. Closing date is the FIRST of the second month preceding the date of issue.

### SERVICES

#### HIGH FIDELITY SPEAKERS REPAIRED

AMPRITE SPEAKER SERVICE

168 W. 23rd St., New York, N. Y. 10011  
CH 3-4812

#### HI-FI SPEAKERS REPAIRED

OLD SPEAKERS UPDATED

AUDIO SPKR TECHNICS

#3 Walker St., New York, N. Y. 10013  
CA 6-7785

**PROTECT YOUR LPS**—Heavy poly sleeves for jackets 5¢, Round bottom for records 3 1/2¢ ea. New LP jackets, White 20¢, Colors 25¢. Min. order \$5.00. LP Supplies, Hillburn, P.O. New York.

**CUSTOM RECORDING SERVICE**—Tape or disc recordings made from live or recorded material. High quality. Reasonable rates. Audio-Tech Laboratories, 2819 Newkirk Avenue, Brooklyn, N. Y. IN 9-7134.

**M. RETTINGER**, Consultant on Acoustics. Analysis. Room Design. Noise Reduction. 5007 Haskell Ave., Encino, Calif. Tel: (213) 784-3985.

**RECORDING SERVICES**—Tape, Disc, and Duplication. Reasonable Rates. Jones and Associates, Box 142, Dayton, Indiana 47941.

**RENT STEREO TAPES**—75¢ week. Catalog. Art's, 1413 1/2 N. Mariposa Ave., Hollywood, Calif. 90027.

### FOR SALE

**KIT EXPERTS**—Dynaco Specialists—Kits at reasonable prices are our specialty. Also custom-wired kits guaranteed to exceed factory standards at substantial savings. Beautiful handcrafted walnut cases for complete Dynaco line, plus everything in audio. Kitcraft, Dept. A168, 738 Washington Avenue, Brooklyn, N. Y. 11238. Tel: MA 2-5230.

#### SHACKMAN ELECTROSTATIC SPEAKERS.

British. 180° dispersion. This mid-range treble can be used with any woofer. Brochure, reports, and prices sent on it and full-range systems manufactured in Canada. Olson's Audio House. Box 1075. Wetaskiwin, Alberta, Canada.

#### DISC RECORDING EQUIPMENT:

Cutterheads, Recording Amplifiers, and Lathes. New and used. From Rek-O-Kut to Scully. Send requirements. Wiegand Audio Labs, 221 Carton, Neptune, N. J. 07753.

**SCULLY Professional Tape Recorders**, from 1 to 12 tracks, complete recording studios available in prewired console cabinets starting at \$8,000.00. 70% financing. WIEGAND AUDIO LABORATORIES, 221 Carton, Neptune, N. J. 07753.

**FRANCHISED: DEALER FOR THE FOLLOWING:** KLIPSCHORN, MARANTZ, ALTEC, DYNACO, SHERWOOD, KENWOOD, BENJAMIN, GARRARD, EMPIRE, WHARFEDALE, SUPERIOR SOUND. 621 S. MAIN ST., N. SYRACUSE, N. Y. 13212.

**FREE!** Send for money saving stereo catalog AM and lowest quotations on your individual component, tape recorder, or system requirements. Electronic Values, Inc., 200 West 20th St., New York, N. Y. 10011.

**HARPSICHORD:** Same as owned by Philadelphia Orchestra and RCA Victor. In kit form for home workshop assembly, \$150. Clavichord kit, \$100. Free brochure. Write: Zuckermann Harpsichords, Dept. R. 115 Christopher St., New York, N. Y. 10014.

**TAPE RECORDERS**, Hi-Fi components, Sleep Learning Equipment, tapes. Unusual Values, Free Catalog. Dressner, 1523T, Jericho Turnpike, New Hyde Park, N. Y. 11040.

**TAPE RECORDER SALE.** Brand new, nationally advertised brands, \$10.00 above cost. Arkay Sales Company, 1028-H Commonwealth Avenue, Boston, Mass. 02215.

**DON'T THROW YOUR OLD CARTRIDGE AWAY.** Send us \$19.95 and any old cartridge. We will ship PREPAID any one of the following top rated elliptical diamond stereo cartridges NEW: Pickering V15AME3, Empire 888SE, Shure M55E, Stanton 500E, Shure M80ED (for Lab 80), M80ED19 (for Dual 1019). Write for lowest quotations all stereo components. DEFA ELECTRONICS, 2207 Broadway, New York, N. Y. 10024.

**CITATION "A"** good condition. See AUDIO Profiles 10/62 and 4/63 \$175.00 w/cabinet. Robert E. Raymond, 730 West Washington Ave., South Bend, Ind. 46601.

**DISPOSAL** — \$80,000.00 hi-fidelity retail store inventory. New/used equipment: Ampex, Marantz, Fisher, others. Hewlett Packard test equipment. Free list—Marco Electronics, Box 336A, Winter Park, Fla. 32789.

**AUDIO:** 52-66, \$10/year. Box AJ8-1

**TWO SYNCRON S-10** Condenser Microphones with wind screens. One year old, \$210 each. Don Sherrill, 14598 Lorain Ave., Cleveland, Ohio.

**DYNA PAS3 and STEREO 70.** \$100. 2 Barzilai speaker enclosures, original cost \$150, \$75. All in perfect condition. K. Warner, 254 E. 203 St., Bronx, N. Y. 10458.

**HARTSFIELD** and Klipsch-type corner speaker systems. Pair Marantz type electronic crossover nets. W. E. Co. 555 and 594A driver and exponential horns. Paul Lambidakis, 7213 Cedar Ave., Takoma Park, Maryland 20012.

**INTRODUCING MORRISON'S** new line of bookshelf speaker systems; free brochure; introductory prices to first 200 customers... write: Morrison Speaker Systems, Box 6203, Coralville, Iowa 52240.

**HAMMOND** reverberation! New mechanism—\$4.—CAL'S! Box 234, Dearborn, Michigan 48121.

**AMPEX AG-350-2** Recorders. Unmounted, condition like new. 3-position head machine, \$1,850.00. 4-position head machine, \$1,900.00. J. M. Edelman, M.D., 4550 North Blvd., Baton Rouge, La. 70806. Phone 504-924-6266.

**COMPONENT CABINETS**—Different styles, sizes, finishes. Send \$1.00 for three 8" x 10" photographs, literature and prices to: FURNITURE and SOUND, Dept. A, 5204 North Lamont Avenue, Chicago, Illinois 60630.

**AMPEX TAPE RECORDER 351-2U**, like new condition, \$1400.00. 2 Collins limiters—2 Cue amplifiers—VU meters—Collins Power Supply, \$400.00. 2 Mixing components consoles, \$175.00. Custom Walnut tape recorder consoles, \$100.00 each. Phone TA 3-0915. J. E. Price, Box 18234, Dallas, Texas.

**2 AMPEX AG-350-2** Recorders in portable cases — LIKE NEW — Guaranteed Perfect, \$1,995.00 or best offer. Also, BALDWIN 9 ft. concert Grand Piano and other miscellaneous Audio Equipment. Stan Miller, Box 396, Kearney, Nebraska 68847.

**AUDIO** from Oct. 54 complete. High Fidelity from Nov. 55 complete. Best offers. Herbert Epstein, 113 Elm St., Woodmere, N. Y. 11598. 516-295-0624.

### EQUIPMENT WANTED

**WANTED:** Used RCA 77-BX mike. Send price and condition. Bill Hagara, 2003 Spruce, Duncan, Okla.

### SERVICE TO THE TRADE

**CASH** for used audio components—describe and price. Ask for free list—Marco Electronics, Box 336A, Winter Park, Fla. 32789.

**NEW!  
SOLID STATE  
CONDENSER  
MICROPHONE  
VEGA/SYNCRON  
S-10**



- Linear frequency response to 20,000 Hz
- Cardioid pattern — 25 dB front-to-back ratio
- Superb transient response — 15 microsecond risetime
- No external power supply
- Price \$260

**VEGA ELECTRONICS CORPORATION**

1161 RICHARD AVENUE  
SANTA CLARA CALIFORNIA

A Subsidiary of  
Computer Equipment Corporation

Check No. 75 on Reader Service Card

get the  
**NEWS  
FREE!**



**MAC  
1700**

**Solid State Stereo Receiver**

The new McIntosh 36 page catalog gives you all the details on the new McIntosh solid state equipment. In addition, you'll receive absolutely free a complete up-to-date FM Station Directory.

**SEND TODAY**

**McIntosh**

McIntosh Audio Company  
2 Chambers St. Dept. C 5  
Binghamton, N. Y. 13903

Send **FREE CATALOG** and **DIRECTORY**

NAME \_\_\_\_\_

ADDRESS \_\_\_\_\_

CITY \_\_\_\_\_

STATE \_\_\_\_\_ ZIP \_\_\_\_\_

Check No. 74 on Reader Service Card

**If you're around  
New York City  
and like shopping  
great Hi-Fi stores -  
see this man...**



**HE'S OUR DEALER!**

Moe Belin, Owner of S & S Audio  
106 West 32nd St., New York, N.Y.

Moe Belin, one of the senior members of the New York hi-fi alumni, is now in business for himself. In his new, midtown location, he says, "I'd like my long-standing customers to know that since going into business for myself I find that Pioneer has become one of my most reliable lines. It gives my customers the quality they're looking for . . . and at the most reasonable prices."

**PIONEER**   
PIONEER ELECTRONICS U.S.A. CORP.  
140 Smith St., Farmingdale, L. I., N. Y. 11735  
(516) 694-7720

**If you're around  
Tucson, Arizona  
and like shopping  
great Hi-Fi stores -  
see this man...**



**HE'S OUR DEALER!**

Reg Lowander, Manager of The Sound Shop  
4659 E. Broadway, Tucson, Arizona

The Sound Shop features superior high fidelity components and shows them in attractive surroundings. Speaking of the Pioneer line, Reg Lowander said, "It is contributing substantially to our steady growth. We are particularly impressed with such instruments as the SX-700T Receiver. Its reception of distant FM — an important asset in Arizona — is phenomenal."

**PIONEER**   
PIONEER ELECTRONICS U.S.A. CORP.  
140 Smith St., Farmingdale, L.I., N.Y. 11735  
(516) 694-7720

**ADVERTISING  
INDEX**

Acoustic Research .....	37
Acoustical Manufacturing Co. ....	62
AKG .....	27
Allied Radio Corp. ....	72
Altec Lansing .....	41, 67
Audio Dynamics Corp. ....	57
Benjamin Electronic Sound Corp. ....	15
Bogen Communications .....	Cover III
Bozak .....	21
British Industries Corp. ....	3
BSR (USA) Ltd. ....	23
Crown International .....	47
Dolby Laboratories .....	39
Dynaco, Inc. ....	10
Electro-Voice, Inc. ....	1, Cover IV
Elpa Marketing Industries .....	51, 70
Fairchild Recording Equipment Corp..	74
Garrard Sales Co. ....	3
Gotham Audio Corp. ....	33
Harman-Kardon, Inc. ....	35
Heath Company .....	49
Kenwood .....	53
Koss Electronics, Inc. ....	63
Langevin .....	5
Lansing, James B., Sound, Inc. ....	8-9
Marantz Company .....	31
McIntosh Laboratory, Inc. ....	73
Microsound Company .....	69
Morhan Sales Co. ....	74
Nagra .....	72
Norelco (AKG) .....	27
Oaktron .....	71
Pickering & Company, Inc. ....	17
Pioneer Electronics U.S.A. Corp. ....	43, 74
Sansui Electronics Corp. ....	25
Schober Organ Corporation .....	64
Scott, H. H., Inc. ....	Cover II
Sennheiser Electronics .....	71
Sherwood Electronic Labs, Inc. ....	18
Shure Brothers, Inc. ....	13, 65
Sony Corp. of America .....	45
Sony/Superscope .....	11, 55
Stanton Magnetics .....	29
Superex .....	4
United Audio Products .....	61
University Sound .....	59
Utah Electronics .....	68
Vega Electronics Corp. ....	73



**INSTANT  
REVERBERATION**  
only with **FAIRCHILD  
REVERBERTRONS**

Reproduce the thrilling sounds of the Grand Canyon or the colorful reverberation qualities inherent only in good acoustical chambers. And because reverberated sound is apparently louder than the same non-reverberated signal, by utilizing the FAIRCHILD REVERBERTRON in motion picture, radio, television, or your own recording studio, you can create attention holding and realistic sound effects.

In addition to low cost the advantages of a FAIRCHILD REVERBERTRON are virtually unlimited for creating wide audience impact and literally hundreds of "ear appealing" sounds.

The next time you want to "glue" your audience's ears to the sound you're making be sure to use a FAIRCHILD REVERBERTRON.

**SPECIFICATIONS OF MODEL 658B (Pictured above)**

Compact, reverberation system for the 'big' sound in a small space. Contains reverb equalization in mid and low frequency range; level control; solid state design. Size: Only 5 1/4" x 3 x 10" deep.



**PROFESSIONAL MODEL  
658A ALSO AVAILABLE:**

The 658A is a complete solid state reverberation system with electronically controlled reverb time adjustments up to 5 seconds; mixing control for adjustment of reverberated to non-reverberated signal ratios; reverb equalization at 2, 3, and 5 KHZ. Size: 24 1/2" x 19"

Write to FAIRCHILD — the pacemaker in professional audio products — for complete details.

**FAIRCHILD**  
RECORDING EQUIPMENT CORPORATION  
10-40 45th Ave., Long Island City 1, N. Y.

Check No. 76 on Reader Service Card

**You can't buy a better  
tape at any price!**

Complete line of cassettes, 4 and 8 track cartridge tape, reel-to-reel tape and 1/2 and 1 inch video tapes.

Write for complete details.

**IRISH TAPE** 458 Broadway, N.Y. 10013

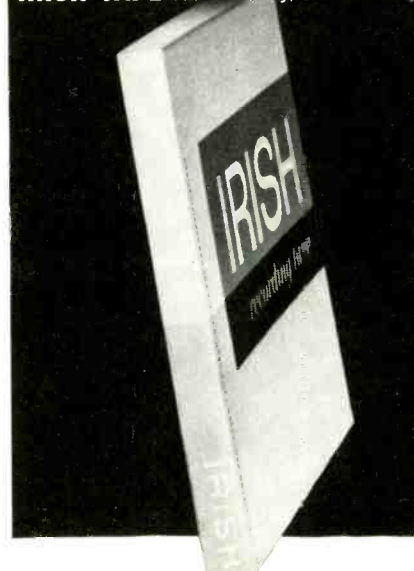

Check No. 77 on Reader Service Card