

Fluke 93/95/97 Philips PM93/95/97 SCOPEMETER

Service Manual

Fluke: 915970
Philips: 4822 872 05349
920121

Warning: These servicing instructions are for use by qualified personnel only. To reduce the risk of electric shock, do not perform any servicing other than that specified in the operating instructions unless you are fully qualified to do so.



PHILIPS

FLUKE®

IMPORTANT

In correspondence concerning this instrument please give the model number and serial number as located on the type number plate on the instrument.

All modifications up to production data 21 January 1992 are incorporated in this manual.

For your reference:

Model number:	PMxx	Fluke xx
Code number :	9444 yyy yyyyy	9444 yyy yyyyy
Serial number:	DM nn mmmm	DM nn mmmm

Note: The design of this instrument is subject to continuous development and improvement. Consequently, this instrument may incorporate minor changes in detail from the information contained in this manual.

© Copyright Philips Export B.V., 1992

All rights reserved. No part of this publication may be reproduced by any means or in any form without written permission of the copyright owner.

Printed in The Netherlands

TABLE OF CONTENTS**Page**

1. SAFETY INSTRUCTIONS.....	1-1
1.1 INTRODUCTION.....	1-1
1.2 SAFETY PRECAUTIONS.....	1-1
1.3 CAUTION AND WARNING STATEMENTS.....	1-1
1.4 SYMBOLS.....	1-1
1.5 IMPAIRED SAFETY.....	1-1
1.6 GENERAL SAFETY INFORMATION.....	1-1
2. CHARACTERISTICS.....	2-1
2.A PERFORMANCE CHARACTERISTICS.....	2-1
2.B SAFETY CHARACTERISTICS.....	2-1
2.1 DISPLAY.....	2-1
2.2 SIGNAL ACQUISITION.....	2-1
2.3 CHANNELS A&B.....	2-2
2.4 TIMEBASE.....	2-4
2.5 TRIGGER.....	2-5
2.6 SIGNAL MEMORY (MODELS 95 AND 97 ONLY).....	2-6
2.7 TRACE DISPLAY.....	2-6
2.8 SETUP MEMORY (MODEL 95 ONLY).....	2-6
2.9 SETUP MEMORY (MODEL 97 ONLY).....	2-7
2.10 CALCULATION FACILITIES (MODEL 95 ONLY).....	2-8
2.11 CALCULATION FACILITIES (MODEL 97 ONLY).....	2-8
2.12 CURSORS (MODELS 95 AND 97 ONLY).....	2-9
2.13 MULTIMETER.....	2-9
2.14 AUTO SETTING.....	2-14
2.15 GENERATOR (MODEL 93 AND 95).....	2-16
2.16 GENERATOR (MODEL 97 ONLY).....	2-16

2.17	POWER ADAPTOR BATTERY CHARGER	2-17
2.18	POWER SUPPLY	2-17
2.19	MECHANICAL	2-18
2.20	ENVIRONMENTAL	2-19
2.21	INTERFACE (MODEL 97 ONLY).....	2-21
2.22	SAFETY.....	2-22
2.23	ACCESSORIES.....	2-23
2.24	SERVICE AND MAINTENANCE.....	2-23
3.	CIRCUIT DISCRIPTIONS	3-1
3.1	INTRODUCTION TO CIRCUIT DISCRIPTION	3-1
3.1.1	GENERAL	3-1
3.1.2	LOCATION OF ELECTRICAL PARTS	3-1
3.2	FUNCTIONAL BLOCK DISCRIPTION	3-2
3.2.1	INTRODUCTION	3-2
3.2.2	DATA ACQUISITION	3-4
3.3.3	MICROPROCESSOR	3-7
3.3.4	DIGITAL ASIC (D-ASIC) CIRCUITRY	3-9
3.3.5	LCD CIRCUITRY	3-12
3.4	ANALOG CIRCUITS (A2)	3-14
3.4.1	INTRODUCTION	3-14
3.4.2	OVERVIEW ANALOG CIRCUITS	3-14
3.4.3	ATTENUATOR SECTIONS, CHANNEL A AND B	3-14
3.4.4	EXTERNAL (BANANA) INPUT/OUTPUT CIRCUITRY	3-18
3.4.5	ANALOG ASIC (A-ASIC) AND ADC CIRCUITRY	3-20
3.4.6	ANALOG CONTROL CIRCUIT	3-24
3.4.7	GENERATOR CIRCUIT	3-30
3.4.8	BATTERY CHARGER	3-32
3.4.9	POWER SUPPLY.....	3-34
4.	PERFORMANCE VERFICATION PROCEDURE	4-1
4.1	GENERAL INFORMATION	4-1
4.2	STANDARD PERFORMANCE VERFICATION PROCEDURE.....	4-2
4.3	STANDARD PERFORMANCE VERFICATION PROCEDURE SUMMARY	4-16
4.4	ADDITIONAL PERFORMANCE VERFICATION PROCEDURE.....	4-17

5. CALIBRATION ADJUSTMENT PROCEDURE	5-1
5.1 GENERAL INFORMATION	5-1
5.2 RECOMMENDED CALIBRATION ADJUSTMENT EQUIPMENT	5-1
5.3 ENTERING THE CALIBRATION PROCEDURE	5-2
5.4 OPERATING THE CALIBRATION PROCEDURE	5-3
5.5 CONTRAST CALIBRATION ADJUSTMENT PROCEDURE	5-4
5.6 SCOPE CALIBRATION ADJUSTMENT PROCEDURE	5-4
5.6.1 HARDWARE SCOPE CALIBRATION ADJUSTMENTS	5-4
5.6.2 CLOSED CASE SCOPE CALIBRATION ADJUSTMENTS	5-8
5.7 METER CALIBRATION ADJUSTMENT PROCEDURE	5-15
5.8 CALIBRATION ADJUSTMENT PROCEDURE SUMMARY	5-24
6. DISASSEMBLING THE SCOPEMETER	6-1
6.1 GENERAL INFORMATION	6-1
6.2 DISASSEMBLY PROCEDURE	6-1
6.2.1 REMOVING THE BATTERY PACK	6-2
6.2.2 OPENING THE SCOPEMETER	6-2
6.2.3 REMOVING THE ANALOG A2 PCB, TO ENABLE HARDWARE SCOPE CALIBRATION ADJUSTMENTS	6-4
6.2.4 REMOVING THE DIGITAL A1 PCB	6-4
7. CORRECTIVE MAINTENANCE	7-1
7.1 DIAGNOSTIC TESTING AND TROUBLESHOOTING	7-1
7.1.1 INTRODUCTION	7-1
7.1.2 TROUBLESHOOTING TECHNIQUES	7-1
7.1.3 DISPLAY AND ERROR MESSAGES	7-2
7.1.4 MAIN TESTS	7-5
7.1.5 TROUBLESHOOTING	7-7
7.1.6 DIGITAL A1 PCB TROUBLESHOOTING	7-7
7.1.7 ANALOG A2 PCB TROUBLESHOOTING	7-28
7.2 REPLACEMENTS	7-40
7.2.1 STANDARD PARTS	7-40
7.2.2 SPECIAL PARTS	7-40
7.2.3 TRANSISTORS AND INTEGRATED CIRCUITS	7-40
7.2.4 STATIC-SENSITIVE COMPONENTS	7-40
7.2.5 REPLACEMENT OF PARTS	7-42
7.3 SOLDERING TECHNIQUES	7-51
7.3.1 GENERAL SOLDERING TECHNIQUES	7-51
7.3.2 SOLDERING MICRO-MINIATURE SEMICONDUCTORS	7-51

7.4	SPECIAL TOOLS	7-52
7.4.1	EXTENDER FLAT CABLE	7-52
7.5	RECALIBRATION AFTER REPAIR	7-52
7.6	INSTRUMENT REPACKING	7-52
8.	MAINTENANCE OF THE PRIMARY CIRCUIT (PM8907/...).	8-1
9.	REPLACEABLE PARTS LIST	9-1
9.1	INTRODUCTION	9-1
9.2	HOW TO OBTAIN PARTS	9-2
10.	CIRCUIT DIAGRAMS	10-1

1.5 IMPAIRED SAFETY

Whenever it is likely that safety has been impaired, the instrument must be turned off and disconnected from all external voltage sources, and the batteries must be removed. The matter should then be referred to qualified technicians. Safety is likely to be impaired if, for example, the instrument fails to perform the intended measurements or shows visible damage.

1.6 GENERAL SAFETY INFORMATION

WARNING: Removing the instrument covers or removing parts, except those to which access can be gained by hand, is likely to expose live parts and accessible terminals which can be dangerous to life.

The instrument must be disconnected from all voltage sources and batteries must be removed before it is opened.

Capacitors inside the instrument can hold their charge even if the instrument has been separated from all voltage sources and batteries are removed. Components which are important for the safety of the instrument may only be replaced by components obtained through your local FLUKE/PHILIPS organization. These components are indicated by an asterisk (*) in the parts list section (chapter 9).

2 CHARACTERISTICS

A. Performance Characteristics

- PHILIPS and FLUKE guarantee the properties expressed in numerical values with stated tolerance. Specified non-tolerance numerical values indicate those that could be nominally expected from the mean of a range of identical instruments.
- For definitions of terms, reference is made to IEC Publication 351-1.
- The accuracy of all measurements is within $\pm \{(\% \text{ of reading}) \pm (\text{one least-significant digit})\}$ from 18C to 28C.
Add $0.1 \times (\text{specified accuracy})/C$ for $< 18C$ or $> 28C$ ambient.

B. Safety Characteristics

The instrument has been designed and tested in accordance with IEC Publication 348, Safety Requirements for Electronic Measuring Apparatus, and has been supplied in a safe condition. This manual contains information and warnings that must be followed by the user to ensure safe operation and to keep the instrument in a safe condition.

2.1 DISPLAY

CHARACTERISTICS	SPECIFICATIONS	ADDITIONAL INFORMATION
* Type	LCD	
* Useful Screen Area	84 mm x 84 mm	1 div equals 25 pixels. 1 div equals 8.75 mm.
Resolution	240 x 240 pixels	
* Contrast Ratio		Adjustable via LCD Menu.
* Backlight (Model 97 only)	Electro Luminescence	

2.2 SIGNAL ACQUISITION

* Sampling Type	Real Time	
@ 1 μ s/div...60s/div	Quasi Random	
@ 10 ns/div...500 ns/div		
* Maximum Sample Rate	25 MS/s	Sampling Rate depends on time/div setting.
* Maximum Vertical (voltage) Resolution	8 bits	Over 10 divisions.
* Maximum Horizontal (time) Resolution	25 Samples/div	Per Channel.
* Record Length		
With capture 20 div	512 Samples	Per Channel.
With capture 10 div	256 Samples	Per Channel.

CHARACTERISTICS	SPECIFICATIONS	ADDITIONAL INFORMATION
* Acquisition Time (for 20.4 div) 60s/div...1 μs/div	20.5 x time/div + 140 ms	Excluding delay time. Delay time is the selected trigger delay.
500 ns/div...10 ns/div	20.5 x time/div + 120 ms	Excluding delay time. In Quasi-Random Mode, the acquisition time depends on triggers.
* Sources	Channel A Channel ± B mV Input	
* Acquisition Modes	1 Channel Only 2 Channels	CHAN A, CHAN B Chopped Mode from 60s/div...50 μs/div. Alternating Mode from 20 μs/div...10 ns/div.

2.3 CHANNELS A & B

* Signal Inputs	Isolated BNC	Signal input BNC commons are connected together.
Common Input	Black Safety Banana Jack	Part of External Trigger Input.
* Input Impedance		Frequency dependent, see Figure 2.1.
R parallel	1 MΩ ± 1%	For DC coupled input. For AC coupled input or GND, add 22 nF in series with R and C parallel.
C parallel	25 pF	

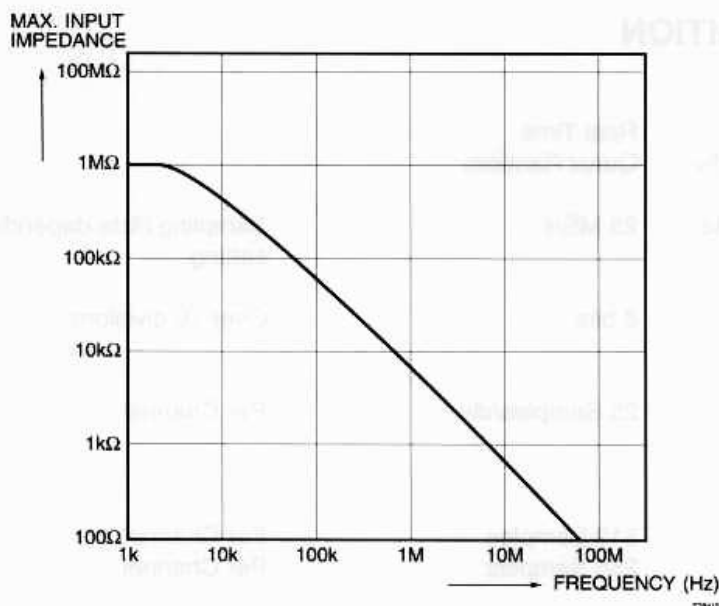


Figure 2.1 Max. Input Impedance Versus Frequency

CHARACTERISTICS	SPECIFICATIONS	ADDITIONAL INFORMATION
-----------------	----------------	------------------------

* Input Coupling	AC DC GND	Sequence: ac-dc-GND (pre-charge ac), and back to ac.
------------------	-----------	--

* Maximum Input Voltage (rms)	300 V	Frequency dependent see fig. 2.2 Between BNC inner and outer contact. Outer BNC contacts and Ground (Black) Banana Jack are internally connected together.
-------------------------------	-------	--

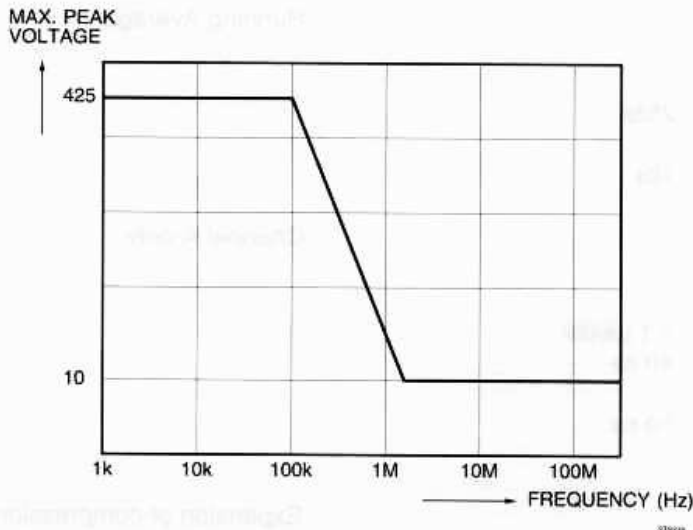


Figure 2.2 Max Input Voltage Versus Frequency

* Deflection Coefficient		
--------------------------	--	--

Steps	1 mV/div...2 mV/div (Models 95 and 97 only)	Only for repetitive signals and timebase 60s...1μs. If one of the channels is in this sensitivity, both channels will be switched to Average = 4.
-------	---	---

Steps	5 mV/div...100V/div	In a 1-2-5 sequence of 14 positions.
-------	---------------------	--------------------------------------

Error Limit Overall Nonlinearity	± (2% ± 1 digit) ± (2% ± 1 digit)	Add 3% for 1 mV and 2 mV per IEC 351 for frequencies < 1 MHz.
----------------------------------	--------------------------------------	---

* Dynamic Range	9.5 div 4 div	for frequencies < 10 MHz. for frequencies up to 50 MHz.
-----------------	------------------	--

* Position Range (move control)	- 4 div...+ 4 div	
---------------------------------	-------------------	--

* Frequency Response		Z source = 50Ω.
----------------------	--	-----------------

Lower Transition Point of Bandwidth		
-------------------------------------	--	--

DC Input Coupling	DC	
AC Input Coupling - 3dB	≤ 10 Hz	< 1 Hz including 10 MΩ probe.

Upper Transition Point of Bandwidth	≥ 50 MHz (-3 dB)	Subtract 5 MHz for < 18 °C and > 28 °C Ambient. Rise time 7 ns.
-------------------------------------	------------------	--

CHARACTERISTICS	SPECIFICATIONS	ADDITIONAL INFORMATION
* Max. Baseline Instability		
Jump	0.1 div or 1 mV	The baseline is automatically readjusted after switching the attenuator or AC/DC/GND.
* Average (Models 95 and 97 only)		Running Average.
Maximum Constant	256x	
Constant in Roll	10x	
* MIN MAX (Models 95 and 97 only)		Channel A only.
Timebase setting	$\geq 1 \mu\text{s}/\text{div}$	
Pulse-width for 100% Probability	40 ns	
Pulse-width for 25% Probability	10 ns	
* ZOOM (Models 95 and 97 only)		Expansion or compression in 1,2,5 sequence around the 4th division.
Range for Delay	< 640 div	

2.4 TIMEBASE

* Modes	Recurrent Single Shot Roll	Automatic selected.
* Ranges		
Recurrent	5s/div...10 ns/div	
Dual Channel Chopped	5s/div...50 $\mu\text{s}/\text{div}$	
Dual Channel Alternate	20 $\mu\text{s}/\text{div}$...10 ns/div	
Single Shot	5s/div...10 ns/div	Every sweep needs a trigger. A sweep first; B sweep arms automatically. For 500 ns, 200 ns, and 100 ns; an automatic interpolation takes place. Chopped.
Roll Mode	60s/div...10s/div	
Maximum Timebase Error	$\pm 0.1\% \pm 1 \text{ LSB}$	

CHARACTERISTICS	SPECIFICATIONS	ADDITIONAL INFORMATION
2.5 TRIGGER		
* Sources		Selected independently.
Channel A Signal	CHAN A	
Channel B Signal	CHAN B	
External Trigger Input	EXT	
* External Trigger Input Connector	Dual Safety Banana Jack	External Trigger Input common (low) jack is electrically connected to the Channel A and Channel B commons (outer contact of BNC's).
* External Trigger Input Impedance		
R parallel	1 MΩ ± 1%	If used for mV DC > 1 MΩ.
C parallel	25 pF	Including Banana to BNC adapter.
* Trigger Error		For frequencies < 1 MHz.
Voltage Level	± 1 LSB ± 0.5 div	5s/div...50 μs/div. 20 μs/div...10 ns/div.
Time Delay	± 1 LSB ± 5 ns	
* Maximum External Trigger Input (rms)	300 V	Frequency dependent, see fig. 2.2.
* Trigger Sensitivity		For Models 95 and 97, values must be multiplied by 5 in 2 mV/div. and 1 mn/div.
Channel A or B		
@ 100 MHz	≤ 4 div	
@ 60 MHz	≤ 1.5 div	
@ 10 MHz	≤ 0.5 div	
External Trigger Input		TTL logic compatible using 10:1 attenuation Probe.
* Trigger Slope Selection	positive going negative going	
* Trigger Level Control Range		
Channel A or B	± 4 div	
Trigger at 50%	0.5 x peak/peak value	Measured during 20 ms.
External Trigger Input	Fixed @ TTL:10	Switchable to TTL via set-up menu.

CHARACTERISTICS	SPECIFICATIONS	ADDITIONAL INFORMATION
N-cycle mode (Models 95 and 97 only) 5s/div...1 μ s/div, N=	2...255	For timebase settings from 20 μ s/div...1 μ s/div acquisition and trigger on Channel A only.
Events (5s/div...1 μ s/div)	1...1023	Start via Ext; count with channel A.
* Trigger Delay		
Range	- 20...640 div	

2.6 SIGNAL MEMORY (MODELS 95 AND 97 ONLY)

* Signal Memory Size		
Memories	8	Memory #1 up to #8.
Memory Depth	512 words	
Wordlength	8 Bit	
Functions	Store	Storage of signals.
	Save	Contents of Channel A and Channel B are saved in temp memory #1 and #2, and (A \pm B) in temp memory #3.

2.7 TRACE DISPLAY

* Sources	Channel A Channel B A \pm B A vs B	A Maximum of 4 traces plus A vs B can be selected.
	Memory #1 up to #8	(Models 95 and 97 only).
* Position range		
Horizontal	+ 4 div...- 16.5 div	
Vertical	- 4 div...+ 4 div	From screen center, select per trace.

2.8 SETUP MEMORY (MODEL 95 ONLY)

* Memory Size	8 maximum	Combined with waveform.
---------------	-----------	-------------------------

CHARACTERISTICS	SPECIFICATIONS	ADDITIONAL INFORMATION
-----------------	----------------	------------------------

2.9 SETUP MEMORY (MODEL 97 ONLY)

* Memory Size	10 maximum	Front Panel setups.
* Functions	Save	Actual front panel settings are stored in memory, replacing contents of memory location indicated on LCD.
	Delete	Contents of memory location indicated on LCD are deleted.
	Recall	Actual front panel settings are replaced by contents of memory location indicated on LCD.
With soft up/down keys	Next	Actual settings are replaced by contents of the next (+1) memory location indicated on LCD.
	Previous	Actual settings are replaced by contents of the previous (-1) memory location indicated on LCD.
* Initial setup selection of AUTO SET	only Amplitude only Time Time and Amplitude	
trace identification	on/off	
trigger identification	on/off	
trigger sensitivity external	0.2V/2V	
Clear after Hold/Run	on/off	
refresh time @ RECORD in scope mode	infinite 2 seconds 5 seconds 10 seconds 60 seconds	

CHARACTERISTICS

SPECIFICATIONS

ADDITIONAL INFORMATION

2.10 CALCULATION FACILITIES (MODEL 95 ONLY)

* Measurement Functions

- delta V
- delta t
- RMS value
- Mean (Average) value
- Peak to Peak value
- Rise or Fall time
- Frequency
- 1 ÷ delta t
- Maximum value
- Minimum value
- Phase
- Trigger time to cursor
- Ratio

Maximum of 5 simultaneous measurement functions.

of portion between portion.

Expression of value in % or absolute on any one of the above values.

2.11 CALCULATION FACILITIES (MODEL 97 ONLY)

* Measurement Functions

- delta V
- delta t
- RMS value
- Mean (Average) value
- Peak to Peak value
- Rise or Fall time
- Frequency
- 1 ÷ delta t
- Maximum value
- Minimum value
- Phase
- Trigger time to cursor
- Ratio

Maximum of 5 simultaneous measurement functions.

of portion between portion.

Expression of value in % or absolute on any one of the above values.

* Mathematics

- Multiplication
- Add
- Subtract
- Filter
- Invert
- Integrate

of whole memory or Channel.
For timebase settings
20 µs...10 ns, only displayed
Channels can be used.

CHARACTERISTICS	SPECIFICATIONS	ADDITIONAL INFORMATION
-----------------	----------------	------------------------

2.12 CURSORS (MODELS 95 AND 97 ONLY)

* Horizontal		
Display Resolution	25 parts per div	
Digital Readout Resolution	3 digits	
Error Limit	± 0.1% ± 1 LSB	
Cursor Range	Visible part of signal	Cursors cannot pass each other.
* Vertical		
Display Resolution	25 parts per div	
Digital Readout Resolution	3 digits	
Error Limit	± 2%	Referred to input at BNC or Probe tip, after Probe recalibration.

2.13 MULTIMETER

The Multimeter uses the Channel A input for VDC & VAC measurements and the Safety Banana Jack Inputs for Resistance, Diode Test, Continuity, and DC mV measurements. An internal reference is used to optimize the accuracy of the Channel A Input and any probes used. The accuracy of all Multimeter measurements is within ± {(% of reading) + (number of least-significant digits)} from 18 °C to 28 °C with relative humidity up to 90% for a period of one year after calibration. Add 0.1 x (specified accuracy)/C for 18 °C or 28 °C Ambient.

- Displayed range include used probe, if calibrated.
- Values listed are without attenuating probe.
- A Vrms AC and V DC dual display mode is optimized for power line (mains) related measurements.

* DC Voltage		
Ranges	300 mV, 3V, 30V & 300V	Manual or automatic ranging on peak voltage. High Voltage x10 Probe extends measurement to 600V. Peak voltage is 2.5x range, except 375V in 300V range.
Resolution	0.1 mV, 1 mV, 0.01V, & 0.1V	Multiply x10 with High Voltage Probe.
Accuracy	± (0.5% + 5)	
Digital Display	3000 counts	Up to 4500 counts, 3500 counts in 300V range.
Display update Response Time	< 300 ms < 3.5s	
Zeroing	automatic	
Series Mode Rejection Ratio	> 50 dB @ 50 Hz or 60 Hz	

CHARACTERISTICS	SPECIFICATIONS	ADDITIONAL INFORMATION
* AC Voltage		
Ranges	300 mV, 3V, 30V, 250V	Manual or automatic ranging on peak voltage. High Voltage x10 Probe extends measurement to 600V. Peak voltage is 2.5x range and 375V in 250V range.
Resolution	0.1 mV, 1 mV, 0.01V, 0.1V	Multiply x10 with High Voltage Probe.
Accuracy (AC Coupled) Using High Voltage 10:1 Probe		Valid from 5%..100% of range.
50 Hz...60 Hz	$\pm (1\% + 10)$	
20 Hz...20 kHz	$\pm (2\% + 15)$	
5 Hz...1 MHz	$\pm (3\% + 20)$	
Accuracy (DC Coupled) Using High Voltage 10:1 Probe		
50 Hz...60 Hz	$\pm (1\% + 10)$	
1 Hz...20 kHz	$\pm (2\% + 15)$	
Crest Factor		Meter prevents crest factor errors by autoranging on input waveform peaks.
Digital Display	3000 counts	Up to 4500 counts, at 250V range: 2500.
Display Update	< 300 ms	
Response Time @ Input freq >50 Hz	< 3.5s	
SMOOTH	< 10s	
FAST	< 1s	
DC Common Mode Rejection Ratio	> 100 dB @ dc	
	> 100 dB @ 50, 60, or 400 Hz	
AC Common Mode Rejection Ratio	> 60 dB @ dc..60 Hz	

CHARACTERISTICS	SPECIFICATIONS	ADDITIONAL INFORMATION
* Resistance		
Open Circuit Voltage	< 4V	
Full Scale Voltage 300Ω...3 MΩ 30 MΩ	< 250 mV < 2V	
Ranges	300Ω, 3 kΩ, 30 kΩ, 300 kΩ, 3 MΩ, 30 MΩ	Manual or automatic ranging.
Resolution	0.1Ω, 0.001 kΩ, 0.01 kΩ, 0.1 kΩ, 0.001 MΩ, 0.01 MΩ	
Accuracy	± (0.5% + 5)	
Digital Display	3000 counts	Up to 4500 counts, at 30 MΩ 3000.
Measurement Current	0.5 mA...70 nA	Decreases as range increases.
Display Update	< 300 ms	
Response Time SMOOTH FAST	< 3.5s < 10s < 1s	
Protection	600V RMS	
Continuity Beeps if resistance is <:	5% of selected	
* Diode Test		OL is indicated if measured voltage is > 2.8V.
Maximum Voltage	4V	
Range	2.800V	
Resolution	0.001V	
Accuracy	± (2% + 5)	
Digital Display	3000 counts	If value > 2800 readout gives OL.
Measurement Current	0.5 mA	
Display update	< 300 ms	
Response Time SMOOTH FAST	< 3.5s < 10s < 1s	
Protection	600 V RMS	
Polarity	+ on RED Banana Jack - on BLACK Banana Jack	
Continuity (Alert)	Beeps if reading is below 1V	

CHARACTERISTICS	SPECIFICATIONS	ADDITIONAL INFORMATION
* DC mV	Banana Jack Inputs	Used for Accessory (including Temperature) input.
Ranges	300 mV & 3V	Manual or Automatic ranging.
Resolution	0.1 mV & 1 mV	
Accuracy	$\pm (0.5\% + 5)$	
Digital Display	3000 Counts	Up to 3500 Counts.
Display update	< 300 ms	
Response Time	< 3.5s	
SMOOTH	< 10s	
FAST	< 1s	
Input	+ on RED Banana Jack on BLACK Banana Jack	
* Multimeter Math (Display) Functions (Models 95 and 97 only)		
Relative	ZERO delta	Displayed Value = Reading Reference Reading.
% Change (% Relative)	ZERO % delta	Displayed Value = $\{(Reading/Reference Reading) - 1\} \times 100$.
% Scale		Displayed Value = $\{(Reading - Set 0\% Reading)/(Set 100\% Reading - Set 0\% Reading)\} \times 100\%$.
Set 0% Reference	Set 0%	Present, Maximum, Minimum, Average.
Set 100% Reference	Set 100%	Present, Maximum, Minimum, Average.
Power with respect to 1 mW in selected load resistance	dBm	
Select load resistance	1200, 1000, 900, 800, 600, 500, 300, 250, 150, 135, 125, 110, 93, 75, 60 & 50	
Voltage Ratio in dB with respect to 1V	dBV	
Audio power	WATTS or dBW	
Select load resistance	50, 16, 8, 4, 2 & 1 Ω	

CHARACTERISTICS	SPECIFICATIONS	ADDITIONAL INFORMATION
* Other Multimeter Operating Modes		
Touch Hold	HOLD	Causes the meter to capture the next measured reading (and beep) when a new stable measurement has been detected. When first enabled, the numeric display is frozen (held) until a stable measurement is detected. Stable measurements are defined as within ± 100 display counts for 4 measurements (~1s.); and above a floor of 200 display counts in volts (300 counts in ac, below 4000 counts in Ω and below 2800 counts in diode). Overload is a valid stable condition except in Ω and diode test.
MIN MAX recording (Models 95 and 97 only)	RECORD	Simultaneous displays of Maximum, Minimum, Peak to Peak, Average, and Present reading.
* Frequency		
Range	1 Hz...5 MHz	Manual for frequencies < 20 Hz.
Accuracy	+/- (0.5% + 2 counts)	
Timebase Accuracy	+/- 0.01%	
Resolution	4 digits	
Measuring Time SMOOTH FAST	3.5s < 10s < 1s	gradually degradation from 100 Hz and down. Running average over 32 measurements.
Ranging	Automatic	
* AUTO RANGE		
Voltage Range_Up	3500	Maximum reading in manual range @ 300 mV, 3V, 30V : 4500.
Voltage Range_Down	0300	@external input: 3500.
Time Range_Up 5 ms...50 μ s	> 8 periods in display	TIME switch selects manual timebase.
20 μ s...1 μ s	> 4 periods in display	AUTOSET starts timebase ranging.
Time Range_Down 5 ms...50 μ s 20 μ s...1 μ s	< 1.5 periods in display < 0.75 periods in display	

CHARACTERISTICS	SPECIFICATIONS	ADDITIONAL INFORMATION
2.14 AUTO SETTING		
* Settling time	3s	The default values are indicated (Model 97 only). If this can be changed with the aid of the SETUP (auto-set) menu, this is shown.
Selectable mode of operation (Model 97 only)	Selected @ initial setup, Complete	
* Display functions		
Channel Baseline	mid screen	One channel display.
Separate	A = + 1 div B = - 1 div	} Dual Channel display.
X-position	zero	SETUP: not affected (Model 97 only).
Y-position	zero	SETUP: not affected or separation (Model 97 only).
X-expand	x 1	
A vs B	off	SETUP: not affected (Model 97 only).
* Cursors	not affected	if cursors are on a not the selected channel, Channel A. SETUP: not affected (Model 97 only).
Mathematics	off	SETUP: not affected (Model 97 only).
* Text	Not affected	Except for actual setting, that is adapted (Model 97 only).
Trace identification	on	SETUP: OFF (Model 97 only).
* Vertical Acquisition		
Y deflection source	Every source having a triggerable signal at its input	Channel A if no trigger is found.
Input coupling	ac	SETUP: not affected (Model 97 only).
Y deflection		Each channel is independently set.
Input voltage > 20 mV	approx. 5 div	
Input voltage < 20 mV	Channel at 200 mV/div	Due to trigger uncertainty at freq. > 2 MHz or at duty cycle <> 50% sensitivity can deviate from above, but signal will remain on the screen.

CHARACTERISTICS	SPECIFICATIONS	ADDITIONAL INFORMATION
Average	off	SET-UP: not affected (Model 97 only).
* Horizontal Acquisition	Free Run Recurrent	
TB Deflection coefficient		
Signal 40 Hz...5 MHz	min. 2, max 6 signal periods over 8 div	
Signal 5 MHz...50 MHz	min. 2, max 20 signal periods over 8 div	
When no trigger found	5 ms/div	
* Triggering		
Delay ≥ 0	Off	SETUP: not affected (Model 97 only).
Negative delay	Not affected	
Triggerable signal @ ext. input	Ext	SETUP: select A or B (Model 97 only).
No signal @ ext input, but trig. signal @ channel A or B	channel A or channel B	Channel with lowest input frequency is selected (Channel A when frequencies are equal).
No triggerable signal. @ any input	Channel A	
Level	40...60% of peak-to-peak value	After Autoset. SETUP: not affected (Model 97 only).
Slope	Positive	SETUP: not affected (Model 97 only).
Events (Models 95 and 97 only)	OFF	SET-UP: not affected (Model 97 only).
N-Cycle (Models 95 and 97 only)	OFF	SET-UP: not affected (Model 97 only).
* Various		
Generator (Model 97 only)	OFF	SETUP: not affected.
Record restart timing (Model 97 only)	OFF	SETUP: 2, 5, 10 or 60s or acquisitions, whichever is the shortest.

CHARACTERISTICS	SPECIFICATIONS	ADDITIONAL INFORMATION
2.15 GENERATOR (MODEL 93 AND 95)		
* Probe Adjust		A square wave voltage is available via the external trigger input for adjusting probe compensation.
Voltage (p-p)	5V	
Frequency	976 Hz	
Source resistance	400Ω	
* DC Calibration		Including 10:1 attenuation Probe.
Voltage	3V	Inaccuracy is optimized internally.
Source resistance	400Ω	
2.16 GENERATOR (MODEL 97 ONLY)		
* Probe Adjust		A square wave voltage is available via the external trigger input for adjusting probe compensation.
Voltage (p-p)	5V	
Frequency	976 Hz	
Source resistance	400Ω	
* DC Calibration		Including 10:1 attenuation Probe.
Voltage (p-p)	3V	Inaccuracy is optimized internally.
Source resistance	400Ω	
* LF Sine wave		
Amplitude (p-p)	1V	
Frequency	976 Hz	
Max. Individual Harmonic	3%	
Source resistance	400Ω	
* Square wave		
Amplitude (p-p)	5V	
Frequency	1.95 kHz 976 Hz 488 Hz	} selectable
Source Resistance	400Ω	

CHARACTERISTICS	SPECIFICATIONS	ADDITIONAL INFORMATION
* DAC Output Current		Can be used for a component tester.
Amplitude	0 mA...+ 3 mA	In max. 128 amplitude steps. The time for every step can differ.
Max. voltage	2V	
* DAC output voltage		In max. 128 amplitude steps. The time for every step can differ.
Amplitude	- 2V...+ 2V	
Max. Current	± 1 mA	

2.17 POWER ADAPTOR /BATTERY CHARGER

* Input Connector	5 mm Power Jack	Per DIN 45323
* Source Voltage dc		
Nominal	15V dc	
Limits of Operation	8V...20V dc	
* Charging Current		
Instrument ON	60 mA	
Instrument OFF	170 mA	
* Allowable Temperature During Charging	0 °C...45 °C	
* Power Consumption		
Instrument ON	5W	
Instrument OFF	3W	

2.18 POWER SUPPLY

* Battery Voltage Range	4V...6V	<p>The batteries are not charged at delivery. A warning is given if the battery voltage becomes lower than 4.4V. The instrument is switched off if the battery voltage becomes lower than 4 V.</p> <p>If the instrument is Battery Powered, it will switch off automatically after 10 minutes of no operator actions, except in RECORD or ROLL mode.</p>
-------------------------	---------	--

CHARACTERISTICS	SPECIFICATIONS	ADDITIONAL INFORMATION
★ Recommended Batteries		
NiCad Battery Pack	PM 9086/001	Only this Battery Pack is internally re-chargeable.
Recharging time	16 hours	
Life time		After 500 cycles the capacity will be > 1100 mAh. The nominal capacity is 2200 mAh.
Operating time	> 4 hours	After Charging for > 15 hours.
Stand Alone Batteries (4x)		
Model	KR27/50 K70 C-CELL	per IEC. per ANSI.
Operating time	> 4 hours	
Temperature Rise of Batteries	20 °C	After instrument has reached a stable operating temperature.
Temperature Range of Alkaline Batteries.		
Working	- 20...65 °C	
Storage	- 30...65 °C	It is recommended to remove the batteries from the instrument when it is stored longer than 24 hours below - 30 °C or above 60 °C. CAUTION! UNDER NO CIRCUMSTANCES SHOULD BATTERIES BE LEFT IN THE INSTRUMENT @ TEMPERATURES BEYOND THE RATED SPECIFICATIONS OF THE BATTERIES BEING USED!

2.19 MECHANICAL

★ Height	262 mm	With holster 281 mm.
★ Width	129 mm	With holster 140 mm.
★ Depth	60 mm	With holster 62 mm.
★ Weight	1.5 kg	With holster ca 1.8 kg.

CHARACTERISTICS	SPECIFICATIONS	ADDITIONAL INFORMATION
-----------------	----------------	------------------------

2.20 ENVIRONMENTAL

The characteristics are valid only if the instrument is checked in accordance with the official checking procedure.

* Meets Environmental Requirements of:	MIL-T-28800D Type III Class 3, Style C	
* Temperature		Batteries removed from instrument unless batteries meet the required temperature specifications. Maximum Operating Temperature derated 3 °C for each km. (each 3000 feet) above sea level.
Operating	0 °C...50 °C	
Non Operating (Storage)	- 20 °C...70 °C	
* Maximum Humidity		
Non Operating (Storage)	95% Relative Humidity	
Operating		
20 °C...30 °C	90%	
30 °C...50 °C	70%	
* Maximum Altitude		Memory backup batteries removed from instrument unless batteries meet maximum altitude specifications.
Operating	3 km (10 000 feet)	
Non Operating (Storage)	12 km (40 000 feet)	
* Vibration (Operating)		
Frequency 5...15 Hz	Sweep Time 7 min.	
Excursion (pk to pk)	1.5 mm	
Max Acceleration	7 m/s ² (0.7 x g)	@ 15 Hz.
Frequency 15...25 Hz	Sweep Time 3 min.	
Excursion (pk to pk)	1.0 mm	
Max Acceleration	13 m/s ² (1.3 x g)	@ 25 Hz.
Frequency 25...55 Hz	Sweep Time 5 min.	
Excursion (pk to pk)	0.5 mm	
Max Acceleration	30 m/s ² (3.0 x g)	@ 55 Hz.

CHARACTERISTICS	SPECIFICATIONS	ADDITIONAL INFORMATION
Resonance Dwell	10 min.	@ each resonance frequency (or @ 33 Hz if no resonance is found).
* Shock (Operating)		
Number of shocks	18 Total 6 Each Axis	(3 in each direction).
Shock Wave Form	Half Sine	
Duration	6...9 ms	
Peak Acceleration	400 m/s ² (40 x g)	
* Bench Handling Meets requirements of:	MIL-STD-810, Method 516, Procedure V	
* Salt Atmosphere Structural parts meet	MIL-STD-810, Method 509, Procedure I with 5 % salt solution	
* EMI (Electro Magnetic Interference) Meets requirements of:	MIL-STD-461 Class B	Applicable requirements of Part 7: CE03, CE07, CS01, CS02, CS06, RE02, RS03.(RS02: max 2 div distorsion in 20 mV/div).
	VDE 0871 and VDE 0875 Grenzwertklasse B	
Packing meets requirements of:	UND 1400	
Transportation meets requirements of:	AN-D628	
Packaged Transportation Drop meets requirements of:	Nat. Safe Transp. Assoc. Procedure 1A-B-2	
Packaged Transportation Vibration meets requirements of:	Nat. Safe Transp. Assoc. Procedure 1A-B-1	
* ESD (ElectroStatic Discharge) meets requirements of:	IEC 801-2	Test severity level 15 kV.

CHARACTERISTICS	SPECIFICATIONS	ADDITIONAL INFORMATION
2.21 INTERFACE (MODEL 97 ONLY)		
* Type of interface	RS-232-C	Optical.
Plug	9 pole D-plug male	
* Spacing		
"0"	Light	
"1"	No light	
* Interface function repertoire for printers		
Baud Rate	1200, 9600	Input and Output are the same.
Number of STOP bits	1	
Parity	No	
Character length	8	
Transmission mode	Asynchronous, full duplex	
Handshake	XON/XOFF	Software handshake only.
* Interface function repertoire for interface		
Baud Rate	75...19K2	Input and Output are the same. Selectable by controller.
Number of STOP bits	1	
Parity	No, Odd or Even	
Character length	8	
Transmission mode	Asynchronous, full duplex	
Handshake	XON/XOFF or no Handshake	Software handshake only; default: no Handshake.
* Print facilities		
Protocol	EPSON FX, LQ compatible HP ThinkJet compatible	
Print out	Screen log of readings: single every 2, 5, 10 or 60s selectable waveform	
* Front Panel Control		
Modes	Local	Front panel exclusively under manual control.
	Remote-locked	Front panel exclusively under RS-232-C control.
	Remote-unlocked	Return To Local by User ReQuest

CHARACTERISTICS	SPECIFICATIONS	ADDITIONAL INFORMATION
<ul style="list-style-type: none"> CPL Protocol implemented: 		
Go to Remote	GR	
Go to Local	GL	
Local Lockout	LL	
Reset Instrument (Master Reset)	RI	
Status Query	SQ	
IDentification query	ID	Restricted; only 0= 1= 2= . Gives Type number and software version.
Auto Setup	AS	
Default Setup	DS	Default Scope setting.
Program Setup	PS	Has to be done with the string that comes out with QS.
Query Setup	QS	
Recall Setup	RS	
Save Setup	SS	
Program Communication parameter	PC	
Arm Trigger	AT	
Trigger acquisition	TA	
Query Waveform	QW	
Program Waveform	PW	
Query for Measurement data	QM	

2.22 SAFETY

<ul style="list-style-type: none"> Meets requirements of: 	IEC 348 Class II VDE 0411 Class II ANSI/ISA S82 UL 1244 CSA C22.2 No. 231	With or without battery charger.
<ul style="list-style-type: none"> Approvals 	VDE 0411 (applied for) UL 1244 (applied for) CSA C22.2 No. 231 (applied for)	With or without battery charger.

CHARACTERISTICS	SPECIFICATIONS	ADDITIONAL INFORMATION
-----------------	----------------	------------------------

2.23 ACCESSORIES

* Accessories furnished with instrument:	Users Manual Quick Operating Guide	
	PM 8918/002	2 x 10 MΩ 10:1 Passive Probe, 1.5m.
ScopeMeter Accessory set: 2 x HF adapter 2 x High voltage testpin 2 x Earth lead 2 x Trim screwdriver 4 mm adapter Banana to BNC adapter	PM9081/001	shrouded.
Set Testleads and Testpins: 2 x testleads 2 x testpins 2 x banana adapter		1.5m.
Holster	PM 9083/001	
Accessory case	C 75	
Power Adaptor/Battery Charger:	PM 8907/001 PM 8907/003 PM 8907/004 PM 8907/008	Depends on model: Universal Europe. North American. United Kingdom. Universal 115V/ 230V.
PM9080/001 (Model 97 only)		RS-232-C Interface

2.24 SERVICE AND MAINTENANCE

* Main Time Between Failures (MTBF)	40 000 hours	Predicted value, calculated through parts counting method, according to MIL HDBK- 217E.
* Calibration Interval	1 year	
* Mean Time To Calibrate (MTTC)	30 minutes	

3 CIRCUIT DESCRIPTIONS

3.1 INTRODUCTION TO CIRCUIT DESCRIPTION

3.1.1 General

This chapter presents a layered description of the ScopeMeter circuitry. First the ScopeMeter's overall theory of operation is described, referring to the overall block diagram (section 3.2).

The next section gives some information concerning the ScopeMeter's data acquisition.

Then the circuits on both digital (A1) and analog (A2) printed circuit boards (PCB) are described. After a short introduction, a detailed circuit description is given for each circuit part.

The various circuit descriptions refer to the circuit diagrams in chapter 10.

NOTE: The large digital (A1) and analog (A2) printed circuit board diagrams are provided as separate drawings. Whenever a signal line continues on another drawing, it is indicated by the following comment:

"FROM A1" ----> coming from the digital (A1) circuit (figure 10.2)

"TO A2a" ----> the signal continues on the first circuit diagram of the analog A2 PCB (figure 10.5)

3.1.2 Location of electrical parts

The item numbers of C..., R..., V..., N..., D... and K... have been divided into groups. These groups relate to the functional parts on the PCBs:

Table 3.1 Location of electrical parts.

Item number	Functional part	PCB diagram	
		A1	A2
1200-1299	μ P, Digital ASIC and related circuitry	A1	A1
1300-1399	battery sense, RAM power, backlight	A1	A1
1400-1499	LCD and related circuitry	A1	A1
1500-1599	ON/OFF circuit	A1	A1
1600-1699	keypad	A1	A1
2100-2199	attenuator channel B	A2	A2a
2200-2299	attenuator channel A	A2	A2a
2300-2399	Analog ASIC and ADC	A2	A2a/b
2500-2599	battery charger and power supply	A2	A2c
2700-2799	EXTERNAL input-/output circuitry	A2	A2b
2800-2899	generator	A2	A2b
2900-2999	analog control circuitry	A2	A2a

3.2 FUNCTIONAL BLOCK DESCRIPTION

3.2.1 Introduction

This section contains an overall block diagram of the ScopeMeter. Refer to figure 3.1.

The block diagram can be divided in two parts. The upper part of the diagram shows the components that are situated on the Printed Circuit Board (in the following text: PCB), that is connected to the ScopeMeter's bottom cover. Because this PCB contains mainly analog circuits, it is called the **analog A2 PCB**.

The lower part of the diagram contains the digital circuitry of the ScopeMeter. This circuitry is located on the **digital A1 PCB**, the PCB connected to the ScopeMeter's top cover.

The general layout of the block diagram is the same as the layout of the circuit diagrams in chapter 10. The circuits that can be found on the same circuit diagram (chapter 10) are placed in a dashed box in the *block diagram*.

Analog A2 PCB

The signals at the red and gray BNC input connectors are attenuated by the **CHANNEL A ATTENUATOR** section and the **CHANNEL B ATTENUATOR**. These attenuators are set by the Microprocessor (on the digital A1 PCB) via the **ANALOG CONTROL CIRCUIT**. Also input protection circuits are provided here.

The output signals of the attenuator blocks are fed to the **ANALOG ASIC** (ASIC = Application Specific Integrated Circuit). This component is controlled by the ScopeMeter's microprocessor (on the digital A1 PCB). The Analog ASIC incorporates signal amplification and channel selection. It also prepares the signal for sampling by the **Analog to Digital Converter (ADC)**.

The red and black banana connectors are connected to the **EXTERNAL (BANANA) INPUT/OUTPUT CIRCUIT**. When the ScopeMeter is set to mV, DIODE or OHM METER mode, the External (banana) input/output circuit outputs its signal into the Channel A Attenuator section. In SCOPE mode, the circuit can act as a trigger input. The trigger signal is fed to the Analog ASIC. In the Analog ASIC "channel A", "channel B" or "External trigger" can be selected as trigger source. The trigger signal is used to generate the DELTA- T voltage (time relation between trigger moment and sampling moment).

The built-in **GENERATOR** uses the External (banana) input/output circuitry as output. It is possible to generate a DC voltage and a square wave voltage. ScopeMeter model 97 also can generate sine wave voltages, a ramp voltage, and a ramp current.

CIRCUIT DESCRIPTIONS

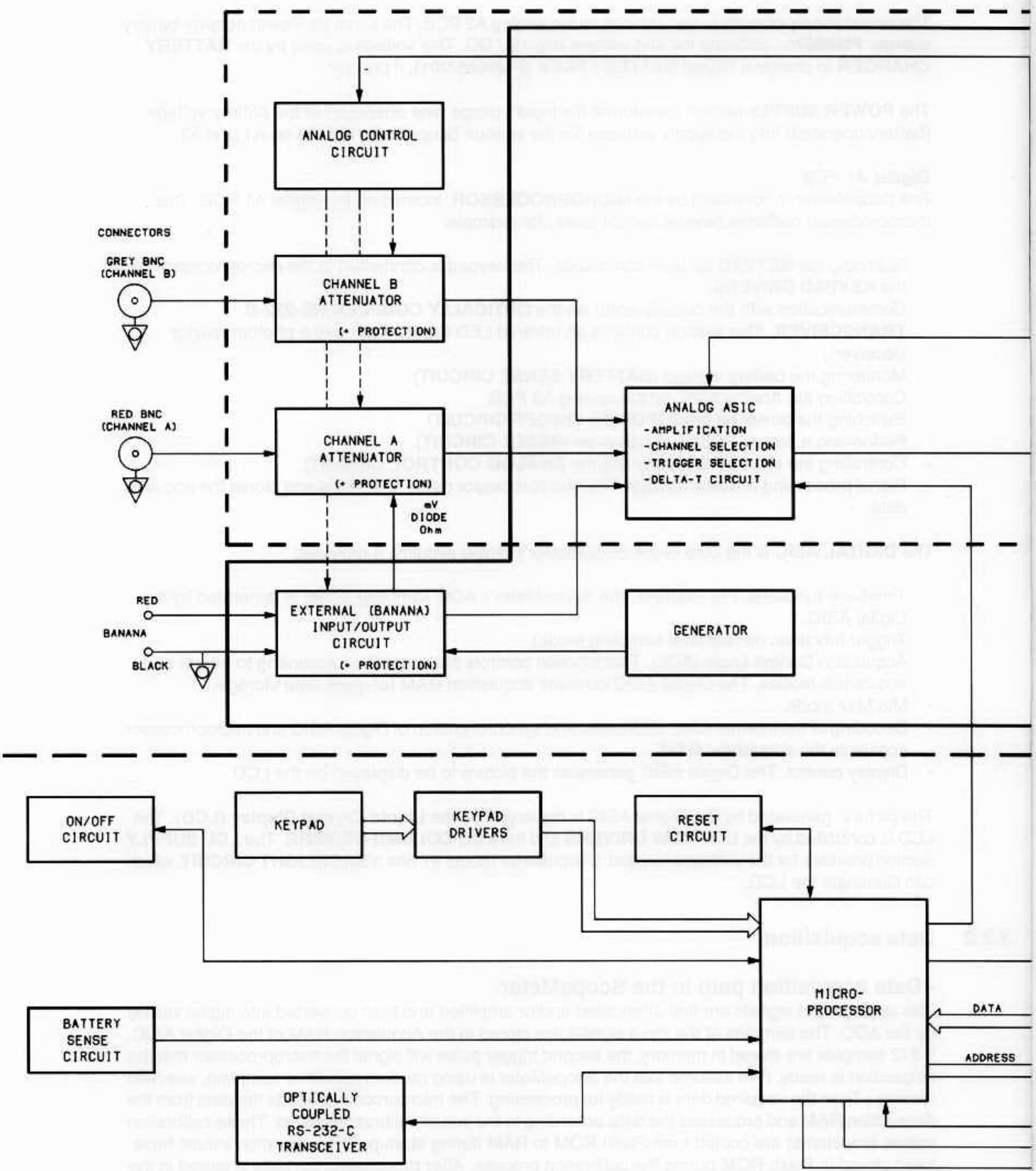
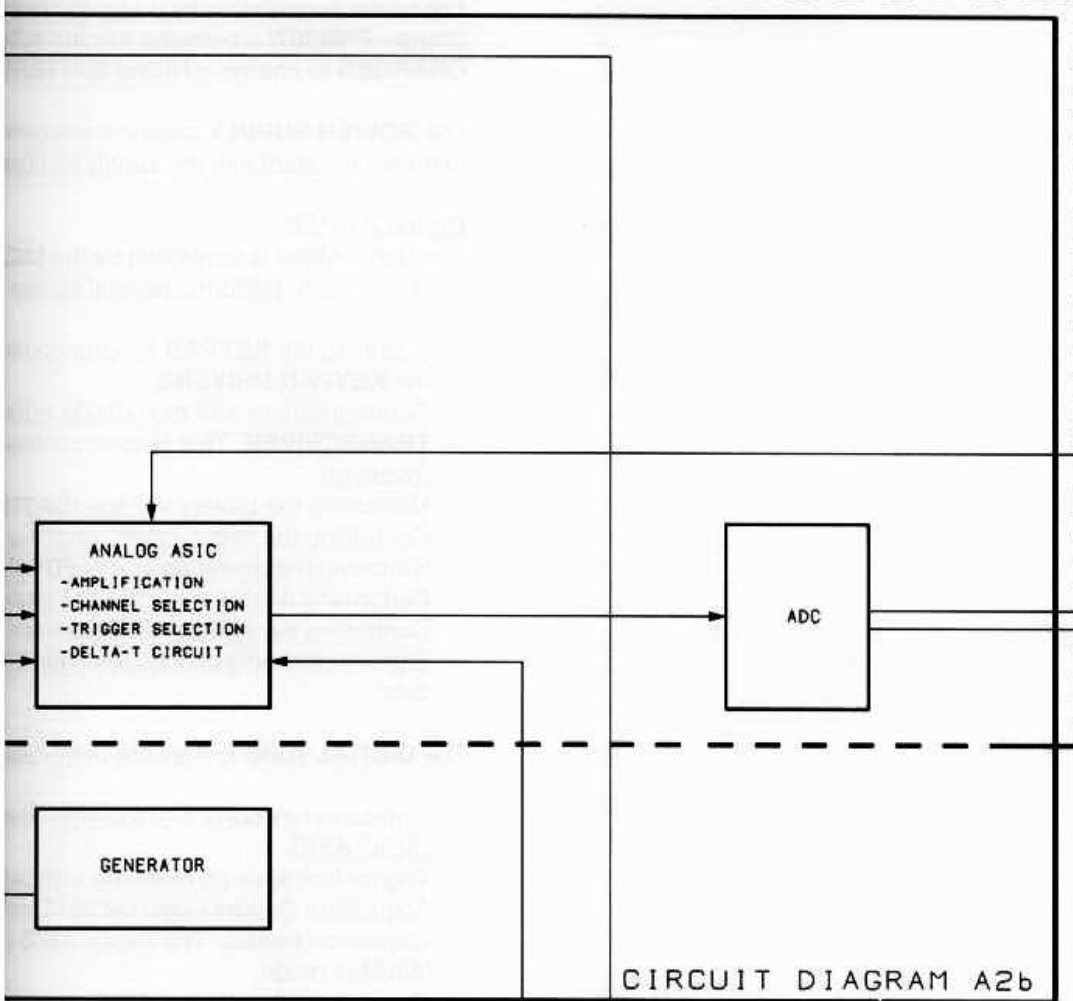
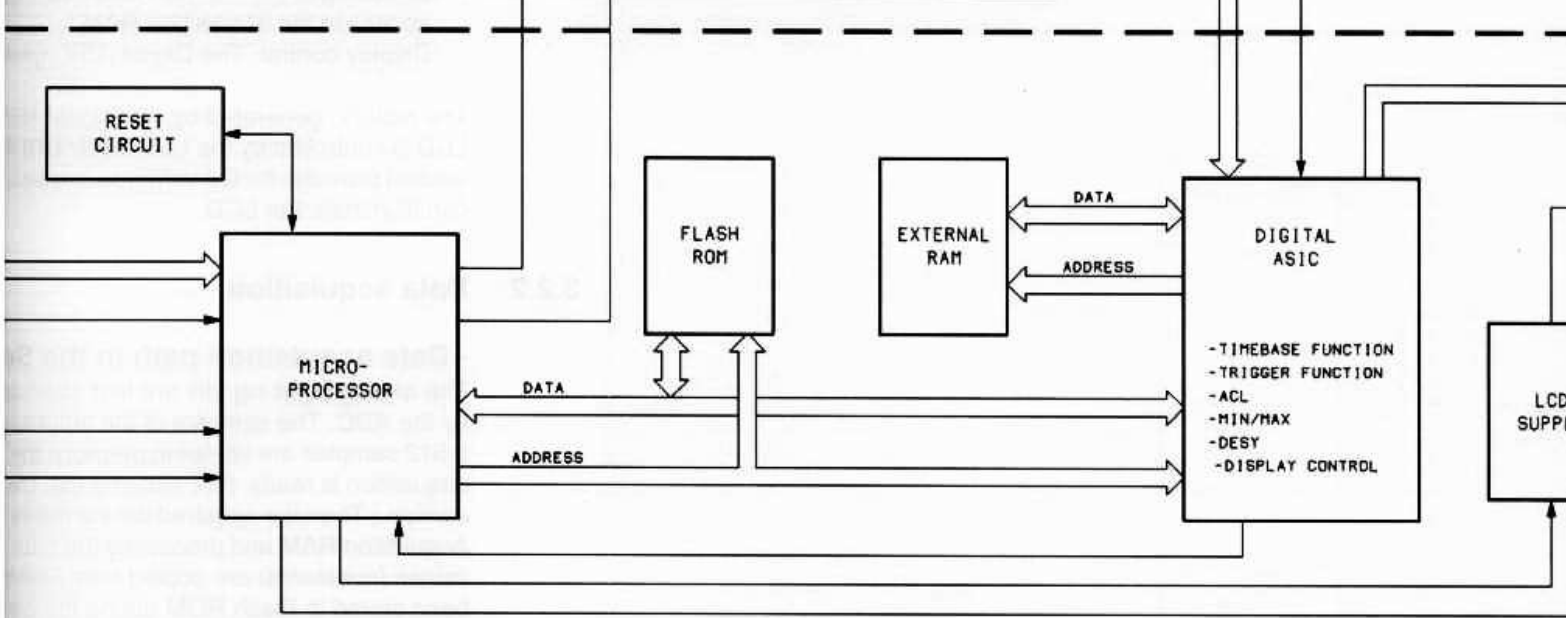


Figure 3.1 Overall Functional Block Diagram ScopeMeter

CIRCUIT DIAGRAM A2a

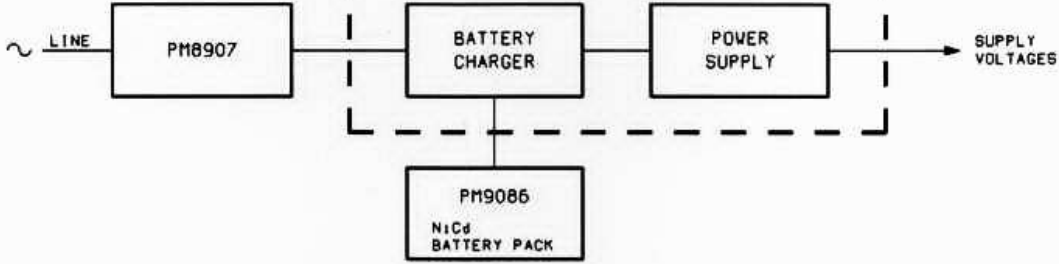


CIRCUIT DIAGRAM A2b



2a

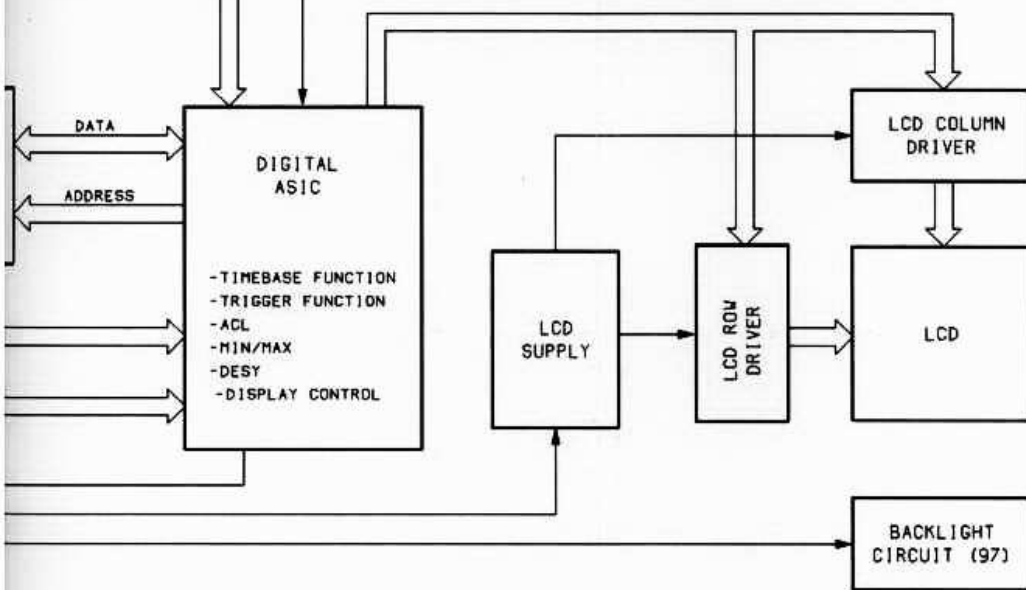
CIRCUIT DIAGRAM A2c



2b

ANALOG A2 PCB

DIGITAL A1 PCB
(CIRCUIT DIAGRAM A1)



ST6336
920204

The power supply circuitry is also located on the analog A2 PCB. The separate Power adapter/battery charger **PM8907/...** converts the line voltage into 15V DC. This voltage is used by the **BATTERY CHARGER** to charge a **NiCad BATTERY PACK (PM9086/001)**, if present.

The **POWER SUPPLY** section transforms the input voltage (line operated) or the battery voltage (battery operated) into the supply voltages for the various ScopeMeter circuits on A1 and A2.

Digital A1 PCB

The ScopeMeter is controlled by the **MICROPROCESSOR**, located on the digital A1 PCB. This microprocessor performs several control tasks, for example:

- Scanning the **KEYPAD** for user commands. The keypad is connected to the microprocessor via the **KEYPAD DRIVERS**.
- Communication with the outside world via the **OPTICALLY COUPLED RS-232-C TRANSCEIVER**. This section contains an Infrared LED (transmitter) and a phototransistor (receiver).
- Monitoring the battery voltage (**BATTERY SENSE CIRCUIT**).
- Controlling the Analog ASIC on the analog A2 PCB.
- Switching the power on or off (**POWER ON/OFF CIRCUIT**).
- Performing a proper RESET at power on (**RESET CIRCUIT**).
- Controlling the analog A2 circuits (via the **ANALOG CONTROL CIRCUIT**).
- Signal processing of acquired data. The microprocessor reads, calibrates and stores the acquired data.

The **DIGITAL ASIC** is the core of the ScopeMeter's digital circuitry. It provides:

- Timebase functions. For example: the ScopeMeter's ADC sampling signal is generated by the Digital ASIC.
- Trigger functions (in real-time sampling mode).
- Acquisition Control Logic (ACL). This function controls the acquisition according to trigger and acquisition modes. The Digital ASIC contains acquisition RAM for quick data storage.
- Min/Max mode.
- Decoding of the internal ASIC addresses and synchronization of Digital ASIC and microprocessor access to the acquisition RAM.
- Display control. The Digital ASIC generates the picture to be displayed on the LCD.

The picture, generated by the Digital ASIC is displayed on the **Liquid Crystal Display (LCD)**. The LCD is controlled by the **LCD ROW DRIVERS** and the **LCD COLUMN DRIVERS**. The **LCD SUPPLY** section provides for the voltages needed. ScopeMeter model 97 has a **BACKLIGHT CIRCUIT**, which can illuminate the LCD.

3.2.2 Data acquisition

- Data acquisition path in the ScopeMeter

The analog input signals are first attenuated and/or amplified and then converted into digital values by the ADC. The samples of the input signals are stored in the Acquisition RAM of the Digital ASIC. If 512 samples are stored in memory, the second trigger pulse will signal the microprocessor that the acquisition is ready. (We assume that the ScopeMeter is using random repetitive sampling, see next section.) Then the acquired data is ready for processing. The microprocessor reads the data from the Acquisition RAM and processes the data according to the actual calibration values. These calibration values (constants) are copied from Flash ROM to RAM during startup. The calibration values have been stored in Flash ROM during the calibration process. After processing, the data is stored in the External RAMs. These RAMs also contain the more static picture elements, for example the grid-, cursor- and text data.

- A multitasking kernel for hardware and software scheduling

Processing the acquired data is only one of the tasks of the microprocessor. The ScopeMeter uses a multitasking kernel for hardware and software scheduling, based on internal and external interrupts. The microprocessor contains internal timers, which can be programmed by the software. One of these timers is used to generate interrupts, e.g. to scan the keypad for depressed or released keys.

Except processing (calibrating) the acquired data, the microprocessor also does mathematical computations and controls the hardware. The multitasking kernel takes care that every 20 ms of processing time, a task is interrupted. This task will then be held and rescheduled, unless it requires execution without interruption. In this way a variety of user-requested tasks can be handled quasi-simultaneously, without the user being aware of the heavy loads on the microprocessor. The display of the data on the LCD is done by the Digital ASIC, also taking part in the multitasking scheme.

- Sampling and Triggering

The ScopeMeter uses two types of sampling, commonly used in many Digital Storage Oscilloscopes: **REAL-TIME SAMPLING** and **RANDOM REPETITIVE SAMPLING**.

In the real-time sampling mode (timebase settings: 60s/div...1 μ s/div) the ScopeMeter takes a series of samples from a single period of the input signal. These samples are later used to reconstruct the signal. During the real-time sampling mode, the Digital ASIC calculates the trigger pulses out of the acquired data (for timebase settings between 60s/div...50 μ s/div). For timebase settings between 20 μ s/div and 1 μ s/div, the triggering is done by the Analog ASIC, using analog comparators.

In random repetitive sampling mode, the ScopeMeter takes a sample from successive cycles in a repetitive signal. These samples are stored in memory and combined to reconstruct the original signal.

In this sampling mode, samples are taken from the input signal at intervals determined by the internal ScopeMeter clock. Since there is no time-correlation between the system's clock and the incoming signal, all samples are taken at random points of the signal. The time between the trigger moment and the sampling moment must be tracked to enable reconstruction of the signal from the samples. This time, DELTA T, is generated by the Analog ASIC. See section 3.4.5 and figure 3.12. During random repetitive sampling mode, the ScopeMeter always uses analog triggering (Analog ASIC).

3.3 DIGITAL CIRCUITS (A1)

3.3.1 Introduction

The following paragraphs describe the circuits on the digital A1 PCB in detail. Refer to circuit diagram A1 (figure 10.2 in chapter 10).

3.3.2 Overview digital circuits

The digital circuitry of the ScopeMeter can be separated into three main parts:

- Microprocessor circuitry
- Digital ASIC (in the following text: D-ASIC) circuitry
- LCD circuitry

A block diagram, which clearly shows the connections between these main parts, is shown in figure 3.2

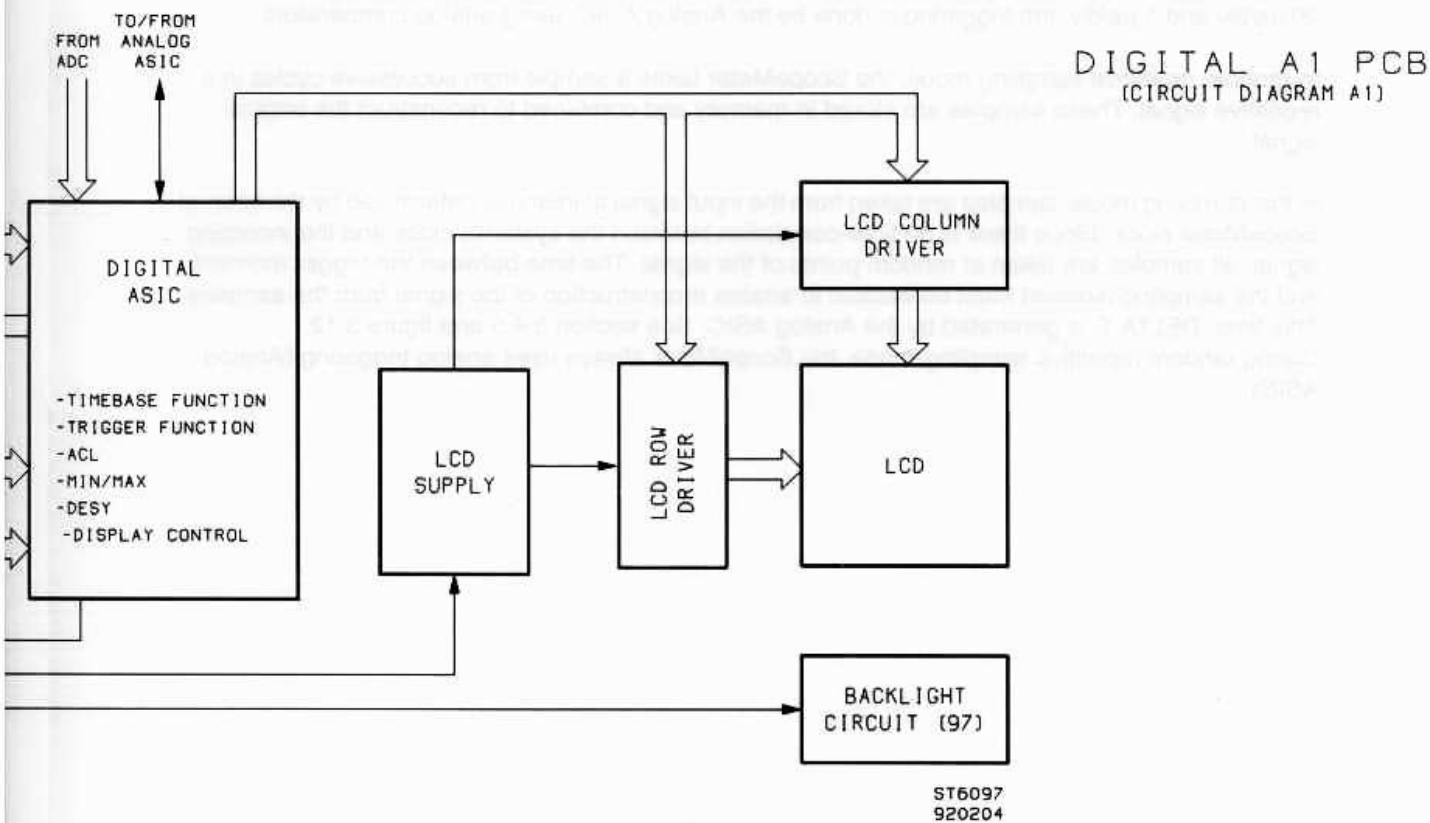


Figure 3.2 Block diagram main parts digital circuitry

3.3 DIGITAL

3.3.1 Introduction

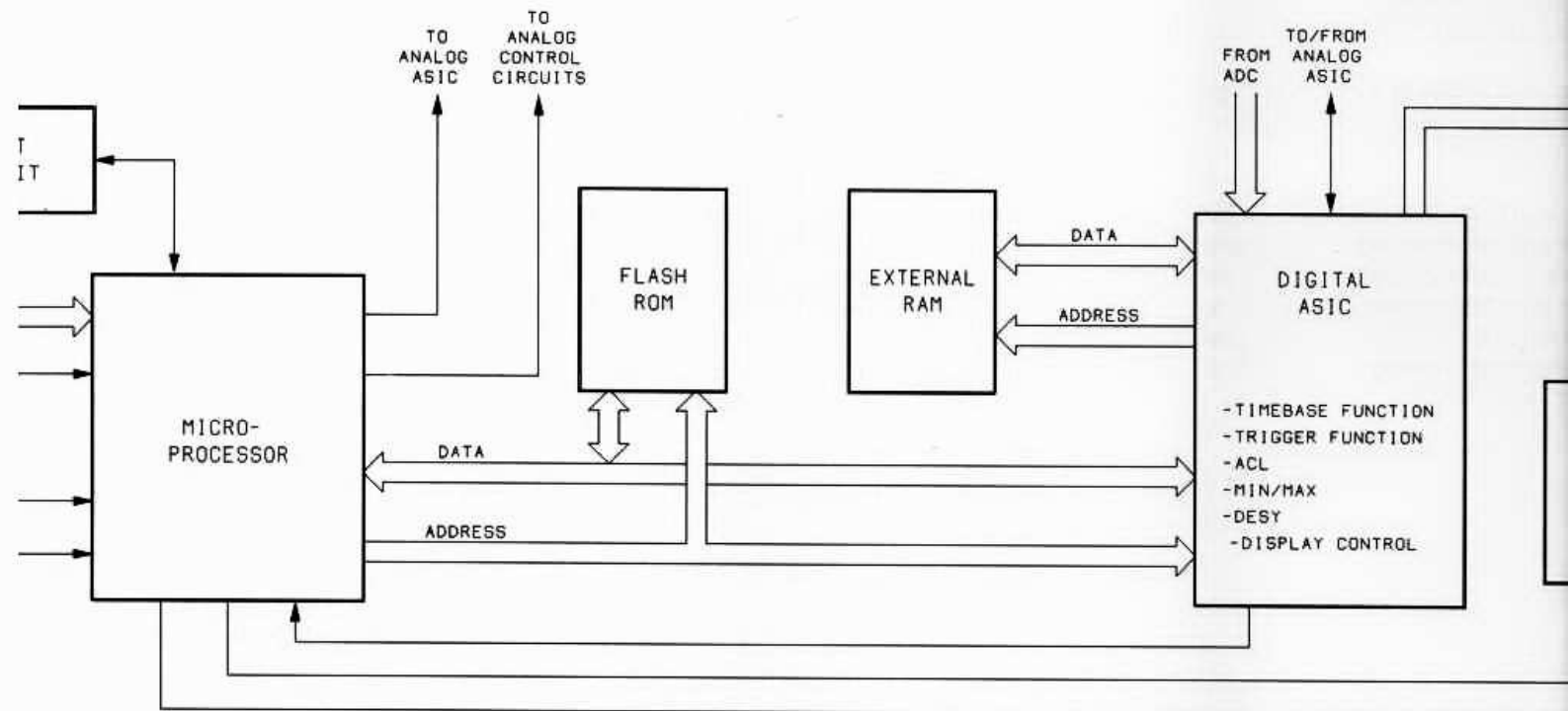
The following figure (figure 3.2)

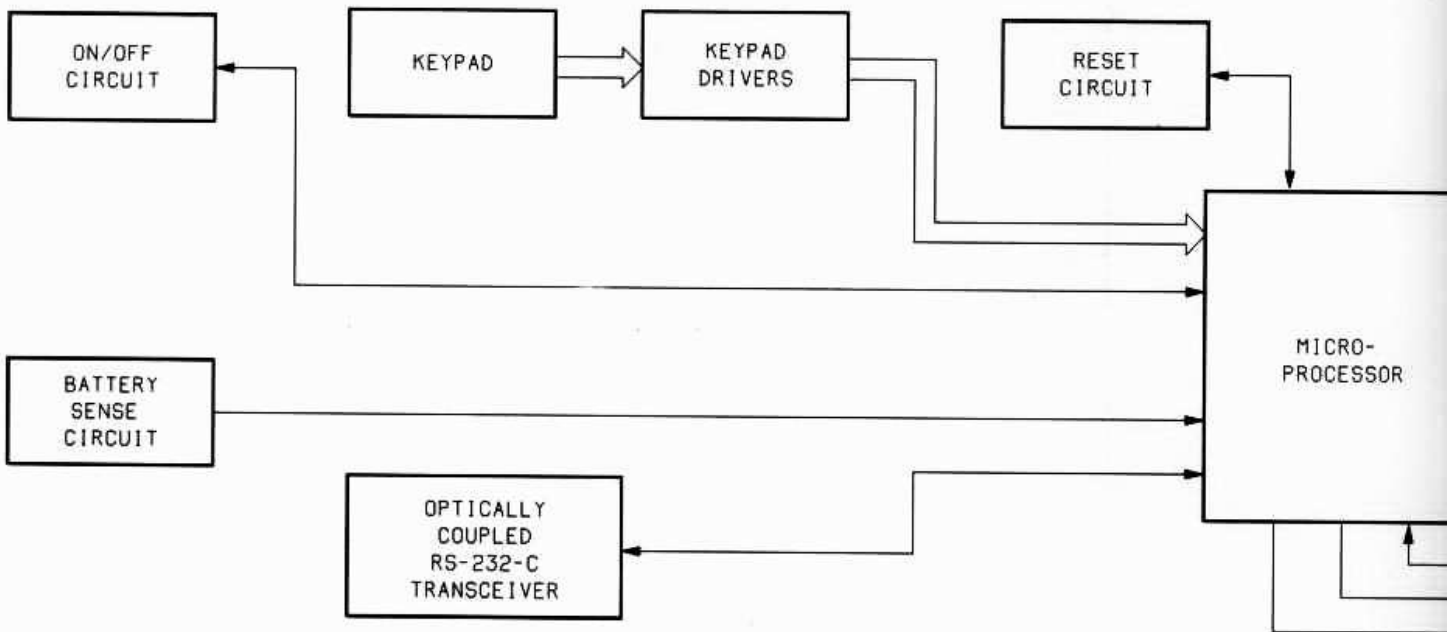
3.3.2 Overview

The digital system consists of:

- Microprocessor
- Digital ASIC
- LCD circuit

A block diagram of the digital system is shown in figure 3.2





3.3.3 MICROPROCESSOR circuitry (μ P)

- Introduction

The ScopeMeter is controlled by a single chip microcomputer with on-board ROM (called Mask ROM in the following text). This microprocessor controls the total system operation and communication between the ScopeMeter and the outside world (key pad, RS-232-C interface). It also controls the communication between the internal system components.

- Detailed circuit description

See figure 3.2 and circuit diagram A1 (figure 10.2).

The ScopeMeter uses an Intel 83C196 microprocessor D1201, with on-board Mask-programmed ROM (Mask ROM). This microprocessor has an 8-bit data bus and a 16-bit address bus. The lower 8 address bits A0...A7 are combined with the data bits (multiplexed data bus). ADDRESS LATCH D1210 is used to separate data bits and address bits.

The microprocessor's Mask ROM contains the startup software and a diagnostic kernel test (see chapter 7). It also contains the software necessary to drive the serial interface and to clear and program the Flash ROMs.

The two Flash ROMs (FROMs) D1207 and D1208 contain the system software. The FROMs are directly connected to the microprocessor via the data and address busses. The microprocessor addresses the RAMs via the D-ASIC (D1203).

The microprocessor contains five 8-bit I/O ports. Port 3 and 4 share their bits with the data and address busses. The other I/O ports 0, 1, 2 are used for various purposes. For example: reading the keypad, operating the RS-232-C interface, battery voltage sense, switching the power on/off, etc.

Keypad circuitry

The keypad circuitry consists of five shift registers, D1601...D1606, each of which has eight inputs. These inputs are normally kept "high" by 56 K Ω resistor arrays connected to the +5V supply voltage. Whenever a key on the keypad is pressed, the corresponding line is connected to ground, resulting in a "low" signal. All signals are clocked into the shift registers (with the FRONT_CLOCK and FRONT_LATCH signals). Then they are converted into two signals FRONT_DATA1 (shift registers D1603, D1604, D1606) and FRONT_DATA2 (D1601 and D1602).

Optically isolated RS-232-C interface

The serial communications circuitry, which is built into the microprocessor, is used to operate the infrared (IR) RECEIVER and TRANSMITTER of the ScopeMeter. For this purpose a stripped version of the RS-232-C protocol is used.

Only the TXD (transmit data) and RXD (receive data) lines from the RS-232-C standard are used. The IR transmitter LED H1201 is driven directly from the TXD-not pin of the microprocessor. If a "0" is transmitted, the LED lights.

The IR receiver uses operational amplifier N1301 to power the collector of phototransistor H1202. If any IR light is received, the phototransistor will drive V1207 in saturation. This results in a "low" RXD line, interpreted by the microprocessor as a "1".

Battery sense circuitry

The battery voltage -VBAT generated on the analog unit is amplified by -2/3 at operational amplifier N1301. The resulting signal BAT_LEVEL is connected to an A/D converter input of the microprocessor. In this way the microprocessor can monitor the battery voltage level. If the battery voltage level drops below 4.4V, the microprocessor generates the BATTERY LOW indication on the LCD.

Analog ASIC bus

The Analog ASIC (A-ASIC D2301, see circuit diagram A2a/A2b, figure 10.5/10.6) or A-ASIC, as used in the following text, is controlled by the microprocessor. The microprocessor uses the signals CDAT, CCLK and DTAEa,b,c to set the A-ASIC and the attenuator sections on the analog A2 PCB. These signals together form the CONTROL bus.

Flash ROM type selection

The ScopeMeter hardware allows the usage of different types of Flash ROMs. The actual Flash ROM configuration is indicated by resistors R1222 and R1224.

FLASH ROM CONFIGURATION

Resistor(s)	F512 (1x)	F512 (2x)	F010 (1x)
R1222		*	*
R1224	*		*

The resulting voltage levels (0 volt, 2.5 volt or 5 volt) are read directly by the microprocessor A/D converter inputs.

ON/OFF circuit

The ON/OFF circuit operates almost like a thyristor. When the ON/OFF key is pressed, a current is drawn from the base of V1503, via R1503 and V1501. Transistor V1503 will now start to conduct. This results in a current through R1507, R1504, V1502 and R1506. The signal POWER_ON will now become "high". Also transistor V1506 will conduct, supplying base current to V1503 after the ON/OFF key is released. The POWER-ON signal will latch "high". The ON/OFF signal will go high, turning off V1506 and V1503, the next time the ON/OFF key is depressed. The POWER_ON signal will become "low" and the ScopeMeter power turns off.

RESET circuit

The RESET circuit consists of V1203, V1205, V1215, V1201, D1205 and related components. When the ScopeMeter power is switched on, the +5V supply voltage starts to rise. This causes the zener diode V1202 to conduct. After some time transistor V1203 also starts to conduct. R1204 and C1203 form a time delay (see figure 3.3).

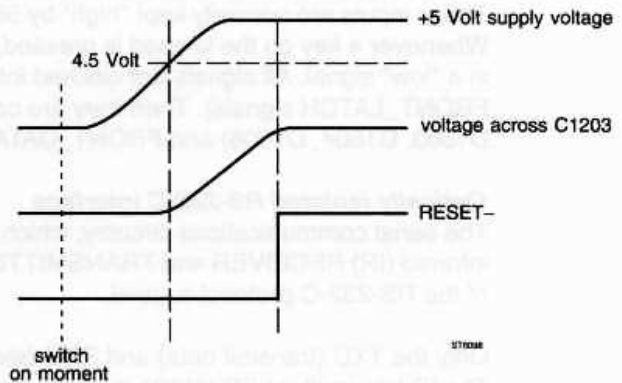


Figure 3.3 RESET signal timing

The RESET signal now is buffered by D1205 and connected with the RESET inputs of the microprocessor and the D-ASIC circuitry.

After a reset, the voltage on the EA (External Address) input of the microprocessor (pin 14) is "high". The Microprocessor starts up using the internal Mask ROM software. First the Flash ROMs are checked to see if they contain valid software. If this is true, output pin 6 of flip-flop D1202 is set "low". Now the microprocessor invokes a software reset. Because of the "low" voltage on the EA input of the microprocessor, the microprocessor will "start up" again, using the external Flash ROM software. The reset pulse is blocked by transistor V1201 to prevent the RESET signal from performing a "hard-reset" on the microprocessor again. At this software reset, the microprocessor enables the LCD by means of the signal LCDPWR. Then the buffers that control the LCD contain valid data.

3.3.4 DIGITAL ASIC (D-ASIC) circuitry

- Introduction

The Digital Application Specific Integrated Circuit (or D-ASIC) D1203 forms the core of the digital circuitry of the ScopeMeter, all located on the digital A1 PCB.

Many functions are incorporated in this complex CMOS integrated circuit (see figure 3.4 on the next page):

- Timebase
- Trigger
- Acquisition Control Logic
- Acquisition RAM
- Min/max
- Display control
- Decoding and synchronization
- Digital-to-analog converters (DACs)

- Detailed circuit description:

See figure 3.4 and circuit diagram A1 (figure 10.2).

The following gives a short description of the separate parts of the D-ASIC, which perform the functions mentioned above:

Timebase

The D-ASIC contains a crystal oscillator, which uses the 25 MHz crystal G1201. An internal programmable divider generates timebase signal TRACK with a frequency from 0.8333 Hz up to 25 MHz (see section 3.4.5). This TRACK signal is used to sample the ScopeMeter input signals.

Trigger

The trigger module in the D-ASIC takes care of all trigger related functions:

- pre triggering
- post triggering
- event counting: the time interval corresponding to the trigger delay is increased by a programmed number of "events" (trigger level crossings of the external trigger signal), which must occur before triggering.
- n-cycle mode: trigger level crossings of the input signal are counted, and triggering occurs every n^{th} crossing ($2 < n < 255$). The n-cycle mode can be used as a digital trigger hold-off.

In the real-time sampling mode ($< 1 \mu\text{s}/\text{div}$), the D-ASIC determines the trigger moment with digital comparators. In the quasi-random sampling mode, the A-ASIC determines the trigger moment with analog comparators.

Display control

This module reads screen data from the External RAMs (D1204 and D1205) and sends it to the LCD. It also sends line pulses LINECL (17 kHz) and frame pulses FRAME (70 Hz). This screen data, consisting of for example cursor and grid information, is stored in External RAMs as bitplane information. The trace data is stored as a value for every vertical line on the LCD. This data is converted to bitplane data and added to the cursor and grid information. The display control module also makes it possible to change the dotsize of the signal displayed and to use dot joining.

Decoding and synchronization (DESY)

The DESY section is the decoder for the D-ASIC's internal addresses. This module also synchronises the microprocessor with the D-ASIC's Display control module, as both access the same Acquisition RAM.

Digital to analog converters (DACs)

The DACs module contains 10 one-bit pulse width modulated monotonous DACs, whose resolution ranges from five to ten bits. The DACs are used to control level shifting, analog trigger level, LCD contrast and the generator function (see section 3.4.7).

External RAMs

The External RAM section consists of two 32K * 8 SRAMs (D1204 and D1206). These RAMs contain:

- waveforms (stored with the WAVEFORM key)
- frontsettings (stored with the SETUP key)
- bitplane data for the LCD picture
- text, to be used on the display
- data in RECORD mode
- data in A versus B mode (A= ↑ B= →)
- bitplane data used while making a printout of the screen

Ram Power circuit

The External RAMs are powered by the RAM Power circuit. The RAM Power circuit is fed directly by the batteries, independently of the main power supply.

The RAM Power circuit is a simple oscillator, used to generate a stabilised voltage +VRAM out of the battery voltage -VBAT. The basic oscillator circuit is shown in figure 3.5.

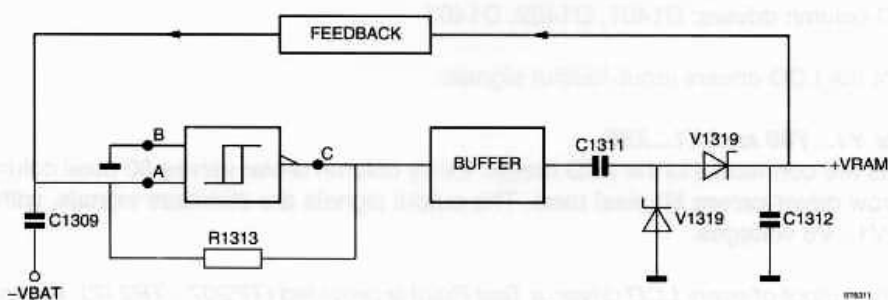


Figure 3.5 Oscillator RAM Power circuit

Input B of Schmitt input NAND D1301 is connected to ground. When the voltage on input A is also "low", the output C will become "high". Capacitor C1309 will charge via R1313. After some time input A will become "high", resulting in a "low" output C.

Capacitor C1309 will then discharge via resistor R1313. The generated output pulses are buffered and converted into a DC voltage by C1311, C1312 and V1319. The output voltage +VRAM is fed back to the NAND input A, via several transistors (voltage gap). If the output voltage +VRAM has reached the correct value, the pulse train at NAND output C is stopped via this feedback (see figure 3.6). In

this way capacitor C1312 is charged just enough to keep the output voltage +VRAM at a stable value (3V DC).

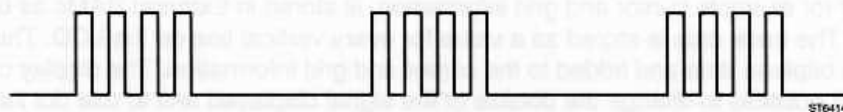


Figure 3.6 Pulse train signal on input A of Schmitt input NAND (Test Point 223)

3.3.5 LCD circuitry

- Introduction

The LCD used in the ScopeMeter is controlled by six LCD driver integrated circuits. These drivers get their information (data- and control signals) directly from the D-ASIC. The microprocessor enables the display when valid data is present.

ScopeMeter models 93 and 95 use a reflexive LCD. Model 97 is provided with a transflexive LCD with a backlight, which can be switched on or off by the user.

- Detailed circuit description

See figure circuit diagram A1 (figure 10.2).

LCD

The ScopeMeter uses a Super Twisted Nematic Liquid Crystal Display (LCD H1401, see circuit diagram A1, figure 10.2), with a resolution of 240 * 240 pixels.

The picture on the LCD screen is written column (vertical line) after column, rather than row (horizontal line) after row. The LCD screen is divided horizontally in 3 row-sections, each 80 pixels wide and vertically into 3 column-sections, each 80 pixels wide.

LCD drivers

The LCD display is controlled by the D-ASIC, via six LCD drivers:

- three LCD row drivers: D1404, D1406, D1407
- three LCD column drivers: D1401, D1402, D1403

Description of the LCD drivers input-/output signals:

LCD outputs Y1...Y80 and X1...X80

These outputs are connected to the LCD matrix. Every column driver serves 80 pixel columns of the LCD. Every row driver serves 80 pixel rows. The output signals are staircase signals, with levels equal to the V1...V6 voltages.

NOTE: On the output of every LCD driver, a Test Point is provided (TP207...TP212). When the driver is working properly, a staircase voltage can be measured on these test points.

- Data inputs D0...D3 (row drivers only!)

The actual display data coming from the D-ASIC is sent via the DRIVERBUS to the LCD drivers D0...D3 inputs.

- Terminal input voltages V1...V6

Out of these DC signals, with $V_{EE} = -20$ V, the LCD drivers generate the staircase signals. The input voltages V1...V6 are generated by the LCD supply section.

- Display control signals LINECL, DATACL, M, FRAME

These signals are used to control the LCD. The LCD picture is constructed from these display control signals and the data signals and sent to the LCD via the LCD outputs.

DATACL is the clock signal, used to clock the data D0...D3 into the driver buffer.

LINECL is a clock signal, used to clock one complete line (column) into the LCD.

The M signal is described furtheron (see M-randomize section).

LCD supply section

The pulse modulated signal, CONTRAST, comes from the D-ASIC. CONTRAST is filtered by R1401 and C1401 to get a DC voltage. The value of this DC voltage depends on the duty cycle of the CONTRAST signal. Opamps N1401 convert the DC signal into stabilized DC voltages V1...V6. If the signal, LCDPWR, coming from the D-ASIC, is "high" (+5V), the -20V voltage is generated and the system is active. The -20V supply voltage is temperature corrected to compensate for the temperature dependency of the LCD (-80 mV/C). The LCD supply voltages have to be corrected by the same amount to get a constant (over a temperature range) brightness and contrast of the LCD. This temperature compensation is made by Positive Temperature Coefficient (PTC) R1418. The -20V voltage is made out of the -30V voltage, coming from the analog A2 PCB. Transistors V1404 and V1402 form a protection circuit, that limits the current in case the -20V voltage is short circuited.

M-randomize section

The signal M ("LCD backplane modulation") has a time relation with the display control signals LINECL and DATACL. The M-randomize section converts M into M1, which is no longer time related to the other display control signals. The M1 signal is used by the LCD drivers to convert all DC voltages into AC voltages, able to drive the LCD.

Depending on the type (brand) of LCD mounted, integrated circuits D1408, D1409 and D1410 or D1411 are used.

Backlight circuitry

The backlight circuitry is based on the Hartley oscillator principle. Components V1307, T1301, and C1302 form the oscillator. Transistor V1304 supplies current to the circuit. This transistor is switched on/off by the ON OFF signal, coming from the microprocessor. When the output voltage across the backlight becomes higher than 100V, transistor V1305 will be driven open via V1308, V1309, and V1311. This will draw away current (energy) supplied to the oscillating circuit (feedback regulation).

3.4 ANALOG CIRCUITS (A2)

3.4.1 Introduction

This paragraph describes the circuits on the analog A2 PCB in detail. Refer to circuit diagrams A2a, A2b, and A2c (figures 10.5, 10.6, and 10.7 in chapter 10).

3.4.2 Overview analog circuits

The analog A2 PCB contains several functional parts:

- circuits in the acquisition path
 - attenuator sections
 - EXTernal (banana) input/output circuitry
 - Analog ASIC and ADC circuitry
- control circuitry
- signal generator
- power supply and battery charger

Each of these parts will be described separately. First a short introduction is given, followed by a detailed description.

3.4.3 ATTENUATOR sections, CHANNEL A and B

- Introduction

See figure 3.7.

The attenuator sections of both channels A and B are identical. In the following only channel A is described. The corresponding components for channel B have the same numbering, except the second number, which is '1' instead of '2'. For example: R2202 in channel A corresponds with R2102 in channel B.

The attenuator section consists of a high frequency (here after referred to as H.F.) path and a low frequency (here after referred to as L.F.) path, which are combined again in the impedance converter (see figure 3.7). To get a flat frequency characteristic, both paths must overlap over a wide frequency range. Circuits are provided for automatic offset compensation.

The output of the attenuator sections of channel A and B is processed further by the A-ASIC.

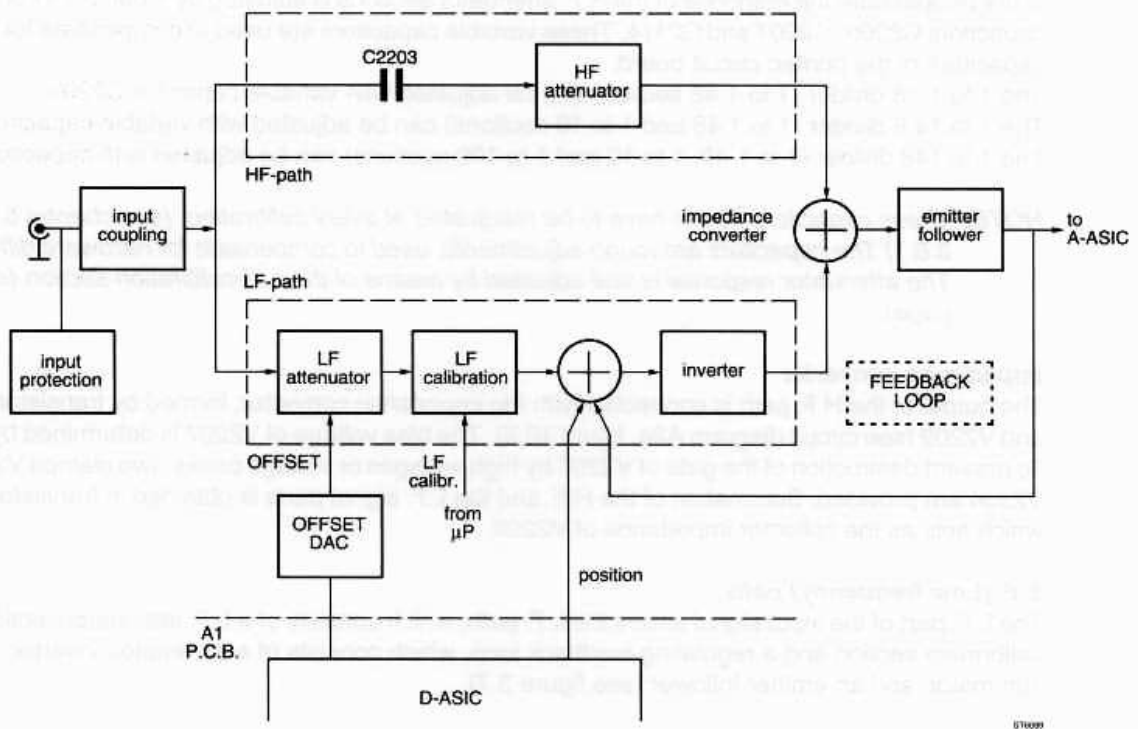


Figure 3.7 Schematic diagram attenuator section

- Detailed circuit description

See figure 3.7 and circuit diagram A2a (figure 10.4).

Input coupling

The incoming signal first passes the AC/DC coupling section (C2202). When relay K2201 is opened, the signal is AC coupled via C2202.

H.F. (high frequency) path

After the coupling section, the L.F. part of the signal is blocked by capacitor C2203. Only the H.F. part of the input signal enters the H.F. attenuator. This is a triple capacitive divider, consisting of a 1 to 100, a 1 to 10, and a 1 to 1.48 divider.

The 1 to 1.48 divider section is switched on when relay switches K2202 and K2203 are in the "upper" position (as shown on circuit diagram A2a, figure 10.5).

The 1 to 1.48 divider consists of C2203 and C2209 in parallel with some parasitic capacitors. The attenuation of 1.48 times in this straight-on path is compensated for later in the circuitry.

The separate sections are switched in the signal path, depending on the attenuation required:

Table 3.2 Sections used in various attenuator settings.

Attenuator Settings	Sections Used	Attenuation
5 mV/div 100 mV/div	1.48x	1.48 times
200 mV/div 1 V/div	1.48x, 10x	14.8 times
2 V/div 10 V/div	1.48x, 100x	148 times
20 V/div 100 V/div	1.48x, 10x, 100x	1480 times

In the ScopeMeter the response of the H.F. attenuator sections is adjusted by means of three variable capacitors C2209, C2207 and C2114. These variable capacitors are used to compensate for parasitic capacitors of the printed circuit board.

The 1 to 1.48 divider (1 to 1.48 section) can be adjusted with variable capacitor C2209.

The 1 to 14.8 divider (1 to 1.48 and 1 to 10 sections) can be adjusted with variable capacitor C2207.

The 1 to 148 divider (1 to 1.48, 1 to 10 and 1 to 100 sections) can be adjusted with capacitor C2214.

NOTE: These capacitors do not have to be readjusted at every calibration. (see chapter 5, section 5.6.1) The capacitors are rough adjustments, used to compensate for hardware differences. The attenuator response is fine adjusted by means of the L.F. calibration section (see next page).

Impedance converter

The output of the H.F. path is connected with the impedance converter, formed by transistors V2207 and V2209 (see circuit diagram A2a, figure 10.5). The bias voltage of V2207 is determined by R2216. To prevent destruction of the gate of V2207 by high voltages or voltage peaks, two clamps V2206 and V2204 are provided. Summation of the H.F. and the L.F. signal parts is obtained in transistor V2207, which acts as the collector impedance of V2208.

L.F. (Low frequency) path

The L.F. part of the input signal enters the L.F. path, which consists of a L.F. attenuator section, a L.F. calibration section and a regulating feedback loop, which consists of a summator, inverter, another summator, and an emitter follower (see figure 3.7).

L.F. attenuator

Fig 3.8 shows the L.F. attenuator section in detail:

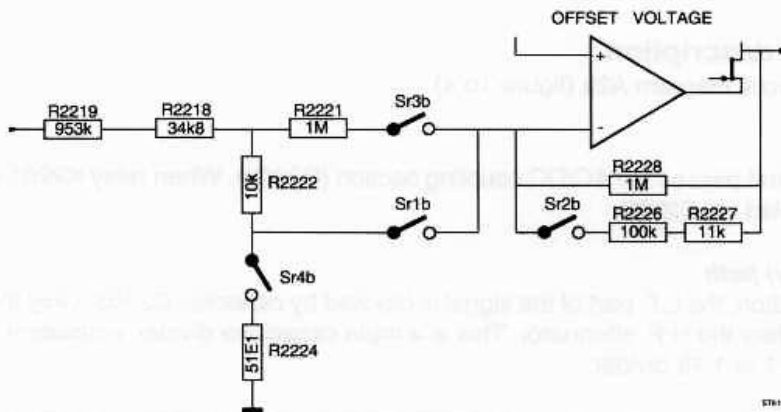


Figure 3.8 Principal diagram L.F. attenuator section

The L.F. attenuator consists of an inverting amplifier, N2201, which attenuates the L.F. signal by a factor, depending on the settings of switches D2201. These switches are controlled by signals named Sr1b...Sr4b. A "high" signal switches on the corresponding latched relays.

Table 3.3 Attenuator drive signals Sr1b...Sr4b.

Attenuator settings	Sr1b	Sr2b	Sr3b	Attenuation
5 mV/div...100 mV/div	high	low	low	1.48 times
200 mV/div...1 V/div	high	high	low	14.8 times
2 V/div...10 V/div	low	low	high	148 times
20 V/div...100 V/div	low	high	high	1480 times

The signal Sr4b operates the switch, which is used to ground the L.F. part of the input signal during offset calibration. This is done automatically to prevent drift.

The offset DAC circuitry (see figure 3.7) provides the offset voltage for operational amplifier N2201. The offset compensation is done automatically by means of the signals So10b...So14b, coming from the D-ASIC.

L.F. Calibration

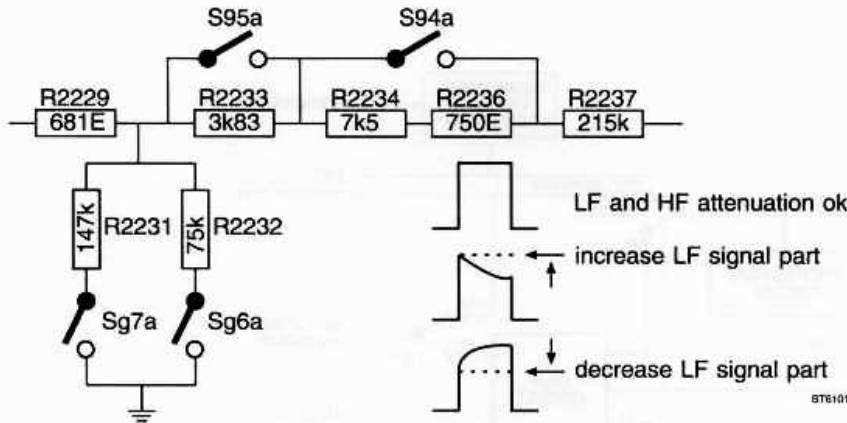


Figure 3.9 Automatic adjustment of the L.F. attenuation

Fine adjustment of the L.F. path attenuation is completed during calibration of the H.F. path attenuation. This is done by means of a simple 4-bits D-to-A converter, consisting of resistors R2229, R2231, R2232, R2233, R2234, R2236, and switches D2202. These switches are operated by signals Sg4a, Sg5a, Sg6a, and Sg7a, see figure 3.6. Resistors R2229, R2231 and R2232 divide the output signal of the attenuator section. Resistors R2233, R2234, and R2236 increase the input resistance of the inverting amplifier of the regulating loop.

Feedback loop

The output signal of the impedance converter is fed back to the input of operational amplifier N2201, with the signal coming from the L.F. calibration section (via R2237) and a DC position voltage (5V via R2248), proportional with the MOVEMENT of the trace (via R2248). Transistor V2210 is used to enlarge the dynamic range: when D-POSCHA is active, R2270 is incorporated in the circuitry.

The feedback loop operates as follows. If, for example, the output signal of the L.F. path is too small, the correction amplifier N2201 will drive V2207 via V2208. In this way the amplitude of the L.F. path and the position voltage are increased (compensation).

Input protection

The input protection safeguards the ScopeMeter against overvoltage. The input protection circuit consists of C2203 and V2206/V2204 (clamp HF attenuator) and R2219 and V2212/V2213 (clamp LF attenuator).

3.4.4 EXTERNAL (BANANA) INPUT/OUTPUT circuitry

- Introduction

See figure 3.10.

The ScopeMeter is provided with two banana connectors, which are used as inputs in the mV, DIODE, and OHM METER modes or as EXTERNAL trigger input in SCOPE mode. These connectors also serve as outputs for the built-in generator. Protection circuitry is provided to prevent damage by overvoltage.

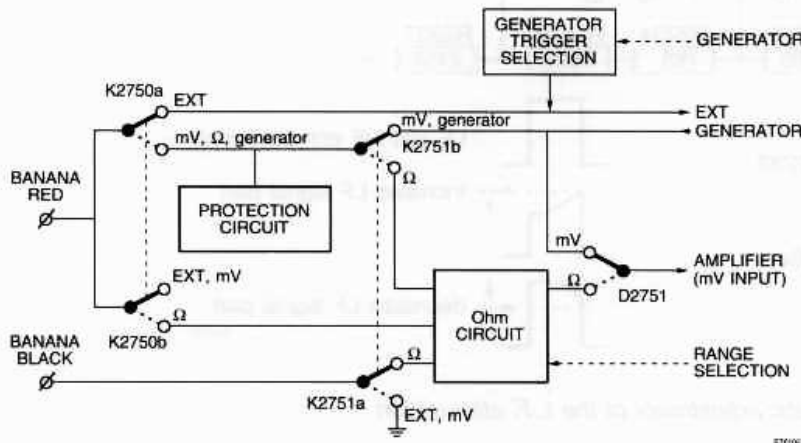


Figure 3.10 Schematic diagram signal flow in EXTERNAL (banana) input/output circuitry

- Detailed circuit description

See figure 3.10 and circuit diagram A2b (figure 10.6).

mV DC measurement circuitry

The mV DC input voltage on the red banana terminal is fed to the L.F. part of the channel A attenuator section, via the following path: R2750, K2750a, K2751b, R2761, D2751 (refer to circuit diagram A2b, figure 10.6). When the ScopeMeter is switched to mV DC measurement using the EXT banana terminals, the settings are as follows:

Table 3.4 A-ASIC and attenuator settings in mV DC mode.

mV DC RANGE	A-ASIC (D2301)	LF-ATTENUATOR (channel A)
300 mV	100 mV/div	1*
3 V	100 mV/div	0.1*

Ohm measurement circuitry

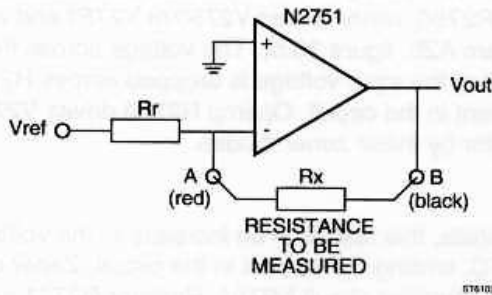


Figure 3.11 Ohm measurement circuitry (principle of operation)

The resistance R_x to be measured is connected as a feedback resistor of an amplifier circuit (opamps N2751). The output voltage of this measuring amplifier is proportional to resistance R_x :

$$V_{out} = (V_{ref}/R_r) \times R_x$$

The different ranges are obtained by selecting different values for resistor R_r . This can be done with the Ohm range selection circuit (D2750 and surrounding resistors), which is controlled by the Analog Control circuitry (circuit diagram A2a, figure 10.5, B-OFFSET lines).

Table 3.5 Ohm range selection circuit control lines.

RANGE	Sc15	Sc16	Sc17	Sc18
300Ω	1	0	1	1
3kΩ	1	0	1	0
30kΩ	1	0	0	0
300kΩ	1	1	0	0
3MΩ	0	1	0	0
30MΩ	0	1	0	0

Switches D2751 choose between the mV DC voltage and the voltage from the Ohm circuit. The outputs of these switches are connected to the L.F. part of the channel A attenuator (circuit diagram A2a, figure 10.5).

Diode measurement circuitry

While in DIODE METER mode, the ScopeMeter uses the same circuitry as in OHM mode.

WARNING: The BLACK terminal is not connected to the BNC grounds, while in OHM or DIODE METER mode! While in OHM or DIODE METER mode, the ScopeMeter can not be grounded via the BLACK banana terminal.

External triggering

The trigger signal is fed to the A-ASIC on A2a (figure 10.5) via resistor R2750 and voltage divider R2753/R2754 (see circuit diagram A2b, figure 10.6). It is also possible to trigger on the signal made by the generator. Then the trigger signal is made out of the signals STIMUL and G-OUTP by D2850, V2758, and related components.

Generator signal

The output of the generator (see paragraph 3.4.7) is sent to the EXT banana terminals via K2751b, K2750a and R2750.

Protection circuit (generator mode)

If a high voltage is applied to the banana terminals A and B, a current will flow from terminal A, through PTC (Positive Temperature Coefficient) R2750, zener diodes V2750 or V2751 and via V2752 and V2753 back to terminal B (see circuit diagram A2b, figure 10.5). The voltage across the zener diodes is limited to 7.5V for each diode. The rest of the input voltage is dropped across R2750. The resistance of this PTC will rise and limit the current in the circuit. Opamp N2750 drives V2752 and V2753, to prevent capacitive load of the generator by these zener diodes.

Protection (Ohm and diode measurement)

If a high voltage is put on the EXT banana terminals, this results in an increase of the voltage over PTC R2750. This increases the value of this PTC, limiting the current in the circuit. Zener diode V2764 limits the output voltage of the measuring amplifier circuit N2751. Resistor R2771 and clamp diodes V2759...V2763 protect the input of the measuring amplifier.

3.4.5 ANALOG ASIC (A-ASIC) and ADC circuitry**- Introduction**

See figure 3.12.

The signals coming from the channel A and B attenuators are fed to D2301. Various oscilloscope functions are integrated in this Application Specific Integrated Circuit (ASIC).

Analog ASIC D2301 selects the signal source and prepares the signal for further processing by the ADC circuitry. Also a trigger signal is derived from one of the channel A or B inputs or the external trigger input (banana connectors).

- Detailed circuit description

See figure 3.12 and circuit diagram A2a/A2b (figure 10.5/10.6).

First a short description is given for the internal circuits of the A-ASIC. The schematic diagram of the A-ASIC D2301 is shown in figure 3.12. The A-ASIC input/output signals are also described in the following sections.

Channel A Amplifier and Channel B Amplifier

The output signals of the channel A and B attenuator sections are amplified in the A-ASIC to obtain the most sensitive ranges.

Table 3.6 A-ASIC relative amplification at various attenuator settings.

Attenuator setting:	A-ASIC relative amplification:
100 mV/div	1 time
50 mV/div	2 times
20 mV/div	5 times
10 mV/div	10 times
5 mV/div	20 times
2 mV/div*	10 times
1 mV/div*	20 times

(* both 1mV/div and 2 mV/div settings are made by multiplying times five and averaging the signal in 5 mV/div and 10 mV/div.)

The A-ASIC itself can handle input signals with a maximum amplitude of 750 mV peak-peak. A vertical offset voltage YPOS is added to the signal in the attenuator sections (section 3.4.3). This means that 0V on an A- ASIC input terminal results in a trace in the vertical middle of the screen.

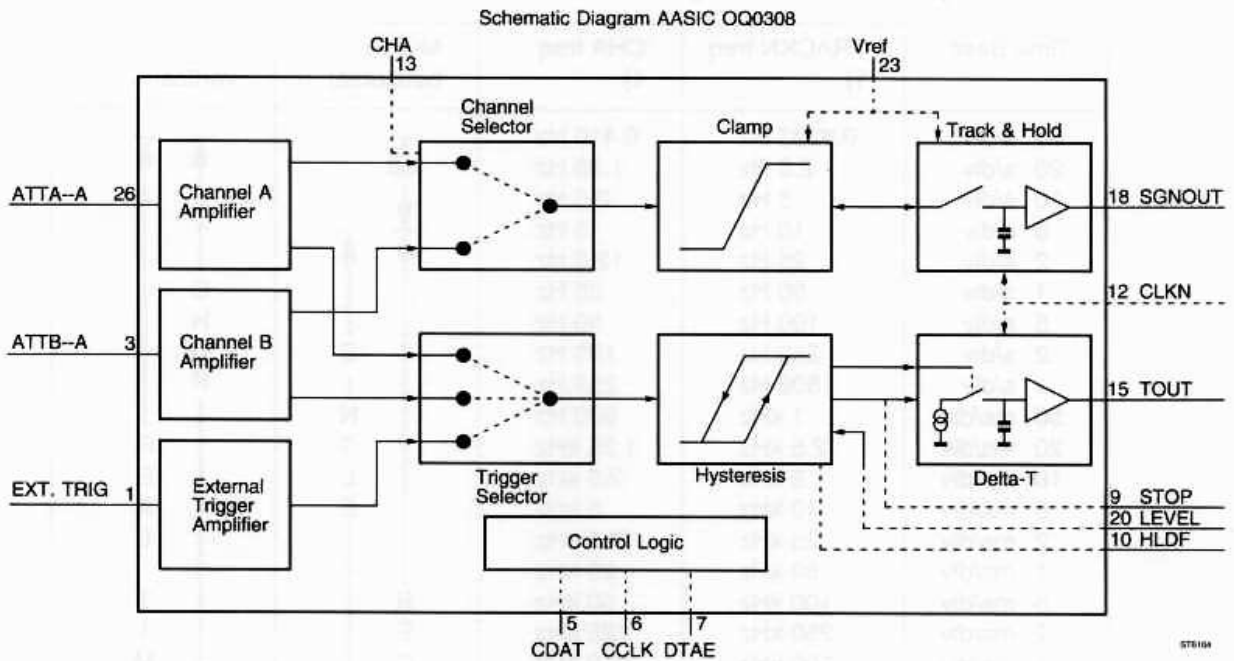


Figure 3.12 Schematic diagram A-ASIC D2301

Channel Selector

The channel selector selects channel A or channel B, depending on the level of the CHANA signal (input 13).

- If CHA is "high" (> 3.5 V) channel A is selected.
- If CHA is "low" (< 1.5 V) channel B is selected.

If a timebase speed faster than 20 μ s is selected, both channels are displayed in alternate mode and CHA is a square wave signal with a timebase-dependent frequency (see table 3.7). If a timebase speed slower than 50 μ s is selected, both channels are displayed in chopped mode. The CHA signal is a square wave signal with a trigger-dependent frequency of 500 kHz maximum.

Table 3.7 Frequencies of A-ASIC signals in various modes.

Time Base	TRACKN freq 1)	CHA freq 1)	MODE	
			horizontal	vertical
60 s/div	0.8333 Hz	0.416 Hz	roll	roll
20 s/div	2.5 Hz	1.25 Hz		
10 s/div	5 Hz	2.5 Hz	roll	roll
5 s/div	10 Hz	5 Hz		
2 s/div	25 Hz	12.5 Hz	roll	roll
1 s/div	50 Hz	25 Hz		
.5 s/div	100 Hz	50 Hz	roll	roll
.2 s/div	250 Hz	125 Hz		
.1 s/div	500 Hz	259 Hz	roll	roll
50 ms/div	1 kHz	500 Hz		
20 ms/div	2.5 kHz	1.25 kHz	roll	roll
10 ms/div	5 kHz	2.5 kHz		
5 ms/div	10 kHz	5 kHz	roll	roll
2 ms/div	25 kHz	12.5 kHz		
1 ms/div	50 kHz	25 kHz	roll	roll
.5 ms/div	100 kHz	50 kHz		
.2 ms/div	250 kHz	125 kHz	roll	roll
.1 ms/div	500 kHz	250 kHz		
50 µs/div	1 MHz	500 kHz	roll	roll
20 µs/div	1.25 MHz			
10 µs/div	2.5 MHz	Trigger	roll	roll
5 µs/div	5 MHz	dependent		
2 µs/div	12.5 MHz		roll	roll
1 µs/div	25 MHz			
.5 µs/div	25 MHz		roll	roll
.2 µs/div	25 MHz			
.1 µs/div	25 MHz		roll	roll
50 ns/div	25 MHz			
20 ns/div	25 MHz		roll	roll
10 ns/div	25 MHz			

1) In MIN/MAX mode (only possible for one channel), the frequency of CHA is zero and the sample frequency TRACK is always 25 MHz.

Clamp

To prevent the Track & Hold circuit from overdrive, the signal is clamped. The level of the output signal can be adjusted by means of VREF (input 23). VREF is the reference voltage, made by the circuit consisting of V2301, V2302 and R2323, R2324, and R2325 (see ADC section).

Track & Hold

The maximum sampling frequency of the ADC used in the ScopeMeter is 25 MHz. This means that the ADC can only handle signals with frequencies up to 12.5 MHz (half the sample frequency). Because of this a Track & Hold circuit is incorporated in the A-ASIC. The Track & Hold circuit determines the frequency range of the whole system.

The timing in this part of the A-ASIC is determined by clock signal TRACKN (input 12). The frequency of the TRACKN signal depends on the selected timebase speed (see table 3.7).

The output signal, SGNOUT, (output 18) is fed to the ADC. The voltage range of SGNOUT is 1.5V...3.5V. The intermediate level of SGNOUT is derived from the VREF voltage level, which is made by the ADC.

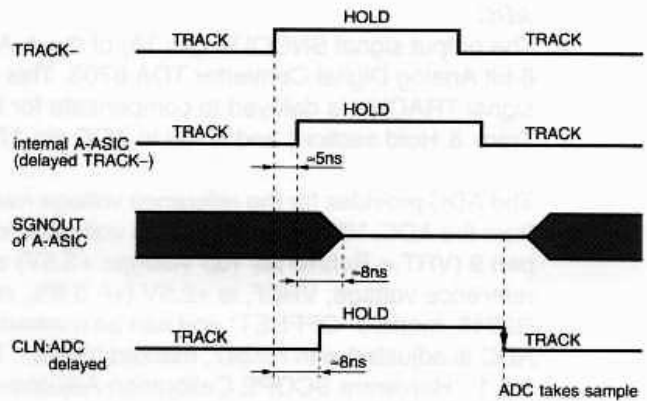


Figure 3.13 Track & Hold timing

External Trigger Amplifier

This amplifier section processes the incoming external trigger signal so that it can be used in the trigger section. The input of this section is TTL compatible.

Trigger Selector

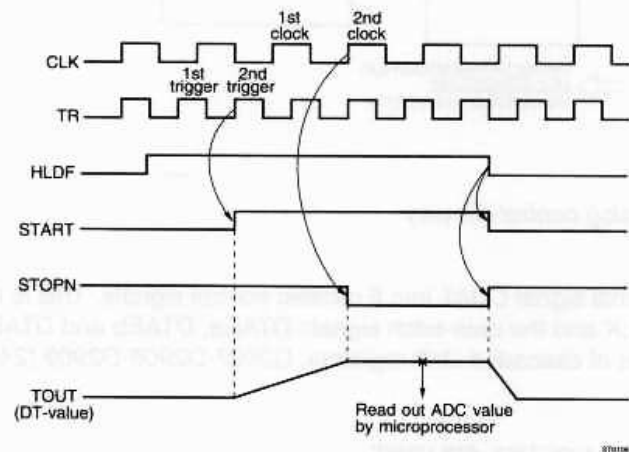
In this section the channel A, channel B or external trigger input signal is selected to act as trigger source. The trigger slope is also selected in this block.

Hysteresis

The hysteresis section converts the trigger signal into a pulse shaped signal. Because of the hysteresis, the circuit will not trigger on noisy signals. The LEVEL signal (input 20) that determines the trigger level, is a DC voltage between +0.5V and +2.0V. The LEVEL signal is a DC voltage, generated in the Digital ASIC. Resistor R2309 and capacitors C2312 and C2313 form a lowpass filter, to convert a pulse width modulated signal into the DC voltage.

Delta-T circuit

The Delta-T circuit measures the time between a trigger pulse and the moment the input signal is sampled. Figure 3.14 shows the timing diagram with relation to the signal HLDF (input 10), START (internal), STOPN (output 9), and TOUT (output 15).



START: internal (in the A-ASIC) start signal for the Delta-T measurement.
 TOUT: a voltage proportional to the measured value (time) of Delta T.

Figure 3.14 Timing diagram Delta-T circuit

Control logic

The control logic section contains a serial-in parallel-out shift register. This section gets its data from the microprocessor (D1201, circuit diagram A1, figure 10.2) via the CDAT (serial data), CCLK (serial clock), and DTAE (data-latch) lines. The control logic section controls all functional blocks within the A-ASIC.

ADC

The output signal SNGOUT (pin 18) of the A-ASIC is fed to the 8-bit Analog Digital Converter TDA 8703. This component operates on a 25 MHz clock signal. The signal TRACKN is delayed to compensate for the internal signal delay in the A-ASIC (behind the Track & Hold section) and is fed to ADC pin 17.

The ADC provides for the reference voltage needed by the A-ASIC. This reference voltage is derived from the ADC. VREF is made of the voltages on pin 4 (VRB = Reference Bottom Voltage: +1.5V) and pin 9 (VRT = Reference Top Voltage: +3.5V) of the ADC. During normal operating conditions this reference voltage, VREF, is +2.5V (+/- 3.6%, ref. to ground). VREF is adjusted with potentiometer R2346, marked "OFFSET" and can be measured between TP331 and ground. The sensitivity of the ADC is adjusted with R2347, marked "GAIN". These calibrations are described in chapter 5, section 5.6.1: "Hardware SCOPE Calibration Adjustments".

The 8-bit output of the ADC: ADC0...ADC7 is connected to the Digital ASIC on the digital A1 PCB.

3.4.6 ANALOG CONTROL CIRCUIT

- Introduction

See figure 3.13.

The various sections of the ScopeMeter, situated on the analog A2 PCB, are controlled by the microprocessor on the digital A1 PCB. This is done by means of the CCLK (serial clock), CDAT (serial data) and DTAE (data-latch) lines. This bus system creates several control signals, which for example drive the relays switches in the attenuator sections.

- Detailed circuit description

See figure 3.13 and circuit diagram A2a (figure 10.5).

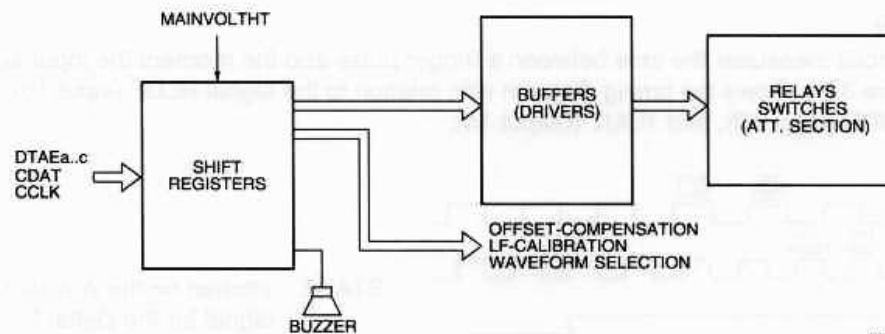


Figure 3.15 Schematic diagram analog control circuitry

Each shift register transforms the serial signal CDAT into 8 parallel control signals. This is done by means of the serial clock signal CCLK and the data-latch signals DTAEa, DTAEb and DTAEc. The control circuitry comprises two series of cascaded shift registers: D2907-D2908-D2909 (24 signals) and D2904- D2906(16 signals).

The signals, that are made by the shift registers, are used:

- to control the buffers (D2901 / D2902 / D2903), which drive the relays in the attenuator section.
- for offset compensation (A-RANGE and B-RANGE) in the attenuator sections.
- for L.F.-calibration (A-OFFSET and B-OFFSET) in the attenuator sections.
- to select the waveform in the signal generator section (sinewave/squarewave/DC).
- to drive the buzzer (beeper).

- Relay tables

In the following tables the number "1" means "high" (active) signal. "0" means "low" signal and "X" means "can be high or low (don't care)".

Channel B DC coupled

	K2101	K2102	K2103	K2201	K2202	K2203	K2750	K2751
¹⁾ 100 mV/div	1	0	0	x	x	x	x	0
²⁾ 1V/div	1	1	0	x	x	x	x	0
10V/div	1	0	1	x	x	x	x	0
100V/div	1	1	1	x	x	x	x	0
GROUND	0	1	1	x	x	x	x	0

Channel B AC coupled

	K2101	K2102	K2103	K2201	K2202	K2203	K2750	K2751
100 mV/div	0	0	0	x	x	x	x	0
1V/div	0	1	0	x	x	x	x	0
10V/div	0	0	1	x	x	x	x	0
100V/div	0	1	1	x	x	x	x	0
GROUND	0	1	1	x	x	x	x	0

Channel A DC coupled

	K2101	K2102	K2103	K2201	K2202	K2203	K2750	K2751
100 mV/div	x	x	x	1	0	0	x	0
1V/div	x	x	x	1	1	0	x	0
10V/div	x	x	x	1	0	1	x	0
100V/div	x	x	x	1	1	1	x	0
GROUND	x	x	x	0	1	1	x	0

Channel A AC coupled

	K2101	K2102	K2103	K2201	K2202	K2203	K2750	K2751
100 mV/div	x	x	x	0	0	0	x	0
1V/div	x	x	x	0	1	0	x	0
10V/div	x	x	x	0	0	1	x	0
100V/div	x	x	x	0	1	1	x	0
GROUND	x	x	x	0	1	1	x	0

¹⁾ Relay information valid for SCOPE attenuator settings up to 100 mV/div.

²⁾ Relay information valid for SCOPE attenuator settings between 100 mV/div and 1V/div, etc.

EXTernal input

	K2101	K2102	K2103	K2201	K2202	K2203	K2750	K2751
Ext. Trig	x	x	x	x	x	x	0	0
Generator	x	x	x	x	x	x	1	0

METER V DC mode

	K2101	K2102	K2103	K2201	K2202	K2203	K2750	K2751
300 mV	0	1	1	1	1	0	x	0
3V	0	1	1	1	0	1	x	0
30V	0	1	1	1	1	1	x	0
300V	0	1	1	1	1	1	x	0

METER V AC mode

	K2101	K2102	K2103	K2201	K2202	K2203	K2750	K2751
300 mV	0	1	1	0	1	0	x	0
3V	0	1	1	0	0	1	x	0
30V	0	1	1	0	1	1	x	0
300V	0	1	1	0	1	1	x	0

METER V DC + AC mode

	K2101	K2102	K2103	K2201	K2202	K2203	K2750	K2751
300 mV	0	1	1	1	1	0	x	0
3V	0	1	1	1	0	1	x	0
30V	0	1	1	1	1	1	x	0
300V	0	1	1	1	1	1	x	0

METER mV mode (EXTernal inputs)

	K2101	K2102	K2103	K2201	K2202	K2203	K2750	K2751
300 mV	0	1	1	0	0	1	1	0
3V	0	1	1	0	0	1	1	0

METER Ω mode

	K2101	K2102	K2103	K2201	K2202	K2203	K2750	K2751
300 Ohm	0	1	1	0	0	1	1	1
3 KOhm	0	1	1	0	0	1	1	1
30 KOhm	0	1	1	0	0	1	1	1
300 KOhm	0	1	1	0	0	1	1	1
3 MOhm	0	1	1	0	0	1	1	1
30 MOhm	0	1	1	0	0	1	1	1

- Control lines tables

Channel B DC coupled

	Sr1a	Sr2a	Sr3a	Sr4a	Sgnd8b	Sr1b	Sr2b	Sr3b	Sr4b	Sgnd8a	mV	OHM
100 mV/div	1	0	0	0	0	x	x	x	x	x	x	x
1V/div	1	1	0	0	0	x	x	x	x	x	x	x
10V/div	0	0	1	1	0	x	x	x	x	x	x	x
100V/div	0	1	1	1	0	x	x	x	x	x	x	x
GROUND	0	0	0	1	1	x	x	x	x	x	x	x

Channel B AC coupled

	Sr1a	Sr2a	Sr3a	Sr4a	Sgnd8b	Sr1b	Sr2b	Sr3b	Sr4b	Sgnd8a	mV	OHM
100 mV/div	1	0	0	0	0	x	x	x	x	x	0	0
1V/div	1	1	0	0	0	x	x	x	x	x	0	0
10V/div	0	0	1	1	0	x	x	x	x	x	0	0
100V/div	0	1	1	1	0	x	x	x	x	x	0	0
GROUND	0	0	0	1	1	x	x	x	x	x	0	0

Channel A DC coupled

	Sr1a	Sr2a	Sr3a	Sr4a	Sgnd8b	Sr1b	Sr2b	Sr3b	Sr4b	Sgnd8a	mV	OHM
100 mV/div	x	x	x	x	x	1	0	0	0	0	0	0
1V/div	x	x	x	x	x	1	1	0	0	0	0	0
10V/div	x	x	x	x	x	0	0	1	1	0	0	0
100V/div	x	x	x	x	x	0	1	1	1	0	0	0
GROUND	x	x	x	x	x	0	0	0	1	1	0	0

Channel A AC coupled

	Sr1a	Sr2a	Sr3a	Sr4a	Sgnd8b	Sr1b	Sr2b	Sr3b	Sr4b	Sgnd8a	mV	OHM
100 mV/div	x	x	x	x	x	1	0	0	0	0	0	0
1V/div	x	x	x	x	x	1	1	0	0	0	0	0
10V/div	x	x	x	x	x	0	0	1	1	0	0	0
100V/div	x	x	x	x	x	0	1	1	1	0	0	0
GROUND	x	x	x	x	x	0	0	0	1	1	0	0

METER V DC mode

	Sr1a	Sr2a	Sr3a	Sr4a	Sgnd8b	Sr1b	Sr2b	Sr3b	Sr4b	Sgnd8a	mV	OHM
300 mV	0	0	0	1	1	1	1	0	0	0	0	0
3V	0	0	0	1	1	0	0	1	1	0	0	0
30V	0	0	0	1	1	0	1	1	1	0	0	0
300V	0	0	0	1	1	0	1	1	1	0	0	0

METER V AC mode

	Sr1a	Sr2a	Sr3a	Sr4a	Sgnd8b	Sr1b	Sr2b	Sr3b	Sr4b	Sgnd8a	mV	OHM
300 mV	0	0	0	1	1	1	1	0	0	0	0	0
3V	0	0	0	1	1	0	0	1	1	0	0	0
30V	0	0	0	1	1	0	1	1	1	0	0	0
300V	0	0	0	1	1	0	1	1	1	0	0	0

METER V DC + AC mode

	Sr1a	Sr2a	Sr3a	Sr4a	Sgnd8b	Sr1b	Sr2b	Sr3b	Sr4b	Sgnd8a	mV	OHM
300 mV	0	0	0	1	1	1	1	0	0	0	0	0
3V	0	0	0	1	1	0	0	1	1	0	0	0
30V	0	0	0	1	1	0	1	1	1	0	0	0
300V	0	0	0	1	1	0	1	1	1	0	0	0

METER mV mode (EXTERNAL inputs)

	Sr1a	Sr2a	Sr3a	Sr4a	Sgnd8b	Sr1b	Sr2b	Sr3b	Sr4b	Sgnd8a	mV	OHM
300 mV	0	0	0	1	1	0	0	0	1	1	1	0
300V	0	0	0	1	1	0	1	0	1	1	1	0

METER Ω / \rightarrow modes

	Sr1a	Sr2a	Sr3a	Sr4a	Sgnd8b	Sr1b	Sr2b	Sr3b	Sr4b	Sgnd8a	mV	OHM
300 Ohm	0	0	0	1	1	0	0	0	1	1	0	1
3 KOhm	0	0	0	1	1	0	0	0	1	1	0	1
30 KOhm	0	0	0	1	1	0	0	0	1	1	0	1
300 KOhm	0	0	0	1	1	0	0	0	1	1	0	1
3 MOhm	0	0	0	1	1	0	0	0	1	1	0	1
30 MOhm	0	0	0	1	1	0	1	0	1	1	0	1
Diode	0	0	0	1	1	0	1	0	1	1	0	1

	Sc15	Sc16	Sc17	Sc18
300 Ohm	1	0	1	1
3 KOhm	1	0	1	0
30 KOhm	1	0	0	0
300 KOhm	1	1	0	0
3 MOhm	0	1	0	0
30 MOhm	0	1	0	0
Diode	1	0	1	1

	G_OUTP
Ext. Trig.	0
Generator	1

	BUZ
Buzzer off	1
Buzzer on	0

	SCOPE mode Attenuator settings		METER mode
	≥ 20 mV/div	≤ 10 mV/div	
D-POSCHA	0	1	1
D-POSCHB	1	1	x

While the ScopeMeter is operating in METER mode or when the instrument is calibrated, the signals Si, mV, OHM, Sr1b, Sr2b, Sr3b, Sr4b, and D_POSCHB can change ("high/low"). Signals Ex and Ey are used to switch the relays. Both signals are "high" when the relays are not operated.

Signals Sg4a, Sg5a, Sg6a, and Sg7a set the L.F. gain for channel A. Sg4b, Sg5b, Sg6b, and Sg7b set the L.F. gain for channel B. Sg4a (Sg4b) is the most significant bit (MSB), Sg7a (Sg7b) is the least significant bit (LSB).

Signals So10b, So11b, S012b, So13b, and So14b are used to set the offset compensation in the preamplifier circuits of channel A. Signals Sc15, Sc16, Sc17, Sc18, and S014a are used to set the offset compensation in the preamplifier circuits of channel B. S010b (Sc15) is the most significant bit (MSB), So14b (So14a) is the least significant bit (LSB).

3.4.7 GENERATOR circuit

- Introduction

See figure 3.14.

The ScopeMeter has a built-in signal generator, which can produce the following signals, used to adjust the probes:

- square wave voltage, amplitude: 5V peak-to-peak
 frequency: 976 Hz
- DC voltage: 3V

ScopeMeter model 97 can also produce:

- sine wave voltages, amplitude: 5V peak-to-peak
 frequency: 976 Hz
- square wave voltages, amplitude: 5V peak-to-peak
 frequencies: 488 Hz
 1.95 kHz
- slow ramp voltage, -2V...+2V
- slow ramp current, -3 mA...+3mA

The signal generator uses a square wave voltage, coming from the D-ASIC to generate the various signals. The circuit consists of an operational amplifier, a fourth order filter, and a current source. The configuration can be changed by means of programmable switches to produce different output signals.

- Detailed circuit description

See figure 3.16 and circuit diagram A2b (figure 10.6).

Figure 3.16 shows the basic generator circuitry:

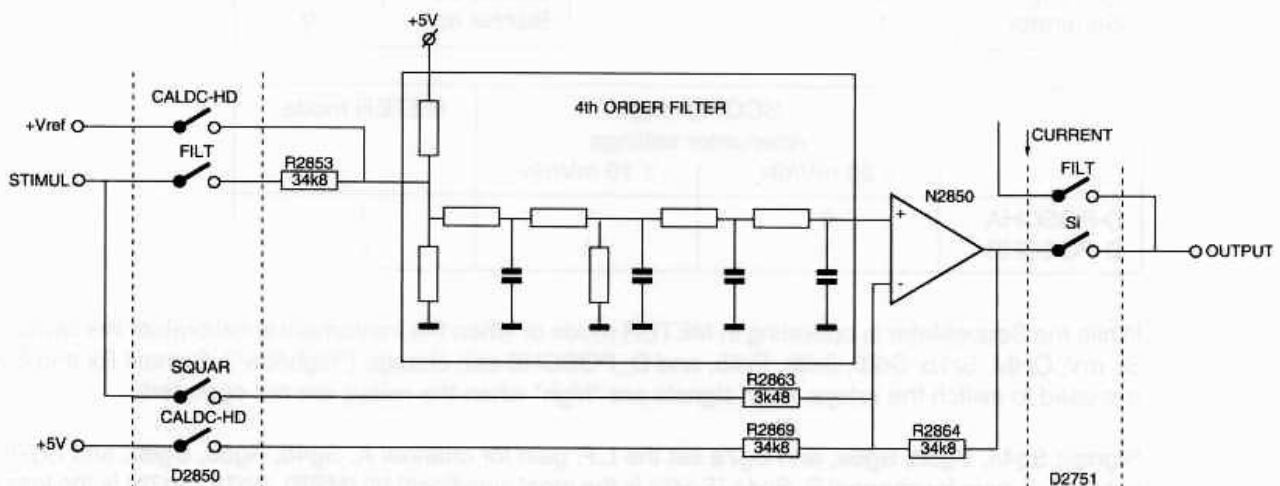


Figure 3.16 Basic generator circuitry

This circuit uses a square wave voltage, STIMULO, coming from the D-ASIC. This signal has an amplitude between 0V and +5V. The duty cycle of the square wave signal is varied depending on the signal to be generated. The reference voltage +Vref is used to generate the DC voltage.

The configuration depends on the settings of switches D2850 and D2751. These switches are controlled by the signals FILT, CALDC- HD, SQUAR and Si. Table 3.8 lists the various settings and resulting generator output signals.

Table 3.8 Generator control signals for various generator output signals.

STIMUL		CONTROL SIGNALS				OUTPUT SIGNAL	
frequency	duty cycle	CALDC- HD	FILT	SQUAR	Si	amplitude	waveform
488 Hz	50%	0	0	1	1	5 V p-p	Square wave voltage
976 Hz	50%	0	0	1	1	5 V p-p	
1.95 kHz	50%	0	0	1	1	5 V p-p	
-	-	1	0	0	1	3 V p-p	DC voltage
976 Hz	50%	0	1	0	1	1 V p-p	Sine wave voltage
20 kHz	0-100%	0	1	0	1	-2...+2 V p-p	Slow ramp voltage
20 kHz	0-100%	0	1	0	0	0...+3 mA	Slow ramp current

In this table "1" means: signal "high" (switch closed) and "0" means signal "low" (switch open).

The slow ramp current signal is made with a current source. A simplified schematic diagram is given in figure 3.17:

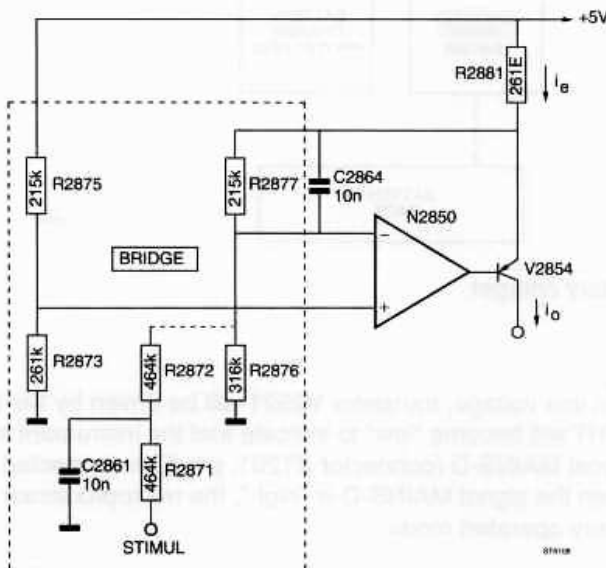


Figure 3.17 Current source section of generator

When the duty cycle of STIMUL is 0%, the bridge will be in balance and current $i_e = 0$. When the duty cycle of STIMUL is increased, a DC component is generated, which has a linear relation to the duty cycle. The operational amplifier tries to keep the voltages on both inputs the same. The operational amplifier will now drive transistor V2854 to increase i_e . Because i_e is almost equal to i_o , the output current will also increase. In this way it is possible to regulate the current i_o by means of the duty cycle of STIMUL.

3.4.8 BATTERY CHARGER

- Introduction

See figure 3.18.

The battery charger consists of a switched mode power supply and some auxiliary circuitry. Whenever the ScopeMeter is connected to the line voltage (via the separate power adapter/battery charger PM8907), the instrument switches over to line voltage operation automatically. If a NiCd battery pack is installed, the ScopeMeter will charge this if line voltage is present. Special circuitry prevents discharge of the batteries when the instrument is not being used.

- Detailed circuit description

See figure 3.18 and circuit diagram A2c (figure 10.7).

HF Filter

The input voltage (between 8V and 20V) first passes HF FILTER Z2501 and is used to drive a flyback converter.

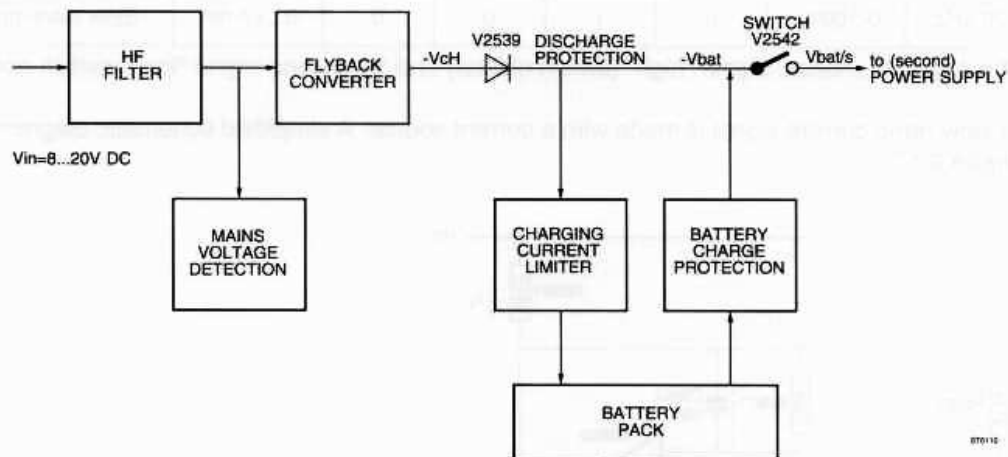


Figure 3.18 Schematic diagram battery charger

Line voltage detection

When the ScopeMeter is operated on line voltage, transistor V2521 will be driven by the (filtered) input voltage. The signal MAINVOLTHT will become "low" to indicate that the instrument is operated from the line voltage. The related signal MAINS-D (connector X1201, pin 5) is connected to the microprocessor analog input 19. When the signal MAINS-D is "high", the microprocessor will not switch off the ScopeMeter, as in battery operated mode.

Flyback converter

See figure 3.19 and circuit diagram A2c (figure 10.7).

The main components of this flyback converter are V2532 (converter-switch), L2504 and L2505 (windings), R2582 (sense resistor), and C2536 and V2533 (secondary circuit). The main regulating element is N2503 (see figure 3.19).

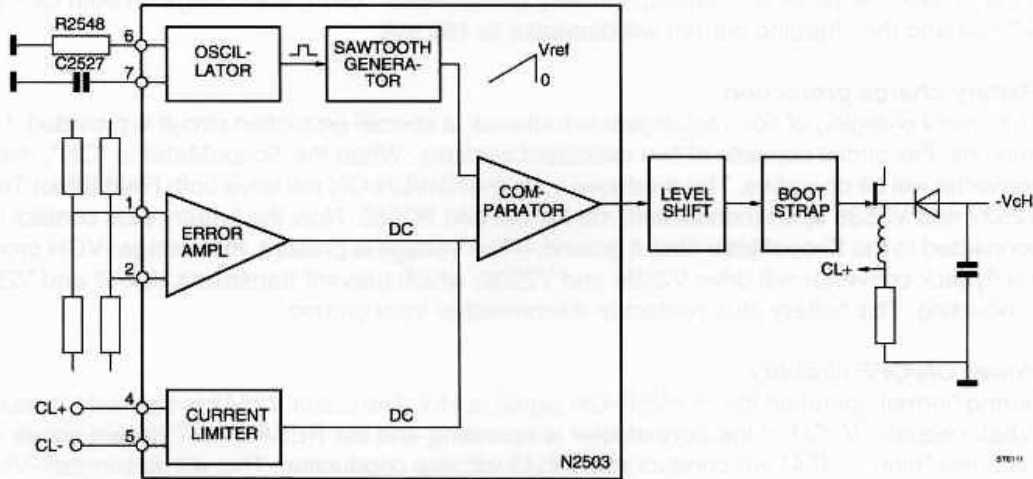


Figure 3.19 Schematic diagram flyback converter

N2503 incorporates an oscillator, the frequency of which is determined by R2548 and C2527 (fixed frequency of 100 kHz). This oscillator drives a sawtooth generator. The produced sawtooth voltage is compared to a DC voltage. This DC voltage is made by an internal error amplifier (voltage regulator), which compares the produced converter voltage -V_CH to a stable 5V reference voltage. This is done with a bridge circuit (R2554, R2555, R2557, R2558).

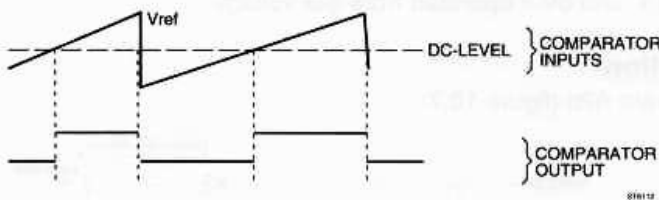


Figure 3.20 Internal N2503 voltage waveforms

When the sawtooth voltage is larger than the DC voltage, the output signal (CA, CB on pins 12,13) is "high". When the sawtooth voltage is less than the DC voltage, the output signal is "low". In this way the duty cycle of N2503's output signal can be changed, thus changing the energy transferred to the secondary converter circuit.

The output signal is level shifted by transistor V2526 and related circuitry. Now this square wave signal is used to drive converter switch V2532, which is bootstrapped via V2528, V2529, R2546, R2562, and C2537.

Charging current limiter

N2503 limits the voltage difference between CL+ (pin 4) and CL- (pin 5) to 200 mV. If the voltage between these two inputs starts to rise, the internal DC voltage will rise, and the duty cycle of the output square wave voltage will decrease (see voltage regulation described earlier).

If the ScopeMeter is connected to the line voltage and is not operational, the flyback converter operates almost without a load (only the NiCd battery pack). This implies that the current floating through windings L2504 and L2505 (averaged in time) is almost zero. Because of this, the voltage on CL+ is about 30 mA and the voltage on CL- is about 170 mV. The battery pack will be charged with 170 mA.

If the flyback converter is operated normally (ScopeMeter "ON"), the voltage on both CL- and CL+ will rise and the charging current will decrease to 100 mA.

Battery charge protection

To prevent charging of non-rechargeable batteries, a special protection circuit is provided. For safety reasons, this circuit consists of two cascaded sections. When the ScopeMeter is "ON", the flyback converter will be operative. The produced voltage POWER-ON will drive both Field Effect Transistors V2537 and V2538 open (conductive) via R2568 and R2569. Now the battery plus contact is connected to the ScopeMeter circuit ground. If line voltage is present, the voltage -VCH produced by the flyback converter will drive V2534 and V2536, which prevent transistors V2537 and V2538 from conducting. The battery plus contact is disconnected from ground.

Power ON/OFF circuitry

During normal operation the POWER-ON signal is +5V. Transistor V2542 is opened (conductive), so -Vbat/s equals -V_CH. If the ScopeMeter is operating and the RESPOWHT ("reset power supply") becomes "high", V2541 will conduct and V4542 will stop conducting. This will disconnect -Vbat/s from -V_CH.

3.4.9 POWER SUPPLY

- Introduction

See figure 3.19.

Different supply voltages are needed for various ScopeMeter sections. A second flyback converter is used to convert -Vbat/s to supply voltages of -30V, -5V and +5V. This voltage, -Vbat/s, is made by the first flyback converter (in the battery charger section) or comes from the batteries. -Vbat/s is 5V if operated with NiCad battery pack, and 8V if operated from line voltage.

- Detailed circuit description

See figure 3.19 and circuit diagram A2c (figure 10.7).

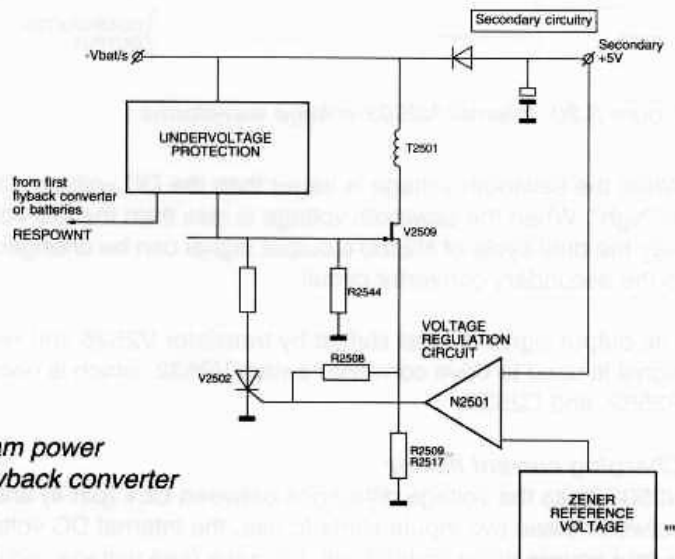


Figure 3.21 Schematic diagram power supply, second flyback converter

This self-oscillating flyback converter consists of:

- V2509 (converter-switch)
- R2509...R2517 (sense-resistors)
- V2502 (thyristor switch)
- R2544 (start-up resistor)
- T2501 (windings)
- 3 separate secondary circuits for -30V, -5V, and +5V

The main regulating component is operational amplifier N2501. This op-amp compares the produced secondary +5V voltage with a reference voltage, produced by zener diode N2502. If the secondary +5V increases, the fault signal generated by the N2501 will produce a current that causes an extra voltage drop over R2508. Because of this, thyristor V2502 will fire earlier. The switching frequency of the flyback converter increases and the secondary +5 V voltage decreases.

When the ScopeMeter is switched on (RSSLSTN is "active low"), V2544 (see circuit diagram A2c, figure 10.6) connects the inverting input of N2501 to ground. When the ScopeMeter starts up, capacitor C2509 causes the reference voltage and therefore the output voltage, to rise slowly, limiting the inrush ("starting") current drawn from the batteries or line voltage.

Undervoltage detection and protection circuit

When the flyback converter is oscillating, capacitor C2532 is charged every period via R2543 and V2516. During normal operation C2532 is discharged by V2517, which is driven via R2541, V2511, R2529, and V2509. If, for example, the secondary +5V voltage becomes too low, C2532 is not discharged by V2517. This will activate the RESPOWHT signal, and the power will be switched off completely, preventing further damage of circuits. (The +5V voltage can become too low because the input voltage -Vbat/s is too low, or the power output to the ScopeMeter circuitry is too high.)

R2542, C2531, and diode V2508 will reset C2532 during the start up of the power supply (the voltage across C2532 will become zero). This is necessary because V2517 cannot be driven via V2541, just after the ScopeMeter is switched on.

Reference source

The reference source provides a stable positive (+Vref) and negative reference voltage (-Vref) used in other parts of the ScopeMeter. It also uses the voltage across zener diode N2502 as an input voltage.

NOTE: *The flyback converter, used in the battery charger section (section 3.4.8) has a fixed oscillating frequency of 100 kHz. The amount of energy supplied is regulated by varying the duty cycle. The flyback converter used in this power supply, however, is self-oscillating and operates on a variable oscillating frequency and a fixed duty cycle. For alkaline batteries, for example, the oscillating frequency is about 62 kHz.*

4 PERFORMANCE VERIFICATION PROCEDURE

4.1 GENERAL INFORMATION

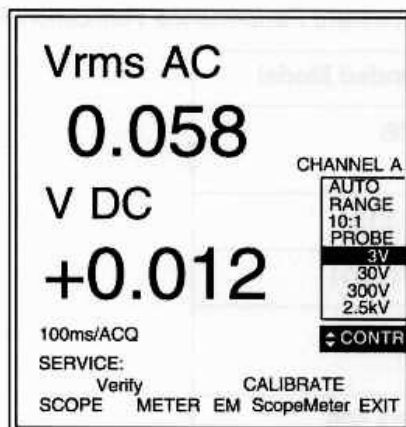
The ScopeMeter should be calibrated and in operating condition when you receive it.

The following performance tests are provided to ensure that the ScopeMeter is in a proper operating condition. If the instrument fails any of the performance tests, calibration adjustments (see chapter 5) and/or repair (see chapter 7) is necessary.

The Performance Verification Procedure described here consists of two parts:

- Standard Performance Verification Procedure
(separate SCOPE- and METER-section)
- Additional Performance Verification Procedure

The **Standard Performance Verification Procedure** uses built-in ScopeMeter front panel settings or frontsettings, that can be accessed via the SERVICE MENU. To enter the SERVICE MENU, press both AC/DC/GROUND keys simultaneously. This menu allows you to choose between SCOPE and METER performance testing ("Verify").



8T5977

Figure 4.1 Service menu

When the ScopeMeter is in SERVICE mode, only the softkeys, the select/adjust keys and the ON/OFF key can be operated.

It is possible to move forward or backward through the frontsettings, that apply to the separate performance test steps. This can be done using the adjust/select keys. You can leave the Performance Verification Procedure any time by pressing the EXIT softkey. The Performance Verification Procedure steps are explained in the following sections.

The **Additional Performance Verification Procedure** can be used to do some extra checks, depending on the ScopeMeter version (93, 95 or 97). In these tests the ScopeMeter must be set up manually.

NOTE: This Performance Verification Procedure is a quick way to check most of the instrument's specifications. Because of the highly integrated design of the ScopeMeter, it is not always necessary to check all features separately. The procedure described here often combines many test steps in one procedure step, thereby minimizing total test time.

The Performance Verification Procedure is based on the specifications, listed in chapter 2 of this Service Manual. The values (requirements) given here are valid for ambient temperatures between 18C and 28C.

4.2 STANDARD PERFORMANCE VERIFICATION PROCEDURE

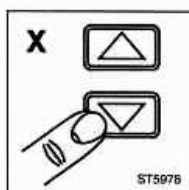
This section explains the required Performance Verification Procedure setup, with the actions that have to be done for each step. Follow the instructions described with each step. The recommended test equipment, required for this Standard Performance Verification Procedure, is listed in table 4.1.

Table 4.1 Recommended test equipment Standard Performance Verification Procedure

Instrument Type	Recommended Model
Multifunction Calibrator	Fluke 5100B
Function Generator	Philips PM 5134
Time Mark Generator	Tektronix TG 501
Constant Amplitude Sine wave Generator	Tektronix SG 503
Square wave Calibration Generator	Tektronix PG 506

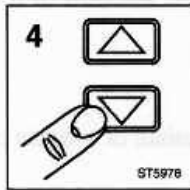
- Cables and terminations for the generators (all BNC type)
- Two standard banana test leads (delivered with the ScopeMeter)
- BNC (female)-to-banana (male) (delivered with the ScopeMeter)

NOTE: During the following Performance Verification Procedure, the ScopeMeter input sockets are connected to the signal generator outputs by means of cables (BNC connector channel A or B) or two standard banana test leads (COM and mV/Ohm/Diode banana connectors). The oscilloscope probes delivered with the instrument are not used during the Standard Performance Verification Procedure. The calibration of the probes is described in the Users Manual.



In the following text, this figure is used to indicate that one of the select/adjust keys (up/down) must be pressed, to display the indicated step number "x" on the ScopeMeter screen.

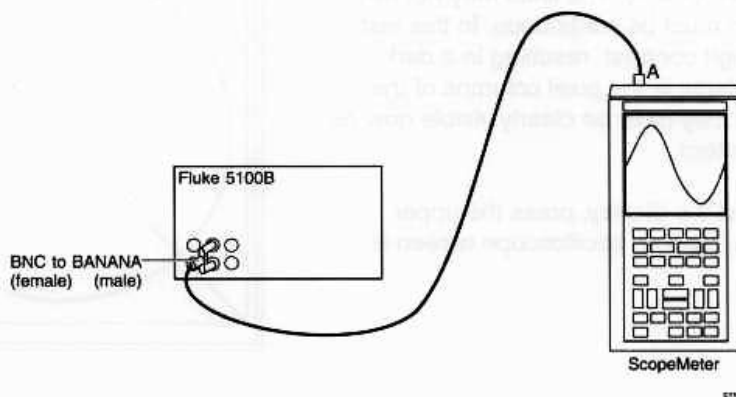
4. Vertical deflection coefficients channel A



These tests check the vertical deflection coefficients for channel A in the 100 mV/div DC and AC ranges.

Test equipment:
Fluke 5100B Calibrator

Test setup:



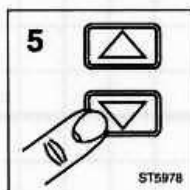
Procedure/requirements for AC test:

- A Apply a 1 kHz sine wave signal with an amplitude of 600 mV AC peak-to-peak to the channel A BNC connector.
(Set the Fluke 5100B to 212.13 mV RMS, 1 kHz sine wave).
Verify that the amplitude of the sine wave signal displayed is 5.88...6.12 divisions.

Procedure/requirements DC test:

- B Apply 300 mV DC to channel A.
Verify that the distance between the trace for channel A and the vertical middle of the screen (ground level) is 2.94...3.06 divisions.

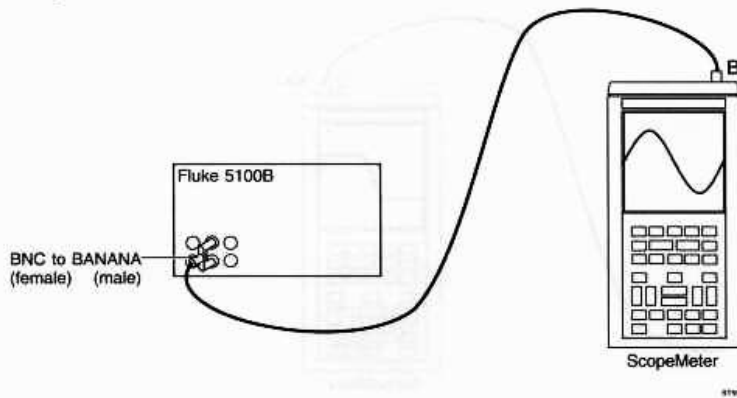
5/6/7. Vertical deflection coefficients channel B



These tests check the vertical deflection coefficients for channel B in the DC and AC ranges.

Test equipment:
Fluke 5100B Calibrator

Test setup:



Procedure/requirements for channel B AC and DC tests:

- A Apply 300 mV DC to channel B.
- B Change the input voltage and the setting of channel B according to table 4.2 and check that the amplitude of the signal agrees with the value listed. Use the select/adjust keys to select each step number.

NOTE: The AC voltages listed in this are peak-to-peak voltages (sine wave). The values listed between brackets () are the RMS values that have to be chosen on the Fluke 5100B calibrator.

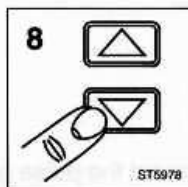
Requirements:

Table 4.2 Requirements vertical deflection coefficients for channel B.

Input voltage	Step number on display	Requirements
300 mV DC	"5"	2.94...3.06 div.
600 mV AC pp (212.13mV RMS), 1 kHz	"5"	5.88...6.12 div.
3V DC	"6"	2.94...3.06 div.
6V AC pp (2.1213V RMS), 1 kHz	"6"	5.88...6.12 div.
30V DC	"7"	2.94...3.06 div.
60V AC (21.213 V RMS), 1 kHz	"7"	5.88...6.12 div.

The ScopeMeter uses the same input circuitry (hardware) for the SCOPE and the METER modes (in the above attenuator settings). When the voltage accuracy is checked (see the description "METER Performance Verification Procedure" step 1), the deflection coefficients for SCOPE channel A are also tested.

8/9. Rise time

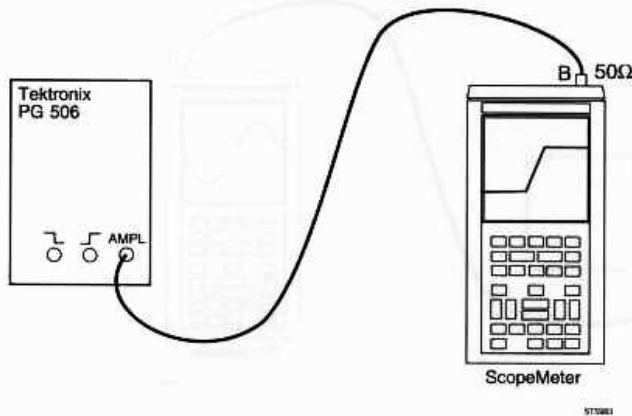


The rise time of the ScopeMeter is checked by means of a fast rise time pulse. First channel B is measured.

Test equipment:

Tektronix PG 506 Square Wave Calibration Generator

Test setup channel B rise time measurement:



Procedure for channel B rise time measurement:

- A Apply a fast rise time pulse, repetition frequency 1 MHz, amplitude 0.5V to channel B. Use a 50Ω termination. Set the generator in position "FAST RISE".
- B Adjust the pulse amplitude to exactly 5 divisions. See figure 4.4.

Requirements:

NOTE:

$$t_r(\text{measured}) = \sqrt{(t_r(\text{input signal})^2 + t_r(\text{ScopeMeter})^2)}$$

- C Check the rise time, measured between 10% and 90% of the pulse amplitude. See figure 4.4. The rise time $t_r(\text{measured})$ must be 7 ns (0.7 div) or less.

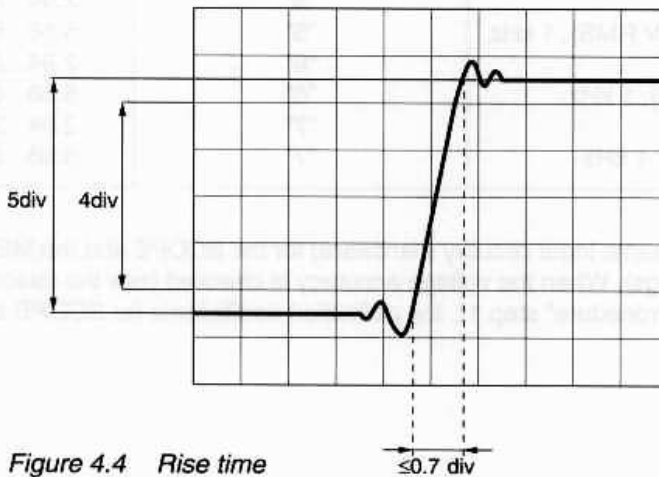
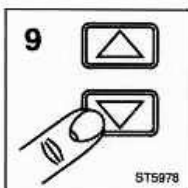


Figure 4.4 Rise time

5T5904



Test setup channel A rise time measurement:

Refer to the test set-up for channel B measurement. Connect the pulse generator to the channel A BNC input connector.

5T5978

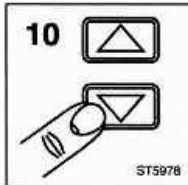
Procedure for channel A rise time measurement:

Refer to the settings/procedure for channel B measurement.

Requirements:

Refer to channel B requirements.

10/11/12/13. Frequency response

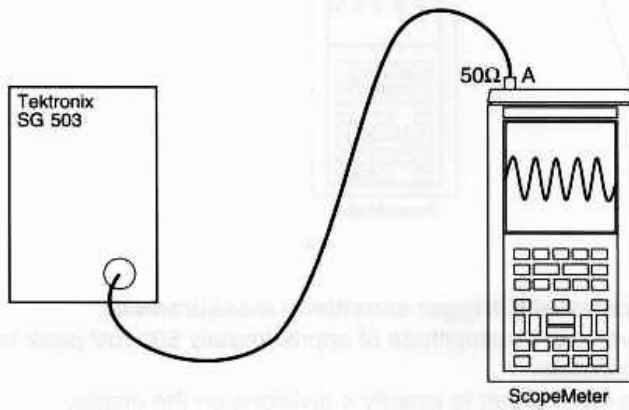


These tests check the upper transition point of the bandwidth for ScopeMeter vertical channels A and B.

Test equipment:

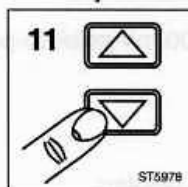
Tektronix SG 503 Constant Amplitude Sine wave Generator

Test setup:

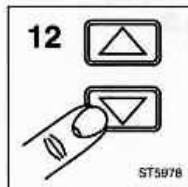


Procedure/requirements for channel A frequency response measurement:

- A Apply a 50 kHz sine wave with an amplitude of 120 mV peak-to-peak to channel A. Use a 50Ω termination. Adjust the input signal to a trace height of exactly 6 divisions.

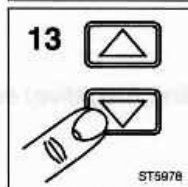


- B Without changing the amplitude of the sine wave signal, switch over to step 11 using the upper select/adjust key. Increase the frequency of the sine wave to 50 MHz and verify that the vertical deflection is 4.2 divisions or more.



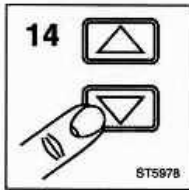
Procedure/requirements for channel B frequency response measurement:

- C Apply a 50 kHz sine wave with an amplitude of 120 mV peak-to-peak to channel B. Use a 50Ω termination. Adjust the input signal to a trace height of exactly 6 divisions.



- D Without changing the amplitude of the sine wave signal, switch over to step 13 using the upper select/adjust key. Increase the frequency of the sine wave to 50 MHz and check that the vertical deflection is 4.2 divisions or more.

14/15/16/17. Trigger sensitivity channel A and B

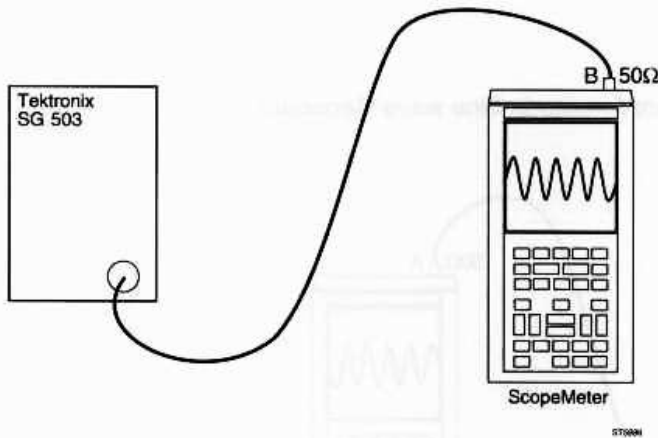


The trigger sensitivity depends on the amplitude and frequency of the trigger signal. This test checks the trigger sensitivity of the ScopeMeter. Also the +SLOPE/-SLOPE function (triggering on negative slope) is tested for both channels A and B. Channel B is tested first.

Test equipment:

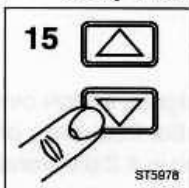
Tektronix SG 503 Constant Amplitude Sine Wave Generator

Test setup:



Procedure/requirements for channel B trigger sensitivity measurement:

- A Apply a 100 MHz sine wave, with an amplitude of approximately 500 mV peak-to-peak to channel B. Use a 50Ω termination.
- B Adjust the amplitude of the input signal to exactly 4 divisions on the display.
- C Verify that the signal is well triggered.
- D Apply a 60 MHz sine wave, with an amplitude of approximately 100 mV peak-to-peak to channel B. Use a 50Ω termination.
- E Adjust the amplitude of the input signal to exactly 1.5 divisions on the display.
- F Verify that the signal is well triggered.



G Apply a 10 MHz sine wave, with an amplitude of 300 mV peak-to-peak to channel B. Use a 50Ω termination.

- H Adjust the amplitude of the input signal to exactly 1.5 divisions. on the display.
- I Verify that the signal is well triggered on the **falling** edge. See figure 4.5.

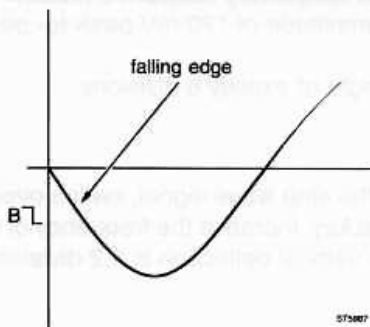
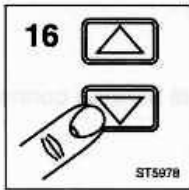
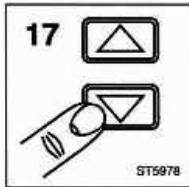


Figure 4.5 Signal triggered on the falling (negative) edge

Procedure/requirements for channel A trigger sensitivity measurement:

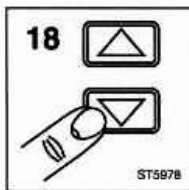


16 K Repeat steps G...I for channel A.



17 L Repeat steps A...F for channel A.

18. Timebase

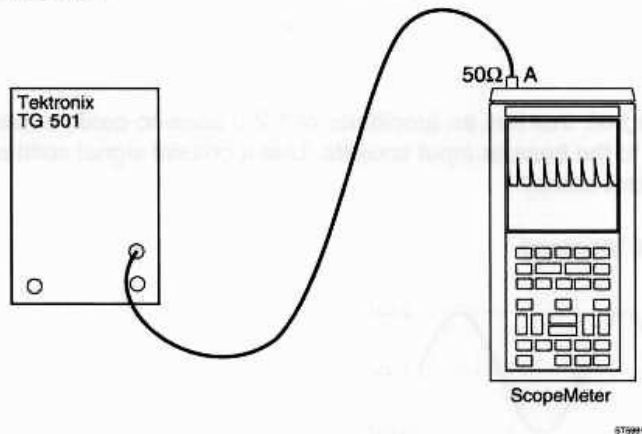


18 This test uses a marker pulse calibration signal to verify the deflection coefficient of the time base.

Test equipment:

Tektronix TG 501 Time Mark Generator

Test set-up:



Procedure/requirements:

- A Apply a 1 μ s (1V peak-to-peak) time marker signal to channel A. Use a 50 Ω termination.
- B Verify that the distance between the 10th marker pulse and the 10th vertical grid line is the same as the distance between the 2nd marker pulse and the 2nd vertical grid line. (Tolerance ± 1 pixel = ± 0.04 divisions).

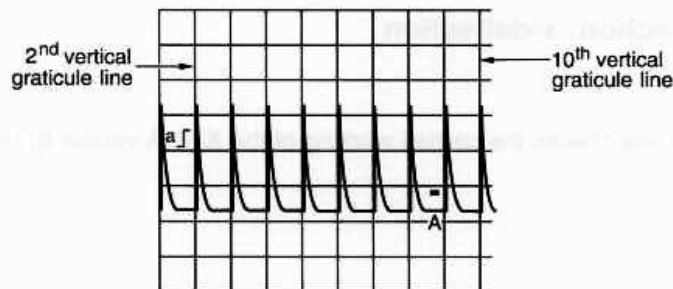
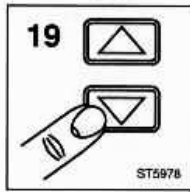


Figure 4.6 The distance between the 10th marker pulse and the 10th vertical grid line must be the same as the distance between the 2nd marker pulse and the 2nd vertical grid line.

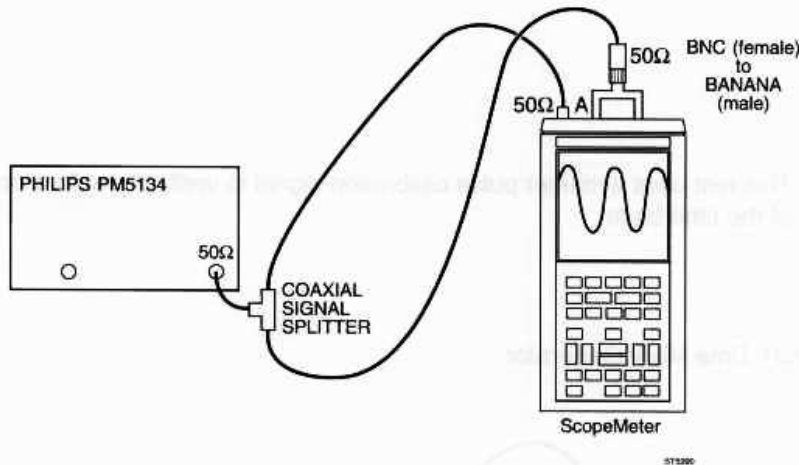
19. Trigger sensitivity external channel



This test checks the trigger sensitivity, using the external banana connectors as the trigger input.

Test equipment:
Philips PM 5134 Function Generator

Test setup:



Procedure/requirements:

- A Apply a 1 kHz sine wave signal, that has an amplitude of 1.2 V peak-to-peak, superimposed on 1.4V DC to channel A and to the banana input sockets. Use a coaxial signal splitter and a BNC-to-banana converter (see test setup). Use 50Ω terminations.
- B Verify that the signal is well triggered.

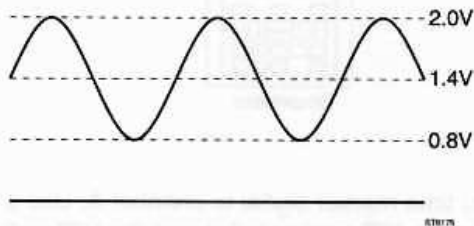
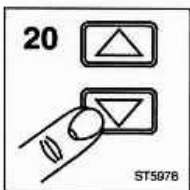


Figure 4.7 1.2V peak-to-peak sine wave superimposed on 1.4V DC

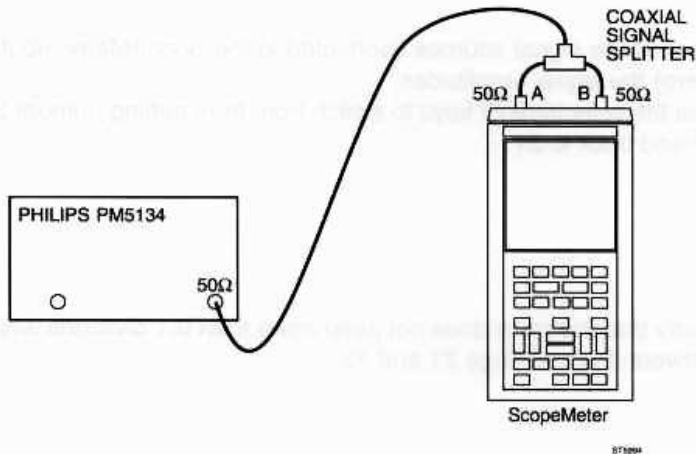
20. Horizontal deflection: x-deflection



This test checks the correct working of the X-Y (A versus B) mode.

Test equipment:
Philips PM 5134 Function Generator

Test set-up:



Procedure:

- A Apply a 2 kHz sine wave signal of 800 mV peak-to-peak to channel A and channel B. Use 50Ω terminations.
Adjust the input signal to a trace height of 8 divisions.

Requirements:

Verify that a line with an angle of 45° is displayed.
See figure 4.8.

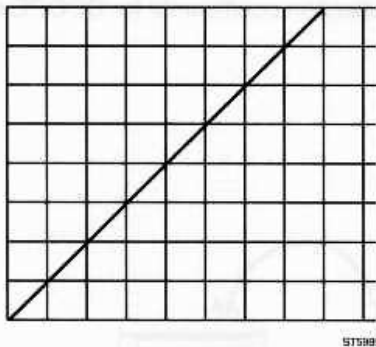
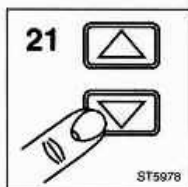


Figure 4.8 A versus B display

21/22. Base line instability



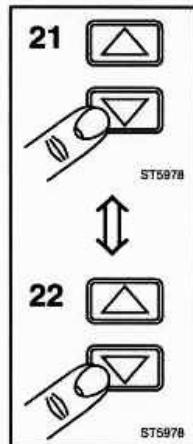
This test checks the maximum base line instability.

Test equipment:

none

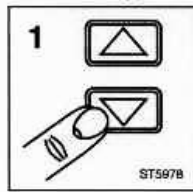
Test setup:

no special setup required

Procedure/requirements:

- A Turn off the signal sources connected to the ScopeMeter input or minimize (zero) the signal amplitudes.
- B Use the select/adjust keys to switch from front setting number 21 to number 22 and back to 21.
- C Verify that the trace does not jump more than 0.1 divisions while switching between front settings 21 and 22.

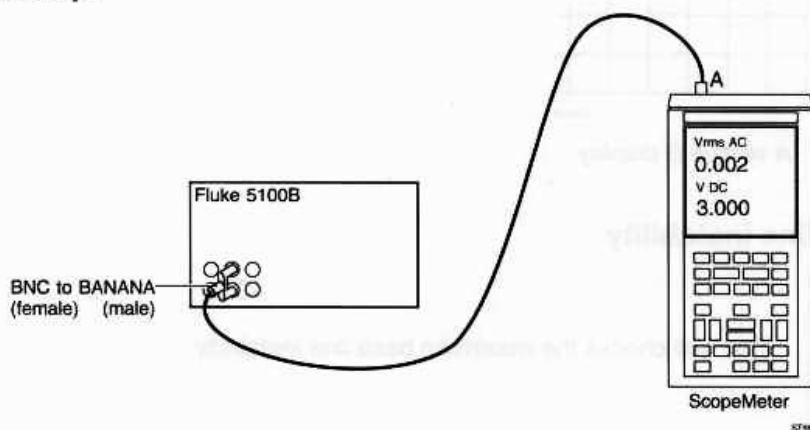
While in the SERVICE menu, press the METER softkey to enter the **METER part of the Performance Verification Procedure**.

1. Voltage accuracy METER mode

The following section checks the voltage accuracy in METER mode. The ScopeMeter uses the same input circuitry (hardware) for the SCOPE (channel A) and the METER modes (in these attenuator settings). When the voltage accuracy of the METER is checked, the deflection coefficients for SCOPE channel A are also tested.

Test equipment:

Fluke 5100B Calibrator

Test setup:**Procedure:**

- A Apply 300 mV DC to channel A.
- B Change the input voltage and the setting of channel A according to table 4.3 and check that the amplitude of the signal agrees with the value listed.

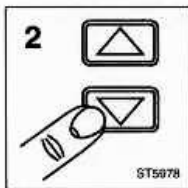
NOTE: The ScopeMeter is set to METER "AUTORANGE" (step 1) with a dual (AC and DC) readout. This implies that the ScopeMeter range is set automatically according to the input signal.

Requirements:

Table 4.3 Requirements for voltage accuracy test channel A, METER mode.

Input signal	Requirements
300 mV DC	298.0...302.0V DC
300 mV RMS AC, 1 kHz	292.5...307.5V RMS AC
3V DC	2.980...3.020V DC
3V RMS AC, 1 kHz	2.925...3.075V RMS AC
30V DC	29.80...30.20V DC
30V RMS AC, 1 kHz	29.25...30.75V RMS AC

2. DC mV accuracy METER mode

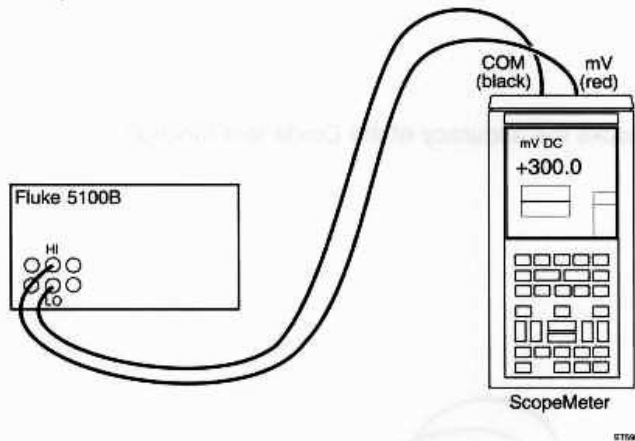


These tests check the accuracy of the DC mV function. The signal must be supplied to the banana input connectors of the ScopeMeter.

Test equipment:

Fluke 5100B Calibrator

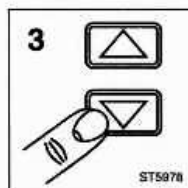
Test setup:



Procedure/requirements:

- A Apply 300 mV DC to the banana connectors of the ScopeMeter.
- B Verify that the readout is between 298.2...301.8 mV DC.
- C Apply 3V DC to the banana connectors of the ScopeMeter.
- D Verify that the readout is between 2.982...3.018V DC.

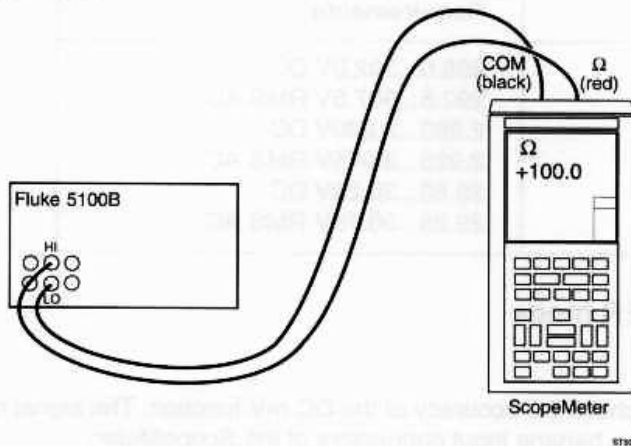
3. Resistance accuracy



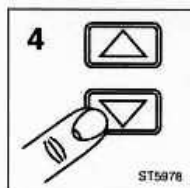
These tests check the accuracy of the resistance measurement function. The signal has to be supplied to the banana input connectors of the ScopeMeter.

Test equipment:

Fluke 5100B Calibrator

Test setup:**Procedure/requirements for resistance function accuracy test:**

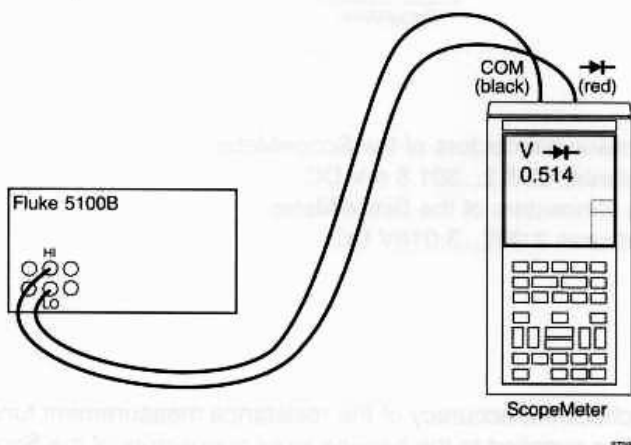
- A Set the Fluke 5100B to 100Ω.
- B Check that the readout is between 99.00...101.0Ω.
- C Set the Fluke 5100B to 10 MΩ.
- D Check that the readout is between 9.900...10.10 MΩ.

4. Diode test accuracy

This test checks the accuracy of the Diode test function.

Test equipment:

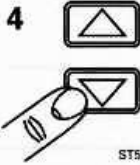
Fluke 5100B Calibrator

Test setup:

Procedure/requirements for diode accuracy test:

- A Set the Fluke 5100B to 1 k Ω .
- B Check that the readout is between 0.420...0.589V DC.

5. Signal display and frequency measurement

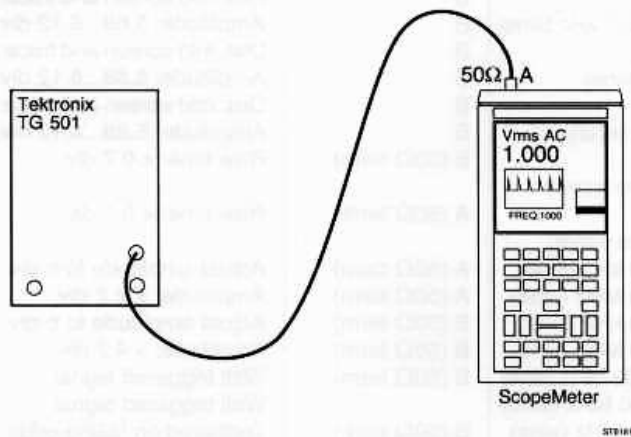


This test checks the waveform display and the frequency measurement function in METER MODE.

Test equipment:

Tektronix TG 501 Time Mark Generator

Test setup:



Procedure/requirements for testing waveform display and frequency function:

- A Apply a 1 ms (1V peak-to-peak) time marker signal to channel A. Use a 50 Ω termination.
- B Check that a stable (triggered) signal is displayed.
- C Check that the frequency displayed is between 993...1007 Hz.

4.3 STANDARD PERFORMANCE VERIFICATION PROCEDURE SUMMARY

This table provides an overview of all steps in the Standard Performance Verification Procedure. It is intended to be used as a reference for frequent users. For details on how to perform each Standard Performance Verification Procedure step, refer to section 4.2.

SCOPE PART

STEP	SIGNAL SOURCE	SIGNAL AMPL/FREQ	SCOPEMETER INPUTS	REQUIRED
1	-	-	-	No interrupted lines
2	-	-	-	No interrupted lines
3	-	-	-	Traces on mid screen
4	Fluke 5100B	212.1 mV(RMS)/1 kHz (sine)	A	Amplitude: 5.88...6.12 div.
		300 mV/DC	A	Dist. mid screen and trace: 2.94...3.06 div.
5	Fluke 5100B	300 mV/DC	B	Dist. mid screen and trace: 2.94...3.06 div.
		212.1 mV(RMS)/1 kHz (sine)	B	Amplitude: 5.88...6.12 div.
6	Fluke 5100B	3V/DC	B	Dist. mid screen and trace: 2.94...3.06 div.
		6V(pp)/1 kHz (sine)	B	Amplitude: 5.88...6.12 div.
7	Fluke 5100B	30V/DC	B	Dist. mid screen and trace: 2.94...3.06 div.
		60V(pp)/1 kHz (sine)	B	Amplitude: 5.88...6.12 div.
8	Tek PG 506	0.5V/1 MHz (fast rise/square wave)	B (50Ω term)	Rise time: < 0.7 div.
9	Tek PG 506	0.5V/1 MHz (fast rise/square wave)	A (50Ω term)	Rise time: < 0.7 div.
10	Tek SG 503	120 mV(pp)/50 kHz (sine)	A (50Ω term)	Adjust amplitude to 6 div.
11	Tek SG 503	120 mV(pp)/50 MHz (sine)	A (50Ω term)	Amplitude: > 4.2 div.
12	Tek SG 503	120 mV(pp)/50 kHz (sine)	B (50Ω term)	Adjust amplitude to 6 div.
13	Tek SG 503	120 mV(pp)/50 MHz (sine)	B (50Ω term)	Amplitude: > 4.2 div.
14	Tek SG 503	≈500 mV(pp)/100 MHz (sine)	B (50Ω term)	Well triggered signal
		≈100 mV(pp)/60 MHz (sine)	B (50Ω term)	Well triggered signal
15	Tek SG 503	300 mV(pp)/10 MHz (sine)	B (50Ω term)	Triggered on falling edge
16	Tek SG 503	300 mV(pp)/10 MHz (sine)	A (50Ω term)	Triggered on falling edge
17	Tek SG 503	≈500 mV(pp)/100 MHz (sine)	A (50Ω term)	Well triggered signal
		≈100 mV(pp)/60 MHz (sine)	A (50Ω term)	Well triggered signal
18	Tek TG 501	1V(pp)/1 μs (marker)	A (50Ω term)	Markers on lines (tolerance ± 1 pixel = ± 0.04 div.)
19	PM 5134	1.2V/1 kHz (sine) (pp) on 1.4V/DC	A & EXT (both 50Ω term)	Well triggered signal
20	PM 5134	800 mV(pp)/2 kHz (sine)	A & B (both 50Ω term)	Line with angle 45° displayed on screen
21	-	-	-	Trace jumps < 0.1 div. when switching
22	-	-	-	between setting 21 and 22.

METER PART

STEP	SIGNAL SOURCE	SIGNAL AMPL/FREQ	SCOPEMETER INPUTS	REQUIRED
1	Fluke 5100B	300 mV/DC	A	298.0...302.0 mV
		300 mV(RMS)/1 kHz		292.5...307.5 mV
		3V/DC		2.980...3.020V
		3V(RMS)/1 kHz		2.925...3.075V
		30V/DC		29.80...30.20V
		30V(RMS)/1 kHz		29.25...30.75V
2	Fluke 5100B	300 mV/DC	banana	298.2...301.8 mV
		3V/DC		2.982...3.018V
3	Fluke 5100B	100Ω	banana	99.00...101.0Ω
		10 MΩ		9.900...10.10 MΩ
4	Fluke 5100B	1 kΩ	banana	0.420...0.589V
5	Tek TG 501	1V(pp)/1 ms (marker)	A (50Ω term)	Stable oscilloscope picture Frequency displayed: 993...1007 Hz.

4.4 ADDITIONAL PERFORMANCE VERIFICATION PROCEDURE

This paragraph describes the Additional Performance Verification Procedure. This procedure can be used to do some extra performance tests, depending on the ScopeMeter version (93, 95, or 97). Follow the instructions described with each step.

The recommended test equipment required for this Additional Performance Verification Procedure is listed in table 4.4.

Table 4.4 Recommended test equipment for Additional Performance Verification Procedure.

Instrument Type	Recommended Model
Function Generator	Philips PM 5134
Multimeter	Philips PM 2525
Power Supply	Philips PE 1537
Time Mark Generator	Tektronix TG 501
Constant Amplitude Sine wave Generator	Tektronix SG 503
Square wave Calibration Generator	Tektronix PG 506

- Cables and terminators for the generators (all BNC type)
- Two standard banana test leads (delivered with the ScopeMeter)
- BNC (female)-to-banana (male) (delivered with the ScopeMeter)
- 5 mm. Power Jack connector plug with attached cable (e.g.: 4822 321 20125)

NOTE: During the following Performance Verification Procedure, you must connect the ScopeMeter input connectors to the signal generator outputs. This connection must be made by cables (BNC connector channel A or B) or two standard banana test leads (COM and mV/Ohm/Diode banana connectors). The Additional Performance Verification Procedure does not use the oscilloscope probes delivered with the instrument. The calibration of the probes is described in the Operating Manual.

1. Autoset

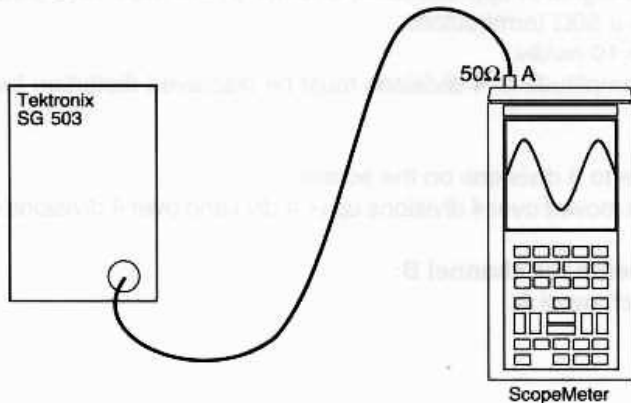
*** All models ***

This test checks the correct operation of the AUTO SET function.

Test equipment:

Tektronix SG 503 Constant Amplitude Sine wave Generator

Test setup:



Settings/procedure/requirements:

- A Apply a 50 MHz sine wave signal of 100 mV peak-to-peak to channel A. Use a 50Ω termination.
- B Switch on the ScopeMeter and press the SCOPE key to get into SCOPE mode. Now press the AUTO SET key. Check that the display is stable and well triggered. Minimal 2 and maximal 20 signal periods must be displayed, over 8 divisions. The signal amplitude must be approximately 5 divisions. The NOTRIG indication on the display must not flash.
- C Repeat settings/procedure for channel B.

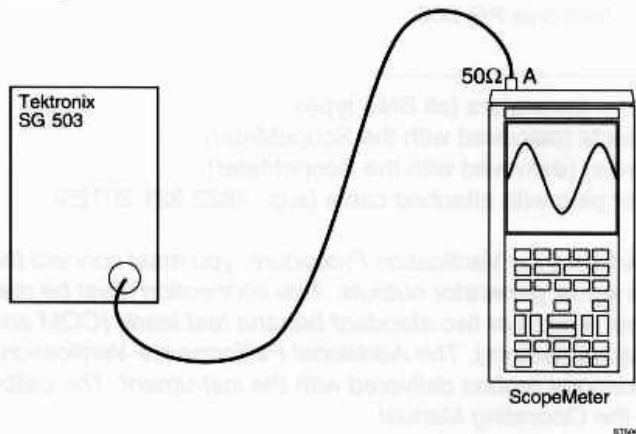
2. Vertical dynamic range and position range (move control)

*** All models ***

This test checks the vertical dynamic range, together with the position range (move control). A certain overdrive of the ScopeMeter must be allowed.

Test equipment:

Tektronix SG 503 Constant Amplitude Sine wave Generator

Test setup:**Settings/procedure/requirements for channel A:****Vertical dynamic range check:**

- A Switch on the ScopeMeter and press the SCOPE key to get into SCOPE mode.
- B Apply a 50 kHz sine wave signal of 950 mV peak-to-peak to channel A. Use a 50Ω termination.
- C Press the AUTO SET key. Set channel A to 100 mV/div. and set the timebase speed to 10μs/div.
- D Use the vertical MOVE key to shift the bottom of the sine wave vertically over the screen in the lower division. Shift the top of the sine wave in the upper division. Verify that the top and bottom of the sine wave signal of 9.5 divisions can be displayed distortion free.
- E Apply a 50 MHz sine wave signal of approximately 500 mV peak- to-peak (4 divisions on the screen) to channel A. Use a 50Ω termination.
- F Set the timebase speed to 10 ns/div.
- G Now a sine wave with an amplitude of 4 divisions must be displayed distortion free.

Move control check:

- A Adjust the signal amplitude to 8 divisions on the screen.
- B Check that the trace can be moved over 4 divisions up (+ 4 div.) and over 4 divisions down (- 4 div.).

Settings/procedure/requirements for channel B:

Repeat the total procedure for channel A.

3. Trigger level control range channel A and B

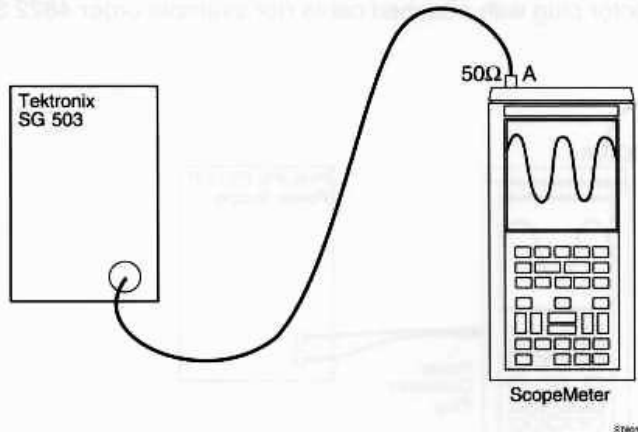
*** All models ***

This test checks the trigger level control range.

Test equipment:

Tektronix SG 503 Constant Amplitude Sine wave Generator

Test setup:



Settings/procedure/requirements:

- A Apply a 500 kHz sine wave with an amplitude of 950 mV peak-to-peak to channel A. Use a 50Ω termination.
- B Switch on the ScopeMeter and press the SCOPE key to get into SCOPE mode. Now press the AUTO SET key.
- C Verify that the signal is well triggered.
- D Set channel A to 100 mV/div.
- E Press the TRIGGER key. Use the select/adjust keys to verify that the trigger level range is more than 8 divisions (4 divisions up and 4 divisions down). The selected trigger level is shown on the display (reversed indication "◊ LEVEL"). Also the trigger level indication, marked with an A \lrcorner will shift, while shifting the trigger level. See figure 4.9.
- F Repeat the same procedure for channel B.

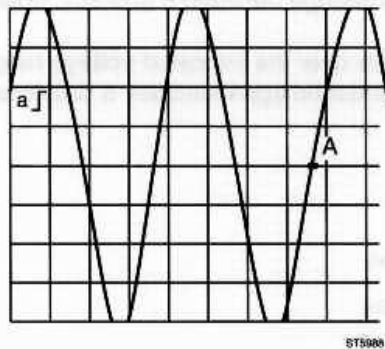


Figure 4.9 Trigger level indication on screen

4. Power supply voltage range

*** All models ***

This test checks the correct operation of the ScopeMeter within the boundaries of the DC supply voltage.

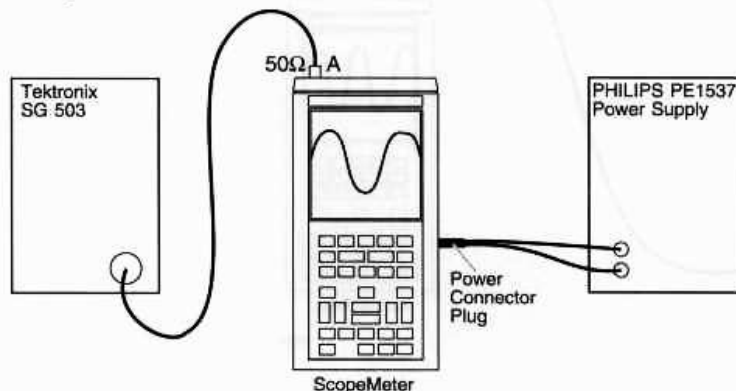
Test equipment:

Philips PE 1537 Power Supply 0-40V/0-1A

Tektronix SG 503 Constant Amplitude Sine Wave Generator

5 mm Power Jack connector plug with attached cable (for example order 4822 321 20125)

Test set-up:



Settings/procedure:

- A Insert the power plug into the power adapter contact on the side of the ScopeMeter.
- B Switch on the power supply and set the voltage to a wanted value between 8 and 20V DC.
- C Apply a 50 kHz sine wave with an amplitude of 100 mV peak-to-peak to channel A. Use a 50Ω termination.
- D Switch on the ScopeMeter. At power on, a beep tone must be audible.
- E Press AUTO SET and verify that a well triggered signal with an amplitude of approximately 5 divisions is displayed over the whole supply voltage range.

Requirements:

- A The ScopeMeter must start at any DC voltage between 8 and 20V, applied at its power adapter contact.
- B The ScopeMeter must remain operative over the indicated voltage range.
- C The amplitude of the trace displayed must be approximately 5 divisions, independent of the supply voltage.



Figure 4.10 Power Jack connector

5. Supply current

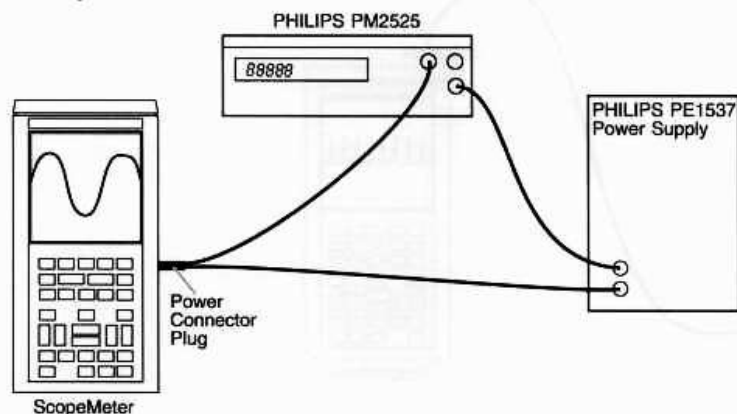
*** All models ***

This test checks the total supply current (ScopeMeter supply current and the built-in battery charger current).

Test equipment:

- Philips PE 1537 Power Supply 0-40V/0-1A
- Digital Multimeter (Philips PM 2525 or equivalent)
- 5 mm Power Jack connector plug with attached cable (for example order 4822 321 20125).

Test set-up:



Settings/procedure/requirements:

*NOTE: A PM 9086 battery pack (included in the shipment) has to be installed for this test.
Only NiCad batteries can be charged by the ScopeMeter!*

- A Set the power supply to 15V DC.
- B Check that the charging current is 200 mA (typical reading on multimeter).
- C Switch on the ScopeMeter.
- D Check that the total supply current is 330 mA (typical reading on multimeter).

6. Battery backup functional test

*** All models ***

This test verifies that the ScopeMeter settings will be kept in memory if power is switched off while the batteries are installed.

Test equipment:

none

Test setup:

no specific test setup required

Settings/procedure:

- A Switch on the ScopeMeter and press the SCOPE key to get into scope mode.
- B Press the AUTO SET key and set channel A and B to 500 mV/div. Set the timebase to 1 ms/div.
- C Switch off the ScopeMeter with the ON/OFF key and keep it switched off for one hour to enable all capacitors to discharge.
- D Press the ON/OFF key to switch on the ScopeMeter again, and verify that the settings for the timebase and attenuator have not changed.

Requirements:

ScopeMeter settings at power off must be restored the next time power is switched on.

7. Cursor measurements: time accuracy

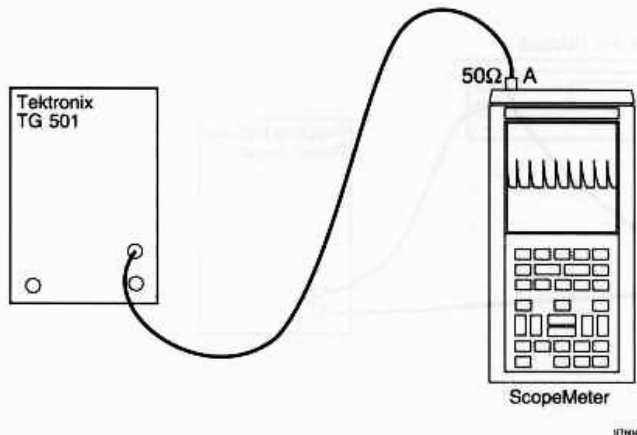
*** Models 95/97 only! ***

This test checks the accuracy of the cursors while measuring time.

Test equipment:

Tektronix TG 501 Time Mark Generator

Test setup:



Setting/procedure:

- A Apply a 1 ms time marker signal to channel A. Use a 50Ω termination.
- B Switch on the ScopeMeter and press the SCOPE key to get into SCOPE mode. Now press the AUTO SET key.
- C Set the timebase to 1 ms/div.
- D Press the HOLD/RUN key to freeze the display.
- E Press the CURSOR DATA key to get into the cursor menu.
- F Press the CURSOR softkey to turn on the cursor lines.
- G Position the cursor lines with the <CURSOR -1-> and <CURSOR 2-> keys, so that they cover a distance of 6 time marker intervals. Position the markers exactly to the top of the marker pulses. See figure 4.11.

Requirements:

The measured time distance between the cursors is displayed at the right side next to the traces. This value must be 5.99...6.01 ms.

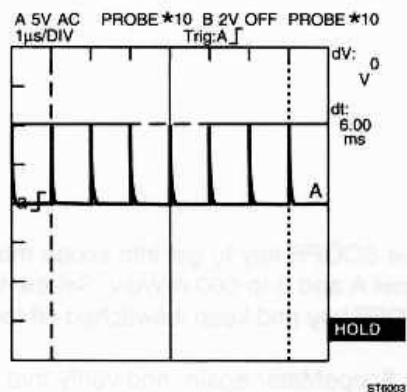


Figure 4.11 Cursor lines on marker pulses

8. Cursor measurements: voltage accuracy

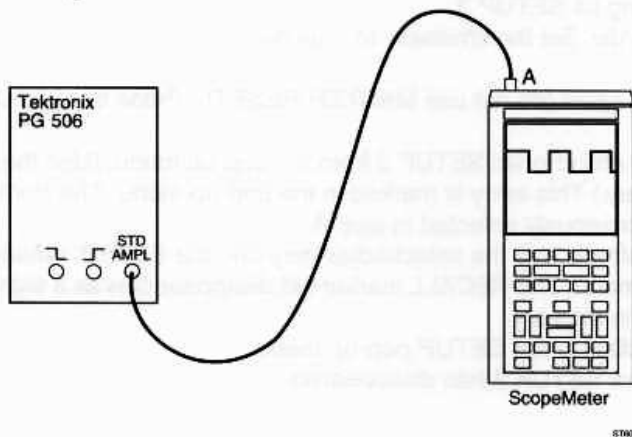
*** Models 95/97 only! ***

This test checks the accuracy of the cursors while measuring voltage.

Test equipment:

Tektronix PG 506 Square Wave Calibration Generator

Test setup:



Settings/procedure:

- A Apply a 1 kHz square wave voltage of 1V peak-to-peak to channel A. Use the "STD AMPL" output of the PG 506.
- B Switch on the ScopeMeter and press the SCOPE key to get into SCOPE mode. Now press the AUTO SET key.
- C Set channel A to 200 mV/div and to AC coupling.
- D Press the HOLD/RUN key to freeze the display
- E Press the CURSOR DATA key to get into the cursor menu.
- F Press the CURSOR softkey to activate the cursor lines.
- G Position the first cursor in the horizontal middle of the top of the waveform. Use the <CURSOR -1-> key to position cursor 1.
- H Position the second cursor in the horizontal mid of the bottom of the waveform. Use the <CURSOR -2-> key to position cursor 2.
- I Use the most right softkey to select NORMAL readout.

Requirements:

The measured voltage between the cursors is displayed at the right side next to the traces. This value must be 0.98V...1.02V.

9. SETUP memory functions

*** Model 97 only! ***

ScopeMeter model 97 enables storing up to 10 front settings that will be kept in a memory with a battery backup.

This test checks this function.

Test equipment:

none

Test setup:

no specific set-up required

Setting/procedure:

- A Switch on the ScopeMeter and switch to SCOPE mode.
Operate the keys to get a front setting that differs from the default settings:
Set channel A and B to 500 mV/div.
Set the timebase to 1 ms/div.
- B Press the SETUP key to get into the SETUP menu
- C Press the SAVE softkey, select SETUP 3 from the pop-up menu, and press ENTER. This will save the current front setting as SETUP 3.
- D Set channel A and B to 2V/div. Set the timebase to 1 μ s/div.
- E Switch off the ScopeMeter.
- F Switch on the ScopeMeter again (do not use MASTER RESET!). Press the SETUP key to get into the SETUP menu.
- G Press the RECALL softkey and choose SETUP 3 from the pop-up menu. (Use the select/adjust keys and the ENTER softkey.) This entry is marked in the pop-up menu. The front setting must be restored to the setting previously selected in step A.
- H Now press the DELETE softkey. Use the select/adjust key and the ENTER softkey to choose SETUP 3 from the pop-up menu. The RECALL marker will disappear now as a sign that the front setting is no longer stored in memory.
- I Press the SAVE button to display the SETUP pop-up menu.
Verify that the marker before SETUP 3 has disappeared.

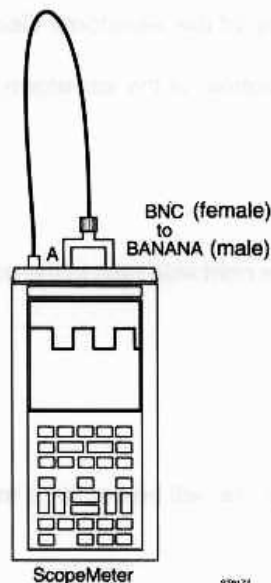
10. Generator

*** Model 97 only! ***

This test checks the built-in generator.

Test equipment:

none

Test setup:

97er77

Settings/procedure/requirements:

Square wave

- A Switch on the ScopeMeter and press the SCOPE key to get into scope mode.
- B Press the SPECIAL FUNCT key. Now press the left most softkey, marked GENERATE. This will reveal the GENERATE pop- up menu.
- C Use the select/adjust keys to select "Square: 976 Hz" and press the right most ENTER softkey to activate the generator.
- D Press the LCD key, and then press the softkey PROBE CAL. This will reveal the CAL&ADJUST pop-up menu. Use the select/adjust keys to select "Channel A 1:1" and press the ENTER softkey to activate 1:1 coupling.
- E Now press AUTO SET.
- F Press the CURSOR DATA key. This will get you to the CURSOR DATA menu.
- G Press the CURSOR softkey. Use the <-CURSOR 1-> key to position the left cursor line on the most negative part of the square wave signal. Use the <-CURSOR 2-> key to position the right cursor line on the top of the square wave signal.
- H Now press the FUNCTION softkey. This will reveal the FUNCTION pop-up menu. Use the select/adjust keys to select "FREQUENCY" and press the ENTER softkey to activate the frequency measurement. Press the FUNCTION softkey again. This will remove the FUNCTION pop-up menu.
- I The ScopeMeter display will look like figure 4.12. The generator must produce a square wave signal with an amplitude of 5V and a frequency of 976 Hz (typical values).

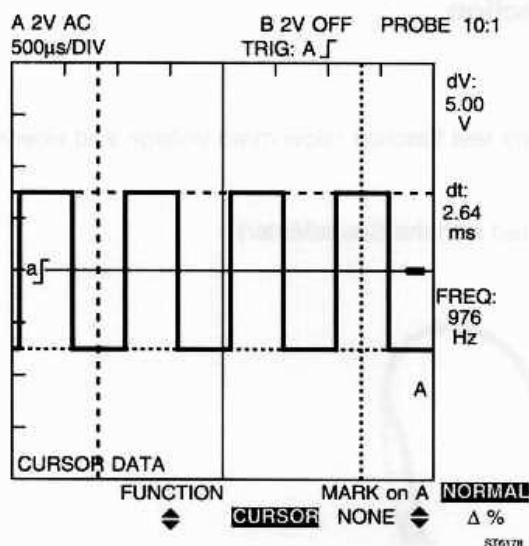


Figure 4.12 Generator produces square wave signal

Sine wave

- J Now press the SPECIAL FUNCT key. Press the GENERATE softkey to reveal the GENERATE pop-up menu. Use the select/adjust keys to select "SINEWAVE" and press the ENTER softkey to activate the generator.
- K Use the mV/V keys to adjust the attenuator.

- L The ScopeMeter display will look like figure 4.13. The generator must produce a sine wave signal with an amplitude of 1V and a frequency of 976 Hz (typical values).

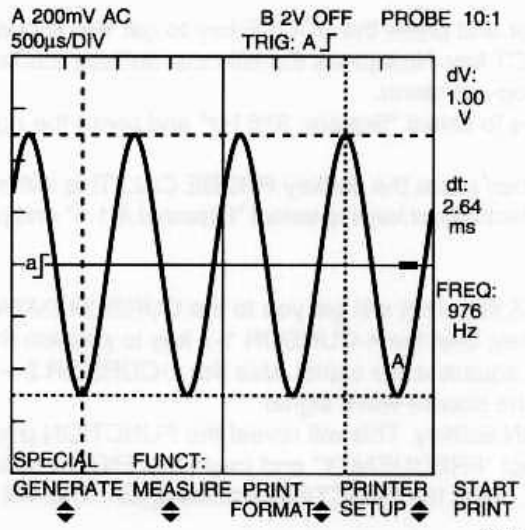


Figure 4.13 Generator produces sine wave signal

11. Component test function

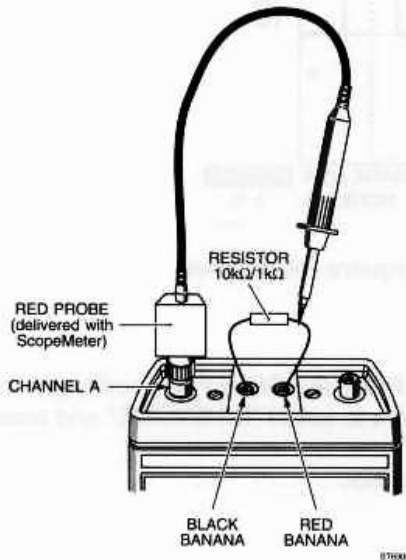
*** Model 97 only! ***

This test checks the component test function (slow ramp voltage and slow ramp current).

Test equipment:

Red scope probe (delivered with the ScopeMeter)

Test setup:



Settings/procedure/requirements:

- A Switch on the ScopeMeter and press the SPECIAL FUNCT key to enter the SPECIAL FUNCT menu.
- B Now press the MEASURE softkey. This will reveal the MEASURE pop-up menu.

- C Use the select/adjust keys to select "Components: VOLTAGE", and press the ENTER softkey (most right) to start the component test function.
- D Adjust the channel A attenuator (press the mV/V key once in the direction "mV") to set the vertical axis to 500 mV/div.
- E The ScopeMeter display will now look like figure 4.14.
If you use a 10 kΩ resistor, a 45° line will be shown.
- F Press the MEASURE softkey and use the select/adjust keys to select "Components: CURRENT" from the MEASURE pop-up menu. Activate the selection by pressing the ENTER softkey.
- G Exchange the 10 kΩ resistor for a 1 kΩ resistor.
- H Now the ScopeMeter display will show a line under 45°, in the upper left quadrant.

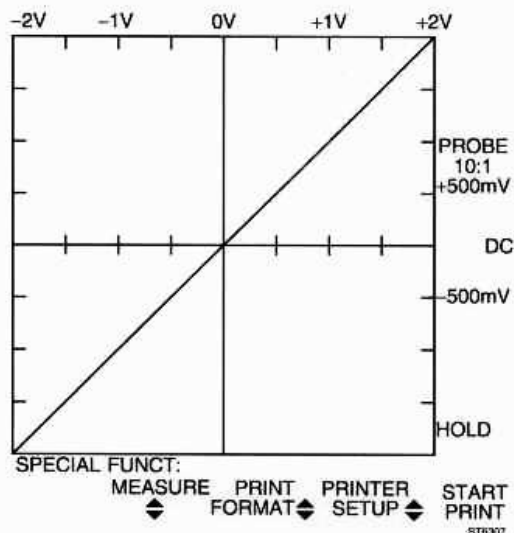


Figure 4.14 Component test "VOLTAGE" mode

5 CALIBRATION ADJUSTMENT PROCEDURE

5.1 GENERAL INFORMATION

The following information provides the complete Calibration Adjustment Procedure for the ScopeMeter. Because various control functions are interdependent, a certain order of adjustment is necessary. The procedure is therefore presented in a sequence that is best suited to this order. Before you make calibration adjustments, always use the Performance Verification Procedure in chapter 4 to check the ScopeMeter performance.

The Calibration Adjustment Procedure, described here, consists of the following three parts:

- CONTRAST Calibration Adjustment Procedure
- SCOPE Calibration Adjustment Procedure
- METER Calibration Adjustment Procedure

Almost all Calibration Adjustments can be done without opening the instrument. Only the first four steps of the SCOPE Calibration Adjustment Procedure require disassembling of the ScopeMeter (see section 5.6.1).

NOTE: Every year use the Performance Verification Procedure in chapter 4 to check the ScopeMeter. If the ScopeMeter fails the Performance Verification Procedure, Calibration Adjustments must be made. If the ScopeMeter also fails the Calibration Adjustment Procedure, repair is necessary (see chapter 7). (After repair, it is sometimes also necessary to do also a Hardware Calibration Adjustment, see section 5.6.1)

Sections 5.5, 5.6 and 5.7 describe the calibration process in detail. Section 5.8 contains a summary of all calibration adjustments as a reference for more frequent users.

5.2 RECOMMENDED CALIBRATION ADJUSTMENT EQUIPMENT

The equipment recommended for the Calibration Adjustment Procedure is listed in table 5.1.

All calibration adjustments must be done in ambient temperatures between 18C and 28C. The ScopeMeter can be used immediately: there is no warm-up time specified.

Table 5.1 Recommended calibration adjustment equipment survey.

Instrument Type	Recommended Model
Multifunction Calibrator	Fluke 5100B
Square Wave Calibration Generator	Tektronix PG 506
Function Generator	Philips PM 5134
*) Personal Computer	Any IBM compatible PC, running MS-DOS
*) Optical to RS-232 Interface Cable	PM9080/001
*) Flash ROM Refresh software	Contact your Service Center
*) +12V ($\pm 2.5\%$) Programming voltage	

*) These items are required after three calibrations, see note paragraph 5.3, pag 5.3 for details.

- Cables and terminators for the generators (all BNC type)
- Standard banana test leads
(two banana test leads are delivered with the ScopeMeter)
- BNC (female)-to-banana (male) (delivered with the ScopeMeter)
- The red and grey probes, delivered with the ScopeMeter.

5.3 ENTERING THE CALIBRATION PROCEDURE

The Calibration Adjustment Procedure is operated via built-in sequences. Before you can activate a calibration sequence, you must first connect a 12V DC programming voltage to the ScopeMeter. To do this, first remove the battery pack. See section 6.2.1.



Figure 5.1 Position of the +12V and 0 contacts for calibration (items 25)

If you have removed the ScopeMeter battery pack and the battery cover (figure 5.1, item 17), you will have access to the +12V/0 contacts (figure 5.1, item 25). These contacts are placed in the left middle (+12V) and the right middle (0) of the battery compartment. Connect +12V DC to the contact marked "+12V" and 0V to the contact marked "0".

CAUTION: To avoid damaging the Flash ROM circuitry be sure to apply the polarity of 12V programming voltage correctly.

NOTE: After you have performed the Calibration Procedure, remove the 12V programming voltage. Do not perform measurements with the ScopeMeter, while the programming voltage is still present.

Connect the ScopeMeter to the Power Adapter/Battery Charger PM 8907. Use MASTER RESET to switch the ScopeMeter on. (To do this press the LCD key and keep it pressed. Then also press the ON/OFF key. When the ScopeMeter switches on, you will hear two beeps.) Now press both AC/DC/GROUND keys simultaneously. This will start the SERVICE menu (see figure 4.1, chapter 4). This menu allows you to start the calibration sequence. Press the corresponding softkey marked "CALIBRATE ScopeMeter". This will start the CALIBRATE menu.

NOTE: The ScopeMeter will show the message:
"Space for X more calibration sessions." (X is: 2, 1, or 0)

After three electronic calibrations, the ScopeMeter will display: "Space for 0 more calibration sessions". This means that the internal Flash ROMs of the ScopeMeter are full. To enable another calibration, you must first empty the Flash ROMs and reinstall the ScopeMeter operating software. To do this, send the ScopeMeter to your nearest Service Center. It is also possible to "refresh" the FlashROMs by yourself, using a PC. For more information: contact your nearest Service Center.

5.4 OPERATING THE CALIBRATION PROCEDURE

Softkeys in the CALIBRATE menu

In the CALIBRATE menu, it is possible to choose the calibration mode (sequence) to be performed.

Press the softkey marked:

- CONTRAST for the CONTRAST Calibration Adjustment Procedure (see section 5.5).
- SCOPE for the SCOPE Calibration Adjustment Procedure (see section 5.6).
- METER for the METER Calibration Adjustment Procedure (see section 5.7).

When one of these three calibration sequences is chosen, the corresponding text on the screen will be shown in reverse. This shows that this calibration mode is active.

If you press the ESCAPE softkey, the ScopeMeter will leave the CALIBRATE menu and return to the SERVICE menu.

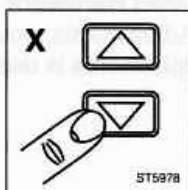
NOTE: If you use the ESCAPE softkey to leave the CALIBRATION menu before storing the calibrations with the CAL STORE softkey, you will lose all new calibration values. The instrument will continue using the calibration values that were used before entering the CALIBRATE menu.

The CAL STORE softkey saves the new calibration values that are obtained in the CONTRAST, SCOPE or METER sequences, to the Flash ROM. From the moment you press the CAL STORE softkey, the ScopeMeter uses the new calibration data. The old calibration data is no longer valid. This will also fill one calibration field in the Flash ROM. See section 5.3.

NOTE: After calibrating the ScopeMeter, reset the instrument (use a MASTER RESET), before performing measurements.

Keys in CONTRAST, SCOPE, or METER Calibration mode

The calibration is presented as a sequence. You can advance through this sequence by pressing the select/adjust keys. Pressing the upper select/adjust key advances one step; pressing the lower adjust/select key brings you back one step.



In sections 5.5, 5.6 and 5.7 this figure is used to indicate that one of the select/adjust keys (up/down) must be pressed to display the indicated step number "x" displayed on the ScopeMeter screen.

When the ScopeMeter LCD displays the indication " CAL ", you must first apply the appropriate input (calibration) signal. When the correct signal is present at the correct terminal, you start the built-in calibration by pressing the most right READY softkey. The text "READY" will be in reverse video, to show that the ScopeMeter's internal calibration is active. When the process is ready, the "READY" text will change again, from inverted to normal. Now you can use the select/adjust keys to advance to the next calibration step or return to a previous calibration step.

After you have completed a calibration sequence, press either CONTRAST, SCOPE or METER softkey again to return to the CALIBRATE menu. The new calibration data will stay in memory to enable you to store it permanently with the CAL STORE key.

Press the ESCAPE softkey to leave the active calibration mode without storing the new calibration data. This will also return you to the CALIBRATE menu.

5.5 CONTRAST CALIBRATION ADJUSTMENT PROCEDURE

You activate the CONTRAST Calibration Adjustment Procedure from the CALIBRATE menu, by pressing the left most CONTRAST softkey. When this softkey is depressed, the text "CONTRAST" is shown in reverse video, to show that this calibration mode is active.

Now use the adjust/select keys to adjust the contrast of the LCD to your own (personal) setting. When you have found the correct setting, you can make this setting ready for calibration storage, by pressing the READY softkey once.

NOTE: When you press the READY softkey, this does not mean that the new value of the LCD contrast is actually stored in the Flash ROMs of the ScopeMeter. This only happens when you press the CAL STORE softkey.

Press the CONTRAST softkey again to leave the CONTRAST Calibration Adjustment Procedure. The text "CONTRAST" will change from reverse video into normal again.

5.6 SCOPE CALIBRATION ADJUSTMENT PROCEDURE

You can start the SCOPE Calibration Adjustment Procedure from the CALIBRATE menu by pressing the SCOPE softkey. When this softkey is pressed, the text "SCOPE" is shown in reverse video, to show that this calibration mode is active.

The SCOPE Calibration Adjustment Procedure is divided into two parts:

- Hardware SCOPE Calibration Adjustments: steps H1 to H4
- Closed Case SCOPE Calibration Adjustments: steps S5 to S29

NOTE: During the following Calibration Adjustment Procedure, you must connect the ScopeMeter input connectors to the signal generator outputs by means of cables (BNC connector channel A or B) or two standard banana test leads (COM and mV/Ohm/Diode banana connectors).

5.6.1 Hardware SCOPE Calibration Adjustments

The first four steps of the SCOPE Calibration Adjustment Procedure are called **Hardware SCOPE Calibration Adjustments**. To perform the Hardware SCOPE Calibration Adjustments, you must open the ScopeMeter. The disassembly procedure for these calibration adjustments is described in chapter 6 (section 6.1 and 6.2.3).

WARNING: To prevent personal injury, do not perform any disassembly procedures before reading chapter 6.

When the ScopeMeter is disassembled, it is not possible to apply the +12V programming voltage in the normal way. It is possible to apply the +12V programming voltage by means of two test clips (see figure 5.2).

Remove all voltage sources from the ScopeMeter. Turn the digital A1 PCB, mounted in the top cover so that the display and the keyboard are facing down. Connect the +12V programming voltage to the appropriate places on the PCB. It can be helpful to first install two metal screws again. See figure 5.2. Be sure not to short circuit with the metal shielding, mounted on the analog A1 PCB. Turn the top cover and the mounted PCB. Connect the ScopeMeter to the power supply and switch the instrument on. Go to the SERVICE menu and press the CALIBRATE ScopeMeter softkey. You can make the adjustments necessary with six trim capacitors (three for the attenuator of each channel) and two adjustment potentiometers (for the Analog ASIC).

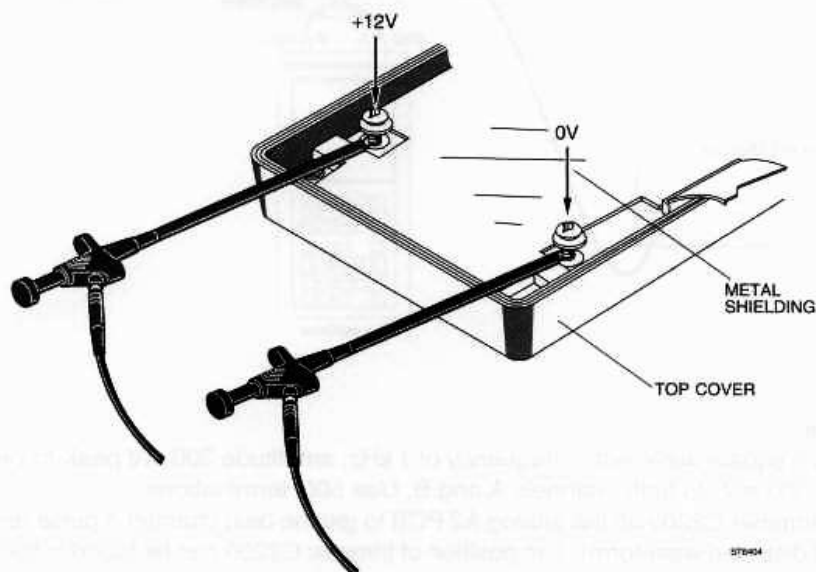
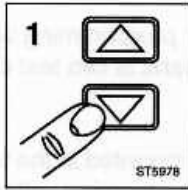


Figure 5.2 Connecting the +12V programming voltage for Hardware SCOPE Calibration Adjustments.

NOTE: You only have to do Hardware SCOPE Calibration Adjustments, if you have repaired the ScopeMeter in the Attenuator sections or in the Analog ASIC circuitry. After you have done a Hardware SCOPE Calibration Adjustment or you have adjusted one of the potentiometers, you always need to do a full (software) SCOPE and METER calibration. If you decide not to do the Hardware Calibration Adjustment now, you can advance to calibration S5 by pressing the upper select/adjust key 4 times.

H1. Hardware pulse response of the *1 attenuation

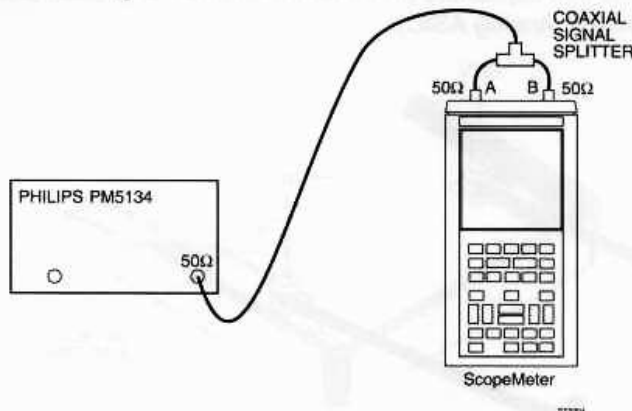


Purpose: optimal pulse response of the *1 attenuation circuit.

Calibration equipment:

Philips PM 5134 Function Generator

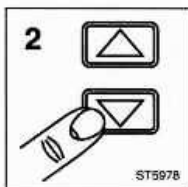
Calibration setup:



Procedure:

- A - Apply a square wave with a frequency of 1 kHz, amplitude 300 mV peak-to-peak (between 0 mV and +300 mV) to both channels A and B. Use 50Ω terminations.
- B - Turn trimmer C2209 on the analog A2 PCB to get the best channel A pulse response on the LCD (least distorted waveform). The position of trimmer C2209 can be found in section 10: figure 10.3 (A2 PCB layout SMD).
- C - Turn trimmer C2109 on the analog A2 PCB to get the best channel B pulse response on the LCD. The position of trimmer C2109 can be found in section 10: figure 10.3 (A2 PCB layout SMD).
- D - Press the READY softkey.

H2. Hardware pulse response of the *10 attenuation



Purpose: optimal pulse response of the *10 attenuation circuit.

Calibration equipment:

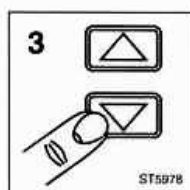
Philips PM 5134 Function Generator

Calibration setup:

See calibration setup H1.

Procedure:

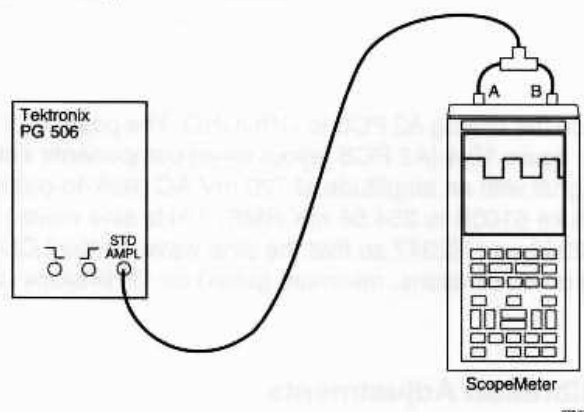
- A - Apply a square wave with a frequency of 1 kHz, amplitude 3V peak-to-peak (between 0V and +3V) to both channels A and B. Use 50 Ω terminations.
- B - Turn trimmer C2207 on the analog A2 PCB to get the best channel A pulse response on the LCD (least distorted waveform). The position of trimmer C2207 can be found in section 10: figure 10.3 (A2 PCB layout SMD).
- C - Turn trimmer C2107 on the analog A2 PCB to get the best channel B pulse response on the LCD. The position of trimmer C2107 can be found in section 10: figure 10.3 (A2 PCB layout SMD).
- D - Press the READY softkey.

H3. Hardware pulse response of the *100 attenuation

Purpose: optimal pulse response of the *100 attenuation circuit.

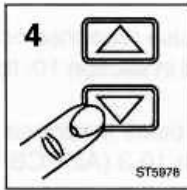
Calibration equipment:

Tektronix PG 506 Square Wave Calibration Generator

Calibration setup:**Procedure:**

- A - Apply a square wave with a frequency of 1 kHz, amplitude 20V peak-to-peak (between 0V and +20V) to both channels A and B. Set the generator to the position "STD AMPL".
- B - Turn trimmer C2214 on the analog A2 PCB to get the best channel A pulse response on the LCD (least distorted waveform). The position of trimmer C2214 can be found in section 10: figure 10.3 (A2 PCB layout SMD).
- C - Turn trimmer C2114 on the analog A2 PCB to get the best channel B pulse response on the LCD. The position of trimmer C2114 can be found in section 10: figure 10.3 (A2 PCB layout SMD).
- D - Press the READY softkey.

H4. Hardware offset and gain

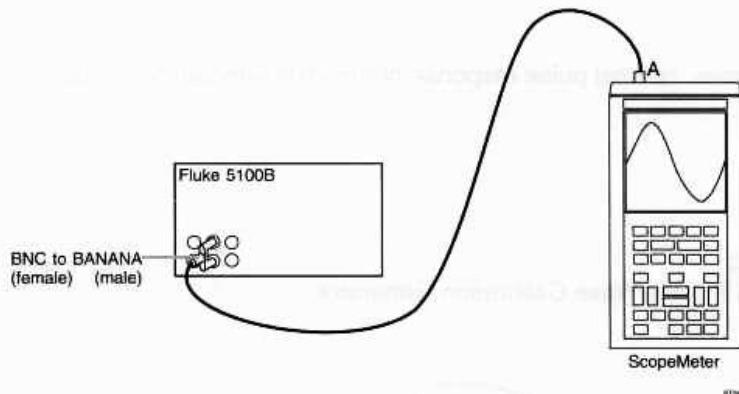


Purpose: optimal response of complete analog A2 circuitry.

Calibration equipment:

Fluke 5100B Calibrator

Calibration setup:



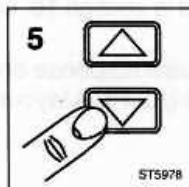
Procedure:

- A - Connect Test Point TP209 on the analog A2 PCB to GROUND. The position of Test Point TP209 can be found in section 10: figure 10.4 (A2 PCB layout wired components side).
- B - Apply a 1 kHz sine wave signal with an amplitude of 720 mV AC peak-to-peak to the channel A BNC connector. (Set the Fluke 5100B to 254.56 mV RMS, 1 kHz sine wave.)
- C - Turn the potentiometers R2346 and R2347 so that the sine wave on the LCD is exactly 6 divisions: maximum (peak) on +3 divisions, minimum (peak) on -3 divisions (tolerance ± 1 dot).
- D - Press the READY softkey.

5.6.2 Closed Case SCOPE Calibration Adjustments

NOTE: The following calibration adjustments are done electronically. For these calibrations, the ScopeMeter must be in a fully assembled state!

S5. Offset correction

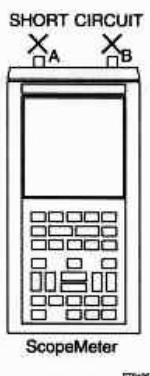


Purpose: remove offset of channel A and B input operational amplifiers.

Calibration equipment:

none.

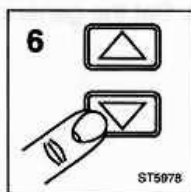
Calibration setup:



Procedure:

- A - Short circuit both channel A and channel B inputs.
- B - Press the READY softkey.

S6/7. Pulse response of the *1/*10 attenuation (fine adjustments)



Purpose: optimal pulse response of the *1, *10 attenuation circuit.

Calibration equipment:

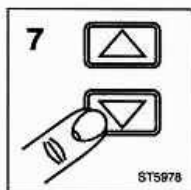
Philips PM 5134 Function Generator

Calibration setup:

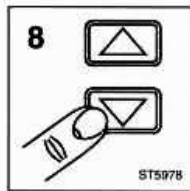
See calibration setup H1.

Procedure:

- A - Apply a square wave with a frequency of 1 kHz, amplitude 300 mV peak-to-peak (between 0 mV and +300 mV) to both channels A and B. Use 50Ω terminations.
- B - Press the READY softkey.



- C - Apply a square wave with a frequency of 1 kHz, amplitude 3V peak-to-peak (between 0V and +3V) to both channels A and B. Use 50Ω terminations.
- D - Press the READY softkey.

S8/9. Pulse response of the *100/*1000 attenuation (fine adjustments)

Purpose: optimal pulse response of the *100, *1000 attenuation circuit.

Calibration equipment:

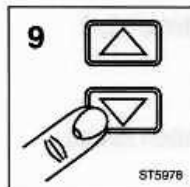
Tektronix PG 506 Square Wave Calibration Generator

Calibration setup:

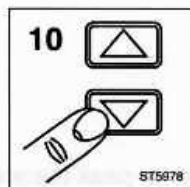
See calibration setup H3.

Procedure:

- A - Apply a square wave with a frequency of 1 kHz, amplitude 20V peak-to-peak (between 0V and +20V) to both channels A and B. Set the generator to the position "STD AMPL".
- B - Press the READY softkey.



- C - Apply a square wave with a frequency of 1 kHz, amplitude 50V peak-to-peak (between 0V and +50V) to both channels A and B. Set the generator to the position "STD AMPL".
- D - Press the READY softkey.

S10/11/12/13/14/15/16/17**Gain for 5 mV, 10 mV, 20 mV, 50 mV, 100 mV, 200 mV, 2V, 20V**

Purpose: correction of the system gain (from BNC to microprocessor) in attenuator settings: 5 mV, 10 mV, 20 mV, 50 mV, 100 mV, 200 mV, 2V, 20V.

Calibration equipment:

Tektronix PG 506 Square Wave Calibration Generator

Calibration setup:

See calibration setup H3.

Procedure:

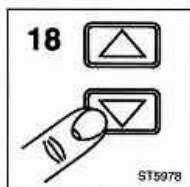
- A - Apply a square wave with a frequency of 1 kHz, amplitude 20 mV peak-to-peak to both channels A and B. Set the generator to the position "STD AMPL".
- B - Press the READY softkey.
- C - Change the input voltage according to table 5.2.
After each calibration press the READY softkey. Use the adjust/select keys to advance/go back in the list.

NOTE: These steps calibrate both channel A and B at the same time.

Table 5.2 Calibration signals for step S10...S17.

Calibration step number	Calibration voltage
S10	square wave, 1 kHz, 20 mV peak-to-peak
S11	square wave, 1 kHz, 50 mV peak-to-peak
S12	square wave, 1 kHz, 100 mV peak-to-peak
S13	square wave, 1 kHz, 200 mV peak-to-peak
S14	square wave, 1 kHz, 500 mV peak-to-peak
S15	square wave, 1 kHz, 1V peak-to-peak
S16	square wave, 1 kHz, 10V peak-to-peak
S17	square wave, 1 kHz, 100V peak-to-peak

S18/19. Shift gain +1 mode and /8 mode



Purpose: correct for the shift gain in "times 1 mode" and in "divided by 8 mode".

Calibration equipment:

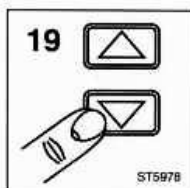
Tektronix PG 506 Square Wave Calibration Generator

Calibration setup:

See calibration setup H3.

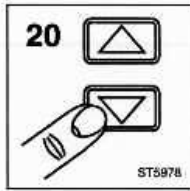
Procedure:

- A - Apply a square wave with a frequency of 1 kHz, amplitude 200 mV peak-to-peak (between 0 mV and +200 mV) to both channels A and B. Set the generator to the position "STD AMPL".
- B - Press the READY softkey.



- C - Apply a square wave with a frequency of 1 kHz, amplitude 20 mV peak-to-peak (between 0 mV and +20 mV) to both channels A and B. Set the generator to the position "STD AMPL".
- D - Press the READY softkey.

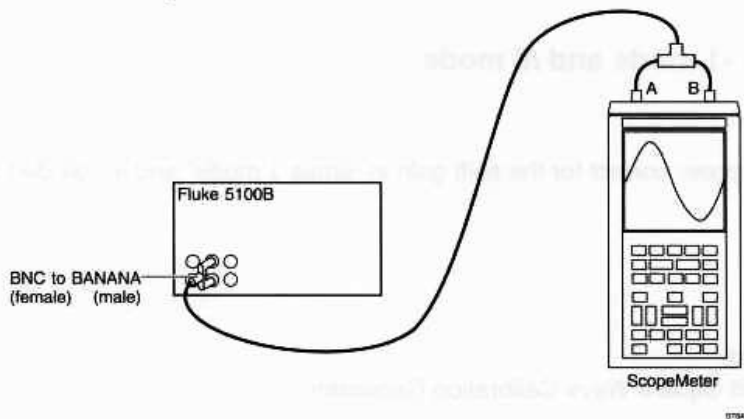
S20/21/22/23. Channel A and channel B 50% and 90% trigger level



Purpose: calibrate the 50% and 90% analog trigger level of channel A and channel B.

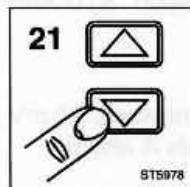
Calibration equipment:
Fluke 5100B Calibrator

Calibration setup:

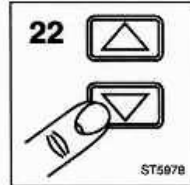


Procedure:

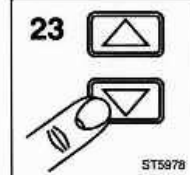
- A - Apply a sine wave with a frequency of 50 kHz, amplitude 1V peak-to-peak to both channels A and B. Use 50Ω terminations. (Set the Fluke 5100B to 0.353.5 mV RMS, 5 kHz sine wave).
- B - Press the READY softkey.



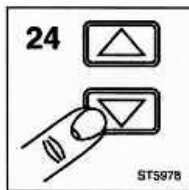
C - Press the READY softkey.



D - Press the READY softkey.



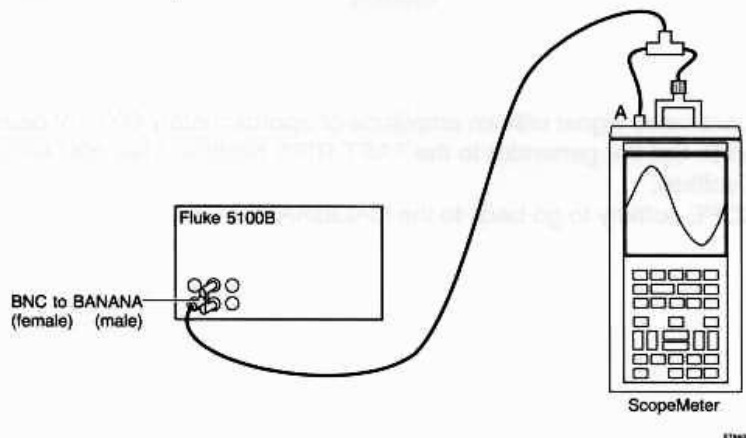
E - Press the READY softkey

S24. External triggering

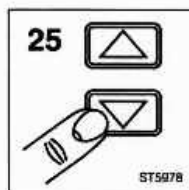
Purpose: calibrate the 0.2V external trigger level.

Calibration equipment:
Fluke 5100B Calibrator

Calibration setup:

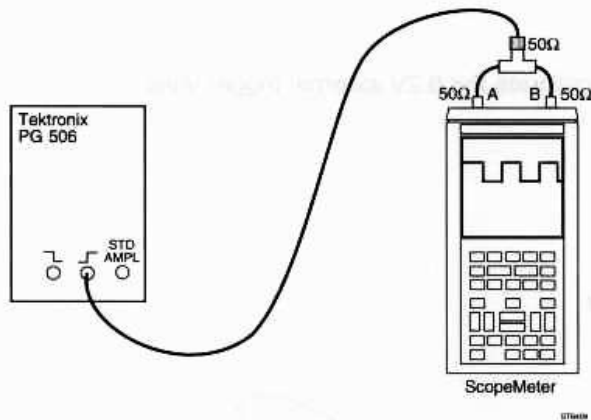
**Procedure:**

- A - Apply a 50 kHz sine wave signal with an amplitude of 1V peak-to-peak to channel A and also to the banana connectors. Use a coaxial signal splitter and a BNC(female)-to-banana(male) converter (see calibration setup). (Set the Fluke 5100B to 0.35355V RMS, 5 kHz sine wave).
- B - Press the READY softkey.

S25. Random sampling

Purpose: calibration of the random sampling levels.

Calibration equipment:
Tektronix PG 506 Square Wave Calibration Generator

Calibration setup:**Procedure:**

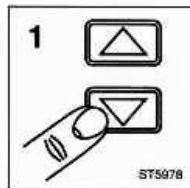
- A - Apply a 1 MHz square wave signal with an amplitude of approximately 600 mV peak-to-peak to both channel A and B. Set the generator to the FAST RISE position. Use 50Ω terminations.
- B - Press the READY softkey.
- C - Now press the SCOPE softkey to go back to the CALIBRATE menu.

5.7 METER CALIBRATION ADJUSTMENT PROCEDURE

Press the METER softkey to activate the METER Calibration Adjustment Procedure from the CALIBRATE menu. When you press this softkey, the text "METER" will be shown in reverse video to show that this calibration mode is active.

NOTE: During the METER calibration, the values displayed on the LCD do not represent the values of the input voltages!

M1. Linearity calibration and M2. Zeroing the ranges

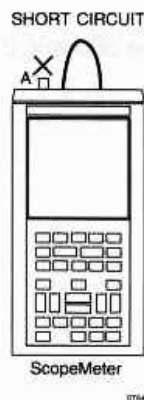


Purpose M1: calibration of the linearization table, used by the ScopeMeter.

Purpose M2: this calibration zeros all ranges of the ScopeMeter in METER mode: 300 mV, 3V, 30V and 300V on channel A and 300 mV and 3V of the banana connectors.

Calibration equipment:
none

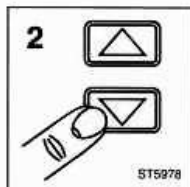
Calibration set-up:



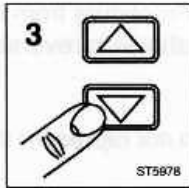
Procedure:

- A - Short circuit the channel A BNC and the banana connectors.
- B - Press the READY softkey.

NOTE: During this calibration step many internal calibration constants are being set. This process can last up to 3 minutes.



- (C - Short circuit the channel A BNC and the banana connectors.)
- D - Press the READY softkey.

M3. Channel A, 300 mV range: zero for open input

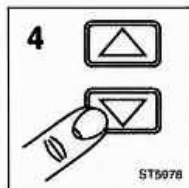
Purpose: zero channel A in the 300 mV range with open input.

Calibration equipment:
none

Calibration setup:
Channel A BNC open.

Procedure:

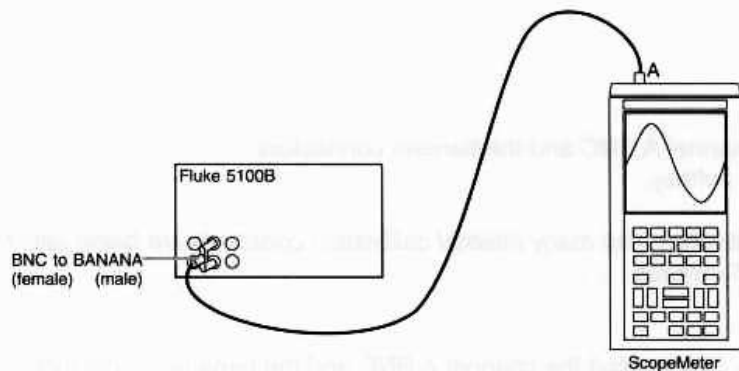
- A - Remove any connection from the channel A BNC.
- B - Press the READY softkey.

M4/5/6/7. Channel A, 300 mV/3V/30V/300V range: gain calibration

Purpose: calibration of the channel A gain in the 300 mV, 3V, 30V and 300V ranges.

Calibration equipment:
Fluke 5100B Calibrator

Calibration setup:

**Procedure:**

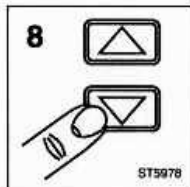
- A - Apply 300 mV DC to channel A.
- B - Press the READY softkey.
- C - Change the input voltage according to table 5.3. After each calibration press the READY softkey. Use the adjust/select keys to advance/go back in the list.

Table 5.3 Calibration signals for step M4...M7.

Calibration Step Number	Calibration Voltage
M4	300 mV DC
M5	3V DC
M6	30V DC
M7	300V DC

WARNING: After you have performed calibration M7, deactivate the Fluke 5100B to remove the 300V DC. Always set the Fluke 5100B to 300 mV DC before touching the connection cables!

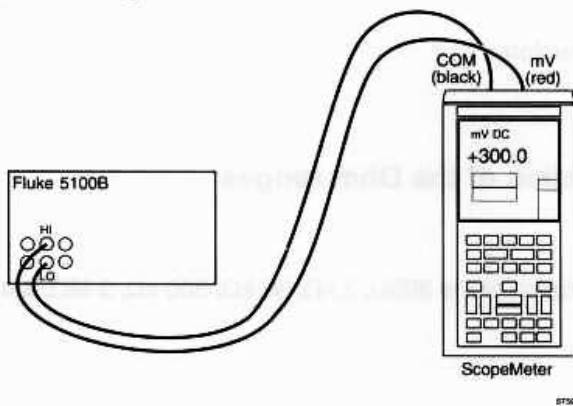
M8/9. External input, 300 mV/3V range: gain calibration



Purpose: calibration of the external input gain in the 300 mV and 3V ranges.

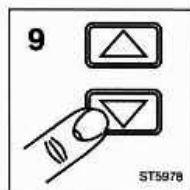
Calibration equipment:
Fluke 5100B Calibrator

Calibration setup:

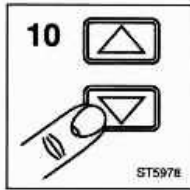


Procedure:

- A - Apply 300 mV DC to the banana connectors.
- B - Press the READY softkey.



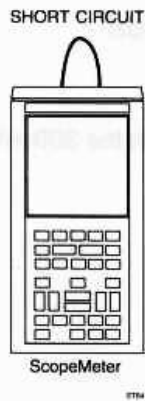
- C - Apply 3V DC to the banana connectors.
- D - Press the READY softkey.

M10. All ranges 0Ω calibration

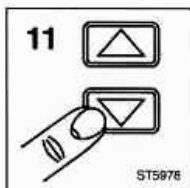
Purpose: calibration of the 0Ω points in all ranges.

Calibration equipment:
none

Calibration setup:

**Procedure:**

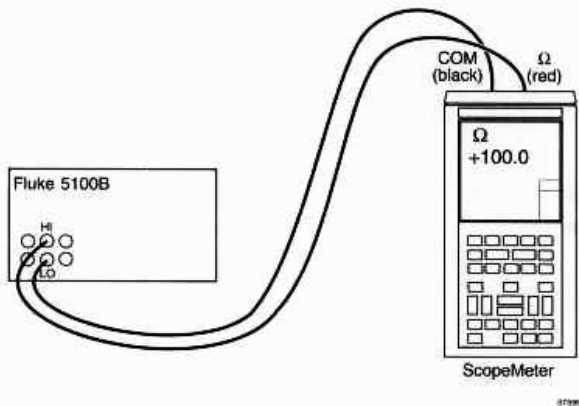
- A - Short circuit the banana connectors.
- B - Press the READY softkey.

M11/12/13/14/15/16. Calibration of the Ohm ranges

Purpose: calibration of the 300Ω, 3 kΩ, 30 kΩ, 300 kΩ, 3 MΩ, and 30 MΩ ranges.

Calibration equipment:
Fluke 5100B Calibrator

Calibration setup:



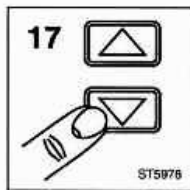
Procedure:

- A - Connect 100Ω to the banana connectors.
- B - Press the READY softkey.
- C - Change the resistance according to table 5.4. After each calibration press the READY softkey. Use the adjust/select keys to advance/go back in the list.

Table 5.4 Calibration signals for step M11...M16.

Calibration Step Number	Calibration Resistance
M11	100Ω
M12	1 kΩ
M13	10 kΩ
M14	100 kΩ
M15	1 MΩ
M16	10 MΩ

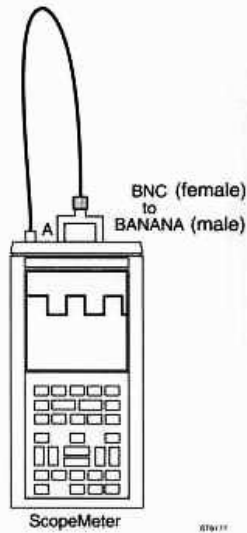
M17. Voltage ramp calibration



Purpose: calibration of the voltage ramp of the circuit tester.

Calibration equipment:
none

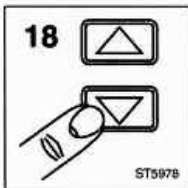
Calibration setup:



Procedure:

- A - Connect the channel A BNC to the red GENERATOR OUT banana connector, by means of a BNC cable and a BNC (female)-to- banana(male) connector.
- B - Press the READY softkey.

M18. Current ramp calibration

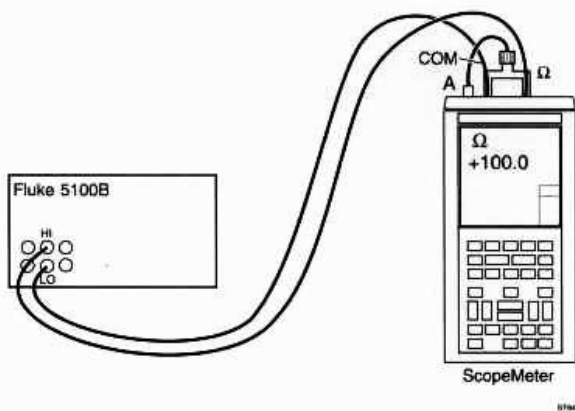


Purpose: calibrate the current ramp of the circuit tester.

Calibration equipment:

Fluke 5100B Calibrator

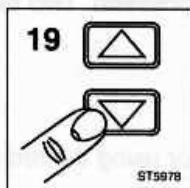
Calibration setup:



Procedure:

- A - Connect a resistance of 100Ω between both banana connectors. Connect channel A to the red banana connector. Do not use a probe! Refer to the calibration setup.
- B - Press the READY softkey.

M19/20
10:1 calibration for channel A (red) and channel B (grey) probes

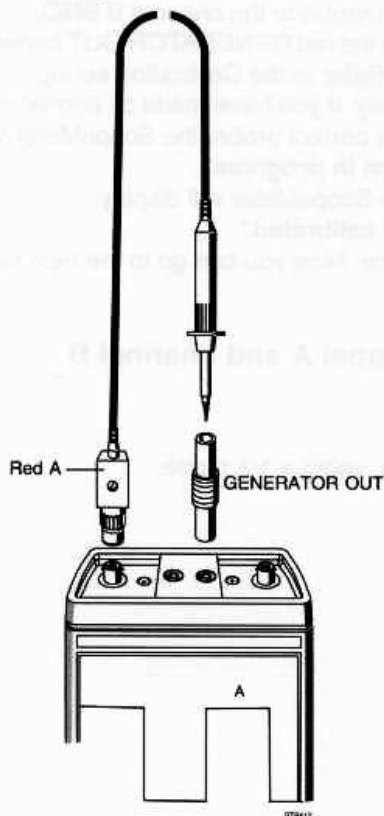


Purpose: determine the gain, using a 10:1 probe.

Calibration equipment:

- Red scope probe (delivered with the ScopeMeter)
- Grey scope probe (delivered with the ScopeMeter)
- Red adjust adapter (delivered with the ScopeMeter)

Calibration setup:



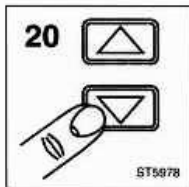
IMPORTANT: Calibration steps M19 and M20 determine the internal calibration constants that compensate for probe characteristics. To achieve full accuracy (as listed in the specifications in chapter 2), calibrations M19 and M20 must be performed, using the probes that are normally to be used with the instrument.

If the probes delivered with the ScopeMeter are not available at the time of calibration, use other probes specifically designed for the ScopeMeter. In this case you must notify the user that these calibrations have been performed, using different probes. To achieve full accuracy, the user must do a User Probe Calibration, using his own probes. This procedure is described in the ScopeMeter Users Manual. Because the results of these User Probe Calibrations

are stored in battery backed up RAM, they must be repeated if the batteries are removed for a longer period. You will also lose the results of the User Probe Calibration when you do a MASTER RESET. (A MASTER RESET is done when the ScopeMeter is switched on while the LCD key is depressed. Two beeps are audible.)

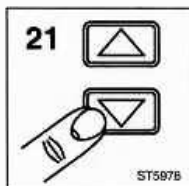
Procedure:

- A - Connect the red scope probe to the channel A BNC.
- B - Connect the probe tip to the red GENERATOR OUT banana connector using the red adjust adapter. Refer to the Calibration setup.
- C - Press the READY softkey. If you have made all connections correctly and you have connected the correct probe, the ScopeMeter will display the text:
"DC PROBE calibration in progress".
 After a few seconds the ScopeMeter will display:
"PROBE successfully calibrated"
 and will also beep once. Now you can go to the next calibration step.



- D - Connect the grey scope probe to the channel B BNC.
- E - Connect the probe tip to the red GENERATOR OUT banana connector using the red adjust adapter. Refer to the Calibration set-up.
- F - Press the READY softkey. If you have made all connections correctly and you have connected the correct probe, the ScopeMeter will display the text:
"DC PROBE calibration in progress".
 After a few seconds the ScopeMeter will display:
"PROBE successfully calibrated"
 and it will also beep once. Now you can go to the next calibration step.

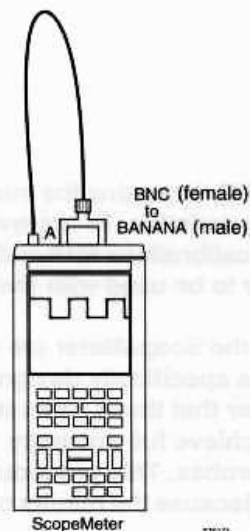
M21/22. 1:1 probe calibration for channel A and channel B



Purpose: determine the gain, using a 1:1 probe.

Calibration equipment:
 none

Calibration set-up:



Procedure:

A - Connect the channel A BNC to the red GENERATOR OUT banana connector, by means of a BNC cable and a BNC (female)-to- banana(male) connector.

B - Press the READY softkey.

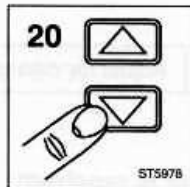
If all connections are good, the ScopeMeter will display the text:

"DC PROBE calibration in progress".

After a few seconds the ScopeMeter will display:

"PROBE successfully calibrated"

and will also beep once. Now you can go to the next calibration step.



C - Connect the channel B BNC to the red GENERATOR OUT banana connector, by means of a BNC cable and a BNC(female)-to-banana(male) connector.

D - Press the READY softkey. If all connections are good, the ScopeMeter will display the text:

"DC PROBE calibration in progress".

After a few seconds the ScopeMeter will display:

"PROBE successfully calibrated"

and it will also beep once.

Calibration is now complete.

5.8 Calibration Adjustment Procedure Summary

This table provides an overview of all steps in the Calibration Adjustment Procedure. It is intended to be used as a reference for frequent users. For details on how to perform each Calibration Adjustment step, refer to sections 5.5, 5.6 and 5.7.

Table 5.5 Calibration Adjustment Procedure Summary.

STEP	SIGNAL SOURCE	SIGNAL AMPL/FREQ	SCOPEMETER INPUTS	ACTIONS
CONTRAST Calibration Adjustment Procedure				
-	-	-	-	Adjust for clear picture.
SCOPE Calibration Adjustment Procedure				
Hardware SCOPE Calibration Adjustments: only to be done when ScopeMeter is repaired!				
H1	PM 5134	300 mV(pp)/1 kHz (square)	A & B (50Ω termin.)	Adjust C2109/C2209.
H2	PM 5134	3V(pp)/1 kHz (square)	A & B (50Ω termin.)	Adjust C2107/C2207.
H3	Tek PG 506	20V(pp)/1 kHz (square)	A & B	Adjust C2114/C2214.
H4	Fluke 5100B	254.5 mV (RMS)/1 kHz (sine)	A	Adjust R2346/R2347, Ground testpoint 209.
Closed case SCOPE Calibration Adjustments				
S5	-	-	-	Short circuit BNCs.
S6	PM 5134	300 mV(pp)/1 kHz (square)	A & B (50Ω termin.)	-
S7	PM 5134	3V(pp)/1 kHz (square)	A & B (50Ω termin.)	-
S8	Tek PG 506	20V(pp)/1 kHz (square)	A & B	-
S9	Tek PG 506	50V(pp)/1 kHz (square)	A & B	-
S10	Tek PG 506	20 mV(pp)/1 kHz (square)	A & B	-
S11	Tek PG 506	50 mV(pp)/1 kHz (square)	A & B	-
S12	Tek PG 506	100 mV(pp)/1 kHz (square)	A & B	-
S13	Tek PG 506	200 mV(pp)/1 kHz (square)	A & B	-
S14	Tek PG 506	500 mV(pp)/1 kHz (square)	A & B	-
S15	Tek PG 506	1V(pp)/1 kHz (square)	A & B	-
S16	Tek PG 506	10V(pp)/1 kHz (square)	A & B	-
S17	Tek PG 506	100V(pp)/1 kHz (square)	A & B	-
S18	Tek PG 506	200 mV(pp)/1 kHz (square)	A & B	-
S19	Tek PG 506	20 mV(pp)/1 kHz (square)	A & B	-
S20	Fluke 5100B	353.5 mV (RMS)/50 kHz (sine)	A & B	-
S21	Fluke 5100B	353.5 mV (RMS)/50 kHz (sine)	A & B	-
S22	Fluke 5100B	353.5 mV (RMS)/50 kHz (sine)	A & B	-
S23	Fluke 5100B	353.5 mV (RMS)/50 kHz (sine)	A & B	-
S24	Fluke 5100B	353.5 mV (RMS)/50 kHz (sine)	A & banana	-
S25	Tek PG 506	500 mV(pp)/1 MHz	A & B (50Ω termin.)	-

STEP	SIGNAL SOURCE	SIGNAL AMPL/FREQ	SCOPEMETER INPUTS	ACTIONS
------	---------------	------------------	-------------------	---------

METER Calibration Adjustments

M1	-	-	-	Short circuit BNCs & banana
M2	-	-	-	Short circuit A BNC & banana
M3	-	-	-	A BNC open
M4	Fluke 5100B	300 mV DC	A	-
M5	Fluke 5100B	3V DC	A	-
M6	Fluke 5100B	30V DC	A	-
M7	Fluke 5100B	300V DC	A	-
M8	Fluke 5100B	300 mV DC	bananas	-
M9	Fluke 5100B	3V DC	bananas	-
M10	-	-	-	Short circuit banana input
M11	Fluke 5100B	100 Ω	bananas	-
M12	Fluke 5100B	1 kΩ	bananas	-
M13	Fluke 5100B	10 kΩ	bananas	-
M14	Fluke 5100B	100 kΩ	bananas	-
M15	Fluke 5100B	1 MΩ	bananas	-
M16	Fluke 5100B	10 MΩ	bananas	-
M17	-	-	A BNC to bananas	-
M18	Fluke 5100B	100 Ω	resistor between bananas, connect A BNC to banana	-
M19	red probe	-	probe tip to bananas	-
M20	grey probe	-	probe tip to bananas	-
M21	-	-	A BNC to bananas	-
M22	-	-	B BNC to bananas	-

6 DISASSEMBLING THE SCOPEMETER

6.1 GENERAL INFORMATION

Whenever the ScopeMeter needs repair and/or Hardware SCOPE Calibration Adjustments, the instrument must be disassembled.

NOTE: For replacement of components refer to section 7.2; for Hardware SCOPE Calibration Adjustments refer to section 5.6.1.

This section provides the required disassembling procedures. Both printed circuit boards removed from the instrument must be adequately protected against damage, and all normal precautions regarding the use of tools must be observed. During the disassembly process, make a careful note of all disconnected leads so that they can be reconnected to their correct terminals when you reassemble the instrument.

WARNING: Removing the instrument covers or removing parts, except those to which access can be gained by hand, is likely to expose live parts and accessible terminals may be live. To avoid electric shock, disconnect the instrument from all voltage sources and remove batteries before disassembling the instrument. If any adjustment, maintenance, or repair of the disassembled instrument under voltage is required, it shall be carried out only by qualified personnel using customary precautions against electric shock. Capacitors inside the instrument can hold their charge even if the instrument has been separated from all voltage sources and batteries have been removed.

6.2 DISASSEMBLY PROCEDURES

The following sections describe the disassembly process of the ScopeMeter in sequence (from fully assembled instrument to separate printed circuit boards and chassis parts). Start and end disassembly at the appropriate heading levels.

WARNING: To avoid electric shock, disconnect test leads, probes and power supply from any live source and from the ScopeMeter itself.

6.2.1 Removing the battery pack

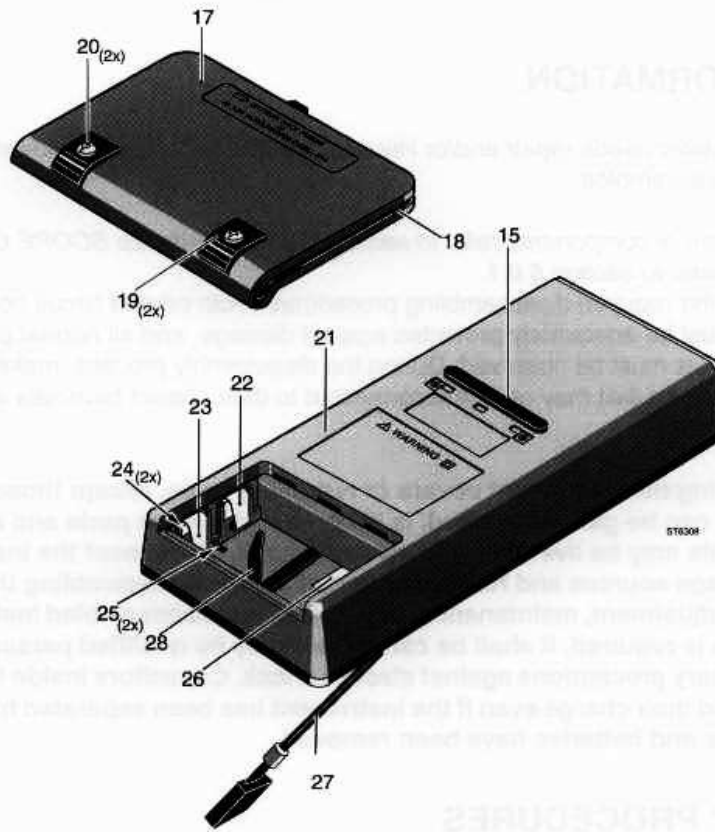


Figure 6.1 Removing the battery pack

1. The battery cover (item 17) is secured to the ScopeMeter with two black M3 Torx screws (item 20). Use a Torx screwdriver to loosen the two screws (do not remove them) from the battery cover.
2. Lift the battery cover from the ScopeMeter.
3. Pull the black battery pull strip (item 28) carefully to lift the battery pack.
4. Remove the battery pack.

6.2.2 Opening the ScopeMeter

Referring to figure 6.2, use the following procedure to open the ScopeMeter.

1. Loosen the two black M3 Torx screws (item 4) (do not remove them) from the front cover.
2. Lift the front cover assembly (item 3) from the ScopeMeter.

NOTE: The gasket, between the front cover and the two case halves, is sealed to, and must remain with, the front cover. The front cover assembly lifts away from the top and bottom case halves easily. Do not damage the gasket or separate it from the front cover. A correctly fitted gasket assures the sealing of the ScopeMeter.

3. Remove the battery pack (see Section 6.2.1).

4. The bottom cover assembly is secured to the top cover with two M3 Torx screws (item 29) that are accessible in the battery compartment. Use a Torx screwdriver to remove the two screws.
5. Lift the bottom cover a little from the top cover and unfold the ScopeMeter.

NOTE: Do not damage the black gaskets and keep them with the front cover and the lower case half. A correctly fitted gasket assures proper sealing of the ScopeMeter.

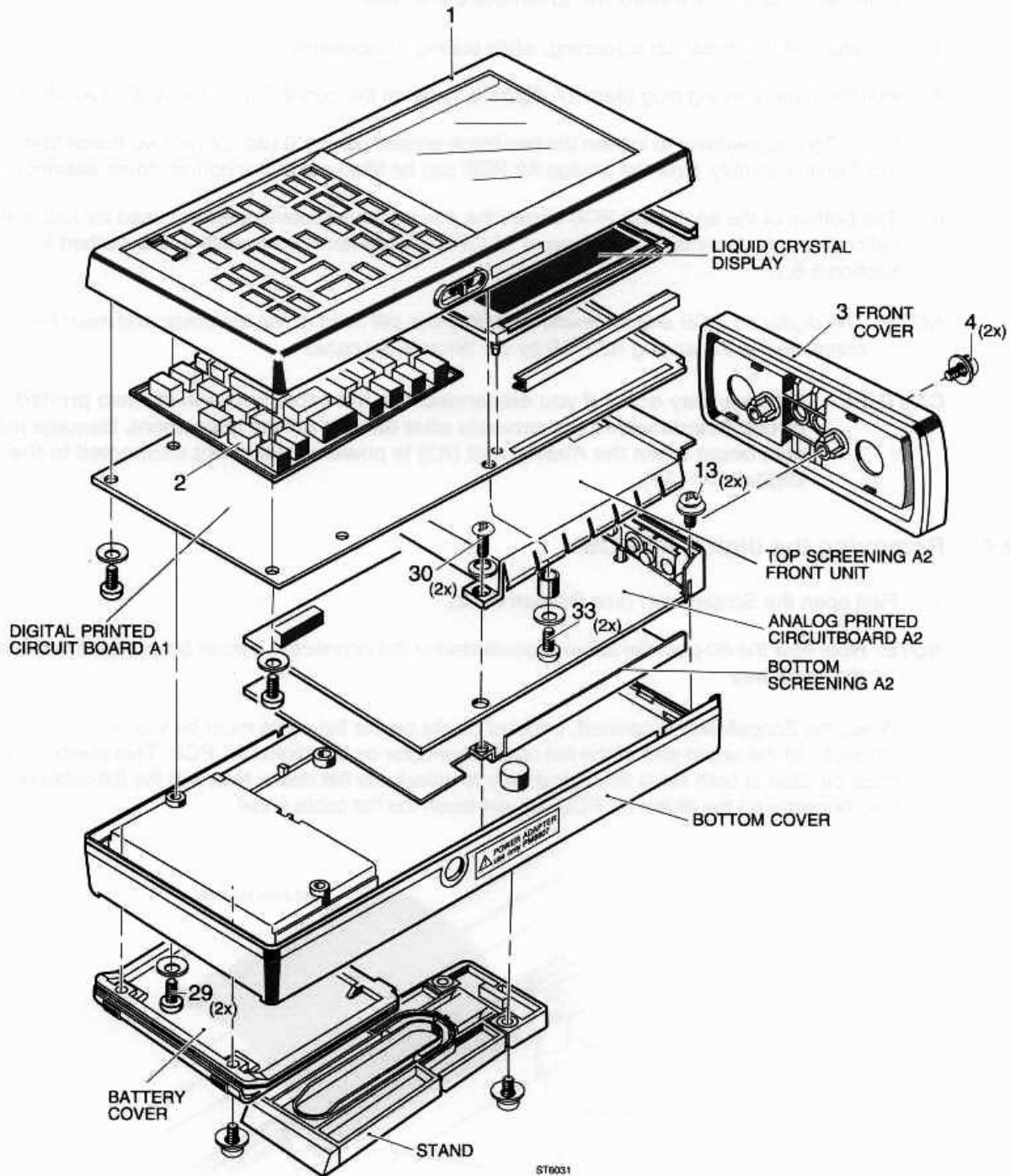


Figure 6.2 Opening the ScopeMeter

6.2.3 Removing the analog A2 PCB, to enable Hardware SCOPE Calibration Adjustments

Referring to figure 6.2, use the following procedure to remove the analog A2 PCB.

1. First open the ScopeMeter (see Section 6.2.2).
2. The analog A2 PCB and top screening are secured to the bottom cover with two M3 Torx screws (item 30). Use a Torx screwdriver to remove the screws.
3. Carefully lift the metal top screening, while pulling it backwards.
4. Pull the battery wiring plug (item 27, figure 6.1) out of the connector on the analog A2 PCB.
5. Use a Torx screwdriver to loosen the two black screws (item 13) (do not remove them) from the input unit assembly. Now the analog A2 PCB can be lifted out of the bottom cover assembly.
6. The bottom of the analog A2 PCB shows the components (potentiometers) used for hardware calibration adjustments. The Hardware SCOPE Calibration Adjustments are described in section 5.6.1.

NOTE: The digital A1 PCB and the metal shielding are still fixed to the top cover and must be connected to the analog A2 PCB by the 30-pole flat cable.

CAUTION: Damage may occur if you disconnect the flat cable between the two printed circuit boards within ten seconds after turning off the instrument. Damage may also occur when the Analog unit (A2) is powered when not connected to the Digital unit (A1).

6.2.4 Removing the digital A1 PCB.

1. First open the ScopeMeter (see Section 6.2.2).

NOTE: Note how the 30-pole flat cable is positioned in the connector: it must be replaced in exactly the same way

When the ScopeMeter is opened, the blue marks on the flat cable must be visible. Carefully lift the upper part of the flat cable connector on the digital A1 PCB. This plastic clamp must be lifted at both sides simultaneously to unlock the flat cable. Now pull the flat cable out of the connector on the digital A1 PCB. Do not touch the flat cable ends!

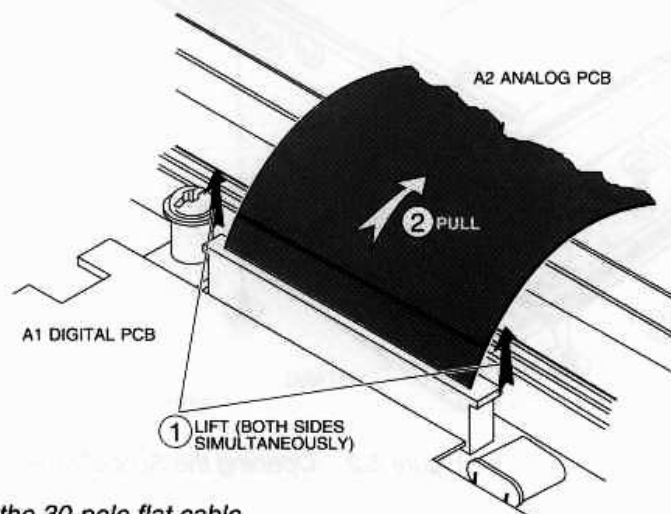


Figure 6.3 Removing the 30-pole flat cable

3. The digital A1 PCB and metal screening are secured to the top cover with four M3 Torx screws (item 33). Two of these screws contain small standoffs. Be sure to reinstall them in the correct place when the ScopeMeter is reassembled. Use a Torx screwdriver to remove the screws.
8. Remove the metal A1 screening from the digital A1 PCB.
9. Remove the digital A1 PCB from of the top cover. Be careful not to damage the infrared LED and phototransistor of the optical interface.

NOTE: When reassembling the digital A1 PCB, make sure that the infrared LED and phototransistor are exactly aligned with the holes in the top cover.

7 CORRECTIVE MAINTENANCE

7.1 DIAGNOSTIC TESTING AND TROUBLESHOOTING

7.1.1 Introduction

The ScopeMeter provides semimodular design to aid in troubleshooting. This section describes procedures needed to isolate a problem in a specific functional area. Finally, troubleshooting hints for each functional area are presented.

If the ScopeMeter fails, first verify that you are operating the ScopeMeter correctly by reviewing the Operation Verification Procedure found in the Users Manual.

WARNING: Opening the case may expose hazardous voltages. Always disconnect the instrument from all voltage sources and remove the batteries before opening the case. Remember that repairs or servicing should be performed by qualified personnel only.

7.1.2 Troubleshooting techniques

If a fault appears, the following test sequence can be used to help you to locate the defective component:

- Check to verify that the control settings of the instrument are correct. Consult the operating instructions in the Users Manual.
- Check the equipment to which the instrument is connected and check the interconnection cables.
- Verify that the instrument is properly calibrated. If it is not, refer to Chapter 5: "Calibration Adjustment Procedure".
- Locate the circuit(s) in which you suspect the fault: the symptom often suggests the faulty circuit. If the power supply is defective, the symptom may appear to be caused by several circuits.
- Check the circuit(s) in which you suspect the fault. Often it is possible to find faults such as cold or defective solder joints, intermittent or open interconnection plugs and wires or damaged components.

7.1.3 Display and error messages

To ease the ScopeMeter operation display messages are generated. If you operate the ScopeMeter incorrectly, it will display error messages. Each error message is displayed for 5 seconds.

The following table describes the display messages and error messages and the possible solutions. If no specific model number is stated, the message and solution apply to all ScopeMeter models.

MESSAGE	CAUSE
<p>Key not possible in this ScopeMeter mode. (SCOPE/METER mode)</p> <p>Solution: Press a correct key.</p>	<p>You have pressed an incorrect key. For example: you have pressed the trigger key, while in meter mode.</p>
<p>Not executed: at least one trace on LCD (SCOPE mode)</p> <p>Solution: Turn on another channel.</p>	<p>You have attempted to switch off the only displayed trace in the CHAN AB menu or WAVEFORM menu (Model 97).</p>
<p>Not executed: already max. traces on LCD (SCOPE mode)</p> <p>Solution: Turn off another trace.</p>	<p>(Model 97) You have attempted to turn on more than four traces simultaneously in the CHAN AB menu and the WAVEFORM menu.</p>
<p>Chosen function changed other settings. (SCOPE mode)</p> <p>Solution: Switch off the chosen function and check the settings.</p>	<p>Sometimes some functions, for example events and n-cycle, can adapt (change) other ScopeMeter settings automatically.</p>
<p>Time base limit reached for present mode (SCOPE mode)</p> <p>Solution: Select RECURRENT trigger mode.</p>	<p>The s TIME ns key has been pressed, forcing the timebase to exceed the limit. For example, if the limit of 100 ns in single trigger mode is exceeded.</p>
<p>ScopeMeter auto shut down in 5 minutes! (SCOPE/METER mode)</p> <p>Solution: Press a key.</p>	<p>No new key has been activated in the last 10 minutes. To save battery power, the ScopeMeter shuts down.</p>
<p>ScopeMeter model 9x ; Vx.xx ; yy-yy-yy (SCOPE/METER mode)</p> <p>Solution: -</p>	<p>ScopeMeter "model number; software version; software date". Both softkeys 1 (left) and 5 (right) have been pressed at the same time.</p>

Scope mode: not more than 5 measurements
(SCOPE mode)

You have attempted to switch on more than five cursor measurements simultaneously in the cursor function pop-up menu.

Solution: Turn off another cursor function.

Unknown probe or wrong connection.
(SCOPE/METER mode)

No probe or a defective probe has been connected during probe DC calibration.

Solution: Connect a correct probe and do another DC calibration. If the warning is still displayed, refer to the troubleshooting information of the Analog A2 PCB later in this section.

No valid memory setup that can be used.
(SCOPE mode)

You have tried to recall a waveform and the corresponding setup (Setup recall active), while a setup has not been saved for the stored waveform.

Solution: Choose a waveform for which there is a valid setup stored, or switch off the "Setup recall" function.

Not executed: no 12V programming voltage
(SCOPE/METER mode)

The CALIBRATE ScopeMeter softkey has been pressed in the SERVICE menu without the 12V programming voltage being connected to the programming contacts in the battery compartment.

Solution: Connect the 12V programming voltage, before pressing the CALIBRATE softkey.

NOTE: Calibration is to be done by qualified service personnel. Incorrect calibration data is stored if 12V programming voltage is connected, while the CALIBRATE ScopeMeter mode is turned on. For calibration of the Scopemeter refer to chapter 5: "Calibration Adjustment Procedure".

CAL STORE error: no 12V or no space left
(SCOPE/METER mode)

1. **No 12V.** The 12V programming voltage that is connected to the programming contacts in the battery compartment has disappeared during the calibration adjustments.

2. **No space left.** The internal Flash ROMs with the calibration constants are full.

Solution: 1. Check the 12V programming voltage connection in the battery compartment.

2. The calibration constants part in the Flash Roms must be emptied before other calibrations can be made. For refreshing the Flash ROMs, contact your nearest Fluke/Philips Service Center.

PRINTER error: please reset printer.
(SCOPE/METER mode, model 97 only)

No printing or the printing has stopped via the optically isolated RS- 232-C interface PM9080.

Solution: Check the settings on the printer (ON LINE and BAUD RATE). Reset the printer. Verify that if the optically isolated RS-232-C interface is still connected to the ScopeMeter.

- CALIBRATION error: wrong input signal(s)**
(SCOPE/METER mode) The ScopeMeter has rejected the connected calibration adjustment signal during calibration.
- Solution: Check the calibration signal and repeat the calibration step. If the signal is correct and the error message remains, refer to the troubleshooting information of the Analog A2 PCB later in this section.
- PROBE successfully calibrated.**
(SCOPE/METER mode) The probe calibration has been successful.
- ** ERROR *** PLEASE RESET INSTRUMENT *****
(SCOPE/METER mode) General error message: something has gone wrong, which cannot be undone easily.
- Solution: Switch off the ScopeMeter and switch it on again, using MASTER RESET: Press the LCD key and keep it pressed. Now press the ON/OFF key. The ScopeMeter will give two beeps and will start up in a default condition.
- No AUTOSET on time or att: no channels**
(SCOPE mode) You have tried to do an AUTOSET, while both channels A and B were switched off (only waveforms in memory displayed!).
- Solution: Switch on channel A and/or channel B before you activate AUTOSET.
- REF differs from present meter mode.**
(METER mode) The settings of the ScopeMeter have been changed, so that previously determined references are not valid.
- Solution: Set new references.
- PROBE CAL. Use AUTO SET to exit.**
(SCOPE/METER mode) The ScopeMeter has been set into the AC ADJUST mode for channel A or B in the PROBE CAL popup menu.
- Solution: AC adjust the probe and/or press the AUTO SET key.
- AUTO SET .. AUTO SET .. AUTO SET**
(SCOPE/METER mode) The ScopeMeter performs an auto set after the AUTO SET key has been pressed.
- Solution: Wait until the warning disappears (about 1 second). If the warning stays, refer to the troubleshooting information later in this section.
- Connect PROBE to GENERATOR OUT.**
(SCOPE/METER mode) The AC ADJUST or the DC CAL item in the PROBE CAL pop up menu has been selected.
- Solution: Connect a probe to the generator output and select AC ADJUST or DC CAL or wait for five seconds.
- DC PROBE calibration in progress**
(SCOPE/METER mode) The DC CAL item in the PROBE CAL pop-up menu has been selected.
- Solution: Wait until the warning disappears. A beep signals the end of the DC PROBE calibration. If the calibration has been successful, the message "PROBE successfully calibrated" will appear.

7.1.4 Main tests



7.1.4.1 Operation Verification Procedure

This test verifies the ScopeMeter with a minimum of test steps and actions. It does not check every facet of the ScopeMeter's characteristics, but it gives you an indication of correct operation.

For operation verification purposes, the ScopeMeter generates a 975 Hz/ 5V peak-to-peak square wave signal that can be measured and verified. This signal is measured in the SCOPE and METER mode.

NOTE: To use the ScopeMeter to its fullest capability it is essential to use only calibrated probes with your instrument. These calibrated probes are delivered with the ScopeMeter.

Operation Verification Procedure:

1. Turn ON the ScopeMeter.
2. Connect the red 10:1 scope probe to channel A (red BNC) input.
3. Connect the red adjust adapter to the red banana GENERATOR OUTput connector.
4. Connect the red probe to the red banana/scope tip adapter.
5. Press the **SCOPE** key.
6. Press the **LCD/CAL** key.
7. Press the **PROBE CAL** softkey to select the CALibration & ADJUST pop-up menu.
8. Press the   select/adjust keys to select AC ADJUST of channel A.
9. Press the **ENTER** softkey to enter the AC ADJUST mode.

- Check the **SCOPE** display on the following settings and results:

Channel Configuration	Channel A
Vertical Amplitude	1V/div
Channel Input Coupling	AC
Probe Selected	PROBE x10
Time Base	100 μ s/div
Trigger Mode (Press SCOPE key)	Recurrent
Trigger Source (Press TRIGGER key)	Channel A
Trigger Slope (Press TRIGGER key)	+ Slope

Result (see Figure 7.1): Square wave,
Ampl 5V peak-to-peak $\pm 10\%$
Freq 976 Hz $\pm 1\%$

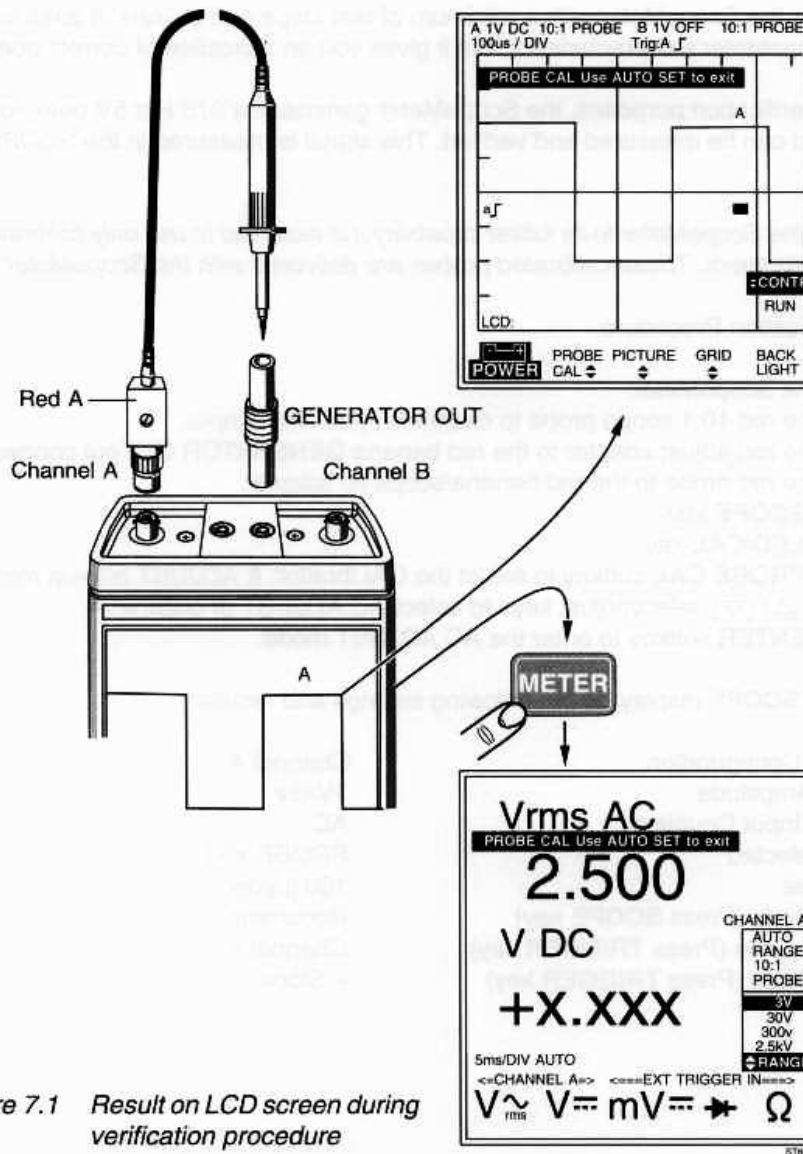


Figure 7.1 Result on LCD screen during verification procedure

10. Press the **METER** key.
The ScopeMeter sets itself to the initial METER measurement function.
- Check the **METER** display on the following settings and results:
Result (see Figure 7.1): Vrms AC 2.500 $\pm 10\%$
Ranging (see Figure 7.1): AUTO, 3V
11. Press the **AUTO SET** key to end the operation verification procedure for channel A.

NOTE: To verify the SCOPE operation of Channel B, proceed in the same order as Channel A, use the grey channel B BNC socket and the grey 10:1 scope probe.

7.1.4.2 Performance Verification Procedure

The Performance Verification Procedure is a very quick way to check most of the ScopeMeter's specifications. It is based on the specifications listed in Chapter 2 of this Service Manual. If the instrument fails of any of these tests, Calibration Adjustments (see chapter 5) and/or repair (see chapter 7) is necessary. The complete Performance Verification Procedure is described in chapter 4.

7.1.5 Troubleshooting

7.1.5.1 Trouble shooting hints

OPENING THE SCOPEMETER:

To troubleshoot the ScopeMeter, open the instrument as described in subsection 6.2.2 "Opening the ScopeMeter" of chapter 6 "DISASSEMBLING THE SCOPEMETER".

TEST POINT AND COMPONENTS LOCATION:

Added with the PCB layouts figures 10.1, 10.4, and 10.5 and the circuit diagrams figures 10.2, 10.3, 10.6, 10.7, and 10.8 are location reference lists for fast location of the test points and the components.

CONNECTING THE GROUND (ZERO) LOGIC 0 REFERENCE:

While performing measurements, it is possible to use the metal shielding as zero reference. It is also possible to install the metal screws, as is described in section 5.6.1 "Hardware SCOPE Calibration Adjustments". You can use one of the screws as a zero reference: refer to figure 5.2.

LOGIC 1 LEVEL:

The logic one level is +5V.

7.1.6 Digital A1 PCB Troubleshooting

First remove the digital A1 PCB as described in section 6.2.4 "Removing the digital PCB".

7.1.6.1 Powering the ScopeMeter

Power the ScopeMeter with the powerAdapter/Battery Charger PM8907.

7.1.6.2 Kernel Test

The Kernel tests the Address/Data outputs from the microprocessor (D1201), the interface transmitter and receiver circuits of the optical interface, and the Random Access Memories (RAM). The test results are measured with an oscilloscope.

NOTE: If loading the ScopeMeters FlashROMs fails, it is possible to get a ScopeMeter which is not functioning. For example: if the operating system of the ScopeMeter is corrupted, it is not possible to operate the instrument normally. In this case you should also use the following procedure to establish communication with the ScopeMeter. When communication is established, you can reload the operating software into the FlashROMs. (For this action you need special software: contact your nearest Fluke/Philips Service Center.)

1. Power the ScopeMeter with the Power Adapter/Battery Charger PM8907.
2. Ground testpoint TP216, turn on the ScopeMeter and release the ground (from testpoint TP216).

MICROPROCESSOR D1201

3. Measure on connector contact X1201/6 to test the microprocessor D1201.
Correct = 0.5 Hz.
Incorrect (defect microprocessor D1201) = not 0.5 Hz.

OPTICAL INTERFACE

4. Shine with a lamp in the "Optical Interface" holes to test the optical interface receiver.
5. Measure on the transceiver line D1201/32.
Apply light and verify that the signal level changes from 0V DC (dark) to 0.3V DC (light).

ADDRESS/DATA LINES

6. Measure on address/data bus 00 (AD00, D1201/2).
Correct = Logic 0.
All other address data lines (AD01 to AD15) are logic 1 (+5V).
7. Ground and release testpoint TP217 (first time) and the next address/data AD01 line will go low (to logic 0).
Continue grounding and releasing testpoint TP217 until address/data line AD15 goes low (fifteenth time).
With steps 6 and 7 the buffered addresses throughout the whole instrument are active and can be traced.

RAMS D1204 AND D1206.

8. The next grounding of testpoint TP217 (sixteenth time) starts the RAM test of the first RAM D1204. Measure on connector contact X1201/6.
During the RAM test connector contact starts at logic 0.
RAM correct = 0.5 Hz.
RAM incorrect = logic 1.
9. Ground and release testpoint TP217 (seventeenth time) to start the RAM test of the second RAM D1206. Measure on connector contact X1201/6.
During the RAM test connector contact X1201/6 starts at logic 0.
RAM correct = 0.5 Hz.
RAM incorrect = logic 1.

ESTABLISHING COMMUNICATION.

10. After the seventeenth time of grounding TP217, the ScopeMeter sends an <XON> via the RS-232 interface. Now communication is established, it is possible to reprogram the FlashROMs. For special software contact your nearest Fluke/Philips Service Center.
11. Ground testpoint TP216 one more time to abort the Kernel Test.

7.1.6.3 Test point signals.

The digital A1 PCB is provided with test points, marked: "TP" See figure 10.1: A1 PCB layout (component side). These can be used to check correct functioning of the PCB.

All measurements are made in the default MASTER RESET condition (start the measurements in the ScopeMeter using **MASTER RESET**).

A MASTER RESET is performed as follows:












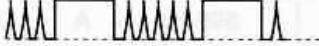


1. Remove all signals from the ScopeMeter.
2. Turn off the ScopeMeter.
3. Hold down the LCD key and press the ON/OFF key simultaneously. Two beeps are audible, and all volatile memories (RAM with battery backup) are reset. The ScopeMeter is automatically set to the METER mode.

Use another oscilloscope with high input impedance and 10:1 probe to measure the signals on the test points. See table 7.1:

Table 7.1. Overview on Test Points on the digital A1 PCB.

Logic 0=0V, Logic 1=+5V

TP	Name	Scope	Freq.	Data H/L/A	Description
207	Y40		595 Hz	A	Output 40, D1404
208	Y120		595 Hz	A	Output 120, D1406
209	Y200		595 Hz	A	Output 200, D1407
210	X40		595 Hz	A	Output 40, D1401
211	X120		595 Hz	A	Output 120, D1402
212	X200		595 Hz	A	Output 200, D1403
213	WEN			A	Write Enable Not, point 10 of D1203
214	REN			A	Read Enable Not, point 11 of D1203
216	TEST1		0	H	TEST 1/analog channel 3, point 16 of D1201
217	TEST2		12.1 kHz	A	TEST 2/timer 2 clock, point 64 of D1201
219	ON_OFF		0	L	ON OFF/high speed input 0.2, point 53 of D1201
221	POWER_ON		0	H	POWER ON

TP	Name	Scope	Freq.	Data H/L/A	Description
222	NOT_ON		0	L	NOT ON
223	RAM_POWER		0	H	RAM POWER
224	+VRAM		0	H	+Supply Voltage for the RAM/...
233	V1		0	H	Power supply for LCD drive (+2.3V)
234	V2		0	L	Power supply for LCD drive (-23V)
235	V3		0	L	Power supply for LCD drive (-0.8V)
237	V5		0	L	Power supply for LCD drive (-22V)
239	μPCLK		12.5 MHz	A	μProcessor clock, point 9 of D1201
241	BAT_LEVEL		0	H	BATtery LEVEL/analog channel 6, point 20 of D1201
244	RAMSELN			A	RAM SElect Not, point 20 of D1204
246	OPTSELN		500 kHz	A	Option Select Not
247	A15		100 kHz	A	.../ROM 1 select not
248	-20V		0	H	-20V supply
249	+5V		0	H	+5V supply

7.1.6.4 Default signals measured in the digital circuits.

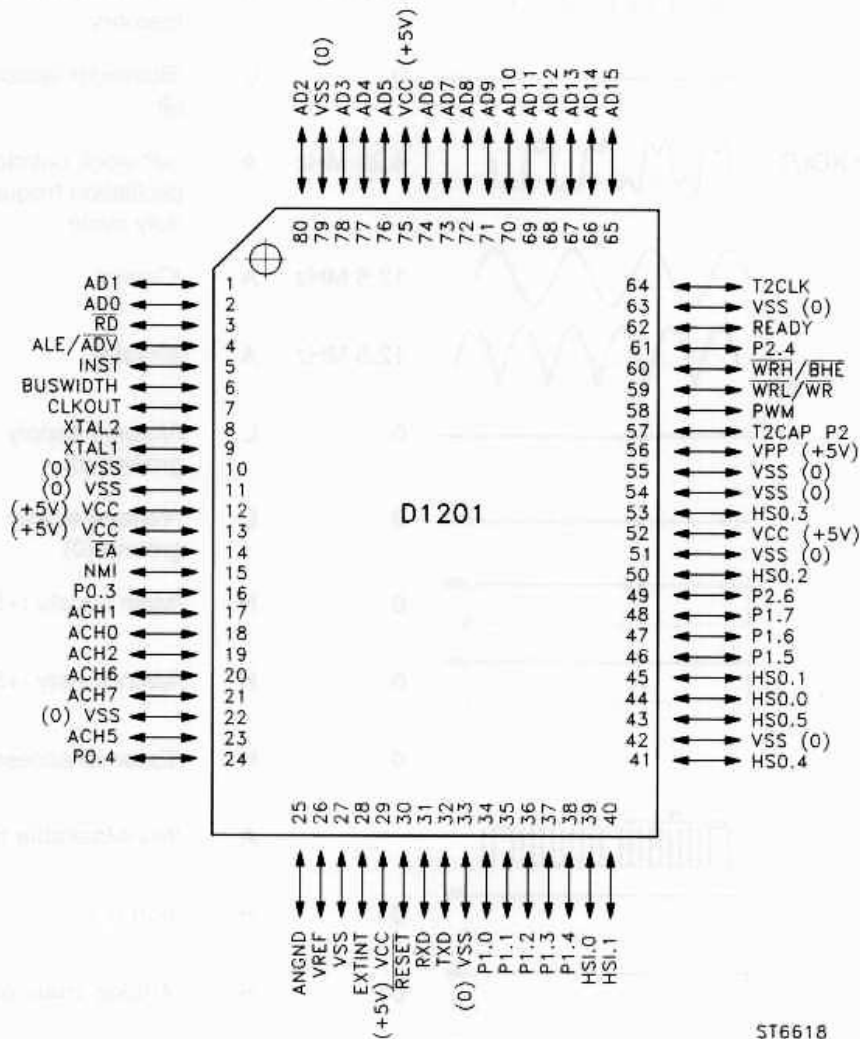
The Digital A1 PCB is provided with large integrated circuits. For testing the board, the input signals and output signals of the large integrated circuits are given in tables 7.2 up to 7.5. and the corresponding figures. These signals can be used to check correct functioning of the large Integrated Circuits on the digital A1 PCB.

All measurements are made in the default MASTER RESET condition (start the measurements in the ScopeMeter using **MASTER RESET**).

A MASTER RESET is performed as follows:

1. Remove all signals from the ScopeMeter.
2. Turn off the ScopeMeter.
3. Hold down the LCD key and press the ON/OFF key simultaneously. Two beeps are audible, and all volatile memories (RAM with battery backup) are reset. The ScopeMeter is automatically set to the Meter mode.

Use another oscilloscope with high input impedance and 10:1 probe to measure the signals on the integrated circuits.

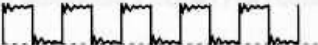


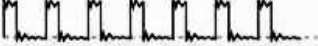



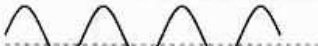








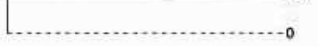




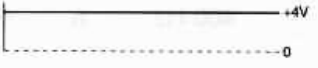







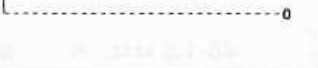


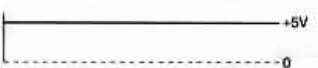






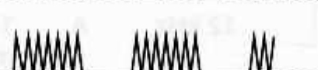
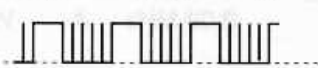
ST6618
911114


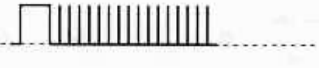















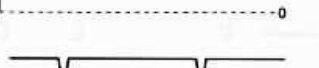

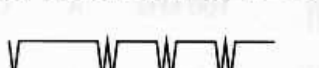
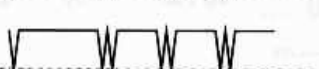
Figure 7.2 Microprocessor D1201





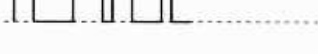
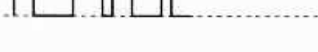
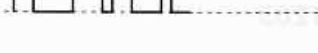
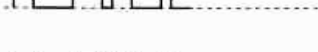
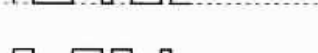









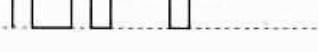

Table 7.2 Signals measured on microprocessor D1201.

Logic 0=0V, Logic 1=+5V

Comp	Name (pin) Circ /IC	Scope	Freq.	Data H/L/A	Description
D1201					
1	AD01 /AD1/P3		1.5 MHz	A	Address Data1/Address Data1 port3
2	AD00 /AD0/P3		2 MHz	A	Address Data0/Address Data0 port3
3	RDIN /RD		2 MHz	A	Read not/Read
4	ADVN /ALE/ADV		2 MHz	A	Address valid not/Address latch enable/Address valid output
5	/INST		200 kHz	A	/Instruction fetch for external memory
6	/BUSWIDTH		0	L	/Buswidth selection, 8 or 16 bit
7	μ PCLKOUT/CLKOUT		6.25 MHz	A	μ P clock out/clock out 1/2 oscillation frequency 50% duty cycle
8	/X-TAL2		12.5 MHz	A	/Crystal
9	/X-TAL1		12.5 MHz	A	/Crystal
10	/VSS		0	L	/Voltage supply ground (0)
11	/VSS		0	L	/Voltage supply ground (0)
12	/VCC		0	H	/Main supply (+5V)
13	/VCC		0	H	/Main supply (+5V)
14	/EA		0	H	/External access
15	/NMI			A	/NonMaskable Interrupt
16	/PO.3		0	H	/port 0.3
17	/ACH1		0	H	/Analog channel 1
18	/ACH0		0	H	/Analog channel 0

Comp	Name (pin) Circ /IC	Scope	Freq.	Data H/L/A	Description
19	/ACH2		0	H	/Analog channel 2
20	/ACH6		0	H	/Analog channel 6
21	/ACH7		0	A	/Analog channel 7
22	/VSS		0	L	/Voltage supply ground (0)
23	/ACH5		0	L	/Analog channel 5
24	HLDOFN/ACH4			H	/A Hold off not /Analog channel 4
25	/ANGND		0	L	/Analog ground (A/D convertor)
26	/VREF		0	H	/Reference (A/D convertor)
27	/VSS		0	L	/Clock Detect Enable
28	ACQRDY/EXTINT		5 Hz	A	Acquisition ready/External interrupt
29	/VCC		0	H	/Main supply (+5V)
30	μ PRESET/ $\overline{\text{RESET}}$		0	H	μ P reset /reset
31	/RXD		0	H	/Receive data/port 2
32	/TXD		0	H	/Transmit data/port 2
33	/VSS		0	L	/Voltage supply ground (0)
34	CDAT /P1.0		5 Hz	A	Cbus DATA /Port 1.0
35	DTAEB/P1.1		0	L	DATA enable /Port 1.1
36	FRONTCLOCK/P1.2		60 kHz	A	Front clock /Port 1.2
37	CCLK /P1.3		100 kHz	A	Cbus clock /Port 1.3
38	PS0 /P1.4		40 Hz	A	page select 0 /Port 1.4
39	FRONTDATA1/HS1.0		0	H	Frontdata 1 /High speed input 1.0

Comp	Name (pin) Circ /IC	Scope	Freq.	Data H/L/A	Description
40	FRONTDATA2/HS1.1		0	H	Frontdata2 /High speed input 1.1
41	/HS0.4		400 Hz	A	/High Speed input 0.4
42	/VSS		0	L	/Voltage supply ground (0)
43	AD15 /HS0.5			L/A	Address data 15/High Speed input 0.5
44	LIGHT/HS0.0		0	L	Light /High Speed input 0.0
45	/HS0.1		0	L	/High Speed input 0.1
46	PS1 /P1.5		0	L	page select 1 /port 1.5
47	PS2 /P1.6		45-1.5 kHz	A	page select 2 /port 1.6
48	PS3 /P1.7		45-1.5 kHz	A	page select 3 /port 1.7
49	DTAEC/P2.6		0	L	Data enable C /port 2.6
50	/HS0.2		0	L	/High Speed input 0.2
51	/VSS		0	L	/Voltage supply ground (0)
52	/VCC		0	H	/Main supply (+5V)
53	ON OFF/HS0.3		0	L	on off /High Speed input 0.2
54	/VSS		0	L	/Voltage supply ground (0)
55	/VSS		0	L	/Voltage supply ground (0)
56	/VPP		0	H	/(+5V)
57	FRONT LATCH /T2CAP/P2			H/A	Front latch /
58	TEST2/PWM		12 kHz	A	Test 2 /Pulse width modulator
59	WRIN /WRL/WR		2.08 MHz	A	Write not /Write low/Write
60	/WRH/BHE		2.08 MHz	A	/Write high, Bus High Enable

Comp	Name (pin) Circ /IC	Scope	Freq.	Data H/L/A	Description
61	ADC7 /P2.4			A	Analog digital convertor/ port 2.4
62	SYNCRDY/READY		2 MHz	A	Synchronisation ready/Ready
63	/VSS		0	L	/Voltage supply ground (0)
64	TEST2/T2CLK		12 kHz	A	Test 2 /Timer 2 clock
65	AD15 /AD15		100 kHz	A	Address data 15/Address data 15
66	AD14 /AD14		100 kHz	A	Address data 14/Address data 14
67	AD13 /AD13		100 kHz	A	Address data 13/Address data 13
68	AD12 /AD12		100 kHz	A	Address data 12/Address data 12
69	AD11 /AD11		100 kHz	A	Address data 11/Address data 11
70	AD10 /AD10		100 kHz	A	Address data 10/Address data 10
71	AD09 /AD		100 kHz	A	Address data 09/Address data 09
72	AD08 /AD		100 kHz	A	Address data 08/Address data 08
73	AD07 /AD		1-2 MHz	A	Address data 07/Address data 07
74	AD06 /AD		1-2 MHz	A	Address data 06/Address data 06
75	/VCC		0	H	/Main supply (+5V)
76	AD05 /AD		1.5 MHz	A	Address data 05/Address data 05
77	AD04 /AD		1.5 MHz	A	Address data 04/Address data 04
78	AD03 /AD		1.5 MHz	A	Address data 03/Address data 03
79	/VSS		0	L	/Voltage supply ground (0)
80	AD02 /AD2		1.5 MHz	A	Address data 02/Address data 02

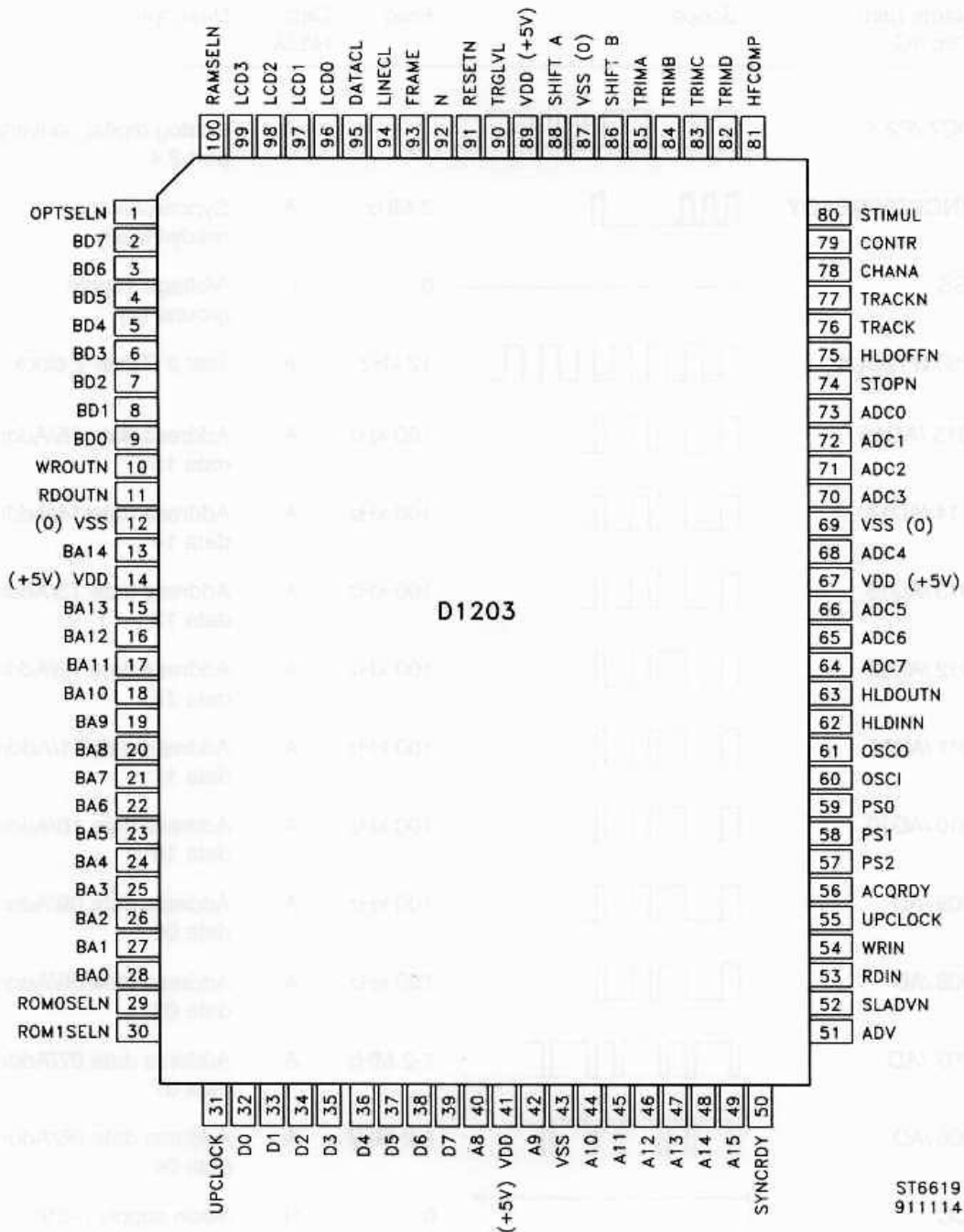

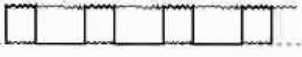

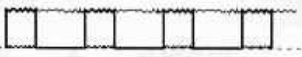


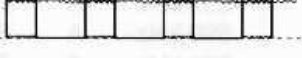
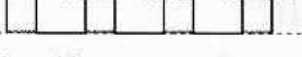

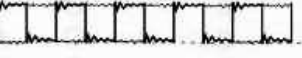




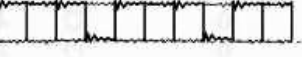



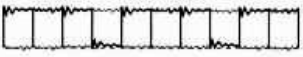
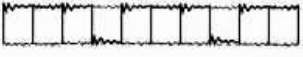
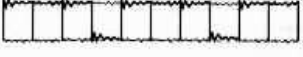
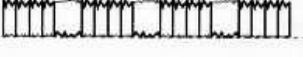
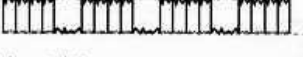
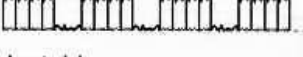
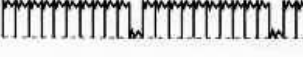
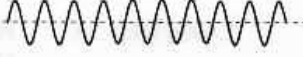
Figure 7.3 Digital ASIC D1203

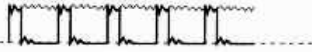
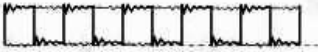








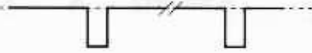
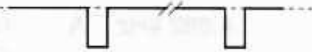




Table 7.3 Signals measured on digital ASIC D1203.


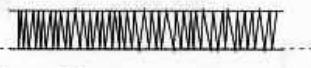

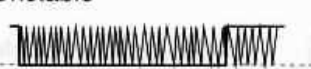


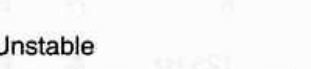

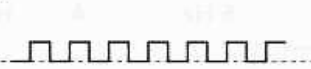

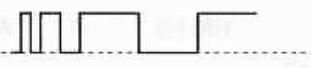

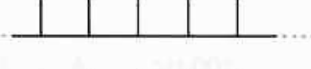
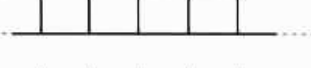
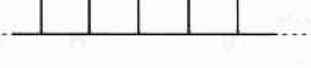

Logic 0=0V Logic 1=+5V







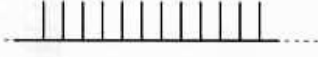






Comp	Name (pin) Circ /IC	Scope	Freq.	Data H/L/A	Description
D1203					
1	/OPTSELN		499.8 kHz	A	Optional RAM Select Not

Comp	Name (pin) Circ /IC	Scope	Freq.	Data H/L/A	Description
2	BD07/BD7	Unstable 	100 kHz	A	Buffered Data
3	BD06/BD6	Unstable 	100 kHz	A	Buffered Data
4	BD05/BD5	Unstable 	100 kHz	A	Buffered Data
5	BD04/BD4	Unstable 	100 kHz	A	Buffered Data
6	BD03/BD3	Unstable 	100 kHz	A	Buffered Data
7	BD02/BD2	Unstable 	100 kHz	A	Buffered Data
8	BD01/BD1	Unstable 	100 kHz	A	Buffered Data
9	BD00/BD0	Unstable 	100 kHz	A	Buffered Data
10	WEN/WROUTN	Unstable 	32 kHz	A	Write Enable Not/Write Out Not
11	REN/RDOUTN	Unstable 	1.4995 MHz	A	Read Enable Not/Read Out Not
12	VSS		0	L	Volt Supply ground
13	BA14/BA14	Unstable 	200 kHz	A	Buffered Address
14	+5VD/VDD		0	H	Volt Supply
15	BA13/BA13	Unstable 	635 kHz	A	Buffered Address
16	BA12/BA12	Unstable 	635 kHz	A	Buffered Address
17	BA11/BA11	Unstable 	635 kHz	A	Buffered Address

Comp	Name (pin) Circ /IC	Scope	Freq.	Data H/L/A	Description
18	BA10/BA10	Unstable 	635 kHz	A	Buffered Address
19	BA09/BA9	Unstable 	635 kHz	A	Buffered Address
20	BA08/BA8	Unstable 	635 kHz	A	Buffered Address
21	BA07/BA7	Unstable 	616 kHz	A	Buffered Address
22	BA06/BA6	Unstable 	616 kHz	A	Buffered Address
23	BA05/BA5	Unstable 	616 kHz	A	Buffered Address
24	BA04/BA4	Unstable	590 kHz	A	Buffered Address
25	BA03/BA3	Unstable	599 kHz	A	Buffered Address
26	BA02/BA2	Unstable	599 kHz	A	Buffered Address
27	BA01/BA1	Unstable	599 kHz	A	Buffered Address
28	BA00/BA0	Unstable 	624 kHz	A	Buffered Address
29	CEN/ROM0SELN	1	0	H/Rom 0 Select Not
30	A15/ROM1SELN	1	0	H	Address 15/Rom 1 Select Not
31	UPCLOCK		12.496 MHz	A	Micro-processor Clock
32	AD00/D0	0	0	O	Address Data/Data Bus I/O 0
33	AD01/D1	0	0	O	Address Data/Data Bus I/O 1
34	AD02/D2	0	0	O	Address Data/Data Bus I/O 2
35	AD03/D3	0	0	O	Address Data/Data Bus I/O 3
36	AD04/D4	0	0	O	Address Data/Data Bus I/O 4
37	AD05/D5	0	0	O	Address Data/Data Bus I/O 5
38	AD06/D6	0	0	O	Address Data/Data Bus I/O 6
39	AD07/D7	0	0	O	Address Data/Data Bus I/O 7
40	AD08/D8	0	0	O	Address Data/Data Bus I/O 8
41	+5VD/VDD	1	0	H	Volt Supply
42	AD09/D9	0	0	O	Address Data/Data Bus I/O 9
43/VSS	0	0	L	Volt Supply Ground
44	AD10/A10	0	0	O	Address Data/Data Bus I/O 10
45	AD11/A11	0	0	O	Address Data/Data Bus I/O 11
46	AD12/A12	0	0	O	Address Data/Data Bus I/O 12
47	AD13/13	0	0	O	Address Data/Data Bus I/O 14
48	AD14/A14	0	0	O	Address Data/Data Bus I/O
49	AD15/A15	0	0	O	Address Data/Data Bus I/O 15
50	SYNCRDY /SYNCRDY	0	0	O	Synchronisation ready

Comp	Name (pin) Circ /IC	Scope	Freq.	Data H/L/A	Description
51	ADVN/ADVN	Unstable 	1.200 MHz	A	Address Valid Not
52	SLADVN	1	0	H	Slow Address Valid Not (not used)
53	RDIN/RDIN	Unstable 	1.200 MHz	A	Read In
54	WRIN/WRIN	Unstable 	33 kHz	A	Write In
55	UPCLOCK/UPCLOCK		6.248 MHz	A	Micro Processor Clock
56	ACQRDY/ACQRDY		5Hz	A	Acquisition Ready
57	PS2/PS2	Unstable 	130 Hz	A	Page Select 2
58	PS1/PS1		0	O	Page Select 1
59	PS0/PS0	Unstable 	125 Hz	A	Page Select 0
60	.../OSCI		25 MHz	X	Oscillator In
61	.../OSCO		25 MHz	X	Oscillator Out
62	/HLDINN	Unstable 	5 Hz	A	Hold In Not
63	/HLDOUTN	Unstable 	5 Hz	A	Hold Out Not
64	ADC7/ADC7	Unstable 	100 Hz	A	ADC data output 7
65	ADC6/ADC6	Unstable 	100 Hz	A	ADC data output 6
66	ADC5/ADC5	Unstable 	100 Hz	A	ADC data output 5
67	+5VD/VDD		0	H	Volt Supply

Comp	Name (pin) Circ /IC	Scope	Freq.	Data H/L/A	Description
68	ADC4/ADC4	Unstable 	100 Hz	A	ADC data output 4
69	.../VSS	0	0	L	Volt Supply Ground
70	ADC3/ADC3	Unstable 	500 Hz	A	ADC data output 3
71	ADC2/ADC2	Unstable 	1 kHz	A	ADC data output 2
72	ADC1/ADC1	Unstable 	2.5 kHz	A	ADC data output 1
73	ADC0/ADC0	Unstable 	2.7 kHz	A	ADC data output 0
74	STOPN/STOPN	Unstable 	5 Hz	A	Acquisition Stop Not
75	HLDOFFN /HLDOFFN	Unstable 	5 Hz	A	Trigger Hold Off Not
76	TRACK/TRACK	Unstable 	11 kHz	A	Track (acquisition clock ADC)
77	.../TRACKN	not used			Track
78	CHANA/CHANA	1	0	H	Channel A
79	CONTR/CONTR		4.88 kHz	A	Contrast
80	STIMUL/STIMUL		976 Hz	A	Stimulus output
81	HF-COMP/HFCOMP	Unstable 	4.882 kHz	A	High Frequency Compensation (32 digit zero meter correction)
82	TRIMD/TRIMD		4.882 kHz	A	Trimming output D
83	.../TRIMC		0	L	Trimming output C
84	.../TRIMB		4.882 kHz	A	Trimming output B (not used)
85	.../TRIMA		4.882 kHz	A	Trimming output A (not used)
86	POS-CHB/SHIFTB		4.882 kHz	A	Position-Channel B/Shift channel B

Comp	Name (pin) Circ /IC	Scope	Freq.	Data H/L/A	Description
87	.../VSS	Logic 0=0V	0	L	Voltage Supply Ground
88	POS-CHA/SHIFTA		4.882 kHz	A	Position Channel A/Shift channel A
89	+5VD/VDD		0	H	Volt Supply
90	LEVEL/TRGLVL		4.882 kHz	A	Level/Trigger Level
91	RESETN/RESETN		0	H	Reset Not
92	M/M		35 Hz	A	Multiplex LCD
93	FRAME/FRAME		70 Hz	A	Frame clock
94	LINECL/LINECL		16.66 kHz	A	Line Clock
95	DATACL/DATACL		999.6 kHz	A	Data Clock
96	D0/LCD0	Unstable 	60 kHz	A	Data 0/Liquid Crystal Display D0
97	D1/LCD1	Unstable 	60 kHz	A	Data 1/Liquid Crystal Display D1
98	D2/LCD2	Unstable 	58 kHz	A	Data 2/Liquid Crystal Display D2
99	D3/LCD3	Unstable 	58 kHz	A	Data 3/Liquid Crystal Display D3
100	.../RAMSELN		999.6 kHz	A	Ram Select Not

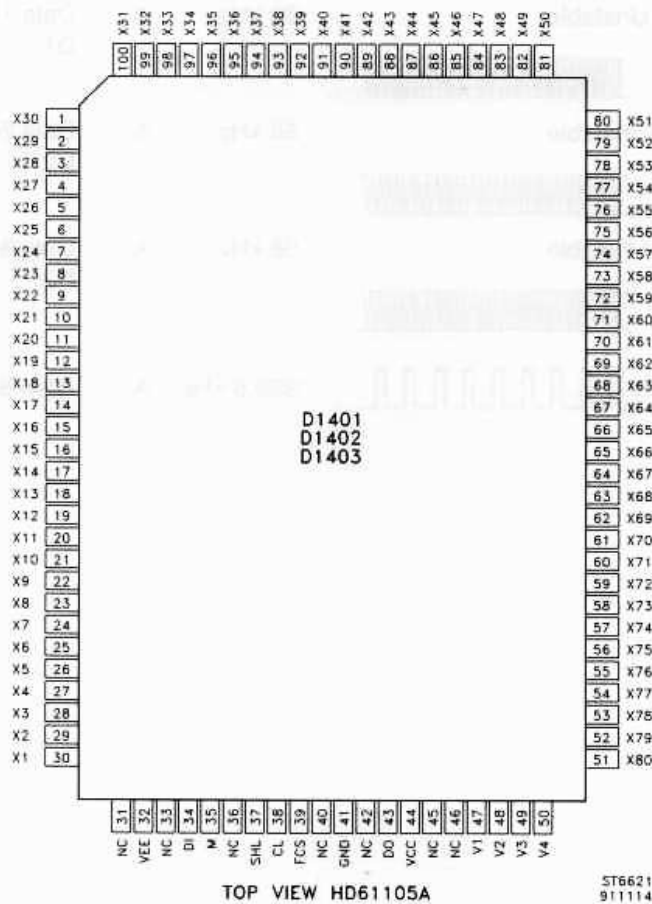
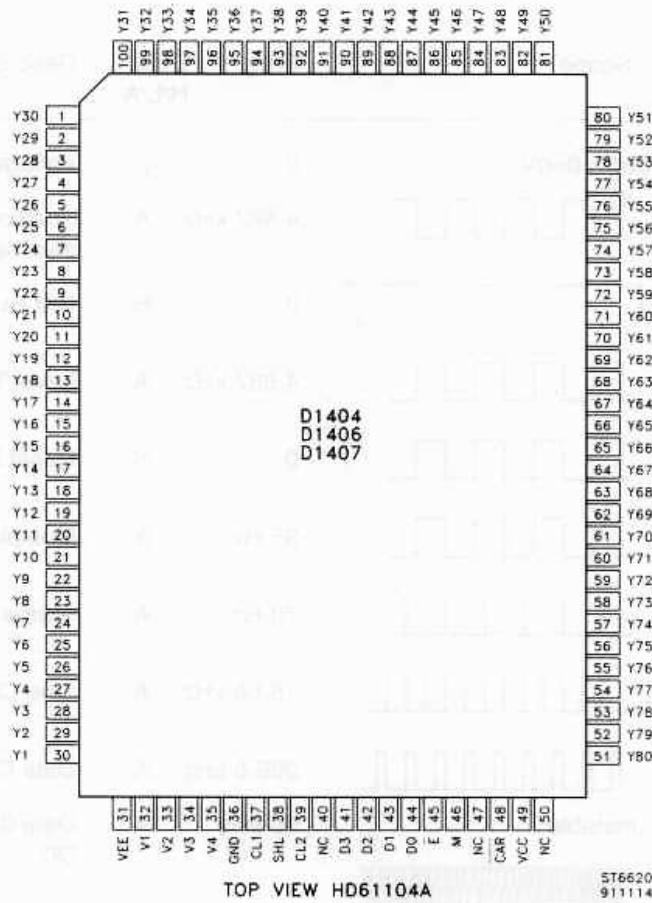


Figure 7.4 D1401/02/03/04/06/07 Display drivers

Table 7.4 Signals measured on display drivers D1401/02/03.

Logic 0=0V Logic 1=+5V

Comp	Name Circ/IC	Scope	Freq.	Data H/L/A	Description
D1401/D1402/D1403					
31	NC		0	L	Not Connected
32	-20V /VEE		0	H	Power supply
33	NC		0	L	Not Connected
34	FRAME/DI		70 Hz	A	.../shift register Data Input
35	M /M		34.7 Hz	A	Signal to convert LCD driver signal into AC
36	NC		0	L	Not Connected
37	/SHL		0	L	Select shift direction
38	/CL		16.7 kHz	A	shift CLock
39	/FCS		0	L	shift clock phase
40	NC		0	L	Not Connected
41	GND		0	L	GROUND (0V)
42	NC		0	L	Not Connected
43	/DO		70 Hz	A	shift register Data Output
44	VCC		0	H	Volt supply (+5V)
45	NC		0	L	Not Connected
46	NC		0	L	Not Connected
47	V1 /V1		0	H	Power supply for LCD drive
48	V2 /V2		0	H	Power supply for LCD drive
49	V5 /V5		0	H	Power supply for LCD drive


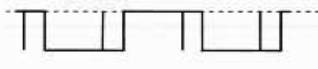


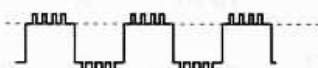
















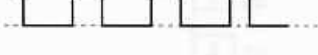
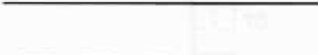
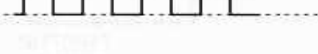


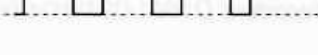
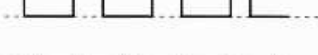
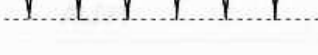

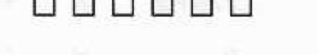
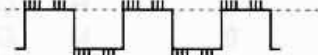
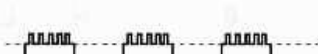

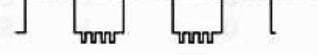
Comp	Name Circ/IC	Scope	Freq.	Data H/L/A	Description
50	V6 /V6		0	H	Power supply for LCD drive
5	X26 /X26 X106 /X26 X186 /X26		34.7 Hz	A	Liquid crystal driver output 5
21	X10 /X10 X90 /X10 X170 /X10		34.7 Hz	A	Liquid crystal driver output 21
55	X76 /X76 X156 /X76 X236 /X76		34.7 Hz	A	Liquid crystal driver output 55
79	X52 /X52 X132 /X52 X212 /X52		34.7 Hz	A	Liquid crystal driver output 79
96	X35 /X35 X115 /X35 X195 /X35		34.7 Hz	A	Liquid crystal driver output 96

Table 7.5 Signals measured on display drivers D1404/06/07.

Logic 0=0V Logic 1=+5V

Comp	Name Circ/IC	Scope	Freq.	Data H/L/A	Description
D1404/D1406/D1407					
31	-20V /VEE		0	H	Power supply (-20V)
32	V1 /V1		0	H	Power supply for LCD drive
33	V2 /V2		0	H	Power supply for LCD drive
34	V3 /V3		0	H	Power supply for LCD drive
35	V4 /V4		0	H	Power supply for LCD drive
36	/GND		0	L	GROUND (0V)
37	LINECL/CL1		16.7 kHz	L/A	LINE CLock/Latch Clock 1
38	/SHL		0	H	.../Shift direction
39	DATACL/CL2		833 kHz	A	.../shift CLock 2
40	NC		0	L	Not Connected
41	D0 /D3		16.7 kHz	A	

Comp	Name Circ/IC	Scope	Freq.	Data H/L/A	Description
42	D1 /D2		41.6 kHz	A	
43	D2 /D1		112 kHz	A	
44	D3 /D0		100 kHz	A	
45	/E_N D1404		16.7 kHz	A	.../Enable input
	/E_N D1406		16.7 kHz	A	.../Enable input
	/E_N D1607		0	L	.../Enable input
46	M /M		34.7 Hz	A	switch signal to convert LCD drive waveform in AC
47	NC		0	L	Not Connected
48	/CAR_N D1404		16.7 kHz	H/A	Enable output for cascade connection
	/CAR_N D1406		16.7 kHz	H/A	Enable output for cascade connection
	/CAR_N D1407		16.7 kHz	H/A	Enable output for cascade connection
49	/VCC		0	H	Power supply (+5V)
50	NC		0	L	Not Connected
5	Y26 /Y26 Y106 /Y26 Y186 /Y26		35 Hz	A	Liquid crystal driver output 5
21	Y10 /Y10 Y90 /Y10 Y170 /Y10		35 Hz	A	Liquid crystal driver output 21
55	Y76 /Y76 Y156 /Y76 Y236 /Y76		35 Hz	A	Liquid crystal driver output 55
79	Y52 /Y52 Y132 /Y52 Y212 /Y52		35 Hz	A	Liquid crystal driver output 79
96	Y35 /Y35 Y115 /Y35 Y195 /Y35		35 Hz	A	Liquid crystal driver output 96

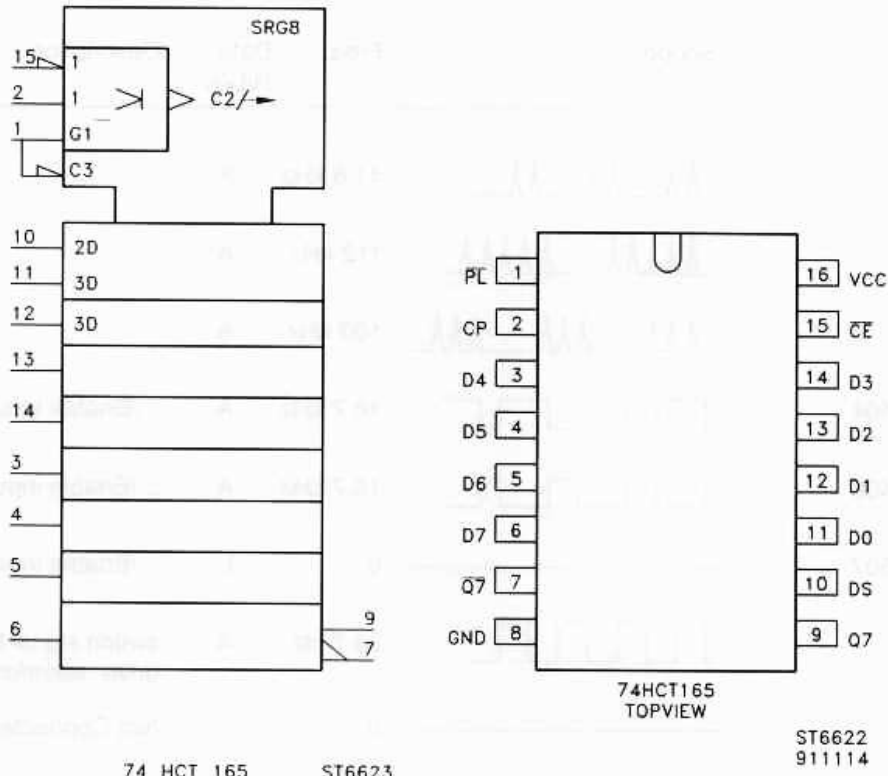




Figure 7.5 Keyboard decoders D1601/02/03/04/06

Table 7.6 Signals measured on keyboard decoders D1601/02/03/04/06.

Logic 0=0V Logic 1=+5V

Comp	Name Circ/IC	Scope	Freq.	Data H/L/A	Description
D1601/D1602/D1603/D1604/D1606					
1	FRONT-LATCH/G1	Unstable	34 Hz	A	FRONT LATCH signal
2	FRONT-CLOCK/>1	Unstable	775 Hz	A	FRONT CLOCK signal
3	CURSOR2-L/...	D1601	0	H	CURSOR2-Left key
	B-MOVE-UP/...	D1602	0	H	Channel B-MOVE-UP key
	CURSOR1-R/...	D1603	0	H	CURSOR1-Right key
	TIME-ns/...	D1604	0	H	TIME-ns key
4	LCD/...	D1606	0	H	Liquid Crystal Display key
	CURSOR1-L/...		0	H	CURSOR1-Left key
	TIME-s/...		0	H	TIME-s key
	SOFT-5/...		0	H	Soft key -5
	A-MOVE-UP/...		0	H	Channel A-MOVE-UP key
5	SPECIAL/...		0	H	SPECIAL FUNCTION key
	SOFT-4/...		0	H	Soft key -4
	A-mV/...		0	H	Channel A-mV key
	SOFT-3/...		0	H	Soft key -3
	B-AC/DC/...		0	H	Channel B-AC/DC/GROUND key
	HOLD/RUN/...		0	H	HOLD/RUN

Comp	Name Circ/IC	Scope	Freq.	Data H/L/A	Description
6	SOFT-2/...		0	H	Soft key -2
	CHAN-A/B/...		0	H	CHANnel A/B key
	SOFT-1/...		0	H	Soft key -1
	TRIGGER/...		0	H	TRIGGER key
	SETUP/...		0	H	SETUP key
7	not used		0	L	not used
8	VSS	Logic 0=0V	0	L	Volt Supply ground
9	FRONT-DATA2/...		0	H	FRONT-DATA block 2
	D1602/9 connected to D1601/10		0	H	
	FRONT-DATA1/...		0	H	FRONT-DATA block 1
	D1604/9 connected to D1603/10		0	H	
	D1606/9 connected to D1604/10		0	H	
10	D1601/10 connected tp D1602/9		0	H	
	WAVEFORM/...		0	H	WAVEFORM key
	D1603/10 connected tp D1604/9		0	H	
	D1604/10 connected tp D1606/9		0	H	
	E/...		0	H	not used
11	AUTOSET/...		0	H	AUTOSET key
	RECORD/...		0	H	RECORD key
	A AC/DC/...		0	H	Channel A- AC/DC/GROUND key
	B V/...		0	H	Channel B-V key
	D/...		0	H	not used
12	METER/...		0	H	METER key
	B MOVE DOWN/...		0	H	Channel B-MOVE DOWN key
	CURSOR DATA/...		0	H	CURSOR DATA key
	A MOVE DOWN/...		0	H	Channel A-MOVE DOWN key
	UNDO/...		0	H	UNDO key
13	SCOPE/...		0	H	SCOPE key
	MOVE L/...		0	H	MOVE Left key
	DOWN/...		0	H	DOWN key
	A MOVE DOWN/...		0	H	Channel A MOVE DOWN key
	MATH/...		0	H	MATH key
14	UP/...		0	H	UP key
	A V/...		0	H	Channel A-V key
	CURSOR 2 R/...		0	H	CURSOR 2-Right key
	B mV/...		0	H	Channel B-mV key
	A/...		0	H	not used
15	FRONTCLOCK/...		60kHz	A	
16	VCC/...		0	H	Main supply

7.1.7 Analog A2 PCB Troubleshooting.

7.1.7.1 Test point signals.

The analog A2 PCB is provided with test points, marked: "TP" See figure 10.4: A2 PCB layout (wired components side). These can be used to check correct functioning of the PCB.

All measurements are made in the default MASTER RESET condition (start the measurements in the ScopeMeter using **MASTER RESET**).

A MASTER RESET is performed as follows:

1. Remove all signals from the ScopeMeter.
2. Power the ScopeMeter with the Power Adapter/Battery charger PM8907.
3. Turn off the ScopeMeter
4. Hold down the LCD key and press the ON/OFF key simultaneously. Two beeps are audible, and all volatile memories (RAM with battery backup) are reset. The ScopeMeter is automatically set to the meter mode.

NOTE: For the measurements on Test Points 101...529 and 901...921 apply a 10 kHz square wave signal to the channel A BNC. Press the SCOPE button to go to SCOPE mode and press AUTOSET to get a stable picture on the LCD.












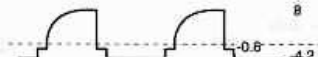






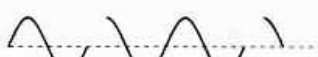
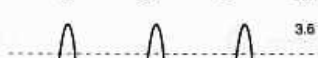

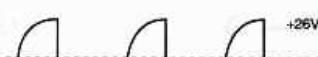
NOTE: For the measurements on Test Points 700...806 first switch on the ScopeMeter using a MASTER RESET. Then press the SPECIAL FUNCTION key and the GENERATE softkey. Use the select/adjust keys to select "square 1.95 kHz", and press the right most ENTER softkey to activate the generator.



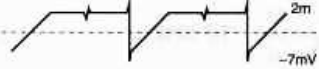

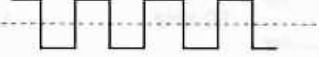

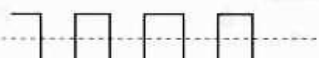


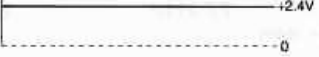


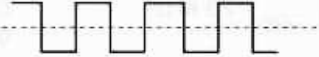

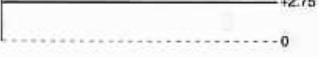








Use another oscilloscope with high input impedance and 10:1 probe to measure the signals on the test points. See table 7.7:





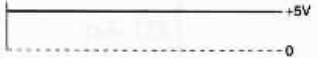



Table 7.7 Overview signals on Test Points (TP) on analog A2 PCB.

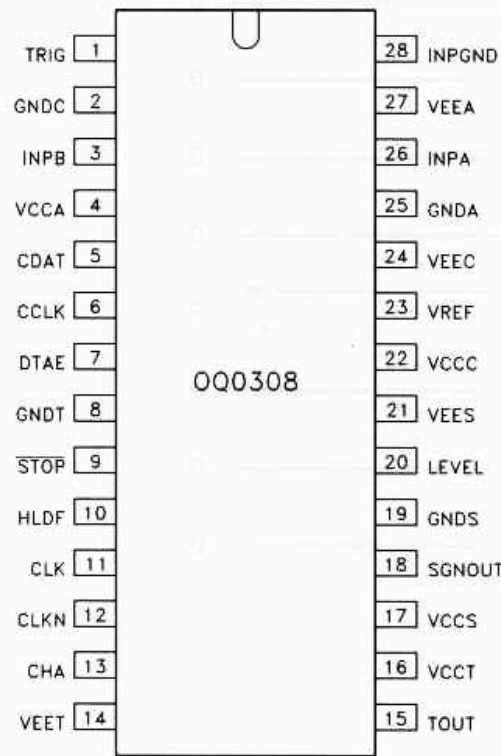
Logic 0=0V, Logic 1=+5V

TP	Name	Scope	Freq.	Data	Description
101			0		Base V2112
102			0		Output D2101
103			0		Output N2101
104			0		Collector V2105
106			0		Base V2104
107	ATTB--A		0		Collector V2111
108			0		TP for OFFSET DAC
109	POS-CHB		0		POS-CHB
201			0		Base V2212

202	mV-in from A2d		0	Output D2201
203			10 kHz	Output N2201, $V_{DC} = -1.5V$
204			10 kHz	Collector V2205
206			0	Base V2204
207	ATTA--A		10 kHz	Collector V2211
208			0	TP for offset DAC
209	POS-CHA		0	POS-CHA
331			0	VREF D2301
332			LF: sq. 10 KHz HF: sq. 500 KHz	SGN-in N2301 $V_{DC} = 2.3V$
501			77 kHz	Collector V2517, $V_{DC} = -7.7V$
502			77 kHz	Base V2517
503			73 kHz	Base V2503, $V_{DC} = -3.83 V$
504			73 kHz	Sense Resistors, Pos. side $V_{DC} = -7.7V$
506			73 kHz	Sense Resistors, Neg. side $V_{DC} = -7.75V$
507	+Vref		0	+Vref
508	-Vref		0	-Vref
509			0	Output N2501
511			0	TP for FEEDBACK AMPLIFIER
521			100 kHz	PSG-Input Z2501, $V_{DC} = -1.1 mV$
522			100 kHz	Oscillator N2503, $V_{DC} = 0.24V$
523			0	INV N2503
524			100 kHz	Collector V2526, $V_{DC} = -0.12V$

526		100 kHz Source	V2532, $V_{DC} = -0.4V$
527		100 kHz Source	V2537, $V_{DC} = -1.05V$
528		100 kHz Source	V2538, $V_{DC} = -1.7V$
529		0	CLN N2503
700		1.95 kHz	Relay contact K2750a/K2751b $V_{DC} = 0.29V$
701		1.95 kHz	Anode Zener V2752 $V_{DC} = 0.27V$
702		0	Output D2850
704		0	Collector V2761, $V_{DC} = 0.27V$
706		0	Anode zener V2764
801		0	Output D2850, $V_{DC} = 2.5V$
802		0	Emitter V2852
803		0	Non-inverting input N2850a
804		1.953 kHz	Output N2850, $V_{DC} = 0.29V$
805		0	Non-inverting input N2850b
806		0	TP for CURRENT SOURCE
901		0	Output 1&2 D2901
902		0	Output 3&4 D2901
903		0	Output 5&6 D2901
904		0	Output 7&8 D2901
906		0	Output 1&2 D2902
907		0	Output 3&4 D2902
908		0	Output 5&6 D2902
909		0	Output 7&8 D2902

911			0	Output 1&2 D2903
912			0	Output 3&4 D2903
914			0	Output 7&8 D2903
916	Sgnd8a		0	Sgnd8a D2904
917	Ex/Ey		0	Ex/Ey D2906
918	Sgnd8b		0	Sgnd8b D2907
919	Sr4b		0	Sr4b D2908
921	D-POSCHB		0	D-POSCHB D2909



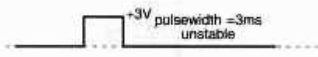
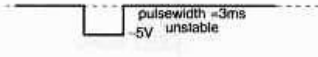
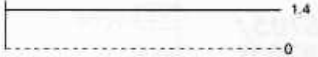
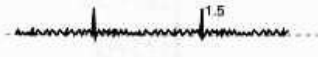



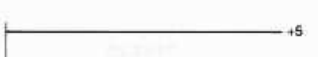
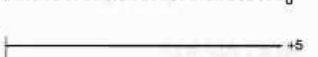

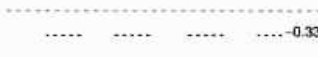







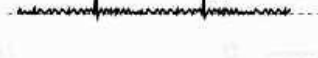
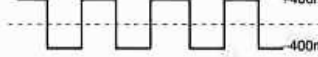
ST6624

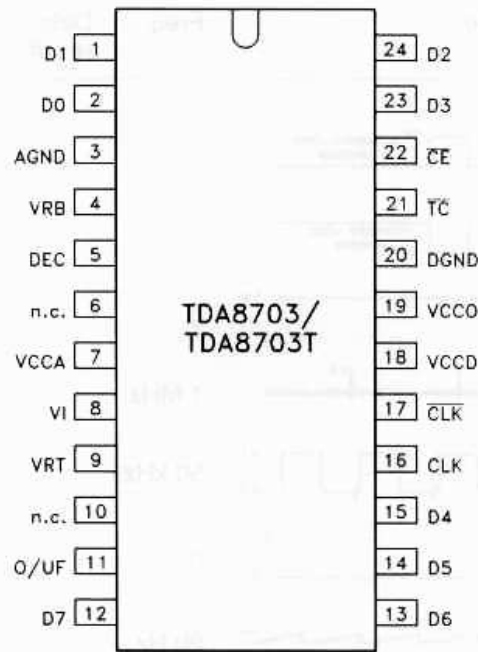
Figure 7.6 Analog ASIC D2301

Table 7.8 Signals measured on analog ASIC D2301.

Logic 0=0V Logic 1=+5V

Comp	Name Circ/IC	Scope	Freq.	Data H/L/A	Description
1	TRIG		0		EXT. Trigger input
2	GNDA		0		Ground Analog-input-circuit
3	INPB		0		Input signal B
4	VCCa		0		Positiv power supply Analog-input-circuit
5	CDAT		500 kHz		Serial Data line VDC = 5V
6	CCLK		100 kHz		Clock line VDC = 18 mV
7	DTAE		500 kHz		Latch enable line VDC = 20.7 mV
8	GNDt		0		Ground Trigger-output-circuit

Comp	Name Circ/IC	Scope	Freq.	Data H/L/A	Description
9	STOP				Trigger output $V_{DC} = 0.5V$
10	HLDf VDC = 5				Hold off
11	CLK		0		Clock
12	CLKN		1 MHz		$V_{DC} = 0.55V$
13	CHA		50 kHz		Chanel switch $V_{DC} = 2.4V$
14	VEEt		0		Negativ power supply Trigger-output-circuit
15	TOUT		20 Hz		DC-Trigger output
16	VCCt		0		Positiv power supply Trigger-output-circuit
17	VCCs		0		Positiv power supply Signal-output-circuit
18	SNGOUT		LF: sq. 10 kHz HF: sq. 500 kHz		Output signal, $V_{DC} = 2.3V$
19	GNDs		0		Ground Signal-output-circuit
20	LEVEL		0		Trigger level input
21	VEEs		0		Negativ power supply Signal-output-circuit
22	VCCc		0		Positiv power supply Control-logica-circuit
23	VREF		0		Reference potential
24	VEEc		0		Negativ power supply Control-logica-circuit
25	GNDc		0		Ground control-logica-circuit
26	INPa		10 kHz		Input signal A, $V_{DC} = -17 mV$
27	VEEa		0		Negativ power supply Analog-input-circuit
28	INPGND		0		Ground input





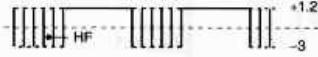


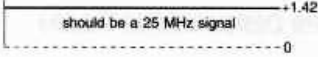








ST6625
911114

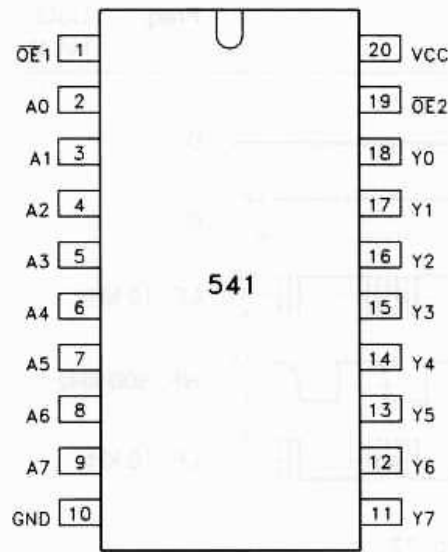
Figure 7.7 ADC N2302

Table 7.9 Signals measured on ADC N2302.

Logic 0=0V Logic 1=+5V

Comp	Name Circ/IC	Scope	Freq.	Data H/L/A	Description
1	D1				Data output bit no.1 $V_{DC} = 2.6V$; for HF see no. 12
2	D0				Data output bit no.0 $V_{DC} = 2.1V$; for HF see no. 12
3	AGND		0		
4	VRB		0		
5	DEC		0		
6	NC		0		Not Connected
7	VCCa		0		
8	IN		LF: sq. 10 kHz HF: sq. 500 kHz		$V_{DC} = 2.3V$
9	VRT		0		

Comp	Name Circ/IC	Scope	Freq.	Data H/L/A	Description
10	NC		0		Not Connected
11	O/UFL		0		Not Connected
12	D7		LF: 10 kHz		Data output bit no.7 $V_{DC} = 3.1V$
			HF: 500 kHz		
13	D6		LF: 10 kHz		Data output bit no.6 $V_{DC} = 1.1V$; for HF see no.12
14	D5	see pin no. 13			Data output bit no.5, $V_{DC} = 1.1V$
15	D4	see pin no. 13			Data output bit no.4, $V_{DC} = 1.1V$
16	CL		0		$V_{DC} = 1.42V$
17	CLN		1 MHz		$V_{DC} = 0.55V$
18	VCCD		0		
19	VCCO		0		
20	DGND		0		
21	OCTN		0		
22	CEN		0		
23	D3				Data output bit no.3 $V_{DC} = 0.27V$; for HF see no. 12
24	D2				Data output bit no.2 $V_{DC} = 1.84V$; for HF see no. 12



ST6626
911114

Figure 7.8 Buffer/drivers D2901/D2902/D2903

Table 7.10 Signals measured on buffer/driver D2901.

Logic 0=0V Logic 1=+5V

Comp	Name Circ/IC	Scope	Freq.	Data H/L/A	Description
1	Ex		0		Control signal
2	Sg4b		0		Input no.1
3	Sg4b		0		Input no.2
4	Sg5b		0		Input no.3
5	Sg5b		0		Input no.4
6	Sg6b		0		Input no.5
7	Sg6b		0		Input no.6
8	So10b		0		Input no.7
9	So10b		0		Input no.8
10	GND		0		Ground



















Comp	Name Circ/IC	Scope	Freq.	Data H/L/A	Description
11			0		Output no.8
12			0		Output no.7
13			0		Output no.6
14			0		Output no.5
15			0		Output no.4
16			0		Output no.3
17			0		Output no.2
18			0		Output no.1
19	Ex		0		Control signal
20	Vcc		0		Power supply

Table 7.11 Signals measured on buffer/driver D2902

Logic 0=0V Logic 1=+5V

Comp	Name Circ/IC	Scope	Freq.	Data H/L/A	Description
1	Ey		0		Control signal
2	Sg4b		0		Input no.1
3	Sg4b		0		Input no.2
4	Sg5b		0		Input no.3
5	Sg5b		0		Input no.4
6	Sg6b		0		Input no.5
7	Sg6b		0		Input no.6
8	So11b		0		Input no.7

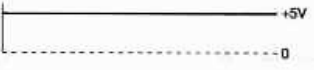














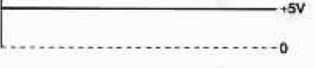
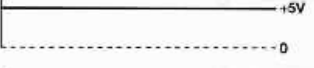




Comp	Name Circ/IC	Scope	Freq.	Data H/L/A	Description
9	So11b		0		Input no.8
10	Gnd		0		Ground
11			0		Output no.8
12			0		Output no.7
13			0		Output no.6
14			0		Output no.5
15			0		Output no.4
16			0		Output no.3
17			0		Output no.2
18			0		Output no.1
19	Ey		0		Control signal
20	Vcc		0		Power supply

Table 7.12 Signals measured on buffer/driver D2903.

Logic 0=0V Logic 1=+5V

Comp	Name Circ/IC	Scope	Freq.	Data H/L/A	Description
1	Ey		0		Control signal
2	Sg4a		0		Input no.1
3	Sg4a		0		Input no.2
4	Sg5a		0		Input no.3
5	Sg5a		0		Input no.4
6	Sg6a		0		Input no.5
7	Sg6a		0		Input no.6

Comp	Name Circ/IC	Scope	Freq.	Data H/L/A	Description
8	Sc16	_____	0		Input no.7
9	Sc16	_____	0		Input no.8
10	Gnd	_____	0		Ground
11		_____	0		Output no.8
12		_____	0		Output no.7
13		_____	0		Not connected
14		_____	0		Not connected
15		_____	0		Output no.4
16		_____	0		Output no.3
17		_____	0		Output no.2
18		_____	0		Output no.1
19	Ey		0		Control signal
20	Vcc		0		Power supply



7.2 REPLACEMENTS

7.2.1 Standard parts

Electrical and mechanical parts replacements can be obtained through your local FLUKE/PHILIPS organization or representative. However, many generic electronic components can be obtained from other sources. Before purchasing or ordering replacement parts, check the parts list for value, tolerance, rating, and description.

NOTE: Physical size and shape of a component may affect instrument performance, particularly at high frequencies. Always use direct-replacement components, unless it is known that a substitute will not degrade the instrument's performance.

7.2.2 Special parts

In addition to the standard electronic components, some special components are used:

- Components, custom manufactured or selected by FLUKE/PHILIPS to meet specific performance requirements.
- Components that are important for the safety of personnel.

NOTE: Both type of components may only be replaced by components obtained through your local FLUKE/PHILIPS organization or representative.

7.2.3 Transistors and integrated circuits

Some notes on handling these components:

- Do not replace or swap semiconductor devices unnecessarily, because the change may affect the calibration of the instrument.
- When a device has been replaced, check the circuit that may be affected for proper operation. See also the Performance Verification Procedure in chapter 4.

7.2.4 Static-sensitive components

In the ScopeMeter the black/yellow "static-sensitive components" symbol is present (see also figure 7.4). This means that this instrument contains electrical components that can be damaged by electrostatic discharge. Although all MOS integrated circuits incorporate protection against electrostatic discharge, they nevertheless can be damaged by accidental overvoltages.

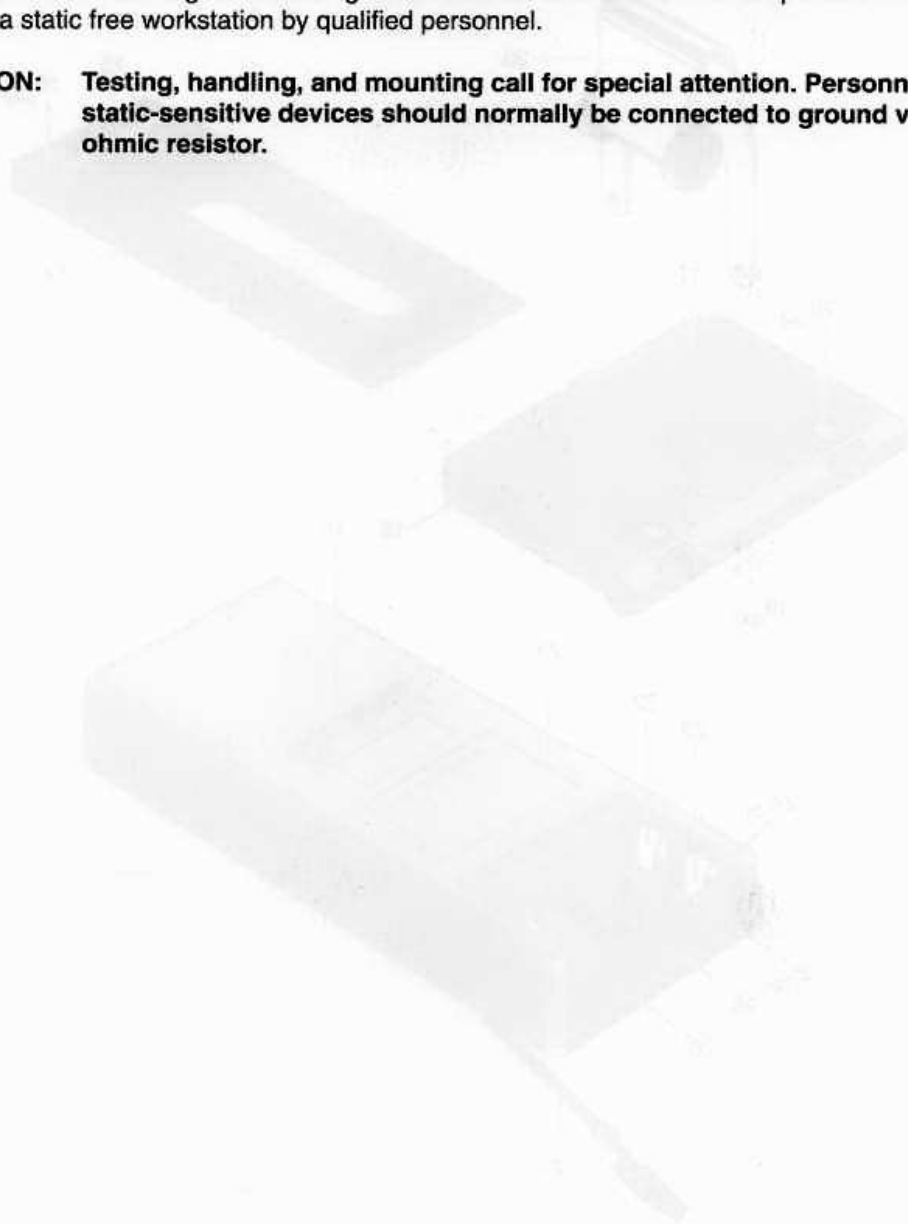


Figure 7.9 Static-sensitive symbol (black/yellow)

It is also possible that a delayed failure or "winding" effect may occur. When this happens, the component will fail anywhere between two hours to six months later.

When storing and handling static-sensitive components, the normal precautions for these devices are recommended. Handling and servicing static-sensitive assemblies and components should be done only at a static free workstation by qualified personnel.

CAUTION: Testing, handling, and mounting call for special attention. Personnel handling static-sensitive devices should normally be connected to ground via a high-ohmic resistor.



7.2.5 Replacement of parts

7.2.5.1 Replacing parts in the battery compartment

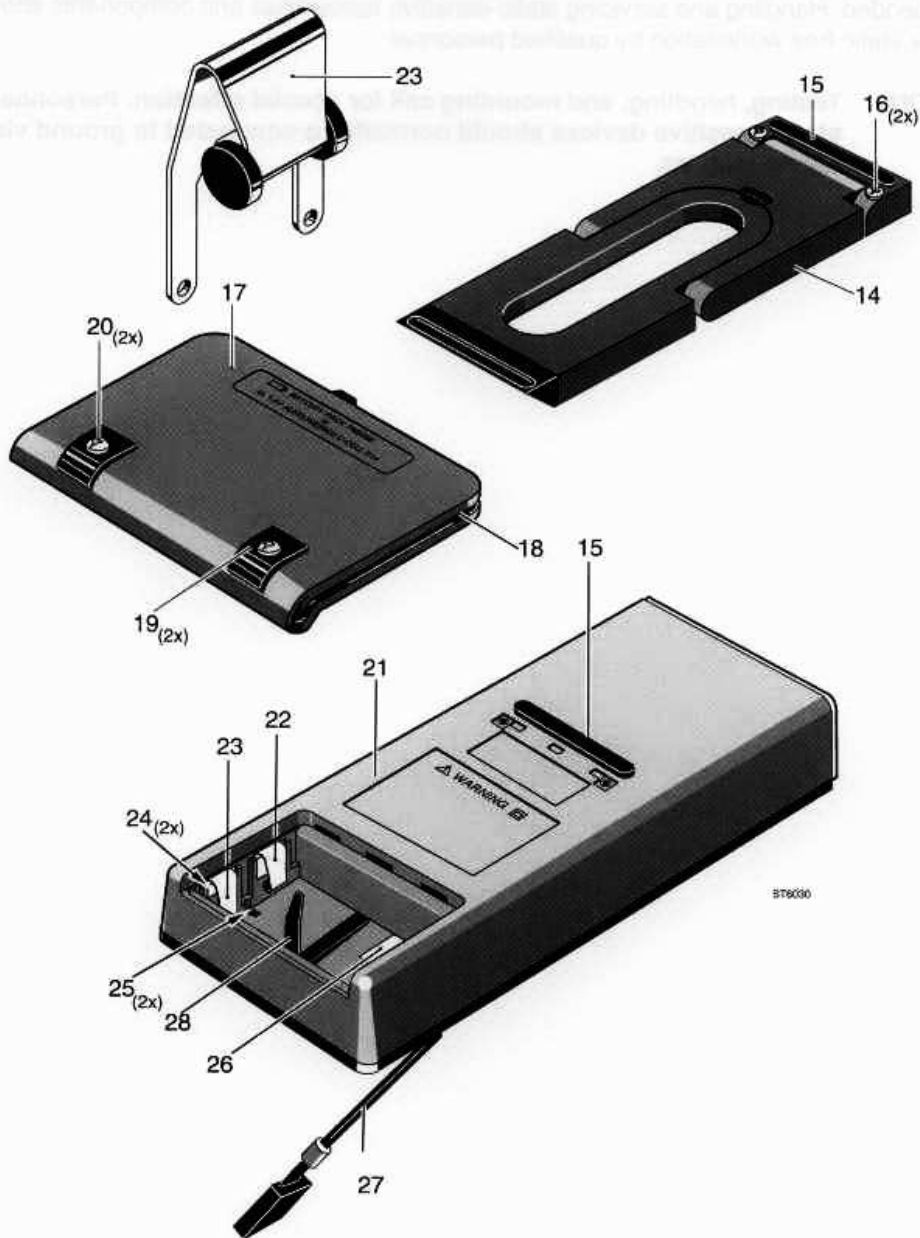


Figure 7.10 Replacing parts in battery compartment

Referring to figure 7.10, use the following procedure for replacements in the battery compartment.

Battery cover assembly replacement

1. The battery cover (item 17) is secured to the ScopeMeter with two black M3 Torx screws (item 20). Use a Torx screwdriver to loosen the two screws (do not remove them) from the battery cover.
2. Lift the battery cover from the ScopeMeter.

3. Reinstall the new battery cover.

Battery-cover Gasket replacement

1. Remove the battery cover (item 17).
2. Use a pair of tweezers to pull the elastic gasket (item 18) from the battery cover.
3. Mount the new elastic gasket on the battery cover.

NOTE: Take care that the gasket is not damaged. A correctly fitted gasket assures the sealing of the ScopeMeter.

Battery cover Torx screws and Feet replacement

1. Remove the battery cover.
2. The black M3 Torx screws are of a captured type (item 20). Remove screws by unscrewing them with a Torx screwdriver. Add a little pressure with another small screwdriver at the back of the screw.

NOTE: Do not force the screws by pressing them in or out. The screw action is vital for the captured screws.

3. Pull the two rubber feet (item 19) from the battery cover.
4. Push the new rubber feet onto the battery cover.
5. Reinstall the (new) black M3 Torx screws into the battery cover.

7.2.5.2 Replacing parts on front cover

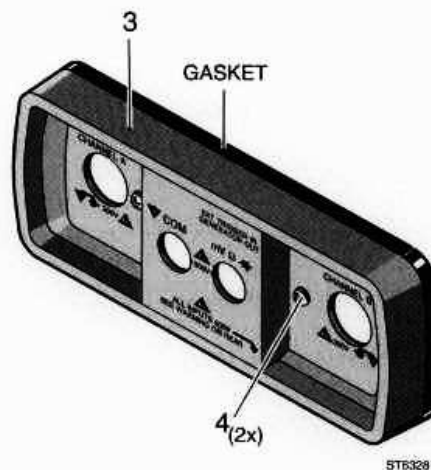


Figure 7.11 Replacing parts on front cover

Referring to figure 7.11, use the following procedure for replacements on the front cover.

Front cover assembly replacement

1. The front cover is secured to the ScopeMeter with two black M3 Torx screws (item 4). Use a Torx screwdriver to loosen the two screws (do not remove them) from the front cover.

2. Lift the front cover assembly (item 3) from the ScopeMeter.

NOTE: *The gasket between the front cover and the two case halves is sealed to, and must remain with, the front cover. The front cover lifts away easily. Do not damage the gasket and do not separate the front cover from the gasket. A correctly fitted gasket assures the sealing of the ScopeMeter.*

3. Reinstall the new front cover.

Front cover Torx screw replacement

1. Remove the front cover.
2. The two black M3 Torx screws (item 4) are captured type screws. Remove screws by unscrewing them with a Torx screwdriver. Add a little pressure with another small screwdriver at the back of the screw.

NOTE: *Do not force the screws by pressing them in or out. The screw action is vital for the captured screws.*

3. Reinstall the new Torx screws into the front cover.



7.2.5.3 Replacing parts on bottom cover

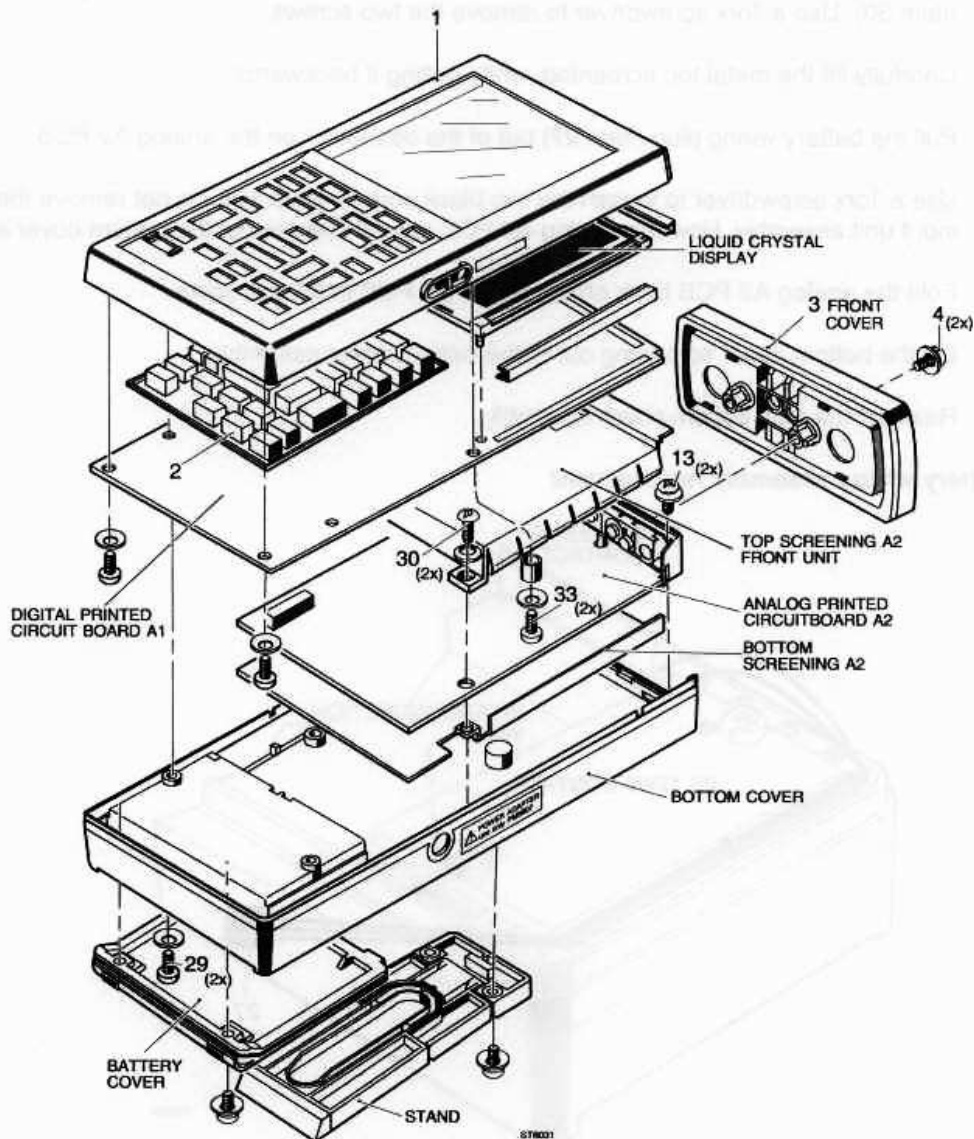


Figure 7.12 Bottom cover replacements

Referring to figure 7.12, use the following procedure for replacements in the bottom cover.

Bottom cover assembly replacements

1. First remove the battery cover assembly (see Section 7.2.5.1.)
2. The bottom cover is secured to the top cover by two M3 Torx screws (item 29) that are accessible in the battery compartment. Use a Torx screwdriver to remove the two screws.
3. Lift the bottom cover a little from the top cover and unfold the ScopeMeter.

NOTE: A flat cable is used for interconnection between the bottom cover with the analog A1 PCB and the digital A2 PCB. To remove the flat cable, refer to Section 6.2.4. The gasket between the two case halves is sealed to, and must remain with, the lower case half. The upper case half lifts away easily. Do not damage the gasket and do not separate the lower case half from the gasket. A correctly fitted gasket assures the sealing of the ScopeMeter.

4. The analog A2 PCB and top screening are secured to the bottom cover by two M3 Torx screws (item 30). Use a Torx screwdriver to remove the two screws.
5. Carefully lift the metal top screening, while pulling it backwards.
6. Pull the battery wiring plug (item 27) out of the connector on the analog A2 PCB.
7. Use a Torx screwdriver to loosen the two black screws (item 13). Do not remove them from the input unit assembly. Now the analog A2 PCB can be lifted out of the bottom cover assembly.
8. Fold the analog A2 PCB back on the digital A1 PCB in the top cover.
9. Lift the bottom cover screening out of the bottom cover assembly.
10. Reinstall the new bottom cover assembly.

Battery wiring assembly replacement

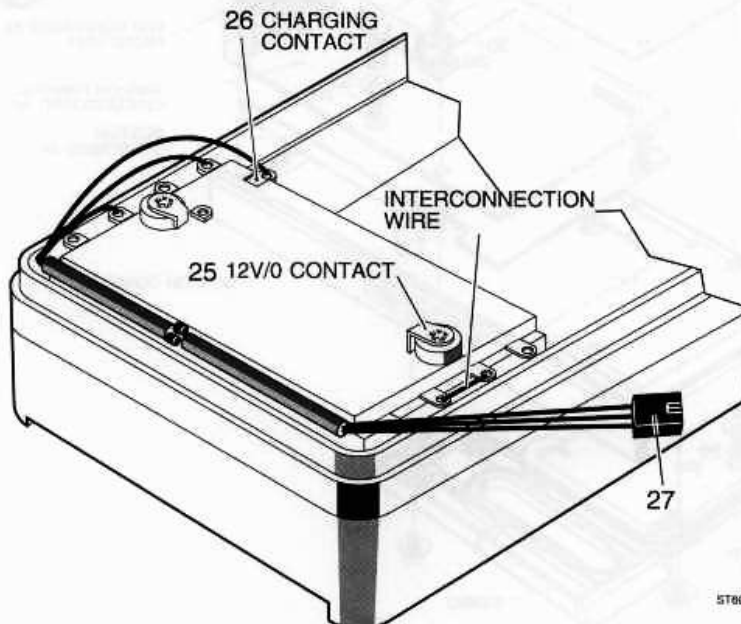


Figure 7.13 Wiring assembly replacement

Referring to figures 7.10 and 7.13, use the following procedure for replacing the battery wiring and battery contacts.

1. First remove the bottom cover assembly.
2. Unsolder the battery wiring assembly (item 27) from the battery compartment.
3. Reinstall the new battery wiring assembly.

Battery contacts replacement

1. First remove the bottom cover assembly.
2. Remove the battery wiring assembly.

3. Unsolder the small battery contact interconnection wire (see figure 7.13).
4. Bend the solder tags of the battery contacts (figure 7.10, item 23) in the bottom cover in such way that the contacts can be pulled out of the battery compartment.
5. Pull the battery contacts (figure 7.5, items 22 and 23) and the black buffers (figure 7.10, item 24) out of the battery compartment with a pair of tweezers.

NOTE: The extra black plastic buffers in two battery contacts (see figure 7.10, item 23) prevent erroneous charging of the battery. Mount these battery contacts in the correct position!

6. Reinstall the new battery contacts.

Battery charging contact and +12V/0 contact replacement

1. First remove the bottom cover assembly.
2. Remove the battery wiring assembly.
3. Bend the solder lugs of the contacts (figure 7.10, items 25 and 26) in the bottom cover so that the contacts can be pulled from the battery compartment.
4. Pull the contacts from the battery compartment.
5. Reinstall the new charging contact and/or the new +12V/0 contacts.

7.2.5.4 Stand replacement

Referring to figure 7.10, use the following procedure for stand replacement.

Stand assembly replacement

1. The stand is secured to the ScopeMeter with two black M3 Torx screws (figure 7.10, item 16). Use a Torx screwdriver to loosen the two screws.
2. Lift the stand from the ScopeMeter.
3. Reinstall the new stand.

Stand Torx screw replacement

1. Remove the stand assembly (figure 7.10, item 15).
2. The black M3 Torx screws are of a captured type (item 16). Remove screws by unscrewing them with a Torx screwdriver. Add a little pressure with another small screwdriver at the back of the screw.

NOTE: Do not force the screws by pressing them in or out. The screw action is vital for the captured screws.

3. Reinstall the new Torx screws.

7.2.5.5 30-pole flat cable replacement

Refer to Section 6.2.4. of this Service Manual for instructions on how to replace the 30-pole flat cable.

7.2.5.6 Input unit assembly replacement

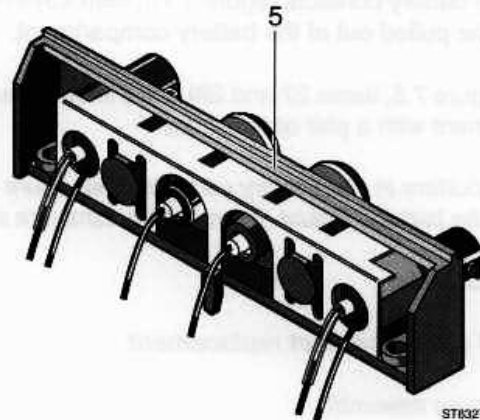


Figure 7.14 Input unit assembly

Referring to figure 7.14, use the following procedure for input unit assembly replacement.

1. Remove the front cover assembly.
2. Disassemble the bottom cover assembly.
3. Remove the 30-pole flat cable.
4. Unsolder the wiring (6x) of the input terminals from the analog A2 PCB.
5. The input unit assembly is clamped onto the analog A2 PCB. Loosen these clamps and pull the input unit assembly from the analog A2 PCB.

NOTE: The white gaskets on the input terminals (4x) are sealed to, and must remain with the input unit assembly. Do not damage the gaskets and do not separate them from the input unit assembly. Correctly fitted gaskets assure the sealing of the ScopeMeter.

6. Reinstall the front unit assembly.

7.2.5.7 Top cover assembly replacement.

Referring to figure 7.12, use the following procedure for top cover assembly replacement.

1. Remove the bottom cover assembly.
2. Remove the 30-pole flat cable.
3. The digital A1 PCB and metal screening are secured to the top cover with four M3 Torx screws (item 33). Two of these screws contain standoffs. Be sure to put them on the right place again. Use a Torx screwdriver to remove the screws.
4. Remove the metal A1 screening from the digital A1 PCB.
5. Lift the digital A1 PCB out of the top cover. Be careful not to damage the infrared LED and phototransistor of the optical interface.

NOTE: The gasket between the two Optical RS-232-C Interface LEDs on the digital A1 PCB and front cover must remain with the LEDs. The top cover lifts away easily. Do not damage the gasket. A correctly fitted gasket assures the sealing of the ScopeMeter.

6. Lift the keypad from the top cover (item 2).
7. Reinstall the new top cover (item 1).

7.2.5.8 Keypad replacement

1. Remove the bottom cover assembly.
2. Remove the 30-pole flat cable.
3. Disassemble the top cover assembly.
4. Lift the keypad from the top cover (item 2).
5. Reinstall the new keypad.

7.2.5.9 Liquid crystal display (LCD), contact strips and backlight foil (Model 97 only) replacement.

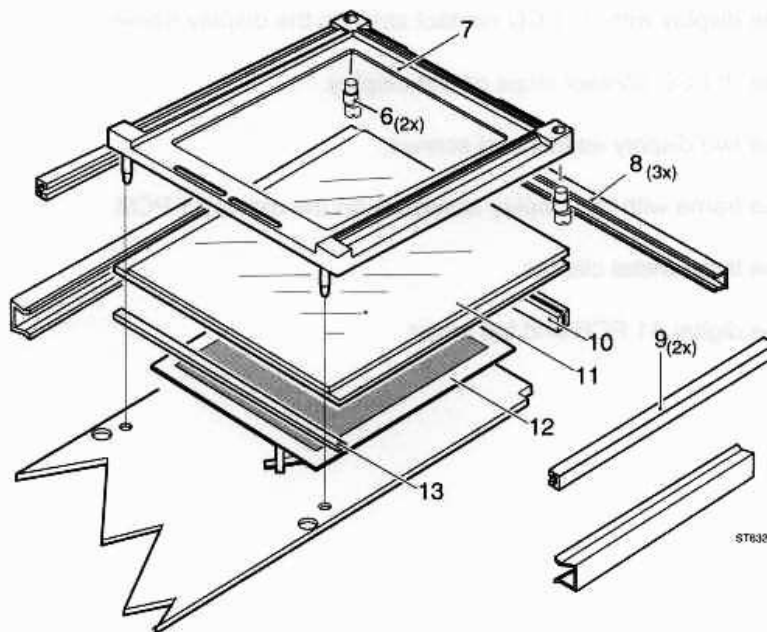


Figure 7.15 LCD replacement

Referring to figure 7.15, use the following procedure for LCD replacement.

1. Remove the bottom cover assembly.
2. Remove the 30-pole flat cable.
3. Disassemble the top cover assembly.

NOTE: Oils or dirt from the hands are enemies of the LCD contact strips used in the LCD assembly. Whenever handling these strips, it is advised that tweezers be used so as not to contaminate them. Care should also be taken when handling the front panel lens or LCD glass. Dirt or finger prints on these parts will be visible to the user and may impair the readability of the display.

4. Pull the three metal clamps from the display (item 8).
5. Lift the LCD complete in its frame from the digital A1 PCB.
6. Push the LCD including the LCD contact strips out of the display frame.
7. Take the two display adjustment screws (item 6) out of the display frame.
8. Lift the top "I" LCD contact strip (item 10) from the display.
9. Pull the left and right "L" LCD contact strips (item 9) from the display.
10. (MODEL 97 ONLY)
The backlight foil (item 12) is glued to the reflective LCD (Model 97 only). The backlight foil has two contact legs that make contact with two large rectangle spots on the digital A1 PCB.
11. Pull the backlight foil from the display.
12. Reinstall the LCD rubber filling part (item 13) and the back light foil.
13. Reinstall the two "L" LCD contact strips.
14. Reinstall the display with "L" LCD contact strips in the display frame.
15. Reinstall the "I" LCD contact strips on the display.
16. Reinstall the two display adjustment screws.
17. Reinstall the frame with the display assembly on the digital A1 PCB.
18. Reinstall the three metal clamps.
19. Reinstall the digital A1 PCB and top cover.

7.3 SOLDERING TECHNIQUES

7.3.1 General soldering techniques

Method:

- Carefully unsolder the soldering leads of the semiconductor one after the other.
- Remove all superfluous soldering material. Use desoldering wick, ordering code: 4822 321 40042.
- Verify that the leads of the replacement part are clean and have pre-tinned leads.
- Place the replacement semiconductor exactly in the same position, and solder each lead to the relevant printed circuit pad on the PCB.

NOTE: *The maximum permissible soldering time is 10 seconds during which the temperature of the leads must not exceed 250C. The use of solder with a low melting point is recommended. Take care not to damage the plastic encapsulation of the semiconductor (softening point of the plastic is 150C).*

CAUTION: **When you are soldering inside the instrument it is essential to use a low voltage soldering iron, the tip of which must be connected to the ground of the ScopeMeter.**

A suitable soldering iron is:

- Mini soldering iron station, WECP-COD3 (regulated transformer) and Weller LR-20 (soldering iron).

Ordinary 60/40 tin/lead solder with flux core and a 35W to 40W pencil-type soldering iron can be used to do most of the soldering. If a higher wattage soldering iron is used on the circuit PCB, excessive heat may cause the circuit wiring to separate from the PCB base material.

7.3.2 Soldering micro-miniature semiconductors

Because of the small dimensions of these SOT semiconductors and the lack of space between the components on the PCB, it is necessary to use a miniature soldering iron with a pinpoint tip (max. diameter 1 mm.) to solder a SOT onto a PCB.

Suitable soldering tools are:

- Mini soldering iron station, WECP-COD3 (regulated transformer) and Weller MLR-20 (mini soldering iron).
- A hot-air solder tool: Leister Hot-Jet

Next, the following materials are recommended:

- Soldering tin, diameter 0.8 mm., SnPb 60/40 with a Resin Mildly Activated (RMA) flux. Ordering code: 4822 390 80133.
- Desolder braided wire. Ordering code 4822 321 40042.
- Solder paste 26.
- Non-corrosive and Resin Mildly Activated (RMA) flux-Colophony. Ordering code: 4822 390 50025.

Refer to the **Support Bulletin OSC 296 (ordering code 4822 872 08407)** for a complete discussion of the soldering techniques for SMD's.

7.4 SPECIAL TOOLS

7.4.1 Extender flat cable.

For diagnostic testing and troubleshooting, a 30-pole 50 cm extender flat cable can be used. Using this extender flat cable makes it easier to separate the two units A1 and A2 without breaking the interconnection.

The ordering code for the extender flat cable is: 5322 321 61369.

7.5 RECALIBRATION AFTER REPAIR

After any electrical component has been replaced the performance of that particular circuit should be checked, as well as the performance of other closely-related circuits. If necessary a recalibration must be performed. Since the power supply influences all circuits, the performance of the entire instrument should be verified if work has been done in the power supply or if the transformer has been replaced. If necessary a recalibration must be done. If parts of the attenuator circuits and/or the Analog ASIC have been replaced, it might be necessary to do Hardware SCOPE Calibration Adjustments. Refer to section 5.6.1 of this Service Manual.

7.6 INSTRUMENT REPACKING

If the ScopeMeter is to be reshipped to a Service Centre for service or repair, attach a tag showing the full address and the name of the individual at the users firm that can be contacted.

The Service Centre needs the complete ScopeMeter, **including the RED and the GREY scope probe**, its serial number, and a complete description of the problem and the work that is to be done. If the original container is not available, repack the instrument so that no damage occurs during transport.

8 MAINTENANCE OF THE PRIMARY CIRCUIT (PM8907/...)

The ScopeMeter itself has no primary (mains) power supply. The instrument is powered with a separate **Power adapter/battery charger PM8907/...**, in which the primary power supply is located. The PM8907/... is non-repairable. It can be ordered at your nearest Fluke/Philips Service Center.

Table 8.1 Power adapter/battery charger survey.

Typenumber	Description
PM8907/001	Universal Europe 220V, 50 Hz
PM8907/003	North American UL, CSA, 110V, 60 Hz
PM8907/004	United Kingdom 240V, 50 Hz
PM8907/008	Universal 115V / 230V

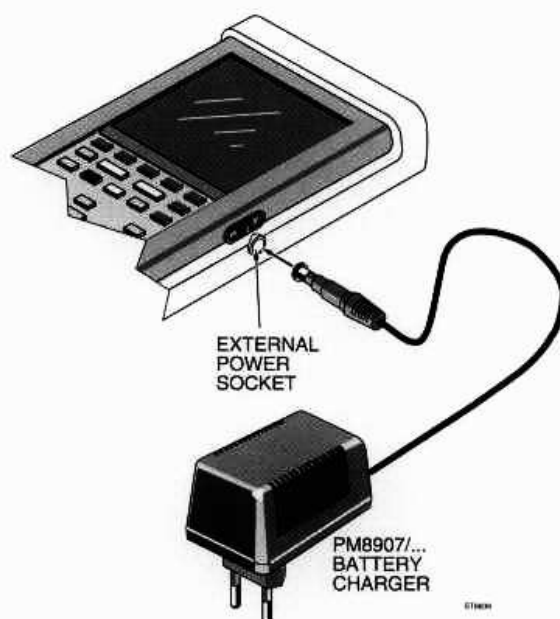


Figure 8.1 ScopeMeter Power Adapter/battery Charger PM8907/....

9 REPLACEABLE PARTS LIST

Assembly name	Figure/page	Table/page
ScopeMeter final assembly	9.1 9-3	9.1 9-2
Front cover assembly	9.2 9-5	9.2 9-4
Input unit assembly	9.2 9-5	9.2 9-4
Display assembly	9.2 9-5	9.2 9-4
Battery contact assembly	9.3 9-7	9.3 9-6
Stand assembly	9.3 9-7	9.3 9-6
Battery cover assembly	9.3 9-7	9.3 9-6
Bottom cover assembly	9.3 9-7	9.3 9-6
Digital A1 PCB assembly	9.4. 9-8	9.4. 9-8
Analog A2 PCB assembly	9.5/9.6 9-14/9-15	9.5. 9-13
Accessories replacements Fluke	9.7	9.6
Accessories replacements Philips	9.8	9.7

9.1 INTRODUCTION

The replaceable parts section provides illustrated parts lists for the ScopeMeter models Philips PM93/PM95/PM97 and Fluke 93/95/97.

The mechanical parts are listed numerically by assembly. The electrical parts on the printed circuit boards A1 and A2 are listed alphanumerically by assembly. Each part is shown in an accompanying illustration.

The parts lists provide the following information for each part:

- Item number
- Figure number
- Description
- Ordering code
- Total quantity of components per assembly

9.2 HOW TO OBTAIN PARTS

For Philips Export B.V.:

Contact your local Philips Sales and Service representative. The addresses and telephone numbers are listed in this manual in section 11: "Sales & Service all over the world".

For the John Fluke Mfg. Co., Inc.:

Contact your local Fluke authorized representative. In the U.S. order directly from the Fluke Parts Dept. by calling 1- 800-526-4731.

To ensure prompt and efficient handling of your order, include the following information:

1. Mode number (PM xx), (Fluke xx), Code number (9444) and Serial number (DM.....). The items are printed on the type plate on the bottom cover.
2. Ordering code
3. Item number
4. Description
5. Quantity

Table 9.1 ScopeMeter final assembly. (See figure 9.1)

When servicing the ScopeMeter, use only the replacement parts specified.

Item	Figure	Description	Ordering code	Qty
1	9.1	Top cover assembly PM93	5322 447 70108	1
1	9.1	Top cover assembly PM95	5322 447 70109	1
1	9.1	Top cover assembly PM97	5322 447 70104	1
1	9.1	Top cover assembly 93	5322 447 70105	1
1	9.1	Top cover assembly 95	5322 447 70111	1
1	9.1	Top cover assembly 97	5322 447 70115	1
2	9.1	Keypad PM93/93	5322 218 61461	1
2	9.1	Keypad PM95/95	5322 218 61459	1
2	9.1	Keypad PM97/97	5322 218 61457	1
29	9.1	Bottom cover torx-screw blank M3	5322 502 13772	2
30	9.1	Board A2 torx-screw blank M3	5322 502 13772	2
31	9.1	Input unit torx-screw blank M3	5322 502 13772	2
32	9.1	30-pole flat cable	5322 321 61238	1
-	-	30-pole extender flat cable for repair purposes	5322 321 61369	1
33	9.1	Top cover torx-screw blank M3	5322 502 13772	2

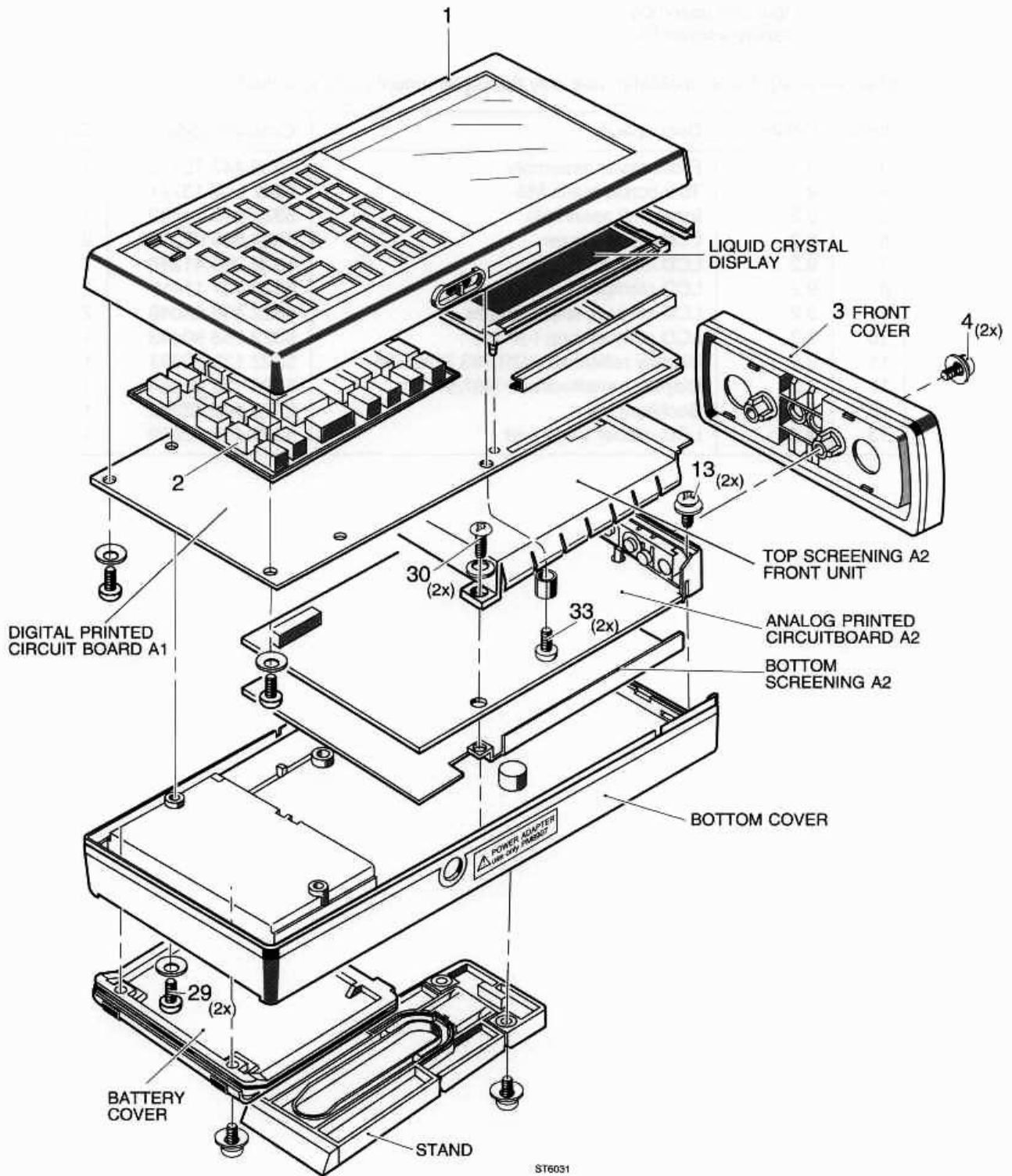


Figure 9.1 ScopeMeter final assembly

*Table 9.2 Front cover assembly (See figure 9.2)
Input unit assembly
Display assembly*

When servicing the ScopeMeter, use only the replacement parts specified.

Item	Figure	Description	Ordering code	Qty
3	9.2	Front cover assembly	5322 447 70112	1
4	9.2	Torx screw black M3	5322 502 13771	2
5	9.2	Input unit assembly	5322 218 61462	1
6	9.2	LCD adjust screw	5322 535 93237	2
7	9.2	LCD frame	5322 255 41246	1
8	9.2	LCD clamps	5322 401 11411	3
9	9.2	LCD contact strip L-shape	5322 466 62048	2
10	9.2	LCD contact strip I-shape	5322 268 90443	1
11	9.2	Display reflective PM93/93 PM95/95	5322 130 90991	1
11	9.2	Display transfective PM97/97	5322 130 91054	1
12	9.2	Backlight foil	5322 466 62052	1
13	9.2	LCD rubber filling part	5322 466 62049	1

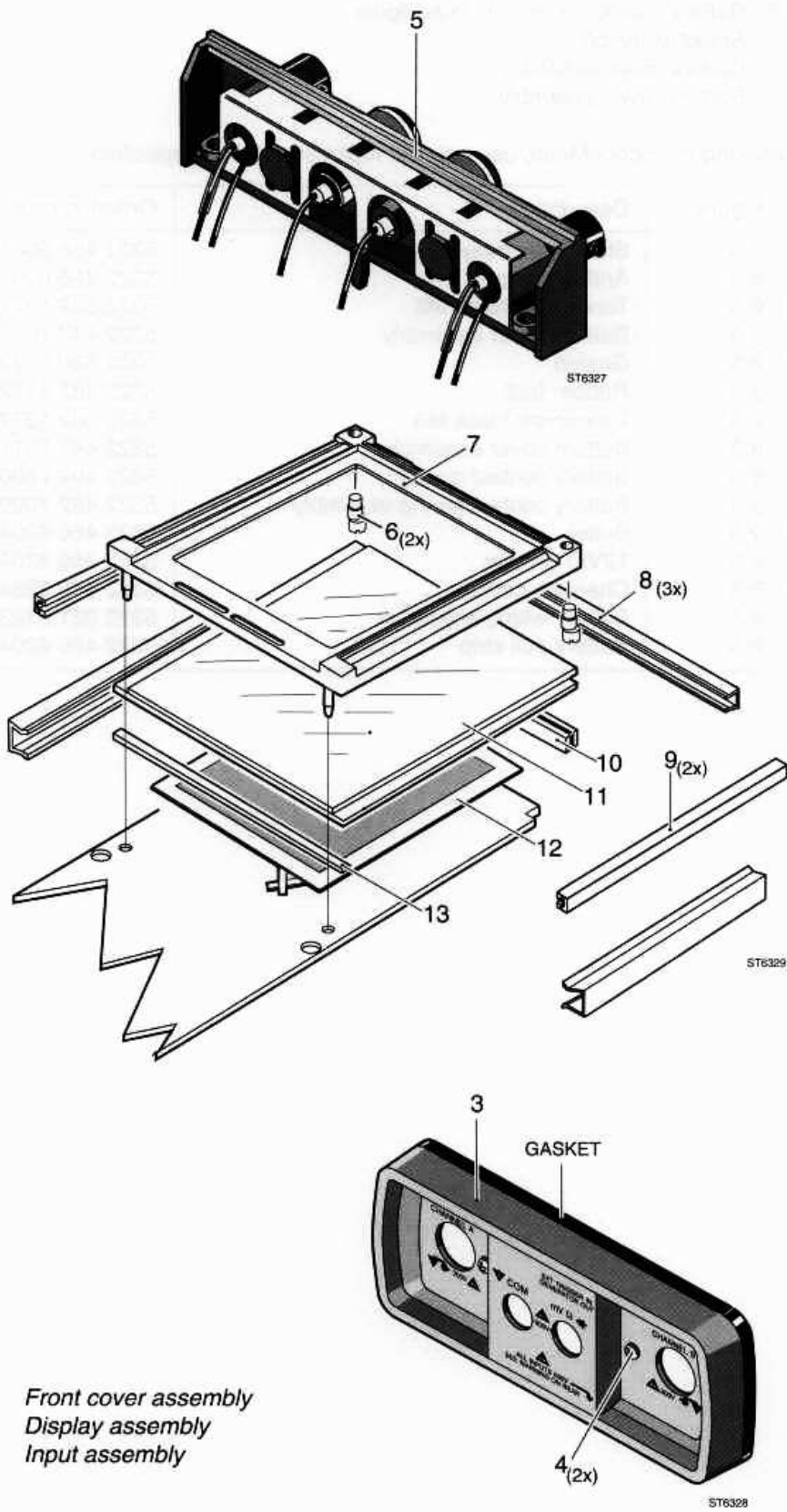


Figure 9.2 Front cover assembly
 Display assembly
 Input assembly

Table 9.3 Battery contact assembly. (See figure 9.3)
Stand assembly
Battery cover assembly
Bottom cover assembly

When servicing the ScopeMeter, use only the replacement parts specified.

Item	Figure	Description	Ordering code	Qty
14	9.3	Stand assembly	5322 456 90416	1
15	9.3	Anti slip strip	5322 466 62045	1
16	9.3	Torx screw black M3	5322 502 13771	1
17	9.3	Battery cover assembly	5322 447 70116	1
18	9.3	Gasket	5322 530 51238	1
19	9.3	Rubber foot	5322 462 41825	2
20	9.3	Torx screw black M3	5322 502 13771	2
21	9.3	Bottom cover assembly	5322 447 70113	1
22	9.3	Battery contact spring	5322 492 70908	3
23	9.3	Battery contact spring assembly	5322 492 70909	1
24	9.3	Buffer	5322 466 62047	4
25	9.3	12V/0 contact	5322 466 82843	2
26	9.3	Charging contact	5322 466 82842	1
27	9.3	Battery wiring assembly	5322 321 61237	1
28	9.3	Battery pull strip	5322 466 62046	1

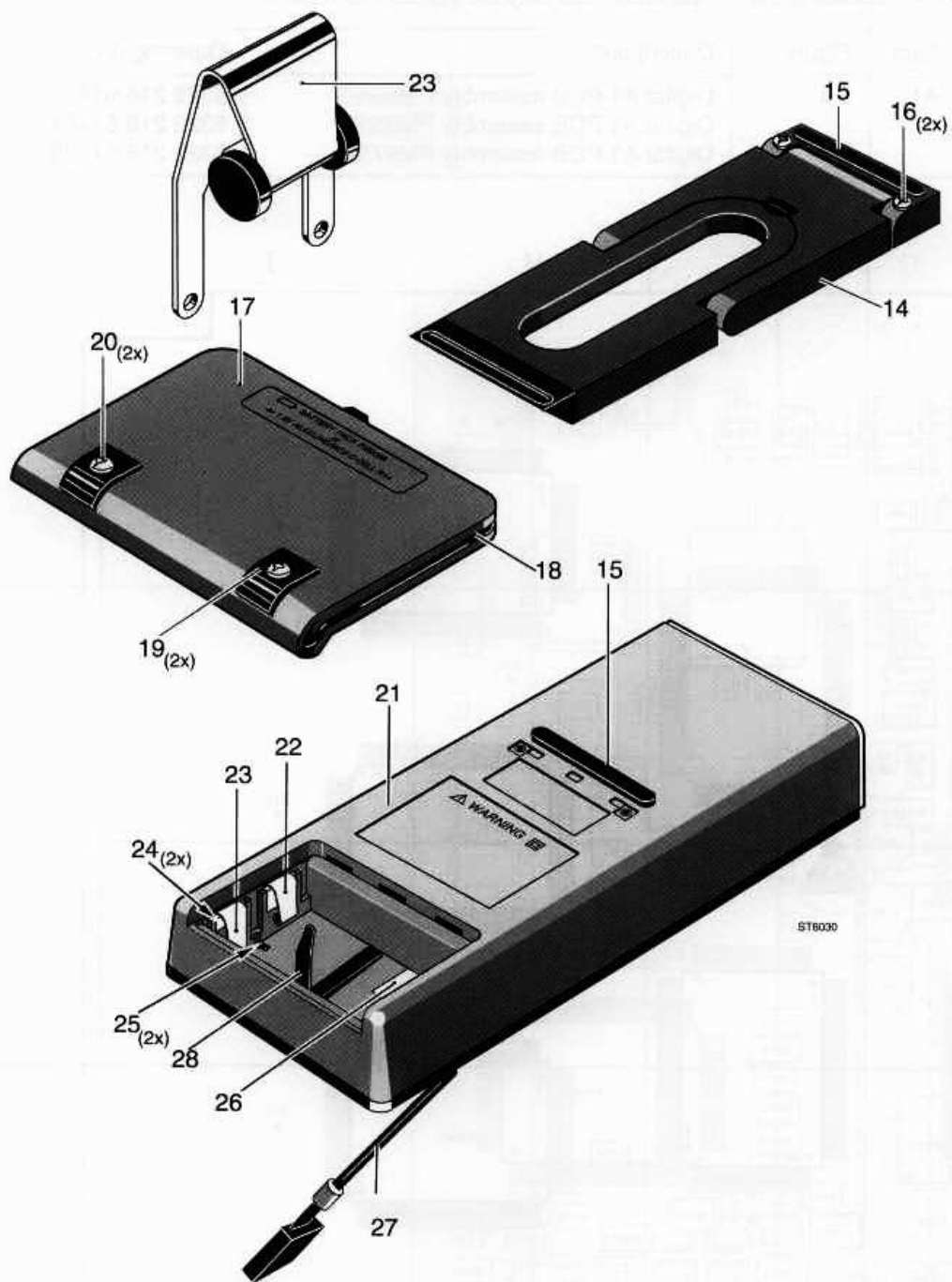


Figure 9.3 Battery contact assembly
 Stand assembly
 Battery cover assembly
 Bottom assembly

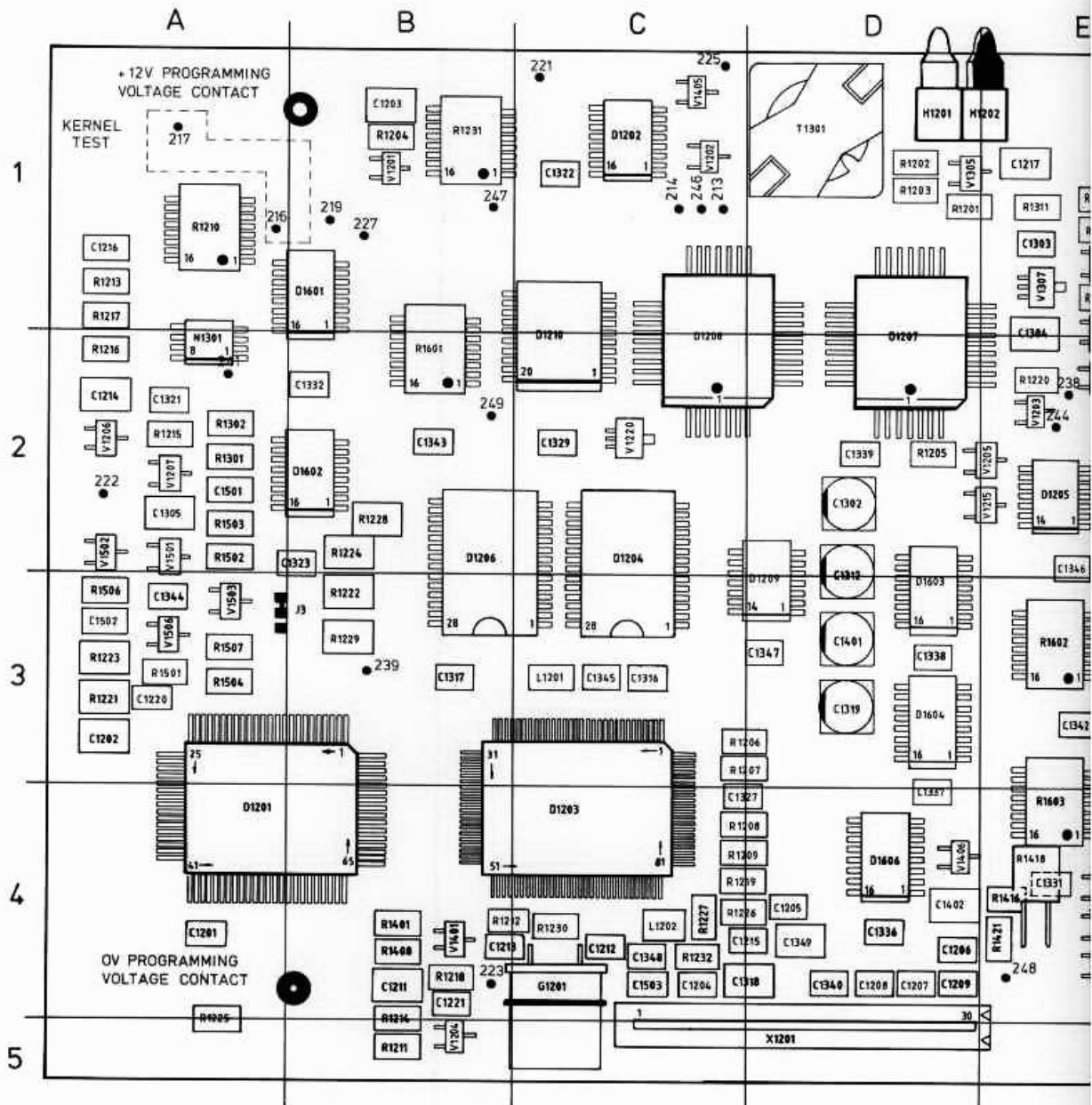
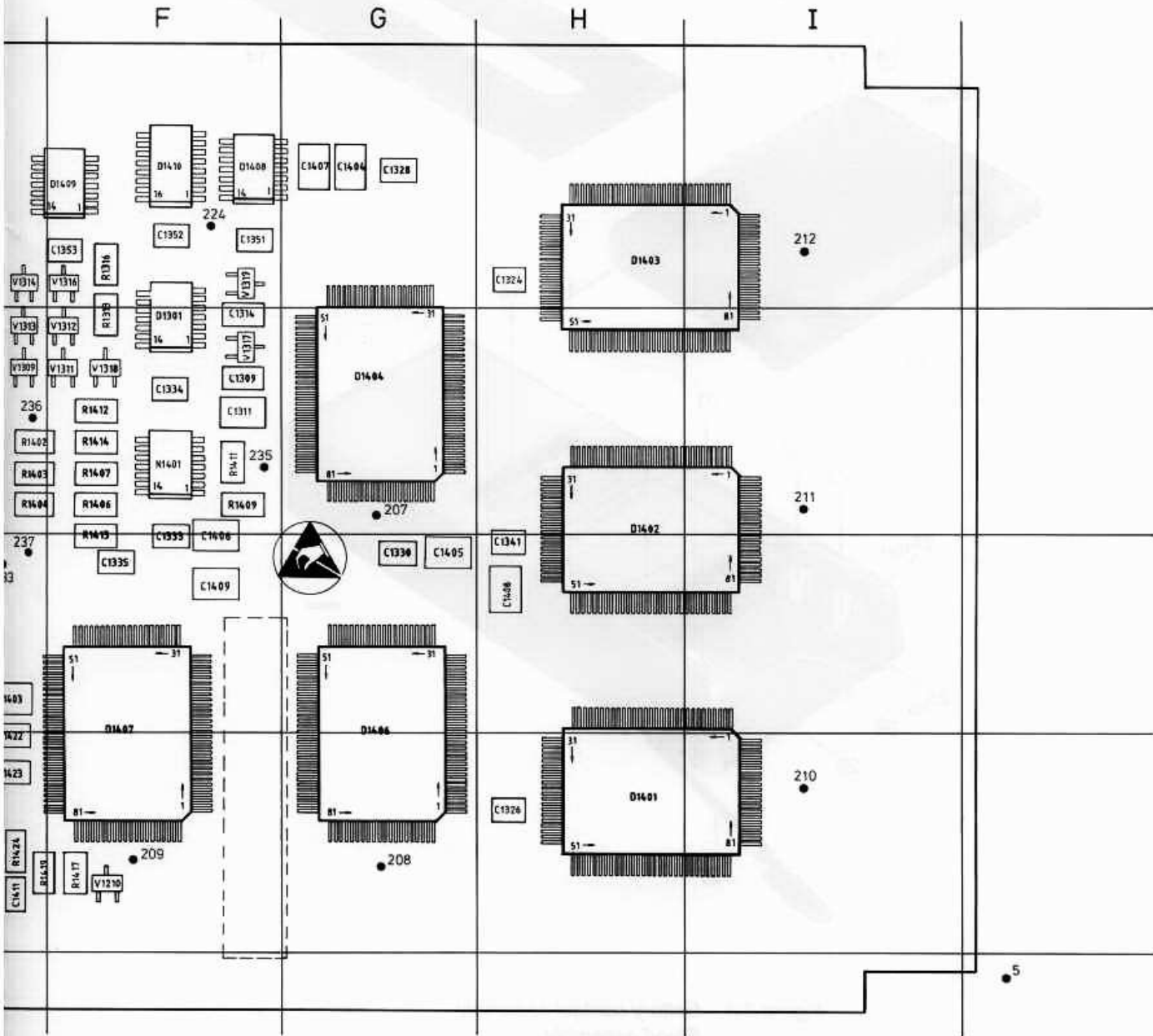


Table 9.4 Digital A1 PCB assembly (figure 9.4)

When servicing the ScopeMeter, use only the replacement parts specified.

Item	Figure	Description	Ordering code	Qty
A1	9.4	Digital A1 PCB assembly PM93/93	5322 218 61463	1
		Digital A1 PCB assembly PM95/95	5322 218 61464	1
		Digital A1 PCB assembly PM97/97	5322 216 51275	1



ST6615
920203

Figure 9.4a Digital A1 PCB assembly

REPLACEABLE PARTS LIST

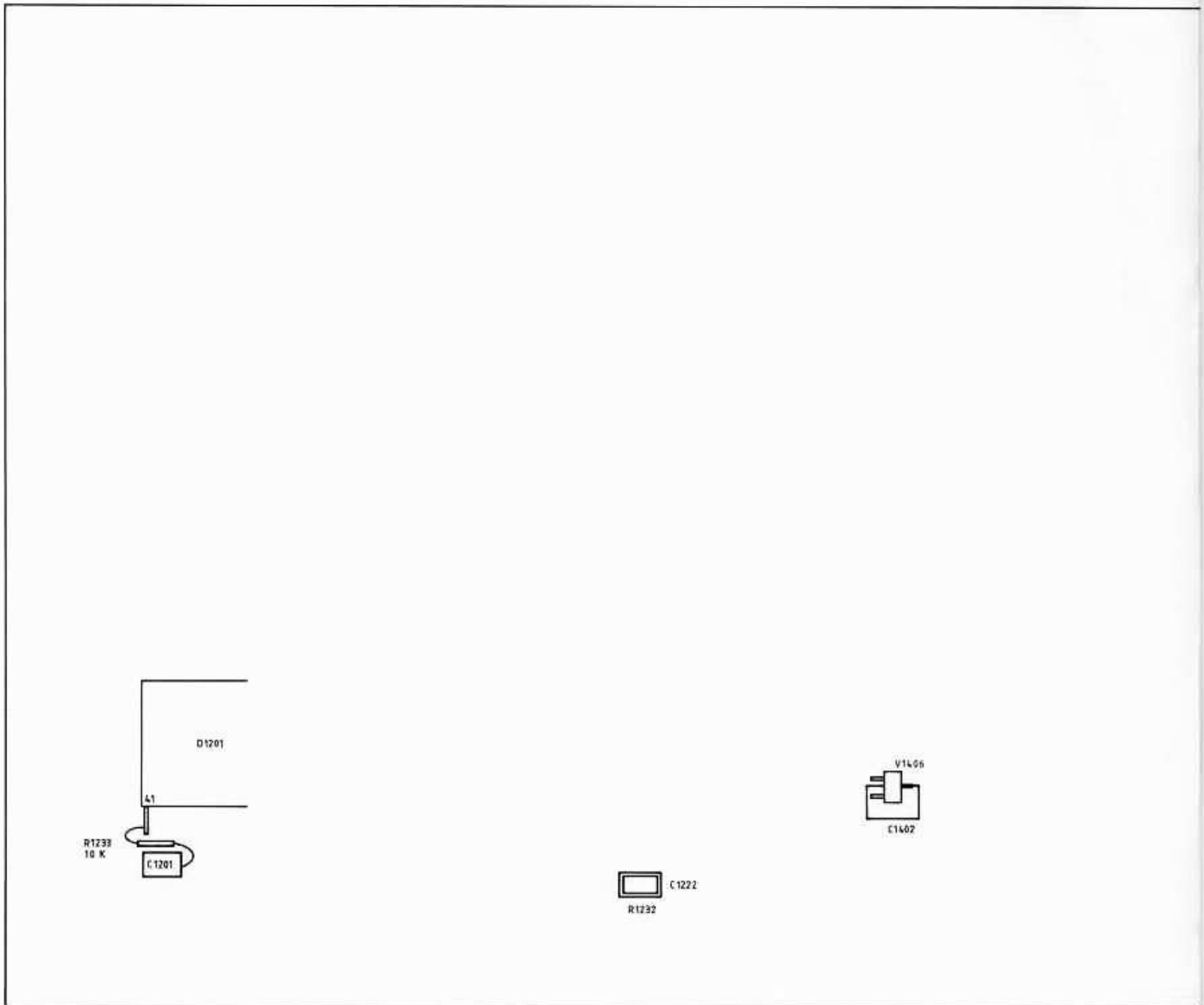


Figure 9.4b Modifications Digital A1 PCB assembly

ST6849
920203

Ordering code	Description				Item
CAPACITORS					
5322 122 34098	CAP.CHIP	63V	10%	10NF	C 1201
5322 126 10785	CAP.CHIP	63V	10%	100NF	C 1202
4822 122 32916	CAP.CHIP	63V	10%	220NF	C 1203
5322 122 32654	CAP.CHIP	63V	10%	22NF	C 1204
5322 122 33869	CAP.CHIP	63V	5%	15PF	C 1205
5322 122 34098	CAP.CHIP	63V	10%	10NF	C 1206
5322 122 34098	CAP.CHIP	63V	10%	10NF	C 1207
5322 122 34098	CAP.CHIP	63V	10%	10NF	C 1208
5322 122 34098	CAP.CHIP	63V	10%	10NF	C 1209
4822 122 32916	CAP.CHIP	63V	10%	220NF	C 1211
5322 122 33869	CAP.CHIP	63V	5%	15PF	C 1212
5322 122 33869	CAP.CHIP	63V	5%	15PF	C 1213
4822 122 32916	CAP.CHIP	63V	10%	220NF	C 1214
5322 122 33869	CAP.CHIP	63V	5%	15PF	C 1215
4822 122 33498	CAP.CHIP	63V	10%	2.7NF	C 1216
4822 122 32916	CAP.CHIP	63V	10%	220NF	C 1217
5322 126 10733	CAP.CHIP	63V	5%	680PF	C 1220
5322 122 32448	CAP.CERAMIC	63V	5%	10PF	C 1221
4822 126 10004	CAP.CHIP	63V	5%	120PF	C 1222
5322 124 42332	CAP.ELECTROLYT.	50V	20%	10UF	C 1302
5322 122 34098	CAP.CHIP	63V	10%	10NF	C 1303
5322 126 10785	CAP.CHIP	63V	10%	100NF	C 1304
4822 122 32916	CAP.CHIP	63V	10%	220NF	C 1305
4822 122 33498	CAP.CHIP	63V	10%	2.7NF	C 1309
5322 126 10785	CAP.CHIP	63V	10%	100NF	C 1311
5322 124 42331	CAP.ELECTROLYT.	6.3V	20%	100UF	C 1312
5322 122 34098	CAP.CHIP	63V	10%	10NF	C 1316
5322 122 34098	CAP.CHIP	63V	10%	10NF	C 1317
4822 122 32916	CAP.CHIP	63V	10%	220NF	C 1318
5322 124 42332	CAP.ELECTROLYT.	50V	20%	10UF	C 1319
5322 122 34098	CAP.CHIP	63V	10%	10NF	C 1321
5322 122 34098	CAP.CHIP	63V	10%	10NF	C 1322
5322 122 34098	CAP.CHIP	63V	10%	10NF	C 1323
5322 122 34098	CAP.CHIP	63V	10%	10NF	C 1324
5322 122 34098	CAP.CHIP	63V	10%	10NF	C 1326
5322 122 34098	CAP.CHIP	63V	10%	10NF	C 1327
5322 122 34098	CAP.CHIP	63V	10%	10NF	C 1328
5322 122 34098	CAP.CHIP	63V	10%	10NF	C 1329
5322 122 34098	CAP.CHIP	63V	10%	10NF	C 1330
5322 122 34098	CAP.CHIP	63V	10%	10NF	C 1332
5322 122 34098	CAP.CHIP	63V	10%	10NF	C 1333
5322 122 34098	CAP.CHIP	63V	10%	10NF	C 1334
5322 122 34098	CAP.CHIP	63V	10%	10NF	C 1335
5322 122 34098	CAP.CHIP	63V	10%	10NF	C 1336
5322 122 34098	CAP.CHIP	63V	10%	10NF	C 1337

Ordering code	Description				Item
5322 122 34098	CAP.CHIP	63V	10%	10NF	C 1338
5322 122 34098	CAP.CHIP	63V	10%	10NF	C 1339
5322 122 34098	CAP.CHIP	63V	10%	10NF	C 1340
5322 122 34098	CAP.CHIP	63V	10%	10NF	C 1341
5322 122 34098	CAP.CHIP	63V	10%	10NF	C 1344
5322 122 34098	CAP.CHIP	63V	10%	10NF	C 1346
5322 122 34098	CAP.CHIP	63V	10%	10NF	C 1347
5322 122 34098	CAP.CHIP	63V	10%	10NF	C 1348
4822 122 32916	CAP.CHIP	63V	10%	220NF	C 1349
5322 122 34098	CAP.CHIP	63V	10%	10NF	C 1351
5322 122 34098	CAP.CHIP	63V	10%	10NF	C 1352
5322 122 34098	CAP.CHIP	63V	10%	10NF	C 1353
5322 124 42332	CAP.ELECTROLYT.	50V	20%	10UF	C 1401
4822 122 32916	CAP.CHIP	63V	10%	220NF	C 1402
5322 126 10785	CAP.CHIP	63V	10%	100NF	C 1403
4822 122 32916	CAP.CHIP	63V	10%	220NF	C 1404
4822 122 32916	CAP.CHIP	63V	10%	220NF	C 1405
4822 122 32916	CAP.CHIP	63V	10%	220NF	C 1406
4822 122 32916	CAP.CHIP	63V	10%	220NF	C 1407
4822 122 32916	CAP.CHIP	63V	10%	220NF	C 1408
4822 122 32916	CAP.CHIP	63V	10%	220NF	C 1409
5322 126 10733	CAP.CHIP	63V	5%	680PF	C 1411
5322 122 34098	CAP.CHIP	63V	10%	10NF	C 1503

RESISTORS

5322 111 91899	RES.CHIP	RMC1/8	1%	261E	R 1201
5322 116 81226	RES.CHIP	RC-02H	1%	215E	R 1202
4822 111 91814	RES.CHIP	RC-02H	1%	121E	R 1203
4822 116 81165	RES.CHIP	RC-02H	1%	1M	R 1204
4822 116 82532	RES.CHIP	RC-02H	1%	11K	R 1205
4822 116 82532	RES.CHIP	RC-02H	1%	11K	R 1206
4822 116 82532	RES.CHIP	RC-02H	1%	11K	R 1207
4822 116 82532	RES.CHIP	RC-02H	1%	11K	R 1208
5322 111 91811	RES.CHIP	RC-02H	1%	5K62	R 1209
5322 111 91993	RES.NETWORK	002-563		56K	R 1210
4822 116 82532	RES.CHIP	RC-02H	1%	11K	R 1211
4822 116 81165	RES.CHIP	RC-02H	1%	1M	R 1212
4822 116 82532	RES.CHIP	RC-02H	1%	11K	R 1213
4822 116 82885	RES.METAL FILM	RC-02H	1%	51K1	R 1214
5322 116 80427	RES.CHIP	RC-02H	1%	1K	R 1215
5322 116 82904	RES.MET.GLAZED	RMC1/8	1%	464K	R 1216
5322 116 80427	RES.CHIP	RC-02H	1%	1K	R 1217
4822 116 82532	RES.CHIP	RC-02H	1%	11K	R 1218
5322 116 80427	RES.CHIP	RC-02H	1%	1K	R 1219
4822 116 82532	RES.CHIP	RC-02H	1%	11K	R 1220
4822 116 82532	RES.CHIP	RC-02H	1%	11K	R 1221
4822 116 82532	RES.CHIP	RC-02H	1%	11K	R 1222
4822 116 82532	RES.CHIP	RC-02H	1%	11K	R 1223

Ordering code	Description				Item
5322 116 80427	RES.CHIP	RC-02H	1%	1K	R 1225
4822 116 81789	RES.CHIP	RMC1/8	1%	316E	R 1226
5322 111 91899	RES.CHIP	RMC1/8	1%	261E	R 1227
5322 116 80427	RES.CHIP	RC-02H	1%	1K	R 1228
4822 111 91826	RES.CHIP	RC-02H	1%	511E	R 1229
4822 111 91814	RES.CHIP	RC-02H	1%	121E	R 1230
5322 111 91993	RES.NETWORK	002-563		56K	R 1231
5322 116 80427	RES.CHIP	RC-02H	1%	1K	R 1232
5322 116 82011	RES.METAL FILM	RC-02H	1%	147K	R 1301
5322 116 80429	RES.CHIP	RC-02H	1%	100K	R 1302
5322 116 81795	RES.CHIP	RC-02H	1%	3K48	R 1309
5322 116 81226	RES.CHIP	RC-02H	1%	215E	R 1311
5322 116 80428	RES.CHIP	RC-02H	1%	10K	R 1312
4822 111 91891	RES.METAL FILM	RC-02H	1%	34K8	R 1313
4822 111 91814	RES.CHIP	RC-02H	1%	121E	R 1314
5322 116 81794	RES.CHIP	RC-02H	1%	2K15	R 1316
5322 116 81226	RES.CHIP	RC-02H	1%	215E	R 1319
4822 116 82532	RES.CHIP	RC-02H	1%	11K	R 1401
5322 111 91811	RES.CHIP	RC-02H	1%	5K62	R 1402
5322 111 91811	RES.CHIP	RC-02H	1%	5K62	R 1403
4822 111 91828	RES.CHIP	RC-02H	1%	68K1	R 1404
5322 111 91811	RES.CHIP	RC-02H	1%	5K62	R 1406
5322 111 91811	RES.CHIP	RC-02H	1%	5K62	R 1407
4822 111 91885	RES.CHIP	RMC1/8	1%	10E	R 1408
5322 111 91963	RES.CHIP	RMC1/8	1%	34E8	R 1409
5322 111 91963	RES.CHIP	RMC1/8	1%	34E8	R 1411
5322 111 91963	RES.CHIP	RMC1/8	1%	34E8	R 1412
5322 111 91963	RES.CHIP	RMC1/8	1%	34E8	R 1413
4822 111 91885	RES.CHIP	RMC1/8	1%	10E	R 1414
4822 116 82532	RES.CHIP	RC-02H	1%	11K	R 1416
5322 116 82902	RES.MET.GLAZED	RMC1/8	1%	23K7	R 1417
4822 130 90972	TEMP.SENSOR	KTY81-220			R 1418
5322 116 81794	RES.CHIP	RC-02H	1%	2K15	R 1419
5322 111 91893	RES.CHIP	RMC1/8	1%	51E1	R 1421
4822 116 82532	RES.CHIP	RC-02H	1%	11K	R 1422
4822 116 82889	RES.METAL FILM	RC-02H	1%	90K9	R 1423
5322 116 80427	RES.CHIP	RC-02H	1%	1K	R 1424
5322 116 80429	RES.CHIP	RC-02H	1%	100K	R 1501
5322 116 80429	RES.CHIP	RC-02H	1%	100K	R 1502
5322 116 80429	RES.CHIP	RC-02H	1%	100K	R 1503
5322 116 80429	RES.CHIP	RC-02H	1%	100K	R 1504
5322 116 80429	RES.CHIP	RC-02H	1%	100K	R 1506
5322 116 80427	RES.CHIP	RC-02H	1%	1K	R 1507
5322 111 91993	RES.NETWORK	002-563		56K	R 1601
5322 111 91993	RES.NETWORK	002-563		56K	R 1602
5322 111 91993	RES.NETWORK	002-563		56K	R 1603

Ordering code	Description		Item
SEMI-CONDUCTORS			
4822 130 42513	TRANSISTOR,CHIP	BC858C	V 1201
5322 130 32731	DIODE,CHIP	BZX84-C3V6	V 1202
4822 130 42513	TRANSISTOR,CHIP	BC858C	V 1203
4822 130 42513	TRANSISTOR,CHIP	BC858C	V 1205
5322 130 34337	DIODE,CHIP	BAV99	V 1206
5322 130 42136	TRANSISTOR,CHIP	BC848C	V 1207
5322 130 34337	DIODE,CHIP	BAV99	V 1210
4822 130 42513	TRANSISTOR,CHIP	BC858C	V 1215
5322 130 82043	DIODE,CHIP	BZV49-C13	V 1220
4822 130 42513	TRANSISTOR,CHIP	BC858C	V 1304
5322 130 34337	DIODE,CHIP	BAV99	V 1305
4822 130 42513	TRANSISTOR,CHIP	BC858C	V 1306
5322 130 62237	TRANSISTOR,CHIP	BCX54-16	V 1307
5322 130 34337	DIODE,CHIP	BAV99	V 1308
4822 130 82521	DIODE,CHIP	BZX84-B47	V 1309
4822 130 82521	DIODE,CHIP	BZX84-B47	V 1311
5322 130 42136	TRANSISTOR,CHIP	BC848C	V 1312
5322 130 42136	TRANSISTOR,CHIP	BC848C	V 1313
5322 130 42136	TRANSISTOR,CHIP	BC848C	V 1314
5322 130 42136	TRANSISTOR,CHIP	BC848C	V 1316
4822 130 42132	TRANSISTOR,CHIP	BC807	V 1317
4822 130 42513	TRANSISTOR,CHIP	BC858C	V 1318
4822 130 82262	DIODE,CHIP	BAT54S	V 1319
5322 130 42136	TRANSISTOR,CHIP	BC848C	V 1401
4822 130 42513	TRANSISTOR,CHIP	BC858C	V 1402
4822 130 42513	TRANSISTOR,CHIP	BC858C	V 1403
5322 130 42136	TRANSISTOR,CHIP	BC848C	V 1404
5322 130 34337	DIODE,CHIP	BAV99	V 1405
4822 130 82262	DIODE,CHIP	BAT54S	V 1406
5322 130 34337	DIODE,CHIP	BAV99	V 1501
5322 130 34337	DIODE,CHIP	BAV99	V 1502
4822 130 42513	TRANSISTOR,CHIP	BC858C	V 1503
5322 130 42136	TRANSISTOR,CHIP	BC848C	V 1506
INTEGRATED CIRCUITS			
5322 209 30822	U-PROCESSOR	S83C196	D 1201
5322 209 73179	INTEGR.CIRCUIT	PC74HCT74T	D 1202
5322 209 30819	DIGITAL ASIC	SCOPEMETER	D 1203
5322 209 30228	SRAM 32Kx8	HM62256	D 1204
5322 209 60428	INTEGR.CIRCUIT	PC74HC132T	D 1205
5322 209 30228	INTEGR.CIRCUIT	HM62256	D 1206
4822 209 63758	FROM 16Kx8	N28F256-A200	D 1207
5322 209 30674	FROM 32Kx8	N28F512-200P1C4	D 1208
5322 209 60428	INTEGR.CIRCUIT	PC74HC132T	D 1209
5322 209 73181	INTEGR.CIRCUIT	PC74HCT373T	D 1210

Ordering code	Description		Item
5322 209 11147	INTEGR.CIRCUIT	HEF4093BT	D 1301
4822 209 63761	LCD DRIVER	HD61105A	D 1401
4822 209 63761	LCD DRIVER	HD61105A	D 1402
4822 209 63761	LCD DRIVER	HD61105A	D 1403
4822 209 63759	LCD DRIVER	HD61104A	D 1404
4822 209 63759	LCD DRIVER	HD61104A	D 1406
4822 209 63759	LCD DRIVER	HD61104A	D 1407
4822 209 30208	INTEGR.CIRCUIT	PC74HCT86T	D 1408
5322 209 11996	INTEGR.CIRCUIT	PC74HCT393T	D 1409
5322 209 30675	INTEGR.CIRCUIT	PC74HCT163T	D 1410
4822 209 63762	I.C. INTERFACE	PC74HCT165T	D 1601
4822 209 63762	I.C. INTERFACE	PC74HCT165T	D 1602
4822 209 63762	I.C. INTERFACE	PC74HCT165T	D 1603
4822 209 63762	I.C. INTERFACE	PC74HCT165T	D 1604
4822 209 63762	I.C. INTERFACE	PC74HCT165T	D 1606
4822 209 60175	INTEGR.CIRCUIT	LM358M	N 1301
5322 209 61473	INTEGR.CIRCUIT	LM324M	N 1401
COILS			
5322 157 63648	COIL	1UH 5%	L 1201
5322 157 63651	COIL	CB-322513T	L 1202
MISCELLANEOUS			
5322 242 80215	CRYSTAL	25MHZ HC-49/U	G 1201
5322 130 61296	INFRARED ELEMENT	SFH409-2	H 1201
5322 130 62923	PHOTO TRANSISTOR	SFH309F-4	H 1202
CONNECTORS			
5322 267 70302	CONNECTOR	30-PIN STRAIGHT	X 1201

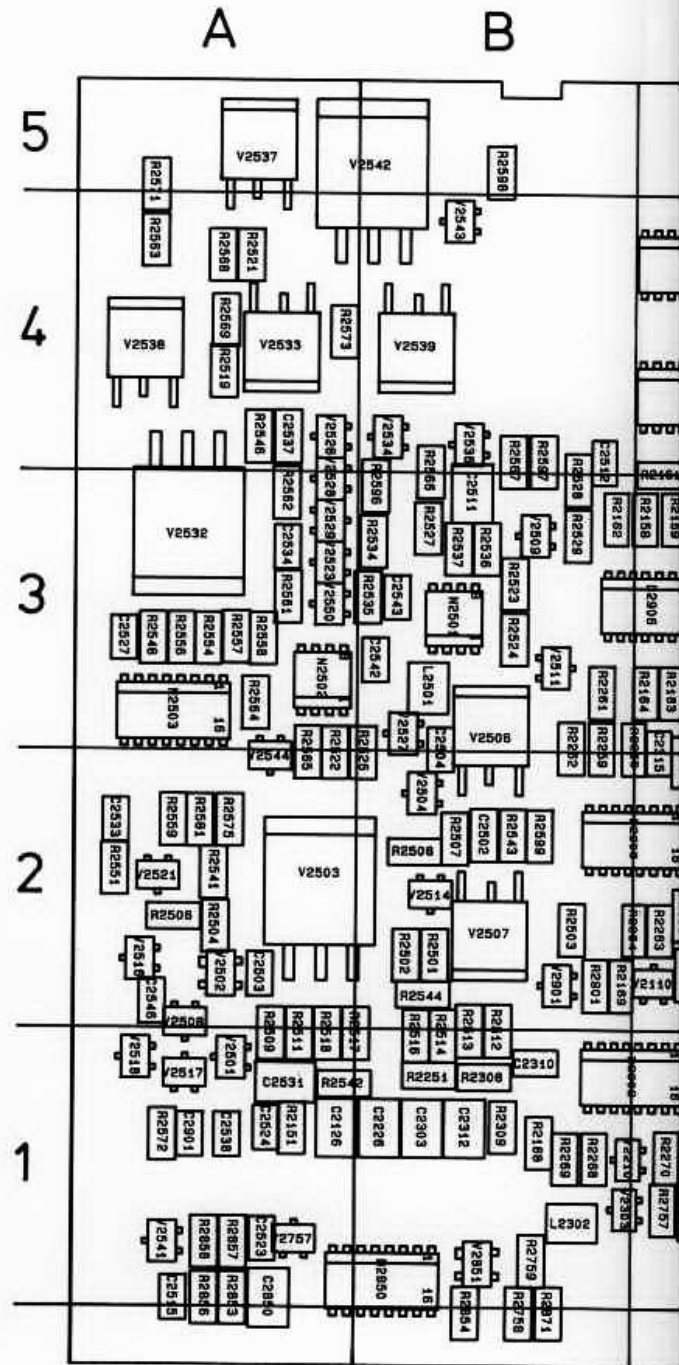
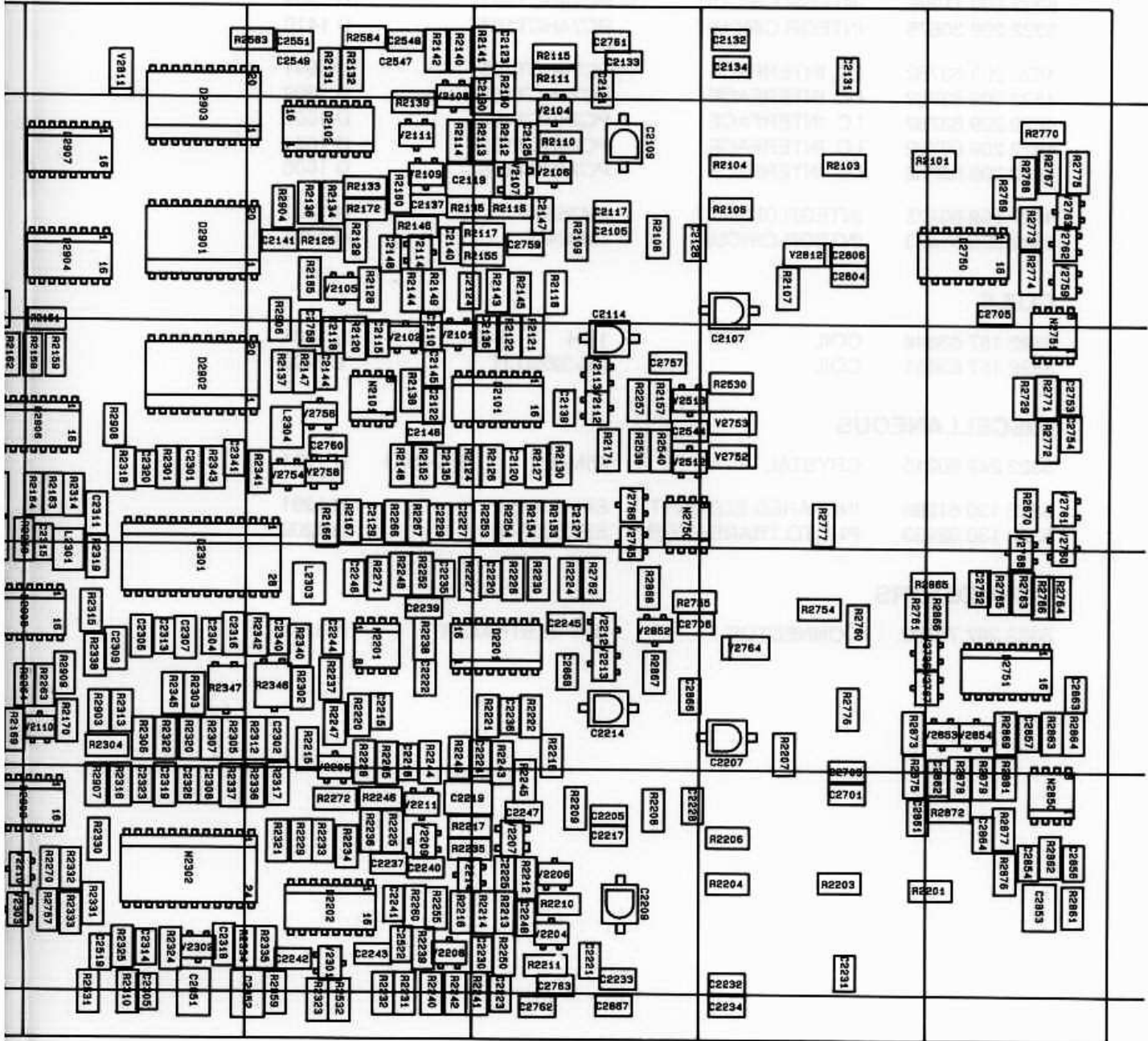


Table 9.5 Analog A2 PCB assembly (Figure 9.5)

When servicing the ScopeMeter, use only the replacement parts specified.

Item	Figure	Description	Ordering code	Qty
A2	9.5/9.6	Analog A2 PCB assembly	5322 218 61465	1

C D E F G



ST 6617
920203

Figure 9.5a Analog A2 PCB assembly (SMD components side)

REPLACEABLE PARTS LIST

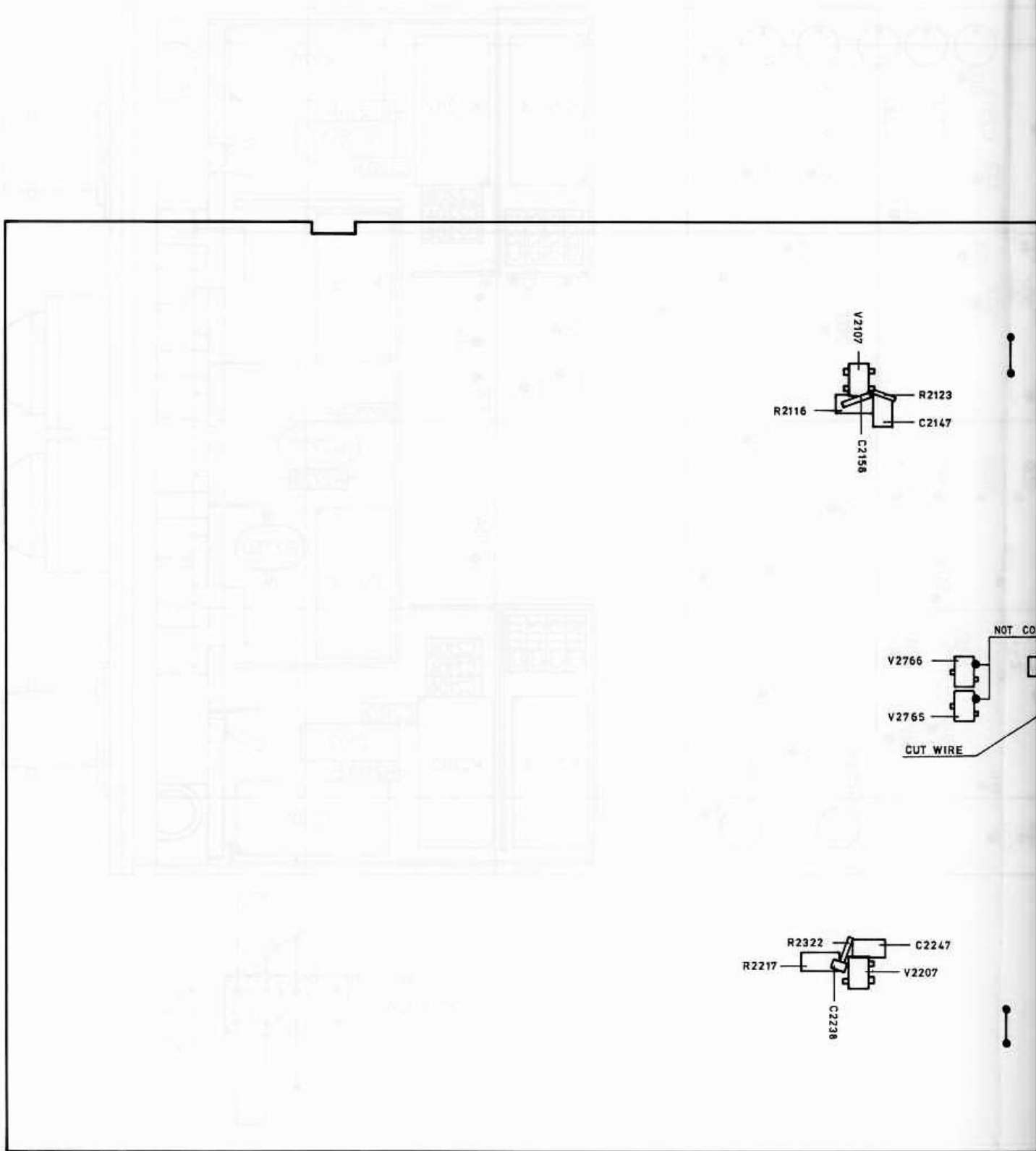
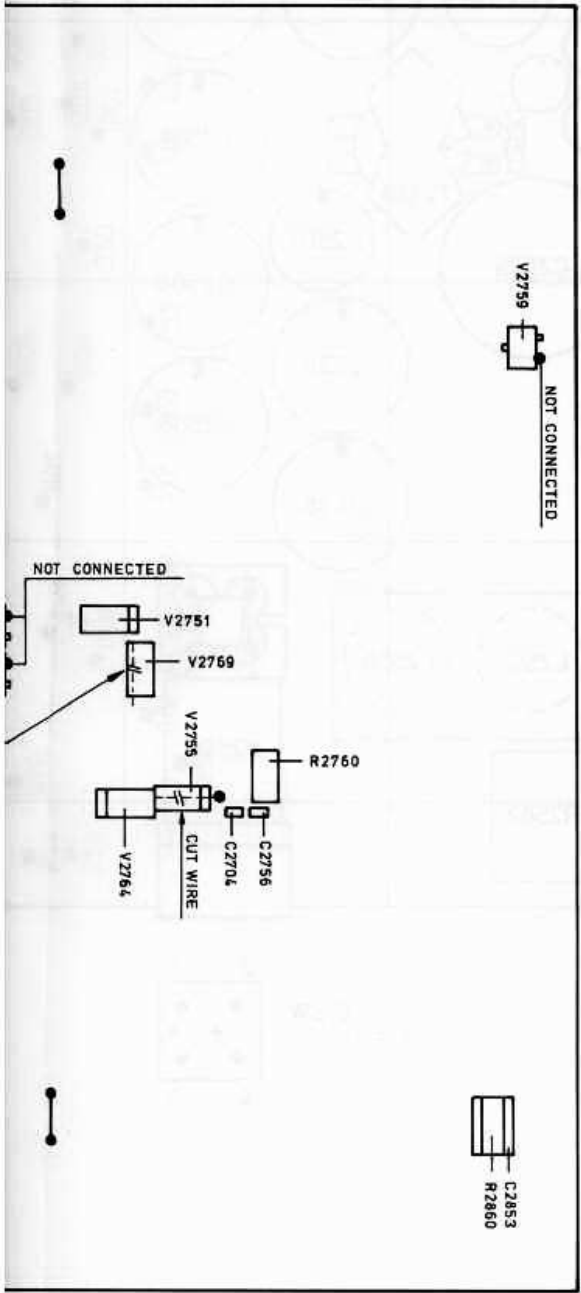
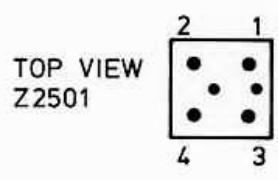
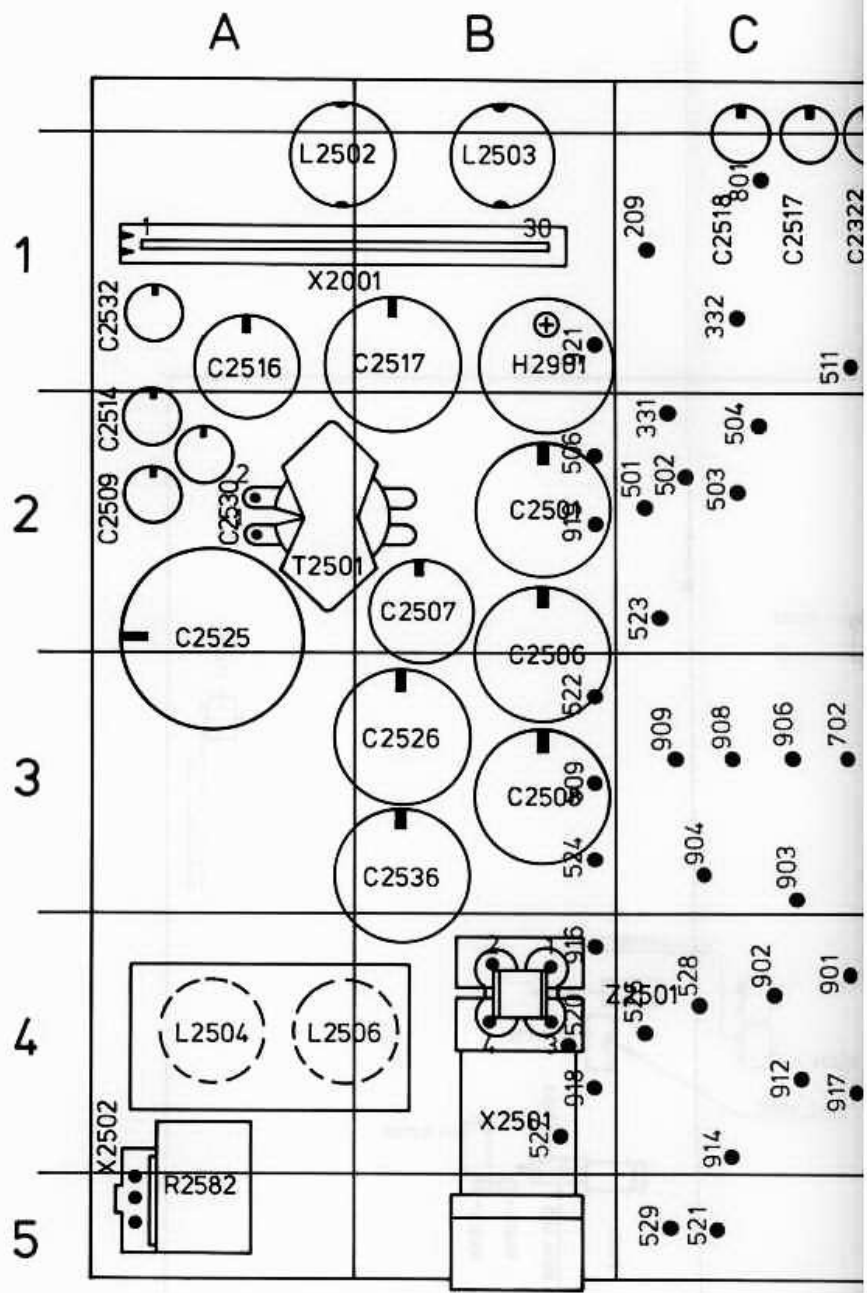
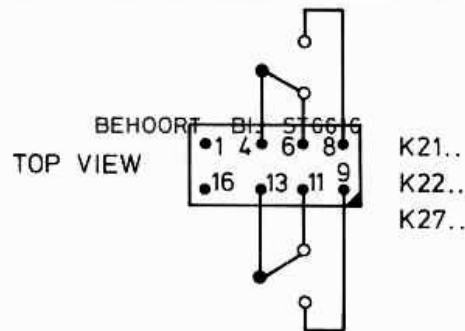
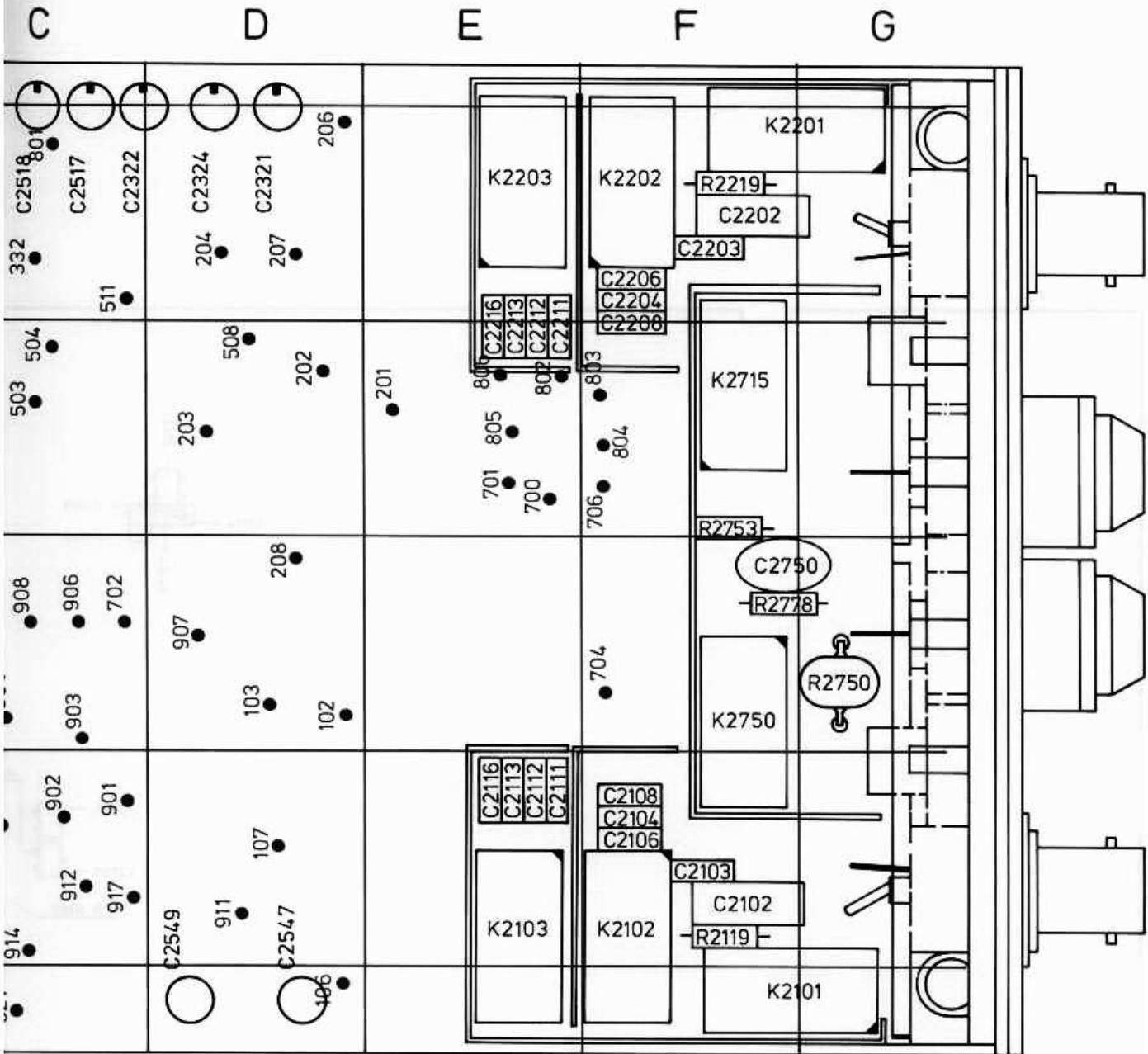


Figure 9.5b Modifications Analog A2 PCB (SMD Component side)



ST6850
920210





ST6616
920204

Figure 9.6 Analog A2 PCB assembly (Wired components side)

Ordering code	Description				Item
CAPACITORS					
5322 121 40308	CAP.FOIL	400V	10%	22NF	C 2102
5322 122 32982	CAP.CERAMIC		2%	56PF	C 2103
4822 122 31194	CAP.CERAMIC		0.25PF	8.2PF	C 2104
5322 122 33869	CAP.CERAMIC	63V	5%	15PF	C 2105
4822 122 31195	CAP.CERAMIC		2%	10PF	C 2106
5322 125 11029	CAP.VARIABLE		10 PF	MUR	C 2107
4822 122 31072	CAP.CERAMIC		2%	47PF	C 2108
5322 125 11029	CAP.VARIABLE		10 PF	MUR	C 2109
4822 122 30149	CAP.CERAMIC		0.25PF	6.8PF	C 2111
4822 122 31049	CAP.CERAMIC		0.25PF	6.8PF	C 2112
4822 122 32027	CAP.CERAMIC		2%	56PF	C 2113
5322 125 11029	CAP.VARIABLE		10 PF	MUR	C 2114
5322 861 12331	CAP.CHIP	63V	5%	330PF	C 2115
4822 122 31194	CAP.CERAMIC		0.25PF	8.2PF	C 2116
5322 122 32661	CAP.CHIP	63V	5%	56PF	C 2117
5322 861 12331	CAP.CHIP	63V	5%	330PF	C 2118
4822 122 32916	CAP.CHIP	63V	10%	220NF	C 2119
5322 122 32967	CAP.CERAMIC	63V	5%	5.6PF	C 2120
5322 122 34098	CAP.CHIP	63V	10%	10NF	C 2121
4822 122 33339	CAP.CHIP	63V	10%	4.7NF	C 2122
4822 122 33891	CAP.CHIP	63V	10%	3.3NF	C 2123
4822 122 33891	CAP.CHIP	63V	10%	3.3NF	C 2124
4822 126 10004	CAP.CHIP	63V	5%	120PF	C 2125
4822 122 32916	CAP.CHIP	63V	10%	220NF	C 2126
4822 122 32891	CAP.CERAMIC	63V	10%	68NF	C 2127
4822 122 32448	CAP.CERAMIC	63V	0.5PF	10PF	C 2128
4822 122 33891	CAP.CHIP	63V	10%	3.3NF	C 2129
4822 122 33496	CAP.CHIP	63V	10%	100NF	C 2130
5322 122 34098	CAP.CHIP	63V	10%	10NF	C 2131
5322 122 34098	CAP.CHIP	63V	10%	10NF	C 2132
5322 122 34098	CAP.CHIP	63V	10%	10NF	C 2133
5322 122 34098	CAP.CHIP	63V	10%	10NF	C 2134
5322 122 32654	CAP.CHIP	63V	10%	22NF	C 2135
5322 122 32654	CAP.CHIP	63V	10%	22NF	C 2138
4822 122 33515	CAP.CHIP	63V	5%	82PF	C 2137
4822 122 33127	CAP.CHIP	63V	10%	2.2NF	C 2139
4822 122 33127	CAP.CHIP	63V	10%	2.2NF	C 2140
4822 122 33127	CAP.CHIP	63V	10%	2.2NF	C 2141
4822 122 33127	CAP.CHIP	63V	10%	2.2NF	C 2144
4822 122 33127	CAP.CHIP	63V	10%	2.2NF	C 2145
4822 122 33127	CAP.CHIP	63V	10%	2.2NF	C 2146
4822 122 33127	CAP.CHIP	63V	10%	2.2NF	C 2147
4822 122 33127	CAP.CHIP	63V	10%	2.2NF	C 2148
5322 121 40308	CAP.FOIL	400V	10%	22NF	C 2202
5322 122 32982	CAP.		2%	56P	C 2203

Ordering code	Description				Item
4822 122 31194	CAP.CERAMIC		0.25PF	8.2PF	C 2204
5322 122 33869	CAP.CERAMIC	63V	5%	15PF	C 2205
4822 122 31195	CAP.CERAMIC		2%	10PF	C 2206
5322 125 11029	CAP.VARIABLE		10 PF	MUR	C 2207
4822 122 31072	CAP.CERAMIC		2%	47PF	C 2208
5322 125 11029	CAP.VARIABLE		10 PF	MUR	C 2209
4822 122 30149	CAP.CERAMIC		0.25PF	6.8PF	C 2211
4822 122 31049	CAP.CERAMIC		0.25PF	6.8PF	C 2212
4822 122 32027	CAP.CERAMIC		2%	56PF	C 2213
5322 125 11029	CAP.VARIABLE		10 PF	MUR	C 2214
5322 861 12331	CAP.CHIP	63V	5%	330PF	C 2215
4822 122 31194	CAP.CERAMIC		0.25PF	8.2PF	C 2216
5322 122 32661	CAP.CHIP	63V	5%	56PF	C 2217
4822 122 33216	CAP.CHIP	63V	5%	270PF	C 2218
4822 122 32916	CAP.CHIP	63V	10%	220NF	C 2219
5322 122 32967	CAP.CERAMIC	63V	5%	5.6PF	C 2220
5322 122 34098	CAP.CHIP	63V	10%	10NF	C 2221
4822 122 33339	CAP.CHIP	63V	10%	4.7NF	C 2222
4822 122 33891	CAP.CHIP	63V	10%	3.3NF	C 2223
4822 122 33891	CAP.CHIP	63V	10%	3.3NF	C 2224
4822 126 10004	CAP.CHIP	63V	5%	120PF	C 2225
4822 122 32916	CAP.CHIP	63V	10%	220NF	C 2226
4822 122 32891	CAP.CERAMIC	63V	10%	68NF	C 2227
4822 122 32448	CAP.CERAMIC	63V	0.5PF	10PF	C 2228
4822 122 33891	CAP.CHIP	63V	10%	3.3NF	C 2229
4822 122 33496	CAP.CHIP	63V	10%	100NF	C 2230
5322 122 34098	CAP.CHIP	63V	10%	10NF	C 2231
5322 122 34098	CAP.CHIP	63V	10%	10NF	C 2232
5322 122 34098	CAP.CHIP	63V	10%	10NF	C 2233
5322 122 34098	CAP.CHIP	63V	10%	10NF	C 2234
5322 122 32654	CAP.CHIP	63V	10%	22NF	C 2235
4822 122 33515	CAP.CHIP	63V	5%	82PF	C 2237
5322 122 32654	CAP.CHIP	63V	10%	22NF	C 2238
4822 122 33127	CAP.CHIP	63V	10%	2.2NF	C 2239
4822 122 33127	CAP.CHIP	63V	10%	2.2NF	C 2240
4822 122 33127	CAP.CHIP	63V	10%	2.2NF	C 2241
4822 122 33127	CAP.CHIP	63V	10%	2.2NF	C 2242
4822 122 33127	CAP.CHIP	63V	10%	2.2NF	C 2243
4822 122 33127	CAP.CHIP	63V	10%	2.2NF	C 2244
4822 122 33127	CAP.CHIP	63V	10%	2.2NF	C 2245
4822 122 33127	CAP.CHIP	63V	10%	2.2NF	C 2246
4822 122 33127	CAP.CHIP	63V	10%	2.2NF	C 2247
4822 122 33127	CAP.CHIP	63V	10%	2.2NF	C 2248
4822 122 33496	CAP.CHIP	63V	10%	100NF	C 2301
4822 122 33496	CAP.CHIP	63V	10%	100NF	C 2302
4822 122 33496	CAP.CHIP	63V	10%	100NF	C 2303
5322 122 32654	CAP.CHIP	63V	10%	22NF	C 2304
5322 122 33869	CAP.CHIP	63V	5%	15PF	C 2305
4822 122 33496	CAP.CHIP	63V	10%	100NF	C 2306
4822 122 33496	CAP.CHIP	63V	10%	100NF	C 2307

Ordering code	Description				Item
5322 122 34098	CAP.CHIP	63V	10%	10NF	C 2308
4822 122 33496	CAP.CHIP	63V	10%	100NF	C 2309
5322 122 34098	CAP.CHIP	63V	10%	10NF	C 2310
4822 122 33496	CAP.CHIP	63V	10%	100NF	C 2311
4822 122 32916	CAP.CHIP	63V	10%	220NF	C 2312
5322 122 32654	CAP.CHIP	63V	10%	22NF	C 2313
5322 122 32654	CAP.CHIP	63V	10%	22NF	C 2314
4822 122 32139	CAP.CHIP	63V	5%	12PF	C 2315
4822 122 33496	CAP.CHIP	63V	10%	100NF	C 2316
4822 124 11162	CAP.ELECTROLYT.		20%	68UF	C 2317
4822 122 33496	CAP.CHIP	63V	10%	100NF	C 2318
4822 122 33496	CAP.CHIP	63V	10%	100NF	C 2319
5322 122 32654	CAP.CHIP	63V	10%	22NF	C 2320
5322 122 34098	CAP.CHIP	63V	10%	10NF	C 2321
4822 124 23627	CAP.ELECTROLYT.		20%	4.7UF	C 2322
4822 122 33127	CAP.CHIP	63V	10%	2.2NF	C 2323
4822 124 23627	CAP.ELECTROLYT.		20%	4.7UF	C 2324
5322 122 32452	CAP.CERAMIC	63V	5%	47PF	C 2326
5322 122 33869	CAP.CHIP	63V	5%	15PF	C 2340
5322 122 33869	CAP.CHIP	63V	5%	15PF	C 2341
5322 121 43885	CAP.FOIL		20%	470UF	C 2501
4822 122 32891	CAP.CERAMIC	63V	10%	68NF	C 2502
4822 122 33127	CAP.CHIP	63V	10%	2.2NF	C 2503
4822 122 33127	CAP.CHIP	63V	10%	2.2NF	C 2504
5322 121 43884	CAP.FOIL		20%	1200UF	C 2506
5322 121 43886	CAP.FOIL		20%	180UF	C 2507
5322 121 43884	CAP.FOIL		20%	1200UF	C 2508
4822 124 11162	CAP.ELECTROLYT.		20%	68UF	C 2509
4822 122 32916	CAP.CHIP	63V	10%	220NF	C 2511
5322 122 32654	CAP.CHIP	63V	10%	22NF	C 2512
4822 124 11162	CAP.ELECTROLYT.		20%	68UF	C 2514
5322 122 32654	CAP.CHIP	63V	10%	22NF	C 2515
5322 121 43887	CAP.FOIL		20%	470UF	C 2516
5322 121 43887	CAP.FOIL		20%	470UF	C 2517
4822 124 11162	CAP.ELECTROLYT.		20%	68UF	C 2518
5322 122 32654	CAP.CHIP	63V	10%	22NF	C 2519
4822 124 11162	CAP.ELECTROLYT.		20%	68UF	C 2521
5322 122 32654	CAP.CHIP	63V	10%	22NF	C 2522
5322 122 32654	CAP.CHIP	63V	10%	22NF	C 2523
5322 122 32654	CAP.CHIP	63V	10%	22NF	C 2524
5322 121 43885	CAP.FOIL		20%	470UF	C 2526
5322 126 10733	CAP.CHIP	63V	5%	680PF	C 2527
4822 124 11162	CAP.ELECTROLYT.		20%	68UF	C 2530
4822 122 32916	CAP.CHIP	63V	10%	220NF	C 2531
4822 124 11162	CAP.ELECTROLYT.		20%	68UF	C 2532
4822 122 33127	CAP.CHIP	63V	10%	2.2NF	C 2533
5322 122 32654	CAP.CHIP	63V	10%	22NF	C 2534
5322 121 43885	CAP.FOIL		20%	470UF	C 2536

Ordering code	Description					Item
4822 122 32891	CAP.CERAMIC	63V	10%	68NF		C 2537
5322 122 32654	CAP.CHIP	63V	10%	22NF		C 2538
5322 122 34098	CAP.CHIP	63V	10%	10NF		C 2542
5322 122 34098	CAP.CHIP	63V	10%	10NF		C 2543
4822 126 10004	CAP.CHIP	63V	5%	120PF		C 2544
5322 122 32654	CAP.CHIP	63V	10%	22NF		C 2546
4822 124 11162	CAP.ELECTROLYT.		20%	68UF		C 2547
5322 122 32654	CAP.CHIP	63V	10%	22NF		C 2548
4822 124 11162	CAP.ELECTROLYT.		20%	68UF		C 2549
5322 122 32654	CAP.CHIP	63V	10%	22NF		C 2551
5322 124 42329	CAP.ELECTROLYT.		20%	3900UF		C 2552
5322 122 34098	CAP.CHIP	63V	10%	10NF		C 2701
5322 122 34098	CAP.CHIP	63V	10%	10NF		C 2703
5322 122 34098	CAP.CHIP	63V	10%	10NF		C 2705
5322 126 11389	CAP.CERAMIC		10%	22PF		C 2750
5322 122 32654	CAP.CHIP	63V	10%	22NF		C 2752
4822 122 33127	CAP.CHIP	63V	10%	2.2NF		C 2753
4822 122 33127	CAP.CHIP	63V	10%	2.2NF		C 2754
5322 122 32654	CAP.CHIP	63V	10%	22NF		C 2756
4822 122 33127	CAP.CHIP	63V	10%	2.2NF		C 2757
4822 122 33127	CAP.CHIP	63V	10%	2.2NF		C 2758
4822 122 33127	CAP.CHIP	63V	10%	2.2NF		C 2759
4822 122 33127	CAP.CHIP	63V	10%	2.2NF		C 2760
4822 122 33127	CAP.CHIP	63V	10%	2.2NF		C 2761
4822 122 33127	CAP.CHIP	63V	10%	2.2NF		C 2762
4822 122 33127	CAP.CHIP	63V	10%	2.2NF		C 2763
5322 122 34098	CAP.CHIP	63V	10%	10NF		C 2804
5322 122 34098	CAP.CHIP	63V	10%	10NF		C 2806
5322 122 33897	CAP.CERAMIC	63V	5%	3.3NF		C 2850
5322 122 33897	CAP.CERAMIC	63V	5%	3.3NF		C 2851
5322 122 33897	CAP.CERAMIC	63V	5%	3.3NF		C 2852
5322 122 33816	CAP.CERAMIC	63V	5%	2.2NF		C 2853
5322 126 10733	CAP.CHIP	63V	5%	680PF		C 2854
4822 122 33216	CAP.CHIP	63V	5%	270PF		C 2856
5322 122 32452	CAP.CERAMIC	63V	5%	47PF		C 2857
5322 122 34098	CAP.CHIP	63V	10%	10NF		C 2861
5322 122 34098	CAP.CHIP	63V	10%	10NF		C 2862
5322 122 32452	CAP.CERAMIC	63V	5%	47PF		C 2863
5322 122 34098	CAP.CHIP	63V	10%	10NF		C 2864
4822 122 33127	CAP.CHIP	63V	10%	2.2NF		C 2866
4822 122 33127	CAP.CHIP	63V	10%	2.2NF		C 2867
4822 122 33127	CAP.CHIP	63V	10%	2.2NF		C 2868
5322 122 34098	CAP.CHIP	63V	10%	10NF		C 2901

Ordering code	Description				Item
RESISTORS					
5322 116 82895	RES.CHIP	RMC1/8	1%	31E6	R 2101
5322 116 80429	RES.CHIP	RC-02H	1%	100K	R 2103
4822 051 10108	RES.CHIP	RC-01	5%	1E	R 2104
4822 111 91885	RES.CHIP	RMC1/8	1%	10E	R 2106
4822 111 91885	RES.CHIP	RMC1/8	1%	10E	R 2107
5322 111 91893	RES.CHIP	RMC1/8	1%	51E1	R 2108
5322 111 91963	RES.CHIP	RMC1/8	1%	34E8	R 2109
4822 116 81789	RES.CHIP	RMC1/8	1%	316E	R 2110
5322 116 82899	RES.MET.GLAZED	RMC1/8	1%	3K83	R 2111
4822 051 10106	RES.CHIP	RC-01	5%	10M	R 2112
4822 051 10106	RES.CHIP	RC-01	5%	10M	R 2113
4822 051 10106	RES.CHIP	RC-01	5%	10M	R 2114
4822 116 82408	RES.CHIP	RC-02H	1%	1K33	R 2115
4822 051 51331	RES.CHIP	RMC1/8	1%	133E	R 2116
5322 111 91899	RES.CHIP	RMC1/8	1%	261E	R 2117
4822 111 91891	RES.METAL FILM	RC-02H	1%	34K8	R 2118
4822 050 29534	RES.METAL FILM	MRS25	1%	953K	R 2119
4822 051 10106	RES.CHIP	RC-01	5%	10M	R 2120
4822 116 81165	RES.CHIP	RC-02H	1%	1M	R 2121
5322 116 80428	RES.CHIP	RC-02H	1%	10K	R 2122
4822 051 51005	RES.CHIP	RC-02H	1%	1M	R 2123
5322 111 91893	RES.CHIP	RMC1/8	1%	51E1	R 2124
4822 051 57502	RES.MET.GLAZED	RMC1/8	1%	7K5	R 2125
5322 116 80429	RES.CHIP	RC-02H	1%	100K	R 2126
4822 116 82532	RES.CHIP	RC-02H	1%	11K	R 2127
4822 116 81165	RES.CHIP	RC-02H	1%	1M	R 2128
5322 116 82112	RES.CHIP	RMC1/8	1%	681E	R 2129
5322 116 80429	RES.CHIP	RC-02H	1%	100K	R 2130
5322 116 82011	RES.METAL FILM	RC-02H	1%	147K	R 2131
4822 116 82887	RES.CHIP	RC-02H	1%	75K	R 2132
5322 116 82899	RES.MET.GLAZED	RMC1/8	1%	3K83	R 2133
5322 116 80609	RES.MET.GLAZED	RC-02H	1%	7K5	R 2134
5322 111 91893	RES.CHIP	RMC1/8	1%	51E1	R 2135
4822 116 82384	RES.CHIP	RC-02H	1%	750E	R 2136
5322 111 91809	RES.METAL FILM	RC-02H	1%	215K	R 2137
5322 116 80427	RES.CHIP	RC-02H	1%	1K	R 2138
5322 116 80428	RES.CHIP	RC-02H	1%	10K	R 2139
5322 111 91893	RES.CHIP	RMC1/8	1%	51E1	R 2140
5322 116 80428	RES.CHIP	RC-02H	1%	10K	R 2141
4822 051 51781	RES.NETWORK	RMC1/8	1%	178E	R 2142
5322 116 81795	RES.CHIP	RC-02H	1%	3K48	R 2143
4822 111 91814	RES.CHIP	RC-02H	1%	121E	R 2144
5322 116 82899	RES.MET.GLAZED	RMC1/8	1%	3K83	R 2145
5322 116 82899	RES.MET.GLAZED	RMC1/8	1%	3K83	R 2146
5322 116 82011	RES.METAL FILM	RC-02H	1%	147K	R 2147
5322 116 82904	RES.MET.GLAZED	RMC1/8	1%	464K	R 2148
5322 111 91893	RES.CHIP	RMC1/8	1%	51E1	R 2149

Ordering code	Description				Item
4822 111 91885	RES.CHIP	RMC1/8	1%	10E	R 2150
4822 116 82886	RES.CHIP	RC-02H	1%	61K9	R 2151
4822 116 82887	RES.CHIP	RC-02H	1%	75K	R 2152
4822 116 82887	RES.CHIP	RC-02H	1%	75K	R 2153
5322 116 80428	RES.CHIP	RC-02H	1%	10K	R 2154
4822 116 81165	RES.CHIP	RC-02H	1%	1M	R 2155
5322 116 82903	RES.MET.GLAZED	RMC1/8	1%	31K6	R 2157
4822 116 82885	RES.METAL FILM	RC-02H	1%	51K1	R 2158
5322 116 80429	RES.CHIP	RC-02H	1%	100K	R 2159
4822 111 91826	RES.CHIP	RC-02H	1%	511E	R 2160
5322 116 81794	RES.CHIP	RC-02H	1%	2K15	R 2161
5322 111 91809	RES.METAL FILM	RC-02H	1%	215K	R 2162
5322 116 82904	RES.MET.GLAZED	RMC1/8	1%	464K	R 2163
4822 116 82888	RES.METAL FILM	RC-02H	1%	825K	R 2164
4822 051 10108	RES.CHIP	RC-01	5%	1E	R 2165
4822 116 90788	RES.CHIP	RMC1/8	1%	68E1	R 2166
4822 116 81165	RES.CHIP	RC-02H	1%	1M	R 2167
4822 116 82532	RES.CHIP	RC-02H	1%	11K	R 2168
5322 116 82903	RES.MET.GLAZED	RMC1/8	1%	31K6	R 2169
5322 116 82899	RES.MET.GLAZED	RMC1/8	1%	3K83	R 2170
5322 116 80428	RES.CHIP	RC-02H	1%	10K	R 2171
5322 116 81794	RES.CHIP	RC-02H	1%	2K15	R 2172
5322 116 82895	RES.CHIP	RMC1/8	1%	31E6	R 2201
5322 116 80429	RES.CHIP	RC-02H	1%	100K	R 2203
4822 051 10108	RES.CHIP	RC-01	5%	1E	R 2204
4822 111 91885	RES.CHIP	RMC1/8	1%	10E	R 2206
4822 111 91885	RES.CHIP	RMC1/8	1%	10E	R 2207
5322 111 91893	RES.CHIP	RMC1/8	1%	51E1	R 2208
4822 111 91887	RES.CHIP	RMC1/8	1%	42E2	R 2209
4822 116 81789	RES.CHIP	RMC1/8	1%	316E	R 2210
5322 116 82899	RES.MET.GLAZED	RMC1/8	1%	3K83	R 2211
4822 051 10106	RES.CHIP	RC-01	5%	10M	R 2212
4822 051 10106	RES.CHIP	RC-01	5%	10M	R 2213
4822 051 10106	RES.CHIP	RC-01	5%	10M	R 2214
4822 116 82408	RES.CHIP	RC-02H	1%	1K33	R 2215
4822 051 51331	RES.CHIP	RMC1/8	1%	133E	R 2216
5322 111 91899	RES.CHIP	RMC1/8	1%	261E	R 2217
4822 111 91891	RES.METAL FILM	RC-02H	1%	34K8	R 2218
4822 050 29534	RES.METAL FILM	MRS25	1%	953K	R 2219
4822 051 10106	RES.CHIP	RC-01	5%	10M	R 2220
4822 116 81165	RES.CHIP	RC-02H	1%	1M	R 2221
5322 116 80428	RES.CHIP	RC-02H	1%	10K	R 2222
4822 051 51005	RES.CHIP	RC-02	1%	1M	R 2223
5322 111 91893	RES.CHIP	RMC1/8	1%	51E1	R 2224
5322 116 82901	RES.MET.GLAZED	RMC1/8	1%	19K6	R 2225
5322 116 80429	RES.CHIP	RC-02H	1%	100K	R 2226
4822 116 82532	RES.CHIP	RC-02H	1%	11K	R 2227
4822 116 81165	RES.CHIP	RC-02H	1%	1M	R 2228

Ordering code	Description				Item
5322 116 82112	RES.CHIP	RMC1/8	1%	681E	R 2229
5322 116 80429	RES.CHIP	RC-02H	1%	100K	R 2230
5322 116 82011	RES.METAL FILM	RC-02H	1%	147K	R 2231
4822 116 82887	RES.CHIP	RC-02H	1%	75K	R 2232
5322 116 82899	RES.MET.GLAZED	RMC1/8	1%	3K83	R 2233
5322 116 80609	RES.MET.GLAZED	RC-02H	1%	7K5	R 2234
5322 111 91893	RES.CHIP	RMC1/8	1%	51E1	R 2235
4822 116 82384	RES.CHIP	RC-02H	1%	750E	R 2236
5322 111 91809	RES.METAL FILM	RC-02H	1%	215K	R 2237
5322 116 80427	RES.CHIP	RC-02H	1%	1K	R 2238
5322 116 80428	RES.CHIP	RC-02H	1%	10K	R 2239
5322 111 91893	RES.CHIP	RMC1/8	1%	51E1	R 2240
5322 116 80428	RES.CHIP	RC-02H	1%	10K	R 2241
4822 051 51781	RES.NETWORK	RMC1/8	1%	178E	R 2242
5322 116 81795	RES.CHIP	RC-02H	1%	3K48	R 2243
4822 111 91814	RES.CHIP	RC-02H	1%	121E	R 2244
5322 116 82899	RES.MET.GLAZED	RMC1/8	1%	3K83	R 2245
5322 116 82899	RES.MET.GLAZED	RMC1/8	1%	3K83	R 2246
5322 116 82011	RES.METAL FILM	RC-02H	1%	147K	R 2247
5322 116 82904	RES.MET.GLAZED	RMC1/8	1%	464K	R 2248
5322 111 91893	RES.CHIP	RMC1/8	1%	51E1	R 2249
4822 111 91885	RES.CHIP	RMC1/8	1%	10E	R 2250
4822 116 82886	RES.CHIP	RC-02H	1%	61K9	R 2251
4822 116 82887	RES.CHIP	RC-02H	1%	75K	R 2252
4822 116 82887	RES.CHIP	RC-02H	1%	75K	R 2253
5322 116 80428	RES.CHIP	RC-02H	1%	10K	R 2254
4822 116 81165	RES.CHIP	RC-02H	1%	1M	R 2255
5322 116 82903	RES.MET.GLAZED	RMC1/8	1%	31K6	R 2257
4822 116 82885	RES.METAL FILM	RC-02H	1%	51K1	R 2258
5322 116 80429	RES.CHIP	RC-02H	1%	100K	R 2259
4822 111 91826	RES.CHIP	RC-02H	1%	511E	R 2260
5322 116 81794	RES.CHIP	RC-02H	1%	2K15	R 2261
5322 111 91809	RES.METAL FILM	RC-02H	1%	215K	R 2262
5322 116 82904	RES.MET.GLAZED	RMC1/8	1%	464K	R 2263
4822 116 82888	RES.METAL FILM	RC-02H	1%	825K	R 2264
4822 051 10108	RES.CHIP	RC-01	5%	1E	R 2265
4822 116 90788	RES.CHIP	RMC1/8	1%	68E1	R 2266
4822 116 81165	RES.CHIP	RC-02H	1%	1M	R 2267
4822 116 82532	RES.CHIP	RC-02H	1%	11K	R 2268
5322 116 82903	RES.MET.GLAZED	RMC1/8	1%	31K6	R 2269
5322 116 82899	RES.MET.GLAZED	RMC1/8	1%	3K83	R 2270
5322 116 80428	RES.CHIP	RC-02H	1%	10K	R 2271
5322 116 81794	RES.CHIP	RC-02H	1%	2K15	R 2272
4822 051 10108	RES.CHIP	RC-01	5%	1E	R 2301
4822 051 10108	RES.CHIP	RC-01	5%	1E	R 2302
4822 116 82408	RES.CHIP	RC-02H	1%	1K33	R 2303
4822 111 91892	RES.METAL FILM	RC-02H	1%	511K	R 2304
4822 051 10108	RES.CHIP	RC-01	5%	1E	R 2305

Ordering code	Description				Item
4822 051 10108	RES.CHIP	RC-01	5%	1E	R 2306
4822 051 10108	RES.CHIP	RC-01	5%	1E	R 2307
4822 116 82887	RES.CHIP	RC-02H	1%	75K	R 2308
4822 116 82887	RES.CHIP	RC-02H	1%	75K	R 2309
5322 111 91899	RES.CHIP	RMC1/8	1%	261E	R 2310
4822 051 10108	RES.CHIP	RC-01	5%	1E	R 2312
4822 051 10108	RES.CHIP	RC-01	5%	1E	R 2313
4822 051 10108	RES.CHIP	RC-01	5%	1E	R 2314
5322 111 91901	RES.CHIP	RMC1/8	1%	348E	R 2315
5322 116 80429	RES.CHIP	RC-02H	1%	100K	R 2316
4822 111 91828	RES.CHIP	RC-02H	1%	68K1	R 2317
5322 116 82897	RES.MET.GLAZED	RMC1/8	1%	383E	R 2318
4822 111 91888	RES.CHIP	RMC1/8	1%	56E2	R 2319
4822 116 82885	RES.METAL FILM	RC-02H	1%	51K1	R 2320
4822 116 82884	RES.CHIP	RC-02H	1%	316K	R 2321
5322 116 82903	RES.MET.GLAZED	RMC1/8	1%	31K6	R 2322
5322 116 82898	RES.MET.GLAZED	RMC1/8	1%	464E	R 2323
4822 116 81789	RES.CHIP	RMC1/8	1%	316E	R 2324
4822 111 91821	CAP.CHIP	RC-02H	1%	2K61	R 2325
4822 111 91888	RES.CHIP	RMC1/8	1%	56E2	R 2330
4822 111 91888	RES.CHIP	RMC1/8	1%	56E2	R 2331
4822 111 91888	RES.CHIP	RMC1/8	1%	56E2	R 2332
4822 111 91888	RES.CHIP	RMC1/8	1%	56E2	R 2333
4822 111 91888	RES.CHIP	RMC1/8	1%	56E2	R 2334
4822 111 91888	RES.CHIP	RMC1/8	1%	56E2	R 2335
4822 111 91888	RES.CHIP	RMC1/8	1%	56E2	R 2336
4822 111 91888	RES.CHIP	RMC1/8	1%	56E2	R 2337
5322 116 81794	RES.CHIP	RC-02H	1%	2K15	R 2338
5322 116 82895	RES.NETWORK	RMC1/8	1%	31E6	R 2340
5322 116 82895	RES.NETWORK	RMC1/8	1%	31E6	R 2341
5322 116 82896	RES.MET.GLAZED	RMC1/8	1%	46E4	R 2342
5322 116 82896	RES.MET.GLAZED	RMC1/8	1%	46E4	R 2343
5322 116 80429	RES.CHIP	RC-02H	1%	100K	R 2345
5322 101 60082	POTM.TRIMMER	VG4	25%	10K	R 2346
5322 101 60082	POTM.TRIMMER	VG4	25%	10K	R 2347
4822 111 91826	RES.CHIP	RC-02H	1%	511E	R 2501
4822 111 91826	RES.CHIP	RC-02H	1%	511E	R 2502
4822 051 10108	RES.CHIP	RC-01	5%	1E	R 2503
4822 116 82532	RES.CHIP	RC-02H	1%	11K	R 2504
4822 111 91885	RES.CHIP	RMC1/8	1%	10E	R 2506
5322 111 91963	RES.CHIP	RMC1/8	1%	34E8	R 2507
5322 111 91893	RES.CHIP	RMC1/8	1%	5E1	R 2508
4822 051 10108	RES.CHIP	RC-01	5%	1E	R 2509
4822 051 10108	RES.CHIP	RC-01	5%	1E	R 2511
4822 051 10108	RES.CHIP	RC-01	5%	1E	R 2512
4822 051 10108	RES.CHIP	RC-01	5%	1E	R 2513
4822 051 10108	RES.CHIP	RC-01	5%	1E	R 2514

Ordering code	Description				Item
4822 051 10108	RES.CHIP	RC-01	5%	1E	R 2516
4822 051 10108	RES.CHIP	RC-01	5%	1E	R 2517
4822 051 10108	RES.CHIP	RC-01	5%	1E	R 2518
4822 051 10106	RES.CHIP	RC-01	5%	10M	R 2519
4822 051 10106	RES.CHIP	RC-01	5%	10M	R 2521
4822 116 82532	RES.CHIP	RC-02H	1%	11K	R 2522
5322 116 81795	RES.CHIP	RC-02H	1%	3K48	R 2523
4822 111 91814	RES.CHIP	RC-02H	1%	121E	R 2524
4822 111 91891	RES.METAL FILM	RC-02H	1%	34K8	R 2526
5322 116 81794	RES.CHIP	RC-02H	1%	2K15	R 2527
4822 116 82532	RES.CHIP	RC-02H	1%	11K	R 2528
4822 111 91814	RES.CHIP	RC-02H	1%	121E	R 2529
5322 116 81228	RES.CHIP	RC-02H	1%	5K11	R 2530
4822 111 91885	RES.CHIP	RMC1/8	1%	10E	R 2531
4822 111 91885	RES.CHIP	RMC1/8	1%	10E	R 2532
5322 116 82901	RES.MET.GLAZED	RMC1/8	1%	19K6	R 2534
4822 116 82885	RES.METAL FILM	RC-02H	1%	51K1	R 2535
5322 116 80427	RES.CHIP	RC-02H	1%	1K	R 2536
4822 111 91891	RES.METAL FILM	RC-02H	1%	34K8	R 2537
5322 116 82367	RES.METAL FILM	RC-02H	1%	3K16	R 2538
5322 116 82367	RES.METAL FILM	RC-02H	1%	3K16	R 2540
4822 116 82532	RES.CHIP	RC-02H	1%	11K	R 2541
4822 111 91885	RES.CHIP	RMC1/8	1%	10E	R 2542
5322 116 81228	RES.CHIP	RC-02H	1%	5K11	R 2543
4822 111 91891	RES.METAL FILM	RC-02H	1%	34K8	R 2544
4822 111 91814	RES.CHIP	RC-02H	1%	121E	R 2546
4822 111 91816	RES.CHIP	RC-02H	1%	14K7	R 2548
4822 116 82532	RES.CHIP	RC-02H	1%	11K	R 2551
4822 116 82408	RES.CHIP	RC-02H	1%	1K33	R 2554
5322 111 91811	RES.CHIP	RC-02H	1%	5K62	R 2556
5322 116 81794	RES.CHIP	RC-02H	1%	2K15	R 2557
5322 116 81794	RES.CHIP	RC-02H	1%	2K15	R 2558
5322 116 81794	RES.CHIP	RC-02H	1%	2K15	R 2559
5322 111 91809	RES.METAL FILM	RC-02H	1%	215K	R 2561
4822 116 82532	RES.CHIP	RC-02H	1%	11K	R 2562
4822 111 91885	RES.CHIP	RMC1/8	1%	10E	R 2563
5322 111 91811	RES.CHIP	RC-02H	1%	5K62	R 2564
5322 111 91893	RES.CHIP	RMC1/8	1%	51E1	R 2565
4822 111 91891	RES.METAL FILM	RC-02H	1%	34K8	R 2566
4822 111 91891	RES.METAL FILM	RC-02H	1%	34K8	R 2567
5322 111 91809	RES.METAL FILM	RC-02H	1%	215K	R 2568
5322 111 91809	RES.METAL FILM	RC-02H	1%	215K	R 2569
4822 051 10108	RES.CHIP	RC-01	5%	1E	R 2571
5322 116 80429	RES.CHIP	RC-02H	1%	100K	R 2572
5322 111 91809	RES.METAL FILM	RC-02H	1%	215K	R 2573
4822 116 82885	RES.METAL FILM	RC-02H	1%	51K1	R 2575
5322 116 80429	RES.CHIP	RC-02H	1%	100K	R 2581
5322 113 41318	RES.	SMW02	5%	0E1	R 2582

Ordering code	Description				Item
4822 051 10108	RES.CHIP	RC-01	5%	1E	R 2583
4822 111 91885	RES.CHIP	RMC1/8	1%	10E	R 2584
5322 116 82901	RES.MET.GLAZED	RMC1/8	1%	19K6	R 2596
5322 116 82901	RES.MET.GLAZED	RMC1/8	1%	19K6	R 2597
5322 116 80429	RES.CHIP	RC-02H	1%	100K	R 2598
5322 116 82901	RES.MET.GLAZED	RMC1/8	1%	19K6	R 2599
4822 116 82886	RES.CHIP	RC-02H	1%	61K9	R 2729
5322 116 40214	RES.N.T.C.	SPEC			R 2750
5322 116 82905	RES.METAL FILM	R25 487K	1%		R 2753
4822 111 91892	RES.METAL FILM	RC-02H	1%	511K	R 2754
5322 116 80427	RES.CHIP	RC-02H	1%	1K	R 2755
4822 111 91891	RES.METAL FILM	RC-02H	1%	34K8	R 2757
5322 116 80428	RES.CHIP	RC-02H	1%	10K	R 2758
5322 111 91899	RES.CHIP	RMC1/8	1%	261E	R 2759
4822 116 90788	RES.NETWORK	RMC1/8	1%	68E1	R 2760
5322 111 91809	RES.METAL FILM	RC-02H	1%	215K	R 2761
4822 116 81165	RES.CHIP	RC-02H	1%	1M	R 2762
4822 051 10106	RES.CHIP	RC-01	5%	10M	R 2763
4822 111 91828	RES.CHIP	RC-02H	1%	68K1	R 2764
5322 116 82901	RES.MET.GLAZED	RMC1/8	1%	19K6	R 2766
5322 116 81228	RES.CHIP	RC-02H	1%	5K11	R 2767
4822 116 82883	RES.CHIP	RC-02H	1%	237K	R 2768
5322 116 82011	RES.METAL FILM	RC-02H	1%	147K	R 2769
4822 111 91891	RES.METAL FILM	RC-02H	1%	34K8	R 2770
5322 116 80429	RES.CHIP	RC-02H	1%	100K	R 2771
5322 116 80429	RES.CHIP	RC-02H	1%	100K	R 2772
4822 051 51002	RES.CHIP	RC-02H	1%	1K	R 2773
4822 111 91814	RES.CHIP	RC-02H	1%	121E	R 2774
5322 116 81795	RES.CHIP	RC-02H	1%	3K48	R 2775
4822 111 91891	RES.METAL FILM	RC-02H	1%	34K8	R 2776
5322 111 91893	RES.CHIP	RMC1/8	1%	51E1	R 2777
5322 116 82905	RES.METAL FILM	R25	1%	487K	R 2778
4822 051 53483	RES.MET.GLAZED	RMC1/8	1%	34K8	R 2853
5322 116 82903	RES.MET.GLAZED	RMC1/8	1%	31K6	R 2854
4822 111 91828	RES.CHIP	RC-02H	1%	68K1	R 2856
4822 111 91828	RES.CHIP	RC-02H	1%	68K1	R 2857
4822 051 10108	RES.CHIP	RC-01	5%	1E	R 2858
4822 116 82887	RES.CHIP	RC-02H	1%	75K	R 2859
4822 051 10106	RES.CHIP	RC-01	5%	10M	R 2860
4822 116 82883	RES.CHIP	RC-02H	1%	237K	R 2861
5322 111 91812	RES.METAL FILM	RC-02H	1%	562K	R 2862
5322 116 81795	RES.CHIP	RC-02H	1%	3K48	R 2863
4822 111 91891	RES.METAL FILM	RC-02H	1%	34K8	R 2864
4822 111 91891	RES.METAL FILM	RC-02H	1%	34K8	R 2865
4822 111 91814	RES.CHIP	RC-02H	1%	121E	R 2866
4822 111 91891	RES.METAL FILM	RC-02H	1%	34K8	R 2867
4822 111 91891	RES.METAL FILM	RC-02H	1%	34K8	R 2868

Ordering code	Description				Item
4822 051 53483	RES.METAL FILM	RC-02H	1%	34K8	R 2869
5322 116 82111	RES.CHIP	RC-02H	1%	261K	R 2870
5322 116 82904	RES.MET.GLAZED	RMC1/8	1%	464K	R 2871
5322 116 82904	RES.MET.GLAZED	RMC1/8	1%	464K	R 2872
5322 116 82111	RES.CHIP	RC-02H	1%	261K	R 2873
5322 111 91809	RES.METAL FILM	RC-02H	1%	215K	R 2875
4822 116 82884	RES.CHIP	RC-02H	1%	316K	R 2876
5322 111 91809	RES.METAL FILM	RC-02H	1%	215K	R 2877
4822 116 82885	RES.METAL FILM	RC-02H	1%	51K1	R 2878
5322 116 82901	RES.MET.GLAZED	RMC1/8	1%	19K6	R 2879
5322 111 91899	RES.CHIP	RMC1/8	1%	261E	R 2881
5322 116 82901	RES.MET.GLAZED	RMC1/8	1%	19K6	R 2901
5322 116 82011	RES.METAL FILM	RC-02H	1%	147K	R 2903
5322 116 82903	RES.MET.GLAZED	RMC1/8	1%	31K6	R 2904
5322 116 82903	RES.MET.GLAZED	RMC1/8	1%	31K6	R 2906
4822 111 91891	RES.METAL FILM	RC-02H	1%	34K8	R 2907
5322 116 82903	RES.MET.GLAZED	RMC1/8	1%	31K6	R 2908
5322 116 82903	RES.MET.GLAZED	RMC1/8	1%	31K6	R 2909

SEMI-CONDUCTORS

5322 130 42145	TRANSISTOR,CHIP	BFR92		V 2104
5322 130 44787	TRANSISTOR,CHIP	BFR31		V 2105
5322 130 42145	TRANSISTOR,CHIP	BFR92		V 2106
5322 130 61707	TRANSISTOR	BF991		V 2107
5322 130 42718	TRANSISTOR,CHIP	BFS20		V 2108
5322 130 42145	TRANSISTOR,CHIP	BFR92		V 2109
5322 130 42136	TRANSISTOR,CHIP	BC848C		V 2110
5322 130 42145	TRANSISTOR,CHIP	BFR92		V 2111
4822 130 42513	TRANSISTOR,CHIP	BC858C		V 2112
4822 130 42513	TRANSISTOR,CHIP	BC858C		V 2113
5322 130 42145	TRANSISTOR,CHIP	BFR92		V 2114
5322 130 42145	TRANSISTOR,CHIP	BFR92		V 2204
5322 130 44787	TRANSISTOR,CHIP	BFR31		V 2205
5322 130 42145	TRANSISTOR,CHIP	BFR92		V 2206
5322 130 61707	TRANSISTOR	BF991		V 2207
5322 130 42718	TRANSISTOR,CHIP	BFS20		V 2208
5322 130 42145	TRANSISTOR,CHIP	BFR92		V 2209
5322 130 42136	TRANSISTOR,CHIP	BC848C		V 2210
5322 130 42145	TRANSISTOR,CHIP	BFR92		V 2211
4822 130 42513	TRANSISTOR,CHIP	BC858C		V 2212
4822 130 42513	TRANSISTOR,CHIP	BC858C		V 2213
5322 130 42145	TRANSISTOR,CHIP	BFR92		V 2214
5322 130 42136	TRANSISTOR,CHIP	BC848C		V 2301
5322 130 44711	TRANSISTOR,CHIP	BFT92		V 2302
5322 130 34337	DIODE,CHIP	BAV99		V 2303
5322 130 34337	DIODE,CHIP	BAV99		V 2501
5322 130 62661	TRANSISTOR,CHIP	BRY62		V 2502
5322 130 62659	TRANSISTOR,CHIP	BUZ11A		V 2503

Ordering code	Description		Item
5322 130 34337	DIODE,CHIP	BAV99	V 2504
5322 130 62922	DIODE	MBRD630CTT4	V 2506
5322 130 62922	DIODE	MBRD630CTT4	V 2507
5322 130 34337	DIODE,CHIP	BAV99	V 2508
5322 130 42136	TRANSISTOR,CHIP	BC848C	V 2509
4822 130 42513	TRANSISTOR,CHIP	BC858C	V 2511
5322 130 34337	DIODE,CHIP	BAV99	V 2512
4822 130 42513	TRANSISTOR,CHIP	BC858C	V 2513
5322 130 34337	DIODE,CHIP	BAV99	V 2514
4822 130 42513	TRANSISTOR,CHIP	BC858C	V 2516
5322 130 42136	TRANSISTOR,CHIP	BC848C	V 2517
4822 130 42513	TRANSISTOR,CHIP	BC858C	V 2518
5322 130 42136	TRANSISTOR,CHIP	BC848C	V 2521
5322 130 34337	DIODE,CHIP	BAV99	V 2523
4822 130 42133	TRANSISTOR,CHIP	BC817	V 2526
5322 130 34337	DIODE,CHIP	BAV99	V 2527
5322 130 42136	TRANSISTOR,CHIP	BC848C	V 2528
5322 130 34337	DIODE,CHIP	BAV99	V 2529
5322 130 62922	DIODE	MBRD630CTT4	V 2533
5322 130 42136	TRANSISTOR,CHIP	BC848C	V 2534
5322 130 42136	TRANSISTOR,CHIP	BC848C	V 2536
5322 130 62921	TRANSISTOR	2SK974STR	V 2537
5322 130 62921	TRANSISTOR	2SK974STR	V 2538
5322 130 62922	DIODE	MBRD630CTT4	V 2539
5322 130 42136	TRANSISTOR,CHIP	BC848C	V 2541
4822 130 82262	DIODE,CHIP	BAT54S	V 2543
4822 130 42513	TRANSISTOR,CHIP	BC858C	V 2544
4822 130 42513	TRANSISTOR,CHIP	BC858C	V 2736
4822 130 82522	DIODE,CHIP	BZD27-C7V5	V 2751
4822 130 82522	DIODE,CHIP	BZD27-C7V5	V 2752
4822 130 82522	DIODE,CHIP	BZD27-C7V5	V 2753
4822 130 82522	DIODE,CHIP	BZD27-C7V5	V 2755
5322 130 44787	TRANSISTOR,CHIP	BFR31	V 2754
5322 130 44787	TRANSISTOR,CHIP	BFR31	V 2756
5322 130 34337	DIODE,CHIP	BAV99	V 2757
5322 130 60502	TRANSISTOR,CHIP	BSS83	V 2758
5322 130 34337	DIODE,CHIP	BAV99	V 2759
5322 130 42136	TRANSISTOR,CHIP	BC848C	V 2760
5322 130 42136	TRANSISTOR,CHIP	BC848C	V 2761
5322 130 34337	DIODE,CHIP	BAV99	V 2762
5322 130 34337	DIODE,CHIP	BAV99	V 2763
4822 130 82522	DIODE,CHIP	BZD27-C7V5	V 2764
5322 130 42136	TRANSISTOR,CHIP	BC848C	V 2765
5322 130 42136	TRANSISTOR,CHIP	BC848C	V 2766
5322 130 42136	TRANSISTOR,CHIP	BC848C	V 2767
5322 130 42136	TRANSISTOR,CHIP	BC848C	V 2768
4822 130 82522	DIODE,CHIP	BZD27-C7V5	V 2811

Ordering code	Description		Item
4822 130 82522	DIODE,CHIP	BZD27-C7V5	V 2769
4822 130 82522	DIODE,CHIP	BZD27-C7V5	V 2812
5322 130 60502	TRANSISTOR,CHIP	BSS83	V 2851
4822 130 42513	TRANSISTOR,CHIP	BC858C	V 2852
4822 130 42513	TRANSISTOR,CHIP	BC858C	V 2853
4822 130 42513	TRANSISTOR,CHIP	BC858C	V 2854
4822 130 42513	TRANSISTOR,CHIP	BC858C	V 2901

INTEGRATED CIRCUITS

4822 209 63764	I.C. INTERFACE	PC74HC4316T	D 2101
4822 209 63764	I.C. INTERFACE	PC74HC4316T	D 2102
4822 209 63764	I.C. INTERFACE	PC74HC4316T	D 2201
4822 209 63764	I.C. INTERFACE	PC74HC4316T	D 2202
5322 209 30821	ANALOG ASIC	OQ00308	D 2301
4822 209 63764	I.C. INTERFACE	PC74HC4316T	D 2750
4822 209 63764	I.C. INTERFACE	PC74HC4316T	D 2751
4822 209 63764	I.C. INTERFACE	PC74HC4316T	D 2850
4822 209 63763	I.C. INTERFACE	PC74HC541T	D 2901
4822 209 63763	I.C. INTERFACE	PC74HC541T	D 2902
4822 209 63763	I.C. INTERFACE	PC74HC541T	D 2903
5322 209 12171	INTEGR.CIRCUIT	PC74HC4094T	D 2904
5322 209 12171	INTEGR.CIRCUIT	PC74HC4094T	D 2906
5322 209 12171	INTEGR.CIRCUIT	PC74HC4094T	D 2907
5322 209 12171	INTEGR.CIRCUIT	PC74HC4094T	D 2908
5322 209 12171	INTEGR.CIRCUIT	PC74HC4094T	D 2909
4822 209 63757	INTEGR.CIRCUIT	LF453CM	N 2101
4822 209 63757	INTEGR.CIRCUIT	LF453CM	N 2201
5322 209 30676	INTEGR.CIRCUIT	TDA8703T/C4	N 2302
4822 209 60175	INTEGR.CIRCUIT	LM358M	N 2501
4822 209 63765	INTEGR.CIRCUIT	LM285M-1.2	N 2502
5322 209 71807	INTEGR.CIRCUIT	SG3524D	N 2503
5322 209 31309	INTEGR.CIRCUIT	TLC27M2ACDR	N 2750
5322 209 31309	INTEGR.CIRCUIT	TLC27M2ACDR	N 2751
4822 209 63757	INTEGR.CIRCUIT	LF453CM	N 2850

COILS

5322 157 63649	COIL	39NH 20%	L 2301
5322 157 63648	COIL	1UH 5%	L 2302
5322 157 63647	COIL	0.1UH 5%	L 2303
5322 157 63647	COIL	0.1UH 5%	L 2304
5322 157 63648	COIL	1UH 5%	L 2501
5322 157 63092	COIL	68UH	L 2502
5322 157 63092	COIL	68UH	L 2503
5322 157 52707	COIL	22UH	L 2504
5322 157 52707	COIL	22UH	L 2506
5322 156 11139	COIL	FILTER 50V-10A	Z 2501

Ordering code	Description		Item
MISCELLANEOUS			
5322 280 10245	BUZZER	MEB-12B-12	H 2901
5322 280 80745	RELAY	RAL3W-K	K 2101
5322 280 80745	RELAY	RAL3W-K	K 2102
5322 280 80745	RELAY	RAL3W-K	K 2103
5322 280 80745	RELAY	RAL3W-K	K 2201
5322 280 80745	RELAY	RAL3W-K	K 2202
5322 280 80745	RELAY	RAL3W-K	K 2203
5322 280 80745	RELAY	RAL3W-K	K 2750
5322 280 80745	RELAY	RAL3W-K	K 2751
CONNECTORS			
5322 267 70302	CONNECTOR	30-PIN STRAIGHT	X 2001
4822 267 30431	SOCKET	HEC0739-01-010	X 2501
5322 265 30434	CONNECTOR	3-PIN STRAIGHT	X 2502

Table 9.7 Accessories replacements Fluke

ORDER NUMBER /MODEL NUMBER	DESCRIPTION	ITEM
PM9086/001	NiCad Battery Pack	-
PM8907/003	Line Voltage Adapter/Battery Charger (North America)	15
PM8918/002	Safety-Designed ScopeMeter Probe Set	16, 17, 18, 19, 3, 4, 7, 8,
PM9081/001	Safety-Designed Dual Banana Plug to Female BNC Adapter	1
PM9083/001	ScopeMeter Yellow Protective Holster	-
C75	Accessory Case	-
Fluke 916015	Multimeter Test Lead Set	9, 10, 11, 12, 13, 14,
Fluke 916010	ProbeTip to Banana Plug Adapter/Adjust adapter	2
Fluke 916127	Quick Operating Guide	-
Fluke 916119	ScopeMeter English Users Manual	-
Fluke 916122	ScopeMeter French, Spanish, Italian Users Manual	-
Fluke 915970	Service Manual	-

Figure 9.6 Accessories replacements Fluke

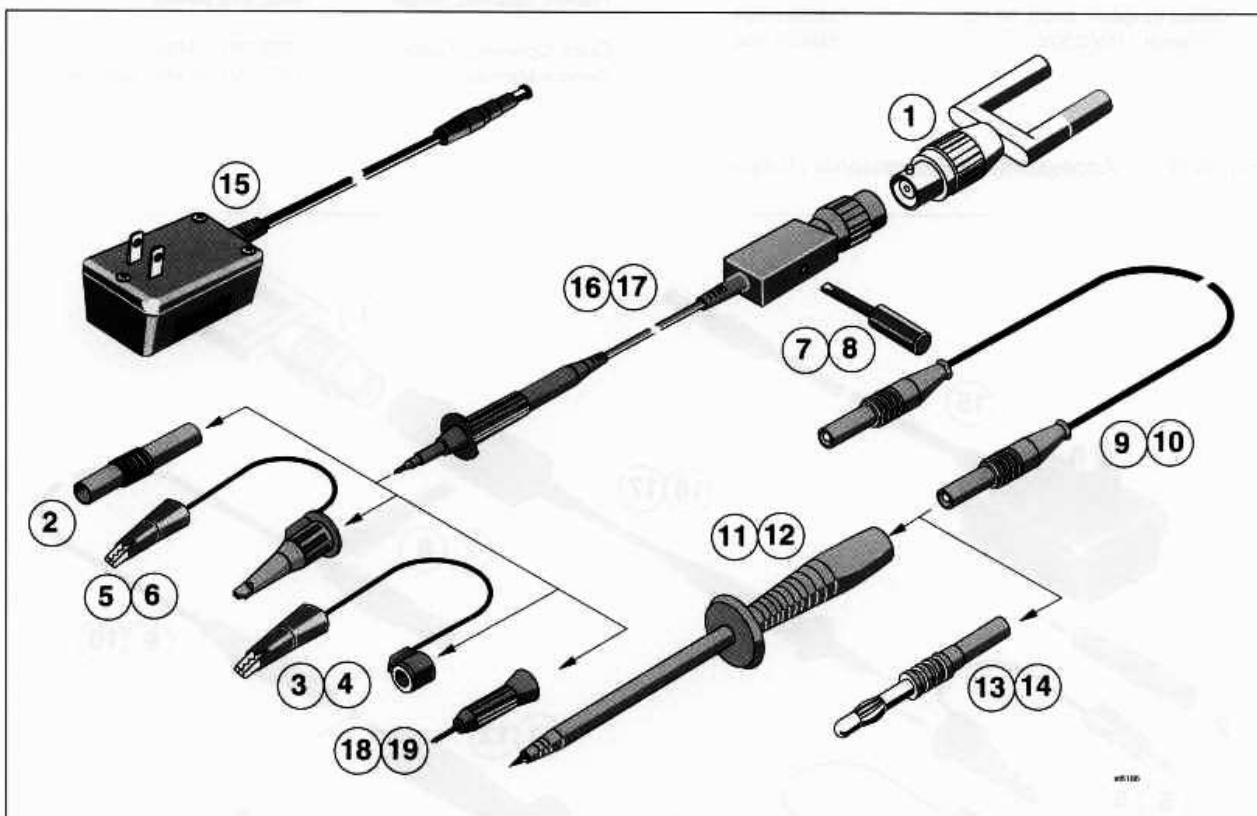
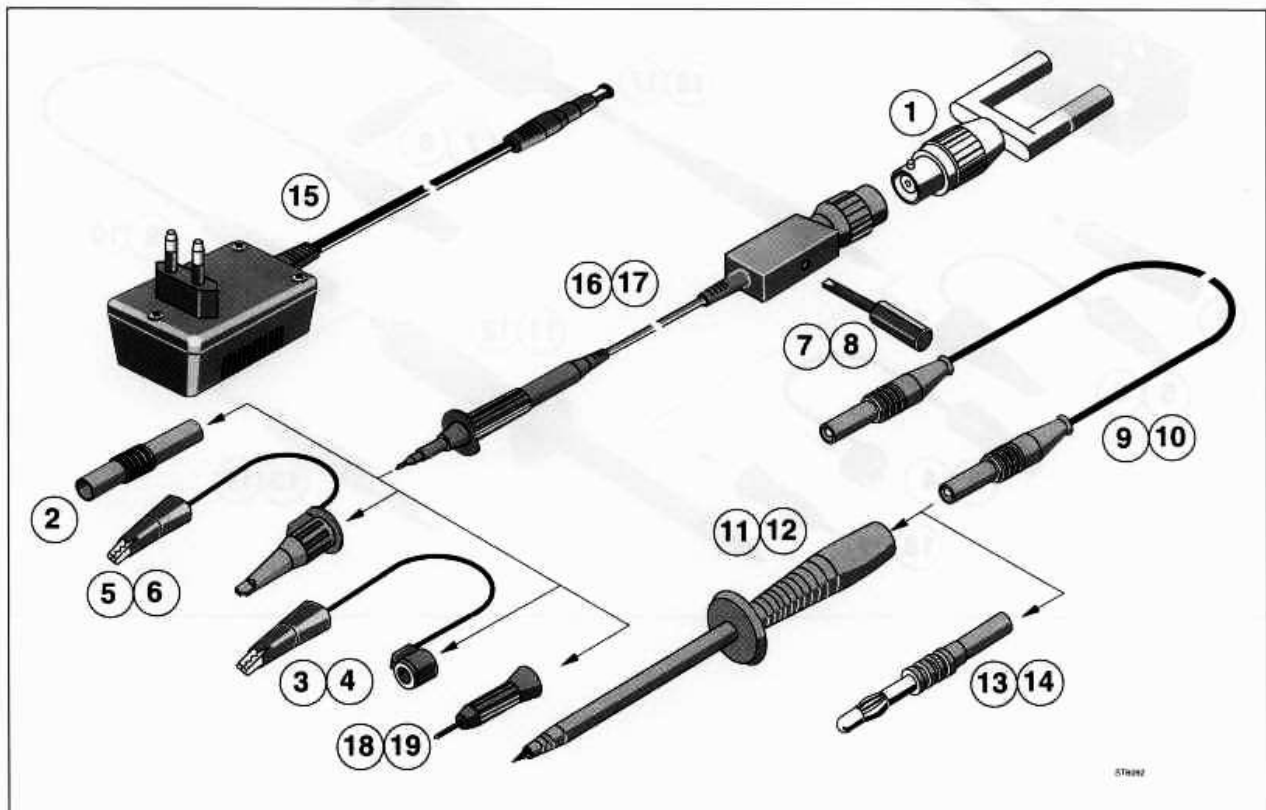


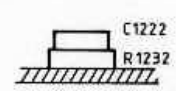
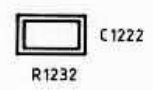
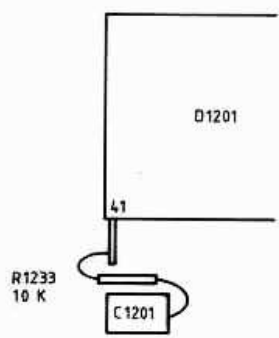
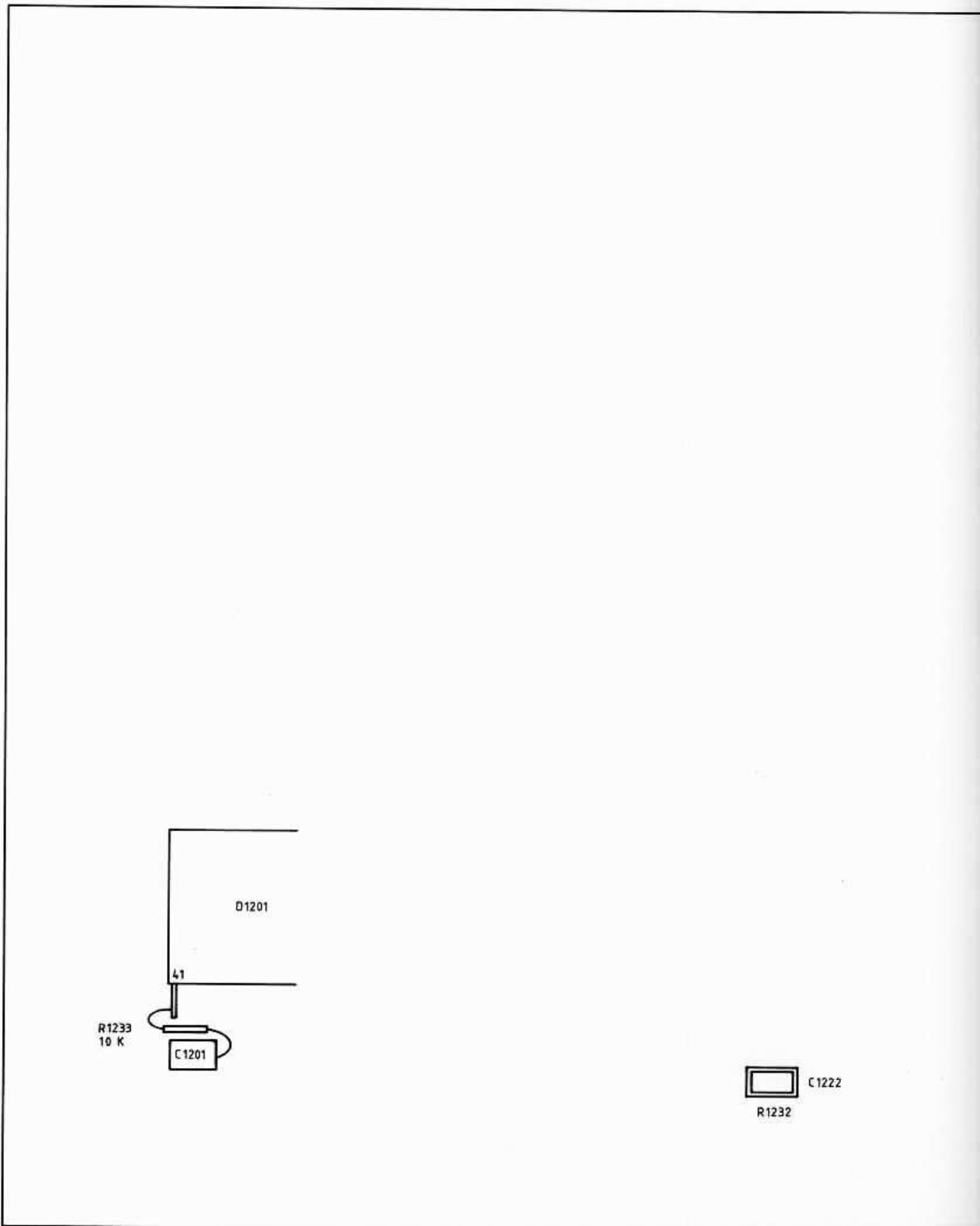
Table 9.8 Accessories replacements Philips

ITEM DESCRIPTION	ORDER NUMBER /MODEL NUMBER	ITEM DESCRIPTION	ORDER NUMBER /MODEL NUMBER	
1 Adapter Banana/BNC	PM9081/001	16 Scope probe RED	} PM8918/002	
2 Adjust adapter RED	5322 263 50192	17 Scope probe GREY		
3 HF adapter BLACK	5322 263 50193	18 High voltage testpin RED		5322 264 20087
4 HF adapter BLACK	5322 263 50193	19 High voltage test pin GREY		5322 264 20088
5 Mini test hook RED	5322 210 70131	3 HF adapter BLACK		5322 263 50193
6 Mini test hook GREY	5322 210 70129	4 HF adapter BLACK		5322 263 50193
7 Trim screwdriver RED	5322 395 50417	7 Trim screwdriver RED		5322 395 50417
8 Trim screwdriver GREY	5322 395 50416	8 Trim screwdriver GREY		5322 395 50416
9 Test lead RED	} PM8266/041	- NiCad Battery Pack		PM9086/001
10 Test lead BLACK		5322 397 60157		- Holster
11 Test pin RED		5322 397 60156	- Accessory case	C 75
12 Test pin BLACK		5322 264 20046		
13 Banana adapter RED	5322 264 20045	Users Manuals		
14 Banana adapter BLACK	5322 264 20051	English	4822 872 00492	
15 Power adapters/Battery chargers	5322 264 20052	Dutch, German, French	4822 872 00494	
Universal Europe 220V, 50 Hz	PM8907/001	Swedish, Danish,		
North America UL, CSA, 110V, 60 Hz	PM8907/003	Finnish, Norwegian	4822 872 00495	
United Kingdom 240V, 50 Hz	PM8907/004	French, Spanish, Italian	4822 872 00493	
Universal 115V/230V	PM8907/008	Quick Operating Guide	4822 872 00491	
		Service Manual	4822 872 05346 (optional)	

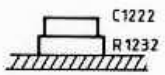
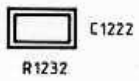
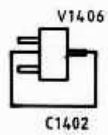
Figure 9.6 Accessories replacements Philips



10 CIRCUIT DIAGRAMS



C1222 MOUNTED OVER R1232



C1222 MOUNTED OVER R1232

CIRCUIT DIAGRAMS 01

ST6849
920203

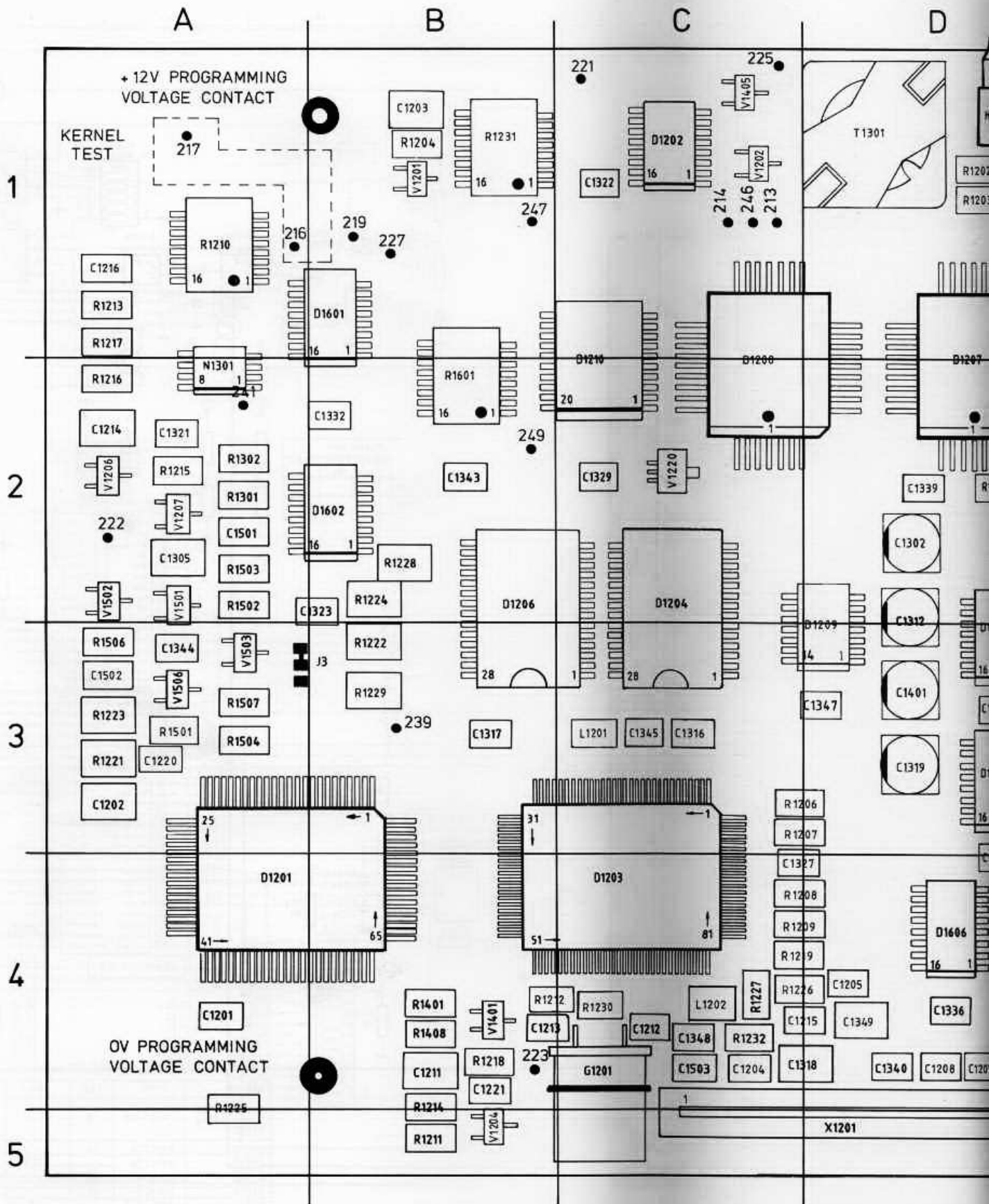
Figure 10.1a Modifications Digital A1 PCB

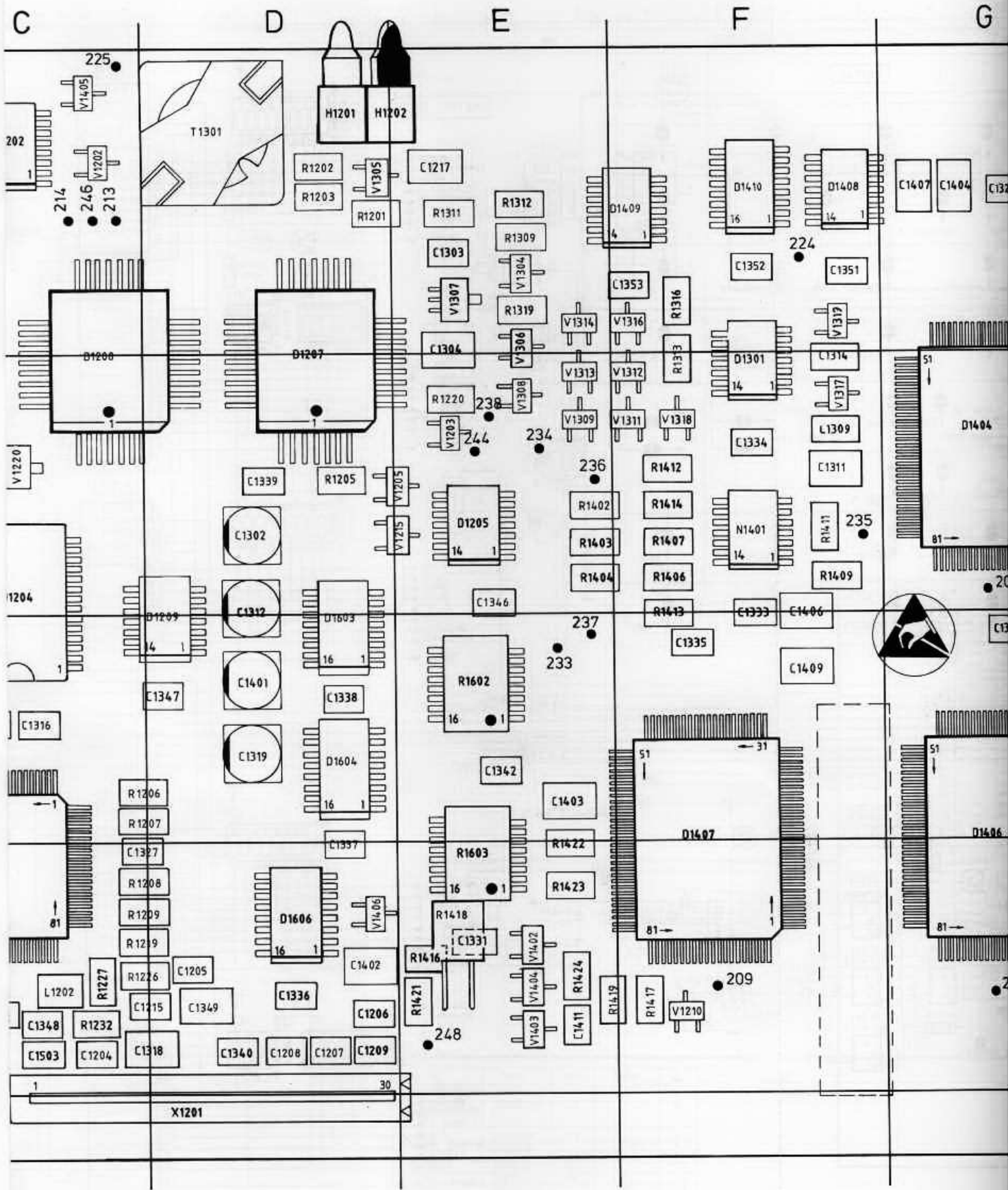
CIRCUIT DIAGRAMS

This chapter contains all circuit diagrams and PCB layouts of both the ScopeMeter analog and digital PCBs.

PARTS LOCATION A1 (PCB)

C1201	A4	C1340	D4	D1603	D2	R1313	F2	V1311	F2
C1202	A3	C1341	H2	D1604	D3	R1316	F1	V1312	F2
C1203	B1	C1342	E3	D1606	D4	R1319	E1	V1313	E2
C1204	C4	C1343	B2	G1201	C4	R1401	B4	V1316	F1
C1205	D4	C1344	A3	H1201	D1	R1402	E2	V1317	F2
C1206	D4	C1345	C3	H1202	D1	R1403	E2	V1318	F2
C1207	D4	C1346	E2	J3	A3	R1404	E2	V1319	F1
C1208	D4	C1347	D3	L1201	C3	R1406	F2	V1401	B4
C1209	D4	C1348	C4	L1202	C4	R1407	F2	V1402	E4
C1211	B4	C1349	D4	N1301	A2	R1408	B4	V1403	E4
C1212	C4	C1351	F1	N1401	F2	R1409	F2	V1404	E4
C1213	B4	C1352	F1	R1201	D1	R1411	F2	V1405	C1
C1214	A2	C1353	F1	R1202	D1	R1412	F2	V1407	C1
C1215	C4	C1401	D3	R1203	D1	R1413	F2	V1501	A2
C1216	A1	C1402	D4	R1204	B1	R1414	F2	V1502	A2
C1217	E1	C1403	E3	R1205	D2	R1415	E4	V1503	A3
C1220	A3	C1404	G1	R1206	C3	R1416	E4	V1506	A3
C1221	B4	C1405	G3	R1207	C3	R1417	F4	TP207	G2
C1302	D2	C1406	D4	R1208	C4	R1419	E4	TP208	G4
C1303	E1	C1406	F2	R1209	C4	R1421	E4	TP209	F4
C1304	E1	C1407	G1	R1210	A1	R1422	E3	TP210	I4
C1305	A2	C1408	H3	R1211	B5	R1423	E4	TP211	I2
C1309	F2	C1409	F3	R1212	B4	R1424	E4	TP212	I1
C1311	F2	C1411	E4	R1213	A1	R1501	A3	TP213	C1
C1312	D2	C1501	A2	R1214	B4	R1502	A2	TP214	C1
C1314	F1	C1502	A3	R1215	A2	R1503	A2	TP214	A2
C1316	C3	D1201	A3	R1216	A2	R1504	A3	TP216	A1
C1317	B3	D1202	C1	R1217	A1	R1506	A3	TP217	A1
C1318	C4	D1203	C4	R1218	B4	R1507	A3	TP219	B1
C1319	D3	D1204	C2	R1219	C4	R1601	B2	TP221	C1
C1321	A2	D1205	E2	R1220	E2	R1602	E3	TP222	A2
C1322	C1	D1206	B2	R1221	A3	R1603	E4	TP223	B4
C1323	B2	D1207	D1	R1222	B3	T1301	D1	TP224	F1
C1324	H1	D1208	C1	R1223	A3	V1201	B1	TP225	C1
C1326	H4	D1209	D2	R1224	B2	V1203	E2	TP227	B1
C1327	C4	D1210	C1	R1225	A4	V1204	B5	TP233	E3
C1328	G1	D1301	F2	R1226	C4	V1205	E2	TP234	E2
C1329	C2	D1401	H4	R1227	C4	V1206	A2	TP235	F2
C1330	G3	D1402	H2	R1228	B2	V1207	A2	TP237	E3
C1331	E4	D1403	H1	R1229	B3	V1210	F4	TP239	B3
C1332	B2	D1404	G2	R1230	C4	V1215	E2	TP244	E2
C1333	F2	D1406	G3	R1231	B1	V1220	C2	TP244	F1
C1334	F2	D1407	F3	R1232	C4	V1304	E1	TP246	C1
C1335	F3	D1408	F1	R1301	A2	V1305	D1	TP247	B1
C1336	D4	D1409	F1	R1302	A2	V1306	E1	TP248	E4
C1337	D3	D1410	F1	R1309	E1	V1307	E1	TP249	B2
C1338	D3	D1601	B2	R1311	E1	V1308	E2		
C1339	D2	D1601	B1	R1312	E1	V1309	E2		





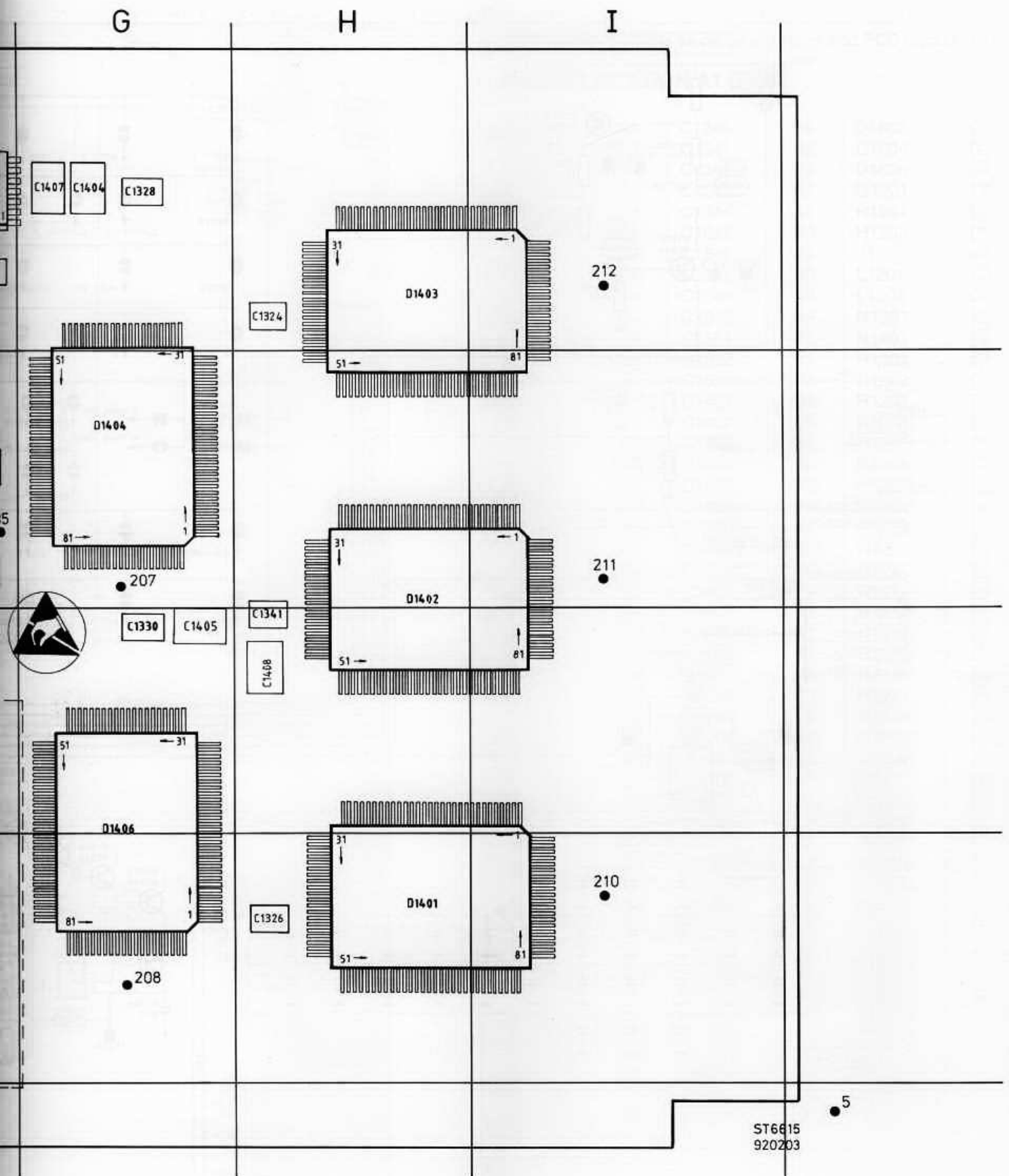
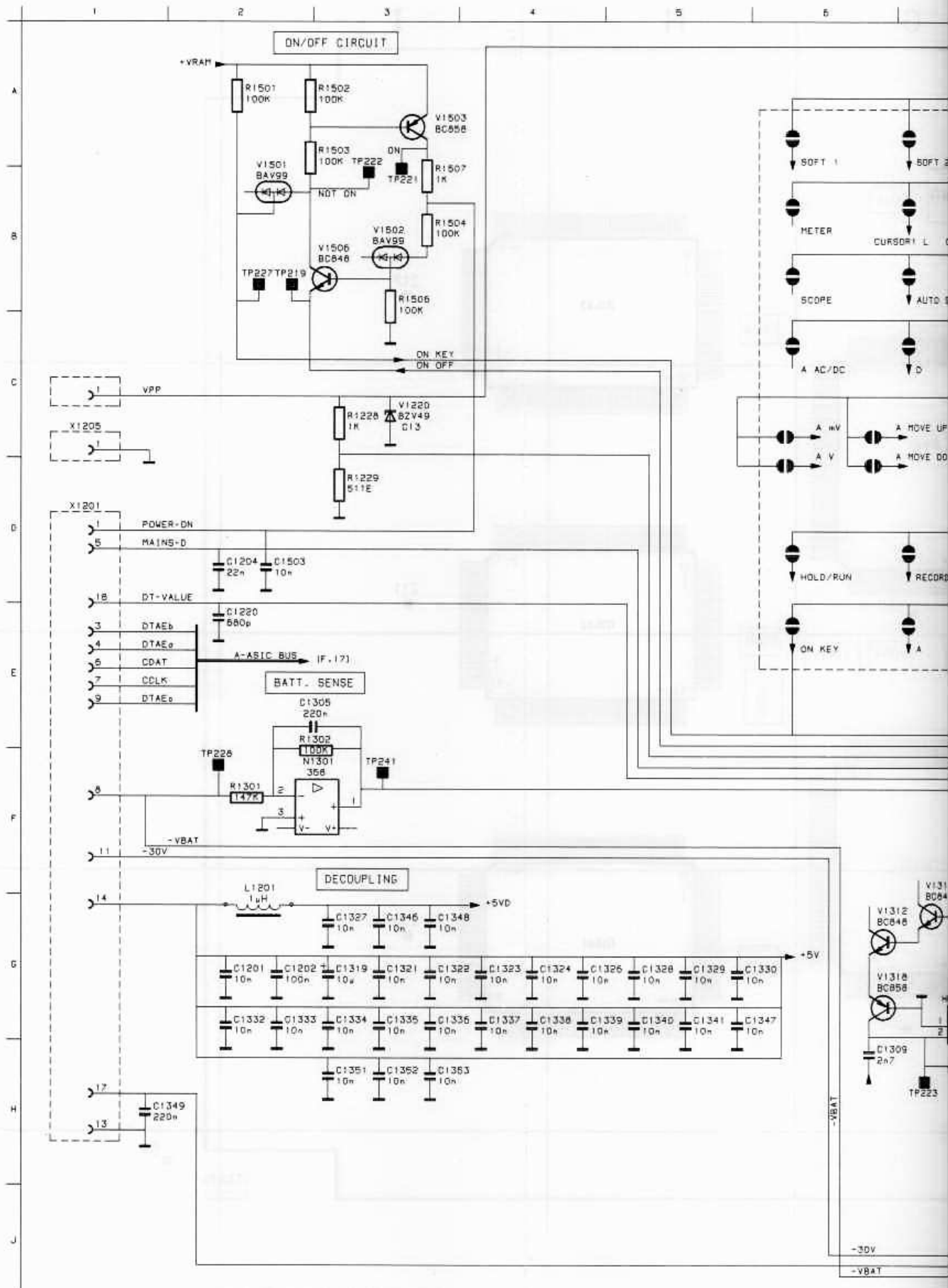
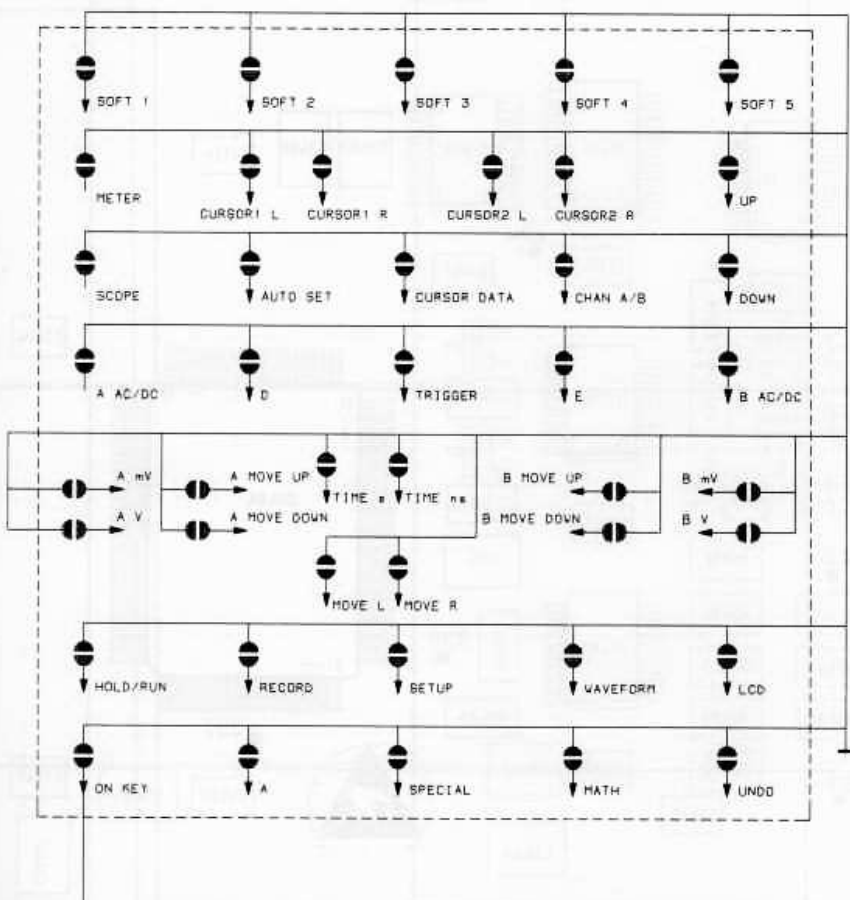


Figure 10.1b Digital A1 PCB

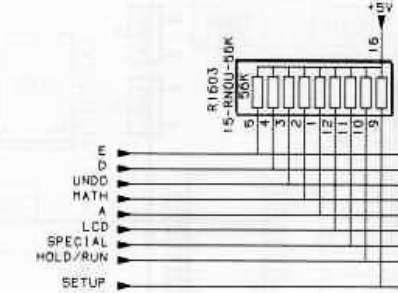
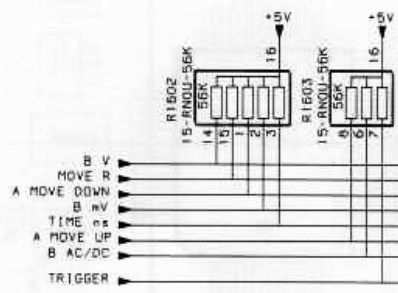
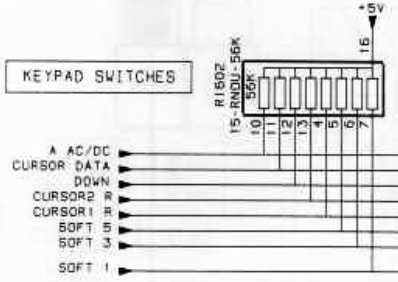


VPF

KEYPAD

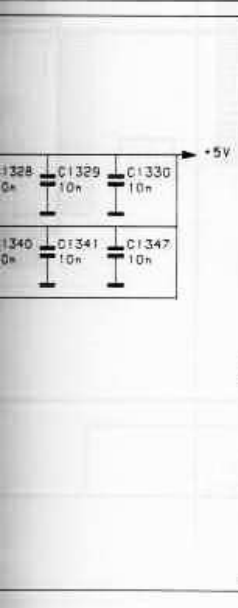
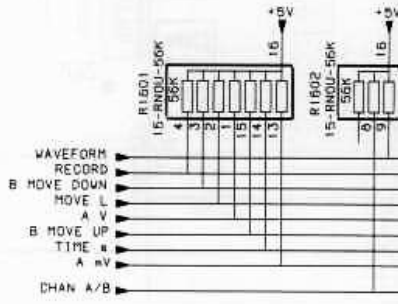
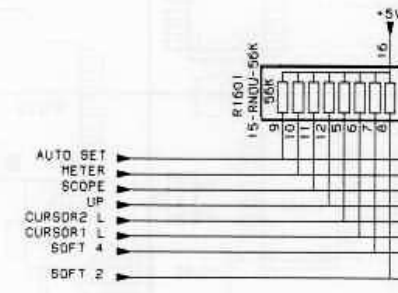
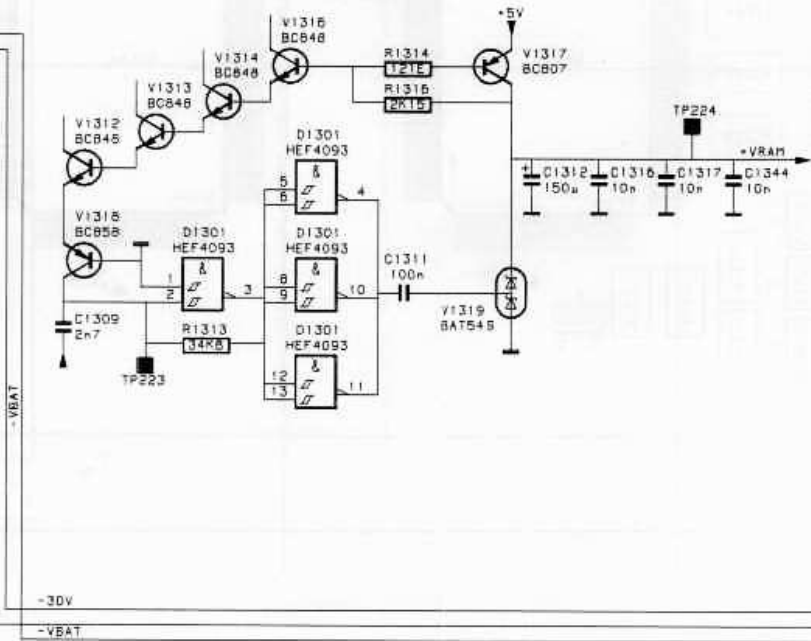


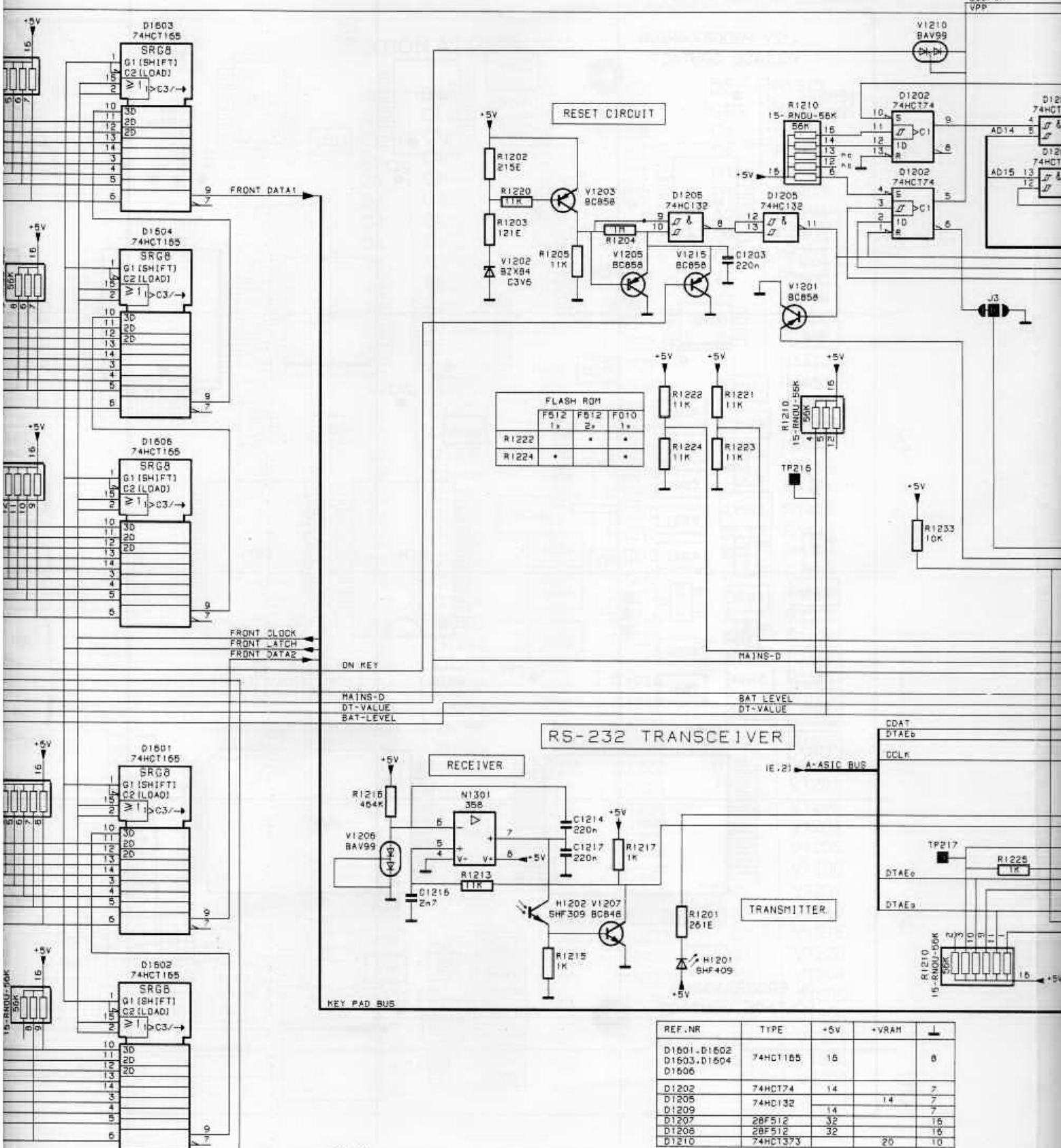
KEYPAD SWITCHES



ON KEY
ON OFF
MAINS-D
DT-VALUE
BAT LEVEL

RAM POWER





REF.NR	TYPE	+5V	+VRAM	↓
D1601-D1602 D1603-D1604 D1606	74HCT165	16		6
D1202	74HCT74	14		7
D1205	74HC132		14	7
D1209		14		7
D1207	2BF512	32		16
D1208	2BF512	32		16
D1210	74HCT373		20	10

ON OFF
-30V
-VBAT

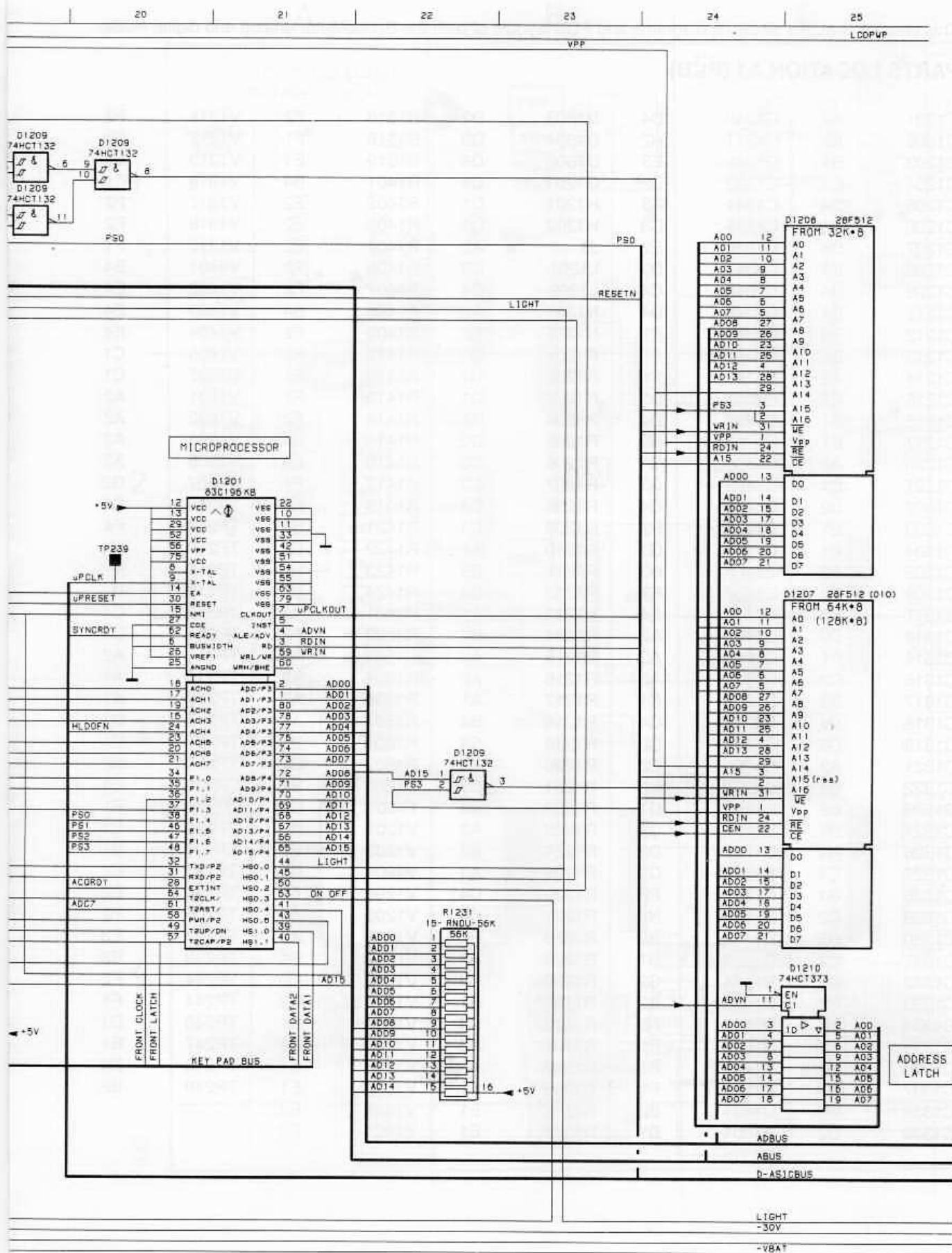


Figure 10.2a Digital A1 circuit diagram (part a)

PARTS LOCATION A1 (CIRCUIT DIAGRAM)

A	E7	C1335	G3	D1604	B13	R1231	G22	TP222	A3
A MOVE UP	C7	C1336	G3	D1606	D13	R1301	F2	TP223	H7
A MOVE DN	C7	C1338	G4	DOWN	B9	R1302	E2	TP224	G9
A AC/DC	C6	C1339	G4	E	C8	R1313	H7	TP228	F2
A mV	C6	C1340	G5	G1337	G4	R1314	F8	TP239	D20
AUTOSET	B7	C1341	G5	H1201	G17	R1316	F8	TP241	F3
B MOVE DN	C8	C1346	G3	H1202	G16	R1501	A2	TRIGGER	C6
B MOVE UP	C8	C1347	G5	HOLD/RUN	D6	R1502	A3	UNDO	E8
B V	C9	C1348	G3	J3	C19	R1503	A3	UP	B9
B mV	C9	C1349	H1	L1201	G2	R1504	B3	V1201	C17
B AC/DC	C9	C1350	H2	LCD	D8	R1506	B3	V1202	B15
B1209	B19	C1351	H3	MATH	E8	R1507	A3	V1203	B16
C1201	G2	C1352	H3	METER	B6	R1601	H11	V1205	B16
C1202	G2	C1353	H3	MOVE L	D7	R1601	F11	V1206	G14
C1203	B17	C1503	D2	MOVE R	D7	R1602	C11	V1207	G16
C1204	D2	CHAN A/B	B8	N1301	F2	R1602	A11	V1210	A18
C1214	F16	CURSOR DA	B7	N1301	F15	R1602	H12	V1215	B17
C1217	G16	CURSOR1 L	B7	ON KEY	E6	R1602	C12	V1220	C3
C1305	E2	CURSOR1 R	B7	R1201	G17	R1603	D11	V1301	G7
C1309	H6	CURSOR2 L	B8	R1202	B15	R210	G18	V1312	G6
C1311	G8	CURSOR2 R	B8	R1203	B15	RECORD	D7	V1313	G7
C1312	G9	D	C6	R1204	B16	SCOPE	B6	V1314	F7
C1316	G9	D1201	D21	R1205	B16	SETUP	D7	V1316	F7
C1317	G9	D1202	A18	R1210	A17	SOFT1	A6	V1317	F8
C1319	G3	D1202	B18	R1210	D17	SOFT2	A7	V1318	G6
C1321	G3	D1205	B17	R1213	G15	SOFT3	A7	V1319	G8
C1322	G3	D1207	E25	R1215	G16	SOFT4	A8	V1501	A3
C1323	G4	D1208	B25	R1216	F14	SOFT5	A9	V1501	B2
C1324	G4	D1209	F16	R1217	G16	SPECIAL	E7	V1502	B3
C1326	G4	D1209	A20	R1221	C17	TEST1	D17	V1506	B3
C1327	G3	D1209	A19	R1222	C17	TEST12	G18	WAVEFORM	D8
C1328	G5	D1210	G25	R1223	D17	TIME ns	C7	X1201	D1
C1329	G5	D1301	G7	R1224	D17	TIME s	C7	X1205	C1
C1330	G5	D1301	H7	R1225	G19	TP216	D17		
C1332	G2	D1601	F13	R1226	C9	TP217	G18		
C1333	G2	D1602	H13	R1228	C3	TP219	B2		
C1334	G3	D1603	A13	R1229	D3	TP221	A3		

PARTS LOCATION A1 (CIRCUIT DIAGRAM)

C1205	C9	D1205	A3	R1206	A6	R1409	E14	TP234	H14
C1207	A7	D1205	B3	R1207	B6	R1411	F14	TP237	G14
C1207	B7	D1206	A2	R1211	E9	R1412	F14	TP244	B4
C1208	B7	D1230	D5	R1212	E9	R1413	G14	TP246	A2
C1209	B7	D1401	C12	R1214	E9	R1414	H14	TP247	F4
C1211	R9	D1401	A17	R1218	E9	R1416	G11	TP248	H14
C1212	E9	D1402	A18	R1219	C9	R1417	H13	TP249	D14
C1213	E9	D1403	A20	R1220	E8	R1418	G13	V1304	G19
C1215	C9	D1404	C16	R1220	E7	R1419	F14	V1306	H19
C1221	E10	D1406	D16	R1226	C9	R1421	H11	V1307	G20
C1302	H19	D1407	F16	R1227	C9	R1422	H12	V1308	J20
C1303	G20	D1408	A13	R1230	E9	R1423	G12	V1309	J20
C1304	J19	D1408	B13	R1232	C9	R1424	G12	V1311	J19
C1318	H11	D1409	A12	R1309	G19	T1301	H20	V1401	D13
C1401	E12	D1409	B12	R1311	H20	T1301	H19	V1402	H12
C1402	H13	D1410	B14	R1312	H18	TP207	C17	V1403	G12
C1403	G11	G1201	E9	R1319	H19	TP208	D17	V1405	E12
C1404	E14	H1401	D19	R1401	D12	TP209	F17	V1406	H14
C1405	E14	J1401	C11	R1402	E13	TP210	B18	V1503	H18
C1406	F14	L1202	C8	R1403	E13	TP211	B18	X1201	A22
C1407	F14	N1401	G13	R1404	F14	TP212	B18	X1202	H22
C1409	H14	N1401	E14	R1406	G13	TP213	D2		
C1411	G12	N1401	F14	R1407	G13	TP214	D2		
D1204	E2	N1404	G12	R1408	D14	TP233	D14		

CIRCUIT DIAGRAMS

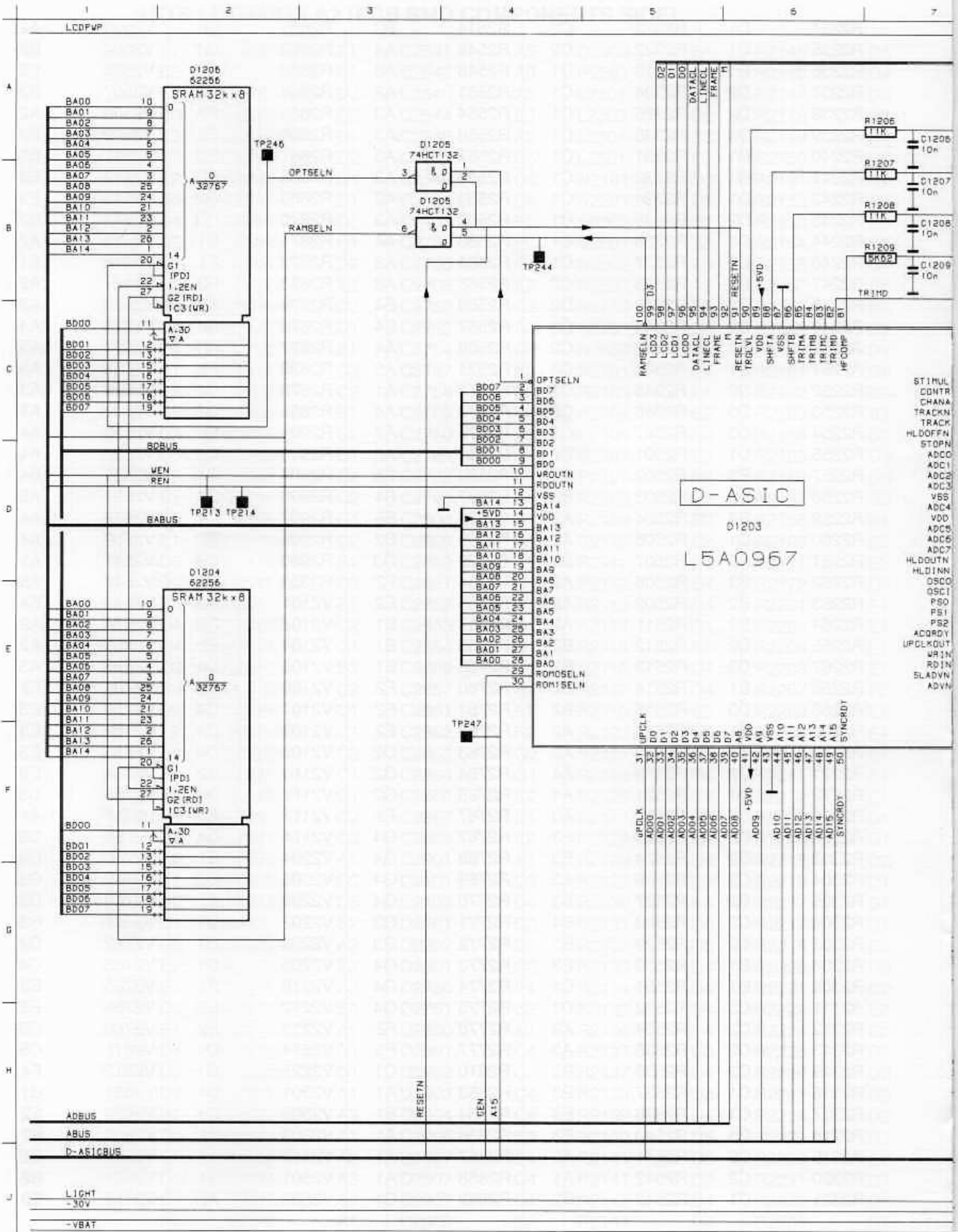
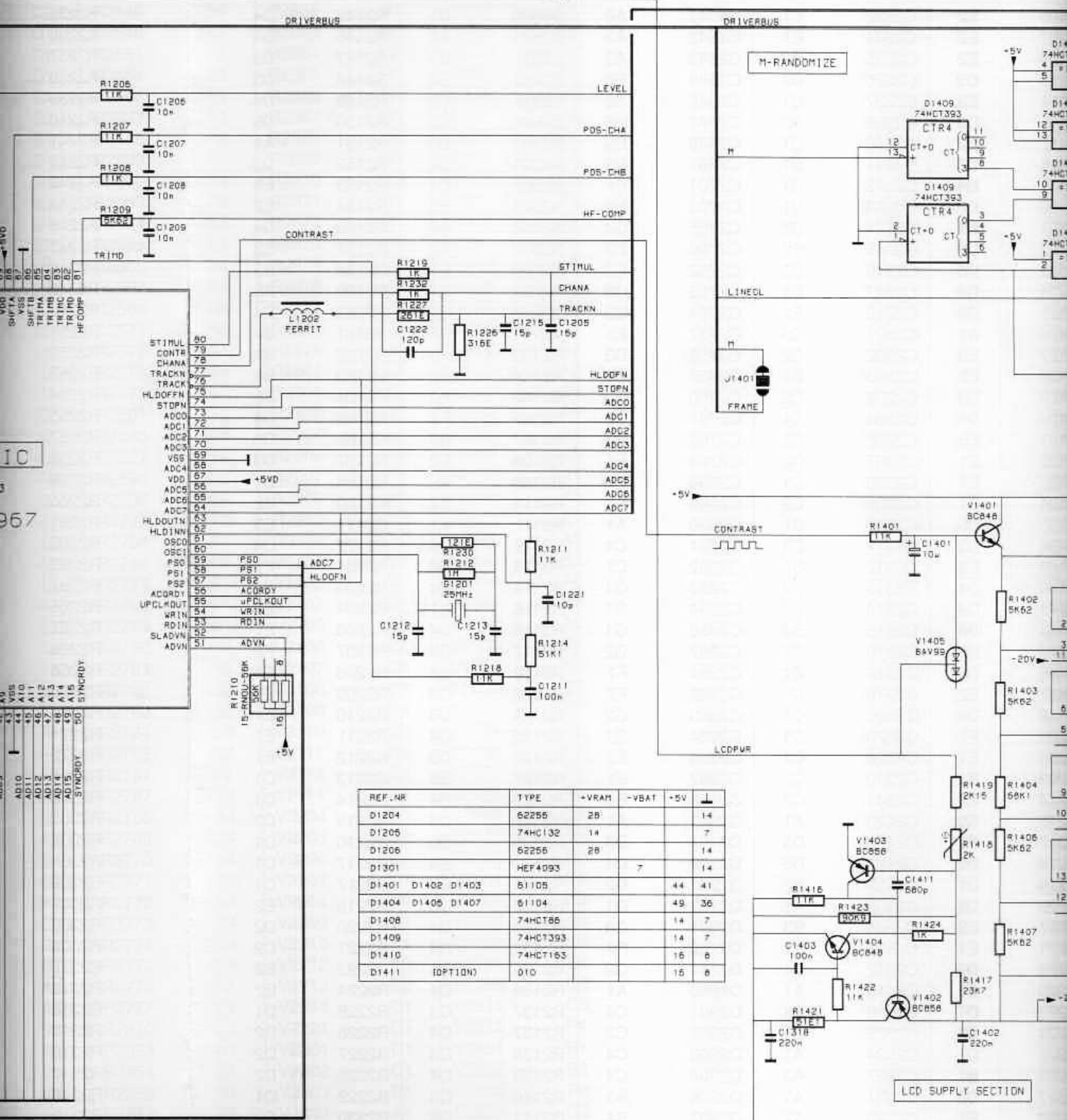
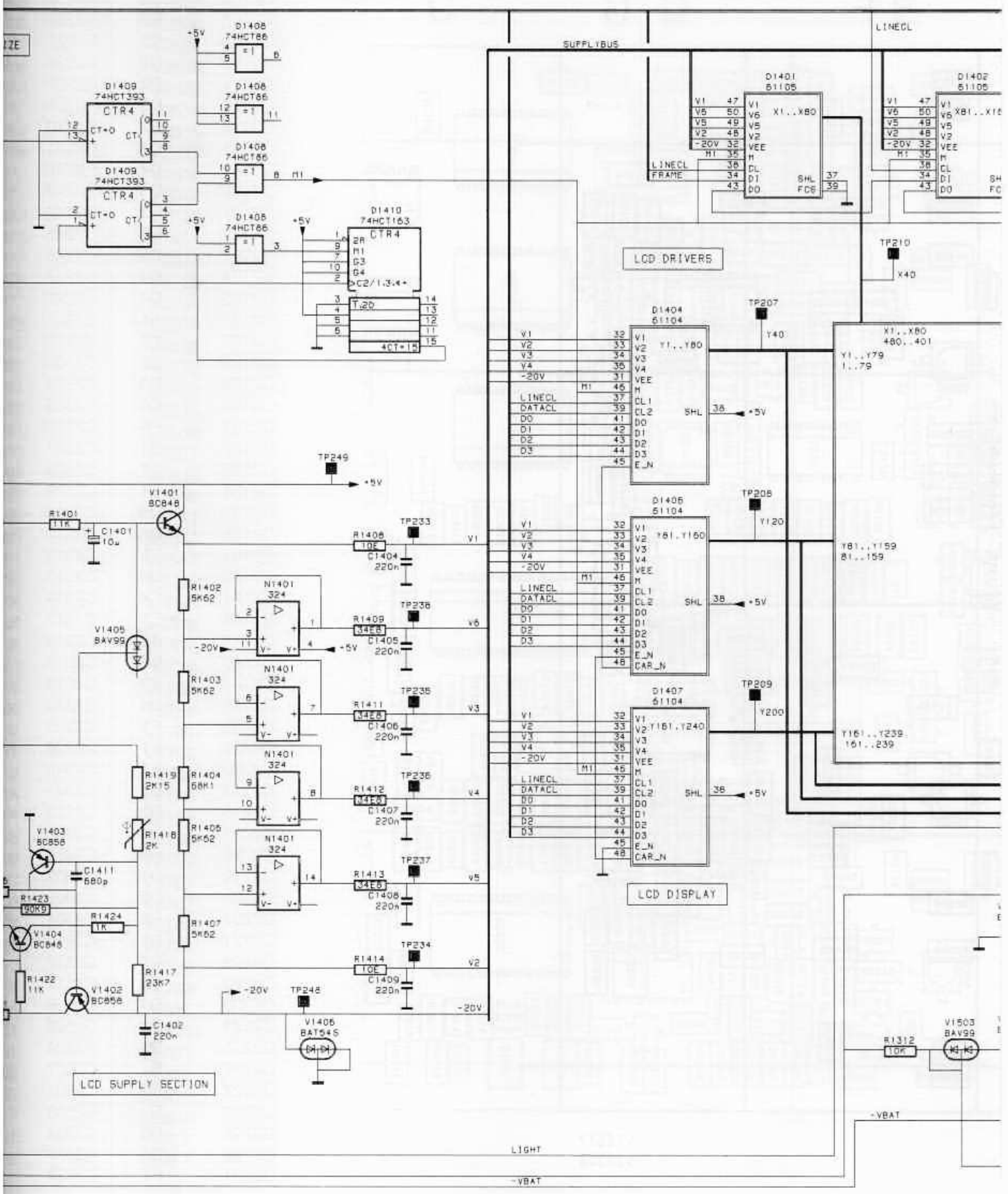
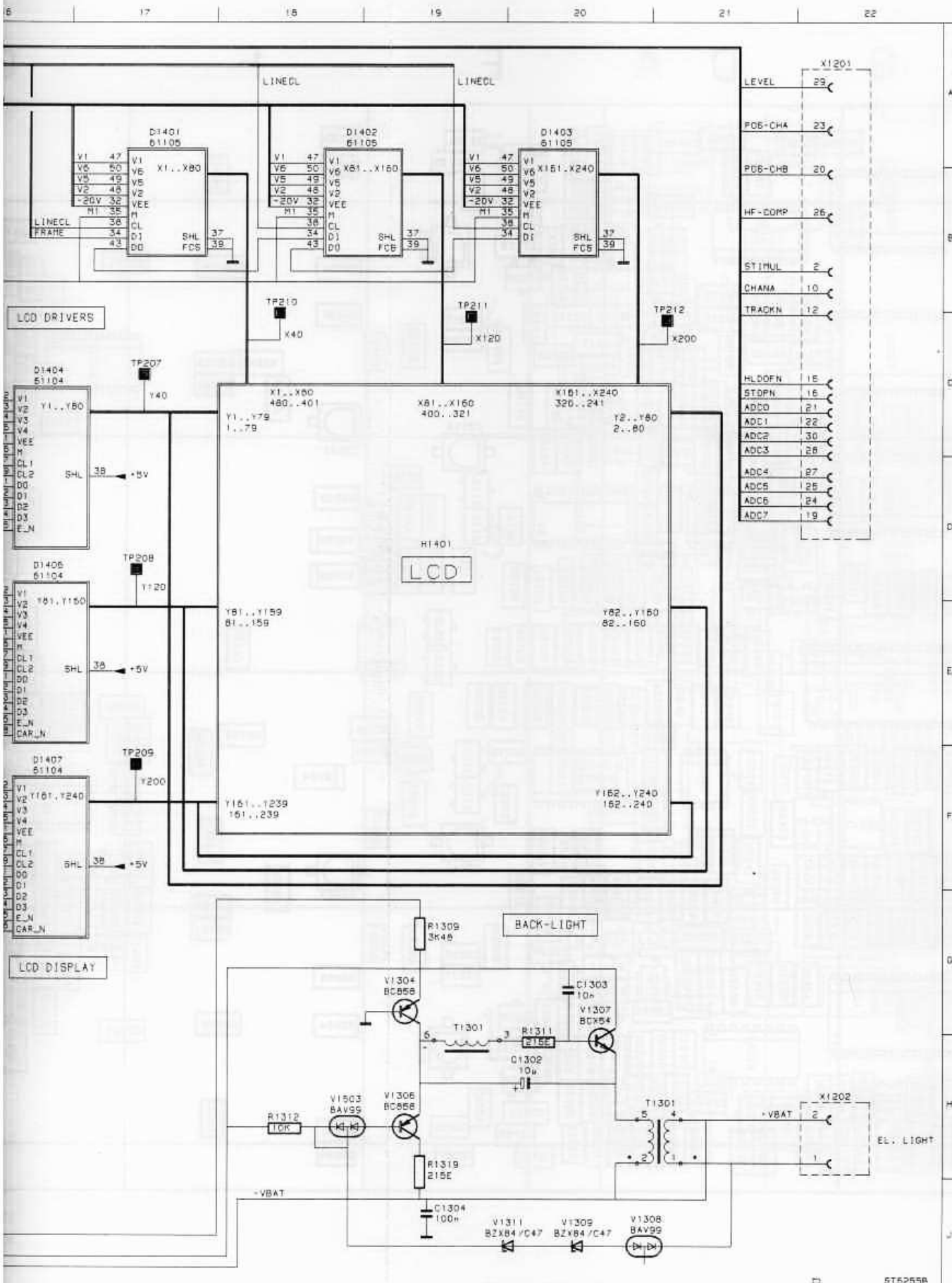


Figure 10.2b Digital A1 circuit diagram (part b)



REF. NR	TYPE	+VRAM	-VBAT	+5V	⊥
D1204	62255	28			14
D1205	74HC132	14			7
D1206	62255	28			14
D1301	HEF4093		7		14
D1401 D1402 D1403	61105			44	41
D1404 D1405 D1407	61104			49	36
D1408	74HC186			14	7
D1409	74HC7393			14	7
D1410	74HC1163			16	8
D1411	IDPT10N			15	8





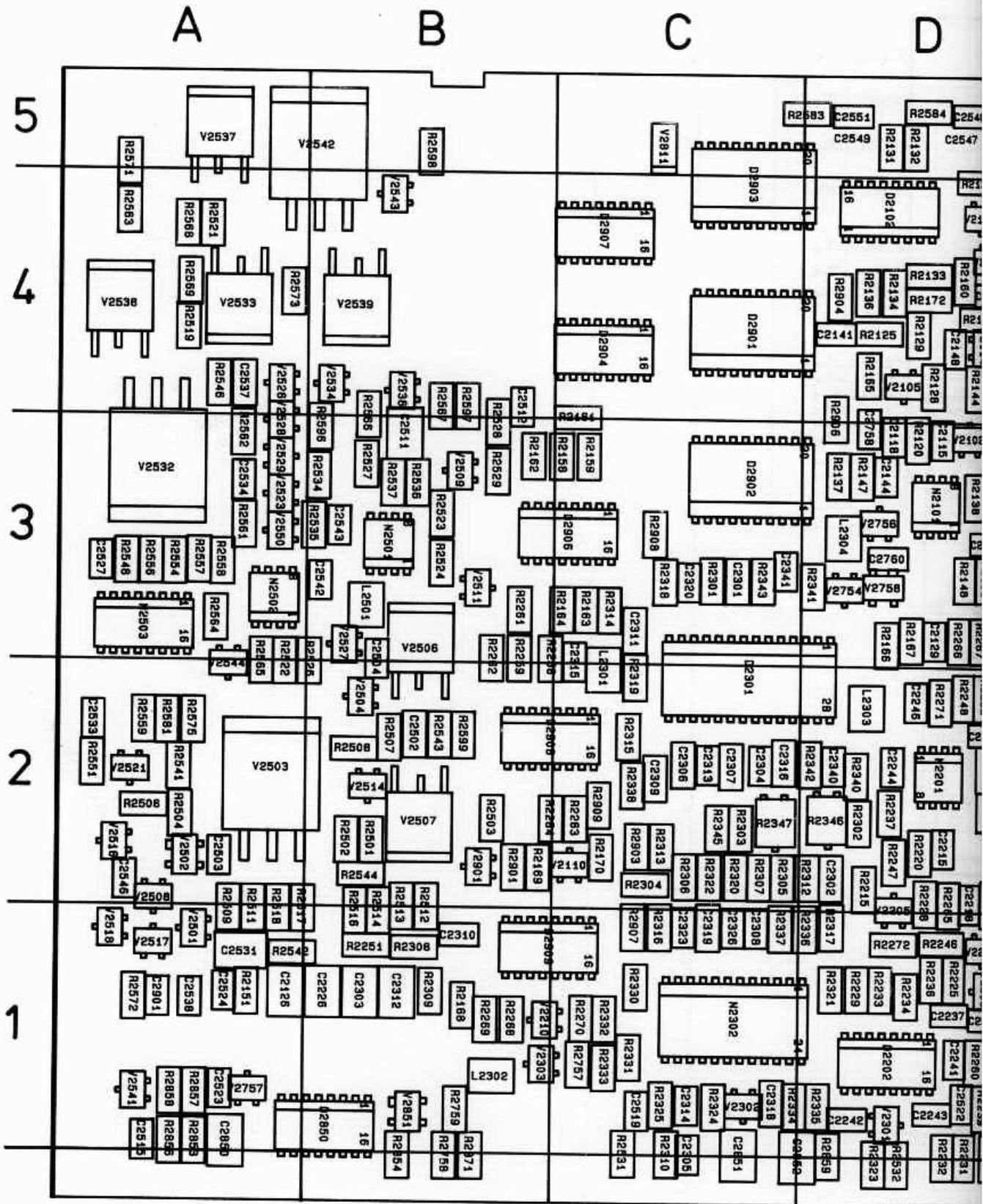
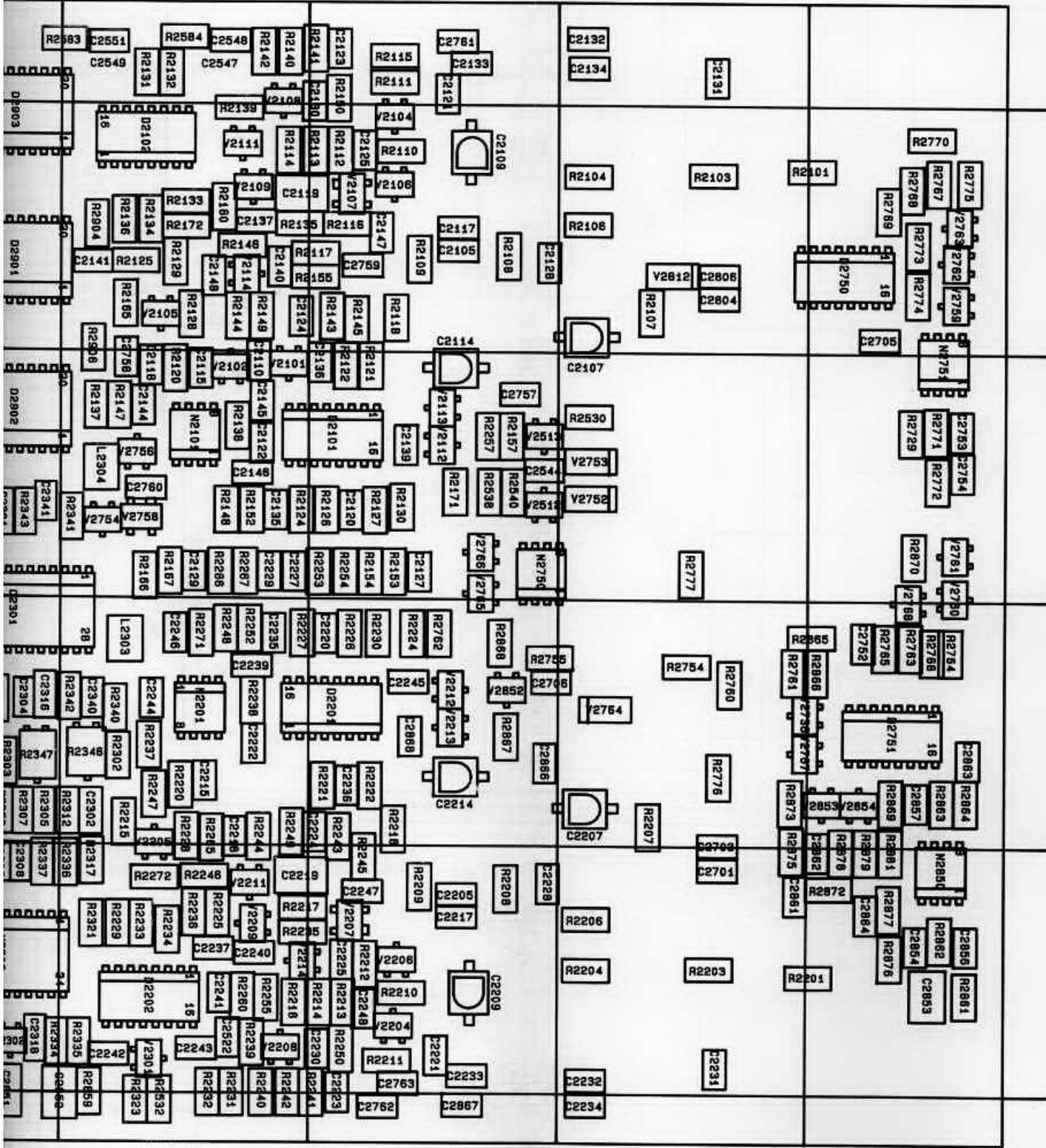


Figure 10.3a Analog A2 PCB (SMD components side)

D E F G



ST6617
920203

PARTS LOCATION A2 (PCB SMD COMPONENTS SIDE)

C2105	E2	C2232	E1	C2541	A5	D2909	B1	R2145	D4
C2107	E2	C2234	E1	C2542	A3	H2561	A3	R2146	D4
C2109	E2	C2235	D2	C2543	A3	L2301	B1	R2147	D3
C2110	D3	C2236	D2	C2544	E3	L2303	D2	R2148	D3
C2114	E3	C2237	D1	C2546	A2	L2304	C3	R2149	D4
C2115	D3	C2239	D2	C2547	D5	L2501	B3	R2150	D5
C2117	E2	C2240	D1	C2549	D5	N2101	D3	R2151	A1
C2118	D3	C2241	D1	C2551	D5	N2201	D2	R2152	D3
C2119	D4	C2242	D1	C2701	F1	N2302	C1	R2153	E3
C2120	D3	C2243	D1	C2703	F2	N2501	B3	R2154	E3
C2121	E1	C2244	D2	C2705	G4	N2502	A3	R2155	D4
C2122	D3	C2245	E2	C2706	E2	N2503	A3	R2157	E3
C2123	D5	C2246	D2	C2752	G2	N2750	E3	R2158	B3
C2124	D4	C2247	D1	C2753	G3	N2751	G4	R2159	B3
C2125	D4	C2248	E1	C2754	G3	N2850	G2	R2160	D4
C2126	A1	C2301	C3	C2757	E3	R2101	F4	R2161	B4
C2127	E3	C2302	C2	C2758	D3	R2103	F4	R2162	B3
C2128	E2	C2303	B1	C2759	D4	R2104	E2	R2163	B3
C2129	D3	C2304	C2	C2760	D3	R2106	E2	R2164	B3
C2130	D5	C2305	C1	C2761	E1	R2107	F3	R2165	D4
C2131	F5	C2306	C2	C2762	E2	R2107	B2	R2166	D3
C2132	E1	C2307	C2	C2763	E1	R2108	E2	R2167	D3
C2133	E1	C2308	C1	C2804	F4	R2109	E2	R2168	B1
C2134	E1	C2309	C2	C2806	F4	R2110	E2	R2169	B2
C2135	D3	C2310	B1	C2850	A1	R2111	E1	R2171	E3
C2136	D3	C2311	C3	C2851	C1	R2112	D4	R2172	D4
C2139	E3	C2312	B1	C2852	C1	R2113	D4	R2201	F1
C2140	D4	C2313	C2	C2853	G1	R2114	D4	R2204	E1
C2141	C4	C2314	C1	C2854	G1	R2115	E1	R2204	E1
C2144	D3	C2315	B3	C2856	G1	R2116	D4	R2206	E1
C2145	D3	C2316	C2	C2857	G2	R2117	D4	R2207	F2
C2146	D3	C2318	C1	C2861	F1	R2118	E2	R2208	E1
C2147	E2	C2319	C1	C2862	F2	R2122	D3	R2209	E1
C2148	D4	C2320	C3	C2863	G2	R2124	D3	R2210	E1
C2203	F1	C2323	C1	C2864	G1	R2125	D4	R2211	E1
C2205	E1	C2326	C1	C2866	E2	R2126	D3	R2212	E1
C2209	E1	C2340	C2	C2867	E1	R2127	E3	R2213	D1
C2214	E2	C2341	C3	C2868	E2	R2128	D4	R2214	D1
C2215	D2	C2423	A1	C2901	A1	R2129	D4	R2215	D2
C2217	E1	C2458	D5	D2101	D3	R2129	D3	R2216	D1
C2218	D2	C2484	D5	D2102	D4	R2130	E3	R2217	D1
C2219	D1	C2502	B2	D2201	D2	R2131	D5	R2217	D1
C2220	D2	C2503	A2	D2202	D1	R2132	D5	R2218	E2
C2207	E2	C2504	B3	D2301	C3	R2133	D4	R2220	D2
C2221	E1	C2511	B3	D2750	F4	R2134	D4	R2221	D2
C2222	D2	C2512	B4	D2751	G2	R2135	D4	R2222	E2
C2223	E1	C2515	A1	D2850	A1	R2136	D4	R2224	E2
C2223	D1	C2519	C1	D2901	C4	R2137	C3	R2225	D1
C2224	D2	C2522	D1	D2902	C3	R2137	D4	R2226	D2
C2225	D1	C2524	A1	D2903	C4	R2138	D3	R2227	D2
C2226	B1	C2527	A3	D2904	C4	R2139	D4	R2228	D2
C2227	D3	C2531	A1	D2906	B3	R2140	D5	R2229	D1
C2228	E1	C2533	A2	D2907	B4	R2141	D5	R2230	E2
C2229	D3	C2534	A3	D2907	C4	R2141	D5	R2231	D1
C2230	D1	C2537	A4	D2907	B4	R2143	D4	R2232	D1
C2231	F1	C2538	A1	D2908	B2	R2144	D4	R2233	D1

R2234	D1	R2322	C2	R2544	B2	R2861	G1	V2503	A2
R2235	D1	R2322	C2	R2546	A4	R2862	G1	V2504	B2
R2236	D1	R2323	D1	R2548	A3	R2863	G2	V2506	B3
R2237	D2	R2324	C1	R2551	A2	R2864	G2	V2507	B2
R2238	D2	R2325	C1	R2554	A3	R2865	F2	V2508	A2
R2239	D1	R2330	C1	R2556	A3	R2866	F2	V2509	B3
R2240	D1	R2331	C1	R2557	A3	R2867	E2	V2511	B3
R2241	D1	R2332	C1	R2558	A3	R2868	E2	V2512	E3
R2242	D1	R2334	C1	R2559	A2	R2869	G2	V2513	E3
R2243	D2	R2335	C1	R2562	A3	R2870	G3	V2514	B2
R2244	D2	R2336	C1	R2563	A4	R2871	B1	V2516	A2
R2246	D1	R2337	C1	R2564	A3	R2872	F1	V2518	A1
R2247	D2	R2338	C2	R2565	A3	R2873	F2	V2521	A2
R2248	D2	R2340	D2	R2566	B4	R2875	F2	V2523	A3
R2249	D2	R2341	C3	R2567	B4	R2876	G1	V2526	A4
R2250	D1	R2342	C2	R2568	A4	R2877	G1	V2527	A3
R2251	B1	R2343	C3	R2571	A5	R2878	F2	V2528	A3
R2252	D2	R2345	C2	R2572	A1	R2879	G2	V2529	A3
R2253	D3	R2346	C2	R2573	A4	R2881	G2	V2532	A3
R2254	D3	R2347	C2	R2575	A2	R2901	B2	V2533	A4
R2255	D1	R2501	B2	R2581	A2	R2903	C2	V2534	A4
R2257	E3	R2502	A2	R2583	C5	R2904	C4	V2536	B4
R2258	B3	R2503	B2	R2597	B4	R2906	C4	V2537	A5
R2259	B3	R2504	A2	R2598	B5	R2907	C1	V2538	A4
R2260	D1	R2506	A2	R2599	B2	R2909	B2	V2539	A4
R2261	B3	R2507	B2	R2729	G3	R2980	C3	V2541	A1
R2262	B3	R2508	A2	R2754	F2	R3333	C1	V2542	A5
R2263	B2	R2509	A2	R2755	E2	V2101	D3	V2543	B4
R2264	B2	R2511	A2	R2757	B1	V2102	D3	V2544	A2
R2265	D2	R2512	B2	R2758	B1	V2104	E2	V2550	A3
R2267	D3	R2513	B2	R2759	B1	V2105	D4	V2596	A3
R2268	B1	R2514	B2	R2760	F2	V2106	E2	V2736	F2
R2268	D3	R2516	B2	R2761	F2	V2107	D4	V2750	E3
R2269	B1	R2517	A2	R2762	E2	V2108	D4	V2752	E3
R2270	B1	R2518	A2	R2763	G2	V2109	D4	V2753	E3
R2271	D2	R2519	A4	R2764	G2	V2110	B2	V2754	C3
R2272	D1	R2521	A4	R2766	G2	V2111	D4	V2756	D3
R2301	C3	R2522	A3	R2767	F2	V2112	E3	V2757	A1
R2302	D2	R2523	B3	R2767	G4	V2114	D4	V2758	D3
R2303	C2	R2524	B3	R2768	G4	V2204	E1	V2759	G4
R2304	C2	R2526	A3	R2769	G4	V2205	D2	V2760	G3
R2305	C2	R2527	B3	R2770	G4	V2206	E1	V2760	D3
R2306	C2	R2528	B4	R2771	G3	V2207	D1	V2761	G3
R2307	C2	R2529	B3	R2772	G3	V2208	D1	V2762	G4
R2308	B1	R2530	E3	R2773	G4	V2209	D1	V2763	G4
R2309	B1	R2531	C1	R2774	G4	V2210	B1	V2765	E3
R2311	C3	R2532	D1	R2775	G4	V2212	E2	V2766	E3
R2312	C2	R2534	A3	R2776	F2	V2213	E2	V2768	G3
R2313	C2	R2535	A3	R2777	F3	V2214	D1	V2811	C5
R2315	C2	R2536	B3	R2810	C1	V2221	D1	V2812	F4
R2316	C1	R2537	B3	R2853	A1	V2301	D1	V2851	B1
R2317	C1	R2538	E3	R2854	B1	V2302	C1	V2852	E2
R2318	C3	R2540	E3	R2856	A1	V2303	B1	V2853	F2
R2319	C2	R2541	A2	R2857	A1	V2417	A1	V2854	G2
R2320	C2	R2542	A1	R2858	A1	V2501	A1	V2901	B2
R2321	C1	R2543	B2	R2859	C1	V2502	A2	V3113	E3

CIRCUIT DIAGRAMS

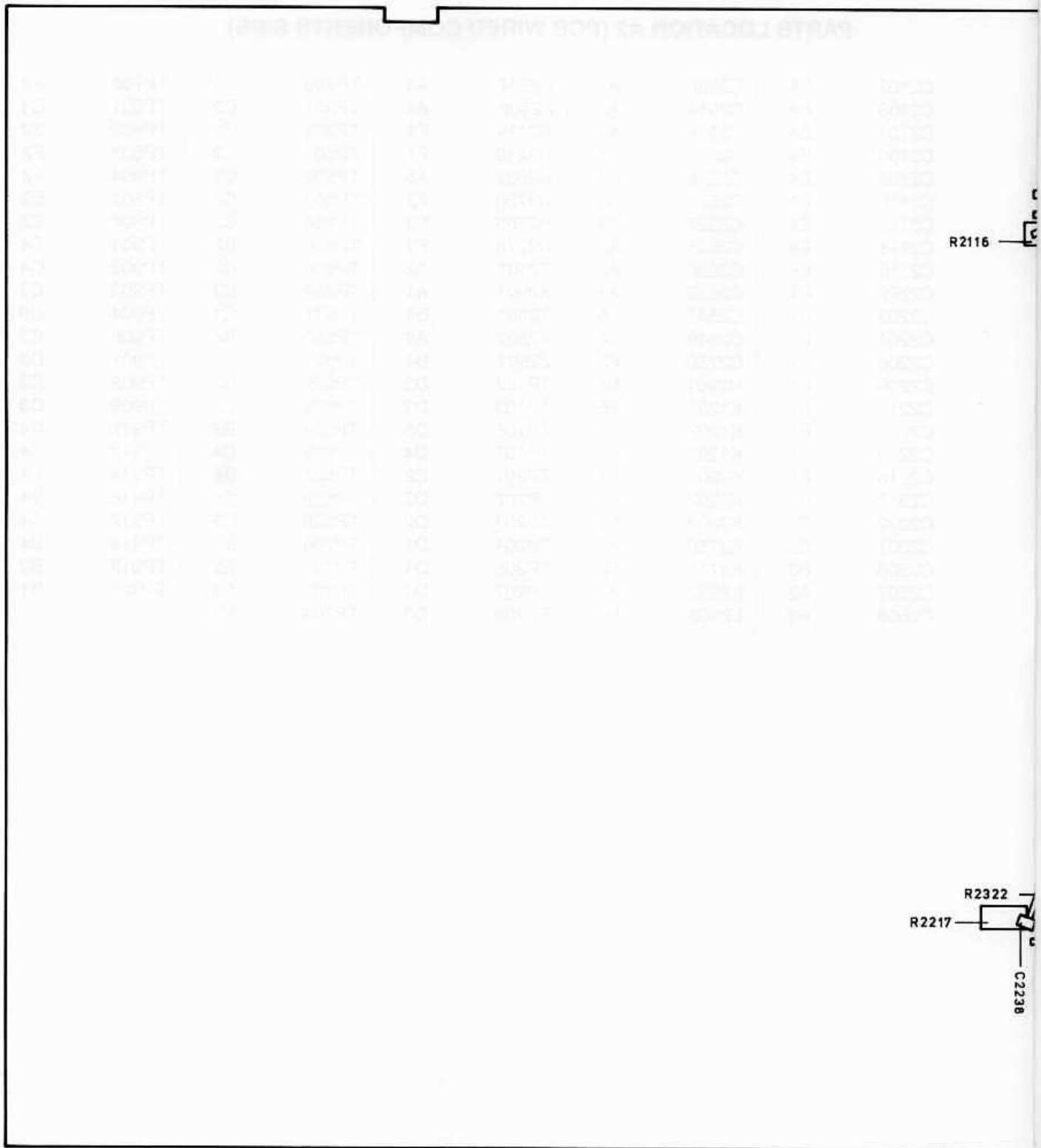
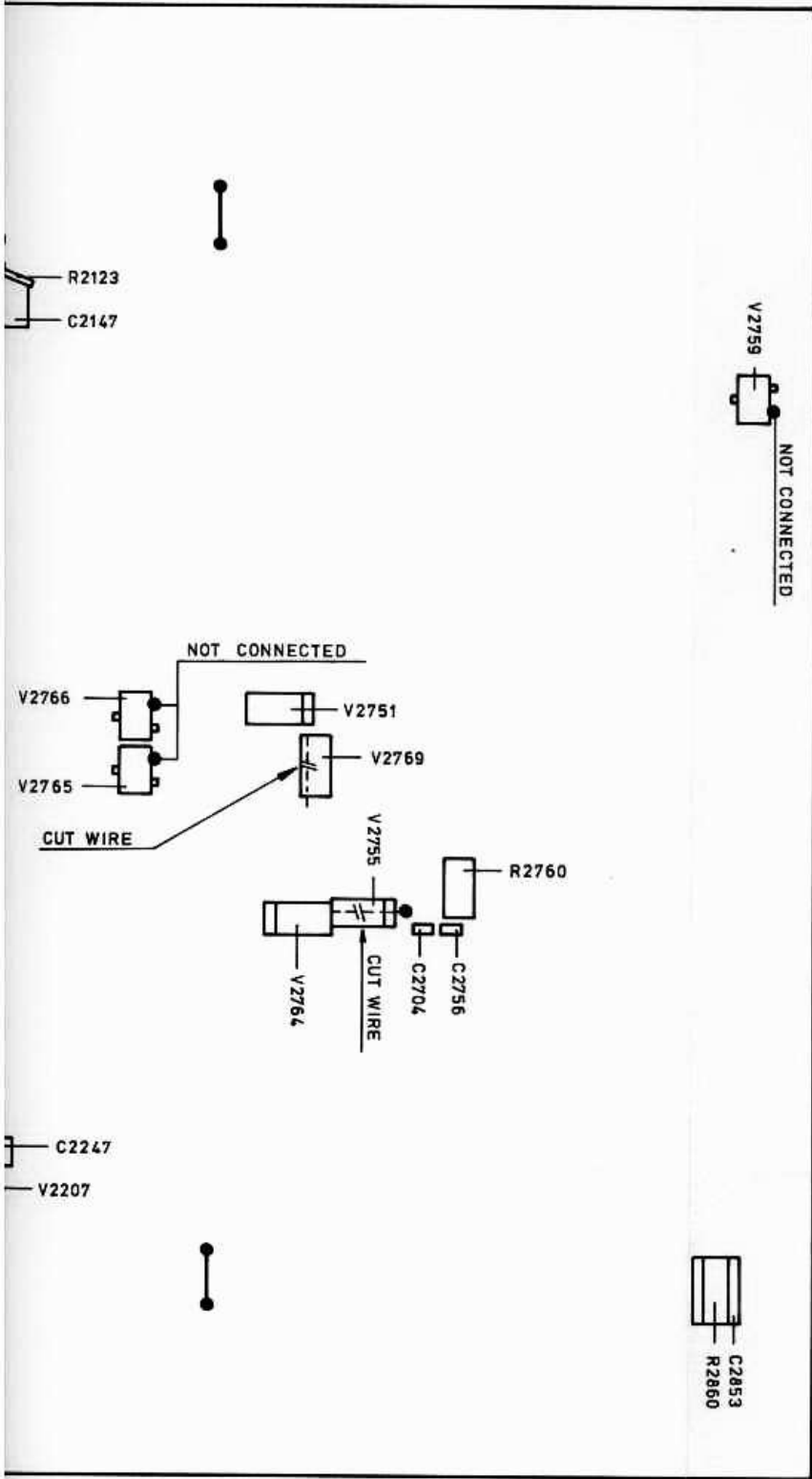


Figure 10.3b Modifications Analog A2 PCB (SMD component side)



ST6850
920210

PARTS LOCATION A2 (PCB WIRED COMPONENTS SIDE)

C2102	F4	C2509	A2	L2504	A4	TP209	C1	TP706	F2
C2103	F4	C2514	A2	L2506	A4	TP331	C2	TP801	C1
C2104	E4	C2516	A1	R2119	F4	TP332	C1	TP802	E2
C2106	E4	C2517	A1	R2219	F1	TP501	C2	TP803	F2
C2108	E4	C2518	C1	R2582	A5	TP502	C2	TP804	F2
C2111	E4	C2521	D1	R2750	F3	TP503	C2	TP805	E2
C2112	E4	C2524	D1	R2753	F3	TP504	C2	TP806	E2
C2113	E4	C2525	A3	R2778	F3	TP506	B2	TP901	C4
C2116	E4	C2530	A2	T2501	A2	TP508	D2	TP902	C4
C2202	F1	C2532	A1	X2001	A1	TP509	B3	TP903	C3
C2203	F1	C2547	D5	X2501	B4	TP511	C1	TP904	C3
C2204	E1	C2549	C5	X2502	A4	TP520	B4	TP906	C3
C2206	E1	C2750	F3	Z2501	B4	TP521	C5	TP907	D3
C2208	E1	H2901	B1	TP102	D3	TP522	B3	TP908	C3
C2211	E1	K1201	F5	TP103	D3	TP523	C2	TP909	C3
C2212	E1	K1202	E4	TP106	D5	TP524	B3	TP911	D4
C2213	E1	K1203	E4	TP107	D4	TP526	C4	TP912	C4
C2216	E1	K2201	F1	TP201	E2	TP527	B4	TP914	C4
C2317	C1	K2202	E1	TP202	D2	TP528	C4	TP916	B4
C2322	C1	K2203	E1	TP203	D2	TP529	C5	TP917	C4
C2501	B2	K2750	F3	TP204	D1	TP700	E2	TP918	B4
C2506	B3	K2751	F2	TP206	D1	TP701	E2	TP919	B2
C2507	A2	L2502	A1	TP207	D1	TP702	C3	TP927	B1
C2508	B3	L2503	B1	TP208	D3	TP704	F3		

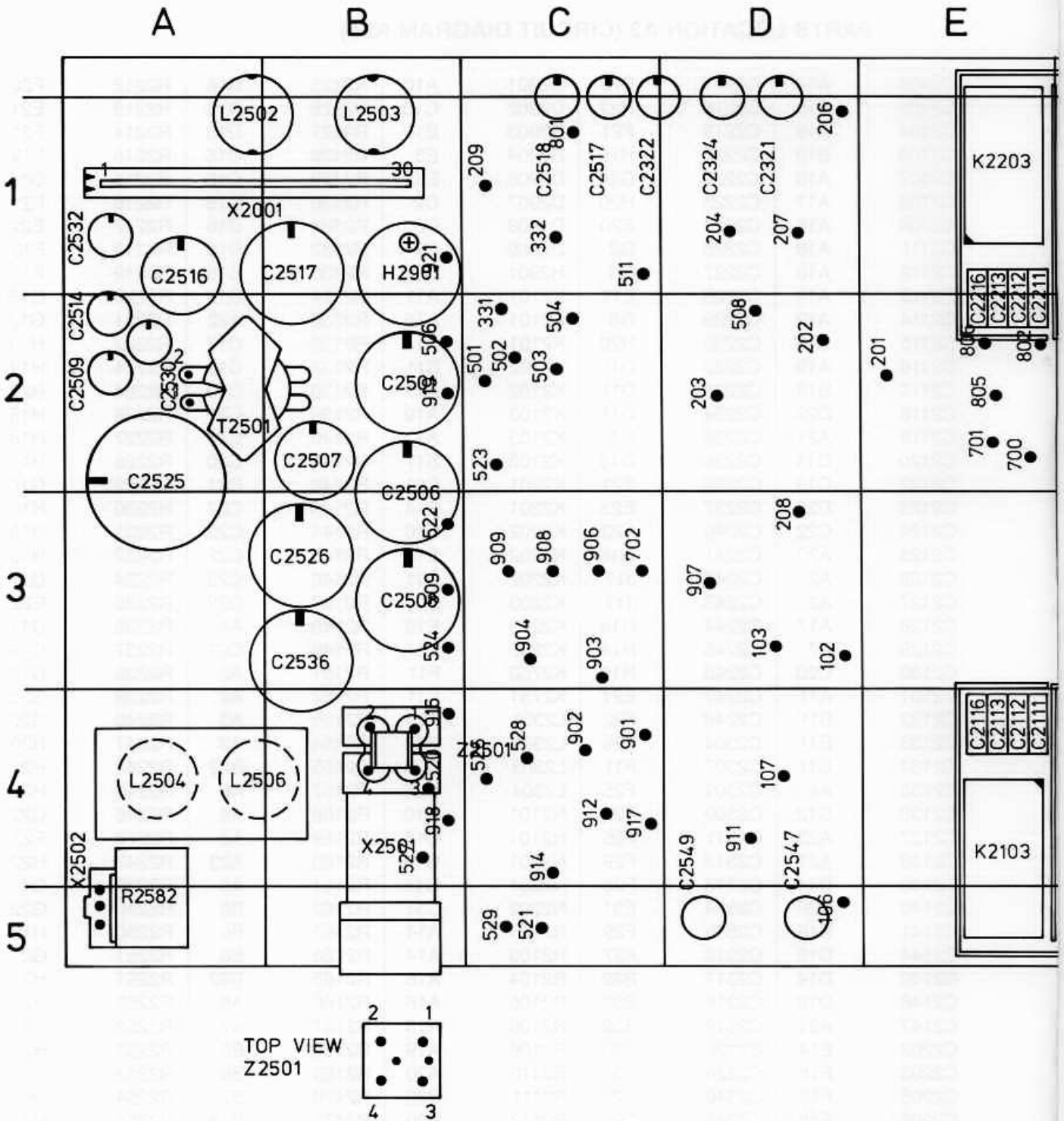
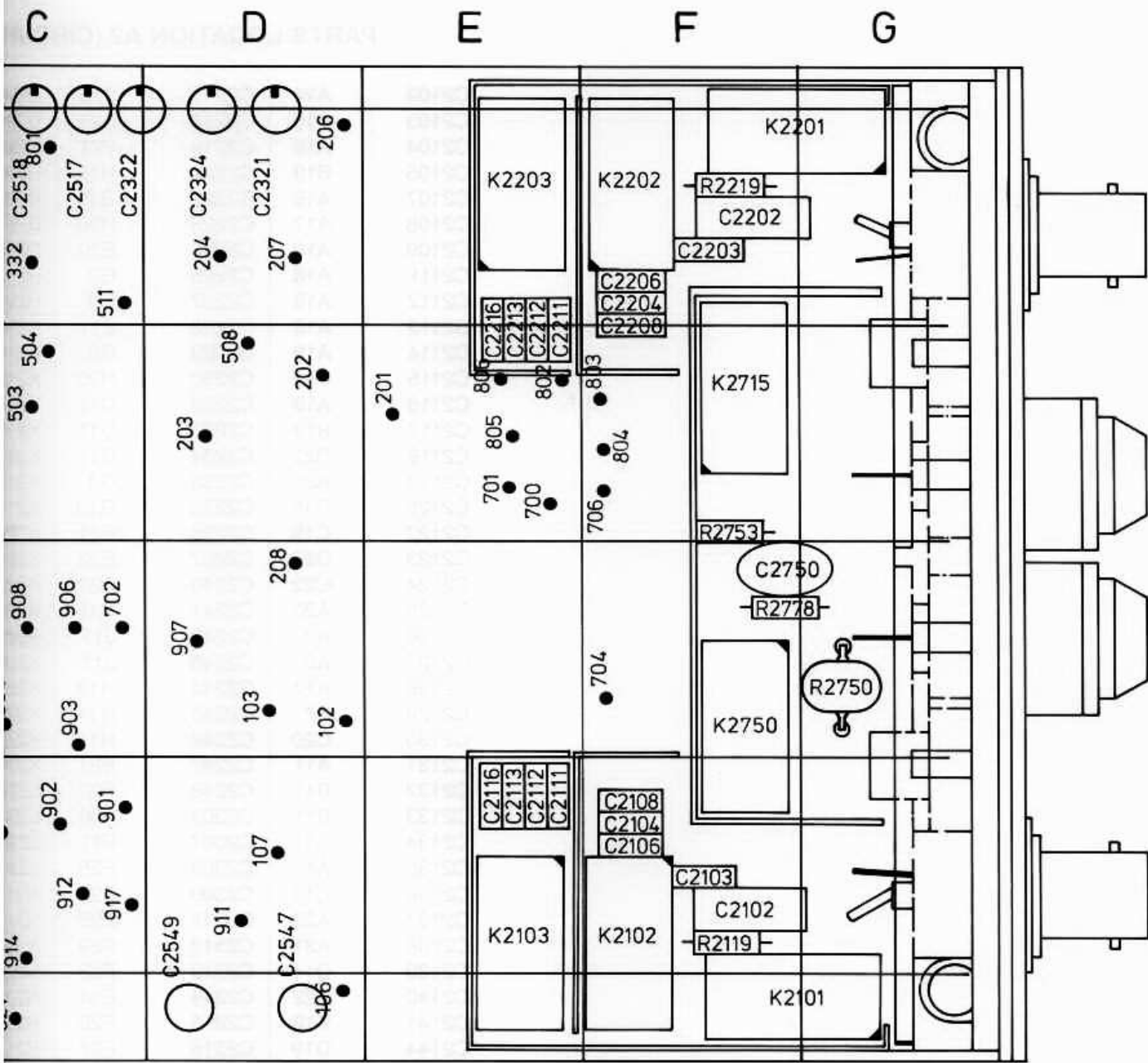
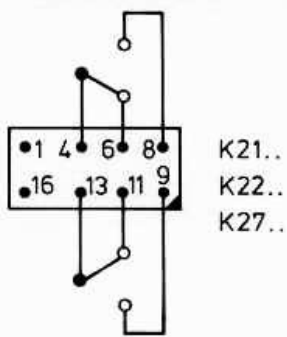


Figure 10.4 Analog A2 PCB (wired component side)



TOP VIEW



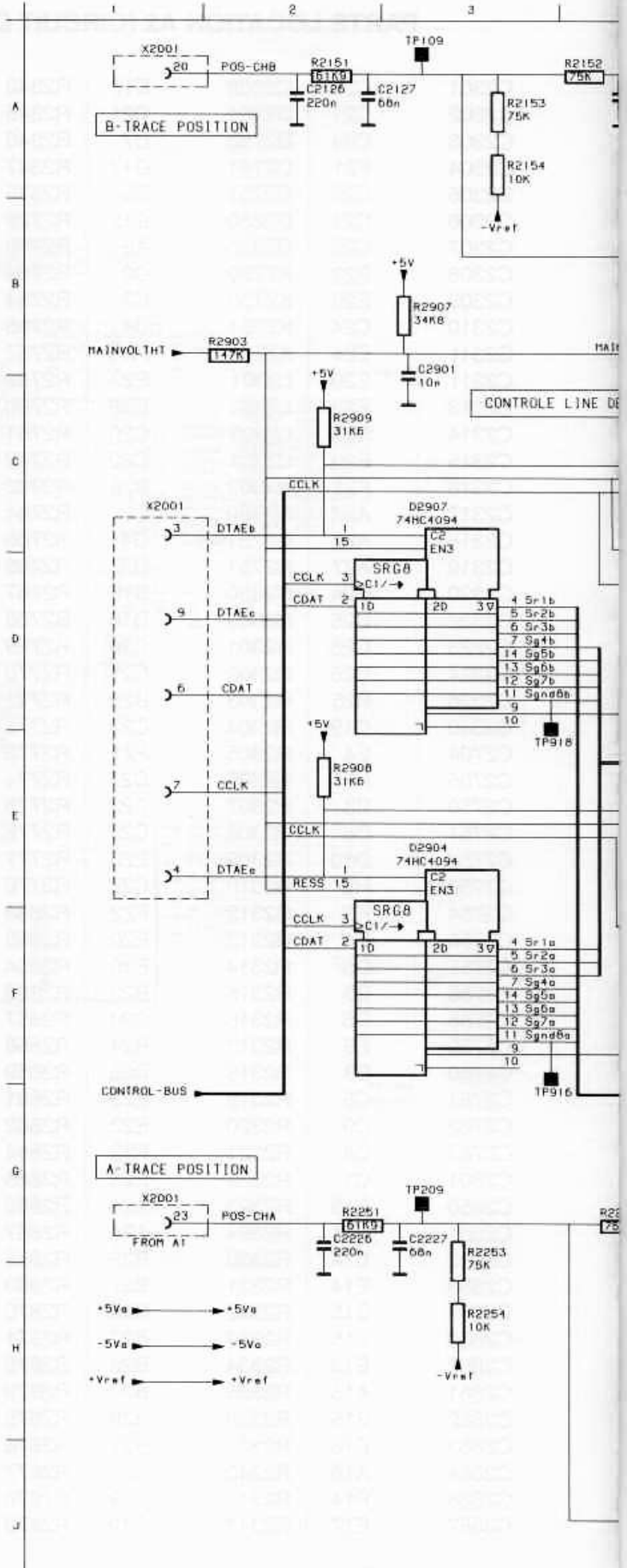
ST6616
920204

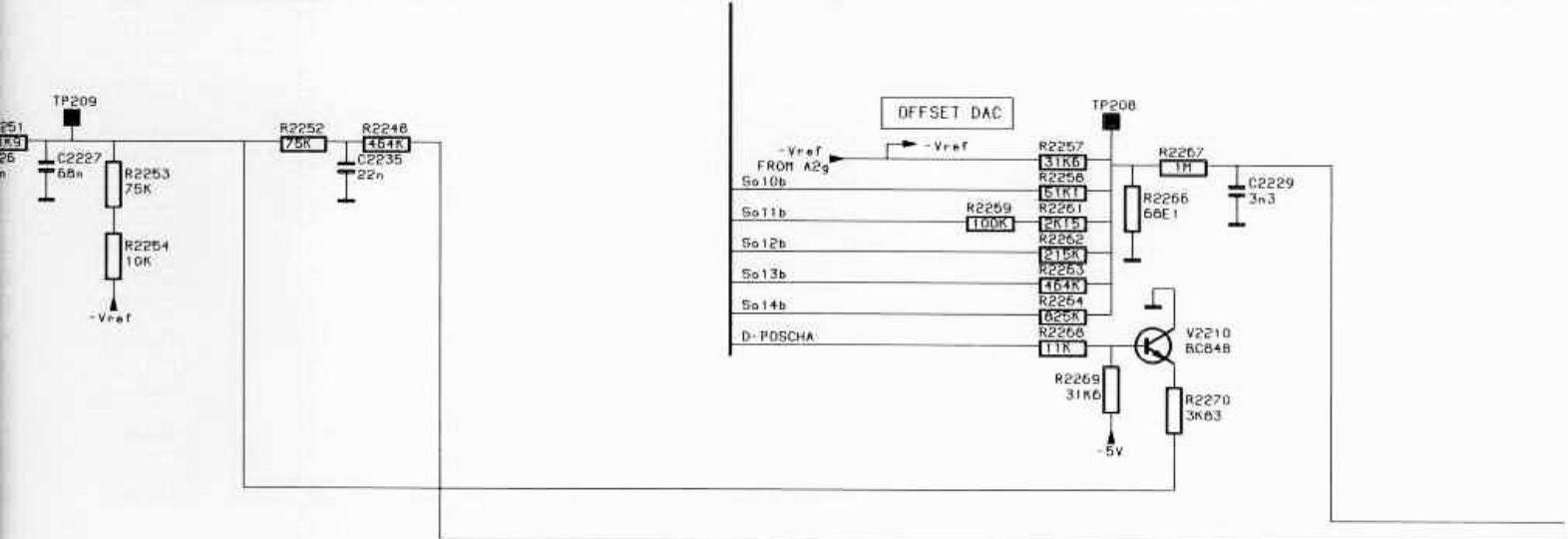
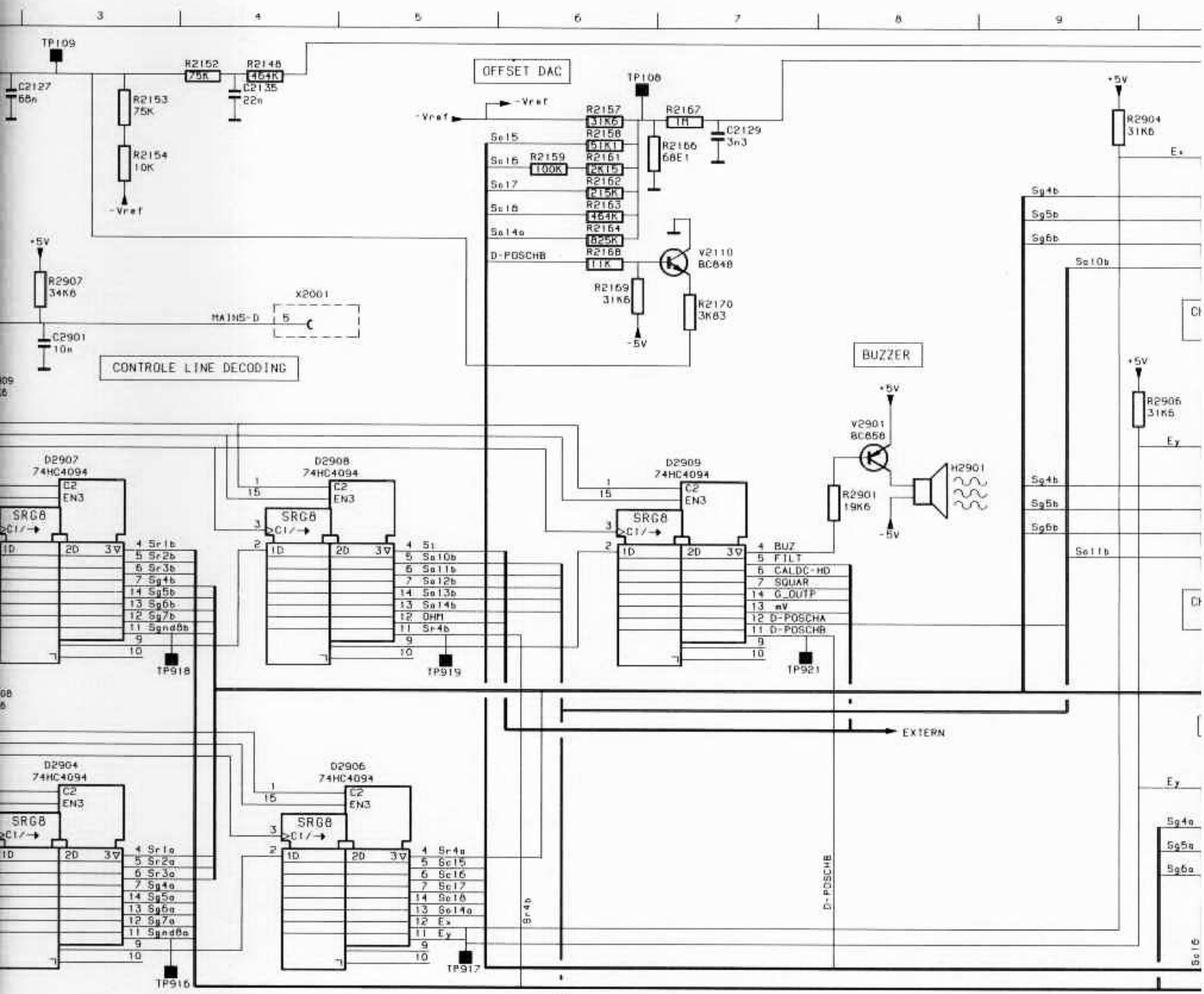
PARTS LOCATION A2 (CIRCUIT DIAGRAM A2a)

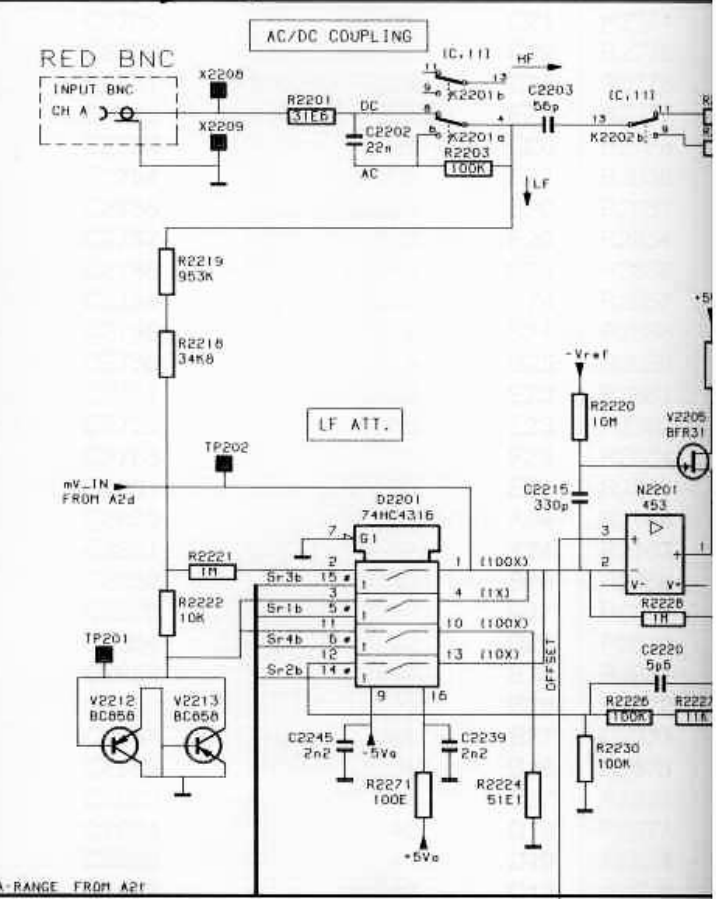
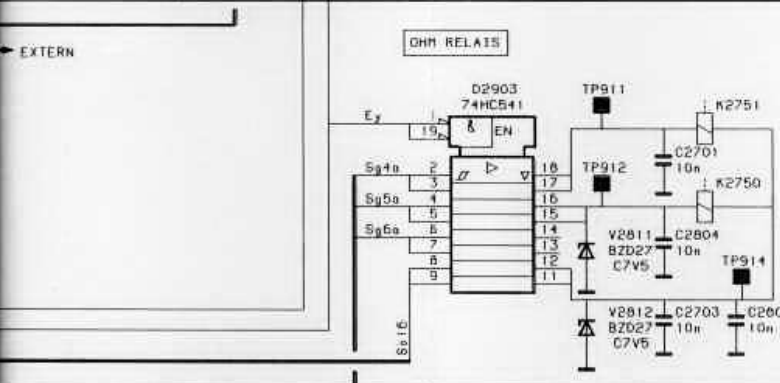
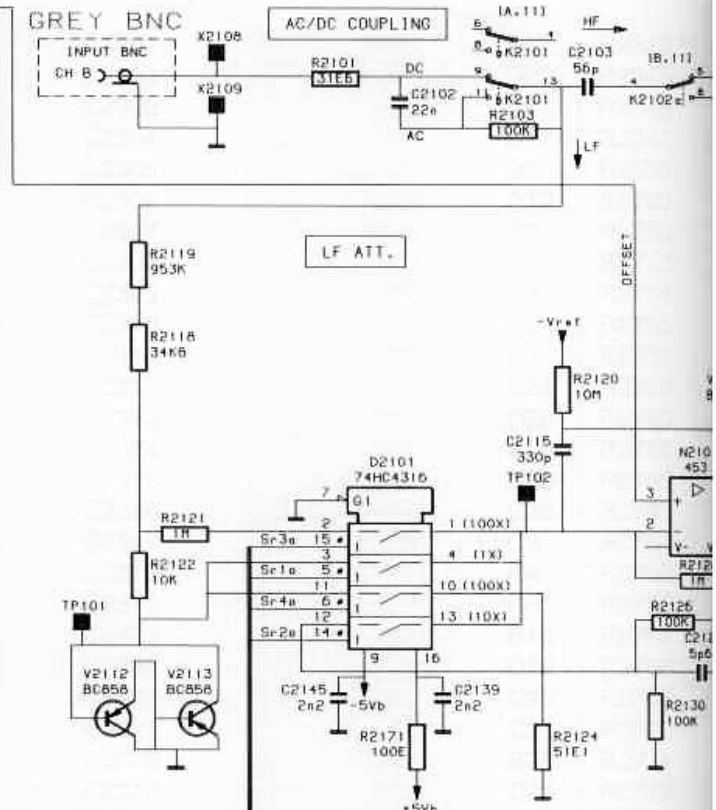
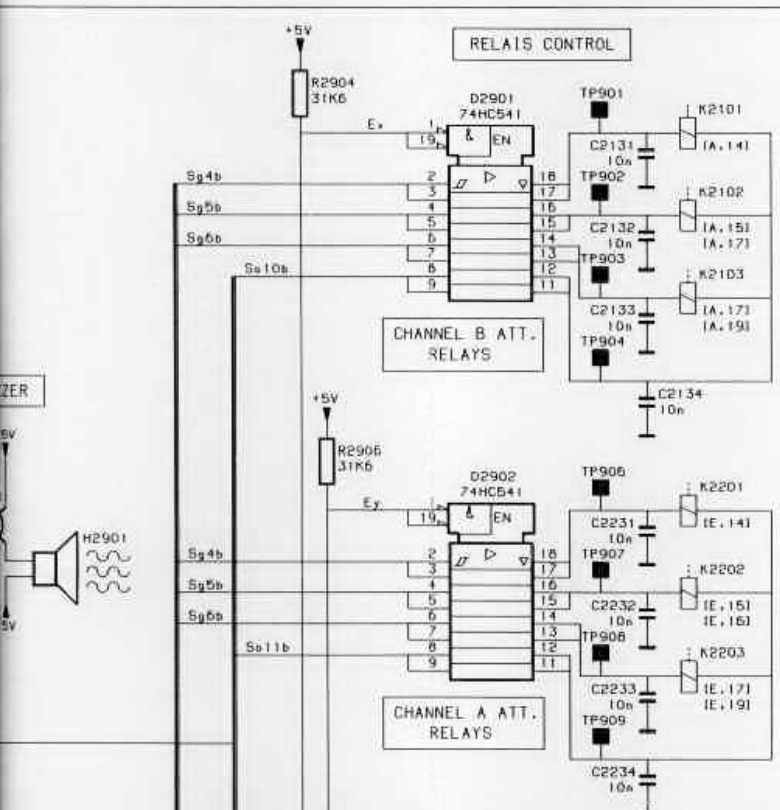
C2102	A14	C2217	F19	D2901	A10	R2125	B16	R2212	F20
C2103	A15	C2218	H22	D2902	C10	R2126	D15	R2213	E21
C2104	A16	C2219	F21	D2903	E10	R2127	D15	R2214	F21
C2105	B19	C2220	H15	D2904	E3	R2128	C15	R2215	F19
C2107	A16	C2222	G19	D2906	E5	R2129	C16	R2215	G15
C2108	A17	C2223	H20	D2907	C2	R2130	D15	R2216	F21
C2109	A18	C2225	E20	D2908	C3	R2131	D16	R2217	E22
C2111	A18	C2226	G2	D2909	C7	R2132	D16	R2218	F13
C2112	A18	C2227	G3	H2901	C8	R2133	C16	R2219	F13
C2113	A18	C2228	E17	K2101	A11	R2134	C17	R2220	G15
C2114	A19	C2229	G8	K2101	A15	R2135	A22	R2221	G13
C2115	C15	C2230	H20	K2101	A14	R2136	C17	R2222	H13
C2116	A19	C2232	D11	K2102	B11	R2137	C18	R2224	H14
C2117	B19	C2233	D11	K2102	A17	R2138	C19	R2224	H22
C2118	D22	C2234	D11	K2103	A19	R2139	C20	R2226	H15
C2119	A21	C2235	G4	K2103	A17	R2140	C20	R2227	H15
C2120	D15	C2236	G13	K2103	B11	R2141	C20	R2228	H15
C2122	C19	C2238	E21	K2201	C11	R2142	C21	R2229	G16
C2123	D20	C2237	E23	K2201	E14	R2143	C22	R2230	H15
C2124	C22	C2240	F22	K2202	E16	R2144	C23	R2231	H16
C2125	A20	C2241	G16	K2202	E15	R2145	C22	R2232	H16
C2126	A2	C2242	J17	K2202	C11	R2146	C23	R2234	G17
C2127	A2	C2243	J17	K2203	D11	R2147	D22	R2235	E22
C2128	A17	C2244	H19	K2203	E19	R2148	A4	R2236	G17
C2129	A7	C2245	H14	K2203	E17	R2149	C22	R2237	G18
C2130	C20	C2246	H19	K2750	F11	R2151	A2	R2238	G19
C2131	A11	C2247	E21	K2751	E11	R2152	A4	R2239	G20
C2132	B11	C2248	F22	L2301	F28	R2153	A3	R2240	G20
C2133	B11	C2304	F26	L2302	E32	R2154	A3	R2241	H20
C2134	C11	C2307	F11	L2303	D25	R2155	B22	R2242	H21
C2135	A4	C2309	F25	L2304	D25	R2157	A6	R2243	H22
C2136	C12	C2309	F28	N2101	C19	R2158	A6	R2245	G22
C2137	A23	C2311	F25	N2101	C15	R2159	A6	R2246	F23
C2138	A21	C2312	F29	N2201	G19	R2160	A23	R2247	H22
C2139	D14	C2313	F28	N2201	G15	R2161	A6	R2248	G4
C2140	B22	C2314	E31	N2302	C31	R2162	B6	R2249	G22
C2141	B16	C2315	F29	R2101	A14	R2163	B6	R2250	H19
C2144	D19	C2316	F27	R2103	A14	R2164	B6	R2251	G2
C2145	D14	C2317	B32	R2104	A16	R2165	D22	R2251	H7
C2146	D19	C2318	B32	R2106	A16	R2166	A6	R2252	H7
C2147	A21	C2319	B32	R2108	A18	R2167	A7	R2252	G4
C2202	E14	C2320	E30	R2109	A19	R2168	B6	R2253	H7
C2203	E15	C2326	C31	R2110	A20	R2169	B6	R2253	G3
C2205	F19	C2340	D25	R2111	B20	R2170	B7	R2254	H4
C2206	E16	C2341	D25	R2112	A20	R2171	D14	R2254	H7
C2207	E16	C2342	D25	R2114	B21	R2172	B22	R2255	F22
C2208	E17	C2804	F11	R2115	B19	R2201	E13	R2257	G7
C2209	F17	C2806	F11	R2116	B21	R2203	E14	R2258	H7
C2210	G13	C2901	B3	R2117	A22	R2204	E15	R2258	G7
C2211	F18	CH A	E12	R2118	B13	R2206	E15	R2259	H8
C2212	E18	D2101	C14	R2119	B13	R2207	G16	R2259	G7
C2213	F18	D2102	C17	R2120	B15	R2208	E17	R2260	E23
C2214	F18	D2201	G14	R2121	C13	R2209	E19	R2265	H22
C2215	G15	D2202	F17	R2122	C13	R2210	E19	R2266	G8
C2216	E19	D2301	E26	R2123	A21	R2211	F20	R2267	G8

CIRCUIT DIAGRAMS

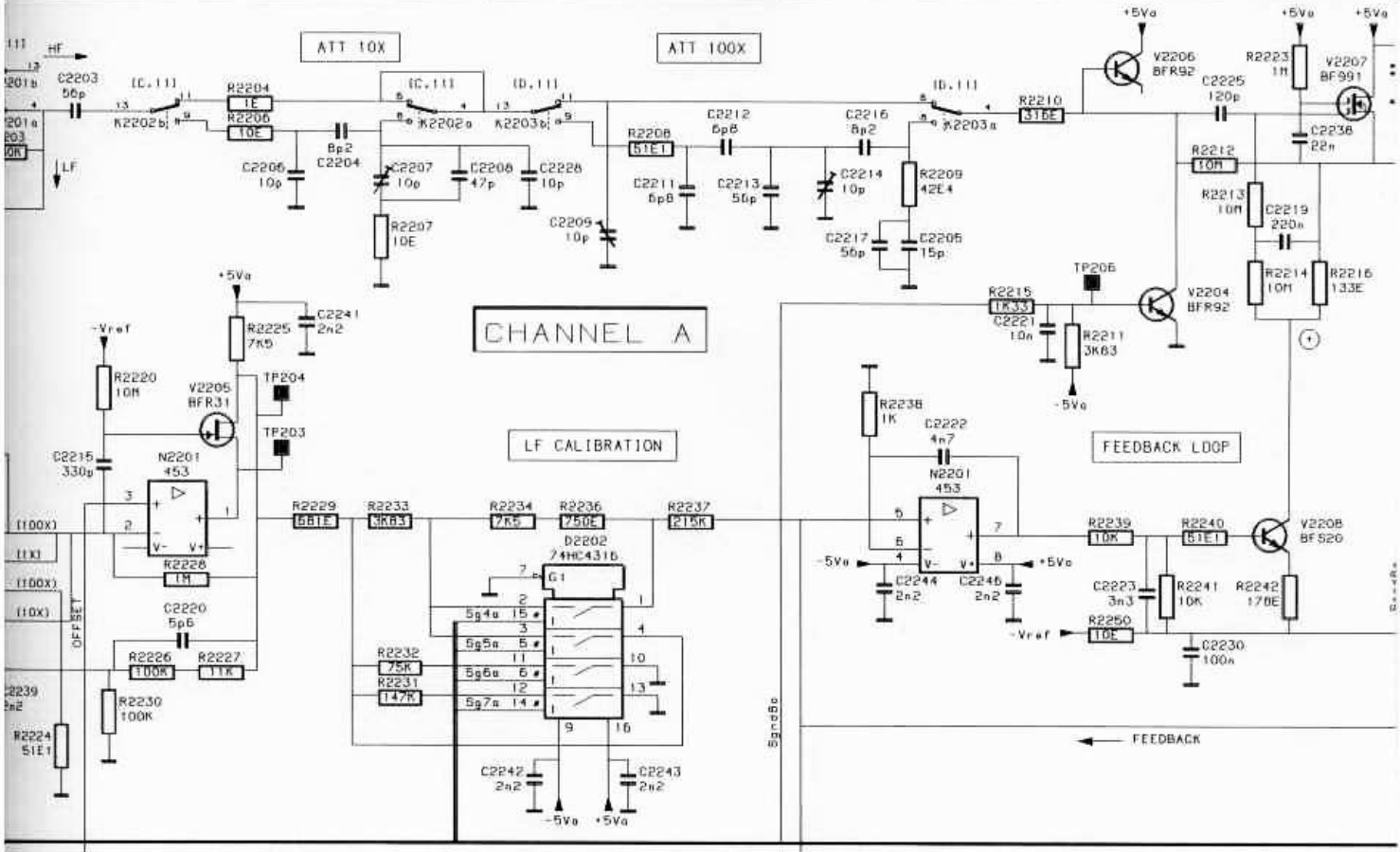
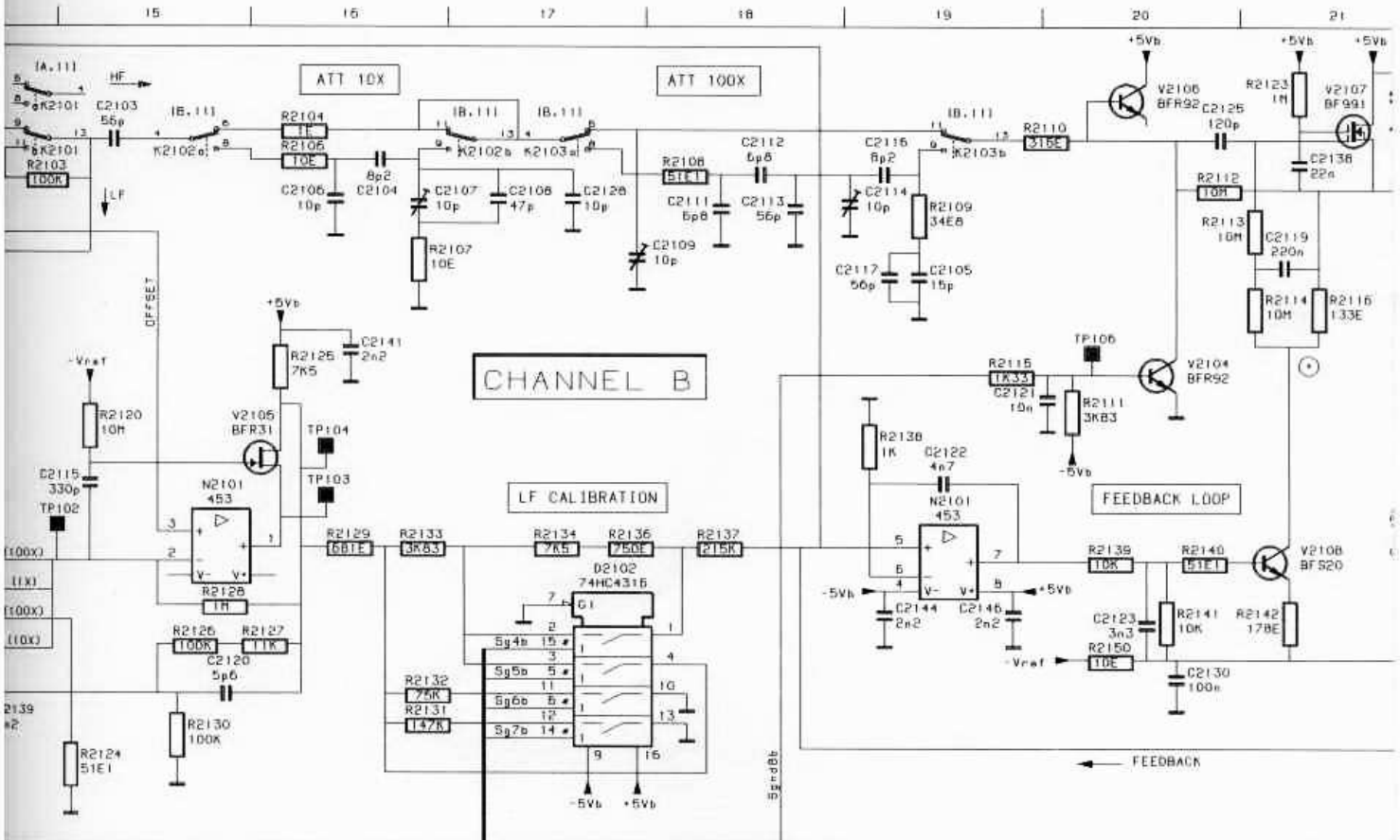
R2270	H8	TP902	B11
R2271	H14	TP903	B11
R2272	F22	TP904	B11
R2301	D25	TP906	C11
R2303	C30	TP907	C11
R2305	F26	TP908	D11
R2312	F27	TP909	D11
R2313	F25	TP911	E11
R2314	F25	TP912	E11
R2315	C28	TP914	F11
R2316	C29	TP916	F3
R2317	C29	TP918	D3
R2318	E31	TP919	D5
R2319	F28	TP921	D7
R2320	F28	V2104	B20
R2321	F28	V2105	B15
R2322	F28	V2106	A20
R2323	B29	V2107	A21
R2324	B29	V2108	C21
R2325	B30	V2109	A23
R2330	C33	V2110	B7
R2331	C32	V2111	C23
R2332	C33	V2112	D12
R2333	C32	V2113	D13
R2334	C33	V2114	B22
R2335	C32	V2204	F20
R2336	C33	V2205	G15
R2337	C32	V2206	E20
R2338	C28	V2207	E21
R2340	E24	V2208	G21
R2341	E24	V2209	E23
R2343	D25	V2210	H8
R2345	C29	V2211	G23
R2346	C29	V2212	H13
R2901	C8	V2213	H13
R2903	B2	V2214	F22
R2904	A9	V2301	B30
R2906	C10	V2302	B30
R2907	B3	V2303	E31
R2908	E2	V2811	F11
R2909	C2	V2812	F11
TP101	D12	V2901	C8
TP103	C16	X2001	G1
TP104	C14	X2001	A1
TP104	C16	X2001	B4
TP106	B20	X2001	B33
TP107	B22	X2001	C1
TP108	A6	X2108	A13
TP109	A3	X2109	A13
TP202	G13	X2208	E13
TP206	F20	X2209	E13
TP207	F23		
TP208	G8		
TP209	G3		
TP331	C29		
TP332	C29		
TP717	F5		
TP901	A11		

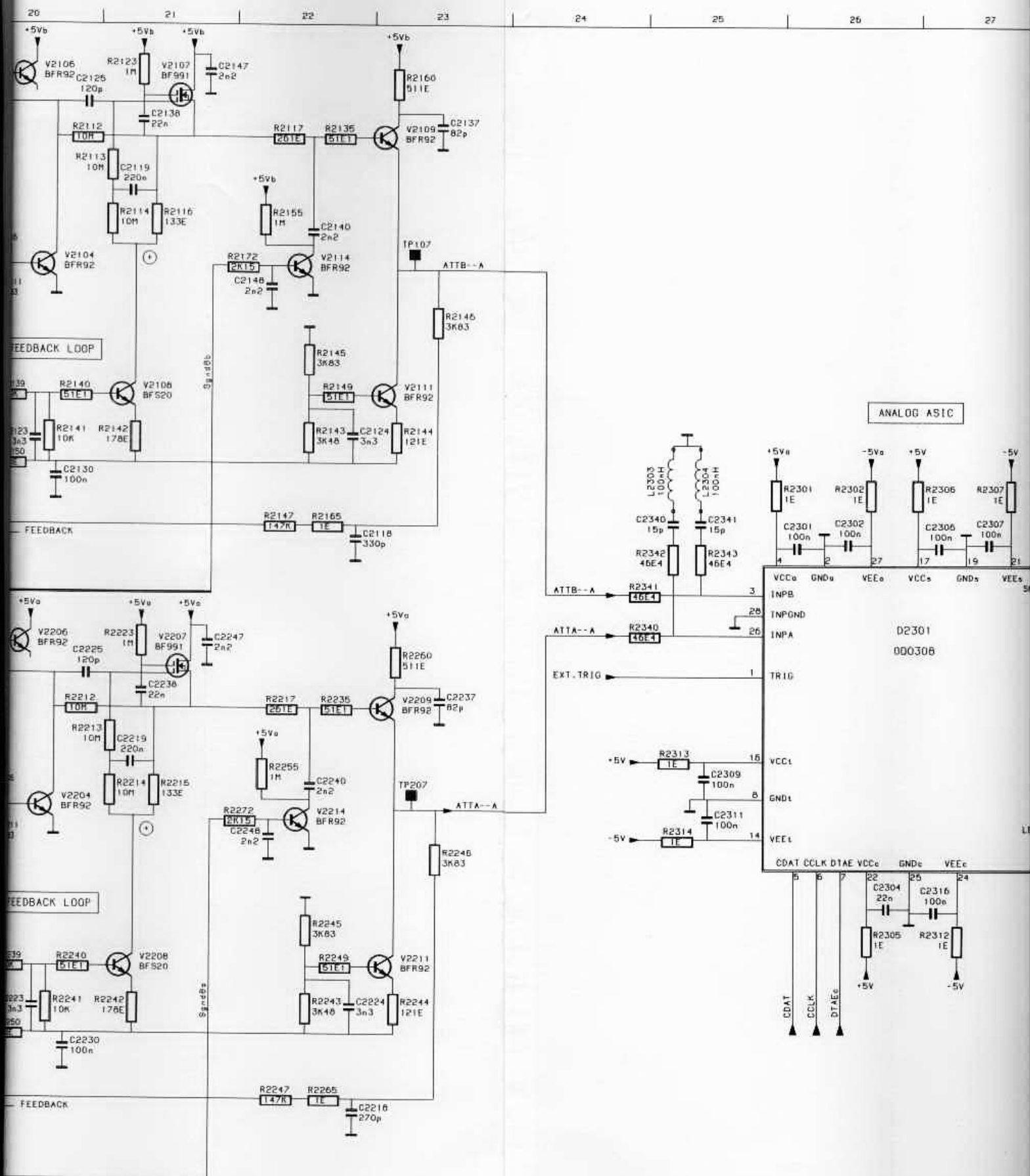






A-RANGE FROM A21





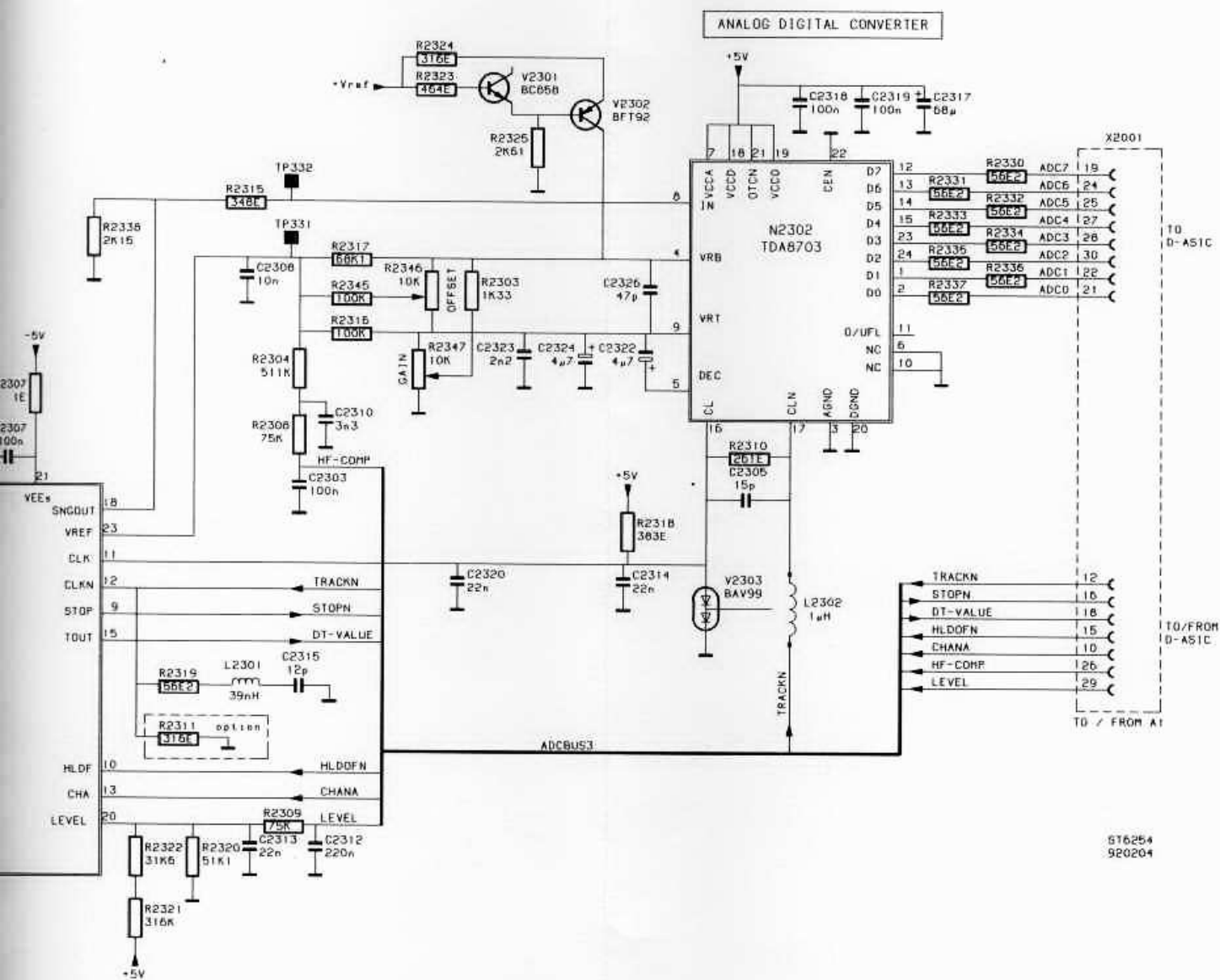


Figure 10.5 Analog A2 circuit diagram A2a

PARTS LOCATION A2 (CIRCUIT DIAGRAM A2b)

C2301	C20	C2868	E17	R2343	C20	R2881	A17
C2302	C21	D2301	D21	R2345	B24	TP331	B23
C2303	C24	D2750	D7	R2346	B24	TP332	B23
C2304	F21	D2751	D17	R2347	C24	TP700	D4
C2305	C26	D2751	D9	R2535	A25	TP701	D4
C2306	C21	D2850	D12	R2729	G3	TP702	B3
C2307	C22	D2850	A2	R2750	C3	TP704	G3
C2308	B23	K2750	D2	R2753	C4	TP706	G4
C2309	E20	K2750	C3	R2754	C5	TP801	D12
C2310	C24	K2751	D4	R2755	D3	TP802	F14
C2311	E24	K2751	F2	R2757	A4	TP803	D15
C2311	E20	L2301	E23	R2759	B3	TP804	E16
C2313	E23	L2302	D26	R2760	D5	TP805	B15
C2314	D25	L2303	C20	R2761	D7	TP806	A16
C2315	E23	L2304	C20	R2762	D10	V2301	A25
C2316	F21	N2302	B26	R2763	D5	V2302	A25
C2317	A27	N2750	C3	R2764	D5	V2303	D26
C2318	A26	N2751	G4	R2766	C5	V2736	D8
C2319	A27	N2751	G3	R2766	E5	V2751	C4
C2320	D24	N2850	B16	R2767	D6	V2752	D4
C2322	C25	N2850	D16	R2768	D6	V2753	D4
C2323	C25	R2301	C20	R2769	D7	V2754	C6
C2324	C25	R2302	C21	R2770	E5	V2755	H5
C2326	B25	R2303	B25	R2771	H3	V2756	C6
C2340	C19	R2304	C23	R2772	H4	V2757	A4
C2704	E4	R2305	F21	R2773	G4	V2758	B3
C2705	H3	R2306	C21	R2774	G4	V2759	F5
C2750	B3	R2307	C22	R2775	E5	V2760	F4
C2751	C5	R2308	C23	R2776	E9	V2761	G4
C2752	D10	R2309	E23	R2777	C4	V2762	F5
C2753	H3	R2310	C26	R2778	C1	V2763	F6
C2754	H3	R2312	F22	R2838	B22	V2764	H5
C2756	E4	R2313	E20	R2853	E13	V2765	D2
C2757	D6	R2314	E20	R2854	E13	V2766	D2
C2758	B3	R2315	B23	R2856	D13	V2767	D8
C2758	D6	R2316	C24	R2857	E13	V2768	E10
C2759	E6	R2317	B24	R2858	E13	V2769	C4
C2760	B3	R2318	D25	R2859	E14	V2851	E13
C2761	C6	R2319	E23	R2861	E15	V2852	F15
C2762	D9	R2320	E23	R2862	E15	V2853	B14
C2763	D8	R2321	F23	R2864	E16	V2854	B17
C2801	C1	R2322	E23	R2865	B14	X2001	F1
C2850	E13	R2323	A24	R2866	E17	X2001	B28
C2851	E14	R2324	A24	R2867	F14	X2201	F1
C2852	E14	R2330	B28	R2868	F14		
C2853	E14	R2331	B27	R2869	F15		
C2854	E15	R2332	B28	R2870	C14		
C2856	E15	R2333	B27	R2871	A15		
C2857	E13	R2334	B28	R2872	A15		
C2861	A15	R2335	B27	R2873	B15		
C2862	B15	R2336	B28	R2875	B15		
C2863	E16	R2337	B27	R2876	A15		
C2864	A16	R2340	D19	R2877	A16		
C2866	F14	R2341	D19	R2878	B16		
C2867	E17	R2342	C19	R2879	B16		

CIRCUIT DIAGRAMS

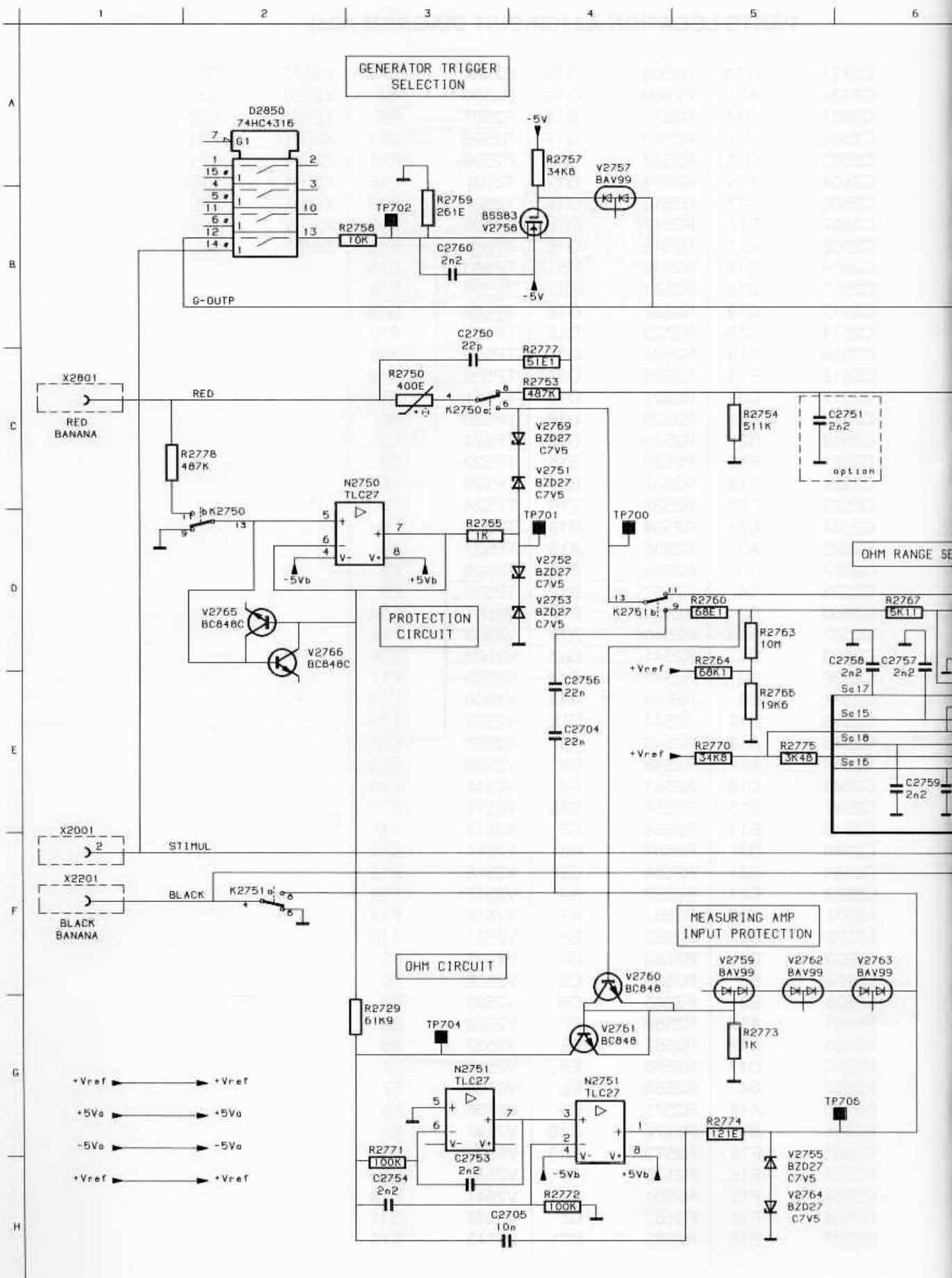


Figure 10.6 Analog A2 circuit diagram A2b

5

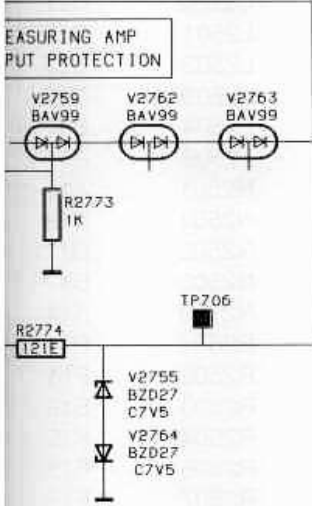
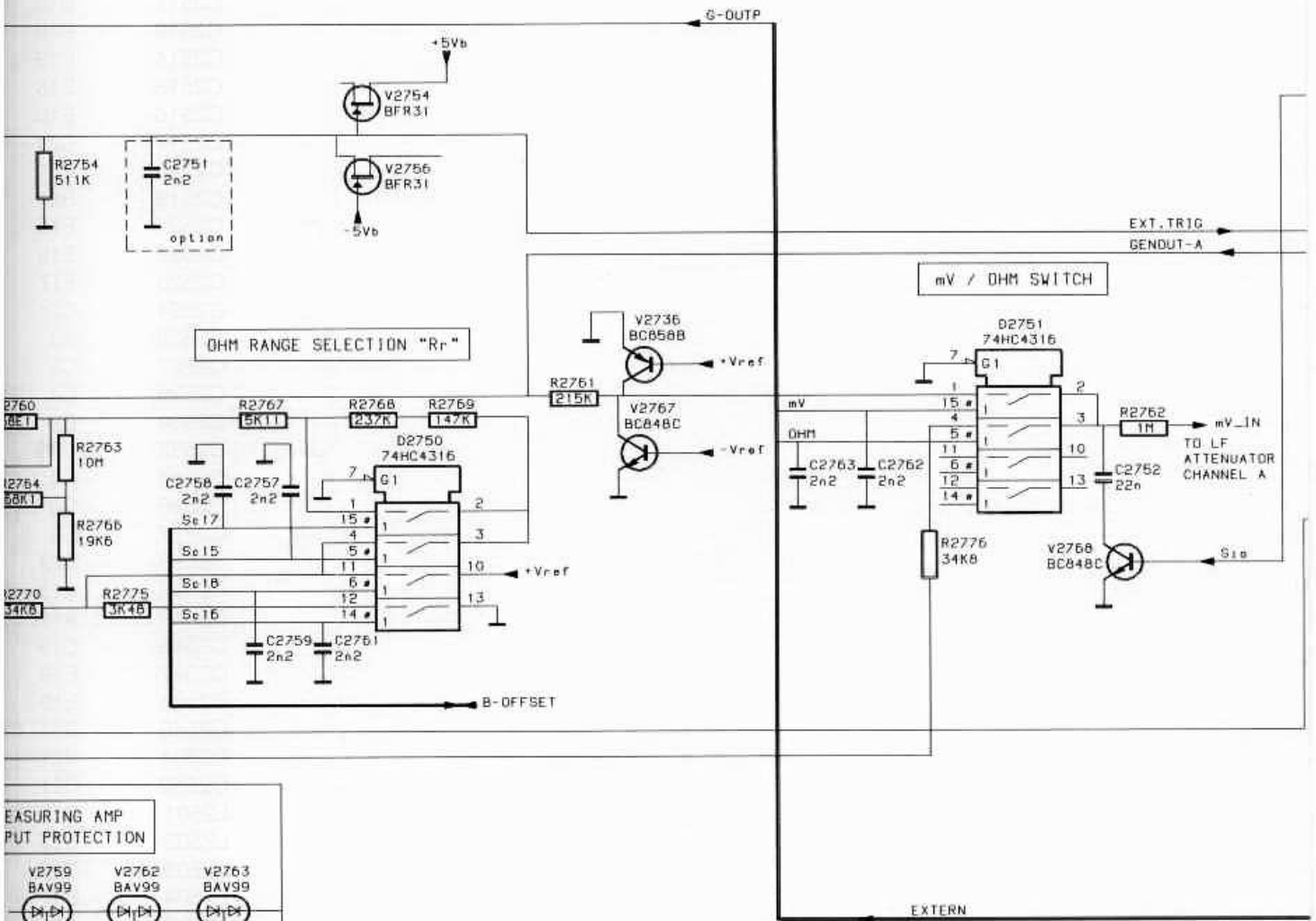
6

7

8

9

10



10

11

12

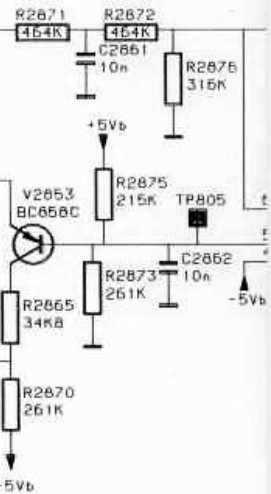
13

14

15

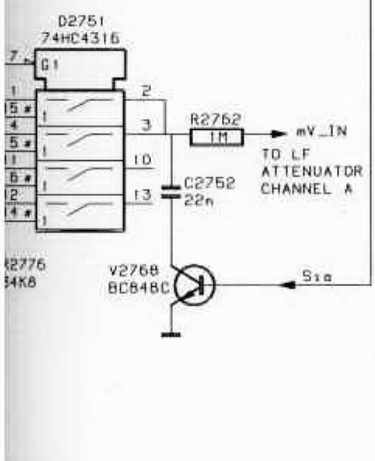
CURRENT SOURCE

STIMUL

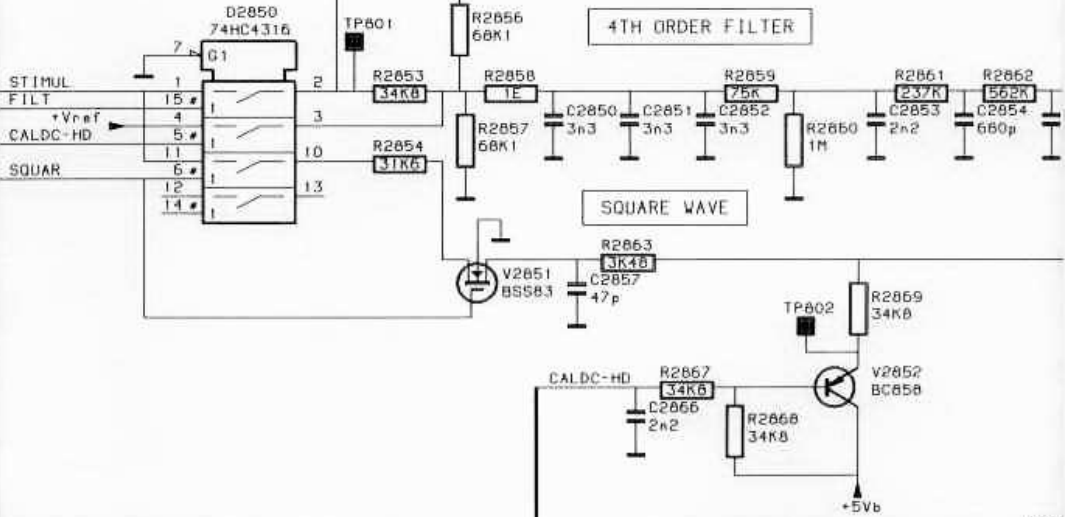


EXT. TRIG
GENOUT-A

V / OHM SWITCH



4TH ORDER FILTER

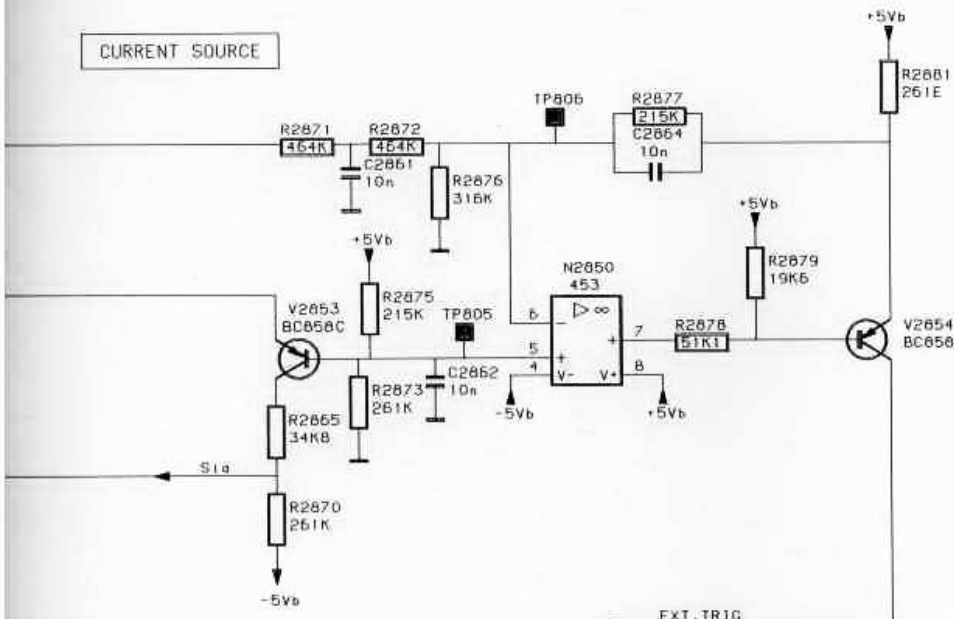


SQUARE WAVE

RN

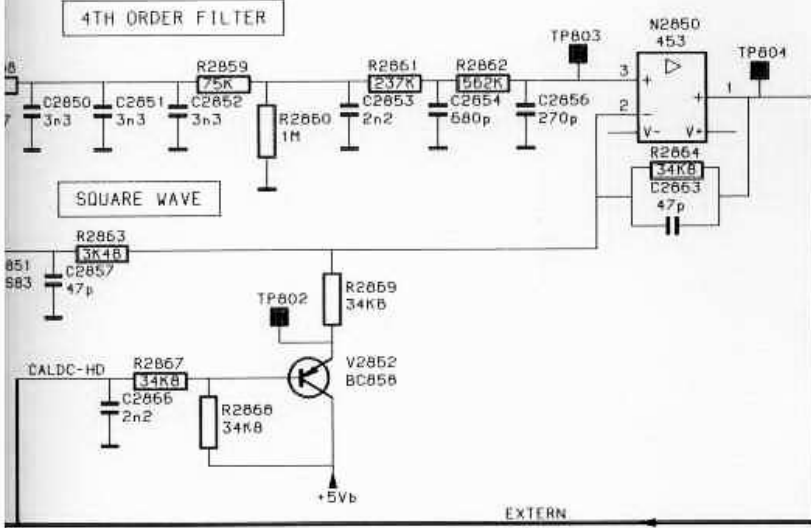
EXTI

CURRENT SOURCE

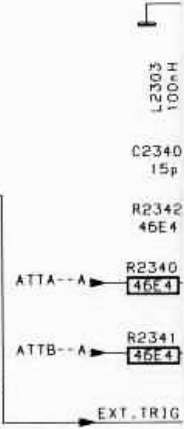
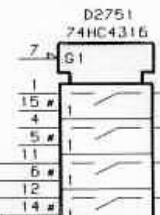
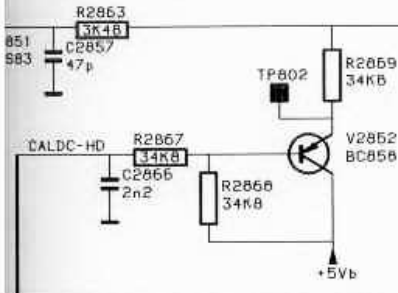


EXT. TRIG
GENOUT - A

4TH ORDER FILTER



SQUARE WAVE



EXTERN

18

19

20

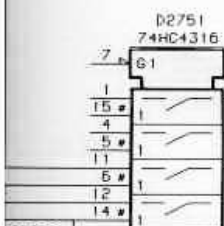
21

22

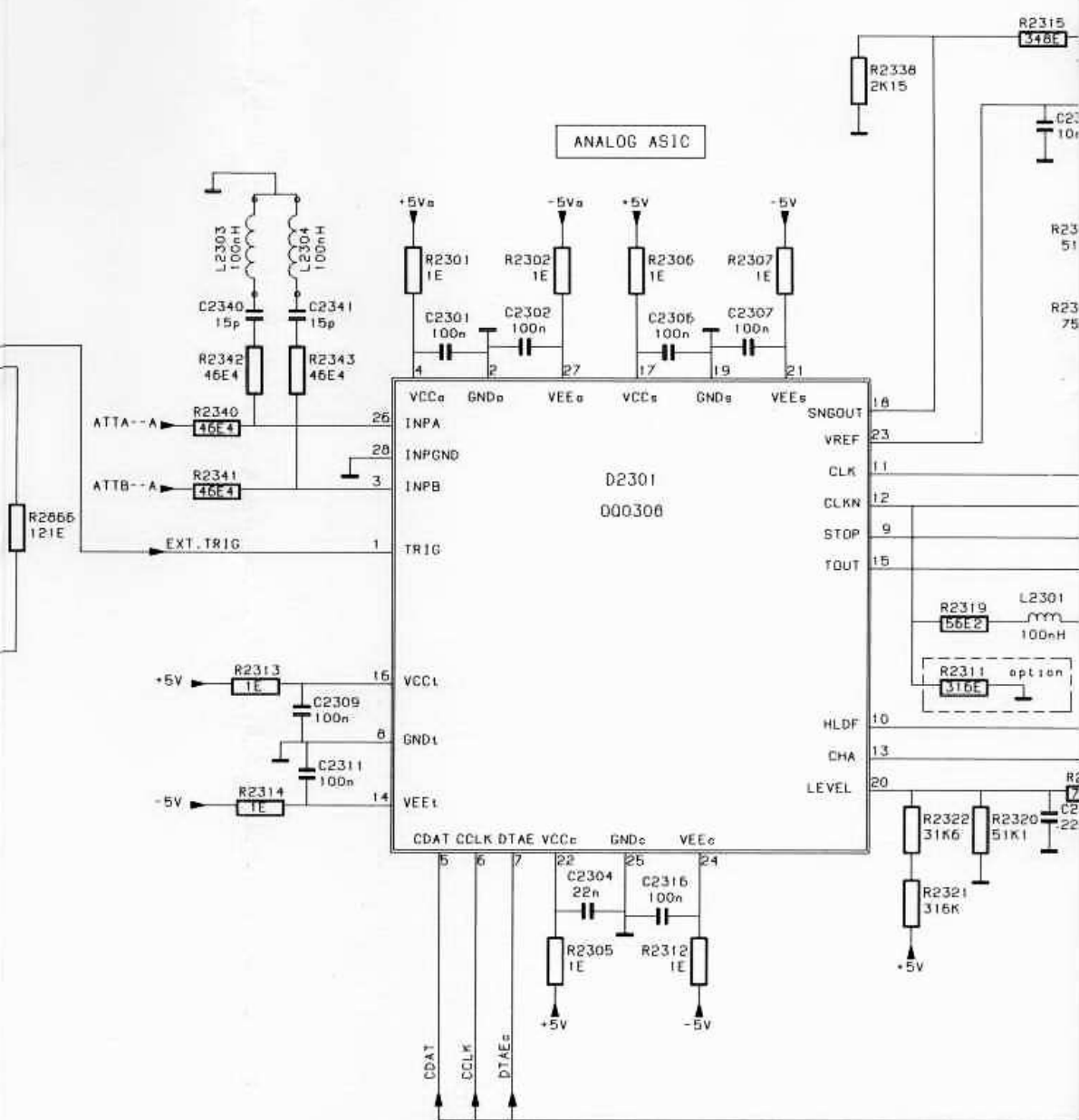
23

R2881
251E

V2854
BC858



C2866
2n2



R2315
348E

C2310
10r

R2313
1E

R2314
1E

R2319
56E2

L2301
100nH

R2311
316E

R2322
31K6

R2320
51K1

R2321
316K

C2310
10r

R2313
1E

R2314
1E

C2309
100n

C2311
100n

R2305
1E

R2312
1E

C2304
22n

C2316
100n

PARTS LOCATION A2 (CIRCUIT DIAGRAM A2c)

C2431	G13	R2508	G15	R2584	E18	V2544	D17
C2434	A5	R2509	G16	R2596	G7	V2550	G5
C2501	G14	R2511	G16	R2597	G8	X2001	C22
C2502	E14	R2512	G17	R2598	D17	X2001	G11
C2503	G15	R2513	G17	R2599	E14	X2001	E11
C2504	E15	R2514	G17	T2501	F16	X2001	C22
C2506	C17	R2516	G18	T2501	E16	X2501	B1
C2507	F17	R2517	G18	TP501	F13	X2502	H11
C2508	E17	R2518	G18	TP502	F13	Z2501	A2
C2509	D17	R2519	F8	TP503	E15		
C2511	D19	R2521	F8	TP504	F18		
C2512	D19	R2522	C18	TP506	G18		
C2514	C19	R2523	D18	TP507	A15		
C2515	E18	R2524	D18	TP508	A15		
C2516	E18	R2526	C17	TP509	D19		
C2517	C21	R2527	D18	TP511	E18		
C2518	B21	R2528	D19	TP520	B1		
C2519	B21	R2529	D20	TP521	C2		
C2521	E19	R2530	B15	TP522	B4		
C2522	E19	R2531	B21	TP523	B5		
C2523	F17	R2532	E18	TP524	C5		
C2524	C21	R2534	B13	TP526	B8		
C2526	A3	R2535	A13	TP527	F9		
C2527	C3	R2536	B12	TP528	F9		
C2529	C4	R2537	B12	TP529	D9		
C2530	B3	R2538	B13	V2501	E14		
C2532	G13	R2540	A14	V2502	F15		
C2533	C4	R2541	G15	V2503	E16		
C2536	G6	R2542	G13	V2504	F17		
C2537	B6	R2543	A13	V2506	C17		
C2538	B13	R2544	F15	V2507	E16		
C2543	A13	R2546	A8	V2508	F13		
C2544	A14	R2548	B3	V2509	D20		
C2546	C19	R2551	C4	V2511	E20		
C2547	E19	R2554	BA5	V2512	B14		
C2548	E19	R2556	C5	V2513	A15		
C2549	B21	R2557	B5	V2514	G15		
C2551	B21	R2558	C5	V2516	E13		
C2552	C21	R2559	A4	V2517	F13		
L2501	C18	R2561	A5	V2518	E13		
L2502	E17	R2562	B6	V2521	A10		
L2503	C20	R2563	D8	V2523	F5		
L2504	B8	R2564	C8	V2526	F5		
L2506	B8	R2565	C8	V2527	B6		
N2501	A13	R2566	F7	V2528	B6		
N2501	D19	R2567	F8	V2532	A8		
N2502	D17	R2568	E8	V2533	F7		
N2503	B4	R2569	E8	V2534	F7		
N2750	A14	R2571	D8	V2536	F8		
R2501	E14	R2572	G10	V2537	E9		
R2502	F14	R2573	G10	V2538	F9		
R2503	E16	R2575	A9	V2539	G9		
R2504	F15	R2581	A9	V2541	E10		
R2506	F15	R2582	D8	V2542	G11		
R2507	E15	R2583	B21	V2543	E10		

Bureau de Liaison Philips

El Mauradia, Alger
Tel: 60 14 05

Angola

LUANDA
Tel: 244-2-372250

Philips Antilana N.V.

Willemstad, Curacao
Tel: 599-9-615277

Philips Argentina S.A.

1430 Buenos Aires
Tel: 54-1-5414106/5417141
Tel: 54-1-5422411/5422451*

Coasin S.A.

Buenos Aires, Argentina
Tel: (54) (1) 552-5248

Philips Scientific & Industrial PTY Ltd.

Auckland 3
New Zealand
Tel: 09-894180

Philips Scientific & Industrial PTY Ltd.

North Ryde
Sydney New South Wales 2113
Tel: 02-888 0416
Tel: 02-888 8222*

Philips Scientific & Industrial PTY Ltd.

Melbourne Victoria 3151
Tel: 03-235 3666

Philips Scientific & Industrial PTY Ltd.

Adelaide South Australia 5008
Tel: 08-3482888

Philips Scientific & Industrial PTY Ltd.

Brisbane Queensland 4101
Tel: 07-8440191

Philips Scientific & Industrial PTY Ltd.

Perth West Australia 6104
Tel: 09-277-4199

Philips Professionelle Elektronik GmbH

A 1102 Wien
Tel: 0222/60101-0

Philips Professionelle Elektronik GmbH

1101 Wien
Tel: 0222-60101 ext. 818

Messrs. Mohamed Fakhroo & Bros

Bahrain
Tel: 973-253529

Philips Bangladesh Ltd.

DHAKA
Tel: 325081-5

Motherland Corporation

Dacca-3, Bangladesh
Tel: 880257249

Manning Wilkinson & Challenor

Bridgetown
Tel: 436-6185

Philips Professional Systems S.A.

1070 Brussel
Tel: 02-525 6692
Tel: 02-525 6694*

Holmes, Williams and Purvey

Hamilton
Tel: 809-2955000

E.P.T.A. INGENIERA S.R.L.

LA PAZ
Tel: 3-25952

Coasin Bolivia S.R.L.

La Paz, Bolivia
Tel: (591) (2) 40962

Philips Medical Systems Ltda.

04661 Sao Paulo S.P.
Tel: 55-11-5234811

ATP Hi-Tek Electronica Ltda.

Sao Paulo, Brazil
Tel: (55) (11) 4215477

Brunei (via Singapore) Philips Project Development (S) PTY Ltd.

Singapore 1231
Tel: 65-3502000

Rank O'Connor's, 5nd Bhd

Bandar Seri Begawan
Negara Brunei Darussalam
Tel: (673) (2) 23109 or 23557

Interconsult (Philips Service)*

1309 SOFIA
Tel: 359-2-200785

Fluke Electronics Canada Inc.

Burnaby, British Columbia
Tel: (604) 439-9004.

Fluke Electronics Canada Inc.

Mississauga, Ontario
L4Z 1X9 Canada
Tel: (416) 890-7600

Fluke Electronics Canada Inc.

Ottawa, Ontario
Tel: (613) 723-9453

Fluke Electronics Canada Inc.

Dorval, Quebec
Tel: (514) 885-0022

Fluke Electronics Canada Inc.

Calgary, Alberta
Tel: (403) 291-5215

Philips Chilena S.A. de Product Electr.

Casilla 2678
Santiago de Chile
Tel: 56-2-770038

Itronsa

Santiago, Chile
Tel: (56) (2) 232-4308

Philips HongKong Ltd.

Tel: 7735588

Fluke International Corp.

Beijing 100004
People's Republic of China
Tel: (86) 1 512-3435

Industrias Philips de Columbia S.A.

Apartado Aereo 4282
Bogota
Tel: 57 1-2600600

Sistemas E Instrumentation, Ltda.

Bogota, Colombia
Tel: (57) 232-4532

Electrocom

San Jose
Costa Rica
Tel: 53-0083/57

Branch Office Brno*

61300 BRNO
Tel: 42-2-377426

Obnova Pamatek n.p.*

16041 PRAHA 6
Tel: 42-2-594426/60351

D. Ouzounian M. Soutanian & Co. Ltd.

Nicosia
Tel: 357-2-442220

Philips A/S Test & Measurement

DK 2300 Kobenhavn S
Tel: +45-32-882100

Philips Ecuador S.A.

1188Y Cordero
Tel: 593-2-565835

Proteco Coasin Cia., Ltda.

Quito, Ecuador
Tel: (59) 32 529684

Proteco Coasin Cia., Ltda.

Guayaquil, Ecuador
Tel: (593) (4) 387519

Philips Egypt Branch

Middle East B.V.
Dokki, Cairo
Tel: 20-2-3490922

Philips Ethiopia (Priv. Ltd. Co.)

Addis Ababa
Tel: 010-231-1-518300

Awa Southwest Pacific

Suva, Fiji
Tel: (679) 312079

OY Philips AB

SF-02631 Espoo
Tel: +358 0 50261

S.A. Philips Industrielle et Commerciale

93002 Bobigny Cedex
Tel: (1) 49428080
Tel: (1) 49428073*

Philips GmbH - EWI

D-3500 Kassel
Tel: 0561-501466

Philips GmbH - EWI

D 1000 Berlin 30
Tel: 030-21006364

Philips GmbH - EWI

D 4300 Essen 11
Tel: 0201-3610-245

Philips GmbH - EWI

D 6000 Frankfurt 90
Tel: 069-794093-31

Philips GmbH - EWI

D 2000 Hamburg 73
Tel: 040-6797-278
Tel: 040-6797471*

Philips GmbH - EWI

D 8045 Ismaning
Tel: 089-9605-121

Philips GmbH - EWI

D 7012 Fellbach
Tel: 0711-5204-121
Tel: 0711-5204150*

Malawi Engineering Co. Ltd.

ACCRA
Fax: 233-667-131

Philips Scientific Test & Measurement

Watford Herts WD2 4TT
Tel: 0923-240511

Philips Scientific Test & Measurement

Cambridge CB1 2PX
Tel: 0223-358866

Philips S.A. Hellénique

15 GR 17778 Tavros/Athens
Tel: 30-1-4894911

Guyana Stores Ltd.

GEORGETOWN
TLX: 2212 GUYSTORE GY

Philips Hong Kong Ltd.

Hung Hom, Kowloon, HongKong
Tel: 7735588

Schmidt & Co (H.K.), Ltd.

Wanchai, Hong Kong
Tel: (852) (5) 8330-222

MTA-MMSZ Philips Service*

1502 BUDAPEST
Tel: 36-1-1869760

Heimelistaeki S.F.

125 Reykjavik
Tel: 354-1-691500

Sameind H.F.

125 Reykjavik
Tel: 354-1-25833

Peico Electronics & Electricals Ltd. I&E Division

Bombay 400 025
Tel: 022 4930311/4930590

Peico Electronics & Electricals Ltd. I&E Division
Calcutta 700 020
Tel: 473621

Peico Electronics & Electricals Ltd. I&E Division
New Delhi 110 015
Tel: 530153
Tel: 533956/57*

Peico Electronics & Electricals Ltd. I&E Division
Madras 600 006
Tel: 472341

Peico Electronics & Electricals Ltd. I&E Division
Bangalore 560 001
Tel: 579119/579164

Hinditron Services Pvt., Ltd.
Andheri (E) Bombay
400 093, India
Tel: (91) (22) 636-4560
(91) (22) 634-8268

Hinditron Services Pvt., Ltd.
Bangalore 560 080, India
Tel: (91) (812) 363-139

Hinditron Services Pvt., Ltd.
Calcutta 700 017, India
Tel: (91) (33) 432-628

Hinditron Services Pvt., Ltd.
New Delhi, 110 019, India
Tel: (91) (11)-641-0380

Hinditron Services Pvt., Ltd.
Secunderabad 500 003, India
Tel: (91) (842) 821-1117

P.T Daeng Brothers
Jakarta 12950
Tel: 021 5201122

Fluke International Corp.
Everett, WA 98206-9090
Tel: (206) 356-5500

Philips Iran Ltd.
Private Joint Stock Comp.
TEHRAN
Tel: 98-21-674138/675158

Al-Tel Co. Ltd.
Baghdad
Tel: 964-1-7191982

Circuit Specialists Ltd.
Castleroy, Limerick
Tel: 061 330333

Philips S.p.A.
20052 Monza
Tel: (039) 3635240/8/9

NF Circuit Design Block Co., Ltd.
Kokokuku, Yokohama 223
Tel: (045) 452-0411

Nihon Philips Corporation*
Minatu-ku Tohyo 108
Tel: 4485511

John Fluke Mfg. Co., Inc.
Minato-ku, Tokyo 105, Japan
Tel: (81) (3) 434-0181

John Fluke Mfg. Co. Inc.
Chuo-ku, Osaka 541
Japan
Tel: (81) (6) 229-0871

Jordan Medical Supplies & Services
Amman Jordan
Tel: 962-6-819929

Philips Kenya Ltd.
Nairobi
Tel: 254-2-557999

Korea, Republic of Myoung Corporation
Seoul, Korea
Tel: (82) (2) 784-9942

IL Myoung, Inc.
Seoul, Korea
Tel: 82 2 552-8582-4

Myoung Corporation
Taegu, Korea
Tel: 82 53 753-8163/4

Yusaf A. Alghanim & Sons
KUWAIT
Tel: 965-4843988

Philips Industries (Korea) Ltd.
Seoul
Tel: 82-2-7970378

Hanmac Electronics Co. Ltd.
Seoul
Tel: 82-2-5537441

Electronic Supplies S.A.R.L.
Beirut
Tel: 01-894243

Philips Luxembourg
L-1818 Howald
Tel: 496111

Electronic Systems (Malaysia)
Sdn. Bhd.
Petaling Jaya - Selangor 46200
Tel: 60-3-7560112

Mecomb Malaysia Sdn. Bhd.
Selangor, Malaysia
Tel: (60) (3) 774-3422

Charles A. Micallef & Co. Ltd.
Valletta
Tel: 356-221168

Mexicana de Electronica Industrial S.A. (Mixel)
C.P. 03100, Mexico
Tel: (90) (5) 680-4323

Mixel Servicios en Computacion*
Mexico D.F.
Tel: 90-5-563-5411

Samtel*
Casablanca
Tel: 243050

Somaciel
Casablanca 05
Tel: 308051/52

Interelectra E.E.
MAPUTO
TLX: 6203 NEGONHO

Bhajaratna Engineering & Sales (P) Ltd.
Kathmandu
Tel: 2-25134

Associated Enterprises
Kathmandu, Nepal
Tel: 13868

Philips Nederland B.V.
Test en Meetapparaten
5000 AC Tilburg
Tel: 013-390112

Philips Nederland
Technische Service Prof. Akt.*
5652 AJ Eindhoven
Tel: 040-723293

Philips Scientific & Industrial PTY Ltd. Test & Measurement Dept.
Auckland 3
Tel: 09-084-160

Associated Electronic Products (Nigeria) Ltd.
Lagos
Tel: 234-1-900160/69

Norsk A/S Philips
0612 Oslo 6
Tel: 47-2-741010
Tel: 47-2-290942

Messrs. Mustafa Jawad Trading Co.
RUWI - MUSKAT
Tel: 968-709955

Philips Electrical Co. of Pakistan (Private) Ltd.
Karachi - 74400
Tel: 92-21-725772-8

Fluke International Corp.
Everett, WA 98206-9090
Tel: (206) 356-5500
TLX: 185103 FLUKE UT
FAX: (206) 356-5116

Philips del Paraguay S.A.
Asuncion
Tel: 595-21-291924/291934

Philips Peruana S.A.
Lima 100
Tel: 51-14-350059

Importaciones y Representaciones Electronicas S.A.
Lima 1, Peru
Tel: (51) (14) 28-8650

Philips Industrial Development Inc.
Makati, Metro Manila
Philippines
Tel: 810-0161

Spark Radio & Electronics, Corp.
Philippines
Tel: (63) (2) 775192

Electronic Instrument Service*
60-188 PODZNAN
Tel: 48-61-481998

Philips Portuguesa, S.A.R.L. Division of I & E
1009 Lisboa Codex
Tel: 1-657181

Philips Portuguesa* Division I & E
4100 Porto
Tel: (2) 678278

Darwish Trading Company
Doha, Qatar
Tel: 974-434308

Polytechnic Inst. Bucarest* L.C.M.S. Philips Service
BUCAREST 70100
Tel: 40-0-505935

Messrs. A. Rajab & A. Silsilah
Jeddah 21411
Tel: 966-2-6610006

Messrs. A. Rajab & A. Silsilah
Riyadh 11411
Tel: 966-1-4122425

Messrs. A. Rajab & A. Silsilah
Damman
Tel: 966-3-8322596/8331870

Philips Project Development (S) PTY Ltd.
Singapore 9131
Tel: 65-3502000

Rank O'Connor's Pte Ltd.
Singapore 0511
Tel: (65) 473-7944

South African Philips PTY Ltd.
Johannesburg 2000
Tel: 27-11-889-3911

South African Philips PTY Ltd.*
Martindale, New Ville 2092
Tel: 27-11-470-5937

Philips Iberica SAE
08004 Barcelona
Tel: 34-3-3361061

Philips Iberica*
28027 Madrid
Tel: 34-1-4042200

Philips Iberica SAE*
48012 Bilbao
Tel: 34-4-4313800

Hayleys Electronics & Engineering Ltd.
COLOMBO 10
Tel: 94-1-699087

Computerlink Data Systems, Ltd.

Colombo, 5, Sri Lanka
Tel: (94) (1) 502202/3

C. Kersten & Co. N.V.

P.O. Box 1808
PARIMARIBO

Surtel

PARIMARIBO
Tel: 597-72118/77880

Philips Kistaindustri AB

16493 Kista
Tel: 46-8-7031370

Philips AG Test und Messtechnik

8027 Zurich
Tel: 01 4882390

Philips SA Test et Mesure

1196 Gland
Tel: 022/647171

Al-Shahed Electronics and**Trading Co.**

Damascus
Tel: 228003/218605

Philips Taiwan Ltd.

10446 Taipei
Tel: 886-2-5097666

Schmidt Scientific

Taipei
Taiwan
Tel: 02-5005779

Philips (Tanzania) Ltd.

Dar es Salaam
Tel: 2555129571

Philips Electrical Co. of**Thailand Ltd.**

Bangkok 10500
Tel: 66-2-233-6330/9

Measuretronix Ltd.

Bangkok 10240
Thailand
Tel: (66) (2) 375-2733

Compression & Power Services (1988) Ltd.

SAN FERNANDO By Pass
Tel: 653-5445/6/7

S.T.I.E.T.

32 bis rue Ben Ghedahem
Tunis
Tel: 348666

Turk Philips Ticaret A.S.

80640 Levent-Istanbul
Tel: 90-1-1792770

Al Sanani Trading Est.

Abu Dhabi, U.A.E.
Tel: 971-2-771370

Haris Al-Afaq Ltd.

Dubai, U.A.E.
Tel: 971-4-283625

Industrias Philips del Uruguay S.A.

Montevideo, Uruguay
Tel: (598) (2) 921111

N.V. Philips Gloeilampenfabrieken

MOSCOW
Tel: 7095-2302485

Infomedia Sotrudnichestvo

121111 MOSCOW
Tel: 240 52 52

Inds. Venezolanas Philips S.A.

Caracas 1010-A
Tel: 58-2-905.7061

Cossin C.A.

Caracas 1070-A, Venezuela
Tel: (58) (2) 241-03-09

Rashed Trading & Travel Agency

Sana'a, Yemen
Tel: 967-2-273231

N.V. Philips Gloeilampenfabrieken

BEOGRAD
Tel: 38-11-625344

Jugoelectro*

11070 BEOGRAD
Tel: 38-11-178134

Technicar Servis*

41000 ZAGREB
Tel: 041-276333

Philips Electronics S.A.R.L.

Kinshasa
Tel: 31693

Philips Electrical Zambia Ltd.

Lusaka
Tel: 218511/218701

Philips Electrical (Pvt.) Ltd.

Harare
Tel: 263-4-47211

For Countries not listed above:**Philips Export B.V. & E Export****Test & Measurement**

Building HVW-3
PO Box 218
5600 MD Eindhoven
The Netherlands
Tel: +31 40 766546
Fax: +31 40 766612
TLX 35000 phtc nl

Fluke Int'l Corp.

PO Box 9090
Mail Stop 206A
Everett, WA 98206-9090
Tel: 206-356-5500
Fax: (206) 356-5116
TLX: 185103 FLUKE UT

USA**Huntsville**

Huntsville, AL 35805-6202
(205) 837-0581

Phoenix

Tempe, AZ 85282
(602) 438-8314

Irvine*

Irvine, CA 92714
(714) 863-9031

Nothorn*

Fremont, CA 94538
(415) 651-5112

Denver*

Aurora, CO 80014
(303) 695-1000

Hartford

Glastonbury, CT 06033
(203) 659-3541

Altamonte Springs*

Altamonte Springs, FL 32803
(407) 331-4881

Atlanta

Marietta, GA 30067
(404) 953-4747

Chicago*

Palatine, IL 60067
(708) 705-0500

Indianapolis

Indianapolis, IN 46268
(317) 875-7870

Boston

Billercia, MA 01821
(508) 663-2400

Rockville*

Rockville, MD 20852
(301) 770-1570

Detroit

Plymouth, MI 48170
(313) 522-9140

Minneapolis

Eagan, MN 55121
(612) 854-5526

St. Louis

St. Louis, MO 63146
(314) 993-3805

Paramus*

Paramus, NJ 07652
(201) 262-9550

Rochester

Rochester, NY 14622
(716) 323-1400

Greensboro

Greensboro, NC 27408
(919) 273-1918

Cleveland

Middleburg Heights, OH 44130
(216) 234-4540

Philadelphia

Malvern, PA 19355
(215) 647-9550

Dallas*

Dallas, TX 75229
(214) 869-0311

San Antonio

San Antonio, TX 78216
(512) 340-0498

Seattle*

Bellevue, WA 98005
(206) 881-6966

Northern California

Fremont, California
(1) (415) 651-5112

Southern California

Irvine, California
(1) (714) 863-9031

Denver

Aurora, Colorado
(1) (303) 695-1171

Orlando

Altamonte Springs, Florida
(1) (407) 331-2929

Chicago

Palatine, Illinois
(1) (708) 705-0500

Washington D.C.

Rockville, Maryland
(1) (301) 770-1576

Paramus

Paramus, New Jersey
(1) (201) 599-9500

Dallas

Carrollton, Texas
(1) (214) 406-1000

Seattle

Everett, Washington
(1) (206) 356-5560

OTHER COUNTRIES:**Buenos Aires, Argentina**

Coasin S.A.
(54) (1) 552-5248

La Paz, Bolivia

Coasin Bolivia S.R.L.
(591) (2) 340-962 or 363-365

Sao Paulo, Brazil

ATP/Hi-Tek Electronica Ltda.
(55) (11) 421-5477

Mississauga, Ontario, Canada

Fluke Electronics Canada Inc.
(416) 890-7600

Santiago, Chile

Itronsa
(56) (2) 232-4308

Beijing, People's Republic of China

Fluke International Corp.
(86) (1) 512-3435

Bogota, Colombia

Sistemas E Instrumentation, Ltda.
(57) 287-5424

Quito, Ecuador

Proteco Coasin Cia., Ltda.
(593) (2) 230-283

Wanchai, Hong Kong

Schmidt & Co (H.K.), Ltd.
(852) (5) 833-0222

Tel Aviv, Israel

R.D.T. Electronics Engineering Ltd.
(972) (3) 548-3737

Tokyo, Japan

John Fluke Mfg. Co., Inc.
(81) (3) 3434-0181

Seoul, Korea

IL Myoung, Inc.
(82) (2) 552-8582-4

Selangor, Malaysia

Mecomb Malaysia Sdn. Bhd.
(60) (3) 774-3422

Colonia del Valle, Mexico

Mexicana de Electronica Industrial, S.A. (Mexel)
(52) (5) 682-8040

Lima, Peru

Importaciones y Representaciones Electronicas S.A.
(51) (14) 28-8650

Metro Manila, Philippines

Spark Radio & Electronics, Corp.
(63) (2) 700-821

Singapore, Republic of Singapore

Rank O'Connor's Singapore PTE Ltd.
(65) 473-7944

Taipei, Taiwan, R.O.C.

Schmidt Scientific Taiwan
(886) (2) 501-3468

Bangkok, Thailand

Measuretronix Ltd.
(66) (2) 375-2733-4

Montevideo, Uruguay

Coasin Uruguay S.A.
(598) (2) 789-015

Caracas, Venezuela

Coasin C.A.
(58) (2) 241-03-09

FOR COUNTRIES NOT LISTED ABOVE:**Fluke International Corp.**

PO Box 9090
Mail Stop 206A
Everett, WA 98206-9090
U.S.A.

Tel: (1) (206) 356-5500

Fax: (1) (206) 356-5116

Tlx: 185103 FLUKE UT

CIRCUIT DIAGRAMS

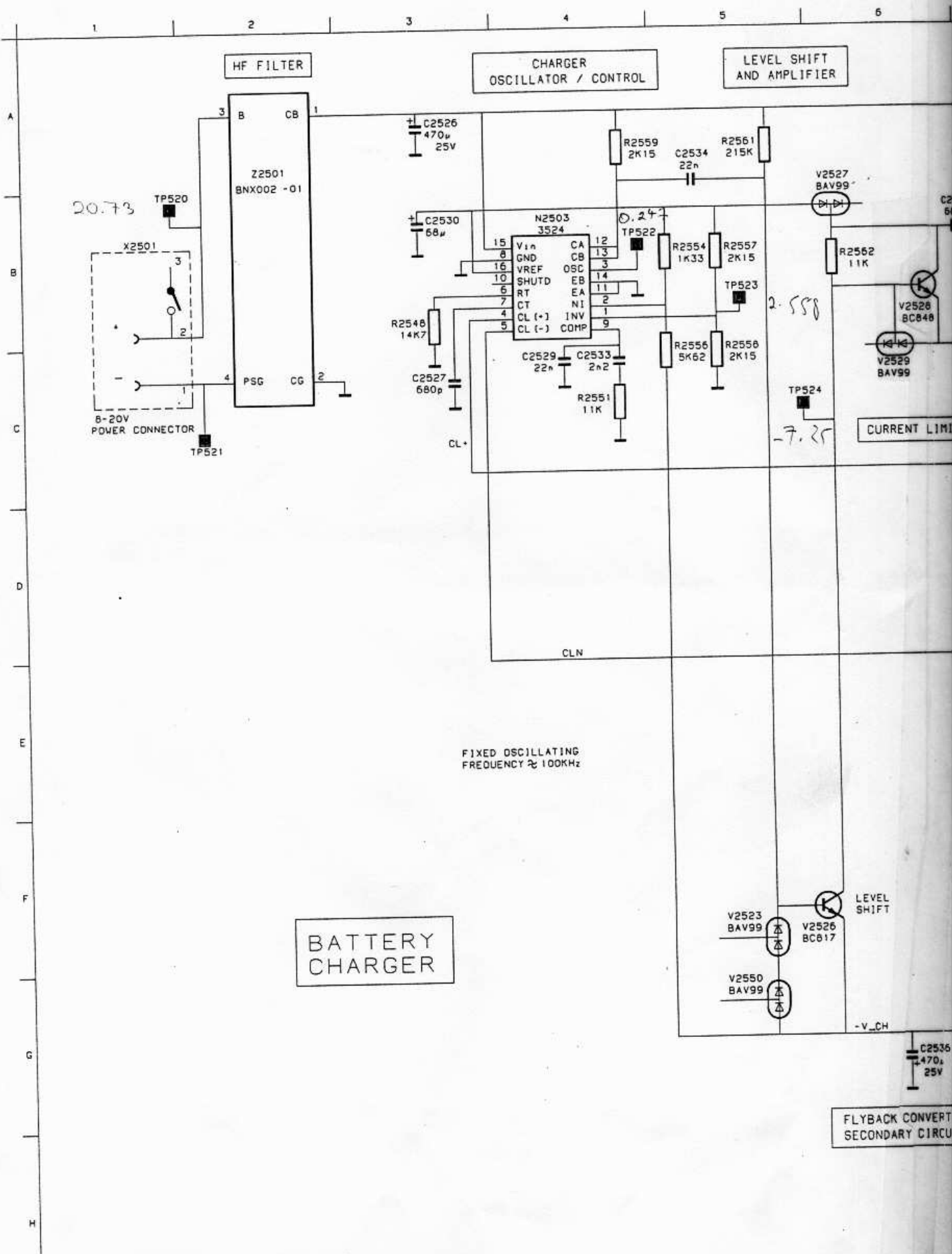
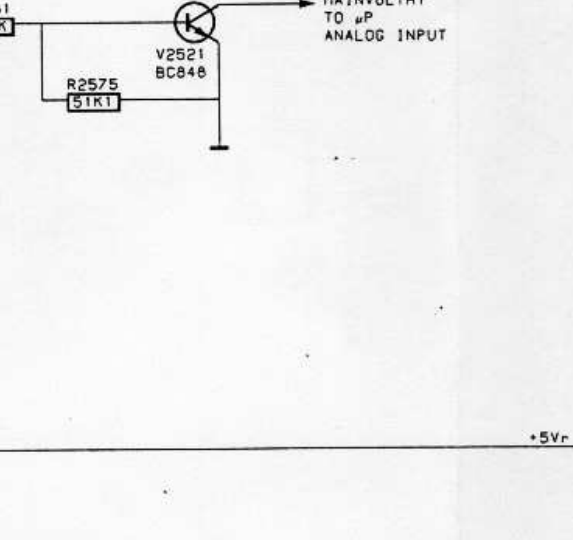
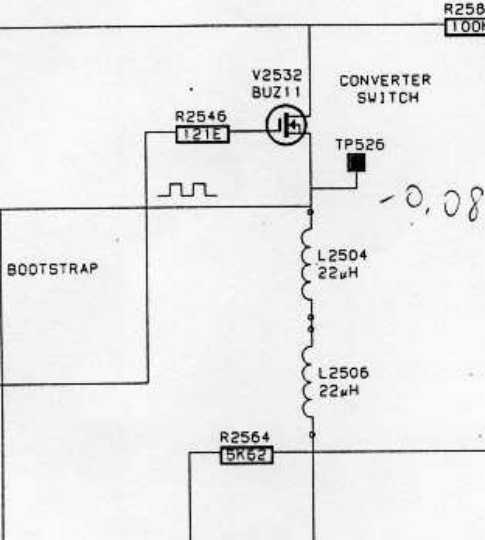
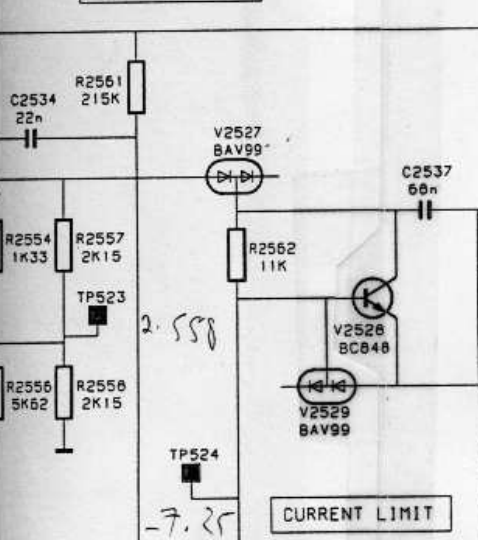
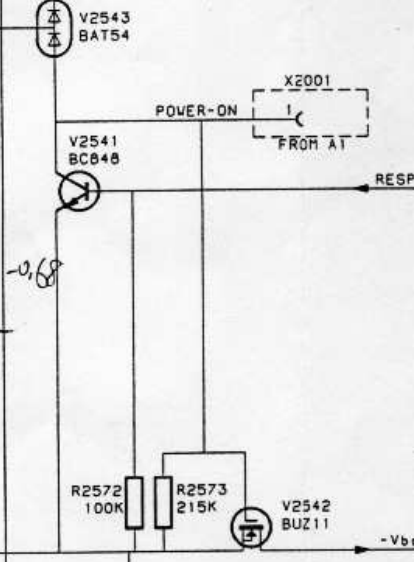
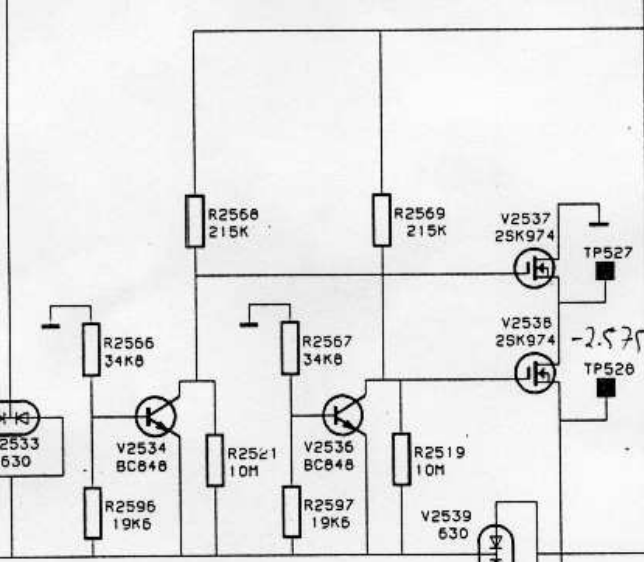
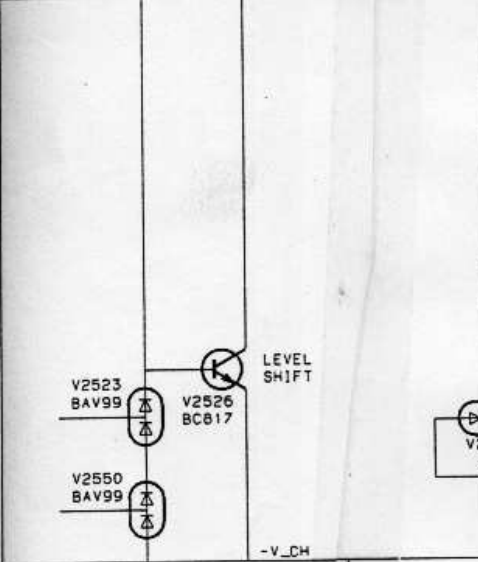
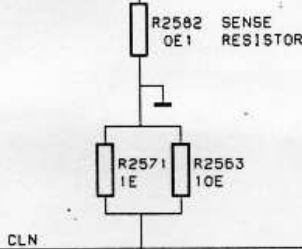


Figure 10.7 Analog A2 circuit diagram A2c

LEVEL SHIFT AND AMPLIFIER



CURRENT LIMIT

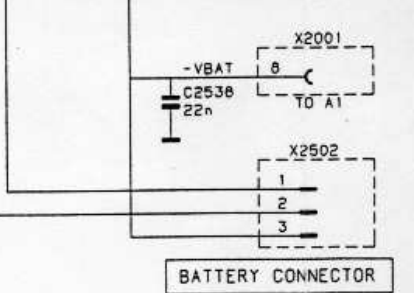


FLYBACK CONVERTER SECONDARY CIRCUIT

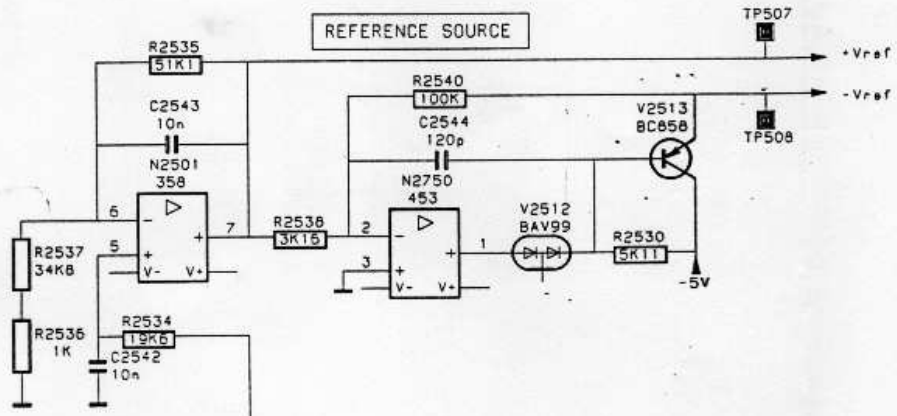


BATTERY CHARGE PROTECTION

BATTERY CONNECTOR



REFERENCE SOURCE



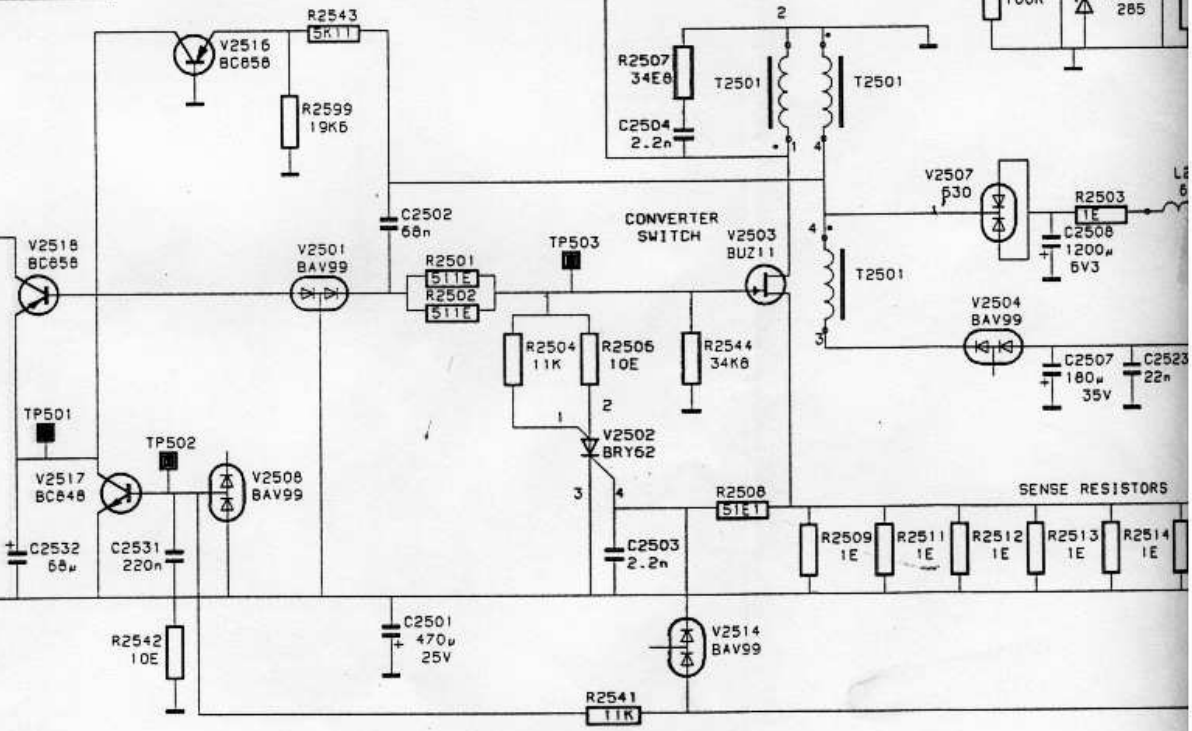
SELF
POWER SUP

+5Vr

RSSLSTN

UNDER VOLTAGE
DETECTION

OSCILLATOR



1.2V

001
R AT

RESPQWHT

~5V (N₂Cod)
~8V (LINE VOLTAGE)

002
CONNECTOR

VARIABLE OSCILLATING
FREQUENCY

18

19

20

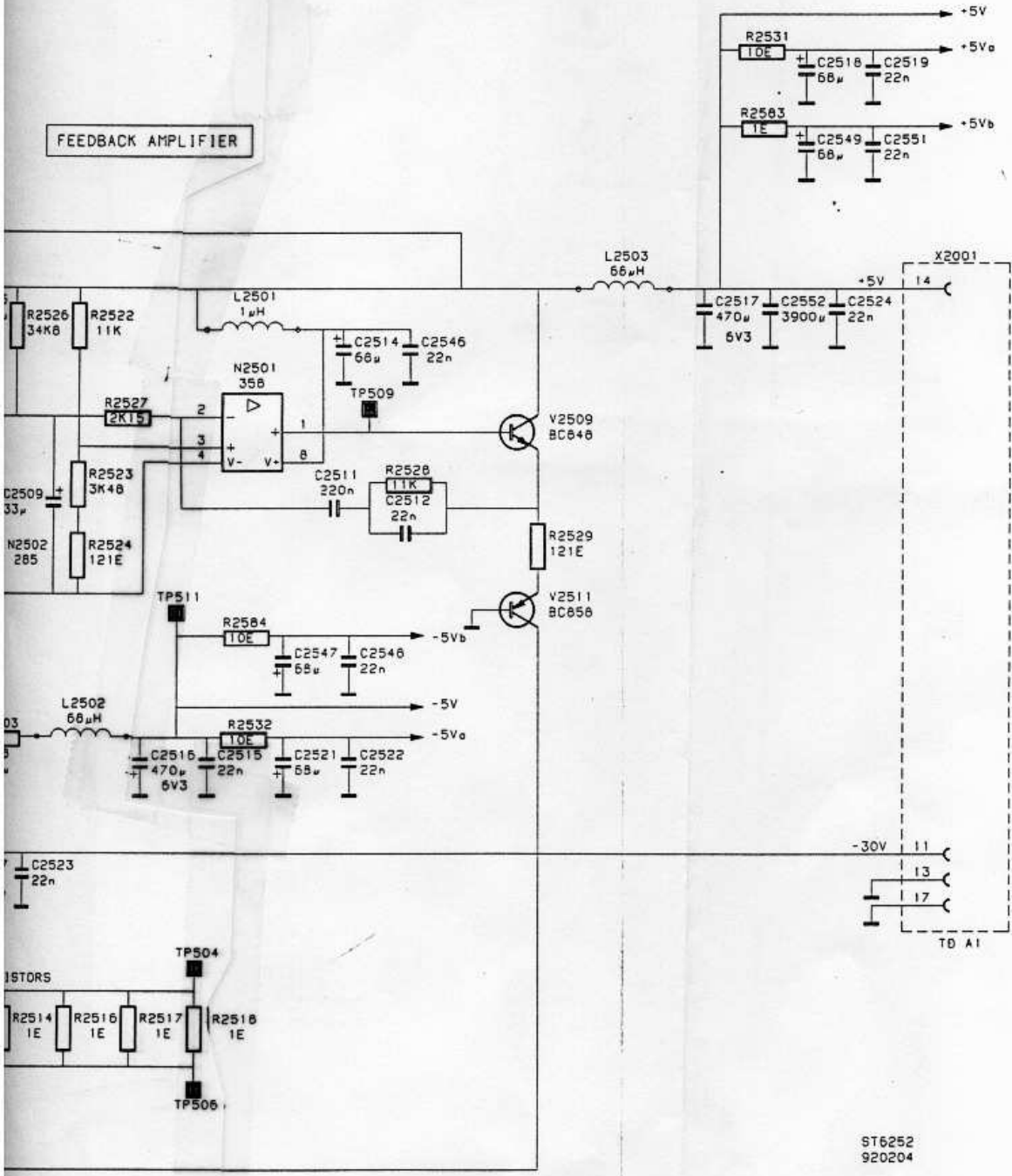
21

22

23

LF OSCILLATING
SUPPLY (S.O.P.S.)

FEEDBACK AMPLIFIER



ST6252
920204