

RESTRICTED

TM 11-850 N

WAR DEPARTMENT

TECHNICAL MANUAL

RADIO RECEIVER BC-312-N

RADIO RECEIVER BC-312-NX

RADIO RECEIVER BC-342-N

RADIO RECEIVER BC-314-G

RADIO RECEIVER BC-344-D

February 4, 1943

RESTRICTED

TECHNICAL MANUAL

No. 11-850 N

WAR DEPARTMENT

Washington, February 4, 1943

RADIO RECEIVER BC-312-N
 RADIO RECEIVER BC-312-NX
 RADIO RECEIVER BC-342-N
 RADIO RECEIVER BC-314-G
 RADIO RECEIVER BC-344-D

TABLE OF CONTENTS

	Paragraph
SECTION I	DESCRIPTION
	1
	2
	3
	4
SECTION II	EMPLOYMENT
	5
	6
SECTION III	PREPARATION FOR USE
	7
	8
	9
	10
	11
	12
	13
SECTION IV	MAINTENANCE
	14
	15
	16
	17
	18
	19
	20

(Continued)

TABLE OF CONTENTS (Continued)

SECTION V	SUPPLEMENTARY DATA	Paragraph
	Tables of Voltages.....	21
	Chart of Minimum Performance.....	22
	Chart of Normal Performance.....	23
	Tabular List of Replaceable Parts for Radio Receiver BC-312-N.....	24
	Tabular List of Replaceable Parts for Radio Receiver BC-312-NX.....	25
	Tabular List of Replaceable Parts for Radio Receiver BC-342-N.....	26
	Tabular List of Replaceable Parts for Radio Receiver BC-314-G.....	27
	Tabular List of Replaceable Parts for Radio Receiver BC-344-D.....	28
	Index of Manufacturers.....	29

LIST OF ILLUSTRATIONS

Figure No.		Page
1	Radio Receiver BC-312-N, Front View	6
2	Radio Receiver BC-312-NX, Front View.....	21
3	Radio Receiver BC-342-N, Front View.....	21
4	Radio Receiver BC-314-G, Front View.....	22
5	Radio Receiver BC-344-D, Front View.....	22
6	Radio Receiver BC-312-N, Circuit Diagram.....	23
7	Radio Receiver BC-312-NX, Circuit Diagram.....	24
8	Radio Receiver BC-342-N, Circuit Diagram.....	25
9	Radio Receiver BC-314-G, Circuit Diagram.....	26
10	Radio Receiver BC-344-D, Circuit Diagram.....	27
11	Radio Receivers BC-312-N, BC-312-NX and BC-342-N, Wiring Diagram.....	28
12	Radio Receivers BC-314-G and BC-344-D, Wiring Diagram.....	29

DESTRUCTION OF ABANDONED MATERIEL IN THE COMBAT ZONE

In case it should become necessary to prevent the capture of this equipment, and when ordered to do so, DESTROY IT SO THAT NO PART OF IT CAN BE SALVAGED, RECOGNIZED, OR USED BY THE ENEMY, BURN ALL PAPERS AND BOOKS.

MEANS:—

1. Explosives, when provided.
2. Hammers, axes, sledges, or whatever heavy object are readily available.
3. Burning by means of incendiaries such as gasoline, oil, paper or wood.
4. Grenades and shots from available arms.

PROCEDURE:—

1. Obliterate all identifying marks. Destroy nameplates and circuit labels.
2. Demolish all panels, castings, switch and instrument-boards.
3. Destroy all controls, switches, relays, connecting means and meters.
4. Rip out all wiring in electrical equipment. Smash gas, oil, and water cooling systems in gas-engine generators, etc.
5. Smash every electrical or mechanical part whether rotating, moving or fixed.
6. Break up all operating instruments such as keys, phones, microphones, etc.
7. Destroy all classes of carrying cases, straps, containers, etc.

DISPOSAL:—

1. Where possible, and time permits, bury all debris or dispose of it in streams or other bodies of water.

SAFETY NOTICE

HANDLE ALL OF THE CONTROLS IN THESE RECEIVERS WITH THE GREATEST CARE. FORCING ANY CONTROL BEYOND ITS NORMAL STOP WILL CAUSE SERIOUS DAMAGE.

BEFORE THE RECEIVER CHASSIS IS REMOVED FROM THE CABINET ALWAYS DISCONNECT THE POWER CORD FROM THE POWER SOURCE.

BE CAREFUL TO OBSERVE ALL PRECAUTIONS IN SERVICING THESE RECEIVERS. SERVICING SHOULD BE ATTEMPTED ONLY BY COMPETENT PERSONNEL SUPPLIED WITH ADEQUATE EQUIPMENT.

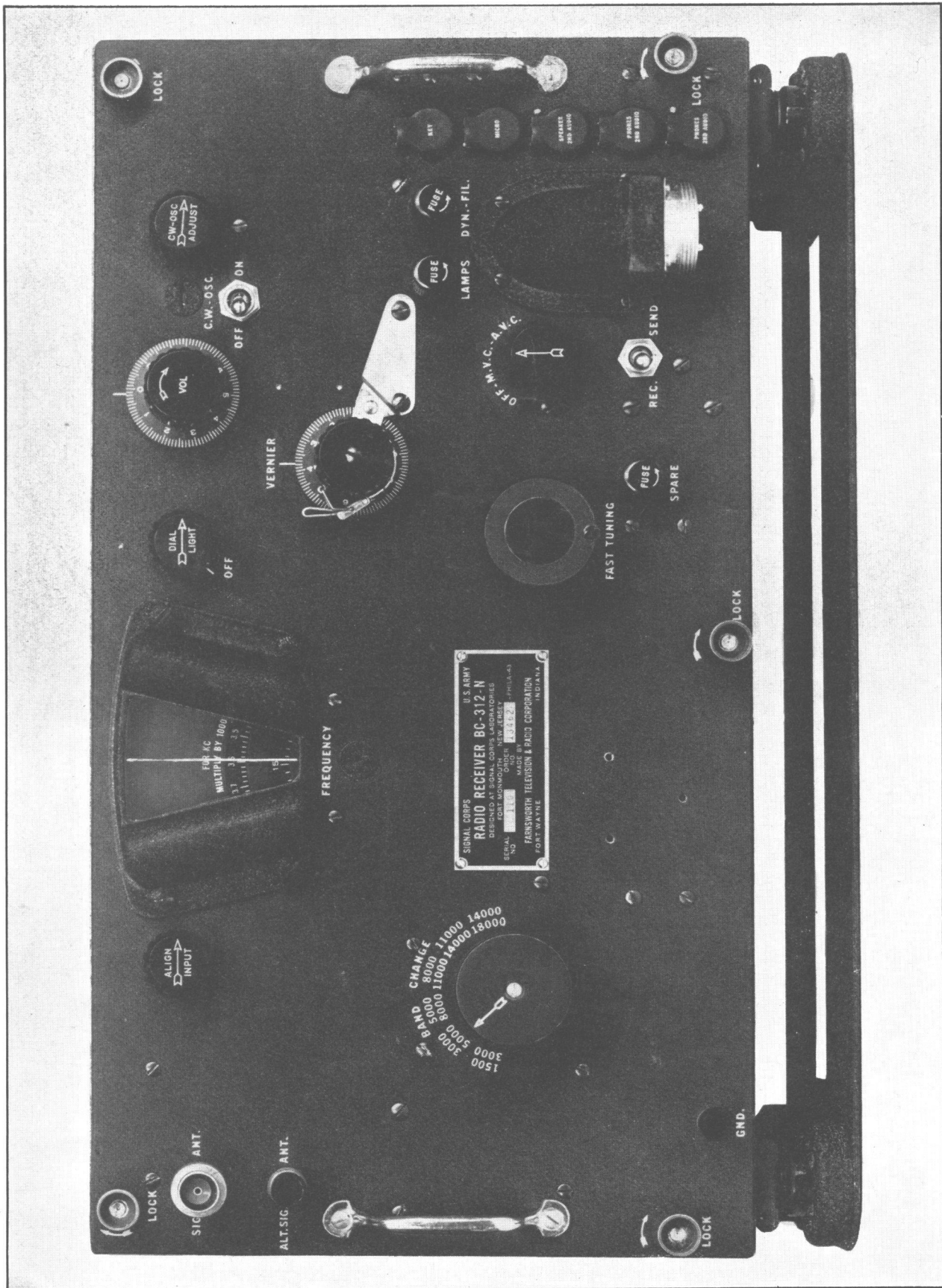

FIGURE 1, RADIO RECEIVER BC-312-N, FRONT VIEW.

SECTION I DESCRIPTION

1. General:

Radio Receivers BC-312-N, BC-312-NX, BC-342-N, BC-314-G and BC-344-D are of the multi-band, integral-coil, superheterodyne type. Metal tubes are employed in all stages except as the first intermediate-frequency amplifier, second intermediate-frequency amplifier and second detector-first audio amplifier. These latter stages are equipped with "GT" (glass, tubular) type tubes. These radio receivers are designed to receive an amplitude modulated signal. Provision is made for the reception of continuous wave (c-w), tone modulated (m-c-w), or voice modulated signals. The circuit also provides reception using either automatic or manual control of volume. Each receiver has two stages of radio-frequency amplification, a first detector (mixer) stage, two stages of intermediate-frequency amplification, a combined second detector and first stage of audio-frequency amplification, and a separate stage of audio-frequency amplification. Also each receiver has a separate high-frequency oscillator and a separate c-w beat oscillator. The intermediate-frequency amplifier in Radio Receiver BC-342-N only is designed to permit the use of a crystal filter circuit.

2. List of Main Components:

Each radio receiver is issued with the necessary vacuum tubes mounted in place. In addition, a complete receiver includes the following:

a. 1500 to 18000 Kc in 6 bands—

(1) *12-14 volts d-c—*

RADIO RECEIVER BC-312-N

- 1 Dynamotor DM-21-B
- 3 Fuses FU-21-A; 2 installed, 1 spare
- 2 Lamps LM-27
- 1 Mounting FT-162

(2) *24-28 volts d-c—*

RADIO RECEIVER BC-312-NX

- 1 Dynamotor DM-21-CX
- 3 Fuses FU-25-A; 2 installed, 1 spare
- 2 Lamps LM-42
- 1 Mounting FT-162

(3) *110-120 volts a-c—*

RADIO RECEIVER BC-342-N

- 3 Fuses FU-21-A; 2 installed, 1 spare
- 2 Lamps LM-27
- 1 Mounting FT-162
- 1 Rectifier RA-20

b. 150 to 1500 Kc in 4 bands—

(1) *12-14 volts d-c—*

RADIO RECEIVER BC-314-G

- 1 Dynamotor DM-21-B
- 3 Fuses FU-21-A; 2 installed, 1 spare
- 2 Lamps LM-27
- 1 Mounting FT-162

(2) *110-120 volts a-c—*

RADIO RECEIVER BC-344-D

- 3 Fuses FU-21-A; 2 installed, 1 spare
- 2 Lamps LM-27
- 1 Mounting FT-162
- 1 Rectifier RA-20

c. Accessory Equipment—

The following items, not included as parts of the receivers, will be required to operate them:

RADIO RECEIVER BC-312-N

- 1 Power Cord with Plug PL-114
- *1 Headset HS-30-(*) and Cord CD-604 or CD-605
- 2 Tubes VT-65
- 1 Tube VT-66
- 4 Tubes VT-86
- 1 Tube VT-87
- 1 Tube VT-88
- Antenna
- Source of Power (12 to 14 volts d-c)

RADIO RECEIVER BC-312-NX

- 1 Power Cord with Plug PL-114
- *1 Headset HS-30-(*) and Cord CD-604 or CD-605
- 2 Tubes VT-65
- 4 Tubes VT-86
- 1 Tube VT-87
- 1 Tube VT-88
- 1 Tube VT-134
- Antenna
- Source of Power (24 to 28 volts d-c)

RADIO RECEIVER BC-342-N

- 1 Cord CD-370, or equivalent (a-c input)
- *1 Headset HS-30-(*) and Cord CD-604 or CD-605
- 2 Tubes VT-65
- 1 Tube VT-66
- 4 Tubes VT-86
- 1 Tube VT-87
- 1 Tube VT-88
- 1 Tube VT-97
- Antenna
- Source of Power (110 to 120 volts a-c)

RADIO RECEIVER BC-314-G

- 1 Power Cord with Plug PL-114
- *1 Headset HS-30-(*) and Cord CD-604 or CD-605
- 2 Tubes VT-65
- 1 Tube VT-66
- 4 Tubes VT-86
- 1 Tube VT-87
- 1 Tube VT-88
- Antenna
- Source of Power (12 to 14 volts d-c)

RADIO RECEIVER BC-344-D

- 1 Cord CD-370, or equivalent (a-c input)
- *1 Headset HS-30-(*) and Cord CD-604 or CD-605
- 2 Tubes VT-65
- 1 Tube VT-66
- 4 Tubes VT-86
- 1 Tube VT-87
- 1 Tube VT-88
- 1 Tube VT-97
- Antenna
- Source of Power (110 to 120 volts a-c)

If Headset HS-30-() and associated cords are not available, Headset P-19 may be used.

(*) The asterisk within parentheses denotes the applicable issue letter.

3. Frequency Coverage:

a. Radio Receivers BC-312-N, BC-312-NX and BC-342-N are designed for reception over the continuous frequency range of 1500 to 18,000 kilocycles in six bands as follows:

Band	Frequency Coverage
A	1500 to 3000 kc
B	3000 to 5000 kc
C	5000 to 8000 kc
D	8000 to 11000 kc
E	11000 to 14000 kc
F	14000 to 18000 kc

The intermediate-frequency amplifier of these three radio receivers is set at 470 kilocycles. On Band A, B and C the high-frequency oscillator tunes 470 kilocycles higher in frequency than the incoming signal. On Bands D, E and F the high-frequency oscillator tunes 470 kilocycles lower in frequency than the incoming signal.

b. Radio Receivers BC-314-G and BC-344-D are designed for reception over the continuous frequency range of 150 to 1500 kilocycles in four bands as follows:

Band	Frequency Coverage
A	150 to 260 kc
B	260 to 450 kc
C	450 to 820 kc
D	820 to 1500 kc

The intermediate-frequency amplifier of these two radio receivers is set at 92.5 kilocycles. On all bands, the high-frequency oscillator tunes 92.5 kilocycles higher in frequency than the incoming signal.

4. Weight, Size, Source of Power and Input Wattage:

APPROXIMATE WEIGHT AND SIZE

Description	Pounds	inches
Radio Receiver BC-312-N.....	58	18x10 $\frac{3}{4}$ x9 $\frac{1}{4}$
Radio Receiver BC-312-NX.....	58	18x10 $\frac{3}{4}$ x9 $\frac{1}{4}$
Radio Receiver BC-342-N.....	61.5	18x10 $\frac{3}{4}$ x9 $\frac{1}{4}$
Radio Receiver BC-314-G.....	58	18x10 $\frac{3}{4}$ x9 $\frac{1}{4}$
Radio Receiver BC-344-D.....	61.5	18x10 $\frac{3}{4}$ x9 $\frac{1}{4}$
Mounting FT-162.....	3 $\frac{3}{4}$	18x6 $\frac{7}{8}$ x1 $\frac{1}{4}$
Dynamotors DM-21-B and DM-21-CX.....	7	6x5 $\frac{1}{2}$ x3 $\frac{1}{4}$
Rectifier RA-20.....	10 $\frac{1}{2}$	6 $\frac{1}{2}$ x6 $\frac{1}{8}$ x3 $\frac{1}{4}$

Radio Receiver BC-312-N and Radio Receiver BC-314-G are designed to operate on 12 volts direct-current and use Dynamotor DM-21-B for their plate power source. Radio Receiver BC-312-NX is designed to operate on 24 volts direct-current and uses Dynamotor DM-21-CX

for its plate power source. Radio Receiver BC-342-N and Radio Receiver BC-344-D are designed to operate from a 110-120 volts, 60 cycles alternating-current power supply system and use Rectifier RA-20 for their plate power source.

INPUT POWER

Receiver	Volts	Amperes (approx.)	Watts (approx.)
Radio Receiver BC-312-N	12—14 d-c	4.3 —4.8	51.6—67.2
Radio Receiver BC-312-NX	24—28 d-c	2.2 —2.4	52.8—67.2
Radio Receiver BC-342-N	110—120 a-c	.64—.71	70—85
Radio Receiver BC-314-G	12—14 d-c	4.8 —5.3	57.6—63.6
Radio Receiver BC-344-D	110—120 a-c	.72—.81	79.2—97.2

SECTION II

EMPLOYMENT

5. Unpacking:

Be careful when unpacking and handling this equipment. After removal from the shipping box, examine the equipment for damage that might have occurred during shipment, and, if necessary, clean it with a brush or blower *before installation*.

6. Installation:

Install Mounting FT-162 on a substantial support. If installed in a vehicle, add Mounting FT-178 to prevent excessive horizontal movement of the receiver. Connect *shielded* antenna lead to the

shielded antenna binding post. In Radio Receivers BC-312-N, BC-312-NX and BC-314-G, insert the plug of the power cord in Socket SO-94 located on the front panel. In Radio Receivers BC-342-N and BC-344-D insert the power plug in the receptacle in the rectifier at the back of the cabinet. Insert a headset at either of the Jacks marked PHONES 2ND AUDIO.

NOTE:—BEFORE APPLYING POWER TO THE RECEIVER, CAREFULLY CHECK CORDING AND WIRING AND STUDY THE PARAGRAPH ON "OPERATION."

SECTION III

PREPARATION FOR USE

7. Precautionary Measures:

Be sure the correct input power is being applied to these radio receivers. Power having an incorrect voltage or frequency will result in a damaged dynamotor or rectifier power unit. Before inserting the power cord, make tests with the voltmeter of Test Set I-56- (*) to make certain the applied power is correct.

8. Pilot Lamps:

In Radio Receivers BC-312-N, BC-342-N, BC-314-G and BC-344-D mount two lamps

LM-27 in the sockets underneath the reflector. In Radio Receiver BC-312-NX, mount two Lamps LM-42 in the sockets. The reflector is part of the assembly on the front panel of the receivers which contains the dial window. The two pilot lamps may be inspected after removing the four knurled screws holding the reflector to the front panel.

9. Vacuum Tubes:

The following octal base vacuum tubes of either the metal or glass-enclosed (GT) type are employed:

a. Radio Receiver BC-312-N

Function	Signal Corps Tube	Commercial Type
1st r-f	VT-86	6K7
2nd r-f	VT-86	6K7
1st detector (mixer)	VT-87	6L7
1st i-f	VT-86 or VT-86-B	6K7 or 6K7GT
2nd i-f	VT-86 or VT-86-B	6K7 or 6K7GT
2nd detector AVC and 1st audio amplifier	VT-88 or VT-88-B	6R7 or 6R7GT
R-f oscillator	VT-65	6C5
C-w oscillator	VT-65	6C5
Audio amplifier	VT-66	6F6

b. Radio Receiver BC-312-NX

Function	Signal Corps Tube	Commercial Type
1st r-f	VT-86	6K7
2nd r-f	VT-86	6K7
1st detector (mixer)	VT-87	6L7
1st i-f	VT-86 or VT-86-B	6K7 or 6K7GT
2nd i-f	VT-86 or VT-86-B	6K7 or 6K7GT
2nd detector AVC and 1st audio amplifier	VT-88 or VT-88-B	6R7 or 6R7GT
R-f oscillator	VT-65	6C5
C-w oscillator	VT-65	6C5
Audio amplifier	VT-134	12A6

c. *Radio Receiver BC-342-N*

Function	Signal Corps Tube	Commercial Type
1st r-f	VT-86	6K7
2nd r-f	VT-86	6K7
1st detector (mixer)	VT-87	6L7
1st i-f	VT-86 or VT-86-B	6K7 or 6K7GT
2nd i-f	VT-86 or VT-86-B	6K7 or 6K7GT
2nd detector AVC and 1st audio amplifier	VT-88 or VT-88-B	6R7 or 6R7GT
R-f oscillator	VT-65	6C5
C-w oscillator	VT-65	6C5
Audio amplifier	VT-66	6F6
Rectifier	VT-97	5W4

d. *Radio Receiver BC-314-G*

Function	Signal Corps Tube	Commercial Type
1st r-f	VT-86	6K7
2nd r-f	VT-86	6K7
1st detector (mixer)	VT-87	6L7
1st i-f	VT-86 or VT-86-B	6K7 or 6K7GT
2nd i-f	VT-86 or VT-86-B	6K7 or 6K7GT
2nd detector AVC and 1st audio amplifier	VT-88 or VT-88-B	6R7 or 6R7GT
R-f oscillator	VT-65	6C5
C-w oscillator	VT-65	6C5
Audio amplifier	VT-66	6F6

e. *Radio Receiver BC-344-D*

Function	Signal Corps Tube	Commercial Type
1st r-f	VT-86	6K7
2nd r-f	VT-86	6K7
1st detector (mixer)	VT-87	6L7
1st i-f	VT-86 or VT-86-B	6K7 or 6K7GT
2nd i-f	VT-86 or VT-86-B	6K7 or 6K7GT
2nd detector AVC and 1st audio amplifier	VT-88 or VT-88-B	6R7 or 6R7GT
R-f oscillator	VT-65	6C5
C-w oscillator	VT-65	6C5
Audio amplifier	VT-66	6F6
Rectifier	VT-97	5W4

f. These radio receivers are ordinarily issued with tested radio tubes installed. Do not interchange or remove them unless they become defective since changing tubes may cause misalignment.

Except for the r-f and c-w oscillator, all tube sockets can be reached when the receiver chassis has been removed from its cabinet.

To reach the c-w oscillator tube socket:

(1) Remove the screw at the top of the c-w oscillator compartment, and the screws about halfway down the center of the right and left side of the oscillator compartment.

(2) Loosen, but do not remove, the screw at the bottom of the rear of this compartment.

(3) Lift off the compartment cover.

To reach the tube socket in the r-f oscillator compartment:

(1) Loosen the two screws near the top of the right side of this compartment.

(2) Then lift the hinged cover occupying the rear third of the top of this compartment.

Check the tubes listed with the tube checker of Test Set, I-56-(*).

10. Line Voltage Compensation:

Remove Radio Receiver BC-342-N or Radio Receiver BC-344-D from the cabinet and turn it upside down so that the terminal strip near the rectifier is accessible. If the prevailing line voltage, measured across terminals 1 and 4 of the connection strip, is below 115 volts, unsolder the lead in the rectifier normally on the 120-volt tap and connect it to the 110-volt tap. Remove the cover of the rectifier by taking out the two screws at the outside edge of the rectifier unit; and by loosening, but not removing, the two screws at the opposite side of the cover. The rectifier terminal board and the line voltage compensating taps, marked 110 V and 120 V will now be exposed.

11. Fuses:

The fuses marked LAMPS and DYN-FIL on the front panel of Radio Receivers BC-312-N, BC-342-N, BC-314-G and BC-344-D are Fuse FU-21-A. Check them for proper rating (10 amperes) and for continuity, *before* installation. Fuse FU-25-A is used in Radio Receiver BC-312-NX and is rated at 5 amperes. Fuse FU-27 in

Rectifier RA-20 of Radio Receivers BC-342-N and BC-344-D can be reached from the rear of the receiver cabinet. Check it for proper rating of 2 amperes and for continuity.

12. Operation:

a. To Turn Power On:

For Radio Receivers BC-312-N, BC-312-NX and BC-314-G connect the proper battery. For Radio Receivers BC-342-N and BC-344-D plug the power cord in the alternating-current power source and throw the alternating-current power switch, located at the back of the cabinet, ON. Now turn the OFF-MVC-AVC switch to either MVC or AVC.

b. To Turn the Receivers Off:

Turn the OFF-MVC-AVC switch to OFF.

c. To Select Different Modes of Operation:

With the receivers operating:

(1) *Continuous Wave.*—Place the switch marked CW-OSC OFF-ON at ON.

(2) *Tone or Phone.*—Place the switch marked CW-OSC OFF-ON at OFF.

(3) *Manual Volume Control.*—Place the switch marked OFF-MVC-AVC at MVC.

(4) *Automatic Volume Control.*—Place the switch marked OFF-MVC-AVC at AVC.

d. To Tune in a Signal:

Use the control marked BAND CHANGE to select the frequency band which covers the frequency of the signal. With the switch marked OFF-MVC-AVC and the switch marked CW-OSC OFF-ON, select the correct mode of operation. Using the control marked FAST TUNING, tune to the approximate frequency of the signal. Adjust the control marked ALIGN INPUT for the maximum noise level. This assures maximum receiver sensitivity. Using the control marked VERNIER, tune in the signal. Adjust the control marked VOL to secure the desired volume level. Turning this control clockwise increases the volume (sensitivity). The receivers are usually a little more sensitive when operated with the control marked OFF-MVC-AVC set at MVC. Placing this control at AVC may reduce the sensitivity somewhat but tends to maintain volume at a constant level as determined by the setting of the control marked

VOL. When receiving c-w signals (C-W OSC switch ON), throw the OFF-MVC-AVC switch to MVC. If this switch is set at AVC, the noise-level of the receiver would rise and fall with the keyed signal, making the c-w signal hard to copy. The proper setting of the OFF-MVC-AVC control is therefore determined by the character of the received signal.

e. To Change Frequency:

To change frequencies it is necessary to tune to the new frequency in the manner described. Advance the control marked VOL so as to prevent passing over a weak signal without hearing it.

f. To Control Sensitivity:

The sensitivity of the receivers is affected by the controls marked ALIGN INPUT, VOL, (CRYSTAL PHASING on Radio Receiver BC-342-N only), and OFF-MVC-AVC.

To obtain maximum sensitivity:

(1) Adjust the control marked ALIGN INPUT to secure the maximum noise output from the receivers.

(2) Turn the control marked VOL clockwise as far as possible.

(The control marked CRYSTAL PHASING on Radio Receiver BC-342-N, should be at OUT.)

(3) Place the control marked OFF-MVC-AVC at MVC.

g. To Control Selectivity.

A means of controlling selectivity is provided only in Radio Receiver BC-342-N. A crystal filter is incorporated in the intermediate-frequency amplifier in this receiver. Turn the control marked CRYSTAL PHASING away from OUT to increase selectivity. (The operation of this control also decreases sensitivity.) The CRYSTAL PHASING control is intended for use primarily in reception of c-w signals. When tuning in voice signals it may increase the selectivity of the receiver to such a degree as to distort them. However, in receiving a voice signal with a very heavy background noise, or a voice signal which is very much distorted, it may be found that the proper operation of the CRYSTAL PHASING control will improve the intelligibility of the signal. Experiment with the use of this control on various

types of signals in order to determine what may be expected from its operation.

h. To Change the Pitch of a C-W Signal:

The pitch of a c-w signal may be changed by operating the control marked VERNIER (which changes the tuning of the receiver) or by operation of the control marked CW-OSC ADJUST. This latter control permits a change of approximately four thousand cycles in the pitch without changing the tuning of the receivers. Once a signal has been satisfactorily tuned in, it will usually be found preferable to make desired changes in signal pitch by the latter method; that is, by the operation of the control marked CW-OSC ADJUST.

i. Panel Controls:

(1) *Radio-Frequency Tuning:*

On Radio Receivers BC-312-N, BC-312-NX and BC-342-N the main tuning dial is of the flat disc type carrying seven scales, six of which are calibrated in kilocycles and one in 45 equal divisions. On Radio Receivers BC-314-G and BC-344-D the main tuning dial is also of the flat disc type but carries five scales, four of which are calibrated in kilocycles and one calibrated in 45 equal divisions. The dials in these radio receivers are driven through an arc of about 300 degrees by either of two controls on the front panel. The control marked FAST TUNING provides for a 25 to 1 reduction. The control marked VERNIER provides for a 90 to 1 reduction and carries a scale graduated with 100 equal divisions which permits interpolation of the 0-45 scale of the main dial. Two dial lights illuminate the main dial. A masking plate rotates in conjunction with the band changing mechanism and covers all portions of the dial except the 0-45 scale and that for the particular frequency band selected.

(2) *Band Changing:*

The control marked BAND CHANGE operates switches located in the high-frequency oscillator, first radio-frequency stage, second radio-frequency stage and first detector (mixer) stage compartments and, in addition, operates the masking plate referred to previously. All unused coils are short-circuited.

(3) *OFF-MVC-AVC Switch:*

The switch marked OFF-MVC-AVC permits the use of manual volume control or automatic

volume control. This control also serves as the power on-off switch, when the control switch in Rectifier RA-20 of Radio Receivers BC-342-N and BC-344-D is on, and is the only on-off switch on Radio Receivers BC-312-N, BC-312-NX and BC-314-G.

(4) *Antenna Alignment Control:*

The knob marked ALIGN INPUT permits tuning a 50 to 200 micromicrofarad antenna to resonance in Radio Receivers BC-312-N, BC-312-NX and BC-342-N

In Radio Receivers BC-314-G and BC-344-D it permits tuning a 250 to 1000 micromicrofarad antenna to resonance.

(5) *C-W Oscillator Control:*

The switch marked CW-OSC OFF-ON permits the use of the c-w oscillator. An additional control is provided, marked CW-OSC ADJUST, which allows a four-thousand cycle variation in resultant beat frequency.

(6) *Crystal Filter Control:*

This control is on Radio Receiver BC-342-N only and is a knob marked CRYSTAL PHASING which permits the use of a crystal filter. The filter is connected into the circuit at all settings of this control except the one marked OUT. The purpose of a crystal filter is to increase the selectivity of the receiver.

(7) *Volume Control:*

A knob marked VOL operates a dual potentiometer for control of volume and sensitivity.

(8) *Binding Posts:*

Three binding posts are provided. The one marked SIG ANT provides a means of connecting a shielded antenna to the receivers. The binding post marked ALT SIG ANT is unshielded and may be used when a shielded antenna is *not* required. The binding post marked GND is a direct connection to the panel and chassis of the radio receivers, and should be connected to a good ground wherever possible.

(9) *Pilot Lamp Dimmer Control:*

Radio Receivers BC-312-N and BC-312-NX are equipped with a control which adjusts the brilliance of the pilot lamps LM-27 and LM-42.

Turning the knob marked DIAL LIGHT counter-clockwise decreases the brilliance of the pilot lamps.

(10) *Send-Receive Switch:*

When the receivers are used with a transmitter and associated cables (as in Radio Set SCR-245-(*)), the switch marked REC-SEND in the SEND position connects a relay through the key jack. This relay short-circuits the antenna and grid of Tube VT-88 to ground when the key is depressed.

(11) *Fuses:*

Fuse holders are mounted on the front panel so that the fuses may be easily replaced. The fuse marked LAMPS protects the circuit of the dial lamps. The fuse marked DYN-FIL protects the circuit supplying power to the filaments and power supply. The fuse marked SPARE replaces either of the other two fuses when necessary. In addition to the above, there is a 2-ampere, 110 volt fuse located in Rectifier RA-20 and accessible from the rear of the cabinet in Radio Receivers BC-342-N and BC-344-D.

(12) *Panel Jacks:*

Jacks are located on the front panel as follows:

KEY—To connect a telegraph key when the receiver is used with a transmitter (as in Radio Set SCR-245-(*)).

MICRO—To connect a microphone for voice transmission when the receiver is used with a transmitter (as in Radio Set SCR-245-(*)).

SPEAKER 2ND AUDIO—To connect a permanent-magnet type loudspeaker.

PHONES 2ND AUDIO—To use the maximum output of the receivers, insert the head-set plug into this jack.

PHONES 2ND AUDIO—This jack is connected in parallel with the jack mentioned above and is used for the same purpose or to connect a second head-set.

(13) *Power Socket:*

For Radio Receivers BC-312-N, BC-312-NX and BC-314-G connections to the direct-current source are made by connecting the proper power

cord terminated by Plug PL-114 to Socket SO-94 mounted on the front panel of the radio receivers. Note: When making this connection insert Plug PL-114 fully and firmly into the socket before tightening the knurled ring. By removing the top

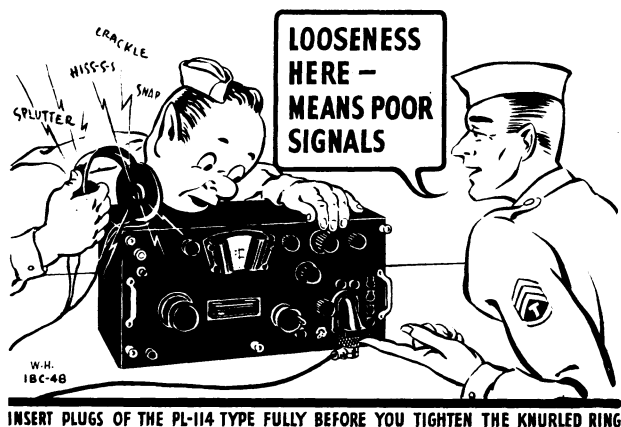

cover of the power socket (SO-94) the filament power and control connections to the interior of these radio receivers can be reached without removing them from the cabinet. On Radio Receivers BC-342-N and BC-344-D this socket is fitted with a cap which may be removed if necessary. For power connections of these latter radio receivers see paragraph 6.

(14) *Panel Locks:*

Panel locks are provided to secure the chassis of the radio receivers into the cabinet. By turning the five straight knurled knobs clockwise the receiver panel is pressed firmly against the rubber gasket. To remove the receiver from its cabinet turn these lock knobs counter-clockwise as far as they will go.

j. Power Connections and Controls of Radio Receivers BC-342-N and BC-344-D.

(1) *A-C Power Socket:*

A-c power connections are made to a receptacle located in Rectifier RA-20 and can be reached from the rear of the receivers.

(2) *A-C Power Switch:*

This switch is located in Rectifier RA-20 and is accessible from the rear of the receiver. It controls the a-c power input to the receivers. After

this switch is closed the receiver power is controlled entirely by the OFF-MVC-AVC switch located on the front panel.

k. Power Units:

Each radio receiver uses a different power unit.

(1) Radio Receivers BC-312-N and BC-314-G use Dynamotor DM-21-B.

(2) Radio Receiver BC-312-NX uses Dynamotor DM-21-CX.

(3) Radio Receivers BC-342-N and BC-344-D use Rectifier RA-20 for their plate power supply.

(4) Dynamotor DM-21-B and Dynamotor DM-21-CX differ only in that the first is for 12 volts direct-current operation and the latter is for 24 volts direct-current operation.

(5) Rectifier RA-20 operates directly from a 110-120 volt, 60 cycles, alternating-current source.

13. Operating Precautions:

a. Controls:

BE CAREFUL WHEN HANDLING ALL OF THE CONTROLS OF THESE RADIO RECEIVERS. MOST OF THE CONTROLS ARE EQUIPPED WITH STOPS TO LIMIT THE AMOUNT THAT THEY MAY BE TURNED. FORCING ANY CONTROL BEYOND ITS NORMAL STOP WILL SERIOUSLY DAMAGE IT. THIS CAUTION APPLIES PARTICULARLY TO THE CONTROLS MARKED BAND CHANGE AND CRYSTAL PHASING.

b. Power Cords.

Before the receiver chassis is removed from the cabinet always disconnect the power cord from the power source.

c. Band Change:

In changing frequency bands it is possible to stop the band-change switch between connection points. Take care that this control is turned until it definitely engages the connection point for the desired band.

SECTION IV MAINTENANCE

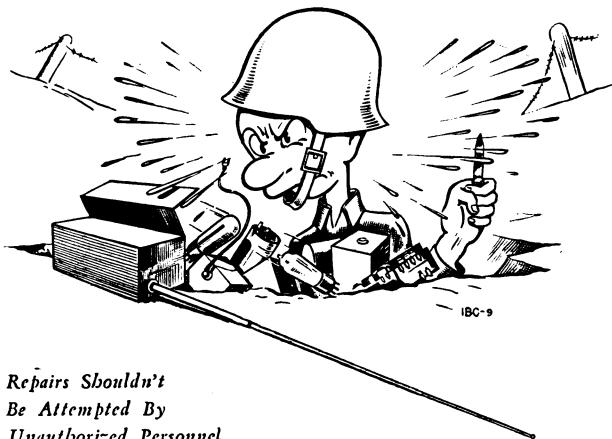

*Repairs Shouldn't
Be Attempted By
Unauthorized Personnel*

14. Inspection:

Give the radio receiver a thorough examination before each use, and again before returning it to storage. Properly conducted inspections will insure that it is left in operating condition and thus be ready to use at any time. This inspection should include examination of the power cords to see that the plug is securely fastened and that it has not been damaged. Examine all accessible components and, if dirty, clean them.

15. Lubrication:

The various gears and bearings of the radio receiver chassis are lubricated during manufacture with sufficient lubricant to last the life of the equipment and unless operated under abnormal conditions should never require further lubrication. In the event that such lubrication becomes necessary, use petrolatum *very sparingly*.

16. Dynamotors DM-21-B and DM-21-CX:

The bearings of these dynamotors are of the sealed, ball-bearing type, packed with grease at the time of manufacture. They will require the following additional lubrication: *One drop* of light lubricating oil at each bearing at the end of 500 hours of operation. Any oil in excess of this amount will do more harm than good. To remove the cover of the dynamotor compartment loosen the two knurled thumb screws provided on the left-hand side and the two flat head screws on the right-hand side of the dynamotor.

17. Rectifier RA-20:

Rectifier RA-20 does not require lubrication and the only external servicing possible is to make sure that Tube VT-97 is firmly seated in its socket and that Fuse FU-27 is intact. In the event of failure of power, check the 2 ampere fuse which is accessible from the back of the receiver cabinet near the a-c power switch in Radio Receivers BC-342-N and BC-344-D.

18. Miscellaneous:

Insert the vacuum tubes all the way into their proper sockets and be sure grid-cap connections are firmly made. Lock the chassis into its box by means of the five locking knobs on the front panel. Be very careful when servicing these radio receivers. Servicing should be attempted only by competent personnel adequately supplied with the necessary tools and instruments. It is possible for an inexperienced operator, in attempting to locate and repair a minor trouble, to damage this equipment to such an extent as to require that it be shipped to a depot for repairs.

19. Procedure In Case of Failure:

Failure of these radio receivers to operate properly may be due to external causes such as a disconnected or grounded antenna, failure of the power source or a damaged headset. Successively eliminate these causes before the receiver chassis is removed from its cabinet. Check the receiver itself by setting all controls for maximum sensitivity and noting the noise level. Lack of normal noise output, or no response when the antenna terminal is touched with a metallic object, indicates trouble within the receiver. The trouble, if actually within the receiver, will most frequently be a blown-out fuse, a loose or defective tube, or a defective power unit.

20. Adjustment For Field Upkeep:

Service of this equipment in the field consists, almost entirely, of the replacing of tubes, pilot light bulbs and fuses, and minor repairs. Alignment and major adjustment or repair of these receivers is accomplished at authorized depots by personnel adequately supplied with the necessary tools and instruments.

SECTION V

SUPPLEMENTARY DATA

21. Tables of Voltages:

a. *Radio Receivers BC-312-N, BC-312-NX and BC-314-G.*

Readings are made at the tube prong using the set analyzers of Test Set I-56-(*), with an input voltage of 14 volts direct-current for Radio Receivers BC-312-N and BC-314-G and 28 volts direct-current for Radio Receiver BC-312-NX. Throw the OFF-MVC-AVC switch to MVC and the VOL control to maximum. For the c-w oscillator readings, the CW-OSC OFF-ON switch is

at ON. For all other readings this switch is at OFF. Adapter FT-211 must be used when the set analyzer of Test Set I-56-(*) is employed for measurement on the two radio-frequency and first detector tubes of these radio receivers, because the space available does not permit entry of the regular set analyzer plug. The plug of the adapter is inserted into the tube socket and its grid stud connected to the receiver gridcap. The socket end of the adapter is connected to the set analyzer plug and the grid clip on the adapter is connected to the stud on the set analyzer plug. Measurements are then made in the usual manner.

VOLTAGE MEASUREMENTS ON RADIO RECEIVER BC-312-N

Tube	Filament	Cathode To Ground	Screen Grid To Ground	Plate To Ground
1st r-f (VT-86)	6.8	4.2	90	225
2nd r-f (VT-86)	7.0	4.0	90	225
1st detector (VT-87)	6.6	3.5	95	225
1st i-f (VT-86)	6.8	4.3	95	225
2nd i-f (VT-86)	6.8	4.0	90	225
C-w osc. (VT-65)	6.8	0		110
Diode 1st audio (VT-88)	6.8	7.2		225
2nd audio (VT-66)	6.8	22	235	225
Band A	7.0	28		105
Band B	7.0	20		110
R-f osc. Band C	7.0	12		105
(VT-65) Band D	7.0	0		80
Band E	7.0	0		90
Band F	7.0	0		95

VOLTAGE MEASUREMENTS ON RADIO RECEIVER BC-312-NX

Tube	Filament	Cathode To Ground	Screen Grid To Ground	Plate To Ground
1st r-f (VT-86)	6.8	4.2	95	236
2nd r-f (VT-86)	7.0	4.3	96	238
1st detector (VT-87)	6.9	3.7	104	240
1st i-f (VT-86)	7.1	4.1	94	235
2nd i-f (VT-86)	6.8	4.0	92	235
C-w osc. (VT-65)	6.8	0		110
Diode 1st audio (VT-88)	6.8	7.2		235
2nd audio (VT-134)	15.0	22	245	232
	Band A	6.8	28	112
	Band B	6.8	20	115
R-f osc. (VT-65)	Band C	6.8	12	105
	Band D	6.8	0	69
	Band E	6.8	0	80
	Band F	6.8	0	84

VOLTAGE MEASUREMENTS ON RADIO RECEIVER BC-314-G

Tube	Filament	Cathode To Ground	Screen Grid To Ground	Plate To Ground
1st r-f (VT-86)	6.8	3.8	98	235
2nd r-f (VT-86)	6.8	3.6	98	235
1st detector (VT-87)	7.0	4.8	128	235
1st i-f (VT-86)	7.0	4.5	95	235
2nd i-f (VT-86)	7.0	4.2	96	235
C-w osc. (VT-65)	7.0	0		30
Diode 1st audio (VT-88)	7.0	8.0		235
2nd audio (VT-66)	7.0	21.0	240	235
R-f osc. (VT-65)	6.8	0		100

b. Radio Receivers BC-342-N and BC-344-D.

All measurements are made with the a-c line voltage adjusted to 120 volts. Throw the OFF-

MVC-AVC switch to MVC and turn the VOL control to maximum. Direct-current voltage readings are made with the voltmeter of Test Set I-56-(*) the same as in a above.

VOLTAGE MEASUREMENTS ON RADIO RECEIVER BC-342-N

Tube	Filament	Cathode To Ground	Screen Grid To Ground	Plate To Ground
1st r-f (VT-86)	6.4 a-c	4.6	100	250
2nd r-f (VT-86)	6.5 a-c	4.3	110	250
1st detector (VT-87)	6.2 a-c	3.2	110	250
1st i-f (VT-86)	6.3 a-c	4.6	115	250
2nd i-f (VT-86)	6.3 a-c	4.5	110	250
C-w osc. (VT-65)	6.3 a-c	0		125
Diode 1st audio (VT-88)	6.3 a-c	8.5		250
2nd audio (VT-66)	6.3 a-c	25	260	240
	Band A	6.2 a-c	34	115
	Band B	6.2 a-c	22	120
R-f osc. (VT-65)	Band C	6.2 a-c	13	115
	Band D	6.2 a-c	0	85
	Band E	6.2 a-c	0	90
	Band F	6.2 a-c	0	95

RECTIFIER RA-20

(With volume control set at maximum)

Tube VT-97—

Filament.....5.0 v, a-c.....Plate.....310 v, a-c.

B+ to ground.....260 v, d-c.

Average current.....95 ma. d-c.

VOLTAGE MEASUREMENTS ON RADIO RECEIVER BC-344-D

Tube	Filament	Cathode To Ground	Screen Grid To Ground	Plate To Ground
1st r-f (VT-86)	6.5 a-c	3.8	98	255
2nd r-f (VT-86)	6.5 a-c	3.6	98	250
1st detector (VT-87)	6.5 a-c	4.8	128	265
1st i-f (VT-86)	6.5 a-c	4.5	95	260
2nd i-f (VT-86)	6.5 a-c	4.2	96	260
C-w osc. (VT-65)	6.5 a-c	0		30
Diode 1st audio (VT-88)	6.5 a-c	8.0		250
2nd audio (VT-66)	6.5 a-c	21.0	265	245
R-f osc. (VT-65)	6.5 a-c	0		110

RECTIFIER RA-20

(With volume control set at maximum)

Tube VT-97—

Filament.....5.2 v, a-c.....Plate.....315 v, a-c.

B+ to ground.....265 v, d-c.

Average Current.....92 ma. d-c.

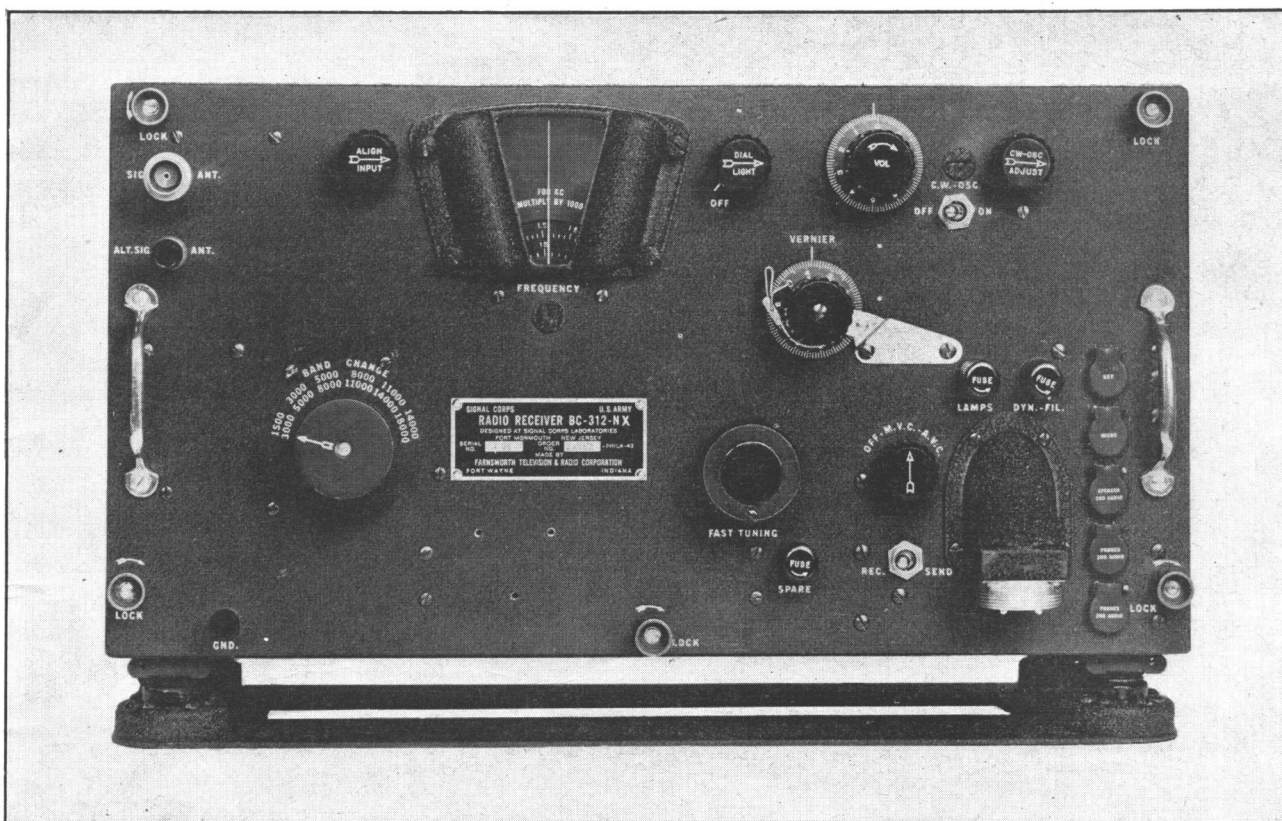

FIGURE 2, RADIO RECEIVER BC-312-NX, FRONT VIEW.

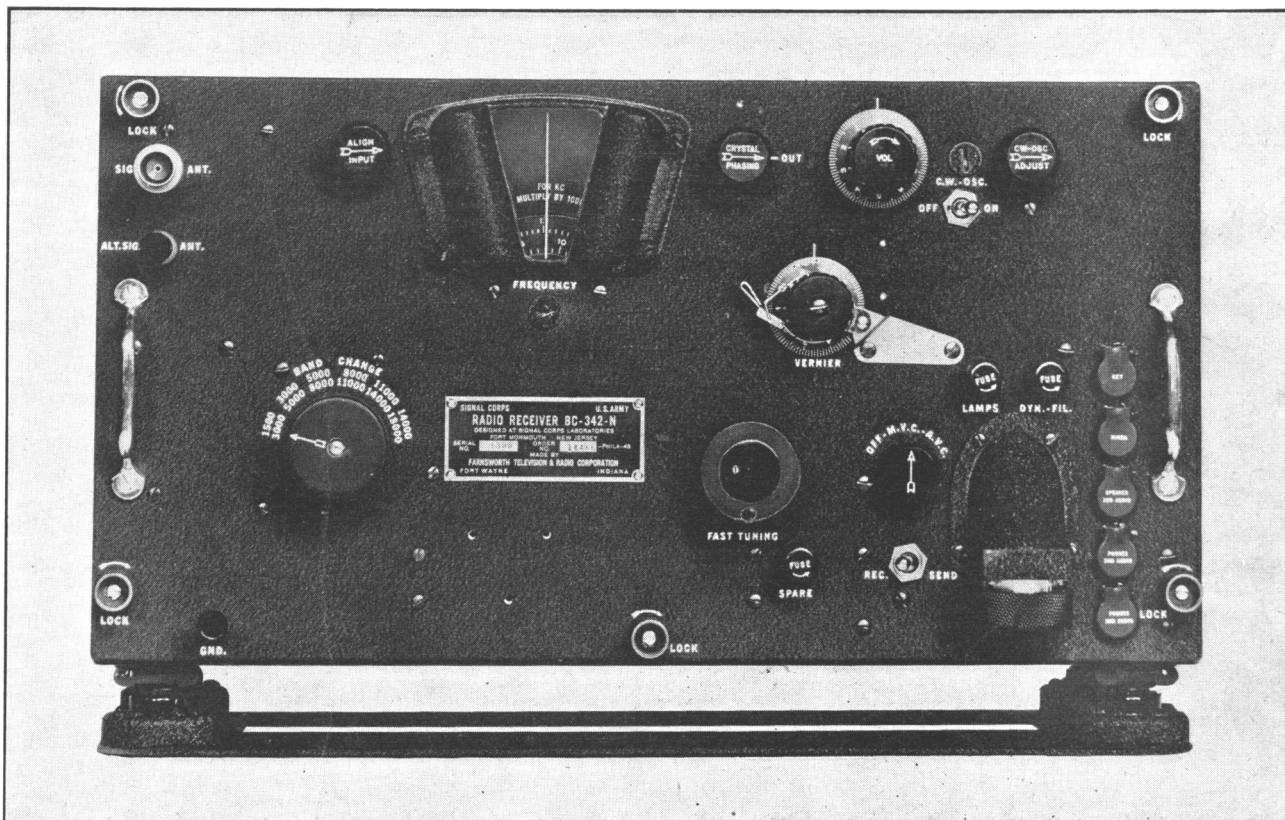

FIGURE 3, RADIO RECEIVER BC-342-N, FRONT VIEW.

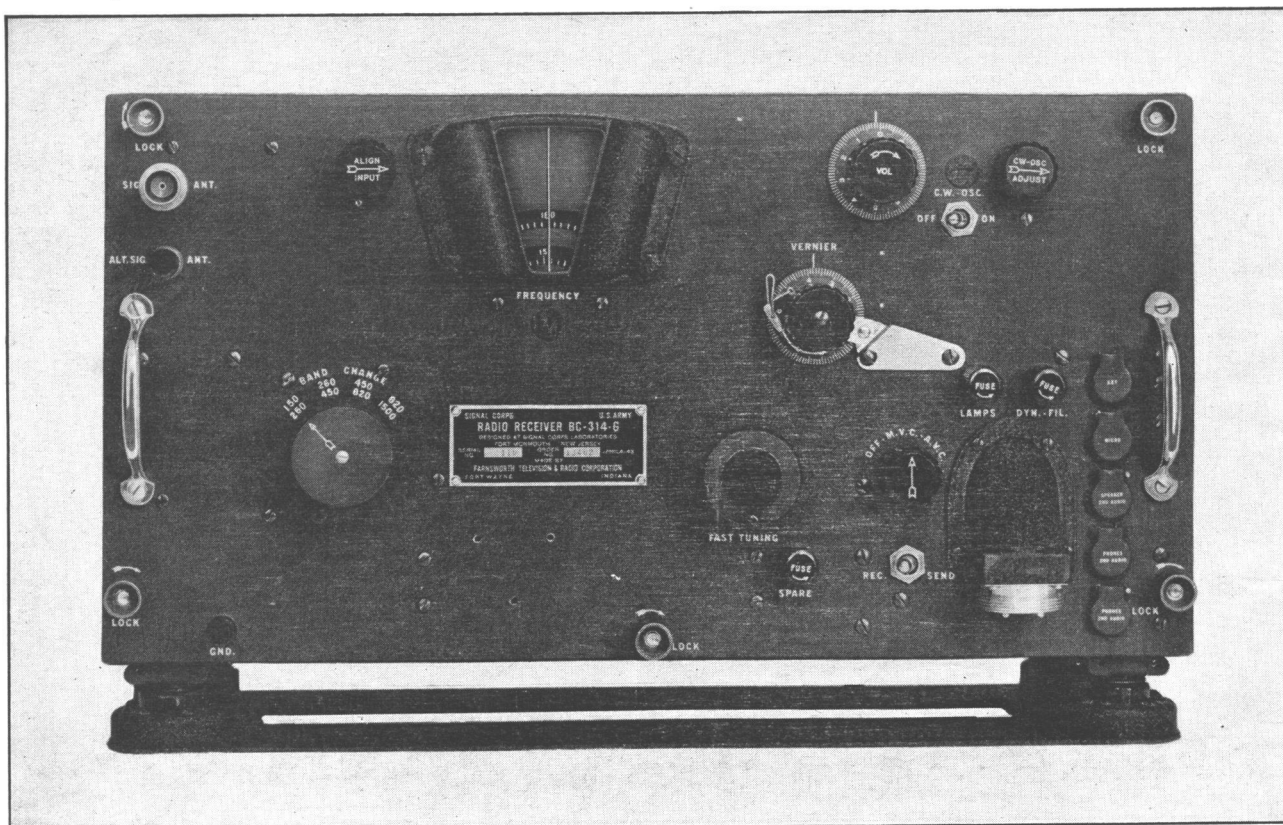

FIGURE 4, RADIO RECEIVER BC-314-G. FRONT VIEW.

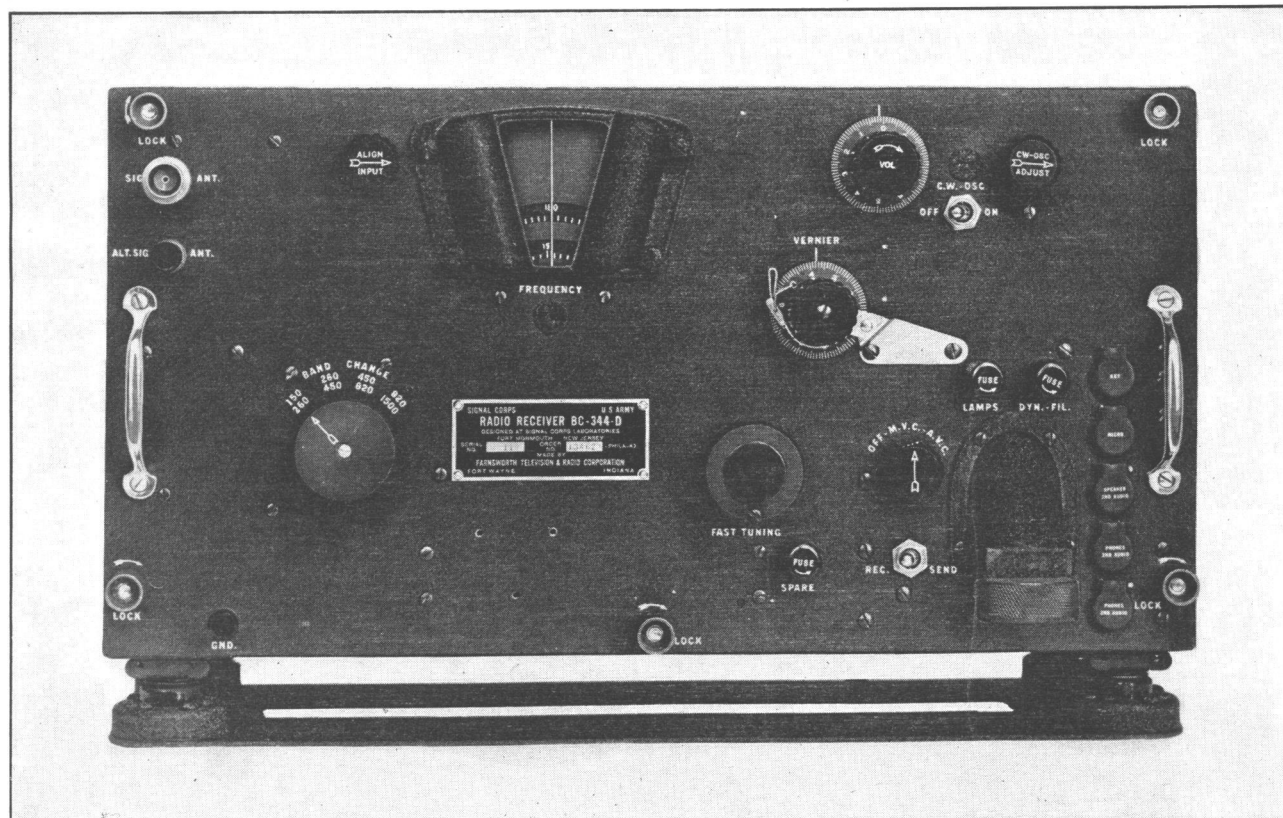

FIGURE 5, RADIO RECEIVER BC-344-D, FRONT VIEW.

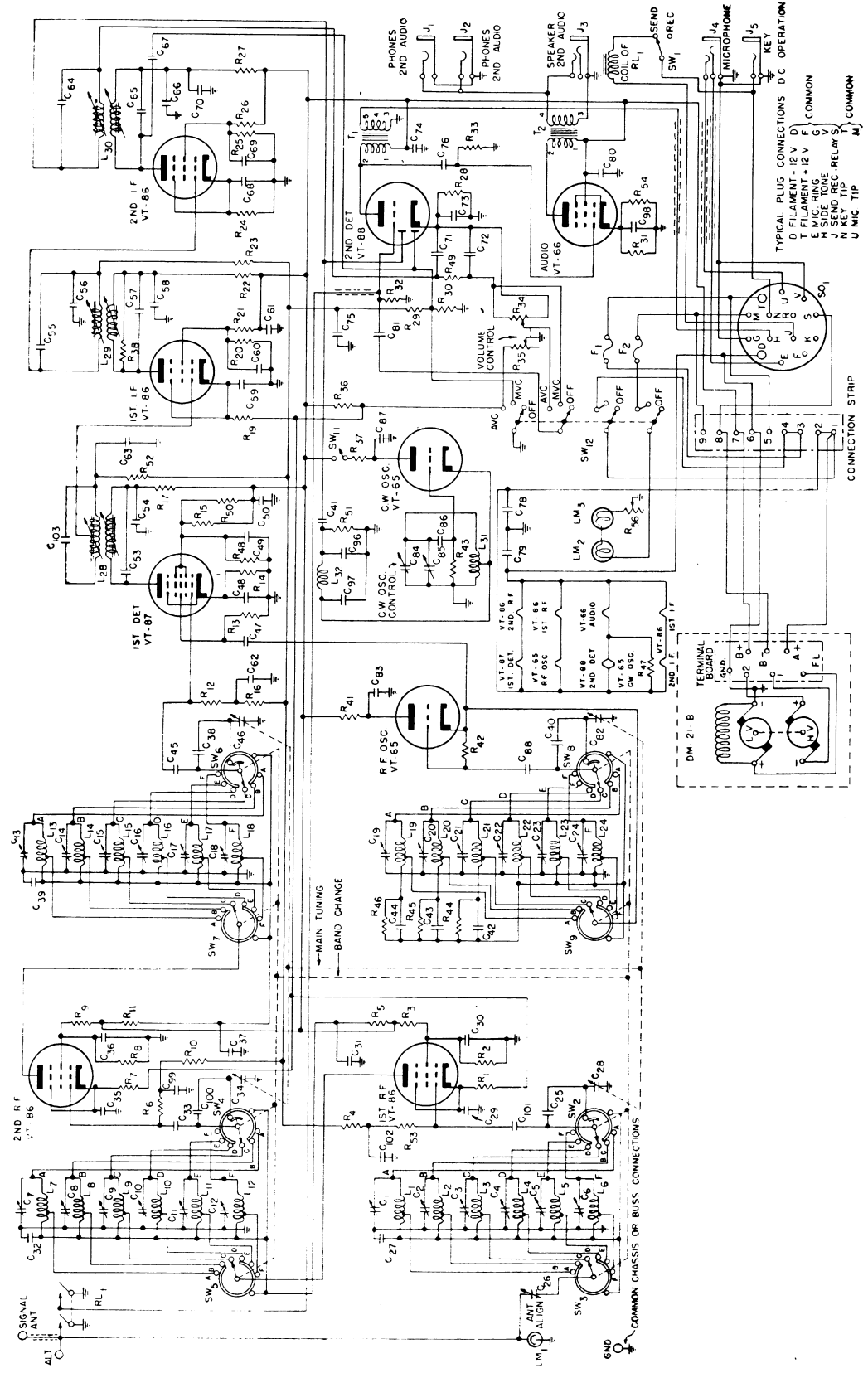
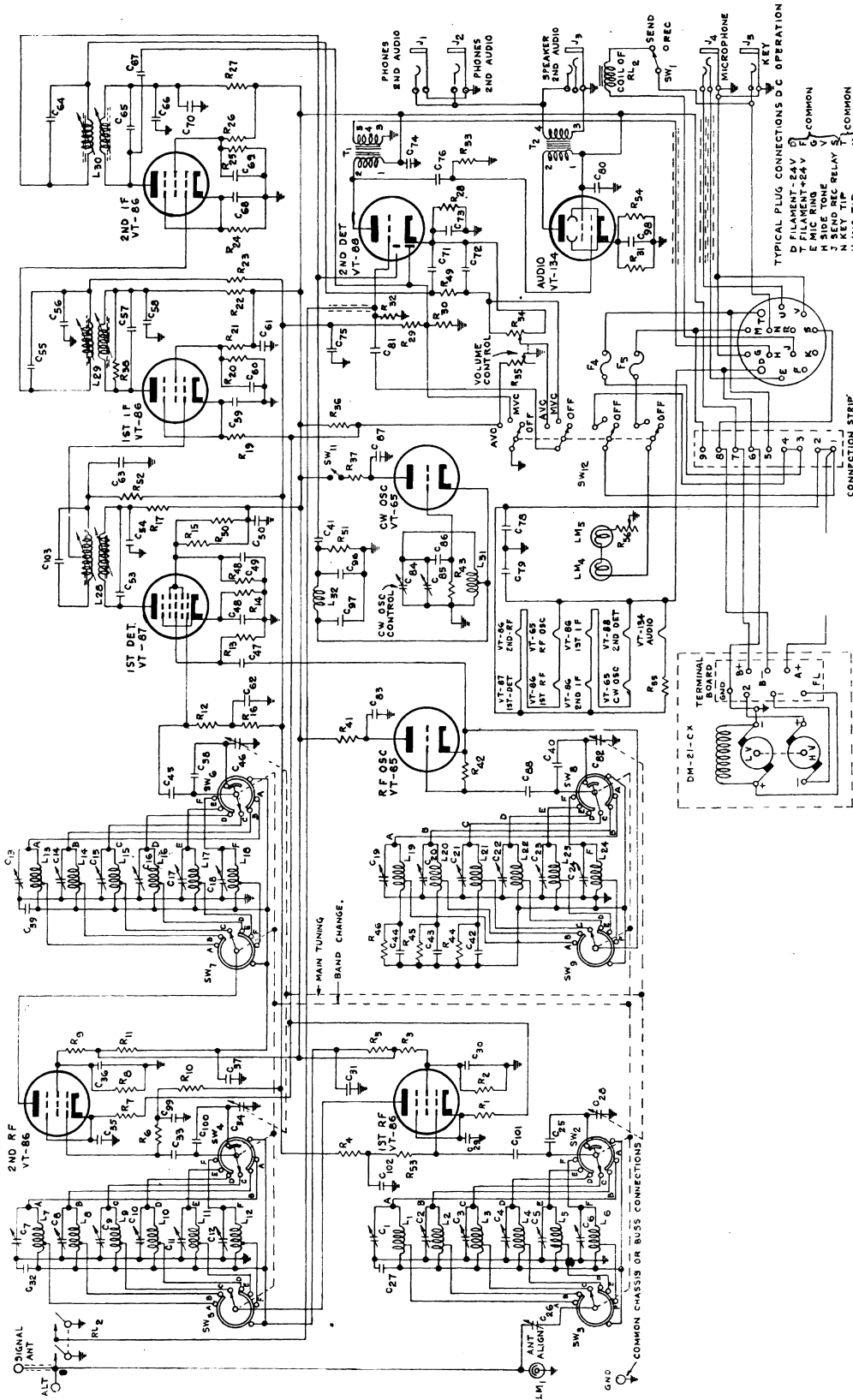

FIGURE 6. RADIO RECEIVER BC-312-N, CIRCUIT DIAGRAM.



RADIO RECEIVER BC-312-NX

FIGURE 7, RADIO RECEIVER BC-312-NX, CIRCUIT DIAGRAM.

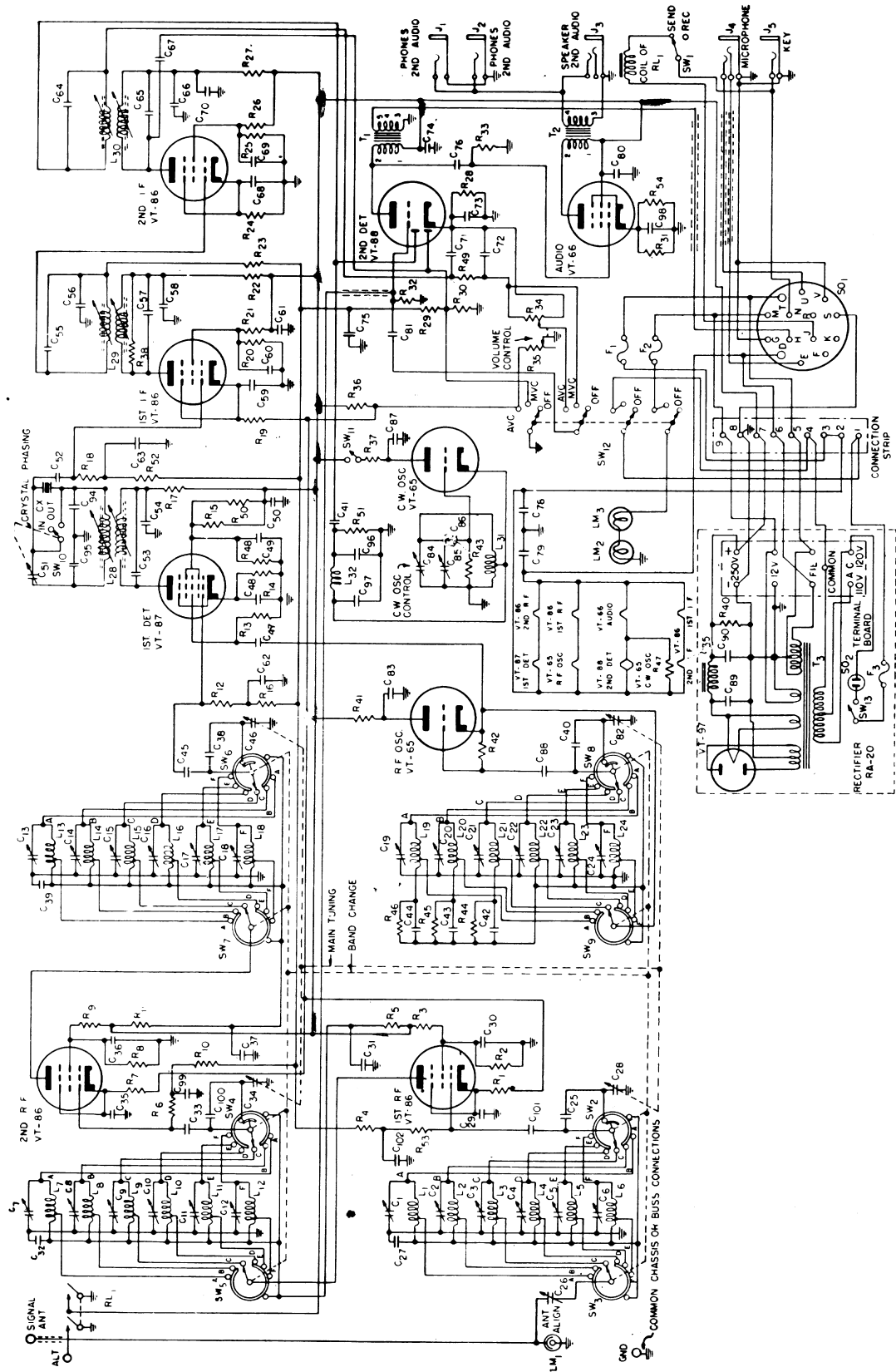

FIGURE 8, RADIO RECEIVER BC-342-N, CIRCUIT DIAGRAM.

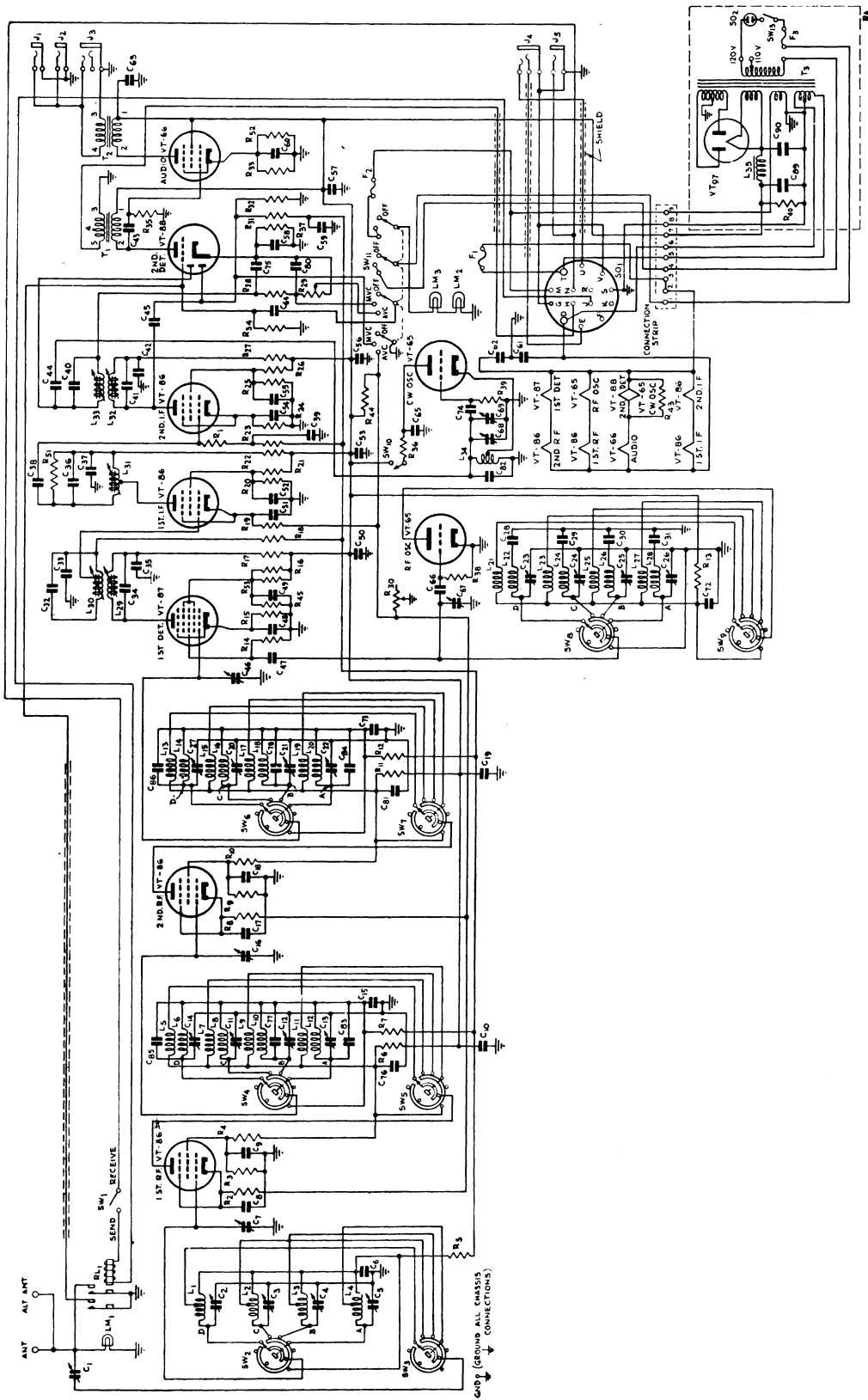

FIGURE 10, RADIO RECEIVER BC-344-D, CIRCUIT DIAGRAM.

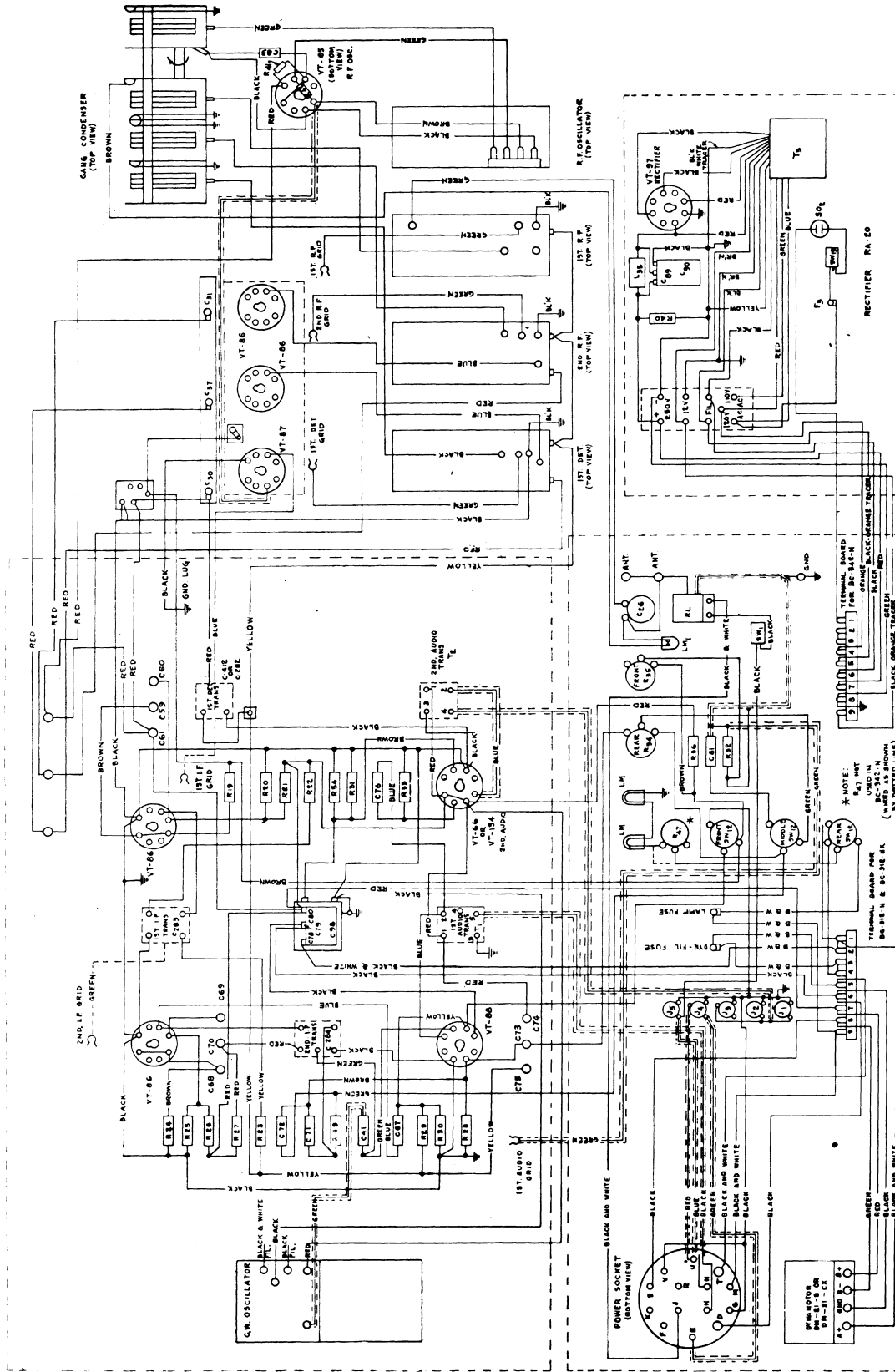

FIGURE 11, RADIO RECEIVERS BC-312-N, BC-312-NX AND BC-342-N, WIRING DIAGRAM.

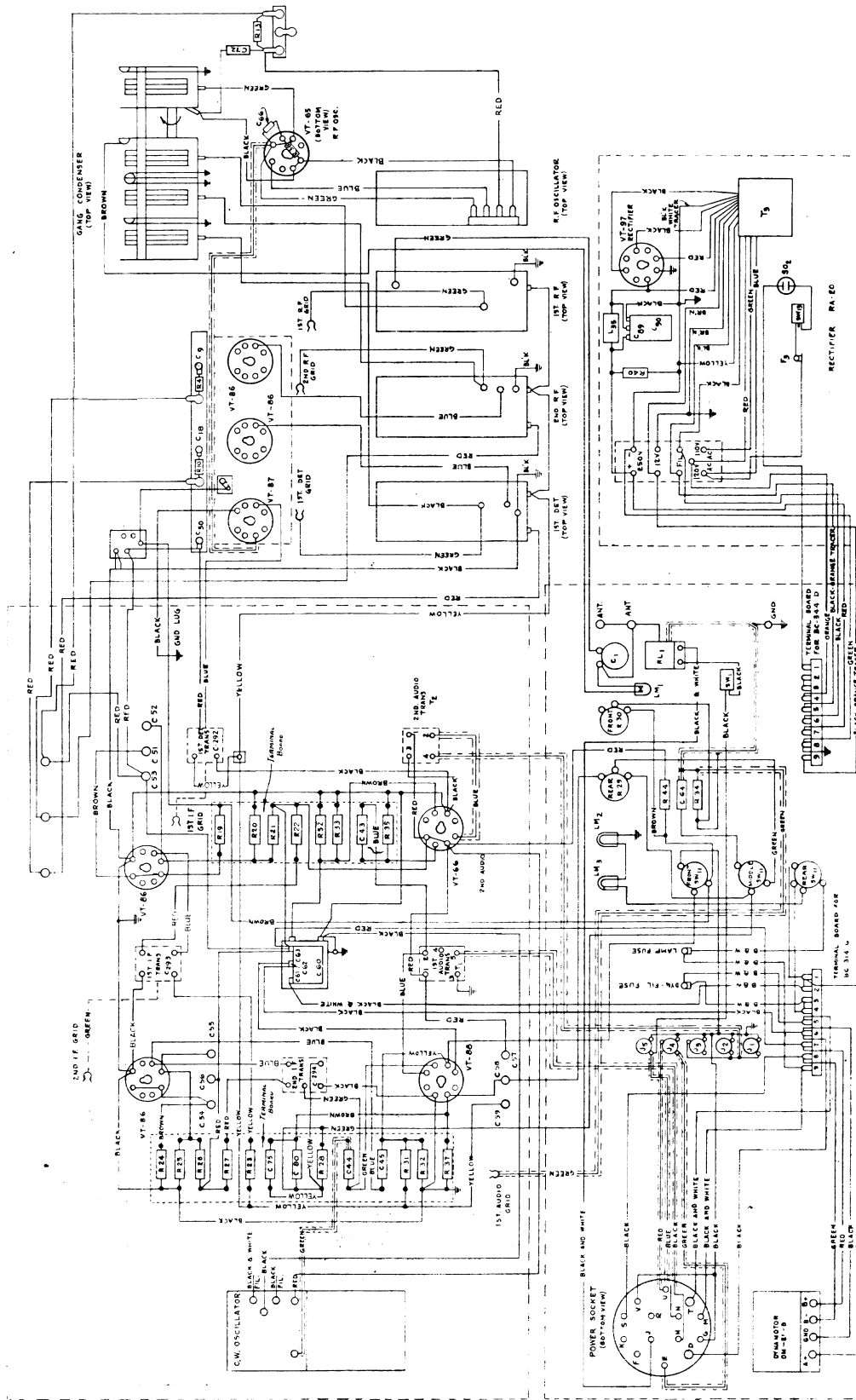

FIGURE 12, RADIO RECEIVERS BC-314-G AND BC-344-D, WIRING DIAGRAM.

22. Chart of Minimum Performance:

a. *Minimum Performance Characteristics for Radio Receivers BC-312-N, BC-312-NX and BC-342-N.*

Band	Freq. Kc	Calib. Kc Dev.	Noise MW Output	Overlap Kc Hi-Lo end	Sensitivity μv AVC-MVC	Image Ratio
A	1500	± 15	12	1455 1492	7.5	180 M
A	2200	15	21	6.0	20
A	3000	15	30	3015 3060	6.0	7.5
B	3000	15	12	2910 2985	6.0	50
B	4000	15	17	5.0	20
B	5000	15	22	5025 5100	4.2	7.5
C	5000	15	12	4850 4975	4.0	20
C	6500	19.5	19	4.0	7.5
C	8000	24	26	8040 8160	4.0	2.5
D	8000	24	10	7760 7960	4.0	5.0
D	9500	28.5	10	4.0	2.5
D	11000	33	10	11055 11220	4.0	1.5
E	11000	33	10	10670 10945	4.0	1.8
E	12500	37.5	10	4.0	.75
E	14000	42	10	14070 14282	4.0	.475
F	14000	42	10	13580 13930	4.0	.475
F	16000	48	10	4.0	.35
F	18000	54	10	18090 18360	5.0	.19

Selectivity MVC
2000 kc
10 \times =11 to 20 kc

Crystal Selectivity MVC
(BC-342-N only)
Width 10 \times =1400 cycles

Crystal Sensitivity μv
(BC-342-N only)

Frequency kc	MVC
1500	10
2200	7
3000	6

I-f Rejection

Frequency kc	I-f Ratio
1500	250 M

C-w Sensitivity μv

Frequency kc	MVC	AVC
1500	3	3

b. Minimum Performance Characteristics for Radio Receivers BC-314-G and BC-344-D.

Band	Freq. Kc	Calib. Kc Dev.	Noise MW Output	Overlap Kc Hi-Lo end	Sensitivity μ v AVC-MVC	C-W	Image Ratio	Selectivity 10 x Limit
A	150	± 10	10	145 149	7	3	178 M
A	200	10	50	6		126	3.5 7.5
A	260	10	70	262 265	5	3	100
B	260	10	10	252 258	6	3	100
B	360	10	50	5	3	71	3.5 7.5
B	450	10	60	453 459	4	3	40
C	450	10	10	436 447	6	3	31.7
C	600	10	44	5.3		10	4.0 10.0
C	820	10	60	824 836	4	3	4.5
D	820	10	10	795 816	6	3	14.2
D	1200	10	37	4.8	3	4	5.0 10.0
D	1500	10	50	1508 1530	4	3	0.8

I-f Rejection Ratio
Frequency kc **Limit**
 150 100 M

C-w Spurious Response
Frequency **Limit**
 185 kc 100 MW

23. Chart of Normal Performance:

a. Normal Performance Characteristics for Radio Receiver BC-312-N.

Band	Freq.	Calib.	Noise MW	Overlap Kc	Sensitivity μ v		Image Ratio
	Kc	Kc Dev.	Output	Hi-Lo end	AVC	MVC	
A	1500	+5	3	1483	4.1	5.4	418 M
A	2200	+10	8	2.0	3.4	115
A	3000	0	17	3037	1.4	2.4	13.3
B	3000	-7	1	2955	3.5	4.3	84
B	4000	+5	8	1.4	2.5	44
B	5000	-7	20	5075	1.2	1.7	20
C	5000	-5	3	4903	2.2	3.5	29
C	6500	+5	14	1.0	1.9	17
C	8000	+5	15	8099	0.9	1.5	8.7
D	8000	-5	3	7882	1.6	2.2	40
D	9500	+5	4	1.3	1.5	7.3
D	11000	-5	2	11159	1.1	1.1	2.2
E	11000	-5	6	10755	1.1	1.5	2
E	12500	+5	8	0.9	1.3	1.2
E	14000	0	5	14196	0.8	1.0	.66
F	14000	-5	1	13780	2.3	1.9	.9
F	16000	-5	2	1.1	1.1	.6
F	18000	+5	2	18228	1.0	1.1	.3

Selectivity MVC

2000 kc
 $10\times=12.7$ kc

I-f Rejection

Frequency kc I-f Ratio
 1500 No response

C-w Sensitivity μ v

Frequency kc MVC AVC
 1500 .7 .8

b. Normal Performance Characteristics of Radio Receiver BC-312-NX.

Band	Freq. Kc	Calib. Kc Dev.	Noise MW Output	Overlap Kc Hi-Lo end	Sensitivity AVC	μ v MVC	Image Ratio
A	1500	+5	2	1483	2.8	3.5	446 M
A	2200	-10	14	1.4	2.0	128
A	3000	0	25	3037	1.2	1.7	36
B	3000	-5	1	2955	2.0	2.2	100
B	4000	+5	4.7	1.1	1.5	42.5
B	5000	-5	14	5075	0.9	1.3	32
C	5000	-5	3	4903	1.4	1.8	42
C	6500	+5	10	0.7	1.1	19
C	8000	+5	20	8099	0.6	1.0	8.2
D	8000	-5	3	7882	1.3	1.6	16.5
D	9500	+5	3	1.1	1.3	7.3
D	11000	-5	1	11159	1.5	1.4	2.8
E	11000	-5	9	10755	0.6	0.9	6.7
E	12500	+5	5	0.6	0.8	2.7
E	14000	0	2	14196	0.6	0.8	0.96
F	14000	-5	2	13780	0.7	0.9	3.0
F	16000	-10	2	0.7	0.9	1.2
F	18000	+5	1	18228	0.9	1.0	0.37

Selectivity MVC

2000 kc
10 \times =13.5 kc

I-f Rejection

Frequency kc I-f Ratio
1500 No Response

C-w Sensitivity μ v

Frequency kc MVC AVC
1500 .9 .8

c. Normal Performance Characteristics of Radio Receiver BC-342-N.

Band	Freq. Kc	Calib. Kc Dev.	Noise MW Output	Overlap Kc Hi-Lo end	Sensitivity μ v AVC	MVC	Image Ratio
A	1500	+5	3	1483	4.9	5.3	450 M
A	2200	+5	13	2.9	3.9	100
A	3000	-5	15	3045	2.0	2.8	26
B	3000	0	1	2956	5.4	4.7	62
B	4000	-5	5	1.5	2.1	40
B	5000	0	12	5077	1.1	1.6	15
C	5000	+5	3	4901	2.0	2.6	50
C	6500	0	4	1.3	1.7	14
C	8000	0	10	8113	1.1	1.4	4
D	8000	-5	3	7884	1.8	2.2	18
D	9500	0	3	1.4	1.7	7
D	11000	+5	2	11172	1.2	1.2	4
E	11000	0	3	10751	1.0	1.3	6
E	12500	0	5	0.9	1.1	3
E	14000	+5	5	14203	0.8	0.9	2
F	14000	-15	1	13789	1.7	1.4	2
F	16000	-10	2	1.1	1.2	1.3
F	18000	-10	2	18240	1.0	1.2	0.5

Selectivity MVC

2000 kc

10 \times =13.6 kc

Crystal Selectivity MVC

Width 10 \times =200 cycles

I-f Rejection

Frequency kc

1500

I-f Ratio

No Response

Crystal Sensitivity μ v

Frequency kc

1500

2200

3000

MVC

2.7

0.6

0.6

C-w Sensitivity μ v

Frequency kc

1500

MVC

.86

AVC

1.2

d. Normal Performance Characteristics of Radio Receiver BC-314-G.

Band	Freq. Kc	Calib. Kc Dev.	Noise MW Output	Overlap Kc Hi-Lo end	Sensitivity μ v			Image Ratio	Selectivity 10 x Limit
					AVC	MVC	CW		
A	150	0	6	147	5.6	6.0	1.8	210 M
A	200	—1	30	5.2	5.4	190	6.0
A	260	—2	50	263	4.3	4.4	1.2	160
B	260	0	4	254	5.0	5.2	1.3	140
B	360	—2	30	4.1	4.2	1.1	95	5.8
B	450	—2	50	455	3.2	3.3	1.0	60
C	450	0	4	440	4.8	5.0	1.3	52
C	600	—3	20	4.1	4.3	21	8.0
C	820	—2.5	40	829	3.1	3.3	1.0	7.5
D	820	0	3	809	5.2	5.3	1.5	19.4
D	1200	—2	15	3.3	3.6	1.1	6	7.0
D	1500	—5	38	1518	3.0	3.1	1.0	1.7

I-f Rejection Ratio

Frequency kc	Ratio
150	500 M

C-w Spurious Response

Frequency kc	Response
185	20 MW

e. Normal Performance Characteristics of Radio Receiver BC-344-D.

Band	Freq. Kc	Calib. Kc Dev.	Noise MW Output	Overlap Kc Hi-Lo end	Sensitivity μ v			Image Ratio	Selectivity 10 x Limit
					AVC	MVC	CW		
A	150	0	7	147	5.8	6.2	2.0	208 M
A	200	—2	28	5.0	5.2	197	6.5
A	260	—1	49	262	4.1	4.3	1.8	164
B	260	0	6	254	4.7	5.0	1.3	138
B	360	—3	32	4.0	4.2	1.0	97	6.0
B	450	—2	49	455	3.4	3.6	1.0	59
C	450	—2	7	441	4.6	5.0	1.4	54
C	600	—1	30	4.3	4.3	21	7.7
C	820	0	50	829	2.9	3.2	1.1	7.8
D	820	0	8	809	4.8	4.9	1.3	20
D	1200	—3	23	3.2	3.3	1.1	7	7.3
D	1500	—3	40	1516	2.9	3.1	1.1	1.3

I-f Rejection Ratio

Frequency kc	Ratio
150	580 M

C-w Spurious Response

Frequency kc	Response
185	30 MW

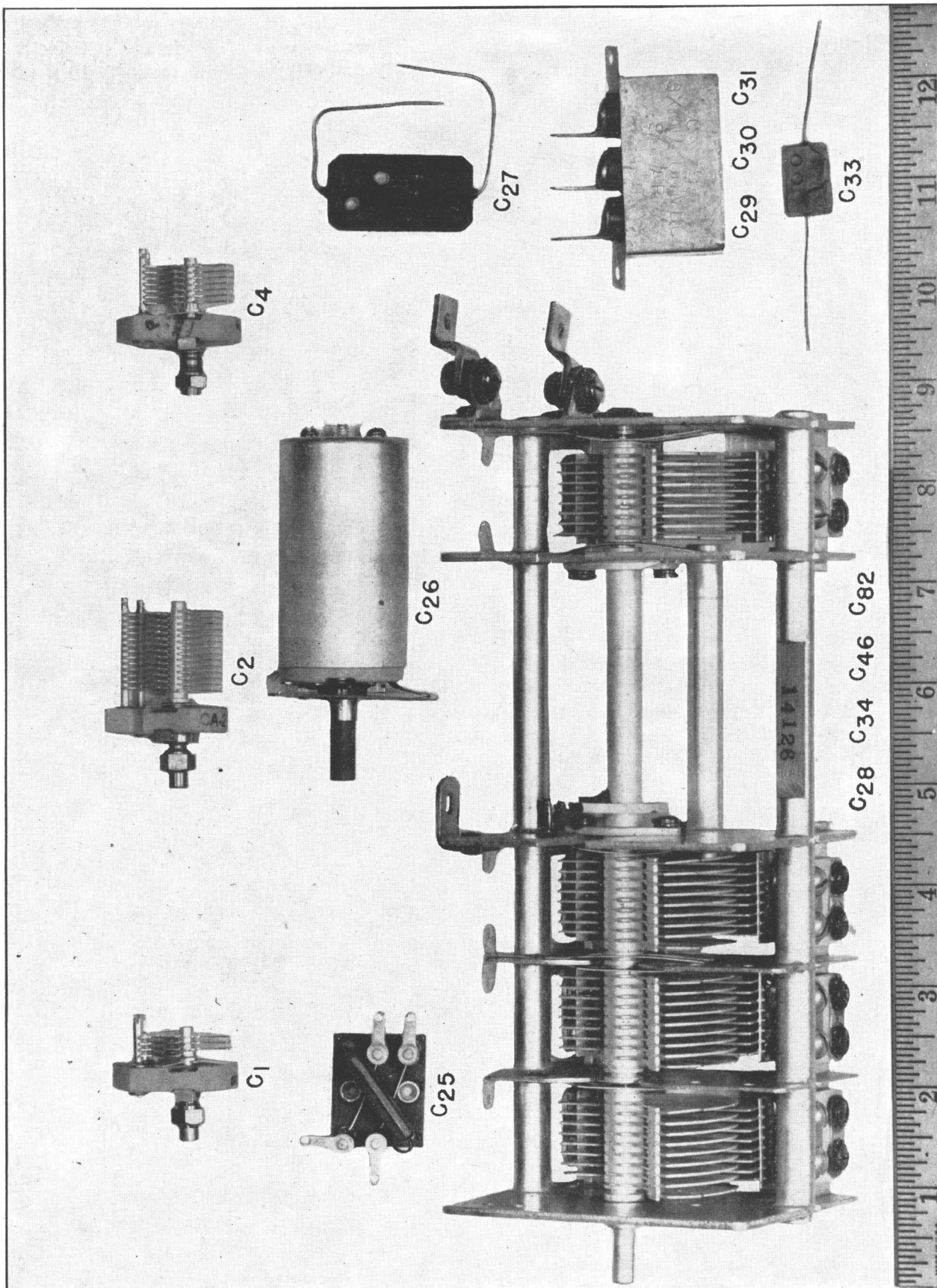

24. Tabular List of Replaceable Parts, Radio Receiver BC-312-N:

a. Electrical Parts.

Note: The list of stock numbers is intended to supplement the Signal Corps. General Catalog until such time as the Catalog is revised to include the stock numbers herein. Order replacement parts by stock numbers and description.

Ref. No.	Stock No.	Name of Part	Description	Function	Mfg.*	Signal Corps Drawing No.
C ₁	3D289	Capacitor CA-289	Variable, air; 3-25 $\mu\mu\text{f}$	Band-A trimmer, 1st r-f	A, C, or E	SC-A-1728
C ₂	3D291	Capacitor CA-291	Variable, air; 6-100 $\mu\mu\text{f}$	Band-B trimmer, 1st r-f	A, C, or E	SC-A-1728
C ₃	3D291	Capacitor CA-291	Same as C ₂	Band-C trimmer, 1st r-f	A, C, or E	SC-A-1728
C ₄	3D290	Capacitor CA-290	Variable, air; 4-50 $\mu\mu\text{f}$	Band-D trimmer, 1st r-f	A, C, or E	SC-A-1728
C ₅	3D290	Capacitor CA-290	Same as C ₄	Band-E trimmer, 1st r-f	A, C, or E	SC-A-1728
C ₆	3D290	Capacitor CA-290	Same as C ₄	Band-F trimmer, 1st r-f	A, C, or E	SC-A-1728
C ₇	3D289	Capacitor CA-289	Same as C ₁	Band-A trimmer, 2nd r-f	A, C, or E	SC-A-1728
C ₈	3D291	Capacitor CA-291	Same as C ₂	Band-B trimmer, 2nd r-f	A, C, or E	SC-A-1728
C ₉	3D291	Capacitor CA-291	Same as C ₂	Band-C trimmer, 2nd r-f	A, C, or E	SC-A-1728
C ₁₀	3D290	Capacitor CA-290	Same as C ₄	Band-D trimmer, 2nd r-f	A, C, or E	SC-A-1728
C ₁₁	3D290	Capacitor CA-290	Same as C ₄	Band-E trimmer, 2nd r-f	A, C, or E	SC-A-1728
C ₁₂	3D290	Capacitor CA-290	Same as C ₄	Band-F trimmer, 2nd r-f	A, C, or E	SC-A-1728
C ₁₃	3D289	Capacitor CA-289	Same as C ₁	Band-A trimmer, 1st det.	A, C, or E	SC-A-1728
C ₁₄	3D291	Capacitor CA-291	Same as C ₂	Band-B trimmer, 1st det.	A, C, or E	SC-A-1728
C ₁₅	3D291	Capacitor CA-291	Same as C ₂	Band-C trimmer, 1st det.	A, C, or E	SC-A-1728
C ₁₆	3D290	Capacitor CA-290	Same as C ₄	Band-D trimmer, 1st det.	A, C, or E	SC-A-1728
C ₁₇	3D290	Capacitor CA-290	Same as C ₄	Band-E trimmer, 1st det.	A, C, or E	SC-A-1728
C ₁₈	3D290	Capacitor CA-290	Same as C ₄	Band-F trimmer, 1st det.	A, C, or E	SC-A-1728
C ₁₉	3D289	Capacitor CA-289	Same as C ₁	Band-A trimmer, r-f osc.	A, C, or E	SC-A-1728
C ₂₀	3D291	Capacitor CA-291	Same as C ₂	Band-B trimmer, r-f osc.	A, C, or E	SC-A-1728
C ₂₁	3D291	Capacitor CA-291	Same as C ₂	Band-C trimmer, r-f osc.	A, C, or E	SC-A-1728
C ₂₂	3D290	Capacitor CA-290	Same as C ₄	Band-D trimmer, r-f osc.	A, C, or E	SC-A-1728
C ₂₃	3D290	Capacitor CA-290	Same as C ₄	Band-E trimmer, r-f osc.	A, C, or E	SC-A-1728
C ₂₄	3D290	Capacitor CA-290	Same as C ₄	Band-F trimmer, r-f osc.	A, C, or E	SC-A-1728
†C ₂₅	3D294	Capacitor CA-294	Fixed; 125 $\mu\mu\text{f}$	Padder, 1st r-f	A	SC-D-2575
C ₂₆	3D293	Capacitor CA-293	Variable, air; 10-210 $\mu\mu\text{f}$	Antenna alignment	A, C, or E	SC-A-2580
†C ₂₇	3D284	Capacitor CA-284	Molded, paper, .05 μf -400 v	1st r-f, bypass	J	SC-D-1995
C ₂₈	**	Capacitor	Ganged 13-226 $\mu\mu\text{f}$	1st r-f, tuning	D or F	SC-D-2568
†C ₂₉	3D195	Capacitor CA-195	Metal-encased	1st r-f, cathode bypass	G, H, or I	SC-D-512
†C ₃₀			as	1st r-f, screen bypass		SC-D-512
†C ₃₁			one unit	1st r-f, "B" supply bypass	J	SC-D-1995
†C ₃₂	3D284	Capacitor CA-284	Same as C ₂₇	1st r-f, plate bypass	I or K	SC-D-1993
†C ₃₃	3D266	Capacitor CA-266	Mica; 100 $\mu\mu\text{f}$	2nd r-f, grid coupling		

* See Index of Manufacturers.

** C₂₈, C₃₄, C₄₀, and C₈₂ ganged comprise Capacitor CA-292 (3D292)

† Furnished in Maintenance Parts Group.

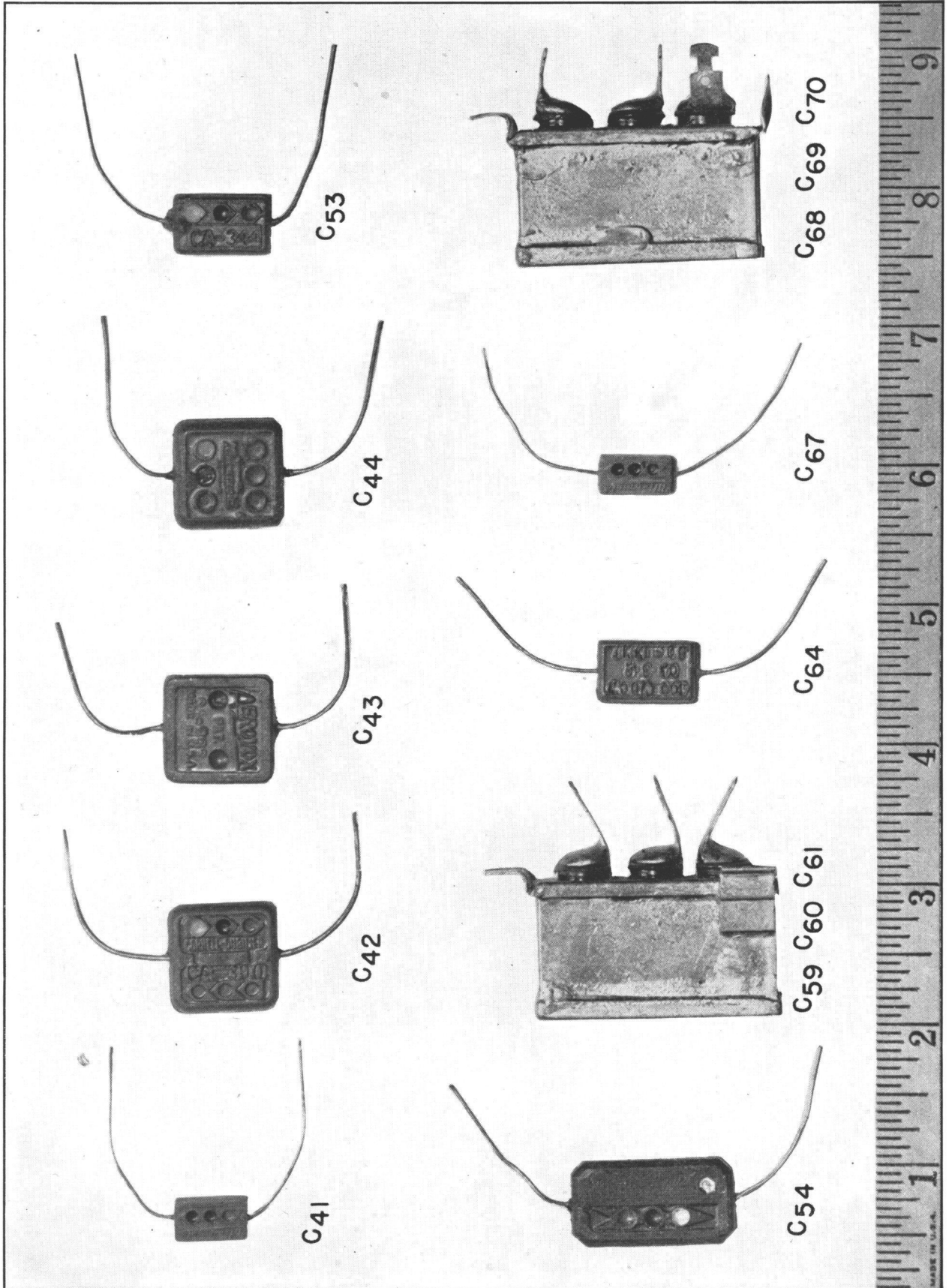

Tabular List of Replaceable Parts (Continued),—

Ref. No.	Stock No.	Name of Part	Description	Function	Mfg.*	Signal Corps Drawing No.
C ₃₄	**	Capacitor	Ganged 13-226 $\mu\mu\text{f}$	2nd r-f, tuning	D or F	SC-D-2568
	†C ₃₅	Capacitor CA-195	{ Same as C ₂₉	2nd r-f, cathode bypass	G, H or I	SC-D-512
†C ₃₆	{ Same as C ₃₀		2nd r-f, screen bypass	SC-D-512		
†C ₃₇	3D195		{ Same as C ₃₁	2nd r-f, "B" supply bypass		SC-D-512
†C ₃₈	3D294	Capacitor CA-294	Same as C ₂₅	Padder, 1st det.	A	SC-D-2575
†C ₃₉	3D284	Capacitor CA-284	Same as C ₂₇	2nd r-f, plate bypass	J	SC-D-1995
†C ₄₀	3D294	Capacitor CA-294	Same as C ₂₅	Padder, r-f osc.	A	SC-D-2575
†C ₄₁	3D278	Capacitor CA-278	Mica; 5 $\mu\mu\text{f}$	C-W osc., coupling	J	SC-D-1993
†C ₄₂	3D300	Capacitor CA-300	Mica, aged; 3000 $\mu\mu\text{f}$	Band-C padder, r-f osc.	K	SC-D-1993
†C ₄₃	3D297	Capacitor CA-297	Mica, aged; 1600 $\mu\mu\text{f}$	Band-B padder, r-f osc.	G, J, or K	SC-D-1993
†C ₄₄	3D299	Capacitor CA-299	Mica, aged; 750 $\mu\mu\text{f}$	Band-A padder, r-f osc.	J or K	SC-D-1993
†C ₄₅	3D266	Capacitor CA-266	Same as C ₃₃	1st det., grid coupling	I or K	SC-D-1993
C ₄₆	**	Capacitor	Ganged 13-226 $\mu\mu\text{f}$	1st det., tuning	D or F	SC-D-2568
†C ₄₇	3D266	Capacitor CA-266	Same as C ₃₃	R. F. osc., coupling	I or K	SC-D-1993
†C ₄₈	3D195	Capacitor CA-195	{ Same as C ₂₉	1st det., cathode bypass	G, H, or I	SC-D-512
†C ₄₉			{ Same as C ₃₀	1st det., screen bypass		SC-D-512
†C ₅₀			{ Same as C ₃₁	1st det., "B" supply bypass		SC-D-512
†C ₅₃	3D344	Capacitor CA-344	Mica; 400 $\mu\mu\text{f}$	1st det., plate	G, J, or K	SC-D-1993
†C ₅₄	3D281	Capacitor CA-281	Molded, paper; .01 μf —400 v.	1st det., plate bypass	J	SC-D-1995
†C ₅₅	3D344	Capacitor CA-344	Same as C ₅₃	2nd i-f, grid	G, J, or K	SC-D-1993
†C ₅₆	3D281	Capacitor CA-281	Same as C ₅₄	2nd i-f, AVC bypass	J	SC-D-1995
†C ₅₇	3D344	Capacitor CA-344	Same as C ₅₃	1st i-f, plate	G, J, or K	SC-D-1993
†C ₅₈	3D281	Capacitor CA-281	Same as C ₅₄	1st i-f, cathode bypass	J	SC-D-1995
†C ₅₉	3D302	Capacitor CA-302	Modification	1st i-f, cathode bypass	G, H, or I	SC-D-2567
†C ₆₀			of	{ .05 μf —300 v.		1st i-f, screen bypass
†C ₆₁			CA-195	1st i-f, "B" supply bypass		SC-D-2567
†C ₆₂	3D284	Capacitor CA-284	Same as C ₂₇	1st det., AVC bypass	J	SC-D-1995
†C ₆₃	3D281	Capacitor CA-281	Same as C ₅₄	1st i-f, AVC bypass	J	SC-D-1995
†C ₆₄	3D342	Capacitor CA-342	Mica; 100 $\mu\mu\text{f}$	1st i-f, AVC bypass	J or K	SC-D-1993
†C ₆₅	3D342	Capacitor CA-342	Same as C ₆₄	2nd det., grid	J or K	SC-D-1993
†C ₆₆	3D281	Capacitor CA-281	Same as C ₅₄	2nd i-f, plate	J or K	SC-D-1993
†C ₆₇	3D279	Capacitor CA-279	Same as C ₅₄	2nd i-f, plate bypass	J	SC-D-1995
†C ₆₈	3D301	Capacitor CA-301	Modification	Diode, AVC, Coupling	G, H, or I	SC-D-1993
†C ₆₉			of	{ .05 μf —300 v.		2nd i-f, cathode bypass
†C ₇₀			CA-195	2nd i-f, screen bypass		SC-D-2567
				2nd i-f, "B" supply bypass		SC-D-2567

* See Index of Manufacturers.

** C₂₈, C₃₄, C₄₆, and C₈₂ ganged comprise Capacitor CA-292 (3D292)

† Furnished in Maintenance Parts Group.

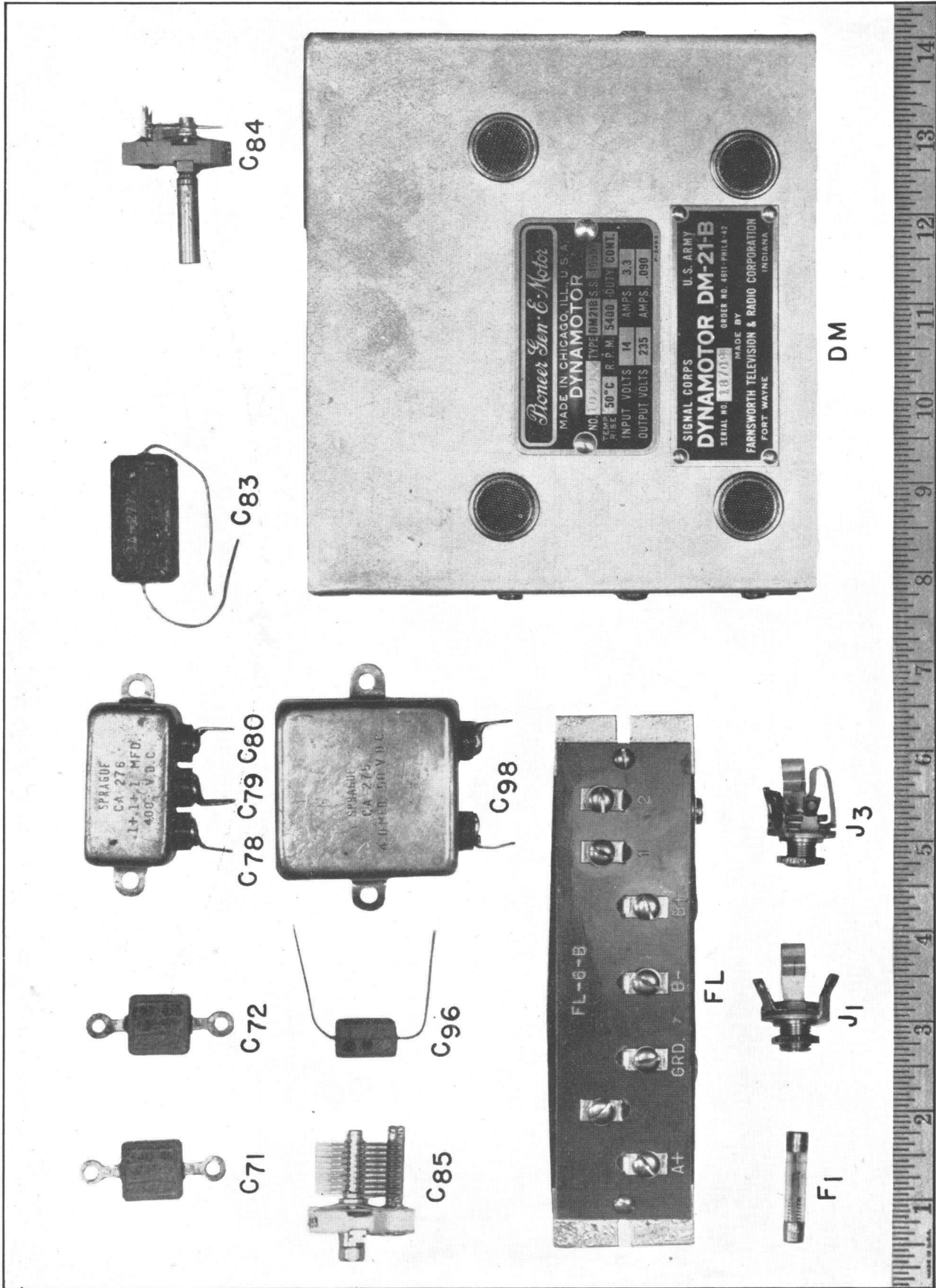

Tabular List of Replaceable Parts (Continued),—

Ref. No.	Stock No.	Name of Part	Description	Function	Mfg.*	Signal Corps Drawing No.
†C ₇₁	3D218	Capacitor CA-218	Mica; 150 μμf	Diode, r-f bypass	G	SC-D-1993
†C ₇₂	3D193	Capacitor CA-193	Mica; 500 μμf	Diode, r-f filter	G	SC-D-1993
†C ₇₃	3D301	Capacitor CA-301	{ Same as C ₆₈ Same as C ₆₉ Same as C ₇₀ Same as C ₅₄	Diode, cathode bypass	G, H, or I	SC-D-2567
†C ₇₄				1st audio, plate bypass		
†C ₇₅				AVC filter, bypass		
†C ₇₆				1st audio plate, R. F. bypass		
†C ₇₈	3D281	Capacitor CA-281	Metal-encased as one unit { 0.1 μf—400 v. 0.1 μf—400 v. 0.1 μf—400 v.	Heater, bypass	J	SC-D-1995
†C ₇₉	3D276	Capacitor CA-276	as	Heater, bypass	G, H, or I	SC-D-512
†C ₈₀	3D281	Capacitor CA-281	Same as C ₅₄	2nd audio, plate bypass	J	SC-D-512
†C ₈₁				1st audio, coupling		
C ₈₂	3D277	Capacitor CA-277	Ganged 13-226 μμf	r-f osc., tuning	D or F	SC-D-1995
†C ₈₃	3D383	Capacitor CA-383	Molded, paper; 0.1 μf—400 v.	r-f osc., plate bypass	J	SC-D-2568
C ₈₄	3D253	Capacitor CA-253	Variable, air; 1-10 μμf	C-W osc., tuning	A, C, or E	SC-A-1728
C ₈₅	3D266	Capacitor CA-266	Variable, air; 4-75 μμf	C-W osc., trimmer	A, C, or E	SC-A-1728
†C ₈₆	3D284	Capacitor CA-284	Same as C ₃₃	C-W osc., grid	I or K	SC-D-1993
†C ₈₇	3D266	Capacitor CA-266	Same as C ₂₇	C-W osc., plate bypass	J	SC-D-1995
†C ₈₈	3D286	Capacitor CA-286	Mica; 75 μμf	r-f osc., grid	I or K	SC-D-1993
†C ₉₆	3D286	Capacitor CA-286	Same as C ₉₆	C-W osc., filter	J or K	SC-D-1993
†C ₉₇	3D275	Capacitor CA-275	Paper; 4 μf	C-W osc., filter	J or K	SC-D-1993
†C ₉₈	3D284	Capacitor CA-284	Same as C ₂₇	C-W osc., filter	J or K	SC-D-1993
†C ₉₉	3D294	Capacitor CA-294	Same as C ₂₅	2nd audio, cathode bypass	H	SC-D-512
†C ₁₀₀	3D266	Capacitor CA-266	Same as C ₃₃	2nd R. F., AVC bypass	J	SC-D-1995
†C ₁₀₁	3D284	Capacitor CA-284	Same as C ₂₇	2nd R. F., padder	A	SC-D-2575
†C ₁₀₂	3D344	Capacitor CA-344	Same as C ₅₃	1st R. F., grid coupling	I or K	SC-D-1993
†C ₁₀₃	3H1621B	Dynamotor DM-21-B	Motor-Generator	1st R. F., AVC bypass	J	SC-D-1995
F ₁	3Z1921A	Fuse FU-21-A	10 a.—25 V.	1st i-f, grid	G, J, or K	SC-D-1993
F ₂	3Z1921A	Fuse FU-21-A	Same as F ₁	Power Supply	Y	SC-D-2723
†FL	3Z1890-6B	Filter FL-6-B	Filter Unit	Dynamotor and filaments	B or Q	SC-D-2723
J ₁	2Z5534A	Jack JK-34-A	Open circuit Jack	LM ₂ and LM ₃ Pilot Lights	B or Q	SC-D-2339
J ₂	2Z5534A	Jack JK-34-A	Same as J ₁	Dynamotor Filter	Y	SC-D-2339
J ₃	2Z5533A	Jack JK-33-A	3 circuit Jack	2nd audio phones	O	SC-D-2332
J ₄	2Z5533A	Jack JK-33-A	Same as J ₃	2nd audio phones	O	SC-D-2332
J ₅	2Z5534A	Jack JK-34-A	Same as J ₁	Speaker	O	SC-D-2332
				Microphone	O	SC-D-2339
				Key	O	SC-D-2339

* See Index of Manufacturers.

** C₂₈, C₃₄, C₄₆, and C₈₂ ganged comprise Capacitor CA-292 (3D292)

† Furnished in Maintenance Parts Group.

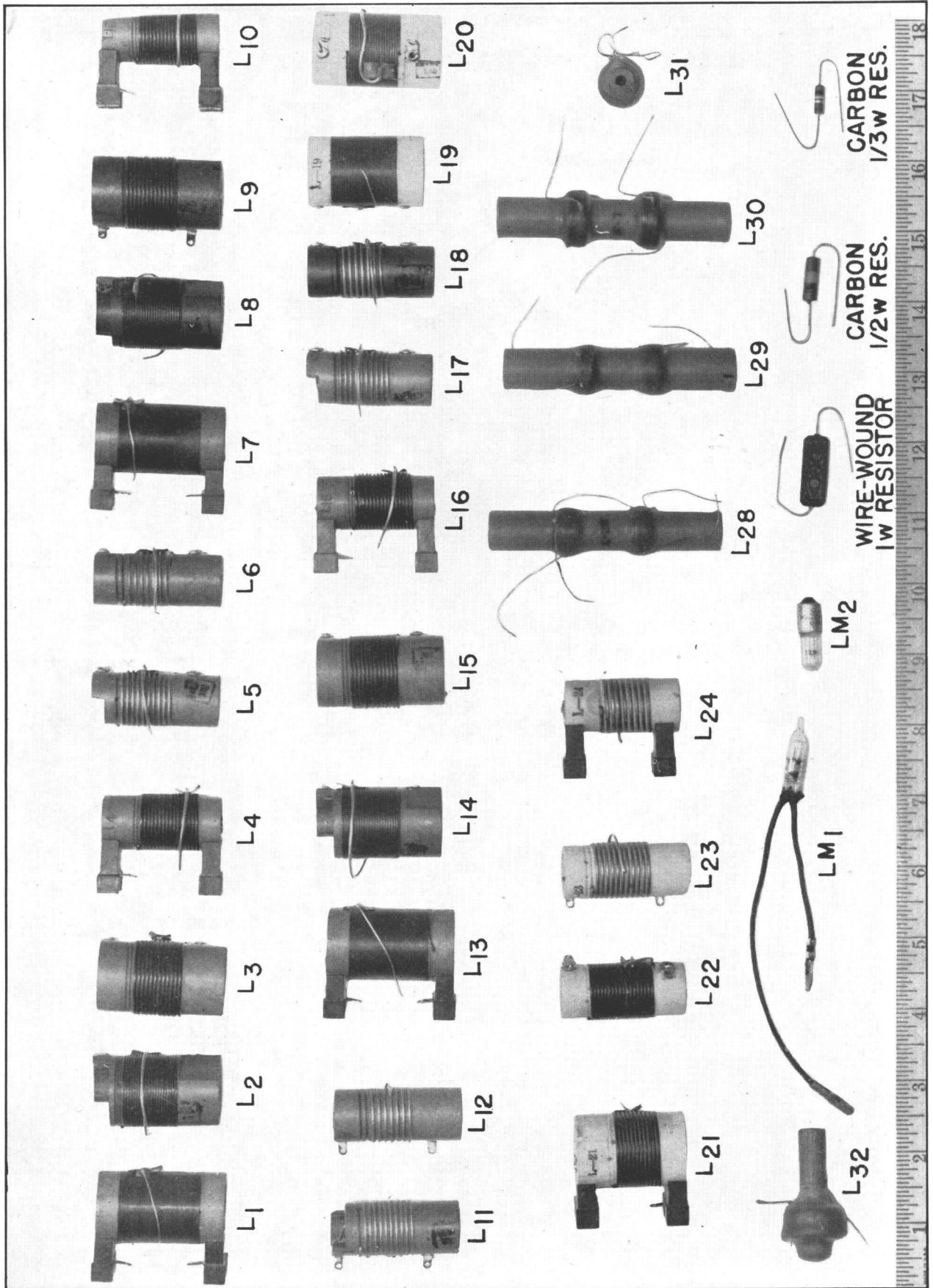

Tabular List of Replaceable Parts (Continued),—

Ref. No.	Stock No.	Name of Part	Description	Function	Mfg.*	Signal Corps Drawing No.
L ₁	3C1083	Coil		Band-A, 1st r-f	Z	SC-D-2556
L ₂	3C1083-3	Coil		Band-B, 1st r-f	Z	SC-D-2556
L ₃	3C1083-6	Coil		Band-C, 1st r-f	Z	SC-D-2556
L ₄	3C1083-9	Coil		Band-D, 1st r-f	Z	SC-D-2556
L ₅	3C1083-12	Coil		Band-E, 1st r-f	Z	SC-D-2556
L ₆	3C1083-15	Coil		Band-F, 1st r-f	Z	SC-D-2556
L ₇	3C1083-1	Coil		Band-A, 2nd r-f	Z	SC-D-2556
L ₈	3C1083-4	Coil		Band-B, 2nd r-f	Z	SC-D-2556
L ₉	3C1083-7	Coil		Band-C, 2nd r-f	Z	SC-D-2556
L ₁₀	3C1083-10	Coil		Band-D, 2nd r-f	Z	SC-D-2556
L ₁₁	3C1083-13	Coil		Band-E, 2nd r-f	Z	SC-D-2556
L ₁₂	3C1083-16	Coil		Band-F, 2nd r-f	Z	SC-D-2556
L ₁₃	3C390	Coil		Band-A, 1st Det.	Z	SC-D-2556
L ₁₄	3C390-1	Coil		Band-B, 1st Det.	Z	SC-D-2556
L ₁₅	3C390-2	Coil		Band-C, 1st Det.	Z	SC-D-2556
L ₁₆	3C390-3	Coil		Band-D, 1st Det.	Z	SC-D-2556
L ₁₇	3C390-4	Coil		Band-E, 1st Det.	Z	SC-D-2556
L ₁₈	3C390-5	Coil		Band-F, 1st Det.	Z	SC-D-2556
L ₁₉	3C1083-2	Coil		Band-A, r-f Osc.	Z	SC-D-2556
L ₂₀	3C1083-5	Coil		Band-B, r-f Osc.	Z	SC-D-2556
L ₂₁	3C1083-8	Coil		Band-C, r-f Osc.	Z	SC-D-2556
L ₂₂	3C1083-11	Coil		Band-D, r-f Osc.	Z	SC-D-2556
L ₂₃	3C1083-14	Coil		Band-E, r-f Osc.	Z	SC-D-2556
L ₂₄	3C1083-17	Coil		Band-F, r-f Osc.	Z	SC-D-2556
L ₂₈	2Z9940-412/1	Coils of Transformer C-412		1st Detector Transformer	Z	SC-D-2566
L ₂₉	2Z9883/1	Coils of Transformer C-283		1st i-f Transformer	Z	SC-D-2566
L ₃₀	2Z9884/1	Coils of Transformer C-284		2nd i-f Transformer	Z	SC-D-2566
†L ₃₁	2C2775/2	Coil		C-W beat osc.	Z	SC-D-2561
†L ₃₂	2C2775/3	Coil		Filter, C-W Osc.	Z	SC-D-2561
LM ₁	2Z5893	Neon Lamp	Pilot Lamp	Antenna overload protection	R	SC-A-1801
LM ₂	2Z5927	Lamp LM-27	Same as LM ₂	Dial Light	S	SC-D-2573
LM ₃	2Z5927	Lamp LM-27	Same as LM ₂	Dial Light	S	SC-D-2573
†R ₁	3Z4564	Resistor RS-164	Wire-wound, 500 ohm 1 w.	Cathode bias, 1st r-f	J	SC-D-970
†R ₂	3Z4569	Resistor RS-169	Carbon, insul; 60,000 ohm ½ w.	Screen grid, 1st r-f	M	SC-D-970
†R ₃	3Z4549	Resistor RS-149	Carbon, insul; 40,000 ohm ½ w.	Screen grid, 1st r-f	M	SC-D-970
†R ₄	3Z4572	Resistor RS-172	Carbon, insul; 100,000 ohm ½ w.	AVC filter, 1st r-f	N	SC-D-970
†R ₅	3Z4525	Resistor RS-125	Carbon; 1,000 ohm ½ w.	Plate filter, 1st r-f	M	SC-D-970
†R ₆	3Z4573	Resistor RS-173	Carbon; 2 megohm ½ w.	Grid, 2nd r-f	N	SC-D-970

* See Index of Manufacturers.
 † Furnished in Maintenance Parts Group.

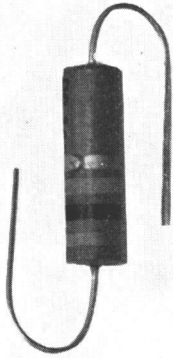

CARBON
1W RESISTOR

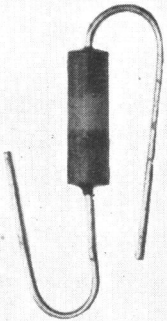

CARBON
1/2 W RESISTOR

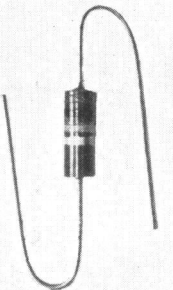

CARBON
1/3 W RESISTOR

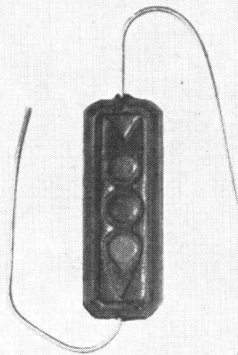

WIRE-WOUND
1W RESISTOR

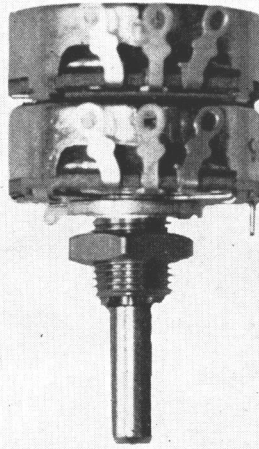

R34 R35

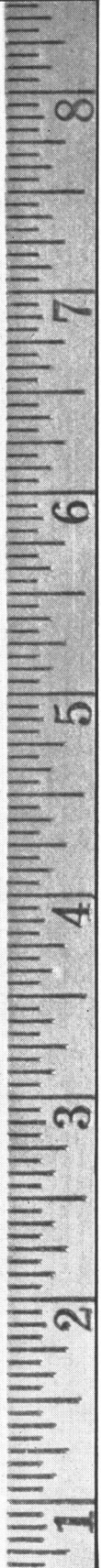

Tabular List of Replaceable Parts (Continued),—

Ref. No.	Stock No.	Name of Part	Description	Function	Mfg.*	Signal Corps Drawing No.
†R ₇	3Z4564	Resistor RS-164	Same as R ₁	Cathode, bias, 2nd r-f	J	SC-D-970
†R ₈	3Z4569	Resistor RS-169	Same as R ₂	Screen grid, 2nd r-f	M	SC-D-970
†R ₉	3Z4549	Resistor RS-149	Same as R ₃	Screen grid, 2nd r-f	M	SC-D-970
†R ₁₀	3Z4572	Resistor RS-172	Same as R ₄	AVC filter, 2nd r-f	N	SC-D-970
†R ₁₁	3Z4525	Resistor RS-125	Same as R ₅	Plate filter, 2nd, r-f	M	SC-D-970
†R ₁₂	3Z4573	Resistor RS-173	Same as R ₆	Grid, 1st det.	N	SC-D-970
†R ₁₃	3Z4568	Resistor RS-168	Carbon; 50,000 ohm ½ w.	Injector bias, 1st det.	N	SC-D-970
†R ₁₄	3Z4566	Resistor RS-166	Wire-wound; 350 ohm 1 w.	Cathode bias, 1st det.	J	SC-D-970
†R ₁₅	3Z4540	Resistor RS-140	Carbon, insul; 30,000 ohm ½ w.	Screen grid, 1st det.	M	SC-D-970
†R ₁₆	3Z4572	Resistor RS-172	Same as R ₄	AVC filter, 1st det.	N	SC-D-970
†R ₁₇	3Z4525	Resistor RS-125	Same as R ₅	Plate filter, 1st det.	M	SC-D-970
†R ₁₉	3Z4564	Resistor RS-164	Same as R ₁	Cathode bias, 1st i-f	J	SC-D-970
†R ₂₀	3Z4563	Resistor RS-163	Carbon, insul; 60,000 ohm 1 w.	Screen grid, 1st i-f	L	SC-D-970
†R ₂₁	3Z4549	Resistor RS-149	Same as R ₃	Screen grid, 1st i-f	M	SC-D-970
†R ₂₂	3Z4525	Resistor RS-125	Same as R ₅	Plate filter, 1st i-f	M	SC-D-970
†R ₂₃	3Z4550	Resistor RS-150	Carbon, insul; 100,000 ohm ½ w.	AVC filter, 2nd i-f	M	SC-D-970
†R ₂₄	3Z4564	Resistor RS-164	Same as R ₁	Cathode bias, 2nd i-f	J	SC-D-970
†R ₂₅	3Z4563	Resistor RS-163	Same as R ₂₀	Screen grid, 2nd i-f	L	SC-D-970
†R ₂₆	3Z4549	Resistor RS-149	Same as R ₃	Screen grid, 2nd i-f	M	SC-D-970
†R ₂₇	3Z4525	Resistor RS-125	Same as R ₅	Plate filter, 2nd i-f	M	SC-D-970
†R ₂₈	3Z4571	Resistor RS-171	Wire-wound, 750 ohm 1 w.	Cathode bias, diode	J	SC-D-970
†R ₂₉	3Z4562	Resistor RS-162	Carbon, insul; 250,000 ohm ½ w.	AVC filter, diode	M	SC-D-970
†R ₃₀	3Z4561	Resistor RS-161	Carbon; 1 megohm ½ w.	AVC load	M	SC-D-970
†R ₃₁	3Z4623	Resistor RS-223	Wire-wound; 2,000 ohm 1 w.	Cathode bias, 2nd audio	J	SC-D-970
†R ₃₂	3Z4562	Resistor RS-162	Same as R ₂₉	Grid, 1st a-f	M	SC-D-970
†R ₃₃	3Z4531	Resistor RS-131	Carbon, insul; 50,000 ohm ½ w.	Grid, 2nd a-f	M	SC-D-970
†R ₃₄	2Z7289	Potentiometer RS-174	{ 0—500,000 ohm	Dual volume Control	P	SC-D-1982
†R ₃₅			} 0—50,000 ohm			
†R ₃₆	3Z4511	Resistor RS-111	Carbon, insul; 100,000 ohm 1 w.	Minimum bias bleeder	L	SC-D-970
†R ₃₇	3Z4550	Resistor RS-150	Same as R ₂₃	C-W osc., plate	M	SC-D-970
†R ₃₈	3Z4569	Resistor RS-169	Same as R ₂	Plate circuit, loading	M	SC-D-970
†R ₄₁	3Z4539	Resistor RS-139	Carbon, insul; 30,000 ohm 1 w.	Plate, r-f osc.	L	SC-D-970
†R ₄₂	3Z4540	Resistor RS-140	Same as R ₁₅	Grid, r-f osc.	M	SC-D-970
†R ₄₃	3Z4548	Resistor RS-148	Carbon, insul; 200,000 ohm ½ w.	Grid, C-W osc.	M	SC-D-970
†R ₄₄	3Z4635	Resistor RS-235	Carbon, insul; 3,000 ohm 1 w.	Cathode, band C, r-f osc.	L	SC-D-970
†R ₄₅	3Z4637	Resistor RS-237	Carbon, insul; 5,000 ohm 1 w.	Cathode, band B, r-f osc.	L	SC-D-970
†R ₄₆	3Z4638	Resistor RS-238	Carbon, insul; 7,500 ohm 1 w.	Cathode, band A, r-f osc.	L	SC-D-970

* See Index of Manufacturers.

† Furnished in Maintenance Parts Group.

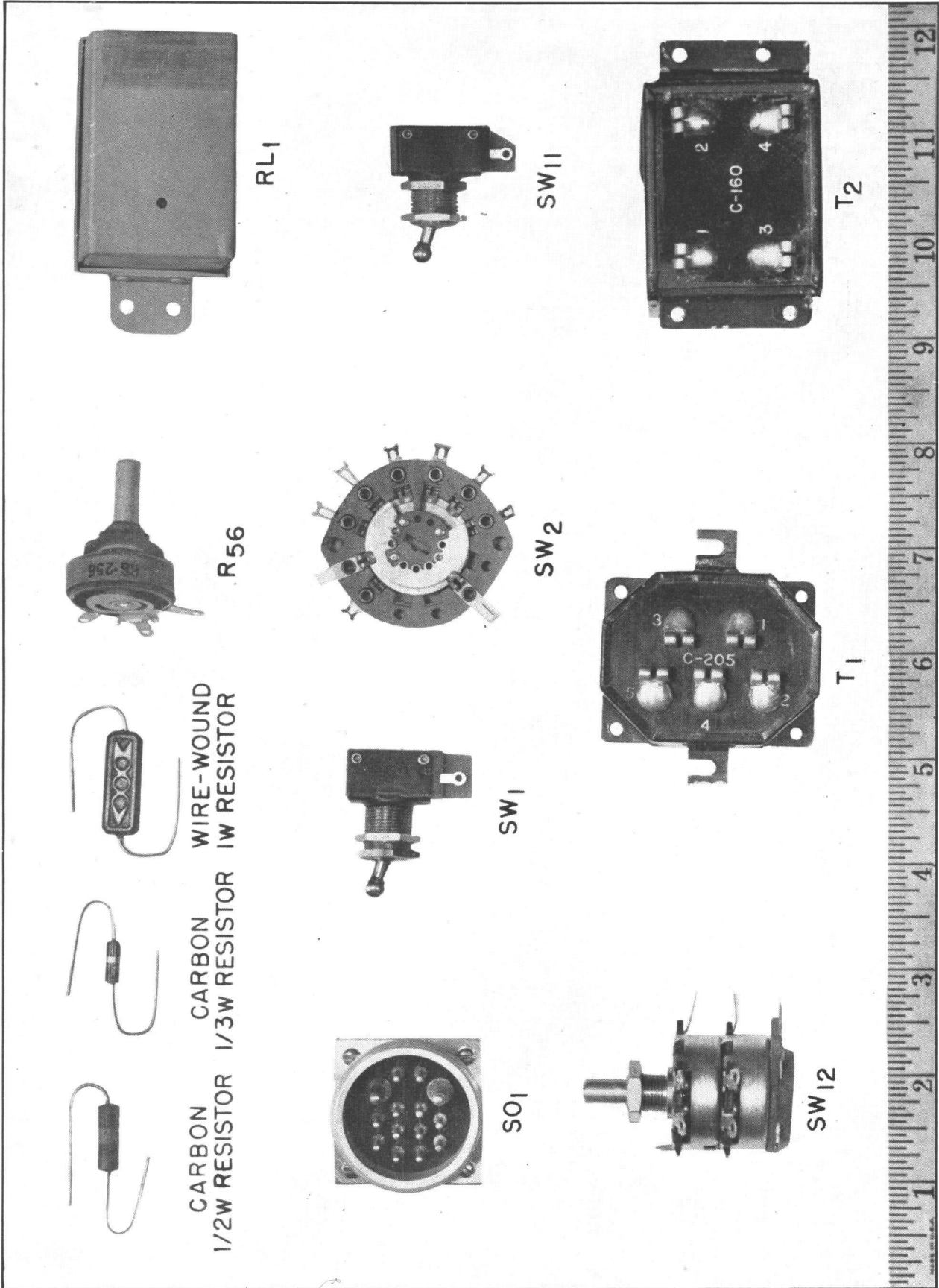

Tabular List of Replaceable Parts (Continued).—

Ref. No.	Stock No.	Name of Part	Description	Function	Mfg.*	Signal Corps Drawing No.
†R ₄₇	3Z4576	Resistor RS-176	Carbon, insul; 60 ohm ½ w.	Filament shunt, diode	L	SC-D-970
†R ₄₈	3Z4569	Resistor RS-169	Same as R ₂	Screen grid, 1st det.	M	SC-D-970
†R ₄₉	3Z4533	Resistor RS-133	Carbon, insul; 500,000 ohm ½ w.	r-f filter, diode	M	SC-D-970
†R ₅₀	3Z4540	Resistor RS-140	Same as R ₁₅	Screen grid, 1st det.	M	SC-D-970
†R ₅₁	3Z4529	Resistor RS-129	Carbon, insul; 10,000 ohm ½ w.	Filter load, C-W osc.	M	SC-D-970
†R ₅₂	3Z4575	Resistor RS-175	Carbon, 10,000 ohm ½ w.	AVC filter, 1st i-f	N	SC-D-970
†R ₅₃	3Z4573	Resistor RS-173	Same as R ₆	Grid, 1st r-f	N	SC-D-970
†R ₅₄	3Z4623	Resistor RS-223	Same as R ₃₁	2nd audio, bias	N	SC-D-970
†R ₅₆	3Z7256	Rheostat RS-256	75 ohm 2 w.	Dimmer	O	SC-A-6593
†RL ₁	2Z7613	Relay BK-13	Send-Receive Relay	Antenna grounding	U	SC-D-1942
†SO ₁	2Z8794.1	Socket SO-94	Connector	Power supply and control	Z	SC-D-2592
SW ₁	3Z8131	Switch SW-131	Toggle	Send-Receive	V	SC-A-1042
†SW ₂	3Z8310-2	Switch	Ceramic, wafer	Band change, 1st r-f grid	X	SC-D-4046
†SW ₃	3Z8310-2	Switch	Same as SW ₂	Band change, 1st r-f antenna	X	SC-D-4046
†SW ₄	3Z8310-2	Switch	Same as SW ₂	Band change, 2nd r-f grid	X	SC-D-4046
†SW ₅	3Z8310-2	Switch	Same as SW ₂	Band change, 1st r-f plate	X	SC-D-4046
†SW ₆	3Z8310-2	Switch	Same as SW ₂	Band change, 1st det. grid	X	SC-D-4046
†SW ₇	3Z8310-2	Switch	Same as SW ₂	Band change, 2nd r-f plate	X	SC-D-4046
†SW ₈	3Z8310-2	Switch	Same as SW ₂	Band change, r-f osc. grid	X	SC-D-4046
†SW ₉	3Z8310-2	Switch	Same as SW ₂	Band change, r-f osc. plate	X	SC-D-4046
†SW ₁₁	3Z8139	Switch SW-139	Toggle	C-W osc.	V	SC-A-1042
†SW ₁₂	3Z8119	Switch SW-119	Rotary	ON-OFF, MVC-AVC	L	SC-D-2574
†T ₁	2Z9805	Transformer C-205	Audio frequency	1st audio	T	SC-D-2567
†T ₂	2Z9760	Transformer C-160	Audio frequency	2nd audio	T	SC-D-2569

* See Index of Manufacturers.

† Furnished in Maintenance Parts Group.

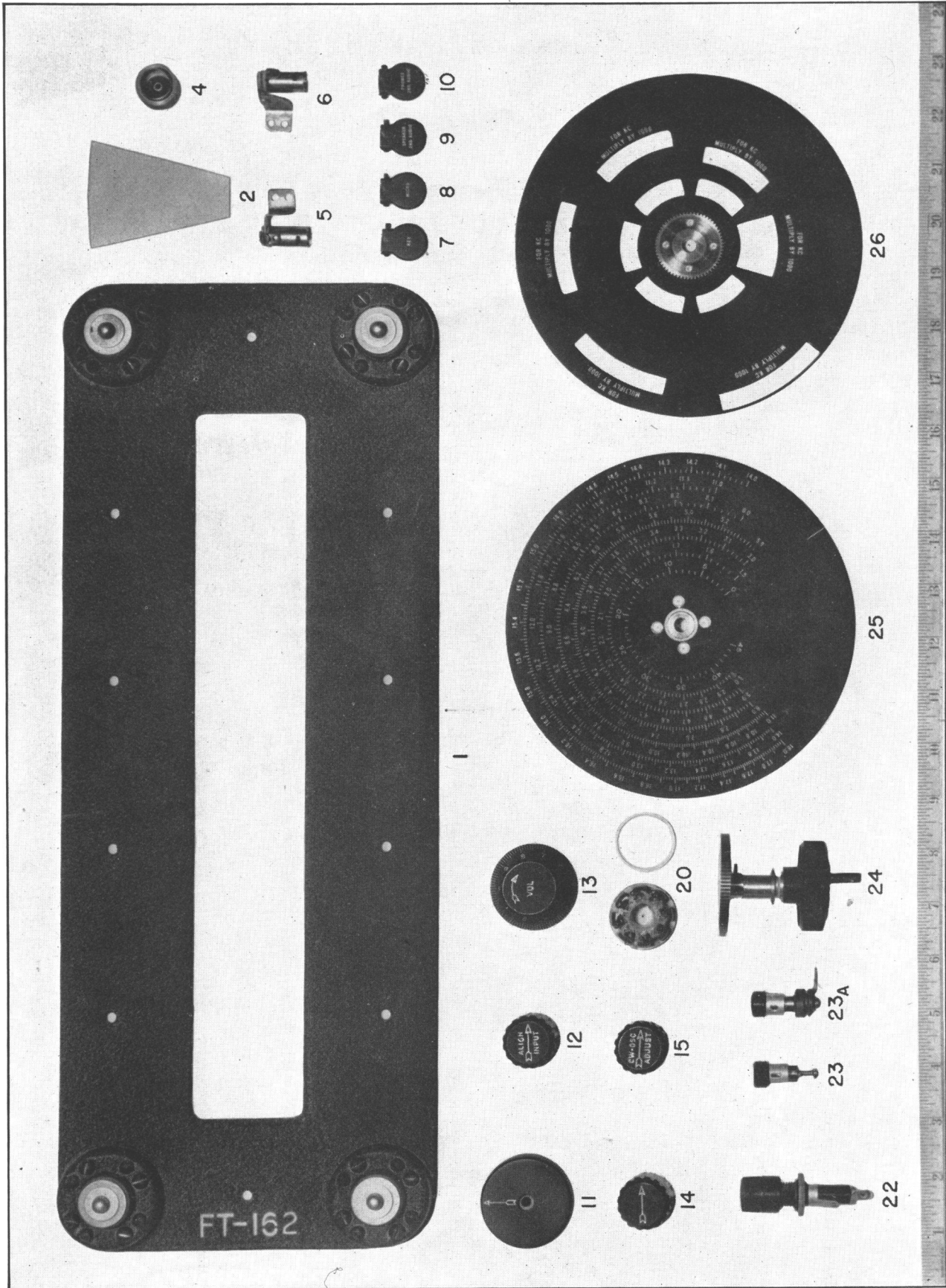

Tabular List of Replaceable Parts (Continued),—

b. Mechanical Parts.

Ref. No.	Stock No.	Name of Part	Description	Function	Mfg.*	Signal Corps. Drawing No.
†1	2Z6702	Mounting FT-162	Shock Mounting Plate	Receiver Mounting	Z	SC-D-2577
†2	2Z7560/2	Reflector Glass	Clear Glass	Dial Pane	Z	SC-D-2532-13
†3	2C4312/N1	Nut & Ferrule Assembly	Connector Assembly	Shielded Connector	Z	SC-D-2578
†4	2Z5986/1	Lamp Mounting R. H.	Socket R. H.	Pilot Lamp Socket	Z	SC-D-2573-1
†5	2Z5986/2	Lamp Mounting L. H.	Socket L. H.	Pilot Lamp Socket	Z	SC-D-2573-2
†6	2Z5650-K	Jack Cover, Key	Jack Cover	Jack Cover	Z	SC-D-2532-36
†7	2Z5650-M	Jack Cover, Micro	Jack Cover	Jack Cover	Z	SC-D-2532-37
†8	2Z5650-S2A	Jack Cover, Speaker 2nd Audio	Jack Cover	Jack Cover	Z	SC-D-2532-38
†9	2Z5650-P2A	Jack Cover, Phones 2nd Audio	Jack Cover	Jack Cover	Z	SC-D-2532-39
†10	2Z5783	Knob, Band Change	Die Cast Knob	Frequency Change	Z	SC-D-5431-56
†11	2Z5779	Knob, Align Input	Bakelite Knob	Antenna Alignment	AA	SC-D-2532-44
†12	2Z5773	Knob, Volume	Bakelite Knob and Plate	Volume Control	Z	SC-D-2532-45
†13	2Z5778	Knob, OFF-MVC-AVC	Bakelite Knob	Switch Control	AA	SC-D-2532-43
†14	2Z5780	Knob, CW-Osc Adjust	Bakelite Knob	Pitch Adjustment	AA	SC-D-2561-17
†15	2Z8761.4	Socket, 8 Prong	Molded, Octal Socket	Tube Socket	AB	SC-D-2538-63
†16	3Z3275	Fuse Post	Bakelite Fuse Holder	Fuse Holder	Q or B	SC-D-2532-76
†17	3Z763	Binding Post, Ground	Push Post Assembly	Ground Connection	AC	SC-D-2532-78
†18	3Z510	Binding Post, Alt. Sig. Ant.	Push Post Assembly	Alt. Sig. Connection	AC	SC-D-2532-71
†19	2Z5782.1	Fast Tuning Knob and Drive Assembly	Fast Tuning Assembly	Fast Tuning Drive	Z	SC-D-5431
†20	2C4312J/D1	Dial Assembly	Calibrated Dial Assembly	Tuning Dial	Z	SC-D-5431
†21	2Z8550	Shutter Assembly	Dial Shutter Assembly	Dial Shutter	Z	SC-D-5431

* See Index of Manufacturers.

† Furnished in Maintenance Parts Group.

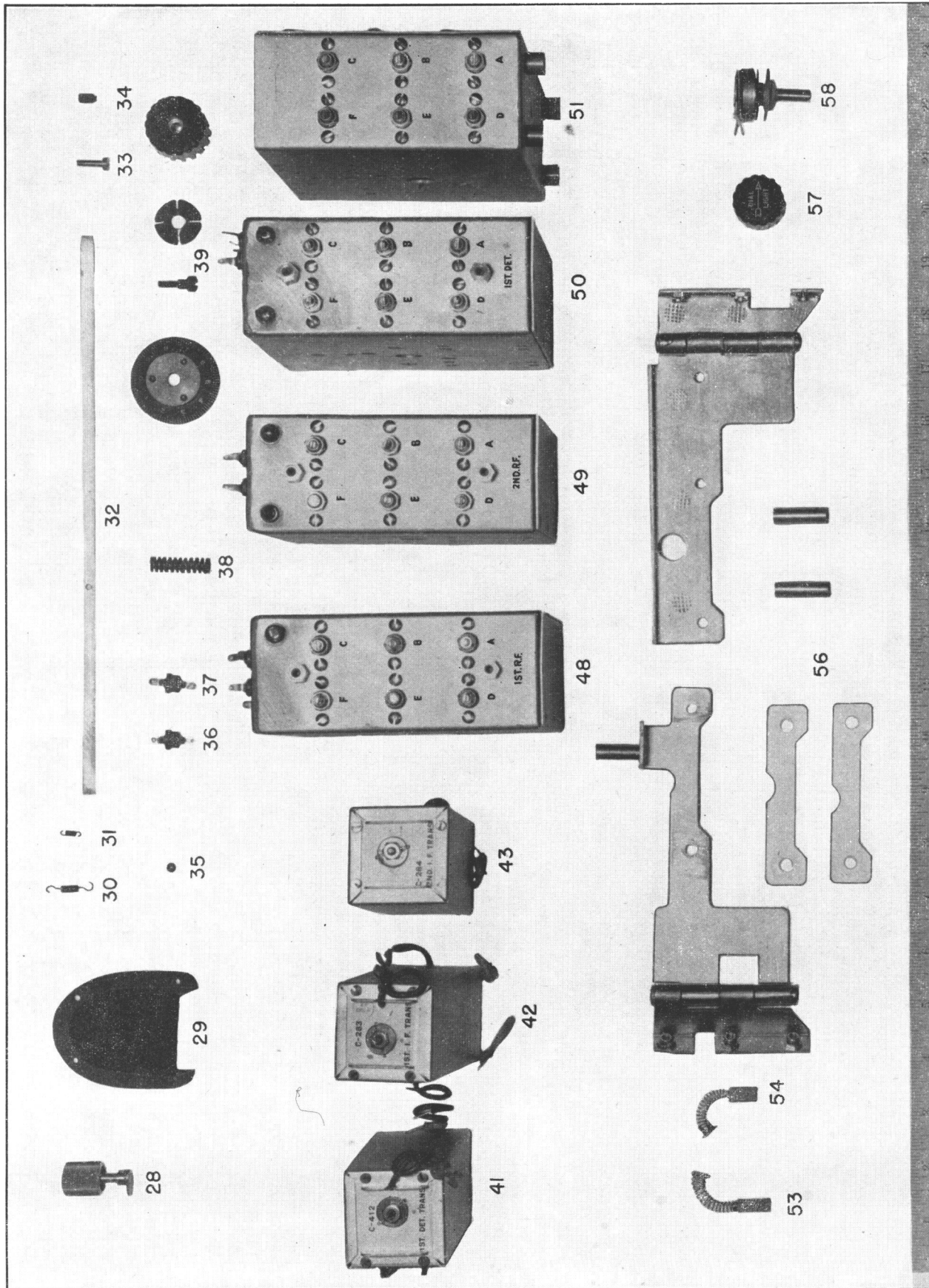

Tabular List of Replaceable Parts (Continued),—

Ref. No.	Stock No.	Name of Part	Description	Function	Mfg.*	Signal Corps. Drawing No.
†28	2Z6931/21	Panel Lock	Knurled Knob and Latch Assembly	Receiver Locks	Z	SC-D-2532
†29	2Z8794.1/C1	Cover	Aluminum Die-Cast Cover	SO-94 Socket Cover	Z	SC-D-2532-6
†30	2Z1650/7.3	Spring	Backlash Spring	Backlash Take-up	Z	SC-D-5431-14
†31	2Z1650/7.4	Spring	Backlash Spring	Backlash Take-up	Z	SC-D-5431-36
†32	2Z1650/42	Shaft	Band Switch Shaft	Band Change	Z	SC-D-5431-42
†33	6L6632-8.23	Screw	Brass Taper Screw No. 6-32	Secure Shaft	Z	SC-D-5431-4
†34	6L7032-6.85	Screw	Steel Set Screw, No. 10-32	Band Switch Screw	Z	SC-D-5431-85
†35	2Z1650/2	Ball	.217" dia. Steel Ball	Detent Index	Z	SC-D-5431-94
†36	3G1921	Insulator	Bakelite Feed-Through	Feed Thru	Z	SC-D-2538
†37	3G1921-1	Insulator	Bakelite Feed-Through	Feed Thru	Z	SC-D-2553
†38	2Z1650/17.2	Spring	Steel Coil Spring	Detent Adjust	Z	SC-D-5431-6
†39	2Z5784	Knob, Vernier	Bakelite Knob, Plate and Clutch Assembly	Vernier Tuning	Z	SC-D-5431-58
†41	2Z9940-412	Transformer C-412	470 kc 1st Detector Transformer, I. F.	1st Detector Transformer	Z	SC-D-4166
†42	2Z9883	Transformer C-283	470 kc Interstage Transformer, I. F.	1st I. F. Transformer	Z	SC-D-4166
†43	2Z9884	Transformer C-284	470 kc Diode Transformer, I. F.	2nd I. F. Transformer	Z	SC-D-4166
†48	2C4342N/A2	1st R. F. Unit Assembly	R-F Coil Box, Complete	1st R-F Stage	Z	SC-D-2553
†49	2C4342N/A3	2nd R. F. Unit Assembly	R-F Coil Box, Complete	2nd R-F Stage	Z	SC-D-2553
†50	2C4342N/A1	1st Detector Unit Assembly	R-F Coil Box, Complete	1st Detector Stage	Z	SC-D-2553
†51	2C4342N/A4	R. F. Oscillator Unit Assembly	Oscillator Coil Box, Complete	R-F Oscillator Stage	Z	SC-D-2558
†53	3H1621B/4	Brush, L. V.	Carbon Brush	Low Voltage	Y	
†54	3H1621B/3	Brush, H. V.	Carbon Brush	High Voltage	Y	
†56	2C4314G/B2	Bracket Set	Dynamotor Mounting Brackets	Dynamotor Mounting	Z	SC-D-2532
†57	2Z5777.1	Knob, Dial Light	Bakelite Knob	Pilot Light Dimmer	AA	SC-D-730-1
†58	3Z7256	Rheostat RS-256	75 ohm, 1 watt	Pilot Light Dimmer	O	SC-A-6593

* See Index of Manufacturers.

† Furnished in Maintenance Parts Group.

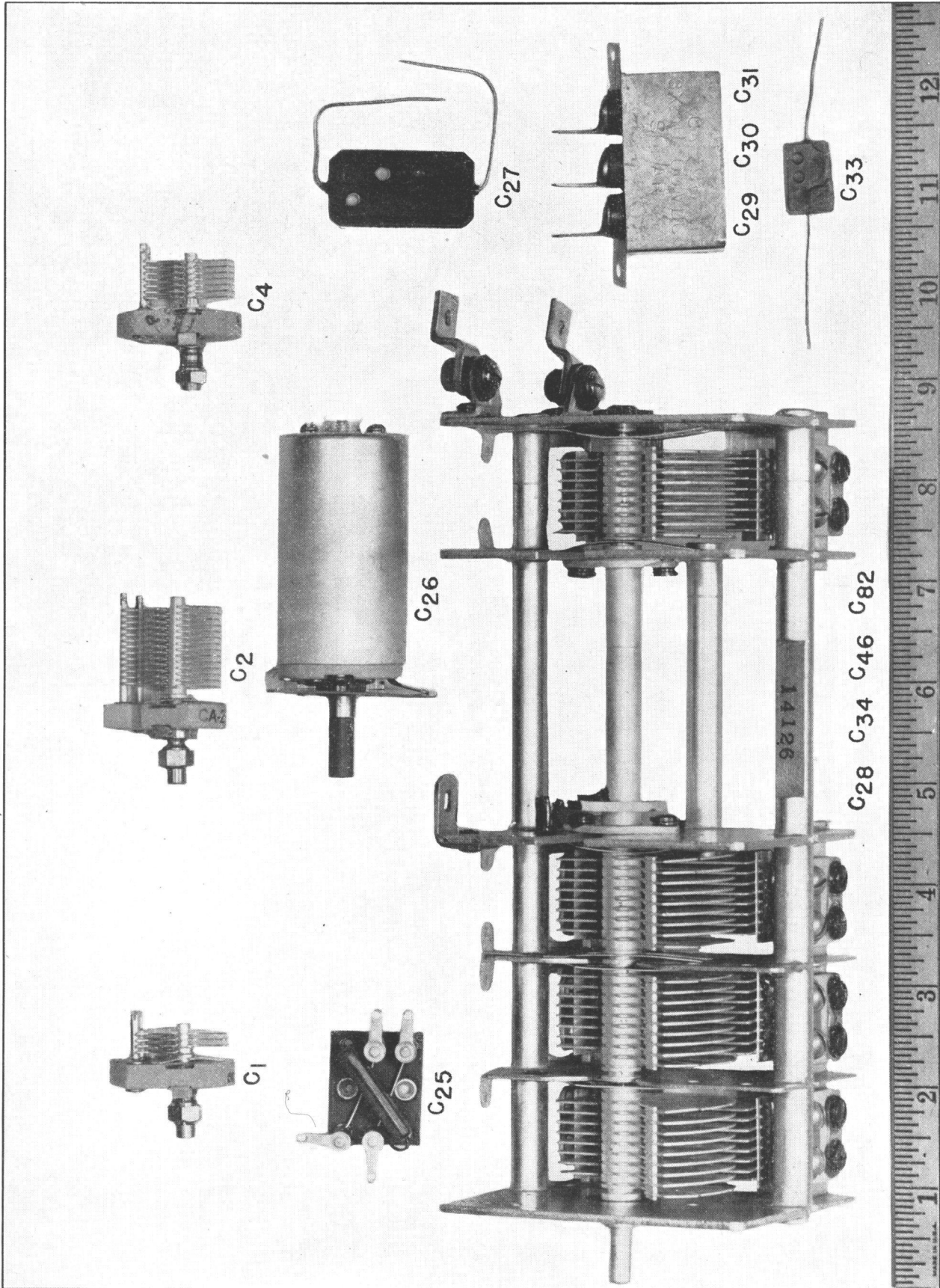

25. Tabular List of Replaceable Parts, Radio Receiver BC-312-NX:

a. Electrical Parts.

Note: The list of stock numbers is intended to supplement the Signal Corps General Catalog until such time as the Catalog is revised to include the stock numbers herein. Order replacement parts by stock numbers and description.

Ref. No.	Stock No.	Name of Part	Description	Function	Mfg.*	Signal Corps Drawing No.
C ₁	3D289	Capacitor CA-289	Variable, air; 3-25 $\mu\mu\text{f}$	Band-A trimmer, 1st r-f	A, C, or E	SC-A-1728
C ₂	3D291	Capacitor CA-291	Variable, air; 6-100 $\mu\mu\text{f}$	Band-B trimmer, 1st r-f	A, C, or E	SC-A-1728
C ₃	3D291	Capacitor CA-291	Same as C ₂	Band-C trimmer, 1st r-f	A, C, or E	SC-A-1728
C ₄	3D290	Capacitor CA-290	Variable, air; 4-50 $\mu\mu\text{f}$	Band-D trimmer, 1st r-f	A, C, or E	SC-A-1728
C ₅	3D290	Capacitor CA-290	Same as C ₄	Band-E trimmer, 1st r-f	A, C, or E	SC-A-1728
C ₆	3D289	Capacitor CA-289	Same as C ₄	Band-F trimmer, 1st r-f	A, C, or E	SC-A-1728
C ₇	3D289	Capacitor CA-289	Same as C ₁	Band-A trimmer, 2nd r-f	A, C, or E	SC-A-1728
C ₈	3D291	Capacitor CA-291	Same as C ₂	Band-B trimmer, 2nd r-f	A, C, or E	SC-A-1728
C ₉	3D291	Capacitor CA-291	Same as C ₂	Band-C trimmer, 2nd r-f	A, C, or E	SC-A-1728
C ₁₀	3D290	Capacitor CA-290	Same as C ₄	Band-D trimmer, 2nd r-f	A, C, or E	SC-A-1728
C ₁₁	3D290	Capacitor CA-290	Same as C ₄	Band-E trimmer, 2nd r-f	A, C, or E	SC-A-1728
C ₁₂	3D290	Capacitor CA-290	Same as C ₄	Band-F trimmer, 2nd r-f	A, C, or E	SC-A-1728
C ₁₃	3D289	Capacitor CA-289	Same as C ₁	Band-A trimmer, 1st det.	A, C, or E	SC-A-1728
C ₁₄	3D291	Capacitor CA-291	Same as C ₂	Band-B trimmer, 1st det.	A, C, or E	SC-A-1728
C ₁₅	3D291	Capacitor CA-291	Same as C ₂	Band-C trimmer, 1st det.	A, C, or E	SC-A-1728
C ₁₆	3D290	Capacitor CA-290	Same as C ₄	Band-D trimmer, 1st det.	A, C, or E	SC-A-1728
C ₁₇	3D290	Capacitor CA-290	Same as C ₄	Band-E trimmer, 1st det.	A, C, or E	SC-A-1728
C ₁₈	3D290	Capacitor CA-290	Same as C ₄	Band-F trimmer, 1st det.	A, C, or E	SC-A-1728
C ₁₉	3D289	Capacitor CA-289	Same as C ₁	Band-A trimmer, r-f osc.	A, C, or E	SC-A-1728
C ₂₀	3D291	Capacitor CA-291	Same as C ₂	Band-B trimmer, r-f osc.	A, C, or E	SC-A-1728
C ₂₁	3D291	Capacitor CA-291	Same as C ₂	Band-C trimmer, r-f osc.	A, C, or E	SC-A-1728
C ₂₂	3D290	Capacitor CA-290	Same as C ₄	Band-D trimmer, r-f osc.	A, C, or E	SC-A-1728
C ₂₃	3D290	Capacitor CA-290	Same as C ₄	Band-E trimmer, r-f osc.	A, C, or E	SC-A-1728
C ₂₄	3D290	Capacitor CA-290	Same as C ₄	Band-F trimmer, r-f osc.	A, C, or E	SC-A-1728
†C ₂₅	3D294	Capacitor CA-294	Fixed; 125 $\mu\mu\text{f}$	Padder, 1st r-f	A	SC-D-2575
C ₂₆	3D293	Capacitor CA-293	Variable, air; 10-210 $\mu\mu\text{f}$	Antenna alignment	A, C, or E	SC-A-2580
†C ₂₇	3D284	Capacitor CA-284	Molded, paper, .05 μf -400 v	1st r-f, bypass	J	SC-D-1995
C ₂₈	**	Capacitor	Ganged 13-226 $\mu\mu\text{f}$	1st r-f, tuning	D or F	SC-D-2568
†C ₂₉	3D195	Capacitor CA-195	Metal-encased	1st r-f, cathode bypass	G, H, or I	SC-D-512
†C ₃₀			as	1st r-f, screen bypass		
†C ₃₁	3D284	Capacitor CA-284	one unit	1st r-f, "B" supply bypass	J	SC-D-512
†C ₃₂			Same as C ₂₇	1st r-f, plate bypass		
†C ₃₃	3D266	Capacitor CA-266	Mica; 100 $\mu\mu\text{f}$	2nd r-f, grid coupling	I or K	SC-D-1995 SC-D-1993

* See Index of Manufacturers.

** C₂₈, C₃₄, C₄₆, and C₈₂ ganged comprise Capacitor CA-292 (3D292)

† Furnished in Maintenance Parts Group.

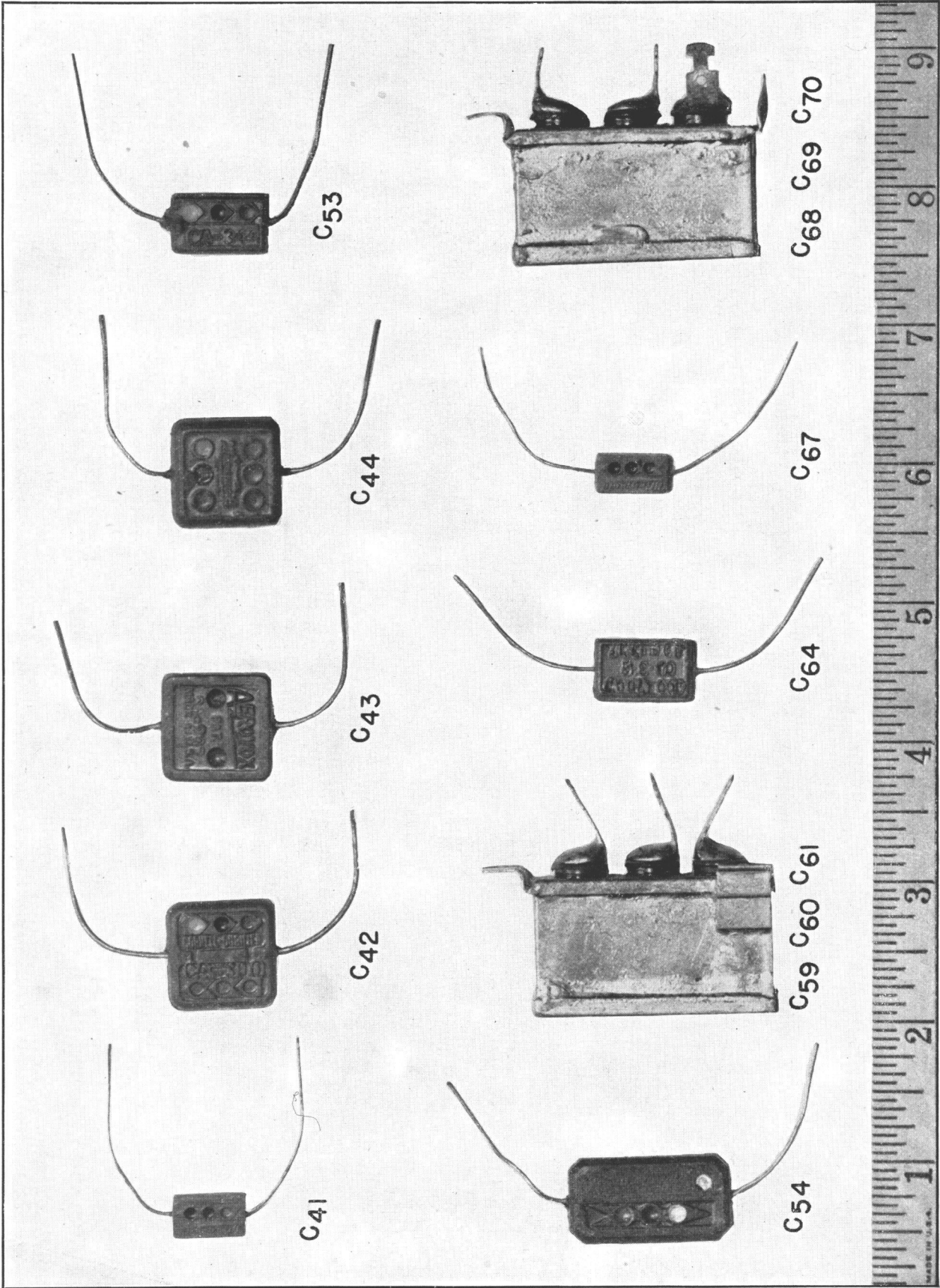

Tabular List of Replaceable Parts (Continued),—

Ref. No.	Stock No.	Name of Part	Description	Function	Mfg.*	Signal Corps Drawing No.
C ₃₄ †C ₃₅ †C ₃₆ †C ₃₇	**	Capacitor	Ganged 13-226 μμf	2nd r-f, tuning	D or F	SC-D-2568
	3D195	Capacitor CA-195	{ Same as C ₂₉ Same as C ₃₀ Same as C ₃₁	2nd r-f, cathode bypass	G, H or I	SC-D-512
†C ₃₈	3D294	Capacitor CA-294	Same as C ₂₅	2nd r-f, "B" supply bypass	A	SC-D-512
†C ₃₉	3D284	Capacitor CA-284	Same as C ₂₇	Padder, 1st det.	J	SC-D-2575
†C ₄₀	3D294	Capacitor CA-294	Same as C ₂₅	2nd r-f, plate bypass	A	SC-D-1995
†C ₄₁	3D278	Capacitor CA-278	Mica; 5 μμf	Padder, r-f osc.	J	SC-D-2575
†C ₄₂	3D300	Capacitor CA-300	Mica, aged; 3000 μμf	C-W osc., coupling	K	SC-D-1993
†C ₄₈	3D297	Capacitor CA-297	Mica, aged; 1600 μμf	Band-C padder, r-f osc.	G, J, or K	SC-D-1993
†C ₄₄	3D299	Capacitor CA-299	Mica, aged; 750 μμf	Band-B padder, r-f osc.	J or K	SC-D-1993
†C ₄₅	3D266	Capacitor CA-266	Same as C ₃₃	Band-A padder, r-f osc.	I or K	SC-D-1993
C ₄₆	**	Capacitor	Ganged 13-226 μμf	1st det., grid coupling	D or F	SC-D-2568
†C ₄₇	3D266	Capacitor CA-266	Same as C ₃₃	1st det., tuning	I or K	SC-D-1993
†C ₄₈	3D195	Capacitor CA-195	{ Same as C ₂₉ Same as C ₃₀	R. F. osc., coupling	G, H, or I	SC-D-512
†C ₄₉			{ Same as C ₂₉ Same as C ₃₀	1st det., cathode bypass		
†C ₅₀	†C ₅₃	Capacitor CA-344	Same as C ₃₁	1st det., screen bypass	G, J, or K	SC-D-512
†C ₅₄	3D281	Capacitor CA-281	Mica; 400 μμf	1st det., "B" supply bypass		
†C ₅₅	3D344	Capacitor CA-344	Molded, paper; .01 μf—400 v.	1st det., plate	G, J, or K	SC-D-1993
†C ₅₆	3D281	Capacitor CA-281	Same as C ₅₃	1st det., plate bypass	J	SC-D-1995
†C ₅₇	3D344	Capacitor CA-344	Same as C ₅₄	2nd i-f, grid	G, J, or K	SC-D-1993
†C ₅₈	3D281	Capacitor CA-281	Same as C ₅₃	2nd i-f, AVC bypass	J	SC-D-1995
†C ₅₉	3D302	Capacitor CA-302	Modification of CA-195	1st i-f, plate bypass	G, J, or K	SC-D-1995
†C ₆₀				1st i-f, cathode bypass		
†C ₆₁	†C ₆₂	Capacitor CA-284	{ .05 μf—300 v. .05 μf—300 v.	1st i-f, screen bypass	G, H, or I	SC-D-2567
†C ₆₃	3D281	Capacitor CA-281	.05 μf—300 v.	1st i-f, "B" supply bypass		
†C ₆₄	3D342	Capacitor CA-342	Same as C ₂₇	1st det., AVC bypass	J	SC-D-2567
†C ₆₅	3D342	Capacitor CA-342	Same as C ₅₄	1st i-f, AVC bypass	J	SC-D-1995
†C ₆₆	3D281	Capacitor CA-281	Mica; 100 μμf	2nd det., grid	J or K	SC-D-1993
†C ₆₇	3D279	Capacitor CA-279	Same as C ₆₄	2nd det., plate	J or K	SC-D-1993
†C ₆₈	3D301	Capacitor CA-301	Modification of CA-195	2nd i-f, plate bypass	J	SC-D-1993
†C ₆₉				Diode, AVC, Coupling		
†C ₇₀	†C ₇₀	Capacitor CA-301	{ .05 μf—300 v. .05 μf—300 v.	2nd i-f, cathode bypass	G, H, or I	SC-D-2567
			.05 μf—300 v.	2nd i-f, screen bypass		

* See Index of Manufacturers.

** C₂₈, C₃₄, C₄₆, and C₈₂ ganged comprise Capacitor CA-292 (3D292)

† Furnished in Maintenance Parts Group.

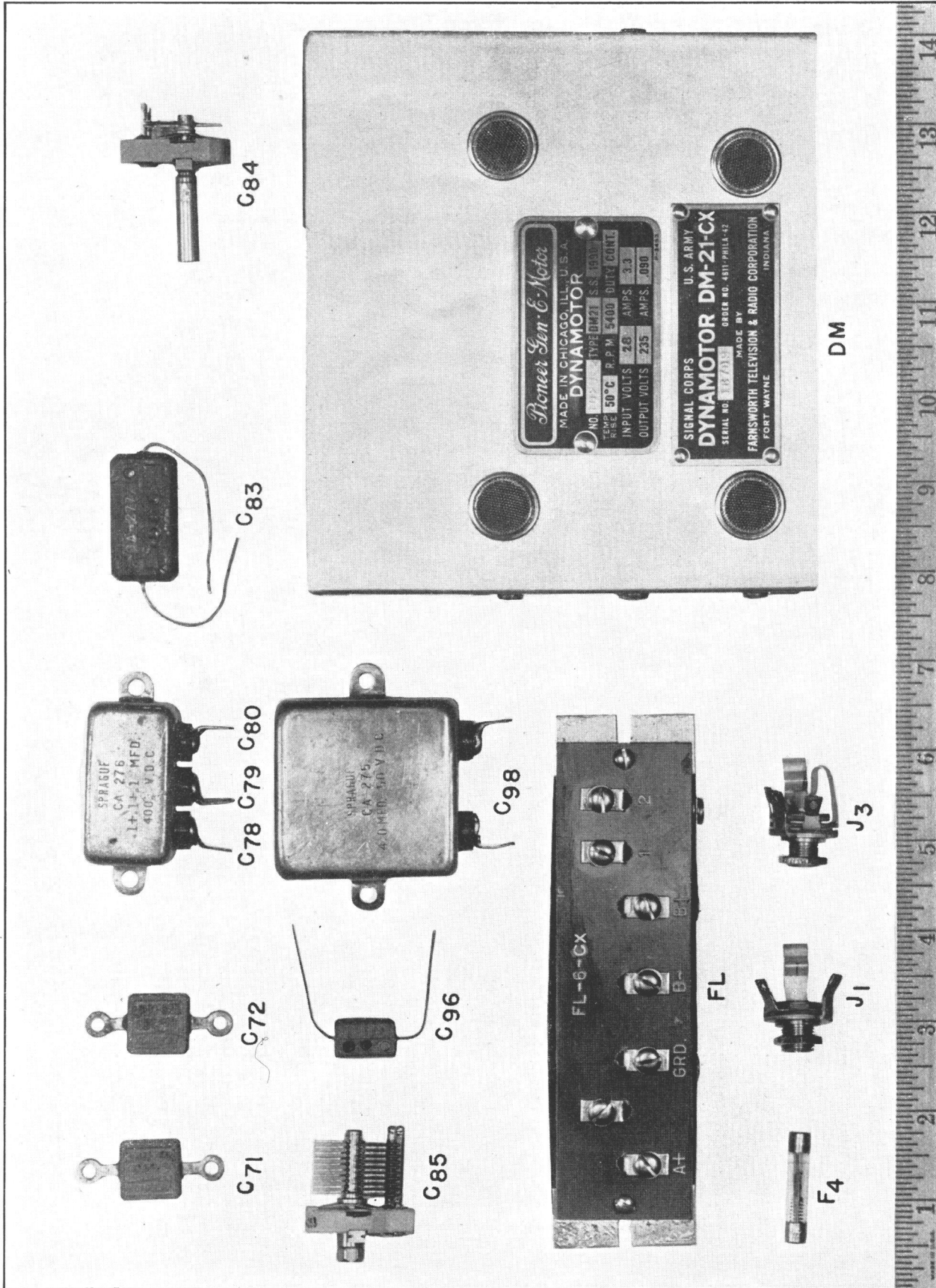

Tabular List of Replaceable Parts (Continued),—

Ref. No.	Stock No.	Name of Part	Description	Function	Mfg.*	Signal Corps Drawing No.	
†C ₇₁	3D218	Capacitor CA-218	Mica; 150 μf	Diode, r-f bypass	G	SC-D-1993	
†C ₇₂	3D193	Capacitor CA-193	Mica; 500 μf	Diode, r-f filter	G	SC-D-1993	
†C ₇₃	3D301	Capacitor CA-301	Same as C ₆₈	Diode, cathode bypass	G, H, or I	SC-D-2567	
†C ₇₄							Same as C ₆₉
†C ₇₅							
†C ₇₆	3D281	Capacitor CA-281	Same as C ₃₄	AVC filter, bypass	J	SC-D-2567	
†C ₇₈	3D276	Capacitor CA-276	Metal-encased as one unit	1st audio plate, R. F. bypass	G, H, or I	SC-D-1995	
†C ₇₉							as
†C ₈₀	3D281	Capacitor CA-281	Same as C ₅₄	Heater, bypass	G, H, or I	SC-D-512	
†C ₈₁				Ganged 13-226 μf			
C ₈₂	3D277	Capacitor CA-277	Molded, paper; 0.1 μf—400 v.		Heater, bypass	J	SC-D-1995
†C ₈₃	3D383	Capacitor CA-383	Variable, air; 1-10 μf	2nd audio, plate bypass	D or F	SC-D-2568	
C ₈₄	3D253	Capacitor CA-253	Variable, air; 4-75 μf	1st audio, coupling	J	SC-D-1995	
C ₈₅	3D266	Capacitor CA-266	Same as C ₃₃	r-f osc., tuning	A, C, or E	SC-A-1728	
†C ₈₆	3D284	Capacitor CA-284	Same as C ₃₇	r-f osc., tuning	A, C, or E	SC-A-1728	
†C ₈₇	3D266	Capacitor CA-266	Same as C ₃₃	C-W osc., trimmer	I or K	SC-D-1993	
†C ₈₈	3D286	Capacitor CA-286	Mica; 75 μf	C-W osc., grid	J	SC-D-1995	
†C ₉₆	3D286	Capacitor CA-286	Same as C ₉₆	C-W osc., plate bypass	I or K	SC-D-1993	
†C ₉₇	3D275	Capacitor CA-275	Paper; 4 μf	r-f osc., grid	J or K	SC-D-1993	
†C ₉₈	3D284	Capacitor CA-284	Same as C ₂₇	C-W osc., filter	J or K	SC-D-1993	
†C ₉₉	3D294	Capacitor CA-294	Same as C ₂₅	C-W osc., filter	J or K	SC-D-1993	
†C ₁₀₀	3D266	Capacitor CA-266	Same as C ₃₃	2nd audio, cathode bypass	H	SC-D-512	
†C ₁₀₁	3D284	Capacitor CA-284	Same as C ₂₇	2nd R. F. AVC, bypass	J	SC-D-1995	
†C ₁₀₂	3D344	Capacitor CA-344	Same as C ₃₃	2nd R. F., paddler	A	SC-D-2575	
†C ₁₀₃	3H1621CX	Dynamotor DM-21-CX	Motor Generator	1st R. F., grid coupling	I or K	SC-D-1993	
F ₄	3Z1925A	Fuse FU-25-A	5 a.-25 V	1st R. F. AVC, bypass	J	SC-D-1995	
F ₅	3Z1925A	Fuse FU-25-A	Same as F ₄	1st i-f, grid	G, J, or K	SC-D-1993	
†FL	3Z1890-6CX	Filter FL-6-CX	Filter Unit	Power Supply	Y	SC-D-2723	
J ₁	2Z5534A	Jack JK-34-A	Open circuit Jack	Dynamotor and filaments	Q	SC-D-1866	
J ₂	2Z5534A	Jack JK-34-A	Same as J ₁	LM ₄ and LM ₅ Pilot Lights	Q	SC-D-2339	
J ₃	2Z5533A	Jack JK-33-A	3 circuit Jack	Dynamotor Filter	Y	SC-D-2339	
J ₄	2Z5533A	Jack JK-33-A	Same as J ₃	2nd audio phones	O	SC-D-2332	
J ₅	2Z5534A	Jack JK-34-A	Same as J ₁	Speaker	O	SC-D-2332	
				Microphone	O	SC-D-2332	
				Key	O	SC-D-2339	

* See Index of Manufacturers.

** C₂₈, C₃₄, C₄₆, and C₈₂ ganged comprise Capacitor CA-292 (3D292)

† Furnished in Maintenance Parts Group.

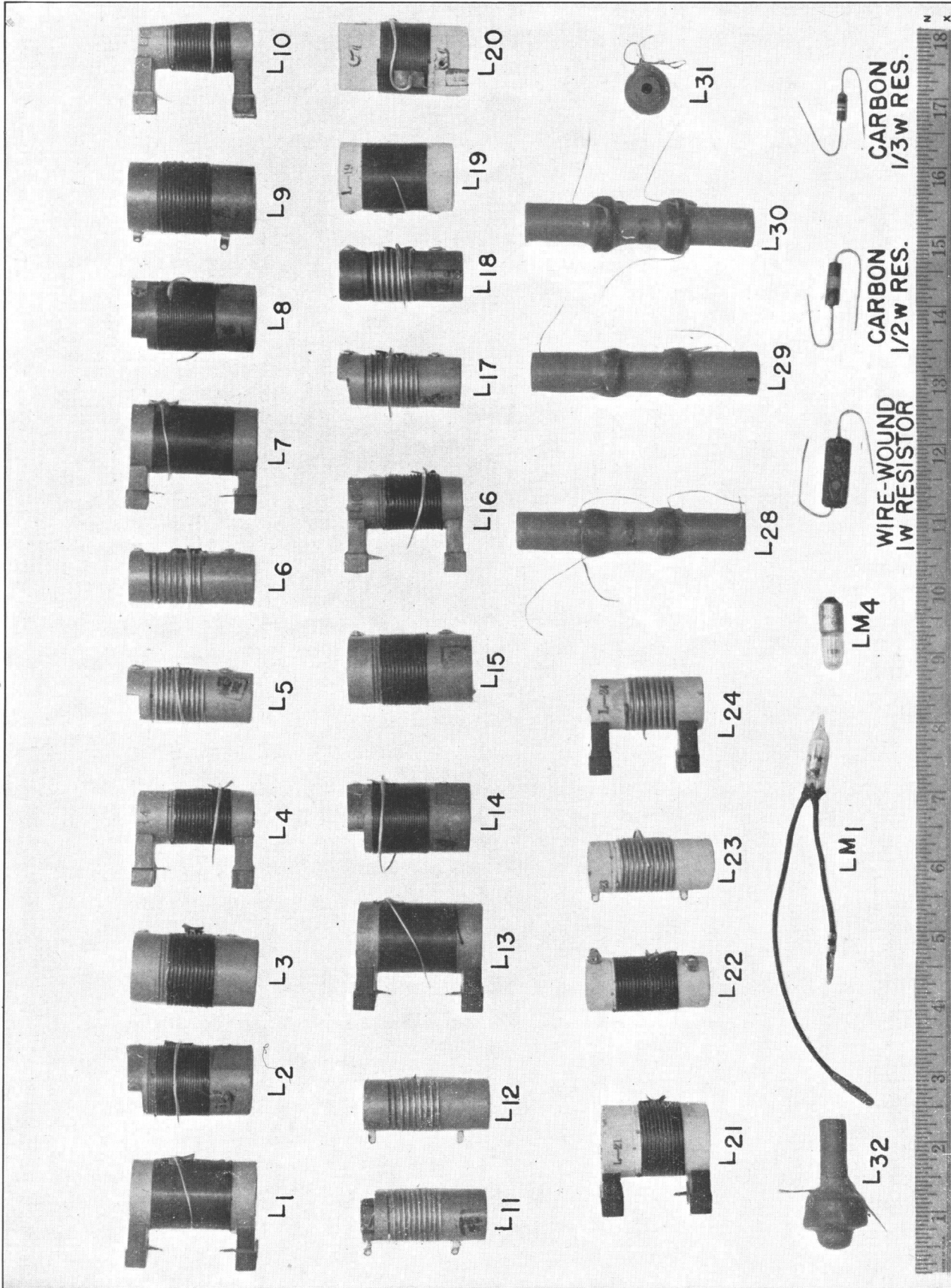

Tabular List of Replaceable Parts (Continued),—

Ref. No.	Stock No.	Name of Part	Description	Function	Mfg.*	Signal Corps Drawing No.
L ₁	3C1083	Coil		Band-A, 1st r-f	Z	SC-D-2556
L ₂	3C1083-8	Coil		Band-B, 1st r-f	Z	SC-D-2556
L ₃	3C1083-6	Coil		Band-C, 1st r-f	Z	SC-D-2556
L ₄	3C1083-9	Coil		Band-D, 1st r-f	Z	SC-D-2556
L ₅	3C1083-12	Coil		Band-E, 1st r-f	Z	SC-D-2556
L ₆	3C1083-16	Coil		Band-F, 1st r-f	Z	SC-D-2556
L ₇	3C1083-1	Coil		Band-A, 2nd r-f	Z	SC-D-2556
L ₈	3C1083-4	Coil		Band-B, 2nd r-f	Z	SC-D-2556
L ₉	3C1083-7	Coil		Band-C, 2nd r-f	Z	SC-D-2556
L ₁₀	3C1083-10	Coil		Band-D, 2nd r-f	Z	SC-D-2556
L ₁₁	3C1083-13	Coil		Band-E, 2nd r-f	Z	SC-D-2556
L ₁₂	3C1083-16	Coil		Band-F, 2nd r-f	Z	SC-D-2556
L ₁₃	3C390	Coil		Band-A, 1st Det.	Z	SC-D-2556
L ₁₄	3C390-1	Coil		Band-B, 1st Det.	Z	SC-D-2556
L ₁₅	3C390-2	Coil		Band-C, 1st Det.	Z	SC-D-2556
L ₁₆	3C390-3	Coil		Band-D, 1st Det.	Z	SC-D-2556
L ₁₇	3C390-4	Coil		Band-E, 1st Det.	Z	SC-D-2556
L ₁₈	3C390-5	Coil		Band-F, 1st Det.	Z	SC-D-2556
L ₁₉	3C1083-2	Coil		Band-A, r-f Osc.	Z	SC-D-2556
L ₂₀	3C1083-5	Coil		Band-B, r-f Osc.	Z	SC-D-2556
L ₂₁	3C1083-8	Coil		Band-C, r-f Osc.	Z	SC-D-2556
L ₂₂	3C1083-11	Coil		Band-D, r-f Osc.	Z	SC-D-2556
L ₂₃	3C1083-14	Coil		Band-E, r-f Osc.	Z	SC-D-2556
L ₂₄	3C1083-17	Coil		Band-F, r-f Osc.	Z	SC-D-2556
L ₂₈	2Z9882.1/1	Coils of Transformer C-412		1st Detector Transformer	Z	SC-D-2566
L ₂₉	2Z9883/1	Coils of Transformer C-283		1st i-f Transformer	Z	SC-D-2566
L ₃₀	2Z9884/1	Coils of Transformer C-284		2nd i-f Transformer	Z	SC-D-2566
†L ₃₁	2C2775/2	Coil		C-W beat osc.	Z	SC-D-2561
†L ₃₂	2C2775/3	Coil		Filter, C-W Osc.	Z	SC-D-2561
LM ₁	2Z5893	Neon Lamp		Antenna overload protection	R	SC-A-1801
LM ₄	2Z5942	Lamp LM-42	Pilot Lamp	Dial Light	S	SC-D-2573
LM ₅	2Z5942	Lamp LM-42	Same as LM ₄	Dial Light	S	SC-D-2573
†R ₁	3Z4564	Resistor RS-164	Wire-wound, 500 ohm 1 w.	Cathode bias, 1st r-f	J	SC-D-970
†R ₂	3Z4569	Resistor RS-169	Carbon, insul; 60,000 ohm ½ w.	Screen grid, 1st r-f	M	SC-D-970
†R ₃	3Z4549	Resistor RS-149	Carbon, insul; 40,000 ohm ½ w.	Screen grid, 1st r-f	M	SC-D-970
†R ₄	3Z4572	Resistor RS-172	Carbon, 100,000 ohm ½ w.	AVC filter, 1st r-f	N	SC-D-970
†R ₅	3Z4525	Resistor RS-125	Carbon; 1,000 ohm ½ w.	Plate filter, 1st r-f	M	SC-D-970
†R ₆	3Z4573	Resistor RS-173	Carbon; 2 megohm ½ w.	Grid, 2nd r-f	N	SC-D-970

* See Index of Manufacturers.

† Furnished in Maintenance Parts Group.

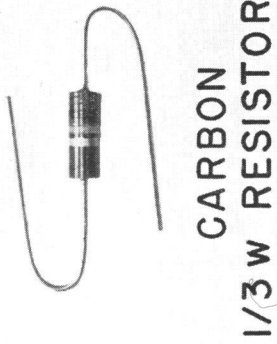

CARBON
1/3 W RESISTOR

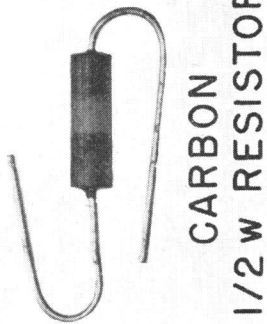

CARBON
1/2 W RESISTOR

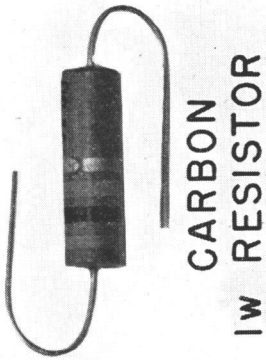

CARBON
1 W RESISTOR

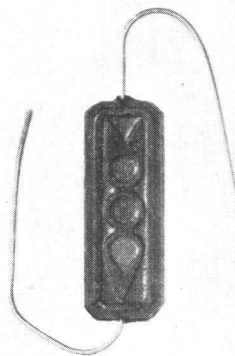

WIRE-WOUND
1 W RESISTOR

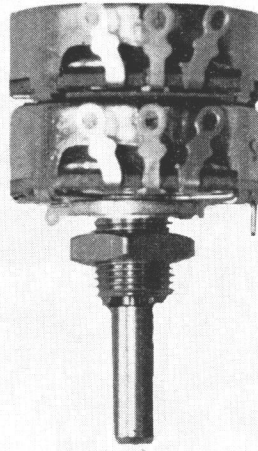

R34 R35

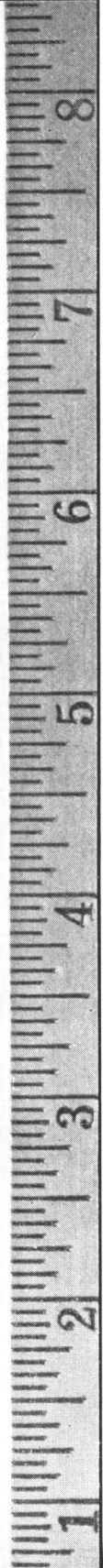

Tabular List of Replaceable Parts (Continued),—

Ref. No.	Stock No.	Name of Part	Description	Function	Mfg.*	Signal Corps Drawing No.
†R ₇	3Z4564	Resistor RS-164	Same as R ₁	Cathode bias, 2nd r-f	J	SC-D-970
†R ₈	3Z4569	Resistor RS-169	Same as R ₂	Screen grid, 2nd r-f	M	SC-D-970
†R ₉	3Z4549	Resistor RS-149	Same as R ₃	Screen grid, 2nd r-f	N	SC-D-970
†R ₁₀	3Z4572	Resistor RS-172	Same as R ₄	AVC filter, 2nd r-f	N	SC-D-970
†R ₁₁	3Z4525	Resistor RS-125	Same as R ₅	Plate filter, 2nd, r-f	M	SC-D-970
†R ₁₂	3Z4573	Resistor RS-173	Same as R ₆	Grid, 1st det.	N	SC-D-970
†R ₁₃	3Z4568	Resistor RS-168	Carbon; 50,000 ohm ½ w.	Injector bias, 1st det.	N	SC-D-970
†R ₁₄	3Z4566	Resistor RS-166	Wire-wound; 350 ohm 1 w.	Cathode bias, 1st det.	J	SC-D-970
†R ₁₅	3Z4540	Resistor RS-140	Carbon, insul; 30,000 ohm ½ w.	Screen grid, 1st det.	M	SC-D-970
†R ₁₆	3Z4572	Resistor RS-172	Same as R ₄	AVC filter, 1st det.	N	SC-D-970
†R ₁₇	3Z4525	Resistor RS-125	Same as R ₅	Plate filter, 1st det.	M	SC-D-970
†R ₁₉	3Z4564	Resistor RS-164	Same as R ₁	Cathode bias, 1st i-f	J	SC-D-970
†R ₂₀	3Z4563	Resistor RS-163	Carbon, insul; 60,000 ohm 1 w.	Screen grid, 1st i-f	L	SC-D-970
†R ₂₁	3Z4549	Resistor RS-149	Same as R ₃	Screen grid, 1st i-f	M	SC-D-970
†R ₂₂	3Z4525	Resistor RS-125	Same as R ₅	Plate filter, 1st i-f	M	SC-D-970
†R ₂₃	3Z4550	Resistor RS-150	Carbon, insul; 100,000 ohm ½ w.	AVC filter, 2nd i-f	M	SC-D-970
†R ₂₄	3Z4564	Resistor RS-164	Same as R ₁	Cathode bias, 2nd i-f	J	SC-D-970
†R ₂₅	3Z4563	Resistor RS-163	Same as R ₃₀	Screen grid, 2nd i-f	L	SC-D-970
†R ₂₆	3Z4549	Resistor RS-149	Same as R ₃	Screen grid, 2nd i-f	M	SC-D-970
†R ₂₇	3Z4525	Resistor RS-125	Same as R ₅	Plate filter, 2nd i-f	M	SC-D-970
†R ₂₈	3Z4571	Resistor RS-171	Wire-wound, 750 ohm 1 w.	Cathode bias, diode	J	SC-D-970
†R ₂₉	3Z4562	Resistor RS-162	Carbon, insul; 250,000 ohm ½ w.	AVC filter, diode	M	SC-D-970
†R ₃₀	3Z4561	Resistor RS-161	Carbon; 1 megohm ½ w.	AVC load	M	SC-D-970
†R ₃₁	3Z4623	Resistor RS-223	Wire-wound; 2,000 ohm 1 w.	Cathode bias, 2nd audio	N	SC-D-970
†R ₃₂	3Z4562	Resistor RS-162	Same as R ₂₉	Grid, 1st a-f	J	SC-D-970
†R ₃₃	3Z4531	Resistor RS-131	Carbon, insul; 50,000 ohm ½ w.	Grid, 2nd a-f	M	SC-D-970
†R ₃₄	2Z7289	Potentiometer RS-174	(0—500,000 ohm	Dual volume Control	P	SC-D-1982
†R ₃₅) 0—50,000 ohm			
†R ₃₆	3Z4511	Resistor RS-111	Carbon, insul; 100,000 ohm 1 w.	Minimum bias bleeder	L	SC-D-970
†R ₃₇	3Z4550	Resistor RS-150	Same as R ₂₃	C-W osc., plate	M	SC-D-970
†R ₃₈	3Z4569	Resistor RS-169	Same as R ₂	Plate circuit, loading	M	SC-D-970
†R ₄₁	3Z4539	Resistor RS-139	Carbon, insul; 30,000 ohm 1 w.	Plate, r-f osc.	L	SC-D-970
†R ₄₂	3Z4540	Resistor RS-140	Same as R ₁₅	Grid, r-f osc.	M	SC-D-970
†R ₄₃	3Z4548	Resistor RS-148	Carbon, insul; 200,000 ohm ½ w.	Grid, C-W osc.	M	SC-D-970
†R ₄₄	3Z4635	Resistor RS-235	Carbon, insul; 3,000 ohm 1 w.	Cathode, band C, r-f osc.	L	SC-D-970
†R ₄₅	3Z4637	Resistor RS-237	Carbon, insul; 5,000 ohm 1 w.	Cathode, band B r-f osc.	L	SC-D-970
†R ₄₆	3Z4638	Resistor RS-238	Carbon, insul; 7,500 ohm 1 w.	Cathode, band A r-f osc.	L	SC-D-970

* See Index of Manufacturers.

† Furnished in Maintenance Parts Group.

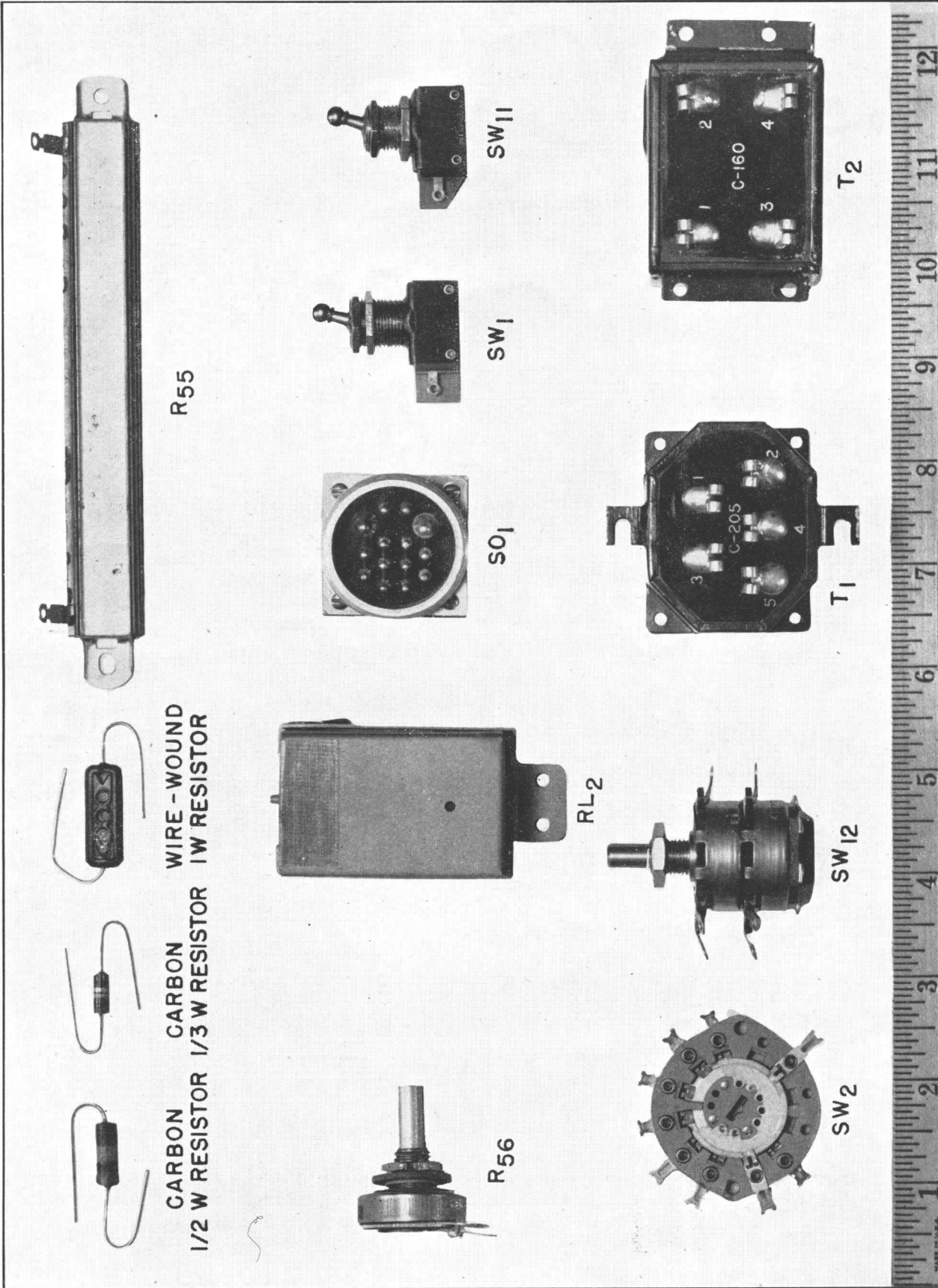

Tabular List of Replaceable Parts (Continued),—

Ref. No.	Stock No.	Name of Part	Description	Function	Mfg.*	Signal Corps Drawing No.
†R ₄₈	3Z4569	Resistor RS-169	Same as R ₂	Screen grid, 1st det.	M	SC-D-970
†R ₄₉	3Z4533	Resistor RS-133	Carbon, insul; 500,000 ohm ½ w.	r-f filter, diode	M	SC-D-970
†R ₅₀	3Z4540	Resistor RS-140	Same as R ₁₅	Screen grid, 1st det.	M	SC-D-970
†R ₅₁	3Z4529	Resistor RS-129	Carbon, insul; 10,000 ohm ½ w.	Filter load, C-W osc.	M	SC-D-970
†R ₅₂	3Z4575	Resistor RS-175	Carbon, 10,000 ohm ½ w.	AVC filter, 1st i-f	N	SC-D-970
†R ₅₃	3Z4573	Resistor RS-173	Same as R ₆	Grid, 1st r-f	N	SC-D-970
†R ₅₄	3Z4623	Resistor RS-223	Same as R ₃₁	2nd audio, bias	J	SC-D-970
†R ₅₅	3Z4667	Resistor RS-267	Molded, insul; 75 ohm, 15 w.	Heater dropping	G	SC-D-970
†R ₅₆	3Z7256	Rheostat RS-256	75 ohm 2 w.	Dimmer	O	SC-A-6593
†RL ₂	3Z7641-A	Relay BK-41-A	Send-Receive Relay	Antenna grounding	U	SC-D-1942
†SO ₁	2Z8794-1	Socket SO-94	Connector	Power supply and control	Z	SC-D-2593
SW ₁	3Z8131	Switch SW-131	Toggle	Send-Receive	V	SC-A-1042
†SW ₂	3Z8310-2	Switch	Ceramic, wafer	Band change, 1st r-f grid	X	SC-D-4046
†SW ₃	3Z8310-2	Switch	Same as SW ₂	Band change, 1st r-f antenna	X	SC-D-4046
†SW ₄	3Z8310-2	Switch	Same as SW ₂	Band change, 2nd r-f grid	X	SC-D-4046
†SW ₅	3Z8310-2	Switch	Same as SW ₂	Band change, 1st r-f plate	X	SC-D-4046
†SW ₆	3Z8310-2	Switch	Same as SW ₂	Band change, 1st det. grid	X	SC-D-4046
†SW ₇	3Z8310-2	Switch	Same as SW ₂	Band change, 2nd r-f plate	X	SC-D-4046
†SW ₈	3Z8310-2	Switch	Same as SW ₂	Band change, r-f osc. grid	X	SC-D-4046
†SW ₉	3Z8310-2	Switch	Same as SW ₂	Band change, r-f osc. plate	X	SC-D-4046
†SW ₁₁	3Z8139	Switch SW-139	Toggle	C-W osc.	V	SC-A-1042
†SW ₁₂	3Z8119	Switch SW-119	Rotary	ON-OFF, MVC-AVC	L	SC-D-2574
†T ₁	2Z9805	Transformer C-205	Audio frequency	1st audio	T	SC-D-2567
†T ₂	2Z9760	Transformer C-160	Audio frequency	2nd audio	T	SC-D-2569

* See Index of Manufacturers.

† Furnished in Maintenance Parts Group.

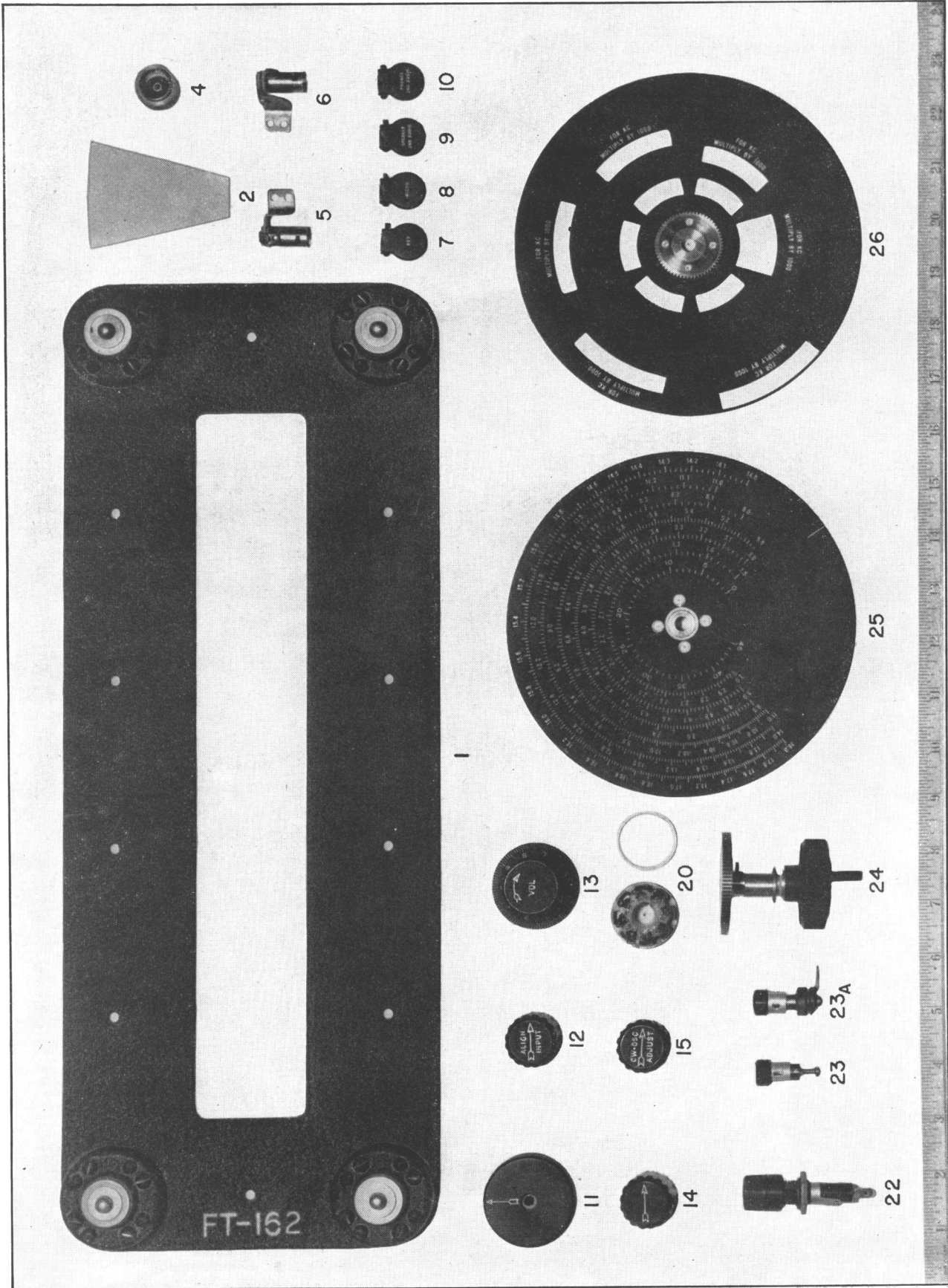

Tabular List of Replaceable Parts (Continued),—

b. Mechanical Parts.

Ref. No.	Stock No.	Name of Part	Description	Function	Mfg.*	Signal Corps. Drawing No.
†1	2Z6702	Mounting FT-162	Shock Mounting Plate	Receiver Mounting	Z	SC-D-2577
†2	2Z7560/2	Reflector Glass	Clear Glass	Dial Pane	Z	SC-D-2532-13
†4	2C4312/N1	Nut & Ferrule Assembly	Connector Assembly	Shielded Connector	Z	SC-D-2578
†5	2Z5986/1	Lamp Mounting R. H.	Socket R. H.	Pilot Lamp Socket	Z	SC-D-2573-1
†6	2Z5986/2	Lamp Mounting L. H.	Socket L. H.	Pilot Lamp Socket	Z	SC-D-2573-2
†7	2Z5650-K	Jack Cover, Key	Jack Cover	Jack Cover	Z	SC-D-2532-36
†8	2Z5650-M	Jack Cover, Micro	Jack Cover	Jack Cover	Z	SC-D-2532-37
†9	2Z5650-S2A	Jack Cover, Speaker 2nd Audio	Jack Cover	Jack Cover	Z	SC-D-2532-38
†10	2Z5650-P2A	Jack Cover, Phones 2nd Audio	Jack Cover	Jack Cover	Z	SC-D-2532-39
†11	2Z5783	Knob, Band Change	Die Cast Knob	Jack Cover	Z	SC-D-5431-56
†12	2Z5779	Knob, Align Input	Bakelite Knob	Frequency Change	Z	SC-D-5431-56
†13	2Z5773	Knob, Volume	Bakelite Knob	Antenna Alignment	AA	SC-D-2532-44
†14	2Z5778	Knob, OFF-MVC-AVC	Bakelite Knob and Plate	Volume Control	Z	SC-D-2532-45
†15	2Z5780	Knob, CW-Osc Adjust	Bakelite Knob	Switch Control	AA	SC-D-2532-43
†20	2Z8761.4	Socket, 8 Prong	Bakelite Knob	Pitch Adjustment	AA	SC-D-2561-17
†22	3Z3275	Fuse Post	Molded, Octal Socket	Tube Socket	AB	SC-D-2538-63
†23	3Z763	Binding Post, Ground	Bakelite Fuse Holder	Fuse Holder	Q or B	SC-D-2532-76
†23a	3Z510	Binding Post, Alt. Sig. Ant.	Push Post Assembly	Ground Connection	AC	SC-D-2532-78
†24	2Z5782.1	Fast Tuning Knob and Drive Assembly	Push Post Assembly	Alt. Sig. Connection	AC	SC-D-2532-71
†25	2C4312J/D1	Dial Assembly	Fast Tuning Assembly	Fast Tuning Drive	Z	SC-D-5431
†26	2Z8550	Shutter Assembly	Calibrated Dial Assembly Dial Shutter Assembly	Tuning Dial Dial Shutter	Z Z	SC-D-5431 SC-D-5431

* See Index of Manufacturers.

† Furnished in Maintenance Parts Group.

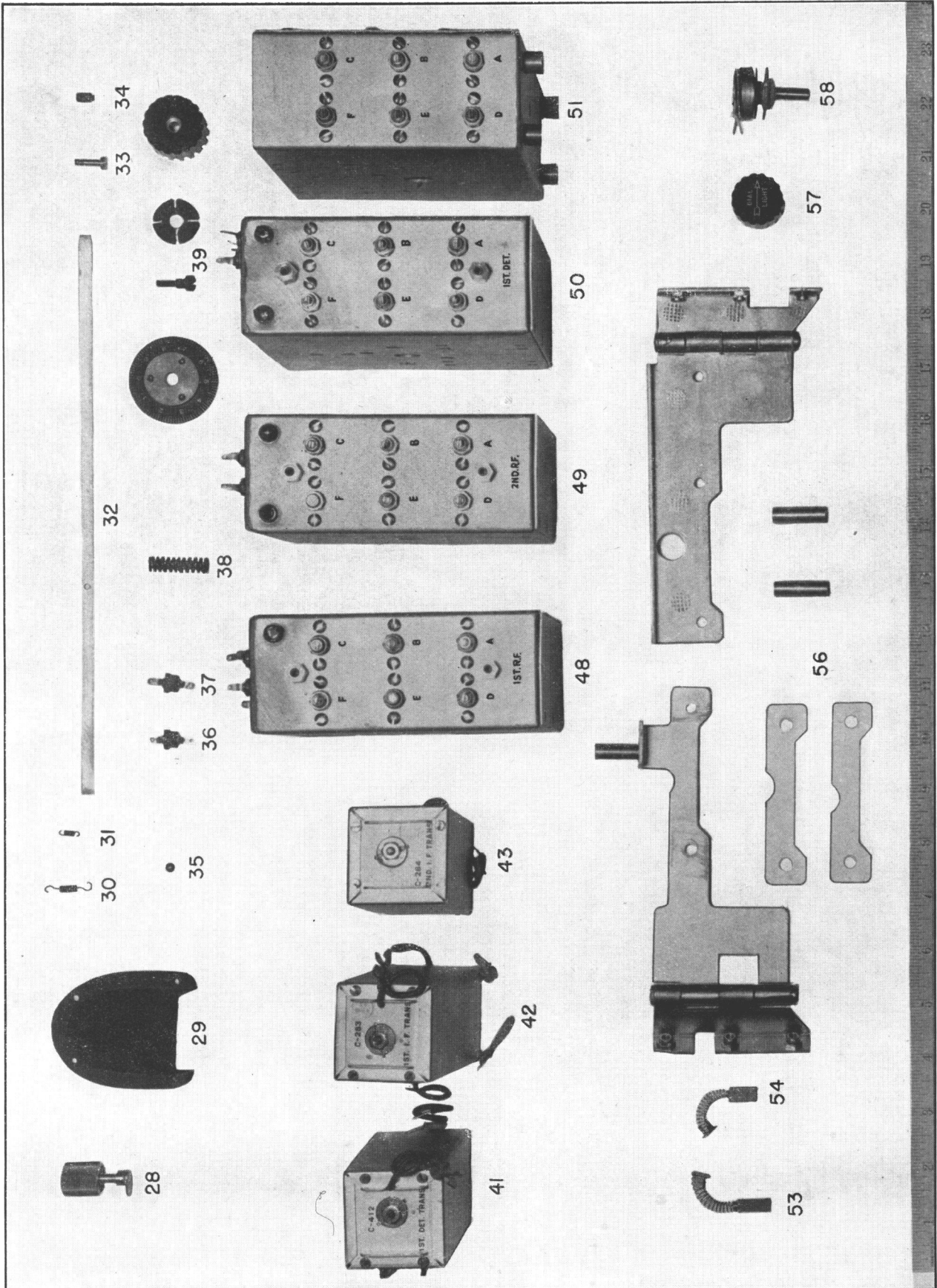

Tabular List of Replaceable Parts (Continued),—

Ref. No.	Stock No.	Name of Part	Description	Function	Mfg.*	Signal Corps. Drawing No.
†28	2Z6931/21	Panel Lock	Knurled Knob and Latch Assembly	Receiver Locks	Z	SC-D-2532
†29	2Z8794.1/C1	Cover	Aluminum Die-Cast Cover	SO-94 Socket Cover	Z	SC-D-2532-6
†30	2Z1650/7.3	Spring	Backlash Spring	Backlash Take-up	Z	SC-D-5431-14
†31	2Z1650/7.4	Spring	Backlash Spring	Backlash Take-up	Z	SC-D-5431-36
†32	2Z1650/42	Shaft	Band Switch Shaft	Band Change	Z	SC-D-5431-42
†33	6L6632-8.23	Screw	Brass Taper Screw No. 6-32	Secure Shaft	Z	SC-D-5431-4
†34	6L7082-6.85	Screw	Steel Set Screw, No. 10-32	Band Switch Screw	Z	SC-D-5431-85
†35	2Z1650/2	Ball	.217" dia. Steel Ball	Detent Index	Z	SC-D-5431-94
†36	3G1921	Insulator	Bakelite Feed-Through	Feed Thru	Z	SC-D-2538
†37	3G1921-1	Insulator	Bakelite Feed-Through	Feed Thru	Z	SC-D-2553
†38	2Z1650/17.2	Spring	Steel Coil Spring	Detent Adjust	Z	SC-D-5431-6
†39	2Z5784	Knob, Vernier	Bakelite Knob, Plate and Clutch Assembly	Vernier Tuning	Z	SC-D-5431-58
†41	2Z9940-412	Transformer C-412	470 kc 1st Detector Transformer, I. F.	1st Detector Transformer	Z	SC-D-4166
†42	2Z9883	Transformer C-283	470 kc Interstage Transformer, I. F.	1st I. F. Transformer	Z	SC-D-4166
†43	2Z9884	Transformer C-284	470 kc Diode Transformer, I. F.	2nd I. F. Transformer	Z	SC-D-4166
†48	2C4342N/A2	1st R. F. Unit Assembly	R-F Coil Box, Complete	1st R-F Stage	Z	SC-D-2553
†49	2C4342N/A3	2nd R. F. Unit Assembly	R-F Coil Box, Complete	2nd R-F Stage	Z	SC-D-2553
†50	2C4342N/A1	1st Detector Unit Assembly	R-F Coil Box, Complete	1st Detector Stage	Z	SC-D-2553
†51	2C4342N/A4	R. F. Oscillator Unit Assembly	Oscillator Coil Box, Complete	R-F Oscillator Stage	Z	SC-D-2558
†53	3H1621B/4	Brush, L. V.	Carbon Brush	Low Voltage	Y	
†54	3H1621B/3	Brush, H. V.	Carbon Brush	High Voltage	Y	
†56	2C4314G/B2	Bracket Set	Dynamotor Mounting Brackets	Dynamotor Mounting	Z	SC-D-2532
†57	2Z5777.1	Knob, Dial Light	Bakelite Knob	Pilot Light Dimmer	AA	SC-D-730-1
†58	3Z7256	Rheostat RS-256	75 ohm, 1 watt	Pilot Light Dimmer	O	SC-A-6593

* See Index of Manufacturers.

† Furnished in Maintenance Parts Group.

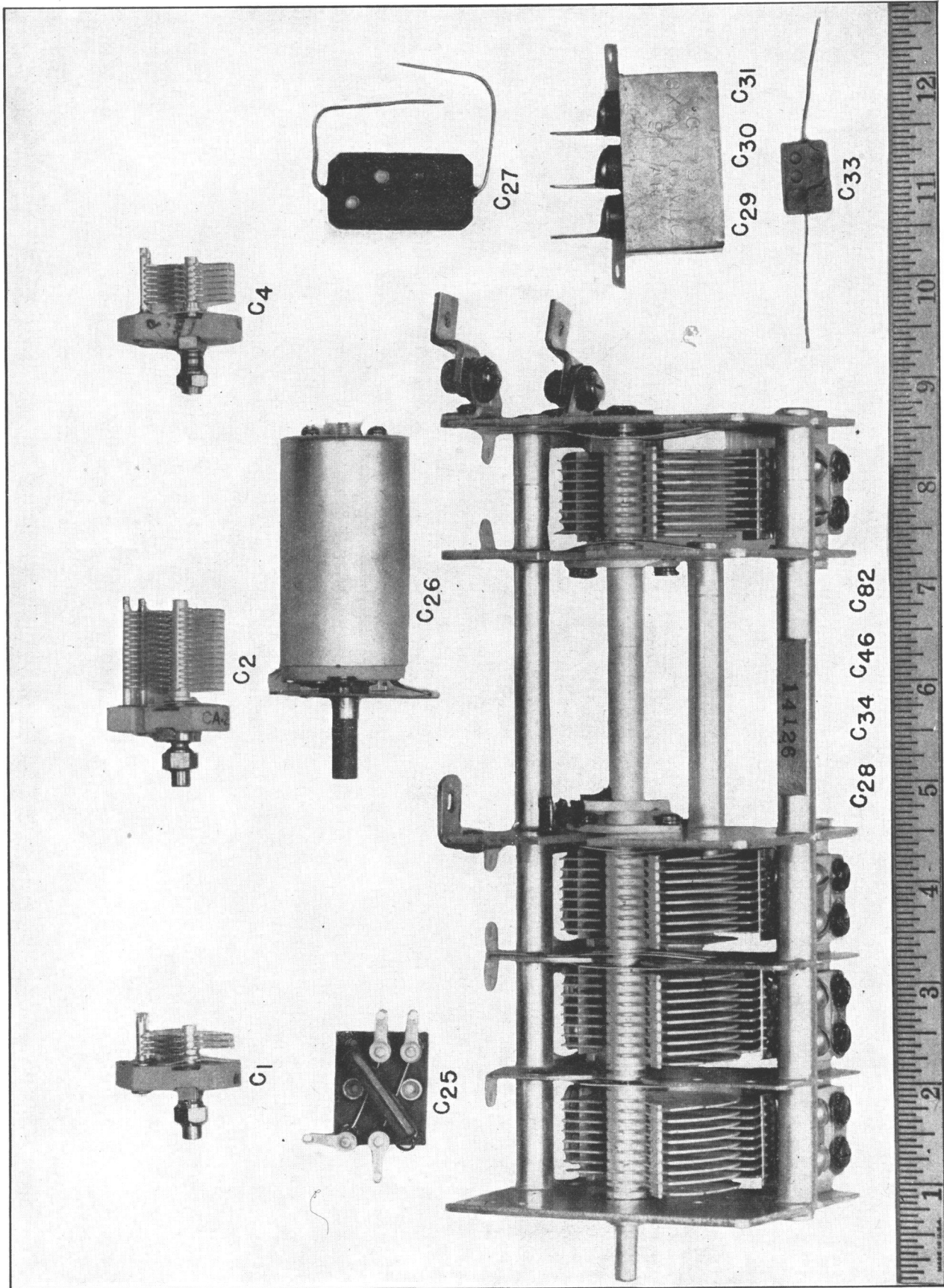

26. Tabular List of Replaceable Parts, Radio Receiver BC-342-N:

a. Electrical Parts.

Note: The list of stock numbers is intended to supplement the Signal Corps General Catalog until such time as the Catalog is revised to include the stock numbers herein. Order replacement parts by stock numbers and description.

Ref. No.	Stock No.	Name of Part	Description	Function	Mfg.*	Signal Corps Drawing No.
C ₁	3D289	Capacitor CA-289	Variable, air; 3-25 $\mu\mu\text{f}$	Band-A trimmer, 1st r-f	A, C, or E	SC-A-1728
C ₂	3D291	Capacitor CA-291	Variable, air; 6-100 $\mu\mu\text{f}$	Band-B trimmer, 1st r-f	A, C, or E	SC-A-1728
C ₃	3D291	Capacitor CA-291	Same as C ₂	Band-C trimmer, 1st r-f	A, C, or E	SC-A-1728
C ₄	3D290	Capacitor CA-290	Variable, air; 4-50 $\mu\mu\text{f}$	Band-D trimmer, 1st r-f	A, C, or E	SC-A-1728
C ₅	3D290	Capacitor CA-290	Same as C ₄	Band-E trimmer, 1st r-f	A, C, or E	SC-A-1728
C ₆	3D290	Capacitor CA-290	Same as C ₄	Band-F trimmer, 1st r-f	A, C, or E	SC-A-1728
C ₇	3D289	Capacitor CA-289	Same as C ₁	Band-A trimmer, 2nd r-f	A, C, or E	SC-A-1728
C ₈	3D291	Capacitor CA-291	Same as C ₂	Band-B trimmer, 2nd r-f	A, C, or E	SC-A-1728
C ₉	3D291	Capacitor CA-291	Same as C ₂	Band-C trimmer, 2nd r-f	A, C, or E	SC-A-1728
C ₁₀	3D290	Capacitor CA-290	Same as C ₄	Band-D trimmer, 2nd r-f	A, C, or E	SC-A-1728
C ₁₁	3D290	Capacitor CA-290	Same as C ₄	Band-E trimmer, 2nd r-f	A, C, or E	SC-A-1728
C ₁₂	3D290	Capacitor CA-290	Same as C ₄	Band-F trimmer, 2nd r-f	A, C, or E	SC-A-1728
C ₁₃	3D289	Capacitor CA-289	Same as C ₁	Band-A trimmer, 1st det.	A, C, or E	SC-A-1728
C ₁₄	3D291	Capacitor CA-291	Same as C ₂	Band-B trimmer, 1st det.	A, C, or E	SC-A-1728
C ₁₅	3D291	Capacitor CA-291	Same as C ₂	Band-C trimmer, 1st det.	A, C, or E	SC-A-1728
C ₁₆	3D290	Capacitor CA-290	Same as C ₄	Band-D trimmer, 1st det.	A, C, or E	SC-A-1728
C ₁₇	3D290	Capacitor CA-290	Same as C ₄	Band-E trimmer, 1st det.	A, C, or E	SC-A-1728
C ₁₈	3D290	Capacitor CA-290	Same as C ₄	Band-F trimmer, 1st det.	A, C, or E	SC-A-1728
C ₁₉	3D289	Capacitor CA-289	Same as C ₁	Band-A trimmer, r-f osc.	A, C, or E	SC-A-1728
C ₂₀	3D291	Capacitor CA-291	Same as C ₂	Band-B trimmer, r-f osc.	A, C, or E	SC-A-1728
C ₂₁	3D291	Capacitor CA-291	Same as C ₂	Band-C trimmer, r-f osc.	A, C, or E	SC-A-1728
C ₂₂	3D290	Capacitor CA-290	Same as C ₄	Band-D trimmer, r-f osc.	A, C, or E	SC-A-1728
C ₂₃	3D290	Capacitor CA-290	Same as C ₄	Band-E trimmer, r-f osc.	A, C, or E	SC-A-1728
C ₂₄	3D290	Capacitor CA-290	Same as C ₄	Band-F trimmer, r-f osc.	A, C, or E	SC-A-1728
†C ₂₅	3D294	Capacitor CA-294	Fixed; 125 $\mu\mu\text{f}$	Padder, 1st r-f	A, C, or E	SC-A-1728
C ₂₆	3D293	Capacitor CA-293	Variable, air; 10-210 $\mu\mu\text{f}$	Antenna alignment	A, C, or E	SC-D-2575
†C ₂₇	3D284	Capacitor CA-284	Molded, paper, .05 μf -400 v	1st r-f, bypass	J	SC-A-2580
C ₂₈	**	Capacitor	Ganged 13-226 $\mu\mu\text{f}$	1st r-f, tuning	D or F	SC-D-1995
†C ₂₉	3D195	Capacitor CA-195	Metal-encased as one unit	1st r-f, cathode bypass	G, H, or I	SC-D-2568
†C ₃₀	3D284	Capacitor CA-284	as one unit	1st r-f, screen bypass	G, H, or I	SC-D-512
†C ₃₁	3D266	Capacitor CA-266	Same as C ₂₇	1st r-f, "B" supply bypass	J	SC-D-512
†C ₃₂			Mica; 100 $\mu\mu\text{f}$	1st r-f, plate bypass	J	SC-D-1995
†C ₃₃				2nd r-f, grid coupling	I or K	SC-D-1993

* See Index of Manufacturers.

** C₂₈, C₃₄, C₄₆, and C₈₂ ganged comprise Capacitor CA-292 (3D292)

† Furnished in Maintenance Parts Group.

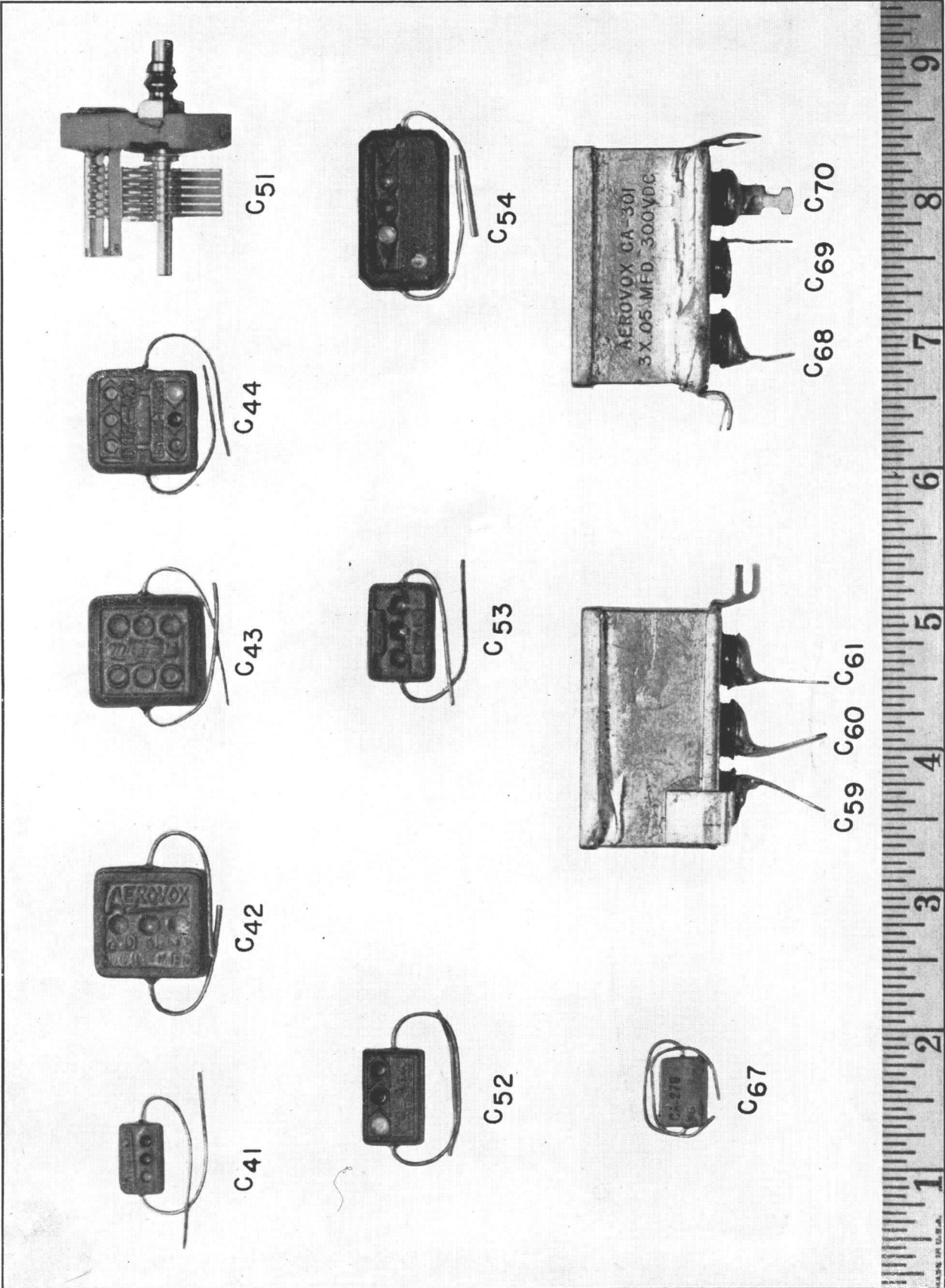

Tabular List of Replaceable Parts (Continued),—

Ref. No.	Stock No.	Name of Part	Description	Function	Mfg.*	Signal Corps Drawing No.
†C ₃₄ †C ₃₅ †C ₃₆ †C ₃₇	**	Capacitor	Ganged 13-226 μμf	2nd r-f, tuning	D or F	SC-D-2568
	3D195	Capacitor CA-195	{ Same as C ₂₉ Same as C ₃₀ Same as C ₃₁	2nd r-f, cathode bypass 2nd r-f, screen bypass 2nd r-f, "B" supply bypass	G, H or I	SC-D-512
†C ₃₈ †C ₃₉ †C ₄₀ †C ₄₁ †C ₄₂ †C ₄₃ †C ₄₄ †C ₄₅	3D294 3D284 3D294 3D278 3D300 3D297 3D299 3D266	Capacitor CA-294 Capacitor CA-284 Capacitor CA-294 Capacitor CA-278 Capacitor CA-300 Capacitor CA-297 Capacitor CA-299 Capacitor CA-266	{ Same as C ₂₅ Same as C ₂₇ Same as C ₂₅ Mica; 5 μμf Mica, aged; 3000 μμf Mica, aged; 1600 μμf Mica, aged; 750 μμf Same as C ₃₃ Ganged 13-226 μμf	Padder, 1st det. 2nd r-f, plate bypass Padder, r-f osc. C-W osc., coupling Band-C padder, r-f osc. Band-B padder, r-f osc. Band-A padder, r-f osc. 1st det., grid coupling 1st det., tuning	A J A J K G, J, or K J or K I or K	SC-D-2575 SC-D-1995 SC-D-2575 SC-D-1993 SC-D-1993 SC-D-1993 SC-D-1993 SC-D-2568
†C ₄₆ †C ₄₇ †C ₄₈ †C ₄₉ †C ₅₀	3D266 3D195	Capacitor CA-266 Capacitor CA-195	{ Same as C ₃₃ Same as C ₂₉ Same as C ₃₀ Same as C ₃₁	R. F. osc., coupling 1st det., cathode bypass 1st det., screen bypass 1st det., "B" supply bypass	D or F I or K G, H, or I	SC-D-1993 SC-D-512 SC-D-512 SC-D-512
†C ₅₁ †C ₅₂ †C ₅₃ †C ₅₄ †C ₅₅ †C ₅₆ †C ₅₇ †C ₅₈	3D323 3D342 3D344 3D281 3D344 3D281 3D344 3D281	Capacitor CA-323 Capacitor CA-342 Capacitor CA-344 Capacitor CA-281 Capacitor CA-344 Capacitor CA-281 Capacitor CA-344 Capacitor CA-281	Variable air, 4-50 μμf Mica; 100 μμf Mica; 400 μμf Molded, paper; .01 μf—400 v. Same as C ₅₃ Same as C ₅₄ Same as C ₅₃ Same as C ₅₄	Crystal phasing 1st i-f, grid coupling 1st det., plate 1st det., plate bypass 2nd i-f, grid 2nd i-f, AVC bypass 1st i-f, plate 1st i-f, cathode bypass	A J or K G, J, or K J G, J, or K J G, J, or K J	SC-A-1728 SC-D-1993 SC-D-1993 SC-D-1995 SC-D-1993 SC-D-1995 SC-D-1993 SC-D-1995
†C ₅₉ †C ₆₀ †C ₆₁	3D302	Capacitor CA-302	Modification of CA-195	1st i-f, cathode bypass 1st i-f, screen bypass 1st i-f, "B" supply bypass	G, H, or I	SC-D-2567 SC-D-2567 SC-D-2567
†C ₆₂ †C ₆₃ †C ₆₄ †C ₆₅ †C ₆₆ †C ₆₇ †C ₆₈ †C ₆₉ †C ₇₀	3D284 3D281 3D342 3D342 3D281 3D279 3D301	Capacitor CA-284 Capacitor CA-281 Capacitor CA-342 Capacitor CA-342 Capacitor CA-281 Capacitor CA-279 Capacitor CA-301	{ Same as C ₂₇ Same as C ₅₄ Same as C ₅₂ Same as C ₅₂ Same as C ₅₄ Mica; 10 μμf Modification of CA-195	1st det., AVC bypass 1st i-f, AVC bypass 2nd det., grid 2nd i-f, plate 2nd, i-f, plate bypass Diode, AVC, Coupling 2nd i-f, cathode bypass 2nd i-f, screen bypass 2nd i-f, "B" supply bypass	J J J or K J or K G or J J G, H, or I	SC-D-1995 SC-D-1995 SC-D-1993 SC-D-1993 SC-D-1995 SC-D-1993 SC-D-2567 SC-D-2567

* See Index of Manufacturers.

** C₂₉, C₃₄, C₄₆, and C₆₂ ganged comprise Capacitor CA-292 (3D292)

† Furnished in Maintenance Parts Group.

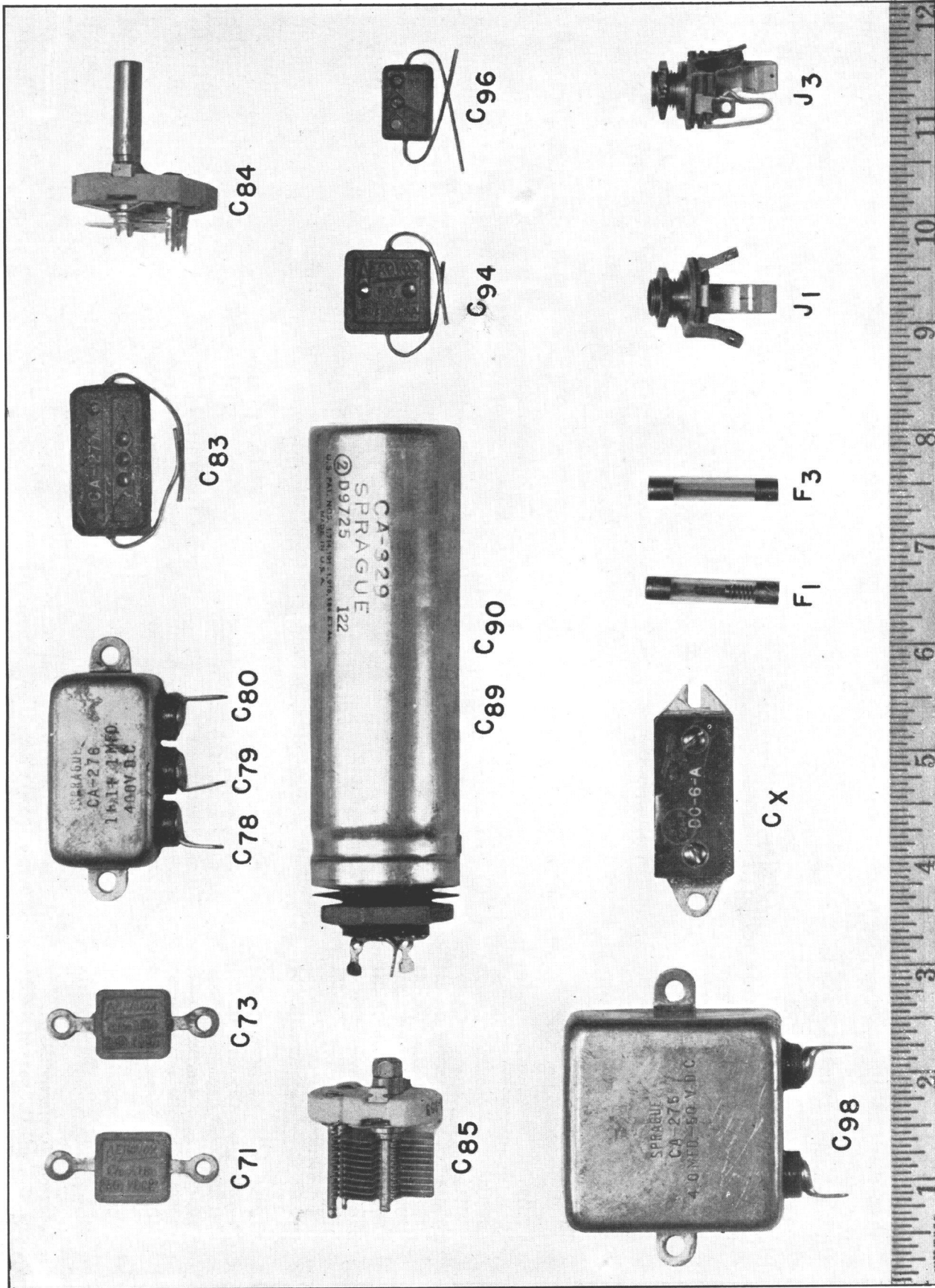

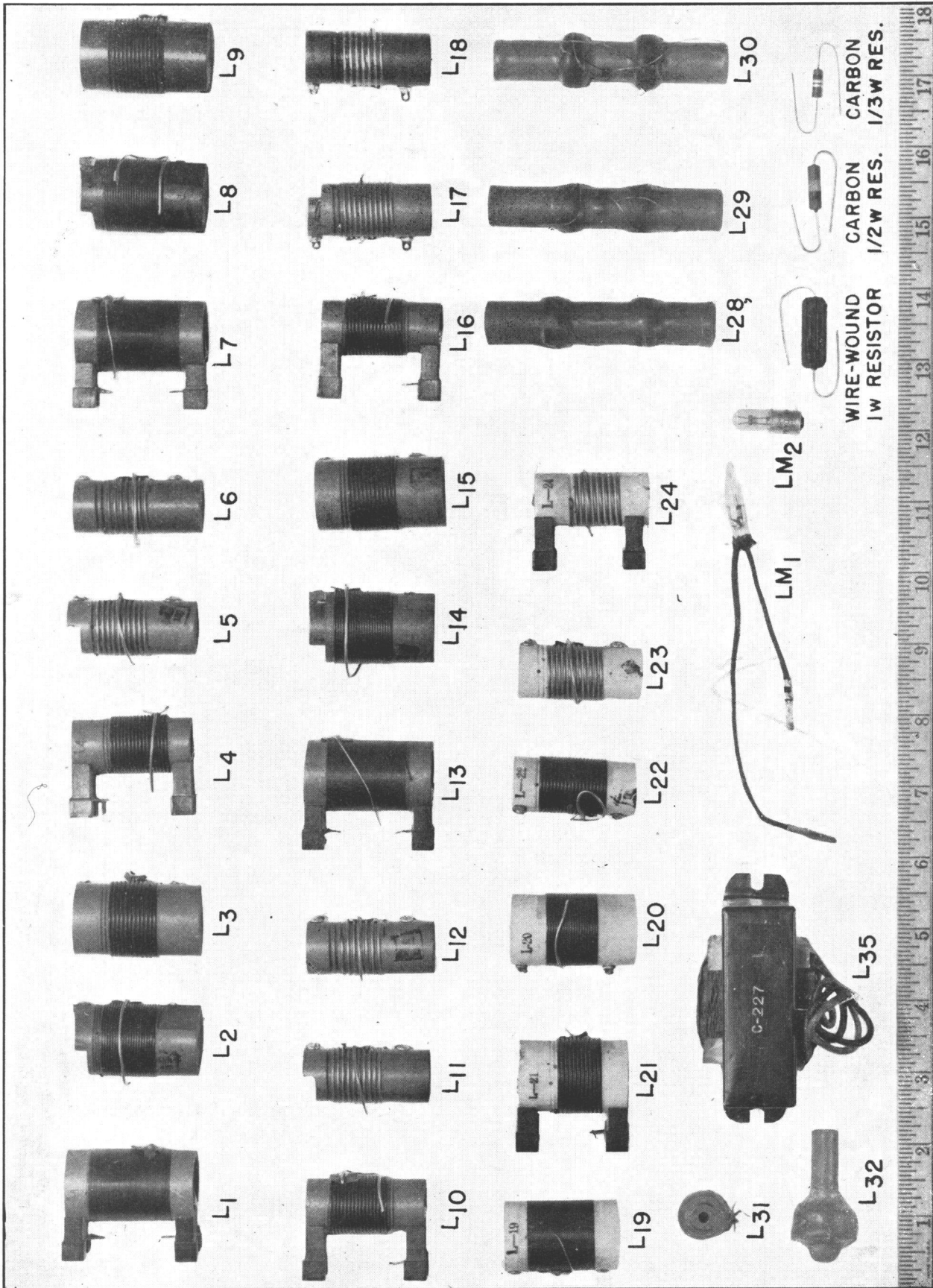

Tabular List of Replaceable Parts (Continued),—

Ref. No.	Stock No.	Name of Part	Description	Function	Mfg.*	Signal Corps Drawing No.
L ₁	3C1083	Coil		Band-A, 1st r-f	Z	SC-D-2556
L ₂	3C1083-3	Coil		Band-B, 1st r-f	Z	SC-D-2556
L ₃	3C1083-6	Coil		Band-C, 1st r-f	Z	SC-D-2556
L ₄	3C1083-9	Coil		Band-D, 1st r-f	Z	SC-D-2556
L ₅	3C1083-12	Coil		Band-E, 1st r-f	Z	SC-D-2556
L ₆	3C1083-15	Coil		Band-F, 1st r-f	Z	SC-D-2556
L ₇	3C1083-1	Coil		Band-A, 2nd r-f	Z	SC-D-2556
L ₈	3C1083-4	Coil		Band-B, 2nd r-f	Z	SC-D-2556
L ₉	3C1083-7	Coil		Band-C, 2nd r-f	Z	SC-D-2556
L ₁₀	3C1083-10	Coil		Band-D, 2nd r-f	Z	SC-D-2556
L ₁₁	3C1083-13	Coil		Band-E, 2nd r-f	Z	SC-D-2556
L ₁₂	3C1083-16	Coil		Band-F, 2nd r-f	Z	SC-D-2556
L ₁₈	3C390	Coil		Band-A, 1st Det.	Z	SC-D-2556
L ₁₄	3C390-1	Coil		Band-B, 1st Det.	Z	SC-D-2556
L ₁₅	3C390-2	Coil		Band-C, 1st Det.	Z	SC-D-2556
L ₁₆	3C390-3	Coil		Band-D, 1st Det	Z	SC-D-2556
L ₁₇	3C390-4	Coil		Band-E, 1st Det.	Z	SC-D-2556
L ₁₈	3C390-5	Coil		Band-F, 1st Det	Z	SC-D-2556
L ₁₉	3C1083-2	Coil		Band-A, r-f Osc.	Z	SC-D-2556
L ₂₀	3C1083-5	Coil		Band-B, r-f Osc.	Z	SC-D-2556
L ₂₁	3C1083-8	Coil		Band-C, r-f Osc.	Z	SC-D-2556
L ₂₂	3C1083-11	Coil		Band-D, r-f Osc.	Z	SC-D-2556
L ₂₃	3C1083-14	Coil		Band-E, r-f Osc.	Z	SC-D-2556
L ₂₄	3C1083-17	Coil		Band-F, r-f Osc.	Z	SC-D-2556
L ₂₈	2Z9882.1/1	Coils of Transformer C-282		1st Detector Transformer	Z	SC-D-2566
L ₂₉	2Z9883/1	Coils of Transformer C-283		1st i-f Transformer	Z	SC-D-2566
L ₃₀	2Z9884/1	Coils of Transformer C-284		2nd i-f Transformer	Z	SC-D-2566
†L ₃₁	2C2775/2	Coil		C-W beat osc.	Z	SC-D-2561
†L ₃₂	2C2775/3	Coil		Filter, C-W Osc.	Z	SC-D-2561
†L ₃₅	3C227	Coil C-227		Filter Choke	T	SC-D-1489
LM ₁	2Z5893	Neon Lamp	Pilot Lamp	Antenna overload protection	R	SC-A-1801
LM ₂	2Z5927	Lamp LM-27		Dial Light	S	SC-D-2573
LM ₃	2Z5927	Lamp LM-27	Same as LM ₂	Dial Light	S	SC-D-2573
†R ₁	3Z4564	Resistor RS-164	Wire-wound, 500 ohm 1 w.	Cathode bias, 1st r-f	J	SC-D-970
†R ₂	3Z4569	Resistor RS-169	Carbon, insul; 60,000 ohm ½ w.	Screen grid, 1st r-f	M	SC-D-970
†R ₃	3Z4549	Resistor RS-149	Carbon, insul; 40,000 ohm ½ w.	Screen grid, 1st r-f	M	SC-D-970
†R ₄	3Z4572	Resistor RS-172	Carbon, insul; 100,000 ohm ½	AVC filter, 1st r-f	N	SC-D-970
†R ₅	3Z4525	Resistor RS-125	Carbon; 1,000 ohm ½ w.	Plate filter, 1st r-f	M	SC-D-970
†R ₆	3Z4573	Resistor RS-173	Carbon; 2 megohm ½ w.	Grid, 2nd r-f	N	SC-D-970

* See Index of Manufacturers.

† Furnished in Maintenance Parts Group.

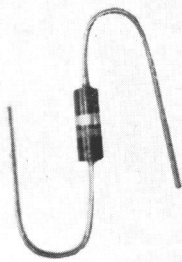

CARBON
1/3W RESISTOR

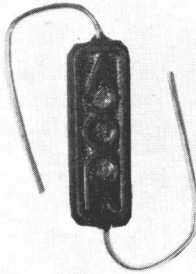

WIRE-WOUND
1W RESISTOR

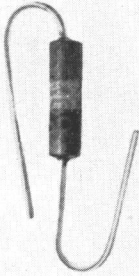

CARBON
1/2W RESISTOR

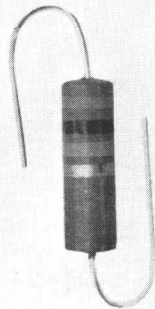

CARBON
1W RESISTOR

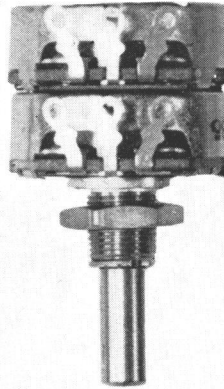

R34 R35

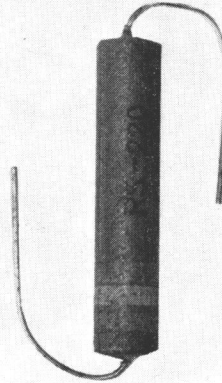

CARBON
2W RESISTOR



Tabular List of Replaceable Parts (Continued),—

Ref. No.	Stock No.	Name of Part	Description	Function	Mfg.*	Signal Corps Drawing No.
†R ₇	3Z4564	Resistor RS-164	Same as R ₁	Cathode bias, 2nd r-f	J	SC-D-970
†R ₈	3Z4569	Resistor RS-169	Same as R ₂	Screen grid, 2nd r-f	M	SC-D-970
†R ₉	3Z4549	Resistor RS-149	Same as R ₃	Screen grid, 2nd r-f	M	SC-D-970
†R ₁₀	3Z4572	Resistor RS-172	Same as R ₄	AVC filter, 2nd r-f	N	SC-D-970
†R ₁₁	3Z4525	Resistor RS-125	Same as R ₅	Plate filter, 2nd, r-f	M	SC-D-970
†R ₁₂	3Z4573	Resistor RS-173	Same as R ₆	Grid, 1st det.	N	SC-D-970
†R ₁₃	3Z4568	Resistor RS-168	Carbon; 50,000 ohm 1/3 w.	Injector bias, 1st det.	N	SC-D-970
†R ₁₄	3Z4566	Resistor RS-166	Wire-wound; 350 ohm 1 w.	Cathode bias, 1st det.	J	SC-D-970
†R ₁₅	3Z4540	Resistor RS-140	Carbon, insul; 30,000 ohm 1/2 w.	Screen grid, 1st det.	M	SC-D-970
†R ₁₆	3Z4572	Resistor RS-172	Same as R ₄	AVC filter, 1st det.	N	SC-D-970
†R ₁₇	3Z4525	Resistor RS-125	Same as R ₅	Plate filter, 1st det.	M	SC-D-970
†R ₁₈	3Z4572	Resistor RS-172	Same as R ₄	AVC filter, 1st i-f	N	SC-D-970
†R ₁₉	3Z4564	Resistor RS-164	Same as R ₁	Cathode bias, 1st i-f	J	SC-D-970
†R ₂₀	3Z4563	Resistor RS-163	Carbon, insul; 60,000 ohm 1 w.	Screen grid, 1st i-f	L	SC-D-970
†R ₂₁	3Z4549	Resistor RS-149	Same as R ₃	Screen grid, 1st i-f	M	SC-D-970
†R ₂₂	3Z4525	Resistor RS-125	Same as R ₅	Plate filter, 1st i-f	M	SC-D-970
†R ₂₃	3Z4550	Resistor RS-150	Carbon, insul; 100,000 ohm 1/2 w.	AVC filter, 2nd i-f	M	SC-D-970
†R ₂₄	3Z4564	Resistor RS-164	Same as R ₁	Cathode bias, 2nd i-f	J	SC-D-970
†R ₂₅	3Z4563	Resistor RS-163	Same as R ₂₀	Screen grid, 2nd i-f	L	SC-D-970
†R ₂₆	3Z4549	Resistor RS-149	Same as R ₃	Screen grid, 2nd i-f	M	SC-D-970
†R ₂₇	3Z4525	Resistor RS-125	Same as R ₅	Plate filter, 2nd i-f	M	SC-D-970
†R ₂₈	3Z4571	Resistor RS-171	Wire-wound, 750 ohm 1 w.	Cathode bias, diode	J	SC-D-970
†R ₂₉	3Z4562	Resistor RS-162	Carbon, insul; 250,000 ohm 1/2 w.	AVC filter, diode	M	SC-D-970
†R ₃₀	3Z4561	Resistor RS-161	Carbon, insul; 1 megohm 1/2 w.	AVC load	M	SC-D-970
†R ₃₁	3Z4623	Resistor RS-223	Wire-wound; 2,000 ohm 1 w.	Cathode bias, 2nd audio	N	SC-D-970
†R ₃₂	3Z4562	Resistor RS-162	Same as R ₂₉	Grid, 1st a-f	J	SC-D-970
†R ₃₃	3Z4531	Resistor RS-131	Carbon, insul; 50,000 ohm 1/2 w.	Grid, 2nd a-f	M	SC-D-970
†R ₃₄	2Z7289	Potentiometer RS-174	0—500,000 ohm	Dual volume Control	P	SC-D-1982
†R ₃₅	3Z4511	Resistor RS-111	0—50,000 ohm	Minimum bias bleeder	L	SC-D-970
†R ₃₆	3Z4550	Resistor RS-150	Carbon, insul; 100,000 ohm 1 w.	C-W osc., plate	M	SC-D-970
†R ₃₇	3Z4569	Resistor RS-169	Same as R ₂₃	Plate circuit, loading	M	SC-D-970
†R ₃₈	3Z4620	Resistor RS-220	Same as R ₂	Bleeder	M	SC-D-970
†R ₄₀	3Z4539	Resistor RS-139	Carbon, insul; 65,000 ohm 2 w.	Plate, r-f osc.	L	SC-D-970
†R ₄₁	3Z4539	Resistor RS-139	Carbon, insul; 30,000 ohm 1 w.	Grid, r-f osc.	M	SC-D-970
†R ₄₂	3Z4540	Resistor RS-140	Same as R ₁₅	Grid, C-W osc.	M	SC-D-970
†R ₄₃	3Z4548	Resistor RS-148	Carbon, insul; 200,000 ohm 1/2 w.	Grid, C-W osc.	M	SC-D-970
†R ₄₄	3Z4635	Resistor RS-235	Carbon, insul; 3,000 ohm 1 w.	Cathode, band C, r-f osc.	L	SC-D-970
†R ₄₅	3Z4637	Resistor RS-237	Carbon, insul; 5,000 ohm 1 w.	Cathode, band B, r-f osc.	L	SC-D-970
†R ₄₆	3Z4638	Resistor RS-238	Carbon, insul; 7,500 ohm 1 w.	Cathode, band A, r-f osc.	L	SC-D-970

* See Index of Manufacturers.
 † Furnished in Maintenance Parts Group.

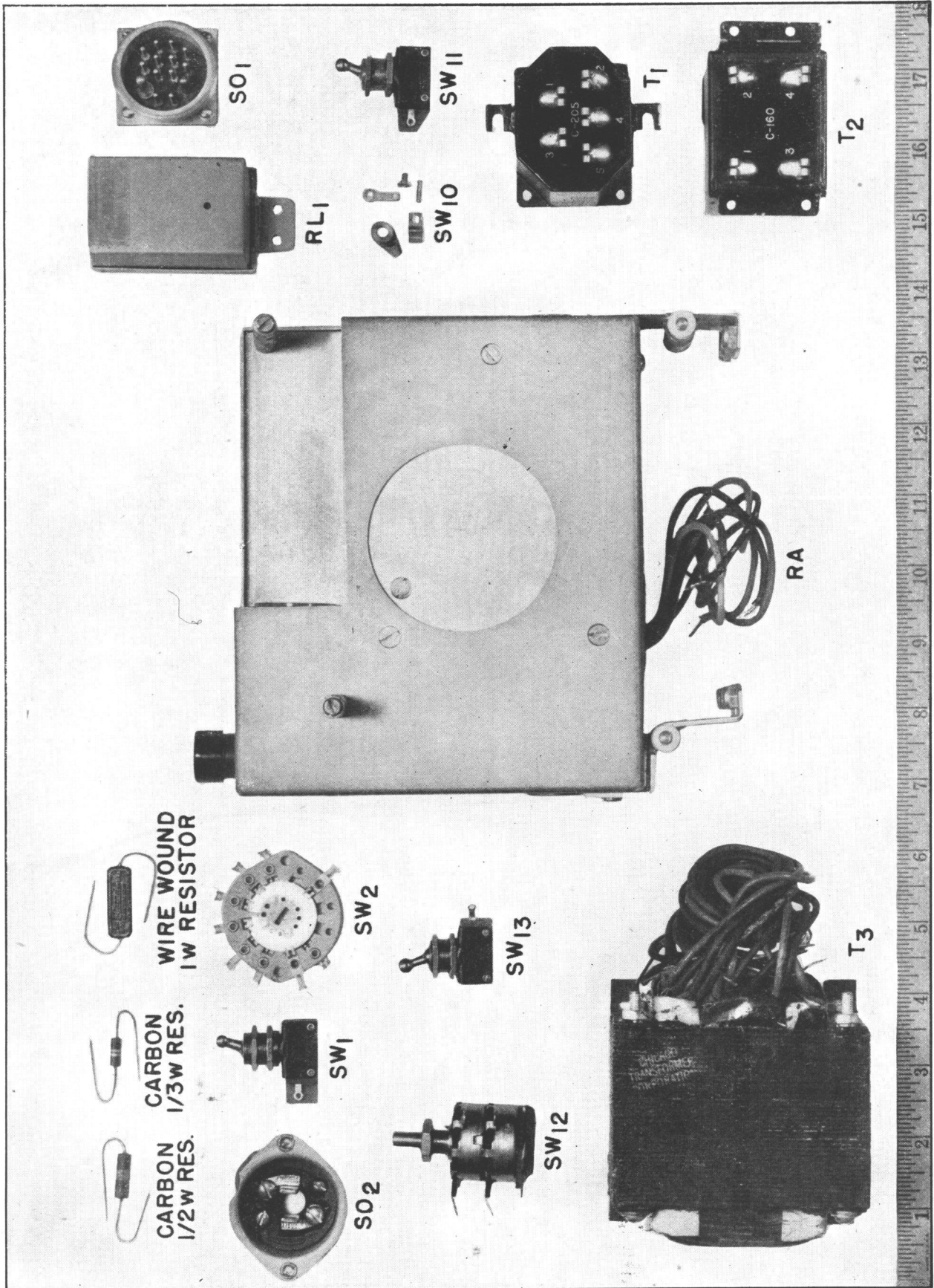

Tabular List of Replaceable Parts (Continued),—

Ref. No.	Stock No.	Name of Part	Description	Function	Mfg.*	Signal Corps Drawing No.
†R ₄₇	3Z4576	Resistor RS-176	Carbon, insul; 60 ohm ½ w.	Filament shunt, diode	L	SC-D-970
†R ₄₈	3Z4569	Resistor RS-169	Same as R ₂	Screen grid, 1st det.	M	SC-D-970
†R ₄₉	3Z4583	Resistor RS-133	Carbon, insul; 500,000 ohm ½ w.	r-f filter, diode	M	SC-D-970
†R ₅₀	3Z4540	Resistor RS-140	Same as R ₁₅	Screen grid, 1st det.	M	SC-D-970
†R ₅₁	3Z4529	Resistor RS-129	Carbon, insul; 10,000 ohm ½ w.	Filter load, C-W osc.	M	SC-D-970
†R ₅₂	3Z4575	Resistor RS-175	Carbon, 10,000 ohm ½ w.	AVC filter, 1st i-f	N	SC-D-970
†R ₅₃	3Z4578	Resistor RS-178	Same as R ₆	Grid, 1st r-f	N	SC-D-970
†R ₅₄	3Z4623	Resistor RS-223	Same as R ₃₁	2nd audio, bias	J	SC-D-970
†RA	2Z7512	Rectifier RA-20	110 v., 60 cycles	Power supply	Z	SC-D-1609
†RL ₁	2Z7613	Relay BK-13	D.P.S.T. 12 v. Relay	Antenna grounding	U	SC-D-1942
†SO ₁	2Z8794.1	Socket SO-94	Multiple contact connector	Power supply and control	Z	SC-D-2592
SO ₂	6Z7589	Socket (A-C power)	Two contact connector	A-C input	Z	SC-D-1610
SW ₁	3Z8131	Switch SW-131	Toggle	Send-Receive	V	SC-A-1042
†SW ₂	3Z8310-2	Switch	Ceramic, wafer	Band change, 1st r-f grid	X	SC-D-4046
†SW ₃	3Z8310-2	Switch	Same as SW ₂	Band change, 1st r-f antenna	X	SC-D-4046
†SW ₄	3Z8310-2	Switch	Same as SW ₂	Band change, 2nd r-f grid	X	SC-D-4046
†SW ₅	3Z8310-2	Switch	Same as SW ₂	Band change, 1st r-f plate	X	SC-D-4046
†SW ₆	3Z8310-2	Switch	Same as SW ₂	Band change, 1st det. grid	X	SC-D-4046
†SW ₇	3Z8310-2	Switch	Same as SW ₂	Band change, 2nd r-f plate	X	SC-D-4046
†SW ₈	3Z8310-2	Switch	Same as SW ₂	Band change, r-f osc. grid	X	SC-D-4046
†SW ₉	3Z8310-2	Switch	Same as SW ₂	Band change, r-f osc. plate	X	SC-D-4046
SW ₁₀		Switch	Ganged to C ₅₁	Crystal Switch	Z	SC-D-2566
†SW ₁₁	3Z8139	Switch SW-139	Toggle	C-W osc.	V	SC-A-1042
†SW ₁₂	3Z8119	Switch SW-119	Rotary	ON-OFF, MVC-AVC	L	SC-D-2574
SW ₁₃	3Z8105	Switch SW-105	Toggle	A-c line	V	SC-A-1042
†T ₁	2Z9805	Transformer C-205	Audio frequency	1st audio	T	SC-D-2567
†T ₂	2Z9760	Transformer C-160	Audio frequency	2nd audio	T	SC-D-2569
†T ₃	2Z9828	Transformer C-228	Power Transformer	Rectifier	T	SC-D-1598

* See Index of Manufacturers.

† Furnished in Maintenance Parts Group.

Tabular List of Replaceable Parts (Continued),—

b. Mechanical Parts.

Ref. No.	Stock No.	Name of Part	Description	Function	Mfg.*	Signal Corps. Drawing No.
†1	2Z6702	Mounting FT-162	Shock Mounting Plate	Receiver Mounting	Z	SC-D-2577
†2	2Z7560/2	Reflector Glass	Clear Glass	Dial Pane	Z	SC-D-2532-13
†4	2C4312/N1	Nut & Ferrule Assembly	Connector Assembly	Shielded Connector	Z	SC-D-2578
†5	2Z5986/1	Lamp Mounting R. H.	Socket R. H.	Pilot Lamp Socket	Z	SC-D-2573-1
†6	2Z5986/2	Lamp Mounting L. H.	Socket L. H.	Pilot Lamp Socket	Z	SC-D-2573-2
†7	2Z5650-K	Jack Cover, Key	Jack Cover	Jack Cover	Z	SC-D-2532-36
†8	2Z5650-M	Jack Cover, Micro	Jack Cover	Jack Cover	Z	SC-D-2532-37
†9	2Z5650-S2A	Jack Cover, Speaker 2nd Audio	Jack Cover	Jack Cover	Z	SC-D-2532-38
†10	2Z5650-P2A	Jack Cover, Phones 2nd Audio	Jack Cover	Jack Cover	Z	SC-D-2532-39
†11	2Z5783	Knob, Band Change	Die Cast Knob	Frequency Change	Z	SC-D-5431-56
†12	2Z5779	Knob, Align Input	Bakelite Knob	Antenna Alignment	AA	SC-D-2532-44
†13	2Z5773	Knob, Volume	Bakelite Knob	Volume Control	Z	SC-D-2532-45
†14	2Z5778	Knob, OFF-MVC-AVC	Bakelite Knob	Switch Control	AA	SC-D-2532-43
†15	2Z5780	Knob, CW-Osc Adjust	Bakelite Knob	Pitch Adjustment	AA	SC-D-2561-17
†20	2Z8761.4	Socket, 8 Prong	Molded, Octal Socket	Tube Socket	AB	SC-D-2538-63
†22	3Z3275	Fuse Post	Bakelite Fuse Holder	Fuse Holder	Q or B	SC-D-2532-76
†23	3Z763	Binding Post, Ground	Push Post Assembly	Ground Connection	AC	SC-D-2532-78
†23a	3Z510	Binding Post, Alt. Sig. Ant.	Push Post Assembly	Alt. Sig. Connection	AC	SC-D-2532-71
†24	2Z5782.1	Fast Tuning Knob and Drive Assembly	Fast Tuning Assembly	Fast Tuning Drive	Z	SC-D-5431
†25	2C4312J/D1	Dial Assembly	Calibrated Dial Assembly	Tuning Dial	Z	SC-D-5431
†26	2Z8550	Shutter Assembly	Dial Shutter Assembly	Dial Shutter	Z	SC-D-5431

* See Index of Manufacturers.

† Furnished in Maintenance Parts Group.

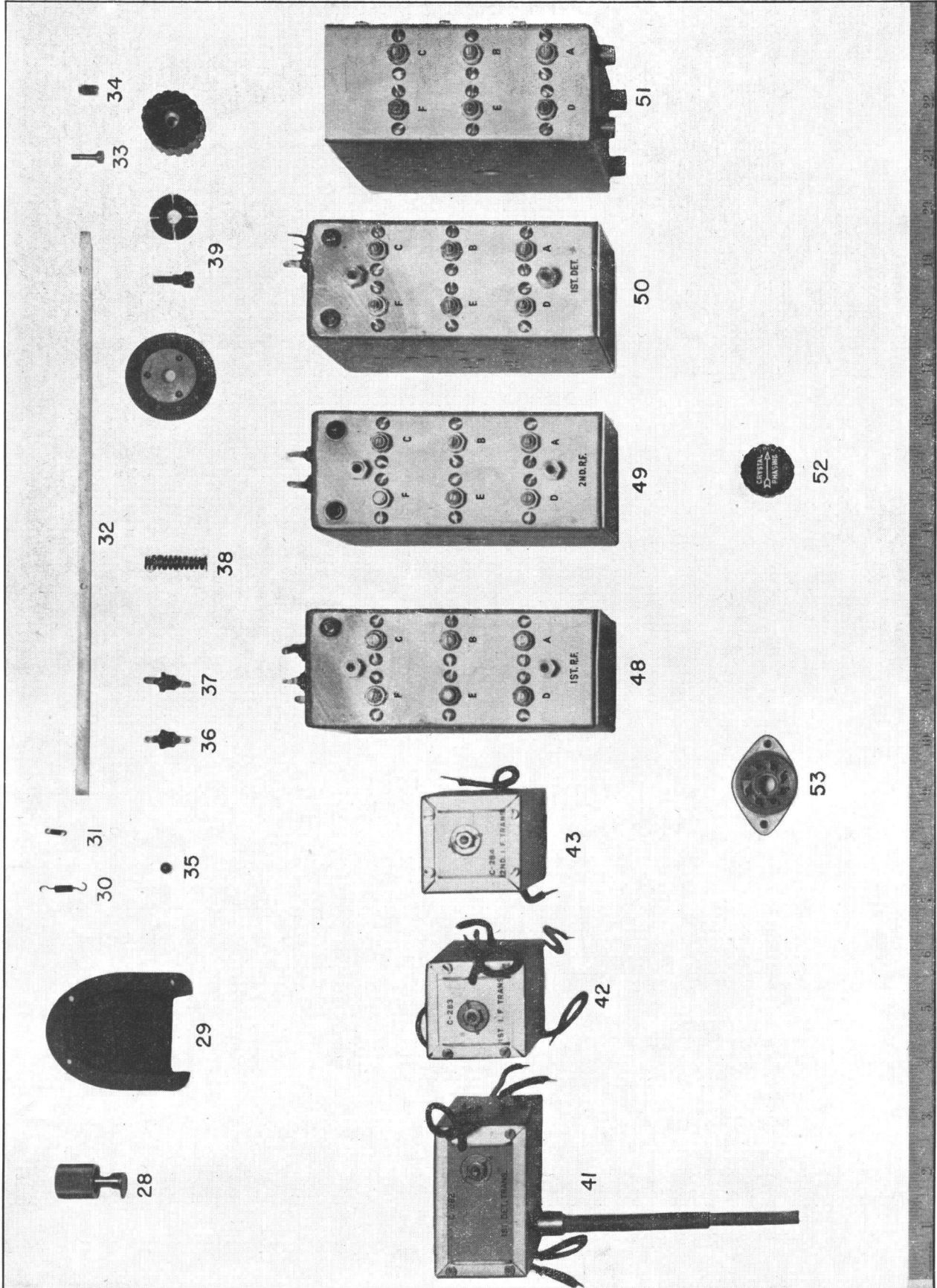

Tabular List of Replaceable Parts (Continued),—

Ref. No.	Stock No.	Name of Part	Description	Function	Mfg.*	Signal Corps. Drawing No.
†28	2Z6981/21	Panel Lock:	Knurled Knob and Latch Assembly	Receiver Locks	Z	SC-D-2532
†29	2Z8794.1/C1	Cover	Aluminum Die-Cast Cover	SO-94 Socket Cover	Z	SC-D-2532-6
†30	2Z1650/7.3	Spring	Backlash Spring	Backlash Take-up	Z	SC-D-5431-14
†31	2Z1650/7.4	Spring	Backlash Spring	Backlash Take-up	Z	SC-D-5431-36
†32	2Z1650/42	Shaft	Band Switch Shaft	Band Change	Z	SC-D-5431-42
†33	6L6632-8.23	Screw	Brass Taper Screw No. 6-32	Secure Shaft	Z	SC-D-5431-4
†34	6L7032-6.85	Screw	Steel Set Screw, No. 10-32	Band Switch Screw	Z	SC-D-5431-85
†35	2Z1650/2	Ball	.217" dia. Steel Ball	Detent Index	Z	SC-D-5431-94
†36	3G1921	Insulator	Bakelite Feed-Through	Feed Thru	Z	SC-D-2538
†37	3G1921-1	Insulator	Bakelite Feed-Through	Feed Thru	Z	SC-D-2553
†38	2Z1650/17.2	Spring	Steel Coil Spring	Detent Adjust	Z	SC-D-5431-6
†39	2Z5784	Knob, Vernier	Bakelite Knob, Plate and Clutch Assembly	Vernier Tuning	Z	SC-D-5431-58
†41	2Z9882.1	Transformer, C-282	470 kc 1st Detector Transformer, I. F.	1st Detector Transformer	Z	SC-D-4166
†42	2Z9883	Transformer C-283	470 kc Interstage Transformer, I. F.	1st I. F. Transformer	Z	SC-D-4166
†43	2Z9884	Transformer C-284	470 kc Diode Transformer, I. F.	2nd I. F. Transformer	Z	SC-D-4166
†48	2C4342N/A2	1st R. F. Unit Assembly	R-F Coil Box, Complete	1st R-F Stage	Z	SC-D-2553
†49	2C4342N/A3	2nd R. F. Unit Assembly	R-F Coil Box, Complete	2nd R-F Stage	Z	SC-D-2553
†50	2C4342N/A1	1st Detector Unit Assembly	R-F Coil Box, Complete	1st Detector Stage	Z	SC-D-2553
†51	2C4342N/A4	R. F. Oscillator Unit Assembly	Oscillator Coil Box, Complete	R-F Oscillator Stage	Z	SC-D-2558
†52	2Z5777	Knob, Crystal Phasing	Bakelite Knob	Crystal Phasing	AA	SC-D-4166
†53	2Z8795.11	Socket, 8 Prong	Octal Socket with Mounting Plate	Tube Socket	AD	SC-D-1612-24

* See Index of Manufacturers.

† Furnished in Maintenance Parts Group.

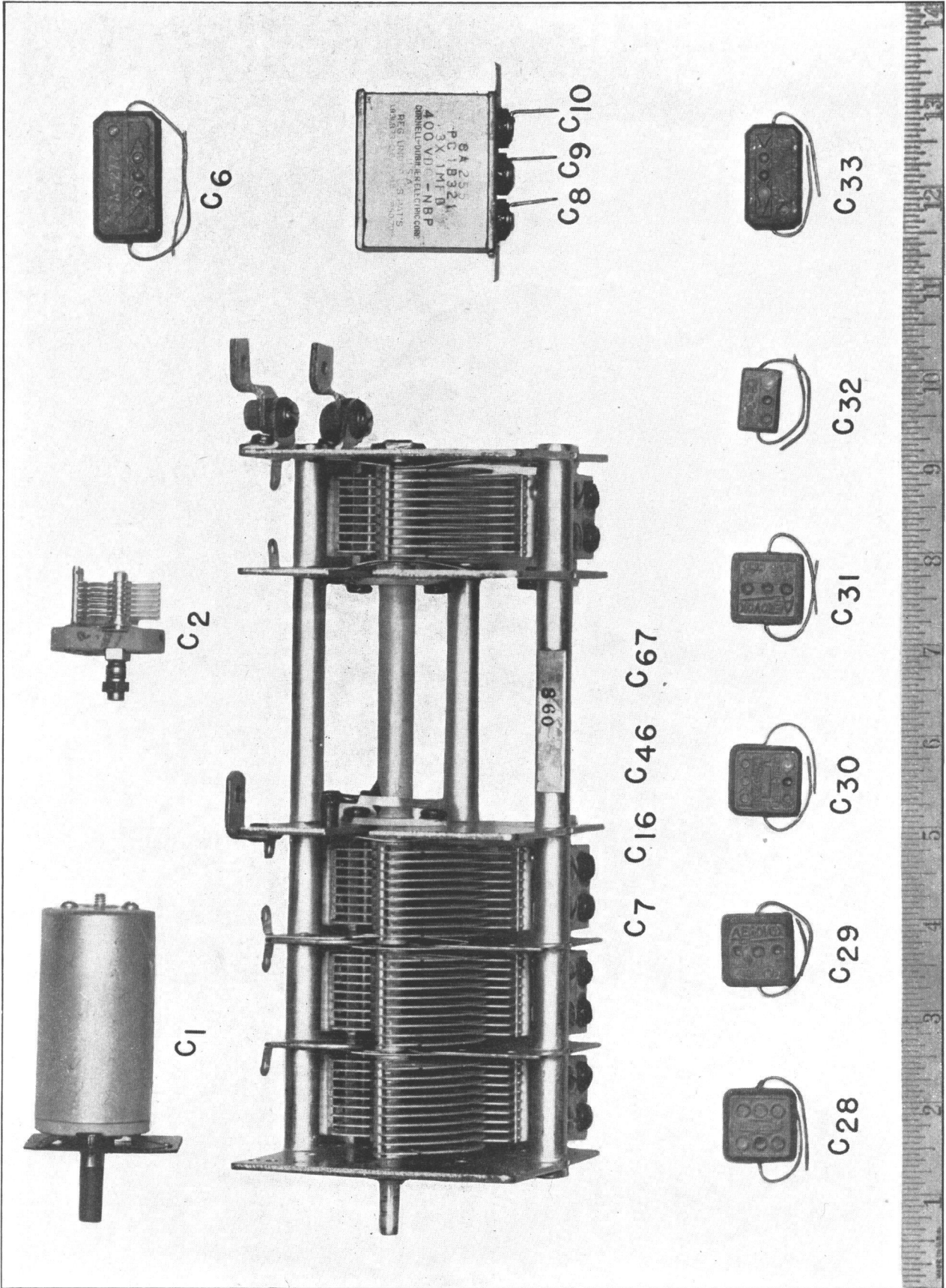

27. Tabular List of Replaceable Parts, Radio Receiver BC-314-G:

a. Electrical Parts.

Note: The list of stock numbers is intended to supplement the Signal Corps General Catalog until such time as the Catalog is revised to include the stock numbers herein. Order replacement parts by stock numbers and description.

Ref. No.	Stock No.	Name of Part	Description	Function	Mfg.*	Signal Corps Drawing No.
C ₁	3D293	Capacitor CA-293	Variable, air; 10-210 $\mu\mu\text{f}$	Antenna alignment	A, C, or E	SC-A-2580
C ₂	3D290	Capacitor CA-290	Variable, air; 4-50 $\mu\mu\text{f}$	Band-D trimmer, 1st r-f	A, C, or E	SC-A-1728
C ₃	3D290	Capacitor CA-290	Same as C ₂	Band-C trimmer, 1st r-f	A, C, or E	SC-A-1728
C ₄	3D290	Capacitor CA-290	Same as C ₂	Band-B trimmer, 1st r-f	A, C, or E	SC-A-1728
C ₅	3D290	Capacitor CA-290	Same as C ₂	Band-A trimmer, 1st r-f	A, C, or E	SC-A-1728
†C ₆	3D277	Capacitor CA-277	Molded, paper; 0.1 μf —400 v.	1st r-f AVC, bypass	J	SC-D-1995
C ₇	**	Capacitor	Ganged 13-256 $\mu\mu\text{f}$	1st r-f, tuning	D or F	SC-D-2568
†C ₈	3D255	Capacitor CA-255	Metal-encased as one unit	1st r-f, cathode bypass	G, H, or I	SC-D-512
†C ₉				1st r-f, screen bypass		
†C ₁₀				1st r-f, "B" supply bypass		
C ₁₁	3D290	Capacitor CA-290	Same as C ₂	Band-C trimmer, 2nd r-f	A, C, or E	SC-D-512
C ₁₂	3D290	Capacitor CA-290	Same as C ₂	Band-B trimmer, 2nd r-f	A, C, or E	SC-A-1728
C ₁₃	3D290	Capacitor CA-290	Same as C ₂	Band-A trimmer, 2nd r-f	A, C, or E	SC-A-1728
C ₁₄	3D290	Capacitor CA-290	Same as C ₂	Band-D trimmer, 2nd r-f	A, C, or E	SC-A-1728
†C ₁₅	3D277	Capacitor CA-277	Same as C ₆	2nd r-f AVC bypass	J	SC-D-1995
C ₁₆	**	Capacitor	Ganged 13-256 $\mu\mu\text{f}$	2nd r-f, tuning	D or F	SC-D-2568
†C ₁₇	3D255	Capacitor CA-255	Same as C ₈	2nd r-f Cathode bypass	G, H or I †	SC-D-512
†C ₁₈				2nd r-f Screen bypass		
†C ₁₉				2nd r-f "B" supply bypass		
C ₂₀	3D290	Capacitor CA-290	Same as C ₂	Band-C trimmer, 1st det.	A, C, or E	SC-D-512
C ₂₁	3D290	Capacitor CA-290	Same as C ₂	Band-B trimmer, 1st det.	A, C, or E	SC-A-1728
C ₂₂	3D290	Capacitor CA-290	Same as C ₂	Band-A trimmer, 1st det.	A, C, or E	SC-A-1728
C ₂₃	3D290	Capacitor CA-290	Same as C ₂	Band-D trimmer, r-f osc.	A, C, or E	SC-A-1728
C ₂₄	3D290	Capacitor CA-290	Same as C ₂	Band-C trimmer, r-f osc.	A, C, or E	SC-A-1728
C ₂₅	3D290	Capacitor CA-290	Same as C ₂	Band-B trimmer, r-f osc.	A, C, or E	SC-A-1728
C ₂₆	3D290	Capacitor CA-290	Same as C ₂	Band-A trimmer, r-f osc.	A, C, or E	SC-A-1728
C ₂₇	3D290	Capacitor CA-290	Same as C ₂	Band-D trimmer, 1st det.	A, C, or E	SC-A-1728
†C ₂₈	3D348	Capacitor CA-348	Mica, aged; 2500 $\mu\mu\text{f}$ —400 v.	Band-D Padder, r-f osc.	G, J or K	SC-D-1993
†C ₂₉	3D347	Capacitor CA-347	Mica, aged; 2000 $\mu\mu\text{f}$ —400 v.	Band-C Padder, r-f osc.	G, J or K	SC-D-1993
†C ₃₀	3D346	Capacitor CA-346	Mica, aged; 900 $\mu\mu\text{f}$ —400 v.	Band-B Padder, r-f osc.	G, J or K	SC-D-1993
†C ₃₁	3D345	Capacitor CA-345	Mica, aged; 800 $\mu\mu\text{f}$ —400 v.	Band-A Padder, r-f osc.	G, J or K	SC-D-1993
†C ₃₂	3D344	Capacitor CA-344	Mica, aged; 400 $\mu\mu\text{f}$ —400 v.	1st det., i-f tuning	G, J or K	SC-D-1993
†C ₃₃	3D281	Capacitor CA-281	Molded, paper; .01 μf —400 v.	1st det., AVC bypass	J	SC-D-1995
†C ₃₄	3D344	Capacitor CA-344	Same as C ₃₂	1st det., i-f tuning	G, J or K	SC-D-1993
†C ₃₅	3D281	Capacitor CA-281	Same as C ₃₃	1st det., "B" supply bypass	J	SC-D-1995

* See Index of Manufacturers.

** C₇, C₁₆, C₄₆, and C₆₇ ganged comprise Capacitor CA-340 (3D340)

† Furnished in Maintenance Parts Group.



C38



C44



C45



C47

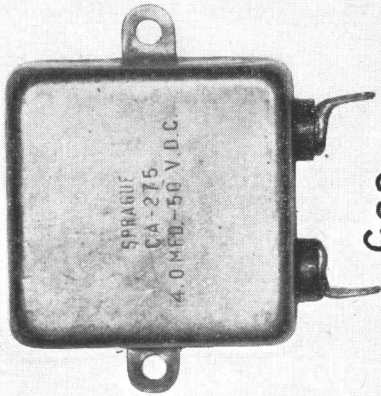

C60

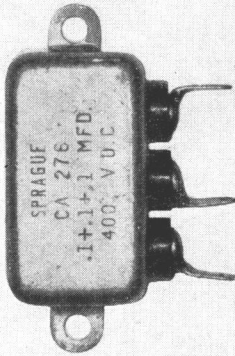

C61 C62 C63

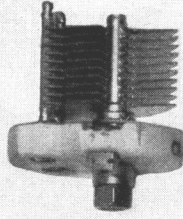

C68



C66

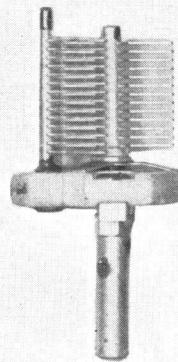

C69



C74



C75



C77

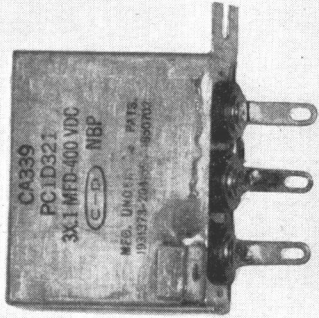

C51 C52 C53

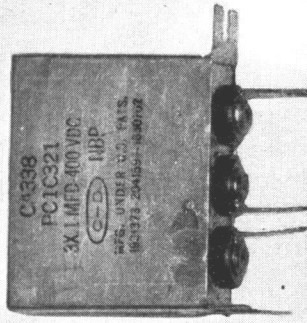

C54 C55 C56



Tabular List of Replaceable Parts (Continued),—

Ref. No.	Stock No.	Name of Part	Description	Function	Mfg.*	Signal Corps Drawing No.
†C ₃₆	3D344	Capacitor CA-344	Same as C ₃₂	1st i-f tuning	G, J or K	SC-D-1993
†C ₃₇	3D277	Capacitor CA-277	Same as C ₆	1st i-f, "B" supply bypass	J	SC-D-1995
†C ₃₈	3D372	Capacitor CA-372	Mica, aged; 1000 μmf—250 v.	1st i-f coupling	G, J or K	SC-D-1993
†C ₃₉	3D277	Capacitor CA-277	Same as C ₆	2nd i-f, AVC bypass	J	SC-D-1995
†C ₄₀	3D344	Capacitor CA-344	Same as C ₃₂	2nd, i-f, tuning	G, J or K	SC-D-1993
†C ₄₁	3D344	Capacitor CA-344	Same as C ₃₂	2nd, i-f, tuning	G, J or K	SC-D-1993
†C ₄₂	3D281	Capacitor CA-281	Same as C ₃₃	2nd i-f "B" supply bypass	J	SC-D-1995
†C ₄₃	3D281	Capacitor CA-281	Same as C ₃₃	2nd a-f, grid coupling	J	SC-D-1995
†C ₄₄	3D279	Capacitor CA-279	Mica; 10 μmf—300 v.	C-W osc., coupling	J	SC-D-1993
†C ₄₅	3D350	Capacitor CA-350	Mica; 25 μmf—300 v.	AVC, diode coupling	J	SC-D-1993
†C ₄₆	**	Capacitor	Ganged 13-256 μmf	1st det., tuning	D or F	SC-D-2568
†C ₄₇	3D349	Capacitor CA-349	Mica; 150 μmf—250 v.	R. F. osc. coupling	G, J or K	SC-D-1993
†C ₄₈	†	†	{ Same as C ₈	1st det., cathode bypass	G, H, or I	SC-D-512
†C ₄₉	†	†	{ Same as C ₉	1st det. screen bypass	G, H, or I	SC-D-512
†C ₅₀	†	†	{ Same as C ₁₀	1st det. "B" supply bypass	G, H, or I	SC-D-512
†C ₅₁	3D339	Capacitor CA-339	Metal-encased	1st i-f cathode bypass	G, H, or I	SC-D-2567
†C ₅₂	†	†	as	1st i-f, screen bypass	G, H, or I	SC-D-2567
†C ₅₃	†	†	one unit	1st i-f "B" supply bypass	G, H, or I	SC-D-2567
†C ₅₄	†	†	Metal-encased	2nd i-f, cathode bypass	G, H, or I	SC-D-2567
†C ₅₅	†	†	as	2nd i-f, screen bypass	G, H, or I	SC-D-2567
†C ₅₆	†	†	one unit	2nd i-f, "B" supply bypass	G, H, or I	SC-D-2567
†C ₅₇	†	†	{ Same as C ₅₄	1st a-f, "B" supply bypass	G, H, or I	SC-D-2567
†C ₅₈	†	†	{ Same as C ₅₅	1st a-f, Cathode bypass	G, H, or I	SC-D-2567
†C ₅₉	†	†	{ Same as C ₅₆	AVC bypass	H	SC-D-2567
†C ₆₀	3D275	Capacitor CA-275	Paper; 4 μf—50 v.	2nd a-f, Cathode bypass	H	SC-D-512
†C ₆₁	†	†	Metal-encased	Heater, bypass	G, H, or I	SC-D-512
†C ₆₂	†	†	as	Heater, bypass	G, H, or I	SC-D-512
†C ₆₃	3D276	Capacitor CA-276	{ 0.1 μf—400 v.	2nd a-f, "B" supply bypass	J	SC-D-512
†C ₆₄	†	†	{ 0.1 μf—400 v.	1st a-f, grid coupling	J	SC-D-1995
†C ₆₅	†	†	{ 0.1 μf—400 v.	C-W osc., plate bypass	J	SC-D-1995
†C ₆₆	†	†	one unit	R-F osc., grid coupling	G, J or K	SC-D-1993
C ₆₇	†	†	Same as C ₆	R-F osc., tuning	D or F	SC-D-2568
C ₆₈	3D253	Capacitor CA-253	Ganged 13-256 μmf	C-W osc., tuning	A, C, or E	SC-A-1728
C ₆₉	3D384	Capacitor CA-384	Variable, air; 4-75 μmf	C-W osc., tuning	A, C, or E	SC-A-1728
†C ₇₂	3D277	Capacitor CA-277	Variable, air; 6-100 μmf	R-F osc., "B" supply bypass	J	SC-D-1995
†C ₇₃	3D277	Capacitor CA-277	Same as C ₆	C-W osc., tuning	J	SC-D-1995
†C ₇₄	3D266	Capacitor CA-266	Same as C ₆	1st Det., A. V. C. bypass	J	SC-D-1993
†C ₇₅	3D193	Capacitor CA-193	Mica; 100 μmf—250 v.	C-W osc., grid coupling	G, J, or K	SC-D-1993
†C ₇₆	3D277	Capacitor CA-277	Mica; 500 μmf—250 v.	2nd Det., a-f bypass	G, J, or K	SC-D-1993
†C ₇₇	3D341	Capacitor CA-341	Same as C ₆	1st r-f, "B" supply bypass	J	SC-D-1995
†C ₇₈	3D341	Capacitor CA-341	Mica, aged; 25 μmf—400 v.	2nd r-f, Band-B tuning	G, J, or K	SC-D-1993
†C ₇₈	†	†	Same as C ₇₇	1st Det., Band-B tuning	G, J, or K	SC-D-1993

* See Index of Manufacturers.

** C₇, C₁₀, C₄₆, and C₆₇ ganged comprise Capacitor CA-340 (3D340)

† Furnished in Maintenance Parts Group.

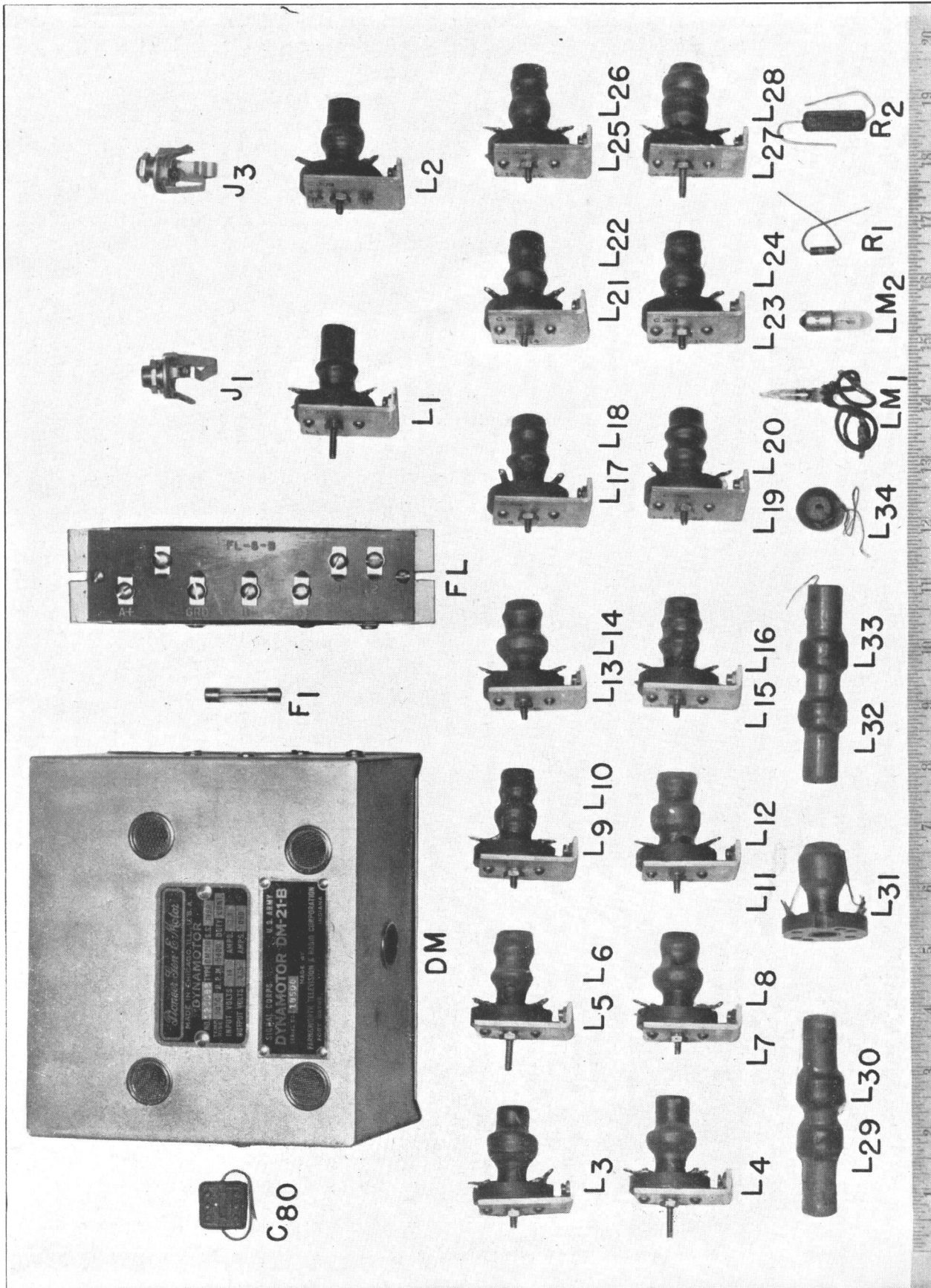

Tabular List of Replaceable Parts (Continued),—

Ref. No.	Stock No.	Name of Part	Description	Function	Mfg.*	Signal Corps Drawing No.
†C ₈₀	3D297	Capacitor CA-297	Mica, aged; 1600 μf—250 v.	2nd Det., a-f bypass	J	SC-D-1995
†C ₈₁	3D277	Capacitor CA-277	Same as C ₆	2nd r-f, "B" supply bypass	J	SC-D-1995
†C ₈₂	3D346	Capacitor CA-346	Same as C ₃₀	C-W osc., tuning	G, J or K	SC-D-1993
†C ₈₃	3D341	Capacitor CA-341	Same as C ₇₇	2nd r-f, Band-A tuning	G, J or K	SC-D-1993
†C ₈₄	3D341	Capacitor CA-341	Same as C ₇₇	1st Det., Band-A tuning	G, J or K	SC-D-1993
†C ₈₅	3D341	Capacitor CA-341	Same as C ₇₇	2nd r-f, Band-D tuning	G, J or K	SC-D-1993
†C ₈₆	3D341	Capacitor CA-341	Same as C ₇₇	1st Det., Band-D tuning	G, J or K	SC-D-1993
†DM	3H1621B	Dynamotor DM-21-B		Power Supply	Y	SC-D-2723
F ₁	3Z1921A	Fuse FU-21-A	10 amp.—25 v.	Dyn-Fil circuits	Q	SC-D-2532
F ₂	3Z1921A	Fuse FU-21-A	Same as F ₁	Dial Light circuits	Q	SC-D-2532
†FL	3Z18906B	Filter FL-6-B		Dynamotor Filter	Y	SC-D-2723
J ₁	2Z5534A	Jack JK-34-A	Open circuit Jack	2nd audio phones	O	SC-D-2339
J ₂	2Z5534A	Jack JK-34-A	Same as J ₁	2nd audio phones	O	SC-D-2339
J ₃	2Z5533A	Jack JK-33-A	3 circuit jack	Speaker	O	SC-D-2332
J ₄	2Z5533A	Jack JK-33-A	Same as J ₃	Microphone	O	SC-D-2332
J ₅	2Z5534A	Jack JK-34-A	Same as J ₁	Key	O	SC-D-2339
L ₁	2Z9899-11	Coil C-310		Band-D, 1st r-f	Z	SC-D-4089
L ₂	2Z9899-10	Coil C-309		Band-C, 1st r-f	Z	SC-D-4089
L ₃	2Z9899-9	Coil C-308		Band-B, 1st r-f	Z	SC-D-4089
L ₄	2Z9899-8	Coil C-307		Band-A, 1st r-f	Z	SC-D-4089
L ₅ & L ₆	2Z9899-7	Transformer C-306		Band-D, 2nd r-f	Z	SC-D-4089
L ₇ & L ₈	2Z9899-6	Transformer C-305		Band-C, 2nd r-f	Z	SC-D-4089
L ₉ & L ₁₀	2Z9899-5	Transformer C-304		Band-A, 2nd r-f	Z	SC-D-4089
L ₁₁ & L ₁₂	2Z9899-4	Transformer C-303		Band-D, 1st Det.	Z	SC-D-4089
L ₁₃ & L ₁₄	2Z9899-3	Transformer C-302		Band-C, 1st Det.	Z	SC-D-4089
L ₁₅ & L ₁₆	2Z9899-2	Transformer C-301		Band-B, 1st Det.	Z	SC-D-4089
L ₁₇ & L ₁₈	2Z9899-1	Transformer C-300		Band-A, 1st Det.	Z	SC-D-4089
L ₁₉ & L ₂₀	2Z9899	Transformer C-299		Band-B, 1st Det.	Z	SC-D-4089
L ₂₁ & L ₂₂	2Z9898	Transformer C-298		Band-A, 1st Det.	Z	SC-D-4089
L ₂₃ & L ₂₄	2Z9897	Transformer C-297		Band-D, r-f Osc.	Z	SC-D-4089
L ₂₅ & L ₂₆	2Z9896	Transformer C-296		Band-C, r-f Osc.	Z	SC-D-4089
L ₂₇ & L ₂₈	2Z9895	Transformer C-295		Band-B, r-f Osc.	Z	SC-D-4089
L ₂₉ & L ₃₀	2Z982/1	Transformer C-292		Band-A, r-f Osc.	Z	SC-D-4089
L ₃₁	2Z9893/1	Transformer C-293		1st Detector Transformer	Z	SC-D-4171
L ₃₂ & L ₃₃	2Z9894/1	Transformer C-294		1st i-f Transformer	Z	SC-D-4171
†L ₃₄	2C4314C/C1	Coil		2nd i-f Transformer	Z	SC-D-4171
†LM ₁	2Z4893	Neon Lamp		C-W osc.	Z	SC-D-2720
†LM ₂	2Z5927	Lamp LM-27	Mazda No. 44, 6.3 v.	Antenna overload protection	R	SC-A-1801
†LM ₃	2Z5927	Lamp LM-27	Same as LM ₂	Dial Light	S	SC-D-2573
†R ₁	3Z4561	Resistor RS-161	Carbon, insul.; 1.0 meg. 1/2 w.	Dial Light	S	SC-D-2573
†R ₂	3Z4566	Resistor RS-166	Wire-wound; 350 ohm 1 w.	2nd i-f, grid input	N	SC-D-970

* See Index of Manufacturers.
 † Furnished in Maintenance Parts Group.

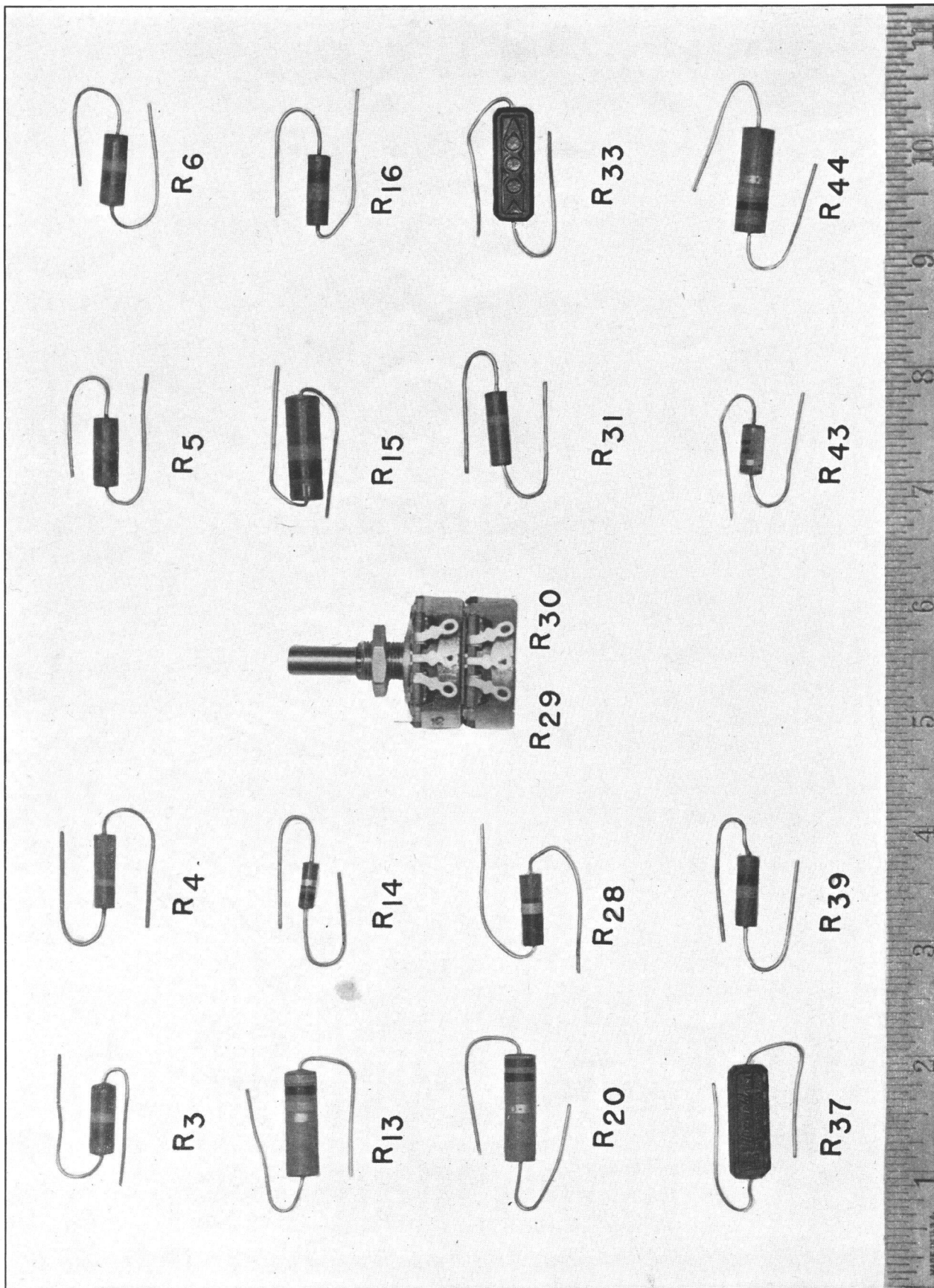

Tabular List of Replaceable Parts (Continued),—

Ref. No.	Stock No.	Name of Part	Description	Function	Mfg.*	Signal Corps Drawing No.
†R ₃	3Z4541	Resistor RS-141	Carbon, insul; 75,000 ohm ½ w.	1st r-f, Screen bleeder	M	SC-D-970
†R ₄	3Z4549	Resistor RS-149	Carbon, insul; 40,000 ohm ½ w.	1st r-f, Screen divider	M	SC-D-970
†R ₅	3Z4550	Resistor RS-150	Carbon, insul; 100,000 ohm ½ w.	1st r-f, AVC filter	M	SC-D-970
†R ₆	3Z4525	Resistor RS-125	Carbon, insul; 1,000 ohm ½ w.	1st r-f, "B" supply filter	M	SC-D-970
†R ₇	3Z4550	Resistor RS-150	Same as R ₅	2nd r-f AVC filter	M	SC-D-970
†R ₈	3Z4566	Resistor RS-166	Same as R ₂	2nd r-f, Cathode bias	J	SC-D-970
†R ₉	3Z4541	Resistor RS-141	Same as R ₃	2nd r-f, Screen bleeder	M	SC-D-970
†R ₁₀	3Z4549	Resistor RS-149	Same as R ₄	2nd r-f Screen divider	M	SC-D-970
†R ₁₁	3Z4525	Resistor RS-125	Same as R ₆	2nd r-f, "B" supply filter	M	SC-D-970
†R ₁₂	3Z4550	Resistor RS-150	Same as R ₅	1st Det., AVC filter	M	SC-D-970
†R ₁₃	3Z4539	Resistor RS-139	Carbon, insul; 30,000 ohm 1 w.	R-F, osc., "B" filter	M	SC-D-970
†R ₁₄	3Z4568	Resistor RS-168	Carbon, insul; 50,000 ohm ½ w.	1st det., Injector bias	N	SC-D-970
†R ₁₅	3Z4564	Resistor RS-164	Carbon, insul; 500 ohm 1 w.	1st det., Cathode bias	M	SC-D-970
†R ₁₆	3Z4540	Resistor RS-140	Carbon, insul; 30,000 ohm ½ w.	1st det., Screen divider	M	SC-D-970
†R ₁₇	3Z4525	Resistor RS-125	Same as R ₆	1st det., "B" divider	M	SC-D-970
†R ₁₈	3Z4550	Resistor RS-150	Same as R ₅	1st i-f, AVC filter	M	SC-D-970
†R ₁₉	3Z4564	Resistor RS-164	Same as R ₁₅	1st i-f, Cathode bias	M	SC-D-970
†R ₂₀	3Z4563	Resistor RS-163	Carbon, insul; 60,000 ohm 1 w.	1st i-f, Screen bleeder	M	SC-D-970
†R ₂₁	3Z4549	Resistor RS-149	Same as R ₄	1st i-f, Screen divider	M	SC-D-970
†R ₂₂	3Z4525	Resistor RS-125	Same as R ₆	1st i-f, "B" filter	M	SC-D-970
†R ₂₃	3Z4550	Resistor RS-150	Same as R ₅	2nd i-f, AVC filter	M	SC-D-970
†R ₂₄	3Z4564	Resistor RS-164	Same as R ₁₅	2nd i-f, Cathode bias	M	SC-D-970
†R ₂₅	3Z4563	Resistor RS-163	Same as R ₂₀	2nd i-f, Screen bleeder	M	SC-D-970
†R ₂₆	3Z4549	Resistor RS-149	Same as R ₄	2nd i-f, Screen divider	M	SC-D-970
†R ₂₇	3Z4525	Resistor RS-125	Same as R ₆	2nd i-f, "B" filter	M	SC-D-970
†R ₂₈	3Z4531	Resistor RS-131	Carbon, insul; 50,000 ohm ½ w.	2nd det., Diode output	M	SC-D-970
†R ₂₉	2Z7289	Potentiometer RS-174	(0-500,000 ohm	Dual volume Control	P	SC-D-1982
†R ₃₀) 0-50,000 ohm			
†R ₃₁	3Z4562	Resistor RS-162	Carbon, insul; 250,000 ohm ½ w.	AVC filter	M	SC-D-970
†R ₃₂	3Z4561	Resistor RS-161	Same as R ₁	Diode A. V. C. output	M	SC-D-970
†R ₃₃	3Z4623	Resistor RS-223	Wire-wound; 2,000 ohm 1 w.	2nd a-f, Cathode bias	J	SC-D-970
†R ₃₄	3Z4562	Resistor RS-162	Same as R ₃₁	1st a-f, grid	M	SC-D-970
†R ₃₅	3Z4531	Resistor RS-131	Same as R ₂₈	2nd a-f, grid	M	SC-D-970
†R ₃₆	3Z4562	Resistor RS-162	Same as R ₃₁	C-W osc., plate	M	SC-D-970
†R ₃₇	3Z4571	Resistor RS-171	Wire-wound, 750 ohm 1 w.	1st a-f, Cathode bias	J	SC-D-970
†R ₃₈	3Z4531	Resistor RS-131	Same as R ₂₈	R-F osc., grid	M	SC-D-970
†R ₃₉	3Z4548	Resistor RS-148	Carbon, insul; 200,000 ohm ½ w.	C-W osc., grid	M	SC-D-970
†R ₄₃	3Z4576	Resistor RS-176	Carbon, insul; 60 ohm ½ w.	Filament shunt, diode	L	SC-D-970
†R ₄₄	3Z4511	Resistor RS-111	Carbon, insul; 100,000 ohm 1 w.	Minimum bias bleeder	M	SC-D-970
†R ₄₅	3Z4541	Resistor RS-141	Same as R ₃	1st Det., Screen bleeder	M	SC-D-970
†R ₅₁	3Z4531	Resistor RS-131	Same as R ₂₈	1st I. F., Trans. shunt	M	SC-D-970

* See Index of Manufacturers.

† Furnished in Maintenance Parts Group.

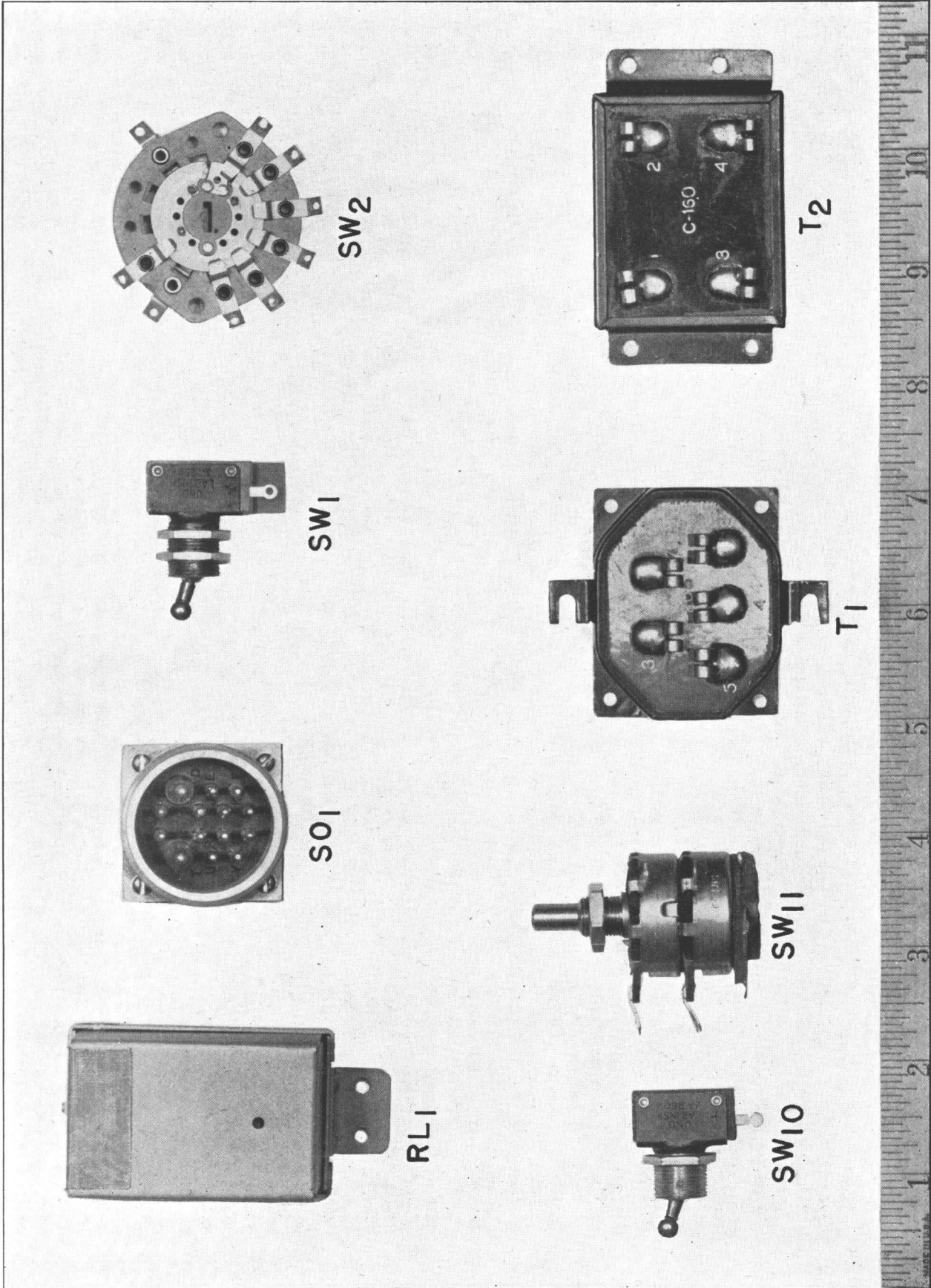

Tabular List of Replaceable Parts (Continued),—

Ref. No.	Stock No.	Name of Part	Description	Function	Mfg.*	Signal Corps Drawing No.
†R ₅₂	3Z4623	Resistor RS-223	Same as R ₃₃	2nd a-f, Cathode bias	J	SC-D-970
†R ₅₃	3Z4540	Resistor RS-140	Same as R ₁₆	1st Det. Screen divider	M	SC-D-970
†RL ₁	2Z7613	Relay BK-13	Send-Receive Relay	Antenna grounding	U	SC-D-1942
†SO ₁	2Z8794.1	Socket SO-94	Connector	Power Supply Control Conn.	Z	SC-D-2592
SW ₁	3Z8131	Switch SW-131	Toggle	Send-Receive Switch	V	SC-A-1042
†SW ₂	3Z8310-2	Switch	Ceramic, wafer	Band change, 1st r-f	X	SC-D-4046
†SW ₈	3Z8310-2	Switch	Same as SW ₂	Band change, 1st r-f	X	SC-D-4046
†SW ₄	3Z8310-2	Switch	Same as SW ₂	Band change, 2nd r-f	X	SC-D-4046
†SW ₆	3Z8310-2	Switch	Same as SW ₂	Band change, 2nd r-f	X	SC-D-4046
†SW ₇	3Z8310-2	Switch	Same as SW ₂	Band change, 1st det.	X	SC-D-4046
†SW ₈	3Z8310-2	Switch	Same as SW ₂	Band change, 1st det.	X	SC-D-4046
†SW ₉	3Z8310-2	Switch	Same as SW ₂	Band change, r-f osc.	X	SC-D-4046
†SW ₁₀	3Z8139	Switch SW-139	Toggle	C-W osc.	V	SC-A-1042
†SW ₁₁	3Z8119	Switch SW-119	Rotary	OFF-MVC-AVC	L	SC-D-2574
†T ₁	2Z9805	Transformer C-205	Audio frequency	1st audio	T	SC-D-2567
†T ₂	2Z9760	Transformer C-160	Audio frequency	2nd audio	T	SC-D-2569

* See Index of Manufacturers.

† Furnished in Maintenance Parts Group.

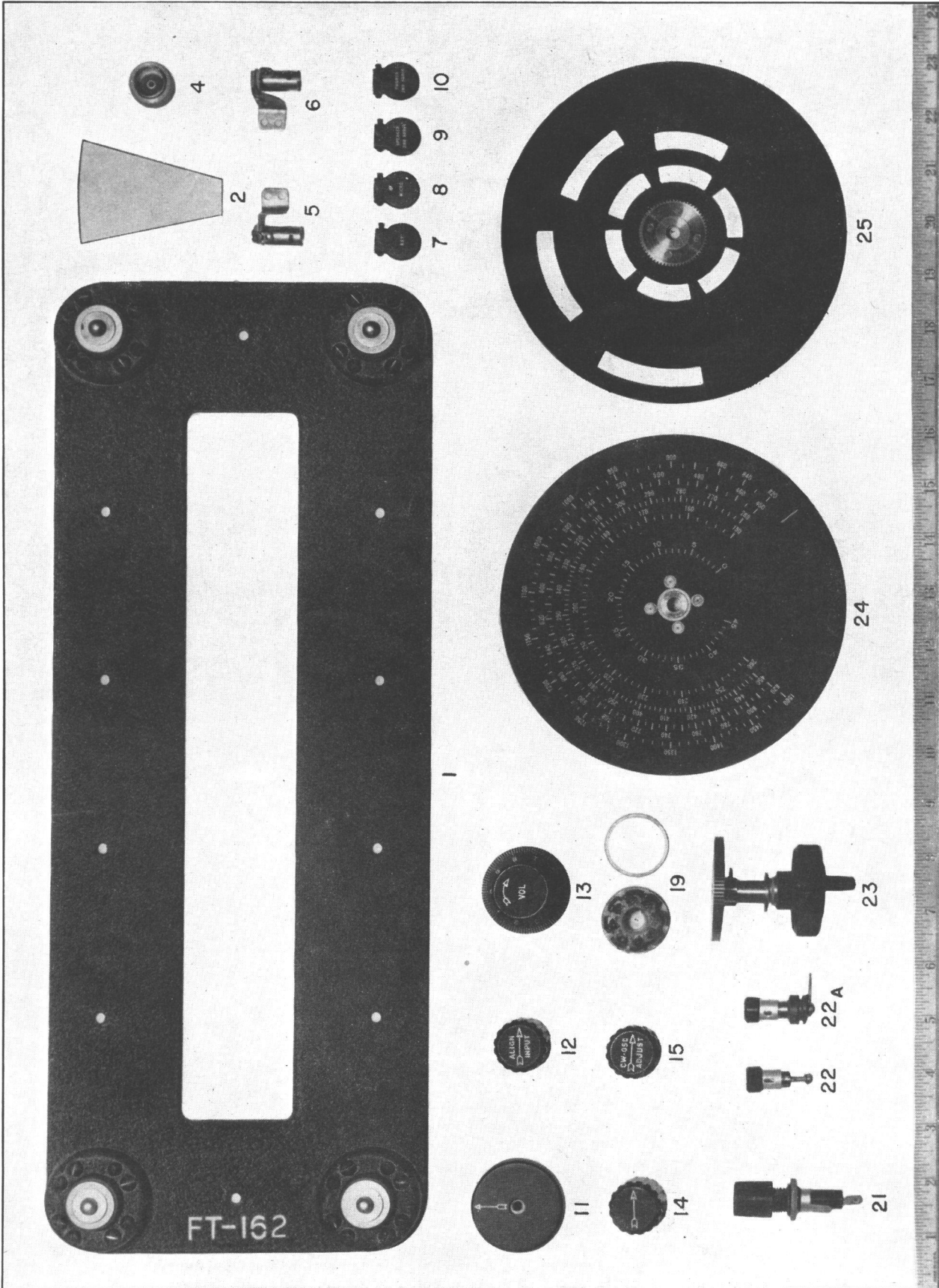

Tabular List of Replaceable Parts (Continued),—

b. Mechanical Parts.

Ref. No.	Stock No.	Name of Part	Description	Function	Mfg.*	Signal Corps. Drawing No.
†1	2Z6702	Mounting FT-162	Shock Mounting Plate	Receiver Mounting	Z	SC-D-2577
†2	2Z7560/2	Reflector Glass	Clear Glass	Dial Pane	Z	SC-D-2535
†4	2C4312/N1	Nut & Ferrule Assembly	Connector Assembly	Shielded Connector	Z	SC-D-2578
†5	2Z5986/1	Lamp Mounting R. H.	Socket R. H.	Pilot Lamp Socket	Z	SC-D-2573
†6	2Z5986/2	Lamp Mounting L. H.	Socket L. H.	Pilot Lamp Socket	Z	SC-D-2573
†7	2Z5650-K	Jack Cover, Key	Jack Cover	Jack Cover	Z	SC-D-3715
†8	2Z5650-M	Jack Cover, Micro	Jack Cover	Jack Cover	Z	SC-D-3715
†9	2Z5650-S2A	Jack Cover, Speaker 2nd Audio	Jack Cover	Jack Cover	Z	SC-D-3715
†10	2Z5650-P2A	Jack Cover, Phones 2nd Audio	Jack Cover	Jack Cover	Z	SC-D-3715
†11	2Z5783	Knob, Band Change	Die Cast Knob	Frequency Change	Z	SC-D-2550
†12	2Z5779	Knob, Align Input	Bakelite Knob	Antenna Alignment	AA	SC-D-730
†13	2Z5773	Knob, Volume	Bakelite Knob and Plate	Volume Control	Z	SC-D-3856
†14	2Z5778	Knob, OFF-MVC-AVC	Bakelite Knob	Switch Control	AA	SC-D-730
†15	2Z5780	Knob, CW-Osc Adjust	Bakelite Knob	Pitch Adjustment	AA	SC-D-730
†19	2Z8761.4	Socket, 8 Prong	Molded, Octal Socket	Tube Socket	AB	SC-D-2538
†21	3Z3275	Fuse Post	Bakelite Fuse Holder	Fuse Holder	B or Q	SC-D-2532
†22	3Z763	Binding Post, Ground	Push Post Assembly	Ground Connection	AC	SC-D-4081
†22a	3Z510	Binding Post, Alt. Sig. Ant.	Push Post Assembly	Alt. Sig. Connection	AC	SC-D-4081
†23	2Z5782.1	Fast Tuning Knob and Drive Assembly	Fast Tuning Assembly	Fast Tuning Drive	Z	SC-D-5431
†24	2C4314G/D1	Dial Assembly	Calibrated Dial Assembly	Tuning Dial	Z	SC-D-5431
†25	2Z8550.1	Shutter Assembly	Dial Shutter Assembly	Dial Shutter	Z	SC-D-5431

* See Index of Manufacturers.

† Furnished in Maintenance Parts Group.

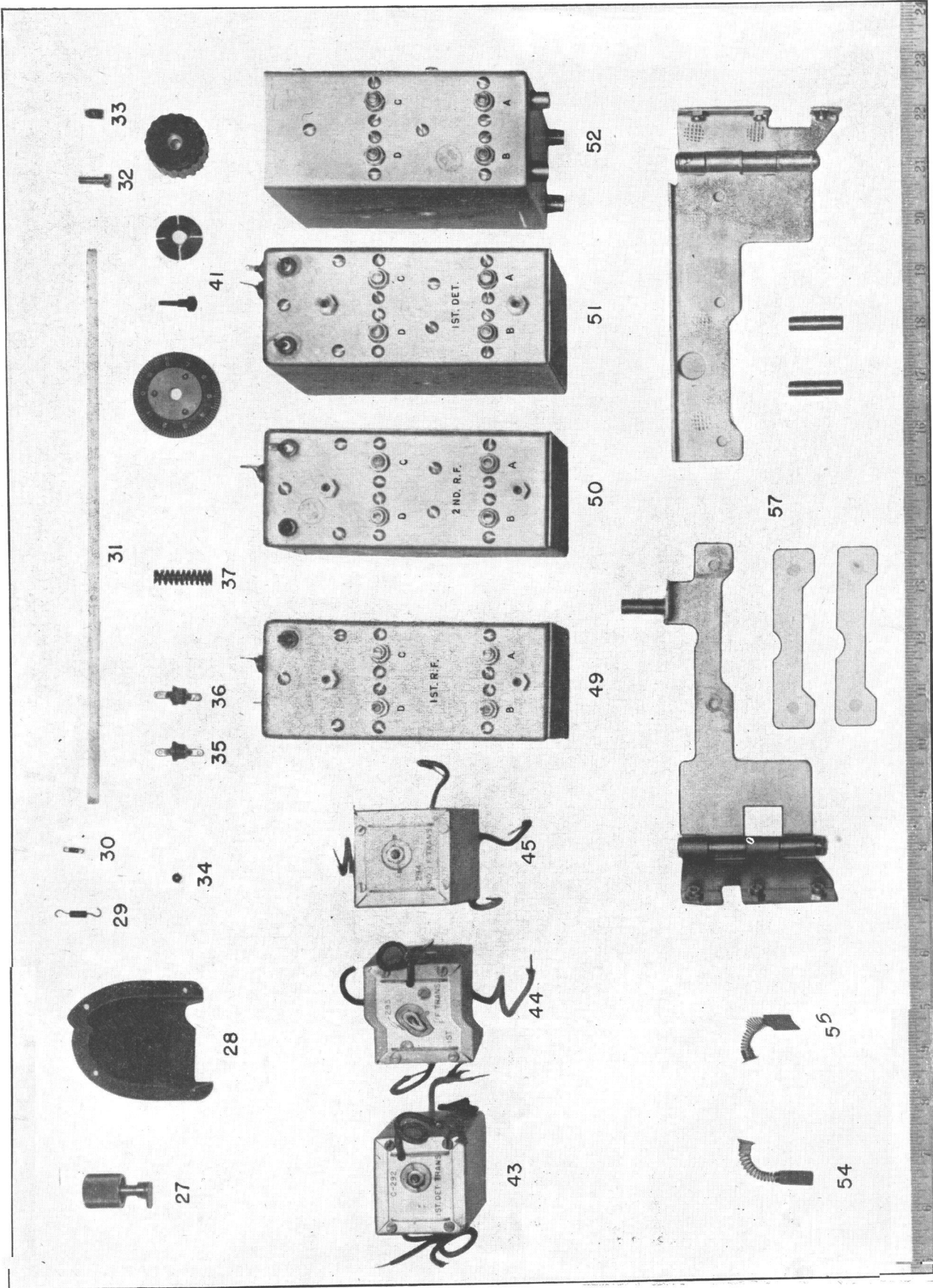

Tabular List of Replaceable Parts (Continued),—

Ref. No.	Stock No.	Name of Part	Description	Function	Mfg.*	Signal Corps. Drawing No.
†27	2Z6931/21	Panel Lock	Knurled Knob and Latch Assembly	Receiver Locks	Z	SC-D-2532
†28	2Z8794.1/C1	Cover	Aluminum Die-Cast Cover	SO-94 Socket Cover	Z	SC-D-2534
†29	2Z1650/7.3	Spring	Backlash Spring	Backlash Take-up	Z	SC-D-2547
†30	2Z1650/7.4	Spring	Backlash Spring	Backlash Take-up	Z	SC-D-2549
†31	2Z1650/42	Shaft	Band Switch Shaft	Band Change	Z	SC-D-2549
†32	6L6632-8.23	Screw	Brass Taper Screw No. 6-32	Secure Shaft	Z	SC-D-2546
†33	6L7032-6.85	Screw	Steel Set Screw, No. 10-32	Band Change Screw	Z	SC-D-5431
†34	2Z1650/2	Ball	.217" dia. Steel Ball	Detent Index	Z	SC-D-5431
†35	3G1921	Insulator	Bakelite Feed-Through	Feed Thru	Z	SC-D-2555-4
†36	3G1921-1	Insulator	Bakelite Feed-Through	Feed Thru	Z	SC-D-2543-28
†37	2Z1650/17.2	Spring	Steel Coil Spring	Detent Adjust	Z	SC-D-5431
†41	2Z5784	Knob, Vernier	Bakelite Knob, Plate and Clutch Assembly	Vernier Tuning	Z	SC-D-3856
†43	2Z9892	Transformer, C-292	92.5 kc 1st Detector Transformer, I. F.	1st Detector Transformer	Z	SC-D-4171
†44	2Z9893	Transformer, C-293	92.5 kc Interstage Transformer, I. F.	1st I. F. Transformer	Z	SC-D-4171
†45	2Z9894	Transformer C-294	92.5 kc Diode Transformer, I. F.	2nd I. F. Transformer	Z	SC-D-4171
†49	2C4314G/A4	1st R. F. Unit Assembly	R-F Coil Box, Complete	1st R-F Stage	Z	SC-D-2705
†50	2C4314G/A3	2nd R. F. Unit Assembly	R-F Coil Box, Complete	2nd R-F Stage	Z	SC-D-2705
†51	2C4314G/A2	1st Detector Unit Assembly	R-F Coil Box, Complete	1st Detector Stage	Z	SC-D-2705
†52	2C4314G/A1	R. F. Oscillator Unit Assembly	Oscillator Coil Box, Complete	R-F Oscillator Stage	Z	SC-D-2710
†54	3H1621B/4	Brush, L. V.	Carbon Brush	Low Voltage	Y	
†55	3H1621B/3	Brush, H. V.	Carbon Brush	High Voltage	Y	
†57	2C4314G/B2	Bracket Set	Dynamotor Mounting Brackets	Dynamotor Mounting	Z	SC-D-2536

† Furnished in Maintenance Parts Group.

* See Index of Manufacturers.

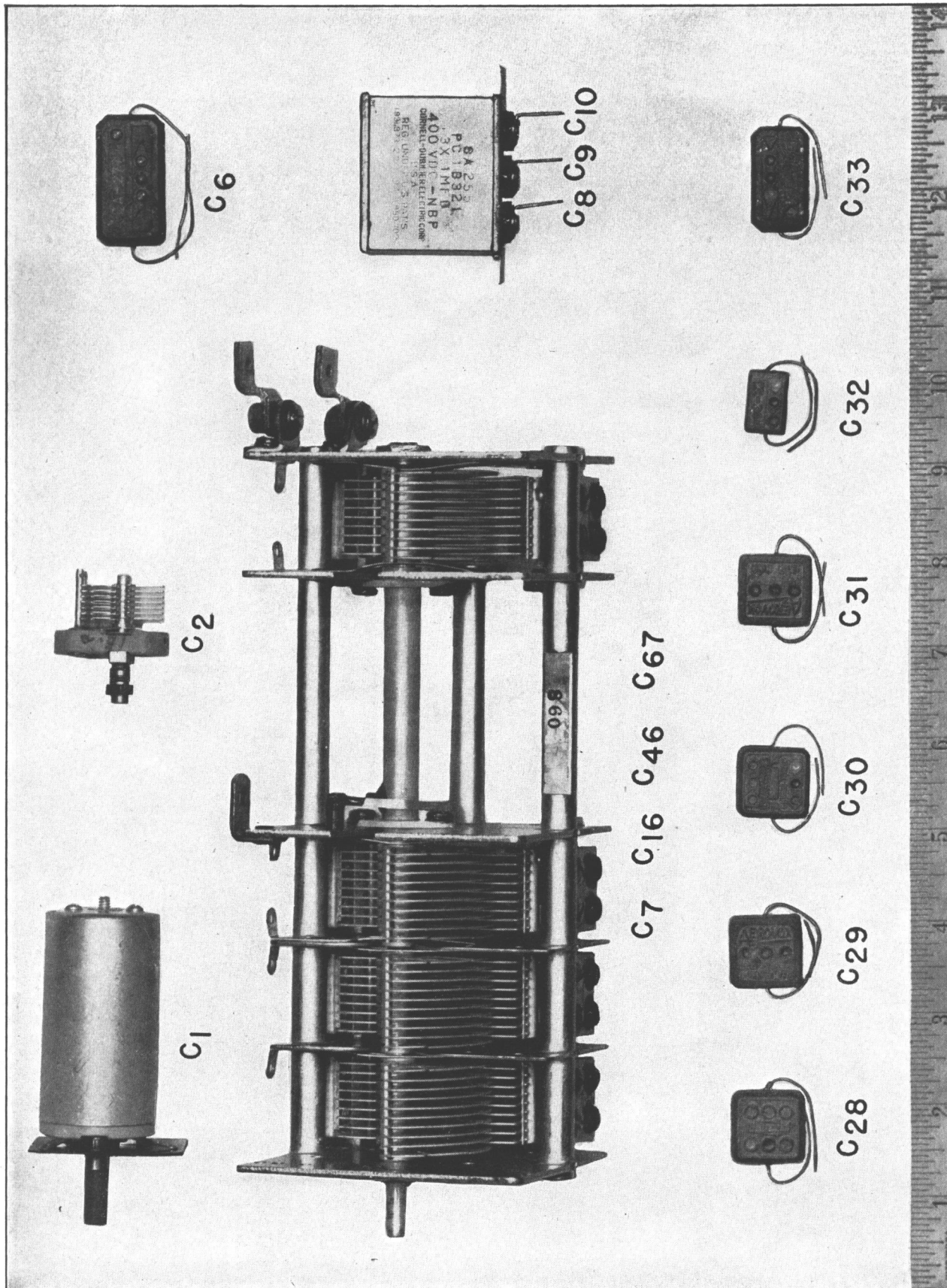

28. Tabular List of Replaceable Parts, Radio Receiver BC-344-D:

a. Electrical Parts.

Note: The list of stock numbers is intended to supplement the Signal Corps General Catalog until such time as the Catalog is revised to include the stock numbers herein. Order replacement parts by stock numbers and description.

Ref. No.	Stock No.	Name of Part	Description	Function	Mfg.*	Signal Corps Drawing No.
C ₁	3D293	Capacitor CA-293	Variable, air; 10-210 $\mu\mu\text{f}$	Antenna alignment	A, C, or E	SC-A-2580
C ₂	3D290	Capacitor CA-290	Variable, air; 4-50 $\mu\mu\text{f}$	Band-D trimmer, 1st r-f	A, C, or E	SC-A-1728
C ₃	3D290	Capacitor CA-290	Same as C ₂	Band-C trimmer, 1st r-f	A, C, or E	SC-A-1728
C ₄	3D290	Capacitor CA-290	Same as C ₂	Band-B trimmer, 1st r-f	A, C, or E	SC-A-1728
C ₅	3D290	Capacitor CA-290	Same as C ₂	Band-A trimmer, 1st r-f	A, C, or E	SC-A-1728
†C ₆	3D277	Capacitor CA-277	Molded, paper; 0.1 μf —400 v.	1st r-f AVC, bypass	J	SC-D-1995
C ₇	**	Capacitor	Ganged 13-256 $\mu\mu\text{f}$	1st r-f, tuning	D or F	SC-D-2568
†C ₈	3D255	Capacitor CA-255	Metal-encased as one unit	1st r-f, cathode bypass	G, H, or I	SC-D-512
†C ₉						
†C ₁₀			0.1 μf —400 v.	1st r-f, screen bypass		
C ₁₁	3D290	Capacitor CA-290	Same as C ₂	1st r-f, "B" supply bypass	A, C, or E	SC-D-512
C ₁₂	3D290	Capacitor CA-290	Same as C ₂	Band-C trimmer, 2nd r-f	A, C, or E	SC-A-1728
C ₁₃	3D290	Capacitor CA-290	Same as C ₂	Band-B trimmer, 2nd r-f	A, C, or E	SC-A-1728
C ₁₄	3D290	Capacitor CA-290	Same as C ₂	Band-A trimmer, 2nd r-f	A, C, or E	SC-A-1728
†C ₁₅	3D277	Capacitor CA-277	Same as C ₂	Band-D trimmer, 2nd r-f	A, C, or E	SC-A-1728
C ₁₆	**	Capacitor	Sams as C ₆	2nd r-f AVC bypass	J	SC-D-1995
†C ₁₇	3D255	Capacitor CA-255	Ganged 13-256 $\mu\mu\text{f}$	2nd r-f, tuning	D or F	SC-D-2568
†C ₁₈						
†C ₁₉			{ Same as C ₈ Same as C ₉ Same as C ₁₀	2nd r-f, cathode bypass		
C ₂₀	3D290	Capacitor CA-290	Same as C ₂	2nd r-f, screen bypass	G, H or I	SC-D-512
C ₂₁	3D290	Capacitor CA-290	Same as C ₂	2nd r-f "B" Supply bypass	A, C, or E	SC-D-512
C ₂₂	3D290	Capacitor CA-290	Same as C ₂	Band-C trimmer, 1st det.	A, C, or E	SC-A-1728
C ₂₃	3D290	Capacitor CA-290	Same as C ₂	Band-B trimmer, 1st det.	A, C, or E	SC-A-1728
C ₂₄	3D290	Capacitor CA-290	Same as C ₂	Band-A trimmer, 1st det.	A, C, or E	SC-A-1728
C ₂₅	3D290	Capacitor CA-290	Same as C ₂	Band-D trimmer, r-f osc.	A, C, or E	SC-A-1728
C ₂₆	3D290	Capacitor CA-290	Same as C ₂	Band-C trimmer, r-f osc.	A, C, or E	SC-A-1728
C ₂₇	3D290	Capacitor CA-290	Same as C ₂	Band-B trimmer, r-f osc.	A, C, or E	SC-A-1728
†C ₂₈	3D348	Capacitor CA-348	Same as C ₂	Band-A Trimmer, r-f osc.	A, C, or E	SC-A-1728
†C ₂₉	3D347	Capacitor CA-347	Mica, aged; 2500 $\mu\mu\text{f}$ —400 v.	Band-D Trimmer, 1st det.	A, C, or E	SC-A-1728
†C ₃₀	3D346	Capacitor CA-346	Mica, aged; 2000 $\mu\mu\text{f}$ —400 v.	Band-D Padder, r-f osc.	G, J, or K	SC-D-1993
†C ₃₁	3D345	Capacitor CA-345	Mica, aged; 900 $\mu\mu\text{f}$ —400 v.	Band-C Padder, r-f osc.	G, J, or K	SC-D-1993
†C ₃₂	3D344	Capacitor CA-344	Mica, aged; 800 $\mu\mu\text{f}$ —400 v.	Band-B Padder, r-f osc.	G, J, or K	SC-D-1993
†C ₃₃	3D281	Capacitor CA-281	Mica, aged; 400 $\mu\mu\text{f}$ —400 v.	Band-A Padder, r-f osc.	G, J or K	SC-D-1993
†C ₃₄	3D344	Capacitor CA-344	Molded, paper; .01 μf —400 v.	1st det., i-f tuning.	J	SC-D-1995
†C ₃₅	3D281	Capacitor CA-281	Same as C ₃₂	1st det., AVC bypass	G, J or K	SC-D-1993
			Same as C ₃₃	1st det., i-f tuning.	J	SC-D-1995
				1st det., "B" supply bypass		

* See Index of Manufacturers.

** C₇, C₁₆, C₄₆, and C₆₇ ganged comprise Capacitor CA-340 (3D340)

† Furnished in Maintenance Parts Group.



C38



C44



C45



C47

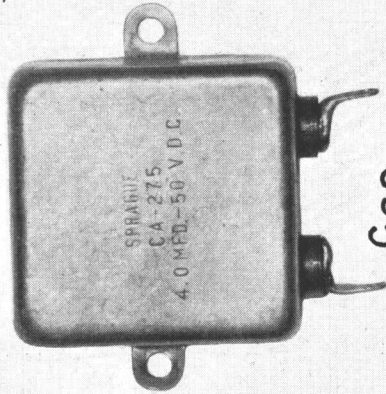

C60

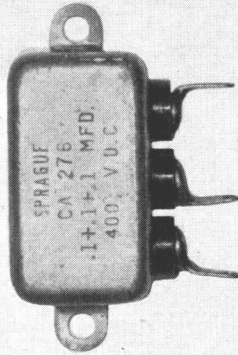

C61 C62 C63

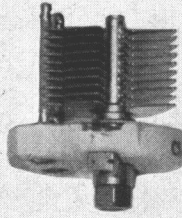

C68

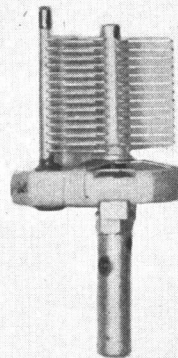

C69



C66



C74



C75



C77

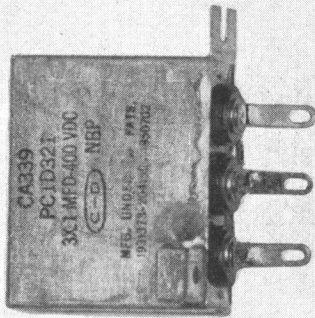

C51 C52 C53

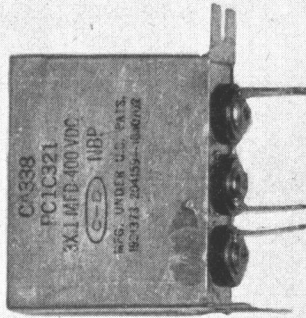

C54 C55 C56



Tabular List of Replaceable Parts (Continued),—

Ref. No.	Stock No.	Name of Part	Description	Function	Mfg.*	Signal Corps Drawing No.
†C ₃₆	3D344	Capacitor CA-344	Same as C ₃₂	1st i-f tuning	G, J or K	SC-D-1993
†C ₃₇	3D277	Capacitor CA-277	Same as C ₆	1st i-f "B" supply bypass	J	SC-D-1995
†C ₃₈	3D372	Capacitor CA-372	Mica, aged; 1000 μμf—250 v.	1st i-f coupling	G, J or K	SC-D-1993
†C ₃₉	3D277	Capacitor CA-277	Same as C ₆	2nd i-f, AVC bypass	J	SC-D-1995
†C ₄₀	3D344	Capacitor CA-344	Same as C ₃₂	2nd, i-f, tuning	G, J or K	SC-D-1993
†C ₄₁	3D344	Capacitor CA-344	Same as C ₃₂	2nd, i-f, tuning	G, J or K	SC-D-1993
†C ₄₂	3D281	Capacitor CA-281	Same as C ₃₃	2nd i-f "B" supply bypass	J	SC-D-1995
†C ₄₃	3D281	Capacitor CA-281	Same as C ₃₃	2nd a-f, grid coupling	J	SC-D-1995
†C ₄₄	3D279	Capacitor CA-279	Mica; 10 μμf—300 v.	C-W osc., coupling	J	SC-D-1993
†C ₄₅	3D350	Capacitor CA-350	Mica; 25 μμf—300 v.	AVC, diode coupling	J	SC-D-1993
C ₄₆		Capacitor	Ganged 13-256 μμf	1st det., tuning	D or F	SC-D-2568
†C ₄₇	3D349	Capacitor CA-349	Mica; 150 μμf—250 v.	R. F. osc. coupling	G, J or K	SC-D-1993
†C ₄₈		Capacitor	Same as C ₈	1st det., cathode bypass	G, J or K	SC-D-512
†C ₄₉	3D255	Capacitor CA-255	Same as C ₉	1st det. screen bypass	G, H, or I	SC-D-512
†C ₅₀		Capacitor	Same as C ₁₀	1st det. "B" supply bypass	G, H, or I	SC-D-512
†C ₅₁	3D339	Capacitor CA-339	Metal-encased	1st i-f cathode bypass	G, H, or I	SC-D-2567
†C ₅₂		Capacitor	as	1st i-f, screen bypass	G, H, or I	SC-D-2567
†C ₅₃		Capacitor	one unit	1st i-f, "B" supply bypass	G, H, or I	SC-D-2567
†C ₅₄	3D338	Capacitor CA-338	Metal-encased	2nd i-f, cathode bypass	G, H, or I	SC-D-2567
†C ₅₅		Capacitor	as	2nd i-f, screen bypass	G, H, or I	SC-D-2567
†C ₅₆		Capacitor	one unit	2nd i-f, "B" supply bypass	G, H, or I	SC-D-2567
†C ₅₇	3D338	Capacitor CA-338	Same as C ₅₄	1st a-f, "B" Supply bypass	G, H, or I	SC-D-2567
†C ₅₈		Capacitor	Same as C ₅₅	1st a-f, Cathode bypass	G, H, or I	SC-D-2567
†C ₅₉		Capacitor	Same as C ₅₆	AVC bypass	H	SC-D-2567
†C ₆₀	3D275	Capacitor CA-275	Paper; 4 μf—50 v.	2nd a-f, Cathode bypass	H	SC-D-512
†C ₆₁	3D276	Capacitor CA-276	Metal-encased	Heater, bypass	G, H, or I	SC-D-512
†C ₆₂		Capacitor	as	Heater, bypass	G, H, or I	SC-D-512
†C ₆₃		Capacitor	one unit	2nd a-f, "B" Supply bypass	J	SC-D-1995
†C ₆₄	3D281	Capacitor CA-281	Same as C ₃₃	1st a-f, grid coupling	J	SC-D-1995
†C ₆₅	3D277	Capacitor CA-277	Same as C ₆	C-W osc., plate bypass	J	SC-D-1995
†C ₆₆	3D364	Capacitor CA-364	Mica; 250 μμf—250 v.	R-F osc., grid coupling	G, J or K	SC-D-1993
C ₆₇		Capacitor	Ganged 13-256 μμf	R-F osc., tuning	D or F	SC-D-2568
C ₆₈	3D253	Capacitor CA-253	Variable, air; 4-75 μμf	C-W osc., tuning	A, C, or E	SC-A-1728
C ₆₉	3D384	Capacitor CA-384	Variable, air; 6-100 μμf	C-W osc., tuning	A, C, or E	SC-A-1728
†C ₇₂	3D277	Capacitor CA-277	Same as C ₆	R-F osc., "B" Supply bypass	J	SC-D-1995
†C ₇₃	3D277	Capacitor CA-277	Same as C ₆	1st det., AVC bypass	J	SC-D-1995
†C ₇₄	3D266	Capacitor CA-266	Mica; 100 μμf—250 v.	C-W osc., grid coupling	G, J or K	SC-D-1993
†C ₇₅	3D193	Capacitor CA-193	Mica; 500 μμf—250 v.	2nd det., a-f bypass	G, J or K	SC-D-1993
†C ₇₆	3D277	Capacitor CA-277	Same as C ₆	1st r-f, "B" Supply bypass	J	SC-D-1995
†C ₇₇	3D341	Capacitor CA-341	Mica, aged; 25 μμf—400 v.	2nd r-f, Band-B tuning	G, J or K	SC-D-1993
†C ₇₈	3D341	Capacitor CA-341	Same as C ₇₇	1st det., Band-B tuning	G, J or K	SC-D-1993

* See Index of Manufacturers.

** C₇, C₁₆, C₄₆, and C₆₇ ganged comprise Capacitor CA-340 (3D340)

† Furnished in Maintenance Parts Group.

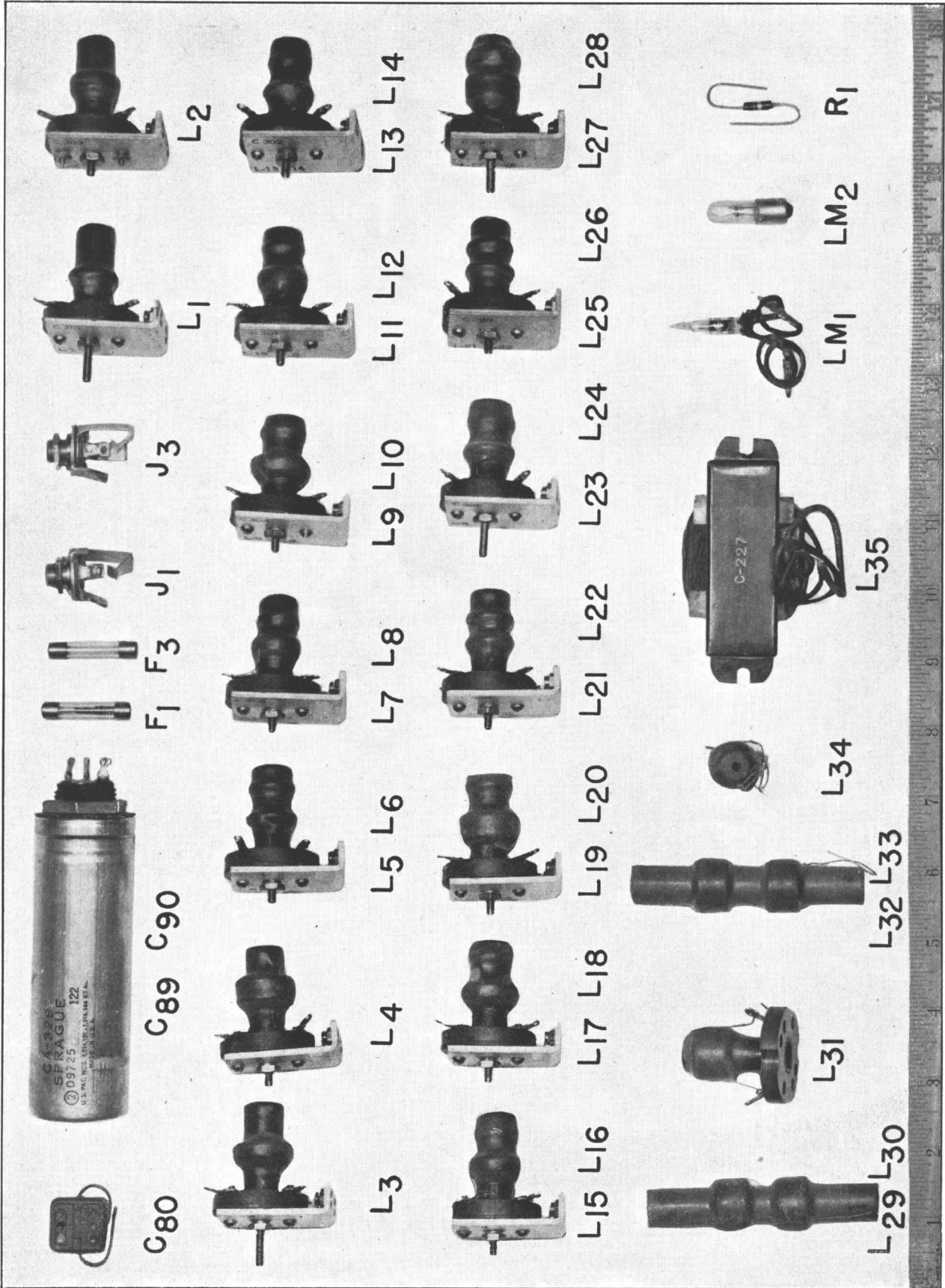

Tabular List of Replaceable Parts (Continued),—

Ref. No.	Stock No.	Name of Part	Description	Function	Mfg.*	Signal Corps Drawing No.
†C ₈₀	3D297	Capacitor CA-297	Mica, aged; 1600 μf—250 v.	2nd det., a-f bypass	J	SC-D-1995
†C ₈₁	3D277	Capacitor CA-277	Same as C ₆	2nd r-f, "B" Supply bypass	J	SC-D-1995
†C ₈₂	3D346	Capacitor CA-346	Same as C ₃₀	C-W osc., tuning	G, J or K	SC-D-1993
†C ₈₃	3D341	Capacitor CA-341	Same as C ₇₇	2nd r-f, Band-A tuning	G, J or K	SC-D-1993
†C ₈₄	3D341	Capacitor CA-341	Same as C ₇₇	1st det., Band-A tuning	G, J or K	SC-D-1993
†C ₈₅	3D341	Capacitor CA-341	Same as C ₇₇	2nd r-f, Band-D tuning	G, J or K	SC-D-1993
†C ₈₆	3D341	Capacitor CA-341	Same as C ₇₇	1st det., Band-D tuning	G, J or K	SC-D-1993
†C ₈₀	3D329	Capacitor CA-329	Electrolytic; 8-8 μf—450 v.	Filter	G	SC-A-1490
†C ₉₀	3Z1921A	Fuse FU-21-A	10 amp.—25 v.	Dyn-Fil circuits	B or Q	SC-D-2532
F ₁	3Z1921A	Fuse FU-21-A	Same as F ₁	Dial Light circuits	B or Q	SC-D-2532
F ₂	3Z1927	Fuse FU-27	2 amp.—250 v.	A-C line	B or Q	SC-D-2332
F ₃	2Z5534A	Jack JK-34-A	Open circuit Jack	2nd audio phones	O	SC-D-2339
J ₁	2Z5534A	Jack JK-34-A	Same as J ₁	2nd audio phones	O	SC-D-2339
J ₂	2Z5534A	Jack JK-34-A	Same as J ₁	Speaker	O	SC-D-2332
J ₃	2Z5533A	Jack JK-33-A	3 circuit Jack	Microphone	O	SC-D-2332
J ₄	2Z5533A	Jack JK-33-A	Same as J ₃	Key	O	SC-D-2339
J ₅	2Z5534A	Jack JK-34-A	Same as J ₁	Band-D, 1st r-f	Z	SC-D-4089
L ₁	2Z9899-11	Coil C-310		Band-C, 1st r-f	Z	SC-D-4089
L ₂	2Z9899-10	Coil C-309		Band-B, 1st r-f	Z	SC-D-4089
L ₃	2Z9899-9	Coil C-308		Band-A, 1st r-f	Z	SC-D-4089
L ₄	2Z9899-8	Coil C-307		Band-D, 2nd r-f	Z	SC-D-4089
L ₅ & L ₆	2Z9899-7	Transformer C-306		Band-C, 2nd r-f	Z	SC-D-4089
L ₇ & L ₈	2Z9899-6	Transformer C-305		Band-B, 2nd r-f	Z	SC-D-4089
L ₉ & L ₁₀	2Z9899-5	Transformer C-304		Band-A, 2nd r-f	Z	SC-D-4089
L ₁₁ & L ₁₂	2Z9899-4	Transformer C-303		Band-D 1st Det.	Z	SC-D-4089
L ₁₃ & L ₁₄	2Z9899-3	Transformer C-302		Band-C, 1st Det.	Z	SC-D-4089
L ₁₅ & L ₁₆	2Z9899-2	Transformer C-301		Band-B, 1st Det.	Z	SC-D-4089
L ₁₇ & L ₁₈	2Z9899-1	Transformer C-300		Band-A, 1st Det.	Z	SC-D-4089
L ₁₉ & L ₂₀	2Z9899	Transformer C-299		Band-D, r-f Osc.	Z	SC-D-4089
L ₂₁ & L ₂₂	2Z9898	Transformer C-298		Band-C, r-f Osc.	Z	SC-D-4089
L ₂₃ & L ₂₄	2Z9897	Transformer C-297		Band-B, r-f Osc.	Z	SC-D-4089
L ₂₅ & L ₂₆	2Z9896	Transformer C-296		Band-A, r-f Osc.	Z	SC-D-4089
L ₂₇ & L ₂₈	2Z9895	Transformer C-295		1st Detector Transformer	Z	SC-D-4089
L ₂₉ & L ₃₀	2Z982/1	Transformer C-292		1st i-f Transformer	Z	SC-D-4171
L ₃₁	2Z9893/1	Transformer C-293		2nd i-f Transformer	Z	SC-D-4171
L ₃₂ & L ₃₃	2Z9894/1	Transformer C-294		C-W osc.	Z	SC-D-4171
†L ₃₄	2C4314C/C1	Coil		Filter Choke	Z	SC-D-2720
†L ₃₅	3C227	Coil C-227		Antenna overload protection	T	SC-D-1489
†LM ₁	2Z4893	Neon Lamp		Dial Light	R	SC-A-1801
†LM ₂	2Z5927	Lamp LM-27	Mazda No. 44, 6.3 v.	Dial Light	S	SC-D-2573
†LM ₃	2Z5927	Lamp LM-27	Same as LM ₂	Dial Light	S	SC-D-2573
†R ₁	3Z4561	Resistor RS-161	Carbon, insul; 1.0 meg. ½ w.	2nd i-f, grid input	N	SC-D-970

* See Index of Manufacturers.

† Furnished in Maintenance Parts Group.

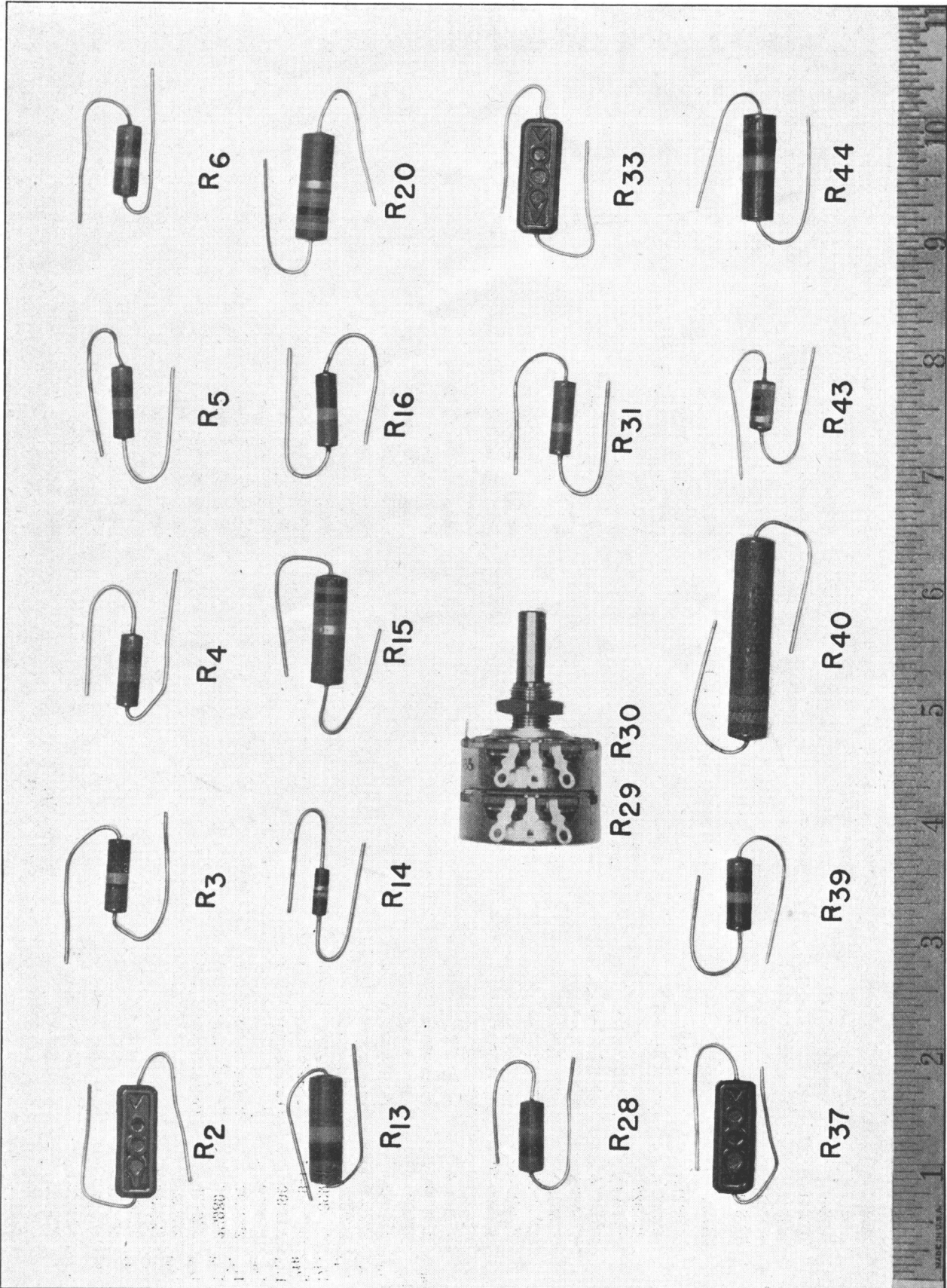

Tabular List of Replaceable Parts (Continued),—

Ref. No.	Stock No.	Name of Part	Description	Function	Mfg.*	Signal Corps Drawing No.
†R ₂	3Z4566	Resistor RS-166	Wire-wound; 350 ohm 1 w.	1st r-f Cathode bias	J	SC-D-970
†R ₃	3Z4541	Resistor RS-141	Carbon, insul; 75,000 ohm ½ w.	1st r-f, Screen bleeder	M	SC-D-970
†R ₄	3Z4549	Resistor RS-149	Carbon, insul; 40,000 ohm ½ w.	1st r-f, Screen divider	M	SC-D-970
†R ₅	3Z4550	Resistor RS-150	Carbon, insul; 100,000 ohm ½ w.	1st r-f, AVC filter	M	SC-D-970
†R ₆	3Z4525	Resistor RS-125	Carbon, insul; 1,000 ohm ½ w.	1st r-f, "B" Supply filter	M	SC-D-970
†R ₇	3Z4550	Resistor RS-150	Same as R ₅	2nd R-F AVC filter	M	SC-D-970
†R ₈	3Z4566	Resistor RS-166	Same as R ₂	2nd r-f, Cathode bias	J	SC-D-970
†R ₉	3Z4541	Resistor RS-141	Same as R ₃	2nd r-f, Screen bleeder	M	SC-D-970
†R ₁₀	3Z4549	Resistor RS-149	Same as R ₄	2nd r-f, Screen divider	M	SC-D-970
†R ₁₁	3Z4525	Resistor RS-125	Same as R ₆	2nd r-f, "B" Supply filter	M	SC-D-970
†R ₁₂	3Z4550	Resistor RS-150	Same as R ₅	1st Det., AVC filter	M	SC-D-970
†R ₁₃	3Z4539	Resistor RS-139	Carbon, insul; 30,000 ohm 1 w.	R-F osc., "B" filter	M	SC-D-970
†R ₁₄	3Z4568	Resistor RS-168	Carbon, insul; 50,000 ohm ½ w.	1st det., Injector bias	N	SC-D-970
†R ₁₅	3Z4564	Resistor RS-164	Carbon, insul; 500 ohm 1 w.	1st det., Cathode bias	M	SC-D-970
†R ₁₆	3Z4540	Resistor RS-140	Carbon, insul; 30,000 ohm ½ w.	1st det., Screen divider	M	SC-D-970
†R ₁₇	3Z4525	Resistor RS-125	Same as R ₆	1st det., "B" divider	M	SC-D-970
†R ₁₈	3Z4550	Resistor RS-150	Same as R ₅	1st i-f, AVC filter	M	SC-D-970
†R ₁₉	3Z4564	Resistor RS-164	Same as R ₁₅	1st i-f, Cathode bias	M	SC-D-970
†R ₂₀	3Z4563	Resistor RS-163	Carbon, insul; 60,000 ohm 1 w.	1st i-f, Screen bleeder	M	SC-D-970
†R ₂₁	3Z4549	Resistor RS-149	Same as R ₄	1st i-f, Screen divider	M	SC-D-970
†R ₂₂	3Z4525	Resistor RS-125	Same as R ₆	1st i-f "B" filter	M	SC-D-970
†R ₂₃	3Z4550	Resistor RS-150	Same as R ₅	2nd i-f, AVC filter	M	SC-D-970
†R ₂₄	3Z4564	Resistor RS-164	Same as R ₁₅	2nd i-f, Cathode bias	M	SC-D-970
†R ₂₅	3Z4563	Resistor RS-163	Same as R ₁₅	2nd i-f, Cathode bias	M	SC-D-970
†R ₂₆	3Z4549	Resistor RS-149	Same as R ₄	2nd i-f, Screen bleeder	M	SC-D-970
†R ₂₇	3Z4525	Resistor RS-125	Same as R ₆	2nd i-f, Screen divider	M	SC-D-970
†R ₂₈	3Z4531	Resistor RS-131	Same as R ₆	2nd i-f, "B" filter	M	SC-D-970
†R ₂₉	2Z7289	Potentiometer RS-174	Carbon, insul; 50,000 ohm ½ w.	2nd det., Diode output	M	SC-D-970
†R ₃₀			(0-500,000 ohm) 0-50,000 ohm	Dual volume Control	P	SC-D-1982
†R ₃₁	3Z4562	Resistor RS-162	Carbon, insul; 250,000 ohm ½ w.	AVC filter	M	SC-D-970
†R ₃₂	3Z4561	Resistor RS-161	Same as R ₁	Diode AVC output	N	SC-D-970
†R ₃₃	3Z4623	Resistor RS-223	Wire-wound; 2,000 ohm 1 w.	2nd a-f, Cathode bias	J	SC-D-970
†R ₃₄	3Z4562	Resistor RS-162	Same as R ₃₁	1st a-f, grid	M	SC-D-970
†R ₃₅	3Z4531	Resistor RS-131	Same as R ₂₈	2nd a-f, grid	M	SC-D-970
†R ₃₆	3Z4562	Resistor RS-162	Same as R ₃₁	C-W osc., plate	M	SC-D-970
†R ₃₇	3Z4571	Resistor RS-171	Wire-wound, 750 ohm 1 w.	1st a-f, Cathode bias	J	SC-D-970
†R ₃₈	3Z4631	Resistor RS-131	Same as R ₂₈	R-F osc., grid	M	SC-D-970
†R ₃₉	3Z4548	Resistor RS-148	Carbon, insul; 200,000 ohm ½ w.	C-W osc., grid	M	SC-D-970
†R ₄₀	3Z4620	Resistor RS-220	Carbon, 65,000 ohm 2 w.	Bleeder	M	SC-D-970
†R ₄₃	3Z4576	Resistor RS-176	Carbon, insul; 60 ohm ½ w.	Filament shunt, diode	L	SC-D-970
†R ₄₄	3Z4511	Resistor RS-111	Carbon, insul; 100,000 ohm 1 w.	Minimum bias bleeder	M	SC-D-970

* See Index of Manufacturers.
 † Furnished in Maintenance Parts Group.

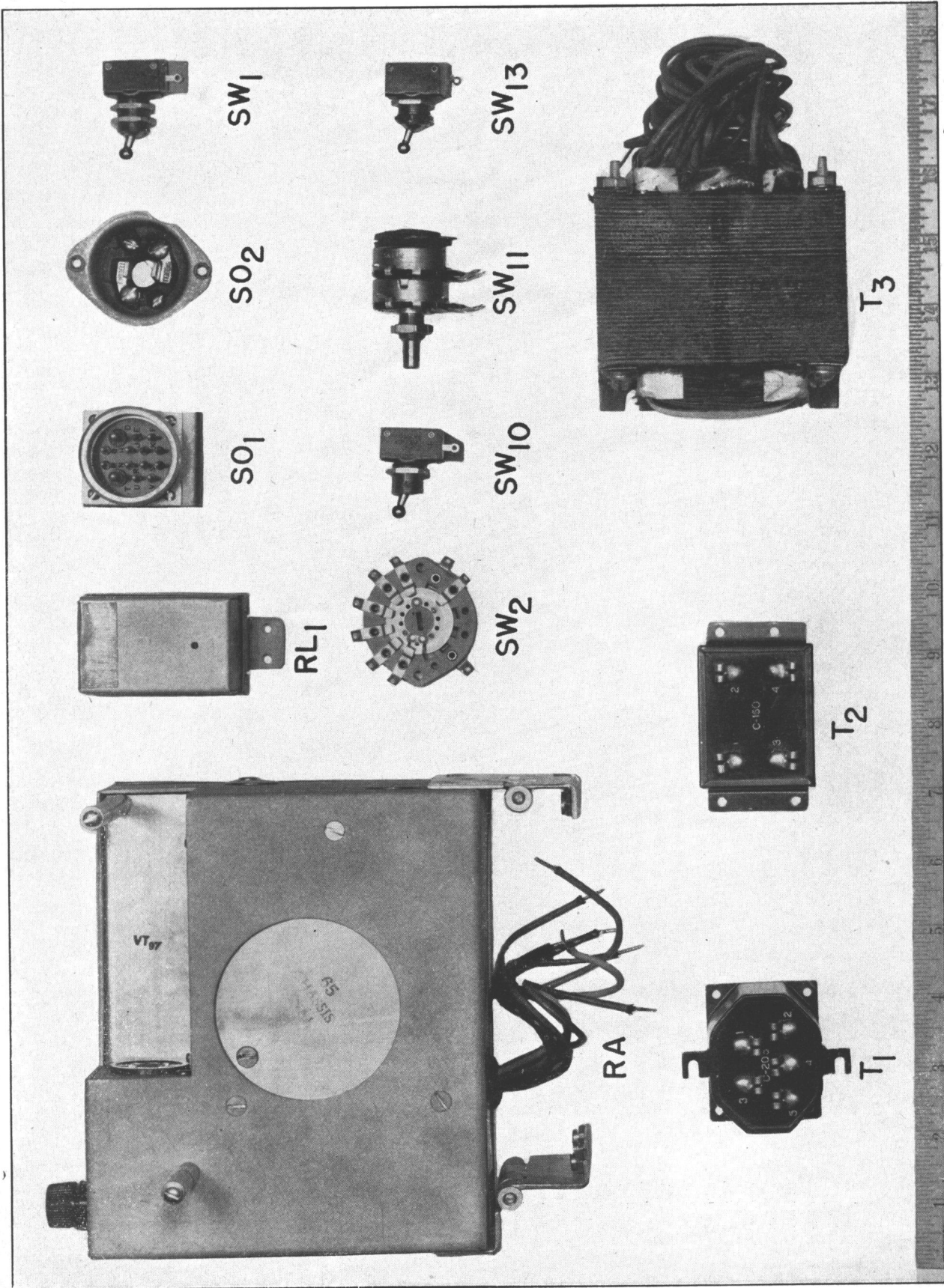

Tabular List of Replaceable Parts (Continued),—

Ref. No.	Stock No.	Name of Part	Description	Function	Mfg.*	Signal Corps Drawing No.
†R ₄₅	3Z4541	Resistor RS-141	Same as R ₃	1st det., Screen bleeder	M	SC-D-970
†R ₅₁	3Z4531	Resistor RS-131	Same as R ₂₈	1st i-f, Trans. shunt	M	SC-D-970
†R ₅₂	3Z4623	Resistor RS-223	Same as R ₃₃	2nd a-f, Cathode bias	J	SC-D-970
†R ₅₃	3Z4540	Resistor RS-140	Same as R ₁₆	1st det. Screen divider	M	SC-D-970
†RA	2Z7512	Rectifier RA-20	110 V. 60 cycle	Power supply	Z	SC-D-1609
†RL ₁	2Z7613	Relay BK-13	Send-Receive Relay Connector	Antenna Grounding	U	SC-D-1942
†SO ₁	2Z8794.1	Socket SO-94	110 V Receptacle	Power Supply Control Conn.	Z	SC-D-2592
SO ₂	6Z7589	Socket (A-C power)	Toggle	A-C input	Z	SC-D-1610
†SW ₁	3Z8131	Switch SW-131	Toggle	Send-Receive Switch	V	SC-A-1042
†SW ₂	3Z8310-2	Switch	Ceramic, wafer	Band change, 1st r-f	X	SC-D-4046
†SW ₃	3Z8310-2	Switch	Same as SW ₂	Band change, 1st r-f	X	SC-D-4046
†SW ₄	3Z8310-2	Switch	Same as SW ₂	Band change, 2nd r-f	X	SC-D-4046
†SW ₅	3Z8310-2	Switch	Same as SW ₂	Band change, 2nd r-f	X	SC-D-4046
†SW ₆	3Z8310-2	Switch	Same as SW ₂	Band change, 1st det.	X	SC-D-4046
†SW ₇	3Z8310-2	Switch	Same as SW ₂	Band change, 1st det.	X	SC-D-4046
†SW ₈	3Z8310-2	Switch	Same as SW ₂	Band change, r-f osc.	X	SC-D-4046
†SW ₉	3Z8310-2	Switch	Same as SW ₂	Band change, r-f osc.	X	SC-D-4046
†SW ₁₀	3Z8139	Switch SW-139	Toggle	C-W osc.	V	SC-A-1042
†SW ₁₁	3Z8119	Switch SW-119	Rotary	OFF-MVC-AVC	L	SC-D-2574
SW ₁₃	3Z8105	Switch SW-105	Toggle	A-C line	V	SC-A-1042
†T ₁	2Z9805	Transformer C-205	Audio frequency	1st audio	T	SC-D-2567
†T ₂	2Z9760	Transformer C-160	Audio frequency	2nd audio	T	SC-D-2569
†T ₃	2Z9828	Transformer C-228	Power	Rectifier Power	T	SC-D-1598

* See Index of Manufacturers.

† Furnished in Maintenance Parts Group.

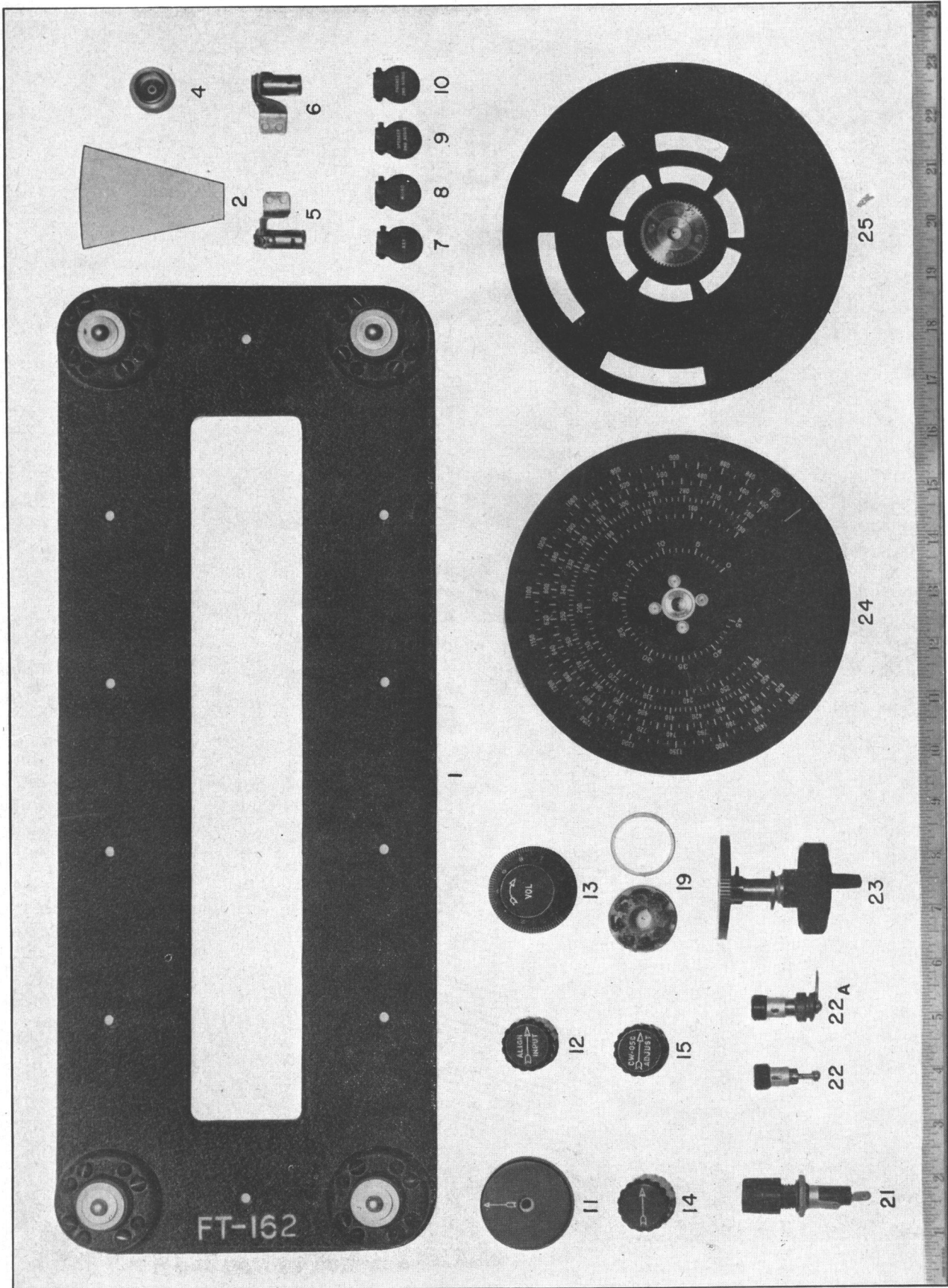

Tabular List of Replaceable Parts (Continued),—

b. Mechanical Parts.

Ref. No.	Stock No.	Name of Part	Description	Function	Mfg.*	Signal Corps. Drawing No.
†1	2Z6702	Mounting FT-162	Shock Mounting Plate	Receiver Mounting	Z	SC-D-2577
†2	2Z7560/2	Reflector Glass	Clear Glass	Dial Pane	Z	SC-D-2532-13
†4	2C4312/N1	Nut & Ferrule Assembly	Connector Assembly	Shielded Connector	Z	SC-D-2578
†5	2Z5986/1	Lamp Mounting R. H.	Socket R. H.	Pilot Lamp Socket	Z	SC-D-2573-1
†6	2Z5986/2	Lamp Mounting L. H.	Socket L. H.	Pilot Lamp Socket	Z	SC-D-2573-2
†7	2Z5650-K	Jack Cover, Key	Jack Cover	Jack Cover	Z	SC-D-2532-36
†8	2Z5650-M	Jack Cover, Micro	Jack Cover	Jack Cover	Z	SC-D-2532-37
†9	2Z5650-S2A	Jack Cover, Speaker 2nd Audio	Jack Cover	Jack Cover	Z	SC-D-2532-38
†10	2Z5650-P2A	Jack Cover, Phones 2nd Audio	Jack Cover	Jack Cover	Z	SC-D-2532-39
†11	2Z5783	Knob, Band Change	Die Cast Knob	Frequency Change	Z	SC-D-5481-56
†12	2Z5779	Knob, Align Input	Bakelite Knob	Antenna Alignment	AA	SC-D-2532-44
†13	2Z5773	Knob, Volume	Bakelite Knob	Volume Control	Z	SC-D-2532-45
†14	2Z5778	Knob, OFF-MVC-AVC	Bakelite Knob and Plate	Switch Control	AA	SC-D-2532-43
†15	2Z5780	Knob, CW-Osc Adjust	Bakelite Knob	Volume Control	AA	SC-D-2532-45
†19	2Z8761.4	Socket, 8 Prong	Bakelite Knob	Pitch Adjustment	AA	SC-D-2561-17
†21	3Z3275	Fuse Post	Molded, Octal Socket	Tube Socket	AB	SC-D-2588-63
†22	3Z763	Binding Post, Ground	Bakelite Fuse Holder	Fuse Holder	Q or B	SC-D-2532-76
†22a	3Z510	Binding Post, Alt. Sig. Ant.	Push Post Assembly	Ground Connection	AC	SC-D-2532-78
†23	2Z5782.1	Fast Tuning Knob and Drive Assembly	Push Post Assembly Fast Tuning Assembly	Alt. Sig. Connection Fast Tuning Drive	AC Z	SC-D-2532-71 SC-D-5431
†24	2C4314G/D1	Dial Assembly	Calibrated Dial Assembly	Tuning Dial	Z	SC-D-5431
†25	2Z8550.1	Shutter Assembly	Dial Shutter Assembly	Dial Shutter	Z	SC-D-5431

* See Index of Manufacturers.

† Furnished in Maintenance Parts Group.

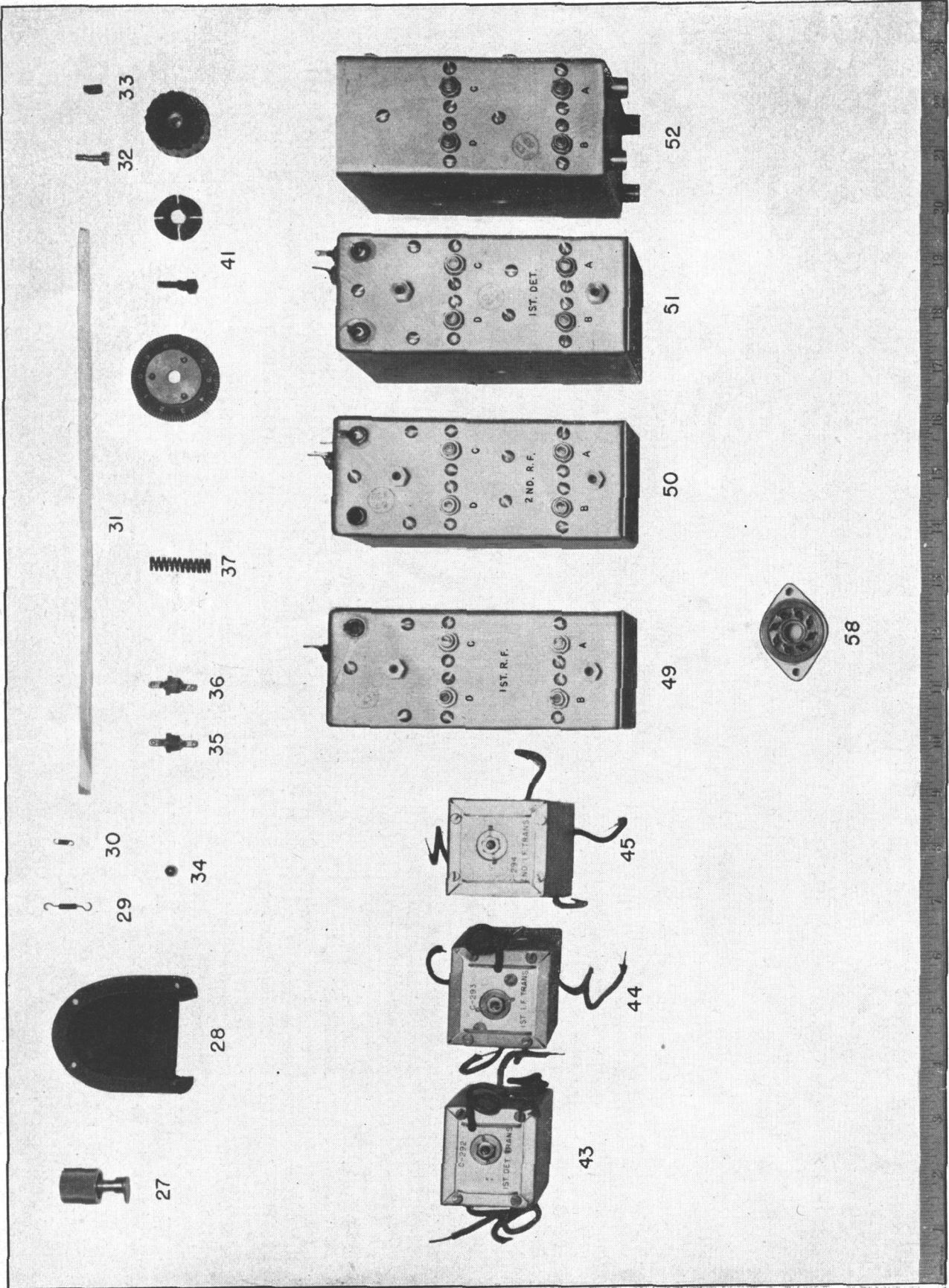

Tabular List of Replaceable Parts (Continued),—

Ref. No.	Stock No.	Name of Part	Description	Function	Mfg.*	Signal Corps. Drawing No.
†27	2Z6931/21	Panel Lock	Knurled Knob and Latch Assembly	Receiver Locks	Z	SC-D-2532
†28	2Z8794.1/C1	Cover	Aluminum Die-Cast Cover	SO-94 Socket Cover	Z	SC-D-2532-6
†29	2Z1650/7.3	Spring	Backlash Spring	Backlash Take-up	Z	SC-D-5431-14
†30	2Z1650/7.4	Spring	Backlash Spring	Backlash Take-up	Z	SC-D-5431-36
†31	2Z1650/42	Shaft	Band Switch Shaft	Band Change	Z	SC-D-5431-42
†32	6L6632-8.23	Screw	Brass Taper Screw No. 6-32	Secure Shaft	Z	SC-D-5431-4
†33	6L7082-6.85	Screw	Steel Set Screw, No. 10-32	Band Change Screw	Z	SC-D-5431-85
†34	2Z1650/2	Ball	.217" dia. Steel Ball	Detent Index	Z	SC-D-5431-94
†35	3G1921	Insulator	Bakelite Feed-Through	Feed Thru	Z	SC-D-2538
†36	3G1921-1	Insulator	Bakelite Feed-Through	Feed Thru	Z	SC-D-2553
†37	2Z1650/17.2	Spring	Steel Coil Spring	Detent Adjust	Z	SC-D-5431-6
†41	2Z5784	Knob, Vernier	Bakelite Knob, Plate and Clutch Assembly	Vernier Tuning	Z	SC-D-5655-58
†43	2Z9892	Transformer, C-292	92.5 kc, 1st Detector Transformer, I. F.	1st Detector Transformer	Z	SC-D-4171
†44	2Z9893	Transformer, C-293	92.5 kc, Interstage Transformer, I. F.	1st I. F. Transformer	Z	SC-D-4171
†45	2Z9894	Transformer, C-294	92.5 kc Diode Transformer, I. F.	2nd I. F. Transformer	Z	SC-D-4171
†49	2C4314G/A4	1st R. F. Unit Assembly	R-F Coil Box, Complete	1st R-F Stage	Z	SC-D-2705
†50	2C4314G/A3	2nd R. F. Unit Assembly	R-F Coil Box, Complete	2nd R-F Stage	Z	SC-D-2705
†51	2C4314G/A2	1st Detector Unit Assembly	R-F Coil Box, Complete	1st Detector Stage	Z	SC-D-2705
†52	2C4314G/A1	R. F. Oscillator Unit Assembly	Oscillator Coil Box, Complete	R-F Oscillator Stage	Z	SC-D-2710
†58	2C8795.11	Socket, 8 Prong	Octal Socket with Mounting Plate	Tube Socket	AD	SC-D-1612-24

* See Index of Manufacturers.
 † Furnished in Maintenance Parts Group.

29. Index of Manufacturers,—

Below is a list of manufacturer's names and addresses which are indicated by the code letters in Column 6 of the Replaceable Parts List.

- | | | |
|----------------------------------------------------------------------------------|----------------------------------------------------------------------------|-----------------------------------------------------------------------------|
| A—F. W. Sickles Co.
P. O. Box 920
Springfield, Mass. | K—Cornell-Dubilier Electric Corp.
South Plainfield, N. J. | U—C. P. Clare and Co.
4719 Sunnyside Ave.
Chicago, Ill. |
| B—Bussman Manufacturing Co.
St. Louis, Mo. | L—Stackpole Carbon Co.
St. Marys, Penna. | V—Arrow-Hart and Hegman Electric Co.
103 Hawthorn St.
Hartford, Conn. |
| C—Oak Manufacturing Co.
1260 Clybourn Ave.
Chicago, Ill. | M—International Resistance Co.
401 N. Broad St.
Philadelphia, Penna. | W—Bilely Electric Co.
Union Station Bldg.
Erie, Penna. |
| D—Hammarlund Manufacturing Co., Inc.
424-438 West 33rd St.
New York, N. Y. | N—Allen-Bradley Co.
136 W. Greenfield Ave.
Milwaukee, Wis. | X—Centralab, Inc.
900 E. Keefe St.
Milwaukee, Wis. |
| E—Automatic Winding Co.
Harrison, N. J. | O—P. R. Mallory and Co.
Indianapolis, Ind. | Y—Pioneer Gen-E-Motor Corp.
5841-49 Dickens Ave.
Chicago, Ill. |
| F—Radio Condenser Co.
Camden, N. J. | P—Chicago Telephone Supply Co.
Elkhart, Ind. | Z—Farnsworth Television & Radio Corp.
Pontiac Ave.
Fort Wayne, Ind. |
| G—Aerovox Corp.
New Bedford, Mass. | Q—Littelfuse, Inc.
4725 No. Ravenswood Ave.
Chicago, Ill. | AA—Chicago Die Molding Co.
Chicago, Ill. |
| H—Sprague Specialities Co.
North Adams, Mass. | R—Graybar Electric Co.
5830 Calumet Ave.
Hammond, Ind. | AB—Cinch Manufacturing Co.
Chicago, Ill. |
| I—Solar Manufacturing Corp.
Bayonne, N. J. | S—General Electric Co.
Cleveland, Ohio. | AC—XL Radio Laboratories
Chicago, Ill. |
| J—Micamold Radio Corp.
New York, N. Y. | T—Chicago Transformer Corp.
Chicago, Ill. | AD—American Phenolic Corp.
Chicago, Ill. |

[A. G. 062.11 (4-20-43)]

By order of the Secretary of War:

G. C. MARSHALL,
Chief of Staff

Official:

J. A. ULIO,
Major General,
The Adjutant General.

Distribution:

X

(For explanation of symbols see FM 21-6.)

ADDENDA SHEET

for

TECHNICAL MANUAL**RADIO RECEIVER BC-312-N****RADIO RECEIVER BC-312-NX****RADIO RECEIVER BC-342-N****RADIO RECEIVER BC-314-G****RADIO RECEIVER BC-344-D**

4 FEBRUARY 1943

The following information changes portions of TM 11-850 N. Personnel using the equipment and having custody of the technical manual will attach this addenda sheet securely in the front of the TM, and will enter suitable notations beside each changed portion in the TM to indicate the presence of this information.

Order No.	Serial No.	Receiver Model
10651-Phila-44	1	BC-342-N
10651-Phila-44	1	BC-344-D
11264-Phila-44	213	BC-312-N
16347-Phila-44	1	BC-312-N
18993-Phila-44	1	BC-312-N

OMISSION OF LM₁

The neon lamp LM₁ formerly used in the antenna circuit is omitted. The following are affected: Figures 6, 8, 9, 10, 11, 12 and Paragraphs 24 to 28 inclusive.

The above neon lamp change has been made starting with receivers bearing the following order numbers and serial numbers:

Order No.	Serial No.	Receiver Model
16133-Phila-43	1132	BC-342-N
31915-Phila-43	846	BC-314-G
31915-Phila-43	123	BC-342-N
31915-Phila-43	104	BC-344-D
32767-Phila-43	138	BC-342-N
3552-Phila-44	1	BC-342-N
3552-Phila-44	200	BC-344-D
4222-Phila-44	1128	BC-342-N
6965-Phila-44	1	BC-344-D
10505-Phila-44	20	BC-312-N
10505-Phila-44	1	BC-314-G

NEW AUDIO OUTPUT TRANSFORMER

In later model receivers provisions have been made for connecting headsets having an impedance of either 4000 ohms or 250 ohms by a wiring change to the phone jacks. This change in wiring is to be made by operating personnel. A reversible nameplate on the front panel indicates the correct output impedance. Output Transformer C-160 has been replaced by Transformer C-160-A and is indicated on circuit diagrams and wiring diagrams as T₂. Connection point number 5 has been added to T₂ which is the 250 ohm tap. The output impedance is changed by removing a phone tip from the 4000 ohm jack and inserting it into the 250 ohm jack on the terminal strip located on the underside of the chassis just adjacent to the 1st Detector Coil Unit Assembly. This circuit change connects the speaker and both phone jacks for the impedance indicated on the chassis below the terminal strip.

Paragraphs 24 to 28 inclusive. T₂, stock number 2Z9760A, is Transformer C-160-A being identical to C-160 except for addition of 250 ohm tap.

The above changes were made starting with receivers bearing the following order numbers and serial numbers:

Order No.	Serial No.	Receiver Model
4611-Phila-42	5824	BC-312-N
16133-Phila-43	364	BC-342-N
16133-Phila-43	1305	BC-344-D
30205-Phila-43	2744	BC-312-N
30205-Phila-43	3062	BC-342-N
30214-Phila-43	983	BC-342-N
31915-Phila-43	1	BC-342-N
32767-Phila-43	1	BC-342-N
3552-Phila-44	1	BC-342-N
3552-Phila-44	1	BC-344-D
4222-Phila-44	1	BC-342-N
6965-Phila-44	1	BC-344-D
10651-Phila-44	1	BC-342-N
10651-Phila-44	1	BC-344-D

Order No.	Serial No.	Receiver Model
11264-Phila-44	1	BC-312-N
10505-Phila-44	1	BC-312-N
10505-Phila-44	1	BC-314-G
16347-Phila-44	1	BC-312-N
18993-Phila-44	1	BC-312-N

CORRECTION

Page 25, figure 8. Add connection from bottom side of C₄₈ to ground symbol below 1st Det. Tube VT-87.

COLOR CODING OF CAPACITORS

Capacitors used in this family of receivers may be color coded with either RMA (Radio Manufacturers Association) or AWS (American War Standards) codings. Below is an explanation of these codes.

RMA COLOR CODE FOR CAPACITORS

Color	Significant Figure	Decimal Multiplier	Tolerance	Voltage Rating
Black	0	1	--	--
Brown	1	10	1%	100 Volts
Red	2	100	2%	200 Volts
Orange	3	1000	3%	300 Volts
Yellow	4	10,000	4%	400 Volts
Green	5	100,000	5%	500 Volts
Blue	6	1,000,000	6%	600 Volts
Violet	7	10,000,000	7%	700 Volts
Gray	8	100,000,000	8%	800 Volts
White	9	1,000,000,000	9%	900 Volts
Gold	--	0.1	5%	1000 Volts
Silver	--	0.01	10%	2000 Volts
No Color	--	----	20%	500 Volts

When holding the capacitor so as to read the manufacturers name:

- (a) 1st color top row indicates the first significant figure of the capacitance.
- (b) 2nd color top row indicates the second significant figure of the capacitance.
- (c) 3rd color top row indicates the third sig-

nificant figure of the capacitance.

- (d) The decimal multiplier is indicated by the 1st color in the bottom row.
- (e) The tolerance, if any, shall be indicated by the 2nd color in the bottom row.
- (f) The voltage rating, if any, shall be indicated by the 3rd color in the bottom row.

AWS COLOR CODE FOR CAPACITORS

Color	Significant Figure	Decimal Multiplier	Tolerance	Characteristic
Black	0	1	--	A
Brown	1	10	--	B
Red	2	100	2% (G)	C
Orange	3	1000	--	D
Yellow	4	---	--	E
Green	5	---	--	F
Blue	6	---	--	G
Violet	7	---	--	
Gray	8	---	--	
White	9	---	--	
Gold	--	0.1	5% (J)	
Silver	--	0.01	10% (K)	
Black	--	---	20% (M)	

When holding the capacitor so as to read the manufacturers name:

- (a) 1st color top row indicates the first significant figure of the capacitance. This color shall always be black for capacitors used in this equipment.
- (b) 2nd color top row indicates the second significant figure of the capacitance.
- (c) 3rd color top row indicates the third significant figure of the capacitance.

nificant figure of the capacitance.

- (d) The characteristic (refer to American War Standards Specification C75.3-1942) is indicated by the 1st color in the bottom row.
- (e) The tolerance is indicated by the 2nd color in the bottom row.
- (f) The decimal multiplier is indicated by the 3rd color in the bottom row.