

# 73<sup>®</sup>

International Edition

November 1983 \$2.49 1/2  
Issue #278

# Amateur Radio's Technical Journal

A Wayne Green Publication

**Morse  
Maniac's  
Keyboard  
Project**

Page 20

**W5LFL Orbits**

Page 95

**Are MSOs  
For You?**

Page 86

**Supply With  
A Surprise!**

Page 10

**Micro Help  
For Hams:**

**QSLs—Page 46**

**Logs—Page 58**

**Rcvr Specs—Page 36**

**Nets—Page 62**

**1983**

**Contest Results:  
40/75/160m, RTTY**

Pages 101-107



Scanner Squelch—84

### Construct the Callsign Power Supply

KA1QZ put together aesthetics and electronics to produce a power supply that gives you more than good regulation. . . . . KA1QZ 10

### The Magical Audio Filter

A variable-frequency notch filter plus a peaking circuit will do wonders for your reception. And this project will almost build itself. . . . . W6QIF 14

### Keyboard Your Way to Happiness

If happiness is perfect Morse, then this project is pure heaven. Special construction tips make putting it together as much fun as using it. . . . . N7AGK 20

### Reveal the Receiver Behind the Specs

Here's a program that will make sense out of all those numbers. . . . . N6RY 36

### Terrific Top-Band Conversions

Jump up to 160 meters and beat the coming sunspot drought. Surplus gear will get you there cheaply. . . . . K9QLL 40

### CardSoft:

#### The Transportable QSL Generator

If your machine runs Basic, it can run this program. . . . . WB5LLM 46

#### The Six-Meter Vfo That Won't Quit

This hybrid has the best of both worlds. It's as steady as a rock and has broad-band tuning. . . . . N7APE 48

### Foolproof Logging

KL7GRF designed a logbook program that any TRS-80 owner can use. And it manages your QSLs, too. . . . . KL7GRF 58

### The Program No Net Control Should Be Without

Every net generates lists. Keep yours up to date with this TRS-80 Basic program. . . . . WA4VLE 62

### The World's Cheapest Modification

All you need to put the FT-101 on 30 meters is three pieces of wire. What could be cheaper than that? . . . . . WB9DDF, W0UR 70

### A Two-Tone Squelch to Solve Your Scanner Woes

Selective listening is the key to success. This squelch will help you cut the chatter. . . . . WA3REY 84

### Electronic Mail Comes of Age

These mailboxes may be thousands of miles away, but they're instantly accessible. . . . . K0VKH 86

### Octal Ingenuity

It's an old radio. You can't find a replacement tube. Now what do you do? . . . . . W9SIA 88



6m Vfo—48

Never Say Die—6  
Gift  
Subscriptions—67  
73 International—76  
Social Events—92  
Ham Help—  
93, 107, 132  
Satellites—95  
Dr. Digital—96  
Review—97  
Contests—101

DX—109  
Fun!—110  
Reader  
Service—114  
New Products—115  
Awards—117  
Letters—119  
RTTY Loop—138  
Dealer  
Directory—146  
Propagation—146



# ICOM IC-25H

## 45 Watts of Compact Power



**IC-25H**  
2 Meter Mobile  
45 Watts

45 watts / green LED readout / compact size / touchtone<sup>®</sup> scanning microphone / 2"H x 5½"W x 8¾"D / 2 VFO's / 5 memories make the IC-25H the best 2 meter mobile value on the market.



scanning (memory scan scans 5 memories plus 2 VFO's) and each VFO has a different tuning rate for easy QSY.

**5 Memories.** Instant access to most frequencies: VFO A information is transferred to the selected memory by pushing the write button.

**Priority Channel.** Any memory channel may be monitored for activity on a sample basis, every 5 seconds, without disruption of a QSO conducted on a VFO frequency.

**HM14 Microphone.** Smaller and lighter... the HM14 microphone provides a 16 button touchtone<sup>®</sup> pad as well as up and down scan buttons, adding easy frequency control of the radio and repeater access tones.



**IC-25A**  
25 Watts / 2 meters

The IC-25A is a very compact 2 meter FM mobile. Only 2"H x 5½"W x 7"D, the IC-25A features a green LED readout which is visible in any lighting condition, a touchtone<sup>®</sup> /

scanning microphone and 25 watts of output.

These standard features have made the IC-25A the most popular 2 meter mobile on the market.

**New Green LED.** Easier to read in bright sunlight, and not glaring at night, the IC-25A's new readout provides good visibility under all conditions.

**Dual VFO's.** Dual VFO's give an extra stored frequency for

**Scanning.** Pushing the S/S button initiates the scan circuitry. With the mode switch in a memory position the unit will scan all 5 memories plus the

2 VFO frequencies. With the mode switch in a VFO position, the unit will scan the entire band or the portion of the band defined by memories 1 and 2.



**IC-HM14**  
MIC

 **ICOM**  
The World System

# 5-STORE BUYING POWER *in action!*

Unlike some retailers, when Ham Radio Outlet guarantees satisfaction there'll be no question. **YOU CAN COUNT ON IT!**

## KENWOOD **BIG VALUE COMBINATIONS**

### TS-930S



with Antenna Tuner  
**Plus**  
**3 Free Bonus Items**

- 1) SP-930 Speaker.
- 2) MC-60A microphone.
- 3) YK-88C-1 filter.

REG. \$2029 VALUE

**\$1799**

A \$230 SAVING

**PLUS FREE SHIPMENT UPS (Surface) ALL COMBOS**

### TW-4000A FM "Dual Bander"

2m and  
70cm in a  
single  
package!



Buy a TW 4000A for  
**\$599.95**

and select two of the following  
items absolutely free!

- 1) VS-1 Voice Synthesizer.  
\$39.95 value.
- 2) TU-4C sub-audible  
tone generator. \$39.95 value.
- 3) MA-4000 Duo-band  
Mobile Antenna. \$44.95 value.

### TS-430S



Buy a TS 430S for  
**\$899.95**

and select your free  
package from among the  
following three groups:

- 1) MB-430. FM-430. YK-88A  
\$119.85 value.
- or 2) MB-430. MC-42S.  
YK-88-SN. \$112.85 value.
- or 3) Ham Radio Outlet  
\$90 CASH REBATE.

### NEW!!



### IC-751



**\$1399 PRICE**  
INCLUDES: **FREE**  
**PS-35 POWER SUPPLY**  
(Mounts internally)  
REG. \$160 VALUE



**W-51**  
**SALE \$799**  
**W-36**  
**CALL FOR PRICE**  
**LM-470D**  
**CALL FOR PRICE**

### KLM

**KT-34A**  
**SALE \$299**  
**KT-34XA**  
**SALE \$459**  
PRICES ARE FOB CALIF.  
EXCEPT FOR CERTAIN  
COMBINATIONS.  
PLEASE INQUIRE

### FT-208R **YAESU** FT-708R



**CALL FOR LOW**  
**PRICES ON HAND-HELDS**  
**and all YAESU ITEMS.**



**NEW!**  
**FT-980**



### MIRAGE

**B-3016** REG. \$239.95  
**SALE \$199.95**  
**B-1016** REG. \$279.95  
**SALE \$249.95**  
**B-108** REG. \$179.95  
**SALE \$159.95**  
**B-23S** REG. \$89.95  
**SALE \$79.95**

### FREE SHIPMENT UPS (Surface) CONTINENTAL U.S.A.

ON MOST ITEMS THAT CAN BE SHIPPED UPS BROWN.  
THERE ARE SOME EXCEPTIONS IN ALPHA, TRI-EX AND KLM

**FREE**  
**PHONE 800 854-6046**

9:30AM to 5:30PM PACIFIC TIME.

**OVER-THE-COUNTER, 10AM to 5:30PM.**

**MONDAY THROUGH SATURDAY**

CALIFORNIA CUSTOMERS PLEASE PHONE OR VISIT LISTED STORES.

**ANAHEIM, CA 92801**  
2620 W. La Palma,  
(714) 761-3033 (213) 860-2040  
Between Disneyland & Knott's Berry Farm

**BURLINGAME, CA 94010**  
999 Howard Ave., (415) 342-5757  
5 miles south on 101 from S.F. Airport.

**OAKLAND, CA 94609**  
2811 Telegraph Ave., (415) 451-5757  
Hwy 24 Downtown. Left 27th off-ramp.

**SAN DIEGO, CA 92123**  
5375 Kearny Villa Road (619) 560-4900  
Hwy 163 & Clairemont Mesa Blvd.

**VAN NUYS, CA 91401**  
6265 Sepulveda Blvd., (213) 988-2212  
San Diego Fwy at Victory Blvd.

AEA • ALLIANCE • ALPHA • AMECO • AMPHENOL • ARRL • ASTRON  
AVANTI • BELDON • BENCHER • BERK-TEC • BIRD • B & W  
BUTTERNUT • CALLBOOK • CDE • COLLINS • CURTIS • CUSHCRAFT

DAIWA • DRAKE • DX EDGE • DX ENGINEERING • EIMAC  
HUSTLER • HY-GAIN • ICOM • J. W. MILLER • KANTRONICS  
KENWOOD • KLM • LARSEN • LUNAR • METZ • MFJ • MICRO-LOG

MINI-PRODUCTS • MIRAGE • NYE • PALOMAR • ROBOT • ROHN  
SHURE • SIGNAL-ONE • TEMPO • TEN-TEC • TRISTAO • VOCOM  
YAESU and many more!

Prices, specifications, descriptions subject to change without notice. Calif. residents please add sales tax.

**SERVING HAMS  
BETTER.**  
North...south...east...west.

Bob Ferrero, W6RJ  
Jim Rafferty, N6RJ  
other well known hams  
give you courteous,  
personalized  
service.



**HAM  
RADIO  
OUTLET**

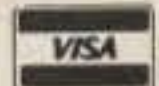

# 1984 CALLBOOKS

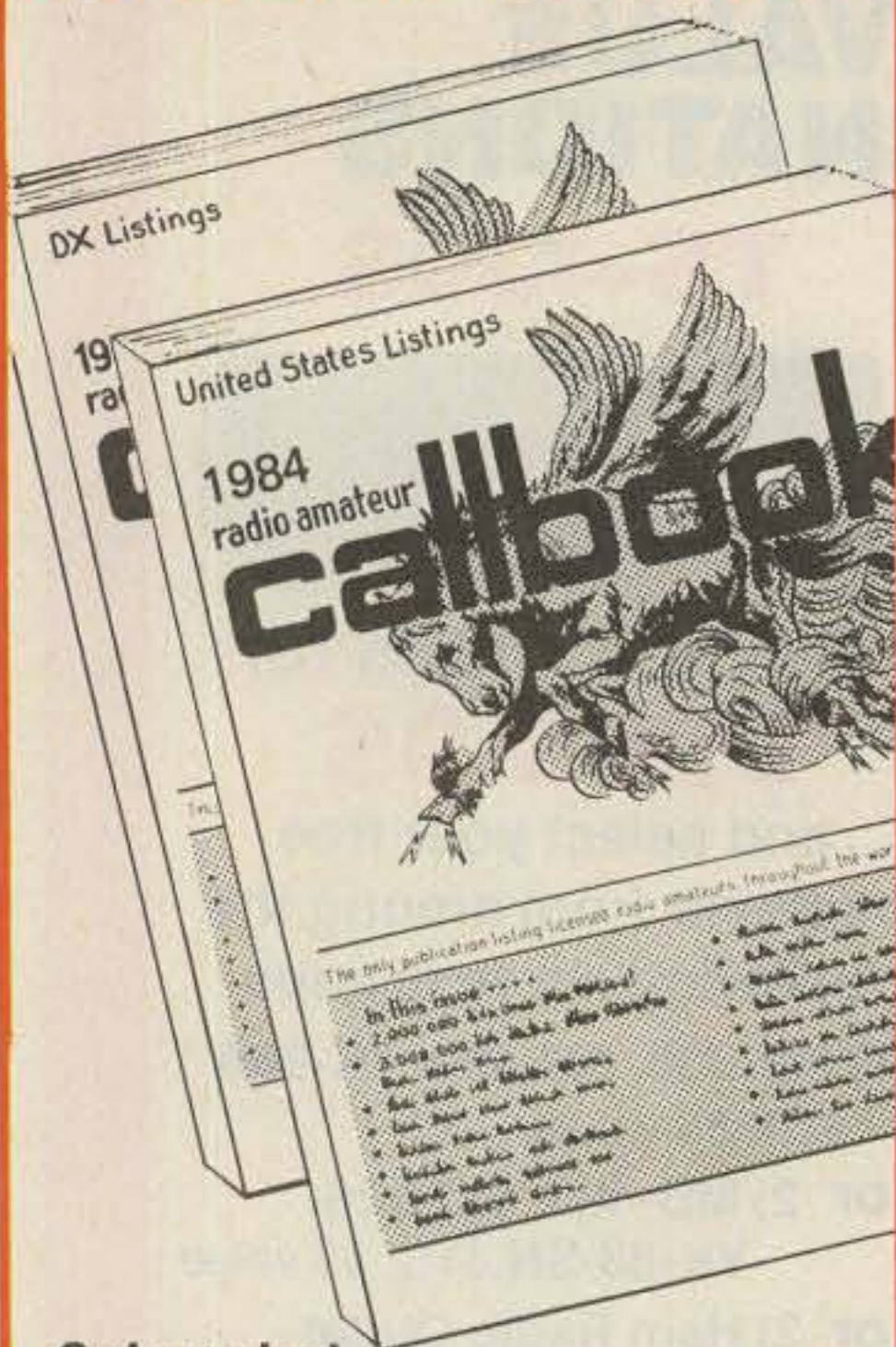

Order today!

**NEW 1984  
RADIO AMATEUR CALLBOOKS  
READY DECEMBER 1st!**

Known throughout the world for accuracy, the 1984 Callbooks are a better value than ever before. The U.S. Callbook contains over 430,000 listings; the Foreign Callbook has over 400,000. More than 75,000 changes have been made in each edition since last year. Special features include call changes, Silent Keys, census of amateur licenses, world-wide QSL bureaus, international postal rates, prefixes of the world, and much more. You can't beat this value! Order your 1984 Callbooks now for earliest delivery.

	Each	Shipping	Total
□ U.S. Callbook	\$19.95	\$3.05	\$23.00
□ Foreign Callbook	18.95	3.05	22.00

Order both books at the same time for \$41.95 including shipping within the USA.

Order from your dealer or directly from the publisher. Foreign residents add \$4.55 for shipping. Illinois residents add 5% sales tax.

### Keep your 1984 Callbooks up to date.

The U.S. and Foreign Supplements contain all activity for the previous three months including new licenses. Available from the publisher in sets of three (March 1, June 1, and September 1) for only \$12.00 per set including shipping. Specify U.S. or Foreign Supplements when ordering. Illinois residents add 5% sales tax. Offer void after November 1, 1984.

**RADIO AMATEUR  
callbook INC.**

Dept. B  
925 Sherwood Dr., Box 247  
Lake Bluff, IL 60044, USA

Tel: (312) 234-6600



## \$15 DTMF DECODER \$15

The LJM2RK decoder kit converts your receiver into a special receiver or control. When a user-selected time-tone combination is received, the output provides a relay control for activating speakers or other devices.

INPUT: Audio from transceiver, scanner, etc.  
OUTPUT: SPST (N.O.) relay.

FEATURES: Single or dual tones adjustable over the 16 digit Touch Tone range • Adjustable response time • Relay output • Manual or auto reset • Single tone ON latching with different single tone reset OFF • Operates on 12VDC • Interfacing of multiple boards for multi-digit sequential activation and reset.

APPLICATIONS: Call-up system • Repeater or commercial controls • Etc. limited only to your imagination •

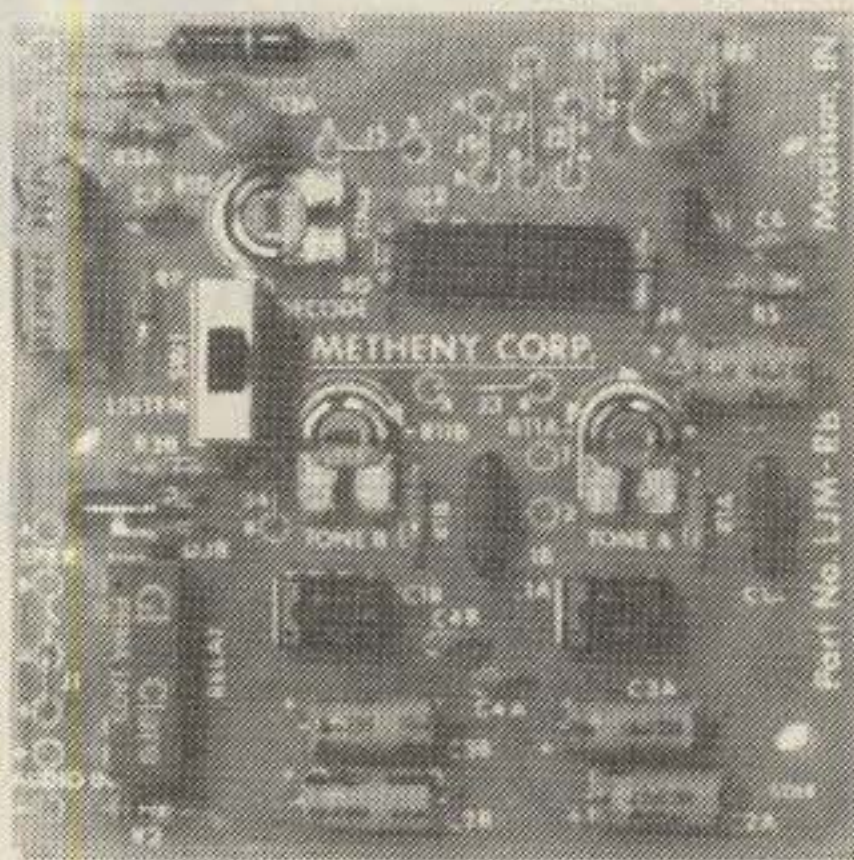

Actual Size 3"x3" - Shown Assembled

LJM2RK decoder kit includes all component, relay, and P.C. Board. . . \$15 plus \$1.50 shipping.

LJM2RC enclosure kit includes molded case, speaker, input cable. . . \$5 plus \$1.50 shipping.

For information and to order write:

**THE METHENY CORPORATION**  
204 Sunrise Drive, Madison, IN 47250 ✓205

## The Computer Specialty Store Inc.

428 Central Ave. Johnstown, PA 15905  
AN AUTHORIZED KANTRONICS DEALER

### The Interface by Kantronics

for:

Apple                      TI 99  
Atari                        TRS-80C  
Commodore 64          VIC-20

Announcing also, Amtorsoft for the C-64, VIC-20, and Apple.

COMPLETE SALES & SERVICE.



✓113

Call for package deals or "one of a kind"; **1-814-535-2432**

Software • Hardware • Telecommunication

# INFO

## Manuscripts

Contributions in the form of manuscripts with drawings and/or photographs are welcome and will be considered for possible publication. We can assume no responsibility for loss or damage to any material. Please enclose a stamped, self-addressed envelope with each submission. Payment for the use of any unsolicited material will be made upon acceptance. All contributions should be directed to the 73 editorial offices. "How to Write for 73" guidelines are available upon request.

## Editorial Offices:

Pine Street  
Peterborough NH 03458  
Phone: 603-924-9471

## Advertising Offices:

Elm Street  
Peterborough NH 03458  
Phone: 603-924-7138

## Circulation Offices:

Elm Street  
Peterborough NH 03458  
Phone: 603-924-9471

## Subscription Rates

In the United States and Possessions:  
One Year (12 issues) \$25.00  
Two Years (24 issues) \$38.00  
Three Years (36 issues) \$53.00

## Elsewhere:

Canada and Mexico—\$27.97/1 year only, U.S. funds. Foreign surface mail—\$44.97/1 year only, U.S. funds drawn on U.S. bank. Foreign air mail—please inquire.

## To subscribe, renew or change an address:

Write to 73, Subscription Department, PO Box 931, Farmingdale NY 11737. For renewals and changes of address, include the address label from your most recent issue of 73. For gift subscriptions, include your name and address as well as those of gift recipients.

## Subscription problem or question:

Write to 73, Subscription Department, PO Box 931, Farmingdale NY 11737. Please include an address label.

73: *Amateur Radio's Technical Journal* (ISSN 0745-080X) is published monthly by Wayne Green, Inc., 80 Pine Street, Peterborough NH 03458. Second class postage paid at Peterborough NH 03458 and at additional mailing offices. Entire contents copyright © 1983, Wayne Green, Inc. All rights reserved. No part of this publication may be reprinted or otherwise reproduced without written permission from the publisher. Microfilm Edition—University Microfilm, Ann Arbor MI 48106. Postmaster: Send address changes to 73, Subscription Services, PO Box 931, Farmingdale NY 11737.

# PLANE TALK . . .



## . . . . . 720 Channel Featherweight Portable

The TR-720 contains the latest microprocessing technology which is responsible for its amazing size (6.6" x 2.6" x 1.5") and weight (1.2 lb.). Features include 3 memory channels, 720 COM and 200 NAV channel operation, twist-off rechargeable battery pack, and multi-function LED to indicate receive signal or low battery. A full set of standard accessories including rechargeable battery, AC and DC chargers, case, flex antenna, and earphone put you straight on the air. Optional accessories are available.

The TR-720 increases the operating safety of balloons, sailplanes, and ultralights by providing communication with ground crews or ATC. It allows receipt of IFR clearances prior to engine start and is indispensable for search and rescue, forest fire fighting,

or law enforcement to coordinate aircraft operations. Sport aircraft, homebuilts, or experimental planes (even those without electrical systems) can now have reliable 720 channel communication. But perhaps the best advantage is the peace of mind that comes from having an emergency back-up transceiver.

The TR-720 comes with a full 1 year warranty with guaranteed 72 hour turnaround and is available for immediate delivery factory direct or from your local Avionics Dealer or FBO.

The TR-720, rugged, reliable communications in the palm of your hand.

**\$795.00** Aircraft Owners Net  
FCC and DOC Approved



117

**Communications Specialists**

426 West Taft Avenue  
Orange, CA 92665-4296  
(800) 854-0547 (714) 998-3021

# W2NSD/1 NEVER SAY DIE

editorial by Wayne Green



## WHAT'S GREEN REALLY UP TO?

A few years ago, I wrote in my editorials in 73 my prediction that microcomputers would one day grow to the size of the car industry. I also pointed out that this growth was a golden opportunity for those interested in getting rich.

Based on that concept, I first started *Byte* magazine as a vehicle to help that industry to speed up its growth (*Byte* was the largest consumer magazine in America last year) and then *80 Micro* to help entrepreneurs get a piece of the action (the third largest consumer magazine in America last year).

The computer field is still in its early growth stages, so there are lots of opportunities yet to make fortunes there. You'll see me starting even more magazines to help it grow and deal entrepreneurs in on the action.

One of the benefits to me of amateur radio has been the interest I've gained in travel. Talking with hams in virtually every country of the world has interested me in getting to personally see their countries and meet them in person. And in each country I visit, I can't help but compare their quality of life with that we enjoy in America.

Most of the Third-World countries have it pretty tough. They are prisoners of poverty, ignorance, and, as a result, tyrannical governments. We've tried throwing money at these countries, but that is divided up among the tyrants, providing little for the people. The answer, of course, is to provide them with education. In the long run, this will change the patterns of poverty.

That, my friends, is Green's

Goal. It is my intention to provide the entire world with a high-quality, low-cost education, using high-technology techniques. I'll make this prediction: Education is going to be a marketable product and the industry manufacturing and selling this product is not only going to be larger than the car industry, but also larger than OPEC.

Being one of the early ones to see what is coming, I'm in a position both to help this come about and also to profit from it, as I did with computers. Indeed, I think several thousand brainwashed ARRL members were pretty surprised when they heard that I'd sold my magazines for \$60 million. That didn't tie in very well with the League theory that I'm a blundering idiot who is destroying amateur radio.

You know, I got started in hamming 45 years ago and it is depressing to me to get on the air and see how little things have changed in all that time. About the only significant changes are sideband and repeaters (both of which I helped make happen with my magazines). It's getting time for some major changes to bring amateur radio into our high-tech age. Perhaps, from that viewpoint, it is time to "destroy" amateur radio—and that seems to be the ARRL position. I want hamming to progress, to be able to provide the quality of communications modern technology allows, and not be stuck fifty years in the past, held to our ancient Morse-code traditions inflexibly.

*Continued on page 108*



## QSL OF THE MONTH

The high-tech city: That's Rochester, New York, and this winning QSL card from the Rochester Amateur Radio Association reflects Rochester's claim to fame. According to the Department of Commerce, this city leads the nation in high-technology exports, and RARA is proud of amateur radio's contributions to the community. There is no doubt that the scene makes for a striking QSL card. It represents the way an area can be linked, not only by streets and sidewalks, but also by the communications network provided by ham radio.

To enter your QSL card in 73's QSL of the Month contest, put it in an envelope with your choice of books from 73's Radio Bookshop and mail it to 73, Pine Street, Peterborough NH 03458, Attn: QSL of the Month. Entries not in envelopes or without a book choice will not be considered.

# STAFF

**PUBLISHER/EDITOR**  
Wayne Green W2NSD/1

**ASSISTANT PUBLISHER/EDITOR**  
Jeff DeTray WB8BTH

**MANAGING EDITOR**  
John Burnett

**ASST. MANAGING EDITOR**  
Susan Philbrick

**EDITORIAL ASSISTANTS**  
Nancy Noyd  
Richard Phenix  
Steve Jewett

**TECHNICAL EDITOR**  
Avery L. Jenkins WB8JLG

**ASSISTANT  
TO THE PRESIDENT**  
Matthew Smith KA1IEI

**ASSOCIATES**  
Robert Baker WB2GFE  
John Edwards KI2U  
Bill Gosney KE7C  
Sanger Green  
Chod Harris VP2ML  
Dr. Marc Leavey WA3AJR  
J. H. Nelson  
Bill Pasternak WA6ITF  
Peter Stark K2OAW  
Robert Swirsky AF2M

**PRODUCTION MANAGER**  
Nancy Salmon

**ASST. PRODUCTION  
MANAGER**  
David Wozmak

**ADVERTISING GRAPHICS  
MANAGER**

Scott W. Philbrick  
**DESIGN DIRECTOR**  
Christine Destrepes

**PRODUCTION**  
Patricia Bradley  
Linda Drew  
Michael Ford  
Marjorie Gillies  
Donna Hartwell  
Alfred Huston  
Taylor Morris  
Kimberly Nadeau  
Paula Ramsey  
Anne Rocchio  
Lynne Simonson  
Kenneth Sutcliffe  
Theresa Verville  
Robert M. Villeneuve  
Karen Wozmak

**PHOTOGRAPHY**  
Thomas Villeneuve  
Sandra Dukette  
Nathaniel Haynes  
Laurie Jennison  
Sturdy Thomas  
**TYPESSETTING**  
Sara Bedell  
Darlene Bailey  
Prem Krishna Gongaju  
Lynn Haines  
Cynthia Letourneau  
Len Lorette  
Debbie Nutting  
Lindy Palmisano  
Heidi Thomas  
Sue Weller

**GENERAL MANAGER/VICE PRESIDENT**  
Debra Wetherbee

**CONTROLLER/VICE PRESIDENT**  
Roger J. Murphy

**ACCOUNTING MANAGER**  
Knud Keller KV4GG/1

**CIRCULATION MANAGER**  
Patricia Ferrante  
603-924-9471

**BULK SALES MANAGER**  
Ginnie Boudrieau  
1-800-343-0728

**ADVERTISING**  
603-924-7138  
Jim Gray W1XU, Mgr.  
Nancy Ciampa, Asst. Mgr.  
Ross Kenyon KA1GAV  
Cornelia Taylor, Office Coordinator

# FM "Dual-Bander"

**NEW**



**2 m & 70 cm in single compact package, LCD, 25 W, optional voice synthesizer.**

## TW-4000A

**KENWOOD's TW-4000A FM "Dual-Bander" provides new versatility in VHF and UHF operations, uniquely combining 2 m and 70 cm FM functions in a single compact package.**

### TW-4000A FEATURES:

- **2 m and 70 cm FM in a Compact Package**  
Covers the 2 m band (142.000-148.995 MHz), including certain MARS and CAP frequencies, plus the 70 cm FM band (440.000-449.995 MHz), all in a single compact package. Only 6-3/8 (161)W x 2-3/8 (60)H x 8-9/16 (217)D inches (mm), and 4.4 lbs. (2.0 kg.).
- **Large, Easy-to-Read LCD Display**  
A green, multi-function back-lighted LCD display for better visibility. Indicates frequency, memory channel, repeater offset, "S" or "RF" level, VFO A/B, scan, busy, and "ON AIR." Dimmer switch.
- **25 Watts RF Power on 2 m/70 cm.**  
Hi/Lo power switch.
- **Optional "Voice Synthesizer Unit"**  
Installs inside the TW-4000A. Voice announces frequency, band, VFO A or B, repeater offset, and memory channel number.
- **Front Panel Illumination**

- **10 Memories with Offset Recall and Lithium Battery Backup**  
Stores frequency, band, and repeater offset. Memory 0 stores receive and transmit frequencies independently for odd repeater offsets, or cross-band operation.
- **Programmable Memory Scan**  
Programmable to scan all memories, or only 2 m or 70 cm memories. Also may be programmed to skip channels.
- **Band Scan in Selected 1-MHz Segments**  
Scans within the chosen 1-MHz segment (i.e., 144.000-144.995 or 440.000-440.995, etc.). The scanning direction may be reversed by pressing either the "UP" or "DOWN" buttons on the microphone.
- **Priority Watch Function**  
Unit switches to memory 1 for 1 second each 10 seconds, to monitor the activity on the priority channel.
- **Common Channel Scan**  
Memory 8 and 9 are alternately scanned every 5 seconds. Either channel may be recalled instantly.
- **Dual Digital VFO's**  
Selectable 5-kHz or 10-kHz for 2 m, and 5-kHz or 25-kHz for 70 cm. Depress "UP" or "DOWN" key on the front panel for band change in 1-MHz steps.
- **16-Key Autopatch UP/DOWN Microphone (Supplied)**
- **Repeater Reverse Switch**

- **High Performance Receiver/Transmitter**  
GaAs FET RF amplifiers on both 2 m and 70 cm, high performance MCF's in the 1st IF section, provide high receive sensitivity and excellent dynamic range. The high reliability RF power modules assure clean and dependable transmissions on either band.
  - **Rugged Die-cast Chassis**
  - **Optional Two-Frequency CTCSS Encoder**  
Easily mounted inside the radio, allows DIP switch programming of two different tone frequencies, for 2 m and 70 cm.
  - **"BEEPER" sounds through speaker.**
  - **Easy-to-Install mobile mount**
- TW-4000A accessories:**
- **VS-1 Voice Synthesizer**
  - **TU-4C Two-Frequency Programmable CTCSS Encoder**
  - **KPS-7A Fixed station power supply**
  - **SP-40 Compact mobile speaker**

More information on the TW-4000A and TS-780 is available from all authorized dealers of Trio-Kenwood Communications, 1111 West Walnut Street, Compton, California 90220.

# KENWOOD

...pacesetter in amateur radio

## All mode "Dual-Bander"

### TS-780

**2 m & 70 cm all mode, dual digital VFO's, 10 memories, scan, IF shift...**

### TS-780 FEATURES:

- USB, LSB, CW, FM all mode, covering the 2 m band (144.000-148.000 MHz) and the middle 70 cm band (430.000-440.000 MHz). UP/DOWN band switch.
- Dual digital VFO's with normal/tight drag switch. VFO steps in 20-Hz, 200-Hz, 5-kHz, or 12.5-kHz, plus "FM CH" channel-

ized tuning. Split (cross) frequency operation possible. F. LOCK switch provided.

- 10 memories include band and frequency data, backed up by internal batteries (not supplied). Battery life exceeds one year. Memories 9 and 10 for priority instant recall.
- Band scan, with selectable 0.5, 1, 3, 5, and 10-MHz scan bandwidth.
- Memory scan selectable for all memories, or 2 m or 70 cm only.
- IF shift circuit rejects adjacent interference.
- High sensitivity and wide dynamic range • 7-digit

fluorescent tube digital display  
• 10 watt RF output • 2 m  $\pm$ 600-kHz TX offset switch with reverse switch • Tone switch for optional TU-4C two frequency tone

encoder unit • VOX and semi break-in CW built-in • FM center-tune meter • Noise blanker for SSB, CW.



# Blueprint for Success

## THE INTERFACE

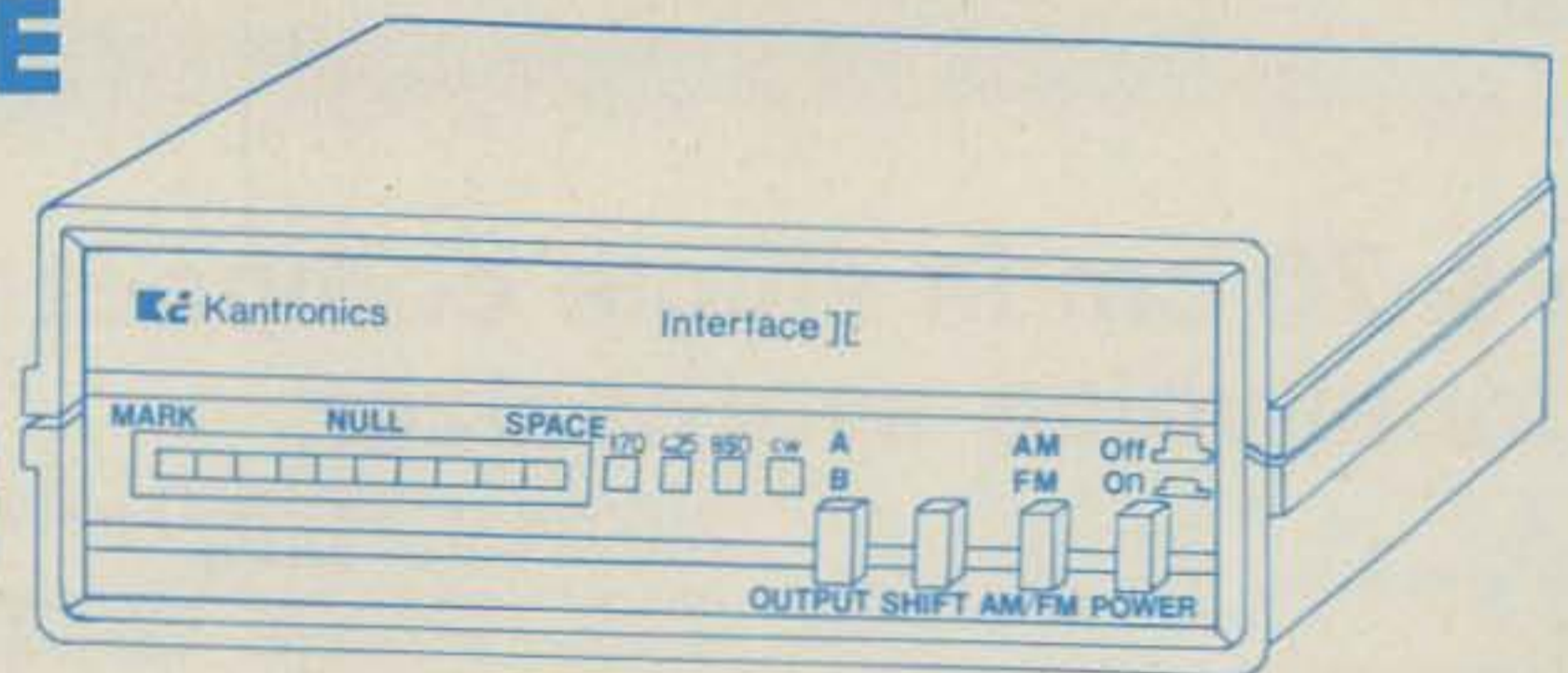
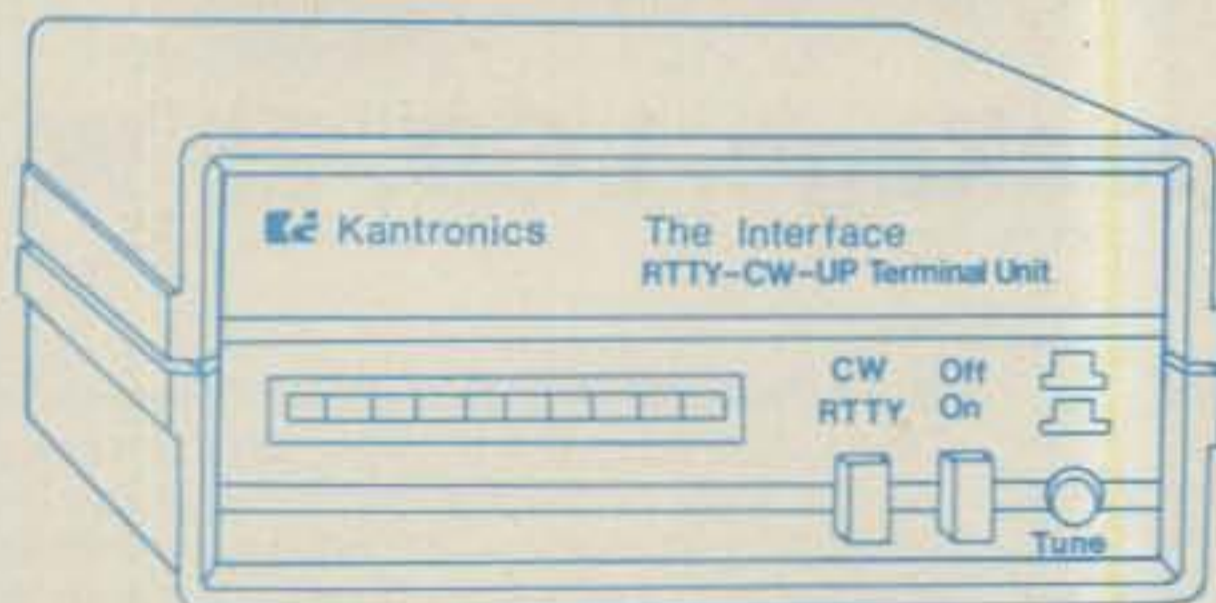

## THE INTERFACE II

 Kantronics

TITLE: THE INTERFACE - INTERFACE II PROPOSAL

**THE INTERFACE** is the original Kantronics terminal unit that broke through the barrier of multi-computer compatibility. **THE INTERFACE** is an amateur modem for transceiver-to-computer communication. With **THE INTERFACE** and Hamsoft or Hamtext for your computer you can send and receive Morse Code, Radioteletype, and ASCII. **THE INTERFACE** is also compatible with our new software for AMTOR communication, AMTORSOFT. **THE INTERFACE** is our most popular unit combining active filtering, easy tuning, six-computer compatibility, and low price for an unbeatable package.

**Suggested Retail** ..... \$169.95

**INTERFACE II** is the new Kantronics transceiver-to-computer interface. **INTERFACE II** features a new highly sensitive front end with mark and space filtering and a unique new tuning system. Even the most discerning operator will be surprised with the **INTERFACE II**'s ability to dig out signals in poor band conditions, and our new tuning system even displays signal fading.

X-Y scope outputs and dual interface outputs for VHF and HF connections make **INTERFACE II** compatible with almost any shack. All three standard shifts are selectable and **INTERFACE II** is compatible with the industry standard Kantronics programs: Hamsoft, Hamtext, and Amtorsoft. Step up to state of the art in computer-amateur communications with **INTERFACE II**.

**Suggested Retail** ..... \$269.95

For more information see your Kantronics dealer, or contact:

 Kantronics 1202 E. 23rd Street Lawrence, KS 66044



# KANTRONICS SOFTWARE

## Hamsoft,™ Hamtext,™ and Amtorsoft™

MORSE 00:00:00  
 TRANSMIT SPEED 25  
 RECEIVE SPEED 28

-----  
 ENJOY YOUR MEAL AND  
 WE'LL TALK TO YOU  
 REAL SOON ... 73'S ...  
 WA5RGU  
 WEATHER HERE IS WARM TODAY  
 WITH LOTS OF SUN. ...XYL SAYS  
 TIME FOR DINNER SO 73'S WØXI

Kantronics has led the amateur community in software and total computer communications systems with our original program, **HAMSOF**T. With five-computer compatibility and reasonable prices **HAMSOF**T has become the industry standard. **HAMSOF**T includes split screen display, type ahead buffer, message ports, and complete keyboard control for Morse Code, Radioteletype, and ASCII communications. With THE INTERFACE or INTERFACE II, **HAMSOF**T can make any of five computers a complete amateur communications terminal. All programs are on a ROM board, except the Apple diskette.

VIC-20 - \$49.95, ATARI - \$49.95, APPLE - \$29.95,  
 TRS-80C - \$59.95, TI-99/4A - \$99.95

**HAMTEXT** is our advanced CW/RTTY/ASCII program for the VIC-20, COMMODORE 64, and APPLE computers. **HAMTEXT** gives you the ability to store incoming messages in the computer's memory, transmit files directly from tape or disk, and use your computer to its fullest potential. Features like Diddle, Time Transmission, Text Transmission, Printer Outputs, and Word Wraparound, make **HAMTEXT** the program for the serious amateur. **HAMTEXT** was created with input from our users as guidelines, and with total use of the computer in mind.  
**Suggested Retail** ..... \$99.95

00:00:00

PROGRAM OPTIONS

- A. RETURN TO BASIC
- B. EDIT MESSAGE PORTS
- C. SAVE MESSAGE PORTS
- D. LOAD MESSAGE PORTS
- E. SET XMIT BUFF SIZE
- F. EDIT HOLDING BUFFER
- G. SAVE HOLDING BUFFER
- H. LOAD HOLDING BUFFER
- I. SET TIME

00:00:00

KANTRONICS AMTORSOFT  
 COPYRIGHT 29 JUNE 1983

CHOOSE  
 S (AMTOR SLAVE)  
 M (AMTOR MASTER)  
 L (AMTOR LISTENER)  
 P (PROGRAM OPTIONS)  
 T (T/R OPTIONS)

On January 27th, 1983, AMTOR, Amateur RadioTeletype Over Radio, became a legal mode for the amateur service. AMTOR is an essentially error-free radioteletype form of communication. **AMTORSOFT**, Kantronics' newest software package, gives your computer the ability to become an AMTOR communications terminal when used with The Interface or interface II. **AMTORSOFT** is currently available for the Apple, VIC-20, and COM-64 computers. **AMTORSOFT** brings you the newest in computer-amateur communications at an affordable price.

**Suggested Retail** ..... \$89.95

For more information see your Kantronics dealer, or contact:  
 Kantronics 1202 E. 23rd Street Lawrence, KS 66044

# Construct the Callsign Power Supply

*KA1QZ put together aesthetics and electronics to produce a power supply that gives you more than good regulation.*

Limited funds along with the hassles of apartment living and QRO hamming forced me to explore QRPp operation as a last-ditch attempt to preserve some form of my ham radio hobby. A friend's donation of a Ten-Tec PM-3 5-Watt CW transceiver and a spare 12-V battery put me on the air while keeping QRM from my neighbors to a minimum. Eventually the battery expired, and I made the decision to dust off the soldering iron and build a small power supply rather than spend precious allowance for expensive batteries. I also wanted to have a power supply that would provide the necessary power for an Argonaut which I eventually hope to acquire.

Visions of state-of-the-art ham equipment with its fancy lights and whistles inspired me to construct something similar in terms of a functional conversation piece for my QRP station. Apart from a power supply to power the rig, few ham shacks can be found without a clock, so a digital-clock module seemed the ideal complement for the supply. Much to my delight, I found that the clock chips currently on the market were inexpensive enough to allow me to purchase a pair: one a 12-hour format and the other a 24-hour format. Thus, I could have the 12-hour clock set to local time and the other to UTC. Finally, a late-night flash of inspiration led me to com-

plete the power supply/clock console with a call-sign that lights up when the supply is on. Combining all into a Ten-Tec-style enclosure resulted in a real conversation piece as well as a multi-functional addition to the QRP station. Most important, the whole project did not bankrupt me and required only a few evenings worth of time.

## The Power Supply

The power supply was designed to provide an adequate amount of power at minimum cost for QRPp rigs in the 5-to-6-Watt class with some reserve for 12-V station accessories. The PM-3 requires 480 mA in the transmit mode, but the Argonaut draws 1 Amp in the transmit mode. The ac power supply available for the Argonaut delivers 13 V  $\pm$  0.5 V at 1.2 A. I decided that a 13-V supply capable of delivering 1.5 A to 2.0 A output current would be desirable.

The next step was to select an IC regulator. I ruled out the 78XX series of fixed-voltage regulators. Even though these regulators can be used for current output in excess of their guaranteed 1-A rating, it is not recommended operating these regulators at or above their

maximum current rating for extended periods of time.

To my knowledge, there are no readily-obtainable 2-A IC regulators. Going to the 3-Amp and above class of regulators was more money than I was willing to part with, especially when that much current capacity wasn't really needed. To utilize the full current capacity of these large regulators would also require a larger, more expensive transformer. A good compromise for this project was reached by using the LM317 variable-voltage regulator.

The LM317 is a 3-terminal positive voltage regulator with a guaranteed current output of 1.5 A. The output voltage is variable from 1.2 V to 37 V. Two external resistors are used to set the output voltage (see Fig. 1). The regulator output voltage is given by the equation:  $V_{out} = V_{ref}(1 + R_2/R_1) + I_{adj}R_2$ .

$V_{ref}$  refers to the 1.25-V reference voltage generated between the output and the adjustment terminal (terminal 2). The constant voltage across  $R_1$  causes a constant current to flow through output resistor  $R_2$ , giving the desired output voltage. For most purposes, the last term in the equation can be ignored since the  $I_{adj}$  term has units

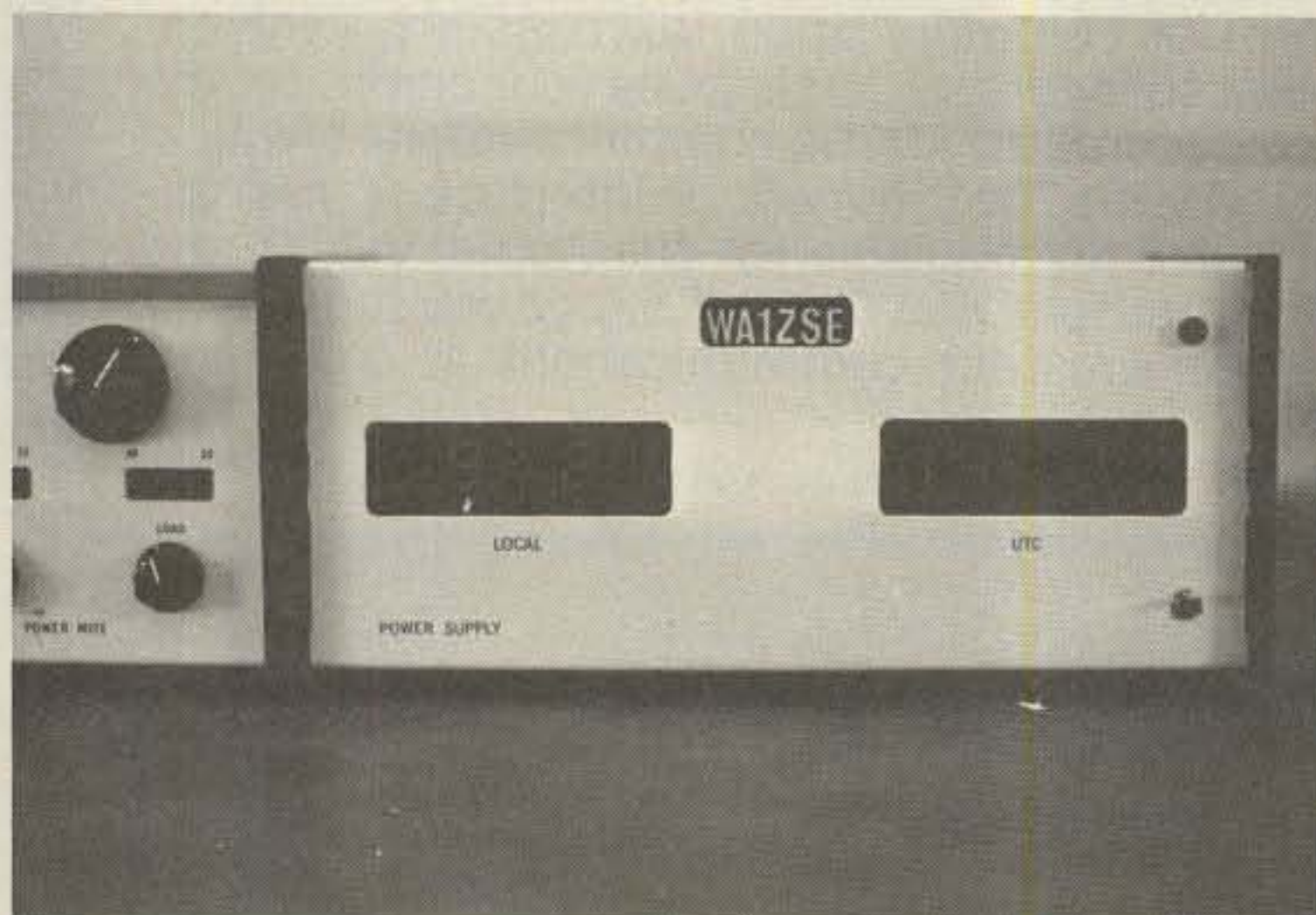

Photo A.

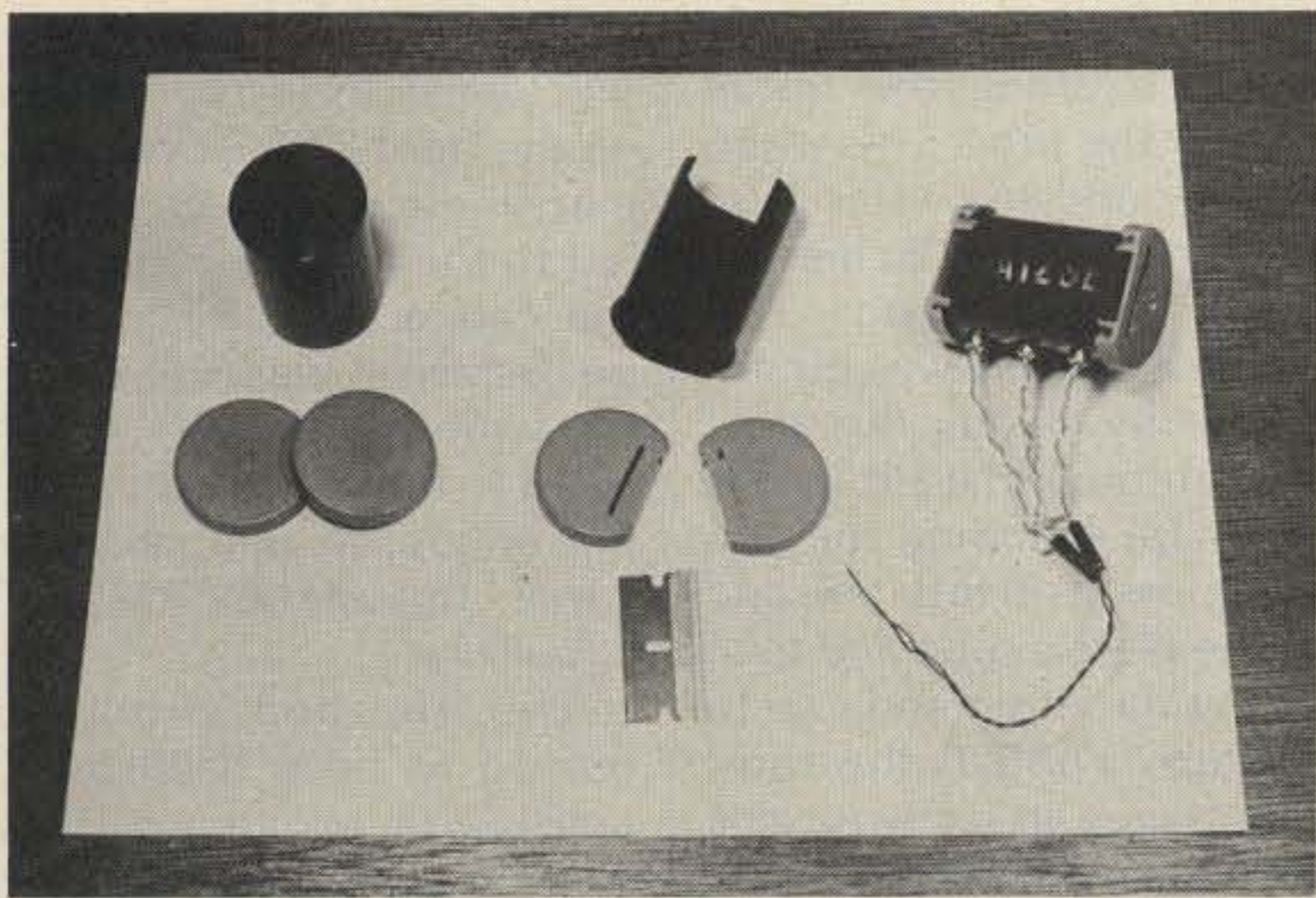

Photo B. Construction of callsign housing using 35mm plastic film cans. Completed unit is shown on the right. (My call then was WA1ZSE.)

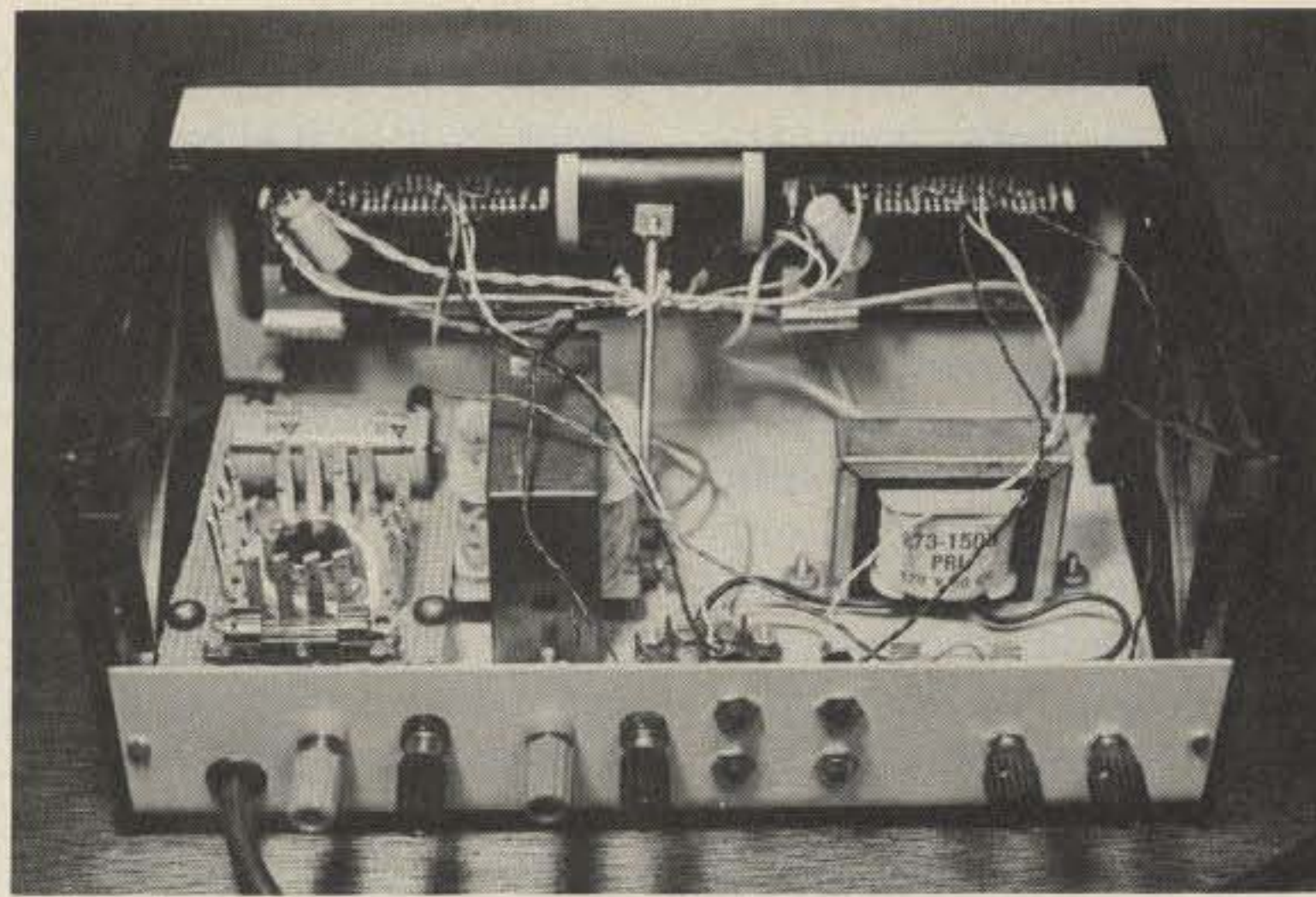

Photo C. Assembly of components into enclosure. Transformer on right powers both clock chips. QRP power supply is on the left. Two sets of binding posts allow for connection of QRP rig and an additional 12-V station accessory. Knobs at far right on the back panel are clock-dimmer pots (optional). The callsign housing in the center background is held in position by a 4" x 1/8"-diameter machine screw anchored to the bottom of the enclosure. An L-shaped bracket attaches the callsign housing to the mounting screw.

of microamps making the entire term insignificantly small.<sup>1</sup> The equation can be arranged to allow for easier calculation of the R2 value, given a desired output voltage and assuming R1 = 220 Ohms—an arbitrary but common value:  $R2 = (V_o - 1.25)220/1.25$ .

For a 13-V output in my supply, R2 = 2068 Ohms. A slightly higher value of R2 (say an additional 100 Ohms) may be necessary to offset the tolerance error of the resistors if an exact output of 13 V is desired. However, none of these values is critical as long as V<sub>o</sub> lies within the 12-14-V range required by most "12-V" rigs.

Although I used the more expensive TO-3 version of this regulator, the TO-220

package would work equally well provided it is mounted to an adequate heat sink.

The complete power supply circuit is shown in Fig. 1. Regulator circuit protection is provided by the current-limiting feature of the LM317. Overvoltage protection of the load is provided by the "crowbar" circuit.

Since direct-conversion receivers like the one in the PM-3 are prone to picking up hum from an ac power supply, 0.01-μF capacitors were inserted parallel to each rectifier diode. The addition of these capacitors to the rectifying portion of the supply eliminated virtually all ac hum from the audio output of the PM-3.<sup>2</sup>

### The Clocks

The digital-clock circuits used in this project were the MA1008A (National MM5385 12-hour-format chip) and the MA1008D (National MM5386 24-hour-format chip). Both clock chips were purchased new (close-out specials from Digital Research Parts) for under ten dollars for the pair. They came ready to use and required only a 12-V, 1.2-A transformer (which powered both chips) and momentary SPST switches (for setting the clocks) to be put into operation.

These chips were purchased in 1980, so their current availability and price may be different. However, there are a number of other parts-supply sources offering similar clock chips at very reasonable prices.<sup>3</sup>

Flea markets and ham conventions are other possible sources.

### The Callsign

The basic idea for the callsign came from the Heathkit SB-104 I once owned back in the pre-neighbor days. The lighted callsign in that rig consists of peel-and-stick letter blocks mounted on a transparent panel behind a red plexiglas™ filter. Each block has a black opaque background except for the outline of the letter which is clear to allow light to pass through when the panel light is turned on. It's a nice effect, and to my knowledge is a feature found only on the SB-104.

A 2" x 1/2" piece of window glass was obtained from the local hardware store as scrap. A dry transfer press-on letter set (#M12

#### Parts List

T1	25.2 V ct 2 A (RS 273-1512)
D1,D2	3 A, 50 piv (RS 276-1141)
C1, C2	0.01 uF (RS 272-1051)
C3	4700 uF 35 V dc (CS 20TM907)
U1	LM317K (CS LM317K)
R1	220 Ohm, 1/2 W (RS 271-015)
R2	2.2k, 1/2 W (RS 271-027)
F1	1 A Fast-blow (RS 270-1273)
CR1	1N4744 1 W, 14 V (CS 1N4744A)
CR2	2N6236 30 V, 4 A (CS 2N6236)
R3	220 Ohm, 1/2 W (RS 271-015)
R4	47 Ohm, 1/2 W (RS 271-009)

Heat sink (RS 276-1364)  
Heat sink compound (RS 276-1372)  
Mounting hardware  
Fuse holder

Note: RS = Radio Shack; CS = Circuit Specialists, PO Box 3047, Scottsdale AZ 85257.

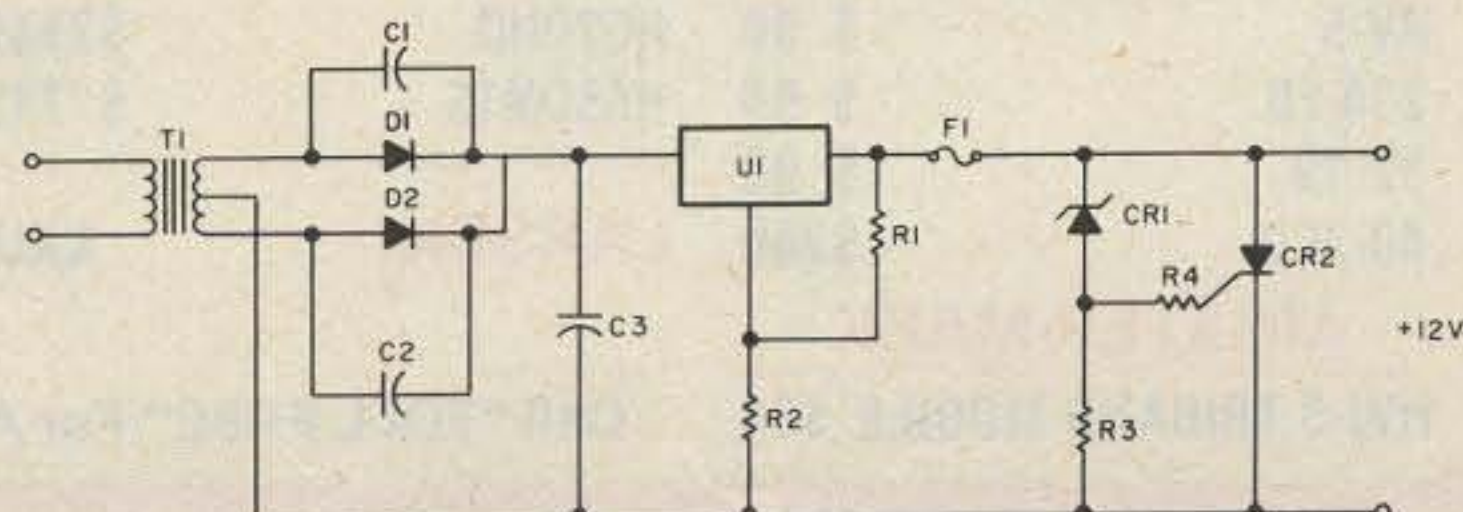

Fig. 1. Power supply schematic.

made by the C-Thru Ruler Co., Bloomfield, Connecticut, obtainable from stationery or art supply stores) was used to apply the call letters to the glass. The call letters were centered in both directions on the glass strip. Black enamel paint (obtainable at hobby stores selling modeling supplies) was applied to the glass surface using a fine-tipped brush. All of the glass surface surrounding the outlines of the letters was painted black. Two or three coats were necessary to ensure that no light could pass through the glass except through the letter outlines. By holding the glass up to a strong light after each coat of paint had dried, it was possible to see if a sufficient amount of paint had been applied to block out stray light.

A plastic 35mm film canister was used as the call-sign housing. The end of the plastic film can was re-

moved with a razor blade. A circumferential strip of about 3/4 inch was removed lengthwise from the plastic can creating an incomplete cylinder. The end cap from this can and the end cap from another film can were fitted to the tube. The caps were then cut flush with tube edges.

Next, slits were cut in the end caps corresponding to the width and thickness of the glass strip. Illumination of the call-sign was achieved by three 12-V bulbs (Radio Shack 272-1141) which were mounted equally spaced along the bottom surface of the tube. Holes were punched in the tube and the bulbs were snug-fitted. (Three small bulbs were used rather than a single, larger bulb in order to ensure even illumination of the call-sign and to ensure that the bulbs remained hidden from view.)

A small piece of white

poster paper was cut and wrapped along the inside wall of the tube. This white background served as a reflector to aid in achieving even illumination. The whole assembly was put together by sliding the glass strip through the slit in one end cap, snapping the end cap/glass strip into one end of the plastic tube and then fitting the other end cap to the tube. Photo B illustrates the stages in constructing the call-sign housing.

### The Enclosure

The enclosure used in this project was a Ten-Tec Model MG-10 (4 3/16" H x 9 1/16" W x 6 5/16" D) obtained at a flea market. Any type of metal cabinet with similar dimensions would do equally as well. The cut-outs for the clocks and the call-sign light were done using square Greenlee tools. The edges of the resulting holes were rounded with a file. In order to eliminate

unsightly clock-chip mounting screws from protruding on the front panel, flathead machine screws were epoxied to the inside surface of the cabinet. Finally, press-on lettering was used for the various labels. Photo C shows how the clocks, power supply, and call-sign were mounted in the enclosure.

The finished product proved to be a handsome and useful addition to the station. Low cost and construction simplicity are two of the most attractive features of this project. ■

### References

1. National Semiconductor *Voltage Regulator Handbook*, 1980.
2. Anderson, J. R., "Direct Conversion Receiver Hum," in "Hints and Kinks," QST, August, 1981.
3. Other sources for the clock chips include: Jameco Electronics, 1355 Shoreway Road, Belmont CA 94002 and Circuit Specialists, PO Box 3047, Scottsdale AZ 85257.

# MISSOURI RADIO CENTER 1-800-821-7323

## KENWOOD TS-430S



- All Bands
- General Coverage
- 200 Watts
- Dual VFO's
- 8 Memories

## ICOM IC-740



- 1.8 to 30 MHz
- Super Receiver
- 200 Watts
- Selectable IF/PBT Tuning

## YAESU -NEW FT-77



- Extremely Compact
- 200 Watts
- 3.5 to 30 MHz
- Inexpensive

## ANTENNA SALE

### CUSHCRAFT

A-3	\$175
A-4	\$226
R-3	\$226
AV-5	\$ 90
214-FB	\$ 69
32-19	\$ 82
40-2CD	\$260

### ANIXTER-MARK

HW-3 TRIBAND MOBILE \$34

### HY-GAIN TOWERS

HG37SS	\$ 649
HG52SS	\$ 919
HG54HD	\$1429
HG70HD	\$2339
HG50MTS	\$ 749

### LARSEN

CALL

### BUTTERNUT

HF6V	\$109
<b>KLM</b>	
KT34A	\$299
KT34XA	\$449
144-148LBA	\$ 69

### AEA

CALL

### HY-GAIN

TH5MK2S	\$318
TH7DXS	\$378
TH3MK3S	\$218
TH3JRS	\$158
TH2MKS	\$138
18AVT/WS	\$ 94
18HTS	\$335
V2S	\$ 37
EXPLORER 14	\$275

Call "TOLL FREE" For All Antennas & Accessories

2900 N.W. VIVION RD. / KANSAS CITY, MISSOURI 64150 / 816-741-8118

# HAM RADIO CENTER

IS GOING OUT  
FOR BUSINESS  
WITH

**CASH DISCOUNTS  
AND  
TERRIFIC  
TRADE-INS**

CALL TOLL-FREE  
**1-800-325-3636**

- FOR CASH PRICES
- FOR TRADE-IN QUOTE
- FOR USED EQUIPMENT PRICES

**WE FEATURE-DRAKE-ICOM-  
KENWOOD-TEN-TEC-YAESU**

**WE TRADE ON NEW OR USED  
EQUIPMENT**

**HAM RADIO CENTER**  
8340-42 Olive Blvd. • P.O. Box 28271 • St. Louis, MO 63132

IN MISSOURI CALL 1-314-993-6060



# The Magical Audio Filter

*A variable-frequency notch filter plus a peaking circuit will do wonders for your reception. And this project will almost build itself.*

**A**udio filtering is a well-known process for improving receiver selectivity and many articles have

been written on the subject. Because I have been in the process of building a direct-conversion receiver, I have been most interested in the subject. However, in order to further improve the receiver, I wanted more than the usual passband type of filter. Since one of the receiver modes is CW, I wanted a notch filter with a variable frequency and a variable-frequency peaking circuit. The notch filter could also be used on SSB reception to reject heterodynes from AM stations. Some of the requirements that I wanted for the notch filter were:

the notch frequency was approximately 200 Hz with a rejection of greater than 20 dB)

- the capability of shifting the notch frequency from 500 to 3 kHz
- a minimum number of parts.

*Manual.*<sup>1</sup> The circuit that interested me the most was the one providing variable frequency-notching using a variable capacitor. This circuit was constructed on a proto board and performed quite well, but the frequency range was limited by the maximum value of the capacitor. The basic circuit is shown in Fig. 1. The major drawback of this circuit was the large physical size of the capacitor as compared with the rest of the circuit.

Looking at the formula for the notch frequency (Fig. 1), one can see that the frequency is a function of R4, C1, and C2. The frequency varies directly as R4 and by the square root of C1 and

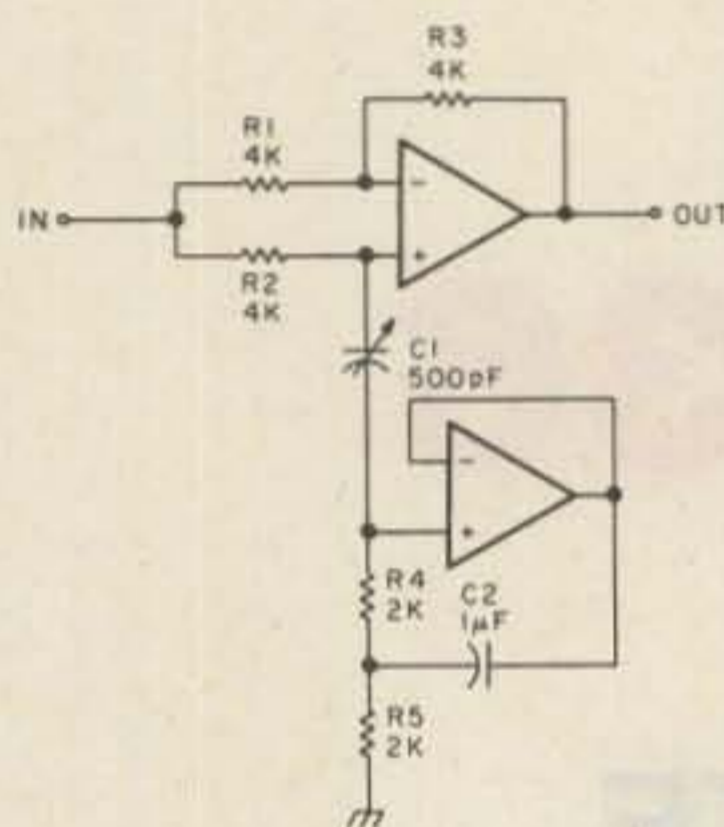

$$f_0 = \frac{1}{2\pi R_4 \sqrt{C_1 C_2}}$$

ALL RESISTORS 0.1%

Fig. 1. Original circuit.

## The Frequency-Notching Circuit

Most articles I'd seen on this subject showed at least three or four operational amplifiers plus a multitude of resistors and capacitors and therefore did not satisfy my third requirement.

One day, I accidentally ran across a number of circuits in a *National Semiconductor Linear Applications*

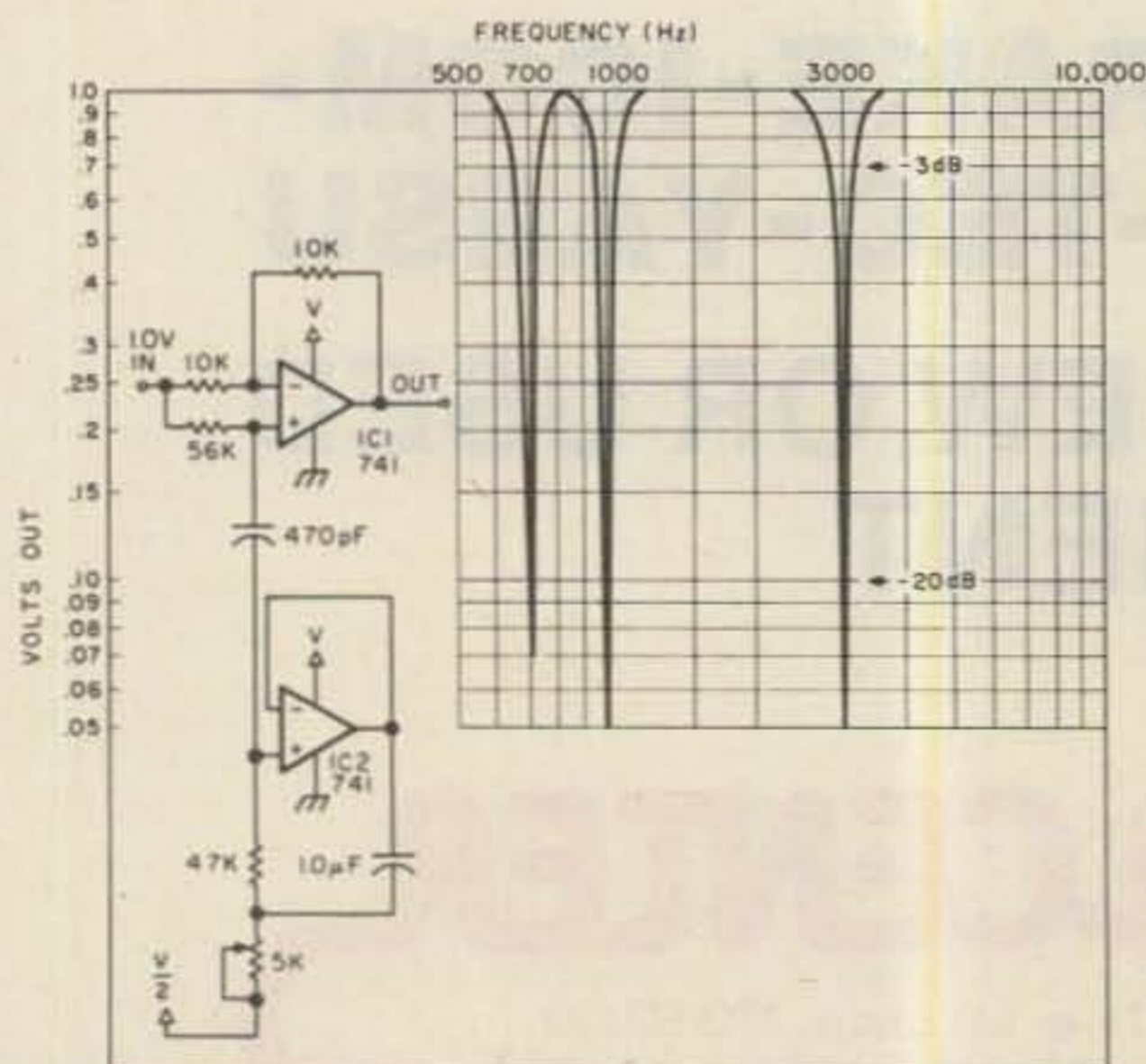

Fig. 2. Notch circuit.

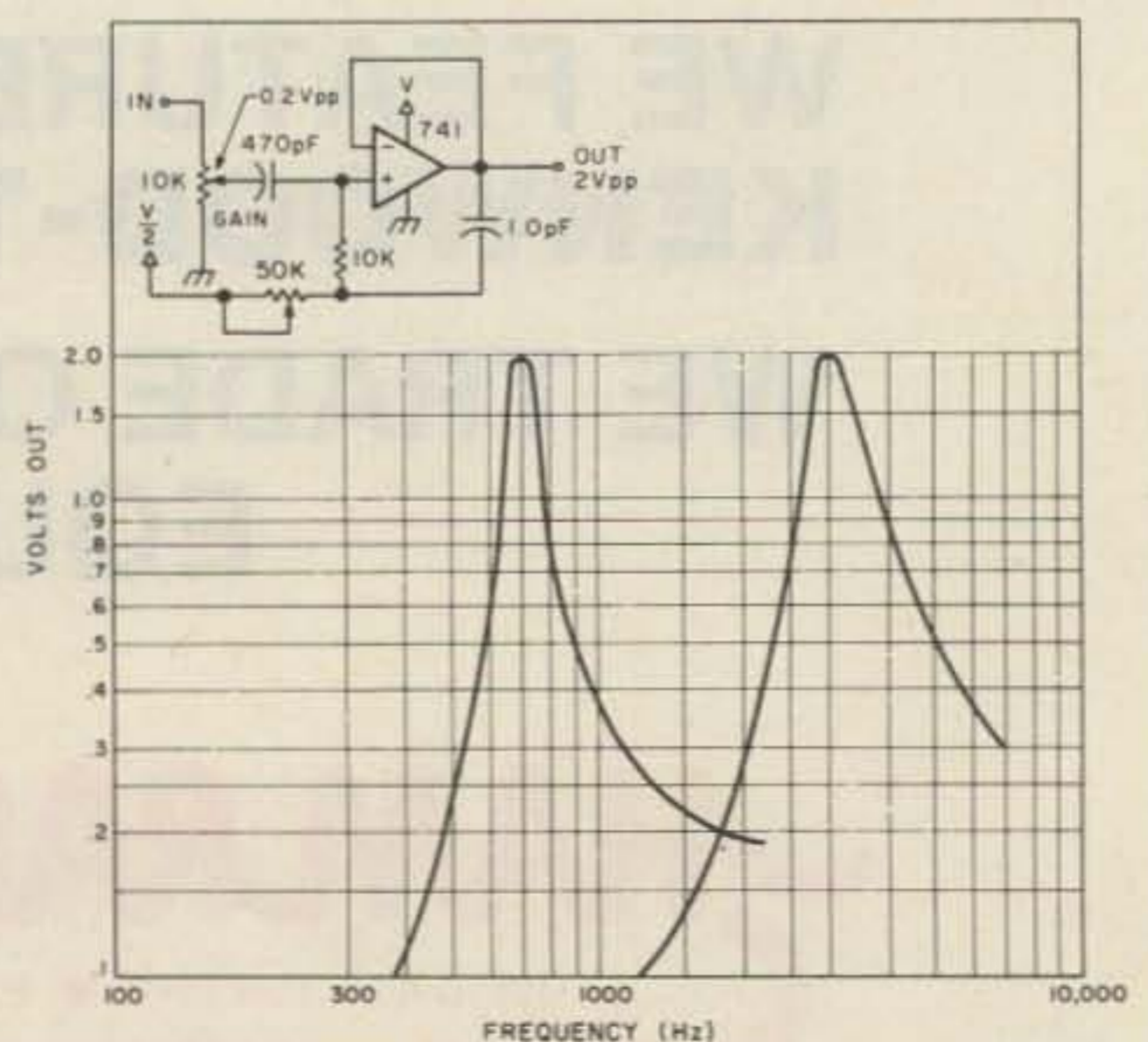

Fig. 3. Peaking circuit.

C2. Thus, if the resistor is doubled in value, the frequency doubles. Doubling the capacitors only gives 1.4 times the change. I decided to build the circuit with R4 variable and again results were very good. The frequency-range requirements were met and the rejection was greater than 20 dB. It did have one problem that was also experienced with the variable-capacitor circuit. In order to achieve maximum rejection at the high end vs. the low end, R3 had to be varied. Experimenting further, I found that if R5 were varied and R3 and R4 were properly chosen, only one control was necessary. Almost equal rejection could then be achieved across the whole range. A typical response is shown in Fig. 2.

### The Peaking Circuit

Since the above circuit was rather novel (there is no signal inversion from input to output at the off null point), I started to look at voltages at various points with an oscilloscope. To my amazement, I found that when the output was going to null on IC1, the output was peaking on IC2. Eureka!—Here was the second circuit I was looking for. To accomplish peaking, only IC2 was needed. This circuit was constructed and the results are shown in Fig. 3.  $R_{in}$  is necessary to prevent saturation of the amplifier. The gain of this stage is about 10—therefore the input must be less than 0.5 volts. The power supply used was plus and minus 8 volts to be equivalent to the supply to be used in the final construction.

It will be noticed that there is an additional resistor that can be switched in or out in the final circuit. When the resistor is in, the peak is broadened and the circuit can be used on AM or SSB to modify the speech characteristics of the trans-

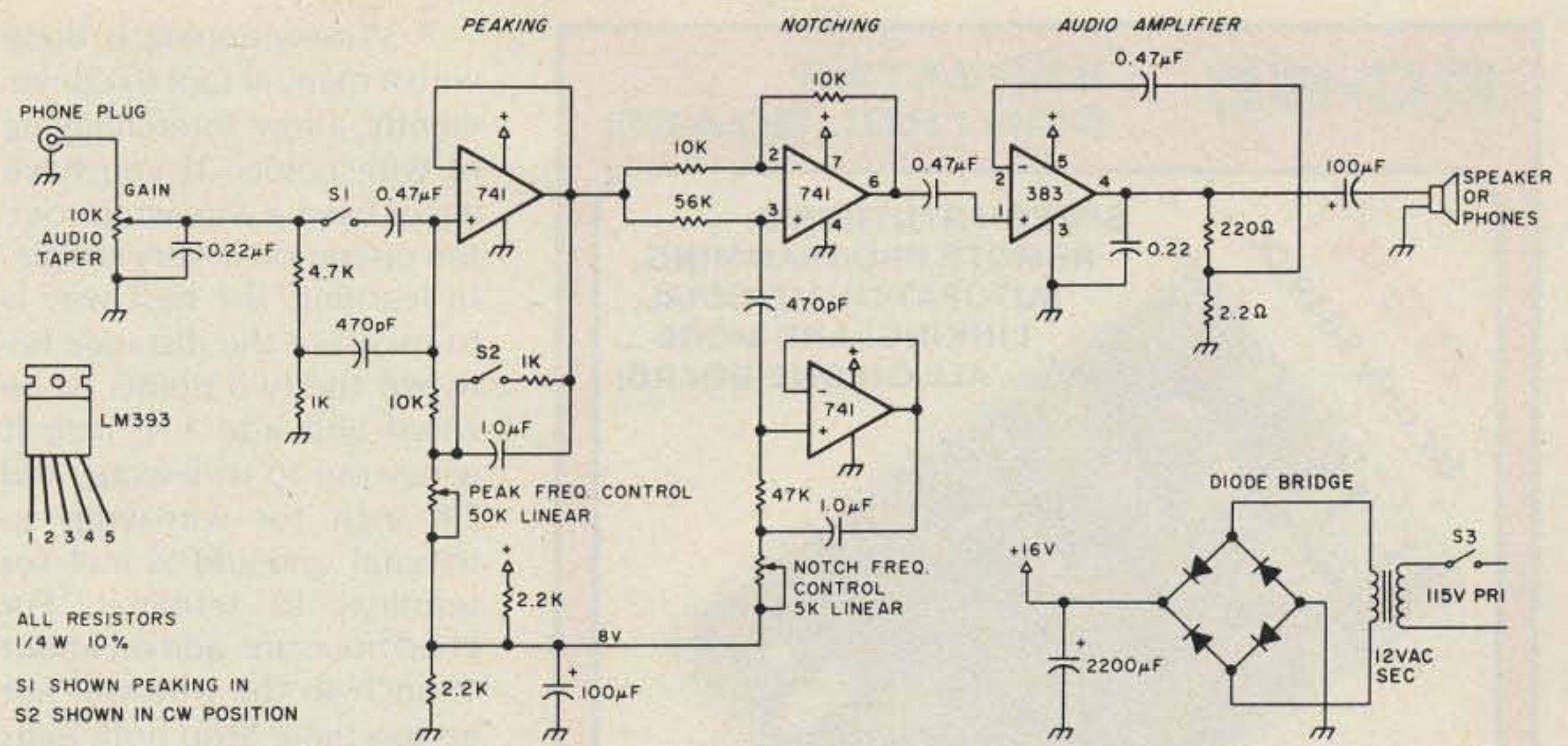

Fig. 4.

mitted signal being received. It can reduce the low frequencies and accentuate the frequencies that transmit the spectrum that contains the most intelligence. It also reduces higher frequencies, thereby reducing background noise.

### Combination Notch and Peaking Circuit

Fig. 4 shows the final circuit combining the two circuits. The circuit was constructed on a perfboard using wire-wrap sockets. The perfboard is mounted in a Radio Shack box with 1-inch spacers. Both the LM383 and the transformer are mounted to the box. One note of caution—the 0.22- $\mu$ F capacitor on the output to ground on the LM383 should be mounted on the device terminals. The input cable, the output jack, and the 115-V-ac input all come in on one end of the box and the potentiometers mount on top.

For some reason, not many articles ever use perfboards and wire-wrap sockets. PC boards should be used for rf work, but the perfboard does very well for audio frequencies. The nice thing about wire-wrap circuits is that if you make a mistake, it can be corrected or modified easily. The following are some hints on building with a perfboard and wire-wrap sockets.

Parts List		
Quantity	Part	R. S. part#
3	LM741	276-007
1	LM383	276-703
1	Phone plug	274-1536
1	Phone jack	274-252
1	50k linear pot	271-1716
1	10k audio taper pot	271-1723
1	5k linear pot	271-1714
2	470-pF capacitors	272-125
3	1.0- $\mu$ F capacitors	272-996
2	100- $\mu$ F capacitors	272-1016
2	0.22- $\mu$ F capacitors	272-1070
1	2200- $\mu$ F capacitor	272-1020
1	12-V-ac transformer	273-1505
3	8-pin DIP w-w sockets	276-1988
1	SPST switch pwr	275-602
2	SPST switches	271-612
1	Chassis box	270-238
1	Line cord	278-1255
3	Knobs	Your choice
1	Perfboard	276-1395
1 pkg	Push-in terminals	270-1392
1	Wire-wrap tool	276-1570
3	10k $\frac{1}{4}$ -W resistors	
2	2.2k $\frac{1}{4}$ -W resistors	
1	56k $\frac{1}{4}$ -W resistor	
1	47k $\frac{1}{4}$ -W resistor	
1	4.7k $\frac{1}{4}$ -W resistor	
2	1k $\frac{1}{4}$ -W resistors	
1	220-Ohm $\frac{1}{4}$ -W resistor	
1	2.2-Ohm $\frac{1}{4}$ -W resistor	
1	Bridge rectifier	276-1151
	Wire-wrap wire	Your choice of colors
	Misc. hardware	

1. Make a Xerox® copy of the schematic; every time you put in a wire, mark it down. This is especially helpful should you put the project away and come back to it later.

2. Using a marking pen on the wire side of the board, indicate which pin is #1 for

the IC sockets. Remember that the numbering on the wire side is opposite to that on top.

3. I use model-airplane cement to hold the IC sockets in place. If you want to reuse the perfboard, this type of glue allows the socket to be easily removed.

# RC-85

# REPEATER CONTROL BOARD

**NEW!**  
for only \$849.00

**SPEECH SYNTHESIS,  
REMOTE PROGRAMMING,  
AUTOPATCH/AUTODIAL,  
LINKING, AND MORE ...  
ALL ON ONE BOARD!**



Now any repeater budget can afford the benefits of an ACC controller. We've pioneered modern repeater control, and continue to lead the way in performance, reliability, and value.

Call or write for detailed specifications on the RC-85 Repeater Control Board.



advanced computer controls, inc.

10816 Northridge Square • Cupertino, CA 95014  
(408) 749-8330

✓ 124

Clean the board with acetone when the sockets are removed.

4. It is also helpful to use different colors of wire for different parts of the circuitry.

5. Push-in terminals (Radio Shack #270-1392) are used to mount the resistors and capacitors. The wire-wrap wires are soldered to these terminals on the wire side of

the board. (A special tool is available to insert these terminals but is not available from Radio Shack. Long-nose pliers can be used but are nowhere near as satisfactory as the tool.)

6. Mount the components when the push-in terminals are in place so as not to lose track of which terminal goes with which component.

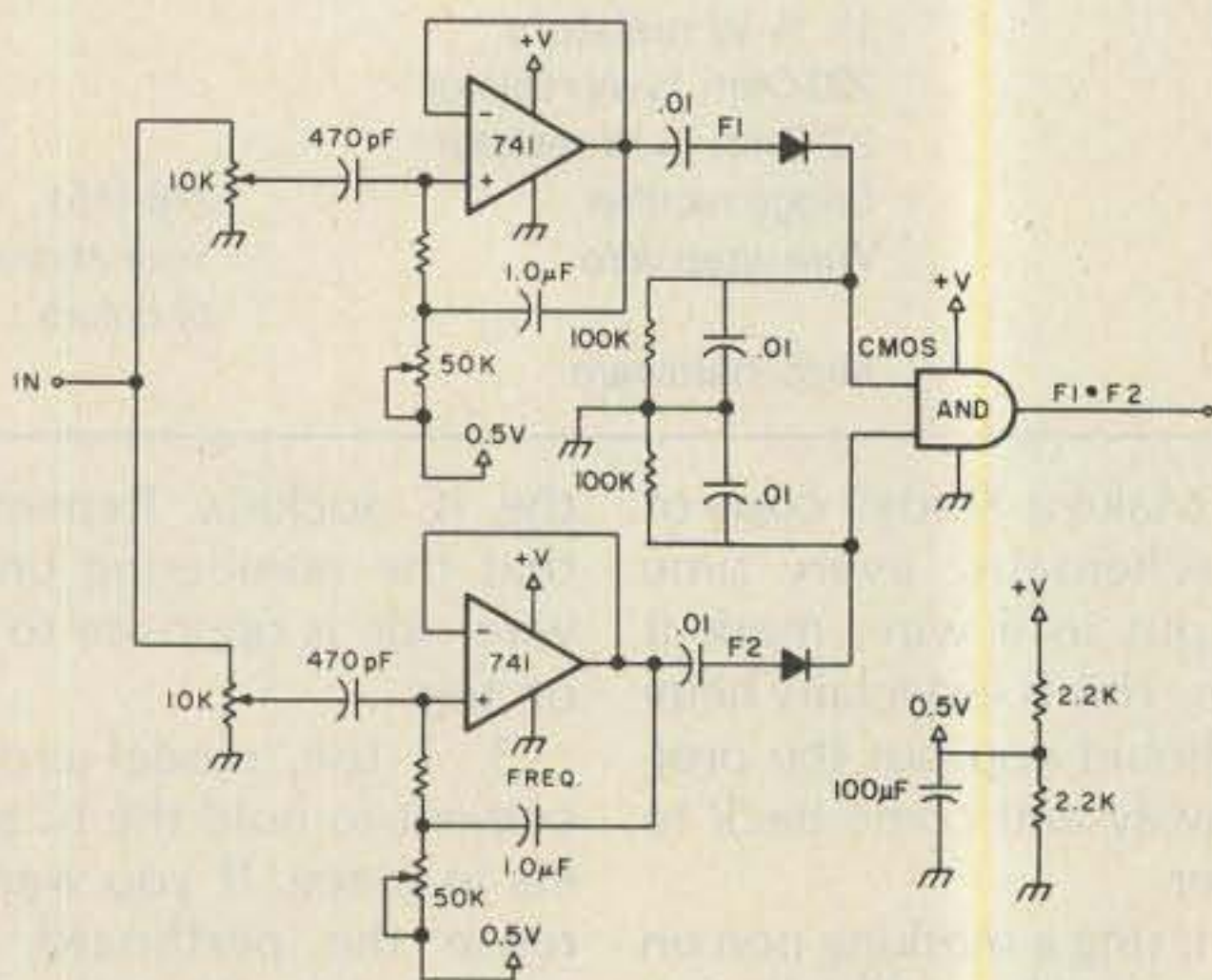

Fig. 5. Another application for peaking-circuit decoder.

7. Wire-wrapping is done with a manual tool to conveniently allow interchanging of wire colors. If you have never used a wire-wrap tool, the operation is very simple. In learning, the best way is to measure the distance between the two points to be wired and add 1 1/4 inch if wire-wrap to wire-wrap, add 7/8 inch for wire-wrap to terminal, and add 1/2 inch for terminal to terminal. For good measure, add on about 1/2 inch so the wire will not be too tight. Strip both ends 5/8 inch for wire-wrapping and 1/4 inch for terminals. Stripping is done with a special tool provided with the wire-wrap tool. The bare wire is inserted into the end of the wire-wrap tool with the wire entering the smallest hole on the end of the tool. Place the tool over the terminal post to be wrapped and rotate the tool in a clockwise direction for about ten turns. The connection is now made. If you make a mistake, a tool is available to rotate in the opposite direction to remove the wire.

### Circuit Operation

When the project is finished, the input cable can be plugged into the phone jack of any receiver and the output to either a speaker or headphones. Set S1, the peaking-circuit switch, to OUT. Tune in a CW signal and adjust the signal frequency to give about an 800-Hz tone. Throw S1 to IN and turn the peaking control to a point where the maximum audio is heard. The first thing you will notice with the peaking switch in is the reduction in noise. As you approach the peaking point, the signal will increase greatly in volume. Of course, if some other frequency suits you better than 800 Hz, that is the listener's choice.

The next thing to check is the notch filter. With the

800-Hz signal coming in, adjust the notch control to a point where the signal drops in volume. On some CW signals with key clicks and thumps, the 800-Hz signal will drop out but the clicks and thumps will still be there. I have found that it is easier to remove a heterodyne with the peaking circuit out; then bring in the peaking circuit, producing an even greater reduction in the interfering signal. When the notch circuit is not used, the pot should be set to the low-frequency end.

### Frequency-Selection Circuit

Another circuit is shown in Fig. 5. Although I have not tried this circuit, it could be of interest. I have tried LM567s in frequency-selective circuits, but noise spikes seem to get through, creating an unwanted output signal. A case in point is my garage-door opener. This unit had a vibrating-reed type of frequency detector and I replaced it with a pair of LM567s. Every once in awhile the door will open without a command due to noise. After I finish this project, reworking the opener will be my next project.

### Conclusion

The peaking/notching circuit should be a worthwhile addition to any receiver for a parts cost of about \$35 excluding the wire-wrap tool and wire that can be used on many other projects. It is a simple but effective way to gain a bit more selectivity that should improve any old receiver and maybe some of the newer ones.

A list of parts is given with all but one being available from Radio Shack. Of course, most hams will have many of these parts available in their junk boxes, bringing the overall cost down. ■

### References

1. National Semiconductor Linear Applications Manual, January, 1972, page AN 31-14.



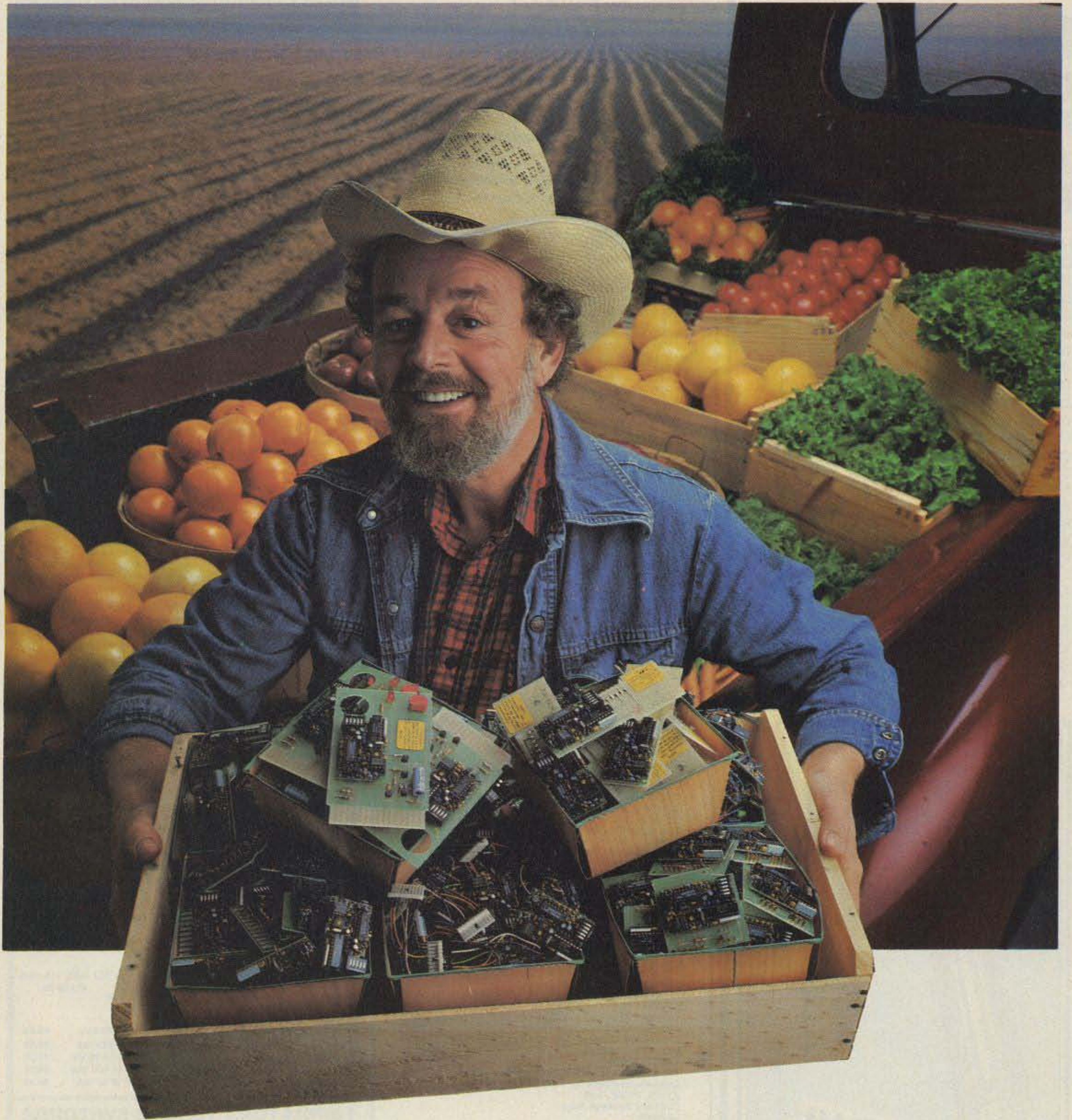

# Plug-In Bumper Crop

From the fertile grounds of Communications Specialists comes our fresh harvest of direct CTCSS plug-ins to spade through valuable installation time and cultivate profits. They're available for most popular mobiles, portables, and repeater panels, and all incorporate our industry standard, field programmable TS-32.

Just call our sales or engineering departments toll free from anywhere in the USA (including California) and reap what we've sown.

**COMMUNICATIONS  
SPECIALISTS** 34  
426 West Taft Avenue, Orange, CA 92667  
714/998-3021 Entire USA 800/854-0547



# HUSTLER

## DELIVERS RELIABLE ALL BAND HF PERFORMANCE

Hustler's new 6-BTV six-band trap vertical fixed station antenna offers all band operation with unmatched convenience. The 6-BTV offers 10, 15, 20, 30, 40, and 75/80 meter coverage with excellent bandwidth and low VSWR. Its durable heavy gauge aluminum construction with fiberglass trap forms and stainless steel hardware ensures long reliability.

Thirty meter kits (30-MTK) for 4-BTV and 5-BTV are also available.



Don't miss our 30 meter excitement.  
**HUSTLER - STILL THE STANDARD OF PERFORMANCE.**



3275 North "B" Avenue  
 Kissimmee, Florida 32741

An **AMATEUR** Company

812-422-0231

Mon-Fri 9AM-6PM  
 Sat 9AM-3PM

449



**The HAM SHACK**  
 808 N. Main  
 Evansville, IN 47711

Prices and Availability Subject to Change

<b>AEA</b>	
CP-1 New Computer Interface	\$189.00
AMT-1 Amtor Terminal	Call
144 Isopole Antenna	40.00
<b>ALLIANCE</b>	
HD73 (10.7 sq ft) Rotator	\$99.00
U-110 Small Rotator	49.00
<b>ASTRON</b>	
RS7A 5-7 Amp Power Supply	\$49.00
RS12A 9-12 Amp Power Supply	69.00
RS20A 16-20 Amp Power Supply	89.00
RS20M 16-20 Amp w/meter	109.00
RS35A 25-35 Amp	135.00
RS35M 25-35 Amp w/meter	149.00
RS50A 37-50 Amp	199.00
RS50M 37-50 Amp w/meter	225.00
<b>B&amp;W</b>	
Continuous Coverage Ant. 2-30 MHz No Tuner Necessary	\$135.00
<b>BASH</b>	
Books and Tapes	\$9.95
<b>BENCHER</b>	
BY-1 Paddle/BY-2 Chrome	\$36.00/45.00
ZA-1A Balun	16.50
<b>BUTTERNUT</b>	
HF6V 80-10 Meter Vertical	\$119.00
<b>CUSHCRAFT</b>	
A3 Tribander 3EL	\$215.00
A4 Tribander 4EL	285.00
214FB Boomer 14EL FM	75.00
32-19 Super Boomer 19EL 2M	95.00
ARX-2B Ringo Ranger II 2M	39.00
416-TB Satellite Ant.	65.00
<b>DAIWA</b>	
CN-520 1.8-60 MHz SWR/Pwr Mtr	\$63.00
CN-620B 1.8-150 MHz SWR/Pwr Mtr	110.00
<b>DRAKE</b>	
TR7A Xcvr w/PS7	\$1,435.00
R7A Receiver	1,189.00
TR5 Xcvr w/PS75	675.00
<b>ENCOMM (SANTEC)</b>	
ST-144uP, 220uP, 440uP	
The Handhelds Offering the Most Features Call for Your Discount Price	
<b>HAL</b>	
DS3100/MPT/ST6000	\$2,825.00
CT2200/KB2200	945.00
CWR6850 Telereader	745.00
<b>HY-GAIN</b>	
TH7 DXS 7EL Tribander	\$375.00
TH5 MK2S 5EL Tribander	319.00
Explorer 14 Tribander	279.00
V2S 2 Meter Vertical	39.00
Ham IV 15 sq ft Rotator	195.00
T2X 20 sq ft Rotator	249.00
Free Shipping on all crank-up towers	
<b>ICOM</b>	
We Have All the Great ICOM Transceivers in Stock Call About the New Ones Now Available	
IC-2AT	Now Only \$215.00
3AT/4AT Handhelds	235.00
25A new display & mic	305.00
290H 2M All Mode	479.00
271A All Mode	625.00
471A Oscar All Mode	Call
751 Ultimate Transceiver	1,250.00
745 New General Coverage Xcvr	Call
45A 440 MHz	349.00
R70 Rcvr/Free World Clock	629.00
<b>KLM</b>	
KT34A 4EL Triband Beam	\$299.00
KT34XA 6EL Triband Beam	459.00
144-148-13LBA 2M Long Boomer	79.00
143-150-14C 2M Satellite Ant.	79.00
420-470-18C Satellite Ant.	59.00
Maximizer Antennas	Call
<b>KANTRONICS</b>	
The Fantastic Interface for CW, RTTY, ASCII Software Available for VIC20, VIC64, APPLE, ATARI, TR80C, TI99 Call for a Package Price	
<b>LARSEN</b>	
NLA-150-MM 5/8 Wave 2M Mag Mt	\$39.00
<b>MFJ</b>	
1224 New Computer Interface	Call
941C Tuner/Meter/Ant. Switch/Balun	\$81.00
422 Keyer/BENCHER Paddle combo	89.00
313 VHF Conv for HT	36.00
989 3KW Tuner	285.00
<b>MIRAGE</b>	
D1010/N 440 MHz Amp	\$279.00
B1016 10/160 Preamp	245.00
B3016 30/160 Preamp	199.00
<b>ROHN</b>	
25G	\$42.00
<b>SHURE</b>	
444D Desk Mic	\$50.00
<b>TEN-TEC</b>	
New 2M Handheld	Call
Argosy II Digital	\$535.00
2KW Tuner Kit	185.00
The Fantastic Corsair	Call
<b>TOKYO HY-POWER</b>	
HL30V 2/30W Amp	\$63.00
HL160V 3 or 10/160W Preamp	295.00
HC2000 2KW Tuner	295.00
HL90U 440 MHz w/Preamp	305.00
<b>YAESU</b>	
Now in Stock	Call for Prices
726R Multiband & Mode Oscar Rig	Call

Send SASE for Our New & Used Equipment List  
 Prices are FOB Evansville

TOLL FREE ORDERS • 1-800-826-5432  
 (IN CALIFORNIA 1-800-258-6666)  
 INFORMATION • (213) 380-8000

### MINIATURE 6 VDC RELAY



SUPER SMALL  
 SPDT RELAY;  
 GOLD COBALT  
 CONTACTS.

RATED 1 AMP AT 30 VDC;  
 HIGHLY SENSITIVE, TTL  
 DIRECT DRIVE POSSIBLE.  
 OPERATES FROM 4.3 TO  
 6 V, COIL RES. 220 OHM.  
 1 3/16" x 13/32" x 7/16"  
 AROMAT # RSD-6V  
**\$1.50 EACH**  
 10 FOR \$13.50

### 120V INDICATOR

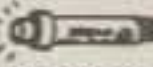

NEON INDICATOR RATED  
 120 V 1/3 W. MOUNTS IN  
 5/16" HOLE ... RED LENS.  
**75¢ EACH**  
 10 FOR \$7.00  
 100 FOR \$65.00

### METERS

#### 1 MA

2 5/16" SQUARE  
 PANEL METER  
 MOUNTS IN  
 2 1/8" HOLE  
**\$5.50 EACH**



#### 0 - 15 V.D.C.



THIS 2-1/4"  
 SQUARE METER  
 MEASURES  
 0-15 VDC.  
**\$4.50 EACH**

### 13 VDC RELAY



CONTACT: S.P.N.C.  
 10 AMP @ 120 VAC  
 ENERGIZE COIL TO  
 OPEN CONTACT ...  
 COIL: 13 VDC 650 OHMS  
**SPECIAL PRICE \$1.00 EACH**

### KEY ASSEMBLY

#### 5 KEY

**\$1.00 EACH**  
 CONTAINS 5 SINGLE-POLE  
 NORMALLY OPEN SWITCHES.  
 MEASURES 3 3/4" LONG

#### 6 KEY

**\$1.25 EACH**  
 CONTAINS 6 SINGLE-POLE  
 NORMALLY OPEN SWITCHES.  
 MEASURES 4 1/4" LONG.

### L.E.D.'S

#### STANDARD JUMBO

#### DIFFUSED

RED 10 FOR \$1.50  
 GREEN 10 FOR \$2.00  
 YELLOW 10 FOR \$2.00

#### FLASHER LED

5 VOLT OPERATION  
 RED JUMBO SIZE  
**\$1.00 EACH**

#### BI POLAR LED

2 FOR \$1.70

#### LED HOLDERS

TWO PIECE HOLDER  
 FOR JUMBO LED  
**10 FOR 65¢ 200 FOR \$10.00**

### MULTI-SWITCHES



5 STATION INTERLOCKING  
 3-2PDT AND 2-6PDT SWITCHES ON FULLY  
 INTERLOCKING ASSEMBLY, 3/4" BETWEEN  
 MOUNTING CENTERS. **\$2.50 EACH**

5 STATION NON-INTERLOCKING  
 SAME AS ABOVE, EXCEPT EACH SWITCH  
 OPERATES INDEPENDENTLY. **\$2.50 EACH**

FREE SEND FOR NEW LARGER 48 PAGE CATALOG

### COMPUTER GRADE CAPACITORS

1700 mfd. 150 VDC \$2.00  
 2 1/2" DIA. x 4 3/4" HIGH  
 3,600 mfd. 40VDC \$1.00  
 1 3/8" DIA. x 3" HIGH  
 6,400 mfd. 60 VDC \$2.50  
 1 3/8" DIA. x 4 1/4" HIGH  
 18,000 mfd. 75 VDC \$4.00  
 2 1/2" DIA. x 4 1/2" HIGH  
 22,000 mfd. 15 VDC \$2.00  
 2" DIA. x 2 1/2" HIGH  
 22,000 mfd. 40 VDC \$3.00  
 2" DIA. x 6" HIGH  
 24,000 mfd. 30 VDC \$3.50  
 1 3/4" DIA. x 4" HIGH  
 31,000 mfd. 15 VDC \$2.50  
 1 3/4" DIA. x 4" HIGH  
 72,000 mfd. 15 VDC \$3.50  
 2" DIA. x 4" HIGH  
 180,000 mfd. at 6V \$1.50  
 2 1/2" DIA. x 4 1/2" HIGH  
 CLAMPS TO FIT CAPACITORS 80¢ ea.

### TRANSFORMERS

#### 120 volt primaries

5.6 VOLTS at 750 MA \$3.00  
 6 VOLTS at 150 MA \$1.25  
 16.5 V. at 3 AMPS \$6.50  
 18 V at 650 MA \$3.50  
 18 VOLTS at 1 AMP \$4.50  
 18 V.C.T. at 2 AMP \$5.50  
 24 VOLTS at 250 MA \$2.50  
 24 VCT at 1 AMP \$4.50  
 42 V.C.T. at 1.2 AMP \$4.50

### WALL TRANSFORMER

#### ALL ARE 115 VAC PLUG IN

4 VDC at 70 MA \$2.50  
 9 VDC at 225 MA \$3.00  
 16.5 VAC at 10 VA \$3.50  
 17 VAC at 500 MA \$4.00  
 22 VDC at 80 MA \$2.50

### MINIATURE TOGGLE SWITCHES

ALL ARE RATED 5 AMPS @ 125 VAC

**S.P.D.T. (on-on)**  
 P.C. STYLE, NON-THREADED BUSHING. **75¢ EACH**  
 10 FOR \$7.00

**S.P.D.T. (on-on)**  
 SOLDER LUG TERMINALS. **\$1.00 EACH**  
 10 FOR \$9.00  
 100 FOR \$80.00

**S.P.D.T. (on-off-on)**  
 SOLDER LUG TERMINALS. **\$1.00 EACH**  
 10 FOR \$9.00  
 100 FOR \$80.00

**S.P.D.T. (on-off-on)**  
 NON-THREADED BUSHING. P.C. STYLE **75¢ EACH**  
 10 FOR \$7.00

**S.P.D.T. (on-on)**  
 P.C. LUGS, THREADED BUSHING. **\$1.00 EACH**  
 10 FOR \$9.00  
 100 FOR \$80.00

**D.P.D.T. (on-on)**  
 SOLDER LUG TERMINALS. **\$2.00 EACH**  
 10 FOR \$19.00  
 100 FOR \$180.00

**ALL ELECTRONICS CORP.**  
 905 S. VERMONT • P.O. BOX 20406 • LOS ANGELES, CA 90006

QUANTITIES LIMITED • FOREIGN ORDERS INCLUDE SUFFICIENT SHIPPING  
 MINIMUM ORDER \$10.00 • USA \$2.50 SHIPPING • CALL, RES. ADD \$1.25  
 NO C.O.D.

# CHAMPAGNE RTTY/CW on a Beer Budget

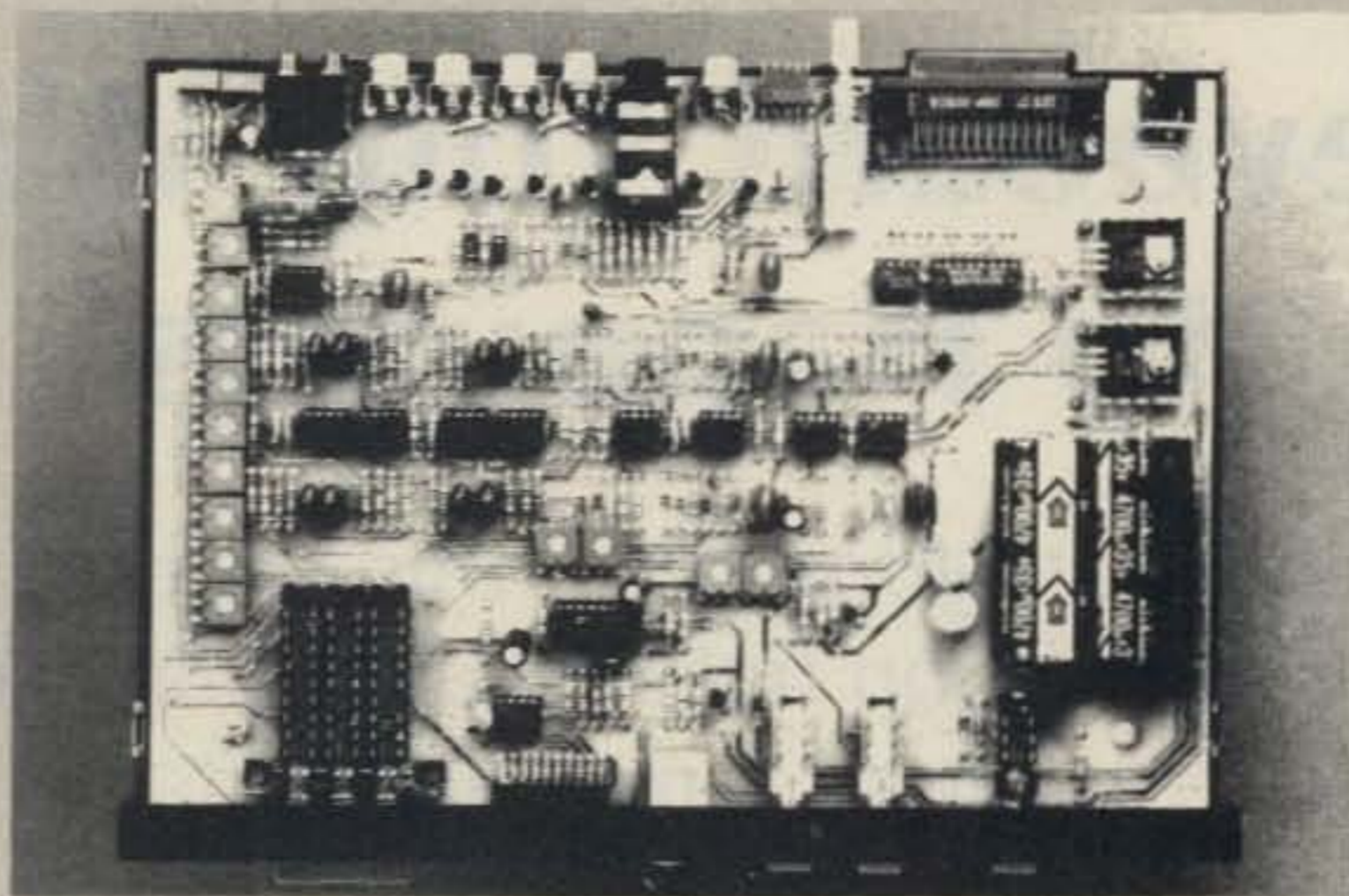

## CP-1 Computer Patch™ Interface

The AEA Model CP-1 Computer Patch™ interface will let you discover the fastest growing segment of Amateur Radio: computerized RTTY and CW operation.

When used with the appropriate software package (see your dealer), the CP-1 will patch most of the popular personal computers to your transceiver for a complete full-feature RTTY/CW station. No computer programming skills are necessary. The CP-1 was designed with the RTTY neophyte in mind, but its sophisticated circuitry and features will appeal to the most experienced RTTY operator.

The CP-1 offers variable shift capability in addition to fixed 170 Hz dual channel filtering. Auto threshold plus pre and post limiter filters allow for good copy under fading and weak signal conditions.

Transmitter AFSK tones are generated by a clean, stable function generator. Plus (+) and minus (-) output jacks are also provided for CW keying of your transmitter. An optional low cost RS-232 port is also available. The CP-1 is powered with 16 VAC which is supplied by a 117 VAC wall adaptor included with the CP-1.



# THE HAM SHACK

808 N. Main St. ...  
Evansville, IN 47711  
(812) 422-0231

# AEA

Brings you the  
Breakthrough!

# Keyboard Your Way to Happiness

*If happiness is perfect Morse, then this project is pure heaven.  
Special construction tips make putting it together  
as much fun as using it.*

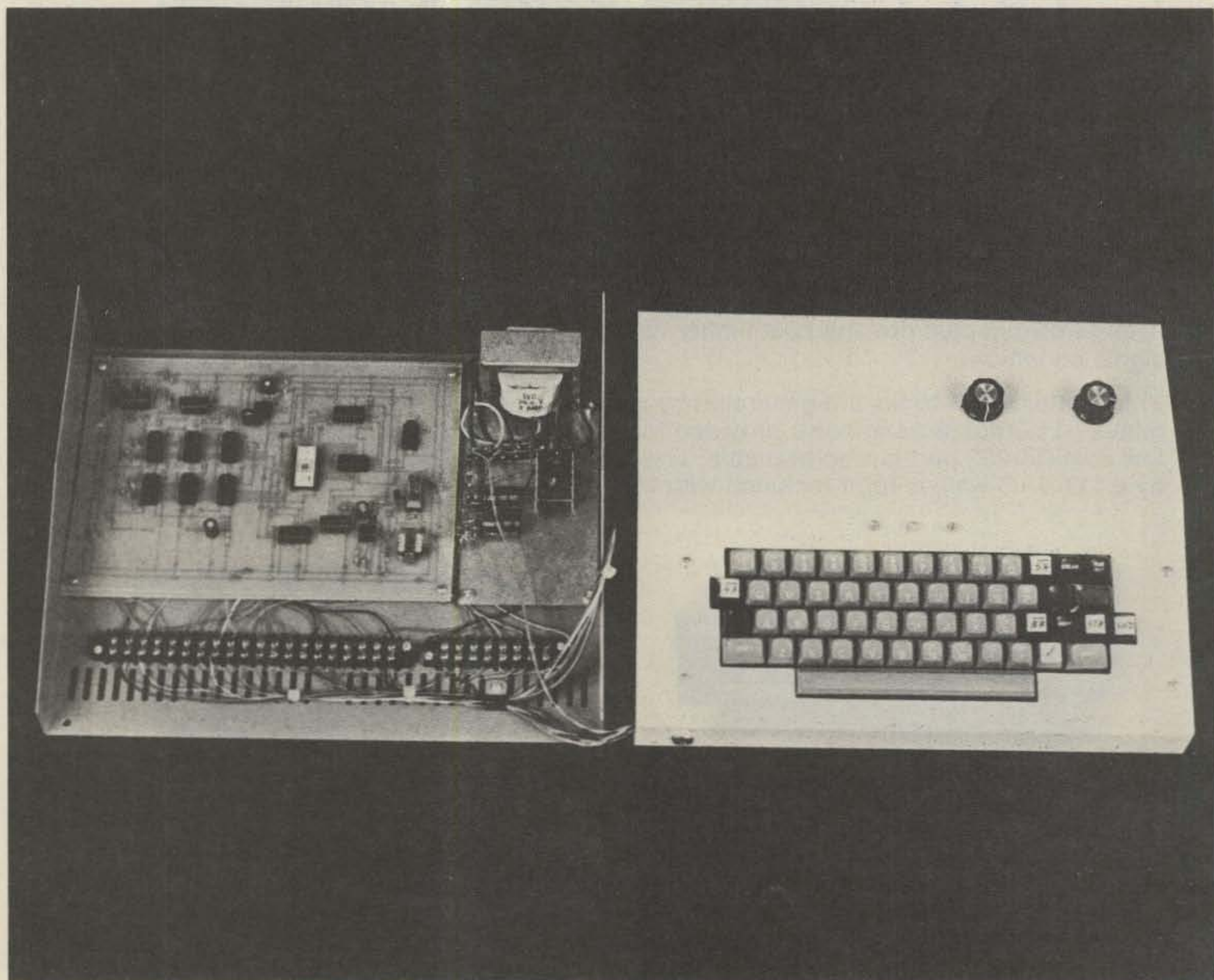

**S**ending Morse code accurately and at relatively high speeds has been made possible with the advent of the Morse keyboard. Perfect Morse code with perfect spacing is possible with a Morse keyboard with a buffer memory. Many of the physical limitations that are encountered while using other manual keying methods have been overcome by the Morse keyboard. The Morse keyboard has become a valuable instrument for sending Morse code and will continue to play an important role in communications.

This article will describe a Morse keyboard with a 192-character buffer memory. It will send perfect Morse code with perfect spacing as long as the operator stays ahead of the outgoing code. If the Morse-code operator tends to fall behind, the spacing may become erratic, but the Morse code itself will not be affected.

The Morse keyboard is made up of an ASCII communications keyboard, a buffer memory, and an ASCII6-to-Morse converter. The 192-character buffer memory allows the operator to type as many as 192 characters and word spaces ahead of the outgoing Morse code. An experienced operator may type ahead and then take time out to fill out the log book while the Morse code is being sent out.

The Morse keyboard may also be used as a code-practice device, allowing a person who does not already know the Morse code to send perfect code to a student who is learning the code.

I have been using the Morse keyboard at speeds of up to 40 words per minute on the ham bands and have checked the Morse-code waveforms on an oscilloscope at much higher speeds. The waveforms in-

dicates that the Morse keyboard is working satisfactorily at speeds well over 80 words per minute.

### ASCII Keyboard

The ASCII keyboard is an ASR-33, 53-key, data-communications type of keyboard. There are several manufacturers who make this type of keyboard. A microcomputer may also be used as an ASCII signal source.

I am using 26 letters, 10 numbers, 4 punctuation marks, and the special Morse-code characters AS (wait), BK (break), AR (end of message), and SK (end of transmission) for a total of 44 Morse-code characters. All of the characters for this particular Morse keyboard are arranged for the lower-case position on the keyboard and some of the keytops have been rearranged so that all of the characters are readily available without having to use the keyboard shift keys. The question mark, which is normally an uppercase character, has been moved to a lower-case position on the key-



Fig. 1. The N7AGK ASR-33 Morse keyboard layout

board. Some of the special Morse-code characters do not have an ASCII equivalent, but have been substituted for other unused characters.

A strobe or keypunch pulse is supplied by the ASCII keyboard each time a character key is pressed and is used to enter data into the buffer memory. This arrangement allows the operator to type at an uneven rate and to enter data into the buffer memory whenever a key is pressed.

Fig. 1 shows the keyboard layout for the Morse keyboard. Most ASCII keyboards have been designed so that the keytops may be easily removed and placed in a different location on the keyboard. Keytops are available that have special titles.

### Buffer Memory

Fig. 2 is a schematic of the buffer memory. The buffer memory is a type of digital storage system which allows the Morse-keyboard operator to enter data at different rates or to store data in the buffer memory until needed. Data will remain stored in the buffer memory as long as power to the buffer memory is not interrupted.

The 192-character buffer memory is made up of 3 pairs of 3341 first-in/first-out shift registers. Each pair will handle 64 ASCII6 characters. (The Morse keyboard uses only 6 bits of the ASCII data from the ASCII keyboard.) Each 3341 FIFO shift register handles 4 bits of information in a 64-by-4 configuration. The buffer memory accepts parallel

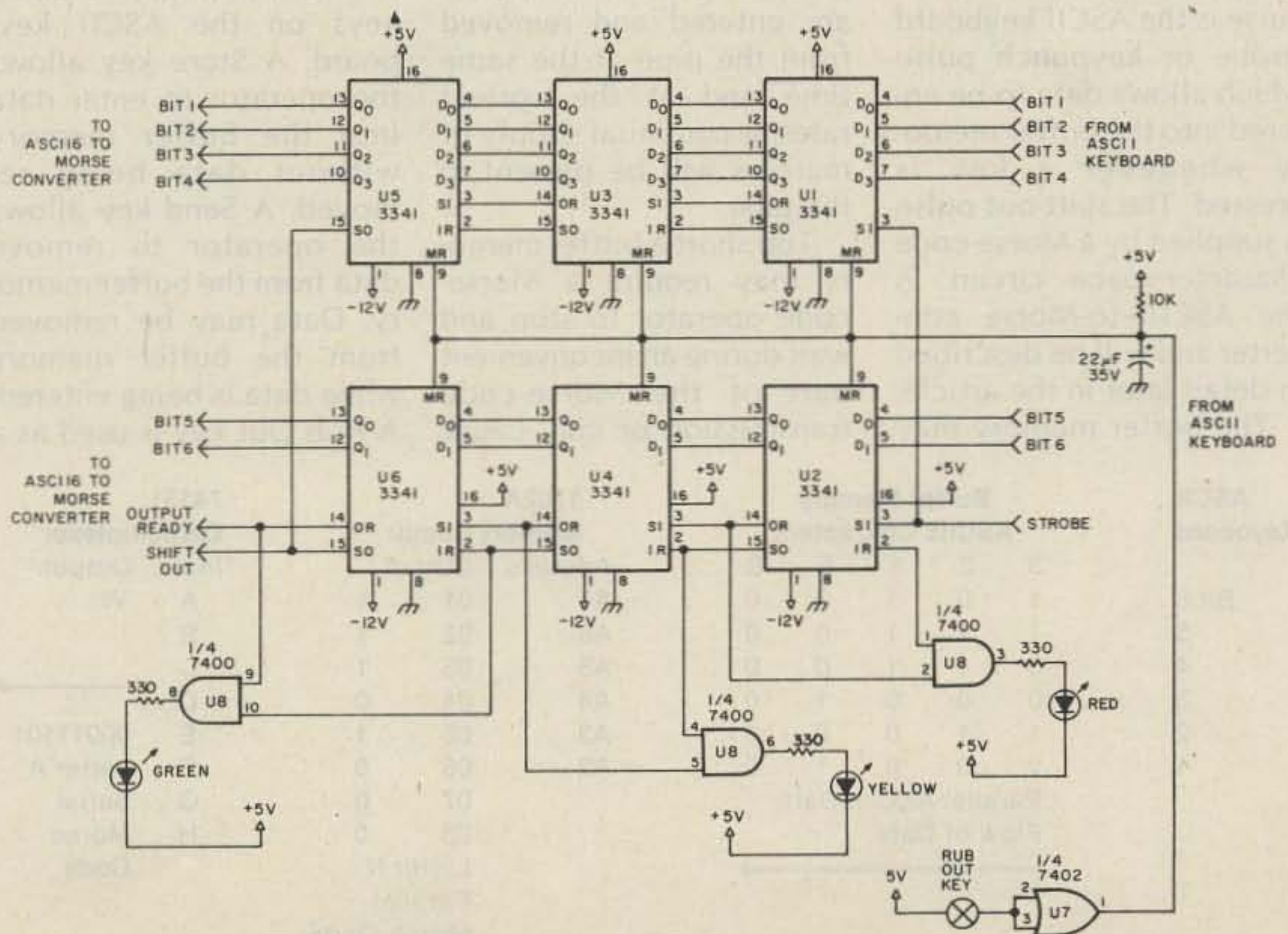

Fig. 2. 192-character buffer memory.

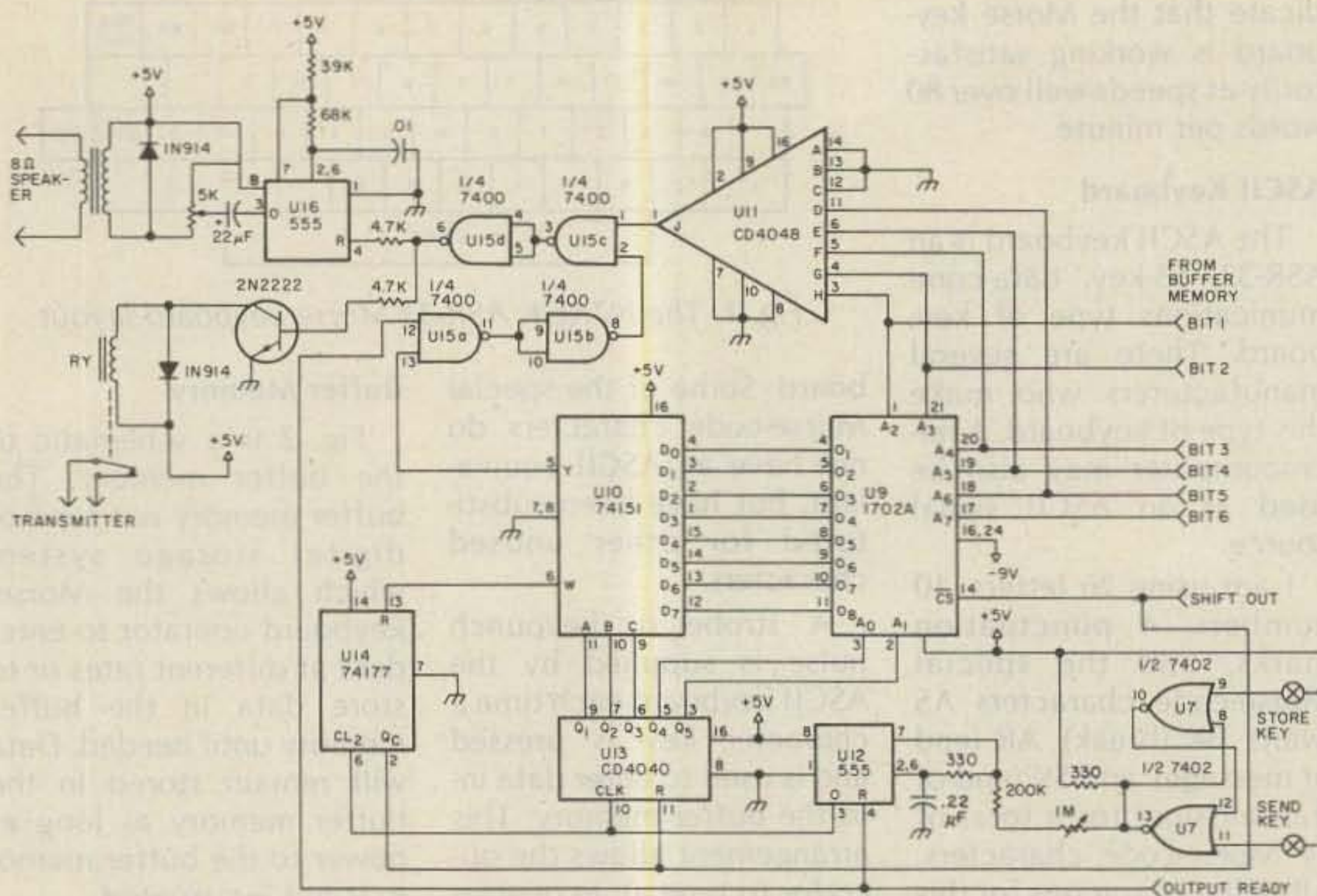

Fig. 3. ASCII6-to-Morse converter.

data only from the ASCII keyboard.

The 3341 FIFO has separate input and output data terminals and has separate input and output clock circuits that can operate at different clock rates. The input clock pulse is called a shift-in pulse and the output clock pulse is called a shift-out pulse. The shift-in pulse is the ASCII keyboard strobe or keypunch pulse which allows data to be entered into the buffer memory whenever a key is pressed. The shift-out pulse is supplied by a Morse-code character-space circuit in the ASCII6-to-Morse converter and will be described in detail later in the article.

The buffer memory may

be thought of as a pipe which will hold up to 192 marbles. The shift-in rate is the rate at which marbles are placed in the pipe. The shift-out rate is the rate at which marbles are removed from the pipe. If marbles are not added to the pipe, but are removed, the pipe will become empty after a period of time. If marbles are entered and removed from the pipe at the same time and at the correct rates, a continual supply of marbles will be present in the pipe.

Too short a buffer memory may require a Morse-code operator to stop and wait during an inconvenient part of the Morse-code transmission or may cause

the operator to stop and wait in the middle of a sentence, thereby interrupting his chain of thought. A large buffer memory will allow the Morse-code operator to type in a larger portion of a message without having to stop and wait as often.

The buffer memory has 3 functions available which are controlled by 3 function keys on the ASCII keyboard. A Store key allows the operator to enter data into the buffer memory without data being removed. A Send key allows the operator to remove data from the buffer memory. Data may be removed from the buffer memory while data is being entered. A Rub Out key is used as a

master reset for the buffer memory and erases any information stored in the buffer memory when pressed.

The function keys supply +5 V when pressed and supply zero or ground potential when not pressed. The Send key and Store key supply signals to a simple flip-flop circuit which ensures that either one or the other function is operating at any given time, but that they are not operating simultaneously. The simple flip-flop circuit is half of U7 or 2 NOR gates of a quad 7402 NOR gate. When the Store function is operating, the ASCII6-to-Morse converter clock generator, U12, is shut off. During this function, data is prevented from leaving the buffer memory.

During the Send mode, the clock generator is allowed to operate, thus allowing data to be shifted out of the buffer memory.

There is an LED indicator light for each pair of 3341 FIFO shift registers. These indicator lights are used as warning or indicator lights for the convenience of the Morse-keyboard operator. I chose a green LED for the first pair of 3341s, a yellow LED for the second pair, and a red LED for the third pair. The red LED blinks whenever a character is typed and acts as a warning that the buffer memory is close to being full. The green LED is lit when there are between one and 64 characters in the buffer memory. The yellow LED is lit when there are between 64 and 128 characters in the buffer memory. The red LED is lit when there are between 128 and 192 characters in the buffer memory. If the buffer memory is empty, none of the LED indicator lights will be lit. The LED indicator lights are positioned on the Morse keyboard so that they may be easily observed by the Morse-keyboard operator.

ASCII Keyboard	Buffer Memory ASCII6 Characters					1702A Memory Circuit			74151 Demultiplexer	
	3	Z	8	E	B	Address	Output		Input	Output
Bit 6	1	0	1	0	0	A7	01	1	A	W
5	1	1	1	0	0	A6	02	1	B	
4	0	1	1	0	0	A5	03	1	C	
3	0	0	0	1	0	A4	04	0	D	
2	1	1	0	0	1	A3	05	1	E	00011101
1	1	0	0	1	0	A2	06	0	F	Letter A
	Parallel ASCII6 Data Flow of Data						07	0	G	Serial
							08	0	H	Morse Code
										Letter N
										Parallel Morse Code

Fig. 4. Flow of data from the ASCII keyboard to the 74151 demultiplexer output.

WE SHIP WORLDWIDE

# Barry Electronics Corp.

WORLD WIDE AMATEUR RADIO SINCE 1950

Your one source for all Radio Equipment!

305

For the best buys in town call: 212-925-7000

Los Precios Mas Bajos en Nueva York...

KITTY SAYS: WE ARE NOW OPEN 7 DAYS A WEEK.  
**Saturday & Sunday 10 to 5 PM**

Monday-Friday 9 to 6:30 PM

Come to Barry's for the best buys in town. For Orders Only Please Call: 1-800-221-2683.



"It's Barry for the Best in Amateur & Commercial Radios"

FT-ONE, FT-980, FT-102, FT-77, FT-707, FT-230R FT-757  
FT-726R, FT-480R, FT-720RU, FT-290R, FRG-7700, FT-625RD

YAESU  
FT-208R  
FT-708R  
FT-1903

ICOM  
IC2AT  
IC3AT  
IC4AT

Land-Mobile H/T  
Midland  
Wilson Mini-Com II  
Yaesu FTC-2203, FT-4703  
Icom IC-M12 (Marine)  
Tempo M-1

DRAKE TR-5, TR-7A, R-7A, L-7, L-15, Earth  
Satellite Receiver ESR-24, THETA 9000E & 500,  
EARTH SATELLITE STATION ESS-2250



ROCKWELL/COLLINS  
KWM-380

VoCom/Mirage  
Tokyo Hy-Power  
Amplifiers &  
5/8λ HT Gain  
Antennas IN STOCK

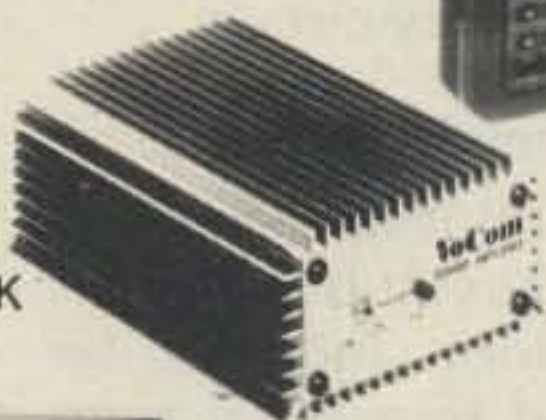

SMART PATCH

CES-Simplex Autopatch 510-SA Will Patch FM  
Transceiver To Your Telephone. Great For  
Telephone Calls From Mobile To Base. Simple  
To Use - \$319.95.

SANTEC  
ST-220/UP  
ST-144/UP  
ST-440/UP

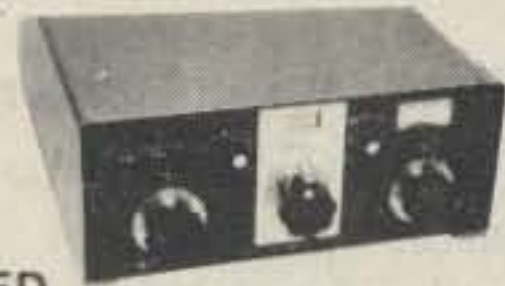

NEW IMPROVED

MURCH Model  
UT2000B

MFJ Models  
900, 940B, 941C, & 496.

HAM MasterTapes—  
Beta or VHS Tapes

Computer Interfaces  
stocked: MFJ-1224  
AEA CP-1, Kantronics  
Big Ham Clock/Ham Tags

Repeaters in Stock:  
Spectrum SCR-1000, 4000, & 77  
ICOM IC-RP 3010 (440 MHz)  
ICOM IC-RP 1210 (1.2 GHz)

Complete Butternut Antenna  
Inventory In Stock!

Robot 800C - 1200C  
Color Mod Kits

Long-range Wireless  
Telephone for export  
in stock

BENCHER PADDLES &  
Vibroplex Keys In Stock!!

New TEN-TEC  
2591 HT, Corsair In Stock

DIGITAL  
FREQUENCY  
COUNTER

Trionyx-  
Model TR-1000  
0-600 MHz  
Digimax Model  
D-510 50 Hz-1GHz



Tri-Ex Towers  
Hy-Gain Towers  
& Antennas,  
and Rotors

will be shipped direct  
to you FREE of shipping cost.

AEA 144 MHz  
AEA 440 MHz  
ANTENNAS



EIMAC  
3-500Z  
572B, 6JS6C  
12BY7A &  
4-400A

BIRD  
Wattmeters &  
Elements  
In Stock



MAIL ALL ORDERS TO BARRY ELECTRONICS CORP., 512 BROADWAY, NEW YORK CITY, NY 10012.

New York City's LARGEST STOCKING HAM DEALER  
COMPLETE REPAIR LAB ON PREMISES

"Aqui Se Habla Espanol"

BARRY INTERNATIONAL TELEX 12-7670  
TOP TRADES GIVEN ON USED EQUIPMENT  
STORE HOURS: Monday-Friday 9 to 6:30 PM  
Parking Lot Across the Street

Saturday + Sunday 10 to 5 p.m. (Free Parking)  
AUTHORIZED DIST. MCKAY DYMEK FOR  
SHORTWAVE ANTENNAS & RECEIVERS.

IRT/LEX-"Spring St. Station"

Subways: BMT-"Prince St. Station"

IND-"F" Train-Bwy. Station"

Bus: Broadway #6 to Spring St.

Hell Sound Eq.  
Mike cartridges  
and books in  
stock.

We Stock: AEA, ARRL, Alpha, Ameco, Antenna Specialists, Astatic, Astron, B & K, B & W, Bash, Bencher, Bird, Butternut, CDE, CES, Collins, Communications Spec. Connectors, Covercraft, Cubic (Swan), Cushcraft, Daiwa, Dentron, Digimax, Drake, ETO (Alpha), Eimac, Encomm, Hell-Sound, Henry, Hustler (Newtronics), Hy-Gain, Icom, KLM, Kantronics, Larsen, MCM (Daiwa), MFJ, J.W. Miller, Mini-Products, Mirage, Newtronics, Nye Viking, Palomar, RF Products, Radio Amateur Callbook, Robot, Rockwell Collins, Saxton, Shure, Swan, Telex, Tempo, Ten-Tec, Tokyo Hi Power, Trionyx TUBES, W2AU, Waber, Wilson, Yaesu Ham and Commercial Radios, Vocom, Vibroplex, Curtis, Tri-Ex, Wacom Duplexers, Repeaters, Phelps Dodge, Fanon Intercoms, Scanners, Crystals, Radio Publications.

WE NOW STOCK COMMERCIAL COMMUNICATIONS SYSTEMS  
DEALER INQUIRIES INVITED. PHONE IN YOUR ORDER & BE REIMBURSED.

COMMERCIAL RADIOS stocked & serviced on premises.

Amateur Radio & Computer Courses Given On Our Premises, Call  
Export Orders Shipped Immediately. TELEX 12-7670

The Rub Out key is a function of the ASCII keyboard and is used when the Morse-keyboard operator desires to erase all of the information that is in the buffer memory. One-fourth of a quad 7402 NOR gate is used as an inverter. The master-reset voltage is zero. The master-reset line is held at +5 V by a 10k resistor and will not reset until a zero-volt level is received from the 7402 NOR gate inverter.

A 22-microfarad electrolytic capacitor from the master-reset line to ground ensures that the master reset has reset the buffer memory when the Morse keyboard is first turned on. If the capacitor was not there, the buffer memory could contain some unwanted information when the power is first turned on.

#### ASCII6-to-Morse Converter

The ASCII6-to-Morse converter portion of the Morse keyboard (Fig. 3) is made up of circuitry that converts the ASCII6 data from the buffer memory to usable Morse code. The ASCII6-to-Morse converter contains a memory circuit that is used as a code converter, a space-bar-operated word-space circuit, an automatic character-space circuit, a clock generator, a divider circuit, a sidetone generator, and output circuitry for operating the keying relay.

#### 1702A Memory Circuit

A 1702A EPROM (erasable programmable memory), U9, is used as an ASCII6-to-Morse converter and converts the data from the buffer memory to Morse code. The 1702A has a total of 2048 storage locations and has an overall configuration of 256 by 8. This means that there are 256 address locations with 8 parallel outputs for each address location.

I have chosen 4 groups of

Signal source	Address inputs
Q1	A 74151
CD4040 Q2	B Demultiplexer
Address Q3	C
Divider Q4	A0
Q5	A1
Bit 1	A2
ASCII6 2	A3 1702A
From 3	A4 Memory circuit
Buffer 4	A5
Memory 5	A6
6	A7

Table 1. Address and divider information.

8 outputs for a total of 32 storage locations for each Morse-code character. This arrangement allows room for up to 62 Morse-code characters and a word space in the 1702A memory circuit.

The ASCII6 data addresses the 1702A for the desired Morse-code character. (The ASCII keyboard will supply 8 bits of information for each character, but with the Morse keyboard, only the ASCII6 or bits 1 through 6 are used.) The ASCII6 data addresses the 1702A memory circuit so that a respective 32-baud storage section of the memory circuit is selected for the desired character.

The 1702A memory circuit is programmed so that each storage location is equivalent to one baud. The Morse-code characters are broken down so that a dot is one baud in length and is programmed into the memory circuit as a 1; a dash is 3 bauds in length and is programmed as 3 ones in a row. A character space is 3 zeroes in a row. A space between dots and dashes is 1 zero. A word space is 7 zeroes in a row and will be handled in a special way in the ASCII6-to-Morse converter circuitry. (The 1702A memory circuit normally contains all zeroes until programmed.)

None of the Morse-code characters uses all of the 32 bauds or 32 storage locations assigned to them. The shortest Morse-code character, the letter E, uses 1

baud for the code character plus 3 bauds for the character space for a total of 4 bauds. The longest Morse-code character used in the Morse keyboard is the number zero. It uses 19 bauds or storage locations for the Morse-code character plus 3 bauds for the character space for a total of 22 bauds or storage locations in the memory circuit.

#### 74151 Demultiplexer

The output of the 1702A memory circuit is in an 8-bit parallel form and must be converted to a serial form in order to key a transmitter properly. The parallel information from the 1702A memory circuit is converted to serial information with a 74151 demultiplexer integrated circuit, U10. The 74151 demultiplexer uses 3 binary address signals to assist in converting from the 8 parallel inputs to the serial outputs. Output Y is inverted.

Fig. 4 shows a flow of the data from the ASCII keyboard to the output of the 74151 demultiplexer. Some examples of code characters are shown in the buffer memory and at the output of the 1702A and 74151.

#### Character-Space and Shift-Out-Pulse Circuit

The ASCII6-to-Morse converter circuitry is designed so that it will accept the Morse-code information for each Morse-code character plus 3 zeroes at the end of the character for a character space. If there

are more than 3 zeroes at the end of a character, the character-space circuitry will accept the first 3 zeroes and then proceed to the next Morse-code character, ignoring the remaining zeroes. In the memory circuit, a letter E, for example, will be followed by 31 zeroes but the character-space circuitry will accept only the first 3 and ignore the remaining 28 zeroes.

The 74177 character-space-divider circuit, U14, is connected so that it will accept 3 zeroes in a row and then supply a very short duration shift-out pulse to the buffer memory. The shift-out pulse initiates the start of the next Morse-code character or word space and also resets the 1702A memory circuit and a CD4040 address-divider circuit, U13. When the memory circuit and divider circuit have been reset, the ASCII6-to-Morse converter circuitry is ready to accept the next ASCII6 character from the buffer memory. The reset and shift-out pulse from the 74177 character-space divider is extremely short in duration. It will not interfere with the timing of the first baud of the next Morse-code character.

The character-space divider is reset every time a dot or dash is received from the 74151 demultiplexer. The Morse-keyboard clock-generator signal is fed into the input of the character-space divider. When 3 zeroes in a row are present at the reset input of the character-space circuit, a pulse is then present at the divider output, Qc, which is the buffer-memory shift-out pulse and also the reset pulse for the CD4040 address divider and the 1702A memory circuit. As soon as the shift-out pulse is generated, a new ASCII6 character is shifted out of the buffer memory and presented to the 1702A memory cir-



# MICROLOG AIR-1



## Connect your computer to the air!

The "AIRWAVES" that is, thru the Microlog AIR-1, a single board terminal unit AND operating program in ROM that needs no external power supply or dangling extras to put your computer on CW & RTTY. And what a program! The famous Microlog CW decoding algorithms, superior computer enhanced RTTY detection, all the features that have made Microlog terminals the standard by which others are compared. Convenient plug-in jacks make connection to your radio a snap. On screen cross tuning indicator and audio pitch reference tone make it easy to use. The simple, one board design makes it inexpensive. And Microlog know-how makes it best! There's nothing left out with the AIR-1. "HARDWARE" front end has: AFSK, PTT,  $\pm$  CW/FSK keying

loop switch, hand key input and dual tone mark/space RTTY DEMOD plus single tone CW detector. "SOFTWARE" in onboard ROM has: split screen, large type ahead transmit buffer, automatic keyword controlled receive data storage, WRU, SELCAL printer control and user programmable memories that can dump/store on disc and tape. Full speed RTTY, 60 to 132 wpm, CW to 150 wpm, 110/300 ASCII and optional 4 mode AMTOR operation covers all the bases. If you've been waiting for the right system at the right price, or you've been disappointed with previous operating programs, your time is now. At \$199, the complete AIR-1 is your answer for VIC-20 and "64" (with 4 mode AMTOR, \$279). Join the silent revolution in RTTY/CW and get ON-THE-AIR! See it at your local dealer or give us a call at Microlog Corporation, 18713 Mooney Drive, Gaithersburg, Maryland 20879. TEL (301) 258 8400. TELEX 908153.

Note: VIC-20 is a trademark of Commodore Electronics, Ltd.

**MICROLOG** ✓51  
INNOVATORS IN DIGITAL COMMUNICATION

	Address	Output		AS	01101100	10111010
A	00000100	10111000			01101101	10100000
B	00001000	11101010			10110000	11101110
	00001001	10000000			10110001	10101110
C	00001100	11101011			10110010	11100000
	00001101	10100000	BK		10110100	11101010
D	00010000	11101010			10110101	10111010
E	00010100	10000000			10110110	11100000
F	00011000	10101110			10111000	10111010
	00011001	10000000			10111001	11101011
G	00011100	11101110	/		10111010	10000000
	00011101	10000000			10111100	11101010
					10111101	11101000
H	00100000	10101010	Word Space			
I	00100100	10100000			10000000	10000000
J	00101000	10111011	0		11000000	11101110
	00101001	10111000			11000001	11101110
K	00101100	11101011			11000010	11100000
	00101101	10000000	1		11000100	10111011
L	00110000	10111010			11000101	10111011
	00110001	10000000			11000110	10000000
M	00110100	11101110	2		11001000	10101110
N	00111000	11101000			11001001	11101110
O	00111100	11101110	3		11001100	10101011
	00111101	11100000			11001101	10111000
P	01000000	10111011	4		11010000	10101010
	01000001	10100000			11010001	11100000
Q	01000100	11101110	5		11010100	10101010
	01000101	10111000			11010101	10000000
R	01001000	10111010	6		11011000	11101010
S	01001100	10101000			11011001	10100000
T	01010000	11100000	7		11011100	11101110
U	01010100	10101110			11011101	10101000
V	01011000	10101011	8		11100000	11101110
	01011001	10000000			11100001	11101010
W	01011100	10111011	9		11100100	11101110
	01011101	10000000			11100101	11101110
X	01100000	11101010	SK		11100110	10000000
	01100001	11100000			11101000	10101011
Y	01100100	11101011	AR		11101001	10101110
	01100101	10111000			11101100	10111010
Z	01101000	11101110	?		11101101	11101000
	01101001	10100000			11111100	10101110
					11111101	11101010

Table 2. 1702A programming truth table.

circuit which in turn is routed through the 74151 as a Morse-code character and resets the 74177 character-space divider. The 74177 character-space divider does not have a chance to generate a very long duration pulse because of the quick action of the 1702A memory circuit and the 74151 demultiplexer.

#### Clock Generator and Address Divider

The ASCII6-to-Morse converter uses a 555 timer

as a clock generator (U12). The clock generator operates at 2 times the bit rate of the Morse code. The clock generator is varied in frequency in order to vary the speed of the outgoing Morse code. The clock-generator signal is fed to the 74177 character-space divider and a CD4040 binary address divider, U13.

The ASCII6 data from the buffer memory addresses the 1702A memory circuit for the respective 32-baud storage section assigned

the Morse-code character. However, additional addressing is needed to break down the Morse-code signals to the 8 parallel outputs of the 1702A memory circuit and to further break down the signal to a serial form in the 74151 demultiplexer. The additional binary addressing is supplied by the CD4040 divider circuit. Table 1 shows a breakdown of the signal sources and address locations. Q1, Q2, and Q3 are binary signals used to address the 74151 demultiplexer; U10 and Q4 and Q5 outputs are address signals for the 1702A memory circuit.

#### 1702A Programming Information

Table 2 is the truth table for programming the 1702A EPROM. The address and output information for the 1702A memory circuit is shown in binary form for simplicity. There are 8 address bits. The first 6 address bits are the ASCII6 data and the last 2 bits are needed to break down the information in the 32-baud storage sections into the 8 parallel outputs of the 1702A memory circuit. Of the 8 address bits, the first 6 bits reading from left to right are bit 6, bit 5, bit 4, bit 3, bit 2, and bit 1 of the ASCII6 data. The 7th address bit, reading from left to right, corresponds to the Q5 output of the CD4040 address divider and the 8th bit corresponds to Q4. The address inputs of the 1702A memory circuit, reading from left to right, are A7, A6, A5, A4, A3, A2, A1, and A0.

The address for the letter A will be 00000100. The letter B, which is more than 8 bauds in length, will have 2 addresses. They are 00001000 and 00001001. Note that bit 8 of the address has changed. The output programming of the 1702A memory circuit will be 11101010 and 10000000.

Note that the first 3 bauds are a dash. Bauds 5, 7, and 1 of the next group are dots. They make up the dash and 3 dots of the letter B. Longer Morse-code characters such as the number zero will take 3 sets of addresses for the programming of the memory circuit.

The 1702A memory circuit is normally all zeroes before programming. The memory circuit need only be programmed for 1s. A special programmer must be used with the 1702A EPROM and the memory circuit may be erased with ultraviolet light and programmed again if desired.

#### CD4048 Word-Space Gate

The Morse keyboard uses an ASCII-keyboard space-bar-operated word space that is handled in much the same way as a regular Morse-code character. The one big difference is that it is silent at the output of the Morse keyboard. The word space must be 7 bauds in length and must work correctly with the 74177 character-space divider.

The ASCII6 code for a word space is 100000. It is the only ASCII6 character that has zeroes for bit 5, bit 4, bit 3, bit 2, and bit 1. There is an ASCII6 blank that has all zeroes, but it is not used with the Morse keyboard. The 1702A programming address for the word space is 10000000. An E is programmed into the 1702A for a word space and is shown as 10000000 also.

An 8-input expandable gate is used as the word-space gate and is connected as an 8-input OR gate. 3 of the inputs to the OR gate are grounded and the other 5 inputs are connected to bit 5, bit 4, bit 3, bit 2, and bit 1. If any input of the CD4048 OR gate is receiving a 1, the output will show a 1. If all of the inputs are zero, then the output will be zero. If there is a zero at the output of the CD4048

# step up to the best...

Without doubt LR-1 is the repeater value leader! Compare its outstanding performance with any repeater -- then look at its price. LR-1 features include individual die-cast shielding of receiver and transmitter plus a separately shielded 6-stage receiver prefilter for peak performance in harsh RF environments • Front panel metering of all vital functions • CW identifier • Symmetric hard limiting for clean natural audio • Low power MOS control logic • Even the cabinet is included -- just plug in and go!

**LINKING?** The LR-1 is also available with control circuitry for Link Transceiver operation. Now link repeater sites with the flexible control capability you've always wanted.

**HIGH POWER?** Our PA-75 power amplifier is the champion! Ruggedly built to give years of dependable operation in continuous duty repeater service.



Mark 3C repeaters and controllers have no equal in performance. Both units feature auto patch, reverse autopatch, autodial, 13 Morse messages and a total of 39 functions. Both feature microprocessor control and both have been proven in the field from icy Alaska to tropical Brazil. A Mark 3C supercontroller can make any repeater a super performer. The Mark 3CR repeater is in a class by itself. It combines superbly designed RF circuitry in one handsome package. It is without doubt the world's most advanced repeater!

CALL OR WRITE FOR FULL DETAILS

## MICRO CONTROL SPECIALTIES

49

23 Elm Park • Groveland, Massachusetts 01834 • Telephone (617) 372-3442

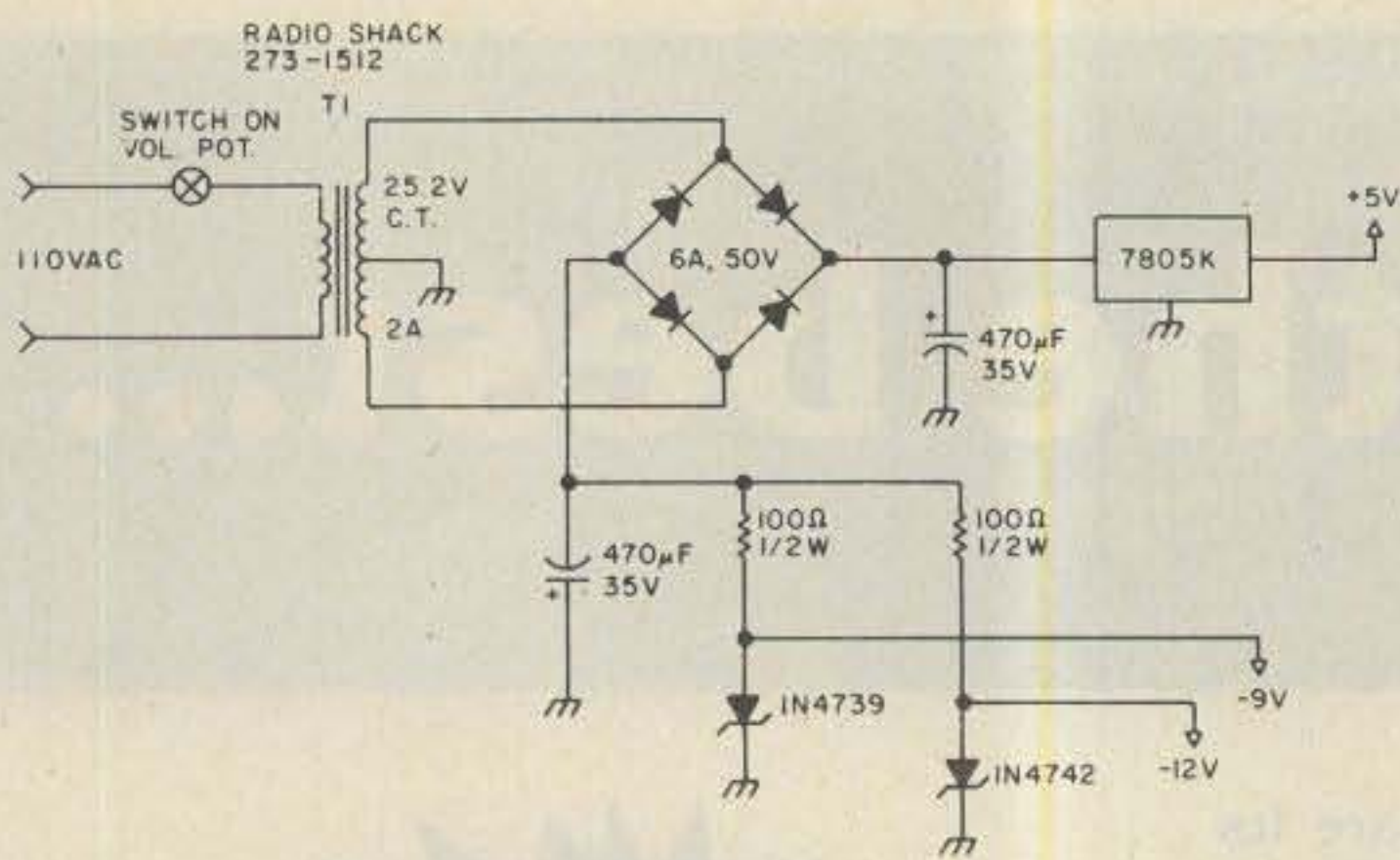

Fig. 5. Power supply schematic.

word-space OR gate, the output circuitry of the ASCII6-to-Morse converter will be silenced. There will be a silent E present at the output of the Morse keyboard which is 4 bauds long. When added to the 3 zeroes of the previous character space, there will be a total of 7 silent bauds, which is the length of a word space. Since the word space is treated much the same as an ASCII6 character, it will be treated like one in the buffer memory.

### Output Gates

In the output circuitry of the ASCII6-to-Morse converter, there are 4 NAND gates, designated U15A, U15B, U15C, and U15D. U15B and U15D are connected as inverters.

U15A is connected as a NAND gate and combines the output-ready signal from the buffer memory and the serial-output signal from the 74151 demultiplexer, U10. The output-ready signal also resets the 555 clock generator, U12. The output-ready signal is used to synchronize the buffer-memory output signals and the clock generator. Without the synchronizing of the signals, it would be possible to miss a part of the first baud of the Morse-code character.

U15C is also connected as a NAND gate and combines the output of the word-space gate with the signal from U15B and de-

termines whether the output will be silenced for a word space or enabled for a regular Morse-code character.

U15D is an inverter and a buffer for the output signal.

### Sidetone Generator

A 555 timer, U16, is connected as a sidetone generator for monitoring the outgoing Morse code. It generates an audio tone and is keyed by the signal from U15D. The sidetone generator has an output transformer with an output for an 8-Ohm speaker or 8-Ohm headphones. The frequency of the sidetone generator is approximately 800 Hertz. The sidetone generator has a volume control. The volume may be turned up when using a speaker and turned down if headphones are used. The 1N914 diode across the primary of the output transformer furnishes a more pleasant tone at the output of the sidetone generator.

### Keying Relay

I am using a Radio Shack #275-215, double-pole double-throw miniature plug-in relay for the transmitter keying relay. It is a 5-volt relay with a 50-Ohm relay coil. I bent the relay contacts closer together to improve the response time of the relay. A 2N2222 transistor amplifier is used as a relay driver. The relay plugs into a regular 16-pin DIP socket.

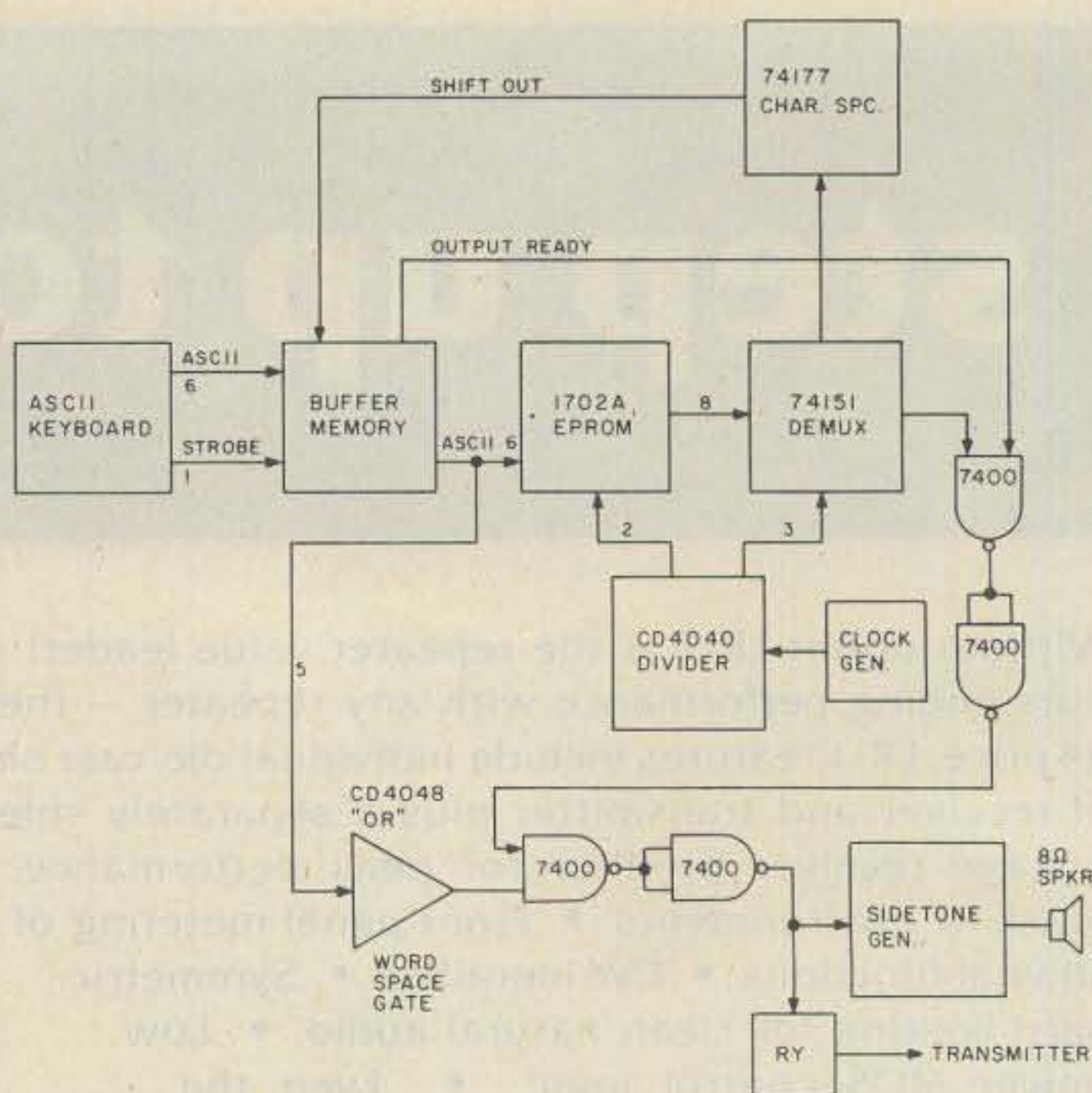

Fig. 6. N7AGK Morse keyboard block diagram.

### Power Supply

Fig. 5 is a schematic of the Morse-keyboard power supply. It supplies 5 volts at approximately 1 Ampere, minus 9 volts at approximately 25 milliamperes and minus 12 volts at approximately 25 milliamperes. A Radio Shack #276-1363 power transformer is used for the low-voltage power source. The secondary winding of the transformer supplies 25.2 volts at 2 Amperes. A bridge rectifier is connected so that one side of the rectifier supplies the plus voltage in reference to the transformer center tap and the other side of the rectifier supplies a minus voltage in reference to the center tap. The plus side goes to a 5-volt regulator and the minus 9 volts and the minus 12 volts are taken from zener-diode circuits. The transformer center tap is at ground potential. The 1702A memory circuit uses plus 5 volts and minus 9 volts. The 3341 first-in/first-out shift register uses plus 5 volts and minus 12 volts. All of the other circuits just require plus 5 volts. A good heat sink must be used with the 5-volt regulator to prevent overheating of the regulator.

### Operating Instructions

The Morse keyboard has been designed to send perfect Morse code with perfect spacing. It has a buffer memory which allows the Morse-code operator to type up to 192 characters ahead of the outgoing Morse code. The buffer memory will store the characters until they are needed. If the operator presses the Store key, he may store a small message and then send it out when the Send key is pressed. The message will be stored in the buffer memory as long as power is supplied to the Morse keyboard. I have stored a message overnight and then listened to it in the morning when I pressed the Send key.

The buffer memory also allows the Morse-code operator to type at an uneven rate and to stop at certain intervals if desired. If the Morse-code operator pauses too long, he may find that the buffer memory has emptied of information and there will be uneven spacing of the Morse-code characters until he has gained a head start on the outgoing Morse code again.

A message or transmis-

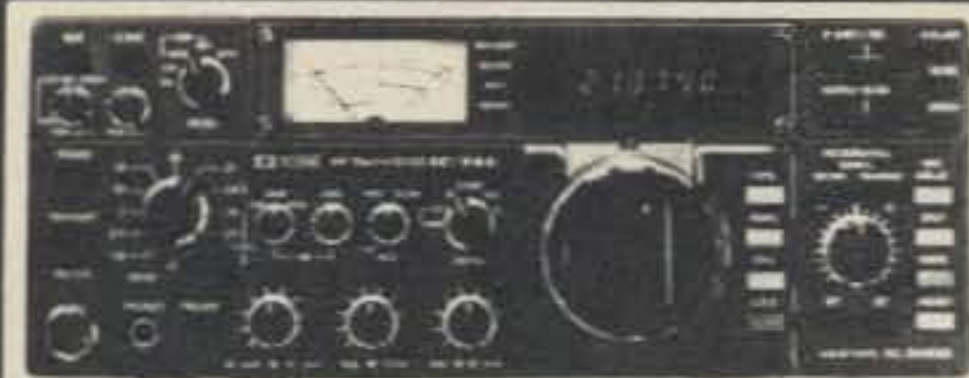

**HF Transceivers:** Regular SALE  
 IC-740 9-band 200w PEP Xcvr ..... \$1099.00 949<sup>95</sup>  
 plus **FREE PS-740** internal power supply &  
**\$50 Factory Rebate** - until gone!

- PS-740 Internal power supply ..... \$159.00 149<sup>95</sup>
- \*EX-241 Marker unit ..... 20.00
- \*EX-242 FM unit ..... 39.00
- \*EX-243 Electronic keyer unit ..... 50.00
- \*FL-45 500 Hz CW filter (1st IF) ..... 59.50
- \*FL-54 270 Hz CW filter (1st IF) ..... 47.50
- \*FL-52A 500 Hz CW filter (2nd IF) ... 96.50 89<sup>95</sup>
- \*FL-53A 250 Hz CW filter (2nd IF) ... 96.50 89<sup>95</sup>
- \*FL-44A SSB filter (2nd IF) ..... 159.00 144<sup>95</sup>
- SM-5 Electret desk microphone ..... 39.00
- HM-10 Mobile scan microphone ..... 39.50
- MB-12 Mobile mount ..... 19.50

\*Options also for IC-745 listed below

- IC-730 8-band 200w PEP Xcvr w/mic... \$829.00 599<sup>95</sup>
- FL-30 SSB filter (passband tuning)... 59.50
- FL-44/A SSB filter (2nd IF) ..... 159.00 144<sup>95</sup>
- FL-45 500 Hz CW filter ..... 59.50
- EX-195 Marker unit ..... 39.00
- EX-202 LDA interface; 730/2KL/AH-1 27.50
- EX-203 150 Hz CW audio filter ..... 39.00
- EX-205 Transverter switching unit... 29.00
- SM-5 Electret desk microphone ..... 39.00
- HM-10 Mobile scan microphone ..... 39.50
- MB-5 Mobile mount ..... 19.50

- IC-720A 9-band Xcvr/.1-30 MHz Rcvr \$1349.00 899<sup>95</sup>
- FL-32 500 Hz CW filter ..... 59.50
- FL-34 5.2 KHz AM filter ..... 49.50
- MB-5 Mobile mount ..... 19.50
- IC-7072 transceiver interface, R-70 .. 112.50

- IC-745 9 band xcvr/.1-30 MHz rcvr.... \$999.00 899<sup>95</sup>
- PS-35 Internal power supply ..... 160.00 144<sup>95</sup>
- CF5-455K5 2.8 KHz wide SSB filter
- SM-6 Desk microphone ..... 39.00
- HM-12 Hand microphone ..... 39.50

See IC-740 list above for other options (\*)



- IC-751 9-band xcvr/.1-30 MHz rcvr\$ 1399.00 1229
- PS-35 Internal power supply ..... 160.00 144<sup>95</sup>
- FL-52A 500 Hz CW filter ..... 96.50 89<sup>95</sup>
- FL-53A 250 Hz CW filter ..... 96.50 89<sup>95</sup>
- FL-33 AM filter ..... 31.50
- SM-6 Desk microphone ..... 39.00
- HM-12 Hand microphone ..... 39.50
- External frequency controller ..... TBA
- High stability reference crystal ..... TBA

- Options: 720/730/740/745/751 Regular SALE
- PS-15 External 20A power supply ..... \$149.00 134<sup>95</sup>
  - EX-144 Adaptor; CF-1/PS-15 ..... 6.50
  - CF-1 Cooling fan for PS-15 ..... 45.00
  - PS-20 20A switching ps w/speaker ..... 229.00 199<sup>95</sup>
  - CC-1 Adaptor; HF radio to PS-20 ..... 10.00



- Options - continued Regular SALE
- CF-1 Cooling fan for PS-20 ..... 45.00
  - SP-3 External speaker ..... 49.50
  - Speaker/phone patch (specify radio)..... 139.00 129<sup>95</sup>
  - BC-10A Memory back-up ..... 8.50
  - EX-2 Relay box w/marker ..... 34.00
  - AT-100 100w 8-band automatic ant tuner 349.00 314<sup>95</sup>
  - AT-500 500w 9-band automatic ant tuner 449.00 399<sup>95</sup>
  - MT-100 Manual antenna tuner ..... 249.00 224<sup>95</sup>
  - AH-1 5-band mobile ant w/tuner ..... 289.00 259<sup>95</sup>
  - GC-4 World clock ..... 99.95 99<sup>95</sup>

HF Linear amplifier  
 IC-2KL 160-15m/WARC solid state linear 1795.00 1299

VHF/UHF Multi-modes  
 IC-251A 2m FM/SSB/CW xcvr ..... \$749.00 549<sup>95</sup>

**\$50 Factory Rebate** - until gone!

- IC-551D 80w 6m Xcvr ..... \$699.00 599<sup>95</sup>
- PS-20 20A switching ps/spkr ..... 229.00 199<sup>95</sup>
- EX-106 FM adaptor ..... 125.00 112<sup>95</sup>
- BC-10A Memory back-up ..... 8.50
- SM-2 Electret desk microphone ..... 39.00
- IC-451A 430-440 SSB/FM/CW Xcvr/ps 899.00 769<sup>95</sup>
- IC-451A/High 440-450 MHz Xcvr/ps 899.00 769<sup>95</sup>
- AG-1 15 db preamp, IC-451A/45A... 89.00 79<sup>95</sup>



- IC-271A 2m, 25w xcvr ..... 699.00 629<sup>95</sup>
- IC-471A 430-450 MHz, 10w xcvr ..... 799.00 719<sup>95</sup>
- PS-25 Internal power supply ..... TBA
- HM-12 Hand microphone ..... 39.50
- SM-6 Electret desk microphone ..... 39.00

VHF/UHF FM Regular SALE

- IC-25A 2m, 25w, up-dn-ttp mic, grn leds \$359.00 319<sup>95</sup>
- IC-25H as above, but 45 watts ..... 389.00 349<sup>95</sup>
- IC-45A 440 FM xcvr, 10w, TTP mic ..... 399.00 359<sup>95</sup>
- BU-1 Memory back-up ..... 38.50
- IC-22U 10w 2m FM non-digital Xcvr.... 299.00 249<sup>95</sup>
- EX-199 Remote frequency selector .. 35.00

- RP-3010 440 MHz repeater ..... 999.00 899<sup>95</sup>

VHF/UHF multi-modes:

- IC-290H 25w 2m SSB/FM Xcvr, TTP mic \$549.00 489<sup>95</sup>
- IC-560 10w 6m SSB/FM/CW Xcvr ..... 489.00 439<sup>95</sup>
- IC-490A 10w 430-440 SSB/FM/CW Xcvr 649.00 579<sup>95</sup>

VHF/UHF Portables:

- IC-202S 2m port. SSB Xcvr, 3w PEP \$279.00 249<sup>95</sup>
- IC-505 3/10w 6m port. SSB/CW Xcvr 449.00 399<sup>95</sup>
- IC-402 432 portable SSB xcvr ..... 389.00 299<sup>95</sup>
- BP-10 Internal nicad battery pack ... 79.50
- BC-15 AC charger ..... 12.50
- EX-248 FM unit ..... 49.50
- SP-4 Remote speaker ..... 24.95
- LC-10 Leather case ..... 34.95

- IC-3PS Power supply for portables ..... 95.00 89<sup>95</sup>
- IC-20L 2m amp, 10w PEP or FM ..... 98.00 89<sup>95</sup>
- IC-30L 432 amp, 10w PEP/FM ..... 105.00 94<sup>95</sup>

1.2 GHz equipment

- IC-120 1w 1.2 GHz FM xcvr ..... \$499.00 449<sup>95</sup>
- RP-1210 10w 1.2 GHz repeater ..... TBA
- Cabinet for RP-1210 or RP-3010 ..... 249.00



**Hand-held Transceivers**

Synthesized; 800 channels; 1.5/1.5 watts; 250 ma. NiCd Pak; AC wall charger; flexible antenna; earphone; wrist strap; belt clip. Models with or without Touch Tone® Pad (TTP).

- | Model                  | Regular   | SALE              |
|------------------------|-----------|-------------------|
| IC-2A for 2 meters ..  | \$ 239.50 | 214 <sup>95</sup> |
| IC-2AT with TTP .....  | 269.50    | 219 <sup>95</sup> |
| IC-3A for 220 MHz .... | 269.95    | 234 <sup>95</sup> |
| IC-3AT with TTP .....  | 299.95    | 239 <sup>95</sup> |
| IC-4A for 440 MHz .... | 269.95    | 234 <sup>95</sup> |
| IC-4AT with TTP .....  | 299.95    | 239 <sup>95</sup> |

Accessories for Hand-holds: Regular

- BC-25U Extra 15-hour wall charger ..... \$10.00
- BC-30 1/15-hour drop-in charger for BP-2/3/5 69.00
- BP-2\* 450 ma, 7.2v 1w ext. time battery ..... 39.50
- BP-3 Extra std. 250ma 8.4v 1.5w battery ..... 29.50
- BP-4 Alkaline battery case ..... 12.50
- BP-5\* 450 ma, 10.8v 2.3w hi-power battery .... 49.50
- \*BC-30 required to charge BP-2 & BP-5
- FA-2 Extra 2m flexible antenna ..... 10.00
- CA-2 Telescoping 1/4-wave 2m antenna ..... 10.00
- CA-5 5/8-wave telescoping 2m antenna ..... 18.95
- CA-3 Extra 220 flexible antenna ..... 9.12
- CA-4 Extra 440 flexible antenna ..... 9.12
- CP-1 Cigarette lighter receptacle chgr for BP-3.... 9.50
- DC-1 DC operation module ..... 17.50
- HM-9 Speaker/microphone ..... 34.50
- LC-2A Leather case without TTP cutout ..... 34.95
- LC-2AT Leather case with TTP cutout ..... 34.95
- ML-1 2m 2.3/10w HT amp. (Reg. \$89) ... SALE 79.95
- 3A-TTN 16-button TTP front for 2A/3A/4A ..... 39.50
- CommSpec SS-32M 32-tone encoder ..... 29.95
- ML-25 2m 20w HT amp. (Reg. \$199.50) SALE 179.95
- IC-M12 12 ch Marine hand-held ..... SPECIAL 269.95



Shortwave receiver Regular SALE

- R-70 100KHz-30MHz digital receiver ... \$749.00 599<sup>95</sup>

'til 10/30/83 - purchase R-70 and receive certificate for free GC-4 World Clock (\$99<sup>95</sup> Value) from ICOM.

- EX-257 FM unit ..... 38.00
- IC-7072 Transceiver interface, 720A 112.50
- FL-44/A SSB filter (2nd IF) ..... 159.00 144<sup>95</sup>
- FL-63 250 Hz CW filter (1st IF) ..... 48.50
- SP-3 External speaker ..... 49.50
- EX-299 (CK-70) 12V option ..... 9.95
- MB-12 Mobile mount ..... 19.50



**HOURS:** Mon. thru Fri. 9-5:30; Sat. 9-3

Milwaukee WATS line 1-800-558-0411 answered evenings until 8:00 pm, Monday thru Thursday.

**Please use WATS line for Placing Orders.** For other information, etc. please use Regular line.

**Order Toll Free: 1-800-558-0411** In Wisconsin (outside Milwaukee Metro Area) 1-800-242-5195

**AMATEUR ELECTRONIC SUPPLY Inc.**

4828 W. Fond du Lac Avenue; Milwaukee, WI 53216 - Phone (414) 442-4200

**AES BRANCH STORES**

- |   |   |   |  |   |
|---|---|---|--|---|
| <b>WICKLIFFE, Ohio</b> 44092<br>28940 Euclid Avenue<br>Phone (216) 585-7388<br>Ohio WATS 1-800-362-0290 | <b>ORLANDO, Fla.</b> 32803<br>621 Commonwealth Ave.<br>Phone (305) 894-3238<br>Fla. WATS 1-800-432-9424 | <b>CLEARWATER, Fla.</b> 33575<br>1898 Drew Street<br>Phone (813) 461-4267<br>No In-State WATS | <b>LAS VEGAS, Nev.</b> 89106<br>1072 N. Rancho Drive<br>Phone (702) 647-3114<br>No In-State WATS | <b>Associate Store</b><br><b>CHICAGO, Illinois</b> 60630<br>ERICKSON COMMUNICATIONS<br>5456 N. Milwaukee Avenue<br>Phone (312) 631-5181 |
| Outside Ohio 1-800-321-3594   | Outside Florida 1-800-327-1917  | No Nationwide WATS  | Outside Nevada 1-800-634-6227  | Outside Illinois 1-800-621-5802   |

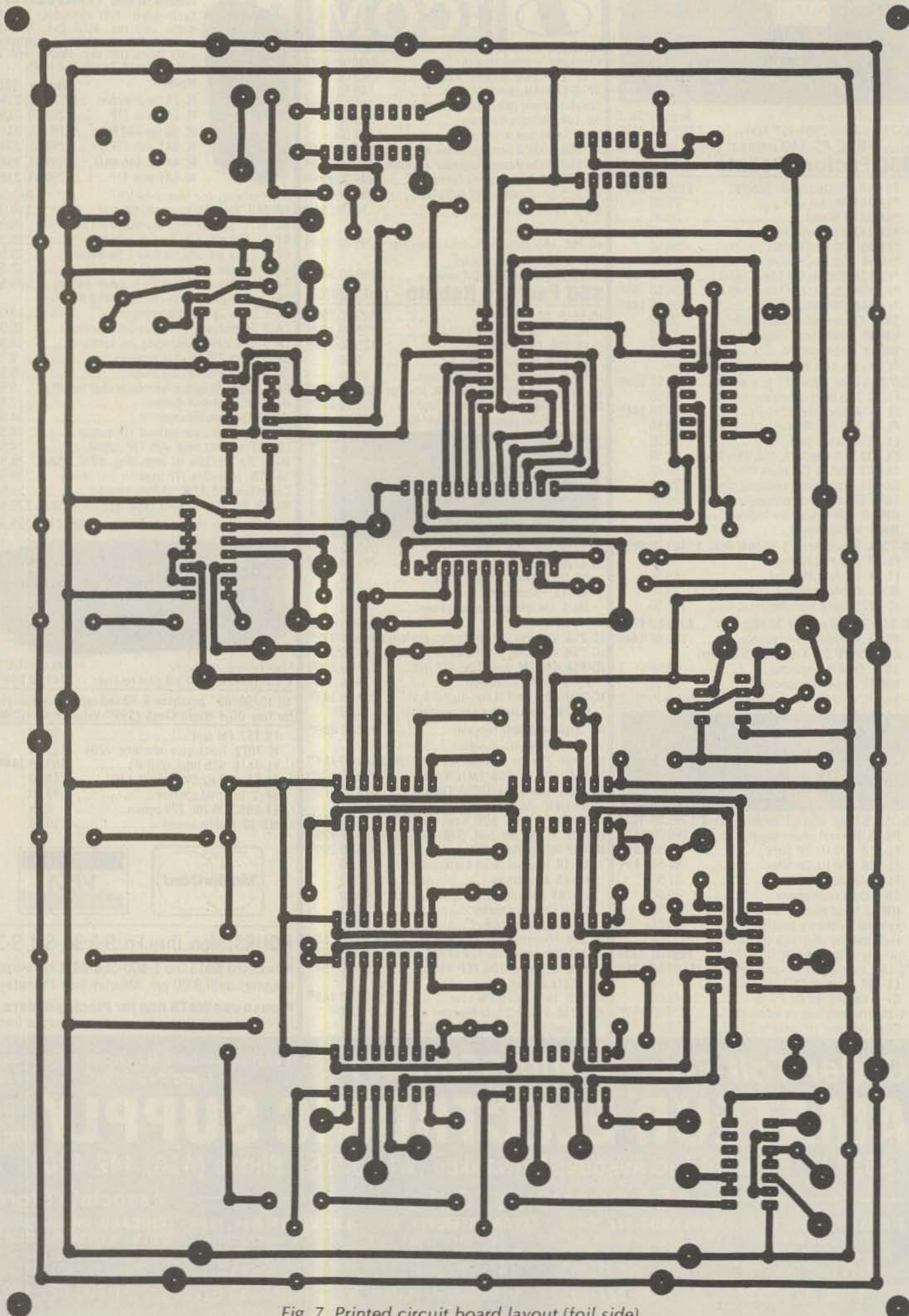

Fig. 7. Printed circuit board layout (foil side).

sion should always be started with at least one word space. If the operator desires to get a good head start on the Morse keyboard, he may need to press several word spaces in rapid succession. If the Morse-code operator desires to store a message, he should start with a word space. If a message is started with a character instead of a word space while in the Store mode, the operator will hear a steady tone. The steady tone may be used to tune the transmitter. To stop the steady tone, press the Rub Out key or the Send key.

Sometimes it is convenient to type part of a message into the buffer memory while receiving Morse code from the other station being worked.

At first, some people may become confused when hearing the Morse code going out after they had previously typed it into the

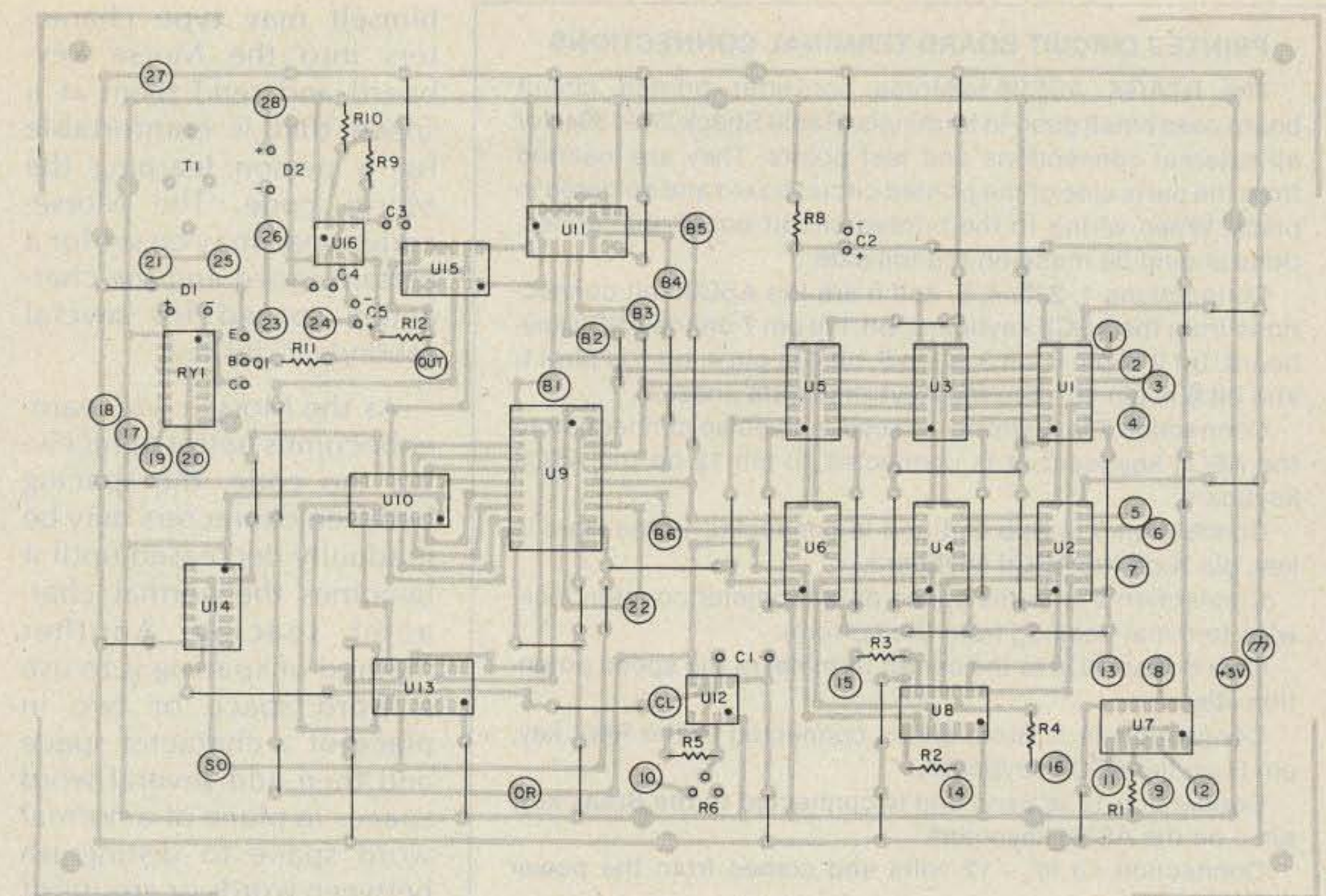

Fig. 8. Component layout.

Morse keyboard. The Morse keyboard has a sidetone generator for monitoring the outgoing Morse code, but not for monitoring the code before it enters the

buffer memory. It would be almost impossible to monitor the Morse code as it is being typed into the Morse keyboard. It would not be practical to use the

extra circuitry that it would require to do it. After a little practice, the Morse-code operator will find that it is very easy to type a message correctly while monitoring

#### PRINTED CIRCUIT BOARD ASSEMBLY

The printed circuit for the N7AGK Morse keyboard has been laid out on a 7-inch by 10-inch single-sided printed circuit board. The printed circuit layout has been especially arranged for ease of assembly. All external wiring connections to the printed circuit are made with push-in terminals.

All jumpers, sockets, terminals, and parts are shown on the printed circuit parts drawing. The drawing shows the parts side of the printed circuit board which is opposite the foil side.

The jumpers should be installed and soldered first. The jumper wire is pre-tinned, 24-gauge, copper bus wire. The jumper wires are shown as dark lines on the parts-side printed circuit drawing.

The resistors and diodes should be installed and soldered next.

Sockets are recommended for the integrated circuits and the keying relay. The sockets must be installed so that the notch end corresponds to the black dot on the parts-side printed circuit drawing. Extreme care must be taken when soldering sockets to prevent bridging across of the solder. A low-power solder iron and good quality, small-diameter, rosin-core solder is recommended. Do not overheat the solder connections and do not use excessive amounts of solder for the solder connections.

When installing C2 and C5, be sure to watch for correct polarity.

Install the 2N2222 keying driver transistor with approximately 3/8 inch of the transistor lead remaining between the transistor and the solder connection. Be careful not to use excessive heat when soldering the transistor leads to the printed circuit.

The black lead of T1 is not used. It may be clipped off if desired.

Install the push-in terminals as shown on the printed circuit drawing. Install output transformer T1 and solder the leads to their respective push-in terminals as shown in Printed Circuit Board Terminal Connections for connections 25, 26, 27, and 28.

Install and solder C4, C3, C1, and R6. (This should complete the printed circuit board assembly.)

Check the assembled printed circuit board carefully before attempting to use the circuit board in your Morse keyboard.

#### PRINTED CIRCUIT BOARD TEST TERMINALS

B1, B2, B3, B4, B5, and B6 are the ASCII information bits coming from the output of the buffer memory and going into the 1702A EPROM, U9, and the CD4048 word-space OR gate, U11.

SO is the shift-out pulse line from the 74177 character-space divider, U14. The shift-out pulse initiates the presentation of the next ASCII6 character from the buffer memory. It may be used as an external sync trigger pulse when viewing the outgoing Morse code on an oscilloscope.

OR is an output-ready signal line from the buffer memory. It resets the clock generator and ensures that the outgoing Morse code is in sync with the clock generator.

CL is the clock-generator output. It has a pulse rate that is 2 times the baud rate of the outgoing Morse code.

OUT is the outgoing Morse-code test point.

The ground and +5-volt connections for the ASCII keyboard may be taken from the extra terminals shown at the right of the parts-side drawing.

## PRINTED CIRCUIT BOARD TERMINAL CONNECTIONS

The N7AGK ASCII6-to-Morse converter printed circuit board uses small push-in terminals (Radio Shack 270-1394) for all external connections and test points. They are inserted from the parts side of the printed circuit board and soldered in place. When wiring to the printed circuit board, all connections should be made on the foil side.

Connections 1, 2, 3, 4, 5, and 6 are the ASCII6 bit connections from the ASCII keyboard. Bit 1 is pin 7 on the ASCII keyboard. Bit 2 is pin 6, bit 3 is pin 5, bit 4 is pin 4, bit 5 is pin 11, and bit 6 is pin 10. (See the Keytronic data sheets.)

Connection 7 is a strobe- or keypunch-pulse connection to the ASCII keyboard. It is connected to pin 12 on the ASCII keyboard.

Connection 8 is Rub Out and is connected to the Here Is key, pin K on the ASCII keyboard.

Connection 9 is to the speed potentiometer counterclockwise terminal (looking from the bottom).

Connection 10 is to the center terminal of the speed potentiometer.

Connection 11 is Store and is connected to the Rept key, pin H on the ASCII keyboard.

Connection 12 is Send and is connected to the Break key, pin J on the ASCII keyboard.

Connection 13 is -12 volts and comes from the power supply.

Connection 14 is a connection to the green LED buffer memory indicator light. The connection is made to the negative side or flatted side of the LED. The positive lead of the LED goes to +5 volts.

Connection 15 goes to the negative side of the yellow LED.

Connection 16 goes to the negative side of the red LED.

Connection 17 is +5 volts from the power supply.

Connection 18 is to ground.

Connections 19 and 20 are the relay contacts for keying the transmitter. Connection 19 goes to the ground connection of the keying jack at the rear of the Morse-keyboard cabinet and connection 20 goes to the other connection of the keying jack. The keying jack is a standard phone jack.

Connection 21 goes to the phone or speaker jack on the front of the Morse keyboard. The other connection is grounded.

Connection 22 is -9 volts from the power supply.

Connection 23 is the counterclockwise connection to the volume potentiometer (looking from the bottom).

Connection 24 is the center connection to the volume pot. The remaining connection on the volume pot goes to +5 volts.

Connection 25 is for the red wire from T1. Connection 26 is for the green wire from T1. Connection 27 is for the white wire from T1. Connection 28 is for the blue wire from T1.

the outgoing code. An error in typing is easily recognized by the Morse-code operator and may be corrected by hitting the word-space bar and then sending a question mark and then hitting the word-space bar again and then sending the word or characters again correctly.

The Morse keyboard is an excellent device for learning the Morse code or for increasing one's code speed. A portion of a

Morse-code practice transmission may be copied on the Morse keyboard by pressing the Store key and copying the Morse code and then playing the Morse code back at a slower speed by adjusting the speed control and pressing the Send key. The Morse code is played back at a slower speed to check for accuracy of receiving the practice transmission.

Another person who does not know the Morse code

himself may type characters into the Morse keyboard and send them at a speed that is comfortable for a person learning the Morse code. The Morse-code speed may be set for a certain speed and the characters spaced for several seconds if desired.

As the Morse-code learner becomes better at receiving the code, the spacing between characters may be gradually decreased until it becomes the normal character spacing. Another method of spacing is to use a word space or two in place of a character space and then add several word spaces in place of a normal word space to distinguish between words or groups of Morse-code characters.

The speed of the Morse keyboard may be set for a range of approximately 5 words per minute to over 70 words per minute. It is easy to stay ahead of the outgoing Morse code when operating at the slower speeds, but at the higher speeds it becomes increasingly more difficult to stay ahead. The Morse-code operator should never send out Morse code at a higher speed than he can copy comfortably unless he is using a video readout for monitoring the transmission. Even with a video readout it can be risky business when external interference prevents the video readout from receiving the Morse code correctly.

Typing will be no problem for the beginning operator as long as he is careful to type according to standard typing procedure. An operator should never type using the "hunt and peck" system because it will hinder him later when he desires to increase his Morse code and typing speed.

Most beginning Morse-code operators will find that it is usually easier to increase one's typing speed

than it is to increase one's Morse-code speed. A beginner should endeavor to type faster than he normally can receive the Morse code in order to stay ahead of the outgoing Morse code when using the Morse keyboard. For instance, a Morse-keyboard operator who can send and receive code at 15 words per minute must be able to type faster to stay ahead of the outgoing Morse code. If he cannot type faster than the outgoing Morse code, he may have trouble when short Morse-code characters like E and I, etc., appear frequently in the message.

One of the principal advantages of the Morse keyboard is the ability to send perfect Morse code at higher speeds than is possible otherwise. Many Morse-code operators reach the limit of their code-sending abilities at approximately 30 words per minute. The Morse keyboard extends the range that the Morse-code operator may otherwise attain. The ability to send and receive Morse code more accurately and more easily is a decided advantage for the Morse-code operator.

## Construction

The printed circuit board is a single-sided, 7-inch by 10-inch board that has been laid out for easy assembly and soldering. I spaced the layout so that none of the jumper connections or terminal connections is very close to any other one. The closest solder connections are for the integrated-circuit socket connections.

I have used push-in solder terminals for the connections to and from the printed circuit board and for some of the test terminals.

The photograph shows two Jones terminal strips for connections between the printed circuit board and other locations of the



Morse keyboard. These are not absolutely necessary and may be omitted. I have been using them for testing purposes.

The printed circuit board and the metal plate for the power supply are mounted on the bottom of the keyboard cabinet on metal standoffs. The wiring from the printed circuit board to other parts of the Morse keyboard is brought out from the bottom side or the foil side of the board.

### Availability of Components

I will supply a drilled and etched printed circuit board for \$25.00 postpaid in the US and Canada along with complete instructions for wiring and assembly. I will supply a programmed 1702A EPROM for \$10.00 or program a reader-supplied 1702A EPROM for \$6.00 postpaid.

I will supply a Keytronic model L1648, 53-key, ASR-33 data-communications ASCII keyboard with the proper keytops for \$100 postpaid in either the US or Canada. The ASCII keyboard uses a capacitance-type keyswitch and has over a 100-million-key-stroke reliability. The keyboard is fully assembled and has a rigid mounting frame and removable two-shot molded keytops. (A two-shot molded keytop is one that has the character molded within the keytop so that it will not wear off with continued use.) The ASCII keyboard is available with schematic and data sheets.

The Morse-keyboard cabinet is a 14-inch-wide by 11.3-inch-deep sloping panel keyboard cabinet manufactured by Hammond. The bottom portion is #1456 PL3 CBU and the matching top portion is #1456 PL3 PWH. It is the same keyboard cabinet as is shown in the photograph.

If the Morse-keyboard builder already has an

ASCII keyboard, he may use it with the Morse keyboard. If the ASCII keyboard is of the same configuration as the one mentioned in the article, he may use it without making any changes to the truth table or the 1702A memory-circuit programming. If the keyboard is different, a new set of truth tables will need to be made and the 1702A memory circuit will need to be programmed for the ASCII keyboard. A layout of the keyboard should be worked out and a list made of the ASCII6 outputs for each of the keys to be used.

Power must be applied to the ASCII keyboard and the voltages read for bits 1 through 6 for each character. A one will usually be plus 5 volts and a zero will be zero volts or ground potential. (Some characters may have the same ASCII6 data as other characters and this must be allowed for in the keyboard layout.)

The 1702A memory circuit does not need to be programmed according to the ASCII6 data but should follow it as closely as possible. There will be no problem with the letters and numbers characters, but some of the punctuation may not follow a strict ASCII6 conformity. None of the special communications characters such as break, wait, end of message, and end of transmission will follow any kind of ASCII pattern. Three function keys should also be selected for the Store, Send, and Rub Out keyboard functions.

Foreign characters may be selected for the Morse keyboard. The keytops will need to be labeled if the keytops are not available. A larger keyboard may be required for alphabets that require a larger number of characters such as the Japanese Kata Kana radio code. None of the foreign characters will be too long

★ RTTY ★ RTTY ★ RTTY ★ RTTY ★ RTTY ★

## BUILT TO WORK WHEN OTHERS WON'T!



*TMC-1B Computer Interface  
for RTTY/CW*

The **best performing unit** under adverse band conditions, **TMC-1B** is designed to compare with the professional equipment that has been on the market for years, not just a piece of gear to get you into computer RTTY. No computer experience needed. Software is included for Vic-20. Will work with most micro computers and with most of the popular software available. Only **CTI** gives you all this and more ★ **Auto start** with a variable control on front panel, will only print on properly tuned RTTY signal ★ L C tuned circuit filters (no active filters) ★ Easy to tune with large meter for greater accuracy, also mark and space LEDs ★ Switchable between 2 rigs (no wires to change) ★ Built-in monitor speaker for monitoring the signal as you send it ★ High gain on input, turn your rig way down ★ Relay isolated CW key and P.T.T. ★ Simple hook-up ★ RS 232 ★ All metal cabinet ★ One year guarantee. **\$299.95**

Price includes Vic-20 software in basic on cassette and computer cable



Write or call for more information:  
**CONTEMPORARY TECHNOLOGY, INC.**  
 P.O. BOX 1083 • SALEM, OR. 97308 ✓37  
 503 - 399-7406

★ RTTY ★ RTTY ★ RTTY ★ RTTY ★ RTTY ★

for the Morse keyboard, since the number zero is the longest Morse-code character used. All of the other characters are shorter than the number zero.

If more than 62 characters are needed, it would be best to redesign the Morse keyboard, use ASCII7 data, and use a larger capacity memory circuit. A 2704 EPROM would supply as many as 126 characters and a word space if there were that many Morse-code characters available. Both uppercase and lowercase positions would need to be used on the ASCII keyboard. There would be very few requirements for that type of arrangement.

Most of the integrated circuits are readily available at most of the large electronics parts houses. Prices are still coming down for some of the integrated circuits being used in the Morse keyboard. The prices are down quite a bit

since I started designing the Morse keyboard.

In the future, I will be selling some assembled printed circuit boards and possibly some completely assembled Morse keyboards.

### Summary

I have enjoyed designing the Morse keyboard and have been using it consistently on the ham bands ever since it was a breadboard circuit. Many hams have mentioned that it was easy to copy code from the Morse keyboard. Many have indicated a desire to try out a Morse keyboard for themselves to see how well they work. Some hams who previously showed very little interest in Morse-code operation have found that it is very enjoyable after all. Morse keyboards are catching on and it looks like there will be very many on the ham bands in the future. ■

# AMAZING

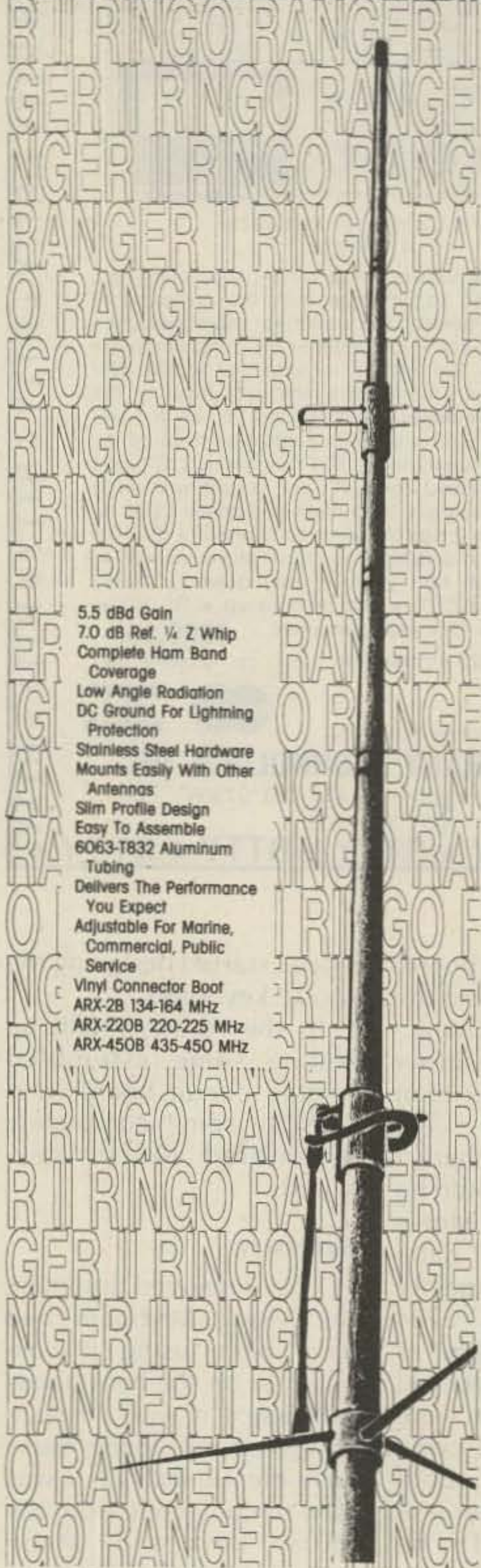

5.5 dBd Gain  
7.0 dB Ref. 1/4 Z Whip  
Complete Ham Band Coverage  
Low Angle Radiation  
DC Ground For Lightning Protection  
Stainless Steel Hardware  
Mounts Easily With Other Antennas  
Slim Profile Design  
Easy To Assemble  
6063-T832 Aluminum Tubing  
Delivers The Performance You Expect  
Adjustable For Marine, Commercial, Public Service  
Vinyl Connector Boot  
ARX-2B 134-164 MHz  
ARX-220B 220-225 MHz  
ARX-450B 435-450 MHz



48 Perimeter Road, P.O. Box 4680  
Manchester, NH 03108 USA  
TELEPHONE 603-627-7877

**YOUR DEALER**  
**THE HAM SHACK**  
808 NO. MAIN STREET  
EVANSVILLE IND 47711  
TEL. 812-422-0231

## DIRECTION FINDING?



- ★ No Receiver Mods
- ★ High Sensitivity
- ★ 135-165 MHz Standard Range
- ★ Mobile, Base or Remote Use
- ★ Bright LED Display
- ★ Optional Digital Readout
- ★ Optional Serial Interface
- ★ Kits or Assembled Units
- ★ 12VDC Operation
- ★ 90 Day Warranty

New Technology (patent pending) converts any VHF FM receiver into an advanced Doppler Direction Finder. Simply plug into receiver's antenna and external speaker jacks. Use any four omnidirectional antennas. Low noise, high gain for weak signal detection. Use serial AFSK option for remote display or tape recording data. Kits from \$270. Assembled units and antennas also available. Call or write for full details and prices.

**DOPPLER SYSTEMS**  
5540 E. Charter Oak  
Scottsdale, AZ 85254  
(602) 998-1151

## UNIVERSAL AMATEUR RADIO INC. AUTHORIZED DEALER FOR • KENWOOD

- DRAKE
- ICOM
- DENTRON
- AZDEN
- KANTRONICS
- MILLER
- ROBOT
- CUSHCRAFT
- SHURE
- ROHN
- YAESU
- TEN TEC
- SONY
- DENTRON
- MFJ
- NYE
- INFO-TECH
- LARSEN
- TEMPO
- PANASONIC

**JAPAN RADIO CO.**  
NRD - 515

Complete Stock of  
all Antennas and Towers  
Excellent Warranty on Used Equipment  
— Qualified and Authorized Service —  
Same Day Shipment — MC — VISA

**614-866-4267**

**UNIVERSAL AMATEUR RADIO INC.**  
1280 AIDA DRIVE  
REYNOLDSBURG (COLUMBUS) OHIO 43068

## TRS-80<sup>®</sup> MODEL III DISK SOFTWARE

— TRSDOS<sup>®</sup> COMPATIBLE —

PROGRAM	DISK-PAK I	REGULAR
Super-Log		\$ 19.95
Custom Beam Heading		\$ 26.95
Compu-Log		\$ 16.95
Antenna Anatomy		\$ 14.95
Super Duper		\$ 9.95
Micro-Clock		\$ 9.95
Micro-DX		\$ 9.95
IRC Management		\$ 9.95
		\$118.60 VALUE

**ONLY \$49<sup>95</sup>**

— ADD \$3.00 Shipping/Handling —

PROGRAM	DISK-PAK II	REGULAR
Novice Theory Review		\$ 19.95
General Theory Review		\$ 19.95
Advanced Theory Review		\$ 19.95
Extra Theory Review		\$ 19.95
Morse Code Trainer		\$ 16.95
		\$ 96.75 VALUE

**ONLY \$29<sup>95</sup>**

OFFER BY MAIL ORDER ONLY  
Write For Detailed Brochure

## MICRO-80 INC.

2665 SOUTH BUSBY ROAD  
OAK HARBOR, WA 98277



# RTTY



**TU-470 WIRED**  
HOLIDAY SPECIAL \$429.95



**TU-300**  
WIRED \$349.95

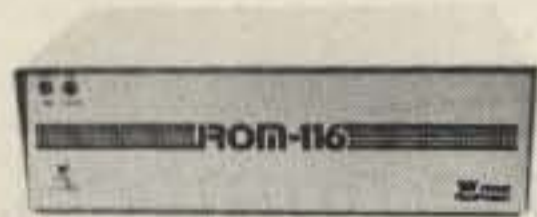

**ROM-116 \* TRS-80 RTTY/CW**

- Split Screen Video
- Real Time
- Fourteen Buffers
- Text Editor
- Auto CW/ID
- Selcal, WRU
- Word Wrapping
- For Model I, III, IV
- Many More Features
- Mail Box software available too
- Call for Prices

\*TRS-80 Trademark of TANDY CORP.

TU-170	TU-170A	TU-300	TU-470	DM-170	TERMINAL UNIT FEATURES
		•	•		3 Shifts (Hi-Tones Standard)
•	•			•	Single Shift (Hi-Tones)
•	•	•	•	•	3 Stage Active Filters
		•	•		AFSK Crystal Controlled
		•	•		RS-232C Compatible
•	•	•	•	•	TTL Compatible
		•	•		FSK Output
				•	Demod Loop Transistor Keying Output
		•	•		Remote Send RS-232C Compatible
		•	•		Remote Send TTL Compatible
				•	Remote Controlled Bi-Polar PTT output.
•	•	•	•	•	Autostart AC Output
•	•	•	•	•	Scope Outputs
•					Meter Tuning
	•	•	•		Bar Graph Tuning
	•	•	•		Status Indicators
	•	•	•		Receive & Send Up To 300 Baud
•				•	Receive & Send Up To 110 Baud
•		•	•		Loop Supply Internal
	•	•	•		Loop Supply External & Optional
		•	•		170 HZ Preselector Filter
				•	CW Demodulator Standard
				•	CW Demodulator Optional
•	•	•	•		Complete Assembly In Case
				•	Board & Parts Only
•	•	•	•		Complete With Connectors

**TU-170A**  
WIRED \$289.95  
KIT \$189.95

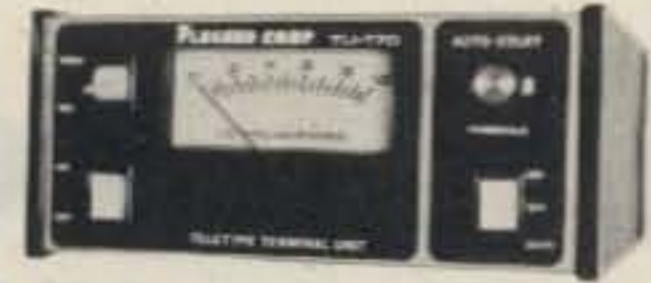

**TU-170**  
KIT \$149.95

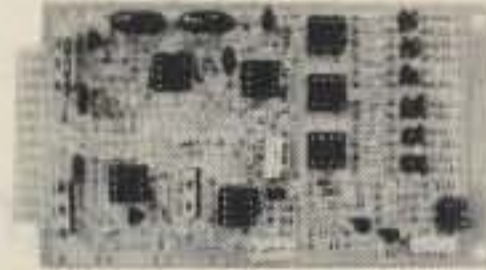

**DM-170**  
KIT \$47.95

For more information & sales  
**1-800-HAM-RTTY**  
SERVICE 1-913-234-0198

 **Flesher Corporation**  
P.O. Box 976  
TOPEKA, KS 66601

## VARIABLE MICROWAVE DOWN CONVERTER



**THIS IS NOT A KIT!!**

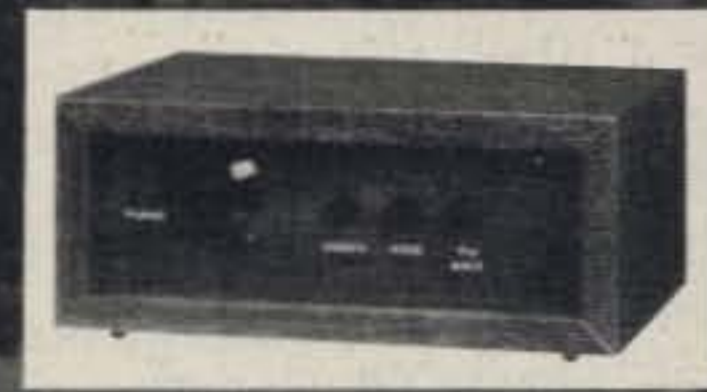

**QUANTITY DISCOUNT**

1.....	79.95
10.....	74.95
25.....	69.95
50.....	64.95
100.....	59.95

All down converters built  
with New HOT Transistor  
for more amplifier gain.  
**GREATER DISTANCE**

**NEW—Power supply built  
with push button simplicity  
ABC Switch built in**

★ Coax cable not included

PLEASE ADD  
SUFFICIENT  
POSTAGE

1 Unit weighs 5 lbs.

To order by Visa or Master Charge  
No C.O.D. orders

**Call 800-428-3500**  
**Information 317-291-7262**  
6254 La Pas Trail  
Indianapolis, Indiana 46268

**ELECTRONIC  
RAINBOW** 

73

# Reveal the Receiver Behind the Specs

*Here's a program that will make sense out of all those numbers.*

**R**ecently, I found myself coming down with a dread disease. I'm sure you've had it, too. It usually starts with a visit to a friend's shack, a hamfest, or the local radio emporium. You begin to experience an itch that can be relieved only by buying a new piece of ham gear.

As the disease progresses, you pore over glossy spec sheets and read equipment reviews in the ham magazines. It doesn't take long to realize that comparing brand K to brand D is almost impossible when it comes to the receiver specifications.

In one spec sheet, receiver sensitivity is given in microvolts for a 10-dB signal-plus-noise-to-noise ratio. For another rig, the measurements in the lab test give the minimum discernible signal. On occasion you may find a mention of the receiver front-end noise figure. And all of these are tested in different bandwidths. How can you cope?

If that's not enough, today's solid-state transceivers are good enough so that the manufacturers are actually beginning to tell us how their equipment is at handling strong nearby signals.

Usually they will spec this as the two-tone dynamic range, but sometimes it is given as the third-order intercept. Is there a way to make a direct comparison?

Fortunately, it isn't too hard to make these comparisons. It's especially easy if you use a computer to do all of the math. Before we get to the program that does this, let's refresh our memories about the specifications that I just mentioned.

## Sensitivity

For HF receivers, sensitivity is a measure of the noise generated by the amplifier stages and mixers in the signal path between the antenna and the speaker. It has nothing at all to do with the gain or amplification of the receiver. This is a point of confusion with many hams.

The most common way of specifying sensitivity is with the voltage required to give a signal-to-noise ratio of about 10 dB. The test is easy. Just use a calibrated generator to feed a signal to the receiver and watch an audio voltmeter connected to the audio output. Increase the level of the signal at the input until the voltmeter reads 10 dB higher than it did with no

signal. By using the calibration of the output level of the generator, the 10-dB S+N/N sensitivity results.

The reason it is called signal-plus-noise to noise is that you can't turn off the noise when the signal is applied because the noise is made by the receiver itself. Notice that there is no absolute reference to the output level of the receiver. Only the change in the output was measured. Two rigs can have the same sensitivity, but one may produce a very high level of received signal in the speaker while the other may hardly produce an audible output. A spec on overall gain would be nice, but I wish you good luck finding it on the glossy spec sheet!

## MDS

The minimum discernible signal that can be heard with a receiver is measured in much the same way as the 10-dB S+N/N sensitivity. The only differences are that the generator level is raised until the audio voltmeter goes up 3 dB, and that usually the MDS is given in dBm (dB referred to one milliwatt in 50 Ohms). By measuring in this way, the signal power and the noise power are exactly the same. To put it another way,

the signal-to-noise ratio is 0 dB. Converting MDS to  $\mu\text{V}$  for 10-dB S+N/N is mostly an exercise in logarithms.

One trap in the sensitivity specs involves the receiver bandwidth that was used when it was measured. An easy way to make the spec look good is to use a narrower i-f filter. Cutting the bandwidth in half cuts the noise power in half. Then the signal power has to be only half as large as before to give the same S/N ratio. It's not that the manufacturers are sneaky, but they do use different receiver bandwidths in their normal SSB position. To make direct comparisons, you have to take the different bandwidths into account.

## Noise Figure

On occasion, the sensitivity of a receiver will be specified as a noise figure. To understand noise figure, imagine that you have a receiver which is entirely noiseless. Connect a 50-Ohm resistor to its input and measure the output of the receiver. Surprise! There is noise there! But you knew that all resistors produce just a tiny bit of noise due to the molecular motion of the resistive material. Your noiseless receiver just amplified that tiny noise.

## Program listing.

```

10 REM R C V R S P E C BY TERRY CONROY, N6RY.
20 REM COMPARES RECEIVER SPECIFICATIONS FOR SENSITIVITY AND
30 REM DYNAMIC RANGE IN STANDARD BANDWIDTHS.
40 REM VIRGIN 1.00 ON 06 JUN 82 ORIG
50 REM VIRGIN 1.10 ON 18 JUL 82 APPLE
90 REM
99 REM VARIABLE LIST...
100 REM B0=KNOWN SENSITIVITY BW
107 REM B9=KNOWN DYN RANGE BW
104 DIM B(2): REM =STANDARD BW'S
106 REM D0=KNOWN 2-TONE DR
108 DIM D(2): REM =STD 2-TONE DR'S
110 REM I=INTERCEPT POINT
112 REM J=LOOP INDEX
114 REM M0=KNOWN MDS
116 DIM M(2): REM =STD MDS'S
118 REM N=NOISE FIGURE
120 REM P=TYPE OF SENS SPEC KNOWN
122 REM Q=TYPE OF DR SPEC KNOWN
124 REM S0=KNOWN 10 DB SENS
130 REM SET CONSTANTS
140 F = 10 / LOG (10)
150 B(1) = 500
160 B(2) = 2400
170 HOME
190 REM INPUT KNOWN SENSITIVITY
200 PRINT "SPECIFY INPUT SENSITIVITY PARAMETER:"
210 PRINT " 1) MINIMUM DISCERNIBLE SIGNAL (DBM)"
220 PRINT " 2) UV FOR 10 DB S+N/N"
230 PRINT " 3) NOISE FIGURE (DB)"
240 INPUT P
290 REM
300 PRINT
310 ON P GOTO 400,500,600
320 GOTO 240
390 REM
400 INPUT "MDS (DBM) ":M0
410 GOSUB 900
420 N = M0 + 174.0 - F * LOG (R0)
430 GOTO 1000
490 REM
500 INPUT "UV FOR 10 DB S+N/N ":S0
510 GOSUB 900

```

```

520 N = 2 * F * LOG (S0) - F * LOG (R0) + 57.47
530 GOTO 1000
590 REM
600 INPUT "NOISE FIGURE (DB) ":N
610 GOTO 1000
790 REM
900 INPUT "MEASUREMENT BANDWIDTH (HZ) ":B0
910 RETURN
990 REM INPUT KNOWN DYNAMIC RANGE
1000 PRINT
1010 PRINT "SPECIFY DYNAMIC RANGE PARAMETER:"
1020 PRINT " 1) TWO-TONE THIRD-ORDER"
1030 PRINT " 2) INPUT INTERCEPT POINT"
1040 INPUT Q
1050 PRINT
1090 REM
1100 ON Q GOTO 1200,1300
1110 GOTO 1040
1190 REM
1200 INPUT "TWO-TONE DYNAMIC RANGE (DB) ":D0
1210 INPUT "MEASUREMENT BANDWIDTH (HZ) ":B9
1220 I = D0 * 3.0 / 2.0 + N - 174.0 + F * LOG (B9)
1230 GOTO 2000
1290 REM
1300 INPUT "INPUT INTERCEPT POINT (DBM) ":I
1310 GOTO 2000
1390 REM
1990 REM CALCULATE EQUIVALENT SPECS
2000 FOR J = 1 TO 2
2010 M(J) = N - 174.0 + F * LOG (B(J))
2020 S(J) = 10.0 ^ ((M(J) + 116.53) / 20.0)
2030 D(J) = (I - M(J)) * 2.0 / 3.0
2040 NEXT J
2090 REM
2990 REM OUTPUT RESULTS
3000 PRINT : PRINT
3005 PRINT "          500 HZ          2400 HZ"
3007 PRINT "          -----          -----"
3010 PRINT "MDS": TAB( 15);M(1); TAB( 29);M(2)
3020 PRINT "10 DB S+N/N": TAB( 15);S(1); TAB( 29);S(2)
3040 PRINT "NOISE FIGURE": TAB( 15);N; TAB( 29);N
3050 PRINT
3060 PRINT "TWO-TONE DR": TAB( 15);D(1); TAB( 29);D(2)
3070 PRINT "INTERCEPT": TAB( 15);I; TAB( 29);I
3080 PRINT
4000 END

```

Now connect my receiver to your 50-Ohm resistor. Set it for the same gain as your noiseless receiver and connect the voltmeter to the output. The difference in dB of the reading on your perfect receiver and that of my real receiver is the noise figure of my receiver.

Since you can't make a perfectly noiseless receiver, you can't measure the NF that way. Instead, a calibrated source of noise is connected to the input of the rig and the output noise is compared to the output with only an input terminating resistor. With suitable calculation, the NF can be found.

One of the interesting things about NF is that the *i-f* bandwidth has no effect on the spec. This comes about because we are measuring noise-to-noise ratios. Both the receiver internal noise and the noise from the calibrated noise source go through the same filter. This is convenient for the computer program. Internally, it converts all sensitivity specs to NF for ease of calculation.

### Dynamic Range

For the contester in a multi-transmitter operation or for the poor soul with another ham just down the street, having a receiver with good dynamic range can mean the difference between enjoying operating or just giving it up altogether.

Solid-state receivers today can be excellent in handling strong signals while listening to weak ones. There are still lots of rigs around, both tube and transistor, that really don't do this well.

The most common way of specifying dynamic range is in terms of the two-tone, third-order intermodulation test. This involves using two signals of the same level separated by about 20 kHz. These signals are fed to the receiver through a combiner and a variable attenuator. The receiver is tuned 20 kHz away from one of the tones. Then the signal level is raised until an audio voltmeter at the receiver output shows a 3-dB change. The difference between the level of one of the tones and the

MDS, in dB, is the two-tone dynamic range.

What happens is that the third-order intermod produced by the receiver came up in level enough to be discernible. Because the distortion signal is being compared to the noise, it is also dependent on the *i-f* bandwidth.

### Intercept Point

With the two-tone test, for every dB that the level of the signals is raised, the intermod product goes up 3

dB. By raising the level of the two signals high enough, the intermod product will, in theory, finally rise enough to catch up with the level of the two tones causing the intermod. In fact, this does not happen, but we can extrapolate measurements that were made at lower levels to find out where it would happen. This imaginary point is called the third-order intermodulation-intercept point. It is specified in dBm.

Because we are comparing test signal amplitudes to

```

SPECIFY INPUT SENSITIVITY PARAMETER:
 1) MINIMUM DISCERNIBLE SIGNAL (DBM)
 2) UV FOR 10 DB S+N/N
 3) NOISE FIGURE (DB)
??

```

```

UV FOR 10 DB S+N/N .75
MEASUREMENT BANDWIDTH (HZ) 2200

```

```

SPECIFY DYNAMIC RANGE PARAMETER:
 1) TWO-TONE THIRD-ORDER
 2) INPUT INTERCEPT POINT
?1

```

```

TWO-TONE DYNAMIC RANGE (DB) 88
MEASUREMENT BANDWIDTH (HZ) 2200

```

	500 HZ	2400 HZ
MDS	-135.005727	-128.193314
10 DB S+N/N	.119182823	.261116483
NOISE FIGURE	12.0045734	12.0045734
TWO-TONE DR	92.2896846	87.7480763
INTERCEPT	3.42880021	3.42880021

Sample run.

## WATCH FOR HAL'S NEW PRODUCTS

HAL 2304 MHz DOWN CONVERTERS (FREQ. RANGE 2000/2500 MHz)	
2304 MODEL #1 KIT BASIC UNIT W/PREAMP LESS HOUSING & FITTINGS	\$19.95
2304 MODEL #2 KIT (with preamp)	\$29.95
2304 MODEL #3 KIT (with High Gain preamp)	\$39.95
MODELS 2 & 3 WITH COAX FITTINGS IN & OUT AND WITH WEATHER-PROOFED DIE CAST HOUSINGS	
BASIC POWER SUPPLY	\$19.95
POWER SUPPLY KIT FOR ABOVE WITH CASE	\$24.95
FACTORY WIRED & TESTED	\$34.95

ANTENNAS & OTHER ACCESSORIES AVAILABLE. SEND FOR MORE INFO.



### 2100-2500 MHZ

\*HMR-II COMPLETE UNIT  
COMPLETE SYSTEM AS SHOWN. NOT A KIT. INCLUDES A PC BOARD, POWER SUPPLY, CABLES & CONNECTORS—PRE-ASSEMBLED AND TESTED. 24dB GAIN OR GREATER.

1-4 units	\$89.95 ea.
5 or more units	\$79.95 ea.

\*HAM MICROWAVE RECEIVER

### PRE-SCALER KITS

HAL 300 PRE	(Pre-drilled G-10 board and all components)	\$14.95
HAL 300 A/PRE	(Same as above but with preamp)	\$24.95
HAL 600 PRE	(Pre-drilled G-10 board and all components)	\$29.95
HAL 600 A/PRE	(same as above but with preamp)	\$39.95

### TOUCH TONE DECODER KIT

HIGHLY STABLE DECODER KIT. COMES WITH 2 SIDED, PLATED THRU AND SOLDER FLOWED G-10 PC BOARD, 7-567's, 2-7402. AND ALL ELECTRONIC COMPONENTS. BOARD MEASURES 3-1/2 x 5-1/2 INCHES. HAS 12 LINES OUT. ONLY \$39.95

NEW—16 LINE DELUXE DECODER \$69.95

DELUXE 12-BUTTON TOUCHTONE ENCODER KIT UTILIZING THE NEW ICM 7206 CHIP PROVIDES BOTH VISUAL AND AUDIO INDICATIONS! COMES WITH ITS OWN TWO-TONE ANODIZED ALUMINUM CABINET MEASURES ONLY 2 3/4" x 3 3/4" COMPLETE WITH TOUCH-TONE PAD, BOARD, CRYSTAL, CHIP AND ALL NECESSARY COMPONENTS TO FINISH THE KIT. PRICED AT \$29.95

NEW—16 LINE DELUXE ENCODER \$39.95

HAL ECD—16 LINE DELUXE ENCODER INCLUDES PC BOARD, ALL PARTS & CASE \$39.95

HAL ECD—12 LINE DELUXE ENCODER COMPLETE WITH PC BOARD, ALL PARTS & CASE \$29.95

ACCUKEYER (KIT) THIS ACCUKEYER IS A REVISED VERSION OF THE VERY POPULAR WB4VVF ACCUKEYER ORIGINALLY DESCRIBED BY JAMES GARRETT, IN QST MAGAZINE AND THE 1975 RADIO AMATEUR'S HANDBOOK \$16.95

ACCUKEYER—MEMORY OPTION KIT PROVIDES A SIMPLE, LOW COST METHOD OF ADDING MEMORY CAPABILITY TO THE WB4VVF ACCUKEYER. WHILE DESIGNED FOR DIRECT ATTACHMENT TO THE ABOVE ACCUKEYER. IT CAN ALSO BE ATTACHED TO ANY STANDARD ACCUKEYER BOARD WITH LITTLE DIFFICULTY \$16.95

BUY BOTH THE MEMORY AND THE KEYS AND SAVE  
COMBINED PRICE ONLY \$32.00

### PRE-AMPLIFIER

HAL-PA-19 WIDE BAND PRE-AMPLIFIER, 2-200 MHz BANDWIDTH (-3dB POINTS), 19 dB GAIN

FULLY ASSEMBLED AND TESTED \$8.95

HAL-PA-1.4 WIDE BAND PRE-AMPLIFIER, 10 MHz TO 1.4 GHz, 12dB GAIN  
FULLY ASSEMBLED \$12.95



**CLOCK KIT**—HAL 79 FOUR-DIGIT SPECIAL—\$7.95. OPERATES ON 12-VOLT AC (NOT SUPPLIED) PROVISIONS FOR DC AND ALARM OPERATION.

### 6-DIGIT CLOCK•12/24 HOUR

COMPLETE KIT CONSISTING OF 2 PC G-10 PRE-DRILLED PC BOARDS, 1 CLOCK CHIP, 8 FND COMM. CATH. READOUTS, 13 TRANS., 3 CAPS, 9 RESISTORS, 5 DIODES, 3 PUSHBUTTON SWITCHES AND INSTRUCTIONS. DON'T BE FOOLED BY PARTIAL KITS WHERE YOU HAVE TO BUY EVERYTHING EXTRA. WILL RUN OFF ANY 12-VOLT AC SUPPLY. PRICED AT \$12.95

CLOCK CASE AVAILABLE AND WILL FIT ANY ONE OF THE ABOVE CLOCKS. REGULAR PRICE...\$6.50 BUT ONLY \$4.50 WHEN BOUGHT WITH CLOCK.

SIX-DIGIT ALARM CLOCK KIT FOR HOME, CAMPER, RV, OR FIELD-DAY USE. OPERATES ON 12-VOLT AC OR DC, AND HAS ITS OWN 60-Hz TIME BASE ON THE BOARD. COMPLETE WITH ALL ELECTRONIC COMPONENTS AND TWO-PIECE, PRE-DRILLED PC BOARDS. BOARD SIZE 4" x 3". COMPLETE WITH SPEAKER AND SWITCHES. IF OPERATED ON DC, THERE IS NOTHING MORE TO BUY\*  
PRICED AT \$16.95

\*TWELVE-VOLT AC LINE CORD FOR THOSE WHO WISH TO OPERATE THE CLOCK FROM 110-VOLT AC  
WHEN PURCHASED WITH CLOCK KIT \$2.95

SHIPPING INFORMATION: ORDERS OVER \$25 WILL BE SHIPPED POST-PAID EXCEPT ON ITEMS WHERE ADDITIONAL CHARGES ARE REQUESTED. ON ORDERS LESS THAN \$25, PLEASE INCLUDE ADDITIONAL \$2.00 FOR HANDLING AND MAILING CHARGES. SEND 20c STAMP FOR FREE FLYER.

DISTRIBUTOR FOR  
Aluma Tower•AP Products  
(We have the new Hobby-Blox System)

## HAL-TRONIX

P. O. BOX 1101

SOUTHGATE, MICH. 48195  
PHONE (313) 285-1782



"HAL" HAROLD C. NOWLAND  
WBZXH

✓31

the amplitude of the intermod product, the if bandwidth is not a factor in the measurement. The computer program uses this for internal calculations because of the bandwidth independence.

### The Program

Once the formulas for the conversions are derived, the program is really quite simple. It has five sections. The first part takes care of opening stage business by dimensioning the arrays and setting the constant values.

In the second part, the program asks for the sensitivity spec from the glossy sheet or equipment review. The third section takes in the known dynamic-range specification. Then the computer calculates the equivalent specs for "standard" bandwidths of 500 and 2400 Hz. Lastly, the program tells the computer to print these specs.

To help you modify the program for your own use, the variables used in the pro-

gram are defined in the beginning of the program listing. So that you will know that your CDC Cyber is finding the right answers, a sample run is included as a check. The program listed was on an Apple II, but the syntax is pretty ordinary and shouldn't present much of a problem in translating to other dialects of Basic.

### Trivial

Be wary of anyone who tells you that any particular task for a computer is trivial. Usually those trivial tasks take months to accomplish (as my boss reminds me afterward). It did take me a while to reduce this program to the simple form that you see here. After I was done, even the job done by the program seemed trivial... until I remembered how long it took to punch in the calculations on my scientific calculator.

I hope this short program makes it easy to compare the competing cures for your itch for new gear. ■



## AFRAID?

You won't  
get the  
BEST deal?

CALL US  
WE  
BUY - SELL  
ALL BRANDS  
NEW, USED  
OR WHOLESALE

LARGE  
STOCKS  
LOW  
PRICES

"HAM HEAVEN"  
U.S.A.

ASSOCIATED RADIO  
8012 Conser  
Overland Park, KS 66204  
(913) 381-5900

Send \$2.00  
for our  
Catalog and  
Wholesale List.

# MORE PERFORMANCE FOR YOUR DOLLAR! COMPETITORS KNOW ABOUT THE ISOPOLE™ DO YOU? STUDY THE FACTS...

The IsoPole antenna is building a strong reputation for quality in design and superior performance. Innovative IsoPole conical sleeve decouplers (pat. pend.) offer many **new** design advantages.

All IsoPole antennas yield the **maximum gain attainable** for their respective lengths and a zero degree angle of radiation. Exceptional decoupling results in simple tuning and a significant reduction in TVI potential. Cones offer greater efficiency over obsolete radials which radiate in the horizontal plane and present an unsightly bird's roost with an inevitable "fallout zone" below. The IsoPoles have the broadest frequency coverage of any comparable VHF base station antenna. This means no loss of power output from one end of the band to the other when used with SWR protected solid state transceivers.

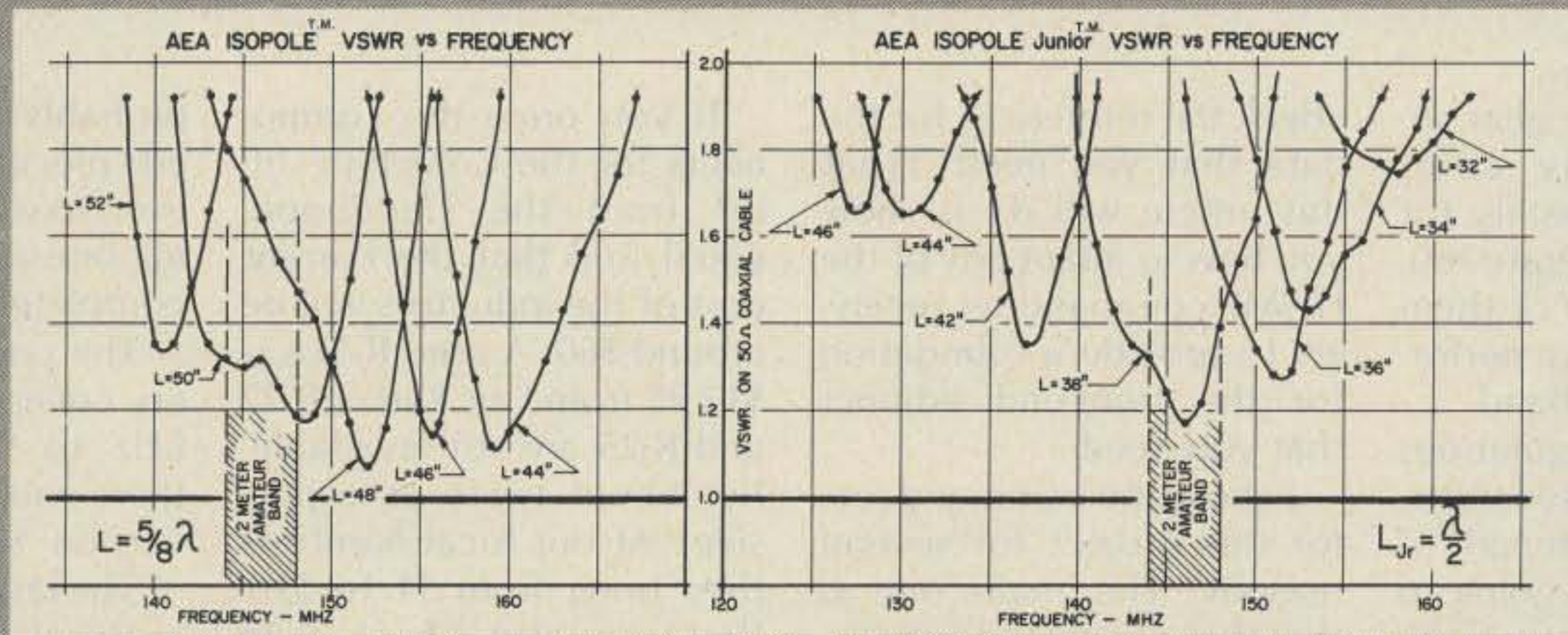

Outstanding mechanical design makes the IsoPole the only logical choice for a VHF base station antenna. A standard Amphenol 50 Ohm SO-239 connector is recessed within the base sleeve (fully weather protected). With the IsoPole, you will not experience aggravating deviation in SWR with changes in weather. The impedance matching network is weather sealed and designed for maximum legal power. All IsoPole antennas are D.C. grounded. The insulating material offers superb strength and dielectric properties, plus excellent long-term ultra-violet resistance. All mounting hardware is stainless steel. The decoupling cones and radiating elements are made of corrosion resistant aluminum alloys. The aerodynamic cones are the only appreciable wind load and are attached directly to the support (a standard TV mast which is **not supplied**).

IsoPole antennas have also become the new standard for repeater applications. They all offer low angle of radiation, low maintenance, easy installation, and low cost with gain comparable to units costing several times as much. Some repeater installations have even eliminated the expense of a duplexer by using two IsoPole antennas separated vertically by about twenty feet. This is possible because of the superior decoupling offered by the IsoPole antennas.

The IsoPole antenna is now available in a 440 MHz version which is fully assembled and tuned.

Our competitors have reacted to the IsoPole, maybe you should too! Order your IsoPole or IsoPole Jr. today from your favorite Amateur Radio Distributor.

**AEA** Brings you the Breakthrough!

PRICES AND SPECIFICATIONS SUBJECT TO CHANGE WITHOUT NOTICE OR OBLIGATION.



ISOPOLE 144  
ISOPOLE 220  
MAST NOT SUPPLIED



ISOPOLE 440



ISOPOLE 144JR  
ISOPOLE 220JR  
MAST NOT SUPPLIED

ADVANCED ELECTRONICS APPLICATIONS

P.O. Box C-2160,  
Lynnwood, WA 98036  
(206) 775-7373  
TELEX: 152571 AEA INTL

# Terrific Top-Band Conversions

*Jump up to 160 meters and beat the coming sunspot drought. Surplus gear will get you there cheaply.*

**D**esigning ham gear involves many compromises; unfortunately for those of us who operate 160, it seems that many of them end up taking away performance on the top band.

With the new regulations and decreasing sunspots, the number and strength of signals on 160 are going to increase. Will your rig be able to cope? Are you looking for a simple and inexpensive way to add a preselector/preamp to your station? This cheap and easy conversion may be just what you're looking for.

I'm not going to provide a treatise on filter design, so

check the references for the data that you need. What this article will do is show you how to adapt any of the HF/MF command-set receivers to provide a foundation for the front-end adjunct that you need.

I chose the command sets for this project for several reasons. The main one is that they are almost a ready-made front end as they are, and the coils lend themselves to easy modification and rewinding. The components are of exceptional quality. In addition, my junk box contains a very high proportion of command-set components.

If you price the components for the Cohn-type filter from the *Handbook*, you'll find that the current cost of the inductors will be around \$50. A used R-11A is \$12.95 from Fair Radio (R-22 and R-25 are still available, but about twice as expensive). At our local hamfests they bring from \$1 to \$10. You can also check with your local OTs; there has to be at least one command receiver left for every ham in the US.

When choosing a unit at a hamfest, the only caution is that those units that have been bandspread (the dial will have homemade markings covering one band) should be bought for coils only as the variable capacitor in these conversions is gutted. Happily, most conversions don't affect the parts used for this conversion. The command sets are

probably the most converted piece of surplus gear ever, so your chances of finding one at a hamfest that is completely original are slim.

The command-set receivers cover the range of 190 kHz to 9.1 MHz. Any of them will work for this conversion. See Table 1.

The last command receiver (civilian version) rolled off the assembly lines 20 years ago, the first well over 40 years ago, so even the diehards will have to admit that their usefulness as receivers is about at an end. With this in mind, get out the hacksaw and get ready for the very last command-set conversion.

The simplest passive unit (Fig. 2) uses the variable capacitor and two of the front-end coils (the small cans under the variable capacitor). The others make use of all the front-end coils and

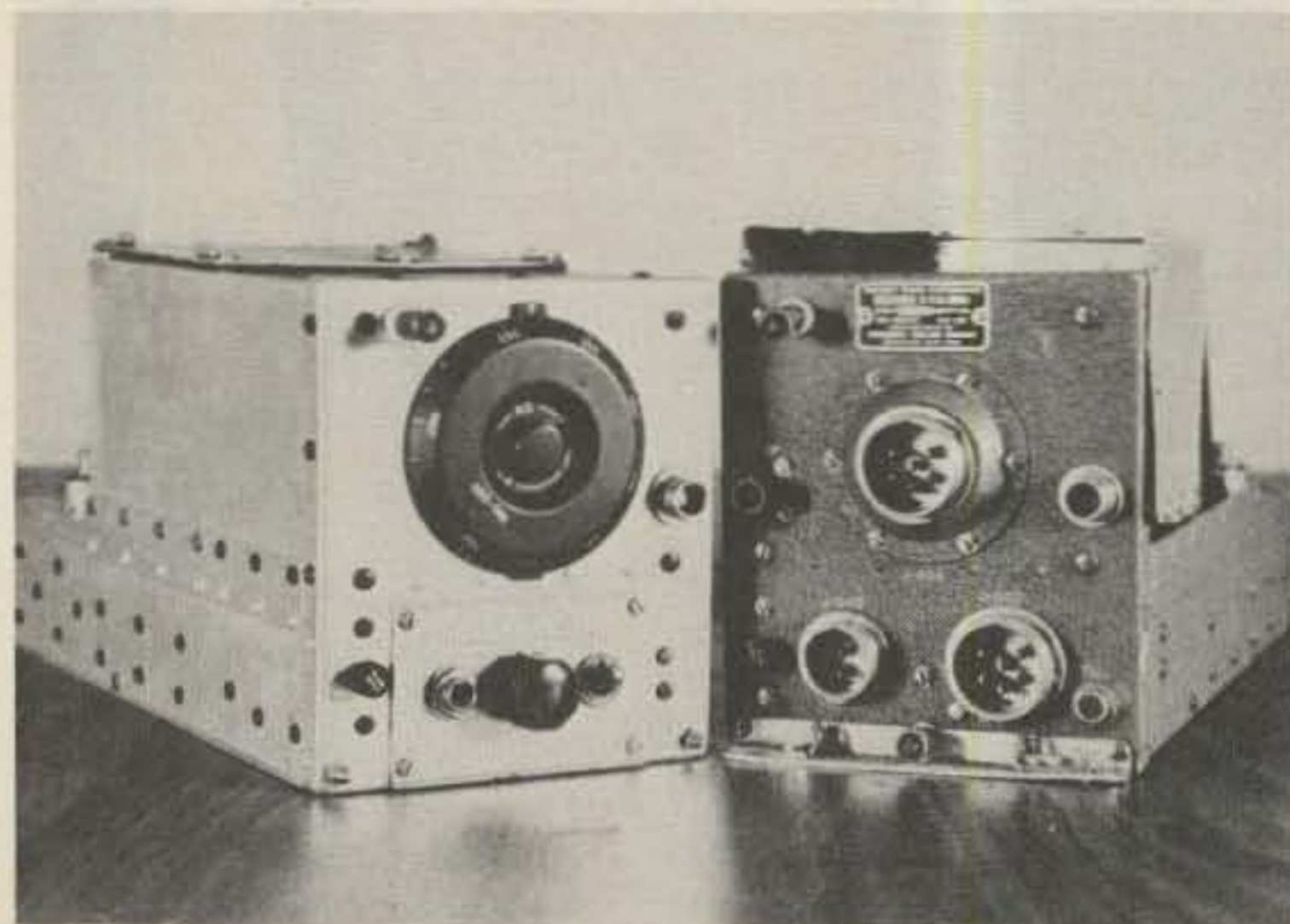

Photo A. The receivers before modification.

Frequency	Model	Notes
190-550 kHz	R-23, BC-453, R-11	Modify variable
520-1500 kHz	R-24, BC-946, R-22	Scarce, seldom found at hamfests
1.5-3 MHz	R-25, BC-454	Least modification needed for 160
3-6 MHz	R-26, BC-454	
6-9.1 MHz	R-27, BC-455	Padding needed for variable capacitor

Table 1.



the i-f coils; shield cans may be used also.

The front-end coils and i-fs on the early models plug in; those on the later models (no dial) do not. The plug-in feature is nice while testing and constructing, but it is not a necessity. Each of the front-end coils is color-coded for frequency range and function as follows: brown—190/550, orange—1.5/3, yellow—3/6, green—6/9.1, red—.52/1.5. This color code is on the screw holding the coil form to the shield-can base.

The function color code, located in one corner of the shield-can base, is as follows: red—antenna, yellow—rf, blue—mixer.

The i-f cans can be used to house a second filter, as a housing for the amplifier circuit, or as the center inductors for a Cohn-type filter. The 2830-kHz i-fs from the 6/9.1 receiver have a very nice coil form that is easily rewound or modified. The i-f cans can be screw-mounted to the chassis or the tube socket holes can be enlarged and the original plugs used. The mounting brackets will have to be removed to fit the three i-f cans across the chassis as shown in Photo D.

If you do not wish to use the original dial mechanism, or if your unit has no frequency dial, you will have to modify the variable capacitor.

The variable capacitors are rated as follows: 6/9.1, 75 pF; 3/6, 150 pF; the rest are 450 pF. These values are for one section and are approximate as there are some variations in the different models. To lower the capacity, you must remove plates; this is not difficult, but it must be done carefully.

### Basic Conversion

First strip the chassis and then the front panel. Set aside the hardware, the front-end coils, the variable capacitor and its shield, the

i-f cans, and the small variable capacitor from the front panel. If you have one of the dial-less units, remove the plugs from the front panel. If the aluminum cup is still in your unit, remove it from the front panel also. The front panel should be clean with the exception of the spline shaft holder. If you intend to use the original right-angle setup, leave it on the panel. If not, remove the two pins and then unscrew the nut that holds it to the chassis.

Are you going to use the i-f cans? If so, remove the two tube sockets located immediately behind the variable capacitor shield. Also remove the i-f plugs (if present) by running a screwdriver under the rolled edges and prying up gently.

Now, using a hacksaw with a fine-tooth blade, cut off the rear of the chassis right behind the two i-f holder nuts. This is 5" measured from the front panel. If you will not be using the i-f cans, cut between the shield holder nuts and the first i-f holder nuts. This is 3-3/16" measured from the front panel. Of course, you can leave more rear apron if you need it for relays, power supply, or whatever.

What you now have is a three-section variable capacitor with coils, shield cans, and an enclosure to mount it all in. Now to assemble the finished product.

See Fig. 2. Using the antenna and rf coils, this unit covers the original frequency range of the receiver.

Modify the antenna coil by adding a two-turn coil to the bottom using #20 wire. Connect one end to the ground end of the original coil and the other to an unused pin. Modify the rf coil by removing the pie-wound coil on top of the form and adding a two-turn link as in the antenna coil. Remove the core locks from both coils and screw the cores all the way into the coil form. At this point you may wish



Photo B. The parts used showing a modified variable capacitor.

to remove the shield cans from the bracket and drill holes in them to clear an alignment tool. The shield cans do change the frequency of the tuned circuit. Now, plug or mount the two coils in the first two sockets or holes using the first two sections of the variable capacitor (the ones with the trimmers). Wire the unit to agree with Fig. 2. Make sure that the coupling capacitor does not interfere with the variable capacitor.

Using the trimmers and adjusting the cores, the unit should track across approximately the original range of the receiver. The response is a bit broad on 6/9.1 and adequate on 3/6 and 1.5/3.

See Fig. 3. This adds a pre-amp and another tuned cir-

cuit to Fig. 2. You will have to rewind the mixer coil using the antenna coil as a model. The link is the same and the tap will depend on the gain desired from the amplifier. A dual-gate device could be used here with a gain-control voltage applied to G2. You can use your favorite amplifier circuit here, or even one of the commercial gain blocks. Just remember to use only the amount of gain needed to overcome filter loss or Rx antenna inefficiency—overdoing it will defeat the purpose of the device.

To cover frequencies other than that for which the receiver was designed, you will of course have to rewind (or unwind) the coils and perhaps add some pad-

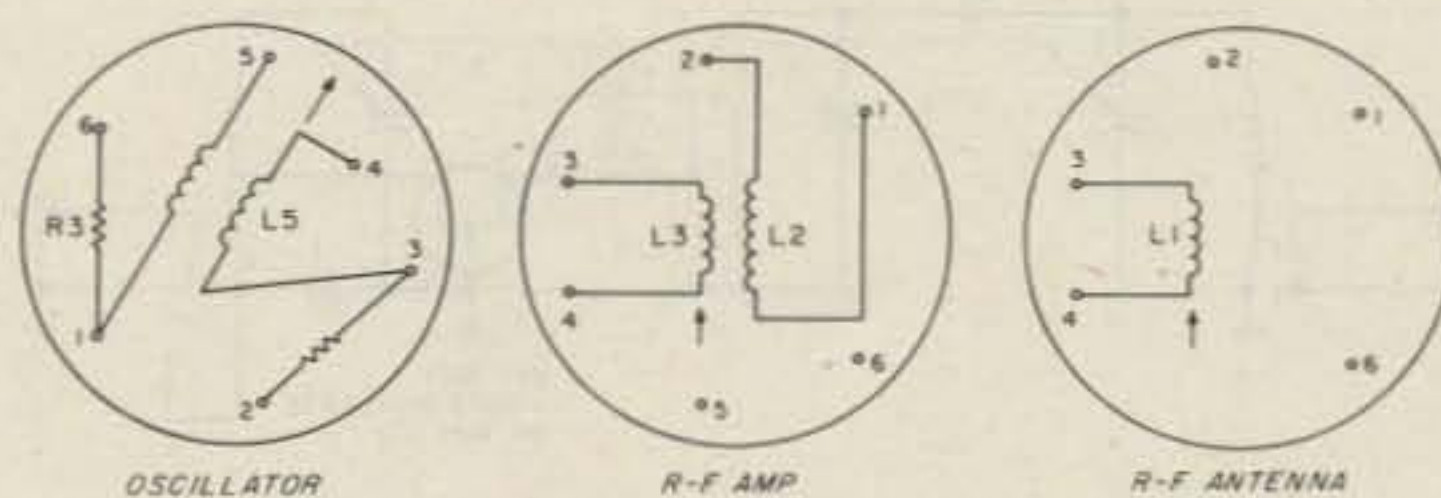

Fig. 1. Typical command-set coils.

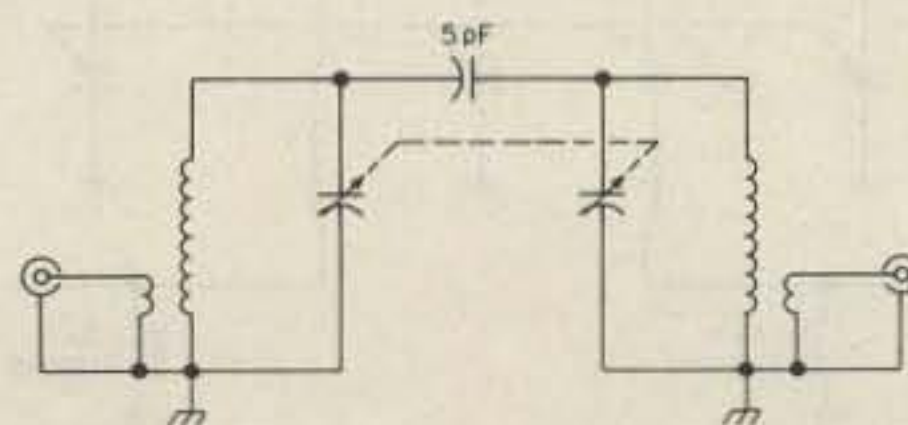

Fig. 2. Simple two-section unit.

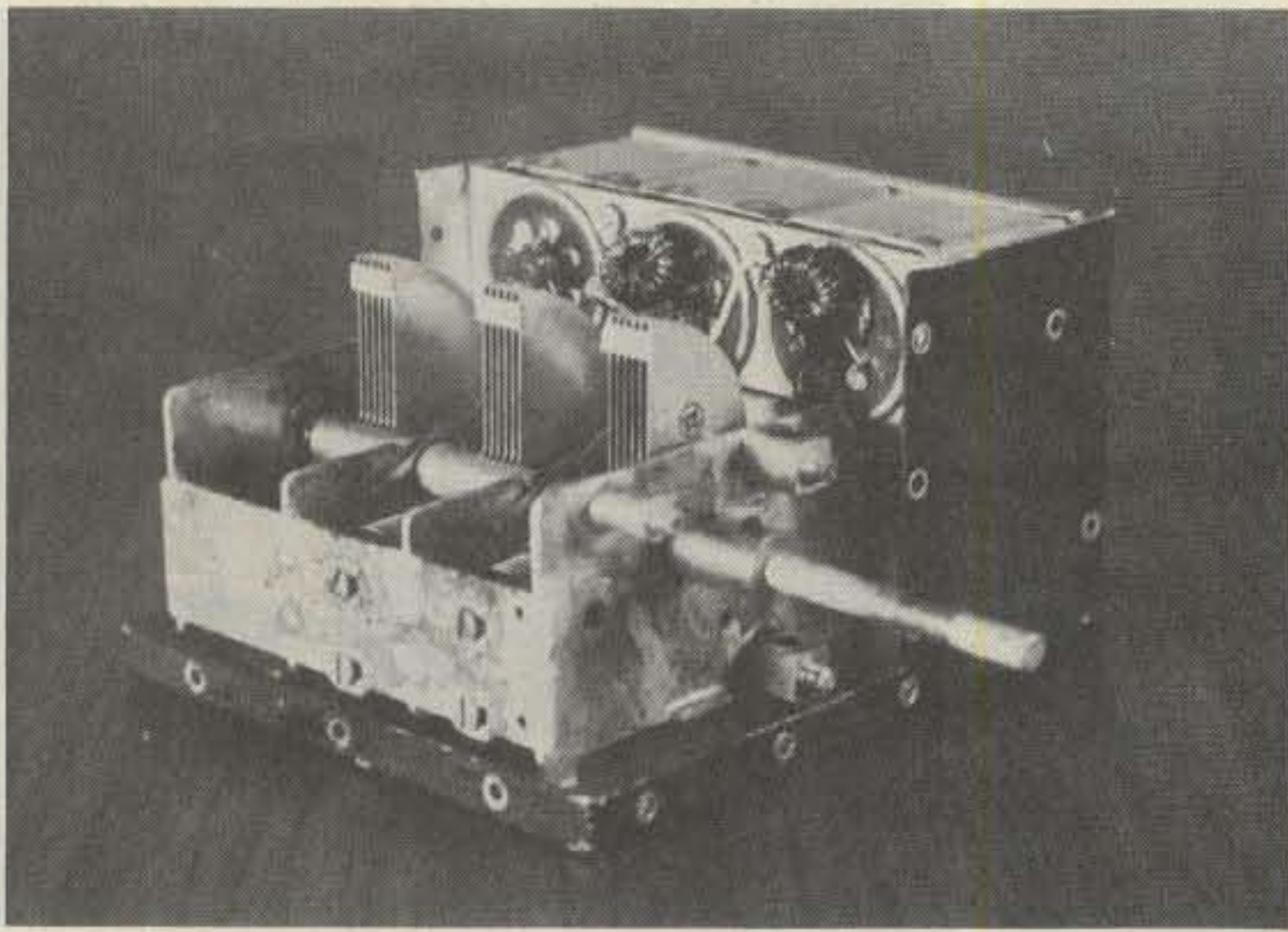

Photo C. Multi-section filter using R-11a parts (no dial assembly), variable capacitor shield removed to show details. Note position of bottom coupling toroid coils.

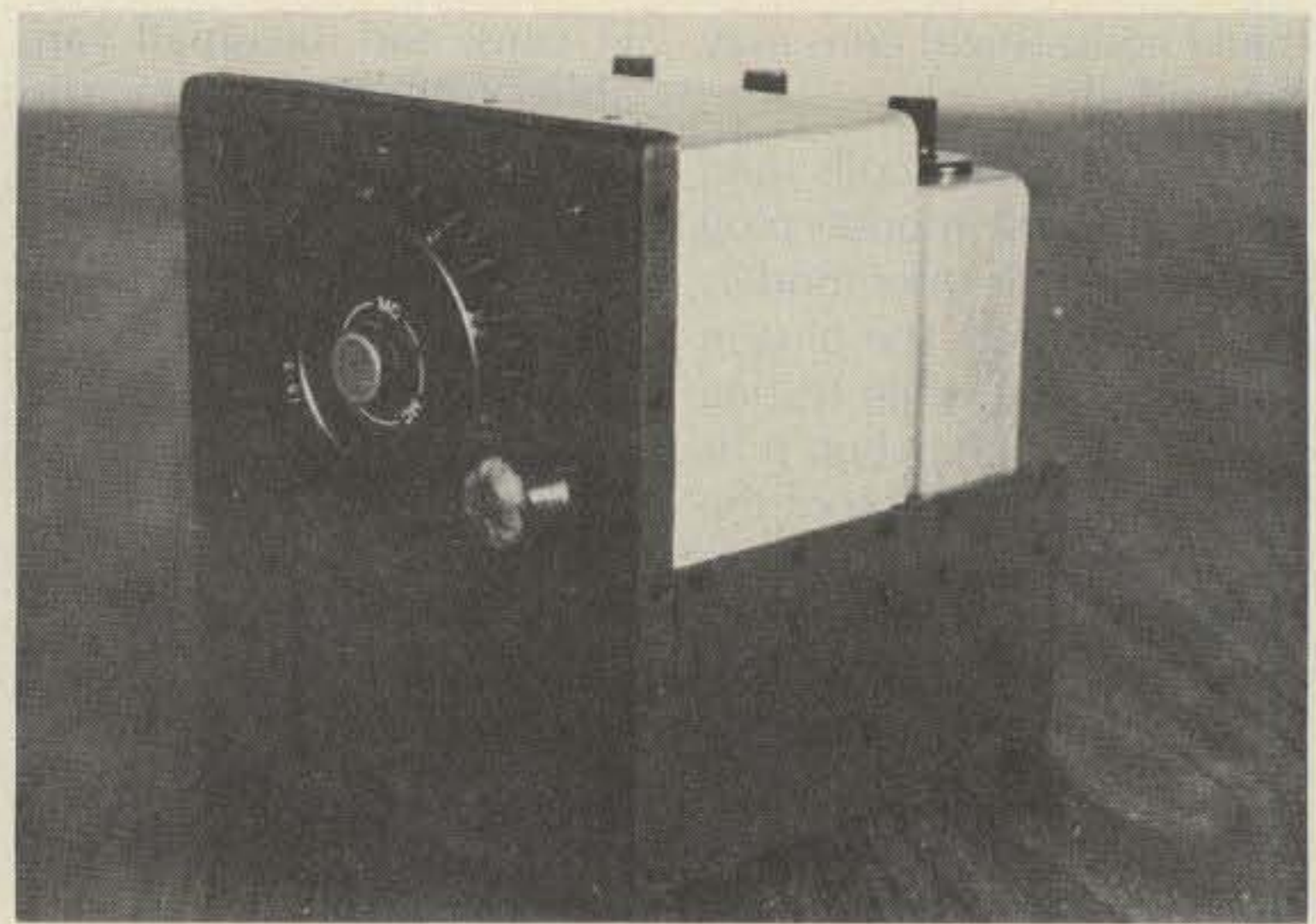

Photo D. Completed unit showing possible placement of i-f cans.

ding to the variable capacitor. If you use the 3/6 and 6/9.1 units, a good starting place for 160 is about an inch of closewound turns of #32 wire. The 190/550 units can be modified by either rewinding the coils or unwinding them. The variables have a bit too much capacitance, but they will work. See Fig. 4. This filter can be made with the coil set from the 190/550 units by unwinding the antenna coil, removing the large coil from the top of the mixer coil, unwinding the small coil, and then unwinding the two coils on the rf coil form until they reach the proper inductance. Unwind only enough from each of the four coils for it to

reach the right frequency. This involves a bit of extra "cut and try" time, but it is worth it. Remember that the two center inductors are twice the inductance of the outside coils and that the bottom coupling links and in/out links should be in place as you bring the inductors to frequency.

I have covered only a few of the possibilities for this conversion here; your needs will determine the final form yours takes.

There is room inside the shield can to build the amplifier. The i-f coils can be used to build a second filter for a different range. The switch should have each section shielded to prevent

stray coupling. To modify the 450-pf variable capacitors to reduce capacity, do the following:

First, remove the end rotor plate, using long-nose pliers, working it gently back and forth until it breaks free. Remove the next rotor plate the same way. This one and the rest will have to be freed from the band stop bar. Trim the band stop bar after removing each plate. The stator plates are a bit easier to remove. Twist gently at the attachment point opposite the trimmers until it breaks free. Do not put too much pressure on either the shaft or the stator plates or the ball bearings will break free and you will have a Chinese puzzle to assemble. If one or more of the glass beads the stator plates are mounted on is missing, acceptable substitutes can be found at your local crafts shop. Leave six rotor and six stator plates in each section and make sure that the plates are properly aligned. More plates may be removed if the capacity is still too high.

#### More Capacitor Modifications

The antenna section of the variable capacitor either has no trimmer or, if there is one, it has fewer plates than

the others. The capacitor that you removed from the front panel can be remounted and used for a trimmer or the trimmer on the shaft end can be used by running an insulated wire from it to the antenna section under the variable capacitor, along the front panel.

To remove the angle drive, first remove the pin in the worm gear shaft, then remove the two gears from the bottom of the capacitor by prying off the retainers with a small screwdriver. Pull the splined end out and then remove the end nut and the worm gear. Remove the gear from the end of the shaft by driving out the pin gently—remember the ball bearings. If the pin is stuck, drill it out. Then remove the triangular plate (this plate helps support the shaft while you remove the pin) and pull the gear off the shaft.

I used as much of the original covers as I could to house the unit. If you remove the drive, you will have to cut a U-shaped slot in the capacitor shield to clear the shaft and coupler.

The time that you spend getting the unit to track will pay off in performance. Take your time and get it right.

I used a GDO to get the circuits close to frequency and then used a signal gen-

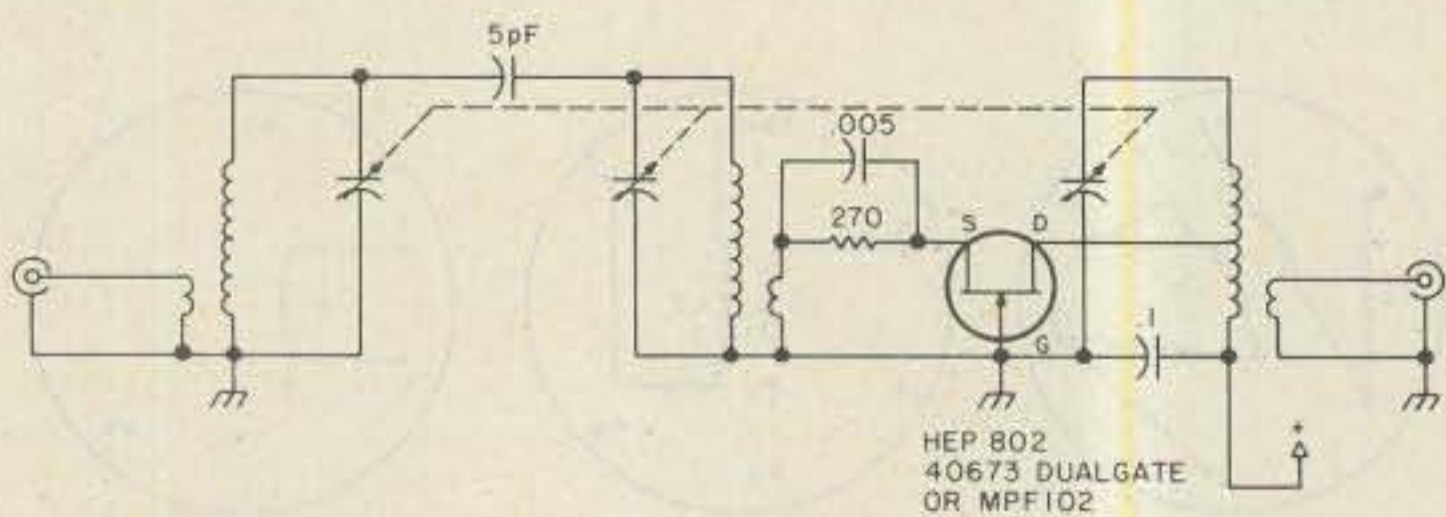

Fig. 3. Preamp and tuned circuit attached.

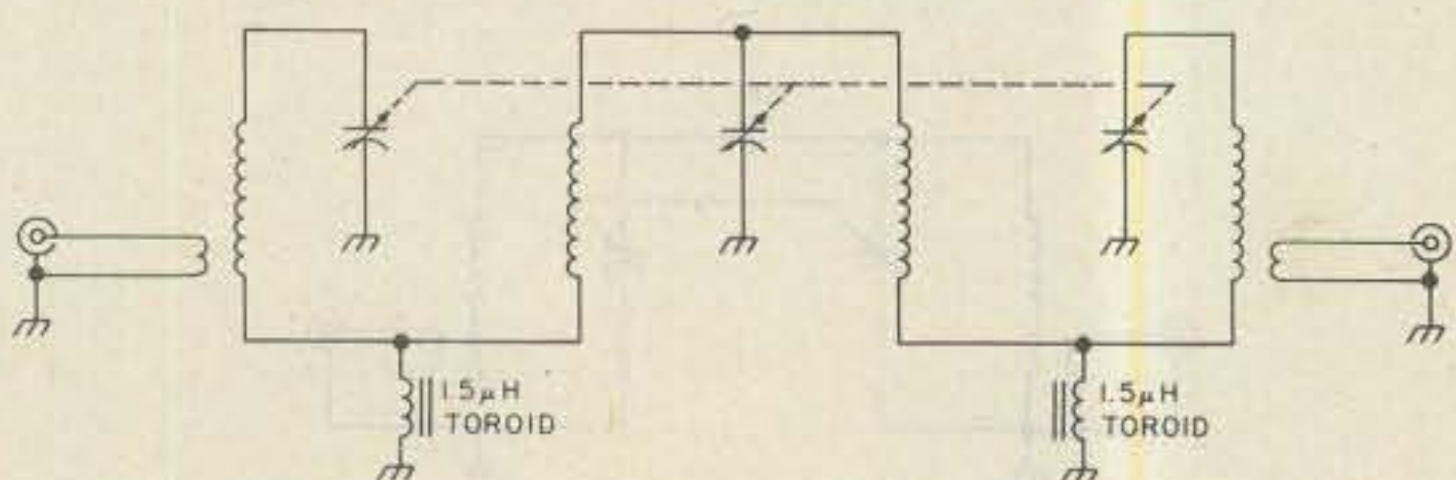

Fig. 4. Multi-coil setup.



# KCS

## ELECTRONICS CORPORATION

### SEMICONDUCTOR PARTS & PRODUCTS

#### FACTORY PRIME DEVICES INCLUDE:

- Capacitors  
all types & styles
- Chokes & Coils
- Connectors
- Digital & Linear IC's
- Hardware & Accessories
- IC Sockets
- Memory
- Microwave Semiconductors
- Resistors  
fixed & variable
- Transformers
- Transistors & MORE!

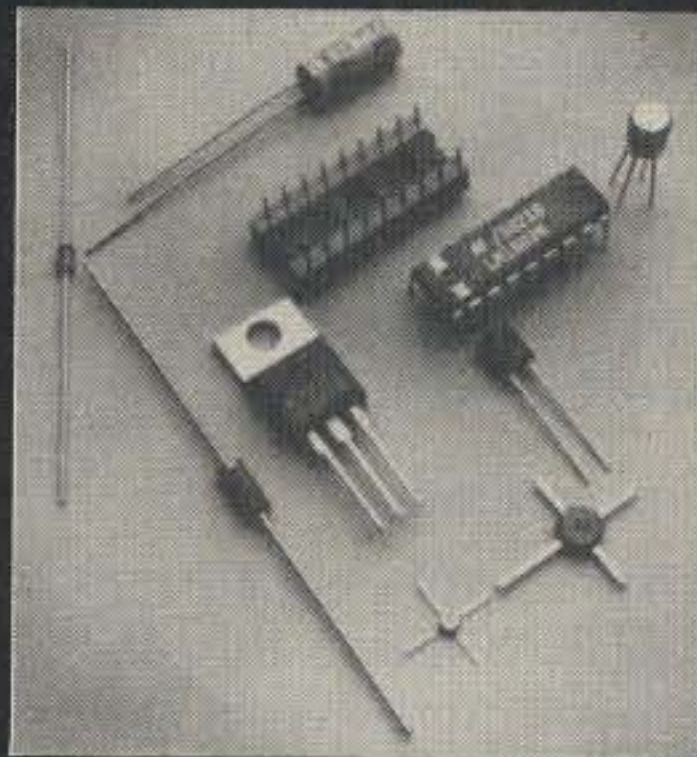

**MANUFACTURERS SUCH AS:** Motorola, National, NEC, J.W. Miller, Texas Instruments and more!

**WE STOCK & SUPPLY DEVICES FOR:** OEM's, Distributors, Hobbyists, Magazine Projects, Engineers, Schools, Technicians & You!

Call or Write for Quantity Pricing and FREE Catalog.

P.O. Box 33205  
Phoenix, AZ 85067 **(602) 274-2885**

✓ 230

## MICROWAVE TV ANTENNA SYSTEMS

Freq. 2.1 to 2.6 GHz • 34 db Gain +



TWO YEAR WARRANTY  
PARTS & LABOR

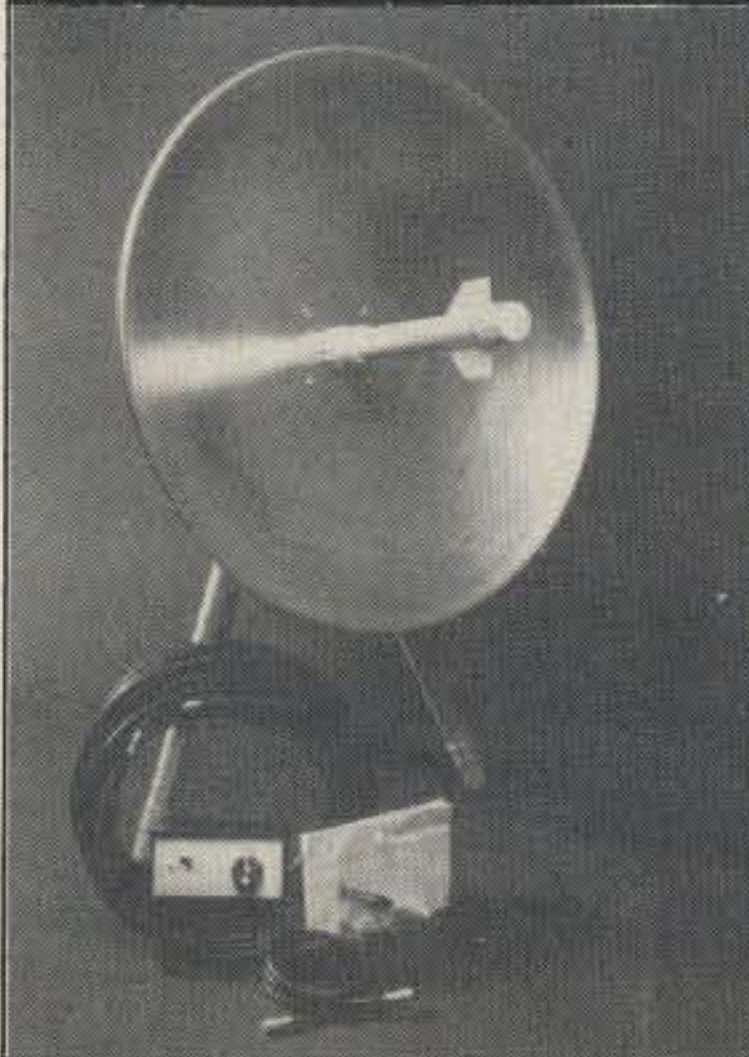

COMPLETE SYSTEMS  
(as Pictured)

Commercial 40"

Rod Style \$ 89.95

Parabolic 20"

Dish Style \$ 79.95

COMPONENTS

Down Converters

(both types) \$ 34.95

Power Supplies

(12V to 16V) \$ 24.95

Data Info (Plans) \$ 9.95

CALL OR WRITE FOR  
KITS, PARTS, INDIVIDUAL  
COMPONENTS

We Repair All Types Down  
Converters & Power Supplies

### Phillips-Tech Electronics

P.O. Box 34772

Phoenix, AZ 85067

(602) 265-8255

Special Quantity Pricing  
Dealers Wanted

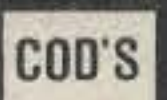
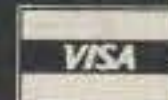

**TEN-TEC 560 Corsair 9-band Digital Transceiver**  
Regular \$1169 - **Sale Price \$1029**

Corsair accessories:		Regular	SALE
260	Deluxe power supply with speaker . . .	\$199.00	\$179 <sup>95</sup>
263	Remote VFO . . . . .	199.00	179 <sup>95</sup>
220	2.4 KHz 8-pole crystal SSB filter . . . . .	59.00	
282	250 Hz 6-pole crystal CW filter . . . . .	59.00	
285	500 Hz 6-pole crystal CW filter . . . . .	59.00	
288	1.8 KHz 8-pole crystal SSB filter . . . . .	59.00	
214	Electret desk microphone . . . . .	45.00	

## TEN-TEC Corsair SPECIAL!

From September 15th, 1983 to January 15th, 1984 purchase a **Corsair** at our Sale Price and receive a **COUPON** for (1) **FREE** accessory **Crystal Filter** of your choice (a \$59.00 value) direct from **TEN-TEC**.

Also - Operate the **Corsair** for **30 Days**. If you are dissatisfied for any reason, you may return it to **AES** for **FULL CREDIT** toward other merchandise or a **FULL REFUND**, not including any Shipping Charges.



**AES® STORE HOURS:** Mon. thru Fri. 9-5:30; Sat. 9-3  
Milwaukee WATS line **1-800-558-0411** answered evenings until 8:00 pm, Monday through Thursday.  
**Please use WATS line for Placing Orders**  
For other information, etc. please use Regular line.

**Order Toll Free: 1-800-558-0411**

In Wisconsin (outside Milwaukee Metro Area)  
1-800-242-5195

# AMATEUR ELECTRONIC SUPPLY<sup>®</sup> Inc.

4828 W. Fond du Lac Avenue; Milwaukee, WI 53216 - Phone (414) 442-4200

### AES BRANCH STORES

**WICKLIFFE, Ohio 44092**

28940 Euclid Avenue

Phone (216) 585-7388

Ohio WATS 1-800-362-0290

Outside Ohio 1-800-321-3594

**ORLANDO, Fla. 32803**

621 Commonwealth Ave.

Phone (305) 894-3238

Fla. WATS 1-800-432-9424

Outside Florida 1-800-327-1917

**CLEARWATER, Fla. 33575**

1898 Drew Street

Phone (813) 461-4267

No In-State WATS

No Nationwide WATS

**LAS VEGAS, Nev. 89106**

1072 N. Rancho Drive

Phone (702) 647-3114

No In-State WATS

Outside Nevada 1-800-634-6227

### Associate Store

**CHICAGO, Illinois 60630**

ERICKSON COMMUNICATIONS

5456 N. Milwaukee Avenue

Phone (312) 631-5181

15 mln. from O'Hare!

Computer Protection

# KLEEN LINE<sup>®</sup> CONDITIONER



**Prevents:**

- Computer Damage
- Lightning Spike Damage
- Brownout Interruptions
- Disruptive Line Noise
- Program Errors

## Regulator • Filter • Suppressor

KLR-250A	250 Watt Load	\$291.95
KLR-250A-1S0	250 Watt Load; Patented Filter Isolated Sockets	\$346.95
KLR-500A	500 Watt Load	\$390.95
KLR-500A-1S0	500 Watt Load; Patented Filter Isolated Sockets	\$445.95

Shipping: \$12.75 Land; \$45.50 Air

Ask Your Local Dealer

**ESP<sup>®</sup> Electronic Specialists, Inc.**

171 South Main Street, Box 389, Natick, Massachusetts 01760

Toll Free Order Desk 1-800-225-4876

MasterCard, VISA, American Express

✓18

erator and scope for final adjustment. If you have access to a sweep generator, it makes alignment very easy.

If you use the unit with a transceiver, automatic switching is a must—the coils don't last long with 100 Watts of rf in them.

If you use the i-f cans to house commercial coil forms, you may have to drill out the center hole for an alignment tool.

For the time spent, this conversion provides a definite improvement in performance at a minimum cost.

### A Note to Elmer:

When one of your current crop of KAs brings this article to you and asks if you might have one of these things lying around, don't get misty-eyed and try to explain why you've kept it all these years. He won't understand the sacrilege of applying a hacksaw to a pristine Q-Fiver. I know how you feel, I know how many you

converted and passed on to prospective Novices (remember, I was one of them), and yes, I remember the R-24 you put in the '54 Chevy. You saved a hundred bucks and the dynamotor didn't make a bit more noise than a vibrator. I remember, too, when we rewound the coils and put it on 15 and my first VK came back. But, to him it's just a homely box. So bite the bullet and help him out; after all, a ham shack without an ARC-5 (or part of one) isn't really complete! ■

### References

- Command Sets*, Cowan Publishing Corporation, 1957, Wayne Green, Editor.
- The Radio Amateur's Handbook*, 55th Ed., ARRL publication.
- DeMaw, "His Eminence the Receiver," *QST*, June and July, 1976.
- Pafenberg, "The AN/ARC-5 Command Receivers," *73*, June, 1963.
- White, "The First and Last Q-Fiver," *73*, March, 1966.

# Introducing The SRT-3000 A High Performance RTTY Communications Send-Receive Terminal



- Built-in demodulator & AFSK modulator for 170,425,850 Hz shifts, high and low tone pairs • 60,66,75,100,132 WPM Baudot, 110,300 Baud ASCII, 5-99 WPM Morse • 1000 character text buffer with BREAK feature • Ten 80 character message memories with battery backup • Selectable display formats, 24 lines x 72 characters (2 pages), 24 lines x 36 characters (4 pages), 16 lines x 36 characters (6 pages) • Split screen operation • On screen status line displays a tuning bar, mode, speed, shift, tone pair, normal/reverse, USOS, WRU, SELCAL, buffer mode and buffer count • Cassette interface for long "Brag Tapes" or unattended message storage • Baudot and ASCII printer outputs • Built-in audio monitor • Built-in 110 VAC power supply • Other features—PTT control, WRU, SELCAL, sync idle, CW ID, USOS, autostart, full or half duplex, scope outputs, weight control, intercharacter spacing, reverse video, RS-232, word wrap around • Compact size only 13.3 x 10.3 x 4 inches • Made in USA.

SRT-3000  
List Price \$ 995.00  
**INTRODUCTORY PRICE \$ 795.00**

Send For  
Free Information

**DGM ELECTRONICS, INC.**

Optional 9" video monitor shown \$149.00

**787 BRIAR LANE, BELOIT, WISCONSIN 53511 (608) 362-0410**

# ALL HF BANDS!



## The SLINKY DIPOLE® Antenna

A broadband, low SWR dipole that really works in apartments, small yards, attics, anywhere a small antenna is a must. Indoors or out, you can work ANY HF BAND, including 10 MHz. No gimmicks or add-ons. Imagine 80M in as little as 24 ft.! Complete kit and instructions, plus 50 ft. of coax. Easy to set up and adjust. More information available - just call or write.

**Blacksburg Group**  
Box 242 Suite 500  
Blacksburg, Virginia 24060  
703/951-9030

**\$67.95 postpaid** (in U.S.A.)  
Money Back Guarantee  
Virginia residents  
add 4% sales tax



# "MAXCOM"

## AUTOMATIC ANTENNA MATCHER

TUNES

# ONE ANTENNA

## .3 MHZ TO 70 MHZ

## VSWR LESS THAN 1.5:1

DIPOLE OR LONGWIRE  
MODELS 200 TO 2KW PEP

CONTACT :

<sup>54</sup>  
**MAGNUM DISTRIBUTORS INC**  
1000 S. DIXIE HY. W. #3  
POMPANO BEACH, FL 33060  
(305) 785-2002

# GLB PACKET RADIO CONTROLLER

**Now you can get in on the fun  
on packet radio!**

- Low cost!
- Adaptable to any transceiver
- Easy to learn, easy to use.
- Built-in packet Modem and CW identifier.
- Use with teletype machines, computers, terminals.
- RS232 serial interface—45 to 9600 baud!
- Uses both ASCII and Baudot
- Vancouver protocol—AX.25 to be released soon.
- Optionally write your own protocol on host computer.
- Nearly 50 commands.
- Stores received messages until requested at a later time.
- Operates in 'connected' and 'general' modes
- Activates teletype motor to print messages.
- Board accepts up to 14K of RAM.
- **Model PK1 can be customized for Commercial Systems.**

We offer a complete line of transmitters and receivers, strips, preselector-preamps, CWID'ers & synthesizers for amateur & commercial use. Request our FREE catalog, MC & Visa welcome. Allow \$2 for UPS shipping.

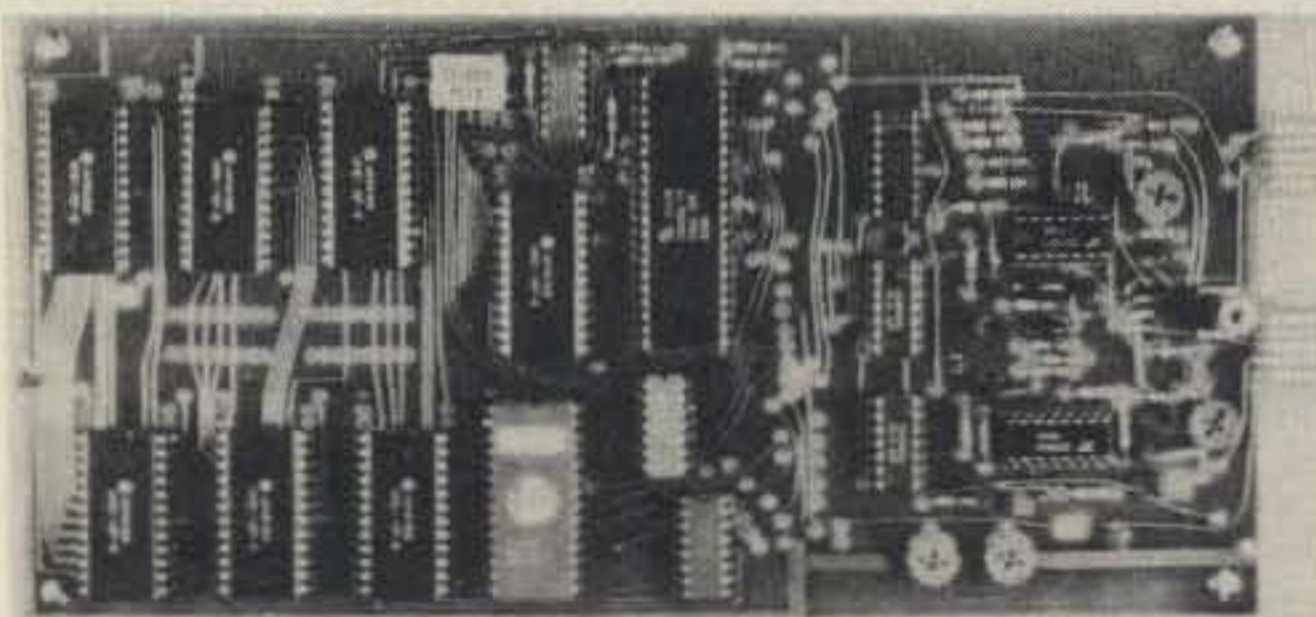

**MODEL PK1**  
(shown with 14K RAM and 8K ROM)

Protocol can be changed by swapping ROM chips. Board designed to accept 6264's for up to 56K of RAM with minor modification.

Dimensions: 4.5 x 8.5 inches; 1" vertical clearance.  
Power requirement: +12 VDC, approx. 200 ma.

Standard equipment includes 4K of RAM (expandable to 14K).

Model PK1, wired & tested— **\$149.95**  
additional memory, installed & tested (up to 12K) **\$10/2K**  
RTTY adaptor board **\$9.95**

Connecting cables & enclosure—optional

# GLB ELECTRONICS

1952 Clinton St., Buffalo, NY 14206  
716-824-7936, 9 to 4

Call or Write  
for Free  
1983 Catalog

# CardSoft: The Transportable QSL Generator

*If your machine runs Basic, it can run this program.*

Anyone out there priced QSL cards lately? Have you noticed how often you get (or send) an SASE with the ole pasteboard? Well, possibly the day is fast coming when the familiar QSL "penny" postcard will be only a memory (or fading on the wall). I, personally, haven't sent or received QSL cards in several years without an SASE being involved, and at the cost of Uncle's postal service, who can afford it these days? Well, for those who have their own microprocessor (and printer)—and there seem to be rapidly growing numbers of them—here's a solution to part of the problem.

## CERTIFICATE

TO ALL WHOM THESE PRESENTS COME: GREETINGS!

KNOW YOU by the Authority invested in Us by the Federal Communications Commission, a regulatory agency of the Government of the United States of America. We do hereby certify that on the date, and at the time and on the frequency herein inscribed:

Two-way radio communication was established between:

**WB5LLM**

A RADIO STATION licensed by the above referenced Federal Agency, to Us, in accordance with the Rules & Regulations of the Amateur Radio Service.

AND

**WD4EDQ**

a radio station operating in the aforesaid Service.

\*QSO DATA\*

DATE 28 / 9 / 82 / TIME(UTC): 1254Z FREQUENCY 14.078 MHZ.  
TRANS.—Hallicrafters HT-32a/RCVR.—Hammarlund HQ-180/A  
RTTY/SSTV — TRS-80(C) w/ CV-89A/URA-8A Converter  
ANT. SYSTEM: 20M. VERT. REMARKS: GUD LUCK WID YR.W.A.S..BOBBY  
SIGNAL REPORT R= 5 S= 9 T= 9 MODE: RTTY

FURTHERMORE, know you that this CERTIFICATE shall be accepted as Confirmation of said contact and exchange of Signal Reports, etc., for any, and all, purposes that the aforesaid Awardee deems his want; be it Contest, Operating Awards, etc., in use of the above referenced Station in the Amateur Radio Service.

THEREFORE, In recognition of the above, We hereby set our Hand and Seal, this, the 28TH day of SEPTEMBER, 1982 .

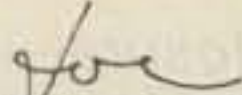
  
JOE RYAN, LICENSEE  
R.F.S. WB5LLM  
P.O. BOX 622  
FLORENCE, MS. 39073

WB5LLM's QSL certificate.

The main reason that all this QSL swapping goes on these days, in view of the growth of RTTY, SSTV, FAX, and FSTV, is the need to have the confirming operator's signature on the written confirmation of a completed two-way contact. With this program and your trusty printer, you'll be able to crank out your QSLs neatly, efficiently, and with little cost in either money or time.

Nothing in the book says that a QSL must be on a postcard in two or more colors, costing anywhere from 5 to 10 cents each (or more). So, I sat down one day and faced my Tandy TRS-80C, which I use for RTTY and SSTV, and considered the problem. What I came up with is a program that is usable by almost anyone with the above micro/printer combination that will run in Basic. Some minor changes, such as changing the PRINT#-2 statements to LPRINT, etc., will let this program run on any Tandy micro, Apple, Star, etc., and even on those dedicated micros sold for RTTY use (if they have the Basic capability).

Now to the program itself. First, you'll notice that the DIM statement is in the middle of the program. That's because we're changing the values in the DIM statement every time we run the program and possibly during the program operation. This is when you've run off one or more certificates and then decide that you missed some.

Notice that in line 1 we have cleared 13000 for string-array space. There are fifteen inputs, three of which don't change from certificate to certificate. These are the date statements for the date of the certificate. Since you may be running a bunch at a time, you might as well leave that set at one date (saves typing it in repeatedly). With a space of 13000 cleared, you will be able to enter the data for at least 100 certificates. Of course, this was written on a micro with 32K of memory available (no, I didn't clear out the video area for additional space). If you have a 16K memory, reduce this statement in line 1. That will, of course, reduce the number of certificates you can make in one run.

Lines 200 to 480 cover the actual printing of the text of the certificate and were merely figments of my imagination. The wording was more or less copied from certificates issued by the State of Mississippi but probably is close enough to that used in most certificates to be acceptable. However, if you want to modify it—go to it! Don't forget to follow the REM statements and insert your own call letters and name and address to replace mine.

Lines 550 to 670 are the query and data input area. I don't recommend exceeding 20 characters or more of text in the COMMENTS or ANT. SYS. inputs as this will throw off the balance of the finished certificate. Other than that, have at it.

I've used this for a while now and have had no kick-back, and it certainly beats spending an evening writing out QSL cards, one after

another after another, etc., ad nauseam. Once you get it debugged (if you make typing errors like I do), just run the program (don't forget to save it, either on tape or disk) and enter the date for the certificates and the number you're running at this time. From then on, follow the prompts.

When you've entered all the callsigns and QSO data for the number of QSLs you're sending out, check your printer. I should mention here that this was written for use with the Tandy Line Printer VII, so if you have a different printer you will want to experiment with the PRINT#-2 (or LPRINT or what have you) statements. You can replace these with control characters that your printer recognizes (you know, CHR\$(?)); I didn't bother, as the VII printer seems to like the PRINT#-2 just as well.

Once you have it all in and your printer is ready with the paper lined up at

the top, you can follow the instructions and hit ENTER and go on about your business—watch TV, get on the air and let out with a CQ, meet your favorite net, etc. The program and printer will carry on until done and, if you are using the TRS-80C, will sound a tone (if you have the TV volume up, that

is) when finished. Alternatively, you can stand or sit there and watch the screen (it displays the data and certificate number of each certificate as it is printing same) and the printer—it doesn't care!

Oh, one last thing—type carefully and don't forget to sign and mail 'em! ■

```

1 CLEAR 13000
10 CLS4:PRINT#40,"QSL CERTIFICATE"
15 PRINT:PRINT
20 PRINT:INPUT"HOW MANY CERTIFICATES ";N
30 PRINT"CERTIFICATE DATE"
40 INPUT"DAY<IE, 1ST., 17TH, ETC.> ";D$
50 INPUT"MONTH<IE, FEBRUARY> ";M$
60 INPUT"YEAR<IE, 1982> ";Y
70 GOTO 520
80 CLS3:LINEINPUT"CALLSIGN OF STATION";C$
90 PRINT"CERTIFICATE DATE";C$
100 INPUT"DAY";D$:INPUT"MONTH";M$:INPUT"YEAR <ALL 4 DIGITS>";Y
110 PRINT"QSO DATES";INPUT"DAY";DC:INPUT"MONTH";MC:INPUT"YEAR";YC
120 INPUT"TIME<IN UTC>";T:INPUT"FREQUENCY";F
130 T$=STR$(T)
140 PRINT"R-S-T RPT";:INPUT"R=";R:INPUT"S=";S:INPUT"T=";T
150 INPUT"MODE";M$
160 INPUT"REMARKS <20 CHAR>";R$
170 INPUT"ANT. SYSTEM";A$
180 CLS:PRINT#64,"CHECK YOUR PRINTER - I'LL PRINT NEXT"
190 INPUT"PRESS <ENTER> TO START";CR$:GOTO 210
200 FOR X=1 TO N:PRINT"PRINTING # ";X:PRINT C$(X);D$(X);M$(X);Y(X);DC(X);MC
(X);YC(X);T$(X);F(X);R(X);S(X);T(X);R$(X);A$(X);MOS(X):PRINTSTRING$(32
,"#")
210 PRINT#-2:PRINT#-2:PRINT#-2:PRINT#-2:CHR$(31);TAB(14);"CERTIFICATE";PRIN
T#-2:PRINT#-2:PRINT#-2:PRINT#-2:PRINT#-2:PRINT#-2:CHR$(30);TAB(16);"TO
ALL WHOM THESE PRESENTS COME GREETINGS!"
220 PRINT#-2:PRINT#-2:TAB(15);"KNOW YOU by the Authority invested in Us by
the Federal"
230 PRINT#-2:TAB(10);"Communications Commission, a regulatory agency
of the";PRINT#-2:TAB(10);"Government of the United States of Amer
ica. We do hereby"
240 PRINT#-2:TAB(10);"certify that on the date, and at the time and
on the";PRINT#-2:TAB(10);"frequency herein inscribed";PRINT#-2
250 PRINT#-2:TAB(15);"Two-way radio communication was established between:"
PRINT#-2
260 PRINT#-2:CHR$(31);TAB(17);"WB5LLM";REM INSERT YOUR OWN CALLSIGN HERE, N
OT MINE.
270 PRINT#-2:CHR$(30)
280 PRINT#-2:CHR$(30);TAB(16);"A RADIO STATION licensed by the above
referenced";PRINT#-2:TAB(10);"Federal Agency, to Us, in accordance
with the Rules &"
290 PRINT#-2:TAB(10);"Regulations of the Amateur Radio Service."
300 PRINT#-2:PRINT#-2:TAB(10);"AND";PRINT#-2:PRINT#-2:CHR$(31);TAB(17);C$(X
):PRINT#-2
310 PRINT#-2:CHR$(30);TAB(11);"a radio station operating in the aforesaid S
ervice.";PRINT#-2:PRINT#-2:TAB(33);"QSO DATA";PRINT#-2:TAB(10);CHR$(
10);CHR$(20);CHR$(255);CHR$(192):PRINT#-2
320 PRINT#-2:CHR$(30);TAB(12);"DATE";DC(X);"/";MC(X);"/";YC(X);"/";PRINT#-
2;" TIME<UTC>";T$(X);"Z";PRINT#-2;" FREQUENCY";F(X)" MHZ."
330 PRINT#-2:TAB(11);"TRANS.-Hallcrafters HT-32a/RCVR.-Hammarlund HQ-100/A
";PRINT#-2:TAB(11);"RTTY/SSTV - TRS-80(C) w/ CV-89A/URA-8A Converter"
REM INSERT YOUR OWN STATION EQUIP. HERE, NOT MINE.
340 PRINT#-2:TAB(12);"ANT. SYSTEM";A$(X);PRINT#-2;" REMARKS";R$(X)
350 PRINT#-2:TAB(17);"SIGNAL REPORT ";R="";R(X)" ";S="";S(X)" ";T="";T(X
);PRINT#-2;"MODE";MOS(X)
360 PRINT#-2:TAB(18);CHR$(18);CHR$(28);CHR$(255);CHR$(192):PRINT#-2:PRINT#-
2
370 PRINT#-2:CHR$(30);TAB(15);"FURTHERMORE, know you that this CERTIFICAT
E shall be"
380 PRINT#-2:TAB(10);"accepted as Confirmation of said contact and exch
ange of"
390 PRINT#-2:TAB(10);"Signal Reports, etc., for any, and all, purposes t
hat the"
400 PRINT#-2:TAB(10);"aforesaid Awardee deems his want; be it Contest, OP
erating"
410 PRINT#-2:TAB(10);"Awards, etc., in use of the above referenced Station
in the";PRINT#-2:TAB(10);"Amateur Radio Service."
420 PRINT#-2
430 PRINT#-2:TAB(15);"THEREFORE, In recognition of the above, We hereby s
et"
440 PRINT#-2:TAB(10);"our Hand and Seal, this, the ";D$(X);" day of ";M$(X)
";";Y(X);"."
450 PRINT#-2:PRINT#-2:PRINT#-2:PRINT#-2
460 PRINT#-2:TAB(28);"JOE RYAN, LICENSEE";PRINT#-2:TAB(30);"A.R.S. WB5LLM"
REM INSERT YOUR OWN NAME AND CALLSIGN HERE, NOT MINE.
470 PRINT#-2:TAB(31);"P.O. BOX 622";PRINT#-2:TAB(28);"FLORENCE, MS. 39073"
REM INSERT YOUR OWN ADDRESS HERE.
480 PRINT#-2:PRINT#-2:PRINT#-2:PRINT#-2:PRINT#-2:PRINT#-2:PRINT#-2:PRINT#-2
:PRINT#-2
490 NEXT X:GOTO 500
500 CLS:SOUND 150,10:INPUT"DO YOU WANT MORE CERT.<Y/N>";AC$:IF AC$="Y" THEN
GOTO 1 ELSE GOTO 510
510 CLS:PRINT#70;"THATS IT!"END
520 NL=N:DIM C$(NL);D$(NL);M$(NL);Y(NL);DC(NL);MC(NL);YC(NL);T$(NL);F(NL);R(
NL);S(NL);T(NL);R$(NL);A$(NL);MOS(NL)
530 FOR X=1 TO N:GOSUB 570:C$(X)=C$:D$(X)=D$:M$(X)=M$:Y(X)=Y:DC(X)=DC:MC(X)=
MC:YC(X)=YC:T$(X)=T$:F(X)=F:R(X)=R:S(X)=S:T(X)=T:R$(X)=R$:A$(X)=A$:MOS
(X)=MOS
540 NEXT X
550 CLS2:INPUT"FINISHED? <Y/N>";CB$:IF CB$="Y" THEN PRINT:PRINT" CHECK YOUR
PRINTER AND PAPER - I'M READY";INPUT" WHEN READY HIT <ENTER>";CR$
560 GOTO 200
570 CLS3:PRINT#80;"INPUT QSL DATA"
580 LINEINPUT "CALLSIGN ";C$
590 PRINT"QSO DATA"
600 INPUT"DATE OF QSO <IE 1 OR 22> ";DC
610 INPUT"MONTH <IE, 8 OR 10> ";MC:INPUT"YEAR <IE, 82 OR 83, ETC.>";YC
620 INPUT"QSO TIME <IN UTC> ";T:T$=STR$(T)
630 INPUT"FREQ. <IE, 14.093> ";F
640 PRINT"R-S-T RPT";:INPUT"R=";R:INPUT"S=";S:INPUT"T=";T
650 LINEINPUT"REMARKS";R$
660 INPUT"ANT. SYS.";A$
670 INPUT"MODE ";M$:RETURN

```

CROSS-REFERENCE

LABEL	REFERENCES
00001	00500
00200	00560
00210	00190
00500	00490
00510	00500
00520	00070
00570	00530
A\$	00170 00530 00660
A\$( )	00200 00340 00520 00530
AC\$	00500 00500
C\$	00000 00530 00500
C\$( )	00200 00300 00520 00530
CB\$	00550 00550
CR\$	00190 00550
D\$	00040 00100 00530
D\$( )	00200 00440 00520 00530
DC	00110 00530 00600
DC( )	00200 00320 00520 00530
F	00120 00530 00630
F( )	00200 00320 00520 00530
M\$	00050 00100 00530
M\$( )	00200 00440 00520 00530
MC	00110 00530 00610
MC( )	00200 00320 00520 00530
MOS	00150
MOS	00530 00670
MOS( )	00200 00350 00520 00530
N	00020 00200 00520 00530
NL	00520 00520 00520 00520 00520 00520 00520 00520 00520 00520
R	00140 00530 00640
R\$	00160 00530 00650
R\$( )	00200 00340 00520 00530
RC( )	00200 00350 00520 00530
S	00140 00530 00640
S( )	00200 00350 00520 00530
T	00120 00130 00140 00530 00620 00620 00640
T\$	00130 00530 00620
T\$( )	00200 00320 00520 00530
T( )	00200 00350 00520 00530
X	00200 00200 00200 00200 00200 00200 00200 00200 00200 00200 00200
	00200 00200 00200 00200 00200 00200 00300 00320 00320 00320 00320
	00320 00340 00340 00350 00350 00350 00440 00440 00440 00490
	00530 00530 00530 00530 00530 00530 00530 00530 00530 00530 00530
	00530 00530 00530 00530 00530 00540
Y	00060 00100 00530
YC( )	00200 00440 00520 00530
YC	00110 00530 00610
YC( )	00200 00320 00520 00530

NUMBER OF LABELS = 44  
NUMBER OF REFERENCES = 192  
NUMBER OF LINES = 69  
NUMBER OF STATEMENTS = 170  
STATEMENTS/MINUTE = 29.7

Cross-reference label references.

Program Listing.

# The Six-Meter Vfo That Won't Quit

*This hybrid has the best of both worlds.  
It's as steady as a rock and has broadband tuning.*

There are certain features I like in a vfo. The prime one is stability as near to a crystal as possible, another is ease of tuning (bandspread), and a third is the ability to tune to any frequency—right down to a Hertz or so. For crystal stability over a narrow range of frequencies, the vxo (variable crystal oscillator) permits infinite resolution. Mixing various crystal frequencies can extend that range, but with considerable complexity and cost. Now that we have ICs that greatly reduce their component count, though, a PLL (phase-locked loop) can provide precise frequencies, at equal spacing over a wide band, quite economically.

The block diagram shows how a PLL with 5-kHz intervals over a range of 500 kHz is combined with a vxo that has analog tuning over a 5-kHz range to give an output of 5.5 to 5.0 MHz. In this configuration, the 5.5 represents the low transmitter frequency and the 5.0 represents the high transmitter frequency. It was chosen because that's what is required by the Heath SB-104 with which it was to be used. By careful selection of the vxo and PL frequencies, the output can be any 500-kHz segment desired, and by choosing the vxo frequency to sum with the PLL generator, the output will not be inverted.

With a 5-kHz reference

for the PLL, the "warping" of the vxo at 7.42 MHz is easily attained and quite linear. It also lets us use most any of the PLL chips found in the later CBs as well as the 10.24-MHz crystal associated with it.

The circuit is relatively simple. Q1 is the 10.24-MHz reference oscillator. Q2 amplifies and shapes its output to drive the 7473 divide-by-two counter. Further division takes place in the PLL (MC145109) to get the 5-kHz reference. Q10 is the vxo; its output goes to the mixer (Q11). The vco is Q8, and its

frequency is controlled by the output of the phase detector in the PLL chip. The output of Q8 is the other mixer input and also goes to the LM703 buffer/amplifier. It, in turn, drives Q9, the vfo output stage. The mixer output is filtered and amplified by Q12 and then applied to the signal input of the PLL.

Q4 adds or removes a 4.7- $\mu$ F tantalum capacitor in the timing network of the 555. The 555 runs all of the time, but its output is diode-gated by the UP or DOWN switches, which also determine which way the 4029

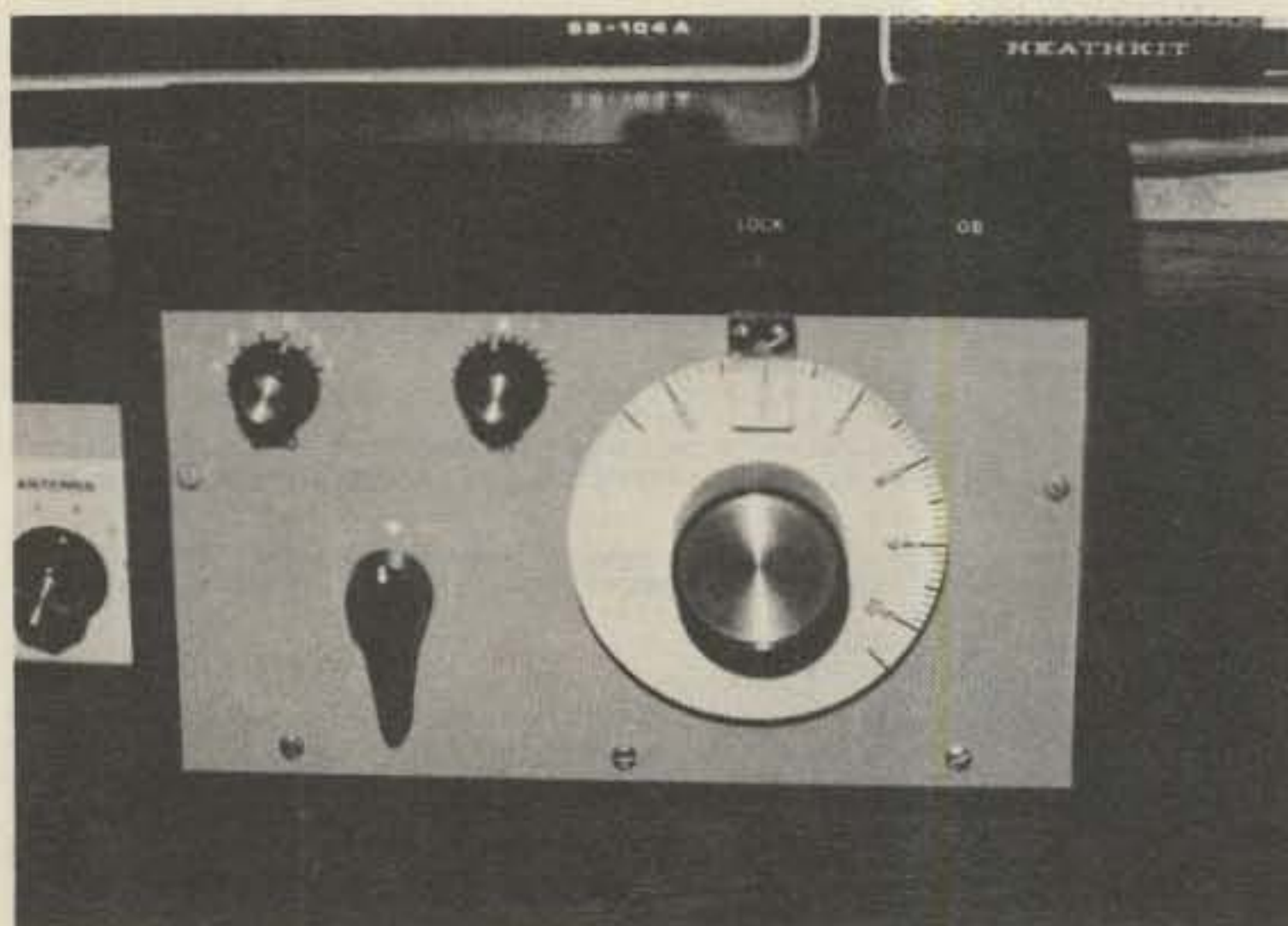

Vfo in operating position, showing panel layout.

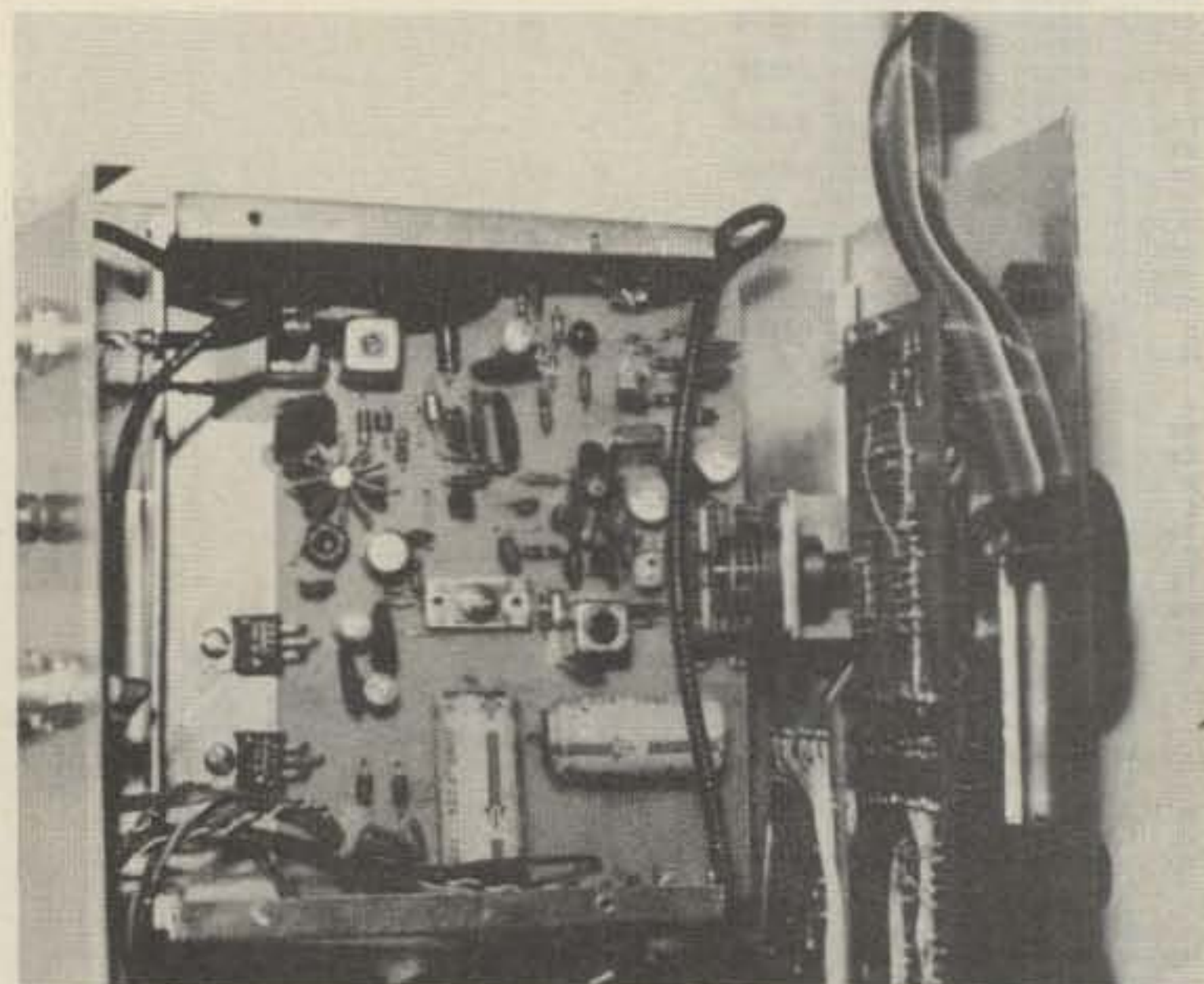

Inside view of oscillator circuit board shows vxo frequency trimmers, tuning capacitor, and voltage regulators.



counters count. Q3 shapes the gated output to ensure clean counting. The first counter is for the 5-kHz increment, and the other counter outputs step the remaining digits. SO1 is for the display connections. If the display is omitted, SO1 can be eliminated or jumpered (pin 2 to 14, 3 to 13, 4 to 12, 5 to 11, 6 to 10, and 7 to 9; pins 1 and 8 are left connected to the other circuitry).

The LD LED is enabled by Q5 when the PLL is in lock. When the PLL is not in lock, Q6 disables the vfo output by applying excessive bias to the LM703 through diode DA. Q7 enables the out-of-band indicator LED and disables the vfo output in the same way as Q6. Out-of-band in this circuit is anything outside of 5.0 to 5.5 MHz and may need modification (or elimination) if, because of the accuracy of the

other transceiver crystals, the vfo must be shifted up or down.

The display portion is not needed with the SB-104 or similar transceivers with self-contained counters. For use with other rigs, it's a nice feature. When the display is used, PI-1 replaces the jumper in SO1, and the 4029 counters are set in the BCD mode by inserting a jumper from pin 9 to ground on the two most significant digit 4029s. The counters directly drive 4511 BCD-to-7-segment encoders and also two 4008 full adders to convert the BCD to binary for the PLL. Another 4008 allows adding 5 to the third digit (hundred thousand Hz) of the display. This permits setting the bandswitch of the vfo to 3.5 and 28.5 and counting from there on those band segments. The two most significant digits

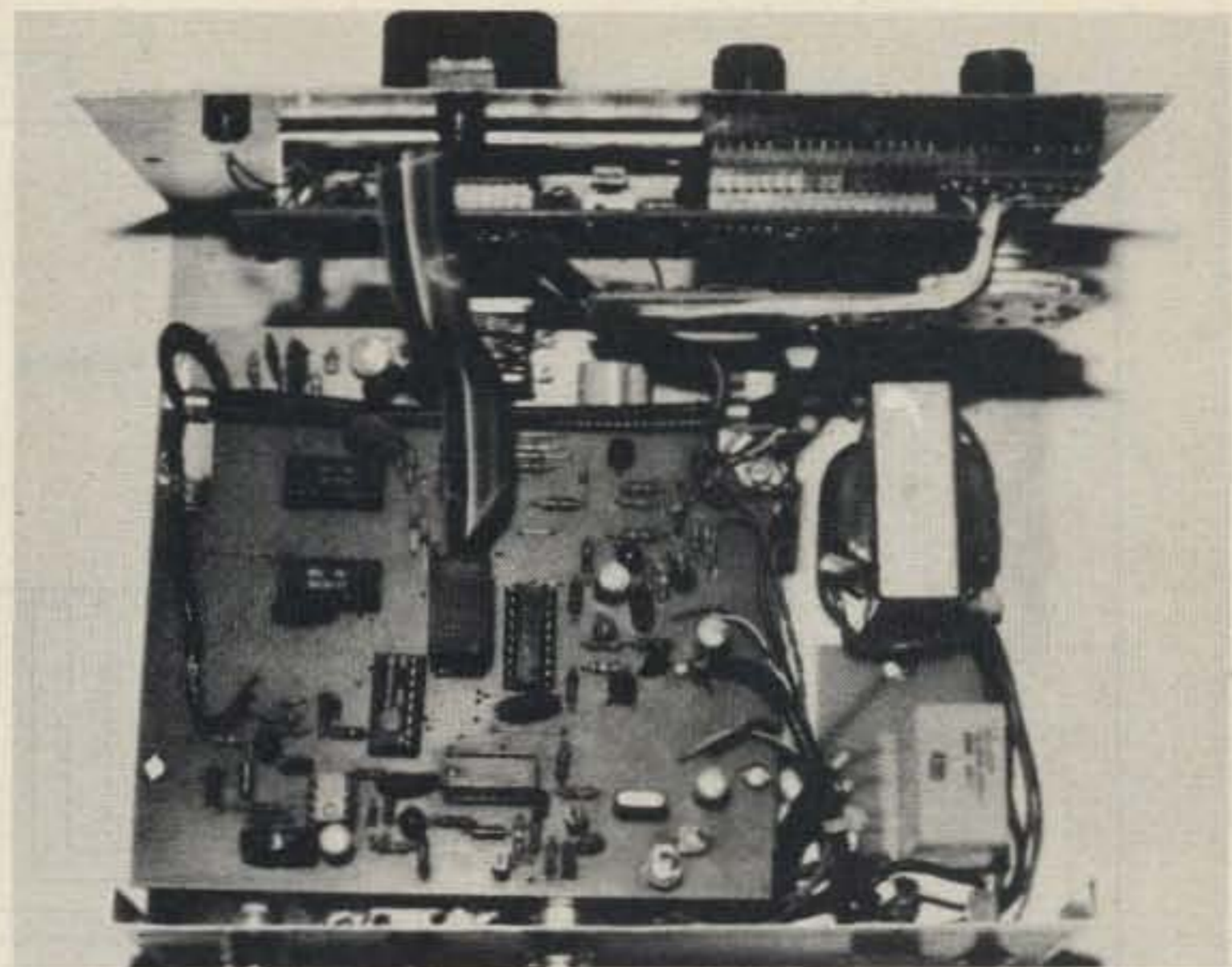

Upper portion is the display board and the PLL section is in the lower left. Power transformer is on the right.

of the display are not a part of the counter but are set by a diode matrix and the bandswitch.

The RIT circuit uses a varactor and a 10k pot to vary the frequency of the

vfo in the receive mode. In the transmit mode, a positive regulated voltage is applied to the varactor to reduce its effect to a minimum. This is accomplished by Q13 and Q14 by the ap-

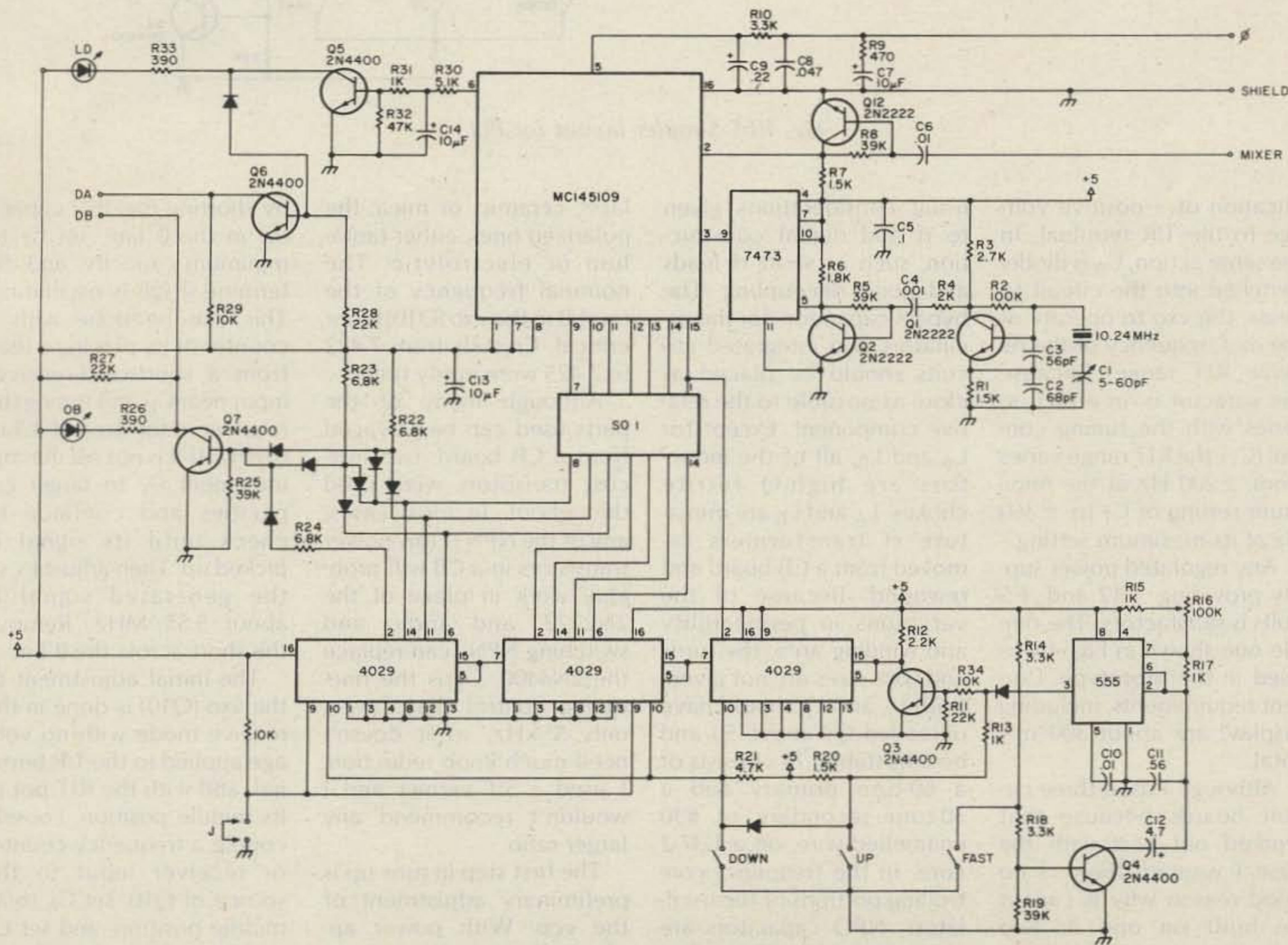

Fig. 1(a). PLL.

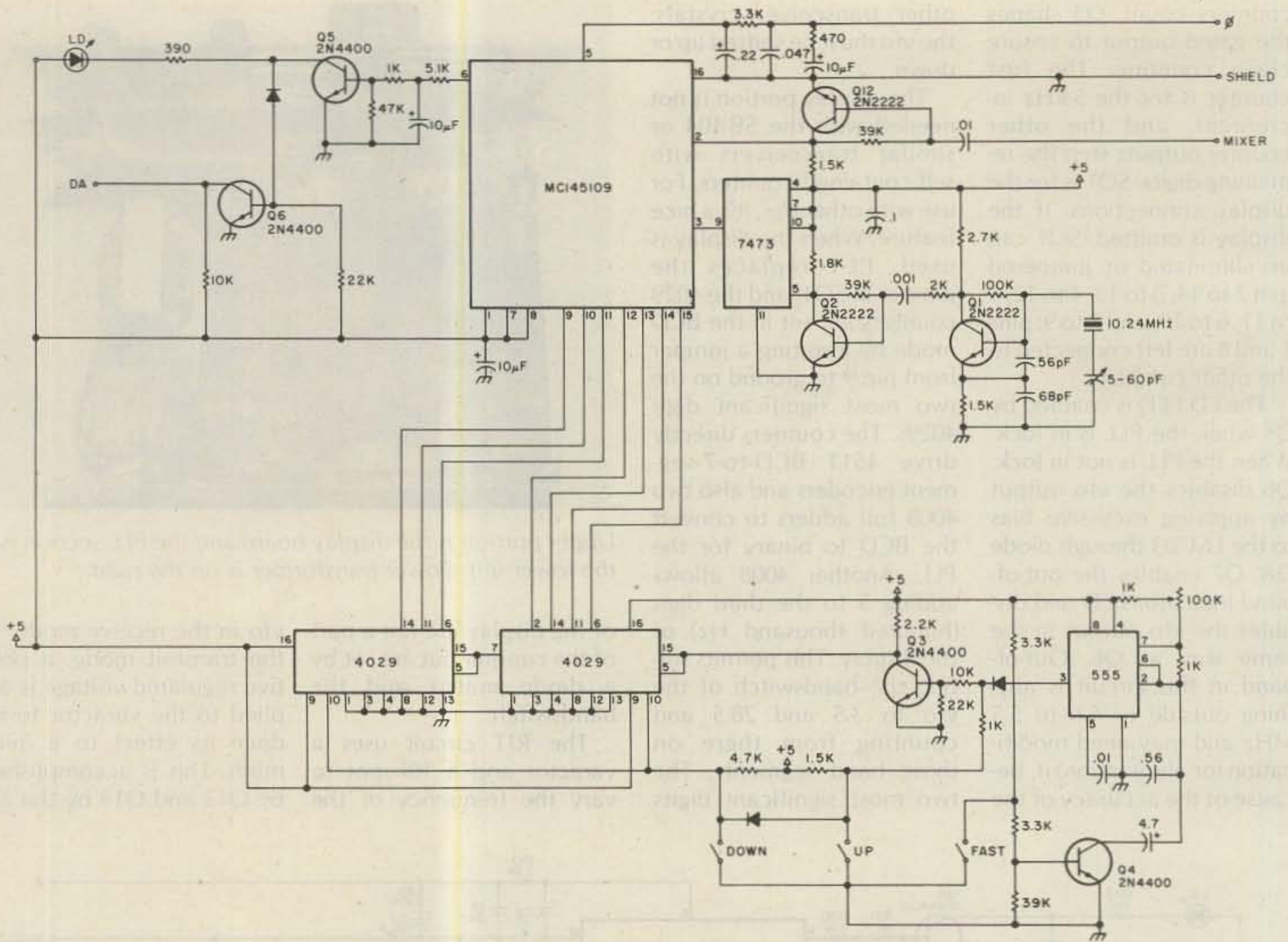

Fig. 1(b). Simpler layout for PLL.

plication of a positive voltage to the T/R terminal. In the same action,  $C_A$  is diode-switched into the circuit to cause the vxo to operate at the mid-frequency of the receive RIT range. Because the varactor is, in effect, in series with the tuning control ( $C_T$ ), the RIT range varies from  $\pm 200$  Hz at the minimum setting of  $C_T$  to  $\pm 360$  Hz at its maximum setting.

Any regulated power supply providing +12 and +5 volts is satisfactory. The simple one shown in Fig. 4 was used in the prototype. Current requirements, including display, are about 300 mA total.

Although I used three circuit boards because that worked out best with the case I wanted, there is no good reason why it cannot be built on one or two boards. Layout is not particularly critical except for the

usual considerations given to rf and digital construction, such as short rf leads and good decoupling. The bypass capacitors for the oscillators and integrated circuits should be placed as close as possible to the relative component. Except for  $L_A$  and  $L_B$ , all of the inductors are high-Q ferrite chokes.  $L_A$  and  $L_B$  are miniature rf transformers removed from a CB board and rewound. Because of the variations in permeability and winding area, the turns and wire sizes are not given. Both  $L_A$  and  $L_B$  should have unloaded Qs above 50 and be adjustable. T1 consists of a 60-turn primary and a 30-turn secondary of #30 enamelled wire, on a T-37-2 core. In the frequency-controlling portions of the oscillators, NPO capacitors are recommended. The other small capacitors can be my-

lar™, ceramic, or mica; the polarized ones, either tantalum or electrolytic. The nominal frequency of the crystal in the vxo (Q10) is not critical. Crystals from 7.422 to 7.425 were easily tuned.

Although many of the parts used can be salvaged from a CB board, two low-cost transistors were used throughout. In most cases, any of the NPN rf low-power transistors in a CB will probably work in place of the 2N2222, and audio and switching NPNs can replace the 2N4400.  $C_T$  is the fine-tuning control that covers only 5 kHz, so it doesn't need much knob reduction. I used a 5:1 vernier and I wouldn't recommend any larger ratio.

The first step in tune-up is preliminary adjustment of the vco. With power applied, temporarily ground the phase-detector output

by shorting the .022 capacitor in the  $\emptyset$  line, set  $C_E$  to minimum capacity, and determine if Q8 is oscillating. This can be done with a counter or by placing a lead from a shortwave-receiver input near  $C_D$  and tuning the receiver in the area of 4.5 to 6 MHz. If it is not oscillating, increment  $C_E$  to larger capacities and continue to check until its signal is picked up. Then adjust  $L_A$  so the generated signal is about 5.55 MHz. Remove the short across the  $\emptyset$  line.

The initial adjustment of the vxo (Q10) is done in the receive mode with no voltage applied to the T/R terminal and with the RIT pot at its middle position. Loosely couple a frequency counter or receiver input to the source of Q10, set  $C_A$  to its middle position, and set  $C_B$  and  $C_C$  to their minimum capacities. Check the frequen-

# Morse Keyers & Trainers by

AEA produces the finest Morse keyers and trainers in the world. All AEA keyers operate with any standard keyer paddle and offer selectable monitor tone, selectable dot and dash ratios, full weighting and selectable dot and/or dash memory. In addition, all our keyers offer full, semi-automatic or straight key modes. The keyers and trainers are keypad controlled which significantly reduces the complexity of operation for all the features offered. Each keyer has separate + and - keyed outputs for keying any modern transmitter. All keyers and trainers operate from 12 VDC (or 117 VAC with optional model AC-1 wall adaptor) which makes them ideal for portable operation. AEA microcomputer-based products are all subjected to a full burn-in and test prior to shipment, as well as being designed for maximum R.F. immunity.

## NEW BT-1



The **BT-1 Basic Trainer** is a hand-held computerized unit which teaches the code one character at a time at 18 or 20 words per minute. The BT-1 contains a self-paced training program that allows serious students the possibility of learning Morse to 20 wpm in as little as one month! Each character represents a separate practice session in which the character is first introduced by itself, and then presented 50% of the time along with all previously learned characters. There are no tapes to memorize, wear out, or break. No programming skills are necessary; the BT-1 is very easy to use. The tone oscillator can also be keyed for sending practice. An earphone jack is provided for private listening. The BT-1 will go as high as 99 WPM in 1 WPM increments. A battery operated version, the BT-1P, is available with wall charger and internal NICAD batteries.

The **KT-3 Keyer-Trainer** unit uses the teaching program used in the BT-1 trainer. In addition, the KT-3 features a full function Morse automatic keyer for keying any modern transceiver, or for sending practice. Speed range is 18-99 wpm for transmitting and 1-99 wpm for training.

The **KT-2 Keyer-Trainer** is a computerized keyer with all the features shown above, plus a Morse proficiency trainer. It is designed to increase your existing code as quickly as possible. The unit can be set for beginning practice speed, ending practice speed, and duration of practice. The microcomputer does all the rest by gradually increasing the speed during the practice time selected. You can even select between fast code (Farnsworth) or slow code methods. The characters are sent in 5 letter groups, or random word lengths. Two levels of difficulty can be selected; common Morse characters or all English Morse characters. A 24,000 character answer book is provided for the 10 separate starting positions. There is also random practice mode for which no answers are available.

## KT-2 Keyer Trainer



The **CK-2 Contester™ Keyer** is the lowest cost automatic keyer available featuring an automatic serial number generator for contesting. The CK-2 keyer features a large 500 character message memory that can be soft-partitioned into as many as 10 sections. An exclusive AEA edit mode makes it possible to correct mistakes made while entering messages or to insert words into previously established messages. Two different speeds can be set for fast recall in addition to a stepped variable speed control. The CK-2 features an automatic message repeat mode with variable delay-before-repeat for automatic CQ transmissions or TVI testing.

## MM-2 MorseMatic™



The **MM-2 Morsematic Keyer** represents the most sophisticated paddle keyer ever designed and features two powerful microcomputers. The Morsematic incorporates virtually all the features (except the preset and stepped variable speeds) of both the CK-2 and KT-2 shown above. In addition, the MM-2 offers an exclusive automatic beacon mode which is invaluable for meteor scatter, moonbounce scheduling, or beacon operation.

## NEW KT-3



## CK-2 Contester™



**AEA** Brings you the Breakthrough!

**Advanced Electronic Applications, Inc.**

P.O. Box C-2160, Lynnwood, WA 98036  
(206) 775-7373 Telex: 152571 AEA INTL

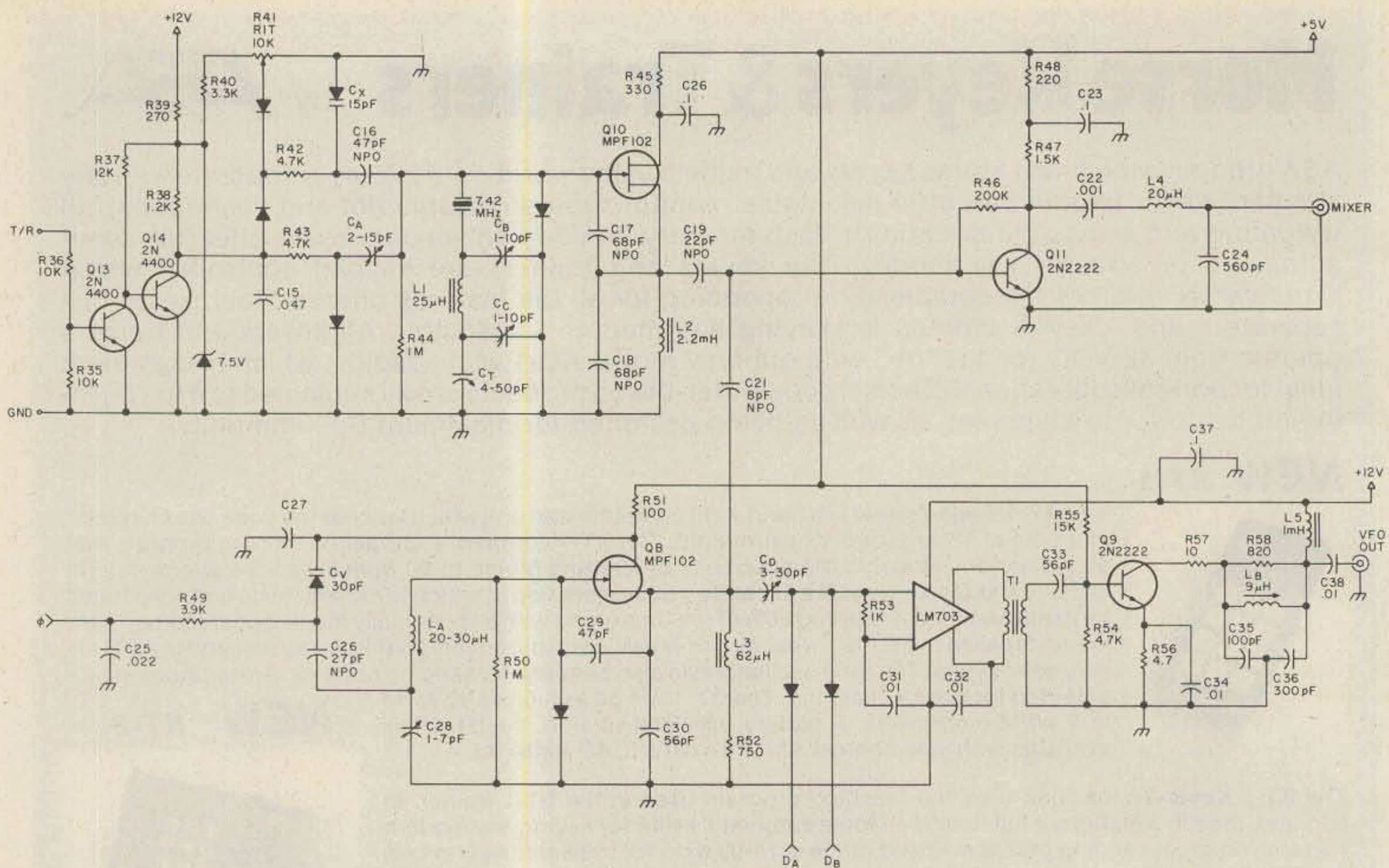

Fig. 2. Oscillators.

cy of Q10 at maximum and minimum settings of  $C_T$ . At 10 degrees short of minimum capacity, the desired frequency is 7.420 MHz. At 10 degrees short of maximum capacity, it should be 7.415 MHz. The ten degrees

on either end allows for some overlap and keeps the dial markings in the more linear range of the capacitor. As  $C_B$  and  $C_C$  interact with each other, it is necessary to repeat their adjustments using  $C_C$  when  $C_T$  is

near minimum and  $C_B$  when  $C_T$  is almost fully meshed.

When these adjustments are completed, set  $C_T$  near maximum and note the frequency. With +12 volts applied to the T/R terminal, adjust  $C_A$  to the same frequen-

cy. Leave the 12 volts connected to the T/R terminal until the rest of the alignment is done. If there are circuit errors, much time can be saved if the rest of the checks and adjustments are done systematically.

Check the waveform at pin 9 of the 7473 with a scope. It should be a clean 5.12-MHz square wave. In lieu of a scope, loosely couple a receiver input to pin 9 by laying the antenna lead close to it and tune the receiver to 5.12 MHz. If the signal is steady and pure, the reference oscillator can be assumed to be working OK.

To check out the counter, measure the dc voltage present at pin 15 of the PLL (MC145109). It should swing from zero to nearly +5 volts as the counters are enabled by either the UP or DOWN switches. Check each of the counter output lines, pins 14 through 9 on the PLL. They, too, should alternate between zero and +5 volts, but at successive-

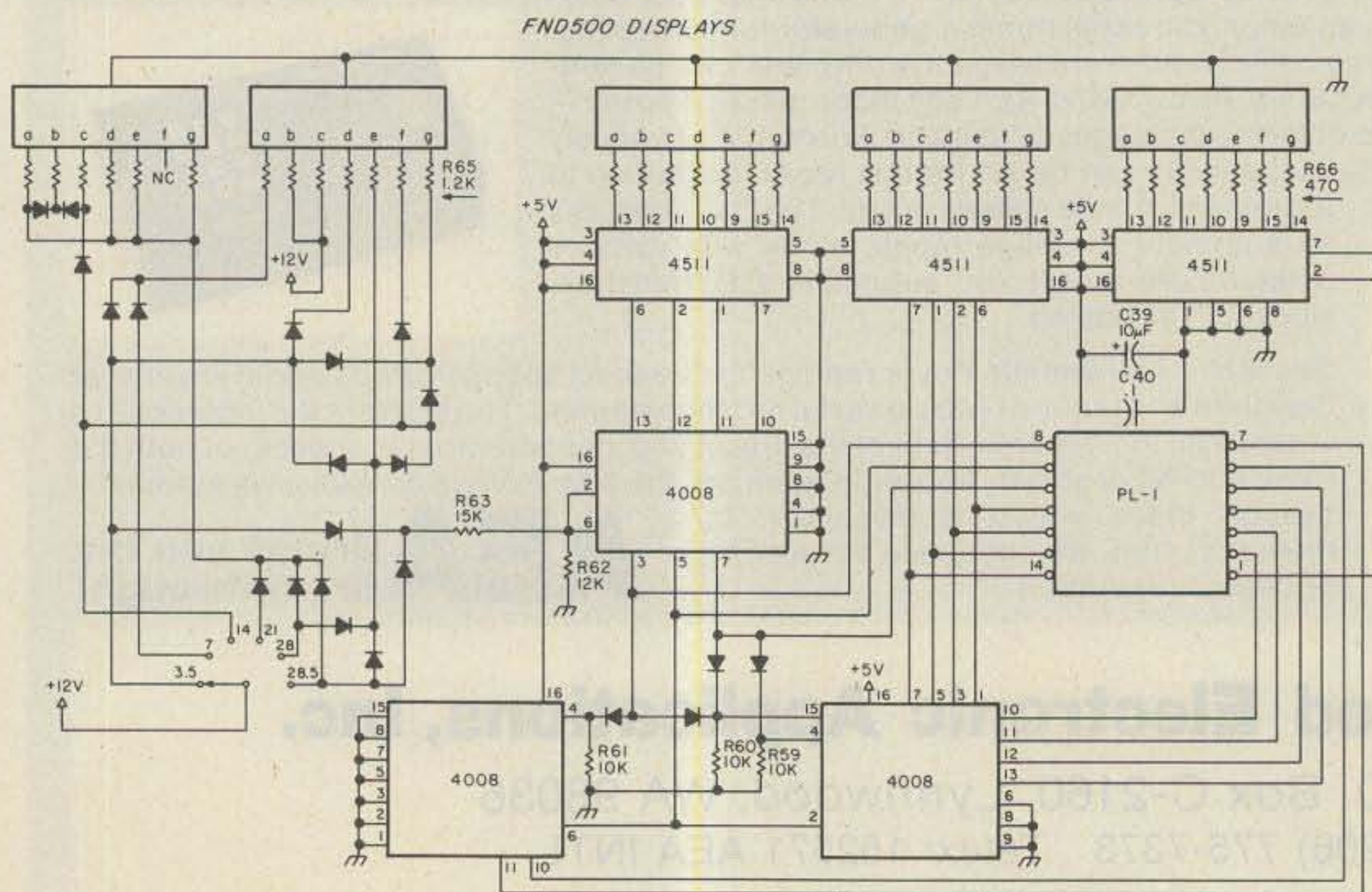

Fig. 3. Display.

SEMICONDUCTORS: P.C. BOARDS FOR MOTOROLA BULLETINS

MRF-208 - 12.00	MHW-252 - 50.00	EB-18A - 12.00	AN-762 - 14.00
MRF-240 - 15.50	MHW-710-1 - 61.00	EB-27A - 14.00	AN-791 - 10.00
MRF-247 - 34.80	MPSH-81 - .50	EB-63 - 14.00	EB-67 - 14.00
MRF-309 - 27.60	MV2205 - .58	KEMET CHIP CAPACITORS: 56 pf, 82 pf, 100 pf, 390 pf, 470 pf; -.50 ea	
MRF-422 - 41.40	78L08CP - .50	680 pf, 1000 pf; -.55 ea	
MRF-454 - 20.00	2N4401 - .75	5600 pf, 6800 pf, .1 $\mu$ f; -1.00 ea	
MRF-901 - 1.75	2N5190 - 1.50	.33 $\mu$ f; -1.90 ea .68 $\mu$ f; -3.90 ea	

SBL-1 Double-Balance Mixer - 6.50  
 CAMBION RF CHOKES: .15  $\mu$ h, .22  $\mu$ h, .33  $\mu$ h, 4.7  $\mu$ h, 10  $\mu$ h - 1.20 ea  
 BROADBAND TRANSFORMERS PER MOTOROLA BULLETINS: AN-762, EB-27A, EB-63  
 UNDERWOOD/SEMCO METAL-CLAD MICA CAPACITORS: 5pf, 10pf, 15pf, 25pf, 30pf, 40pf, 56pf, 60pf, 68pf, 80pf, 91pf, 100pf, 200pf, 250pf, 390pf, 470pf, 1000pf  
 We also carry a line of VHF, UHF amplifiers and ATV equipment.  
 Call or write for our free catalog.

## Communication Concepts Inc.

2648 North Aragon Ave • Dayton, Ohio 45420 • (513) 296-1411 ✓ 14

## RF TRANSISTORS

FRESH STOCK - NOT SURPLUS

2-30 MHz					
P/N	Net	Match/Pr	P/N	Net	Match/Pr
MRF412	\$18.00	\$39.00	MRF455	\$13.50	\$30.00
MRF421	27.00	58.00	MRF455A	13.50	30.00
MRF450	12.50	28.00	MRF458	18.00	40.00
MRF450A	12.50	28.00	MRF492	20.00	43.00
MRF453	15.00	33.00	SRF2072	15.00	33.00
MRF435A	15.00	33.00	SRF2769	15.00	33.00
MRF454	16.50	36.00	CD2545	18.50	40.00
MRF454A	16.50	36.00	CD3424	19.00	41.00

High Gain Matched Pairs & Quads Available			
P/N	Net	P/N	Net
MRF406	\$14.50	MRF475	\$ 5.00
MRF422	39.50	MRF476	3.50
MRF433	14.50	MRF477	13.00
MRF435	42.00	SD1407	37.00
MRF449	14.50	SD1487	28.00
MRF449A	14.50	S10-12	14.50

VHF & UHF TRANSISTORS				
Type	Mount	Rating	MHz	Net/ea.
MRF238	(s)	30W	145-175	\$13.00
MRF240	(s)	40W	145-175	15.00
MRF245	(F)	80W	130-175	27.00
MRF247	(F)	80W	130-175	27.00
MRF492	(F)	70W	27-50	20.00
SD1416	(F)	80W	130-175	29.50
SD1477	(F)	125W	130-175	37.00
SD1441	(F)	150W	130-175	83.50
2N6081	(s)	15W	130-175	7.75
2N6082	(s)	25W	130-175	9.75
2N6083	(s)	30W	130-175	9.75
2N6084	(s)	40W	130-175	12.00
2SC1955	—	1W	130-175	15.00
2SC2289	—	5W	130-175	20.00
MRF641	(F)	15W	430-470	18.00
MRF644	(F)	25W	430-470	21.50
MRF646	(F)	45W	430-470	24.50
MRF648	(F)	60W	430-470	33.50

Technical Assistance and cross-reference information on CD, PT, RF, SRF & SD P/N's; Call our Engineering Dept. (619) 744-0728  
 WE SHIP SAME DAY C.O.D. or VISA/M.C.  
 Minimum Order \$20.00 Add \$3.50 Shipping  
 RF Parts Catalog Avail. OEM & Quantity Discounts  
 ORDERS ONLY: 800-854-1927

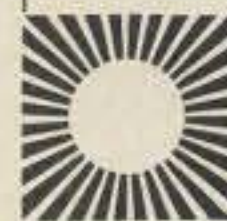

## WESTCOM

1320 Grand Ave. San Marcos  
 California 92069 (619) 744-0728

### CORSAIR SPECIAL OFFER

Buy Ten-Tec's Fantastic HF Transceiver, and get...

- 1) FREE! Your choice of IF Filter from Ten-Tec.
  - 2) 30 Day Money Back Guarantee!
- EXCLUSIVE WESTECH BONUS--
- 3) FREE! Model 220 1st IF Filter (8-pole, 2.4kHz)

ALL FOR ONLY \$1019

WESTECH ELECTRONICS is your dealer for Ten-Tec, Azden, Astron, Hy-Gain, Cushcraft, Butternut, Bencher, Vibroplex, Nye-Viking, MFJ, Daiwa, Kantronics, Digimax, and more.

FREE SHIPPING (UPS Brown) on prepaid orders (Cashier's Check/M.O.). Prices and Availability subject to change; please call for latest information.

MON. 10-6 TUES. 10-8 WED. 10-8

CALL (412) 733-1555 THUR. 10-8 FRI. 10-6 SAT. 10-4



ONLY FROM  
ELECTRONIC  
RAINBOW

\$485<sup>00</sup>

## LIQUID CRYSTAL 1 GHz FREQUENCY COUNTER

- ★ .75" 9 Digit L.C.D. Display
- ★ 24 Hr Clock Hr.-Min.-Sec.
- ★ 10 Min. Timer with warning tone
- ★ Low-Low sensitivity less than 15 Mv from 10 Hz to 1 GHz
- ★ 4 Gate Times .5, 5., 1., 10. Sec.
- ★ Resolution: .1 Hz to 20 MHz 10Hz to 1 GHz

- ★ Time Base: .1 PPM TCXO Standard (10 MHz Crystal)
  - ★ Push Button simplicity
  - ★ Liquid Crystal Easy to read in direct sunlight
  - ★ Size 11 1/4" W x 4" H x 8 1/4" D
- OPTIONS:
- ★ Internal battery source available
  - ★ .01 Crystal oven timebase available

100% Parts and Labor guarantee for 1 year

To order by Visa or Master Charge  
 No C.O.D. orders

Call 800-428-3500  
 Information 317-291-7262  
 6254 La Pas Trail  
 Indianapolis, Indiana 46268 ✓ 58

DEALER  
 INQUIRIES  
 INVITED

ELECTRONIC  
 RAINBOW INC

ly slower rates, when the UP or DOWN switches are closed. When you're satisfied with the results, run the counter up or down until pins 9 through 15 are all at zero volts. This represents a setting of 384 for the divide by N counter in the PLL. As the reference frequency is 5 kHz, the phase detector will lock on a frequency of 1.92 MHz ( $384 \times 5000$ ). If the vxo

tuning capacitor ( $C_T$ ) is set near minimum to a frequency of 7.420 MHz, then the phase detector in the PLL will try to tune the vco to 5.5 MHz ( $7.42 - 1.92$ ). Note that the varicap in the vco returns to a positive voltage so the vco frequency will be lowered as the 0 voltage becomes more positive. Adjust  $L_A$  until it locks with a voltage of about +.3 volts at pin

5 of the PLL. Run the count from the 4029s to 483 (2.415 MHz) to make sure it stays in lock, then stabilize the slug of  $L_A$  with hot wax.

To adjust the vfo buffer and output, temporarily connect a 47- or 51-Ohm, 2-Watt carbon resistor across the vfo output jack and tune  $L_B$  for maximum output at 5.2 MHz. Adjust the rf output to about one

volt with  $C_D$ , and remove the 2-Watt resistor.

The 10.24-MHz reference oscillator is most easily trimmed with the aid of a frequency counter. If the vfo is to be used with a transceiver with a built-in counter, precise alignment is not that important. In any case, you may want to calibrate the 5-kHz dial of  $C_T$ .

For the UP, DOWN, and

### Parts List

#### Resistors (1/4-Watt carbon):

R56 (1)	4.7 Ohm
R57 (1)	10 Ohm
R51 (1)	100 Ohm
R48 (1)	220 Ohm
R39 (1)	270 Ohm
R45 (1)	330 Ohm
R26 (1), R33 (1)	390 Ohm
R9 (1), R66 (21)	470 Ohm
R52 (1)	750 Ohm
R58 (1)	820 Ohm
R13 (1), R15 (1), R17 (1), R31 (1), R53 (1)	1k
R38 (1), R65 (13)	1.2k
R1 (1), R7 (1), R20 (1), R47 (1)	1.5k
R6 (1)	1.8k
R4 (1)	2.0k
R12 (1)	2.2k
R3 (1)	2.7k
R10 (1), R14 (1), R18 (1), R40 (1)	3.3k
R49 (1)	3.9k
R21 (1), R42 (1), R43 (1), R54 (1)	4.7k
R30 (1)	5.1k
R22 (1), R23 (1), R24 (1)	6.8k
R29 (1), R34 (1), R35 (1), R36 (1), R59 (1), R60 (1), R61 (1)	10k
R37 (1), R62 (1)	12k
R55 (1), R63 (1)	15k
R11 (1), R27 (1), R28 (1)	22k
R5 (1), R8 (1), R19 (1), R25 (1)	39k
R32 (1)	47k
R2 (1)	100k
R46 (1)	220k
R44 (1), R50 (1)	1 meg

#### Potentiometers (standard 2-Watt carbon):

R41 (1)	10k
R16 (1)	100k

#### Capacitors (ceramic NPO):

C21 (1)	8 pF
C19 (1)	22 pF
C26 (1)	27 pF
C16 (1), C29 (1)	47 pF
C3 (1), C30 (1), C33 (1)	56 pF
C35 (1)	100 pF
(polystyrene):	
C36 (1)	300 pF
C24 (1)	560 pF

#### Capacitors (disc ceramic):

C4 (1), C22 (1)	.001 uF
C6 (1), C10 (1), C31 (1), C32 (1), C34 (1), C38 (1)	.01 uF
C8 (1), C15 (1)	.047 uF
C5 (1), C20 (1), C23 (1), C27 (1), C37 (1), C40 (1), C44 (1)	.1 uF

#### (mylar):

C25 (1)	.022 uF
C9 (1)	.22 uF

#### (tantalum):

C11 (1)	.56 uF
C12 (1)	4.7 uF

#### (25-volt electrolytic):

C7 (1), C13 (1), C14 (1), C39 (1), C43 (1), C45 (1)	10 uF
C41 (1), C42 (1)	1000 uF

#### (varicaps):

$C_X$ (1)	15 pF
$C_V$ (1)	30 pF

#### (miniature ceramic trimmers):

C28 (1)	1-7 pF
$C_B$ (1), $C_C$ (1)	1-10 pF
$C_A$ (1)	2-15 pF
C1 (1)	5-60 pF

#### (mica compression trimmer):

$C_D$ (1)	3-30 pF
-----------	---------

#### (standard air variable):

$C_T$ (1)	4-50 pF
-----------	---------

#### Inductors (hi-Q, fixed):

L4 (1)	20 uH
L1 (1)	25 uH
L3 (1)	62 uH
L5 (1)	1 mH
L2 (1)	2.2 mH

#### (shielded, variable):

$L_B$ (1)	7-10 uH
$L_A$ (1)	20-30 uH

#### Transformers:

T1 (1) (described in text)	rf
T2 (1) 115-V:12.6-V, 1-A	power

#### Transistors:

Q8 (1), Q10 (1)	MPF102 FET
Q1 (1), Q2 (1), Q9 (1), Q11 (1), Q12 (1)	2N2222
Q3 (1), Q4 (1), Q5 (1), Q6 (1), Q7 (1)	2N4400

#### Diodes:

2 LED	OB, LD
35 1N4148	signal diodes
1 1-A, 50-V	bridge rectifier

#### Integrated circuits:

1 LM340T12	voltage regulator
1 LM340T5	voltage regulator
1 LM703K	rf amplifier
3 4029	counters
3 4008	adders
3 4511	BCD-to-7 segment decoders
1 7473	dual flip-flop
1 MC145109	PLL circuit

Circuit boards, hardware, case, etc.

# SOLE SOURCE?

According to Kenwood's Parts Department, all CW and other crystal filters for its older models such as the TS511, R599, TS520, and TS820 have been discontinued. If so, FOX TANGO becomes the sole known source of high-quality 8-pole crystal filters for drop-in installation in these fine rigs, all of which have a 3395 kHz intermediate frequency.

**3395 kHz FILTER BANDWIDTHS IN STOCK**  
 CW: 250 and 400Hz. SSB: 1.8 and 2.1 kHz ..... \$60 each

For newer models like the TS130, TS430, TS530, TS830, TS930, and R820, FOX TANGO is the sole source of superior 8-pole discrete-crystal substitutes for the smaller YF-88 Monolithic and CF-455 ceramic units. Since they are larger in size, the FOX TANGO filters must be patched into the circuit with coax but all needed materials and detailed instructions are included in the price of the filters; no drilling is required. All have an 8830 kHz center frequency (CW 8830.7 except TS930)

**8830 kHz FILTER BANDWIDTH IN STOCK**  
 CW: 250 and 400 Hz. SSB: 1.8 and 2.1 kHz. AM: 6.0 kHz ..... \$60 each

The more sophisticated TS830, TS930, and R820 use the above 8830 filters plus 455 kHz units for their final intermediate frequency (CW455.7 except TS930).

**455 kHz FILTER BANDWIDTHS IN STOCK**  
 CW: 400 Hz. SSB: 2100 kHz. Price reduced. Now only \$110 each. Replacing (or supplementing) both 8830 and 455 kHz original filters with a **matched-pair** of FOX TANGO discrete-crystal SSB units results in a dramatic improvement of selectivity in both SSB and CW! Indeed, the VBT is so effective at narrow frequencies that separate CW filters are needed by *only the most dedicated CW operators*. For a detailed report send an SASE for a free reprint of a three-page article from "73" magazine and comparative characteristic curves.

### FILTER CASCADING KITS

The TS830, TS930, and R820 owe their exceptional selectivity (with superior filters) to the fact that i-f signals must pass through two filters with 16 poles of filtering. Essentially the same effect can be achieved in the other sets by adding an additional 8-pole FOX TANGO SSB filter and a board for impedance matching and insertion-loss compensation. This is known as Filter Cascading and FOX TANGO kits include a recommended 2.1 kHz filter (1.8 optional) and all needed parts and instructions; wired and tested, ready for easy installation.

**CASCADING KITS FOR TS520 and TS820 ..... \$75 each**

(An improved kit for the TS430S will be available shortly for \$85)

**ORDERING INSTRUCTIONS:** Specify the MODEL in which the filter(s) or kit(s) is to be used and the filter bandwidth and frequency desired. Order by mail or telephone. We accept VISA/MC or ship COD. Add for shipping: \$3 (COD \$1 extra), Airmail \$5, Overseas \$10.

**ONE YEAR WARRANTY**  
**GO FOX-TANGO—TO BE SURE!**  
 Order by Mail or Telephone.

**AUTHORIZED EUROPEAN AGENTS**  
 Scandinavia: MICROTEC, Makedien 26, 3200, Sandefjord, NORWAY  
 Other: INGOIMPEX, Postfach 24 49, D-8070, Ingolstadt, W. GERMANY

**FOX TANGO CORPORATION**  
 Box 15944 S. W. Palm Beach, FL 33416  
 Telephone: (305) 683-9587

## Ducks are getting smaller! and...



## better!



Actual Size

Because you and the leading radio manufacturers want the best-performing, the best looking antenna; Centurion has grown to be the Duck leader. We've developed many smaller antennas to make the hand-held radio perform better, and now the newest duck...the Tuf Duck "mini". It's shorter (about 3") yet it's a full 1/4 wave radiator on VHF.

**CENTURION**  
**TUF DUCK**  
**ANTENNAS**

**CENTURION**  
 Phone 402/467-4491  
 Telex 48-4377 CENTURION LCN  
 P.O. Box 82846 Lincoln, NE 68501 9846

102

# TRAC



### Features:

- State-of-the-Art CMOS Circuitry
- Choice of Message Storage
  - A. Six 50 character messages
  - B. Twelve 25 character messages
  - C. 27 combinations of message C programming
- Records at any speed—plays at any speed
- Memory operating LED
- Use for daily QSO or contests

### PLUS:

- Self-completing dots and dashes
- Both dot and dash memory
- Iambic Keying with any squeeze paddle
- 5.50 w.p.m.
- Speed, volume, tone, tune and weight controls
- Sidetone and speaker
- Low current drain CMOS battery operation—portable
- Rear panel Jack for auxiliary power
- Deluxe quarter-inch jacks for keying and output
- Keys grid block and solid rigs
- WIRED AND TESTED FULLY GUARANTEED—LESS BATTERY

**CHAMPION MESSAGE MEMORY KEYS**

Model TE-292

**\$125.95**

## DELUXE MESSAGE MEMORY KEYS

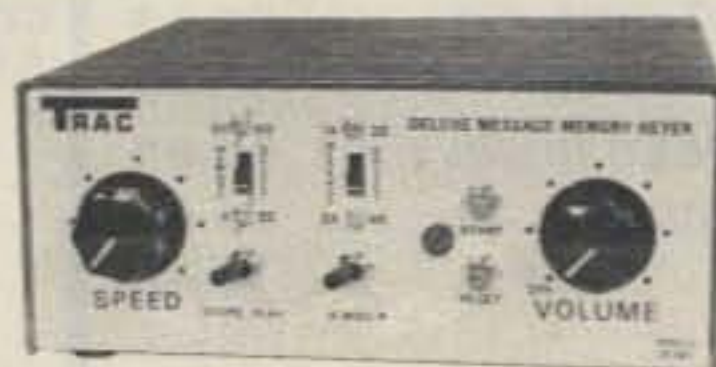

**\$89.95**

Model TE-284

### Features:

- State-of-the-Art CMOS Circuitry
- Three choices of Message Storage
  - A. Two (50 character each) message storage
  - B. Four (25 character each) message storage
  - C. One 50 character and two 25 character message storage
- Records at any speed plays at any speed
- Memory operating LED
- Use for daily QSO or contests

### PLUS:

- Self-completing dots and dashes
- Both dot and dash memory
- Iambic Keying with any squeeze paddle
- 5.50 w.p.m.
- Speed, volume, tone, tune and weight controls
- Sidetone and speaker
- Low current drain CMOS battery operation—portable
- Deluxe quarter-inch jacks for keying and output
- Keys grid block and solid state rigs
- WIRED AND TESTED FULLY GUARANTEED—LESS BATTERY



Model # TE201

**\$75.95**

### Features:

- Advanced CMOS message memory
- Two (50 char each) message storage
- Repeat function
- Records at any speed—plays back at any speed
- Longer message capacity  
 Example: send CQ CQ CQ DX de WB2YJM WB2YJM K—then play second message on contact—de WB2YJM QSL NY NY 579 579 Paul Paul K
- Use for daily QSOs or contests

### PLUS:

- State-of-the-art CMOS keyer
- Self-completing dots and dashes
- Both dot and dash memory
- Iambic keying with any squeeze paddle
- 5.50 w.p.m.
- Speed, volume, tone, tune and weight controls
- Sidetone and speaker
- Low current drain CMOS battery operation—portable
- Deluxe quarter-inch jacks for keying and output
- Keys grid block and solid state rigs
- WIRED AND TESTED FULLY GUARANTEED—LESS BATTERY

**MESSAGE MEMORY KEYS**

76

MODEL TE144—Deluxe CMOS Electronic Keyer \$65.95

MODEL TE133—same as TE144 with wgt. and tone control internal, less semi-auto keying. \$55.95

MODEL TE122—same as TE133 less wgt., tune, solid state keying \$45.95

AT YOUR DEALER OR SEND CHECK OR MONEY ORDER. (plus \$2.00 s.m. N.Y. res. add tax)

**TRAC** ELECTRONICS, INC  
 1106 RAND BLDG.  
 BUFFALO NY 14203

# COMPLETE SYSTEMS

1.9 TO 2.5 GHz

BUILT ANTENNA AND VARIABLE TUNER OPERATES ON TV CHANNELS 2 THRU 6

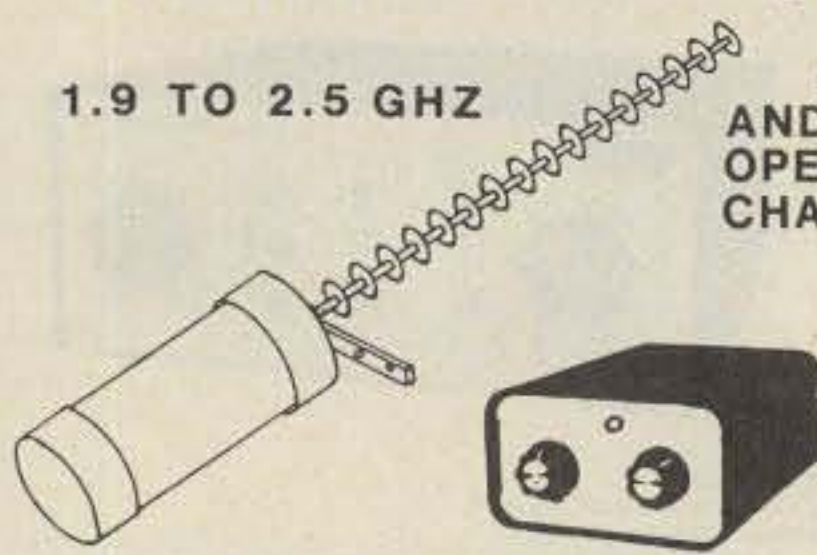

**\$59.95**

ALL SYSTEMS INCLUDES DETAILED INSTRUCTION

DOWN CONVERTER BOARD & PARTS KIT

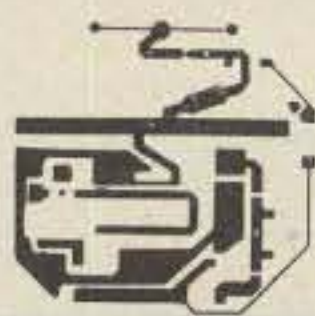

**9.95**

VARIABLE POWER SUPPLY BOARD & PARTS KIT



**9.95**

ALUMINUM CABINET ALL HOLES PRE-PUNCHED **\$6.95**

- MICROWAVE ANTENNA KIT ..... \$9.95
- DOWN CONV KIT ..... \$9.95
- POWER SUPPLY KIT \$9.95
- CABINET ..... \$6.95
- \$36.80**

ALL RG59/U COAX CABLES COME WITH CONNECTOR ATTACHED

- 100 FT ..... \$15.95
- 75 FT ..... \$13.95
- 50 FT ..... \$10.95
- 3 FT ..... \$2.50

**TRIONYX INC**

6219 COFFMAN RD. INDIANAPOLIS, IN 46268

ADD \$3.50 FOR SHIPPING

PHONE OR MAIL (317) 291 7280 291 2995



ANTENNA \$12.95 RUBBER DUCKS FORM \$6.95 TO \$7.95

DC TO DC H.T. CHARGERS \$9.95 AMATEUR TV MICROWAVE SYSTEMS AND KITS

EQUIPMENT 600 MHZ FREQUENCY COUNTERS \$159.95 2 METER 5/8 WAVE HT

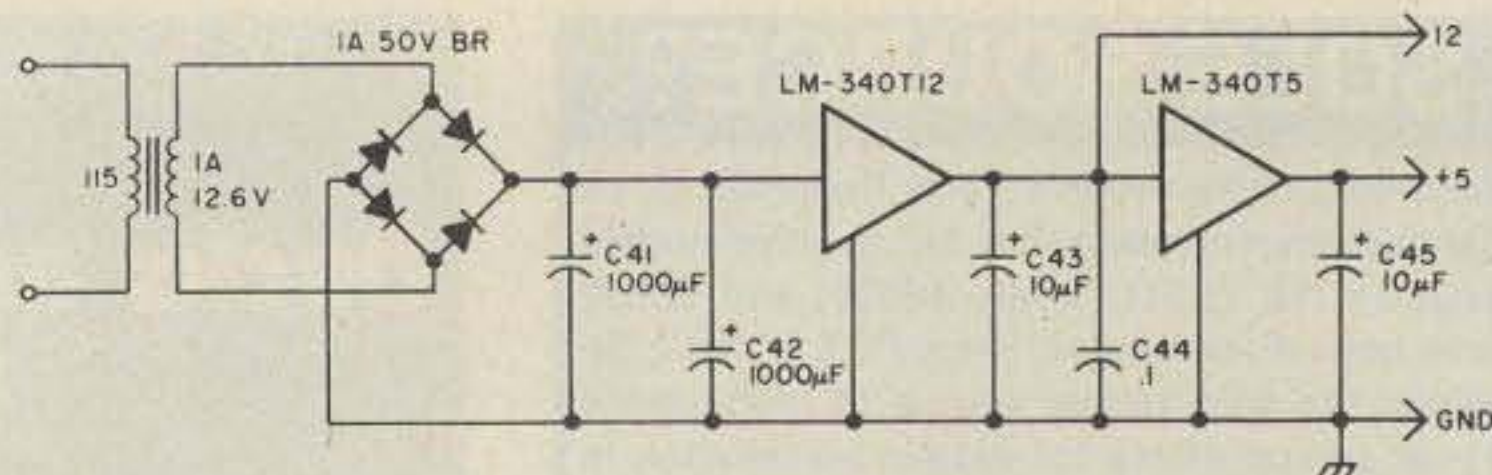

Fig. 4. Power supply.

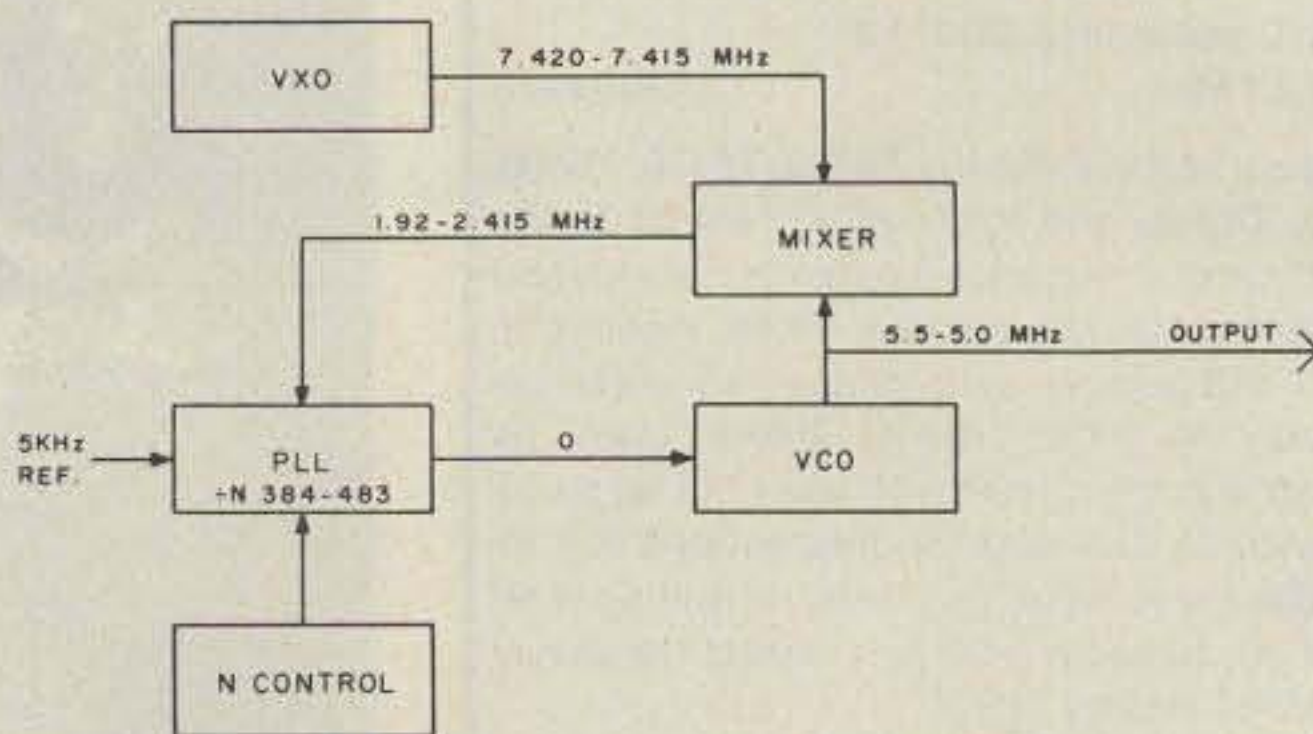

Fig. 5. Block diagram.

FAST switches, I used calculator keypads and the shaft and bushing of a discarded pot. A clockwise pressure closes the UP switch, counterclockwise the DOWN, and a gentle push puts it in FAST.

Construction and adjustment were not difficult. And best of all, several months of use have demonstrated its stability, reliability, and operating ease. It gives me what I want: A rock-hard signal with a soft touch. ■

## COMPLETE READY-TO-USE SYSTEMS

### ATV TRANSMITTER/CONVERTER



TC-1

**\$399**

- ★ High resolution and color video
- ★ 10 watts output
- ★ Broadcast standard sound
- ★ Tunable downconverter and preamp

Connect to the antenna terminals of any TV set, add a good 450 MHz antenna, a camera and there you are... Show the shack, home movies, computer games, video tapes, etc.

### ATV DOWNCONVERTER



TVC-4

For those who want to see the ATV action before they commit to a complete station, the TVC-4 is for you. Great for public service setups, demos, and getting a buddy interested. Just add an antenna and a TV set tuned to CH. 2, 3, or 4 and plug in to 117 volts a.c. **\$89.00**

TVC-4L extra low-noise version... \$105 delivered in USA

## MODULES



**TXA5-4 Exciter/Modulator** ..... \$89.00 ppd.  
Wired and tested module designed to drive PA5 10 watt linear amplifier. The 100 MHz crystal design keeps harmonics out of two meters for talk back. Video modulator is a full 8 MHz for computer graphics and color. Requires 13.8 VDC reg @ 70 ma. 80 mw output power. Tuned with crystal on 439.25, 434 or 426.25 MHz. Dual frequency model available ..... \$115.00 ppd.



**FMA5 Audio Subcarrier Generator** . \$29.00 ppd.  
Puts audio on your camera video just as broadcast does at 4.5 MHz. Puts out 1 V p-p to drive TXA5. Requires low Z mike, 150 to 600 Ω and 12 to 18 VDC @ 25 ma. Works with any transmitter with 5 MHz video bandwidth.



**TVC-2 ATV Downconverter** ..... \$49.00 ppd.  
Stripline MRF 901 preamp and double balanced mixer digs out the weak ones and resists intermod and overload. Connects between UHF antenna and TV set. Output channels 2 or 3. Varicap tuner 420 to 450 MHz. Requires 12 to 18 VDC @ 20 ma. Extrasensitive TVC 2L with NE64535 preamp (.9 dB NF) ..... \$59.00 ppd. Supersensitive TVC 2G with GaAs Fet preamp (.5 dB NF) ant. mount ..... \$79.00 ppd.



**PA5 10 Watt ATV Power Amplifier** . \$89.00 ppd.  
The PA5 will put out 10 watts RMS power on sync tips when driven with 80 mw by the TXA5 exciter. 50 ohms in and out plus bandwidth for the whole band with good linearity for color and sound. Requires 13.8 VDC reg. @ 3 amps.

Call or write for our complete catalog of specifications, station setup diagrams, and optional accessories which include: antennas, modulators, test generators, cameras and much, much more. See Ch. 14 1983 ARRL Handbook.

TERMS: VISA or MASTERCARD by telephone or mail, or check or money order by mail. All prices are delivered in USA. Charge orders normally shipped within 24 hours. Personal checks must clear first.

(213) 447-4565



Let P.C. put you on the air and SAVE!  
All four modules —  
**Complete System price \$245.00**  
SAVE \$11.00 over price if purchased individually

**P.C. ELECTRONICS** 2522 Paxson Lane  
Tom W6ORG Maryann WB6YSS Arcadia, California 91006



# HIGH PERFORMANCE PRESELECTOR-PREAMP

The solution to most interference, intermod, and desense problems in **AMATEUR** and **COMMERCIAL** systems.



- 40 to 1000 Mhz - tuned to your frequency
- 5 large helical resonators
- Low noise - High overload resistance
- 8 dB gain - ultimate rejection > 80 dB
- 10 to 15 volts DC operation
- Size - 1.6 x 2.6 x 4.75" exc. connectors
- **FANTASTIC REJECTION!**

**Typical rejection:**

- ± 600 KHz @ 144 Mhz: -28dB
- ± 1.6 Mhz @ 220 Mhz: -40dB
- ± 5 Mhz @ 450 Mhz: -50dB

Price - **\$79.95** bipolar w/RCA jacks  
Connector options: BNC \$5, UHF \$6, N \$10  
**SUPER HOT!** GaAs Fet option \$20

# AUTOMATIC IDENTIFIERS

ID-1

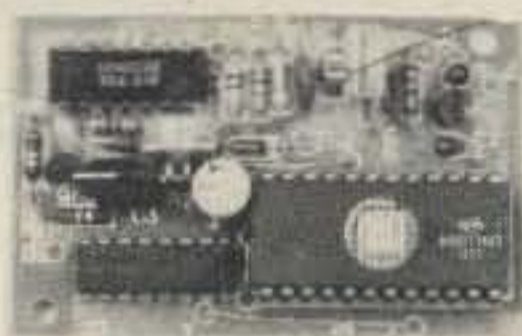

ID-2



- For transceivers and repeaters - **AMATEUR** and **COMMERCIAL**
- Automatic operation - adjustable speed and amplitude
- Small size - easy installation - 7 to 15 volts DC
- 8 selectable, reprogrammable messages - each up to 2 min. long
- Wired, tested, and programmed with your message(s)
- Model ID-1 - \$39.95 Model ID-2 w/2 to 10 minute timer - \$59.95

We offer a complete line of transmitter and receiver strips and synthesizers for amateur and commercial use.

Request our free catalog. Allow \$2 for UPS shipping. Mastercard and VISA welcome.

# GLB ELECTRONICS

1952 Clinton St. Buffalo, NY 14206  
716-824-7936, 9 to 4

✓ 143

# WORK THE U.H.F. BANDS

Add a transverter or converter to your existing 10m, 6m or 2m equipments. Choose from the largest selection of modules available for DX, OSCAR, EME, ATV.

## TRANSVERTERS



- MMT 50-144 \$189.95
- MMT 144-28 \$179.95
- MMT 432-28 (S) \$269.95
- MMT 439-ATV \$349.95
- MMT 1296-144 \$339.95
- OTHER MODELS AVAILABLE write for details

## POWER AMPLIFIERS

all models include RF VOX & Low Noise RX Pre-Ampl. (no pre-amp in MML432-100)

2 Meters:	100W output	MML144-100-LS	1W or 3W in	\$254.95
	100W output	MML144-100-S	10W input	\$264.95
	50W output	MML144-50-S	10W input	\$214.95
	30W output	MML144-30-LS	1W or 3W in	\$109.95
	25W output	MML144-25	3W input	\$114.95
432 MHz:	100W output	MML432-100	10W input	\$399.95
	50W output	MML432-50	10W input	\$239.95
	30W output	MML432-30-L	1W or 3W in	\$199.95
1268-1296 MHz:				Coming soon. Watch for details.

## ANTENNAS (incl. 50 ohm balun)

- 2 Meter J-Beams: 12.3 dBd gain \$63.40
- 8 over 8 Horizon'l pol D8-2M \$76.95
- 8 by 8 Vertical pol D8-2M-vert \$44.95
- 1250-1300 MHz Loop-Yagi 1296-LY \$75.75
- 70 cm/MBM 48 \$105.50
- 70 cm/MBM 88 \$105.50

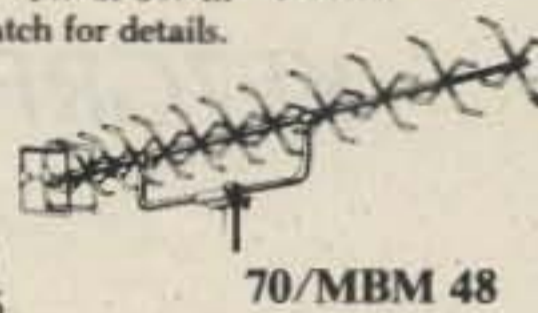

Send 36¢ stamps for full details of all our VHF/UHF items.

- Pre-selector filters
- Pre-amplifiers
- Antennas
- Low-pass filters
- Transverters
- Crystal Filters
- Varactor triplers
- Converters



Spectrum International, Inc.  
Post Office Box 1084S  
Concord, Mass. 01742 USA ✓436



# TUBES



✓108

## AERO ELECTRONICS

Electron Tubes for Industry  
Toll Free (except CA)  
**(800) 421-4219**  
IN CALIFORNIA  
**(800) 556-6700**

2129 Venice Boulevard Los Angeles California 90006 USA  
Telephone (213) 737-7070 Telex 673565 Cable Aero LSA

## AMATEUR AND COMMERCIAL COMMUNICATION SERVICES

\*\*Technical assistance by F.C.C. licensed technicians using the finest repair, test, and alignment equipment to give you results you can count on.

- REPAIRS
- TESTS
- INSTALLATIONS
- ALIGNMENTS
- MODIFICATIONS
- EVALUATIONS

\*\* F.C.C. Licenses;

- General Radiotelephone (ship radar endorsed)
- Second Class Radiotelegraph (ship radar and aircraft radiotelegraph endorsed)
- Amateur Extra Class

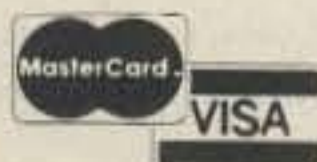

Geff N8CE  
517-626-6044

**PARSEC**  
COMMUNICATIONS  
13313 FOREST HILL RD.  
GRAND LEDGE, MICHIGAN 48837

✓4

# TUNE IN YOUR WORLD WITH HASTINGS!

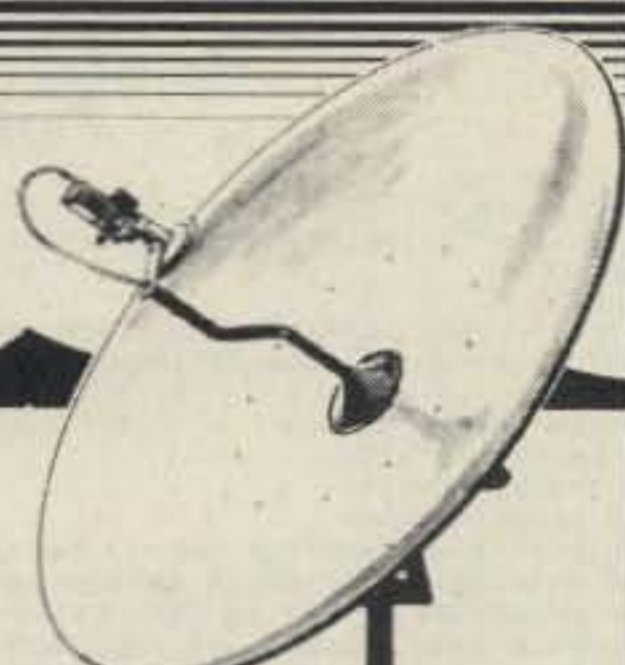

## Introducing System 80A

### With the Permanent 7'11" Antenna

The size you've been waiting for, at a price you can afford. Our one piece spun aluminum dish resists corrosion. Its sturdy offset unipole mount withstands even the strongest winds.

System includes:

- **SAT-TEC 5000**  
24 Channel tuning with AFC, Meter and Modulator
- **LNA - 120" or Better**
- **POLAROTOR II**
- **100 ft. cable kit**

**\$1495<sup>00</sup>**

## HAI HASTINGS ANTENNA, INC.

✓97

847 West First, Hastings, NE 68901  
(800) 228-4407 (In Nebr. (402) 463-3598)

# Foolproof Logging

KL7GRF designed a logbook program that any TRS-80 owner can use. And it manages your QSLs, too.

**A**s all amateurs know, the rules for logbook-keeping have been relaxed considerably by the FCC in recent years. For most amateurs, however, the log is akin to a ship's log. It is kept and kept accurately. In these days when home

computers are invading households all over America, the ham shack is one of most likely places to find a home computer. One of the most common of these is the Radio Shack TRS-80\*, the largest-selling home computer in the world.

Software is plentiful for the TRS-80, and programs of almost any kind can be found at your local computer store, which brings me

to the subject of this article. The home computer is a natural for keeping a log and keeping it well. Described herein is a log-keeping program that should satisfy the requirements of almost any amateur. In designing this

## Program listing.

```
10 CLEAR7000
20 CLS:DIPL*(100,10):FORT=1T010:READLE*(T):NEXTT
30 DATADATE,TIME,STATION,SIGNAL SENT,SIGNAL RCVD,MODE,FREQUENCY,REMARKS,QSL SENT
,QSL RCVD
40 RESTORE
50 C$="KL7GRF":CA$="LOG BOOK FOR AMATEUR RADIO STATION ":TS="UTC":ES=CHR*(255):D
S=STRING$(63,145):LL$=STRING$(79,"-")
60 H$="  % %  % % % % % % %  %  % % % % % "
70 F$="###. % % % % % % % % % %  % %  % % % % % "
80 G$="%  % %  % "
90 IFSK=1THEN1190
100 IFSW=1THEN300
110 PRINT@198,"AMATEUR RADIO LOGBOOK BY JOHN E. FAIL KL7GRF."
120 PRINT@320,"100 DAILY ENTRIES ARE ALLOWED. EXTENSIVE USE OF SINGLE KEY"
130 PRINT@384,"INPUT IS USED EXCEPT DURING ACTUAL DATA ENTRY. SINGLE KEY"
140 PRINT@448,"INPUTS ARE ENCLOSED WITHIN PARENTHESES, EXAMPLE ----> (C)."
150 PRINT@648,"PRESS (C) TO CONTINUE WITH THE PROGRAM."
160 GOSUB1690:IFB$<"C" THEN160
170 CLS:PRINT@10,CA$:C$:PRINT:PRINT$:PRINT:PRINT": CREATE A NEW DAYS LOG.":PRI
NT"2. ADD TO EXISTING LOG.":PRINT"3. UPDATE QSL INFORMATION"
180 PRINT"4. SAVE LOG TO DISK.":PRINT"5. LOAD LOG FROM DISK.":PRINT"6. SUMMARY O
F DAYS LOG.":PRINT"7. OUTPUT LOG TO PRINTER."
190 PRINT$:PRINT@96,"YOUR SELECTION PLEASE (1-8) ?":
200 GOSUB1690:C=VAL(B$):IFC<1ORC>8THEN200
210 ONCGOTO220,700,730,960,1140,1380,1530:GOTO170
220 "NEW LOG
230 IFLN(L$(1,2))=0THEN300
240 GOSUB1790
250 GOSUB1690
260 IFB$="C" THEN290
270 IFB$="R" THEN170
280 GOTO250
290 GOTO1750
300 DY$="":SW=0:CLS:PRINT@448,"(ENTER) THE DATE TODAY, USE FORMAT SHOWN -> MAY21
-":INPUTDY$:IFDY$="" THEN170
310 IFLN(DY$(2))<7 THENGOSUB1710:GOTO300
320 GOSUB1780
330 FORX=1T0101
340 IFX=101 THENGOSUB1870:GOTO170
350 L$(X,1)=LE$(1)
360 IFLN(L$(X,2))=0 THEN690
370 CLS:PRINT@10,CA$:C$:PRINTD$
380 PRINT@192,"LOG ENTRY NUMBER.":X:PRINT@216,"*USE (ENTER) KEY*":PRINT@237,"DA
TE: " :DA$
390 PRINT@320,LE$(2):PRINT@334,STRING$(4,136):PRINT@339,TS:PRINT@332,CHR$(14)
:INPUTL$(X,2):PRINT@332,CHR$(12B)
400 IFLN(L$(X,2))=0ORLEN(L$(X,2))>4 THENPRINT@320,E$:GOSUB1720:GOTO390
410 PRINT@384,LE$(3):PRINT@398,STRING$(8,136):PRINT@396,CHR$(14):INPUTL$(X,3)
:PRINT@396,CHR$(12B)
420 IFLN(L$(X,3))<1ORLEN(L$(X,3))>8 THENPRINT@384,E$:GOSUB1720:GOTO410
430 PRINT@448,LE$(4):PRINT@462,STRING$(4,136):PRINT@460,CHR$(14):INPUTL$(X,4)
:PRINT@460,CHR$(12B)
440 IFLN(L$(X,4))<1ORLEN(L$(X,4))>4 THENPRINT@448,E$:GOSUB1720:GOTO430
```

```
450 PRINT@512,LE$(5):PRINT@526,STRING$(4,136):PRINT@524,CHR$(14):INPUTL$(X,5)
:PRINT@524,CHR$(12B)
460 IFLN(L$(X,5))<1ORLEN(L$(X,5))>4 THENPRINT@512,E$:GOSUB1720:GOTO450
470 PRINT@576,LE$(6):PRINT@590,STRING$(7,136):PRINT@588,CHR$(14):INPUTL$(X,6)
:PRINT@588,CHR$(12B)
480 IFLN(L$(X,6))<1ORLEN(L$(X,6))>7 THENPRINT@576,E$:GOSUB1720:GOTO470
490 PRINT@640,LE$(7):PRINT@654,STRING$(7,136):PRINT@652,CHR$(14):INPUTL$(X,7)
:PRINT@652,CHR$(12B)
500 IFLN(L$(X,7))<1ORLEN(L$(X,7))>7 THENPRINT@640,E$:GOSUB1720:GOTO490
510 PRINT@704,LE$(8):PRINT@718,STRING$(10,136):PRINT@716,CHR$(14):INPUTL$(X,8)
:PRINT@716,CHR$(12B)
520 IFLN(L$(X,8))>40 THENPRINT@704,E$:L$(X,8)="" :GOSUB1720:GOTO510
530 PRINT@768,LE$(9):PRINT@782,STRING$(3,136):PRINT@780,CHR$(14):INPUTL$(X,9)
:PRINT@780,CHR$(12B)
540 IFLN(L$(X,9))>3 THENPRINT@768,E$:L$(X,9)="" :GOSUB1720:GOTO530
550 PRINT@832,LE$(10):PRINT@846,STRING$(3,136):PRINT@844,CHR$(14):INPUTL$(X,
10):PRINT@844,CHR$(12B)
560 IFLN(L$(X,10))>3 THENPRINT@832,E$:L$(X,10)="" :GOSUB1720:GOTO550
570 PRINT@980,"DATA CORRECT (Y/N) ?":
580 GOSUB1690
590 IFB$="Y" THEN640
600 IFB$="N" THEN620
610 GOTO580
620 FORZ=1T010:L$(X,Z)="" :NEXTZ
630 GOTO370
640 PRINT@980,"ANOTHER ENTRY (Y/N) ?":
650 GOSUB1690
660 IFB$="Y" THEN690
670 IFB$="N" THEN170
680 GOTO650
690 NEXTX
700 "ADD TO EXISTING LOG
710 IFLN(L$(1,2))=0 THENGOSUB1730:GOTO170
720 GOTO330
730 "UPDATE QSL INFO
740 IFLN(L$(1,2))=0 THENGOSUB1730:GOTO170
750 CLS:SW=0:PRINT@448,"(ENTER) RECORD NUMBER OF ENTRY TO BE UPDATED, (101) TO E
XIT":INPUTX:IFX=101 THEN170
760 IFX<1ORX>101 THEN750
770 IFLN(L$(X,2))=0 THENCLS:PRINT@464,"NO DATA FOR RECORD NUMBER":X:"IN FILE":FO
RT=1T0500:NEXTT:GOTO750
780 CLS:PRINT@256,USINGB$:LE$(2),LE$(3),RIGHT$(LE$(9),4),RIGHT$(LE$(10),4),LE$(6)
),LE$(7),LEFT$(LE$(9),5),LEFT$(LE$(10),5)
790 PRINT@320,USINGB$:X,L$(X,2),TS,L$(X,3),L$(X,4),L$(X,5),L$(X,6),L$(X,7),L$(X
,9),L$(X,10):L$(X,9)="" :L$(X,10)=""
800 PRINT@388,USINGB$:LE$(8),L$(X,8)
810 PRINT@448,LE$(9):PRINT@462,STRING$(3,136):PRINT@460,CHR$(14):INPUTL$(X,9)
820 IFLN(L$(X,9))>3 THENPRINT@448,E$:GOSUB1720:GOTO810
830 PRINT@512,LE$(10):PRINT@526,STRING$(3,136):PRINT@524,CHR$(14):INPUTL$(X,1
0)
840 IFLN(L$(X,10))>3 THENPRINT@512,E$:GOSUB1720:GOTO830
850 PRINT@661,"DATA CORRECT (Y/N) ?"
860 GOSUB1690
870 IFB$="Y" THENSW=0:GOTO900
880 IFB$="N" THENGOTO780
```

program, I attempted to make it versatile and easy to change to fit an individual amateur's requirements. Most of all, I attempted to make it compatible with 16K cassette TRS-80 owners, as well as those with disk-drive systems. It's a toss-up as to which peripheral most will upgrade to from the cassette-based system, a printer or disk drives. Another consideration was keeping it suitable for those who use cassettes with a printer, but don't have disk drives.

The program uses sequential I/O techniques instead of random-access files. I chose this method so that the program could be easily modified to run on cassette as well as disk. Some purists will argue that random I/O is the only way to go. However, the average amateur does not make more than 10-15 contacts a day. Therefore, the in-memory storage of information is practical if the log and its data are based on daily files instead of keeping a month's log in one file on a disk.

This program is written in Microsoft Basic for the

TRS-80, but should be easily adaptable to other computers, such as Apple, North Star, and others.

The program features the following:

1. In-memory log for all contacts in a day's operation.
2. Add-on to a log or previously-filed log.
3. QSL information and management of received QSL as well as outgoing QSL information. Manipulation of QSL files is provided.
4. A hard-copy printout of each day's log data.
5. Permanent filing of log data on disk or cassette on a daily basis.
6. Compatibility with 16K as well as larger systems.
7. Day's log summary is provided on the video terminal.
8. Allows for 100 entries a day (as is), which should be changed for smaller systems and increased for larger systems if desired (details on this later).
9. "Customizing" the log to fit your requirements is easy.

### The Program

The program is numbered starting at line 10 in increments of 10, so just set

1. CREATE A NEW DAYS LOG.
2. ADD TO EXISTING LOG.
3. UPDATE QSL INFORMATION
4. SAVE LOG TO DISK.
5. LOAD LOG FROM DISK.
6. SUMMARY OF DAYS LOG.
7. OUTPUT LOG TO PRINTER.

YOUR SELECTION PLEASE (1-7) ?

Fig. 1. Sample of directory on video display.

TIME	STATION	SENT	RCVD	MODE	FREQUENCY	QSL	S	QSL	R
5. 1513UTC	W6DOW	59	59	SSB	3850.1	NO		NO	
REMARKS AMSAT NET									
QSL SENT	? YES								
QSL RCVD	? NO.								

DATA CORRECT (Y/N) ?

Fig. 2. Sample of QSL update on video display.

the TRS-80 to AUTO 10,10 and start entering the program. Lines 10-80 set up the variables, DIM statement for the actual data entries (L\$), and establish data statements for use later in the program. Change string variable C\$ in line 50 to your own callsign. String variable T\$ in line 50 is set to UTC (Universal Coordinated Time); if you desire to set time inputs to local time, change T\$ to "PDT" or whatever. Do not exceed three letters in T\$ or it will throw off the PRINT@ strings in lines 60, 70, and 80. The CLEAR statement in line 10 should be changed for smaller systems as well as

the DIM statement in line 20 (more on this later). Variables SK and SW are switches used to reset all variables to null for restarting a new log or loading data from disk or cassette.

Lines 110-160 are merely there to prompt you through the first few times you use the program; they can be deleted when you are familiar with the program, shortening execution time and saving memory. The remainder of the program should be unchanged except as described later when detailing changes for the cassette-based system. Disk-drive operators can use the program "as is."

```

890 GOTO860
900 PRINT@661,"ANOTHER UPDATE (Y/N) ?"
910 GOSUB1690
920 IFB$="Y"THEN730
930 IFB$="N"THEN950
940 GOTO910
950 CLS:PRINT@455,"DON'T FORGET TO SAVE THIS LOG BACK TO DISK!!!!":FORT=1TD1000:
NEXTT:GOTO170
960 "SAVE TO DISK
970 IFLEN(L$(1,2))=0THENGOSUB1730:GOTO170
980 GOSUB1760
990 GOSUB1690
1000 IFB$="D"THEN1030
1010 IFB$="X"THEN170
1020 GOTO990
1030 FS$=DY$+"/LST"
1040 OPEN"D",1,FS$
1050 CLS:PRINT@468,"SAVING ENTRY #:"
1060 FORX=1TD100
1070 IFLEN(L$(X,2))=0THEN1130
1080 PRINT@483,X
1090 FORZ=1TD10
1100 PRINT@1,X,CHR$(34);L$(X,Z);CHR$(34)
1110 NEXTZ
1120 NEXTX
1130 CLOSE:GOTO170
1140 "LOAD FROM DISK
1150 IFLEN(L$(1,2))>0THENGOSUB1790ELSE1190
1160 GOSUB1690
1170 IFB$="C"THENGOTO1740
1180 IFB$="R"THEN170
1190 FS$="":SK=0:CLS:PRINT@448,"(ENTER) FILE DESIRED,USE EXAMPLE, -> MAY2181 (EN
TER) 'X' TO EXIT":INPUTFS$:IFB$="X"THEN170
1200 IFLEN(FS$)<>7THENGOSUB1710:GOTO1190
1210 GOSUB1760
1220 GOSUB1690
1230 IFB$="D"THEN1260
1240 IFB$="X"THEN170
1250 GOTO1220
1260 ONERRORGOTO1360
1270 FS$=FS$+"/LST":CLS:PRINT@468,"LOADING ENTRY #:"
1280 OPEN"1",1,FS$
1290 FORX=1TD100
1300 PRINT@484,X
1310 FORZ=1TD10
1320 IFEOF(1)THEN1360
1330 INPUT@1,X,L$(X,Z)
1340 NEXTZ
1350 NEXTX
1360 CLOSE(1):DY$=LEFT$(FS$,7):GOSUB1780:GOTO170
1370 GOTO170
1380 "PRINT SUMMARY
1390 IFLEN(L$(1,2))=0THENGOSUB1730:GOTO170
1400 P=12B:X=1
1410 CLS:PRINTTAB(20)"LOG SUMMARY: ";DA$

```

```

1420 IFX=101THENGOSUB1770:GOSUB1690:GOTO170
1430 PRINT@64,USINGH$:LE$(2),LE$(3),RIGHT$(LE$(9),4),RIGHT$(LE$(10),4),LE$(6),LE
$(7),LEFT$(LE$(9),5),LEFT$(LE$(10),5)
1440 IFLEN(L$(X,2))=0THENGOSUB1770:GOSUB1690:IFB$="R"THEN170ELSE1440
1450 PRINT@P,USINGF$:X,L$(X,2),T$,L$(X,3),L$(X,4),L$(X,5),L$(X,6),L$(X,7),L$(X,9
),L$(X,10)
1460 P=P+64:PRINT@P+4,USINGG$:LE$(8),L$(X,8)
1470 IFP=832THEN1480ELSEP=P+64:X=X+1:GOTO1440
1480 PRINT@960,"PRESS (C) TO CONTINUE SUMMARY, PRESS (R) TO EXIT TO DIRECTORY":
1490 GOSUB1690
1500 IFB$="C"THENX=X+1:P=12B:GOTO1410
1510 IFB$="R"THEN170
1520 GOTO1490
1530 "PRINT LOG
1540 IFLEN(L$(1,2))=0THENGOSUB1730:GOTO170
1550 CLS:PRINT@460,"LINE UP PAPER, PLACE PRINTER ON LINE.":PRINT@523,"PRESS (P)
TO PRINT, PRESS (X) TO ABORT."
1560 GOSUB1690
1570 IFB$="P"THEN1600
1580 IFB$="X"THEN170
1590 GOTO1560
1600 CLS:PRINT@470,"PRINTING LOG":PG=0:GOSUB1820
1610 FORX=1TD100
1620 IFLEN(L$(X,2))=0THEN1660
1630 LPRINTTAB(5)USINGF$:X,L$(X,2),T$,L$(X,3),L$(X,4),L$(X,5),L$(X,6),L$(X,7),L$
(X,9),L$(X,10)
1640 LPRINTTAB(9)USINGG$:LE$(8),L$(X,8):LPRINTLL$:LC=LC+3:GOSUB1850
1650 NEXTX
1660 LPRINT"":LPRINTTAB(25)"END OF LOG FOR "DA$
1670 GOTO170
1680 END
1690 B$=INKEY$:IFB$=""THEN1690
1700 RETURN
1710 CLS:PRINT@473,"IMPROPER ENTRY":FORT=1TD700:NEXTT:RETURN
1720 PRINT@974,"NO ENTRY PROVIDED OR INPUT TOO LONG":FORT=1TD400:NEXTT:PRINT@96
0,E$:RETURN
1730 CLS:PRINT@459,"THERE IS NO DATA PRESENT IN THE FILE !!!":FORT=1TD800:NEXTT:
RETURN
1740 CLEAR:SK=1:GOTO20
1750 CLEAR:SW=1:GOTO20
1760 CLS:PRINT@453,"INSERT DATA DISK AND PRESS (D), PRESS (X) TO ABORT":RETURN
1770 PRINT@960,"END OF LIST FOR "DA$":PRESS (R) TO RETURN TO DIRECTORY":RETURN
1780 DA$=LEFT$(DY$,3)+" "+MID$(DY$,4,2)+" "+RIGHT$(DY$,2):RETURN
1790 CLS:PRINT@448,"THERE IS DATA ON FILE FOR "DA$", IT WILL BE LOST IF":PRINT@5
12,"YOU CONTINUE FURTHER. PRESS (C) TO CONTINUE OR PRESS (R)"
1800 PRINT@576,"TO RETURN TO DIRECTORY."
1810 RETURN
1820 PG=PG+1:LC=0:LPRINTTAB(5)CA$:C$:" ";DA$: " PAGE: ";PG:LPRINTLL$:LPRINTTAB(5)
USINGH$:LE$(2),LE$(3),RIGHT$(LE$(9),4),RIGHT$(LE$(10),4),LE$(6),LE$(7),LEFT$(LE$
(9),5),LEFT$(LE$(10),5)
1830 LPRINTLL$:LC=LC+4
1840 RETURN
1850 IFLC=58THENLPRINTSTRING$(7,CHR$(10)):GOSUB1820
1860 RETURN
1870 CLS:PRINT@470,"THE LOG IS FULL!!!":FORT=1TD600:NEXTT:RETURN

```

	TIME	STATION	SENT	RCVD	MODE	FREQUENCY	QSL S	QSL R
1.	0413UTC	W6SP	59	59	SSB	144	YES	NO
	REMARKS JOHN RANCHO PALOS VERDES CA. QSL DIRECT							
2.	0615UTC	W6MFK	56	57	OSCAR 8 MODE J		YES	NO
	REMARKS VIC DUARTE CA.							
3.	0812UTC	W6HEW	54	54	OSCAR 7 MODE B		NO	NO
	REMARKS MORT SAN CLEMENTE CALIF.							
4.	1213UTC	W3GEY	59	59	SSB	14282.0	YES	NO
	REMARKS JAN KING MARYLAND QSL VIA BUREAU							
5.	1513UTC	W6DDW	59	59	SSB	3850.1	YES	NO
	REMARKS AMSAT NET							
6.	1514UTC	W6CG	59	59	SSB	3850.0	NO	NO
	REMARKS AMSAT NET							

END OF LOG FOR MAY 21, 1981

Fig. 3. Sample of printer output.

### Operation of the Program

Extensive use is made of the INKEY\$ function in the program, making it faster in use. The only time the ENTER key is used is when more than one character is to be entered. When you see a letter in parentheses, "(C)", it means that a single key input is requested and the ENTER key is not required. When the ENTER key is re-

quired, it will appear as "(ENTER)" a value. Lots of error trapping is included, so it is hard to make a mistake. Wherever a mistake is possible or imminent, a message is provided on the screen and the opportunity to exit the danger area is provided by an exit function.

No delete-entry routine is provided, since a log is defined by law as a legal docu-

1. Change line 10 to: CLEAR4000
2. Change DIMLS\$ statement in line 20 to: LS\$(50,10)
3. Change "DISK" to "CASSETTE" in lines 180 (2 times), 950, 960, and 1140
4. Change line 330 to: FORX = 1TO51
5. Change line 340 to: IFX = 51THENGOSUB1870:GOTO170
6. Change line 1610 to: FORX = 1TO50

### SAVE TO CASSETTE SECTION

7. Change line 1000 to: IFB\$ = "D" THEN 1050
8. Delete line 1030
9. Delete line 1040
10. Add line 1055: PRINT#-1,DYS
11. Change line 1060 to: FORX = 1TO50
12. Delete line 1070
13. Add line 1095:  
IFLEN(LS\$(X,2)) = 0 THEN LS\$(X,2) = "###":PRINT#-1,LS\$(X,2):GOTO170
14. Change line 1100 to PRINT#-1,X,LS\$(X,Z)
15. Change line 1760 to: CLS:PRINT@384,"1. PLACE DATA TAPE IN RECORDER.":PRINT"2. SET RECORDER TO 'PLAY' AND 'RECORD'.":PRINT"3. PRESS (D) TO SAVE OR (X) TO ABORT.":RETURN

### LOAD FROM CASSETTE CHANGES

16. Change line 1210 to: GOSUB1880
17. Add line 1880: CLS:PRINT@448,"1. PLACE DATA CASSETTE IN RECORDER, ADVANCE COUNTER TO LOCATION":PRINT"DESIRED. PRESS (D) TO LOAD, (X) TO ABORT.":RETURN
18. Change line 1260 to: ONERRORGOTO1370
19. Change line 1270 to: CLS:PRINT@468,"LOADING ENTRY #:"
20. Change line 1280 to: INPUT#-1,DYS
21. Change line 1290 to: FORX = 1TO50
22. Change line 1320 to: INPUT#-1,X,LS\$(X,Z)
23. Change line 1330 to: IFLS\$(X,Z) = "###" THEN 1360
24. Change line 1360 to: GOSUB1780:GOTO170
25. Change the 100 in line 120 to 50

Table 1.

ment. Corrections should be made by drawing a line through the deleted or changed entry. They should then be initialed by the person making the change(s). Any changes to the log can be inserted on the hard copy produced by the printer. The printer output routine is based on an 80-column printer. The format of the output to the printer is shown in Fig. 3.

The DIRECTORY video display (Fig. 1) is single-key entry. Selecting "1. CREATE A NEW DAYS LOG" clears and resets all variables. If data is present in memory, you will be warned and given the opportunity to exit to the directory and save the data to disk. If the data has already been saved and you want to start a new log, merely press the (C) key and the program will proceed to start the new setup. If no log data is present in memory, the program will proceed normally. A word of warning: When starting a new log, you will be asked for the date in a specific input manner, i.e., MAY2181. Note that no spaces are allowed. The date display is derived from this input and, more importantly, the Filespec for writing to disk is derived from it. The program checks to make sure you did in fact put 7 characters in and gives you an error message if it detects any fewer or more than 7 characters. No checking is done for proper sequence. A disk and cassette file will not accept a number as the first character of a filespec, so pay particular attention to this question.

"2. ADD TO EXISTING LOG." If data for a given day is already in memory and you wish to add to it, just press 2 and it will select the next available sequential number available and display the data input form. If you wish to add on to a filed log (on disk or cassette), load that log through the "LOAD LOG FROM DISK" function and

then select the "ADD" function. Don't forget to save the log back to disk. Killing the old file is not needed since sequential techniques write over the old file which will have the same Filespec as what you write back out after additions to the log. This is a bit of a problem for cassette systems, as will be described later.

"3. UPDATE QSL INFORMATION" is a routine to account for outstanding QSL cards received. The procedure for this is to load the file for the data to be updated through the "LOAD FROM DISK" function. Then use the "SUMMARY" function to locate the entry you wish to update (or use the printed copy previously printed to locate the entry number). Enter the "UPDATE" function and make the corrections. The display for "UPDATE" is shown in Fig. 2.

"4. SAVE LOG TO DISK." When completing a day's operation, use this function to save the data to disk. The Filespec is automatically created using the date question described earlier. Use this function to save back to disk after using the "UPDATE" function or "ADD TO LOG" function if a file was loaded for addition of entries.

"5. LOAD LOG FROM DISK" is used to retrieve old files for QSL manipulation or "ADD." You will be asked the date question again here. Use care: The computer creates the Filespec from this information.

"6. SUMMARY OF DAYS LOG" gives a rundown of the day's operation (see Fig. 5). This can be looked at after loading an old file or with data already in memory.

"7. OUTPUT LOG TO PRINTER" provides neat, orderly output to a line printer for permanent record purposes. It is based in format on many of the commonly available logbooks (see Fig. 3). Full pagination is

```

LOG ENTRY NUMBER: 1   *USE (ENTER) KEY*   DATE: MAY 21, 1981

TIME      . 0413 UTC
STATION   . W6SP....
SIGNAL SENT . 59..
SIGNAL RCVD . 59..
MODE      . SSB....
FREQUENCY . 144....
REMARKS   . JOHN  RANCHO PALOS VERDES CA. QSL DIRECT
QSL SENT  . YES
QSL RCVD  . NO.

```

DATA CORRECT (Y/N) ?

Fig. 4. Sample of data entry on video display.

provided for 8.5 by 11 inch paper including page numbering.

### Data Input to Log

Data input format to the log is shown in Fig. 4. When this display is presented, a series of graphic blocks will be displayed to indicate the maximum length of the input. You must put an entry into each data block. Merely pressing ENTER will cause an error message and a return to that data entry. On the other hand, exceeding the blocks will also cause an error and a reprint of the requested data. The only entries that will accept no data input are REMARKS, QSL SENT, and QSL RCVD. Since this is optional information, the leeway is allowed. After completing the "form," you will be asked if the data is correct; if not, the program returns to the same entry number and resets the block in order for you to retype the entry. If it is correct, the program will ask if you want to add another entry. If not, you return to the directory. The time entry is done in military 4-digit style, i.e., 2343, 0416, etc. No commas or quotes are allowed by the TRS-80 and any data entered after a comma is inserted will be cut off. Periods are OK. The requirement for power input in the log was not forgotten. The TRS-80

video display is limited to 64 characters and addition of power input would have crowded the display quite a bit. So, I chose to leave the power input for the remarks data input.

### QSL Update

This operates in a manner similar to that of DATA ENTRY, except that you only manipulate the QSL information.

### Hints

Save your data off to disk often during a day of operation to prevent loss of data from accidental turning off of the computer, power failures, etc. Use particular care in entering the PRINT@ variables in lines 60, 70, and 80, and make sure you see and enter the % sign on the extreme right of variable G\$. For disk systems, set the clock in the expansion interface from DOS prior to going to Basic; the time will then appear right next to your callsign through most of the program. Single-disk-drive owners can use this program by killing off all of the programs on a TRS-DOS diskette and loading this program and maintaining all data files on the same disk. Multiple-drive owners should maintain separate data diskettes. If you own a printer, then hard-copy files only could be kept, elimi-

```

LOG SUMMARY: MAY 21, 1981
TIME STATION SENT RCVD MODE FREQUENCY QSL S QSL R
1. 0413UTC W6SP 59 59 SSB 144 YES NO
REMARKS JOHN RANCHO PALOS VERDES CA. QSL DIRECT
2. 0615UTC W6WNK 56 57 OSCAR 8 MODE J YES NO
REMARKS VIC DUARTE CA.
3. 0812UTC W6HEM 54 54 OSCAR 7 MODE B NO NO
REMARKS MORT SAN CLEMENTE CALIF.
4. 1213UTC W3GEY 59 59 SSB 14282.0 YES NO
REMARKS JAN KING MARYLAND QSL VIA BUREAU
5. 1513UTC W6DOW 59 59 SSB 3850.1 NO NO
REMARKS AMSAT NET
6. 1514UTC W6CD 59 59 SSB 3850.0 NO NO
REMARKS AMSAT NET

```

PRESS (C) TO CONTINUE SUMMARY, PRESS (R) TO EXIT TO DIRECTORY

Fig. 5. Sample of summary on video display.

# MITRONIX

## MORSE CODE from MITRONIX



Turn your Radio Shack Color Computer into a complete Morse Code terminal.

MITRONIX MODEM—Interfaces the computer to your transceiver via the ROM PAC slot.

Cartridge: \$54.95

—You have your choice of 5 CW programs to pick from including:

### —MITRONIX TRANSLATOR

This Machine Language program allows you to transmit & receive from 5-60 WPM. Features split-screen with reverse video receive, a 1024 character TX buffer, auto CQ, & 4 message memories.

Cassette: \$26.95

### KA9FSQ PERSONAL CW MAILBOX—

Written in COLOR BASIC, this program allows you to transmit to 50 WPM, & receive to 30 WPM. In the MAILBOX mode, it will answer a CW call, get other station's call letters, message, data & time, and store it in memory for instant recall when you return. Also hard copy.

Cassette: \$21.95

For additional information and programming, write to:

Michael L. Rice, Jr. KA9FSQ  
MITRONIX  
5953 N. Teutonia Ave.  
Milwaukee, WI 53209  
(414) 466-6151

240

Sales please include 5% postage

nating the need for data diskettes or cassettes. To increase the handling capabilities for larger systems, change the CLEAR statement to a larger value, such as 10-12000, and change all 1 to 100 FOR NEXT loops to a value of 300 or so. Contest logs are possible by fixing certain variables to fixed values and inserting a duplicate-checking routine. Write if you want information on this; the changes are beyond the scope of this article.

Those having heavy fingers on the keyboard should beware: If you are not used to single key entry, it's fast. Be sure to experiment with small amounts of data until you get the feel of the program, rather than commit large amounts of data.

### Cassette Operation and Changes

Ah, yes, the cassettes, the one true headache of home-computer operation. This

program will work very well with cassette-based I/O, but it will be very slow on the I/O operations (probably slower than you could ever believe). You must have a minimum of 16K memory for this program. I have intentionally reduced the CLEAR, DIM, and FOR NEXT loops, since you will have trouble finding a digital tape long enough to hold 100 entries. The changes to the program required for cassette operation are shown in Table 1.

### Summary

Contained in this article is a program that is versatile, fast, and easily changed to fit individual requirements. I hope you have fun with it. Write me with any questions.

If demand is high enough, I would consider producing this program on formatted disk and/or cassette. Contact me for information on this. ■

# The Program No Net Control Should Be Without

*Every net generates lists. Keep yours up to date with this TRS-80 Basic program.*

Soon after we began the Central North Carolina Weather Net on the two-meter band, the net-control station needed a better way of keeping track of the hams who had joined the net. In order to facilitate call-up, the net-control stations decided to maintain a sequential list of members, each with an assigned number. At the same time, we needed to determine quickly whether a station checking in had been assigned a number—that is, whether he was already listed as a member of the net. After inadvertently assigning several stations multiple numbers, I wrote a net roster program to keep track of the net membership.

The program lists stations in numeric sequence, thirty at a time, for net call-up and searches for a given call to determine if it is in the register; it corrects an erroneous entry and adds a new member's call to the register.

This program is organized as a series of subroutines called by a main call-

ing program. This approach simplifies programming and debugging; if I want to change one of the features in the program, I change only one subroutine.

## Overview

The program stores each member's call letters, county of residence, and name. The program includes the following routines: read data from tape, save data to tape, list a block of 30 net members, search for and display a specified call, sort the data by call letters, change an entry, and add an entry. The Search routine is fast—about ½ second to search up to 511 entries for a specified call.

Fig. 1 shows a flowchart of the program. The program first initializes variables (lines 10-20), reads a look-up table of county names (subroutine at line 590), and reads the file of net members from tape (subroutine at line 80). You can bypass this tape-read routine if you plan to make all the entries from the keyboard. Immediately after reading the tape, the

program sorts the data by call letters. The Sort routine does not move the main files around physically, but sets up a list of integer pointers indicating the alphabetic order of the callsigns. The callsigns and related data remain in their original order. You can re-enter this routine later to include any new entries in the sorted array of pointers.

At this point the program prints the menu of commands (line 50): #—LIST, 'C'—CHANGE, 'SAVE', 'A'—ADD, 'S'—SORT. The # represents a numeric input. Any entry other than those on the menu initiates a search for that entry among the list of call letters.

When you enter a number, the computer lists the net member with that number, plus the next 29 members (subroutine at line 410). For example, if you enter 25, the program lists the call, county of residence, and name of the operator of the twenty-fifth through the fifty-fourth members of the net. This facilitates calling up the net. At the start

of the net session, you, as net-control station, announce, "Net members, numbers one through thirty check in now." With the first thirty members on the screen, you can greet each member by name even if your memory for names is terrible.

When a member checks in who does not remember his number, enter his call letters. The computer checks to see whether the entry is a C, S, SAVE, or A. If it is none of these, the computer presumes the entry to be call letters, calls the subroutine at line 460, and initiates a binary search through the net roster for that call. Even though it is programmed in BASIC, you can search more than 500 entries in less than ½ second. If a match is found, the call letters, county of residence, and the operator's name are displayed at the center of the screen. If a match is not found, you can add the new station to the roster.

To add a new member to the roster, enter A. The subroutine at line 530 re-

quests call letters, county name, and operator's name. The program stores the call letters and operator's name in memory, but does not store the entire county name. The program stores an integer number that identifies the appropriate county from the list of counties which you read in at program start. This allows many more entries in my 16K machine than would otherwise be possible.

To change an entry, enter C (subroutine at line 330). You can reenter a call, county name, or an operator's name to correct an error. If you do not wish to change the entry, press Enter to retain the original content.

The binary Search routine finds only those calls which have been ordered by the Sort routine. Any time you enter one or more new calls or change one or more call letters, you need the Sort routine. This routine begins at line 120.

In order to save an updated roster to tape, Enter SAVE. At this point, the program gives you an option to turn on the recorder in order to cue the tape or to continue with the Save routine (subroutine at line 270). Outputting 4 to port 255 cues the tape. This turns on the tape recorder motor in Model I machines. Then the program enters a timing loop for a few seconds before turning the recorder off. This same routine spaces into the tape a few seconds before saving the data when you continue with the Save routine. The cueing routine may not work on Model III TRS-80s. As presently constructed, the program causes the computer to first CSAVE the program, then save the data to tape.

### Sort and Search Routines

A children's guessing game goes like this:  
 "I'm thinking of a

number between one and fifty. Guess what it is."

"Is it 10?"

"No, you're too low."

"Is it 40?"

"No, now you're too high."

And so on. The first time you played this game, you probably guessed numbers randomly until you guessed the correct number. In the example above, that could mean as many as fifty guesses. After a few such games, you may have discovered that you could guess the correct number much faster if you first guessed the middle number of the range of possible numbers—25 or 26 in the example above. If that guess is too low, the correct answer must be between 26 and 50. You then guess the middle of that range—38. If that is too high, you next guess the midpoint of the range from 26 to 37, and so on. Each time you divide the size of the range of possible answers by two—hence the name *binary search*. Using the binary search, the correct number between one and fifty will always be found by the sixth guess, at the worst. That is a lot faster than 50 guesses! More than 500 entries can be searched by this method with no more than nine guesses.

In the net roster program, membership is sorted by call letters. A pointer table indicates the order; the master list is not reordered. Moving integers in memory is faster than moving strings. The master list remains in numerical order, which is convenient for display during net call-up.

The first entry in the pointer table is the subscript of the call which would be first in alphabetical order. The second entry in the pointer table is the subscript of the call which is second in alphabetical order, and so on. For example, suppose there are seven net members, with

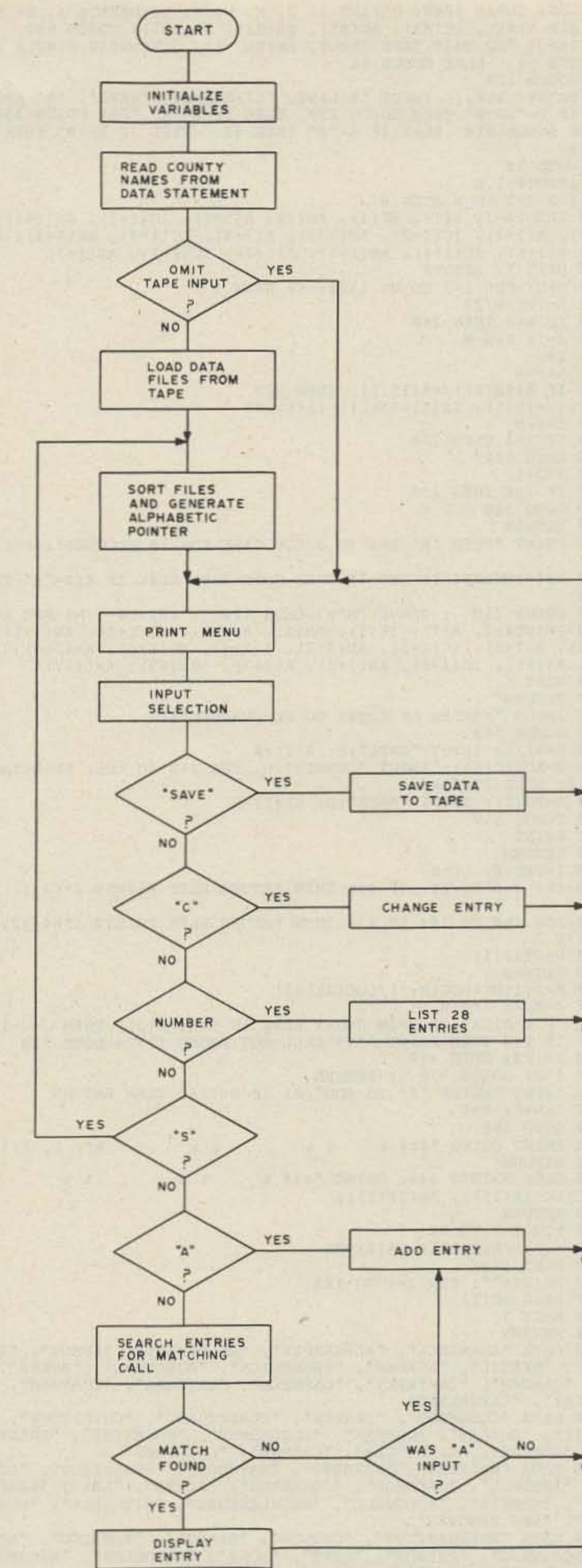

Fig. 1. Flowchart of the ham-radio-net roster.

their call letters stored in the A array as follows:

A(1) W4CBC  
 A(2) W4BAA

```

10 CLS: CLEAR 6000: DEFINT I, J, K, N, M, L: DEFSTR A, B: MX=512
20 DIM A(MX), IC(MX), AN(MX), IA(MX), AC(105): GOSUB 590
30 INPUT "TO OMIT TAPE INPUT, ENTER '1', OTHERWISE SIMPLY PUSH 'ENTER'";I: IF I=
1 THEN 50 ELSE GOSUB 80
40 GOSUB 120
50 PRINT@ 960,;: INPUT "#-LIST, 'C'-CHANGE, 'SAVE', 'A'-ADD, S-SORT";B
60 IF B="SAVE" THEN GOSUB 270 ELSE IF B="C" THEN GOSUB 330 ELSE IF VAL(B)<>0
THEN GOSUB 410 ELSE IF B="S" THEN 40 ELSE IF B="A" THEN GOSUB 530 ELSE GOSUB
460
70 GOTO 50
80 INPUT#-1,N
90 FOR I=1 TO N STEP 8
100 INPUT#-1, A(I), IC(I), AN(I), A(I+1), IC(I+1), AN(I+1), A(I+2), IC(I+2), AN(
I+2), A(I+3), IC(I+3), AN(I+3), A(I+4), IC(I+4), AN(I+4), A(I+5), IC(I+5), AN(I+
5), A(I+6), IC(I+6), AN(I+6), A(I+7), IC(I+7), AN(I+7)
110 NEXT I: RETURN
120 M=N: FOR I=1 TO N: IA(I)=I: NEXT I
130 M=INT(M/2)
140 IF M=0 THEN 260
150 J=1: K=N-M
160 I=J
170 L=I+M
180 IF A(IA(I))<=A(IA(L)) THEN 230
190 IT=IA(I): IA(I)=IA(L): IA(L)=IT
200 I=I-M
210 IF I<1 THEN 230
220 GOTO 170
230 J=J+1
240 IF J>K THEN 130
250 GOTO 160
260 RETURN
270 PRINT "PUSH 'R' KEY TO QUEUE TAPE FOR 10 SECONDS": PRINT "PUSH 'C' TO CONTIN
UE"
280 XX$=INKEY$: IF XX$="" THEN GOTO 280 ELSE IF XX$="R" THEN GOSUB 710 : GOTO
280
290 GOSUB 710 : CSAVE "W": GOSUB 710 : PRINT#-1,N: FOR I=1 TO N STEP 8
300 PRINT#-1, A(I), IC(I), AN(I), A(I+1), IC(I+1), AN(I+1), A(I+2), IC(I+2), AN(
I+2), A(I+3), IC(I+3), AN(I+3), A(I+4), IC(I+4), AN(I+4), A(I+5), IC(I+5), AN(I+
5), A(I+6), IC(I+6), AN(I+6), A(I+7), IC(I+7), AN(I+7)
310 NEXT I
320 RETURN
330 INPUT "NUMBER OF ENTRY TO BE CHANGED";I
340 GOSUB 550
350 B=A(I): INPUT "CALL";B: A(I)=B
360 B=AC(IC(I)): INPUT "COUNTY";B: FOR J=0 TO 105: IF B<>AC(J) THEN NEXT J: GOTO
360 ELSE IC(I)=J
370 B=AN(I): INPUT "NAME";B: AN(I)=B
380 GOSUB 550
390 PRINT
400 RETURN
410 I=VAL(B): CLS
420 FOR J=0 TO 14: IF I>N THEN RETURN ELSE PRINT@ J*64,;: GOSUB 550 : I=I+1: NE
XT J
430 FOR J=0 TO 14: IF I>N THEN RETURN ELSE PRINT@ J*64+32,;: GOSUB 550 : I=I+1:
NEXT J
440 B=STR$(I)
450 RETURN
460 M=2[(INT(LOG(N-1)/LOG(2))+1)
470 J=M/2: I=J/2
480 IF B>A(IA(J)) THEN J=J+I ELSE IF B<A(IA(J)) THEN J=J-I ELSE 510
490 IF I=0 THEN PRINT "**** CALL NOT FOUND ****": GOTO 520
500 I=I/2: GOTO 480
510 I=J: GOSUB 570 : RETURN
520 INPUT "ENTER 'A' TO ADD";B: IF B<>"A" THEN RETURN
530 I=N+1: N=I
540 GOTO 350
550 PRINT USING "### % % % % %"; I, A(I), AC(IC(I)), AN(I);
560 RETURN
570 CLS: PRINT@ 448, USING "### % % % % %"; IA(I), A(IA(I)),
AC(IC(IA(I))), AN(IA(I));
580 RETURN
590 FOR I=1 TO MX
600 A(I)=CHR$(191):IA(I)=MX
610 NEXT I
620 AC(0)="": FOR I=1 TO 105
630 READ AC(I)
640 NEXT I
650 RETURN
660 DATA "ALAMANCE", "ALEXANDER", "ALLEGHANY", "ANSON", "ASHE", "AVERY", "BEAUFO
RT", "BERTIE", "BLADEN", "BRUNSWICK", "BUNCOMBE", "BURKE", "CABARRUS", "CALDWELL
", "CAMDEN", "CARTERET", "CASWELL", "CATAWBA", "CHATHAM", "CHEROKEE", "CHOWAN",
"CLAY", "CLEVELAND"
670 DATA "COLUMBUS", "CRAVEN", "CUMBERLAND", "CURRITUCK", "DARE", "DAVIDSON", "D
AVIE", "DUPLIN", "DURHAM", "EDGECOMBE", "FORSYTHE", "FRANKLIN", "GASTON", "GATES
", "GRAHAM", "GRANVILLE", "GREENE", "GUILFORD"
680 DATA "HALIFAX", "HARNETT", "HAYWOOD", "HENDERSON", "HERTFORD", "HOKE", "HYDE
", "IREDELL", "JACKSON", "JOHNSTON", "JONES", "LEE", "LENOIR", "LINCOLN", "MADIS
ON", "MARTIN", "MCDOWELL", "MECKLENBURG", "MITCHELL", "MONTGOMERY", "MOORE", "NA
SH", "NEW HANOVER"
690 DATA "NORTHAMPTON", "ONSLow", "ORANGE", "PAMLICO", "PASQUOTANK", "PENDER", "
PERQUIMANS", "PERSON", "PITT", "POLK", "RANDOLPH", "RICHMOND", "ROBESON", "ROCKI
NGHAM", "ROWAN", "RUTHERFORD", "SAMPSON",
700 DATA "SCOTLAND", "STANLY", "STOKES", "SURRY", "SWAIN", "TRANSYLVANIA", "TYRR
ELL", "UNION", "VANCE", "WAKE", "WARREN", "WASHINGTON", "WATAUGA", "WAYNE", "WIL
KES", "WILSON", "YADKIN", "YANCEY", "GA", "KY", "TN", "SC", "VA"
710 OUT 255,4: FOR I=1 TO 8000: NEXT I: OUT 255,0: RETURN

```

A(3) W4AFF  
A(4) W4GGO  
A(5) W4HLK  
A(6) W4JXW  
A(7) W4JAV

The pointer table is stored in array IA and indicates the alphabetical order of the calls:

IA(1) 3  
IA(2) 2  
IA(3) 1  
IA(4) 4  
IA(5) 5  
IA(6) 7  
IA(7) 6

The first call in alphabetical order is A(IA(1)). Since IA(1) is 3, the call is in A(3), and this is W4AFF. Similarly, the second call, alphabetically, is A(IA(2)), which is A(2), or W4BAA. A search for W4HLK would proceed this way. The first guess is the fourth call in the alphabetical order, or A(IA(4)), which is A(4), or W4GGO. This is too low. The next guess is the sixth in alphabetical order, A(IA(6)), or A(7) which is W4JAV. This is too high. The next guess is the fifth call in alphabetical order. That is A(IA(5)), or A(5) which is W4HLK—the correct call. The call was found on the third try. A list of up to 511 entries can be searched by checking nine entries at most by this method.

Another "trick" to speed up the search process even more compares only one letter of the call at first, then looks at the rest of the call only when necessary. Unfortunately, if we start the comparison (and the original sorting of the data) with the first letter of the call, we will be comparing Ws with Ws so often that no time will be saved. Another solution is to sort the calls initially by the most variable letter position in the call, and search first on that letter position. Then we can take advantage of the time saved by looking first at only one character.

The first character of any call can be only A, K, N, or

Program listing.



# NEW from BARKER & WILLIAMSON!

## 1.8 - 30 MHz. Continuous Coverage Antenna for Commercial and Amateur Service

### Model AC 1.8 - 30

The AC 1.8 - 30 Antenna uses only 80 feet horizontally, and, when space is limited, can be shortened even further with only slight loss of radiation efficiency.

Patent Pending

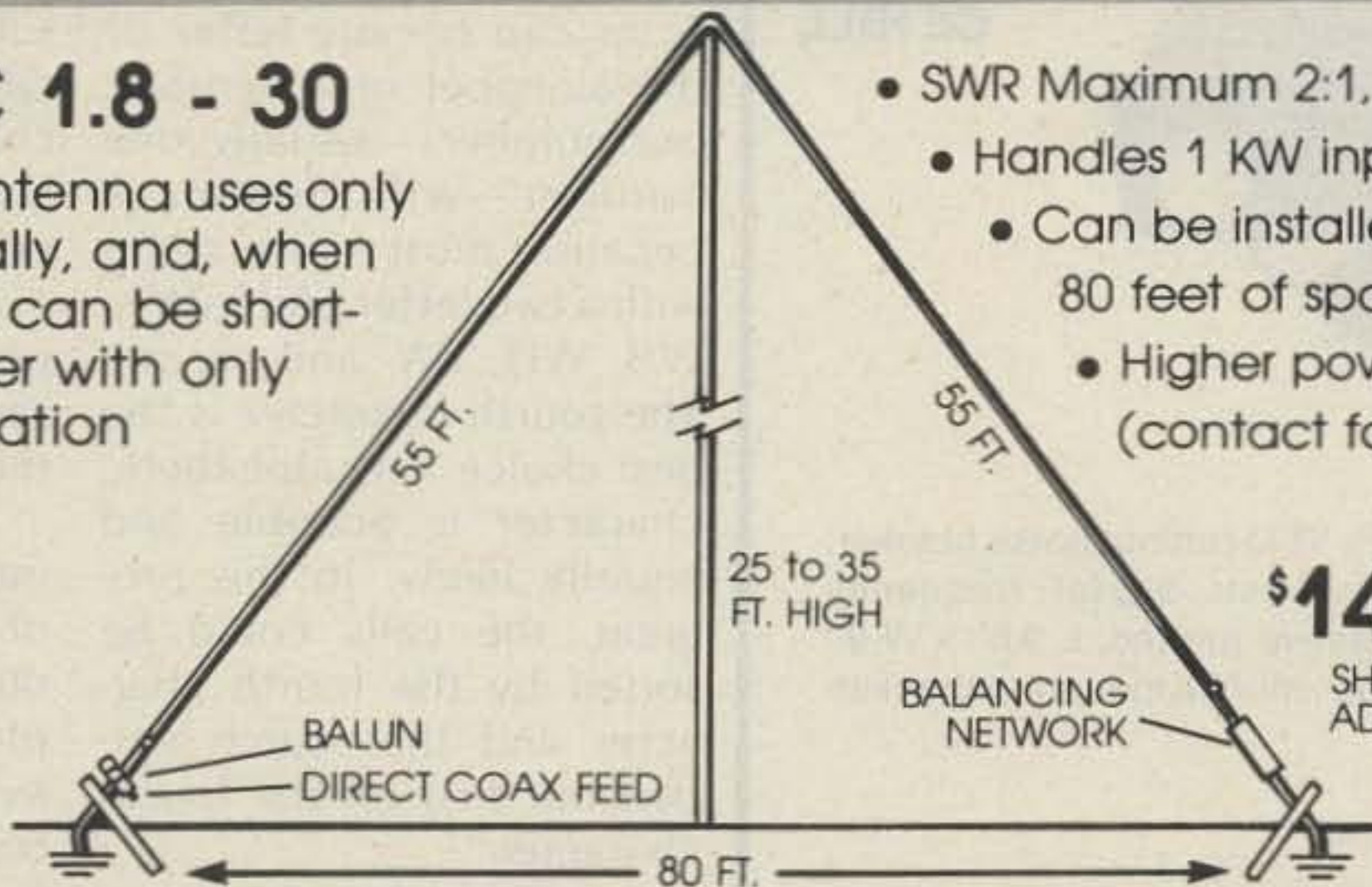

- SWR Maximum 2:1, 1.4:1 Average
- Handles 1 KW input ICAS
- Can be installed in approximately 80 feet of space
- Higher power models available (contact factory)

**\$149.50**

SHIPPING AND HANDLING ADD \$4.00



### BARKER & WILLIAMSON

Quality Communication Products Since 1932

At your Distributors write or call, 10 Canal Street, Bristol PA 19007

(215) 788-5581

ALL OUR PRODUCTS MADE IN USA



11

## Radio World

CENTRAL NEW YORK'S MOST COMPLETE HAM DEALER



Featuring Kenwood, Yaesu, Icom, Drake, Ten-Tec, Swan, Dentron, Alpha, Robot, MFJ, Tempo, Astron, KLM, Hy Grain, Mosley, Larsen, Cushcraft, Hustler, Mini Products, Bird, Mirage, Vibroplex, Bencher, Info-Tech, Universal Towers, Callbook, ARRL, Astatic, Shure, Collins, AEA. We service everything we sell!

Write or call for quote. You Won't Be Disappointed.

We are just a few minutes off the NYS Thruway (I-90) Exit 32

OUT OF STATE  
ORDER TOLL FREE  
800-448-9338

ONEIDA COUNTY AIRPORT TERMINAL BUILDING  
ORISKANY, NEW YORK 13424  
N Y Res Call (315) 736-0184

Warren - K2IXN  
Bob - WA2MSH  
Al - WA2MSI

## REACH OUT. REACH W-A-A-A-Y OUT with the DX HIDDEN ASSET LOOP ANTENNA

This high performance, low-cost, do-it-yourself loop antenna is designed for indoor installation. Ideal for an attic, closet or any location where space is a factor. It's simple and quick to build and you'll be pleased with the remarkable results. For complete instructions and diagrams, send check or money order for \$12.50 to:

H. STEWART DESIGNS  
P.O. BOX 643 OREGON CITY, OR 97045

PLANS FOR 2 THROUGH 15 METERS. . . .

THE WORLD FAMOUS

**ETCO**

CATALOG OF ELECTRONICS

**FREE**

- VIDEO
- TELEPHONE
- CABLE TV
- PARTS
- AUDIO
- ELECTRONICS
- and much, much more!

1000's OF FASCINATING FACTORY CLEAROUTS. SURPLUS SPECIALS AND BARGAIN OFFERS NOT FOUND IN STORES OR CATALOGS ANYWHERE!

ETCO ELECTRONICS  
DEPT. 590  
Mailing List Control Center  
Box 840  
Champlain, N.Y. 12919

NOW  
**112**  
PAGES

I Enclose \_\_\_\_\_ (cash OK);  
Please rush postpaid

- \$1 for 1 year subscription to the world famous ETCO catalog.
- \$3 Canadian & Foreign 1 year subscription to the ETCO catalog.
- 304 page handbook "BUILD YOUR OWN EARTH STATION". (TA025) \$10.00
- 360 pages MASTER HANDBOOK OF TELEPHONES. (TA001) \$11.00
- FREE - sample copy of the bargain packed ETCO catalog. (USA only)

Name \_\_\_\_\_  
Address \_\_\_\_\_  
City \_\_\_\_\_  
State \_\_\_\_\_ Zip \_\_\_\_\_

## 15 Meter Mobile CW & USB

**START YOUR DAY ON A GOOD KEY!!!  
WORK OTHER HAMS LIKE: XE2BGM, ZL1PQ,  
KL7JFV, EA7EU, NN3SI, DJ8RR, DL0BBC,  
US6AK, JA3JMP, PY2-CPQ, FO8GW, KM6FF,  
VK2BD  
OA4ARB  
VE7DYX  
W1AW**



**OE8MOK  
G3BRW  
CE1BLL**

High 10W (PEP) low 2W (PEP); VFO tuning; noise blanker; fine-tuned SB, KHz  $\pm$  CW off-set; digital frequency counter; 13.8V dc @ 3A, negative ground; L 9.5" x W 9" x H 2.5"; weight (2.3 kg) 5.7 lbs.; mobile mounting bracket.



JUST SLIGHTLY AHEAD

DLR. INFO. & ORDER, CALL  
1275 N. GROVE ST.  
ANAHEIM, CALIF, 92806 (714) 630-4541

NOTE: Price, specifications subject to change without notice and obligation.

318

Advertisement

Advertisement

## Why the Spider™ Antenna?

— the ultimate in mobile antennas

C. F. (Fred) Shmitka, K6AQI  
8554 Lurline Avenue  
Canoga Park, CA 91306

This antenna is truly amazing. I have operated H.F. mobile off and on for the past thirty years or so, and I

thought I enjoyed it. But with the combination of a solid state, no-tune rig and the Spider™ Antenna, hey, it's great! No stopping to change resonators or re-tune. Just switch the rig from band to band and enjoy your QSO's! I used a matching network at the base of the antenna in the old days, but not with the Spider™. The base impedance on all four bands, 10 through 40 meters, is approximately 50 ohms. Another plus for the Spider™ is that it can be used in many varied and unusual installations, plus mobile on most any vehicle. Mount it on the roof of a house or mobile home; use it for back-packing or civil defense work—any portable use. It can be mounted at ground level, using radials laid out on top of the ground.

There is also a Spider™ Maritimer™ Antenna made especially to withstand the corrosive action of salt water breezes and spray. Mast is non-magnetic stainless steel, the fittings are nickel-chrome plated bronze.

For complete information on the Spider™ Antennas and installation accessories write or call Multi-Band Antennas, 7131 Owensmouth Ave., Suite 463C, Canoga Park, CA 91303. Telephone (213) 341-5460.

W—four possibilities. The second character can be A, B, D, N, or a number. Although that number can be any value from 0 through 9, only one or two are likely to predominate in any given area. That is little improvement over the first character. The third character can be any letter of the alphabet or a number, but numbers—usually one number—will dominate because most calls begin with a two letter prefix (WA, WB, WD, KA, and so on). The fourth character is the best choice. Any alphabetic character is possible and equally likely. In this program, the calls could be sorted by the fourth character and the search carried out first on the fourth character.

### Improvements

The most time-consuming part of the program is the Sort routine. It takes

about two minutes. Even though it is normally used only during program initialization, a faster routine would be desirable. One possible approach is to use a machine-language subroutine. A much easier approach is to eliminate the sort altogether, and substitute a subroutine that automatically makes the necessary changes in the pointer table whenever you add a new entry or correct an existing entry. Then the pointer table would be saved to tape along with the rest of the data.

Another useful improvement might be the addition of a map with the counties outlined on it to be displayed on the screen whenever you want. Some intriguing possibilities exist for compact storage of such a map in a string variable using the space compression codes—ASCII codes 192-255. ■

# Orbit



**ORBIT** is the Official Journal for the Radio Amateur Satellite Corporation.

For a **SAMPLE COPY** please send \$2 to:

(AMSAT), P.O. Box 27, Washington, DC 20047.

# CES INTRODUCES THE NEW 510SA "SMART PATCH"

## The State of the Art Simplex Interconnect

Communications Electronics Specialties introduces the CES 510SA "Smart" Simplex Autopatch, with many important new features never available before:

- Three digit control codes with user programming.
- A sophisticated toll restrict provides positive long distance lock out.
- Time-out and COR activity timers with warning beeps and digital programming.
- Rotary or DTMF dialing.
- Phone line in-use detector prevents interrupting a call in progress, and sends unique CW sequence.
- Phone ring detection logic enables unique CW sequence.
- Digital programming of the sample rate and width, and noise gate sensitivity control, for easy interfacing with most radios.

Simple and direct connections to radio.

**Options available:**

- Smart CW identifier with unique CW messages for each patch function.
- FCC type accepted phone line coupler.
- Special tone squelch kit to operate patch through repeaters.



The 510SA—the newest advance in interconnect technology, from the innovators at: **Communications Electronics Specialties, Inc.**  
 Post Office Box 507 • Winter Park, Florida 32790  
 (305) 645-0474 • Toll-free (for orders only): (800) 327-9956

462

## UP IN THE AIR ABOUT A CHRISTMAS GIFT FOR YOUR HAM?

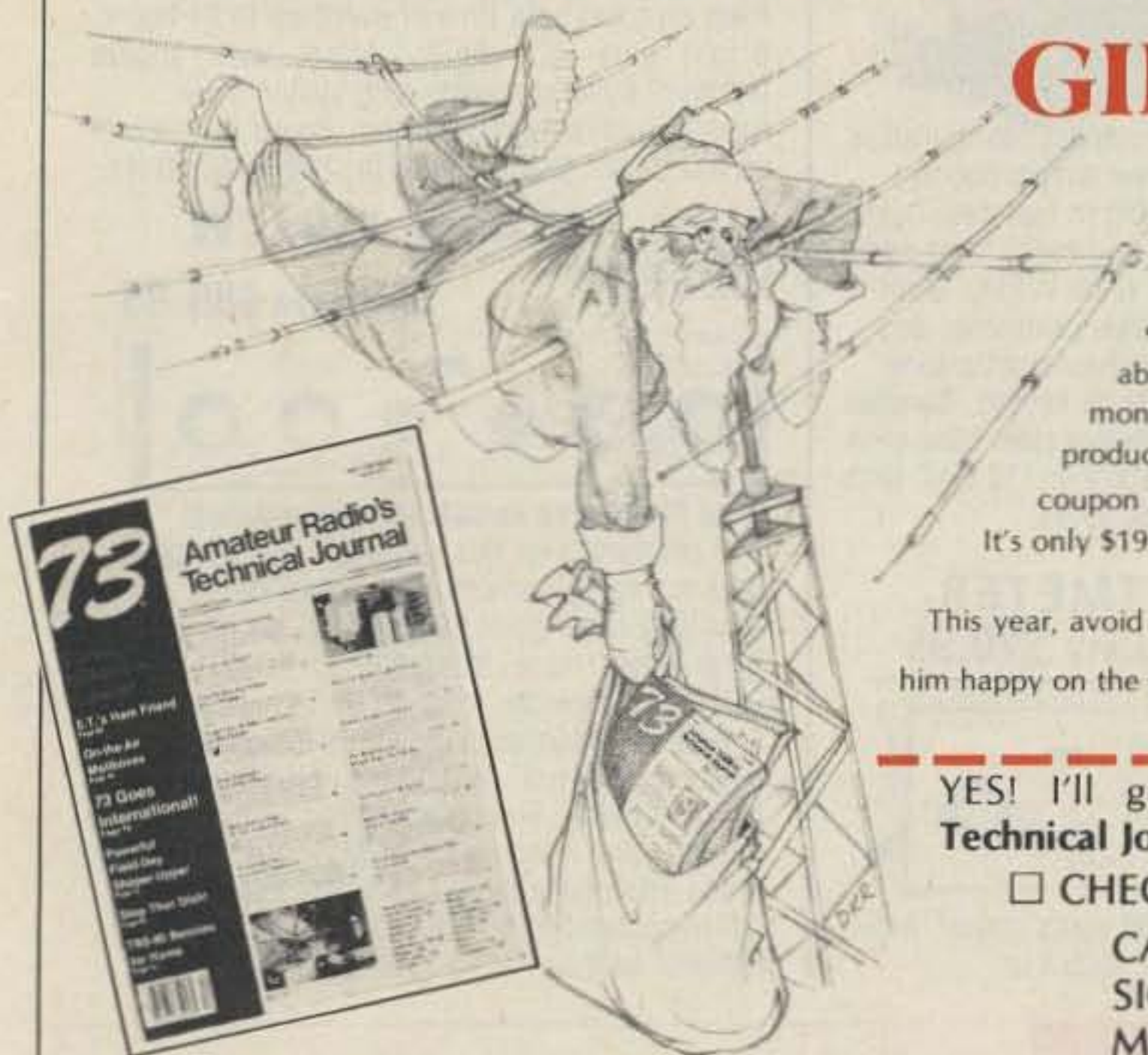

Come down to Earth... give a gift subscription to **73: Amateur Radio's Technical Journal**. Every issue is filled with practical information. Now your favorite ham can:

- have hours of fun in the shack with over 200 construction projects per year.
- keep abreast of the latest developments in amateur radio around the world with the monthly column, "73 International".
- save money through our candid reviews and new-product announcements. Christmas shopping has never been easier. Just fill out the coupon and return it to: 73 Subscription Department, P.O. Box 931, Farmingdale NY 11737. It's only \$19.97 for a full-year subscription. That's a savings of 33% off the newsstand price.

This year, avoid the holiday crowds and pushy salesmen. Give your ham the gift that will keep him happy on the air... **73 Amateur Radio's Technical Journal**.

YES! I'll give a useful gift! Send 12 issues of **73: Amateur Radio's Technical Journal** for only \$19.97 to the person named below:

CHECK/M.O.     MC     VISA     AMEX     BILL ME

CARD# \_\_\_\_\_ EXP. DATE \_\_\_\_\_

SIGNATURE \_\_\_\_\_

MY NAME \_\_\_\_\_

ADDRESS \_\_\_\_\_

CITY \_\_\_\_\_ STATE \_\_\_\_\_ ZIP \_\_\_\_\_

Send gift subscription to:

NAME \_\_\_\_\_

ADDRESS \_\_\_\_\_

CITY \_\_\_\_\_ STATE \_\_\_\_\_ ZIP \_\_\_\_\_

Canada & Mexico \$22.97/1 year only, US funds drawn on US bank.  
 Foreign surface \$25.00/1 year only, US funds drawn on US bank.  
 Foreign air mail please inquire. All gift subscriptions begin with the January 1984 issue.

**73** Amateur Radio's Technical Journal  
 P.O. Box 931  
 Farmingdale, NY 11737

63NR6

# MFJ ACCESSORIES

**300 WATT ANTENNA TUNER HAS SWR/WATTMETER, ANTENNA SWITCH, BALUN. MATCHES EVERYTHING FROM 1.8 to 30 MHz.**



**\$99.95** MFJ-941D

**NEW FEATURES**

- MFJ's fastest selling tuner packs in plenty of new features!
- **New Styling!** Brushed aluminum front. All metal cabinet.
  - **New SWR/Wattmeter!** More accurate. Switch selectable 300/30 watt ranges. Read forward/reflected power.
  - **New Antenna Switch!** Front panel mounted. Select 2 coax lines, direct or through tuner, random wire/balanced line or tuner bypass for dummy load.
  - **New airwound inductor!** Larger more efficient 12 position airwound inductor gives lower losses and more watts out. Run up to 300 watts RF power output. Matches everything from 1.8 to 30 MHz: dipoles, inverted vee, random wires, verticals, mobile whips, beams, balanced and coax lines. Built-in 4:1 balun for balanced lines. 1000V capacitor spacing. Black. 11x3x7 inches. Works with all solid state or tube rigs. Easy to use, anywhere.

**RTTY/ASCII/CW COMPUTER INTERFACE MFJ-1224 \$99.95**



Send and receive computerized RTTY/ASCII/CW with nearly any personal computer (VIC-20, Apple, TRS-80C, Atari, TI-99, Commodore 64, etc.). Use Kantronics or most other RTTY/CW software. Copies both mark and space, any shift (including 170, 425, 850 Hz) and any speed (5-100 WPM RTTY/CW, 300 baud ASCII). Sharp 8 pole active filter for CW and 170 Hz shift. Sends 170, 850 Hz shift. Normal/Reverse switch eliminates retuning. Automatic noise limiter. Kantronics compatible socket plus exclusive general purpose socket. 8x1 1/4x6 in. 12-15 VDC or 110 VAC with adapter, MFJ-1312, \$9.95.

**RX NOISE BRIDGE MFJ-202B \$59.95**



Maximize your antenna performance!

Tells whether to shorten or lengthen antenna for minimum SWR. Measure resonant frequency, radiation resistance and reactance.

**New Features:** individually calibrated resistance scale, expanded capacitance range ( $\pm 150$  pf). Built-in range extender for measurements beyond scale readings. 1-100 MHz. Comprehensive manual. Use 9 V battery. 2x4x4 in.

**INDOOR TUNED ACTIVE ANTENNA MFJ-1020 \$79.95**

"World Grabber" rivals or exceeds reception of outside long wires! Unique tuned Active Antenna minimizes intermod, improves selectivity, reduces noise outside tuned band, even functions as preselector with external antennas. Covers 0.3-30 MHz. Telescoping antenna.

Tune, Band, Gain, On-off bypass controls. 6x2x6 in. Uses 9V battery, 9-18 VDC or 110 VAC with adapter, MFJ-1312, \$9.95.

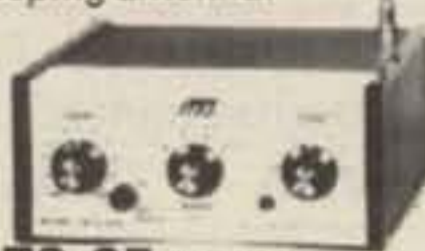

**POLICE/FIRE/WEATHER 2 M HANDHELD CONVERTER MFJ-313 \$39.95**

Turn your synthesized scanning 2 meter handheld into a hot Police/Fire/Weather band scanner! 144-148 MHz handhelds receive Police/Fire on 154-158 MHz with direct frequency readout. Hear NOAA maritime coastal plus more on 160-164 MHz. Converter mounts between handheld and rubber ducky. Feedthru allows simultaneous scanning of both 2 meters and Police/Fire bands. No missed calls. Crystal controlled. Bypass/Off switch allows transmitting (up to 5 watts). Use AAA battery. 2 1/4x1 1/2x1 1/2 in. BNC connectors.



**MFJ/BENCHER KEYS COMBO MFJ-422 \$99.95**

The best of all CW worlds—a deluxe MFJ Keyer in a compact configuration that fits right on the Bencher iambic paddle! MFJ Keyer - small in size, big in features. Curtis 8044 IC, adjustable weight and tone, front panel volume and speed controls (8-50 WPM). Built-in dot-dash memories, Speaker, sidetone, and push button selection of semi-automatic/tune or automatic modes. Solid state keying. Bencher paddle is fully adjustable; heavy steel base with non-skid feet. Uses 9 V battery or 110 VAC with optional adapter, MFJ-1305, \$9.95.



**VHF SWR/WATTMETER MFJ-812 \$29.95**

Low cost VHF SWR/Wattmeter! Read SWR (14 to 170 MHz) and forward/reflected power at 2 meters. Has 30 and 300 watts scales. Also read relative field strength. 4x2x3 in.



**1 KW DUMMY LOAD MFJ-250 \$34.95**

Tune up fast, extend life of finals, reduce QRM! Rated 1KW CW or 2KW PEP for 10 minutes. Half rating for 20 minutes, continuous at 200 W CW, 400 W PEP. VSWR under 1.2 to 30 MHz, 1.5 to 300 MHz. Oil contains no PCB. 50 ohm non-inductive resistor. Safety vent. Carrying handle. 7 1/2x6 3/4 in.



**24/12 HOUR CLOCK/ID TIMER MFJ-103 \$34.95**

Switch to 24 hour GMT or 12 hour format! Battery backup maintains time during power outage. ID timer alerts every 9 minutes after reset. Switchable seconds readout. Elapsed timer. Just start clock from zero and note time of event up to 24 hours. Bright blue .6" digits. Alarm with snooze function. Synchronizable with WWV. Lock function prevents mis-setting. Power out, alarm on indicators. Black. 5x2x3 in. 110 VAC, 60 Hz.



**DUAL TUNABLE SSB/CW FILTER MFJ-752B \$89.95**



Dual filters give unmatched performance! The primary filter lets you peak, notch, low pass or high pass with extra steep skirts. Auxiliary filter gives 70 db notch, 40 Hz peak. Both filters tune from 300 to 3000 Hz with variable bandwidth from 40 Hz to nearly flat. Constant output as bandwidth is varied; linear frequency control. Switchable noise limiter for impulse noise. Simulated stereo sound for CW lets ears and mind reject QRM. Inputs for 2 rigs. Plugs into phone jack. Two watts for speaker. Off bypasses filter. 9-18 VDC or 110 VAC with optional adapter, MFJ-1312, \$9.95.

ORDER ANY PRODUCT FROM MFJ AND TRY IT-NO OBLIGATION. IF NOT DELIGHTED, RETURN WITHIN 30 DAYS FOR PROMPT REFUND (LESS SHIPPING).

- One year unconditional guarantee • Made in USA.
- Add \$4.00 each shipping/handling • Call or write for free catalog, over 100 products.

**MFJ**

MFJ ENTERPRISES, INC. <sup>19</sup>  
Box 494, Mississippi State, MS 39762

TO ORDER OR FOR YOUR NEAREST DEALER, CALL TOLL-FREE  
**800-647-1800**. Call 601-323-5869 in Miss. and outside continental USA  
Telex 53-4590 MFJ STKV



# NEW PRODUCTS

## TINY 2 M POWER AMP MOUNTS ON HANDHELD

7 to 20 watts out for 0.1 to 3 watts in. Carrier operated T-R switch. MFJ-2040, 144-148 MHz, \$79.95. MFJ-2045, 430-440 MHz, \$99.95. MFJ-2041, Portable Power Pack, \$89.95.



This tiny MFJ-2040 2 meter power amplifier mounts on your handheld between your antenna and HT. You can also mount it separately with a cable.

It provides 7 to 20 watts output for .1 to 3 watts input. T-R switching is carrier operated. Covers 144-148 MHz. Die cast aluminum body is 1 1/2 x 3 3/4 inches. Weighs about 6 oz. BNC connectors.

Requires 12 to 13.8 VDC at 50 ma. for receive and 1 to 2 amps for transmit.

MFJ-2045, \$99.95. Like MFJ-2041 but for 430 to 440 MHz. 4 to 15 watts output for .1 to 3 watts input.

MFJ-2041, \$89.95. Portable Power Pack Batteries provides 120 minutes operation of MFJ-2040 or MFJ-2045 at 10 watts output. Has battery check meter. Has carrying case with belt loop and shoulder strap. 1 1/2 x 2 1/4 x 7 1/2 inches. Weighs 2 pounds.



### 2 Meter Handheld Wattmeter



MFJ-840  
\$ 19.95

MFJ-840 lets you accurately check the output of your 2 meter handheld transceiver. 5 watts full scale. 50 ohm load. BNC connector. 2x2 1/4 x 1 1/2 inches. Black.

### 2 Meter Handheld SWR/Wattmeter



MFJ-841  
\$ 39.95

MFJ-841. Connects in line with your 2 meter HT. Read SWR from 1:1 to 6:1 and forward power to 5 watts. Expanded scale. 50 ohm impedance. BNC connectors. 2x2 1/4 x 1 1/2 inches. Black.

### Cross Needle SWR/Wattmeter

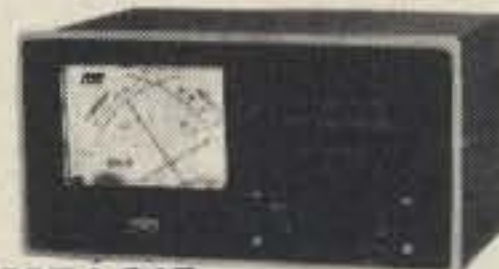

\$ 59.95

New MFJ-815 Cross Needle SWR/Wattmeter lets you monitor SWR, forward and reflected power at a single glance in 3 ranges (20/200/2000 watts forward and 2/20/200 watts reflected) and SWR from 1:1 to 6:1 on a 2 color scale. Works from 1.8 to 60 MHz. Accuracy is ±10% full scale. Mechanical zero adjustment, push button range selection. All aluminum, black w/ brushed front panel. 6 1/2 x 3 1/4 x 4 1/4. SO-239 connectors.

### Antenna/Transmitter Switch

MFJ-1700  
\$ 69.95



If you have several coax feedlines and more than one rig, this MFJ-1700 gives instant selection of 1 of 6 antennas and 1 of 6 transceivers in any combination. Also plug in an antenna tuner, SWR/wattmeter, linear, etc., so that they are always in the circuit for any antenna/transceiver combination. Handles up to the full legal limit of 2 KW PEP for 50-75 ohm loads. SO-239 connectors. All aluminum, black with brushed aluminum front. 8x2x6.

### MFJ-1620 All Band Doublet

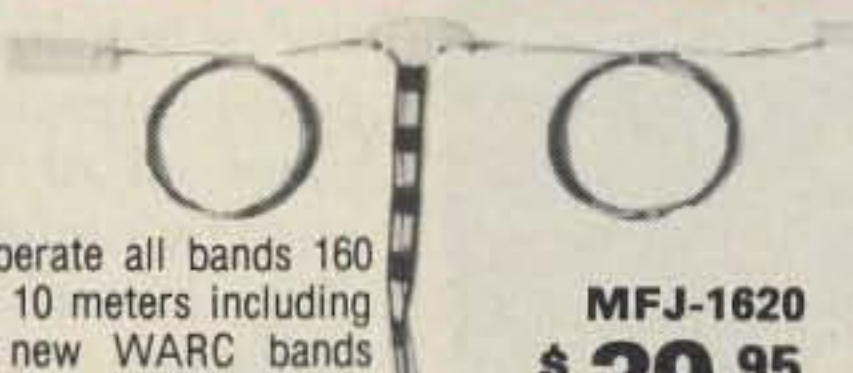

MFJ-1620  
\$ 39.95

Operate all bands 160 thru 10 meters including the new WARC bands with this new MFJ-1620 All Band Doublet. Use as doublet, sloper, inverted-V or as V-beam. Completely assembled. 130 ft. (hard drawn stranded copper antenna wire) but can be trimmed to fit your lot. Center fed with 100 feet of low loss 450 ohm balanced transmission line. You need only add rope to the ends and pull into position. Antenna tuner with balanced output required.

### New Antenna Isolators



MFJ-780  
\$ 59.95

MFJ-782  
\$ 49.95

New MFJ-782 HF/2 Meter Antenna Isolator lets you use a single coax line to feed a 2 meter antenna and any antenna below 30 MHz. The new MFJ-780 Antenna Isolator feeds separate 10, 15, 20 meter antennas (tri bander, etc.) Both isolators handle 2 KW PEP at 50/75 ohms. Negligible insertion loss. Completely automatic with no relays, switches or other moving parts. Easy outdoor mounting (includes hardware). SO-239 connectors.

ORDER ANY PRODUCT FROM MFJ AND TRY IT-NO OBLIGATION. IF NOT DELIGHTED, RETURN WITHIN 30 DAYS FOR PROMPT REFUND (LESS SHIPPING).  
• One year unconditional guarantee • Made in USA.  
• Add \$4.00 each shipping/handling • Call or write for free catalog, over 100 products.

# MFJ

MFJ ENTERPRISES, INC.  
Box 494, Mississippi State, MS 39762

TO ORDER OR FOR YOUR NEAREST DEALER, CALL TOLL-FREE  
800-647-1800. Call 601-323-5869 in Miss. and outside continental USA  
Telex 53-4590 MFJ STKV



# The World's Cheapest Modification

*All you need to put the FT-101 on 30 meters is three pieces of wire. What could be cheaper than that?*

Fred Johnson WB9DDF  
307 Walnut Street  
Knoxville IL 61448

The new WARC bands present a problem to the owner of an older transceiver. How do you modify the receiver and transmitter circuits to operate on these new amateur bands? New crystals and tuned circuits will be needed to put most rigs on the new bands, but I have found that my trusty

old FT-101 needs only three pieces of wire added to be fully operational on the 30-meter (10-MHz) band. This modification should work on the later versions such as the FT-101B, FT-101E, FT-101EE, etc. I have not yet tried it on any of these rigs, but their schematic diagrams are similar and the same modification should work.

The Yaesu FT-101 already has 10-MHz receiving capability built in to allow the operator to check the internal crystal calibrator against

WWV. After studying the schematic for some time, I decided that the only things stopping transmission on this band were the lack of tuned circuits in the driver and final plate circuits. Unlike the 11-meter band upon which the rig was designed to operate, the FT-101 was never built to transmit on the 30-meter band. There is no brightly colored jumper wire disabling the transmitter on 30 meters. In fact, there are no connections at all to several of the bandswitch wafers in the 30-meter position.

The tuned circuit in the driver plate circuit is gang-tuned with circuits in the driver grid circuit and in the gate circuit of the receiver's first rf transistor (T103, T102, and T101 respectively on the schematic). The front-panel preselector control tunes all of these coils at once by running their ferrite slugs in and out together. Whatever I did to modify the FT-101, I had to maintain the proper tracking of all of these tuned circuits in both the transmitter and receiver sections of the FT-101.

## The Driver

In the 10-MHz receive mode, the gate and drain circuits of the first rf transistor are connected to the 20-meter trimmer capaci-

tors. The tuning range of the preselector is such that 10-MHz WWV can be received by running the ferrite slugs further into their coils and resonating the 14-MHz coils at 10 MHz. The FT-101's design made life easy for me in theory. All I had to do was connect the 20-meter and 30-meter band positions together in the transmitter and tune the preselector control for maximum drive.

The tuned circuit (T102) at the drain of the receiver rf stage is diode-switched to the grid of the driver tube during transmit, so no additional modification is needed here. The driver plate circuit (T103) has no connection on 10 MHz, so I had to add a jumper on wafer S1g of the bandswitch from the 20- to the 30-meter positions. The correct lugs to solder to can easily be located by rotating the bandswitch and watching where the wiper points. This operation is simple but requires a soldering iron with a very long thin tip, a pair of long-nose pliers, and the necessary skill to use these tools in tight quarters without burning or melting any important parts. A bright light with a magnifying lens will help tremendously with the modification to the bandswitch throughout this operation. (Bandswitch modifications



The outside appearance of the FT-101 remains essentially unchanged. Only the bottom cover plate and internal shield need be removed during the 30-meter modification. The position of all front-panel controls should be as shown after tuning up on 30 meters.

are definitely not for cowardly or nervous types.)

### The Finals

With the driver stage taken care of, only the pi network (and the FCC) was standing in the way of my 10-MHz signal. I imagined that tying the 30-meter position to the 20-meter band-switch position on wafer S1m would work here just as it did in the driver section, but for maximum power transfer and harmonic suppression, the coil in the pi network should have an inductance between that for the 40- and 20-meter bands. There were five turns between the 40-meter and 20-meter taps. I guessed and soldered the 30-meter tap on at a point three turns from the existing 40-meter tap. Be very careful to avoid shorting adjacent turns of the coil, as this results in very strange operation on most bands later. (This is the voice of experience speaking!) Pushing down one turn on each side of the new tap's location helps avoid shorting turns. (Yes, those tricks in the handbook really do work.) Since there is considerable rf current at this point, I used a piece of number 14 solid copper wire to connect the new tap to the 30-meter position on the bandswitch.

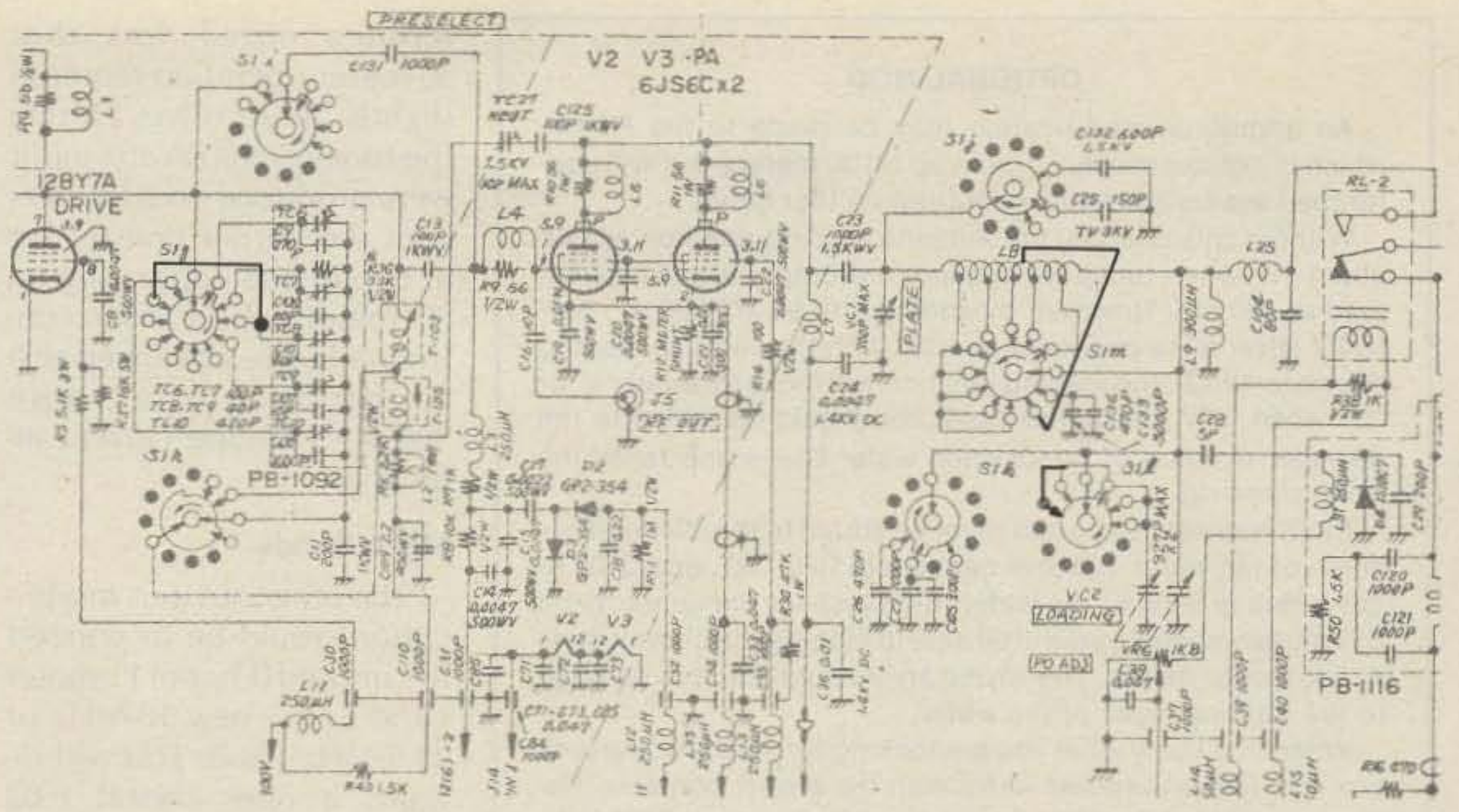

Fig. 1. Schematic diagram from the owner's manual showing the location of the three wires added to allow the FT-101 to transmit on 10 MHz.

The only other modification needed is to switch in the extra section of the variable loading capacitor. On my particular vintage FT-101, there was not a contact on wafer S11 of the bandswitch at the position that I needed to switch the extra loading capacitor section into the pi network. To get around this problem, I bent a short piece of wire to the shape of a contact. Since the 160-meter band used the extra capacitor section that I needed, I soldered the home-brew wire contact to the 160-meter position adjacent to the new 30-meter position. By care-

fully shaping and bending this piece of wire, it was made to function as a switch contact on the 30-meter band position. A little TV tuner grease will lengthen the life of this contact considerably.

### Results

Testing was performed using a Bird 43 wattmeter and a Heathkit Antenna

dummy load. No change was noted in the performance of the modified FT-101 on any of the existing six bands. I made a comparison of the transmitter operation on the 20- and 30-meter bands. The modified FT-101 produced 125 Watts output for 180 Watts input power (300 mA @ 600 volts) on both bands for an efficiency of 70 percent. The only dif-

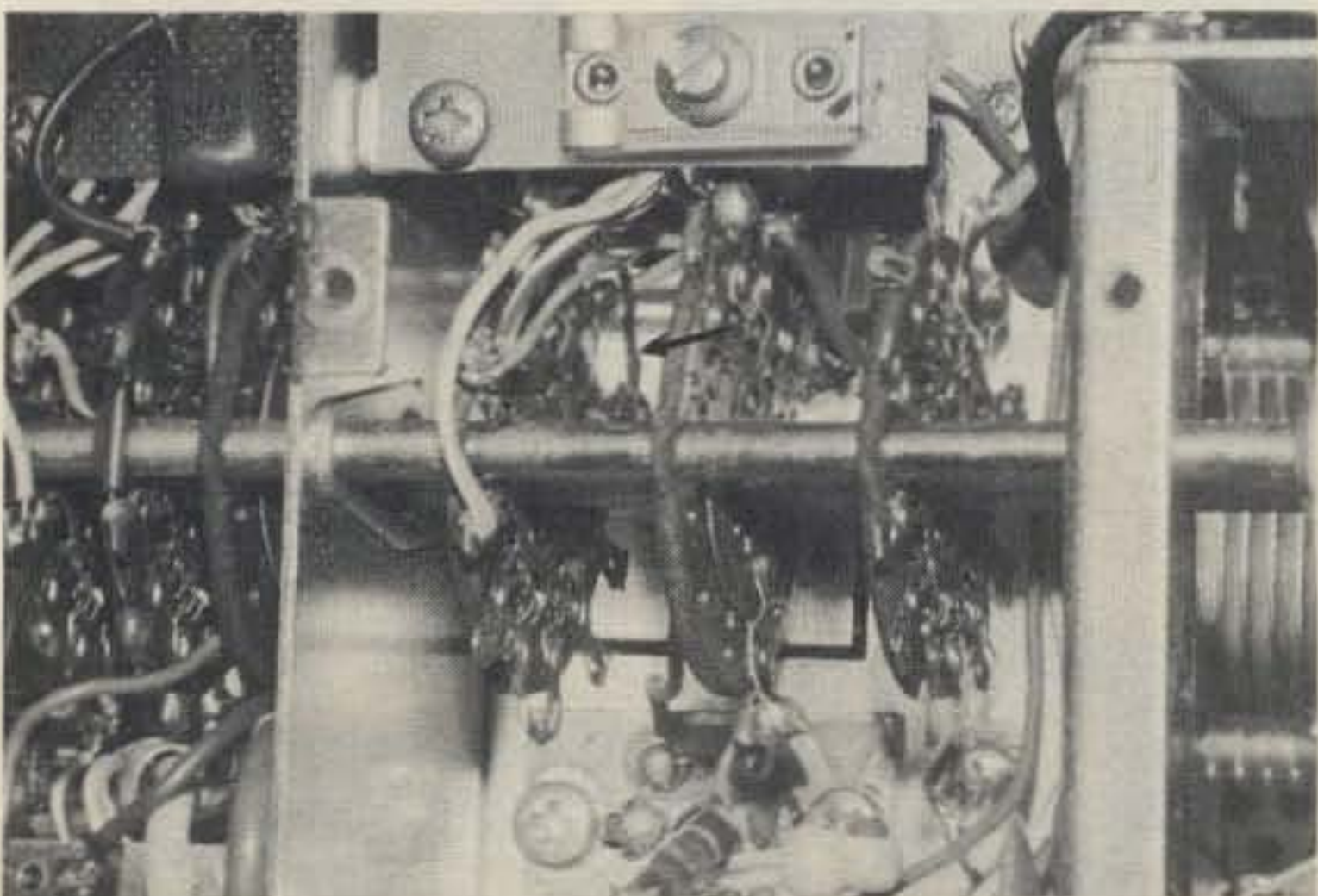

The jumper wire from the 20-meter to the 30-meter position on wafer g of the bandswitch is indicated by an arrow in this photograph. Wafer g is located at the front of the driver plate compartment.

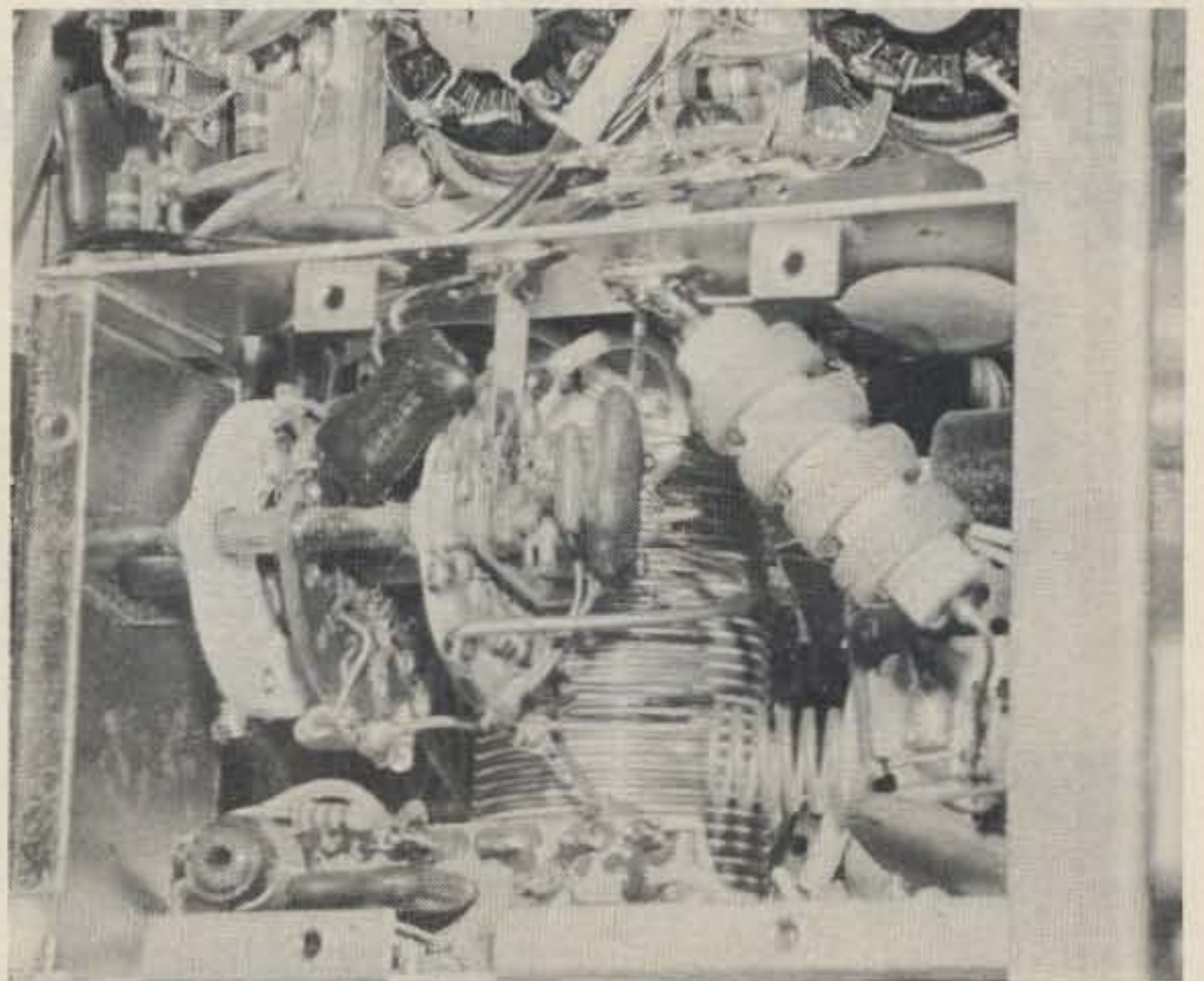

Bottom view of PA plate compartment. The home-brew switch contact can be seen on the center wafer, S11, of the bandswitch. Also seen in this photograph is the heavy wire added from the rear ceramic wafer, S1m, to the new tap on the pi network coil. Since the second harmonic of the 30-meter band is not an amateur band, you will need all the shielding available. Be sure that you replace all of those screws in the PA compartment's bottom shield.

### OPTIONAL MOD

An additional modification may be made to the FT-101 which is not necessary to fire it up on 30 meters, but will center the load control while operating on that band.

Without this change, the antenna loading position will be about "2" when tuned for maximum rf output into a 50-Ohm load at 400 mA. However, by adding a fixed 270-300 pF, 500-600-V silver mica capacitor parallel with the variable loading capacitor (VC2), the loading position will move to about "4" or "5" when fully tuned. The capacitor should be added to the 30-meter position of bandswitch wafer S1k which faces the front of the rig.

First, however, a contact must be added to the 30-meter position of the wafer. Remove capacitors C26, C27, and C105 to get a clearer view of the wafer, then inspect the contacts on S1k closely so that you will be able to identify the correct style of contact to mount. The wrong style could result in damage to the rotating wiper of the wafer.

When you know what you are looking for, head for the junk box and find an unused wafer with the proper contacts. Remove a contact from the "donor" wafer by carefully drilling out the rivets that secure the contacts to the wafer. Mount the contact on the 30-meter position of S1k using a small bolt. Make sure that the contact is mounted on the side facing the front of the rig and tighten the bolt securely. Run the switch wiper across the new contact a few times to ensure that they make proper contact, then solder the 270- or 300-pF capacitor between the contact and ground. Don't forget to resolder capacitors C26, C27, and C105 when you are done.

**James R. Snyder W0UR**  
1050 Hawthorn Avenue  
Boulder CO 80302

ference noted was that 30-meter operation required slightly more drive. During the tune-up, 180 Watts input were produced on 20 meters with the carrier control set at 6, but when operating on 30 meters, the carrier control had to be advanced to 8 to produce the same 300-mA cathode current indication.

### More Bands

The other obvious modification would be to convert the unused (I hope) 11-meter band to the new 18-MHz or 24.5-MHz band. This will require a new crystal 6.02 MHz higher than the bottom edge of the band. In other words, a 30.52-MHz crystal would be needed to operate on the 24.5-MHz band, and a 24.02-MHz crystal to operate on 18 MHz. Since the existing 10/11-meter tuned circuits will probably work fine on 24.5 MHz, only a new crystal should be needed for this band.

If you want to convert the 11-meter band to 18-MHz operation (to get better DX like 20 meters), then the existing tuned circuits cannot be stretched that far and the 15-meter trimmer capacitors will have to be connected to the 11-meter position in all stages of both the transmitter and the receiver. (Sections c, e, g, and m of S1, the bandswitch, will all need this modification.) Adjusting the preselector to a lower frequency should be all that is then needed to be operating on 18 MHz.

### Conclusion

With 10-MHz operation now a reality, the modification to get on 30 meters is simple and cheap. Very cheap! Now that the band is opened, let's use it.

Now, let's see, where is that antenna formula? Hmmmm... a bit over 23 feet on each side of a dipole. ■

## GET MAXIMUM POWER TO YOUR ANTENNA SYSTEM WITH DAIWA TUNERS!



### CNW-419 All Band Tuner

**Specifications**  
● Frequency Range: 1.8 - 30MHz. CONTINUOUS ● Power Rating: 200 watts CW, 500 watts SSB  
● Impedance Range: 10 - 250 ohms ● Dimensions: 225W x 90H x 245D

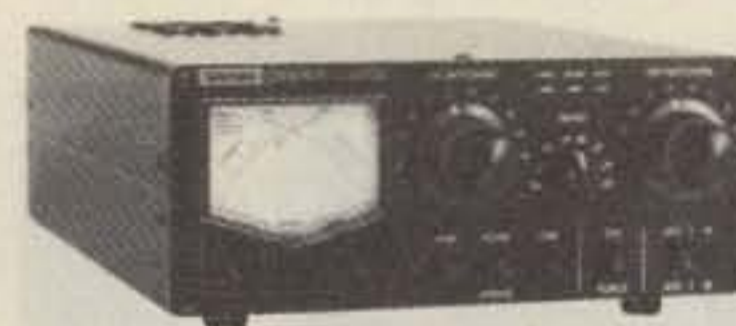

### CNW-518 High Power Tuner

**Specifications**  
● Frequency Range: 3.5 - 30MHz. (8 bands) ●  
● Power Rating: 1 kw CW (50% duty) ● Impedance  
Range: 10 - 250 ohms ● Dimensions: 225W x  
90H x 275D

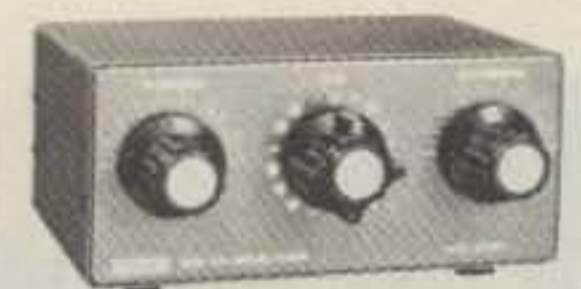

### CL-680 Economy Tuner

**Specifications**  
● Frequency Range: 1.8 - 30MHz CONTINUOUS  
● Power Rating: 200 watts CW, 500 watts SSB  
● Impedance Range: 10 - 250 ohms ● Dimen-  
sions: 165W x 75H x 97D



### DK-200/DK-210 Electronic Keyers

CW is both communication and art.  
Sharpen your "fist" with Daiwa precision!



### AF-606K/AF-406K All Mode Active Filters

Luxurious selectivity at an affordable price!



### CN-520/CN-540/CN-550 Cross Needle Meters

Daiwa cross-needle convenience in a compact case.  
Get SWR and Power readings in a single glance.



858 E. Congress Park Dr. Centerville, Ohio 45459. Phone 1-513-434-0031  
Exclusive U.S. Agents for these DAIWA products. Dealer inquiry invited.

✓82



# MAXIMIZE YOUR POTENTIAL WITH 73!

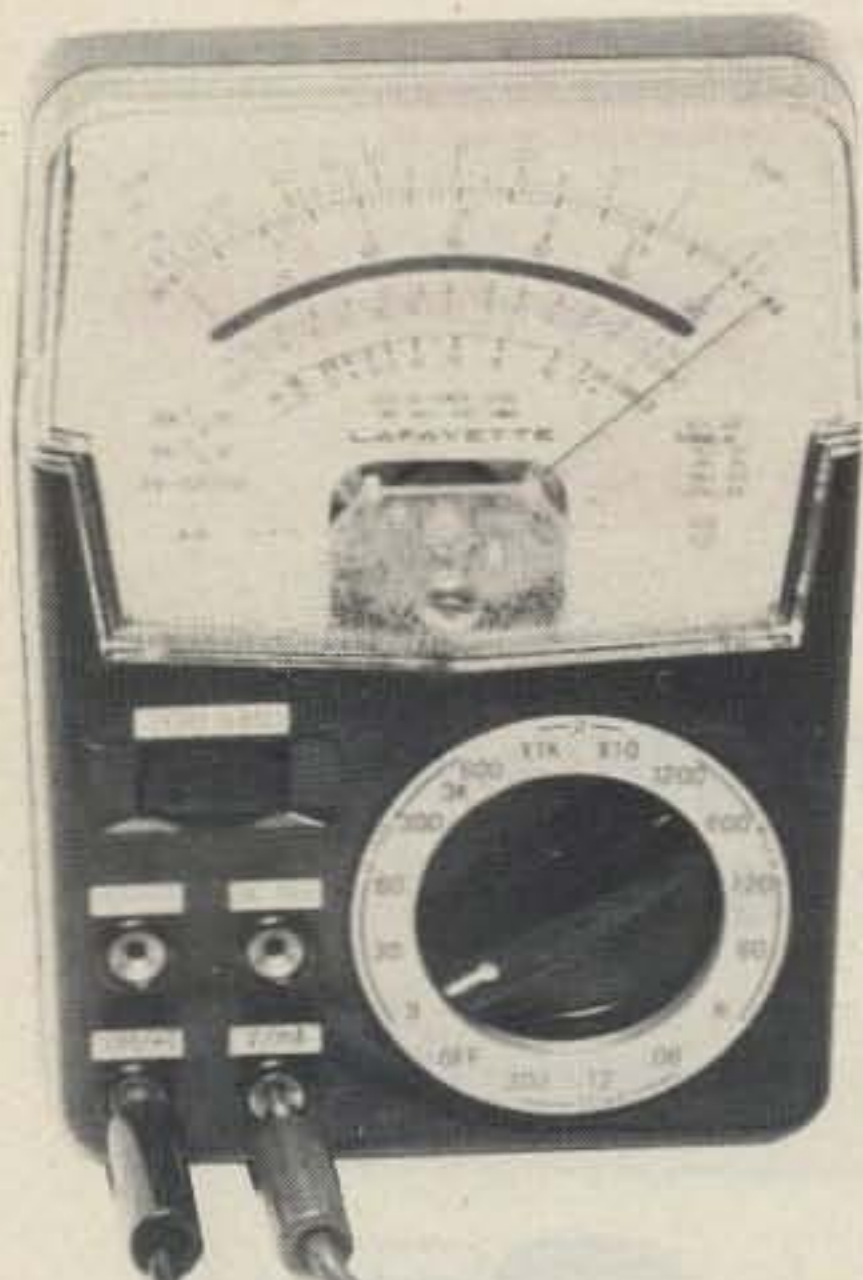

73: Amateur Radio's Technical Journal gives you more easy-to-build construction projects and circuit designs than any other magazine of its kind. Informative articles by the dozens, on all phases of amateur radio, written by hams for hams.

73 always keeps you one step ahead with...

- Scores of useful building projects you'll enjoy by the hour.
- In-depth equipment reviews, guaranteed to save you time, trouble and money.
- 73 International—delivers all the facts you need about licensing laws, club news, contests, and awards all around the globe.
- DXing—valuable tips for newcomers, the personalities behind the callsigns, what's happening on the DXpedition scene, and much, much more!
- New Ham Bands—timely reports on the new WARC bands, how to modify your rig to use them, what to do about antennas.
- Satellite TV—keep up with the technology and all the latest developments in satellite communications.

## PLUS

- RTTY—with over 30,000 hams owning microcomputers, RTTY is developing a whole new life. 73 gives you more articles on RTTY than all the other magazines combined.
- Ham Help—puts you in touch with other readers to get hard-to-find parts, schematics, and owner's manuals.
- Contests—rules and results keep you informed about ham radio's competitive side.

Subscribe to 73 today! We'll keep you involved, informed, and completely entertained. To order, simply send in the attached order form, the coupon, or call toll free 1-800-258-5473. And if you include payment or charge card information you'll get a 13th issue FREE!

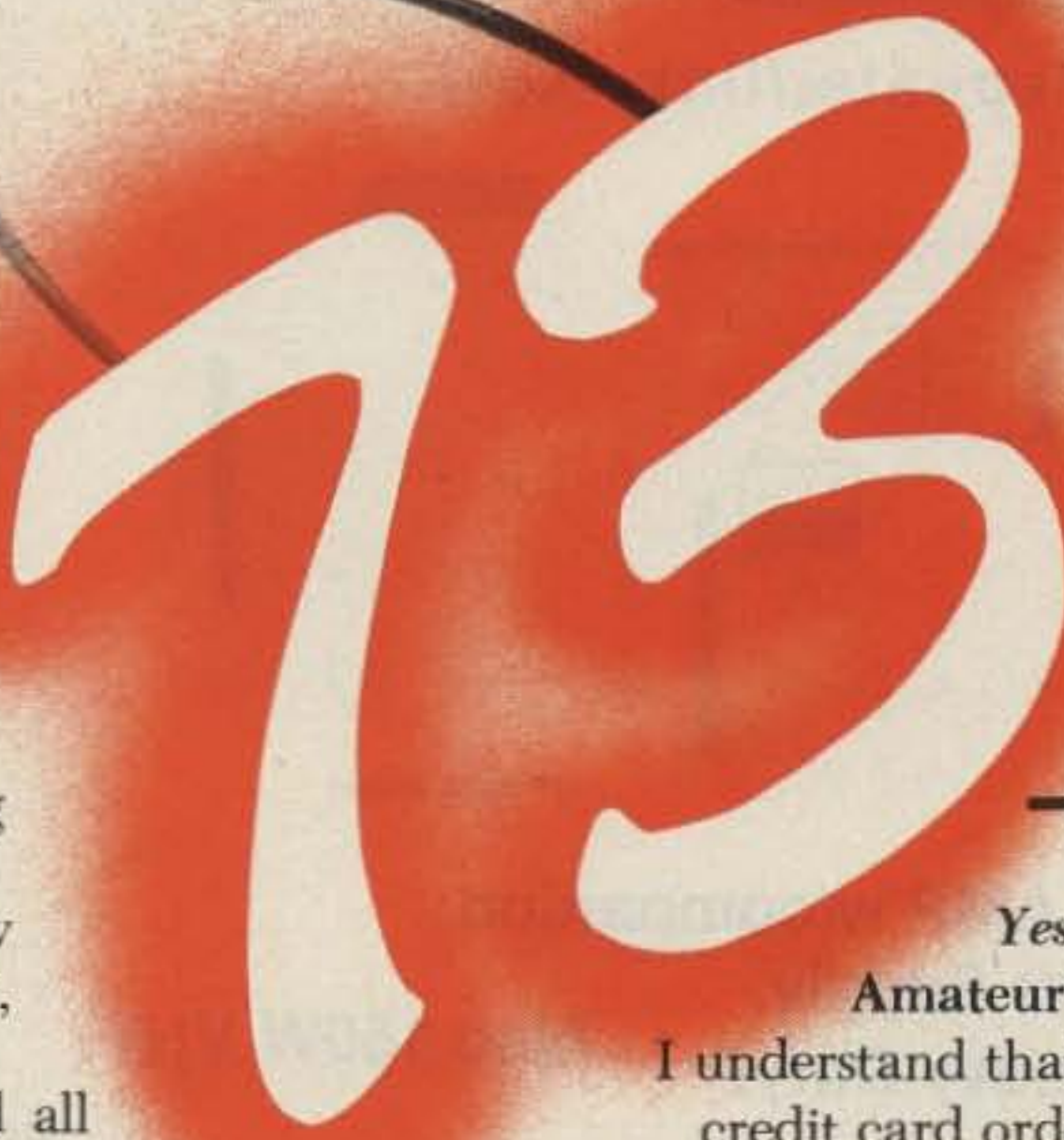

Yes, I want to subscribe to 73: Amateur Radio's Technical Journal. I understand that with payment enclosed or credit card order I will receive a free issue making a total of 13 issues for \$19.97

Check enclosed/MO  MC  VISA  AE  Bill me

Card# \_\_\_\_\_ Exp. Date \_\_\_\_\_

Signature \_\_\_\_\_

Name \_\_\_\_\_

Address \_\_\_\_\_

City \_\_\_\_\_ State \_\_\_\_\_ Zip \_\_\_\_\_

Canada & Mexico \$22.97/1 yr. only US funds drawn on US bank.

Foreign surface \$25.00/1 yr. only, US funds drawn on US bank.

Foreign airmail please inquire.

Please allow 6-8 weeks for delivery.

33NF6

73: Amateur Radio's Technical Journal • PO Box 931 • Farmingdale, NY 11737

*Now's The Time To Buy That New Repeater!*

*- To Replace "The Old Klunker"*

*- For That "New System" you've been*

*Thinking about*

## **Spectrum's Got-**

- **The widest line of Repeater/Link Equipment**
- **The Highest Performance—by far!**
- **The Finest Quality**

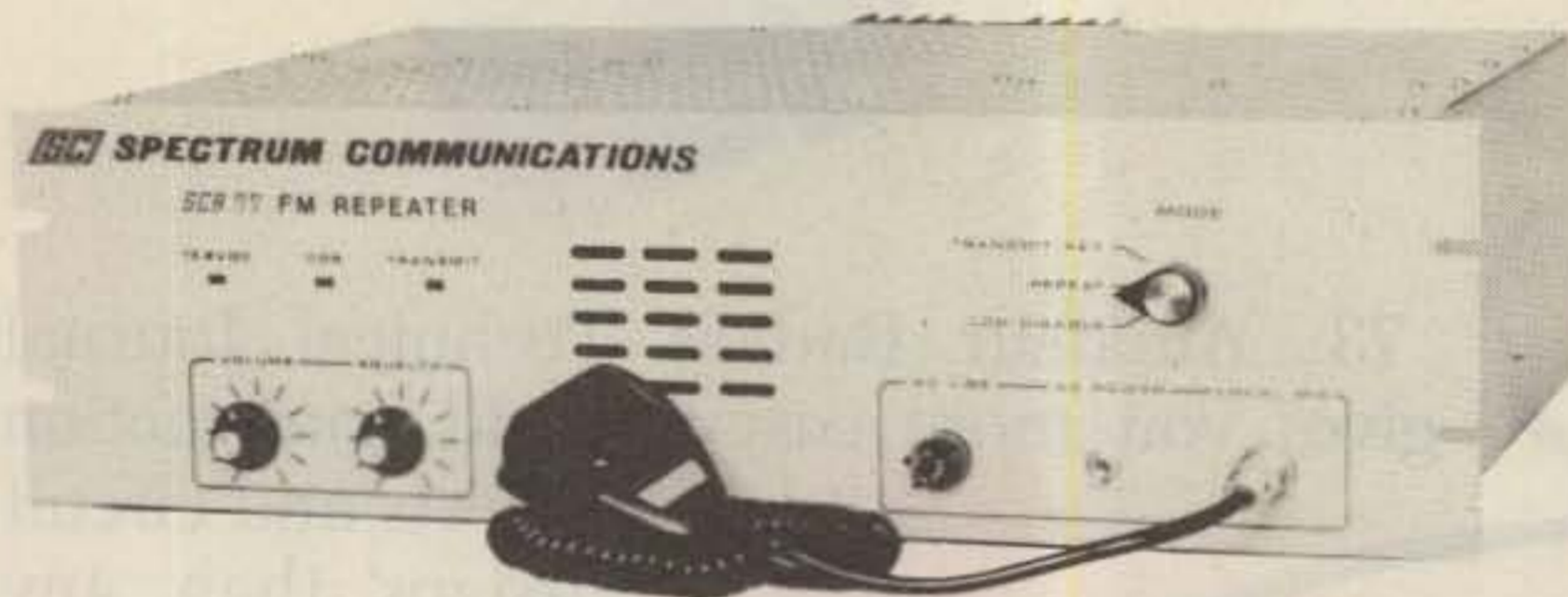

**SCR77 Basic Repeater/link Xcvr.**

**new**

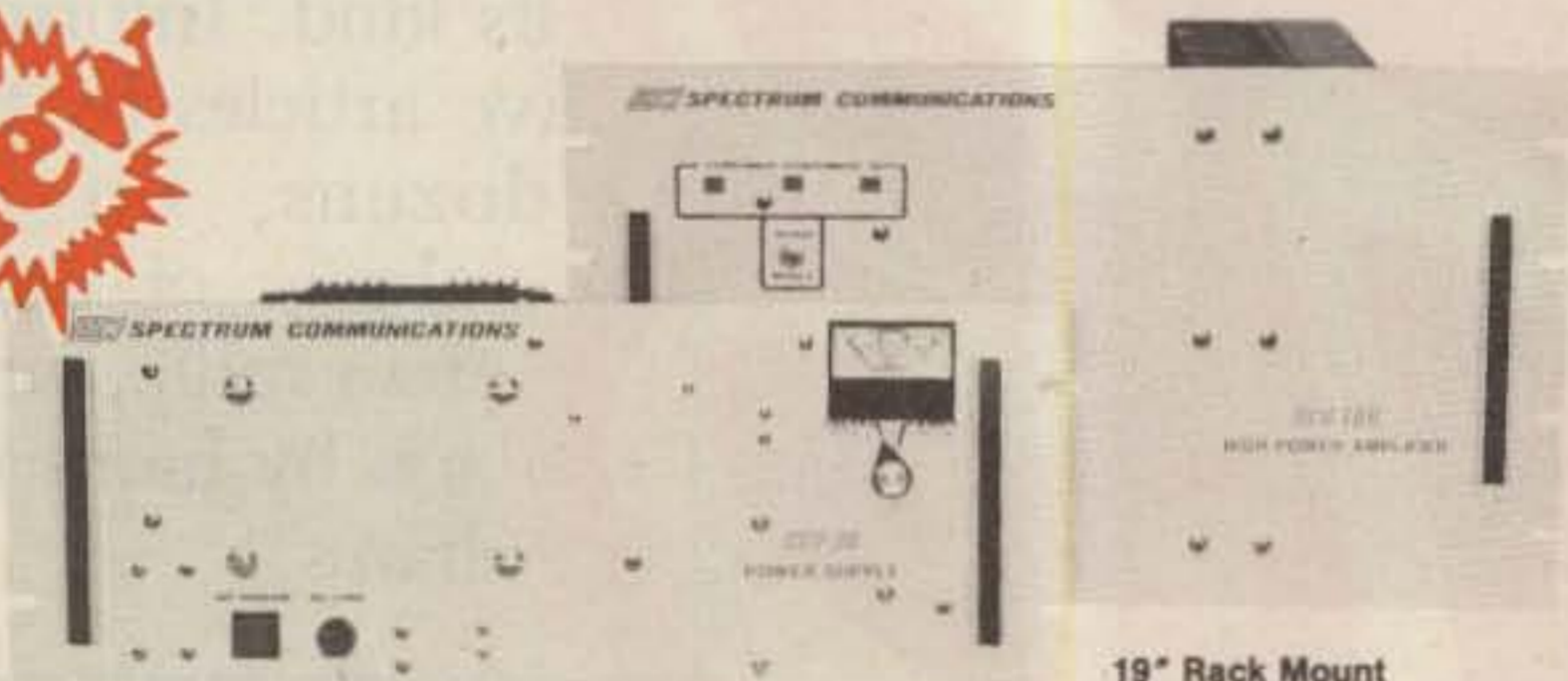

19" Rack Mount

**SCA100W UHF AMP w/companion  
SCP30 30A Power Supply.**

**Both Super Heavy Duty!**

**Also 150W VHF.**

**There's never been a better time to buy a  
Spectrum Repeater or Link Equipment.**

Deliveries are the fastest ever—4-5 wks. as of this writing, with some models in stock. And, with the introduction of our New 100W Repeater Amp/Pwr. Supply Package and UHF Rcvr. Helical Resonator Front End Assembly, we have the best performing, most complete line available!

**Go With The Leader!** Call or write today for a brochure & prices. Sold Factory Direct or through Export Sales Reps.

F.C.C. TYPE ACCEPTED FOR  
COMMERCIAL SERVICES



**SPECTRUM**  
Export Orders Welcomed

1055 W. GERMANTOWN PK., DEPT S11

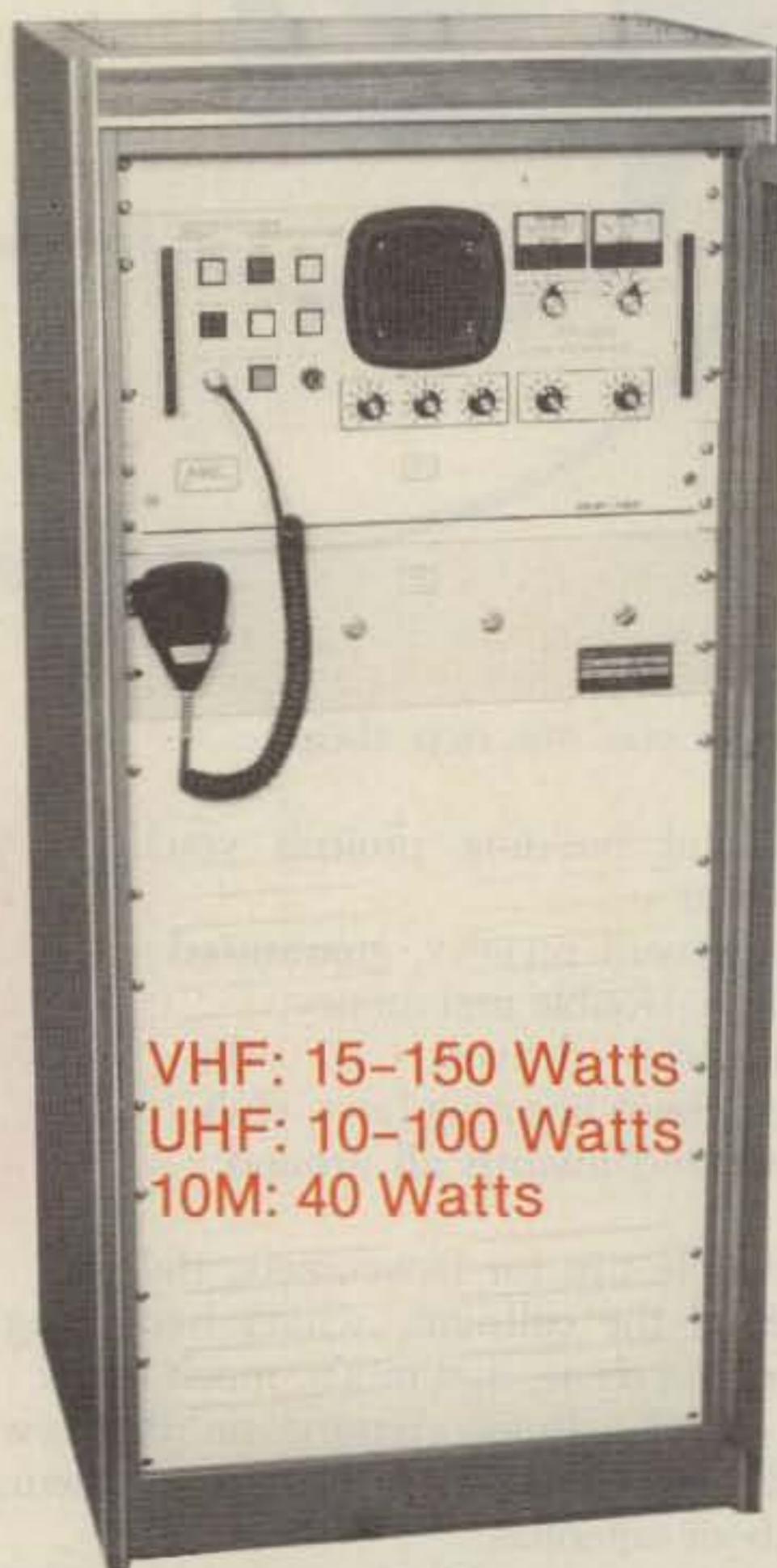

VHF: 15-150 Watts  
UHF: 10-100 Watts  
10M: 40 Watts

**SCR 4000 SUPER DELUXE REPEATER  
WITH OPTIONAL CABINET & ACCESSORIES**

#### AVAILABLE WITH

- Autopatch, w/Reverse Patch & Land Line Control
- Touch Tone Remote Control Functions
- Various Tone & Timer Units
- "Emergency Power ID"
- Duplexers, Cabinets, Antennas, etc. for a complete system

# Spectrum Repeater Boards & Sub-Assemblies

These are professional "Commercial Grade" Units—Designed for Extreme Environments (-30 to 60° C.)

New FL-4 UHF Helical Resonators

All Equipment Assembled & Tested. For 10M, 2M, 220 MHz, & 450 MHz

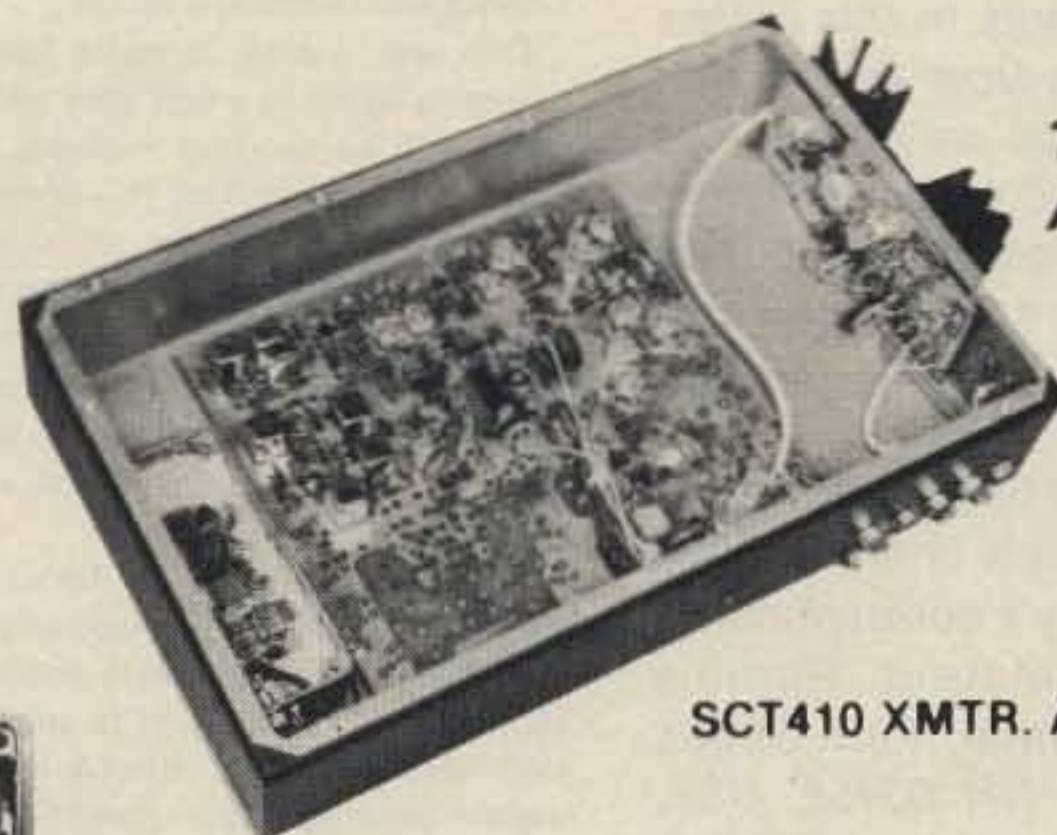

10M ALSO AVAILABLE



FL-6

FL-6 Rcvr. Front-End Preselector

- 6 Hi Q Resonators with Lo-Noise Transistor Amp (2M or 220 MHz).
- Provides tremendous rejection of "out-of-band" signals w/out the usual loss! Can often be used instead of large expensive cavity filters.
- Extremely helpful at sites with many nearby VHF transmitters to "filter-out" these "out-of-band" signals.

SCT110 VHF Xmtr/Exciter Board

- 10 Wts. Output, 100% Duty Cycle!
- Infinite VSWR proof
- True FM for exc. audio quality
- Designed specifically for continuous rpt. service. Very low in "white noise"
- Spurious -70 dB. Harmonics -60 dB.
- With .0005% xtal.
- BA-10 30 Wt. Amp board & Heat Sink, 3 sec. L.P. Filter & rel. pwr. sensor. BA75 75 Wt. unit also available.

SCT110 Transmitter Assembly

- SCT110 mounted in shielded housing
- Same as used on SCR1000
- Completely assembled w/F.T. caps. SO239 conn.
- 10, 30, or 75 Wt. unit.

SCT 410A UHF Transmitter Bd. or Assy.

- Similar to SCT110, 10 Wts. nom.
- \* • Now includes "on board" proportional Xtal Osc./Oven circuitry for very high stability!
- BA-40 40W. UHF AMP. BD. & HEAT SINK.

PCB-1 Xmtr. Power Control Board

- For SCT110 or SCT410 Exciters
- Varies B+ to control Pwr. Out
- Switchable Hi, Low, or Med. Pwr. out, locally or remotely. Adj. levels.

TTC 100 Touch Tone Control Board

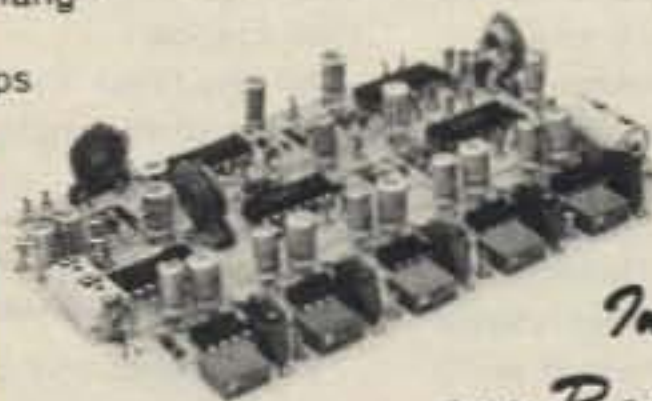

Interface to any Radio or AF system!

- 3 digit ON, 3 digit OFF control of a single repeater function, or (optional) 2 functions (2 digits ON/OFF each).
- Can be used to pull in a relay, trigger logic, etc.
- Typically used for Rptr., ON/OFF, HI/LO Pwr PL ON/OFF, Patch Inhibit/Reset, etc.
- Stable anti-falsing design 5s limit on access
- For add'l function(s), add a "Partial TTC" board.

COMPLETE SHIELDED RCVR. ASSY.

VHF & UHF Receiver Board  
SCR 200-VHF SCR 450 UHF

- **Totally Advanced Design!**
- 8 Pole Front End Fltr. + wide dynamic range—reduces overload, spurious Resp. & IMs!
- Sens. 0.3 uV/12dB SINAD typ.
- Sel. -6dB @ ± 6.5 KHz. -130dB @ ± 30KHz. (8 Pole Crystal + 4 Pole Ceramic Filtrs.)
- "S Meter", Discriminator & Deviation Mtr. Outputs!
- Exc. audio quality! Fast squelch! w/0.0005% Crystal. ("Super Sharp" IF Fltr. also avail.)

Complete Receiver Assemblies

- Rcvr. Bd. mounted in shielded housing.
- Completely asmbld & tested, w/F.T. caps. SO239 conn.
- As used in the SCR1000. Ready to drop into your system!
- UHF Rcvr. Assy. Now Available w/Super Sharp FL-4 Helical Resonators. Greatly reduces IM & "out of band" interference!



SCAP Autopatch Board

- Provides all basic autopatch functions
- Secure 3 Digit Access; 1 Aux On-Off function, Audio AGC; Built-in timers; etc. Beautiful Audio!
- Q1 inhibit bd. also available
- Write/call for details and a data sheet

RPCM Board

- Used w/SCAP board to provide "Reverse Patch" and Land Line Control of Repeater
- Includes land line "answering" circuitry

Lightning Arrester For SCAP

- Gas Discharge Tube shunts phone line surges to ground
- Handles up to 20,000 Amps!
- The Best device available to protect Autopatch equipment from lightning damage. \$14.00 + S/H.



VHF/UHF LINK CONTROL RCVR.  
Complete Shielded RX Assy.  
With 19" Rack Mount.

ID250 CW ID & Audio Mixer Board

- 4 Input AF Mixer & Local Mic. amp.
- PROM memory—250 bits/channel.
- Up to 4 different ID channels! AF Mute circuit.
- Many other features. Factory programmed.

CTC100 Rptr. COR Timer/Control Bd.

- Complete solid state control for rptr. COR, "Hang" Timer, "Time-Out" Timer, TX Shutdown/Reset, etc
- Includes Inputs & Outputs for panel controls & lamps

Repeater Tone & Control Bds.—For SCR1000/4000 & CTC100/ID250 only

- TMR-1 "Kerchunker Killer" or "Time Out Warning Tone" Bd.
- TRA-1 "Courtesy Tone Beeper" Board

PRM200 Power Supply Filter Cap/Regulator/Metering Board

- As used in the SCR1000 as main part of 13.8VDC/8A Pwr. Sply.

PSM-1 Repeater Power Supply Mod Kit

- For SCR1000 or ACR4000. Replaces Darlington Pass Tr. for improved reliability.

# COMMUNICATIONS CORP.

INQUIRE ABOUT 'SURPLUS' RX & TX BOARDS. REDUCED PRICE! ✓68

Norristown, PA 19403 • (215) 631-1710

Call, or  
Send for  
Data Sheets!

# 73 INTERNATIONAL

Each month, 73 brings you amateur radio news from around the world. In this collection of reports from our foreign correspondents, we present the latest news in DX, contests, and events, as well as keep you abreast of the technical achievements of hams in other countries.

If you would like to contribute to your country's column, write to your country's correspondent or to 73: Amateur Radio's Technical Journal, Pine Street, Peterborough NH 03458, USA, Attn: Avery L. Jenkins WB8JLG.



## AUSTRALIA

Jim Joyce VK3YJ  
44 Wren Street  
Altona 3018, Australia

Perhaps the best way of explaining amateur radio in Australia would be to let you know what frequencies we are allowed to operate on and what our different license classes are.

We have 3 classes of license, the first being a Novice license. To obtain this, you have to pass an exam of 50 multi-choice questions on electronic theory (at a fairly easy level), 30 questions on regulations, and a CW exam at 5 wpm, send and receive. The Novice operators are easily recognized, as they have a 3-letter suffix starting with either N, P, or V, e.g., VK3NOL, POL, VOL. They can operate on phone or CW on the 75m, 15m, or 10m bands.

The next grade is the Limited license. For this you have to sit a much harder exam on theory and regulations, with no CW. This license entitles you to operate on all bands allocated to Australian amateurs above 50 MHz. They also have a 3-letter suffix, starting with X, Y, or Z.

The Full Call on AOC (Amateur Operators Certificate of Proficiency), sometimes called the Full Call, entitles you to use all bands and modes available to Australian amateurs. The only difference between this license and the Limited license is that you have to sit a CW exam at 10 wpm, send and receive. The suffix for the Full Call is either 2 letters or 3 letters, starting with A, B, C, D, or E.

It has been said that 10 wpm is below the world standard of 12 wpm. But with our exam on CW, we have to send the equivalent of 25 words (averaging five letters per word), in mixed plain language and figures (each figure counting as two letters), in 2½ minutes. More than four incorrect or improperly corrected errors or failure to complete the test in 2½ minutes will result in failure. In the receiving test, you have to receive 50 words (average five letters per word), in mixed plain language and figures (each figure counting as two letters), in 5 minutes. Each figure or letter incorrectly received counts as one error,

with a maximum of 3 errors being counted in one word or group of figures. More than 7 errors will result in a failure.

This test, I think, is much harder than having to listen to a text sent in CW at 12 wpm, with no sending involved, when all that is required is that you write a rough draft of what has been sent (and, providing you get a fair gist of the message sent, you pass). Even at 16 wpm, I know which one I would prefer to sit for, but we cannot get the reciprocal licenses in some countries unless we get a 12-wpm endorsement on our license.

Speaking of reciprocal licensing, overseas amateurs visiting Australia for less than 12 months may get a license equivalent to their own home privileges. They also have to adhere strictly to the Australian amateur-radio conditions under which the license is issued. To obtain a license in Australia, you must write to the Superintendent of Regulatory and Licensing in the state you propose to visit, with at least 3 months advance notice prior to your visit.

In the next article, I will start to explain something of what Australia is like, with information on our DX locations.



## BRAZIL

Gerson Rissin PY1APS  
PO Box 12178 Copacabana  
20000 Rio de Janeiro, RJ  
Brazil

### CB OPERATION ON 28 MHz

The Brazilian Department of Communications (DENTEL) has been focusing its efforts to find pirate stations using CB equipment to operate at the beginning of the 10-meter CW band.

The CB band ends at 27.605 MHz, but they use modified equipment to extend their operations as far as 28.1 MHz. In this way, it is very difficult to have a QSO on 10-meter CW, especially during the weekends. We can hear pirates from a few countries in South America as well as from Europe.

All Brazilian CW groups are encouraging their members to use the 10-meter band as much as possible and banish the pirates.

### ONE MORE BRAZILIAN BEACON

For propagation purposes, the Brazilian Amateur Radio League/Department of Americana, in the state of Sao Paulo, has constructed a QRP beacon with 10 Watts output on 28.300 MHz. Carlos PY2VRX, Roberto PY2FUZ, and D'Orssay PY2CRI all assisted in establishing the transmitter.

The station is already on the air, with the callsign PY2AMI, and transmits the following message: VVV DE PY2AMI PWR 10W ANT GP LAT 22 45 S LONG 47 16 W AMERICANA SAO PAULO. Any report or QSL may be sent to PY2AMI, Beacon Project, PO Box 31, 13470 Americana, SP, Brazil.

### 10-MHZ BAND

Brazilian amateurs are not yet allowed

to use the 10-MHz band. Most of them have already bought new equipment using the WARC bands, but the authorities are still studying the treaty.

### GPCW AWARD

Sponsored by the Grupo Praiano de CW, the GPCW Award is available to all licensed amateurs for confirmed contacts with three GPCW members.

Contacts must have been made after November 5, 1973, on any amateur band. Only 2-way CW contacts with a minimum RST of 338 are allowed. No QSL is necessary.

Send a list of stations worked (call, date, time, band, mode, and report) and 5 IRCs for mailing expenses to GPCW, PO Box 556, 11100 Santos, SP, Brazil.

GPCW members are: PR7CM, PS8AUJ, PT8AVV, PY1AFA, PY1CMS, PY1DG, PY2ARX, PY2BBO, PY2BKT, PY2BOP, PY2CAR, PY2CE, PY2CJW, PY2CZL, PY2DBU, PY2DCP, PY2DHP, PY2DV, PY2DYX, PY2ESW, PY2ETW, PY2EW, PY2EYF, PY2FDO, PY2FHC, PY2FK, PY2FNB, PY2FNE, PY2FRW, PY2GCP, PY2HAB, PY2HAF, PY2IBH, PY2IEG, PY2IEM, PY2JN, PY2KL, PY2OIL, PY2OIN, PY2ORF, PY2RAD, PY2RAN, PY2RRG, PY2SCR, PY2SFI, PY2SLS, PY2TT, PY2TUE, PY2UGR, PY2US, PY2VFA, PY2ZEB, PY2ZV, PY3BU, PY3CJI, PY4ETW, PY5CMS, PY6WF, PY7BOS, PY8BI, PY9AY, F6HSX, and CT1CFG.



## CYPRUS

Aris Kaponides 5B4JE  
PO Box 1723  
Limassol, Cyprus

### BEACONS IN CYPRUS

For many years, the Cyprus Amateur Radio Society has been running experimental transmitters as beacons for the study of radio-wave propagation.

At the moment, there are three beacons in operation:

a) 28.220 MHz—This beacon is used for the study of shortwave propagation and transmits the call 5B4CY. This beacon is watched by many amateurs throughout the world who often send reports or QSL cards with information about the reception of its signal. The power of this beacon is 15 to 20 W and the antenna is a quarter-wave vertical on the ground with lots of radials under the soil.

b) 50.5 MHz—A transmitter on this frequency aids the study of many phenomena such as sporadic-E and TEP (Trans-equatorial Propagation), and during the period of maximum sunspot activity, it was heard in all continents. The transmitter was home-brewed by 5B4AZ and has an output of 15 W and a ground-plane antenna.

c) 70.11 MHz—This beacon is also used for sporadic-E and TEP studies and has been heard in Europe and South Africa. The transmitter was donated to CARS by G4BPY, whom the Cyprus amateurs would like to thank very much for his most useful and generous offer. We do hope that other amateurs will help our society in other fields. Because of its small size, it is running on a shoestring and every little bit of help is greatly appreciated. The 70.11-MHz beacon gives 15 W, and the antenna is a 4-element yagi beaming to Europe between May and August and beaming to South Africa the rest of the time.

All beacons are located at Zyghi at the

site of the BBC relay station, and they all transmit the callsign 5B4CY.

The beacon keeper is Nick 5B4AZ and all reports of 5B4CY should be sent to him.



## GIBRALTAR

Jimmy Bruzon ZB2BL  
27/2 Flat Bastion Road  
Gibraltar

On June 18, the 1st Battalion, The Duke of Wellington's Regiment, celebrated the 168th anniversary of the Battle of Waterloo, and to mark the occasion, an open day was held at Lathbury Barracks where the Gibraltar Services Amateur Radio Club set up an amateur-radio station using the callsign ZB2DWR. Unfortunately, due to poor conditions and the fact that the date coincided with some contest, not too many stations were worked. The station was operated by Iain Morris ZB2HC and Peter Green ZB2HM. QSL information is either via the Bureau or to PO Box 292, Gibraltar.

Another bit of news was the first-ever two-way QSO on 6 meters between Gibraltar and the United Kingdom. This took place on May 6, when Ken G5KW and I managed to work each other, first on CW and then on SSB. Ken has been doing quite extensive monitoring of the ZB2VHF 6-meter beacon. For those of you who are also operational on 6 meters, the ZB2VHF 6-meter-beacon frequency is 50.035 MHz, running 30 Watts to a 5-element yagi. Reception reports are most welcome and should be mailed to me via the Bureau or, preferably, to my home address.

The oldest licensed amateur still resident on the Rock is Gordon Black ZB2J. Gordon's interest in amateur radio was aroused through ZB2A, the RAF Amateur Radio Club, back in 1948. Of course, home-brewing was the in thing in those days; the RAF Amateur Radio Club station consisted of a couple of T-1131 transmitters, AR-88 and HRO receivers, and other bits and pieces of wartime equipment. Some time later, Gordon and some of his work-mates at the Royal Navy wireless station decided to form the Royal Navy Amateur Radio Club. Through their Commanding Officer, they applied for a club callsign and were issued ZB2G. The RN Amateur Radio Club was active for a number of years on 7, 14, and 28 MHz, and in those days, there was stacks of room to operate in, so receiver selectivity was not necessary. All one had to do was to QSY some kHz up or down the band and find a clear spot to operate on.

In 1950, Gordon decided it was about time he got his own ticket, so after sitting the RAE and CW test, he was issued callsign ZB2J. He then constructed his own receiver and transmitter which he used until he got posted to the UK. While in Wales, Gordon was issued the callsign GW3HIJ, and since the rigs were far from portable in those days, it was a matter of home-brewing once again. From Wales, Gordon operated on CW for a couple of years until he got posted, and then came a period of inactivity.

In 1955, Gordon returned to Gibraltar and re-applied for his ZB2 call. He was active mostly on CW until 1964-65 when he joined the Gibraltar Broadcasting Corporation. With work taking up most of his time, ZB2J was inactive until 1979.

The days of home-brewing were now over, and since the idea of playing around

Actual slow motion frames from Ham MasterTapes



1. Larry, N2NY, Lee, KA2RNV, Virginia, N2EGJ



2. Lee discharges cap



3. In slow motion it's dazzling



4. Wow. Can we see it again?

**You've never seen this, like this,  
before this!**

**And you can see it—in color—again and again  
when you own the N2NY Ham MasterTapes.**

Ever see a cap discharge in slow motion? You will on Ham MasterTapes. Ham MasterTapes can perform the dozens of complicated demonstrations necessary for a beginner's understanding of Ham Radio Theory.

Finally, a step-by-step course in Ham Radio Theory is available on color videotape. The Larry Horne N2NY Ham MasterTapes video course is a unique, effective teaching technique expertly produced by New York's leading professionals in studio and field videotape.

- Video Graphics highlight important details.
- Carefully worked-out demonstrations on video avoid the problem of getting complex gadgets to work on command in front of a class.
- Working examples of every ham radio component, device, or system covered in the FCC guide can be clearly understood.

The N2NY Ham MasterTapes give you a basic grasp of concepts that build theory background—not only for passing the FCC tests, but for understanding electronics.

The hobby has long needed better, clearer, high-tech teaching aids to help newcomers into our wonderful world of Ham Radio.

These six-hour tapes cover completely all the material needed to understand Novice and Tech/General Theory and operations, and include the new 200-question FCC syllabus used beginning September 1983.

Only \$199.95. Order direct and specify Beta or VHS format. Call or write: Larry Horne, N2NY or

Virginia Hamilton, N2EGJ at  
Ham MasterTapes  
295 Park Avenue South  
New York, N.Y. 10010 212-673-0680.

**Ham MasterTapes™**

THE N2NY HAM RADIO COURSE ON VIDEOTAPE

© 1983 N2NY Productions, Inc.



Gordon ZB2J operating his station. Note the home-built ATU on top of the TS-520.

with a soldering iron and voltmeter at home didn't appeal to him any more (having been Chief Engineer for the Gibraltar Broadcasting Corporation for a number of years), he decided to get a TS-520, which forms part of his present setup. The antennas are a 10-meter dipole, a 20- and 15-meter dipole on a single feeder, and a longwire for 40 meters. He eventually intends to get a beam antenna, possibly some compact triband beam.

Gordon is active just about every morning and most evenings on 20 meters; he prefers operating on 15 or 10 meters when it's open. Being a rag-chewer, he prefers to keep away from those "my-name-is-Gordon-you're-RST-599-please-QSL" style QSOs. Gordon has worked about 180 countries, though he admits he is not a wallpaper collector. His QTH is located on the west side of the Rock; from there he has a very good take-off towards the southwest, west, and north.

Though Gordon does not enjoy contest operating, he does enjoy working DX stations and adding new countries to his collection. At present he is the General Manager of the Gibraltar Broadcasting Corporation.

Next month we shall be visiting John ZB2AT. John is also the license-holder for the 1st/4th Scout Group ZB2FFG.

Currently, the Gibraltar Amateur Radio Society is experiencing some TVI problems. However, as soon as that's sorted out, ZB2BU shall be active on 10, 15, and 20 meters. The GARS meets on Tuesday evenings and if all goes well, I shall be able to provide you with more details next month.

Best 73 es CU next month, or perhaps work you before then.



## GREAT BRITAIN

Jeff Maynard G4EJA  
10 Churchfields  
Widnes WA8 9RP  
Cheshire, England

### THE UK SCENE

Those of you awaiting QSL cards for recent contacts with G2MT probably do not appreciate the historical significance of that call.

Some sixty years ago, the callsign 2MT was used to introduce the first scheduled entertainment broadcasting in the United

Kingdom. Recently, the Home Office (the then-regulatory authority for amateur radio in the UK) approved the use of G2MT by the Marconi Radio Society, whose members are drawn from the employees of Marconi Space and Defence Systems Ltd. in North London.

The station will operate from the Stanmore headquarters of the Marconi Radio Society, but bands and operating schedules are subject to prevailing propagation conditions.

At the time of this writing, we are well into the summer mobile rally calendar with two or three events each weekend. (Even though the English summer sometimes lasts only a week or two, the rallies are held resolutely through October!)

On a slightly smaller scale than, say, the Dayton Hamvention, mobile rallies are

very popular over here and are characterized by big crowds, warm beer, and curly sandwiches.

Local events often are held in school or social halls with only a handful of regular trade stalls; filling the remaining space are weekend traders and tables rented by individuals.

Regional events attract more traders who exhibit their full range of Japanese black boxes. Unfortunately, these invariably remain in their shrink-wrap protective covers and no facilities exist for demonstrations (any operating station is usually being provided by a local club). It never ceases to amaze me that fellow hams will part with vast sums of money (a Yaesu FT-One currently retails here at about \$2200) for equipment chosen in these conditions.

Far better to visit one's local store as I do occasionally. Not only do I get to try any gear in which I am interested, but I also get a cup of coffee and a chat with Peter G4KKN (who runs the local Amateur Radio Exchange).

Despite all this, mobile rallies can be fun—particularly listening to the talk-in channel whilst approaching. I recently heard a ham three times do the opposite of the instructions given him and then wonder why he remained lost.

A big complaint against mobile rallies is that they occupy the OM on a Sunday and provide little if any attraction for the family. In one event, at least, this is not so. The RSGB National Mobile Rally is held at Woburn Abbey, seat of the Marquis of Tavistock. Surrounded by beautiful parkland, the house alone is worth a visit, but the intrepid can always take in the wildlife game reserve.

The RSGB's advertising for this event highlights the many side attractions of Woburn but fails to mention the area's most interesting sideline—Woburn Golf

Course, home of the Masters and other tournaments. Perhaps the organizers do not share my interest in golf.

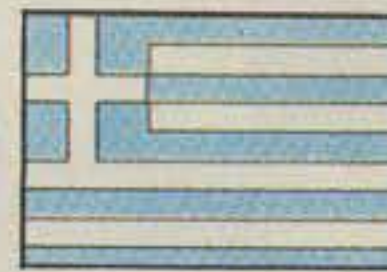

## GREECE

Manos Darkadakis SV1IW  
Box 3751  
Athens, Greece

This month's column will bring you all the necessary information for getting an SV license while in Greece. (See box.) At the moment, reciprocity agreements exist with the US, Canada, and Cyprus. Therefore, only amateurs from these three countries can obtain an SV call during their stay in our country.

Please note that for the first category the minimum requested time for the issue of the license is 3 to 4 weeks, and it is 3 months for the second. Therefore, applicants must apply in advance of that time.

Lately, many efforts have been directed toward the establishment of a guest license in Greece. This one will be valid for a maximum of three months and will be available to every licensed amateur worldwide. Anyway, we will be back with more details after the agreement.



## INDIA

James Kalassery VU2ARL  
PO Box 1446  
36/677 Monastery Road  
Cochin 682 011, India

Under the 1978 Indian Wireless Telegraph (Amateur Service) Rules which are currently in force, we have four categories of licenses—Advanced, Grade I, Grade II, and Grade II (VHF).

Grade II and Grade I are available to anyone who is at least 14 and 16 years old respectively and has passed the respective Amateur Station Operator's Certificate (ASOC) examination. However, an Advanced ASOC examination can be taken only by those who have held a Grade I license for 2 years or a Grade II license for 3 years. Morse-code requirements are the same (12 wpm) for both Grade I and Advanced licenses, and therefore Grade I amateurs need pass only the theory portion of the Advanced ASOC examination, which is of a slightly higher standard, to qualify for the Advanced license. Those who do not qualify in the Morse-code test (5 wpm) of the regular Grade II ASOC examination can get the Grade II (VHF) license, which will permit them operation on 2-meter phone.

Out of the around 1800 amateurs in India, only about 30 are Advanced licensees; almost the same number hold the Grade II (VHF) license. The rest of the ham community is almost equally divided among Grade I and Grade II.

The largest representative body of radio amateurs in India is the Federation of Amateur Radio Societies of India (FARSI), which has more than 60 affiliate clubs and a total membership well over 1000. Most of these clubs are in cities, but some smaller towns also have very active clubs. The largest affiliate is the Radio and Electronic Society of India (RESI), followed by Madras Amateur Radio Society (MARS)

### INSTRUCTIONS FOR FOREIGN AMATEUR-RADIO OPERATORS

(Legislative Decree 1244/72  
Official Gazette 181/A/16 Oct 72)

Foreign amateur-radio operators who are citizens of countries having a reciprocal agreement with Greece may operate amateur-radio stations in Greece if they submit an application with the following supporting documents to the: Ministry of Communications, General Directorate of Posts and Telecommunications, Directorate of Radio Communications Control, Section III, 49 Leoforos Syngrou, Athens, Greece.

- 1) Amateur-radio operators who wish to operate stations in Greece for less than one year must submit:
  - a) An application giving full personal identification data, the intended location of the radio station, and the point and manner of entry of the radio equipment into Greece.
  - b) A photocopy of the amateur-radio license notarized by the appropriate government agency or amateur-radio club of the applicant's home country. If the license has no expiration date, the applicant must provide a certification by the appropriate government agency or amateur-radio club in his home country that the license is still valid.
  - c) Technical characteristics of the radio station.

The above documents must be submitted to the Ministry before a permit to operate is granted. This will be valid for a period equal to the applicant's intended stay in Greece, not to exceed one year, and will not be renewable.

- 2) Amateur-radio operators residing permanently in Greece must submit:
  - a) An application bearing a 10-Drachma revenue stamp.
  - b) Identification data.
  - c) A photocopy of the amateur-radio license notarized by the appropriate government agency or amateur-radio club of the applicant's home country.
  - d) Technical characteristics of the station.
  - e) A document showing the applicant's membership in the Greek Amateur Radio Club.
  - f) A 300-Drachma fee.
  - g) A 50-Drachma revenue stamp.

The permit will be valid for two years and will be renewable. Amateur-radio operators in this category are entitled to transmit using the output wattage permitted by their license, but not to exceed 300 Watts PEP.

# Grab a fistful of TEN-TEC's new 2 meter FM talkie

it has features never  
before available in  
one handheld, it's  
made in the USA  
and it's  
priced right!

## COMPARE TENNESSEE TECHNOLOGY WITH THE OTHERS...

### Do their handhelds have memory lockout?

Exclusive memory lockout on the TEN-TEC 2591 allows scanner to temporarily bypass channels for quick lockout of busy frequencies yet retain them in memory for normal operation on demand.

### Do theirs store transmit offset?

The 10 memories of the 2591 allow stored offset for easiest operation. And memory channel 0 accepts any non-standard offset.

### Do theirs offer selectable SKIP or HOLD?

When scanning with the 2591, choose HOLD to stop and stay on a busy frequency. Choose SKIP to stop for several seconds and continue.

### Do theirs offer modifiable Band Scan without complete reprogramming?

With the 2591 you can scan any section of the band with user defined upper and lower limits in steps of 5, 10, 15, 25, or 30 kHz. Change step size, upper and lower limits independently. Manual Scan also, up or down, in 5 kHz steps.

### Do theirs have Quick-Release NI-CAD Battery Pack?

The 2591 battery pack slides off easily, yet is secure in use, has a heavy duty 450 mA/HR rating at 8.4v, and the 2591 has capacitive memory retention to permit pack changing without reprogramming.

## THE TEN-TEC 2591 HAS ALL THE RIGHT FEATURES...

- Memory Scanner scans only programmed channels and has user selectable HOLD or SKIP
- Selectable 2.5 Watts or 300 Milliwatts power, top panel switched
- Extended Frequency Coverage—143.5 to 148.995 MHz. Covers full Amateur Band plus some CAP and MARS frequencies.
- 4-Digit LCD Readout with Switchable Back Light—large, easy-to-read digits, selectable for frequency or memory channel number.
- Key-Pad Frequency and Function Control—16 key dual tone encoder
- Dual Function LED—shows battery status and transmit mode.
- Electret Microphone plus separate speaker for superior audio.
- Compact, Lightweight, Complete—easy to handle and rugged. Standard equipment includes flexible antenna with BNC connector, AC charger, belt clip, connectors for mike and speaker. Options include: adaptor pack for +12 VDC mobile operation, speaker/mike, 25 watt power amplifier, leather case, desk charger, subaudible tone module, and spare NI-CAD pack.

DESIGNED AND MANUFACTURED IN TENNESSEE and it carries the famous TEN-TEC 1 year warranty. See your dealer for the best in 2 meter FM—the TEN-TEC 2591. Or write for information to TEN-TEC, Inc., Sevierville, TN 37862.

**TEN-TEC**

and Kerala Amateur Radio League (KARL). Many clubs conduct regular classes, assisting candidates preparing for the ASOC examinations. Being World Communications Year, more and more clubs are being formed and affiliated with FARSI this year.

One of the main projects of FARSI is the All-India Convention held every three years. The last one was held in Bombay in 1981 and the next one is expected to be held soon. FARSI also publishes a monthly journal, *Radio*, which is sent free to the members of all affiliate clubs.

With the arrival of many more rigs imported under the Open General License of the Import Policy, more and more Indian amateurs are now being heard on the bands, which means more QSOs and more QSLs. To take care of the flow of these cards, FARSI runs a well-managed QSL Bureau (PO Box 6538, Bombay 400 026), which serves all radio amateurs in India, irrespective of their membership.



### ISRAEL

Ron Gang 4Z4MK  
Kibbutz Urim  
Negev Mobile Post Office 85530  
Israel

#### VHF IN ISRAEL

One of the most popular aspects of ham radio in Israel today is VHF operation—more specifically, two-meter FM. Please note: We do not have a code-free VHF class of license here, so those operating on VHF also have full HF privileges. Thus, Israelis chose two meters on its own merits alone.

Although the widespread use of these shorter wavelengths has occurred here only in the last decade, it would be wrong to assume that the world above 30 MHz was unknown until the early '70s. In the last yearbook of the Israel Amateur Radio Club, we see a couple of snapshots of Bruno 4X4DH taken on a field day in 1965 at Kibbutz Sasa in the mountains of the Upper Galilee. The first one shows him raising a two-meter yagi on the kibbutz's water tower, and the second depicts him crouched over an SCR-522 making the first contact between Sasa and Haifa. A year earlier, in 1964, Bruno had made news by being the first amateur to make satellite contact between Europe and Asia via OSCAR 3. Bruno also had received the signals of pioneer OSCAR 1 transmitting its famous HI beacon.

The real boom in VHF happened in the spring of 1974 when the police department decided to update its communications equipment. The Ministry of Communications, perhaps because of the prompting of a few hams holding key posts there, deemed that the equipment being retired was unfit for commercial use. This left only one possible area for the release of the gear—the radio hams!

So, for a small fee you became the proud possessor of a Motorola D43GGV high-band FM transceiver, sporting about thirty tubes, including a 6146 final. If you were fortunate, you had an ac supply built in—otherwise you had to deal with a real humdinger of a 12-volt vibrator.

The other item made available to the ham population was the Japan Radio Corporation hand-held FM transceiver. This was a real beaut—totally solid state, dual channel, although about 2½ times the volume of today's hand-helds. You may

recall that we then called such units "bricks." I don't remember what these cost us, but the Ministry did give a few of these free of charge to club stations.

Well, through the Israel Amateur Radio Club, a bulk order of crystals was made from Tadiran, Israel Electronic Industries, and two meters came to life! People were having a ball, tasting the joys of this new mode of communications. There we all were on 145.725, thinking that this intercom party line was great, not knowing that bigger and better things were just around the corner.

A few of the boys in Beersheva took a Motorola GGV and turned it into a primitive repeater, Israel's first. The next issue of *HaGal* (The Wave), the IARC periodical, came out with a band plan, allocating repeater and simplex frequencies for the various cities and districts. This was based on the European scheme with 25-kHz spacing between channels—145.000 to 145.225 being the repeater uplinks for R0 to R9, and 145.250 to 145.575 being simplex channels S10 to S23. Of course, 145.600 to 145.825 are the repeater outputs going from R0 to R9—standard 600-kHz splits. (R8 and R9 have been dropped in the last couple of years to accommodate amateur satellites as per the IARU band plan.)

Your correspondent, living in the Negev, had been content to chit-chat on the Beersheva frequency with his GGV, occasionally making a DX contact with the Tel Aviv repeater on the other crystal channel when tropo ducting permitted. One day, I visited a nearby ham who had a synthesized rig, and I was astounded to hear the Haifa repeater 250 km north of here coming in full quieting. I was hooked, and by January, 1979, I had purchased a scanning transceiver.

This was indeed the time of the real two-meter boom here—people had had a lot of fun with the "junk" rigs and were now buying commercial synthesized gear. The repeater and simplex channels were buzzing day and night. By virtue of a few amateurs holding key positions in Motorola Israel, retired repeaters and duplexers were donated to the IARC, and at this time, there are five two-meter machines in operation (R0—Haifa, R1—Jerusalem, R3—the Galilee, R5—Beersheva, and R7—Tel Aviv) and one 70-cm repeater in the center of the country.

Israel, located on the Mediterranean coast and having frequent high-pressure weather systems, is a VHFer's paradise. All summer long (6 months!) there is tropospheric ducting, making long-range contacts commonplace and two-meter QSOs with Cyprus a regular affair. Sometimes sporadic E appears, and on FM I've worked into Greece, Italy, and Yugoslavia and have heard Hungary. Of course, the serious two-meter DXers are on CW and SSB around 144.300, and some have contacted England. But for us run-of-the-mill FMers, this DX is really the icing on the cake.

Two meters has really changed the face of Israeli ham radio almost beyond recognition. Some sneaky fellows have lent their two-meter gear to "retired" old-timers and have thus rekindled their fire, getting them back on the air. Previously, the only local meeting ground was 40 meters for a few hours on the Sabbath, but now hams in the country are in touch with each other all week long at all hours. For better or for worse, the hams now are acquainted with each other very well, and Israeli hamdom has become a kind of village!

The repeaters are now less active than they were a year or two ago. It seems that either the novelty has worn off or the long

roundtables have talked themselves out. Still, I suspect, just as many people are monitoring—it's simply that they don't reach for the microphone as often.

Every time Shimshon 4X4GF, "Gefilte Fish," meets a new operator on two meters, he enters him into his list and tells him what number station he is that he's worked on the band. The last time I heard, he had just passed the 380 mark, definitely deserving a place on the Honor Roll!

Visiting amateurs are always very welcome on our straight carrier-access repeaters. Should you be coming here, by all means bring along that portable rig. It will add another warm human dimension to your trip to Israel. Reciprocal licensing is no problem, and details may be found in my column in the June, 1983, issue of 73.



### ITALY

Mario Ambrosi I2MQP  
Via Stradella, 13  
21029 Milano, Italy

#### RECIPROCITY IN ITALY

In accordance with the Telecommunications Act of March 29, 1973, foreigners are granted permits for short visits and station licenses for longer stays in Italy. A temporary permit is granted for a maximum of three months, and it cannot be extended. However, a foreigner can submit a new application in order to obtain another permit, although consecutive permits will not be granted for more than a 12-month period.

Any foreigner who intends to stay in Italy for more than one year must first register his residence. Then he can request that his amateur license be converted into an Italian operating license, which will then be granted in the same way that Italian nationals receive theirs.

Applications sent from abroad may be written on plain paper, while applications from Italy must be on revenue-stamped paper. All must be filled out in Italian and accompanied by a 3000-lira revenue stamp and an additional 2100 lira for postage. IRCs may be substituted at an exchange rate of about 500 lira per coupon. In addition, the license granted in the country of origin must be valid for the entire period of the Italian temporary permit.

#### Notes

A photocopy of the station license must be mailed with the application, and I recommend that you post the envelope as a registered letter. For overseas airmail service, add 3700 lira, and if the application is handled through the reciprocal licensing department of the ARI, only \$8 US is required to cover expenses.

It is advisable to apply for a temporary permit at least 45–50 days prior to the expected date of arrival in Italy.

You must also pay a fee of 2000 lira at any post office when you fill out the form attached to the permit. Prior to payment, fill out the front sides, and on the back write "Canone per l'autorizzazione temporanea rilasciata a cittadino straniero per impianto e l'esercizio di una stazione di radioamatore in Italia" (Art. N; 331 D.P.R. 156 del 29/3/73).

The postal address of the licensing administration is: Ministero Delle Poste E Delle Telecomunicazioni, Direzione Centrale dei Servizi Radioelettrici, Divisione 5 Sezione 3, Viale Europa 160, 00100 Roma. The telephone number is: International

+ 39 6 54601, extension 4975. All correspondence and calls should be in Italian.

The address of the reciprocal licensing department of the ARI is: ARI-R.L.D., Via Giorgione 16, att. Manuel F. Calero 14CMF, 40133 Bologna. The telephone number is: International + 39 51 389502. Phone calls are answered in English, French, or Spanish after 8 am GMT, except weekends.

Here are instructions on how to fill out the application form:

1) When you fill out the form, please remember that mobile operation is allowed only on VHF and UHF.

2) Indicate the manufacturer and model number of your equipment. The input must not exceed 300 W.

3) It is very convenient to apply to the reciprocal licensing department of the ARI, since they will take care of many of the administrative details.

4) If you do any travel in Europe, it is worthwhile to purchase *The International VHF-FM Guide*, by J. Baldwin G3UHK, 41 Castle Drive, Maidenhead, Berks SL6 6DB, Great Britain. The book contains lots of useful information regarding VHF and UHF repeaters all over Europe. It also provides the addresses of various postal administration offices in Europe and procedures for obtaining temporary licenses. The cost of the book is \$3 US, plus postage, and the editor's phone number is: International + 44 628 37837.



### LIBERIA

Brother "Don" Donard, Steffes, C.S.C.  
EL2AL/WB8HFY  
Brothers of the Holy Cross  
St. Patrick High School  
PO Box 1005  
Monrovia, Republic of Liberia

Liberia amateur radio, when the truth is out, is primarily expatriate amateur radio. Missionaries, doctors, teachers, and even business people like to have an amateur-radio license so that they can talk to their friends and relatives back home. When they travel, they like to pass on information regarding airplane schedules, arrival times, and things like that.

There are many of these people in Liberia. To say that they number in the hundreds is conservative. Not all of them have radios, but as it works out, there are more expatriates operating amateur radios than there are natives. This is not a desirable situation, and we in the Liberia Radio Amateur Association are trying to do something about it.

The point of this article is to discuss amateur radio in Liberia in its relation to medicine. There are a few major cities in Liberia that have hospitals, doctors, and other medical facilities. People who can reach these places can be cared for, but the greater part of the population lives in villages where there may be no communication, difficult transportation, and no doctors or medical facilities. Some of these villages are served by medical missionaries who operate mobile clinics, and some of them are not served at all.

One day, I was turning the dial on my radio when I heard a call come in from one of these outlying areas. The amateur up there was in communication with a doctor, an amateur, here in Monrovia. He was describing severe leg infection which could involve the loss of the limb. The doc-



**The BEST is still  
"made in U.S.A."**



# MIRAGE

**American made RF Amplifiers and Watt/SWR Meters  
of exceptional value and performance.**

• 5 year warranty • prompt U.S. service and assistance

## RF AMPLIFIERS

### 2 METERS-ALL MODE

**B23** 2W in=30W out \$89.95  
(useable in: 100 mW-5W)

**B108** 10W in=80W out \$179.95  
(1W=15W, 2W=30W) RX preamp

**B1016** 10W in=160W out \$279.95  
(1W=35W, 2W=90W) RX preamp

**B3016** 30W in=160W out \$239.95  
(useable in: 15-45W) RX preamp  
(10W=100W)

### 220 MHz ALL MODE

**C106** 10W in=60W out \$199.95  
(1W=15W, 2W=30W) RX preamp

**C1012** 10W in=120W out \$289.95  
(2W=45W, 5W=90W) RX preamp

**C22** 2W in=20W out \$89.95  
(useable in: 200mW-5W)

### RC-1 AMPLIFIER

**REMOTE CONTROL** \$24.95  
Duplicates all switches, 18' cable

## WATT/SWR METERS

- peak or average reading
  - direct SWR reading
- MP-1 (HF)** 1.8-30 MHz  
**MP-2 (VHF)** 50-200 MHz  
\$119.95

### 430-450 MHz ALL MODE

**D24** 2W in=40W out \$199.95  
(1W=25W)

**D1010** 10W in=100W out  
(1W=25W, 2W=50W) \$319.95

Available at local dealers throughout the world.

**MIRAGE**  
COMMUNICATIONS EQUIPMENT, INC.

P.O. Box 1393, Gilroy, CA 95020 (408) 847-1857

tor stated simply that the patient would have to go to a hospital. The answer came back—there isn't any. The next suggestion—he must see a doctor; again the answer—it is out of the question, the nearest doctor is forty miles away and there is no way of getting there.

Running out of alternatives, the doctor here in Monrovia began to ask detailed questions about the situation and to prescribe over the air. A schedule was set for 24 hours later at which time a decision had to be made as to whether or not the infected area would be lanced.

Medical consultation on amateur radio is common here. Many times there are emergencies where this medium is the only communication available. Some weeks ago, I received a frantic call from an amateur in the vicinity of one of the leper colonies. They were out of a medicine which the lepers must have on a regular basis to hold the disease in check. I drove downtown to bring the message to the leprosy control center.

We, the amateurs, lack numbers. We have other commitments; radio is a hobby. So, it is difficult, but we are trying to set up a network of communications (the Liberian Net) which will operate on a regular, daily basis. As we expand our numbers and equipment, we may make this a reality.



### MEXICO

Mark K. Toutjian XE1MKT  
Apartado Postal 42-048  
06470—Mexico, D.F.

Since Mexico borders with the United States and has a lot of tourist attractions in all of its 32 states, many questions have come up in the minds of our fellow hams from outside the country with regards to regulations here, happenings, and anything to do with radio-wave activity from down "south of the border." I hope to answer some of these questions one by one as a correspondent for 73. Some have asked about what awards are offered here. Let's take a peek at one of these awards this month.

#### THE MEXICO CERTIFICATE

Well, one of the unique awards that the Mexican Radio Experimenters League offers to hams around the world is the Mexico Certificate or diploma, with the following requirements.

- 1) Confirm at least 50 Mexican stations; anything from January 1, 1957, on is accepted.
- 2) Confirm 15 different states within Mexico, including what we call "D.F." (Mexico City). (See box.)
- 3) Stations confirmed should be legally authorized by the Secretary of Communications and Transports (SCT).
- 4) Combining CW and phone is not accepted, although either of the two is OK as are SSTV and RTTY.
- 5) Your registered correspondence should be sent to La Liga Mexicana de Radio Experimentadores, A.C., PO Box 907, 06000 Mexico, D.F.
- 6) The Mexican ham operators who apply for this award have to confirm bilateral contacts with at least 20 different states besides Mexico City.
- 7) You should include with your application the confirmed QSL cards, the corresponding list, and \$3.00 US for postage and handling. Don't forget, CW, AM, SSB, RTTY, and SSTV are accepted.

There are quite a few other awards that are available through our Radio Experimenters League here in Mexico and from different radio clubs; I will deal with them in future columns.

Personal satisfaction can be derived through obtaining one of these awards, since time and experience as a radio operator is obviously a factor. Part of the etiquette of the Mexican ham operator is the importance for one to be balanced, not letting the radio control your daily activities; rather you should control the rig so that it doesn't push aside the more important things in life. I, personally, live by that standard. That's the good thing about obtaining awards now and then. You're not pressed for time in order to obtain them. You can take your sweet time (days, weeks, or even years) and eventually begin framing those lovely certificates. And, of course, your ability to work "over the air" and set up your antennas and equipment in emergency situations should improve as time goes on.

So, try for the Mexico Award! Get started soon! And for those of you who already have some QSLs saved up from Mexico, work on the states you lack still, and happy DXing!



### THE NETHERLANDS

Henk Meerman PD0DDV  
Zandvoortweg 33  
2111 GR Aerdenhout  
The Netherlands

#### A TEMPORARY LICENSE IN HOLLAND

When you're planning a visit to the Netherlands and would like to talk to the Dutch amateurs, you'll need a license for it. I will give you all some tips:

The application for a temporary amateur-radio license must be sent to Holland at least six weeks in advance of the date that you desire the license to be used. For the application form that you'll have to fill in and a copy of the Dutch amateur-radio license conditions, send your request to: Radio Control Services, PO Box 570, 9700 AN Groningen, The Netherlands.

Remember, too, that the Dutch Radio Control Services will not deal with any license requests before you have paid the annual charge of D. fls. 65-- (about \$20.00) in advance. Unfortunately, you have to pay for a whole year even if you only stay for a week or so. Furthermore, your payment can only be made by International Money Order addressed to: P.T.T. Centrale Dienst, Kortenaerkade 12, 2518 AX The Hague, The Netherlands.

Note that your callsign must be stated on your money order.

Together with your application form, you have to send a verified photostat copy

of your license and a copy of your money order. The copy of your license must be verified by your postal service or the authorities that deal with licenses in your country. There must be a clear indication on your license that it is still valid.

To be granted an amateur-radio license in The Netherlands, you have to be at the age of sixteen or over.

The license conditions, as you know, vary from country to country. For Holland, they are gathered in a small 39-page booklet in the English language that you'll receive together with your application form. When you open this booklet, you'll find out that 50 and 220 MHz are not amateur frequencies in Holland. Licenses for those bands are very rarely given.

Other things that are not allowed in Holland are:

- a) The use of transmitters in aircraft.
- b) The transmission of messages from third parties.
- c) The transmission of messages of a commercial nature.

It is interesting to know that most of the Dutch amateurs on 2 meters use horizontally-polarized antennas at their QTHs, while most of the mobile stations and repeaters use verticals.

When you arrive at Schiphol Airport (Amsterdam), give a shout on the nearest repeater there: PI3HLM on 145.775 MHz. Almost all Dutch amateurs speak English in some way and they will be glad to hear you and will answer any question you'll ask them. If you have a bit of luck, you will find a YL or an OM who will show you around the beautiful city of Amsterdam—the museums, buildings, etc. If you are in for a romantic trip, take a boat trip through the canals of Amsterdam at night!

So, if you are planning a trip to Amsterdam, there are reasons enough to bring your HT along. Don't forget fresh batteries (Hi).



### NEW ZEALAND

D. J. (Des) Chapman ZL2VR  
459 Kennedy Road  
Napier, New Zealand

Kia Ora atu i Aotearoa! (Hello from New Zealand.) This month I will continue with the special groups within the New Zealand Association of Radio Transmitters; I shall cover the OTC, the Old-Timer's Club, New Zealand's equivalent of the QCWA in the USA.

The formation of the Old-Timer's Club was approved at the 1952 Annual Conference of NZART at Dunedin. During the ensuing year, the old-timers throughout the country worked towards the inaugural meeting of the group to be held during the 1953 Annual Conference of the Association at Palmerston North.

The first meeting was duly held at 1940 NZTime on May 31, 1953, in a convenient room, after the conference sessions were finished. Sixteen eligible "old hams" attended and had discussions on the proposed objectives of the club and the conditions of eligibility for joining the club. The following was decided and remains applicable today, 30 years later.

Membership is available to any ZL amateur who has held an amateur license for the last 25 years or more and is still an active amateur.

The objectives of the Old-Timer's Club (ZL) as set out in its constitution adopted in 1954 are as follows:

- (i) To recognize service to amateur radio.
- (ii) To revive and maintain interests and good fellowship among the older members in the common cause.
- (iii) To offer aid to the "young-timers."

Within the first three months, the numbers of the OTC had grown to 55, and they all were issued with Certificates of Membership on September 30, 1953, and all deemed to be foundation members of the club. The certificates were donated by two old listener members, Monty and Old Fred, and were designed by one of the members.

The OTC has continued to flourish. Today it has over 500 members, 150 who have received their 50-year certificates and one his 60-year certificate. The club meets regularly "on the air" in OTC Nets on 80 and 40 meters on Sunday mornings. Eyeball QSOs also are maintained in the main cities, where old-timers get together during the afternoon for meetings or on the weekends during the summer for picnic outings. The Old-Timer's Club has its Annual Meeting and Reunion during the NZART Annual Conference each year, when they elect their president, the Grand Old Man, who holds office for one year.

There is no set subscription or entry fee for membership, but any small donations made with applications for membership do assist with the club's expenses for postage and stationery. Also, there is usually a collection made at the club's annual meeting each year to supplement the finances.

The OTC also has a regular column in the Association's magazine, *Break-In*, and offers an award, the Old-Timer's Cup, to the elected Grand Old Man each year. A certificate in keeping with this grand office is presented to the holder of the cup as a permanent reminder of his year in office. The Montgomery Cup, another OTC award, is presented to the member or members who have contributed the most worthy item or article to *Break-In* each year.

Recently, the OTC published a Directory of Members containing the names of all members at the date of publication, along with other relevant information such as present call, radio name, original call, other calls held, year first licensed, QTH, and OTC number. The Directory is available to interested overseas amateurs by writing to the Secretary, OTC—G. E. Brown ZL2BD, 35 Chamberlain Street, Nelson, New Zealand, enclosing US\$3.00 or 12 IRCs, which includes return postage.

#### BITS 'N' PIECES

OTC Diamond Jubilee operators, Dan Wilkinson ZL2AB and Len Spackman ZL1AC, are joined by another two old-timers who also celebrate 60 years of ham radio this year. They are George Blake ZL3FX and Bob Robinson ZL4AC. Congratulations, George and Bob, on joining that elite corps of 60-year operators! Also two honorary OTC members have achieved

#### STATES IN THE MEXICAN REPUBLIC

D.F. (Mexico City)	Guerrero	Quintana Roo
Aguascalientes	Hidalgo	San Luis Potosi
Baja California (Northern)	Jalisco	Sinaloa
Baja California (Southern)	Mexico	Sonora
Campeche	Michoacan	Tabasco
Coahuila	Morelos	Tamaulipas
Colima	Nayarit	Tlaxcala
Chiapas	Nuevo Leon	Yucacruz
Chihuahua	Oaxaca	Zacatan
Durango	Puebla	Zacatecas
Guanajuato	Queretaro	

**STOP PRESS**  
**AMTOR NOW OFFICIALLY**  
**APPROVED IN U.S.A.**

# AMT-1

## The Definitive AMTOR Terminal Unit

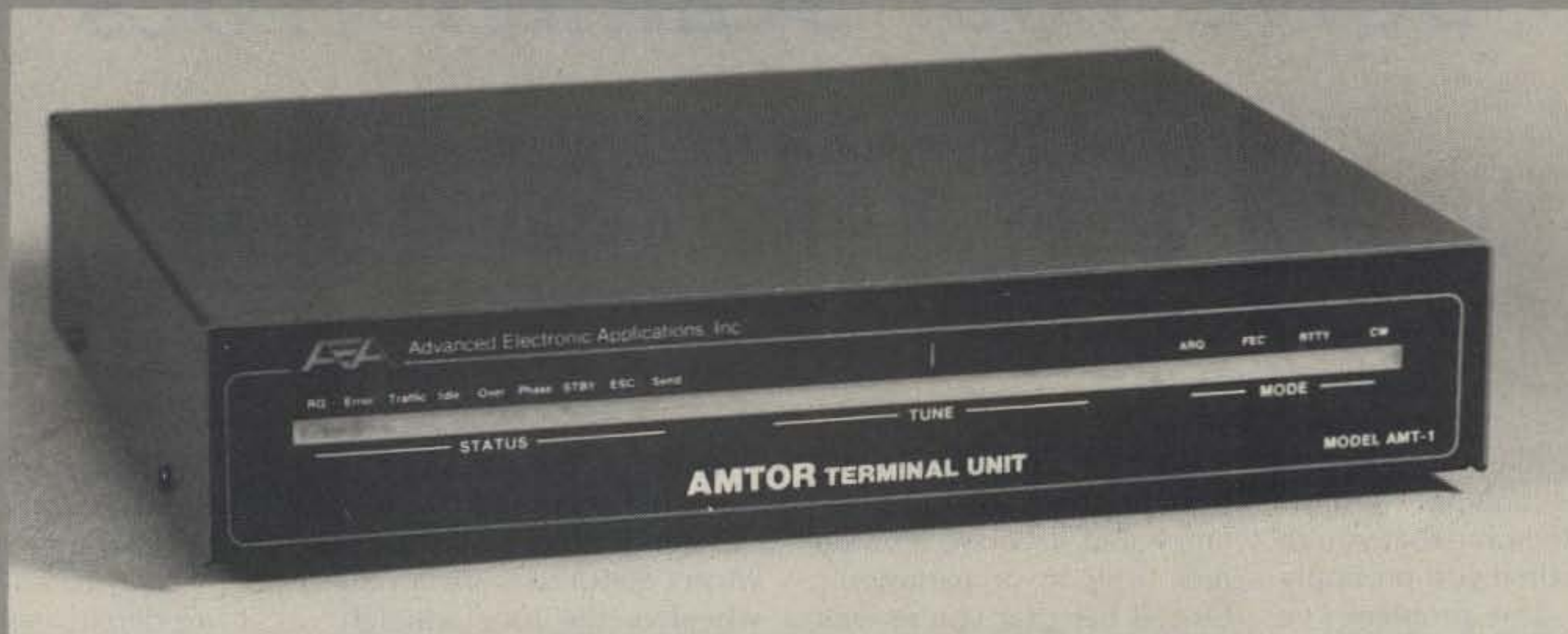

**\$499<sup>95</sup> Introductory Price**

AMTOR is the system of error correcting RTTY which has been rapidly overtaking conventional RTTY in Europe, just as its marine equivalent, SITOR, has been taking over in ship to shore communications.

It was originated by Peter Martinez, G3PLX (see June 1981 QST, p. 25). He first interpreted the international marine CCIR 476-1 specification for amateur use. Virtually all of the 400+ stations presently on AMTOR world wide are using software/hardware designs originated by Peter. The AMT-1 is a proven product which represents his latest and most highly refined design. It represents the culmination of over three years of development and on the air testing, and sets the standard against which all future AMTOR implementations will be judged.

Not only does it incorporate the latest AMTOR specification, but it gives superlative performance on normal RTTY, ASCII and CW (transmit only). As well as some fairly incredible real time microprocessor software, the AMT-1 boasts a four pole active receive filter, a discriminator type demodulator, a crystal controlled transmit tone generator, and a 16 LED frequency analyzer type tuning indicator, which is very easy to use.

Driven from a 12 volt supply, the AMT-1 connects to the speaker, microphone and PTT lines of an HF transceiver and to the RS-232 serial interface of a personal computer or ASCII terminal. All mode control is via ESCAPE and CONTROL codes from the keyboard (or computer program).

It used to be that C.W. was the ultimate mode for "getting through" when QRM and fading were at their worst. That's no longer true — AMTOR will get through with perfect error-free copy when all other conventional transmission modes become useless.

### ADVANCED ELECTRONICS APPLICATIONS

P.O. Box C-2160,  
Lynnwood, WA 98036  
(206) 775-7373  
TELEX: 152571 AEA INTL

**AEA** Brings you the  
**Breakthrough!**

# A Two-Tone Squelch to Solve Your Scanner Woes

*Selective listening is the key to success. This squelch will help you cut the chatter.*

If you're like me and listen to a scanning monitor much of the time that you're at home, then you probably have the same problem I've had: The monitor either drowns out the wife and kids or the family retaliates, turning up the TV and winning the battle of Television vs. Scanner.

Go ahead—try to explain to your wife how important

it is for you to hear the location of that fire or ambulance call if you're a volunteer fireman or paramedic. Or tell her that you're waiting for a call on the local amateur repeater. You'll probably agree with me that you need more than an explanation. I figured I needed a quick and dirty sequential tone squelch to silence the "10-21 or furnish a number" and "QTH is Pine Grove and

the rig is an Icom 2-AT" that filled the scanner's speaker.

I'm not an engineer and I wasn't about to re-invent the wheel or the tone squelch. Instead, I searched through back issues of *QST*, *Ham Radio*, and *73* looking for an easy-to-build two-tone sequential squelch. The closest circuit I could find appeared in the October, 1974, issue of *73* written by Earl Dunn W5LCT. His squelch

used 567 decoders to detect four sequential tones. I wanted to build a squelch for the two tones of my local fire department. So, out came the protoboard and my well-stocked junk box.

## Redesigning the Squelch

Since I was interested in decoding only two tones, I set out to simplify W5LCT's circuit. I used Ramsey Electronics TD-1 tone-decoder kits for each tone. Their PC boards are easy to assemble, reliable, and cheap. Check the ads in the back of any *73*—I believe Ramsey has advertised in every *73* since they opened their doors for business. (Kind of reminds me of the antenna company "In *QST* since '53 without missing an issue." OK, old-timer—name that company.) Back to decoder kits.

The Ramsey TD-1 kit sells for \$5.95 and comes complete with an on-board 5-volt zener. Since I needed 5 volts for the control logic and the TD-1 decoders, I built a regulated supply using a 7805 and eliminated the zener diode and series resistor, D1 and R3, that came with the Ramsey kits. The TD-1 boards are mount-

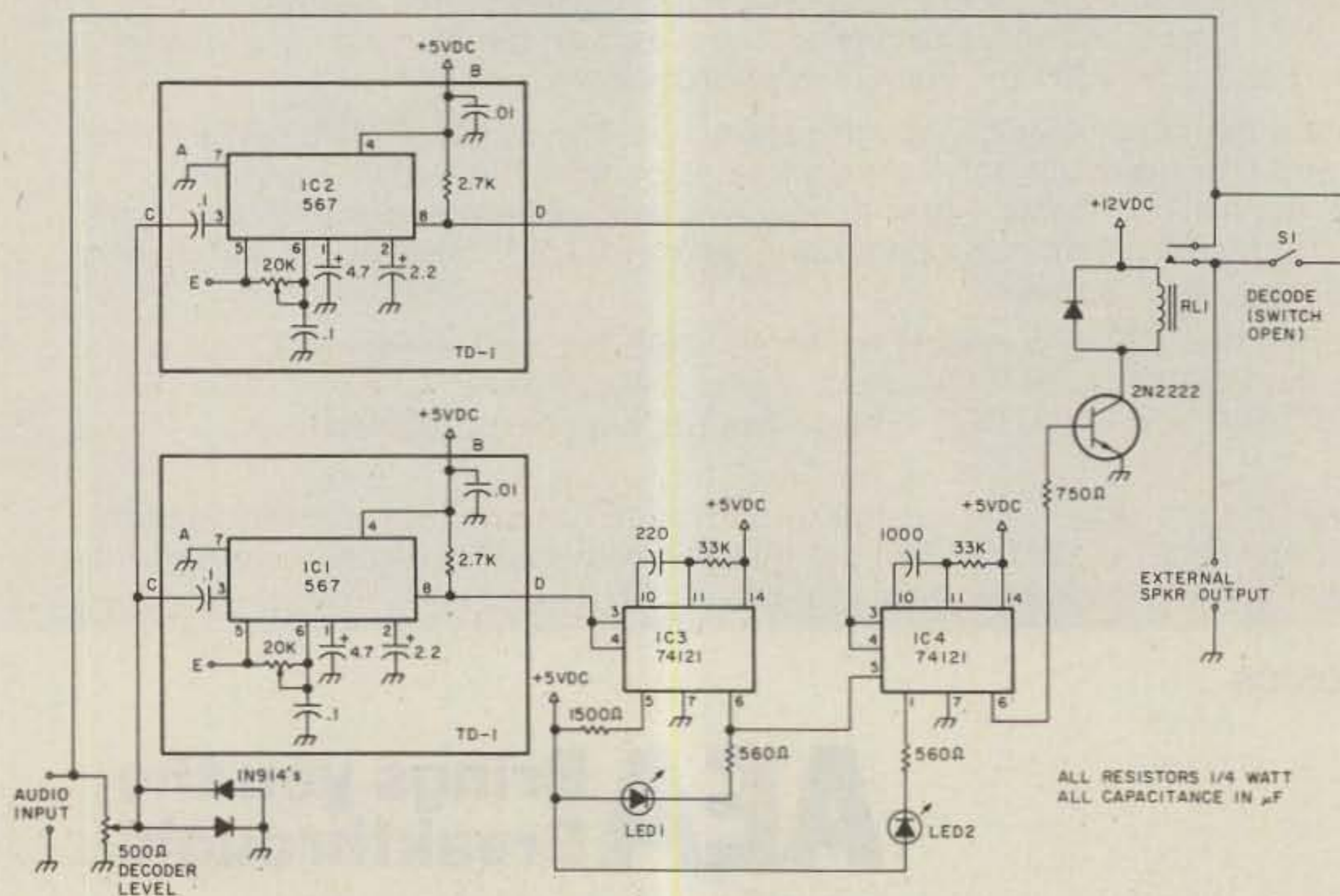
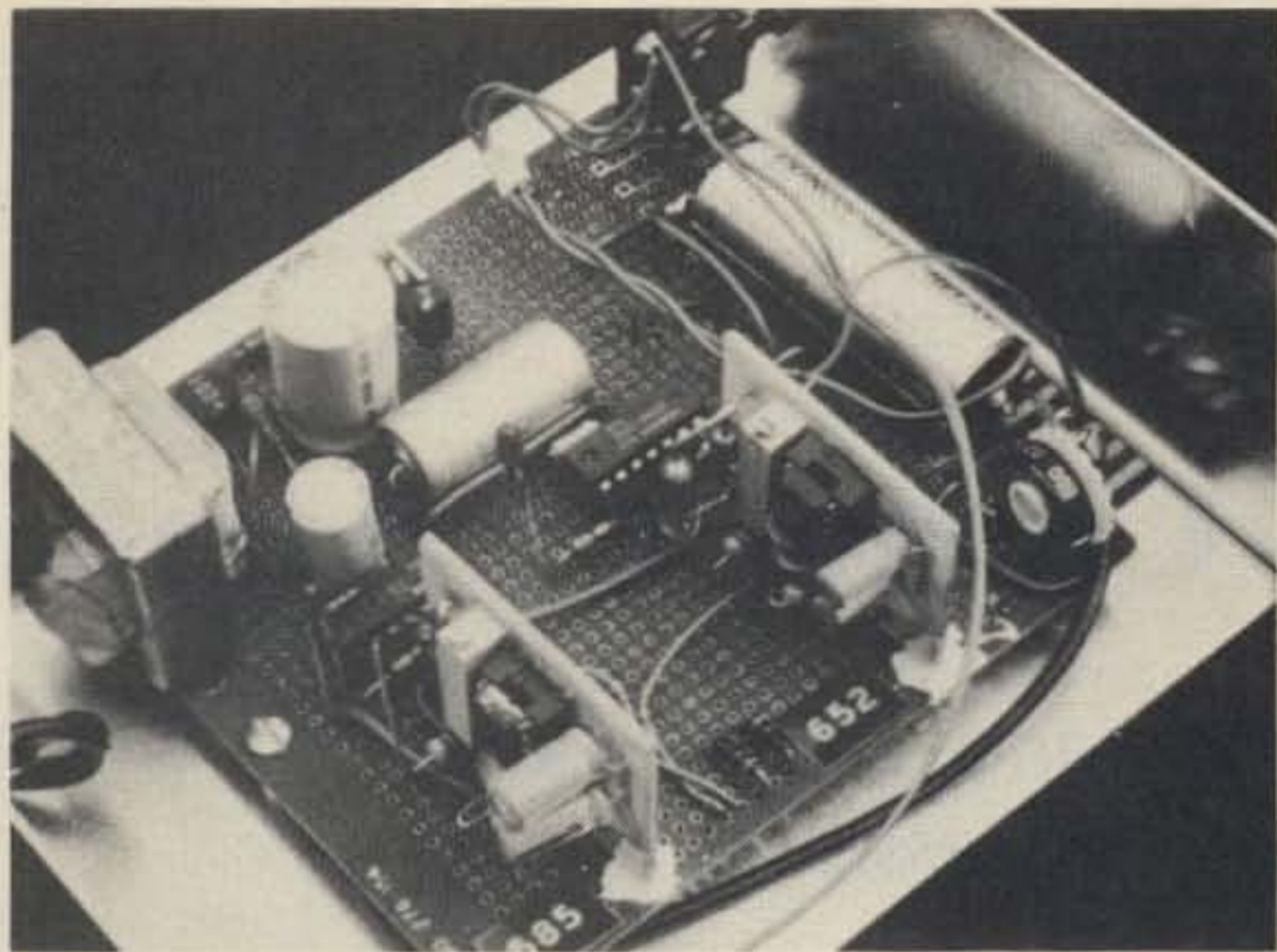

Fig. 1. Schematic.



Inside view of the tone squelch. The TD-1 decoder kits are mounted vertically.

ed vertically on the main board. The photo of my tone squelch shows the TD-1 boards next to the labels marking the decoder frequencies. The control logic, relay, and power supply are on the board behind the decoders. I used the copper pads on the board (Radio Shack 276-156) to wire the control and power-supply circuits.

#### Logic and LEDs

For my squelch to open, a 585-Hz tone must first be received, followed by a 652-Hz tone. Looking at the schematic, IC1 is tuned to 585 Hz. When that tone is received, the output of the decoder goes low. IC3 starts timing a six-second window and LED1 goes off. During this six-second period, a 652-Hz tone must be received and decoded by IC2. LED2 lights when the second tone is decoded. LED2 stays lit for about 25 seconds. During this time (set by the 1000- $\mu$ F cap between pins 10 and 11 of IC4), the 2N2222 is turned on and relay RL1 pulls in, connecting an external speaker to the output of my scanner.

#### Building and Operating the Squelch

Building the tone squelch isn't all that difficult and layout isn't critical. The let-

ters A through E marked on the schematic refer to points on the Ramsey TD-1 decoder boards. Relay RL1 came from my junk box. It's marked 360 Ohms at 12 volts and is a good starting point for substitution. I built a simple power supply using a 12-volt clock-kit transformer. A 1-Amp bridge rectifier followed by a 7805 regulator provides the 12 volts and 5 volts shown on the schematic. Both sides of the ac line are protected with an Elmenco fused plug.

The decoders are adjusted with the tone squelch's input disconnected from the scanner. A frequency counter is attached to point E on the decoder board. The 20k pot is adjusted until the counter reads the frequency you want to decode. Remember, IC1 must be set for the first tone and IC2 set for the second tone in the 2-tone sequence.

To operate the squelch, I plugged the audio input of the tone squelch into the external output of my scanner through a mating plug. An 8-Ohm speaker was connected to the output of the tone decoder. I used the idle tone from a local 152-MHz mobile-telephone channel to set the decoder levels. With the tone present, I set the decoder level pot for about 100 millivolts mea-



Overall view of the completed tone squelch. The squelch fits easily on top of the scanner.

sured with an ac voltmeter at point C on the decoder boards.

Keep the decoder audio input as low as possible to narrow the bandwidth of the decoders. Also, with sequential tones as closely spaced as those in my squelch, the center frequency of each decoder can be slightly offset in opposite directions if decoder-falsing is a problem. In all cases use the minimum amount of audio at point C that permits reliable decoder operation.

After the decoders are set

to frequency and the input level is adjusted, place switch S1 in the open or decode position. Audio from your scanner will be heard only after the correct tones are decoded in the right sequence. The 25 seconds of audio from your scanner can be adjusted by changing the value of the 1000- $\mu$ F capacitor between pins 10 and 11 of IC4.

With the help of this squelch you, too, might end the battle with your television... and hear those tone-encoded calls. ■

#### Parts List

2 Tone decoders, Ramsey Electronics, TD-1	\$11.90
3 Diodes, 1N914 (276-1122)	.33
1 Transistor, 2N2222 (276-2009)	.79
2 LEDs (276-026)	.79
1 Potentiometer, 500 Ohms (271-226)	.59
2 Resistors, 560 Ohms	.19
1 Resistor, 750 Ohms	.10
1 Resistor, 1500 Ohms	.10
2 Resistors, 33k	.19
1 Capacitor, 220 $\mu$ F (272-956)	.79
1 Capacitor, 1000 $\mu$ F (272-958)	.79
1 Relay, RL1 (273-213)	4.49
	<hr/>
	\$21.05

#### Optional Power Supply

1 Transformer, 12 volts, 1.2 Amps (273-1505)	\$3.99
1 Diode bridge, 1.4 Amps at 50 piv (276-115)	1.09
1 Voltage regulator, 7805 (276-1770)	1.59
1 Capacitor, 1000 $\mu$ F, 35 WV dc (272-1019)	1.59
2 Capacitors, .22 $\mu$ F, 50 WV dc (272-1070)	1.78
	<hr/>
	\$10.04

All numbers are from the 1982 Radio Shack Catalog No. 354.

# Electronic Mail Comes of Age

*These mailboxes may be thousands of miles away,  
but they're instantly accessible.*

**H**as your mailbox had a little dust in the bottom of it recently? Have your friends forgotten how to write? Are you tired of all of the junk mail you've been receiving? Well, maybe it's just because you haven't been checking the *right* mailbox!

This article is designed to acquaint you with the new Message Storage Operation, more affectionately known as the MSO or Electronic Mailbox, and to give you some hints on proper ways to exploit the systems, where to find them, and a bit about on-frequency ethics. I hope to present the most important facts about the MSO, but since it is a wide-ranging subject, I'm sure that I will miss something and take this opportunity to invite you not only to experiment with the various MSOs to answer your questions, but also to correspond with me at the above address should you feel it necessary.

The Message Storage Operation is an adjunct to the ever-popular Hal DS-3100 Automatic Send-Receive Terminal, manufactured by the Hal Communications Corporation, Urbana, Illinois. For those of you who presently own a DS-3100 without the MSO, it can be added to your unit with a minimum of trouble and expense. The MSO is a completely solid-state device which adds mass stor-

age to the DS-3100 and which can be accessed either locally or by remote users. It has a 32,768-byte capacity (approximately 450 lines of message storage or retrieval), which has shown to be more than adequate storage.

Control of the MSO can be accomplished by the local or remote user simply by typing a series of commands recognizable by the MSO. Files (messages) can be written to, read from, or deleted from the system by use of these commands, and a "Help" command is provided to assist in using the system. At this point, I would like to mention that the system is fully automatic, written with "fail-safe" features in mind, and cannot be harmed in any way by either the local or remote user. Everyone is a novice when he first uses any sophisticated system; the MSO is not only forgiving, but also will tell you quickly if you make any mistakes.

First and foremost concerning the use of the MSOs is a basic understanding of our frequency usage. No frequency is reserved, set aside, allocated, or otherwise designated for *only* MSO usage! It is important to observe some very basic rules and precautions *before* you activate one of the MSOs in order to prevent QRM to other users of the frequency, whether they be

other MSO users or an already-established QSO on or near the frequency. Just as with any other frequency or mode you use, please *listen* on the frequency before you activate one of the systems. Propagation conditions vary from hour to hour, and it is important to listen for a few minutes on the frequency to keep from stepping on someone else who may be in QSO or using one of the MSOs. Your cooperation in this one area alone will do more for smooth operation of the MSOs than all of the other areas combined!

Just where do you find these mysterious electronic MSOs? Both 20 and 40 meters have well-established MSO operations. The frequencies of 14,085,625 Hertz and 7,096,375 Hertz are popular with many stations, and other smaller operations are appearing daily. I'm told that there is at least one MSO operating on 80 meters (in the western part of the United States), although I'm unaware of its frequency. Those who maintain MSO systems on the various bands almost without exception use some form of crystal control for their transmitters/receivers. Consequently, you can count on these MSOs appearing at the same spot on your dial in day-to-day operations.

This brings up our next

most important subject relative to good frequency usage. It is very important that the tones emanating from your equipment match as closely as possible the tones output from the MSO. In this regard, tradition states that it is the mark frequency with which we measure RTTY frequencies. For instance, in order to successfully activate and use the MSO systems maintained on 20 meters, your mark tone (which is 2125 Hertz lower than your operating or carrier frequency) must land on 14,085,625 Hertz. Your digital readout may read 14,087.7 or some other reading, but it is the mark tone frequency that is important to match with the MSO. Off-frequency operation causes many difficulties, some of which are: unsuccessful activation and de-activation of the MSO, QRM from "fishing expeditions" trying to find the frequency, unsuccessful .WRITE, .READ, and .DELETE commands, and a general lack of smooth operation of the MSO. Modern demodulators have *sharp* front-end filters and, as such, require a very close match to successfully demodulate RTTY signals!

Now that we are sure that the frequency is clear and that we have our transmitting/receiving equipment on the correct frequency, let's talk a bit about some "golden rules" for MSO usage:

1) Anonymity is great, but the FCC *requires* that you properly identify your station! So, please properly identify your station when you are utilizing the MSOs.

2) Always start your transmissions to the MSOs with a short "mark hold" of 2 to 3 seconds, followed by at least one carriage return/line feed (CR/LF). This stabilizes both your equipment and that of the MSO.

3) Each command to the MSO must be preceded by a period, (.WRITE, .READ, .DELETE, etc.) and the command must be "left justified" (positioned on the extreme left margin). Commands sent to the MSO from other than the left margin or without the period are ignored. The only exceptions to this are the Access Code and the four Ns (NNNN), which may be sent from any position in the print line.

4) Limit your messages to that information necessary

to get the message across. In *all* cases, limit your message to *less than* ten minutes in length, in order to comply with FCC identification requirements.

5) Please utilize the .DELETE command to remove messages directed to you from the MSO after you have .READ them.

6) Please use the .SDIR (short-form directory) in lieu of the .DIR (long-form directory) unless you need the information in the long-form directory.

7) Be *sure* to use the .EXIT command to deactivate the MSO when you are through. Failure to shut down one MSO means that it may respond to commands directed to another MSO on the frequency. This does cause a bit of confusion!

As stated earlier, the MSO system does contain a .HELP command to refresh your memory on the various commands available and a

.FILEHELP command to help in constructing files and passwords. Please note that there is a mandatory space character between the .WRITE command and the file name and mandatory carriage return/line feed immediately after the file name. (A carriage return/line feed after each command to the MSO is highly recommended!)

The file name can be any combination of letters and numbers that the receiving station will recognize. Typically, the file name is something like this: .WRITE KØVKH DE K4KOZ (CR/LF). This immediately tells KØVKH that he has a message waiting for him in the MSO and that it is from K4KOZ. The MSO will not accept duplicate file names, so if it is necessary to .WRITE a second message to the same station (while the first one is still on file in the MSO), then make the second file name distinctive

by adding a number or letter, e.g., .WRITE KØVKH2 DE K4KOZ (CR/LF).

Since file names are very distinctive, it is additionally important to send the exact information to the MSO when using the .READ or .DELETE commands, even if it is misspelled in the directory. Without the correct file name, the system will return the "file not found" statement.

In conclusion, the MSOs are providing a very satisfactory service on RTTY, CW, and ASCII, both on the HF and the VHF bands. MSO owners derive a lot of personal pleasure in providing these mailbox services and, speaking for myself, I encourage all those who have need for this service to use my MSO at their leisure. I maintain it on 14,085,625 Hertz during the daylight hours and my access code is MSOVKH (no spaces between letters). Hope to see you on RTTY soon! ■

## The DX EDGE: The Hottest DX Aid Since Sunspots

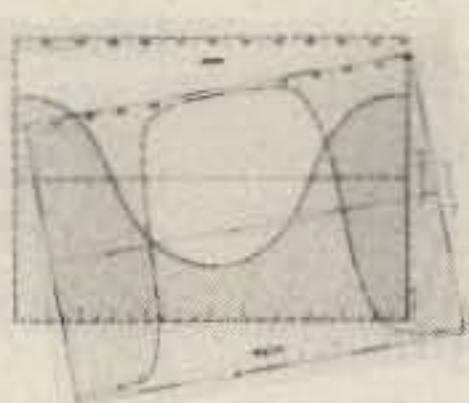

### Improve Your DX Achievements on All Bands

See times of sunrise & sunset propagation peaks instantly for any QTH in the world.

Know when to look for the DX you need;

Long path and Gray Line possibilities seen at a glance.

Plastic slide rule format—Easy to use—Large size

Price: \$14.95 ppd. in U.S., Canada, Mexico. \$18.95 elsewhere, by air. Please make check or M.O. in U.S. funds payable to the DX Edge and mail to:

The DX EDGE, P.O. Box 834, Madison Square Str., New York, N.Y. 10159

An information flyer is available free of charge.

A product of Xantek, Inc. ©Xantek, Inc. 1983

# ALL BAND TRAP ANTENNAS!

PRE-TUNED - COMPLETELY ASSEMBLED - ONLY ONE NEAT SMALL ANTENNA FOR UP TO 7 BANDS! EXCELLENT FOR CONGESTED HOUSING AREAS - APARTMENTS LIGHT - STRONG - ALMOST INVISIBLE!

COMPLETE AS SHOWN with 90 ft. RG58U-52 ohm feedline, and PL259 connector, insulators, 30 ft. 300 lb. test dacron end supports, center connector with built in lightning arrester and static discharge - molded, sealed, weatherproof, resonant traps 1" X 6" - you just switch to band desired for excellent worldwide operation - transmitting and receiving! Low SWR over all bands - Tuners usually NOT NEEDED! Can be used as inverted V's - slopers - in attics, on building tops or narrow lots. The **ONLY ANTENNA YOU WILL EVER NEED FOR ALL DESIRED BANDS - WITH ANY TRANSCEIVER - NEW - EXCLUSIVE! NO BALUNS NEEDED!**

80-40-20-15-10-6 meter - 2 trap --- 104 ft. with 90 ft. RG58U - connector - Model 998BUC ... \$99.95  
40-20-15-10 meter --- 2 trap --- 54 ft. with 90 ft. RG58U - connector - Model 1001BUC ... \$98.95  
20-15-10 meter --- 2 trap --- 26ft. with 90 ft. RG58U - connector - Model 1007BUC ... \$97.95  
SEND FULL PRICE FOR POSTPAID INSURED. DEL. IN USA. (Canada is \$5.00 extra for postage - clerical-customs etc.) or order using VISA - MASTER CARD - AMER. EXPRESS. Give number and ex. date. Ph 1-308-236-5333 9AM - 6PM week days. We ship in 2-3 days. ALL PRICES MAY INCREASE... SAVE - ORDER NOW! All antennas guaranteed for 1 year. 10 day money back trial if returned in new condition! Made in USA. FREE INFO. AVAILABLE ONLY FROM  
WESTERN ELECTRONICS Dept. A7- 11 Kearney, Nebraska, 68847 ✓80

FOR ALL MAKES & MODELS OF AMATEUR TRANSCEIVERS - TRANSMITTERS - GUARANTEED FOR 2000 WATTS SSB 1000 WATTS CW. INPUT FOR NOVICE AND ALL CLASS AMATEURS! IMPROVED DESIGN!

## APPLIED INVENTION

THE SOURCE FOR SOLID STATE / STATE-OF-THE-ART

### GaAs FETS by MITSUBISHI

2M - Ku Band, Very low noise and medium power. 1.4  
MGF 1100 Dual Gate GaAs FET 2.5dBNF @ 4GHz \$ 7.35  
MGF 1202 (1402 chip in a 1200 package) \$ 9.70  
MGF1404 GUARANTEED 0.65dBNF @ 4GHz \$66.60  
MGF1402 . 0.4 dBNF @ 432, 1.1 dBNF @ 4GHz \$14.00  
MGF1412 GUARANTEED 0.8, 0.9 or 1.0 dBNF @ 4GHz \$21. - \$34.75  
MGF1801 10GHz linear PO 150mW \$40.75

### MITSUBISHI X BAND Hybrid Integrated Circuits with tuneable Dielectric Resonator (0.12MHz/°C) GaAs FET Oscillators

FO-1010X - 10.4 GHz, 15mw out, UER100 Flange \$39.37  
FO-1210Y - 11.5 or 12.0 GHz, UER120 Flange \$39.37  
\* FO-UP11KF - Complete Heterodyne Rx, 10.468 GHz LO \$36.22  
Can be used for 12.5 GHz terrestrial and DBS  
\* FO-OP13KF Doppler Module 10.525 GHz UER100 Flange \$43.05  
\* X-Band 15 dBG die cast horn antenna (UER100) \$17.85  
\* GaAs FET Preamp 1.7-2.1 GHz, 2.0-2.35 GHz, 2dBNF \$49.00

### At THE SOURCE for RETICON Universal Audio Active Filters NEW

R5620 digitally programmed switched capacitor audio filter \$ 7.85  
R5621 dual section resistor programmed SCF \$ 6.51  
R5622 quad section resistor programmed SCF \$11.07  
Out performs National MF-10! Application notes \$ 2.00

### OPTOELECTRONICS from MITSUBISHI and SIEMENS CW LASER DIODES, HIGH OUTPUT IRLEDS, PIN PHOTO DIODES.

MITSUBISHI BIPOLAR POWER TRANSISTORS FOR 900/1295  
2SC2931, 2, 3, 4 (1.4 to 30 Watts PO) CALL

MRF 901 Substitute 2SC2876, Ft=70GHz, 2.2dBNF @ 10GHz \$ 1.50  
NEC 64535 direct replacement: Siemens BFQ 74 \$ 9.66

LEADLESS DISK CAPS 100, 220, 470, 680, pF 10/\$ 2.50

MICROWAVE CHIP CAPS - Very low loss VITRAMON P7800 series  
G02(0.7-1.4 GHz) G04(1.3-2.6 GHz) G01(2.6-4.2GHz) \$ 1.25  
VITRAMON VHF/UHF NPO chips: 10, 100, 1000 pF. \$/ \$ 2.50  
A-B type FWSN 1000pF discoidal Feedthru. \$ 0.75

STRIPLINE SHUTTLE TRIMMERS (VOLTRONICS) 0.1, 2.5, 0.5, 9.0pF \$ 3.34  
H-Q SEALED CERAMIC PISTON TRIMMERS (VOLTRONICS) 0.6-9.0pF \$ 3.58  
SAPPHIRE TRIMMERS Johanson 0.4-2.5pF \$ 9.47  
For WA2GFP preamp Sprague 0.6-4.5pF \$ 9.47

Thermo Electric Heat Pumps & Sub-Miniature Cryogenic Refrigerators: CALL

3M 6X250 glass/tie board, Er=2.55 @ 10GHz 0.031 - \$0.31/sq. in.  
0.062 \$0.52 sq. in.

E.F. JOHNSON SMA's: Sq. flange female \$3.50, Male cable \$ 2.88

PROMPT SERVICE. SEND FOR CATALOG. MINIMUM ORDER \$5.00  
VISA/MASTERCARD Accepted. CASH prepay take 5% discount.  
S&H \* (ITEMS (UPS) \$3.75 ALL OTHER ITEMS \$2.50 (1st CLASS)  
NY STATE RESIDENTS ADD 7% SALES TAX

R.D.2 ROUTE 21 HILLSDALE, NY 12529  
518-325-3911 ✓71

## Octal Ingenuity

*It's an old radio. You can't find a replacement tube. Now what do you do?*

One day my mother-in-law handed me an old Philco "antique radio" and said, "Franklin, you're a ham. How about fixing my radio?" I took one look at that old ac/dc battery thing and was about to say I was too busy, but then those words, "you're a ham," shook me up. If I didn't fix it, ham radio would be defamed and I would be one degraded Extra-class amateur. If I did fix it, both ham radio and I would still be

highly esteemed, at least in her mind.

"Sure, I'll give it a try," I said. And the fun began.

Now this old thing was typical for its day. (See the block diagram in Fig. 1.) There were no doubt millions of these sets built, and this particular one looked well-built, mechanically. Electrically, too, it must have been pretty good to survive this long.

After plugging it in and

getting not a peep out of it, I decided to use the usual plan of attack for these jobs. Check the tubes first.

This had to be done without the help of a tube tester. Time to think. If the set is completely dead, a tube fault causing this would probably be catastrophic. Most common in this category is an open filament; then come short circuits and open elements.

It's a good thing I kept that old beat-up RCA tube

manual. A check for which pins to test with the ohmmeter didn't take long, and neither did finding the problem. The 3Q5 audio power amplifier filament was open. What luck! I'll just walk right down to my nearby radio store and get a new one.

What, no 3Q5?! And still no 3Q5 three days later, with a telephone bill to raise my wife's ire. Say, this thing is an antique radio. Oh, I found a place where I

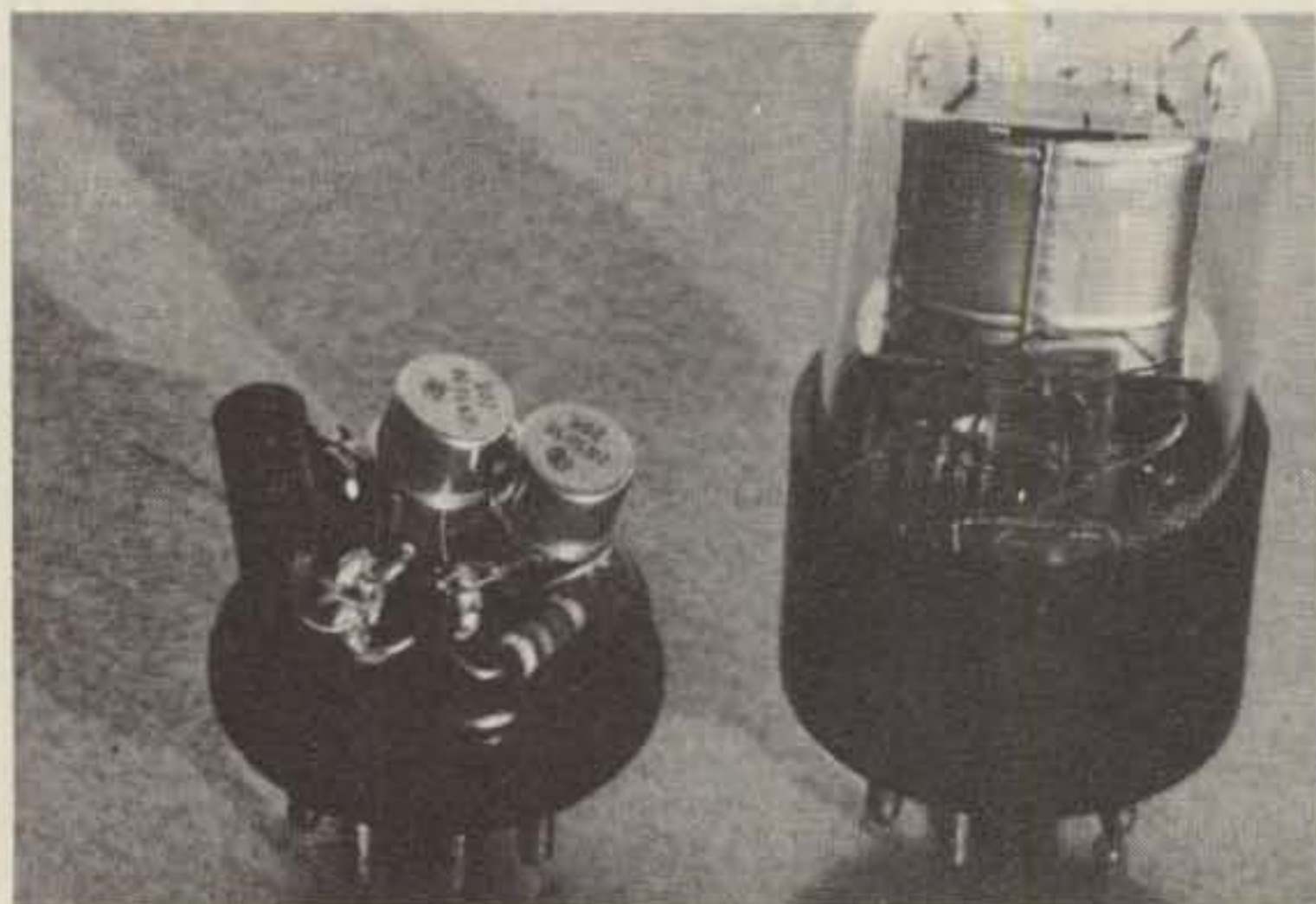

Photo A.

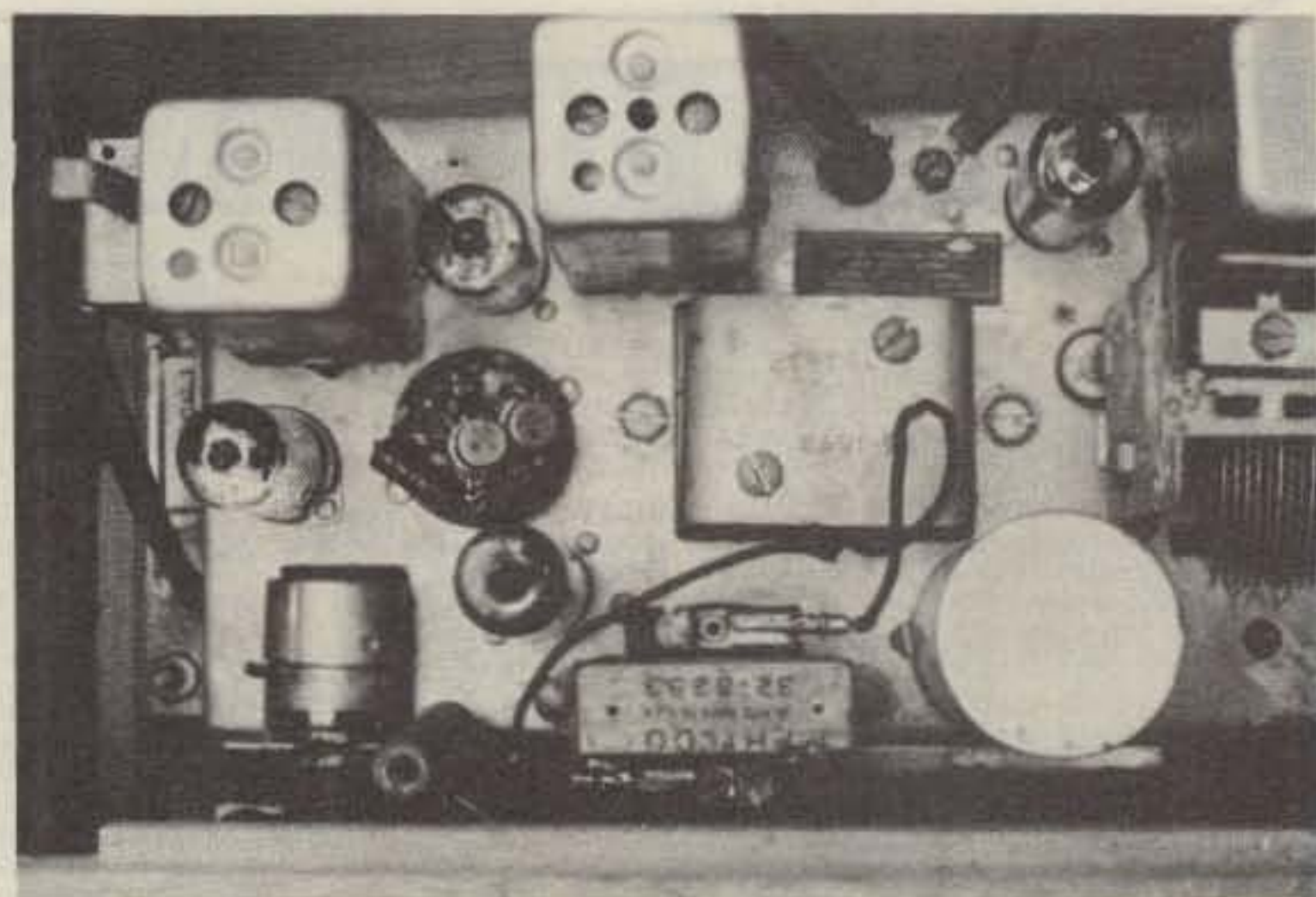

Photo B.



could get a 3Q5 for \$4.00, but minimum orders were for \$25.00.

Why sweat the small stuff? I'll simply transistorize the stage.

Now here begins my story for fellow hams. Not being of the mathematical type, but having a good supply of parts and test equipment, I'll use the tried and proven practical approach.

First, we'll want to know as much as needed about the tube to be replaced. The RCA tube manual gives the essentials: filament 2.8 V at 0.05 A, maximum plate current 8.5 mA, maximum power output 330 mW at 8.5% THD. Obviously, we are not working with high power or high fidelity, so the replacement job looks easy so far.

Next, we'll need to determine what circuit characteristics must be known. Remember, this is an ac/dc battery-type radio. This type had some strange circuitry which was not well standardized. No schematic is available, so an hour or so must be spent in tracing out what is required of the circuit.

The power supply circuit as traced out is shown in Fig. 2. Notice how the filaments of all but the 117Z3 rectifier are supplied from the B+ through suitable dropping resistors R1 and R2. The 3Q5 cathode resistor (680 Ohms) must be viewed as both shunted by the series string of filaments and as affecting the division of B+ current supplied to the filaments. Notice the 30-uF capacitor at pin 7 of the 3Q5 to common. If this is shorted, it could be the cause of open filaments in the 3Q5. Now is the time to check this. (It was OK in this set.)

Further circuit checks show this amplifier as a straightforward pentode

power-amplifier stage (see Fig. 3). The main features to note here are associated with the power supply of Fig. 2. The grid resistor is returned to common through the 1R5 filament. This places the grid 1.4 V dc above common. The 3Q5 filaments are above common by four 1.4-V filaments. This places the 3Q5 cathode potential at about 7 V dc above common. Grid bias was about  $1.4 - 7 = -5.6$  V.

Now we should decide on what type of transistor amplifier circuit to use. Here is where past experience and a general knowledge of transistor amplifier circuits comes in handy. For this case we'll use Darlington-connected, high-voltage transistors such as the 2N5058 (Radio Shack RS-2008); see Fig. 4. This circuit provides a high input impedance as needed for the first af amplifier stage and more than enough gain and power output capability. The choice of transistors meets or exceeds the voltage and power needs.

Resistor R1 is the base bias resistor. It will be determined by experimentation and added as part of the transistor amplifier plug-in module. Resistor R2 is the base bias divider resistor, which may be the 2.2-meg resistor already in the radio. Resistor R3 is added to control the division of current

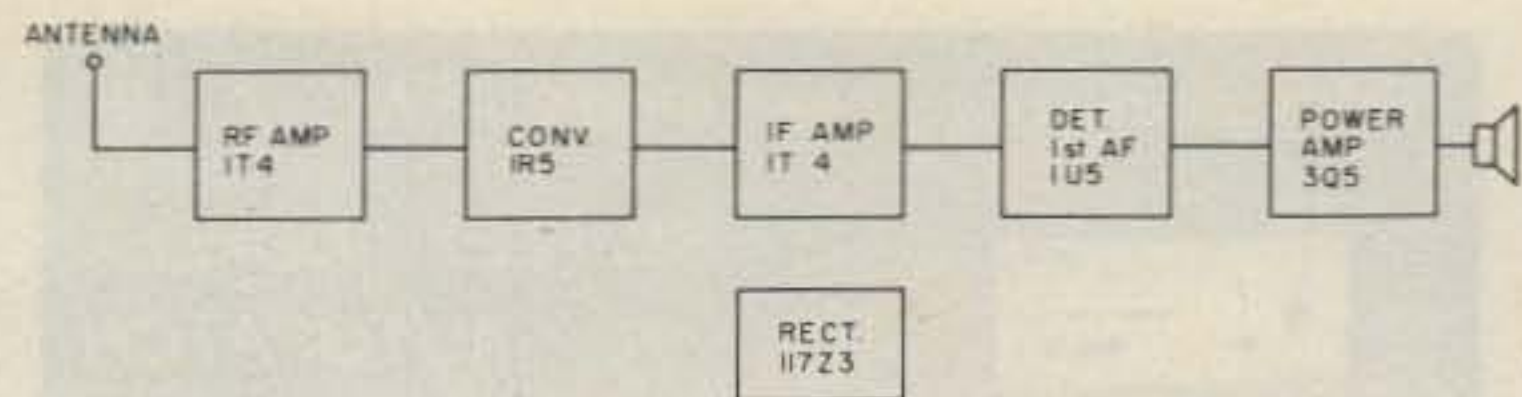

Fig. 1. Block diagram.

between Q1 and Q2. Resistor R4 is the emitter swamping resistor used for temperature stability. It is shown entirely bypassed by C2, but we will experiment with the circuit to determine how much we need or want bypassed. Capacitors C1 and C3 as well as the output transformer are already in the radio. These are used as is.

Let's begin the design and construction. First, use CAUTION. Use an isolation transformer as you always should when working on ac/dc equipment not having its own transformer.

Make up an octal plug with wires out to a breadboard setup. This can be done nicely in this case because we are working with low frequencies and relatively low gain. The octal plug is inserted into the 3Q5 socket and the breadboard set up near by.

Initially, calculate or determine component values by Ohm's Law and past experience examples. The resistor replacement for the 3Q5 filament, for example, is determined by Ohm's Law as  $R = E/I = 2.8/0.05 =$

56 Ohms. Power is  $P = EI = 2.8 \times 0.05 = 0.14$  Watts. So use some value near 56 Ohms having a power of at least 1/4 Watt to start with.

Resistor R3 in Fig. 4 is calculated to guarantee at least 250 uA in Q1 by assuming that this amount of current will be through it when the Q2 normal  $V_{BE}$  of 0.65 V is present.  $R = E/I = 0.65/250 \text{ uA} = 2.7\text{k}$ . Power in this resistor is insignificantly low.

Install the 56-Ohm and 2.7k-Ohm resistors on the breadboard. Use resistor substitution boxes or junk-box resistors for R1 and R4. Initially, set R1 for its highest value (10 meg). Set R4 at 1k Ohms initially. Capacitor C2 may have a starting value of 10 uF at 10 V or more. Try all of the three possible near common pins (2, 8, and 7) of the 3Q5 socket one at a time for the circuit common.

Check radio operation for output at about 1/3 volume-control setting. Also check and record filament voltage at pin 7 relative to common, dc current through R4 (via voltage drop and Ohm's Law), and

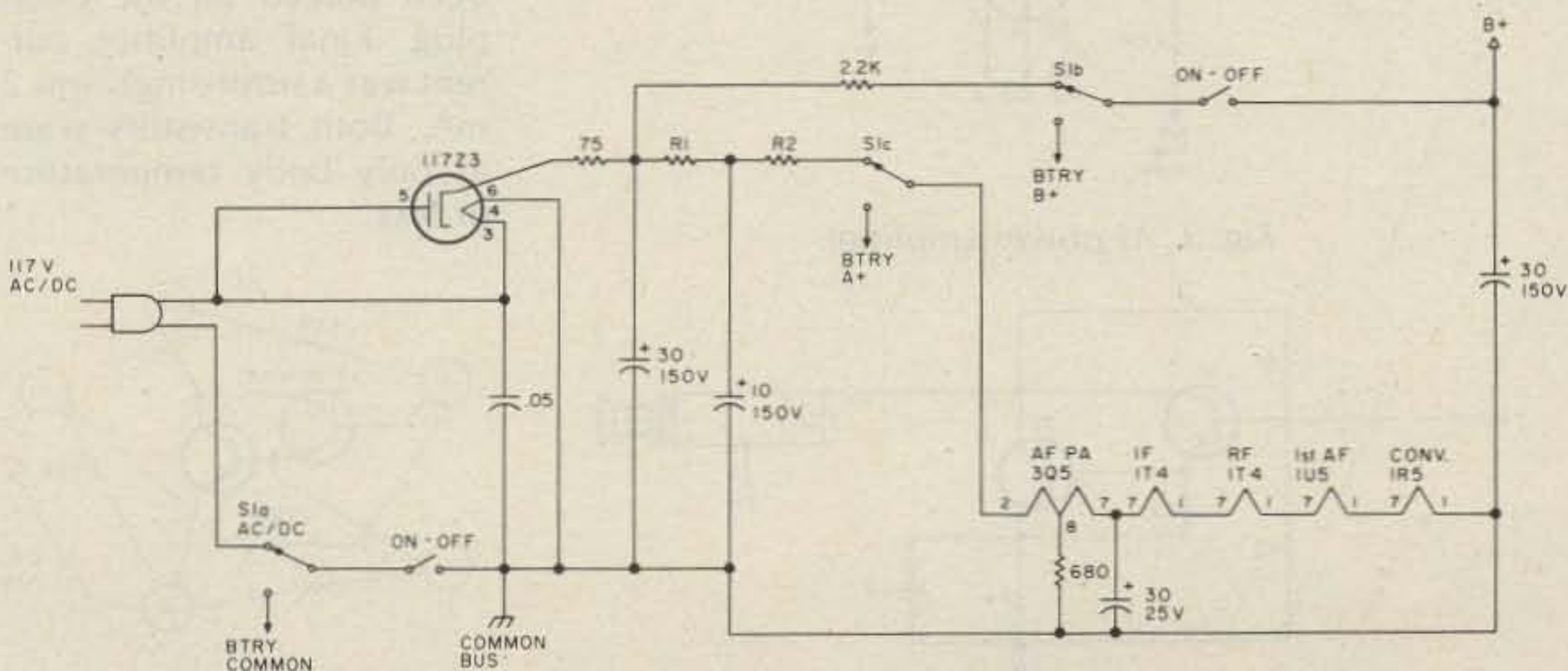
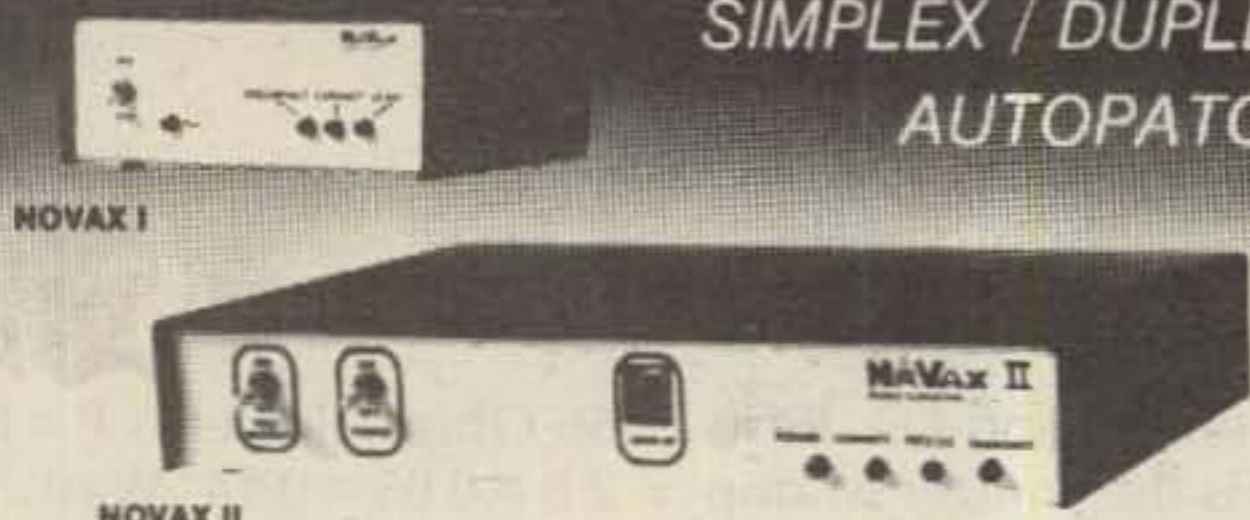

Fig. 2. Power supply.

Introducing our Latest Model — NOVAX II

SIMPLEX / DUPLEX  
AUTOPATCH



NOW TWO MODELS TO  
SERVE YOU BETTER  
YOUR OWN PRIVATE AUTOPATCH

**NOVAX**  
MOBILE CONNECTION

NOVAX interfaces your standard 2 meter; 220; 450; etc. Base station and telephone, using a high speed scan switching technique so that you can direct dial from your automobile or with your HT from the backyard or poolside — Automatically ... Easy installation transceivers, featuring solid state switching, offer best results ... Available interfaced with an ICOM 22U.

FEATURES	NOVAX I	NOVAX II
• 3 min. Call duration timer	YES	YES
• Up to 45 sec. activity timer	YES	YES
• Single digit Access Control	YES	NO
• DTMF (Touch Tone)* phone connection	YES	YES
• 4 digit Access Control	NO	YES
• Toll Restrict	NO	YES
• LED Digital Display	NO	YES
• Vinyl covered alum. case size	5" x 6" x 2"	10" x 8" x 1 1/2"
• Directly Interfaces with Repeater	NO	YES
• Rotary Dial System (incl. Last digit dial)	NO	YES—“Option”
• Ring Back (reverse autopatch) “Option”	YES	YES—Wired

To order, send check, money order to:  
MASTER CHARGE AND VISA ACCEPTED



Box 162 - Tudman Rd.  
Westmoreland, N.Y. 13490  
or Phone 315-829-2785

\* Trademark ITT

# NEW!



## COMPUTER RADIO MODEM

Connect your TRS-80\*, Atari\*, Apple\*, or IBM-PC\* to your radio for the ultimate in two way digital communications (CW/RTTY/ASCII).

CALL OR WRITE FOR DETAILS



(209) 667-2888

**MACROTRONICS, inc.**®

1125 N. Golden State Blvd.  
Turlock, CA 95380

\*TRS-80 is a registered trademark of Tandy Corp. Atari is a registered trademark of Atari Computer Inc. Apple is a registered trademark of Apple Computer Inc. IBM-PC is a registered trademark of International Business Machine Corp.

feel the transistors for heat. **Caution:** Remove voltage just prior to touching the transistors, as up to 100 volts may be present. Change values of components in small steps until you obtain correct filament voltage (5.6 V), less than maximum current (8.5 mA),

sufficient output volume with low distortion, and operation with neither transistor more than slightly warm to the touch.

My final circuit was easily constructed on an octal plug (see Photo A) and provided what seemed to Mother more volume and

clearer tones than she had ever heard from this set.

The final circuit is shown in Fig. 5. The original 680-Ohm resistor was disconnected inside the set so that pin 8 could be used as a tie point on the plug. The final filament resistor value was 150 Ohms (not the calculated value of 56 Ohms). This also was wired inside the set although it could have been placed on the octal plug. Final amplifier current was a surprisingly low 2 mA. Both transistors were at only body temperature or less.

Notice that the 2.2k-Ohm resistor is bypassed with a 0.5-uF capacitor, but connection to pin 2 for the common return effectively places the 150-Ohm filament resistor in the circuit unbypassed. This helped to raise input impedance as well as to lower distortion. The increased input impedance must have offset gain reduction in this stage because gain was still more than enough.

The 220-pF capacitor was added to eliminate high-frequency hiss. The source of this may have been a poorly filtered signal from the detector or a parasitic oscillation in the transistor stage.

For the last two years now, my mother-in-law hasn't had one bad thing to say about ham radio. She seems well satisfied as she sits in her rocking chair listening to those far-away stations. ■

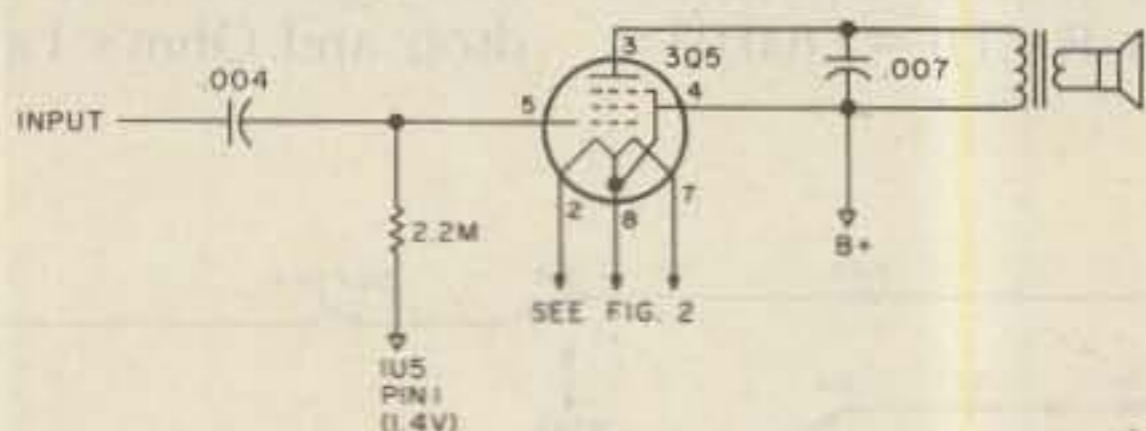

Fig. 3. Af power amplifier.

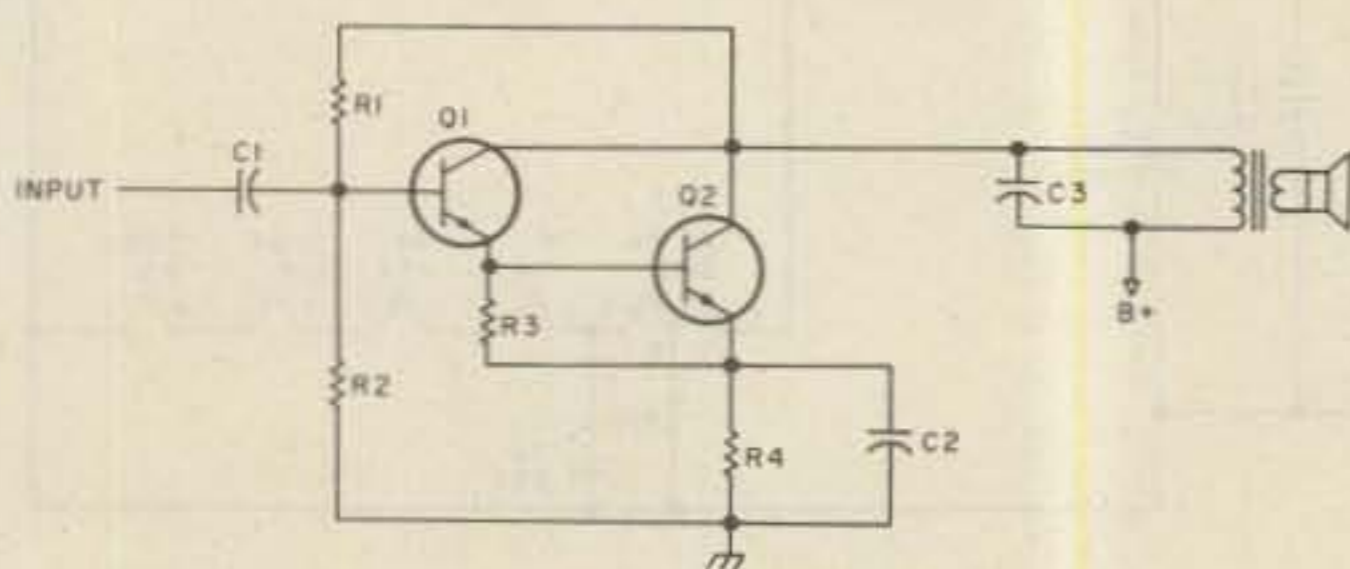

Fig. 4. Transistorized af power amplifier.

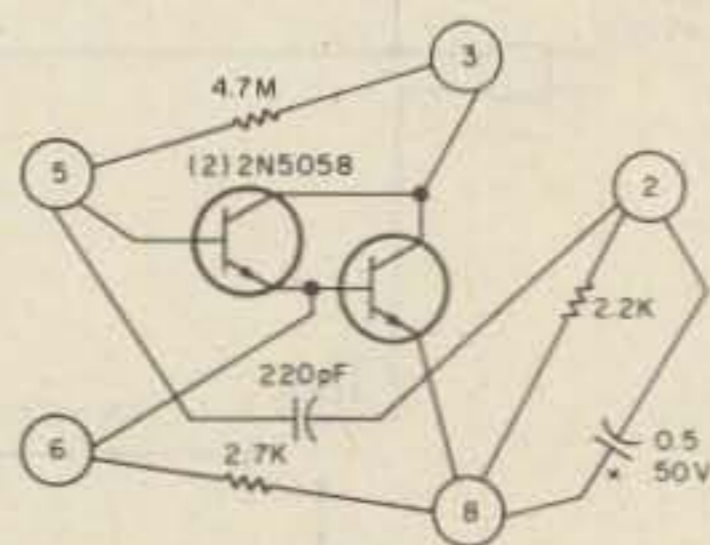

Fig. 5. Final circuit. (Top view of octal plug.)



## ... at last ... your shack organized!

A beautiful piece of furniture — your XYL will love it!

### \$184.50 S-F RADIO DESK

#### Deluxe - Ready to Assemble

Designed with angled rear shelf for your viewing comfort and ease of operation.

FINISHES: Walnut or Teak Stain.

Floor Space: 39" Wide by 30" Deep

Additional Information on Request.

Checks, Money Orders, BankAmericard and Master Charge Accepted.

F.O.B. Culver City. (In Calif. Add 6% Sales Tax.)

DEALER INQUIRIES INVITED

S-f Amateur Radio Services

**SF**

✓65

\$199.50

4384 KEYSTONE AVENUE • CULVER CITY, CALIF. 90230 — PHONE (213) 837-4870

## You've earned your Ham ticket. Now What?

Now you're ready to get on the air but you're not sure about how to actually install that antenna; or how to solder a PL-259 connector; or how to properly ground your station; or identify unknown transistor leads; etc.

Here's the perfect companion for exploring the more practical aspects of the world's greatest hobby.

The new *Heil Ham Radio Handbook* was written by the 1982 Radio Amateur of the Year—Bob Heil, K9EID. Bob heads his own electronic manufacturing company and is respected world-wide for his sound systems, microphones and equalizers.

Bob's new book fills the gap that often makes the difference between sitting there watching the dial lights and actually making contacts that are the real joy of amateur radio.



This book doesn't stop at the intermediate level however; you'll find handy hints no matter how long you've been licensed, and unlike other publications you won't need a PhD in engineering to understand the material.

It's a money-saver too—you can make your own 5amp 12VDC power supply at 1/3 the cost, as shown in this handbook, from parts you may have on hand.

In fact, once you own and start using this Handbook you'll wonder why "somebody" didn't publish it sooner! And the sooner you send for it, the sooner you'll be enjoying more aspects of Amateur Radio... Send \$9.95 (plus \$1.00 shipping) directly to:

### MELCO Publishing

P.O. Box 26  
Marissa, IL 62257

✓103

### SYNTHESIZED SIGNAL GENERATOR



MADE IN  
USA

MODEL  
SG100D  
\$349.95  
plus shipping

- Covers 100 to 185 MHz in 1 kHz steps with thumb-wheel dial • Accuracy 1 part per 10 million at all frequencies • Internal FM adjustable from 0 to 100 kHz at a 1 kHz rate • Spurs and noise at least 60 dB below carrier • RF output adjustable from 5-500 mV at 50 ohms • Operates on 12 Vdc @ 1/2 Amp • Available for immediate delivery • \$349.95 plus shipping
- Add-on Accessories available to extend freq. range, add infinite resolution, voice and sub-audible tones, AM, precision 120 dB calibrated attenuator
- Call for details • Dealers wanted worldwide.

**VANGUARD LABS** ✓311  
196-23 Jamaica Ave., Hollis, NY 11423  
Phone: (212) 468-2720

Custom Mailing Lists on Labels!

### Amateur Radio Operator NAMES

Custom lists compiled to your specifications

- Geographic by ZIP and/or State
- By License Issue or Expiration Date
- On Labels of Your Choice

Total List: 435,000 Price: \$25/Thousand

### Buckmaster Publishing

Whitehall, Mineral VA 23117

✓255

### ANNOUNCING 73 CLASSIFIEDS

## BARTER 'N' BUY

Beginning with the December issue, 73 will accept classified advertising. Individual and non-commercial rates—15¢ per word; commercial rates—50¢ per word; prepaid by check or money order. Ads must pertain to amateur radio products or services, and must be submitted typewritten, doublespaced, 100 words maximum. Include full name and address in ad; telephone number optional. Copy must be received in Peterborough by the 5th of the second month preceding cover date. Example: December issue ad must be in our hands by October 5th. Ads received after deadline will be run in the next issue. Direct all material and inquiries to:

**BARTER 'N' BUY**  
73 ADVERTISING DEPARTMENT  
Elm Street, Peterborough,  
New Hampshire 03458.  
Telephone: (603) 924-7138

## HI-Q BALUN

- For dipoles, yagis, inverted vees & doublets
- Replaces center insulator
- Puts power in antenna
- Broadbanded 3-40 MHz
- Small, lightweight and weatherproof
- 1:1 Impedance ratio
- For full legal power and more
- Helps eliminate TVI
- With SO-239 connector

only \$13.95



### HI-Q ANTENNA CENTER INSULATOR



Small, rugged, lightweight weatherproof

Replaces center insulator

Handles full legal power and more

With SO-239 connector

\$6.95

### HI-Q ANTENNA END INSULATORS



Rugged, lightweight, injection molded of top quality material, with high dielectric qualities and excellent weatherability. End insulators are constructed in a spiral unending fashion to permit winding of loading coils or partial winding for tuned traps.

May be used for

- Guy wire strain insulators
- End or center insulators for antennas
- Construction of antenna loading coils or multiband traps.

\$4.95

## DIPOLES

MODEL	BANDS	LENGTH	PRICE WITH HI-Q BALUN	WITH HI-Q CENTER INSULATOR
<b>Dipoles</b>				
D-80	80,75	130	\$31.95	\$27.95
D-40	40,15	66	28.95	24.95
D-20	20	33	27.95	23.95
D-15	15	22	26.95	22.95
D-10	10	16	25.95	21.95

<b>Shortened dipoles</b>				
SD-80	80,75	90	35.95	31.95
SD-40	40	45	32.95	28.95

<b>Parallel dipoles</b>				
PD-8010	80,40,20,10,15	130	43.95	39.95
PD-4010	40,20,10,15	66	37.95	33.95
PD-8040	80,40,15	130	39.95	35.95
PD-4020	40,20,15	66	33.95	29.95

Dipole shorteners - only, same as included in SD models

S-80	80,75	\$11.95 pr
S-40	40	\$10.95 pr

All antennas are complete with a HI-Q Balun or HI-Q Antenna Center insulator, No. 14 antenna wire, ceramic insulators, 100 nylon antenna support rope (SD models only 50) rated for full legal power. Antennas may be used as an inverted V and may also be used by MARS or SWLs.

**Antenna accessories**—available with antenna orders  
Nylon guy rope 450# test 100 feet \$4.49  
Ceramic (Dogbone Type) antenna insulators \$1.50 pr  
SO-239 coax connectors .55

All prices are postpaid USA 48  
Available at your favorite dealer or order direct from

Dealer Inquiries Invited  
**Van Gorden Engineering**

BOX 21305 B, SOUTH EUCLID, OHIO 44121

# SOCIAL EVENTS

Listings in this column are provided free of charge on a space-available basis. The following information should be included in every announcement: sponsor, event, date, time, place, city, state, admission charge (if any), features, talk-in frequencies, and the name of whom to contact for further information. Announcements must be received by 73 Magazine by the first of the month, two months prior to the month in which the event takes place. Mail to Editorial Offices, 73 Magazine, Pine St., Peterborough NH 03458.

## SOUTH GREENSBURG PA NOV 5

The Foothills ARC will hold its fifteenth annual hamfest on Saturday, November 5, 1983, at St. Bruno's Church, South Greensburg PA. Tickets are \$2.00 or 3 for \$5.00; indoor flea-market tables are \$5.00. Refreshments and food will be available. Talk-in on 146.07/67. For further information, advance tickets, or tables, contact WA3HOL, or write FARC, PO Box 236, Greensburg PA 15601.

## STONE MOUNTAIN GA NOV 5-6

The Alford Memorial Radio Club, Inc., will host its 11th annual Hamvention on November 5-6, 1983, at Stone Mountain Park, Stone Mountain GA. Hours on Saturday are 9:00 am to 5:00 pm and on Sunday, 9:00 am to 3:00 pm. The admission fee of \$3.00 includes a Saturday night cookout for the entire family and variety entertainment. There will be FCC exams, seminars, dealers, a gigantic flea market, and free parking. Camping will be available in the park. Talk-in on 146.16/146.76. For further details, send an SASE to Lew Howard W4LHH, 4132 Creek Stone Court, Stone Mountain GA 30083, or phone (404)-292-5469.

## TAYLOR MI NOV 6

The RADAR seventh annual hamfest, flea market, and swap will be held on Sunday, November 6, 1983, from 8:00 am to 3:00 pm, at Kennedy High School, Kennedy Drive, corner of Northline, Taylor MI. Admission is \$2.00. Tables are \$1.00 per foot (8-foot tables) and reserved tables must be paid for in advance. Dealers may set up at 7:00 pm on Saturday and 6:00 am on Sunday. Send check or money order to RADAR, Inc., PO Box 386, Taylor MI 48180.

Talk-in on 147.93/33 and 146.52. For more information, phone Bea Johnson at (313)-561-3911.

## WEST MONROE LA NOV 12

The Twin City Ham Club will hold a hamfest on Saturday, November 12, 1983, from 8:00 am through 5:00 pm, at the West Monroe Convention Center, West Monroe LA. There will be a variety of dealers as well as plenty of space for swap tables. Talk-in on .25/.85 and .52/.52. For further information, contact Benson Scott AE5V, 107 Contemporary, West Monroe LA 71291.

## MT. PROSPECT IL NOV 13

The Mt. Prospect Amateur Radio Club and Tri-County Emergency will sponsor RA-COM '83 on November 13, 1983, beginning at 8:00 am, at Prospect High School, 801 W. Kensington, Mt. Prospect IL. Features will include a large indoor electronics flea-market area, commercial exhibits, and seminars. Talk-in on 146.52. For more information and flea-market or commercial booth reservation forms, send an SASE to RA-COM, PO Box 452, Mt. Prospect IL 60056.

## NORTH HAVEN CT NOV 13

The Southcentral Connecticut Amateur Radio Association (SCARA) will hold its 4th annual electronics show and flea market on Sunday, November 13, 1983, from 9:00 am to 3:00 pm, at the North Haven Recreation Center, Linsley Street, North Haven CT. Admission for all events all day is \$1.50; children under 12 accompanied by an adult will be admitted free; tables are \$7.00 in advance and \$10.00 at the door. Features will include the latest in ham radio, computer, and domestic electronics and software. There will be free technical seminars. ARRL information and programs, a bake sale, and a Christmas/Chanukah gift bazaar featuring non-electronic gifts. Tables for the gift bazaar will be available only in advance. Doors open for vendors at 8:00 am. Food will be available all day. For reservations, send a check, payable to SCARA, to Ed Goldberg WA1ZZO, 433 Ellsworth Avenue, New Haven CT 06511, and include an SASE for confirmation and directions. For further information, phone (203)-773-0646 (home) or (203)-852-7876 (work).

## FORT WAYNE IN NOV 13

The Allen County Amateur Radio Technical Society (AC-ARTS) will hold its 11th Fort Wayne Hamfest on November 13, 1983, at the Allen County Memorial Coliseum, Fort Wayne IN. Tickets are \$2.50 in advance and \$3.00 at the door; children under 12 will be admitted free. Regular tables are \$6.00, premium tables are \$20.00, and parking is \$1.00. There will be forums on OSCAR, fast- and slow-scan TV, 10m FM, audio, computers, and traffic handling. Talk-in on .88 and .52. For advance tickets (include an SASE with your request and send before the November 1st deadline) and more information, write to Hamfest Chairman, AC-ARTS, Inc., PO Box 10342, Fort Wayne IN 46851.

## SELLERSVILLE PA NOV 13

The R. F. Hill Amateur Radio Club will hold its annual Winterfest Amateur Radio Flea Market and Exhibit on Sunday, November 13, 1983, at the Sellersville National Guard Armory, PA route 152, Sellersville PA. Take Sellersville or Perkasie exits from PA route 309. The location is approximately halfway between Philadelphia and Allentown. Admission for buyers is \$2.00. Rates for sellers for indoor space is \$4.00 and for outside tailgating space, \$3.00. Refreshments will be available on site and there are many good places to eat nearby. Flying hams should land at Pennridge Airport in Perkasie PA. Talk-in on 144.71/145.31 (Almont PA), 146.28/146.88 (Souder-ton PA), and 146.52 simplex (local area). For additional information, write PO Box 29, Colmar PA.

## MASSILLON OH NOV 13

The Massillon Amateur Radio Club will present the ARRL-approved Auction Fest '83 on Sunday, November 13, 1983, at the Massillon Knights of Columbus Hall, 988 Cherry Road NW, Massillon OH. Tickets are \$2.50 in advance and \$3.00 at the door, and children under 12 will be admitted free. Each 8-foot table is \$5.00. The flea market will begin at 7:00 am, doors will open at 8:00 am, and the auction will begin at 11:00 am. Food will be available and the hall is easily accessible for the handicapped. Talk-in on 147.78/18. For advance reservations and tickets, send an SASE to Massillon ARC, 920 Tremont Avenue SW, Massillon OH 44646.

## ALPINE NJ NOV 19

The Stateline Amateur Radio Club of New York and New Jersey will hold Radio-sport '83 on Saturday, November 19, 1983, at the Alpine Boy Scout Campgrounds,

Alpine NJ (just off exit 2 of the Palisades Interstate Parkway). Children under 12 will be admitted free. The demonstrations, technical discussions, and dealer and commercial displays will be in a large, indoor, well-lit, heated facility with ample parking, including spaces for tailgating (weather permitting). A refreshment stand will be available, as well as an engineering table with special test equipment available for checking deviation, output, swr, etc. Talk-in on 146.235/835 and 146.52. For further information and/or table or booth reservations, contact Abel David, Jr. KX2F, 82 Lexington Avenue, Dumont NJ 07628, or phone (201)-387-8129.

## BILLERICA MA NOV 19

The Honeywell 1200 Radio Club and the Waltham Amateur Radio Association will hold their annual amateur radio and electronics auction on Saturday, November 19, 1983, beginning at 10:00 am, at the Honeywell Plant, 300 Concord Road, Billerica MA (exit 27 off route 3). There will be a snack bar, a bargain parts store, and free admission and parking. Talk-in on 147.72/12 and 146.04/64 (club-sponsored repeaters). For more information, contact Doug Purdy N1BUB, 3 Visco Road, Burlington MA 01803.

## VERO BEACH FL NOV 19

The Treasure Coast Hamfest will be held on November 19, 1983, at the Vero Beach Community Center. Admission is \$2.50 in advance and \$3.00 at the door. Features will include tailgating and a QCWA luncheon. Talk-in on 146.13/73, 146.04/64, and 222.34/94. For more information, write PO Box 3088, Beach Station, Vero Beach FL 32960.

## CLEARWATER FL NOV 26-27

The Florida Gulf Coast Amateur Radio Council will sponsor the Florida State ARRL Suncoast Convention on November 26-27, 1983, from 9:00 am to 4:00 pm both days, at the Sheraton Sand Key Resort, Clearwater FL. Registration is \$3.00 in advance (until November 18th) and \$4.00 at the door. Saturday will feature a QCWA luncheon (\$7.00 per ticket), the ARRL forum hosted by Frank Butler W4RH, and a luau in the evening (\$15.00 per ticket). Sunday will feature a ladies' luncheon (\$7.00 per ticket). Activities will include a flea market (\$12.00 for both days for swap tables), technical talks, and demonstrations. Talk-in on .37/97, .96/36, and in Tampa, .16/76. For hotel room reservations, write Sheraton Sand Key Resort, 1160 Gulf Boulevard, Clearwater FL 33515, or call (813)-595-1611 (mention the Sun-

## AN IDEAL CHRISTMAS GIFT



the up-dated  
White's Radio Log  
is available.

AN UP-TO-DATE  
DIRECTORY OF NORTH  
AMERICAN AM, FM AND  
TV STATIONS INCLUDING A SECTION  
ON WORLD-WIDE SHORTWAVE

\$4.95 + \$1.00(postage)

WORLDWIDE PUBLICATIONS INC.

P.O. BOX #5206, NORTH BRANCH, N.J. 08876

(201) 231-1518

## WE INVITE YOU TO COMPARE!

*QUALITY*	*SERVICE*	*PRICE*
Alpine	Drake	Luxor
Arunta	General Inst.	M & L
Auto-Tech	Gillaspie	Macom
Avantek	Home Cable	MTI
Beddingfield	Janiel	Paralipse
Blonder-Tongue	KLM	Polatron
Calif. Amp.	Lindsay	Prodolin
Chaparral	Locom	Regency
		S.G.C.
		Sat-Tec
		Saxon
		Sharp
		T.D.F.
		Wilson
		Winegard
		Vector

## Lewis Electronics Company

P. O. Box 100 West Elm Street  
Humboldt, TN 38343

(901) 784-2191

100

"MANUFACTURER AND DISTRIBUTOR OF QUALITY TVRO SYSTEMS"

coast Convention). For advance tickets or swap-table reservations, send an SASE and check to the order of FGCARC to Florida Gulf Coast Amateur Radio Council, Box 157, Clearwater FL 33517. For more information, write FGCARC at the above address.

**GREENSBORO NC  
NOV 26-27**

The Guilford Amateur Radio Club will hold its annual Hamfest/Computerfest on November 26-27, 1983, beginning at 9:00 am each day, at the National Guard Armory, Greensboro NC. Pre-registration is \$3.50 and registration at the gate is \$5.00. Tailgating is allowed with the price of admission. An equipment check-out booth with test equipment and a technician will be available as a free service for those

wishing to check used equipment prior to purchase. Food and free parking will also be available. Talk-in on 144.65/145.25 and 146.52 simplex. For more information and advance tickets (checks to be made payable to GARC), send an SASE to GARC, PO Box 7007, Greensboro NC 27407.

**OAK PARK MI  
NOV 27**

The Oak Park High School Electronics Club will hold its 14th annual Swap-n-Shop on Sunday, November 27, 1983, from 8:00 am to 4:00 pm, at the Oak Park High School, Oak Park MI. The east and west doors will open at 6:00 am. Admission is \$2.00 and 8-foot tables are \$6.00. Refreshments will be available. For more information, send an SASE to Herman Gardner, Oak Park High School, 13701 Oak Park

Boulevard, Oak Park MI 48237, or phone (313)-968-2675.

**STONY BROOK LI NY  
NOV 27**

The Radio Central ARC will sponsor its 5th annual Ham-Central, 1983 edition. This ARRL hamfest will be held on Sunday, November 27, 1983, from 9:00 am to 3:00 pm, in the social hall of Temple Isaiah, 1404 Stony Brook Road, Stony Brook LI NY. General admission is \$3.00; children under 12 and XYs will be admitted free. An 8-foot table space is \$7.00 and includes one free admission. Doors will open at 7:30 am for dealers and sellers (ham-related items only). There will be food, drinks, and free parking available. Seminars will feature speakers Art Greenburg W2LH and Madeline Greenburg

W2EEO on antennas and Harry Dannals W2HD on the future of ham radio. Talk-in on 144.550/145.150 and 146.52. For reservations and additional information, contact Scotty Policastro KA2EQW, 80 7th Street, Bohemia NY 11716, (516)-589-2557, or Bob Yarmus K2RGZ, 3 Haven Court, Lake Grove NY 11755, (516)-981-2709.

**FARIBAULT MN  
DEC 3**

The annual Handi-Ham Winter Hamfest will be held on Saturday, December 3, 1983, at the Eagles Club in Faribault MN. Registration will begin at 9:00 am. There will be a Handi-Ham equipment auction and a dinner at noon. Talk-in on .19/79. For more information, contact Don Franz W0FIT, 1114 Frank Avenue, Albert Lea MN 56007.

# HAM HELP

I need the schematic for a Digi Scan 8 by Unimetrics. This is an 8-channel scanner.

**Dan Quinn KA4CJE**  
Rt. 3, Box 816  
Palatka FL 32077

Wanted: maintenance manuals for the Alda 103 and 103A HF transceivers. I want to convert the 103 to include 15 meters.

**Fr. Joseph Vaughan KC2LJ**  
Frontier Rd.  
Churubusco NY 12923

Does anyone have a spare range selector switch for the Heath MM-1 VOM? It is no longer available from Heath.

**Charles Guthy**  
24 Pinewood Ave.  
Sudbury MA 01776

I need manuals and schematics for the following equipment: the Eico model 323 VTVM and model 324 signal generator; the Heath model IM-18 VTVM; and the DuMont 401-A oscilloscope. I also need a spare power transformer for the DuMont 401-A. I am willing to purchase originals,

copy and return the original, or reimburse your copying and mailing costs.

**H. W. Hall WB4OGM**  
492 Selfridge Drive  
Colorado Springs CO 80916

I have been searching for the service manual, schematic, and parts list for the Telequipment S-54A oscilloscope. I will gladly pay copying costs.

**Raymond L. Wood WB4MQM**  
Rt. 5, Box 93  
Elizabeth City NC 27909

I need modification information for the Yaesu FT-2 (B or F version). I am especially interested in frequency-synthesis modifications.

**Richard Metro KA2QWH**  
201-D Springmeadow Drive  
Holbrook NY 11741

I need a copy of the manual for the Heath model QF-1 Q-multiplier.

**Robert Schlegel N7BH**  
2302 286th St. East  
Roy WA 98580

I need the schematic and operating manual for the Heath HX-11 CW transmitter. I will pay for copying and mailing costs.

**Carl Walczewski KB1EH**  
141 Booth St.  
New Britain CT 06053

I need help in locating the wiring diagrams for the Hewlett-Packard model 150 oscilloscope and model 152-B dual-trace amplifier.

**Charlie Weiss**  
3625 Lochlane  
North Little Rock AR 72116

**“AUTHOR  
AUTHOR!”**

## The call for authors is out!

**Wayne Green Books** announces a December 31, 1983 deadline for submitting manuscript proposals for the upcoming publication list. Ideas for book-length manuscripts about any micro-computer system or area of electronics will be considered. In addition to payment and royalties, we offer our distribution channels and the marketing support your book deserves.

Send proposals or requests for a copy of our Writer's Guide to:

Editor, **Wayne Green Books**  
Peterborough, NH 03458.

Or call toll-free **1-800-343-0728**.

## ALL NEW H.F. 10/160 METER SOLID STATE P.L.L. TRANSCEIVER



Model 10/160 M

**USB-LSB**  
4 Memories  
3 Way Auto-Scan  
Includes New Bands  
3-Step Tuning Speed  
IF Tune ± 1 KHZ  
Built-in Dual VFO  
Narrow CW filter optional

**CW-W CW-N**  
200 W. PEP (160M-12M)  
100 W. PEP (10M)  
Built-in Power Supply  
AC-120 VAC  
DC-13.8 V -Ground  
External ALC & Relay  
RTTY, FAX, ASCII



**JUST SLIGHTLY AHEAD**

1275 N. GROVE ST.  
ANAHEIM, CA 92806  
Cable: NATCOLGLZ

TO ORDER OR  
DLR INFO. CALL  
(714) 630-4541

254

NOTE: Price, Specifications subject to change without notice and obligation

1983-1984

AMATEUR  
RADIO

# CALL DIRECTORY

THE BARGAIN AT \$14.95  
Plus Shipping



A no frills directory of over 435,000 U.S. Radio Amateurs. 8 1/2 x 11, easy to read format. Completely updated.

Also available for the first time ever—

(Alphabetically arranged—Sold separately)

**Geographical Index**

by State, City and Street No. and Call

**Name Index**

by Name and Call

Ordering Information:

- Directory—\$14.95
- Geographical Index—\$25.00
- Name Index—\$25.00

Add \$3.00 Shipping to all orders.

Dealer / Club inquiries welcome

Send your order—enclosing check or money order in U.S. dollars to:

## Buckmaster Publishing

Whitehall

✓226

Mineral, VA 23117 U.S.A.

## BEEPERS!



**IF YOU HAVEN'T HEARD OUR BEEPERS  
YOU'RE NOT LISTENING!**

What's a BEEPER? Sometimes called a "courtesy beep," both Faxscan BEEPERS add a gentle high frequency beep automatically to the beginning of each transmission and a low beep at the end. "Talk-over" is a thing of the past! INTRODUCING BP-4 "The PRO" BEEPER. The PRO is state-of-the-art beeping! Includes a digitally-programmable timer (use it for ID or time-out warnings), an automatic "Slumber Mode" for long battery life (9V battery required—not included), and programmable volume control of the unique double 4-beep timeout warning. No speaker! Uses a piezo-transducer!

Hook-up's a snap with either model! Interfaces to virtually all modern gear. Manual supplied with each BEEPER. Available in three versions:

"A" versions are complete with case, cable, industry-standard 4-pin connectors

"B" versions are the same as above but without connectors. Add your own!

"C" versions are circuit-board models for custom installations. Perfect for repeaters or building INTO your rig

**BEEPERS ARE A  
FAXSCAN EXCLUSIVE!**

BP-4 "The PRO" BEEPER	BP-3 "The Original" BEEPER	
A- \$79	All units are assembled, tested,	A- \$59
B- \$69	carry a 90-day limited warranty,	B- \$49
C- \$49	and shipped pre-paid in US.	C- \$29

Ohio residents add 8% sales tax

**FAXSCAN INC.** ✓99

3148 Dorf Drive • Dayton, Ohio 45418

## New CMOS DTMF Chip Kit

Teltone's TRK-957 Kit makes it easier and less expensive to breadboard a low-power, central office quality DTMF detection system. All you need is a power source from 5 to 12 VDC. The sensitivity, wide dynamic range, noise immunity, and low-power consumption make the TRK-957 ideal for telephone switching, computer, and remote control applications. The TRK-957 DTMF Kit is only \$24.75. To order call:

(800) 227-3800, ext. 1130.

In CA. (800) 792-0990, ext. 1130.

**TEL TONE** ✓224

N8BKR Introduces A...

## 8 FT. 40M ROTATABLE DIPOLE

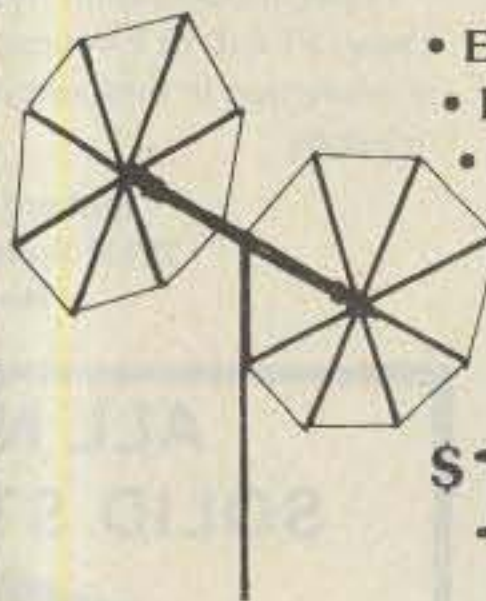

- Efficient
- Full Legal Power
- Lightweight
- Good Band Width
- 6-ft. Turning Radius

**\$159<sup>50</sup>**

Send for Free Literature

**MOLER ANTENNA CORP.**

2623 Morris Lane • Girard, OH 44420

(216) 530-2059

## CONTACT-80...



RTTY your TRS-80 with CONTACT 80 MARK II for 1983!

TRS-80, MOD III/IV INTERFACE (included with system) gives keyboard STATION CONTROL and connects with the TTY TU of your choice.

(No other equipment needed for CW operation)

### Cassette & Disk Features:

- BAUDOT, ASCII & MORSE...
- CW RX speed AUTOSYNC & unique FIST-FIXER...
- TRI-SPLIT screen (user sets HIS way)...
- "Unlimited" STORED MSG. sizes...
- Automatic DYNAMIC BUFFER ALLOCATION...
- Live HARDCOPY plus other Line-printing...
- AUTO-ID, TIME/DATED transmissions...
- On screen "OSCILSCOPE", CLOCK, COUNTERS...
- Unique EDITOR, CLOKED-KEYING, NAME-LINE...
- AUTO-DIDDLE, K/B ROLLOVER, REPEATING KEYS...
- Fast CASSETTE I/O and many other features...

### Additional Disk Features:

- Two-way message SELCALL. A "PERSONAL MSO"...
- AUTO-MONitor frequency activity to disk...
- SAVE, LOAD, KILL & DIR plus other I/O...

### INTRODUCTORY SPECIAL

DISK VERSION ..... \$199.00

CASSETTE VERSION ..... \$179.00

CASSETTE, later upgrade to DISK ..... \$20.00

Guaranteed-Include Amateur CALLSIGN-POST PAID

ROYAL

407 Conkle Road

✓ 150

Hampton, GA 30228 Telephone: (404) 946-9314

SEND FOR THIS  
FREE CATALOG NOW



SAVE MONEY  
HIGH QUALITY  
FAST DELIVERY

We are utilizing the latest equipment and technology to maintain our quality at reasonable prices.

# JAN CRYSTALS

- General Communication
- Industry
- Marine VHF
- Scanners
- Amateur Bands
- CB Standard
- CB Special
- Microprocessor

Call or Write ✓39

**JAN CRYSTALS**

P.O. Box 06017  
Ft. Myers, FL 33906-6017  
All Phones (813) 936-2397

## Your Ham Tube Headquarters!

TOLL 800-221-0860 FREE  
TUBES

3-400Z.....\$85.00	6883B.....\$6.75
3-500Z.....\$85.00	7360.....\$9.15
4-400A.....\$80.00	7735A.....\$29.50
4CX250B.....\$55.00	8122.....\$98.00
572B.....\$48.50	8156.....\$10.95
811A.....\$12.00	8844.....\$29.50
813.....\$29.50	8873.....\$175.00
6146B.....\$6.50	8874.....\$180.00
6360.....\$4.25	8877.....\$450.00
	8908.....\$10.50

E.F. JOHNSON Sockets for 4CX250B & 4-400A @ \$9.95  
RF CONNECTORS

SEMICONDUCTORS		PL 259	10/\$4.95
MRF 245/5D1416	\$30.00	PL 258	10/\$8.95
MRF 454	\$18.95	UG 175/176	10/\$1.60
MRF 455	\$12.50	UG 255/U	\$2.50 ea.
		UG 273/U	\$2.25 ea.
MRF 644/5D1088	\$19.95	M 358	\$2.50 ea.
2N3055	\$ .95	M 359	\$1.75 ea.
2N6084	\$12.50	Type "N" twist-on (RGB/U)	\$4.75

TOP BRAND Popular Receiving Tube Types  
FACTORY BOXED 75/80% OFF LIST  
FREE LIST Available

Includes full line of RF Power Transistors.  
Minimum Order \$25.

Allow \$3.00 Minimum for UPS Charges

Write or phone for free catalog.

TUBES—BOUGHT, SOLD AND TRADED

**CeCo**  
Since 1922

Premium Prices  
Paid  
For EIMAC Tubes

**COMMUNICATIONS, Inc.**

2115 Avenue X

Brooklyn, NY 11235

Phone (212) 646-6300 ✓111

# SATELLITES

## INITIAL ORBITAL TIMES FOR STS-9

Any given orbit begins as the spacecraft crosses the equator traveling west to east. The following orbital operating times are based on an 11:30 AM EDT launch on October 28th. If the launch is delayed for any reason, you must add the amount of the delay to the times stated here to obtain new orbital track timing for an operating pass. Also, what we are listing here are only the "official operating periods" scheduled as of September 3rd. Dr. Garriott says he will attempt to provide other "unofficial" operating periods as well, but these will have little advance notification. Whenever possible, advance notice of these extra operating times will be made available over W1AW, in bulletins issued by NASA-affiliated radio clubs (such as W5RRR in Houston), and on the daily updates of the Westlink Radio Network Hollywood newswire: (213)-465-5550. All North American passes are listed in local time, while those for foreign contacts with the spacecraft are in UTC. All times are approximate for the start of a given pass. You may calculate the specific time over your QTH by adding the forward speed of the space vehicle, which is 17,000 miles per hour.—Thanks to Roy Neal K6DUE and the Westlink Report.

Orbit #	Date	Ground Track	AOS Time
39	10/30	Spokane, Denver, Dallas, Houston, New Orleans, S. America	2000 CDT
40	10/30	N. California, down Pacific coast E. of San Francisco and LA, Mexico	1930 PDT
47	10/31	W. Australia, S. America, Europe	1430 UTC
NOTE: Standard Time begins this date			
63	11/1	S. America, USSR, India, Australia	1330 UTC
64	11/1	Iran, Scandinavia, USSR	1555 UTC
77	11/2	NW Africa, E. Europe, Poland, China	0850 UTC
79	11/2	N. tip of S. America, Caribbean, N. Europe, USSR, India	1250 UTC
80	11/2	Caribbean, all E. Coast states, Newfoundland, UK, central Europe	0815 EST

## AMSAT SYMPOSIUM

AMSAT will hold an Amateur Radio Satellite Symposium in conjunction with its annual meeting on Saturday, November 12, 1983, at the Johns Hopkins University Applied

Physics Laboratory just off I-95, between Baltimore and Washington. The planned programs include: how to get on the new OSCAR 10 satellite, tracking OSCAR 10 with/without a computer, a report on the W5LFL Space Shuttle operation, PACSAT, and, much, much more! Admission is free but advanced reservations are required. For further information and reservations, contact AMSAT, PO Box 27, Washington DC 20044, or call (301)-589-6062.

## Amateur Satellite Reference Orbits

Date	OSCAR 8		RS-5		RS-6		RS-7		RS-8		Date
====	UTC	EQX	UTC	EQX	UTC	EQX	UTC	EQX	UTC	EQX	====
Nov 1	0059	103	0129	155	0113	157	0153	163	0018	135	1
2	0103	104	0123	155	0058	154	0143	162	0015	136	2
3	0108	106	0118	155	0043	152	0134	161	0012	137	3
4	0112	107	0113	155	0027	150	0124	161	0009	138	4
5	0116	108	0107	155	0012	147	0114	160	0006	138	5
6	0121	109	0102	156	0155	175	0105	159	0003	139	6
7	0125	110	0057	156	0140	173	0055	158	0001	140	7
8	0129	111	0051	156	0124	170	0045	157	0158	171	8
9	0134	112	0046	156	0109	168	0036	156	0155	172	9
10	0138	113	0041	156	0054	166	0026	155	0152	173	10
11	0142	114	0035	156	0038	163	0016	154	0149	173	11
12	0004	90	0030	157	0023	161	0007	153	0146	174	12
13	0008	91	0025	157	0007	159	0156	182	0143	175	13
14	0012	92	0019	157	0151	186	0147	182	0141	176	14
15	0017	93	0014	157	0135	184	0137	181	0138	177	15
16	0021	94	0009	157	0120	181	0127	180	0135	178	16
17	0025	95	0003	158	0104	179	0118	179	0132	178	17
18	0030	96	0158	188	0049	177	0108	178	0129	179	18
19	0034	98	0152	188	0034	174	0058	177	0126	180	19
20	0038	99	0147	188	0018	172	0049	176	0124	181	20
21	0043	100	0142	188	0003	170	0039	175	0121	182	21
22	0047	101	0136	189	0146	197	0029	174	0118	182	22
23	0051	102	0131	189	0131	195	0020	174	0115	183	23
24	0056	103	0125	189	0115	193	0010	173	0112	184	24
25	0100	104	0120	189	0100	190	0000	172	0109	185	25
26	0104	105	0115	189	0044	188	0150	201	0107	186	26
27	0109	107	0109	190	0029	186	0140	200	0104	187	27
28	0113	108	0104	190	0014	183	0131	199	0101	187	28
29	0117	109	0059	190	0157	211	0121	198	0058	188	29
30	0122	110	0053	190	0142	208	0111	197	0055	189	30
Dec 1	0126	111	0048	190	0126	206	0102	196	0052	190	1
2	0130	112	0043	190	0111	204	0052	195	0050	191	2
3	0135	113	0037	191	0055	201	0042	195	0047	191	3
4	0139	114	0032	191	0040	199	0033	194	0044	192	4
5	0000	90	0027	191	0024	197	0023	193	0041	193	5
6	0004	91	0021	191	0009	194	0013	192	0038	194	6
7	0009	92	0016	191	0152	222	0004	191	0035	195	7
8	0013	93	0011	192	0137	220	0153	220	0033	195	8
9	0017	94	0005	192	0122	217	0144	219	0030	196	9
10	0022	95	0000	192	0106	215	0134	218	0027	197	10
11	0026	96	0154	222	0051	213	0124	217	0024	198	11
12	0031	97	0149	222	0035	210	0115	216	0021	199	12
13	0035	99	0144	223	0020	208	0105	216	0018	200	13

## PACKET RADIO

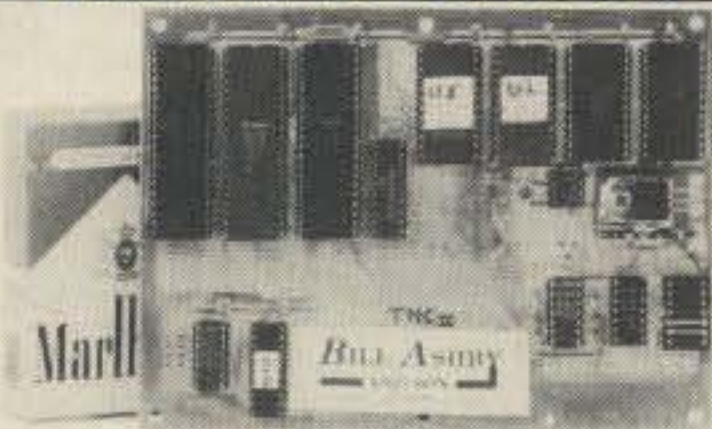

### ASCII—USA/AX.25 HDLC CONVERTER

USA/AX.25 is the AMRAD approved digital format STANDARD used on amateur packet radio networks.

PAC/NET board only \$80.00  
Assembled/Tested. No ICs. 90 day warranty

Package of all ICs except 2-2716 EPROMs \$80.00

## PAC/NET SYSTEM

PAC/NET SYSTEM \$240.00

System Tested 4.5 x 6" board complete with all ICs and programmed EPROMs personalized for each purchaser. Requires only single 8-10 volt 1/2 amp power. 1 year guarantee of hardware/software/AX.25 standard RS232 serial ASCII at any user baud rate. RS232 HDLC for 202 modem used for AFSK or direct to RF equipment for FSK.

Custom Systems Custom Programming

**BILL ASHBY**  
AND SON

K2TKN—KA2OEG 201-658-3087  
BOX 332 PLUCKEMIN N.J. 07978

## AFFORDABLE HARD COPY

Put your personal computer to work printing the log, QSLs, or RTTY... The **Gemini 10** by Star Micronics is a versatile dot-matrix printer that we feel is the best buy for the money. Parallel interface and both friction and tractor feed are included at this low price.

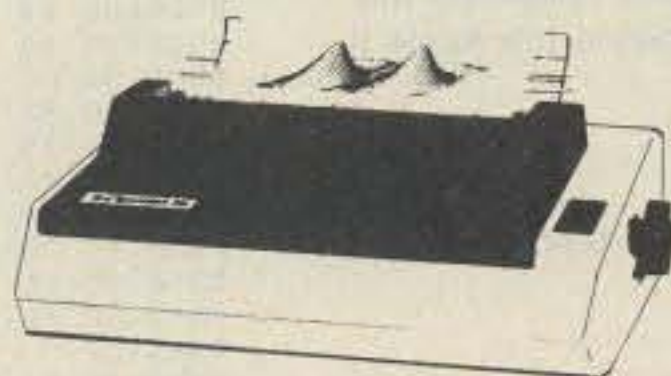

GEMINI 10 ..... \$325

**Ampersand**  
electronics

6065 Mission Gorge Rd. #66  
San Diego, CA 92120

**TO ORDER:** Mail order only, check or money order. Add 6% sales tax on California orders. Allow 2 weeks for personal checks to clear. Price includes UPS shipping in continental US. Prices subject to change without notice. Circle reader service number for print sample.

## NEW EGBERT II RTTY--CW for THE APPLE COMPUTER SOFTWARE ONLY

**NO TU REQUIRED**

Many Standard and UNIQUE FEATURES.

(ALL ON ONE DISK)

any MARK and SPACE frequency.

500 Hz to 3000 Hz

CAN BE USED WITH TTY FOR THE DEAF

Requirements: Apple II 48K, 3.3

TRANSMIT OR RECEIVE

ALSO ACCEPTS TTL INPUT TO GAME I/O

C.W. VERSION AVAILABLE

PRICES: RTTY ..... \$39.95

Back-Ups each ..... \$ 7.50

C.W. .... \$39.95

RTTY with CW ..... \$59.95

\*Shipping ..... \$ 2.50

WRITE FOR DETAILS OR ORDER FROM:

**W.H. NAIL COMPANY**

275 Lodgeview Drive

Oroville, Ca. 95965

(916) 589-2043

\*Foreign Shipping = \$6.00  
(Calif. Residents add 6% tax)

# DR. DIGITAL

Robert Swirsky AF2M  
412 Arbuckle Avenue  
Cedarhurst NY 11516

Practically every mode of communication used by an amateur-radio operator makes use of sound. Obviously, in voice communications, sound is directly processed by our brains. In CW communications, unless you are using a code reader or a flashing light, the radio signal is converted into a tone for us to hear. What is not so obvious is that sound is also crucial for "digital" communications. The only way to send a digital signal over communications equipment designed for voice is to convert it into tone signals. On the receiving end, special hardware is needed to convert the tone signals back into digital pulses.

All modern computers employ digital circuitry; they can only deal with signals that are either "high" or "low" (commonly represented with +5 V and 0 V in TTL-based computer systems). Since sound is of an analog nature, computers cannot deal with it directly. One way of dealing with sound is with circuitry adjusted to respond to certain frequencies. This method is useful if only a small number of sound frequencies needs to be detected. A common example of this is a RTTY decoder. Usually a pair of tuned circuits (or sometimes phase-locked loops) is used—one circuit is tuned to the "mark" frequency while the other is tuned to the "space." If, however, more than a few tones must be decoded, more sophisticated circuitry is needed. For applications such as speech digitizing (recording speech in digital computer memory), usually an analog-to-digital converter circuit is used. These are available as integrated circuits. Some of the more expensive A/D converter chips are quite fast; conversion time is just a few microseconds.

I am a software-oriented person. I will go to extremes to solve a problem by using fancy software techniques rather than hardware. Perhaps it's because I am the world's worst solderer, or maybe because I am totally uncoordinated when it comes to handling small electronic components, that I have developed my distaste for electronic construction projects.

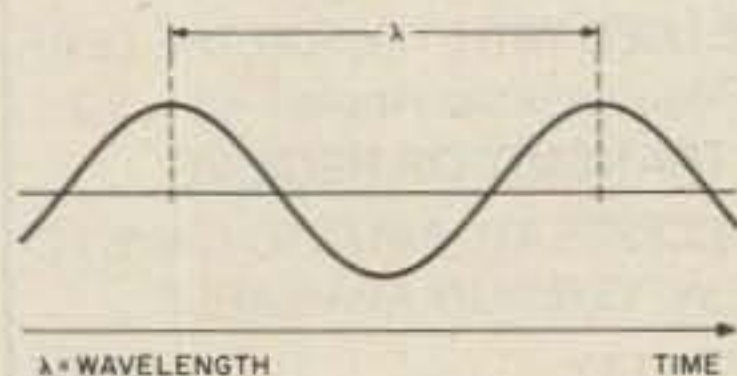

Fig. 1. How a wavelength is measured.

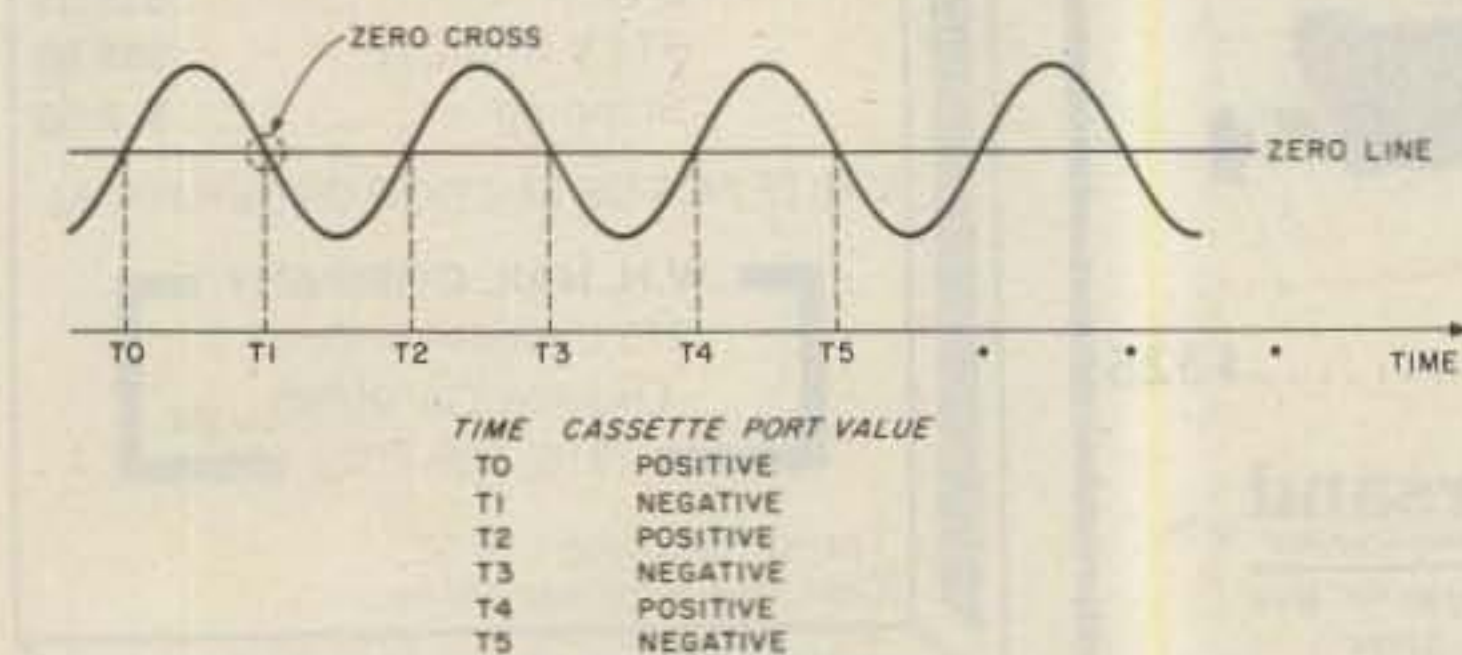

Fig. 2. Apple cassette-port operation.

Because of my software vs. hardware attitude, I use software to deal with sound problems. Using some surprisingly simple algorithms, it is possible to analyze audio information with a microcomputer.

Before I go into software techniques for dealing with sound, let's review what the phenomenon of sound is all about. As you probably know, sound is carried by waves in some sort of a medium. When a reed, for instance, is set vibrating, it compresses the air immediately surrounding it. Due to the elastic nature of air molecules, the compressed air spreads out and compresses its neighboring molecules. It is this "bucket-brigade" effect that causes sound to travel. (Note that the molecules themselves aren't being compressed, it is the space between them.) In a denser medium, such as water, steel, or air at a higher pressure, sound will travel faster because the elasticity is greater. Conversely, less dense media will carry sound at a slower rate.

Sound frequencies that human beings can hear range from about 16 Hertz to about 25,000 Hertz, a Hertz being a cycle per second. Another way of measuring the frequency of a sound is by wavelength. Fig. 1 shows a diagram of a wavelength: a measure of the distance from one point on a wave to another corresponding point. The example I used shows it being measured from peak to peak. A wavelength can be expressed in terms of length in linear units (e.g., inches) or in time units (e.g., milliseconds). When working with a computer, it is convenient to measure wavelength in time units. After all, everything in a computer is clocked to a stable reference frequency.

Last month, we discussed a circuit known as a zero-cross detector. This simple circuit, consisting of an operational amplifier and a few additional components, makes it possible to do a number of things with sound waves. While you can only measure frequency information with such a circuit (any waveshape information is undetected), that is enough for many applications. Besides, the Apple II, II+, and IIe computers have the zero-cross detector built in; it is what the cassette interface uses. This means with an Apple or Apple-compatible computer, no additional interface hardware is needed to measure the frequency of a tone.

When writing software to process audio signals, it is necessary to use assembly language; high-level languages are just too slow to be useful. Also, with assembly language, it is possible to know exactly how much time an instruction takes to execute. This is critical when accurate timing loops are needed. Since the Apple II

computer uses a 6502 microprocessor, the programs here will be written for that microprocessor. The algorithms, however, will be the same for any microprocessor.

Perhaps the simplest way to measure frequency is to have the computer count from one state change of the cassette port (zero-cross detector) to another. Looking at Fig. 2, we see that the state changes every half-cycle. Using this information, an algorithm to measure frequency would be:

1. Wait for the port to become negative.
2. Increment a counter by 1.
3. Check the port.
4. If negative, go to step 2; if not, stop.

Now, to determine frequency from the result in the counter, some things need to be calculated. Take a look at Program 1. Notice the numbers in parentheses after some of the instructions; these are the execution times (i.e., the amount of time it takes for the computer to perform the instruction) measured in clock cycles. The Apple computer runs at a speed of 1,023,000 clock cycles per second. Once around the loop in the program takes 9 clock cycles. If, after exiting the loop, the counter has counted to 50, this means that  $50 \times 9 \times 1/1023000$  seconds have elapsed, or that one half-cycle takes 0.0004399 seconds. Since these are half-cycle, we multiply this by 2 to get 0.0008798 and take the reciprocal. This leaves us with 1136.66667 as the frequency in Hertz.

This method of counting a time interval between half-cycles is simple and quick, but not very accurate. The resolution (i.e., the closest frequencies that can be distinguished) is poor, and gets worse at higher frequencies. Some ways of improving this would be to raise the clock frequency of the computer, or count for a number of cycles. The problem with counting for a number of full cycles, as opposed to one

half-cycle, is that the counting loop gets more complex and takes more clock cycles to execute. If the loop takes a longer amount of time to execute, frequency resolution is lost. Still, this is probably the best method when high speed is needed and close resolution is not. Certainly this method would be useful for decoding wide-shift RTTY, or even the tones needed for SSTV if you are only testing for a limited number of gray levels. The program in listing 1 has some limitations. Perhaps its greatest one is that it uses an 8-bit register to store the count. Because of this, low frequencies cause it to loop around to zero and start again. One possible solution, at the cost of 2 clock cycles per iteration, would be to add a BEQ OUT instruction after the INY. This way, if a result of zero is returned from the subroutine, you know to ignore it. Of course, one can make use of the counter "wraparound" to measure low frequencies.

The most accurate way of measuring frequencies on a microcomputer is to actually count the cycles for 1 second. The result would be directly in Hertz, and resolution would be to 1 Hertz. If a computer has an interrupt timer, it can be used to ensure that the count program runs for one second and then stops. Unfortunately, due to the way the Apple's system ROM is configured, it makes it very difficult to deal with interrupts.

The way around this problem is to have run through the program that counts cycles a fixed number of times. It is essential that the cycle-counting portion of the program take exactly the same amount of time to execute each time it runs. This is

```
CASS EQU $C060
ORG $0302
LDY #0
BACK LDA CASS
BPL BACK
LOOP INY ;(2)
LLAC LDA CASS ;(4)
BNE LOOP ;-(3/2)
OUT RTS
```

Program listing 1.

```
SOURCE FILE: PROG4
0000: 1 ;
0000: 2 ;
0000: 3 ;
0000: 4 ;
C060: 5 CASS EQU $C060
00FC: 6 TZP EQU $FC
00FD: 7 ZP EQU $FD
00FE: 8 CH EQU $FE
00FF: 9 CL EQU $FF
----- NEXT OBJECT FILE NAME IS PROG4.OBJ0
0302: 10 ORG $302
0302:AD 60 C0 11 INIT LDA CASS
0305:29 80 12 AND #$80
0307:80 4E 03 13 STA LAST
030A:A9 00 14 LDA #0
030C:A8 15 TAY
030D:AA 16 TAX
030E:A9 7C 17 LDA #124
0310:85 FD 18 STA ZP
0312:20 2B 03 19 MLOOP JSR LOOP
0315:98 20 TYA
0316:A0 00 21 LDY #0
0318:18 22 CLC
0319:65 FF 23 ADC CL
031B:85 FF 24 STA CL
031D:29 00 25 AND #$00
031F:65 FE 26 ADC CH
0321:85 FE 27 STA CH
0323:C6 FD 28 DEC ZP
0325:D0 EB 29 BNE MLOOP
0327:60 30 RTS
0328:EB 31 LOOP INX ;(2)
0329:F0 1E 32 BEQ LEAVE ;(2/3)
032B:AD 60 C0 33 LDA CASS ;(4)
032E:29 80 34 AND #$80 ;(2)
0330:85 FC 35 STA TZP ;(3)
0332:40 4E 03 36 EOR LAST ;(4)
0335:30 09 37 BMI ADD1 ;(2/3)
0337:4E 4A 03 38 LSR WASTE ;(6)
033A:AD 4A 03 39 LDA WASTE ;(4)
033D:4C 2B 03 40 JMP LOOP ;(3)
0340:A5 FC 41 ADD1 LDA TZP ;(3)
0342:80 4E 03 42 STA LAST ;(4)
0345:C8 43 INY ;(2)
0346:4C 2B 03 44 GOBK JMP LOOP ;(3)
0349:60 45 LEAVE RTS
034A: 46 WASTE DS 1
034B: 47 LAST DS 1
```

\*\*\* SUCCESSFUL ASSEMBLY: NO ERRORS

```
0340 ADD1 C060 CASS FE CH FF CL
?0346 GOBK ?0302 INIT 034B LAST 0349 LEAVE
032B LOOP 0312 MLOOP FC TZP 034A WASTE
FD ZP
```

Program listing 2.



trickier than it sounds; if a conditional branch takes place, the entire routine must execute in the same amount of time as it would if the branch did not occur. Also, to measure reasonably high frequencies, the counting loop must take as little time as possible.

Program 2 shows a frequency-counting subroutine that counts zero crossings on the Apple cassette port for a fixed amount of time. When used with Program 3, a Basic program to do some floating point calculations, it can measure frequencies with a resolution of 1 Hertz. If your Apple's clock is running at the proper frequency, it should give you fairly accurate results.

Lines 10 through 18 of Program 2 initialize various memory locations. The current status of the cassette port is examined and stored in memory location LAST. The X and Y index registers are set to zero, and the zero-page memory location ZP is set to 124. ZP controls the number of iterations that the LOOP, starting at line 31, is executed. As each iteration of LOOP takes 8192 clock cycles, the timing portion of the program will take 1,015,808 clock cycles—just a little bit under a second. (The difference is corrected in Program 3.) Now look at the LOOP portion of the program (line 31). I have indicated the number of clock cycles that each instruction takes in parentheses. (The 2/3 means that the instruction can take 2 or 3 cycles, depending on whether the branch is

LIST

```

5 HOME
10 POKE 254,0: POKE 255,0
20 CALL 770
30 ZC = PEEK (254) * 256 + PEEK (255)
40 TF = ZC / 2
50 FRQ = TF * 1.0070801
60 VTAB 4: HTAB 27: PRINT " "
70 VTAB 4: PRINT "THE FREQUENCY IN HERTZ IS "; INT (FRQ)
80 GOTO 10

```

Program listing 3.

taken.) This routine will always take 32 clock cycles to execute, while it is performing the actual counting. The time spent before it starts to count is irrelevant. Notice that whenever the iteration counter goes through 256 iterations, it returns to MLOOP at line 20. MLOOP clears the registers, accumulates the zero-cross count, and calls the subroutine LOOP again. It does this 124 times (remember lines 17 and 18) and then exits, returning control of the computer to the Basic interpreter. By using the technique of "emptying" the counting register every so often, one can overcome the problem of the 6502's 8-bit register. (Remember that an 8-bit register can only hold 256 different values.) The frequency information is contained in memory locations 254 and 255. These zero-page locations (so called because they are on the bottom 256-byte memory page) take less time for the computer to use: one less clock cycle per instruction.

Listing 3, the Basic program, clears the

zero-cross count locations (line 10). It then calls the routine and calculates the number of zero crosses detected in the counting period. This figure is divided by 2 (line 40) to convert from zero crosses to cycles and multiplied by 1.0070801 to correct the count for a 1-second sampling period. Finally, since the fractional portion of the number isn't accurate, it is discarded, and the integer portion is displayed on the screen as the frequency in Hertz.

To enter the assembly-language portion of the program into the computer, enter the monitor with the command CALL-151 from Basic and enter the hexadecimal data from address 0302 to 0349 hex. After the information is typed in (consult the reference manual if you don't know how to enter hex data), save the information with the command: BSAVE PROG4.OBJ0,A\$302,L79. You might wish to add the statement: 7 Print"BLOOD PROG4.OBJ0" to the Basic program in listing 3. This will ensure that the machine-language routines are loaded in

each time the program is run. (Remember to put a CTRL-D before the BLOAD.)

I found this frequency-counting program to be quite useful. One of the first things I did with it was to measure receiver drift. With the program running, I turned my receiver's calibrator on and tuned the vfo until I heard a tone, which I fed into the Apple's cassette port. By noting the frequency of the tone when the rig was first turned on, and comparing it after a half hour, I was able to determine how many Hertz the receiver had drifted.

If the 1-second sampling time is too long for your needs, you can shorten it, sacrificing some resolution. For example, if you use a 1/100-second sampling rate, the result would be accurate to 100 Hertz. To accomplish this, change the 124 in line 17 of listing 2 to 12. This would make the sample time equal to  $12 \times 8192$  clock cycles, or .00960938 seconds. Multiply by the reciprocal, 10.406494, and divide by 2 (or multiply by 2 and divide by the reciprocal) to get the frequency in Hertz. Obviously, any sampling time can be selected in steps of 8192 clock cycles. (Remember that the LOOP portion of the program always takes  $32 \times 256$  or 8192 clock cycles to execute.)

Next month, we'll take a look at tone and waveform generation on computers. Keep the letters coming in—just remember to include an SASE.

## REVIEW

### THE KENWOOD MULTI-MODE TR-9500 TRANSCEIVER

Are those declining sunspot numbers making you think about a new challenge in the hobby for the coming years? Have you wondered about all that talk of the new OSCAR satellite and its fantastic DX potential? Or possibly a friend has told you about how interesting and sunspot-proof VHF/UHF propagation can be.

Well, a number of manufacturers have now extended the multi-mode-radio concept to the 70-cm band (420-450 MHz). These radios are ideal as a satellite up-link/downlink or for terrestrial DX as well. Kenwood's latest offering is the TR-9500 transceiver. This radio covers the frequency range of 430-440 MHz and provides FM, CW, and SSB modes.

(A word of caution to US and Canadian amateurs: Although the radio is accurately described as being multi-mode, the FM capabilities will not find much use here since present band plans place FM use in the 440-450-MHz portion of the band above the radio's band edge. Don't blame Kenwood for this, however; in most areas of the world, only the 430-440-MHz segment is allocated for all modes of amateur use, and most other radios on the market are similarly designed.)

The TR-9500 is a microprocessor-controlled unit complete with scanning, memories, and 10 Watts of rf power output. An optional base unit which includes a memory backup function, an external PS-20 power supply, and SP-120 speaker make it equally at home under the dash or on the operating table. It can be moved quickly from either thanks to its slide-in-type mobile mounting bracket. The 9500's 2m cousin is the very popular TR-9130, which

makes an ideal companion radio, especially for OSCAR users.

In an approach similar to many state-of-the-art transceivers on the market, the TR-9500 employs a dual-vfo frequency-control system. For example, you could use vfo A for the 432-MHz portion and vfo B for 435-MHz and OSCAR activities. The radio does permit you to change frequency while transmitting—an important consideration for OSCAR users which has been overlooked on some other radios. Either vfo can be used to program the six memory channels. Once programmed, each memory channel can be recalled with a multiple-position switch or scanned automatically by the unit's microprocessor.

Although such features are usually associated with FM operation, I found it useful both for OSCAR and terrestrial QSOs to keep tabs on band activity. During an OSCAR pass, you can program the beacon frequency in one memory and use the other memories for busy stations you hear and want to work. Just switch between channels and wait for the first QSO to end. I also used this technique during a contest.

For those who can make use of the FM capabilities, the TR-9500 is well equipped. Two standard repeater offsets, 5 MHz and 1.6 MHz, are provided as well as a programmable offset for the frequency programmed into memory channel 6. In this case, both transmit and receive frequencies are individually programmed for those odd split repeaters.

Now that we are familiar with some of the basics, let's sit down and actually go through the operation.

I push on the combination power switch and volume control and the bright green LED display shows 3.000.0 (for 433.000

MHz). This is the normal power-up frequency for vfo A. If the vfo B button were pushed, the unit would power up on 430.000 MHz.

I want to look around 432.1 MHz, so I depress the MHz button. This allows me to move one whole MHz for each click of the main-tuning knob. One complete revolution is 50 clicks, so I can move around the band pretty quickly. One click down puts me on 432.000, but now I have to move 100 kHz up in frequency. I push out the MHz button and now each click moves me 100 Hz. This will take a long time. The manual says that the FM2 position on the mode switch will provide steps of 1 kHz and the FM1 position, steps of 25 kHz. Hmm... maybe this FM mode will be of some use after all. I quickly switch from USB to FM1; four clicks of the main-tuning knob and I'm on 432.1 MHz. Sounds pretty quiet, so I try a CQ.

As I let go of the push-to-talk button on the mike, the back-light meter jumps to nearly full scale. It's my friend Glen K1GW. He sounds just a bit off frequency, so I depress the RIT button. A red LED lights to let me know the RIT is on and I tune him in a little better on the combination RIT/rf-gain control. We quickly get our frequencies netted and off goes the RIT. Glen gives me an excellent report both signal strength and audio.

I depress the power switch to the 1-Watt low-power position with equal readability at his end. We decide to QSY up 10 kHz to get off the calling frequency, but before I do I want to put the frequency into memory. I set the memory switch to position 1 and press the button right under it marked M. The radio beeps at me. I guess it wants to tell me I've done something important.

Let's see now, I have to move up to 432.110 MHz. If I tune the main-tuning knob, I should be there in about two revolutions (about 100 steps), or I can switch to the FM2 mode and be there in 10 steps. I opt for the latter. There's Glen and this time there are no netting problems.

We try it on CW for a while. The sidetone sounds good and is just about the



The Kenwood TR-9500.

right level. My keyed signal is reported as clean. The TR-9500 uses the same filter for both SSB and CW. It also switches from a slow agc characteristic on SSB to a fast one on CW.

After we finish, I decide to explore further the scanning and memory features. First, I program in several channels at random. I depress the MR (Memory Recall) button and the channel selected on the memory switch is displayed. A green LED lights to tell me I'm in memory mode. Now I can switch between six channels just like on those old-fashioned radios from way back in the 1970s. Without crystals, of course. I depress the MS (Memory Scan) button and now I don't even have to touch the memory selector. The radio automatically steps through the channels, carefully jumping over those channels which are not programmed. When a signal is heard, the radio stops or stays put until you reinstate scan mode.

Next, we'll try scanning the vfo frequencies. I push out the MR button and the last frequency set on the vfo is displayed. Push the button marked SCAN and the vfo begins scanning up the band continuously in the normal steps according to the mode selected. I can stop it by pushing the HOLD button or the push-to-talk (PTT) button on the mike. Or it will stop automatically when it comes across a signal.

Speaking of the microphone, Kenwood has included an up/down remote-tuning feature which is especially useful for mobile use. Each push of the appropriate button moves you 1 step and lets you know with a beep. To QSX several steps, just count the beeps. Hold down either the up or down button continuously and the tuning rate increases—and so do the beeps.

During the evaluation period, I became quite proficient in using all those buttons and dials on the 9500 and found the radio to be functionally well thought out and a pleasure to use. On-the-air reports have been consistently good and no problems were encountered.

The manual provided is clear and concise, but it does not cover details of circuit design and repairs. There is an optional service manual available which presumably covers these details for those so inclined. I recommend to new owners of the radio that they thoroughly familiarize themselves with the operating manual in order to get the most out of the radio. Although operation is relatively simple, there are some sophisticated features which are not immediately obvious.

Only a couple of minor suggestions for future product revisions: There is no squelch function for SSB or CW operation, and although it's not a necessity as it is on FM, it would be handy. Also, I personally prefer the fast agc time constant even in SSB mode, and the automatic-switch feature did not allow me the option. I did appreciate the use of a type-N antenna. In a number of 70-cm radios on the market, this feature has been overlooked.

For more information, contact *Trlo-Kenwood Communications*, 1111 West Walnut, Compton CA 90220.

Dave Mackey K1KA  
Amherst NH

## THE AEA INC. AMTOR TERMINAL UNIT

New modes of communication have always intrigued me. In past years, I have tried them all: RTTY, SSTV, high-speed CW, fast-scan TV, and even FAX. My favorite mode, by far, has been RTTY. If you are using a CRT, this mode can be completely silent. It also doesn't require continuous



Photo A. The AMTOR terminal unit from AEA, Inc.

concentration, as does CW. One can step out of the shack for a minute and not miss a thing—every word will still be on the CRT.

While RTTY signals are fairly QRM resistant, noise and fading still can distort the copy, leaving a number of "hits" (the RTTY op's term for errors) in the printout. Now that computer-controlled circuitry has become more affordable, it only makes sense that someone would try to come up with a solid-state solution for detection and correction of transmission errors in RTTY communication. One method of accomplishing this is to use the AMTOR protocol.

AMTOR originally was developed for commercial users of RTTY. The AMTOR code is based on the Murray (Baudot) code and has the same character-set restrictions. Each AMTOR letter consists of seven bits arranged so that each letter has four 1 bits and three 0 bits. If, on the receiving end of the teletype circuit, a character is received that does not have the 4:3 ratio, an error has been detected.

AMTOR has two modes. In the first mode (ARQ), data are transmitted in blocks of three characters. If an error is detected by the receiving computer, it sends a control signal back that means "send the 3-character block again." If no errors were detected (all the characters had that 4:3 ratio), the receiving RTTY computer sends a character telling the sender to send the next three letters.

The second mode (FEC) has each letter sent twice. If an error is detected in one character, it ignores it and copies the other one. This mode does not require the transceiver to be constantly switching from transmit to receive.

AMTOR was implemented originally using mechanical devices, but as computer technology improved, it made sense to use microprocessors. Earlier this year, AMTOR was approved for use on the low

bands (any digital code is legal above 50 MHz, but below it only AMTOR, ASCII, and the Baudot code), and various companies have started to support it.

The AMTOR AMT-1 terminal unit by AEA (Advanced Electronic Applications, Inc.) was designed to make it easy for a ham to use the AMTOR standard for RTTY. Consisting of a terminal unit, microcomputer, ROM software, and control circuitry in one integrated package, it makes AMTOR operation fairly automatic; all you have to do is add a computer with a serial port. When I first saw it, I was impressed by the modern design—there are absolutely no switches to be found on the unit! All control of the AMT-1 is accomplished by sending special character combinations through the serial port. The AMT-1 indicates its status via the LED display on the front panel and by sending special information back to the computer.

Setting the unit up takes a little while. In AMTOR operation, it is essential that the transceiver being used can switch from transmit to receive in 50 ms or less. (Remember that the TU takes care of T/R switching and has to switch back and forth between every three characters.) The shorter the T/R switching time, the better. Maximum distance is limited by too long a switching time. My TS-520S just made it. I would imagine that most new solid-state rigs would have absolutely no problems. The AMT-1 connects to the rig's microphone jack, the PTT lines, and the audio output (Photo A). It is convenient to tap the audio from the rig at a point before the volume control. This allows adjusting the rig's audio without disturbing the AMT-1.

Connecting a computer to the AMT-1 requires an RS-232-compatible port set to either 75 or 110 baud, full duplex. It is important to have the full-duplex mode because the unit echoes back as soon as any characters are typed (this can be dis-

abled, but it is better to use the AMT-1 echo feature). AEA included two DIP jumper plugs which bypass the TTL to RS-232 conversion circuitry. While this is mainly for VIC-20 and Commodore-64 computers which use TTL level signals in their serial ports, it can be used in conjunction with other micros. I was able to write a program for my Apple II which "converted" the game port to a full-duplex serial port. After wiring up an appropriate connector, I plugged in the AMT-1 and it worked flawlessly.

The AMT-1 provides for word wrap-around, but only for terminals that are over 60 columns wide. On a 40-column computer, the display looks a bit strange. (See Photo B.) Fortunately this can be disabled, causing the text to go from one end of the screen to another. If you want word wrap-around for a 40-column machine, you can provide for it easily in software. Many terminal control programs incorporate this feature already. While a custom program might provide the most flexibility for using the AMT-1, any terminal communications package that allows control characters and escape characters to be transmitted should do the trick.

When first turned on, the AMT-1 goes through a testing sequence that causes all the LEDs to turn on and off in a pattern. (I don't know if that accomplishes anything, but it looks nice.) It then enters the "escape mode" and is ready to accept a command from the computer. Typing a Q gives the unit's status:

V:03 I:???? T:30 B:45 S:20 L:1 N:1

The V is the revision number of the software. Mine is revision #3. I is for the selcal code. When nothing has been entered, it shows question marks. T is the AMTOR ARQ timeout: how long the unit should wait to receive the confirmation character before indicating an error. B is the baud rate for conventional RTTY operation (the unit also works nicely for "regular" RTTY). S is the CW sending speed, and L and N refer to word-wrap and echo-back modes.

To change a parameter, one types an ESC character followed by the proper letter. For example, to put the selcal code AFTM (no numbers are allowed) in memory, type ESC I. The unit will prompt with a colon, after which you enter a four-letter code of your choice. All the other parameters are changed in much the same way.

After I got through the 16 pages of documentation and wired up all the necessary cables, I tried it out on the air using the Baudot mode. One thing about this TU that took a bit of getting used to is the fact that it copies "upside down"; the receiver must be set for USB instead of the more traditional LSG. There is no disadvantage to doing things this way; it's just different from the way most terminal units operate.

Tuning around 20 meters, I found the TU to be fairly good. It uses an unconventional design: The audio is fed through a 4-stage active 300-Hz bandpass filter and then to a frequency-to-voltage converter. This is to facilitate a bar-code-tuning display. Tuning in a signal is easy; the receiver is tuned until one sees a centered pair of flashing LEDs on the display.

Before actually trying an AMTOR QSO, I decided to try copying the ARRL AMTOR bulletin. The League transmits their RTTY bulletin in the FEC (forward error-correction) mode—the one where each letter is transmitted twice. Absolutely flawless copy was the result; the same bulletin I copied using the Baudot mode did have a number of hits.

Most AMTOR activity is centered around 14.075. I went to this frequency and called CQ in the FEC mode. (It is usual practice to call CQ in the FEC mode and switch to the ARQ mode once communi-

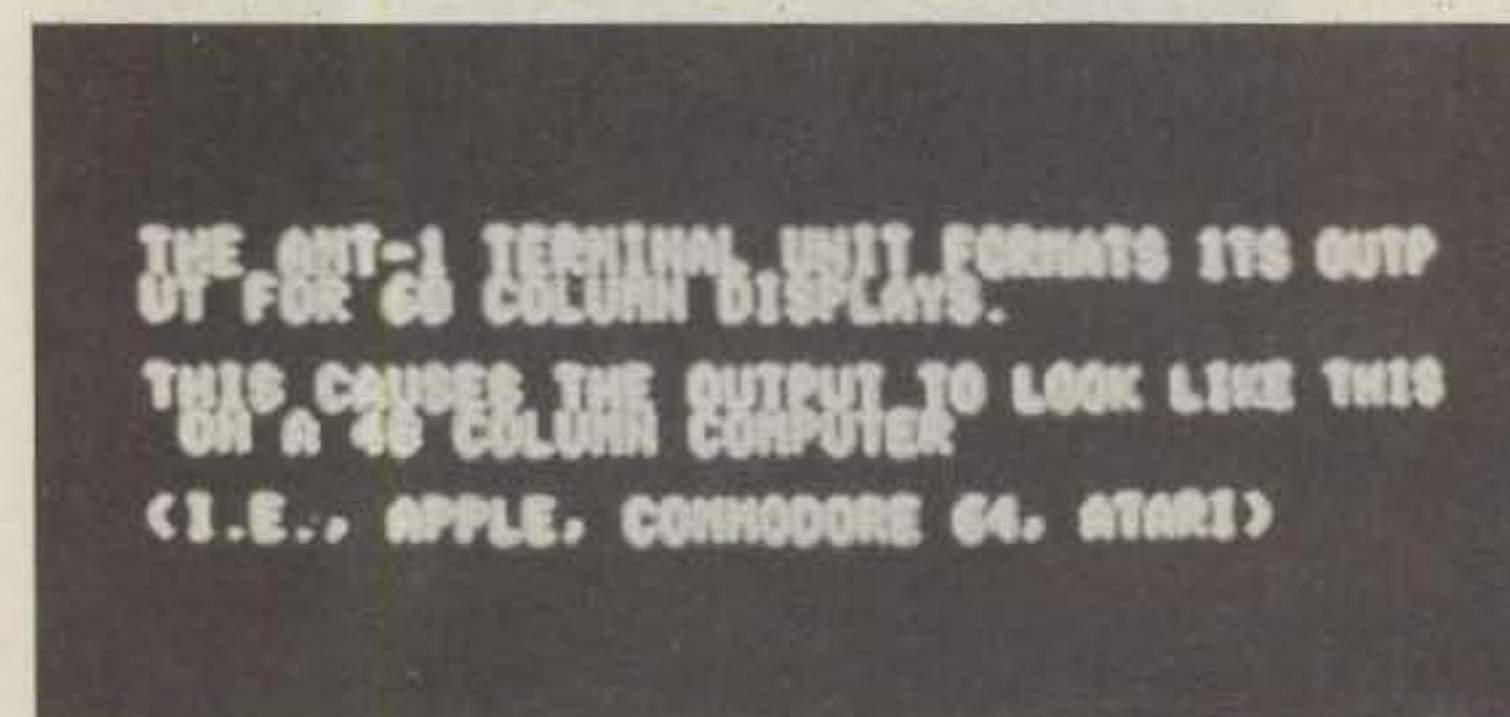

Photo B. AMT-1 output display sample on a 40-column computer.

cation has been established.) There was no reply. I tried again in a few days when the band conditions improved and met with success—I contacted WB2VTN running AMTOR on an IBM-PC using a homebrew interface.

The copy was flawless. Not a single error (except typographical ones) appeared on the copy. The ARQ mode—the one which waits until the other station's computer acknowledges correct reception of the data before sending more data—makes it very difficult for an error to creep through. Of course, if the band dies out completely, both stations will be waiting forever for the other station to reply (although, I would imagine, one would catch on after a little while). Just as with any other mode, if the signal isn't there, it can't be copied. But if conditions are bad and copy would be rough with conventional RTTY, AMTOR can get through—it would just slow down a bit.

Unfortunately, there isn't (as of this writing) much in the way of software support for the unit. Although one can probably get by nicely with a standard modem control program, it is nice to have a custom-tailored ham-radio communications program. Be sure you have the necessary programming skills to control your computer's RS-232 serial port (this can often be done easily in Basic). I was able to get the AMT-1 running on an Apple II, an Atari 400, and an IBM-PC without too much difficulty. Certainly, the necessary computer programming is well within the abilities of even the most casual computer hobbyist.

Based around a 6800 microprocessor, the AMT-1 is of sound design. All the parts are off-the-shelf TTL and linear. The metal enclosure effectively shields out any RFI that the TTL circuitry might generate. I was able to detect absolutely no RFI on a receiver a few inches from the unit.

I found the AEA AMT-1 a pleasure to use. Not only did it make the transition to AMTOR easy to implement, but also it made conventional RTTY more enjoyable. Because the unit controls T/R switching, you can run KOX (Keyboard-Operated Transmitter). All you have to do to switch from transmit to receive is start typing. Oh, yes... the unit also sends CW at any speed from 1 to 100 wpm for those of you who still like to do things the "old-fashioned" way.

For further information, contact AEA, Inc., PO Box C-2160, Lynnwood WA 98036; (206)-775-7373.

Robert Swirsky AF2M  
Cedarhurst NY

## ELECTRONICS IN YOUR POCKET

When I think of all the books I used to study for my "ticket," I just marvel at the fact that anything worthwhile ever happened. I used several college texts, license study guides, reference books, and stacks of back issues of 73. I really wanted to be successful in my venture. One thing I immediately learned is that too much information can be just as bad as too little. This idea is universal, whether you are studying to pass a test or just want to build a simple circuit. The main key is in limiting your resources to a few that you can really study; forget the library approach.

There are literally hundreds of good reference books on the market. The real problem is that the total number of these books is growing at an alarming rate. This leaves the average, uninformed, "I-want-to-learn-ham-radio-on-my-own" person with a very difficult problem. How does a

person cut through the glut of electronic reference books and select the one which will do the most good? Well, one thing which I will not attempt is to tell everyone which is the best. Instead, I will tell you about one text which has helped me in my work as an engineering technician and as a ham.

The book to which I'm referring is *Electronics Pocket Handbook*, by Daniel L. Metzger. I will briefly describe this book, pointing out various aspects, good and bad, which I've encountered while using it. The *Electronics Pocket Handbook* is exactly that. It is just slightly longer than a 3" x 5" index card and not quite as wide. The size makes it ideal for briefcase, coat pocket, or purse. You don't have to worry about all the pounds of books usually associated with study.

The book is sectioned into seven separate chapters and an index. Chapter 1, "Definitions, Formulas, and Charts," contains information very similar to that found in the *ARRL Handbook*. It gives you information on Ohm's Law, inductors, capacitors, complex notation, power-supply formulas, etc. Other information which isn't so typical in this section is on Boolean formulas and thermal, geometric, and bridge formulas. These latter formulas can be very difficult for the lay person to pin down when needed.

Some very needed component information is contained in Chapter 2. The title, "Component Data and Characteristics," says it all. This chapter contains information on wire insulation, wire characteristics, popular connectors, conductivity of various conductors, color codes for resistors, capacitors, and inductors, etc. You will learn how to read component values from any passive component, whether vintage 1932 or 1983. You also will learn how to read MIL-STD resistor designations such as those used on NASA surplus boards. This chapter can provide the individual with new knowledge which can help refine his ability as a scavenger. If the information in this chapter is actively applied when purchasing from the surplus market, a great savings should be realized.

In Chapter 3, "Simplified Circuit Analysis and Design," we start getting into the meat of electronic theory. You will work with resistive circuits, learn about several popular network theorems such as Thevenin's, Norton's, and Millman's, and the reciprocity theorem. You also will get into general circuit analysis, nodal analysis, and ac circuit analysis. In spite of the fact that some of these names may sound a bit scary, don't worry. The author has tried to make these as painless as possible and still maintain some authority in the text. If this information is not enough, you will also find transistor-biasing formulas and a small section on op-amp design. This is a good section to work through to help prepare your mind for any type of circuit analysis. *Especially on tests!*

In Chapter 4, "Units, Conversions, and Constants," we are introduced to the international system of units—Système Internationale d'Unites (SI). This is the system which the international engineering community has adopted as a standard. This chapter goes into detail on the various aspects of the system. You will learn shortcuts and keys which will enable you to use the system more efficiently. In addition to this, you will learn how to perform various unit conversions, such as quarts to liters or meters to feet. There is also a section on the most-frequently-used constants from science. These aren't all pertaining to electronics. This particular

chapter has quite an appeal to all students of the sciences.

In Chapter 5, "Standards, Symbols, and Codes," you will learn about broadcasting frequency standards, wavelengths, electrical wiring practices, hardware standards, etc. Included in the mechanical section is information on drill sizes, metal gauges, and general hardware tidbits. There is also a review (briefly) of teleprinter codes such as Baudot and ASCII. Sorry, no SITOR or AMTOR in this section. If some readers are still latent CB hounds, then the 10-code listing should prove useful for them. This chapter, especially the hardware information, should be interesting to the avid home-brewer.

In Chapter 6, "Test Procedures," you will learn how to test meters, batteries, inductors, capacitors, inductor Q, and resistors. You will learn the ins and outs of semiconductor testing and even get into the mechanics of amplifier testing. If home-brew isn't really your bag, you still could do well to read this even if you only occasionally service your rig.

Finally, in Chapter 7, "Glossary of Electronic Terms," we have a very comprehensive listing containing most of the commonly-used technical terms. This should be especially appealing to the newcomer. This will help give everyone an understanding, even if only rudimentary, of a term and its various associations. Several popular books neglect including this kind of information. They treat it as an unnecessary option. I disagree with that line of thinking totally. This little text has a full sixteen pages of definitions and terms which are extremely useful as well as educational.

Another aspect of this book which I like is the index. Most people, including several new technical writers, take this section of a book for granted. It is very frustrating when you need to find something in a hurry and it takes an hour. The lack of an index is a good indication that the author really doesn't care about the readers at all. This isn't the case with this book. The index could stand to be a little more comprehensive, but the book is organized in such a manner that finding most subjects is easy anyway.

*Electronics Pocket Handbook* is published by Prentice-Hall, Inc. In case you want your local bookstore to order you a copy, the ISBN number is: 0-13-251835-X. (This usually is needed when they have to place a special order.) You can expect to pay about nine dollars for this. In my opinion, it is probably the best nine-dollar investment I've made in quite a while. Now I can think about upgrading no matter where I may be. This is an excellent companion on trips when you can't carry tons of regular references with you.

Samuel G. Williams WB5YNI  
Hiawatha IA

## THE PRIVATE PATCH BY CONNECT SYSTEMS

The Private Patch II, by Connect Systems, is perhaps the most sophisticated simplex autopatch yet to hit the market. Hook the Private Patch up to an FM transceiver and a telephone and you're on the air with your own autopatch. It puts a simplex patch, control system, and CW IDer all in one box.

This patch is different from the other simplex patches on the market because it uses a VOX circuit for control rather than a sampling system. Most simplex patches are designed to switch the transmitter off every few seconds to quickly sample the receiver input. Since the system is simplex (it's either talking or listening, but not

both at once), that's the only way they can tell if a mobile station wants to talk—if a carrier is present during the sampling period, the system stays in receive mode to allow the mobile to talk.

The sampling method works, but it has two disadvantages. First, it's annoying to listen to the squelch tails that are generated every time the unit samples. Second, and more important, the transceiver used with a sampling system has to be able to switch between transmit and receive very rapidly. That means that radios with relay switching won't work, and most radios will need modifications to speed up the action of the squelch circuit.

The Private Patch II avoids these problems by using a sophisticated VOX circuit to control T/R switching. If the party on the telephone stops talking for more than about a half second, the unit switches from transmit to receive. The mobile unit can break in during the normal pauses that occur in conversation. To provide backup control, if the unit stays in transmit mode for more than about 20 seconds, it automatically goes back to receive for about 3 seconds. Thus, the mobile user will never be locked out for more than 20 seconds.

The VOX switching system also allows the Private Patch to work through repeaters since the repeater carrier won't lock the system into receive mode. Because the transceiver switches less often and stays in the receive mode longer, the stringent T/R-switching requirements of sampling-type patches are avoided.

The only disadvantage of the VOX switching system in the Private Patch is that mobile access is also VOX controlled. In other words, you can't capture the system merely by mashing down on the mike button. You actually have to say something before you're in control.

The Private Patch II works very well. It took only a few minutes to get everything hooked up to my Midland 220-MHz radio, and no internal modifications to the radio were necessary—all the connection points were available on the back panel of the Midland. The Private Patch needs only microphone, keying line, and speaker audio connections.

I did have one problem with the unit—the Midland T/R relay draws over 100 milliamps, and a power surge when the relay closed fried the switching transistor in the Private Patch the first time the transmitter switched on. The Midland relay probably draws more current than the average, so this problem shouldn't commonly occur, and the factory reports that they know of no other such failures. My solution was to use the keying circuit to drive a smaller reed relay which in turn drives the T/R relay.

Once the keying problem was taken care of, the Private Patch played well. It was very easy to adjust the audio-level controls to get the proper volume levels, and everyone who used the unit (both radio and landline users) commented on the good audio quality.

The patch has a built-in tone decoder, and control codes are provided for access, disconnect, and timer-reset functions. Front-panel switches allow long-distance dial restriction (by shutting the patch off if the first number dialed is a 1 or 0) and ringback enable and disable.

If the ringback circuit is enabled, the unit will operate as a reverse autopatch. When the telephone rings, the Private Patch will identify once and the telephone can be answered by sending the timer-reset code. The system then works as if a normal autopatch call had been placed.

A lot of thought went into the design of the Private Patch II. Many features that

aren't strictly necessary but are sure nice to have are included. For example, the IDer operates during the last minute before timeout so that the mobile operator has plenty of advance warning to reset the timer. The access codes can be changed to protect system security.

The reverse-patch ringback is disabled if a QSO has been in progress on the channel within the last few moments (so you won't get other users of the channel upset with your machine). A tone-to-rotary converter is built in so that the patch will work on any phone line.

All in all, the Private Patch II is quite an amazing box. The VOX switching system makes it unique, and it has all the other features necessary to make it a thoroughly practical machine. For more information, contact *Connect Systems, PO Box 4155, Torrance CA 90510; (213)540-1053.*

John Ackermann AG9V  
Green Bay WI

## THE TR-720 VHF TRANSCEIVER

Many hams and readers of 73 are pilots and aircraft owners. Therefore, this month we present a review that deals with an AM transceiver for use on the 118-136-MHz aircraft band. We think that this unit will find much favor with pilots because of its small size, light weight, and extreme portability, providing a versatility seldom seen in aircraft equipment, with little if any sacrifice in performance.

One of life's nicer surprises is to find a piece of equipment that performs better than you expected. The TR-720 aircraft-band VHF transceiver is one of these; it is a joy to own and operate.

Although Communications Specialists is well known for its line of amateur and commercial encoders and decoders, it is less well known for its other products...including this new venture into two-way communications equipment for the aircraft owner and pilot...and it is a real pleasure to find that the equipment is almost ideally suited to fill a real need.

The VHF aircraft band extends from 118 MHz to 136 MHz and—unlike other VHF communications services—it is AM, not FM. In the frequencies encompassed by this band, there exist 200 navigation "channels" and 720 communications "channels."

The navigation channels are occupied by VORs (ground-located VHF Omni Ranges), stations which permit a pilot to home in from any point of the compass by means of an instrument mounted on the instrument panel. All the pilot needs to do is tune in the station, center the needle by turning the OBS (Omni Bearing Selector), and then fly the plane on that bearing so that the needle remains centered.

This, of course, is an oversimplification, but it will serve to describe one general way in which the VOR system is used. The instrument tells the pilot whether the radial that he is on is *To* or *From* the station (there are 360 radials...one for each full degree of the compass). When the plane passes over the station, the "To-From card" flips over.

While the pilot flies the needle, he also can listen to the VOR station itself and receive the Morse-code identifier plus voice transmissions of weather and other information needed to fly safely to his destination.

The 720 communications channels are used for the purpose of talking to airport control towers, Unicom stations, other aircraft, Flight Service Stations, and the like. It was the advent of equipment having su-

SPECIFICATIONS	
<b>Model</b>	TR-720 airband transceiver
<b>Frequency range</b>	118.000 MHz–135.975 MHz (Com band), receive and transmit 108.000 MHz–117.975 MHz (Nav band), receive only
<b>Number of channels</b>	720 (Com band) with 25-kHz spacing 200 (Nav band) with 50-kHz spacing
<b>Frequency determination</b>	Microprocessor-controlled CMOS phase-locked loop
<b>Frequency stability</b>	±.001% (–10° C to +60° C) ±.002% (–30° C to +60° C)
<b>Power consumption</b>	39 mA squelched 165 mA @ 300 mW audio output 650 mA transmit
<b>Antenna type</b>	Flexible rubber 50-Ohm unbalanced type
<b>Battery type</b>	9.6-V/450-mAh nicad battery pack (CS-15), or 9.6-V/750-mAh nicad battery pack (CS-18), or 12-V, 8 AA alkaline batteries (CS-19)
<b>Size</b>	6.6" (169 mm) × 2.6" (64 mm) × 1.5" (38 mm)
<b>Weight</b>	1.2 lb. (19 oz./544 kg) with battery
<b>RECEIVER</b>	
<b>Receiver type</b>	Dual conversion superheterodyne
<b>Sensitivity</b>	Less than .5 uV for 10 dB (S + N)/N (Com band) Less than 2 uV for 10 dB (S + N)/N (Nav band)
<b>Selectivity</b>	60 dB at 25 kHz
<b>Squelch sensitivity</b>	.5-uV threshold, FM noise type
<b>Audio output</b>	500 mW maximum, less than 10% THD
<b>I-F image rejection</b>	Greater than 60 dB
<b>Spurious response</b>	Greater than 60 dB
<b>TRANSMITTER</b>	
<b>Rf output power</b>	1 Watt nominal, 800 mW minimum, 3 Watts PEP into 50-Ohm load
<b>Frequency stability</b>	±.002% (–30° C to +60° C)
<b>Spurious &amp; harmonics</b>	Greater than 60 dB below carrier
<b>Modulation type</b>	6A3, high level Class B collector modulation (AM)

perior selectivity and frequency stability that made possible the increase in the number of communications channels from 90 to 360 and then to 720...permitting expansion and growth of the system to meet current needs.

Most of the users of larger aircraft, including the airlines, corporate fleets, and the like, have several sets of VHF communications and navigation radios on each airplane. Some are redundant, for safety's sake, while others are needed for simultaneous reception/transmission and navigation. All of the equipment is expensive, and much of it is beyond the financial reach of many private pilots and aircraft owners who fly for fun. As a consequence, many smaller airplanes have only one radio: a Navcom unit that combines both functions of communications and navigation. Often, these radios are older tube types and are limited in channel spacing to only 90 or 360 channels, thus limiting—or even prohibiting—many smaller, privately-owned aircraft from full use and enjoyment of the national air-traffic system.

Pilots of sailplanes (gliders), balloons, experimental and home-built aircraft, firefighters, ultralights, and other types of aircraft may have a sometime need for VHF communications and navigation radios and often cannot or will not spend the larger amounts of money required for permanent installation of expensive equipment.

Communications Specialists, recognizing the need in this area for small, lightweight, inexpensive rigs, has introduced to the marketplace its new TR-720, a hand-held transceiver of outstanding performance. Here is a unit that is crystal-synthesized to cover all 720 communications channels and 200 navigation channels; it operates on an internal nicad bat-

tery pack which can be recharged from either an automobile or aircraft dc supply of between 12 and 28 volts or from the 115-volt-ac house mains. Further, and still more convenient, the TR-720 has the standard aircraft BNC connector for its antenna. Thus, a coaxial cable may be connected from the aircraft antenna, or the standard flexible (rubber ducky) supplied with the unit may be used.

Just a tiny handful, weighing only 1.2 pounds with the standard nicad battery pack, and measuring 6.6 × 2.6 × 1.5 inches, the TR-720 has giant-size performance. Receiver sensitivity is exceptional, and power output on transmit is nominally 1 Watt dc or 3 Watts PEP, voice modulated. An adapter for an external microphone and headset is provided for those who prefer them for use in the cockpit. One of the prime advantages of a transceiver operated from its own supply is the obvious backup capability it provides in case of failure of the aircraft radio system. Almost as important is the capability of portable operation, where FAA (Federal Aviation Agency) personnel may need to direct traffic from an emergency runway, a helicopter landing pad, or another location where no permanent radio installation exists.

The pilot of a sailplane, which often has no permanent battery or radio setup, would find the TR-720 ideal for his purposes...for contacting the tower at a controlled airport, for example, when wishing to land. The TR-720 is easily and handily carried aboard and mounted by means of its belt loop on the leather carrying case. It can be suspended from the belt, of course, and carried portable in that manner as well. One can visualize stuffing the hand-held into an available glove box (it fits into the glove compart-

ment on my Cessna 150 with plenty of room to spare) or mounting it temporarily somewhere in the vicinity of the instrument panel for quick reference and use.

I was very surprised to find that the TR-720 was hearing stations in flight better than my standard aircraft radio—which, by the way, is one of the older 90-channel types, unable to receive or transmit on the split frequencies in common use today. Thus, for me, the TR-720 allows access to airports and FAA communications facilities that I could not otherwise use.

The TR-720 receives even distant stations on its flexible antenna *inside* the cabin of my all-aluminum Cessna. I have not yet found the need to use the aircraft external antenna for receiving, but I have discovered that it works best on the hand-held for transmitting to distant stations...as you would expect, considering the amount of output power.

Enjoying the TR-720's internal battery pack and its isolation from the aircraft electrical system, I find that much of the hash generated by my engine and its accessories is absent when I try to hear another station. This means that I don't have to ask for a repeat of the transmission, and it certainly saves wear and tear on the ears. I seem to be approaching the situation where I plan to use the TR-720 as my main transceiver for communications and my aircraft radio for navigation only!

I took the TR-720 on vacation with me and found that it attracted attention wherever I went. One FBO (fixed base operator) told me that it was "...the best-sounding radio on the field!" Another told me that he wanted to stock them for his local clientele and for transient visitors to his field. The pilots themselves are really interested, and two local pilots who fly a lot of formation with their Piper Cubs want a pair of them for plane-to-plane communications.

Civil Air Patrol personnel would find these units ideal for search-and-rescue operations. In particular, a recent airplane crash at a remote mountaintop site required ground search teams. Their work and coordination from aircraft in the area might have been greatly simplified and speeded up had some TR-720s been available.

One of the features you will like is the twist-off battery pack, permitting almost instant replacement by a fresh pack when needed, while the original pack is being recharged. Battery packs of 450-milliampere-hour capacity are standard, but 750-mAh packs are available. Supplied accessories include: flex antenna (rubber ducky), simulated leather case, 115-V-ac wall charger, dc charger (cigarette-lighter-adaptor plug), earphone, and operating manual. Available accessories are: alkaline battery pack (batteries not supplied), nicad rapid charger (1 hour), desk-type drop-in charger, 220-V-ac wall charger, simulated leather case for use with larger battery pack, remote hand-held speaker/mike, cable adapter for PJ-068 and PJ-055 to TR-720, and cable adapter for U-174 to TR-720.

An outstanding feature of the TR-720 that I have not seen on similar units for aircraft-band use is the 3-position memory. You can store three different frequencies in the memory merely by setting them, one at a time, on the dial, switching to memory locations 1, 2, or 3, and pushing the memory-store button. This way, for example, you could set up in advance an ATIS frequency, a control-tower frequency, and a ground-control frequency. Perhaps you might want approach-control, tower, and

departure-control frequencies. Another possibility would be the split-frequency or half-duplex option where you set a Nav frequency (VOR, for example) into memory and a Com frequency on the dial. Then you can communicate with a Flight Service Station and hear its reply over the VOR station closest to your location. Frequency selection is by thumbwheel

dials, and a noise-type squelch circuit was used on FM equipment is incorporated so that you don't have to listen to "white noise" between transmissions. This saves the battery, too.

The TR-720 employs 1 microprocessor, 10 integrated circuits, and 50 transistors. Transmitter and receiver incorporate 12 varactor-tuned stages which track with

the selected frequency for optimum performance from band-edge to band-edge. The TR-720 is FCC Type Accepted (US) and DOT Certified (Canada).

Communications Specialists places a 1-year warranty on the TR-720, with a guaranteed 72-hour turnaround for repair or replacement.

Aircraft owner's net price is \$795, in-

cluding the standard supplied accessories described above. For further information, call or write *Communications Specialists, 426 West Taft Avenue, Orange CA 92665-4296; (800)-854-0547; (714) 998-3021.* Dealer inquiries invited. Reader Service number 485.

**Jim Gray W1XU**  
73 Staff

# CONTESTS

**Robert Baker WB2GFE**  
15 Windsor Dr.  
Atco NJ 08004

## ARRL SWEEPSTAKES CW

**Starts: 2100 GMT November 5**  
**Ends: 0300 GMT November 7**  
Phone

**Starts: 2100 GMT November 19**  
**Ends: 0300 GMT November 21**

US and Canadian stations work other US and Canadian stations using the 1.8-through 28-MHz bands, excluding 10 MHz. Operate no more than 24 of the 30 hours with on/off times noted clearly in your log. Listening time counts as operating time. Operating categories include single-operator and multi-operator with a single transmitter.

No cross-mode contacts will be allowed and each station can only be worked once, regardless of frequency band. A transmitter used to contact one or more stations may not subsequently be used under any other call during the contest period (with the exception of family stations where more than one callsign is assigned by FCC/DOC). One operator may not use more than one callsign from any given location during the contest period. The use of two or more transmitters simultaneously is not allowed.

### EXCHANGE:

Consecutive serial number, precedence (A if you run 150-W output or less, B if more than 150 W), your callsign, check (last two digits of the year you were first licensed), and your ARRL section.

### FREQUENCIES:

CW: 1800-1810, 3550-3650, 7050-7100, 14050-14100, 21050-21100, 28050-28100.  
Novice: 3710, 7110, 21110, 28110.  
Phone: 1855-1865, 3850-3950, 7200-7250, 14250-14300, 21300-21400, 28550-28650.

### SCORING:

Count 2 points for each completed 2-way QSO. Multipliers are each ARRL section plus VE8/VY1 (74 maximum). KP4, KV4/KP2, and KG4 stations are in West Indies section, while KH6 and other US possessions in the Pacific count as the Pacific section. Final score is QSO points times the number of ARRL sections (plus VE8/VY1).

### AWARDS:

Certificates to the top single-operator CW and phone scorers in both the A and B categories in each ARRL section, and the top multi-operator entry in each ARRL Division.

### ENTRIES:

Contest forms (log sheets, summary sheet, dupe sheet) are available from ARRL HQ for an SASE. Official forms are recommended. Any entry claiming more than 200 QSOs must submit duplicate checking sheets. Incomplete or late entries will be classified as checklogs. Logs should include dates, QSO times, exchange sent/received, band, and mode. Postmark your entry for either mode by December 21 and send it to: ARRL, Newington CT 06111.

Each entrant agrees to be bound by the provisions as well as the intent of the official ARRL rules, the regulations of his licensing authority, and the decisions of

the ARRL Awards Committee. The usual disqualification rules apply.

## INTERNATIONAL POLICE ASSOCIATION CONTEST 0000-0300, 0700-1000, 1400-1800 GMT November 5-6

Sponsored by the IPARC, this contest will be conducted on both CW and phone.

### EXCHANGE:

Signal report and serial number. US stations also send state; IPA member send "IPA."

### FREQUENCIES:

Phone: 3.650, 3.775-3.8, 7.075, 14.295, 21.295, 28.650.  
CW: 3.575, 7.025, 14.075, 21.075, 28.075.

### SCORING:

Non-IPA stations can work IPA members only, and each station can only be worked once per band. 4 points per QSO on 20, 15, and 10 meters. Each QSO on 40 and 80 meters counts two points, except DX, which is worth 8 points per QSO.

### ENTRIES:

Mail entries by December 31 to: Anton Kohten DK5JA, PO Box 40 01 63, 4152 Kempfen 1, Federal Republic of Germany.

# RESULTS

## 1983 RESULTS WORLD CHAMPIONSHIP RTTY CONTEST Sponsored by *The RTTY Journal* and 73

Indicated are callsign, points, multipliers, and total score.

- \*\*\*World champion
- \*\*DX champion
- \*W/VE champion

State, provincial, and DX country awards will also be given in recognition of this year's accomplishments.

### Single Operator, Multi-Band

\*\*\*G3ZRS — 164 — 96 — 15,744  
\*\*SM6ASD — 167 — 92 — 15,364  
XT2AU — 163 — 85 — 13,855  
I4JXE — 158 — 84 — 13,272  
\*W3BE — 163 — 66 — 10,758  
W3FV — 147 — 73 — 10,731  
SM5FUG — 123 — 74 — 9,102  
IT8EAI — 101 — 87 — 8,787  
K4AGC — 118 — 66 — 7,788  
TO6AUS — 101 — 62 — 6,262  
N7AKQ — 139 — 45 — 6,255  
G4NJW — 96 — 58 — 5,568  
K6WZ — 89 — 55 — 4,895  
K0BJ — 88 — 55 — 4,840  
AE5H — 88 — 55 — 4,400  
W0LHS — 80 — 40 — 3,200  
I2DJX — 76 — 38 — 2,888  
SM7LSU — 68 — 38 — 2,584  
JA1BYL — 61 — 41 — 2,501  
W2DNO — 61 — 40 — 2,440  
I6YPK — 64 — 38 — 2,432  
N5DSK — 62 — 46 — 2,352  
GW3EHN — 64 — 36 — 2,304  
NN6F — 52 — 44 — 2,288  
SM3EZD — 72 — 31 — 2,232  
SM5AAY — 63 — 34 — 2,142  
ON7EP — 55 — 37 — 2,035  
VE3ZX — 52 — 39 — 2,028  
K4JAF — 51 — 37 — 1,887  
TO6HKR — 45 — 38 — 1,710  
OK1AWC — 51 — 24 — 1,224  
VE7VP — 42 — 28 — 1,176  
W7CBY — 36 — 30 — 1,080  
VK2BQS — 40 — 17 — 1,080  
TI2DO — 45 — 22 — 990  
SM6AEN — 35 — 27 — 945  
KE6T — 31 — 27 — 837  
G4KHX — 40 — 17 — 680

G4OJJ — 34 — 12 — 408  
KJ2N — 15 — 14 — 210  
LU3DSU — 13 — 9 — 117  
SM3GT — 27 — 4 — 108  
YB3ON — 41 — 1 — 41

### Single Operator, 20 Meters

\*\*\*KJ8N — 71 — 35 — 2,485  
\*\*YB2BLI — 65 — 22 — 1,430  
GM4KHE — 54 — 22 — 1,188  
PY6ACP — 43 — 27 — 1,161

### Single Operator, 15 Meters

\*\*\*K7NO — 141 — 59 — 8,319  
\*\*OH5YW — 83 — 24 — 1,992  
JA3EOP — 50 — 28 — 1,400  
I5AZX — 58 — 17 — 986  
YO3RF — 26 — 12 — 312

### Single Operator, 10 Meters

\*\*\*OH5IY — 10 — 10 — 100

### Multi-Operator, Multi-Band

\*\*\*OH8TA — 143 — 70 — 10,010  
\*KA4MKG — 113 — 57 — 6,441  
W8UPU — 69 — 39 — 2,628  
VE3NEX — 52 — 37 — 1,924  
\*\*OK3KGI — 57 — 29 — 1,653  
OK3RJB — 48 — 27 — 1,296  
OK3RMW — 45 — 22 — 990  
OK1OAZ — 26 — 23 — 598  
OK3KII — 34 — 21 — 522  
OK3KXM — 11 — 8 — 88

### Multi-Operator, 20 Meters

\*\*\*K8EX — 195 — 62 — 12,210  
\*\*SL5AR — 78 — 29 — 2,262

### Check Logs

DL1VR, OZ6SM, N6ELP, W6JOX

# CALENDAR

**Nov 5-6** International Police Assn. Contest  
**Nov 5-7** ARRL Sweepstakes—CW  
**Nov 6** DARC Corona 10-Meter RTTY Contest  
**Nov 12** OMISS QSO Party  
**Nov 12-13** Delaware QSO Party  
**Nov 12-14** CQWE Contest  
**Nov 12-14** Rhode Island QSO Party  
**Nov 19-21** ARRL Sweepstakes—Phone  
**Dec 3-4** ARRL 160-Meter Contest  
**Dec 10-11** ARRL 10-Meter Contest  
**Jan 7** 73 40-Meter World SSB Championship  
**Jan 8** 73 75-Meter World SSB Championship  
**Jan 14-15** 73 160-Meter World SSB Championship  
**Jan 14-15** Hunting Lions In The Air Contest  
**Feb 4-5** South Carolina QSO Party  
**Feb 18-19** America Radio Club International DX Contest  
**Feb 18-19** YL-ISSB Commo System QSO Party—Phone  
**Feb 25** RTTY World Championship Contest  
**Mar 17-18** YL-ISSB Commo System QSO Party—CW

# RESULTS

## 15NPH, 4M3AZC, K3TUP, AND KC5NQ: 1983 WORLD 40-METER CHAMPS

Multi-band contests are won or lost on the 40-meter band! All the top contest stations will admit that a decent score on 7 MHz may spell the difference between first- and second-place finishers. Why is it, then, that 40 seems to be the forgotten band by so many? The answer is *congestion!*

Broadcast signals make for a very hectic experience if one is to roost on 40. That is why 73 recognized the rare opportunity to prove that 40 meters can in fact be the born-again band it used to be. With all the elements against you, the top contender would be the one who could survive the strong carriers of AM broadcast stations overseas, the sometimes unbearable QRN that even the best filter cannot overcome. To top that, to obtain those necessary multiplier points, here's a band that tests your skill in crossband operation once and for all.

The majority of contestants indicated that the DX paths were excellent to most parts of the world, particularly to Europe and Asia. Stations added a host of new countries to their DX tallies! Stateside conditions were reported to be the best they had been in many weeks.

After all the smoke had cleared and the entries were received and tallied, KC5NQ led the pack for single-operator stations. This championship station managed 756 QSOs in less than 16 hours of 40-meter operation and worked 61 states and provinces and 45 DX countries. A distant second was afforded Florida contester N4BAA, who accumulated 559 QSOs, 55 states and provinces, and 48 countries. For single-operator DX stations, our good friend 4M3AZC of Venezuela became the world champ with 578 QSOs, 53 states and provinces, and 56 DX countries for his total. K3TUP took top honors for all WVE multi-operator stations with a super tally of 1214 QSOs, 58 states and provinces, and 56 DX countries. DX multi-operator honors went to 15NPH, who worked 667 QSOs, 43 states and provinces, and 64 DX countries.

Of all the classes and categories in the 40-meter contest, the WVE multi-operator final heat was the closest. Close on the heels of champion K3TUP was 160-meter contest winner K8ND with 1129 QSOs, 57 states and provinces, and 37 DX countries. Only 85 QSOs and roughly 6,500 points separated these first- and second-place finishers.

In the WVE single-operator class, stations with 500 or more QSOs were KC5NQ (756), KA1XN (718), KC3N (702), KG1E (676), KM9P (618), K4HAV (617), KC8JH (600), WA0IDK (590), N4BAA (559), KA1GHR (523), WA4SVO (506), and KA1WJ (503). DX single-operator stations with 400 or more QSOs included 4M3AZC (578), IO3MAU (478), IO6NOA (438), OK1TN (438), and CT4NH (426). In the multi-operator class, 500 or more QSOs were obtained by K3TUP (1214), K8ND (1129), K5LZO (813), KC0SZ (764), 15NPH (667), I4OUT (648), N8EKE (592), and KB0QA (584).

Well over 50% of the 40-meter contestants worked 40 or more states and provinces, many stating that they worked all states in the 24 hours of the contest period. KC4NQ managed to get a clean sweep of 61 state and provincial multipliers, the only one in the contest to get all WVE multipliers possible. KA1XN lacked only 2 to match KC5NQ's feat, while KC8JH, VE3ICR, K3TUP, and KC0SZ all recorded 58 out of the 61 possible states and provinces.

In DX, the following stations worked 30 or more DX countries: 15NPH (64), I4OUT (62), OK1TN (59), 4M3AZC (56), IO6NOA (56), IO3MAU (50), N4BAA (48),

CT4NH (47), KC5NQ (45), VE3ICR (42), PY5EG (41), DL8NBE (41), OK1AYP (38), K8ND (37), DA1TN (37), KG1E (36), K5LZO (35), KC0SZ (33), VO2CW (32), KA1GHR (32), KA1WJ (32), and KA2CDE (31).

With January just around the corner, it's time to prune those dipoles and inverted vees and get ready for the 3rd annual event. If propagation is in our favor and we can get the word out to as many DX stations as possible, we expect to see some fantastic scores and some new world records!

You still have time, so send in your 1984 contest forms today! Enclose an SASE and send your request to Dennis Younker NE6I, 40-Meter Contest Chairman, 43261 Sixth Street East, Lancaster CA 93535.—Bill Gosney KE7C.

### 40-METER CONTEST SOAPBOX

- KG1E: "Will try a beam next year instead of a dipole at 50 feet!"  
 KA1RC: "A great contest. New delta loop worked well on DX. Blew the linear halfway through the contest though. Will definitely be back next year despite problems this time around."  
 KC3N: "Working 35 DX stations split frequency without an external vfo gives one fast fingers! Loads of fun but couldn't the broadcast stations QSY? Age 16. See you next year."  
 K3TUP: "24 hours is a perfect amount of time for any contest."  
 WA3SPJ: "Enjoyed both 40- and 80-Meter Contests a lot."  
 N4BAA: "Great contest again! Next year will have 4 elements at 140 feet."  
 WC4E: "Thank you, 73, for the opportunity to participate in such a fine contest."  
 WD4RCO: "Most enjoyable contest. Good representation of DX, most of whom willingly listened up."  
 W4TMR: "This is my first 40-Meter Contest, can't wait until next year!"  
 KC5NQ: "The DX was better this year and the band was in extremely good shape. Thank you, 73 and the contest bunch."  
 N7BUP: "Had a great time—wish I had better prepared to go the distance overnight."  
 KC7PA: "Next year, I definitely am getting a second vfo. Hate to miss the rare DX. Got five new countries, however. How about a low-power category next year? Otherwise, I'll need an amp."  
 K9GDF: "My wife (N9DIJ) almost beat me in this contest."  
 KC0SZ: "Would have been nice to have Europeans listening upband. We had several openings but no one would listen up frequency, it seemed."  
 EA1QF: "A great opportunity to work new states or countries."  
 HI8GB: "Thanks very much for an interesting phone contest—it's long overdue!"  
 IO6NOA: "I expected more participation from Europeans. Many asked what contest was going on."  
 VE3ICR: "Didn't expect to be so involved in the contest. However, once I started, it was hard to quit!"

### 40-METER ANTENNA SURVEY

	1982	1983		1982	1983
Dipole/inverted vee	39.8%	44.6%	Delta loop	9.3	3.8
1/4- or 1/2-wave vertical	13.9	4.8	2-element wire beam	2.3	0
Trap vertical	9.3	11.5	3-element yagi	2.3	3.8
2-element yagi	7.0	9.6	4-element yagi	0	5.7
1/4-wave sloper	4.6	9	Longwire	0	4.9
1/2-wave sloper	2.3	6.7	Log periodic	0	9
2-element delta loop	4.6	2.8	2-element quad	2.3	0
			Bobtail curtain	2.3	0

### DARC CORONA

#### 10-METER RTTY CONTEST Starts: 1100 GMT November 6 Ends: 1700 GMT November 6

This is the last of four tests during the year sponsored by the DARC eV to promote RTTY activity on the 10-meter band. Use the recommended portions of the 10-meter band. Each station can be contacted only once. Operating classes include single/multi-operator and SWL printer.

#### EXCHANGE:

Each completed 2 x RTTY QSO is worth 1 point. Multipliers include the WAE and DXCC lists, each US state, and each district in VE/VO and VK. The final score is the total QSO points times the total multiplier.

#### AWARDS:

Appropriate awards to the leading stations in each classification, assuming reasonable scores.

#### ENTRIES:

Logs must contain name, call, and full

address of participants. Also show class, times in GMT, exchange, and final score. SWLs apply the rules accordingly. Logs must be received within 30 days after the test. Send all entries to: Klaus K. Zielski DF7FB, PO Box 1147, D-6455 Erlensee, West Germany.

#### DELAWARE QSO PARTY Starts: 1700 GMT November 12 Ends: 2300 GMT November 13

Sponsored by the Delaware ARC. Stations may be worked once per band and mode for QSO and multiplier credits.

#### EXCHANGE:

CW—1805, 3570, 7070, 14070, 21070, 28070.  
 SSB—1815, 3975, 7275, 14325, 21425, 28650.  
 Novice—3710, 7120, 21120, 28120.

#### SCORING:

Delaware stations score 1 point per QSO. Multiply total by the number of ARRL sections and DX countries worked.

Others score 5 points per Delaware station worked. Multiply total by the number of

Delaware counties worked on each band and each mode (maximum of 36 multipliers possible).

#### ENTRIES AND AWARDS:

Appropriate awards will be given to the top scorers. In addition, a certificate will be given to all stations working all three Delaware counties. If you work all three counties and want the WDEL Award, send two 20-cent stamps and an address label.

Mail logs by December 16 to: Charlie Sculley AE3H, 103 E. Van Buren Avenue New Castle DE 19720. Send an SASE for a copy of the results.

#### OMISS QSO PARTY Starts: 0000 GMT November 12 Ends: 2400 GMT November 12

Sponsored by the Old Man International Sideband Society. Work stations once per band. Exchange RS, name, state, and OM number (if any). Count 5 points per OMISS member, 2 points per nonmember. Multiply by total states, VE provinces, and DX countries. Plaque to top-scoring member and nonmember. Certificate to top-scoring members in each US call district. Mail logs

and cover sheet within 15 days to: Rich Besitka KA1HGY, 480-B Radmere Road, Cheshire CT 06410. Include an SASE for further information.

#### CQWE CONTEST Starts: 1900 GMT November 12 Ends: 0500 GMT November 14

Sponsored by the Bell System Amateur Radio fraternity, the contest contains various sessions during the period. The contest is open to present and retired employees of Bell, Western Electric, AT&T, and subsidiaries of AT&T. Contact your local interworks coordinator for logs and complete rules, or write to: Phil Pearson WA1LXY, Bell Telephone Laboratories, 1600 Osgood St., North Andover MA 01845, Room 3E-46. Telephone: (617)-681-6179 (work) or (603)-362-4297 (home).

#### RHODE ISLAND QSO PARTY 1700 GMT November 12 to 0500 GMT November 13 1300 GMT November 13 to 0100 GMT November 14

Sponsored by the East Bay Amateur

Wireless Association. RI stations work other RI stations and the rest of the world. All others work only RI stations. The same station may be worked twice on each band, once on phone and once on CW.

**EXCHANGE:**

RS(T) and state, province, country, or RI city.

**FREQUENCIES:**

Phone—3900, 7260, 14300, 21360, 28600, 50.110, 144.2, 146.52.

CW—1810, 3550, 3710, 7050, 7110, 14050, 21050, 21110, 28050, 28110.

Use FM simplex, no repeaters.

**SCORING:**

All stations score 2 points per phone QSO, 3 points per CW QSO, and 5 points for QSOs with Novices and Technicians. RI stations multiply QSO points by the number of states, provinces, and countries worked. Others multiply total QSO points by the number of different RI cities and towns worked (39 maximum).

**AWARDS:**

Certificates awarded to top-scoring station in each state, province, country, and RI county, plus top-scoring Novice and Technician in RI and out of state.

**ENTRIES:**

Logs must show date/time in GMT, call, exchange, band, and mode. Include your name, call, mailing address, club affiliation if any, total QSO points, multipliers claimed, and final score. Entries must be postmarked no later than December 15 and addressed to: East Bay Amateur Wireless Association, PO Box 392, Warren RI 02885. Include an SASE for results.

**3RD ANNUAL 40-METER  
WORLD SSB CHAMPIONSHIP  
0000Z to 2400Z  
January 7, 1984**

**SPONSORED BY:**

73: Amateur Radio's Technical Journal.

**MISCELLANEOUS RULES:**

Work as many stations as possible on 40-meter phone during the specified times of allowable operation. The same station may be worked *once*. Crossmode contacts will not count. Single-operator stations may operate a total of 16 hours. All multi-operator stations may operate the entire 24-hour period. Off periods must be noted in your log(s) and on your summary sheet. Off periods are *no less than 30 minutes each*.

**OPERATOR CLASSES:**

(A) Single operator, single transmitter, phone only. (B) Multi-operator, single transmitter, phone only.

**EXCHANGE:**

Stations within the continental 48 United States and Canada transmit an RS report and state, province, or territory. All other stations, including Alaska and Hawaii, transmit RS report and DX country.

**POINTS:**

5 QSO points for contacts with WVE stations located within the continental 48 United States and Canada. All other contacts score 10 points each. List points for each contact on your log sheet(s).

**MULTIPLIERS:**

1 multiplier point is earned for each US state, 48 maximum (a District of Columbia contact may be substituted for a Maryland

multiplier), each Canadian province or territory (13 maximum), and DX country (excluding the continental US and Canada).

**FINAL SCORE:**

Total QSO points times total multiplier points equals *claimed score*.

**CONTEST ENTRIES:**

Each entry must include a contest log, a dupe sheet, a contest summary, and multi-

**1983 RESULTS  
40-METER WORLD SSB CHAMPIONSHIP**

Indicated are call sign, QTH, QSOs, states/provinces worked, DX worked, and total score.

\*World champion  
\*State/province/country champion

**WVE Single Operator**

**KC5NQ	-TX	-756	-61	-45	-86,496
*N4BAA	-FL	-559	-55	-48	-65,714
*KA1XN	-MA	-718	-59	-27	-65,188
KG1E	-MA	-676	-52	-36	-64,592
*KC3N	-PA	-702	-55	-27	-60,926
*VE3ICR	-ONT	-467	-58	-42	-57,200
*KC8JH	-OH	-600	-58	-29	-57,072
*K4HAV	-GA	-817	-55	-22	-50,127
*WA0IDK	-MN	-590	-56	-23	-48,901
KA1GHR	-MA	-523	-52	-32	-43,932
KA1WJ	-MA	-503	-55	-32	-43,761
*KM9P	-IL	-618	-55	-12	-42,612
*W5JW	-NM	-452	-56	-29	-42,245
N8ATR	-OH	-485	-54	-25	-41,080
WA4SVO	-FL	-506	-53	-19	-38,880
*KI7M	-OR	-463	-55	-15	-33,880
*KA2CDE	-NY	-341	-52	-31	-32,370
*VO2CW	-LAB	-288	-54	-32	-29,326
*WB4UFL	-IA	-453	-55	-8	-29,169
*W9UP	-WI	-377	-53	-13	-26,136
WD8IVL	-OH	-397	-53	-12	-25,805
*W4TMR	-NC	-300	-53	-24	-25,718
*KB0C/4	-VA	-503	-46	-3	-24,990
*KA1RC	-VT	-287	-55	-21	-24,528
*W9RE	-IN	-300	-51	-21	-24,192
*W3USS	-MD	-321	-55	-15	-24,080
*N1BFS	-CT	-467	-46	-4	-23,550
K4JPD	-GA	-295	-48	-20	-22,440
KO2W	-NY	-293	-43	-23	-21,714
K3GYD	-PA	-328	-35	-24	-21,181
*W8FGA	-MI	-372	-50	-3	-19,875
WD4RCO	-GA	-212	-49	-28	-19,327
N4FKF	-IN	-351	-47	-0	-16,497
KU2W	-NY	-263	-49	-7	-15,176
W1WEF	-CT	-263	-51	-1	-13,728
N0DQS	-IA	-220	-48	-7	-12,485
*VE4RP	-MAN	-154	-41	-15	-9,576
KA2EAY	-NY	-212	-42	-2	-9,416
*N7BUP	-AZ	-150	-41	-14	-9,350
*NF4F	-TN	-170	-42	-8	-9,050
KA8PPJ	-OH	-217	-36	-0	-7,812
W3ARK	-PA	-225	-34	-0	-7,650
KA4MTK	-VA	-160	-42	-4	-7,544
WA1TCA	-CT	-138	-40	-7	-6,768
KC8HJ	-OH	-150	-42	-1	-6,493
*K3OX	-NJ	-106	-43	-11	-6,480
*N5BMD	-LA	-119	-40	-7	-6,345
K8CV	-MI	-144	-36	-5	-6,232
*WA1YXL	-ME	-157	-36	-2	-6,040
*W8VEN	-WV	-129	-39	-4	-5,719
*KC7PA	-UT	-114	-40	-7	-5,687
WA3JXW	-PA	-172	-32	-0	-5,504
KF1B	-CT	-95	-35	-13	-5,280
W2FTY	-NY	-92	-36	-12	-5,040
*WB8ZRL/0	-NE	-106	-41	-4	-4,950
*W7CB/6	-CA	-81	-25	-17	-4,326
W2GKZ	-NY	-72	-29	-17	-4,324
*K4VB	-AL	-104	-38	-2	-4,280
K2MK	-NJ	-120	-35	-0	-4,200
KS5S/4	-AL	-103	-34	-0	-3,502
WB8YEW	-OH	-97	-35	-0	-3,395
K1NCD	-CT	-81	-35	-2	-3,071
KA2CDJ	-NY	-93	-33	-0	-3,069
N5ACP	-NM	-59	-33	-10	-2,967
W9LYN	-IL	-62	-34	-4	-2,546
N8EOH	-MI	-87	-28	-0	-2,436

KJ2N	-NJ	-48	-23	-13	-2,376
*NL7D	-AK	-58	-34	-3	-2,257
KC8P	-MI	-66	-31	-0	-2,046
W1LUG/4	-VA	-71	-25	-0	-1,775
*W5EIJ	-AR	-57	-30	-0	-1,710
KD4PP	-TN	-49	-29	-3	-1,664
*W0IZV	-CO	-59	-27	-0	-1,593
KB9PB	-IL	-52	-29	-0	-1,508
WC4E	-FL	-52	-22	-1	-1,219
K9GDF	-WI	-39	-19	-0	-741
KB7M	-WY	-30	-20	-0	-600
KH6IJ	-HI	-21	-13	-0	-546
KI7F	-OR	-24	-16	-1	-425
AA6EE	-CA	-7	-4	-0	-28

**DX Single Operator**

**4M3AZC	-Venezuela	-578	-53	-56	-124,805
*IO3MAU	-Italy	-478	-41	-50	-83,447
*OK1TN	-Czech.	-438	-31	-59	-77,940
*CT4NH	-Portugal	-426	-41	-47	-74,888
*PY5EG	-Brazil	-389	-48	-41	-69,064
IO6NOA	-Italy	-438	-17	-56	-68,558
*DL8NBE	-W. Germany	-351	-16	-41	-42,408
OK1AYP	-Czech.	-296	-30	-38	-39,916
*HI8GB	-Dom. Rep.	-202	-44	-17	-24,583
*CN8CO	-Morocco	-248	-37	-27	-20,800
*LX1JX	-Luxembourg	-108	-15	-24	-8,424
*EA1QF	-Spain	-108	-35	-0	-7,560
*VK5BW	-Australia	-101	-20	-18	-7,486
I4CSP	-Italy	-54	-12	-22	-3,434
*F8WE	-France	-79	-0	-22	-3,388
OK1AOZ	-Czech.	-68	-2	-23	-3,250
*JM1NKT	-Japan	-55	-17	-9	-2,808
I8ZLW	-Italy	-57	-0	-22	-2,156
ZS6WB	-S. Africa	-34	-3	-17	-1,260
OK3CRH	-Czech.	-24	-0	-12	-732
EA3DMP	-Spain	-25	-3	-11	-700
LA2TO	-Norway	-18	-10	-0	-360
YU7SF	-Yugoslavia	-18	-0	-9	-306
OZ4ZT	-Denmark	-12	-0	-5	-120
OK3YK	-Czech.	-22	-0	-5	-110
DL7QG	-W. Germany	-4	-0	-4	-32
JL1EJO	-Japan	-8	-0	-1	-8
OZ1ACB	-Denmark	-2	-0	-2	-8

**WVE Multi-Operator**

**K3TUP	-PA	-1214	-58	-35	-120,063
*K8ND	-OH	-1129	-57	-37	-113,646
*K5LZO	-TX	-813	-57	-35	-81,512
*KC0SZ	-CO	-764	-58	-33	-76,713
*KB0QA	-SD	-584	-55	-16	-42,742
*KD4TQ	-KY	-445	-55	-28	-39,840
*N8AKY	-MI	-454	-54	-24	-38,064
*KF2X	-NY	-311	-48	-29	-32,802
*WA3SPJ	-PA	-498	-51	-7	-29,290
N8EKE	-OH	-592	-44	-0	-26,048
*K0UR	-OH	-297	-46	-25	-23,288
*KW7Y	-WA	-295	-47	-13	-19,380
*WB1GMH	-VT	-192	-41	-8	-9,898

**DX Multi-Operator**

**I5NPH	-Italy	-667	-43	-64	-149,051
*I4OUT	-Italy	-648	-32	-62	-126,524
*DA1TN	-W. Germany	-381	-31	-37	-47,736
*JI1QQI	-Japan	-51	-12	-9	-1,806

**SWL Station**

DL-104	-W. Germany	-183	-1	-23	-8,784
--------	-------------	------	----	-----	--------

plier checklist. We recommend that contestants send for a copy of the contest forms. Send an SASE to the contest address listed below.

**CONTEST DEADLINE:**

Each entry must be postmarked no later than February 12, 1984.

**DISQUALIFICATIONS:**

Omission of any required entry form,

operating in excess of legal power, manipulating of contest scores or times to achieve a score advantage, or failure to omit duplicate contacts which would reduce the overall score more than 2% are all grounds for immediate disqualification. Decisions of the contest committee are final.

**AWARDS:**

Contest awards will be issued in each

# RESULTS

## YV3BRF, I5NPH, KG1E, AND N4TY: 1983 WORLD 75-METER CHAMPS

The 1983 World 75-Meter Championship is now history. The scores have been tabulated, checked, and cross-checked. There are four clear-cut winners.

In the WVE single-operator class, it was definitely a photo finish. Only 48 points separated the first- and second-place stations. World Champion KG1E took top honors with 722 QSOs, 98 multipliers, and a total score of 83,104 points. Close on his heels with 777 QSOs, 94 multipliers, and 82,156 points was second-place finisher N5AU of Texas with K5ZD at the helm. Whowee... I wonder if each of them knew how close they were to each other in the closing hours of the contest?!

The single-operator class for DX stations was practically no contest for world-championship station YV3BRF of Venezuela. With 655 QSOs, 101 multipliers, and 132,108 total points, this station led second-place contestant IO3MAU of Italy by nearly 44,000 points.

In the WVE multi-operator category, we had another close finish. Here again, if the two stations had known how close they were to each other, would we have seen different strategy in the closing hours? N4TY of Kentucky becomes the World Champ with 655 QSOs, 62 multipliers, and 41,106 points. Second place goes to K1WW of New Hampshire, who trailed the leader by only 1,073 points. Though the winner had 212 more contacts than his opponent, the scoring gap closed rapidly as K1WW accumulated 81 multipliers compared with only 62 for the champion. Next year, I'm sure both stations will monitor each other's activity more closely.

In DX, I5NPH and crew became the 75-Meter World Champions for DX multi-operator stations. Scoring 520 QSOs and 91 multipliers, they tallied a grand total of 101,092 points.

The following stations worked 500 or more QSOs: N5AU (777), N8II (730), KG1E (722), N4TY (655), YV3BRF (655), WB0NCR (606), KC8JH (600), KA4JNC (571), W3USS (563), IO3MAU (548), I5NPH (520), and K9EC (516).

In the contest, stations could work a total of 61 US states and Canadian provinces and territories. N5AU came the closest to the maximum with 60 worked, closely followed by YV3BRF with 59. Other stations with 50 or more WVE multipliers included N8II (58), KC8JH (57), KG1E (57), K9EC (56), W3USS (56), KB3A (56), WB0NCR (55), N4TY (55), N1BFS (54), KI0F (54), KV0I (53), K1WW (53), HI8GB (52), N8AKY (52), WA1ZAM (52), C6ADV (51), KI7M (51), K5LZO (51), KA4JNC (50), K2GKK/5 (50), and K0UR (50).

Working DX countries on 75 meters is a challenge all its own. From the looks of the DX multipliers claimed, propagation played a big roll in the outcome of contest scoring. Naturally, European stations logged the most countries worked due to their close proximity to one another (as compared with their North American counterparts). IO3MAU had the most countries worked, with a total of 54. He was closely challenged by multi-operator champion I5NPH, who tallied 52 total DX countries. Other stations logging 25 or more included YV3BRF (42),

KG1E (41), N5AU (34), W3USS (31), HI8GB (29), CT4NH (29), K1WW (28), and K8MNG (25).

Of all the contests sponsored by 73, this 75-meter event has got to be the toughest. It has become an event participated in largely by Advanced- and Extra-class operators within the States. This, of course, is due to the band allocations and the fact that General-class licensees are extremely limited in available frequencies for contesting purposes. Adding to this dilemma is the fact that DX countries for the most part all have different parts of the spectrum in which to operate, making simplex operation rather difficult for the majority. In view of these obstacles, FCC action in the future which would further expand phone privileges for American amateurs on this band would greatly enhance the capability stations would have to maneuver. The 75-Meter Contest would see a dramatic increase of activity as a result.

With the rules changed slightly to encourage more DX participation, we expect to see even greater scores and a much larger turnout in the 1984 contest. The sunspot cycle promises to make 75 even more exciting than it has been in the past. It'll be your chance to get another "new one," so plan to attend. Obtain your forms as soon as possible by sending an SASE to Jose Castillo N4BAA, 75-Meter Contest Chairman, 1932 Highland Drive, Amelia Island FL 32034.—*Bill Gosney KE7C.*

### 75-METER CONTEST SOAPBOX

- KA1DZV: "Enjoyed the contest—very unique!"  
 KG1E: "Excellent test! Propagation to all parts of the world was fantastic! Sure was a great contest."  
 WA1ZAM: "A great time again for the second year in a row. I'll be back."  
 KB3A: "Had the best of both worlds, multi-op for 40 and single op for 80."  
 KI3S: "Nice contest. Next year, I will plan to spend more time on the air."  
 W3USS: "Tremendous conditions and turnout!"  
 4BAA: "Wish I had had more time this year. See everyone next year for sure."  
 K4JPD: "I really enjoyed the contest!"  
 N4TY: "This was a super contest!"  
 W4TMR: "Can't wait until next year!"  
 AA6EE: "Learned that I need a better DX antenna than an inverted vee."  
 K8MNG: "This contest surpassed my expectations; worked 8 new countries on 75."  
 K9GDF: "Great contest!"  
 KI0F: "FB contest. Glad to be part of it. Where was Mississippi?"  
 JA2YKA: "Nice contest indeed. See you again next year."  
 VY1DV: "Too cold to stay in the shack even with the heater going. Outside temperature was 40° C. Conditions were poor, to say the least!"

### 75-METER ANTENNA SURVEY

Dipole/inverted vee	65.9 %	W3DZZ array	2.2
Vertical	10.0	3-element yagi	1.1
Sloper (¼- and ½-wave)	7.7	18 AVT	1.1
Delta loop	5.4	Windom	1.1
Longwire	2.2	Phased vertical	1.1

## TOP O' THE ROCK

### NEWSLETTER OF THE MONTH

From the top of Georgia's Stone Mountain and the heart of Atlanta comes this month's newsletter contest winner, *Top O' The Rock*. Printed with pride by the Alford Memorial Radio Club, this newsletter has undergone an amazing metamorphosis in recent months.

Though once it was just another no-name newsletter, shortly after becoming *Top O' The Rock* the publication blossomed. Now it is stuffed with feature articles, news, and humor. The large number of letters to the editor received by Faye Garner N4HLE attests to the interest club members have in their publication.

In addition to the well-designed cover, *Top O' The Rock* sports a table of contests, monthly calendar, and, of all things, advertising. Though many clubs moan and groan about the expenses of printing and distributing a newsletter, the Alford Memorial Radio Club has found a way to support its product. In addition to the supplemental income, the newsletter benefits from a dedicated staff including Alan Langford N4HUD, Production Manager; Jim Garner KE4BI, Advertising Manager; Cary Dinger N4GPL, Circulation Manager; Reed Kreen WA3JBQ, US Post Office Liaison; and, last but not least, Big Willie GO4KILL, Master of Broken Arms.

Congratulations to Faye and her crew for an outstanding publication.

To enter your club's newsletter in 73's Newsletter of the Month Contest, send it to 73, Pine Street, Peterborough NH 03458, Attn: Newsletter of the Month.

operator class in each of the continental 48 United States, Canadian provinces and territories, and each DX country represented. A minimum of 100 QSOs must be worked to be eligible for contest awards.

#### CONTEST ADDRESS:

To obtain entry forms or to submit an entry, contact: 40-Meter Contest, Dennis Younker NE6I, 43261 Sixth Street East, Lancaster CA 93535.

### 3RD ANNUAL 75-METER WORLD SSB CHAMPIONSHIP 0000Z to 2400Z January 8, 1984

#### SPONSORED BY:

73: *Amateur Radio's Technical Journal.*

#### MISCELLANEOUS RULES:

Work as many stations as possible on 75-meter phone during the specified times of allowable operation. The same station may be worked *once*. Crossmode contacts will not count. Single-operator stations may operate a total of 16 hours. All multi-operator stations may operate the entire 24-hour period. Off periods must be noted in your log(s) and on your summary sheet. Off periods are *no less than 30 minutes each*.

#### OPERATOR CLASSES:

(A) Single operator, single transmitter, phone only. (B) Multi-operator, single transmitter, phone only.

#### EXCHANGE:

Stations within the continental 48 United States and Canada transmit an RS report and state, province, or territory. All other stations, including Alaska and Hawaii, transmit RS report and DX country.

#### POINTS:

5 QSO points for contacts with WVE stations located within the continental 48 United States and Canada. All other contacts score 10 points each. List points for each contact on your log sheet(s).

#### MULTIPLIERS:

1 multiplier point is earned for each US state, 48 maximum (a District of Columbia contact may be substituted for a Maryland multiplier), each Canadian province or territory (13 maximum), and DX country (excluding the continental US and Canada).

#### FINAL SCORE:

Total QSO points times total multiplier points equals *claimed score*.

#### CONTEST ENTRIES:

Each entry must include a contest log, a



**1983 RESULTS  
75-METER WORLD SSB CHAMPIONSHIP**

Indicated are callsign, QTH, QSOs, states/provinces worked, DX worked, and total score.

\*\*World champion  
\*State/province/country champion

**W/VE Single Operator**

**KG1E	—MA	—722	—57	—41	—83,104
*N5AU	—TX	—777	—60	—34	—82,156
(K5ZD, op.)					
*N8II	—WV	—730	—58	—21	—61,146
*W3USS	—MD	—563	—56	—31	—54,984
(K3ZJ, op.)					
*KC8JH	—OH	—600	—57	—12	—42,297
*WB0NCR	—IA	—606	—55	—6	—37,332
*N1BFS	—CT	—482	—54	—19	—37,011
*K9EC	—WI	—516	—56	—13	—36,501
*K4JPD	—GA	—437	—48	—22	—32,480
*KB3A	—PA	—522	—56	—5	—32,147
*KV0I	—NE	—479	—53	—7	—29,160
KB3ND	—PA	—445	—47	—11	—26,448
*WA1ZAM	—MA	—406	—52	—9	—25,376
*KI7M	—OR	—356	—51	—10	—24,095
*K2GKK/5	—OK	—360	—50	—10	—22,814
*NR4S	—TN	—379	—45	—12	—22,572
*K0UR	—KS	—291	—50	—18	—21,148
*KI0F	—MN	—323	—54	—3	—18,582
*W4TMR	—NC	—256	—49	—12	—16,592
*W8UVZ	—MI	—298	—48	—5	—16,059
N8ATR	—OH	—281	—47	—5	—15,158
N8TN	—OH	—262	—43	—3	—12,190
KB8WB	—OH	—240	—45	—3	—11,664
*K4ADI	—SC	—200	—44	—7	—10,557
KC3AF	—PA	—225	—42	—4	—10,350
W3ARK	—PA	—181	—39	—1	—7,684
*KA2CDJ	—NY	—163	—41	—4	—7,515
*KN1M	—ME	—156	—35	—11	—7,176
K8CV	—MI	—147	—42	—4	—6,946
*KS5A/4	—AL	—134	—43	—6	—6,860
*N5ACP	—NM	—121	—47	—6	—6,731
KB9S	—WI	—144	—42	—4	—6,716

*N4BAA	—FL	—150	—40	—3	—6,600
*K2MK	—NJ	—155	—36	—4	—6,440
*VE4RP	—MAN	—149	—38	—3	—6,191
WA1TCA	—CT	—151	—39	—1	—6,080
KA1DZV	—CT	—169	—34	—0	—5,746
*KC7PA	—UT	—124	—41	—2	—5,418
K8MNG	—OH	—98	—19	—25	—5,405
W8VEN	—WV	—131	—37	—2	—5,187
WB2TKD	—NY	—129	—36	—2	—4,978
*N4ARO/6	—CA	—93	—45	—3	—4,560
*N0CMC	—ND	—103	—38	—3	—4,346
KI3S	—PA	—108	—33	—5	—4,332
*KT4U	—VA	—115	—32	—4	—4,284
W2FTY	—NY	—108	—35	—3	—4,218
N5AF	—TX	—92	—35	—7	—4,200
KB5DQ	—NM	—109	—36	—2	—4,142
W2GKZ	—NY	—80	—34	—7	—3,567
*KV7L	—WY	—80	—38	—4	—3,528
KJ2N	—NJ	—90	—29	—4	—3,135
W7CB/6	—CA	—79	—35	—2	—3,071
N1SR	—MA	—75	—32	—3	—2,765
*KB8KW/7	—MT	—75	—32	—0	—2,400
KA2EAY	—NY	—94	—23	—0	—2,068
W3BGN	—PA	—41	—24	—13	—2,035
W1LUG/4	—VA	—67	—26	—1	—1,836
VO2CW	—LAB	—41	—15	—9	—1,320
K1NCD	—CT	—60	—21	—0	—1,260
WB8ZRL/0	—NE	—47	—26	—0	—1,222
K9GDF	—WI	—46	—26	—0	—1,196
KB7M	—WY	—36	—28	—0	—1,008
KB9PB	—IL	—38	—23	—0	—874
VE4AKN	—MAN	—36	—24	—0	—864
WA4LDU	—SC	—29	—28	—1	—600
W5SOD	—TX	—30	—18	—1	—589
AA2Z	—CT	—16	—8	—3	—231

W6LFB	—CA	—15	—11	—0	—165
VY1DV	—YUK	—16	—5	—1	—102
AA6EE	—CA	—8	—7	—0	—56
N9DIJ	—WI	—2	—2	—0	—4

**DX Single Operator**

**YV3BRF	—Venezuela	—655	—59	—42	—132,108
*IO3MAU	—Italy	—548	—30	—54	—88,284
*HI8GB	—Dom. Rep.	—466	—52	—29	—75,330
*C6ADV	—Bahamas	—398	—51	—24	—32,550
*CT4NH	—Portugal	—129	—21	—29	—10,700
*EA3CCN	—Spain	—81	—17	—22	—6,123
*OK3CRH	—Czech.	—57	—0	—23	—2,622
I4CSP	—Italy	—55	—7	—14	—2,376
*HA8IE	—Hungary	—51	—0	—19	—1,938
*F8WE	—France	—39	—8	—15	—1,794
EA2AQW	—Spain	—54	—0	—14	—1,442
*DH0FAV	—W. Germany	—55	—0	—12	—1,296
OK3FON	—Czech.	—26	—1	—10	—550
YU7SF	—Yugoslavia	—9	—0	—7	—126

**W/VE Multi-Operator**

**N4TY	—KY	—655	—55	—7	—41,106
*K1WW	—NH	—443	—53	—28	—39,933
*K5LZO	—TX	—446	—51	—16	—31,088
*KA4JNC	—VA	—571	—50	—4	—31,050
*N8AKY	—MI	—381	—52	—12	—25,216
*WA3SPJ	—PA	—380	—49	—8	—21,660
*KF2X	—NY	—355	—47	—20	—20,703
*WB1GMH	—VT	—245	—44	—3	—11,656

**DX Multi-Operator**

**I5NPH	—Italy	—520	—39	—52	—101,092
*JA2YKA	—Japan	—51	—8	—7	—1,185

**HAMEG OSCILLOSCOPE**



- 20 MHz Dual Trace
- Built-in Component Tester
- X-Y Operation (1:1 Ratio)
- 2 x 20 MHz, Max. 2 mV/cm
- Timebase 40 ns - 0.2 s/cm
- Trigger Bandwidth 30 Mhz

133 RFD-5 **Rivendell Assoc.** DERRY, N.H. 03038 WARNER HILL (603) 434-5371

**MICROWAVE COMPONENTS**

25 MW EXCITER	\$49.95
45 MHZ SUBCARRIER	\$19.95
AM VIDEO MODULATOR	\$19.95
50 MW UP CONVERTER	\$149.95

**GIZMO ELECTRONICS, INC.**

P.O. BOX 1205  
PITTSBURG, KS 66762  
PH. 316-231-8171

Kansas residents 3% sales tax

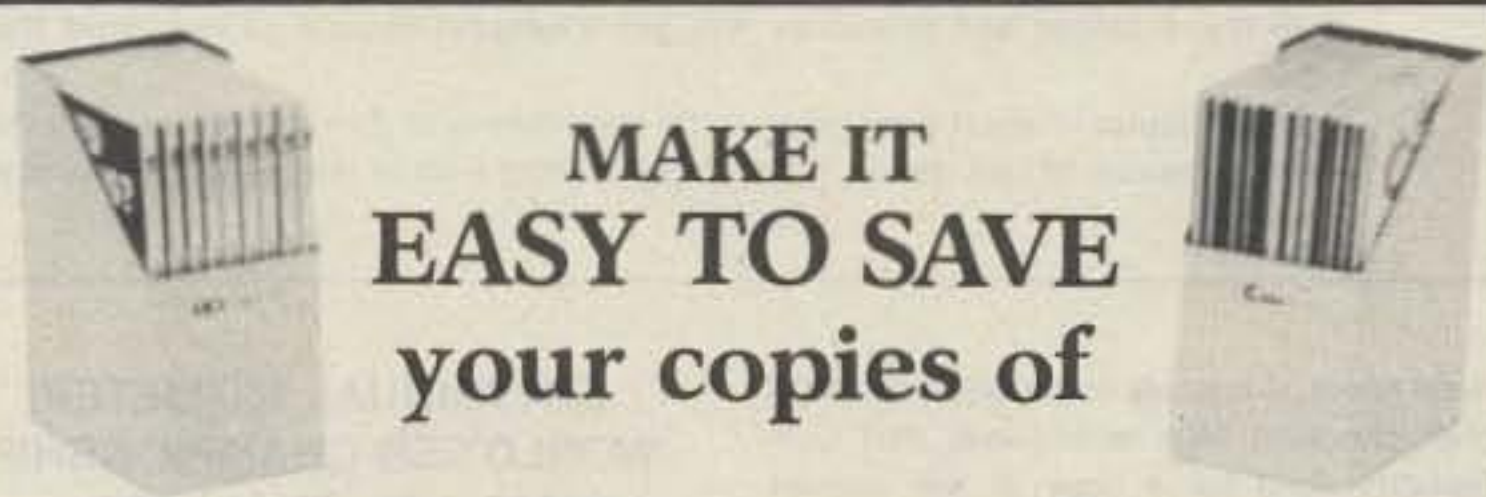

**MAKE IT  
EASY TO SAVE  
your copies of**

**73 Magazine**

Your magazine library is your prime reference source—keep it handy and keep it neat with these strong library shelf boxes. They are made of white corrugated cardboard and are dust resistant. Use them to keep all your magazines orderly yet available for constant reference.

Self-sticking labels are available for the following:

- |                   |             |                    |
|-------------------|-------------|--------------------|
| 80 Micro          | 73 Magazine | Radio Electronics  |
| Microcomputing    | QST         | Personal Computing |
| inCider           | CQ          | HOT CoCo           |
| Desktop Computing | Ham Radio   | Interface Age      |

One box (BX1000) is \$2.00, 2-7 boxes (BX1001) are \$1.50 each, and 8 or more boxes (BX1002) are \$1.25 each. Be sure to specify which labels we should send.

Call TOLL-FREE for credit card orders:

**1-800-258-5473**

**73 Magazine**

Attn: Book Sales, Peterborough, NH 03458

SHIPPING AND HANDLING CHARGES \$2.00 per order, up to and including a quantity of eight. 25¢ for each additional box ordered.

# RESULTS

## K8ND AND KC8JH: 1983 WORLD 160-METER CHAMPS

"Keep this fine gentlemen's contest on the agenda forever"... "the contest support was overwhelming"... "it's the best 160-meter contest going!" This was the general feeling of contestants about this year's World 160-Meter Sideband Championship!

If you participated this year and are from Ohio, we don't need to tell you how devastating the competition was there. Out of the top four scores in the contest, three stations were from the state of Ohio. Between K8ND, WB8JMB, and KC8JH, a total of 2,798 contacts were made totaling 898,930 contest points. That's 160-meter contesting at its best—championship-style!

In the single-operator class, KC8JH (Ohio) accumulated 900 QSOs to become the 1983 World Champ. K8ND earned the same distinction with 1001 QSOs in the multi-operator category.

Stations achieving 500 or more single-operator contacts included KC8JH (900), AA1K (796), K0HA (710), K9QLL (663), KV0G (627), N5CG (605), N5JB (597), KC8P (591), K6SE (590), W8FGA (588), W8GIO (564), K4AQQ (560), W8UP (558), and W4TMR (532). In the multi-operator class, 500 or more contacts were earned by K8ND (1001), WB8JMB (897), W4CN (890), WA2SPL (879), N7DF (664), KB0TJ (586), and KC5DX (523).

According to contestants, propagation was truly fantastic; the majority of entries cited 40 or more WVE multipliers worked. Many indicated they were able to earn that last-needed state or two for their WAS award.

The greatest difference noted in the scores was the amount of DX multipliers earned by competing stations. Single-operator stations working 6 or more DX countries included EA3CCN (13), N4IN (13), OK1JDX (12), AA1K (11), K6SE (9), K0HA (7), KV0G (7), K4AQQ (7), W5GFR (7), WA4SVO (7), N5CG (6), W8GIO (6), KC8JH (6), W0CM (6), and K7VIC (6). Multi-operator stations with 6 or more DX multipliers were WA2SPL (18), YU7JDE (16), K8ND (9), and WB8JMB (7).

Tabulating all the entries and cross-checking all scores revealed that more than 1300 stations were logged during this weekend event. It also appears that over 20 DX countries were represented. 1983's contest was the best ever! If you were from Alabama, Arkansas, Connecticut, Idaho, Louisiana, Minnesota, Missouri, North Dakota, or Utah, sending an entry to our contest manager would have made you an award winner from your state. Though there were many stations participating in all states, not a station from the states listed above submitted an entry. That's unfortunate. Likewise, no entries were received from Alberta, Prince Edward Island, Yukon Territory, Northwestern Territories, Labrador, or Newfoundland. With the 1984 event just around the corner, stations from these states and provinces will get a second chance to represent their areas.

Of particular interest every year is the opportunity to prove to our readers that most hams can in fact get on 160 without owning a lot of real estate. Every style

of inverted vee, delta loop, and wire beam has been tried—even on small city lots! Here are some statistics extracted from contestants' entries.

### 160-METER ANTENNA SURVEY

	1981	1982	1983
Dipole/inverted vee	54.9%	59.6%	64.2%
1/4-wave vertical	9.1	15.8	3.8
Trap vertical	19.8	9.3	16.0
Full-half-wave vertical	2.2	.5	1.2
Wire beam	2.1	.9	2.4
Delta loop	1.7	.9	.0
2/3-element yagi	1.4	.9	.0
1/4-wave sloper	4.4	9.3	7.4
1/2-wave sloper	4.4	2.8	5.1

Awards for the 1983 contest are being prepared at this time and should be to recipients shortly. We congratulate all the winners for their dedication to this year's effort and all the participants who made it all possible. It's been great!

As for 1984, it's promised to be the biggest year ever in 160-Meter Contest history. With the sunspot cycle in our favor, the band should be filled with new ones for the deserving DXer. Just who will be the new World Champs for 1984? Will K8ND and KC8JH retain their titles? Will former champs W9RE, W8NGO, W8LRL, or W4CN regain top honors or will it be someone from the west coast this time? Mark the dates on your calendar; the 5th annual 160-Meter World Championship is slated for January 14 and 15, 1984.

If you intend to enter this year's event, why not send for your contest entry forms today? Foreign stations especially should obtain their forms as soon as possible due to delays in mail-handling between countries. Send your SASE to: Harry Arsenault K1PLR, 160-Meter Contest Chairman, 603 Powell Avenue, Erie PA 16505.—Bill Gosney KE7C.

### 160-METER CONTEST SOAPBOX

**K1LPS:** "Did not hear any nasty remarks or complaining in spite of very crowded conditions, although there were a few instances of deliberate jamming... something that is thankfully rare on 160."

**K3MO:** "Was handicapped with a sore throat. Elixia of Kentucky eased the pain."

**K4IN:** "The present rules discriminate against the DX station. It is much harder to work a second G or VY than another W2 in New Jersey, yet all count the same!" (Editor's note: 1984 rules will allow 5 points per WVE contact and 10 points for all others.)

**N8AKY:** "Was able to work my last state for WAS! Keep this fine gentlemen's contest on the agenda forever."

**W8GIO:** "Could have had a couple more multipliers but refused to operate in the window."

**W9LNO:** "Glad to be back on 160 after a 25-year absence. The band sounds absolutely great!"

**K9QLL:** "The spirit was willing but the flesh went to sleep."

dupe sheet, a contest summary, and multiplier checklist. We recommend that contestants send for a copy of the contest forms. Send an SASE to the contest address listed below.

#### CONTEST DEADLINE:

Each entry must be postmarked no later than February 12, 1984.

#### DISQUALIFICATIONS:

Omission of any required entry form, operating in excess of legal power, manipulating of contest scores or times to achieve a score advantage, or failure to omit duplicate contacts which would reduce the overall score more than 2% are all grounds for immediate disqualification. Decisions of the contest committee are final.

#### AWARDS:

Contest awards will be issued in each operator class in each of the continental 48 United States, Canadian provinces and territories, and each DX country represented. A minimum of 100 QSOs must be worked to be eligible for contest awards.

#### CONTEST ADDRESS:

To obtain entry forms or to submit an entry, contact: 75-Meter Contest, Jose A. Castillo N4BAA, 1832 Highland Drive, Amelia Island FL 32034.

## 5TH ANNUAL 160-METER WORLD SSB CHAMPIONSHIP 0000Z January 14, 1984 to 2400Z January 15, 1984

#### SPONSORED BY:

73: *Amateur Radio's Technical Journal*.

#### OBJECT:

To work as many stations as possible on 160-meter phone in a maximum of 32 hours allowable contest time. Multi-operator stations may operate the entire 48-hour contest period. Stations may be worked only once.

#### ENTRY CATEGORIES:

(A) Single operator, single transmitter, phone only. (B) Multi-operator, single transmitter, phone only.

#### EXCHANGE:

Stations within the continental US and Canada transmit RS report and state or province/territory. All others transmit RS report and DX country.

#### POINTS:

5 QSO points for contact with WVE stations contacted within the continental 48 United States and Canada. All other contacts earn 10 points each.

#### MULTIPLIERS:

1 multiplier point will be earned for each of the continental United States, 48 maximum

(a District of Columbia contact may be substituted for a Maryland multiplier), each of the Canadian provinces/territories (13 maximum), and each DX country outside the continental 48 United States and Canada.

#### FINAL SCORE:

Total QSO points times total multiplier points equals *claimed score*.

#### CONTEST ENTRIES:

Each entry must include log sheets, dupe sheet for 100 or more contacts, a contest summary, and a multiplier check sheet.

#### ENTRY DEADLINE:

All entries must be postmarked no later than February 19, 1984.

#### DX WINDOW:

Stations are expected to observe the DX window from 1.825-1.830 MHz as mutually agreed by top-band operators. Stations in the US and Canada are asked not to transmit in this 5-kHz segment of the band. During the contest, all WVE stations are requested to utilize only those frequencies from 1.808-1.825 and 1.830-1.900 MHz.

#### DISQUALIFICATIONS:

Disqualification may result if a contestant omits any required entry form, operates in excess of legal power authorized for his/her given area, manipulates operating times to achieve a score advantage, or fails to omit

duplicate contacts which reduce the overall score more than 2%. Decisions of the contest committee are final.

#### AWARDS:

Contest awards will be issued in each entry category in each of the continental United States, each Canadian province/territory, and each DX country. A minimum of 100 QSOs must be worked to qualify.

#### CONTEST ADDRESS:

To obtain information or entry forms (enclose an SASE) or to submit a contest entry, contact: 160-Meter Contest, Harry Arsenault K1PLR, 603 Powell Avenue, Erie PA 16505.

## 3RD ANNUAL RTTY WORLD CHAMPIONSHIP 0000Z to 2400Z February 25, 1984

#### SPONSORED BY:

73: *Amateur Radio's Technical Journal* and *The RTTY Journal*.

#### OPERATOR CLASSES:

(A) Single operator, single transmitter. (B) Multi-operator, single transmitter.

#### ENTRY CATEGORIES:

(A) Single band. (B) Allband, 10-80 meters.

#### EXCHANGE:

Stations within the 48 continental United



# W2NSD/1 NEVER SAY DIE

editorial by Wayne Green

from page 6

Now, getting back to education as a product, let's walk this through step by step so you can follow my reasoning. First, I hope you'll grant me that 73 has been educational. And perhaps you've noticed that it is fun to read. Well, that's a big key to what I have in mind. I figure that education can be made into a saleable product if it is fun. People will educate themselves if it is more fun to do that than other things. All of my computer magazines are educational and all are fun to read.

The concept of learning because it is fun instead of because one is a prisoner of the system is one which we will gradually have to get used to. I didn't like school much. I didn't like the idea of being forced to attend, whether I wanted to or

not. And damned few of the courses were fun. Having enslaved students, the teachers and schools had no need to worry about whether the classes were fun. I was forced to be there by the government whether the classes were fun or not.

What was the most popular television program in England last year? If you missed all the fuss, it was Woodhouse teaching people how to train their dogs. Education—and fun. Got the idea?

Okay, now the next step. I've already written about my plans to start a high-tech college. This school is aimed at helping our country to get back into the high-tech race against Japan and will be set up as a pilot model of a new type of college, geared to the needs of the 80s. But once we have the college going, what better place to start

developing the education/fun courses which we may eventually merchandise to the world?

The first step is to develop the new genre of education and put it on video tape. The next is to start selling this via an educational cable television network to get the ball rolling. Then, as video-disk technology is simpler and less costly, move to an interactive video-disk educational system which can be sold anywhere in the world in any language.

The courses should cover everything taught in grade, high, college, and graduate schools. They should go on to those courses which should be taught in school, but aren't. They should also cover business and industrial courses now being taught by businesses. They should cover all aspects of arts and crafts. Anything people may be interested in learning about should be available.

Just as we have several thousand small firms creating wealth for the entrepreneurs who are now producing software for computers, I expect we'll have thousands of small firms producing educational programs which can be distrib-

uted by larger firms, creating even more wealthy entrepreneurs.

We'll need larger firms to set up and run the distribution. That's where I think my early start with the concept may give me some leverage. In addition to having the major magazines in this new field to help it develop, I'm going to try to build IDG's present network of 42 magazines in 18 countries into an international educational distribution system.

When I think back on my time in college, I can remember one course that actually was fun. Most of them were dreadful bores, alternating memorization with written exams. Maybe it's significant that the teacher of that one exciting course eventually committed suicide. If a teacher can make accounting exciting, anything is possible.

The courses in my college will be modeled after those I took in the Navy, which were fun, and will be nothing like those I suffered in college. These will lay the groundwork for the interactive video-disk courses later on.

My recent editorials have encouraged quite a number of readers to send resumes. Obviously my plans are going to call for help from a large number of dedicated people—talented people, hard-working people. I have the ideas, know how to make them work, and have the money for it, but the end result still lies in the people I can find to make all this happen.



## NEMAL ELECTRONICS



### COAXIAL CABLE SALE

This Month's  
Specials

Same Day  
Shipping

<b>POLYETHYLENE DIELECTRIC</b>	
RG59/U mil spec 96% shield.....	14c/ft.
RG213 noncontaminating 95% shield mil spec.....	36c/ft.
RG174/U mil spec 96% shield.....	10c/ft.
RG11U 96% shield, 75-ohm mil spec.....	25c/ft.
RG8U 96% shield, mil spec.....	\$29.95/100 ft. or 31c/ft.
RG6A/U double shield, 75-ohm.....	25c/ft.
RG58AU stranded mil spec.....	12c/ft.
RG58 mil spec 96% shield.....	11c/ft.
<b>LOW LOSS FOAM DIELECTRIC</b>	
RG8X 95% shield.....	\$14.95/100 ft. or 17c/ft.
RG59/U 70% copper braid.....	9c/ft.
RG8U 80% shield.....	18c/ft.
RG58U 80% shield.....	07c/ft.
RG58U 95% shield.....	10c/ft.
RG59U 100% foil shield, TV type.....	10c/ft.
RG8U 97% shield 11 ga. (equiv. Belden 8214).....	31c/ft.
Heavy Duty Rotor Cable 2-16 ga, 6-18 ga.....	36c/ft.
Rotor Cable 8-con. 2-18 ga, 6-22 ga.....	19c/ft.

<b>CONNECTORS MADE IN USA</b>	
Amphenol PL-259.....	79c
PL-259 Teflon/Silver.....	\$1.59
PL-259 push-on adapter shell.....	10/\$3.89
PL-259 & SO-239.....	10/\$5.89
Double Male Connector.....	\$1.79
PL-258 Double Female Connector.....	98c
1 ft. patch cord w/RCA type plugs each end.....	3/\$1.00
Reducer UG-175 or 176.....	10/\$1.99
UG-255 (PL-259 to BNC).....	\$2.95
Elbow (M359).....	\$1.79
F59A (TV type).....	10/\$2.15
UG 21D/U Amphenol Type N Male for RG8.....	\$3.00
BNC UG88C/U, male.....	\$1.25
3/16 inch Mike Plug for Collins etc.....	\$1.25
UG273 BNC to PL-259.....	\$3.00

**FREE CATALOG**  
COD add \$2.00—FLA. Res. add 5% Sales Tax

Orders under \$30.00 add \$2.00

Connectors—shipping 10% add'l, \$3.00 minimum

412

Cable—Shipping \$3.00 per 100 ft.

12240 NE 14th Ave., Dept. 73, No. Miami, FL 33161

Call (305) 893-3924

## New Life for Tired Receivers



Lunar's line of RF actuated in-line receiving preamplifiers can spark up that otherwise dead band. Missing those weak ones? Become an elephant with new ears. Models available from 28-220 MHz bands. Simply insert between your transceiver and antenna, apply 12 VDC and enjoy. Standard SO-239 connectors on RF ports - BNC available. Typical performance at 144 MHz: 1.4 dB NF 10 dB gain. Low noise performance from Lunar - simply, the best.



2775 Kurtz Street, Suite 11  
San Diego, Ca 92110  
(619) 299-9740 • Telex 181747

# DX

Chod Harris VP2ML  
Box 4881  
Santa Rosa CA 95402

## THE SOUTHERNMOST AMATEUR IN THE UNITED STATES

A DXer in Hawaii has some of the best of both worlds: He's a DXer himself and has a good DX location as well. Hawaii counts as a separate "country" for DXCC, and although not hard to work, Hawaiian amateurs are more rare than Texas stations, for example. And Hawaii is far enough south to make it one of the best radio locations in the United States. On the southern island of the Hawaiian chain, at the southernmost tip of the island, resides Dean Paterson KH6OA.

Dean Paterson KH6OA enjoys a beautiful condominium overlooking the black sand beaches of the island of Hawaii in addition to the excellent radio propagation associated with the tropics. On the other hand, Dean feels the same restrictions as other apartment-bound hams: no outside antennas and TVI complaints. His solutions might inspire some DXers whose antennas weren't big enough to come down last winter.

Dean's fascination with radio began at the age of 9 with his first crystal set. However, it was 1973 before he received his first amateur-radio license. At that time, his main interest was rebuilding ARC-5 military radios. A few years later, Dean found himself moving to Hawaii into a condominium complex managed by his wife.

As is common with such projects, the sale-and-lease agreements prohibit any outside antennas. So Dean took advantage of the isolated location of the complex and the unpredictable nature of Hawaii's volcanoes and volunteered to provide emergency communications for the complex if he could have an antenna outdoors.

The owners of the condominium complex agreed to an unobtrusive vertical right outside Dean's door in the bottom corner of the complex. That proved to be enough.

Dean pounded a steel stake a couple of feet into the hard lava and attached a Hustler vertical. A few radials stretch under the vegetation, but the building blocks many of the possible radial directions. Not the best antenna system, but adequate.

To provide true emergency communications, Dean assembled a 12-volt, 2-Amp solar panel with two batteries to give 18 hours of operation. 12-volt, 2-meter rigs and low-band gear complete the emergency station.

The two-meter antenna was another problem. The main repeater on Hawaii, the one that connects into the network which serves the entire Hawaiian chain, was on the other side of the island. Dean could hit the repeater with an 11-element beam, but he couldn't get permission to erect it. He finally settled for an indoor setup. The first four elements of the beam attach to the ceiling-fan support above his head. The four elements and an 80-Watt amplifier provide a copyable signal through the massive Mauna Loa volcano.

To complete his antenna farm, Dean stretched a 60' longwire along the edge of the property to improve signals on the Big Island Emergency Nets on 40 and 80 meters. You really have to look closely to spot it, so it probably falls into the "invisible-antenna" category.

But the antenna restrictions were not the only problems in Murphy's bag of tricks. Dean soon discovered that the combination of salt spray and tropical sun dissolves antennas in months. He recently installed his third vertical in 6 years. He says his present antenna, a Butternut, is "the best vertical I've ever had, by far!"

Even that was not the end of his problems, however. Dean suffers from a common problem among apartment-dwelling hams: lack of ground. Electrical ground, that is. The hard lava of Hawaii doesn't conduct at all, and the 3" layer of top soil trucked in to grow grass is not much help. Television interference (TVI) and radio frequency interference (RFI) were, and continue to be, a serious problem.

His remote location, miles from the only television transmitters on the island, means signals in the community cable-



SM3CXS, who handles the QSLs for SM0AGD on his far-flung travels, met some of the DXers he has helped over the years at the Dayton Hamvention. Photo via The DXers Magazine.

television system are marginal at best. Dean employs three Drake low-pass filters on his HF gear, and he uses toroids liberally on all power cords. But even so, he says, "If there's a football game on, I either have to go QRP or get off the air entirely."

Dean has turned this restriction into an avocation and has become a QRP enthusiast, using an Argonaut 515. He overcomes the difficult combination of apartment-style antennas and QRP power with two important advantages: his southern location and the KH6 callsign.

The low latitude means greatly enhanced radio propagation. Anyone who has operated from the tropics knows what this means: The bands open earlier in the day and close later at night. Signals from the north are much stronger than similar signals from the east or west. This tropical advantage helps to compensate for increased static and reduced grey-line communications.

And that KH6 callsign is good for a few decibels, Dean concurs. In a recent pileup on a Hong Kong station, Dean tried calling "QRP" in the pileup, without success. Then he tried "KH6" and got right through!

Dean's success with QRP shows in his results: Worked All States and Worked All Continents on QRP. He lacks only a few confirmations before earning his DXCC with 5 Watts or less.

## THE CARE AND FEEDING OF QSL MANAGERS

"Thanks for the contact, and please QSL through my manager, K1RH." How often have you received a DX QSL card through a QSL manager? These dedicated volunteers who facilitate the exchange of QSLs are the unsung heroes of the DX world. Treat them well, as they make the task of collecting DX QSLs more efficient and much less expensive.

Let's look first at how a QSL manager operates, and then we'll see what we can do to make his or her task easier to speed our return QSL.

A QSL manager serves as a go-between for the DX station and the hams who work that DX station. After an amateur works the DX station, he sends the QSL card and a self-addressed, stamped envelope

(SASE) to the manager. The manager confers with the DX station, checks that the contact is in the log, and fills out and mails the DX QSL.

There are many advantages to this process over direct QSL exchange with the DX station. First, the QSL manager is usually a stateside ham, so the problems and expense of airmail overseas are greatly reduced. No matter how much you criticize the US Postal Service, they do a remarkable job, especially compared to POs in tiny, out-of-the-way DX locations. In the Galapagos Islands, for example, the mail is handed to any boat going in the right direction from the airport toward the only town. If that ship decides to change course, the mail could be delayed for months, if it ever arrives. QSL exchange with a stateside (or European or Japanese) manager eliminates this risk, is potentially faster than overseas mail, and is much less expensive.

The use of QSL managers simplifies the preparation of your own SASE. Stateside hams can usually use US postage, or, in the case of European or Japanese managers, can use a Green Stamp (US \$1 bill), IRCs, or airmail stamps of that country from a DX stamp service.

So QSL managers make QSL exchange faster, cheaper, and more reliable for the DXer. QSL managers are also of benefit to the DX station. The DX station is relieved of the burden of handling volumes of mail, opening, sorting, etc., as well as the task of filling out the cards, stuffing the envelopes, and mailing. Also, the DX station's QSLs are safer in the States than in his own country. Bob YS9RVE once lost all his QSLs, including some excellent 80-meter DX, in a riot. And few DX stations want to trust several years worth of work in the form of DX QSLs to the international postage system. So when a DX station applies for an award (and they do, you know), the QSL manager can send in the cards, a much safer and more reliable procedure.

Are there any disadvantages to the use of a QSL manager? The major problem with QSL managers is that the logs are in one remote location and the cards are in another. Somehow the DX station must get his or her log information to the QSL manager to check the contacts. If the DX station mails the logs to the manager, you are right back to trusting the erratic inter-



Dean Paterson KH6OA, the southernmost amateur in the United States, operates this well-equipped station into a vertical, a longwire, and other hidden apartment-style antennas.

national postal system. Mail to Pitcairn Island, for example, depends on infrequent visits by yachts and cruise ships. Also, the logs can take months to reach the manager, who obviously cannot answer the QSL until he or she receives the logs.

Fortunately, there is another way the QSL manager can get the log information from the DX station: on the air. To take a typical example, let's look at how a state-side station would get a VP2ML QSL card. After the DXer works VP2ML and hears "QSL via K1RH," he fills out his QSL and puts it and a SASE in an envelope addressed to K1RH. When Ralph Hirsch K1RH receives the envelope, he opens it and sorts the contacts into date and time order, just like a logbook, until his next schedule with VP2ML.

During the on-the-air schedule, Ralph reads the date, time, and callsign. VP2ML checks his logbook and returns with the band, emission, and report, entering a checkmark in the log for "QSLed." Ralph confirms the band and emission and writes the report in pencil on the incoming QSL card. He then goes to the next card.

With practice, this procedure can be very fast. The on-the-air time to confirm the contact can be a matter of a few seconds, although Ralph still has more work after the contact with VP2ML. Ralph takes the stack of checked, incoming QSL cards and types out a stack of VP2ML cards, reading the reports from his note on the

card. He then puts the blue VP2ML card in to the SASE provided and drops it in the mail.

This procedure works so well that some DXers get their VP2ML cards within days of their contact. The DXer sends his card and SASE the same day as the contact with VP2ML. Ralph receives the card the next day, confirms the contact in the sked with VP2ML that night, and mails the return card later that evening. The DXer gets his VP2ML card back the next day, less than 48 hours after the contact!

Of course, all this supposes everything goes well. Reality seldom achieves this ideal. What can go wrong? The worst problem is poorly filled out incoming QSLs, especially those with bad dates and times.

VP2ML keeps his log in Coordinated Universal Time (UTC), as just about every DX station must. If the incoming QSL card has local dates and times or has miscalculated the UTC date or time, quick confirmation of the contact is impossible. VP2ML must search the log for the callsign, often over a span of several pages. If there are many other QSL cards awaiting responses, any card with incorrect information goes to the bottom of the pile for another day.

The most common date/time error is to forget to advance the day to the next UTC day during local evening operation. The next most common problem is miscalculating the time difference between UTC

and local time, either adding the wrong number of hours or subtracting instead of adding.

This became so much of a problem for Ralph that he made a rubber stamp saying that he was unable to locate the contact in the VP2ML log at the date and time specified and suggesting the amateur check his QSO information again, especially the date and time.

There is really no excuse for date/time errors of this sort. Anyone interested in DX should have a clock reading UTC by the rig and keep their entire log in UTC. You can buy a tiny, stick-on digital clock for a couple of dollars. Set it to UTC and use it for all your amateur contacts. The QSL managers will love it.

Another problem which slows confirmation is multiple contacts on a single card. This card is first filed under the first contact time. But after this contact is checked, the card must be refiled into date/time order for the next contact. This increases the on-the-air time and increases the chance that interference or fading will end the schedule for that day.

Some QSL managers, including Ralph, handle cards for more than one DX station. The best way to address the envelope to the manager is to give both the DX station's call and that of the manager: VP2ML c/o K1RH QSL Manager. Then the manager can immediately sort the cards for the different stations he serves.

And finally, a short note thanking the

QSL manager for his services would gladden the heart of many an under-appreciated manager. These volunteers receive nothing tangible for their efforts. They are not paid, and the few dollars which do arrive with the cards barely cover printing and postage.

So why would anyone want to handle the QSL card for a DX station? A QSL manager gets a modicum of publicity for his work, especially if he handles major DX-peditions, such as SM3CXS who handles the cards for Eric SM0AGD on his far-reaching travels. But the real satisfaction comes from the service these amateurs provide to the rest of the DX community.

Have you ever considered handling the cards for a DX station yourself? Consider these qualifications for a good manager: The QSL manager should not move around, so his or her address is good in old, new, and future callbooks. The manager should have a good enough station to maintain communication with the DX station under a variety of conditions, month after month. And the manager should be willing to work hard for remarkably little reward. Infinite patience, the ability to decipher hieroglyphic handwriting, a little ESP (for the QSL cards without date), and an understanding postman are useful but not essential additional qualifications.

Be kind to your friendly QSL manager; he or she makes your DXing a lot more pleasant.

# FUN!

John Edwards K12U  
PO Box 73  
Middle Village NY 11379

## SPACE COMMUNICATIONS

This is shaping up to be quite a year for amateur radio and space communications. With the launch of Phase III OSCAR and W5LFL's little DXpedition into the final frontier, future ham historians may well peg 1983 as a turning point in the development of the hobby.

I, for one, can't wait until amateur space communications really take off. At age 28, I'm still hoping to see the day when hams collect planets and space settlements the way we currently chase after new countries. Imagine heading down to your local ham club to compare QSLs from Mars, Titan, and Europa. Think of the picture possibilities on those pasteboards!

Of course, some things won't change. We'll probably still be grumbling about slow QSL bureaus, DX nets, and pileups. But like today, the excitement will be worth all the hassles. At least the weather reports should be interesting, for a change.

Let's get going and leave the rest to squabble about code/no code.

### ELEMENT 1 MULTIPLE CHOICE

- 1) A blue whizzer is:
  - 1) A meteor that creates a very strong ion trail
  - 2) The name of a new privately-funded amateur satellite

- 3) The name of Phase III OSCAR's mode A transponder
- 4) A type of space antenna
- 2) OSCAR 6's 10-meter antennas were made out of:
  - 1) Tin
  - 2) Silver
  - 3) Molybdenum
  - 4) A disassembled pocket rule
- 3) Owen Garriott's son has also made quite a name for himself. He is:
  - 1) Also an astronaut
  - 2) General Manager of the ARRL
  - 3) A best-selling computer game designer writing under the pseudonym, "Lord British"
  - 4) A pro tennis player
- 4) On which one of the following dates did amateurs first bounce a signal off of the Moon:
  - 1) July 4, 1976
  - 2) November 21, 1954
  - 3) December 4, 1934
  - 4) January 27, 1953
- 5) OSCAR 1 was launched from
  - 1) Cape Kennedy
  - 2) Cape Canaveral
  - 3) Edwards Air Force Base
  - 4) Vandenberg Air Force Base

### ELEMENT 2 TRUE-FALSE

- |   | True  | False |
|---|-------|-------|
| 1) OSCAR 1's output was 10 Watts.                         | _____ | _____ |
| 2) OSCAR 5 was built in Australia.                        | _____ | _____ |
| 3) A Technician-class amateur may be a satellite trustee. | _____ | _____ |

- 4) The Leonids meteor shower occurs in November. \_\_\_\_\_
- 5) Meteors form an ionized trail in the troposphere. \_\_\_\_\_
- 6) The first successful EME transmission used the old 5-meter band. \_\_\_\_\_
- 7) No amateur satellites were launched in 1965 through 1970. \_\_\_\_\_
- 8) OSCAR 8 travels in a north-to-south orbit. \_\_\_\_\_
- 9) One needs to run at least 1000 Watts in order to access OSCAR. \_\_\_\_\_
- 10) In ham satellite terminology, LOS stands for "linked oscillator system." \_\_\_\_\_

### ELEMENT 3 SCRAMBLED WORDS

Unscramble these space communication terms:

- |          |           |
|----------|-----------|
| REOTEM   | SASBPNDA  |
| PLOPRED  | YRTTELEME |
| KLINWODN | ETILLEAST |
| DEOM     | NOCABE    |
| ELTTUHS  | TRHAE     |
| LOPRA    | GINP      |

### THE ANSWERS

- Element 1:
- 1—1 Some have been known to reflect signals for up to two minutes.
  - 2—4 Cheap, but practical.
  - 3—3 No, he didn't write Space Invaders.
  - 4—4 Ross Bateman W4AO and William Smith W3GKP did the deed.

- 5—4 Personally, I've always had a soft spot for ol' Edwards.

#### Element 2:

- 1—False One-tenth of a Watt. Good antenna height helps.
- 2—True University of Melbourne, to be precise.
- 3—False Extras only, according to the FCC.
- 4—True November 14—18.
- 5—False Ionosphere.
- 6—False It was on 2 meters.
- 7—True Dry spell.
- 8—False Depends which side of the world you're on.
- 9—False Hardly. 100 Watts ERP is more like it.
- 10—False "Loss of signal."

#### Element 3:

(Reading from left to right): METEOR, PASSBAND, DOPPLER, TELEMETRY, DOWNLINK, SATELLITE, MODE, BEACON, SHUTTLE, EARTH, POLAR, PING.

### SCORING

- Element 1:  
Six points for each correct answer.
- Element 2:  
Three and one-half points for each correct answer.
- Element 3:  
Three points for each term unscrambled.

Where do you stand in the radio space race?

1-20 points—Stuck on the launch pad

21-40 points—Still listening for Sputnik

41-60 points—Confuse OSCAR signals for a band opening

61-80 points—Satellite Communicator's Club member

81+ points—OSCAR DXCC certificate holder

# Dealers DEAL

Selling 73 will make money for you. Consider the facts:  
**Fact #1:** Selling 73 increases store traffic—our dealers tell us that 73 is the hottest-selling amateur radio magazine on the newsstands.

**Fact #2:** There is a direct correlation between store traffic and sales—increase the number of people coming through your door and you'll increase sales.

**Fact #3:** Fact #1 + Fact #2 = INCREASED SALES, which means more money for you. And that's a fact. For information on selling 73, call 800-343-0728 and speak with Ginnie Boudrieau, our bulk sales manager. Or write to her at 73, 80 Pine St., Peterborough, NH 03458.

**73** Amateur Radio's  
 Technical Journal

80 Pine Street Peterborough, NH 03458  
 800-343-0728

# MOVING?

Let us know 8 weeks in advance so that you won't miss a single issue of **73**.

Attach old label where indicated and print new address in space provided. Also include your mailing label whenever you write concerning your subscription. It helps us serve you promptly. Write to:

**73** Amateur Radio's  
 Technical Journal      Subscription Department  
 P.O. Box 931  
 Farmingdale NY 11737

- Extend my subscription one additional year for only \$19.97  
 Payment enclosed       Bill me

Canada & Mexico \$22.97/1 year only US Funds drawn on US bank. Foreign Surface \$25.00/1 year only US Funds drawn on US bank. Foreign Airmail, please inquire.

*If you have no label handy, print OLD address here.*

Name \_\_\_\_\_

Address \_\_\_\_\_

City \_\_\_\_\_ State \_\_\_\_\_ Zip \_\_\_\_\_

*print NEW address here:*

Name \_\_\_\_\_

Address \_\_\_\_\_

City \_\_\_\_\_ State \_\_\_\_\_ Zip \_\_\_\_\_

AFFIX LABEL

## MAKE SAVING MONEY A WAY OF LIFE

With **LIVING ON A SHOESTRING**: A Scrounge Manual for the Hobbyist. Almost anything you find can be put to good use if you follow the techniques of a master scrounger. George Ewing WA8WTE shows you how to:

- Find electronic parts
- Scrounge by the rules
- Scrounge a vehicle
- Locate tools and other surplus
- Read up on scrounging
- Scrounge a place to live

Cartoons and case histories of scroungers add a humorous touch. With **LIVING ON A SHOESTRING**, you can't always get something for nothing, but you can certainly get it for less. \$7.97 Softcover, 7x9, 128 pp. approx..

ISBN 0-88006-059-X

Call TOLL FREE 1-800-258-5473 for credit card orders. Or mail your order with payment or complete credit card information. Include \$1.50 for shipping and handling. Send to:

Wayne Green Inc.  
 Attn: Book Sales  
 Peterborough, NH 03458

A Wayne Green Publication

Dealer Inquiries Invited

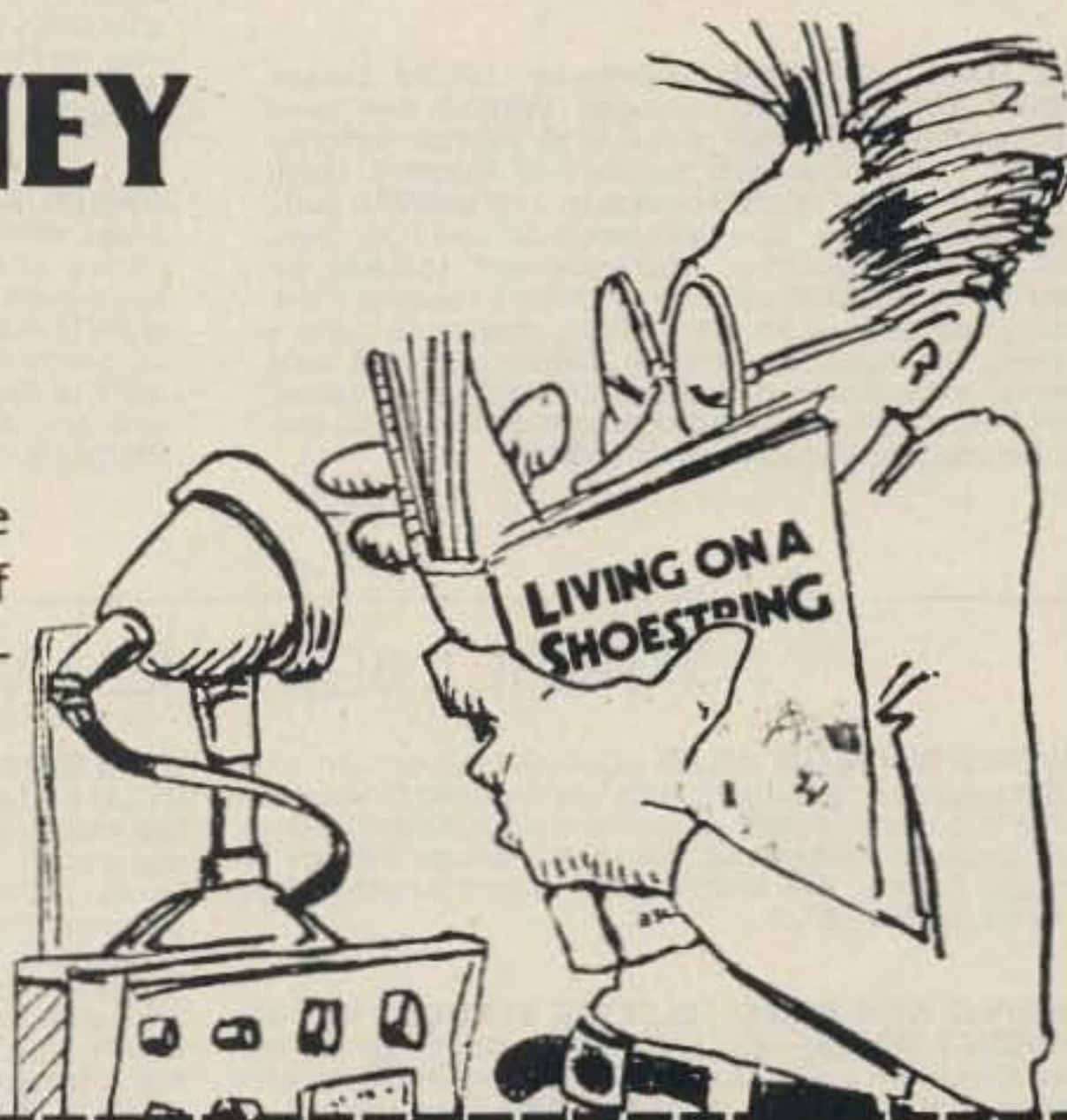

### YES, I want to scrounge!

33NB6L

Send me \_\_\_\_\_ copies of **LIVING ON A SHOESTRING**. Enclosed is \$7.97 (BK7393) per copy plus \$1.50 shipping and handling.

MASTERCARD bank # \_\_\_\_\_  VISA  AMEX

Card # \_\_\_\_\_ Expires \_\_\_\_\_

Signature \_\_\_\_\_

Name \_\_\_\_\_

Address \_\_\_\_\_

City \_\_\_\_\_ State and Zip \_\_\_\_\_

# RADIO BOOKSHOP

**VHF ANTENNA HANDBOOK**—The new VHF Antenna Handbook details the theory, design and construction of hundreds of different VHF and UHF antennas... a practical book written for the average amateur who takes joy in building. Not full of complex formulas for the design engineer. Packed with fabulous antenna projects you can build. BK7368 \$5.95.\*

**THE COMPLETE SHORTWAVE LISTENER'S HANDBOOK**, 2nd Edition by Hank Bennett and Harry L. Helms. This comprehensive volume contains loads of new information from all over the world on the latest developments in SWL technology clubs, associations, practices and stations. A thorough guide to stations of the world by general continental area and frequency is included. BK1241 \$9.95.\*

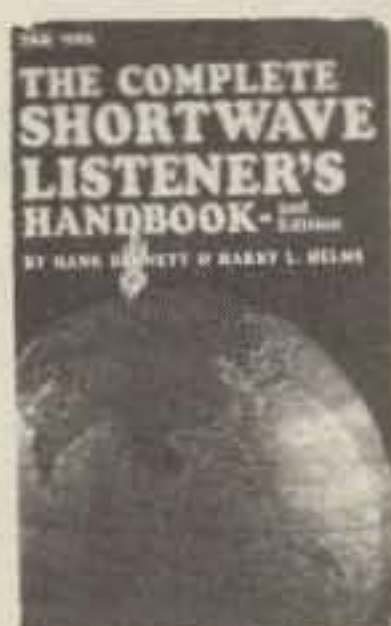

**IC OP-AMP COOKBOOK**—by Walter G. Jung. Covers not only the basic theory of the IC op amp in great detail, but also includes over 250 practical circuit applications, liberally illustrated. 592 pages, 5 1/2 x 8 1/2, softbound. BK1028 \$14.95.\*

**EVERYTHING YOU ALWAYS WANTED TO KNOW ABOUT AMATEUR TELEVISION**, (but were afraid to ask) —By Mike Stone WB0QCD. This book is a complete guide to setting up your own amateur radio television station. It contains—A history, what equipment you need, video theory, cameras, recorders, lighting, special effects, sound ATV DXing, mobile FSTV, ATV repeaters, ATV groups, building projects, test equipment, dealer directory, a cumulative index of over 1000 articles on amateur TV and much more. This is the new, 1982 edition. From the publishers of *Amateur Television Magazine*. BK1244 \$9.95

**THE MAGIC OF HAM RADIO**—by Jerrold Swank W8HXR. Under various call signs, W8HXR has been heard on the ham bands since 1919. He has watched amateur radio grow from the days of Model A spark coils to an era of microprocessors and satellite communications. Jerry has responded to calls for help from earthquake-stricken Managua and tornado-ravaged Xenia. Antarctica, one of man's loneliest outposts, has been a bit less lonely, thanks to Jerry's tireless phonepatching efforts. Drawing on his own colorful experiences and those of many other hams, Jerry has compiled this word-picture of ham radio during the past six decades. BK7312 \$4.95

**PROPAGATION WIZARD'S HANDBOOK**—by J. H. Nelson. When sunspots riddled the worldwide communications networks of the 1940s, John Henry Nelson looked to the planets for an answer. The result was a theory of propagation forecasting based upon interplanetary alignment that made the author the most reliable forecaster in America today. The book provides an enlightened look at communications past, present, and future, as well as teaching the art of propagation forecasting. BK7302 \$6.95.\*

**TOOLS & TECHNIQUES FOR ELECTRONICS**—by A. A. Wicks is an easy-to-understand book written for the beginning kit-builder as well as the experienced hobbyist. It has numerous pictures and descriptions of the safe and correct ways to use basic and specialized tools for electronic projects, as well as specialized metal-working tools and the chemical aids which are used in repair shops. BK7348 \$4.95.\*

**70 YEARS OF RADIO TUBES AND VALVES**—by John Stokes "Great, the best book on the history of radio tubes that I've ever seen!" raved 73's technical editor. Written by an expert who has been involved in radio since '29, this book will be of special interest to "old-timers" and will provide those younger hams with a unique sense of the history of their hobby. BK1272 \$21.95

**SSB... THE MISUNDERSTOOD MODE**—by James B. Wilson. Single Sideband Transmission... thousands of us use it every day, yet it remains one of the least understood facets of amateur radio. J. B. Wilson presents several methods of sideband generation, amply illustrated with charts and schematics, which will enable the ambitious reader to construct his own sideband generator. A must for the technically-serious ham. BK7351 \$5.50.\*

**THE CONTEST COOKBOOK**—This book reveals the secrets of that elite group of operators who top the list when the contest results are published. It contains detailed suggestions for the first-time contestee as well as tips for the advanced operator. Domestic, DX, and specialty contests are all discussed, complete with photographs and diagrams showing the equipment and operating aids used by the top scorers. For the serious contestee. BK7308 \$5.95.

**A GUIDE TO HAM RADIO**—by Larry Kahaner WB2NEL. What's Amateur Radio all about? You can learn the basics of this fascinating hobby with this excellent beginner's guide. It answers the most frequently asked questions in an easy-going manner, and it shows the best way to go about getting an FCC license. A Guide to Ham Radio is an ideal introduction to a hobby enjoyed by people around the world. BK7321 \$4.95.\*

**OWNER REPAIR OF RADIO EQUIPMENT**—by Frank Glass K6RQ. Here's a book that will teach you an approach to troubleshooting without a shack full of test equipment. Written in a narrative, non-mathematical style, it will encourage you to successfully fix your own rig problems 80 to 90% of the time. Even if you don't want to fix, you can learn a lot about how things work and fail. Add to your library and personal expertise. BK7310 \$7.95.\*

## THE 73 TEST EQUIPMENT LIBRARY

**VOL. II AUDIO FREQUENCY TESTERS**—Jam-packed with all kinds of audio frequency test equipment. If you're into SSB, RTTY, SSTV, etc., this book is a must for you... a good book for hi-fi addicts and experimenters, too! LB7360 \$1.95.\*

**VOL. III RADIO FREQUENCY TESTERS**—Radio frequency waves, the common denominator of amateur radio. Such items as SWR, antenna impedance, line impedance, RF output, and field strength; detailed instructions on testing these items includes sections on signal generators, crystal calibrators, grid dip oscillators, noise generators, dummy loads, and much more. LB7361 \$1.95.\*

**VOL. IV IC TEST EQUIPMENT**—Become a troubleshooting wizard! Here are 42 home construction projects for building test equipment to work with your ham station and in servicing digital equipment. Plus a cumulative index for all four volumes for the 73 TEST EQUIPMENT LIBRARY. LB7362 \$1.95.\*

**ALL THREE OF THE ABOVE ONLY \$4.95 ORDER LB7365**

**RF AND DIGITAL TEST EQUIPMENT YOU CAN BUILD**—BK1044—Rf burst, function, square wave generators, variable length pulse generators—100 kHz marker, i-f and rf sweep generators, audio osc, at/rf signal injector, 146 MHz synthesizer, digital readouts for counters, several counters, prescaler, microwave meter, etc. 252 pages. BK1044 \$5.95.\*

**BEHIND THE DIAL**—This book explains, in detail, what's going on on all the frequencies, from shortwave up to microwave. It gives the reader a good idea of what he can find and where to find it, including some of the secret stations such as the C.I.A. and the F.B.I. Everything is covered short of microwave monitoring. Anyone interested in purchasing a shortwave receiver should have a copy of this book. surveillance, station layout consideration, antenna systems, interface, and the electromagnetic spectrum, are included. BK7307 \$4.95

**WORLD PRESS SERVICE FREQUENCIES**—by Thomas Harrington Can't wait to hear the evening news, or are you wondering about the news that you aren't hearing? Receive by Radio Teletype (RTTY) all the world news and financial happenings from the world capitols on a 24 hour a day basis. This book gives you the frequencies and times of broadcast of such news services as AP, UPI, Reuters, TASS, VOA and London Press. Also included is an introduction to RTTY with information on equipment, antennas, abbreviations—everything you need to get started in RTTY. BK1202 \$7.95.\*

**INTERFERENCE HANDBOOK**—by William R. Nelson, WA6EQG—This timely handbook covers every type of RFI problem and gives you the solutions based on practical experience. Covers interference to TV, radio, hi-fi, telephone, radio amateur, commercial and CB equipment. Power line interference is covered in depth—how to locate it, cure it, work with the public, safety precautions, how to train RFI investigators. Written by an RFI expert with 33 years of experience, this profusely illustrated book is packed with practical easy-to-understand information. BK1230 \$11.95

**THE NEW WEATHER SATELLITE HANDBOOK**—by Dr. Ralph E. Taggart WB8DQT. Here is the completely updated and revised edition containing all the information on the most sophisticated and effective spacecraft now in orbit. This book serves both the experienced amateur satellite enthusiast and the newcomer. It is an introduction to satellite watching, providing all the information required to construct a complete and highly effective ground station. Solid hardware designs and all the instructions necessary to operate the equipment are included. For experimenters who are operating stations, the book details all procedures necessary to modify equipment for the new series of spacecraft. Amateur weather satellite activity represents a unique blend of interests encompassing electronics, meteorology and astronautics. Join the privileged few in watching the spectacle of earth as seen from space on your own monitoring equipment. BK7383 \$8.95.\*

## AROUND THE WORLD

**WORLD REPEATER ATLAS**—Completely updated, over 230 pages of repeater listings are indexed by location and frequency. More than 50 maps pinpoint 2000 repeater locations throughout the USA. Foreign listings include Europe, the Middle East, South America, and Africa. BK7315 \$2.00

**WORLD WIDE RADIO TELETYPE STATIONS IN FREQUENCY ORDER**—8th EDITION Compiled by Universal Electronics, Inc. Contains 2198 frequencies of stations that have been logged in 1982. Frequency, call sign, name of station, ITU country symbol, times of reception and details are included. All types of RTTY stations are listed including schedules of 82 press and news agencies operating on 637 frequencies. Includes 77 meteorological stations on 279 frequencies. Covers all RTTY stations from 3 MHz to 30 MHz, air, metro, government, military, diplomatic, covers all services. This is the most accurate RTTY list there is and a must for the serious RTTY enthusiast. BK1270 \$10.95

**WORLDWIDE RADIO TELETYPE CALL SIGN LIST OF UTILITY STATIONS**—8th EDITION Compiled by Universal Electronics, Inc. Contains more than 4000 call signs in alphanumerical order. All types of stations are listed. 183 utility station mnemonics and name abbreviations. Plus abbreviations for regional states in Australia, Canada, USA and USSR. All ITU Symbols designating countries or geographical areas. Table of allocation of international call sign series. Revised radio regulations on identification of stations, including formation or call signs. All services listed. BK1271 \$4.95

**WORLD RADIO TV HANDBOOK 1983, 26TH EDITION**—This book is the bible of international broadcasters, providing the only authoritative source of exact information about broadcasting and TV stations world wide. This 1983 edition is completely revised, giving comprehensive coverage of short, medium and long wave, 560 pages of vital aspects of world listening. BK1184 \$16.50

\*Use the order card in this magazine or itemize your order on a separate piece of paper and mail to: 73 Radio Bookshop • Peterborough NH 03458. Be sure to include check or detailed credit card information. No C.O.D. orders accepted. \$1.50 for the first book, \$1.00 each additional book for U.S. delivery and foreign surface. For foreign airmail \$10.00 per book. Please allow 4-6 weeks for delivery. Questions regarding your order? Please write to Customer Service at the above address. (Prices subject to change on books not published by 73 Magazine.)

FOR TOLL FREE ORDERING CALL 1-800-258-5473



# RADIO BOOKSHOP

## FOR THE NOVICE

New, updated editions  
of our famous novice  
license study guide and novice study tapes.

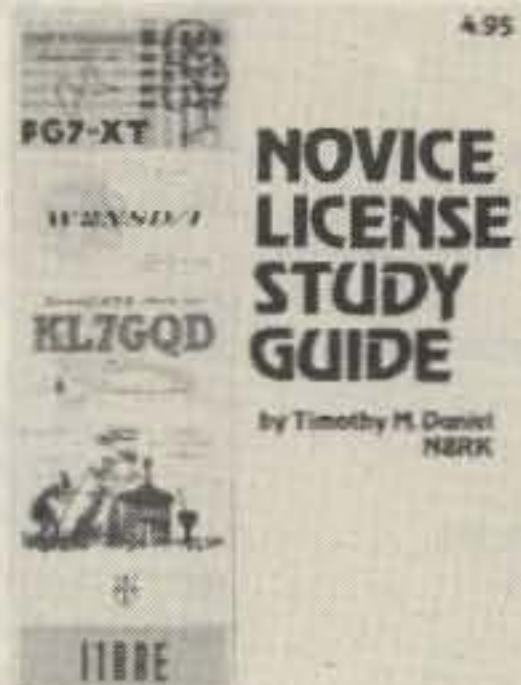

● **NOVICE LICENSE STUDY GUIDE**—by Timothy M. Daniel N8RK. Here is the most up to date novice guide available. It is complete with information about learning Morse Code, has the latest FCC amateur regulations and the current FCC application forms. This guide is not a question/answer memorization course but rather it emphasizes the practical side of getting a ham license and putting a station on the air. It reflects what the FCC expects a Novice to know without page after page of dull theory. The most current information still available at last year's price. SG7357 \$4.95.\*

● **NOVICE STUDY TAPES**—If you are just getting started in ham radio, you'll find these tapes indispensable! This up-to-the-minute revision of the 73 Study Course is the perfect way to learn everything you need to breeze through the Novice written exam. Theory, FCC regulations, and operating skills are all covered, and you'll be amazed at how fast you learn using these tapes!

Once the test is behind you, these tapes will go right on being useful, because they are packed with the latest information on setting up your own ham station, and getting on the air.

Thousands of people have discovered how easy learning from cassette can be—order now and enter the fascinating world of ham radio! CT7300 Set of 3—\$15.95.\*

Scientists have proven that you learn faster by listening than by reading because you can play a cassette tape over and over in your spare time—even while you're driving! You get more and more info each time you hear it. You can't progress without solid fundamentals. These three hour-long tapes give you all the basics you'll need to pass the Novice exam easily. You'll have an understanding of the basics which will be invaluable to you for the rest of your life! Can you afford to take your Novice exam without first listening to these tapes?

**Special Offer! Both Novice License Study Guide and Novice Study Tapes \$19.95 Order NP7300.**

## GENERAL LICENSE STUDY GUIDE

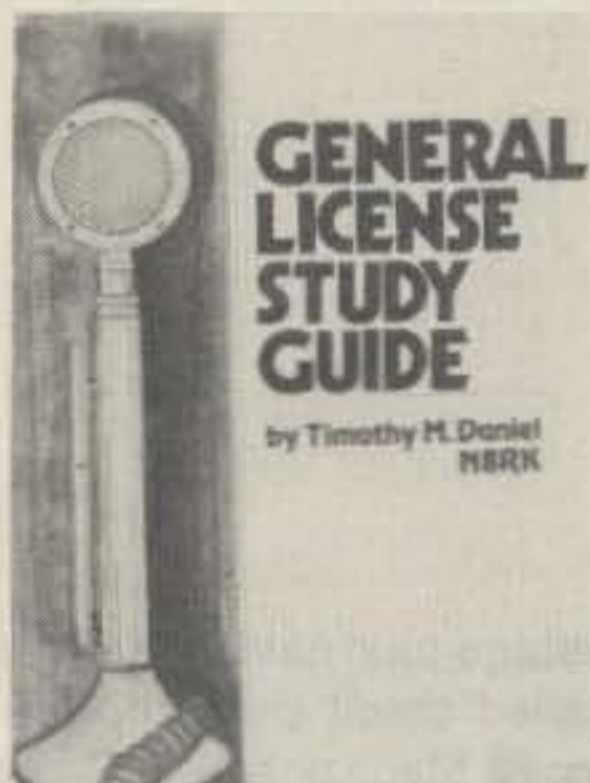

**GENERAL LICENSE STUDY GUIDE**—By Timothy M. Daniel N8RK. This is the complete guide to the General License. Learning rather than memorizing is the secret. This is not a question-and-answer guide that will gather dust when the FCC issues a new test. Instead, this book will be a helpful reference, useful long after a ham upgrades to General. Includes up-to-date FCC rules and an application form. Order yours today and talk to the world. SG7358 \$6.95



Style W

W2NSD/1

Style Y



Style X

● **QSL CARDS**—73 turns out a fantastic series of QSL cards at about half the cost of having them done elsewhere because they are run as a fill-in between printing books and other items in the 73 Print Shop. 250 Style W—QW0250—for \$8.95\*; 500 Style W—QW0500—for \$13.95\*; 250 Style X—QX0250—for \$8.95\*; 500 Style X—QX0500; 250 Style Y—QY0250—for \$8.95\*; 500 Style Y—QY0500—for \$13.95.\* Allow 6-12 wks. for delivery.

**LIBRARY SHELF BOXES**—These sturdy white corrugated, dirt boxes each hold a full year of 73, *Microcomputing* or *80 Micro Desktop Computing*, in *Cider*. With your order, request self-sticking labels for any of the following: 73, *Microcomputing*, *80 Micro*, *CQ*, *QST*, *Ham Radio Personal Computing*, *Radio Electronics*, *Interface Age*, and *Byte*. Order 1—BX1000—for \$2.00\*; order 2-7—BX2002—for \$1.50 each\*; order 8 or more—BX1002—for \$1.25 each\*.

● Preserve and protect your collection for a lifetime! Order these handsome red binders with gold lettering. \$7.50 for 1, 3 for \$21.75, 6 for \$42.00. (Postpaid within USA, please add \$2.50 per order outside USA.) Check or money orders only, no phone or C.O.D. orders. 73 Binders, P.O. Box 5120, Philadelphia, PA 19141.

\*NOTE—Above address for Binders only.

**For Your Ham Shack  
73 Magazine Binders**

73

## Code Tapes

any four tapes for  
**\$15.95! \$4.95 each**

### "GENESIS"

**5 WPM**—CT7305—This is the beginning tape for people who do not know the code at all. It takes them through the 26 letters, 10 numbers and necessary punctuation, complete with practice every step of the way using the newest blitz teaching techniques. It is almost miraculous! In one hour many people—including kids of ten—are able to master the code. The ease of learning gives confidence to beginners who might otherwise drop out.

### "THE STICKLER"

**6+ WPM**—CT7306—This is the practice tape for the Novice and Technician licenses. It is made up of one solid hour of code, sent at the official FCC standard (no other tape we've heard uses these standards, so many people flunk the code when they are suddenly—under pressure—faced with characters sent at 13 wpm and spaced for 5 wpm). This tape is not memorizable, unlike the zany 5 wpm tape, since the code groups are entirely random characters sent in groups of five.

### "BACK BREAKER"

**13+ WPM**—CT7313—Code groups again, at a brisk 14 per so you will be at ease when you sit down in front of the steely-eyed government inspector and he starts sending you plain language at only 13 per. You need this extra margin to overcome the panic which is universal in the test situations. When you've spent your money and time to take the test, you'll thank heaven you had this back-breaking tape.

### "COURAGEOUS"

**20+ WPM**—CT7320—Code is what gets you when you go for the Extra class license. It is so embarrassing to panic out just because you didn't prepare yourself with this tape. Though this is only one word faster, the code groups are so difficult that you'll almost fall asleep copying the FCC stuff by comparison. Users report that they can't believe how easy 20 per really is with this fantastic one hour tape.

### "OUTRAGEOUS"

**25+ WPM**—CT7325—This is the tape for that small group of overachieving hams who wouldn't be content to simply satisfy the code requirements of the Extra Class license. It's the toughest tape we've got and we keep a permanent file of hams who have mastered it. Let us know when you're up to speed and we'll inscribe your name in 73's CW "Hall of Fame."

**BACK ISSUES**—Complete your collection; many are prime collectables now, classics in the field! A full collection is an invaluable compendium of radio and electronics knowledge!

73300	73 BACK ISSUE—BEFORE JULY 1980	\$ 3.00
73350	73 BACK ISSUE JULY 1980 THRU OCT. 1981	\$ 3.50
73350P	73 BACK ISSUE NOV. 1981 TO PRESENT	\$ 3.50
73005	73 BACK ISSUE—5 YOUR CHOICE	\$10.75
73010	73 BACK ISSUE—10 YOUR CHOICE	\$16.00
73025	73 BACK ISSUE—25 YOUR CHOICE	\$27.00
73125	73 BACK ISSUE—25 OUR CHOICE	\$14.00

Shipping: Please add \$1.00 per magazine. Orders of ten magazines or twenty-five magazines add \$7.50 per order.

\*Use the order card in this magazine or itemize your order on a separate piece of paper and mail to: 73 Radio Bookshop • Peterborough NH 03458. Be sure to include check or detailed credit card information. No C.O.D. orders accepted. \$1.50 for the first book, \$1.00 each additional book for U.S. delivery and foreign surface. For foreign airmail \$10.00 per book. Please allow 4-6 weeks for delivery. Questions regarding your order? Please write to Customer Service at the above address. (Prices subject to change on books not published by 73 Magazine.)

**FOR TOLL FREE ORDERING CALL 1-800-258-5473**

# ADVERTISERS

\*Please contact these advertisers directly.  
To receive full information from our advertisers please complete the postage-paid card.

R. S. No.	Page	R. S. No.	Page	R. S. No.	Page	R. S. No.	Page
* AEA/Advanced Electronic Applications	19, 39, 51, 83, 98	* Computer Trader	141	33 Hamtronics, NY	142, 143	61 Radio Amateur Callbook, Inc.	4
124 Advanced Computer Controls	16	* Connect Systems	99	97 Hastings Antenna	57	397 Radio World	65
20 All Electronics	18	37 Contemporary Technology, Inc.	33	59 Heil Sound, Ltd.	140	62 Ramsey Electronics	133, 145
* Amateur Communications, Etc.	134	21 Current Development Corp.	90	* Hustler, Inc.	18, 116	133 Rivendell Associates	105
* Amateur Electronic Supply	29, 43	106 Cushcraft Corp.	34	* ICOM	Cov. II	150 Royal	94
75 Ampersand Electronics	95	12 C. Z. Labs	118	39 Jan Crystals	94	65 S-F Amateur Radio Services	91
109 Analog Technology	140	476 Daiwa	115	230 KCS Electronics	43	500 73 Books	93, 105, 111-114, 130, 132, 141
71 Applied Invention	87	* DGM Electronics, Inc.	44	114 KSG Technologies	140	Dealer Ad.	111
108 Aero Electronics	57	425 Doppler Systems	34	* Kantronics	8, 9	Moving	111
* Associated Radio	38	219 E-Tek	140	* Kenwood	7, 97, Cov. IV	Subscriptions	67, 73, 131, 140
11 Barker & Williamson, Inc.	65	477 Electra	115	* KLM Electronics	137	367 Slep Electronics	132
305 Barry Electronics	23	58 Electronic Rainbow, Inc.	53	100 Lewis Electroniss	92	* Spectronics	144
* Barter 'n' Buy	91	73 Electronic Rainbow, Inc.	35	220 Lunar Electronics	108	68 Spectrum Communications	74, 75
* Bill Ashby & Son	95	18 Electronic Specialists, Inc.	44	* Macrotronics, Inc.	90	436 Spectrum International, Inc.	57
* Blackburn Group	45	483 Encon	116	45 Madison Electronics	135	* Spider Antenna	66
226 Buckmaster Publishing	94	29 Esoteric Engineering	141	54 Magnum Distributing	45	183 Tayco Communications	141
255 Buckmaster Publishing	91	248 Etco Electronics	65	9 MFJ Enterprises	68, 69	224 Tel-tone	94
53 California Antenna Systems	140	22 Fair Radio Sales	141	48 MHz Electronics	120-129	* Ten-Tec	79
111 Ceco Communications, Inc.	94	99 Faxscan Corp.	94	103 Melco Publishing	91	46 The Ham Shack	19
102 Centurion International	55	484 Faxscan	116	27 Micro-80, Inc.	34	449 The Ham Shack	18
13 Coin International	140	23 Flesher Corp.	35	49 Micro Control Specialties	27	205 The Metheny Corp.	4
14 Communications Concepts, Inc.	53	88 Fox-Tango Corp.	55	51 Microlog Corporation	25	76 Trac Electronics	55
462 Communications Electronics Specialties, Inc.	67	95 Fox-Tango Corp.	141	* Mirage Communications	81	104 Trionyx Industries	56
485 Communications Specialists, Inc.	100	480 Fox-Tango Corp.	115	258 Missouri Radio Center	12	478 US Fiberglass	116
15 Communications Specialists, Inc.	139	481 GSM, Inc.	115	240 Mitronix	61	* Universal Electronics, Inc.	34
117 Communications Specialists, Inc.	5	178 Galaxy Electronics	140	* Moler Antenna, Inc.	94	* Van Gorden Engineering	91
34 Communications Specialists, Inc.	17	107 Gary Woodall & Co.	141	249 N. P. S., Inc.	141	311 Vanguard Labs	91
113 Computer Specialty Store, Inc.	4	482 Gary Woodall & Co.	115	254 National Comm. Group Co.	93	* W9INN Antennas	138
		229 Gizmo Electronics	105, 118	318 National Comm. Group Co.	66	* Westcom	53
		105 GLB Electronics	45	412 Nema Electronics	108	* Westech Electronics Co.	53
		143 GLB Electronics	57	137 Nuts & Volts	141	80 Western Radio Electronics	87
		119 H. Stewart Designs	65	* Orbit Magazine	66	244 W. H. Nail Co.	95
		479 Hal Communications	115	* P. C. Electronics	56, 116	112 Worldwide Publications, Inc.	92
		31 Hal-Tronix	38	4 Parsec Communications	57	* Xantek, Inc.	87
		101 Ham Masters Tapes	77	246 Phillips-Tech Electronics Corp.	43	83 Yaesu Electronics	Cov. III
		* Ham Radio Center	13	38 Procast	140		
		* Ham Radio Outlet	3				



## BOOKS, ETC.

To order, complete the postage-paid card, or itemize your order including detailed credit card information or check and mail to: 73 Magazine/Mail Order Dept./Peterborough NH 03458.

Catalog#	Item	Price	Catalog#	Item	Price	Catalog#	Item	Price	Catalog#	Item	Price
73300	73 BACK ISSUE - BEFORE JULY 1980	\$ 3.00	BK7309	CHALLENGE OF 160	\$ 4.95	BK7310	OWNER REPAIR OF RADIO EQUIPMENT	\$ 7.95	SG7358	STUDY GUIDE - GENERAL CLASS	\$ 6.95
73350	73 BACK ISSUE - JULY 1980 THRU OCT. 1981	\$ 3.50	BK1011	CMOS COOKBOOK	\$10.50	BK1185	THE PRACTICAL HANDBOOK OF FM REPEATERS	\$12.95	BK1190	THE TEN METER FM HANDBOOK	\$ 4.95
73350P	73 BACK ISSUE - NOV. 1981 TO PRESENT	\$ 3.50	CT7305	CODE TAPE - 5 WPM	\$ 4.95	BK7302	PROPAGATION WIZARD'S HANDBOOK	\$ 6.95	LB7360	TEST EQUIP LIB V2 - AUDIO TESTERS	\$ 4.95
73095	73 BACK ISSUE - 5 YOUR CHOICE	\$10.75	CT7306	CODE TAPE - 6+ WPM	\$ 4.95	QW0250	QSL CARDS - STYLE W - 250	\$ 8.95	LB7361	TEST EQUIP LIB V3 - RADIO EQUIP	\$ 4.95
73010	73 BACK ISSUE - 10 YOUR CHOICE	\$16.00	CT7313	CODE TAPE - 13+ WPM	\$ 4.95	QW0500	QSL CARDS - STYLE W - 500	\$13.95	LB7362	TEST EQUIP LIB V4 - IC TEST EQ	\$ 4.95
73025	73 BACK ISSUE - 25 YOUR CHOICE	\$27.00	CT7320	CODE TAPE - 20+ WPM	\$ 4.95	QX0250	QSL CARDS - STYLE X - 250	\$ 8.95	BK7367	TEXTEDIT - WORD PROCESSING KIT	\$9.97
73125	73 BACK ISSUE - 25 OUR CHOICE	\$14.00	CT7325	CODE TAPE - 25+ WPM	\$ 4.95	QX0500	QSL CARDS - STYLE X - 500	\$13.95	DS7367	TEXTEDIT - DISK	\$19.97
	Add \$2.50 per order for shipping		CT7394	CODE TAPES (ANY FOUR ABOVE)	\$15.95	QY0250	QSL CARDS - STYLE Y - 250	\$ 8.95	BK7348	TOOLS & TECHNIQUES	\$ 4.95
			BK1241	THE COMPLETE SHORTWAVE LISTENER'S HANDBOOK	\$ 9.95	QY0500	QSL CARDS - STYLE Y - 500	\$13.95	BK1063	TTL COOKBOOK	\$ 9.50
BK1196	ALL ABOUT CUBICAL QUAD ANTENNAS	\$ 5.95	BK7308	THE CONTEST COOKBOOK	\$ 5.95	BK1199	THE RADIO AMATEUR ANTENNA HANDBOOK	\$ 6.95	BK1064	TVT COOKBOOK	\$ 9.95
BK7384	ANNOTATED BASIC, VOL 1	\$10.95	BK7381	40 COMPUTER GAMES	\$ 7.95	BK1044	RF & DIGITAL TEST EQUIPMENT	\$ 5.95	BK7382	UNDERSTANDING & PROGRAMMING MICROCOMPUTERS	\$10.95
BK7385	ANNOTATED BASIC, VOL 2	\$10.95	BK1244	EVERYTHING YOU ALWAYS WANTED TO KNOW ABOUT AMATEUR TV	\$ 9.95	BK1016	73 DIPOLE & LONG WIRE ANTENNAS	\$ 5.50	BK7368	VHF ANTENNA HANDBOOK	\$ 5.95
BK1197	BEAM ANTENNA HANDBOOK	\$ 5.95	BK7321	A GUIDE TO HAM RADIO	\$ 4.95	BK1000	SHELF BOX - 1	\$ 2.00	BK1198	VHF HANDBOOK FOR RADIO AMATEURS	\$ 6.95
BK7307	BEHIND THE DIAL	\$ 4.95	BK7322	HOBBY COMPUTERS ARE HERE	\$ 2.47	BK1001	SHELF BOXES - 2, 7	\$1.50 each	BK1184	WORLD RADIO TV HANDBOOK	\$16.50
			BK1201	HOW TO DEFEND YOURSELF AGAINST RADAR	\$ 6.95	BK1002	SHELF BOXES - 8 AND UP	\$1.25 each	BK7315	WORLD REPEATER ATLAS	\$ 2.00
			BK1028	IC OF AMP COOKBOOK	\$14.95	BK1200	SIMPLE LOW COST WIRE ANTENNAS FOR RADIO AMATEURS	\$ 6.95			
			BK1230	INTERFERENCE HANDBOOK	\$ 8.95	BK7311	SOME OF THE BEST FROM KILOBAUD	\$10.95			
			BK7386	KILOBAUD KLASROOM	\$14.95	BK7351	SSB THE MISUNDERSTOOD MODE	\$ 5.50			
			BK7312	MAGIC OF HAM RADIO	\$ 4.95	SG7357	STUDY GUIDE - NOVICE CLASS	\$ 4.95			
			BK7340	THE NEW HOBBY COMPUTERS	\$ 2.47						
			BK7383	THE NEW WEATHER SATELLITE HANDBOOK	\$ 8.95						
			CT7300	NOVICE THEORY TAPES	\$15.95						

SHIPPING AND HANDLING CHARGES: \$1.50 for the first book, \$1 for each additional book for US delivery and foreign surface, \$10 per book for foreign airmail.

# NEW PRODUCTS

## SOFTWARE-ONLY MORSE CODE INTERFACE

Gary Woodall has announced a new concept in amateur radio and computer interfacing. Comp-Code 1.0 is a software-only Morse code interface for the Radio Shack Models I, III, and IV microcomputers.

This program uses the standard TRS-80 cassette I/O ports for input and output connections to a communications receiver and transmitter or transceiver. The results obtained from this software-only interface have been found to equal those of other hardware and software interface packages.

This 12K+ machine-language program has special routines that check the incoming signal to make sure it is valid code and not noise. Bursts of noise are disregarded and only code is processed and displayed on the video screen. There also is a routine that allows you to view the incoming signal and fine-tune your receiver. The program then samples the received code and automatically adjusts to the proper speed.

The transmitter mode features five programmable buffers for a 200-character total, a type-ahead buffer, and user-selectable sending speeds up to 70 wpm.

For more information, contact Gary Woodall Software, Box 284, Plainfield IN 46168; (317)-271-2565. Reader Service number 482.

## NEW DAIWA/MCM MANUAL ANTENNA TUNER

Daiwa has announced its new CNW419 manual antenna tuner featuring continuous coverage from 1.8 to 30 MHz. It is rated at 200 Watts CW, 500 Watts PEP SSB. Input impedance is 50 Ohms, with the output impedance variable from 10 to 250 Ohms.

The CNW419 also features dual antenna outputs and a switchable tuner bypass option. The tuner comes equipped with Daiwa's cross-needle meter that simultaneously shows forward power, reflected power, and SWR without the sensitivity adjustments commonly found in other meters.

For more information, contact MCM Communications, 858 E. Congress Park Dr., Centerville OH 45459; (513)-434-0031. Reader Service number 476.

## ELECTRA'S FIRST SHORTWAVE RADIO

Electra Company, marketer of Bearcat® scanner radios, has announced that it is entering the shortwave-radio market with the Bearcat DX-1000, a radio that makes dialing in the BBC comparable to dialing a push-button telephone.

Utilizing the same microprocessor digital technology found in Bearcat scanner radios, the DX-1000 features direct-access keyboard tuning. This makes it simple to tune from the BBC (for example) to Radio Ghana without bandswitching. Covering 10 kHz to 30 MHz continuously, with PLL-synthesized accuracy, the Bearcat DX-1000 will monitor all shortwave bands, longwave, standard broadcast-band AM, amateur-radio broadcasts, and the marine band.

The DX-1000 has 10 memory channels, a digital display measuring frequencies to 1 kHz which, at the touch of a button, doubles as a two-time-zone, 24-hour digital quartz clock, and a built-in timer which can be programmed to activate peripheral equipment like a tape recorder to record up to ten broadcasts, in any frequency or mode, while the user is asleep or at work.

Other features include independent selectivity selection, with 12-, 6-, and 2.7-kHz i-f filters to help separate high-powered stations on adjacent frequencies, a two-position noise-blanking system that stops Russian pulse-radar interference, a two-position rf attenuator, FM squelch control, tone control, battery back-up system to hold memorized frequencies and time if power fails, LED indicators for modes and functions, a front-mounted speaker, fast/slow automatic gain control, and separate push-buttons for selecting AM, LSB, USB, CW, or FM modes. The unit comes with a built-in telescoping antenna for portable use and includes an SO-239 antenna connector for 50-Ohm leads and a screw-connector for "High Z."

The Bearcat DX-1000 can be operated with batteries (12 V dc) or from an electrical outlet (120/240 V ac). The unit measures 14-1/2" W x 5" H x 9-3/8" D and weighs 17 lbs. Each radio comes with a free shortwave information guide that includes listings of stations from all corners of the world.

Further details are available by contacting Electra Company, 300 East County Line Road, Cumberland IN 46229. Reader Service number 477.

## WARC BANDS KIT FOR YAESU FT-101 SERIES

Fox Tango Corporation has announced a new kit which provides receive/transmit capability on all three WARC bands for all models of the FT-101 except the ZD. While

only the 10-MHz band has been authorized for use to date, not much additional effort or expense is required to add all the bands while the circuit changes for 10 MHz are being made. In addition to making the old 101 ready when the new bands become available, the added capability increases the trade-in value of the set.

Based on a tried and tested design by G3LLL, the WARC bands kit is complete with all needed crystals, relay switch, and detailed instructions for moderately easy installation. For more information, contact Fox Tango Corporation, Box 15944S, West Palm Beach FL 33416. Reader Service number 480.

## QUARTZ CRYSTAL GUIDE AND DIRECTORY

GSM, Inc., publisher of the *Quartz Crystal Industry Guide and Directory*, has announced availability of its 1983-84 edition. Companies engaged in the production of quartz-crystal products and frequency-control devices, as well as suppliers of goods and services to the industry, are listed. The directory describes the products, capabilities, and specialized services of hundreds of companies located in the United States, Canada, Europe, and Asia. Each company's key personnel, address, telephone number, TWX, and other pertinent information are detailed.

Features of this issue include expanded worldwide listings, used equipment for sale or trade, and technical publications pertinent to the industry that can be ordered from GSM.

Lucille A. Hope, editor-in-chief, is now planning the *Mid-Year Update* scheduled for December. For information regarding advertising in the update or listing your company, contact the editor at GSM, Inc., PO Box 10277, Fort Lauderdale FL 33334. Reader Service number 481.

## THE HAL ARQ1000 AMTOR TERMINAL

The ARQ1000 is a full send-receive terminal for the AMTOR ARQ code. All features of the CCIR 476-2 Recommendation are supported. Modes include: ARQ, FEC, SEL-FEC, and MONITOR. The ARQ1000 may be used with the Hal DS3100 and ST-6000, CT2200, CT2100, or CWR6850 terminals or any ASCII or Baudot terminal at baud rates from 45 to 300 baud. Non-volatile keyboard-programmable ARQ access code, selcal code, and WRU answer-back codes are included. The ARQ1000 is housed in a cabinet that matches the CT-2200 and CT2100. Available options include the DM170 internal demodulator and ARQX10 encryption module.

For further information, write Hal Com-



Electra's new Bearcat DX-1000 shortwave radio.



The Daiwa/MCM manual antenna tuner.



The ARQ1000 send-receive terminal from Hal Communications Corp.

### PHOTOVOLTAIC PANELS FROM ENCON

Encon Corporation has announced to the amateur-radio community two new photovoltaic panels, the SX-10 and the SX-20. The SX-10 is rated at 10 Watts and has different current/voltage selections, 8 V dc at 1.05 Amps and 17.3 V dc at .52 Amps, that the ham can wire himself. The SX-20 is 20 Watts, 8.6 V dc at 2.09 Amps and 17.3 V dc at 1.05 Amps.

According to Paul DeNapoli WD8AHO, Communications Director for Encon, these two new panels can be used for mobile QRP operations or mounted permanently to the roof for charging batteries.

The panels have a 30+ -year life expectancy, an environmental survivability of wind loads over 160 mph and golf-ball-size hail stones, and are waterproof.

For more information, contact *Encon Corp.*, 27584 Schoolcraft Rd., Livonia MI 48150; (313)-261-4130. Reader Service number 483.

### LAND MOBILE TUNABLE ANTENNAS

A land mobile antenna, available in either UHF or VHF, that's tunable over varied ranges was introduced by U. S. Fiberglass at the recent Land Mobile Expo in Denver.

The patented Stage 2 antennas utilize a voltage-fed system, differing from conventional current-fed antennas. The result is an efficient utilization of rf energy and a low angle of radiation that provides increased transmission and reception range.

A patented reactance-canceling tuning sleeve allows the antenna to be tuned for optimum performance and then locked into position. The tuning section also allows the antenna to be tuned for a lower swr than conventional antennas.

The new antennas are suited to today's synthesized radio technology since they perform over a wide band range. They are available in eight different models, including mobile applications and base antennas.

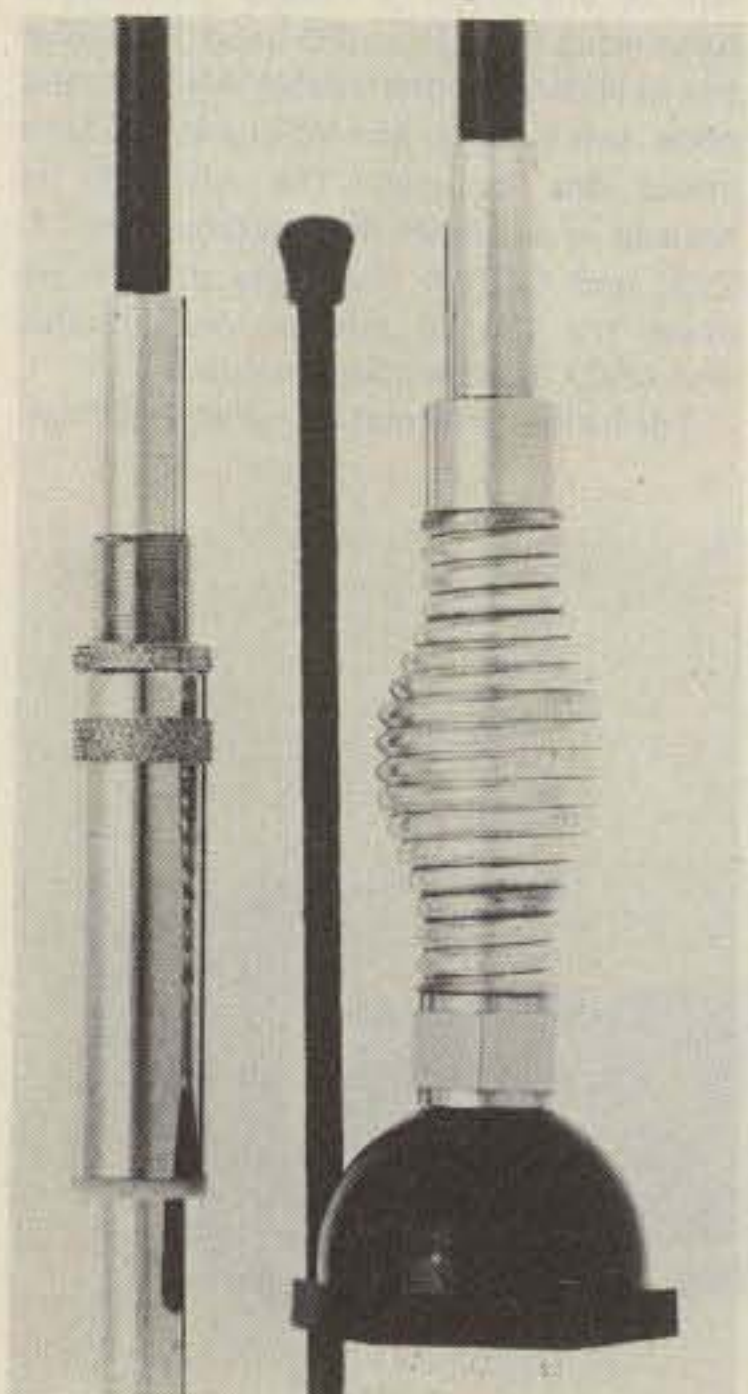

Land mobile antennas from U. S. Fiberglass.

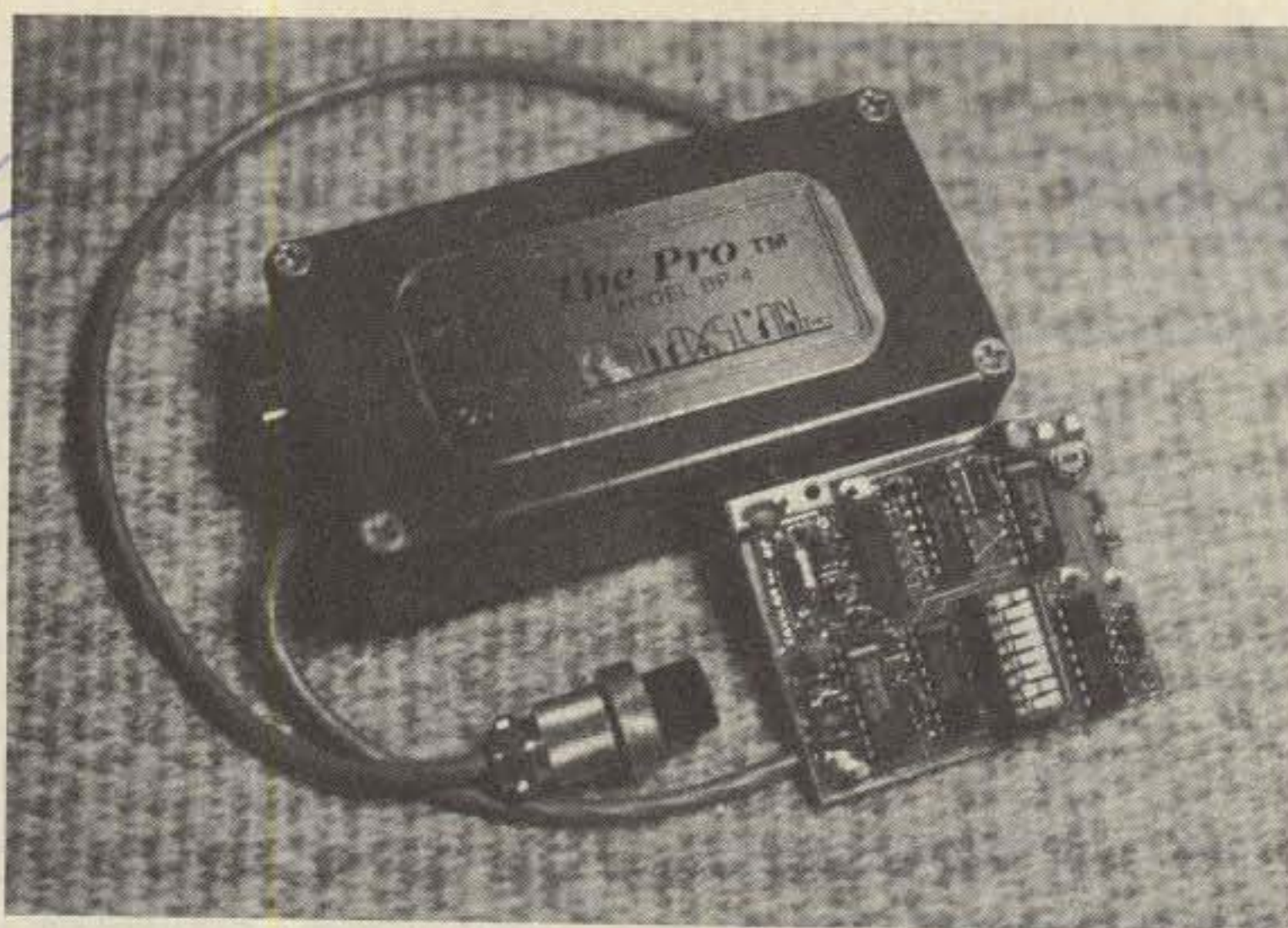

The Pro model BP-4 beeper from Faxscan, Inc.

For further information, contact *U. S. Fiberglass*, 5010 N.W. 36th Ave., Miami FL 33142; (305)-634-1115. Toll-free, nationally: 1-(800)-327-6790; Florida: 1-(800)-432-7142. Reader Service number 478.

### THE PRO—FAXSCAN'S BP-4 BEEPER

Faxscan, Inc., has announced the introduction of their model BP-4 beeper, The Pro™. The Pro continues the concept of a "courtesy beep" to signal the beginning and end of each transmission by automatically injecting a gentle high-frequency beep into the mike line at the start of the transmission and a low one at the end. This basic idea has been used for years in commercial and military applications and NASA has used it for ground-to-space voice communications. The Pro is an upgraded version of Faxscan's model BP-3 which has been marketed to the amateur-radio community worldwide for the past three years.

The Pro adds several features not found in the BP-3. Most notable is the inclusion of a sophisticated digitally-programmable timer. The user may select timing periods from approximately 43 seconds to 10.5 minutes. Programming is accomplished by setting tiny DIP switches on the circuit board. The timer may be used as an ID timer or to warn you of impending time-out on

a repeater. Time-out is noted by a unique double 4-beep sequence via a piezoelectric transducer; there is no speaker. Volume of this warning is also programmable and the warning is not transmitted.

Unlike the earlier BP-3, the beginning beep can be deleted by the setting of a switch. In this mode, a beep is added only to the end of your transmission.

Finally, The Pro incorporates a "slumber mode" to extend battery life. There is no on/off switch. Instead, the unit senses the lack of activity and shuts itself down. A single 9-V battery (not supplied) powers the unit continuously for up to a full year.

Faxscan includes a 5-page manual with The Pro, detailing theory of operation, instructions for programming the various functions, and a full-page schematic/layout along with interfacing tips. In general, The Pro will work with virtually all modern gear. Specifically, this beeper will interface directly to any rig employing a positive potential on the PTT line of less than +24 V dc and which transmits when the PTT line is pulled down to +0.7 V dc at less than 100 mA current.

The beeper comes in three versions. The A version includes a cast-aluminum enclosure, cable, and standard 4-pin mike connectors, installed. The B version is the same but without connectors. You simply add those of your choice. The C version is a circuit-board model for custom installation. For instance, the C version can be

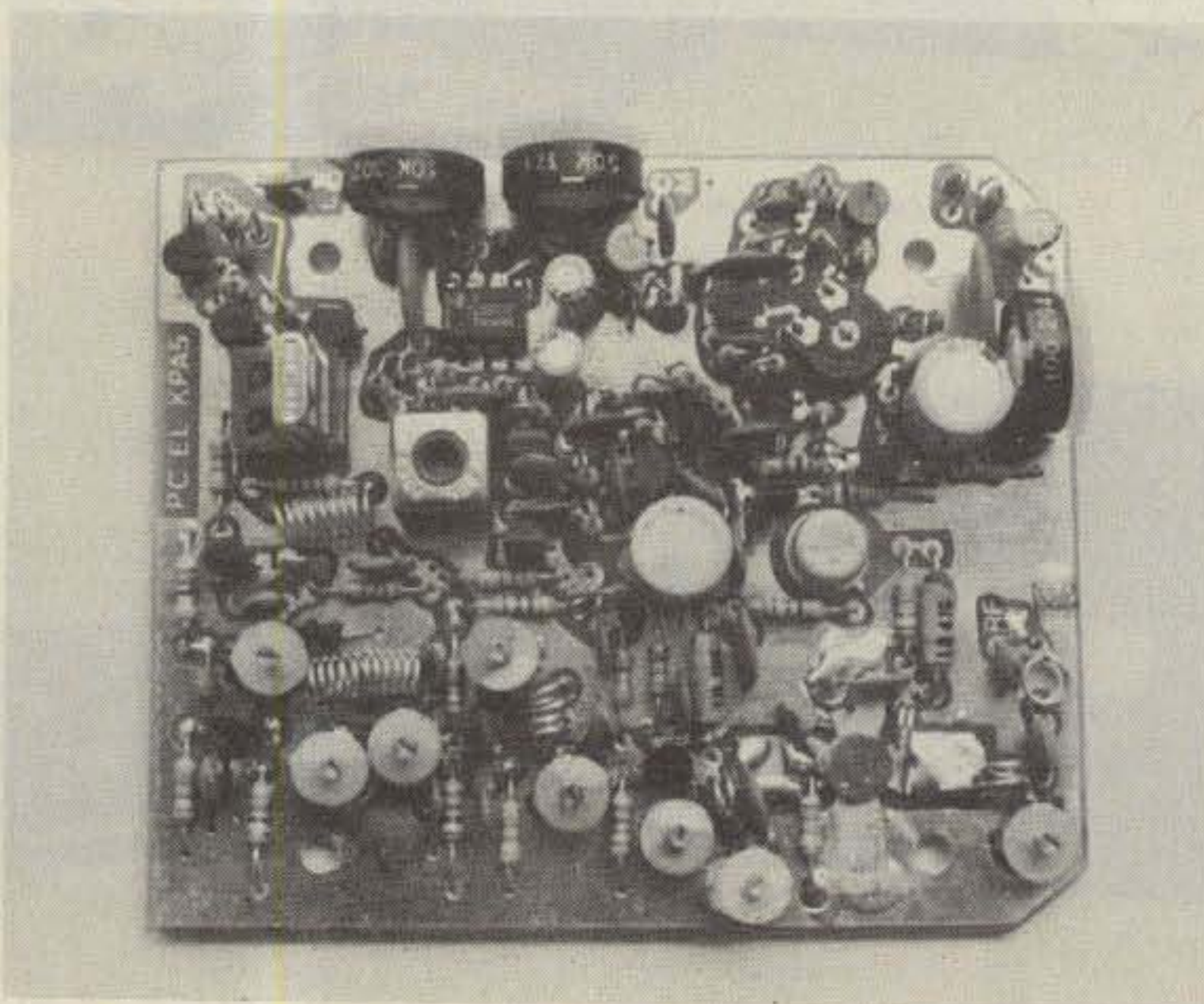

The P. C. Electronics portable ATV transmitter.

tucked inside your rig or is a perfect repeater accessory. The Pro is easily modified for most any application and the manual contains full details.

All units are fully assembled, tested, and carry a 90-day limited warranty. Faxscan ships all units postage-paid in the US.

For more information, contact *Faxscan, Inc.*, 3148 Dorf Drive, Dayton OH 45418; (513)-263-8475. Reader Service number 484.

### THE NEW HUSTLER TRIBAND VERTICAL

Hustler, Incorporated, has announced the addition of a new three-band vertical antenna for 10-, 15-, and 20-meter operation. A two-in-one trap design allows for excellent bandwidth while maintaining an overall height of only 12 feet.

Designated 3-BTV, the antenna is designed for permanent ground mounting with radials or for portable use on travel trailers, condo balcony railings, or wherever there is a sufficient groundplane. Construction is of high-quality aluminum with stainless-steel hardware; supplied is a heavy-duty bracket for pipe or bulkhead mounting.

For additional information on the 3-BTV or other Hustler amateur products, contact your dealer or write *Hustler, Inc.*, 3275 North B Avenue, Kissimmee FL 32741.

### KREEPIE-PEEPIE FOR AMATEUR TV

You may want to call it a handie-lookie rather than a kreepie-peepee, which was what the first cordless TV cameras were called. P. C. Electronics has come out with the KPA5, a 1-Watt UHF ATV-transmitter module board which will allow you to use any portable consumer color-TV camera.

When mounted in an aluminum box above a portable color camera, the KPA5 allows freedom to move around to catch all the action at parades, races, and other such events. If you are into videotaping you won't have to lug around a portable VCR. In fact, a standard ac-powered home VCR can be used with just an ATV down-converter ahead of the tuner set to channel 3.

DX depends a lot on antennas, terrain, etc., but up to a mile is typical under most conditions and 50 miles has been done from an airplane. For base-station use or higher-power mobile, it can be matched to the Mirage D24N amplifier for 40 Watts output. Other applications include video from R/C model airplanes, robots, computer video, weather-radar video, or practically any case where cables become too long for composite video from any source.

The KPA5 is a wired and tested board capable of full color and sound. Output is a nominal 1-Watt PEP of amplitude-modulated rf with standard 4.5-MHz sound sub-carrier into 50 Ohms. It comes standard with one crystal on either 439.25 (east), 434.0 (west), or 426.25 MHz. Two channels are available with the addition of a second crystal and an external SPST switch. Inputs are: composite video from a camera, VCR, or computer, low-Z microphone, and line audio from a VCR, camera mike, or computer. Power requirement is 13.8 V dc at 280 mA. Board size is 4 x 3.25 inches.

Buyers must hold Technician-class or higher amateur licenses to operate or purchase from the manufacturer.

For more information or a complete catalog of ATV products, call or write *P. C. Electronics*, 2522 Paxson Lane, Arcadia CA 91006; (213)-447-4565.

# AWARDS

Bill Gosney KE7C  
Micro-80, Inc.  
2665 North Busby Road  
Oak Harbor WA 98277

## WORKED ALL LA AWARD

The WALA Award is available to any amateur who can provide evidence of having the following requirements of the award:

Applicants in Denmark, Finland, Sweden, and Norway must have two contacts on separate bands with a total of 20 countries of Norway.

Applicants outside Scandinavia must work 20 different LA/LB stations on any amateur band. At least 6 of these stations must be located north of the Arctic Circle. Contacts with stations from JW (Svalbard), JW (Bear Island), and JX (Jan Mayen) count for this award.

All contacts must be made after January 1, 1950. Usual logbook information is required for claiming your contacts, along with the exact QTH of the station worked. Award fee is Nkr. 10, or 10 IRCs mailed to: NRRL Award Manager, Alf Almedal LA5QK, N-4052 Roeyneberg, Norway.

## WORKED NORWEGIAN CITIES AWARD

This award requires applicants to work a minimum of Norwegian cities with no limit to date, band, or mode. It should be noted that this award will not recognize contacts with LJ, LF, or LH stations. The three classes are: Class 3—DX station work 5 cities, Europeans must work 10 cities; Class 2—DX station work 10 cities, Europeans must work 20 cities; Class 1—DX station work 15 cities, Europeans work 30 cities.

GCR apply. Send your completed list of contacts and application along with the award fee of 10 IRCs to: Larvik Society of NRRL, PO Box 59, N-3251 Larvik, Norway.

Valid Norwegian cities are: Alesund, Arendal, Bergen, Bodo, Drammen, Egersund, Fredrikstad, Gjøvik, Halden, Hamar, Hammerfest, Harstad, Haugesund, Horten, Kongsberg, Kragero, Kristiansand S., Kristiansund N., Larvik, Lillehammer, Mandal, Mo i Rana, Molde, Mosjøen, Moss, Namsos, Narvik, Notodden, Oslo, Porsgrunn, Sandefjord, Sandnes, Sarpsborg, Skien, Stavanger, Steinkjer, Tonsberg, Tromsø, Trondheim, Vardo.

From the Vadso Society of the Norwegian Radio Relay League come details about the worked all "communes" award for this Scandinavian country.

## WORKED ALL NORWEGIAN COMMUNES AWARD

Licensed amateurs and SWLs worldwide are encouraged to pursue the requirements of this very challenging awards program. This award is issued for contact with 25 different Norwegian communes; an endorsement sticker recognizes each additional group of 25 communes. At present there are over 454 communes and 5 Norwegian arctic/antarctic areas which qualify for contacts. A special award will be issued to those who can work all communes and all arctic/antarctic areas. Only contacts on or after January 1, 1975, will count for WANCA.

All bands or modes may be used; no crossmode contacts or contacts via repeater will be allowed for credit. QSOs via OSCAR satellites do count. Minimum reports in all cases must be RST 338 or RS 33. Mobile or portable contacts count, but QTH must be stated on the QSL card.

QSL cards are not required. GCR apply. Award fee is Nkr. 30 for the basic award (10 IRCs) and Nkr. 10 (3 IRCs) for endorsement stickers. No fee for handicapped amateurs/SWL stations.

A record book listing all Norwegian communes and areas is available from the Award Manager for 15 Nkr. (3 IRCs).

Certificates are issued for mixed mode, CW only, SSB only, all RTTY, all SSTV, Novice, mobility (only contacts with mobile or portables), and All WANCA.

All fees are contributed to the LA5LG Fund for Norwegian Blind-Handicapped Amateurs. All inquiries should be accompanied with at least 2 IRCs for an expected reply.

All applications should be forwarded with the appropriate fee to: WANCA Award Manager, Sverre J. Schmidt LA1QK, PO Box 3, N-9801 Vadso, Norway.

## DX AWARDS FROM NEW ZEALAND

I just received a very informative packet of information from NZART, the national amateur society of New Zealand. Jock White ZL2GX, as awards manager, indicates that all NZART awards are available for a nominal fee and QSL cards are not required where verified lists can be provided as an alternative. To qualify, all contacts claimed for NZART awards must be made on or after November 1, 1945. Special endorsements are given for single-band or -mode accomplishments. Send all applications to ZL2GX, 152 Lytton Rd., Gisborne, New Zealand.

### Worked All Pacific Award

To qualify for the WAP Award, an applicant must confirm two-way contacts with 30 different Oceanic countries from the WAP list below. The cost of this award is 2 IRCs or US \$60.

Eligible Oceanic contacts: Port Timor, Philippines, Adelie Land, New Caledonia, French Oceania, Wallis Island, New Hebrides Baker/Howland/American Phoenix Islands, East Carolines, West Carolines, Mariana Islands, Marcus Island (Minami Torishima), Guam, Hawaiian Islands, Johnston Island, Midway Island, Palmyra, American Samoa, Wake Island, Marshall Island, Java, Sumatra, Borneo, Celebes, West Irian, Australia, Lord Howe Island, Willis Island, Macquarie Island, New Guinea, Norfolk Island, Papua, Nauru, Christmas, Cocos, Gilbert, Ellice, British Phoenix Islands, Fiji, Fanning and Washington Islands, Solomon Island, Tonga, Pitcairn, Sarawak, Brunei, North Borneo, North Cook Islands, South Cook Islands, Samoa, Tokelau Islands, Kermadec Islands, Niue Island, New Zealand, Chatham Island, Auckland and Campbell Island, Antarctica (ZL5 only).

### New Zealand Award

The NZA is available to all radio amateurs other than ZL. A total of 101 contacts is required to qualify for this award. All contacts must be made after December 8, 1945.

Applicants must make the following contacts: 35 ZL1 contacts, 35 ZL2 contacts, 20 ZL3 contacts, and 10 ZL4 contacts, plus 1 contact with a ZL "territory" (either New Zealand, Antarctica, Chatham Island, or Campbell Island). This one contact may be substituted by 20 additional ZL contacts not already claimed.

### Worked All New Zealand Award

The WAZL Award requires that contact be made with 45 different branches of NZART—except for overseas applicants, for whom only 35 contacts are required.

A special endorsement is given if the WAZL Award is accomplished within a 12-month period. Mobiles operating outside their regular branch area must sign the branch from which they are mobile while operating. Endorsements are also given for single-band or -mode operations. All contacts must be made after November 1, 1945, to qualify.

NZART branches are as follows: 01 Ashburton, 02 Auckland, 03 Western Suburbs, 04 Cambridge, 05 Christchurch, 06 Dannevirke, 07 Blank, 08 East Southland, 09 Egmont, 10 Franklin, 11 Gisborne, 12 Hamilton, 13 Hastings, 14 Hawera, 15 Hawke's Bay Central, 16 Horowhenua, 17 Huntly, 18 Hutt Valley, 19 Inglewood, 20 Manawatu, 21 Manukau, 22 Marlborough, 23 Marton, 24 Motueka, 25 Napier, 26 Nelson, 27 New Plymouth, 28 Northland, 29 North Shore, 30 Otago, 31 Pahiatua, 32 Rahunu Coastal, 33 Rotorua, 34 South Canterbury, 35 South Otago, 36 South Westland, 37 Southland, 38 Taumarunui, 39 Tauranga, 40 Te Awamutu, 41 Thames Valley, 42 Titihi Bay, 43 Waihi, 44 Matamata Radio Club, 45 Waimarino, 46 Wairarapa, 47 Waitara, 48 Wanganui, 49 Westland, 50 Wellington, 51 Eastern Bay of Plenty, 52 Wairoa, 53 Te Puke, 54 Patea, 55 Waitomo, 56 Hornby, 57 Tokoroa, 58 Helenville, 59 Mangakino, 60 Taupo, 61 Central Otago, 62 Reefton Buller, 63 Upper Hutt, 64 North Otago, 65 Papakura, 66 Auckland VHF, 67 Kawerau, 68 North Canterbury, 69 Kapiti, 70 Fielding, 71 Rodney, 72 Opatiki, 73 Hobson, 74 Western VHF.

### New Zealand Counties Award

The Basic NZC Award requires contacts with 20 different New Zealand counties. Endorsements are made for 40, 60, 80, and 100 contacts, with a special certificate for 112. A map showing the counties is available by writing NZART (ZL2GX) directly. Enclose 10 cents or 1 IRC to cover handling.

The initial award with any or all endorsements costs 45 cents or 3 IRCs. Separate endorsements thereafter cost 10 cents or 1 IRC. The special NZC 112 Award costs 45 cents.

Contacts may be made single band or any mode to qualify. GCR apply. Applicants must provide a list of contacts detailing the usual logbook data.

### 5 x 5 Award

This premier award has been instituted to recognize the increasing interest in 5-band DX operation. The initial award requires that the same station be contacted on 5 bands repeated with 5 different countries.

A certified list with full QSO data and fee of \$1.00 is required. The certificate is outstanding and is overprinted in embossed gold. Contacts must date from 1945.

### ZLA Award

To qualify for this award, applicants must contact Auckland City ZL1, Wellington City ZL2, Christchurch City ZL3, Dunedin City ZL4, Antarctica ZL5, Campbell Island, Chatham Island, and Kermadec Is-

land. There are endorsements given for single band or mode.

Award fee is 45 cents or 3 IRCs. GCR apply.

### Individual ZL District Awards

All ZL district awards are 35 cents each or 3 IRCs. Later endorsements are accessed at 10 cents or 1 IRC apiece. All contacts must be dated post war.

ZL1 Award—Contact 125 different ZL1 stations. Endorsements are recognized for 175 and 250 contacts.

ZL2 Award—Basic award requires contact with 100 different ZL2 stations, with endorsements given for 150 and 200.

ZL3 Award—Basic award requires 50 ZL3 contacts, and endorsements are given applicants claiming 75 and 100.

ZL4 Award—This award requires only 25 ZL4s be worked, with endorsements given for 35 and 50.

### Captain James Cook Award

The CJC award, as it is called, perpetuates the memory of this world famous navigator and seaman—in three classes. 1. The basic "Sailor" class requires contacts with G in Yorkshire, FO8, ZL2, VK2, and KH6. 2. For "Officer" class, applicant must first possess all the Sailor-class contacts plus ZL1, ZL3, ZL4, VK3, VK4, VK9 New Guinea, and any Antarctica station. 3. For "Command" class, both the previous classes must be earned plus five of the following: VE2, VO, A35, YJ8, FK8, CE0, and KL7.

Cost of this award is 45 cents in stamps or IRCs. GCR apply.

### YL ZL Award

The Women Amateur Radio Operator Award (WARO) requires VK and ZL stations to work at least 12 members of the WARO. DX stations must work at least 5 members. All contacts must be made after June 1, 1969, and must include one each from ZL1, 2, 3, and ZL4.

Net contacts do not qualify. There are no band or mode limitations; however, all contacts must be made from the same QTH for all.

Unlike all the previous awards shown so far, send your list of contacts along with your QSL cards to the Award Custodian, Thelma Souper ZL2LO, 62 Kirk Street, Otaki, New Zealand.

There was no mention of an award fee, but to be safe and courteous, it is advisable to enclose at least an amount for sufficient postage to return your cards.

In the event you missed the address for all applicants for NZART awards, please forward your requests to Mr. Jock White ZL2GX, 152 Lytton Road, Gisborne, New Zealand. Be sure to tell Jock you heard about the NZART awards from 73 magazine.

## CANADIAN AWARDS FROM CARF

The Canadian Amateur Radio Federation (CARF), Inc., is pleased to announce the following radio-amateur awards available to operators worldwide.

### Canadaward

A colorful certificate will be issued to any amateur who confirms two-way contact with all Canadian provinces and territories. Awards will be issued for any band, six to 160 meters, and any mode via OSCAR satellite. Modes may be mixed, CW, SSB, RTTY, SSTV, or any other authorized emission.

All contacts must be made after July 1, 1977. To qualify, applicants must forward QSL cards with \$2.00 or 10 IRCs plus sufficient funds for the safe return of your

cards. CARF members need only submit sufficient funds for returning QSLs. Mail your fee, application, and QSLs to: Canadawards, PO Box 76752, Vancouver BC, Canada V5R 5S7.

List of Canadian provinces and territories which qualify for this award: VO1/VO2 Newfoundland and Labrador, VE1 Prince Edward Island, VE1 Nova Scotia, VE1 New Brunswick, VE2 Quebec, VE3 Ontario, VE4 Manitoba, VE5 Saskatchewan, VE6 Alberta, VE7 British Columbia, VE8 Yukon Territory, VE8 Northwest Territories. Note: VO1 or VO2 count as one required contact.

#### 5-Band Canadaward

A special plaque will be issued to any amateur who confirms two-way contact with all Canadian provinces and territories on each of five separate bands (12 cards per band for a total of 60 cards). All contacts must be made after July 1, 1977. Submit the 60 cards with \$10.00 or 70 IRCs plus sufficient postage for the safe return of your QSLs. Should you work 6 or 7 bands using the same Canadaward criteria, special endorsements will be provided upon proof of your claim. As with the basic Canadaward, forward your applications to PO Box 76752, Vancouver BC, Canada V5R 5S7.

#### NIAGARA FALLS

The Niagara Falls Radio Club, Inc., will operate a special-event station during the Festival of Lights, from Niagara Falls, New York, seventh wonder of the world. The Festival of Lights is one of New York's top ten winter attractions. The callsign will be W2QYV. Dates are November 26th through January 8th; time will be from 1500 UTC to 0300 UTC. All contacts will be in the General portion of 20, 40, and 80. To apply for this award, send QSL card and

\$2.00 donation, along with an SASE (8 1/2 by 11) with \$.55 postage for the color photograph award, to: Awards Manager, Angelo Zino WA2UJR, 16 Council St., Niagara Falls NY 14304.

#### CW GROUP OF RIO DE JANEIRO CWRJ AWARDS PROGRAM

Important Notes: LOG-GCR apply. 1. All awards CW only, 2-way, or SWL. All bands mixed unless otherwise noted. 2. A single CWRJ Operator Team Member may be used for more than one CWRJ award, but only if worked on other bands, or on a different date. 3. CWRJ Associate Membership is available to foreign amateurs, see: WAMAW Award, below. 4. Endorsement seal fee: none, send an SAE and 1 IRC for surface mail.

CWRJ Operator Team Members (Oct. 82): PY1s: AFA, AFG, AJK, ASI, BFZ, BGI, BMF, BOA, BQQ, BUG, BUL, BVY, CBW, CC, CCX, CCY, DCG, DEA, DFF, DGB, DIN, DJY, DN, DPG, DUB, DUH, DWM, EBK, EWN, FB, HQ, LG, MHQ, MKA, RJ, TCJ, UET, URQ, VB, VEC, VKA, VLR, VMV, VOY, WDS, WO.

#### CWRJ Award: CWRJ

CW only. Work 20 different PY1 stations including 5 members of the CWRJ Operator Team. Endorsements: 6, total. Each 5 new PY1 stations, including 1 new Operator Team Member.

Log: complete. Fee: 6 IRCs. Valid: after Dec. 16, 1980. Manager: PY1EWN, PO Box 621, 24000 Niteroi, RJ, Brazil.

#### Brazilian Stations Award: BSAW

Work 75 Brazilian stations including 10 Federation Units (states/territories) and 2 CWRJ Operator Team Members. CW only.

Each state/terr. has different prefix: PY1, PT2. Endorsements: 2. First: 50 additional Brazilian stations. Second: 25 additional Brazilian stations.

Log: call/date. Fee: 6 IRCs. Valid: after Jan. 1, 1982. Manager: PY1EWN, PO Box 621, 24000 Niteroi, RJ, Brazil.

#### Rio De Janeiro State Cities Award: RJCAW

Work 10 cities of Rio de Janeiro State (RJ)—PY1—including 2 CWRJ Operator Team Members. CW only. Endorsements: none (on initial application, any award will be endorsed QRP upon request and proof).

Log: call/date/cities. Fee: 6 IRCs. Valid: after Jan. 1, 1982. Manager: PY1DWM, PO Box 24039, 20522 Rio de Janeiro, RJ, Brazil.

#### Diploma Brasil Geografico: BGAW

Work 3 stations of each geographical region of Brazil. 15 total contacts, including 1 S.E. region CWRJ Operator Team Member. Endorsements: none (on initial application, any award will be endorsed QRP upon request and proof). CW only.

Geographic regions: Norte (NO-North): PP8, PT8, PU8, PV8, PW8, PY8. Nordeste (NE-Northeast): PP6, PP7, PR7, PR8, PS7, PS8, PT7, PY6, PY7. Sudeste (SE-Southeast): PP1, PY1, PY2, PY4. Sul (SU-South): PY3, PP5, PY5. Centro Oeste (CO-Midwest): PP2, PT2, PT9, PY9.

Log: call/date. Fee: 6 IRCs. Valid: after Jan. 1, 1982. Manager: PY1DFF, PO Box 1045, 24000 Niteroi, RJ, Brazil.

#### Worked CWRJ

##### Associate Members Award: WAMAW

CW only. Work 10 CWRJ Associate Members and/or CWRJ Operator Team Members. Endorsements: 2. First: 5 additional CWRJ Associate Members. Second: same.

Log: call/date. Fee: 6 IRCs. Valid: after Jan. 1, 1982. Manager: PY1EWN, PO Box 621, 24000 Niteroi, RJ, Brazil. Note: CWRJ Associate Membership is available to foreign amateurs with a profound interest in Brazilian CW Groups' activities, awards, etc. SASE to W5XW for details in English; PY1EWN in Portuguese; DJ3WM in German.

##### Brazil's Frontiers Award: BFAW

CW only. Work 5 countries which have frontiers (borders) with Brazil: (FY, PZ, 8R, YV, HK, OA, CP, ZP, LU, CX).

Log: call/date. Fee: 6 IRCs. Valid: after Jan. 1, 1982. Endorsements: none (on initial application, any award will be endorsed QRP upon request and proof). Manager: PY1DFF, PO Box 1045, 24000 Niteroi, RJ, Brazil.

##### CWRJ "YL" Flowers Award: YLAW

CW only. With the first letter of the suffix of the callsigns of stations worked in the 10-meter (28-MHz) band, spell the names of 5 (five) flowers (English or Portuguese names); stations worked must include 5 (five) YL operators. YL stations may be used to substitute letters in the names of flowers (as in poker: wild cards); YL contacts may be on any band. Contacts may be any country. Endorsements: none (on initial application, any award will be endorsed QRP upon request and proof).

Log: call (listed in order to form names of flowers)/YL info/date. Fee: 6 IRCs. Valid: after Jan. 1, 1982. Manager: PY1DWM, PO Box 24039, 20522 Rio de Janeiro, RJ, Brazil.

##### Worked CWRJ Awards: WRJA

CW only. Applicants must have the basic CWRJ Award plus 5 others from the

CWRJ Award Program. Endorsements: none (on initial application, any award will be endorsed QRP upon request and proof).

Log: numbers/names of awards. Fee: 6 IRCs. Manager: PY1DFF, PO Box 1045, Niteroi, RJ, Brazil.

#### GAITHERSBURG MD

The NBS-BRASS will operate K3AA November 3 through November 6, 1983, in observance of the dedication of the first active amateur-radio club station at the National Bureau of Standards. Multi-op activities on CW, phone, and RTTY will be near the low end of the 80- to 10-meter Novice- and General-class bands. Certificates can be obtained by sending an SASE to BRASS, c/o National Bureau of Standards, Mailroom, Washington DC 20234.

#### CHESAPEAKE APPRECIATION DAYS

The Anne Arundel Radio Club will operate W3VPR from Sandy Point State Park, near Annapolis, Maryland, as part of the annual Chesapeake Appreciation Days celebration, October 29 and 30, 1983. Operation will be from 1000 until 1600 EDT in the lower part of the General-class CW and phone bands, 40 and 20 meters, and CW in the 15-meter Novice band. Certificate via PO Box 604, Glen Burnie MD 21061.

#### SPECIAL-EVENT STATION WA2UEC

Rocky Point, New York: The Radio Central Amateur Radio Club will operate WA2UEC from the former RCA High-Frequency Radio Station, called "Radio Central," on Saturday, November 5, and Sunday, November 6, to commemorate the 62nd year of the station (now silent), part of the New York State Park. Operations for the 24-hour period will be on 2-160 meters, up 10 kHz from the edge of the General band, and on two meters on these frequencies: 146.52, and 144.550/145.150 repeat. Novice-band operation will be on 7.110 kHz.

A special QSL card showing a photo of the former station will be available. Send your QSL with a large SASE to Radio Central Amateur Radio Club, PO Box 680, Miller Place NY 11764, or QSL to the Callbook address.

#### MICHIGAN AMATEUR RADIO LADY OF THE YEAR

The recipient of the 1982 Michigan Amateur Radio Lady of the Year Award was Aileen Gagnon WA8DHB of Gladstone, Michigan.

Aileen has been a very active member of the amateur-radio community since she was first licensed in April of 1962. Her particular area of interest is public-service communications and she is highly involved in various aspects of the national traffic system. Aileen is an assistant section manager (for Michigan's upper peninsula), official relay station, net manager of the upper peninsula net, member of the TASYL, UPYL, MACS and MITN Michigan Nets, a net control for the MITN, and is active on the MATW (Michigan amateur traffic workshop). She also is very active in emergency communications and is net control for the upper peninsula ARES net as well as prime organizer for net activities during the SET.

Aileen has received two certificates of

### THE ONE STOP SOURCE SINCE 1959!!

**COAXIAL CABLE**  
RG-8/U (95% BRAID-FOAM)\$235/M'  
MICRO 8/U (95% BRAID-FOAM)115/M'  
RG-213/U (96% BRAID-POLY)270/M'  
RG-214/U (2-96% BRAIDS-POLY)495/M'

**ROTOR CABLE**  
8/C HAMLINE (2-18/6-22)\$150/M'  
8/C HAMLINE HD (2-16/6-18)\$340/M'

CALL COLLECT  
CALL FOR LARGE QUANTITY  
DISCOUNT

#### CONNECTORS

**UHF**  
PL-259 57¢ ea.  
UG-175/U OR 176/U .16¢  
PL-258 79¢

#### TYPE 'N'

UG-21/BU(MALE) \$2.35  
UG-27/CU(RIGHT ANGLE) \$4.45  
UG-57/BU(DOUBLE MALE) \$3.15  
UG-29/BU(DOUBLE FEMALE) \$3.15



**cz labs**

P.O. Box 95-55 Railroad Ave.  
Gamerville, New York 10923

### MICROWAVE COMPONENTS

25 MW EXCITER \$49.95  
45 MHZ SUBCARRIER \$19.95  
AM VIDEO MODULATOR \$19.95  
50 MW UP CONVERTER \$149.95

### GIZMO ELECTRONICS, INC.

P.O. BOX 1205  
PITTSBURG, KS 66762  
PH. 316-231-8171

Kansas residents 3% sales tax

merit from the ARRL and is a past president of her local radio club, the Delta County Amateur Radio Society, and a member of the local repeater association.

During her very rare spare moments, Aileen keeps a constantly updated card file of all the upper peninsula hams. This is used to print an annual UP ham directory.

Aileen is a busy housewife (hubby is Melvin), and she has a son, a daughter, two stepdaughters, a stepson, and six grandchildren. Also, Aileen and Mel have one of the truly outstanding vegetable gardens in Delta County.

The Michigan Amateur Radio Lady of

the Year Award is presented each year at the ARRL state convention in Muskegon, Michigan, by the section manager.

### WORKED ALL "QST" AWARD

If you like to collect awards, here is a new one for you. The Worked ALL "QST" Award, sponsored by the CRRL.

As most of you might already know, the "QST" suffix has been assigned to the CRRL in all Canadian call areas. VE\_QST calls are used by official bulletin stations across the country. These stations are ac-

tive during League contests and public-service events. They also provide regular bulletin services to local nets and on a nationwide basis to Canadian hams.

This Worked ALL "QST" Award is available in five categories: CW, phone, RTTY, mixed, and QRP, with four endorsements: VE0, VO2, VE8, and VY1.

To qualify, one must work all eight stations from VO1, VE1 through VE7. Once you have all eight "QST" QSL cards, you can send them to CRRL, Box 7009, Station E, London, Ontario, Canada N5Y 4J9, or di-

rectly to the award manager, John Gowron VE4ADS.

The licensees who control the use of "QST" calls and maintain logbooks for QSL purposes are: William Kremer VE7CSD (VE7QST), Bill Gillespie VE6ABC (VE6QST), William Munday VE5WM (VE5QST), Peter Guenther VE4PG (VE4QST), Dick Reiber VE3IBV (VE3QST), Don Welling VE1WF (VE1QST), and Clarence Mitchell VO1AW (VO1QST).

The four endorsement calls will be active from time to time. Watch these pages for announcements.

## LETTERS

### COMPU-KIDS

Just a note of appreciation regarding 73. I find it informative, timely, accurate, and comprehensive. I read your editorials with an open mind and feel you do have a progressive attitude. I don't always agree, however. For example: The young fellows I have Elmered had no difficulty with the code but really can't cope with the written. Part of the problem, of course, is the lack of study-habit training in our school systems. However, I agree that amateur growth is the primary necessity.

The VIC-20 code program in the August, 1983, issue is what prompted me to write. This is an excellent little program and it works. This approach should help lots of computer kids get started. I had my nephew type it in and after a few corrections (his mistakes) it ran nicely. I am going to rework it to run on my TI99/4A and will send it in if somebody doesn't beat me.

I, too, am an ex-submariner, Wayne. I served as a Torpedoman on the *Puffer*, *Moray*, *Boarfish*, and *S-12* (training). A great experience!

Well, I'd better get back to learning how to use my new word-processing program so that I can retire this turkey typewriter.

J. W. Guthrie KF6FC  
Carmel CA

*JW, the more I get involved with my college project, the more I understand how much change is needed in our schools. We need to stop thinking of them as public baby-sitting systems and start teaching 'em things again. I can't believe how much lower grade education has changed since I went to school fifty years ago.—Wayne.*

### CW CLUTTER

I have been following your editorials about the elimination of code requirements for a ham license. For over 25 years, I was involved in non-communication electronics. My work involved design, prototype construction, and supervision of technicians.

For over 50 years (since I was about 15), I have wanted to become a ham, but I have refused to clutter my mind with code just to pass some test. I have never had any interest in CW communication and once the test was passed I would never use the code again. As the result of my conviction, I have never had a license.

Keep trying, but I don't think we will live long enough to see the day when "Reason rules the day."

I like 73 very much and find the construction articles very good. Keep up the good work.

James C. Anderson  
Albuquerque NM

### BUY AMERICAN?

It is truly amazing the powers encompassed in the printed word. Your excellent reporting of the contents of Joe Vegh's (W5VSV) letter regarding his attitude about buying American was thought-provoking and meaningful. What a powerful statement was made when he stated he would "straighten screws, glue on decals, touch up paint, and complain like hell before buying foreign products." The only thing I ever did was "complain like hell" because it did not occur to me to do the other things mentioned. The domestic products I have purchased recently seem to need more than screws straightened or decals re-glued. Hell fire, I have some items total rebuilding cannot cure. When I raise hell with the manufacturer, all I get in return are nasty letters or excuses such as: "The union members do not do their job" or "American workers cannot do a dollar's worth of work for a dollar anymore; they have to have \$5.00 and two men to do one man's job." I wonder if Joe gets better results raising hell than I get.

I, too, suffered at the hands of our Nipponese friends in World War II. During their attack on Pearl Harbor, December 7, 1941, my ship (*U.S.S. Utah*) went down so fast many of my friends failed to swim to safety, so I, too, can see where Joe can conjure up ill will toward the Japanese. My father nearly had a stroke in 1974 when I drove up in a brand new Toyota. No amount of explaining could ever convince him my reasoning was sound. "But the car is built better than modern American cars," "But, Dad, my time can be better spent than straightening screws or re-gluing decals and touching up paint," "But, Dad, this car actually runs for days on end without benefit of a push or pull from outside sources."

All of this fell on deaf ears because my father did what Joe advocates: Buy no foreign products. . . unless you need them or want them. My father did not use Joe's disclaimer, however. He did not buy foreign! Not to his knowledge, anyway.

When I pointed out his clock radio was made in Taiwan, his color television was 96% Japanese made, his car radio (in his 100% American-made car) was a Japanese product, and several other items in his household were also foreign, his second near-stroke of the day was not long in coming.

After reading your editorial on the subject, my wife and I decided to re-evaluate our position and become 100% American in our daily purchases. After all, I used to give talks about "Americanism" at local high schools and service clubs. What a traitor! Talking about being loyal on one hand and then going out availing myself of foreign products. So we came up with ideas we think everyone should follow.

No more Italian sausage, French wine, German beer, Swedish meatballs, Russian vodka, caviar (unless the sturgeon checks out to be born and raised in American waters), Spanish rice, Hungarian goulash, French, Italian, and Vienna bread, Chinese noodles, borscht, Irish stew, Soul Food (didn't we import those people from Africa?), Danish rolls, Sukiyaki, Chinese egg rolls, Spanish omelets, spaghetti, Irish potatoes, and many, many other things. For a complete list, don't send me a letter. Just forget it. My wife and I are contemplating losing a lot of weight.

Then we got into wearing apparel. We came to the conclusion that naked is as naked does. There isn't much available that is not made in its entirety or assembled in foreign manufacturing plants. This is going to be tougher than we thought.

Our final conclusion was to buy clothes and food from the only true American extant, the American Indian. There is, however, a rumor that even these people sneaked into the United States via some land bridge between Russia and Alaska. Can anyone confirm or deny this? If this cannot be solved, we simply do not know what we are going to do for survival. By the way, can anyone inform me whether or not the Indians make automobiles and television sets? Radios? Lawn mowers? Computers? I know they make rugs and jewelry, but I don't think I would look good wearing a formal rug, jewelry, and nothing else.

Joe could have refrained from writing and you, Wayne, could have let well enough alone and not commented on it. As it now stands, we (my wife and I) can't find too much to eat, enough clothing, automobiles that don't break down the day after warranties expire, products that don't need screws straightened and decals glued back on, and worst of all—how about that ham I just heard calling CQ? He had a terrible accent and a foreign call! Do I dare invite him into our country by answering his call?

Wayne, you and Joe are troublemakers. Why didn't both of you just keep still so I could go on buying products on merit and

not because it was made here or there? All this time I thought I was a discerning purchaser picking and choosing that which worked best for me, and now you two come along and shatter my whole style of living. I'm thinking of giving up on 73 as I heard a rumor your stapling process for the magazine is of dubious parentage. Shucks!

Jim Obero WA9YV7  
Phoenix AZ

P.S. Was the 77 needed? I am confused now.—J.O.

### BOOTLEGGER!

For the past six months, we have been receiving QSL cards for contacts made with EL7M. All attempts on our part to pinpoint the location of this illegal operator have failed.

Please be advised that the callsign EL7M is not a legally issued callsign by the Ministry of Post and Telecommunications, Republic of Liberia. The user of this callsign is therefore a bootlegger.

It would be appreciated if all legally licensed ham operators would assist us in trying to identify this individual and pass the word around of this illegal operation.

Please note that all QSL cards received by the EL Bureau for contacts made with EL7M will be discarded.

H. Walcott Benjamin EL2BA, President  
Liberia Radio Amateur Association  
Monrovia, Liberia

*Sonofagun, you mean that two-meter contact with EL2M was a pirate? Damn!—Wayne.*

### TO THE HILT

The first thing I read when I get my 73 is your editorial and I always enjoy it to the hilt. If I ever have the chance to meet you face to face, I would like to shake your hand—I've always been an outspoken person myself.

As a new ham—a Novice at the age of 56—I got started late and sure wished I had known about amateur radio 30 years ago. I am now working with my wife and 14-year-old grandson on code.

Keep the good work up—we need more people like you to speak out.

Gene Smith KA6ZAH  
Oroville CA

*A pox on the hams of Oroville for managing to keep amateur radio a secret from you all those years. I sure hope you won't carry on in the Oroville tradition. Get out to the high school and get a ham club started, using your grandson as bait.—Wayne.*



4CX10.0000  
WITH  
SK300 & SK1306  
\$1200.00

EIMAC 4CX10,000D/8171 with SK300 and SK1306 \$1200.00  
SK300 and SK1306 Only. \$ 350.00  
(These are all new not used.) Limited Supply.

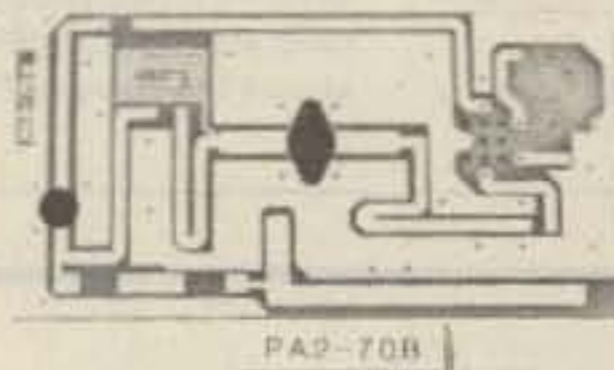
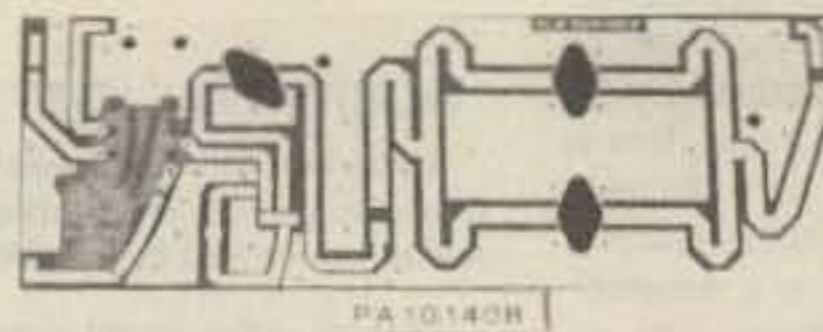

KLM ELECTRONICS, INC. VHF AMPLIFIER PC BOARDS AND RF TRANSISTOR KITS.  
Model PA2-70B RF power input 2watts at 144 to 148MHz output 70watts 13.5vdc at 10amps.  
\$49.99 with data PC Board Only \$14.99  
MODEL PA10140B RF power input 10watts at 144 to 148MHz output 140watts 13.5vdc at 18amps.  
\$89.99 with data PC Board Only \$19.99

**GENEVA CALCULATOR WATCH**

This attractive watch has the following modes:  
Normal Time Setting,  
Calendar Setting,  
Daily Alarm Time Setting,  
Weekly Alarm Time Setting,  
Chronograph,  
Calculator.

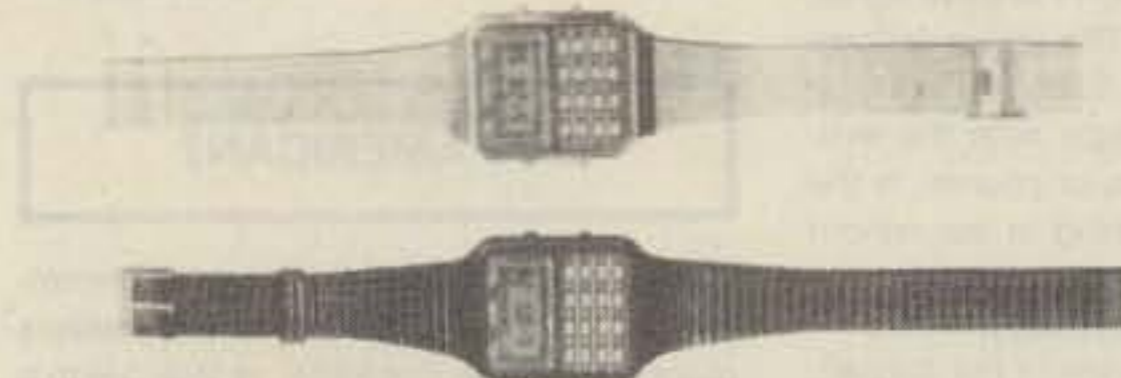

Featured in Black Plastic \$18.99 or Featured in Stainless Steel \$29.99

**SILICON DIODES**

MR751	100vdc	6Amps	10/\$5.00	100/\$38.00
MR510	1000vdc	3Amps	10/\$3.75	100/\$24.00
HEP170	1000vdc	2Amps	20/\$2.00	100/\$15.00
IN3209	100vdc	15Amps	\$2.00	10/ \$15.00
BYX21/200	200vdc	25Amps	\$2.00	10/ \$15.00
IN2138A	600vdc	60Amps	\$5.00	10/ \$40.00
DS85-04C	400vdc	80Amps	\$10.00	10/ \$80.00
IN3269	600vdc	160Amps	\$15.00	10/\$120.00
275241	300vdc	250Amps	\$20.00	10/\$175.00
7-5754	300vdc	400Amps	\$30.00	10/\$250.00
RCD-15	15KVDC	20ma.	\$3.00	10/ \$20.00
SMFR20K	20KVDC	20ma.	\$4.00	10/ \$30.00
IN4148	signal		30/\$1.00	100/ \$3.00

**FEED THRU SOLDER RF CAPACTORS**

470pf +20%
5/\$1.00 or 100/\$15.00 or 1000/\$100.00
1000pf/.001uf +-10%
4/\$1.00 or 100/\$20.00 or 1000/\$150.00

**E PROMS**

2708 1024x1	\$2.00 each
2716 2048x8	\$4.00 each
27L32/25L32	\$10.00 each

**FAIRCHILD 4116 16K DYNAMIC RAMS 200ns. Part # 16K75**

25 For \$25.00 or 100 For \$90.00 or 1000 For \$750.00

**HEWLETT PACKARD MICROWAVE DIODES**

IN5711	(5082-2800)	Schottky Barrier Diodes	\$1.00 or 10 for \$ 8.50
IN5712	(5082-2810)	" " "	\$1.50 or 10 for \$10.00
IN6263	(HSCH-1001)	" " "	\$.75 or 10 for \$ 5.00
5082-2835		" " "	\$1.50 or 10 for \$10.00
5082-2805	Quad Matched	" " "	per set \$5.00 or 10 for \$40.00

For information call: (602) 242-3037

Toll Free Number  
800-528-0180  
(For orders only)

**MHz electronics**

"All parts may be new or surplus, and parts may be substituted with comparable parts if we are out of stock of an item."

PRICES SUBJECT TO CHANGE WITHOUT NOTICE



# "MIXERS"

## WATKINS JOHNSON WJ-M6 Double Balanced Mixer

LO and RF 0.2 to 300MHz	IF DC to 300MHz	\$21.00
Conversion Loss (SSB)	6.5dB Max. 1 to 50MHz	
Noise Figure (SSB)	8.5dB Max. .2 to 300MHz	WITH DATA SHEET
Conversion Compression	same as above	
	8.5dB Max. 50 to 300MHz	
	.3dB Typ.	

## NEC (NIPPON ELECTRIC CO. LTD. NE57835/2SC2150 Microwave Transistor

NF Min F=2GHz	dB 2.4 Typ.	MAG F=2GHz	dB 12 Typ.	\$5.30
F=3GHz	dB 3.4 Typ.	F=3GHz	dB 9 Typ.	
F=4GHz	dB 4.3 Typ.	F=4GHz	dB 6.5 Typ.	

Ft Gain Bandwidth Product at Vce=8v, Ic=10ma. GHz 4 Min. 6 Typ.  
 Vcbo 25v Vceo 11v Vebo 3v Ic 50ma. Pt. 250mw

## UNELCO RF Power and Linear Amplifier Capacitors

These are the famous capacitors used by all the RF Power and Linear Amplifier manufacturers, and described in the RF Data Book.

5pf	10pf	18pf	30pf	43pf	100pf	200pf	1 to 10pcs.	\$1.00 ea
5.1pf	12pf	22pf	32pf	51pf	110pf	220pf	11 to 50pcs.	\$ .90 ea
6.8pf	13pf	25pf	33pf	60pf	120pf	470pf	51 up	pcs. \$ .80 ea
7pf	14pf	27pf	34pf	80pf	130pf	500pf		
8.2pf	15pf	27.5pf	40pf	82pf	140pf	1000pf		

## NIPPON ELECTRIC COMPANY TUNNEL DIODES

Peak Pt. Current ma.	Ip	MODEL 1S2199	1S2200	\$7.50
Valley Pt. Current ma.	Iv	9min. 10Typ. 11max.	9min. 10Typ. 11max.	
Peak Pt. Voltage mv.	Vp	1.2Typ. 1.5max.	1.2Typ. 1.5max.	
Projected Peak Pt. Voltage mv.	Vpp Vf=Ip	95Typ. 120max.	75Typ. 90max.	
Series Res. Ohms	rS	480min. 550Typ. 630max.	440min. 520Typ. 600max.	
Terminal Cap. pf.	Ct	2.5Typ. 4max.	2Typ. 3max.	
Valley Pt. Voltage mv.	VV	1.7Typ. 2max.	5Typ. 8max.	
		370Typ.	350Typ.	

## FAIRCHILD / DUMONT Oscilloscope Probes Model 4290B

Input Impedance 10 meg., Input Capacity 6.5 to 12pf., Division Ratio (Volts/Div Factor) 10:1, Cable Length 4Ft., Frequency Range Over 100MHz.

These Probes will work on all Tektronix, Hewlett Packard, and other Oscilloscopes.

PRICE \$45.00

## MOTOROLA RF DATA BOOK

Lists all Motorola RF Transistors / RF Power Amplifiers, Varactor Diodes and much much more.

PRICE \$7.50

For information call: (602) 242-3037

**Toll Free Number**  
**800-528-0180**  
**(For orders only)**

# MHz electronics

"All parts may be new or surplus, and parts may be substituted with comparable parts if we are out of stock of an item."

PRICES SUBJECT TO CHANGE WITHOUT NOTICE

# RF TRANSISTORS, MICROWAVE DIODES

PART	PRICE	PART	PRICE	PART	PRICE
1S2199	\$ 7.50	2N6083	\$ 13.25	CA2612 (TRW)	\$ 25.00
1S2200	7.50	2N6084	15.00	CA2674 (TRW)	25.00
2N1561	25.00	2N6094 /M9622	11.00	CA2881-1 (TRW)	25.00
2N1562	25.00	2N6095 /M9623	12.00	CA4101 (TRW)	25.00
2N2857	1.55	2N6096 /M9624	15.50	CA4201 (TRW)	25.00
2N2857JAN	2.55	2N6097	17.25	CA4600 (TRW)	25.00
2N2876	11.00	2N6136	21.85	CD1889	20.00
2N2947	18.35	2N6166	40.25	CD2545	20.00
2N2948	15.50	2N6201	50.00	CMD514AB	20.00
2N2949	3.90	2N6459	18.00	D4959	10.00
2N2950	4.60	2N6603	12.00	D4987M	20.00
2N3375	8.00	2N6680	80.00	D5147D	10.00
2N3553	1.57	2SC756A	7.50	D5506	10.00
2N3632	13.80	2SC781	2.80	D5827AM	20.00
2N3818	5.00	2SC1018	1.00	DMD6022	30.00
2N3866	1.30	2SC1042	12.00	DMS-2A-250	40.00
2N3924	3.35	2SC1070	2.50	HEP76	4.95
2N3927	17.75	2SC1239	2.50	HEPS3002	11.30
2N3950	25.00	2SC1251	12.00	HEPS3003	30.00
2N4072	1.80	2SC1306	2.90	HEPS3005	10.00
2N4127	21.00	2SC1307	5.50	HEPS3006	19.90
2N4427	1.30	2SC1760	1.50	HEPS3007	25.00
2N4428	1.85	2SC1970	2.50	HEPS3010	11.34
2N4957	3.45	2SC2166	5.50	HTEF2204 H.P.	112.00
2N4958	2.90	8B1087 (M.A.)	25.00	5082-0112 H.P.	14.20
2N4959	2.30	A50-12	20.00	5082-0253 H.P.	105.00
2N5090	13.90	A283B	5.00	5082-0320 H.P.	58.00
2N5108	4.00	ALD4200N (AVANTEK)	395.00	5082-0386 H.P.	POR
2N5109	1.70	AM123	97.35	5082-0401 H.P.	POR
2N5160	3.45	AM688	100.00	5082-0438 H.P.	POR
2N5177	21.62	BB105B	.52	5082-1028 H.P.	POR
2N5179	1.00	BD4/4JFBD4 (G.E.)	10.00	5082-2711 H.P.	23.15
2N5583	4.00	BFQ85	1.50	5082-3080 H.P.	2.00
2N5589	8.65	BFR90	1.30	5082-3188 H.P.	1.00
2N5590	10.35	BFR91	1.65	5082-6459 H.P.	POR
2N5591	13.80	BFW92	1.50	5082-8323 H.P.	POR
2N5635	10.95	BFX89	1.00	35826E H.P.	POR
2N5637	15.50	BFY90	1.00	35831E H.P.	29.99
2N5641	9.20	BGY54	25.00	35853E H.P.	71.50
2N5642	10.95	BGY55	25.00	35854E H.P.	75.00
2N5643	15.50	BGY74	25.00	HPA0241 H.P.	75.60
2N5645	13.80	BGY75	25.00	HXTR3101 H.P.	7.00
2N5646	20.70	BL161	10.00	HXTR3102 H.P.	8.75
2N5691	18.00	BLX67	11.00	HXTR6101/2N6617 H.P.	55.00
2N5764	27.00	BLY568CF	25.00	HXTR6104 H.P.	68.00
2N5836	5.45	BLY87	13.00	HXTR6105 H.P.	31.00
2N5842	8.00	BLY88	14.00	HXTR6106 H.P.	33.00
2N5849	20.00	BLY89	15.00	QSCH1995 H.P.	POR
2N5913	3.25	BLY90	20.00	JO2000 TRW	10.00
2N5922	10.00	BLY351	10.00	JO2001 TRW	25.00
2N5923	25.00	C4005	20.00	JO4045 TRW	25.00
2N5941	23.00	CA402 (TRW)	25.00	K3A	10.00
2N5942	40.00	CA405 (TRW)	25.00	MA450A	10.00
2N5944	9.20	CA612B (TRW)	25.00	MA41487	POR
2N5945	11.50	CA2100 (TRW)	25.00	MA41765	POR
2N5946	19.00	CA2113 (TRW)	25.00	MA43589	POR
2N6080	9.20	CA2200 (TRW)	25.00	MA43636	POR
2N6081	10.35	CA2213 (TRW)	25.00	MA47044	POR
2N6082	11.50	CA2418 (TRW)	25.00	MA47651	25.50

**Toll Free Number**  
**800-528-0180**  
**(For orders only)**

"All parts may be new or surplus, and parts may be substituted with comparable parts if we are out of stock of an item."

For information call: (602) 242-3037

PRICES SUBJECT TO CHANGE WITHOUT NOTICE

**MHz electronics**

# GaAs, TUNNEL DIODES, ETC.

PART	PRICE	PART	PRICE	PART	PRICE
MA47100	\$ 3.05	MRF503	\$ 6.00	PT4186B	\$ POR
MA47202	30.80	MRF504	7.00	PT4209	POR
MA47771	POR	MRF509	5.00	PT4209C	POR
MA47852	POR	MRF511	8.65	PT4566	POR
MA49558	POR	MRF605	20.00	PT4570	POR
MB4021	POR	MRF629	3.47	PT4571	POR
MBD101	1.00	MRF644	23.00	PT4571A	POR
MDO513	POR	MRF816	15.00	PT4577	POR
MHW1171	42.50	MRF823	20.00	PT4590	POR
MHW1182	48.60	MRF901	3.00	PT4612	POR
MHW4171	49.35	MRF8004	2.10	PT4628	POR
MHW4172	51.90	MS261F	POR	PT4640	POR
MHW4342	68.75	MT4150 Fair.	POR	PT4642	POR
MLP102	25.00	MT5126 Fair.	POR	PT5632	POR
MM1500	32.32	MT5481 Fair.	POR	PT5749	POR
MM1550	POR	MT5482 Fair.	POR	PT6612	POR
MM1552	50.00	MT5483 Fair.	POR	PT6626	POR
MM1553	50.00	MT5596 Fair.	POR	PT6709	POR
MM1614	10.00	MT5764 Fair.	POR	PT6720	POR
MM2608	5.00	MT8762 Fair.	POR	PT8510	POR
MM3375A	11.50	MV109	.77	PT8524	POR
MM4429	10.00	MV1401	8.75	PT8609	POR
MM8000	1.15	MV1624	1.42	PT8633	POR
MM8006	2.30	MV1805	15.00	PT8639	POR
MO277L	POR	MV1808	10.00	PT8659	POR
MO283L	POR	MV1817B	10.00	PT8679	POR
MO3757	POR	MV1863B	10.00	PT8708	POR
MP102	POR	MV1864A	10.00	PT8709	POR
MPN3202	10.00	MV1864B	10.00	PT8727	POR
MPN3401	.52	MV1864D	10.00	PT8731	POR
MPN3412	1.00	MV1868D	10.00	PT8742	POR
MPSU31	1.01	MV2101	.90	PT8787	POR
MRA2023-1.5 TRW	42.50	MV2111	.90	PT9790	41.70
MRF212/208	16.10	MV2115	1.55	PT31962	POR
MRF223	13.25	MV2201	.53	PT31963	POR
MRF224	15.50	MV2203	.53	PT31983	POR
MRF237	3.15	MV2209	2.00	PTX6680	POR
MRF238	12.65	MV2215	2.00	RAY-3	24.99
MRF243	25.00	MWA110	7.45	40081	POR
MRF245	34.50	MWA120	7.80	40281	POR
MRF247	34.50	MWA130	8.25	40282	POR
MRF304	43.45	MWA210	7.80	40290	POR
MRF315	23.00	MWA220	8.25	RF110	25.00
MRF420	20.00	MWA230	8.65	SCA3522	POR
MRF421	36.80	MWA310	8.25	SCA3523	POR
MRF422	41.40	MWA320	8.65	SD1065	POR
MRF427	16.10	MWA330	9.50	SS43	POR
MRF428	46.00	NEC57835	5.30	TP1014	POR
MRF450/A	13.80	ON382	5.00	TP1028	POR
MRF453/A	17.25	PPT515-20-3	POR	TRW-3	POR
MRF454/A	19.90	PRT8637	POR	UTO504 Avantek	70.00
MRF455/A	16.00	PSCQ2-160	POR	UTO511 Avantek	75.00
MRF458	19.90	PT3190	POR	V15	4.00
MRF463	25.00	PT3194	POR	V33B	4.00
MRF472	1.00	PT3195	POR	V100B	4.00
MRF475	2.90	PT3537	POR	VAB801EC	25.00
MRF477	11.50	PT4166E	POR	VAB804EC	25.00
MRF502	1.04	PT4176D	POR	VAS21AN20	25.00

For information call: (602) 242-3037

**Toll Free Number**  
**800-528-0180**  
**(For orders only)**

"All parts may be new or surplus, and parts may be substituted with comparable parts if we are out of stock of an item."

## MHz electronics

PRICES SUBJECT TO CHANGE WITHOUT NOTICE

COAXIAL RELAY SWITCHES SPDT

Electronic Specialty Co./Raven Electronics FSN 5985-556-9683 \$49.00  
 Part # 25N28 Part # SU-01  
 26Vdc Type N Connector, DC to 1 GHz.



Amphenol  
 Part # 316-10102-8  
 115Vac Type BNC DC to 3 GHz.

\$29.99

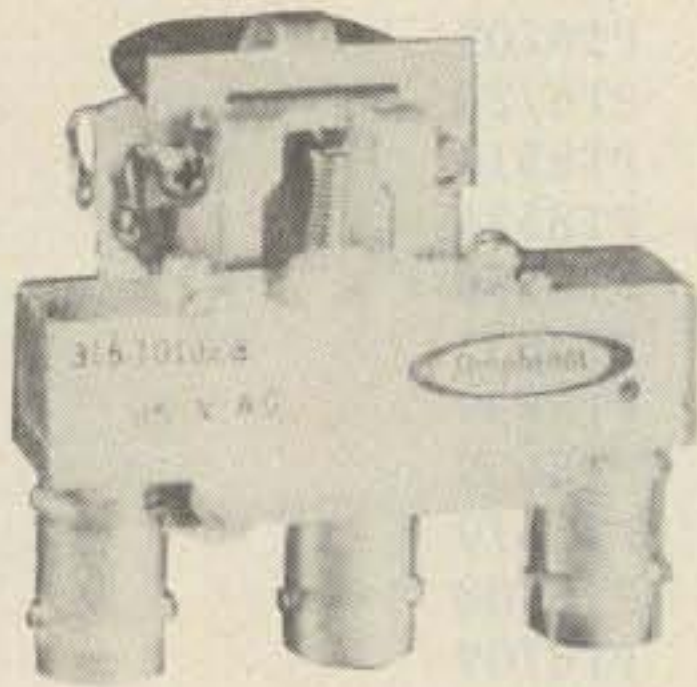

FXR  
 Part # 300-11182  
 120Vac Type BNC DC to 4 GHz.  
 FSN 5985-543-1225

\$39.99

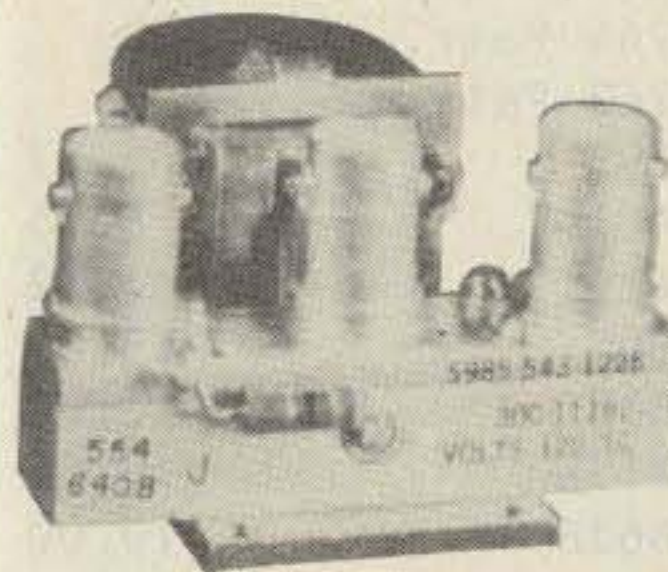

FXR  
 Part # 300-11173  
 120Vac Type BNC Same  
 FSN 5985-543-1850

\$39.99

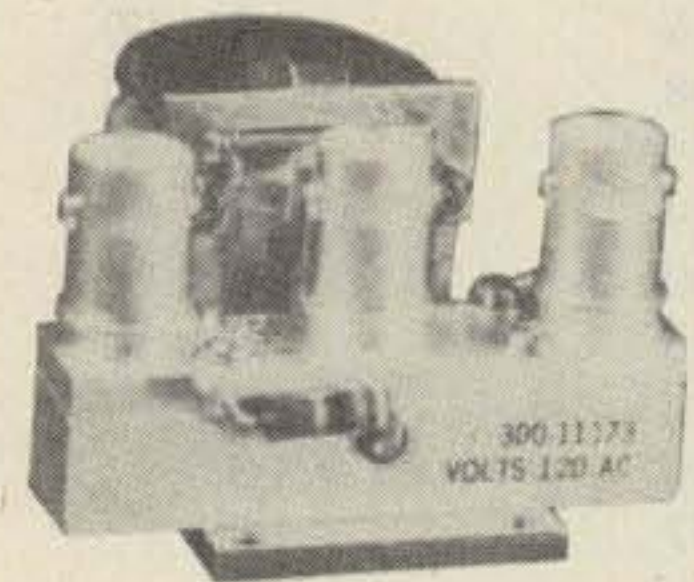

BNC To Banana Plug Coax Cable RG-58 36 inch or BNC to N Coax Cable RG-58 36 inch.

\$7.99 or 2 For \$13.99 or 10 For \$50.00

\$8.99 or 2 For \$15.99 or 10 For \$60.00

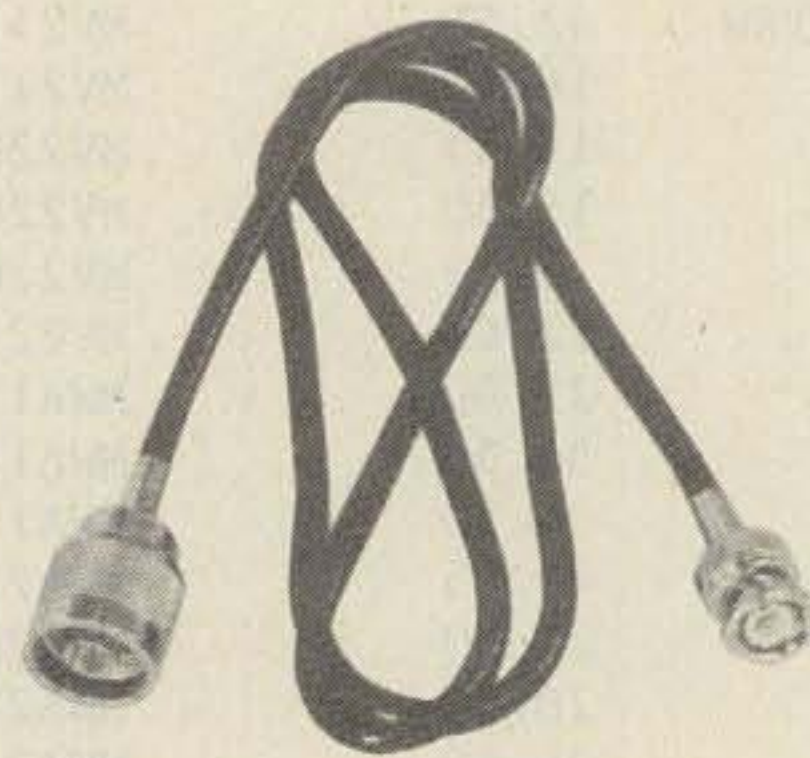
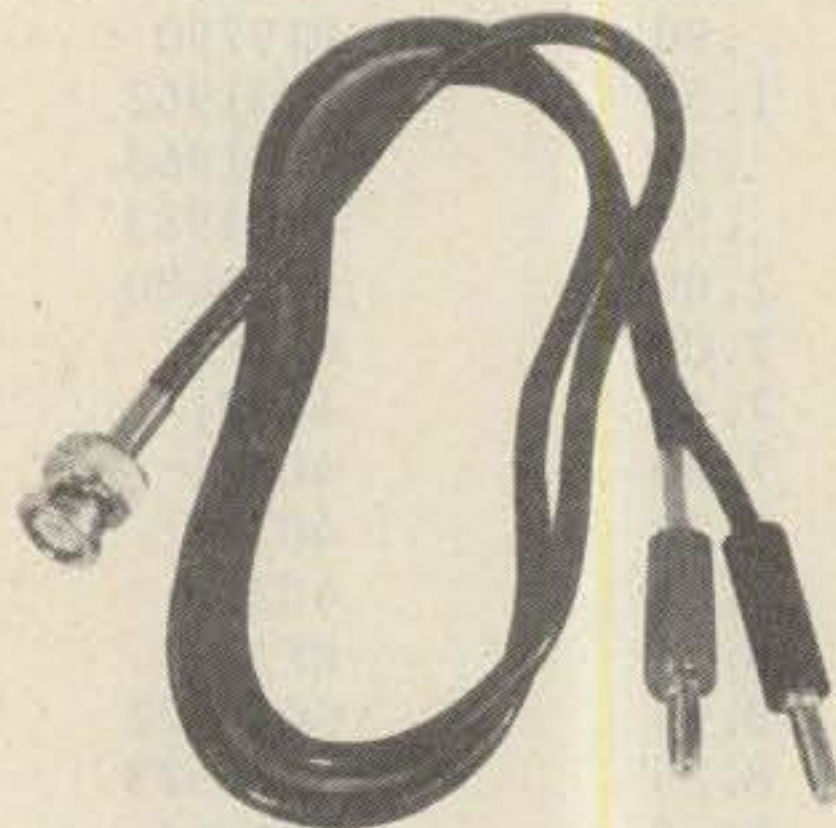

SOLID STATE RELAYS

P&B Model ECT1DB72  
 PRICE EACH \$5.00

5vdc turn on

120vac contact at 7amps or 20amps on a 10"x 10"x .124 aluminum. Heatsink with silicon grease.

Digisig, Inc. Model ECS-215  
 PRICE EACH \$7.50

5vdc turn on

240vac contact 14amps or 40amps on a 10"x 10"x .124 aluminum. Heatsink with silicon grease.

Grigsby/Barton Model GB7400  
 PRICE EACH \$7.50

5vdc turn on

240vac contact at 15amps or 40amps on a 10"x 10"x .124 aluminum. Heatsink with silicon grease.

NOTE: \*\*\* Items may be substituted with other brands or equivalent model numbers. \*\*\*

**MHz** electronics

"All parts may be new or surplus, and parts may be substituted with comparable parts if we are out of stock of an item."

For information call: (602) 242-3037

Toll Free Number  
 800-528-0180  
 (For orders only)

PRICES SUBJECT TO CHANGE WITHOUT NOTICE

RECALL PHONE MEMORY TELEPHONE WITH 24 NUMBER AUTO DIALER

The Recall Phone Telephone employs the latest state of art communications technology. It is a combination telephone and automatic dialer that uses premium-quality, solid-state circuitry to assure high-reliability performance in personal or business applications. \$49.99

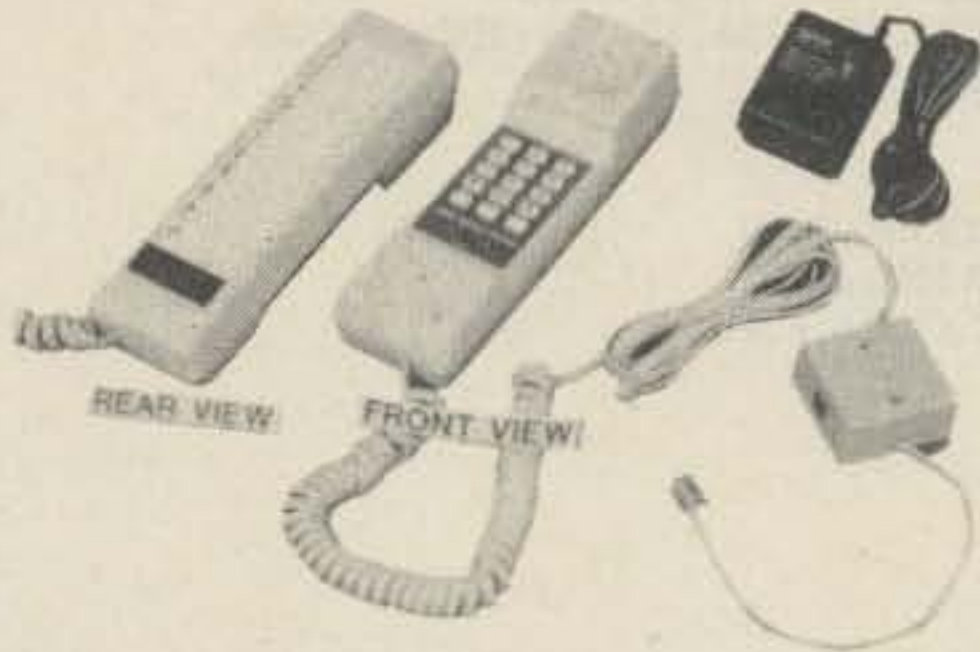

ARON ALPHA RAPID BONDING GLUE

Super Glue #CE-486 high strength rapid bonding adhesive. Alpha Cyanoacrylate. Set-Time 20 to 40 sec., 0.7fl.oz. (20gm.) \$2.00



TOUCH TONE PAD

This pad contains all the electronics to produce standard touch-tone tones. New with data.

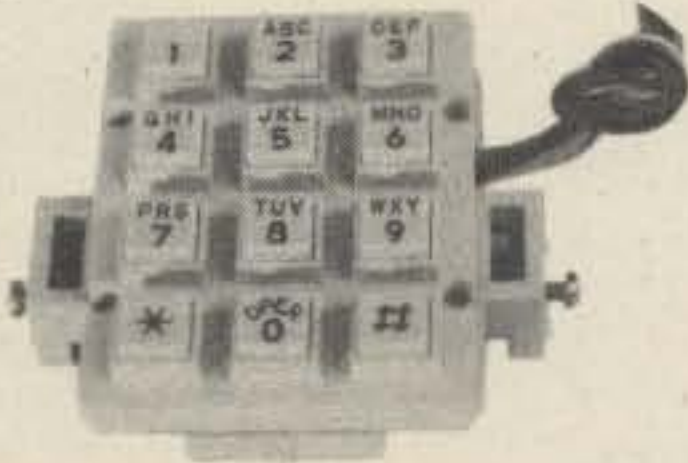

\$9.99 or 10/\$89.99

MITSUMI UHF/VHF VARACTOR TUNER MODEL UVE1A

Perfect for those unscrambler projects. New with data.



\$19.99 or 10/\$149.99

INTEGRATED CIRCUIT.

		1 to 10	11up
MC1372P	Color TV Video Modulator Circuit.	\$ 4.42	\$2.95
MC1358P	IF Amp., Limiter, FM Detector, Audio Driver, Electronic Attenuator.	5.00	4.00
MC1350P	IF Amplifier	1.50	1.25
MC1330A1P	Low Level Video Detector	1.50	1.15
MC1310P	FM Stereo Demodulator	4.29	3.30
MC1496P	Balanced Modulator/Demodulator	1.50	1.25
LM565N	Phase Locked Loop	2.50	2.00
LM380N14	2Watt Audio Power Amplifier	1.56	1.25
LM1889N	TV Video Modulator	5.00	4.00
NE564N	Phase Locked Loop	10.00	8.00
NE561N	Phase Locked Loop	10.00	8.00

FERRANTI ELECTRONICS AM RADIO RECEIVER MODEL ZN414 INTEGRATED CIRCUIT.

Features:

1.2 to 1.6 volt operating range., Less than 0.5ma current consumption. 150KHz to 3MHz Frequency range., Easy to assemble, no alignment necessary. Effective and variable AGC action., Will drive an earphone direct. Excellent audio quality., Typical power gain of 72dB., TO-18 package. With data. \$2.99 or 10 For \$24.99

NI CAD RECHARGEABLE BATTERIES

AA Battery Pack of 6 These are Factory New. \$5.00

SUB C Pack of 10 2.5Amp/Hr. \$10.00

Gates Rechargeable Battery Packs

12vdc at 2.5Amp/Hr. \$11.99  
12vdc at 5Amp/Hr. \$15.99



MOTOROLA MRF559 RF TRANSISTOR

hfe 30min 90typ 200max.  
ft 3000mhz  
gain 8db min 9.5typ at 870mhz  
13db typ at 512mhz  
output power .5watts at 12.5vdc  
at 870mhz.

\$2.05 or 10/\$15.00

For information call: (602) 242-3037

Toll Free Number  
800-528-0180  
(For orders only)

PRICES SUBJECT TO CHANGE WITHOUT NOTICE

**MHz electronics**

"All parts may be new or surplus, and parts may be substituted with comparable parts if we are out of stock of an item."

# "SOCKETS AND CHIMNEYS"

## EIMAC TUBE SOCKETS AND CHIMNEYS

Part Number	Description	Price
SK110	Socket	\$POR
SK300A	Socket For 4CX5000A,R,J, 4CX10,000D, 4CX15,000A,J	\$520.00
SK400	Socket For 4-125A,250A,400A,400C,4PR125A,400A,4-500A,5-500A	260.00
SK406	Chimney For 4-250A,400A,400C,4PR400A	74.00
SK416	Chimney For 3-400Z	36.00
SK500	Socket For 4-1000A/4PR1000A/B	390.00
SK600	Socket For 4CX250B,BC,FG,R,4CX350A,F,FJ	51.00
SK602	Socket For 4CX250B,BC,FG,R,4CX350A,F,FJ	73.00
SK606	Chimney For 4CX250B,BC,FG,R,4CX350A,F,FJ	11.00
SK607	Socket For 4CX600J,JA	60.00
SK610	Socket For 4CX600J,JA	60.00
SK620	Socket For 4CX600J,JA	66.00
SK626	Chimney For 4CX600J,JA	10.00
SK630	Socket For 4CX600J,JA	66.00
SK636B	Chimney For 4CX600J,JA	34.00
SK640	Socket For 4CX600J,JA	36.00
SK646	Chimney For 4CX600J,JA	71.00
SK700	Socket For 4CX300A,Y,4CX125C,F	225.00
SK711A	Socket For 4CX300A,Y,4CX125C,F	225.00
SK740	Socket For 4CX300A,Y,4CX125C,F	86.00
SK770	Socket For 4CX300A,Y,4CX125C,F	86.00
SK800A	Socket For 4CX1000A,4CX1500B	225.00
SK806	Chimney For 4CX1000A,4CX1500B	40.00
SK810	Socket For 4CX1000A,4CX1500B	225.00
SK900	Socket For 4X500A	300.00
SK906	Chimney For 4X500A	57.00
SK1420	Socket For 5CX3000A	650.00
SK1490	Socket For 4CV8000A	585.00

## JOHNSON TUBE SOCKETS AND CHIMNEYS

124-111/SK606	Chimney For 4CX250B,BC,FG,R, 4CX350A,F,FJ	\$ 10.00
122-0275-001	Socket For 3-500Z, 4-125A, 250A, 400A, 4-500A, 5-500A	(pair)15.00
124-0113-00	Capacitor Ring	15.00
124-116/SK630A	Socket For 4CX250B,BC,FG,R, /4CX350A,F,FJ	55.00
124-115-2/SK620A	Socket For 4CX250B,BC,FG,R, /4CX350A,F,FJ	55.00
	813 Tube Socket	20.00

## CHIP CAPACITORS

.8pf	10pf	100pf*	430pf
1pf	12pf	110pf	470pf
1.1pf	15pf	120pf	510pf
1.4pf	18pf	130pf	560pf
1.5pf	20pf	150pf	620pf
1.8pf	22pf	160pf	680pf
2.2pf	24pf	180pf	820pf
2.7pf	27pf	200pf	1000pf/.001uf*
3.3pf	33pf	220pf*	1800pf/.0018uf
3.6pf	39pf	240pf	2700pf/.0027uf
3.9pf	47pf	270pf	10,000pf/.01uf
4.7pf	51pf	300pf	12,000pf/.012uf
5.6pf	56pf	330pf	15,000pf/.015uf
6.8pf	68pf	360pf	18,000pf/.018uf
8.2pf	82pf	390pf	

PRICES: 1 to 10 - .99¢ 101 to 1000 .60¢ \* IS A SPECIAL PRICE: 10 for \$7.50  
 11 to 50 - .90¢ 1001 & UP .35¢ 100 for \$65.00  
 51 to 100 - .80¢ 1000 for \$350.00

## TUBE CAPS (Plate)

HR1, 4	\$11.00
HR2,3, 6 & 7	13.00
HR5, 8	14.00
HR9	17.00
HR10	20.00

## WATKINS JOHNSON WJ-V907: Voltage Controlled Microwave Oscillator \$110.00

Frequency range 3.6 to 4.2GHz, Power output, Min. 10dBm typical, 8dBm Guaranteed.  
 Spurious output suppression Harmonic (nf<sub>0</sub>), min. 20dB typical, In-Band Non-Harmonic, min.  
 60dB typical, Residual FM, pk to pk, Max. 5KHz, pushing factor, Max. 8KHz/V, Pulling figure  
 (1.5:1 VSWR), Max. 60MHz, Tuning voltage range +1 to +15volts, Tuning current, Max. -0.1mA,  
 modulation sensitivity range, Max. 120 to 30MHz/V, Input capacitance, Max. 100pf, Oscillator  
 Bias +15 +/-0.05 volts @ 55mA, Max.

**Toll Free Number**  
**800-528-0180**  
**(For orders only)**

"All parts may be new or surplus, and parts may be substituted with comparable parts if we are out of stock of an item."

# MHz electronics

For information call: (602) 242-3037

PRICES SUBJECT TO CHANGE WITHOUT NOTICE

# TUBES

TYPE	PRICE	TYPE	PRICE	TYPE	PRICE
2C39/7289	\$ 34.00	1182/4600A	\$500.00	ML7815AL	\$ 60.00
2E26	7.95	4600A	500.00	7843	107.00
2K28	200.00	4624	310.00	7854	130.00
3-500Z	102.00	4657	84.00	ML7855KAL	125.00
3-1000Z/8164	400.00	4662	100.00	7984	14.95
3B28/866A	9.50	4665	500.00	8072	84.00
3CX400U7/8961	255.00	4687	P.O.R.	8106	5.00
3CX1000A7/8283	526.00	5675	42.00	8117A	225.00
3CX3000F1/8239	567.00	5721	250.00	8121	110.00
3CW30000H7	1700.00	5768	125.00	8122	110.00
3X2500A3	473.00	5819	119.00	8134	470.00
3X3000F1	567.00	5836	232.50	8156	12.00
4-65A/8165	69.00	5837	232.50	8233	60.00
4-125A/4D21	79.00	5861	140.00	8236	35.00
4-250A/5D22	98.00	5867A	185.00	8295/PL172	500.00
4-400A/8438	98.00	5868/AX9902	270.00	8458	35.00
4-400B/7527	110.00	5876/A	42.00	8462	130.00
4-400C/6775	110.00	5881/6L6	8.00	8505A	95.00
4-1000A/8166	444.00	5893	60.00	8533W	136.00
4CX250B/7203	54.00	5894/A	54.00	8560/A	75.00
4CX250FG/8621	75.00	5894B/8737	54.00	8560AS	100.00
4CX250K/8245	125.00	5946	395.00	8608	38.00
4CX250R/7580W	90.00	6083/AZ9909	95.00	8624	100.00
4CX300A/8167	170.00	6146/6146A	8.50	8637	70.00
4CX350A/8321	110.00	6146B/8298	10.50	8643	83.00
4CX350F/8322	115.00	6146W/7212	17.95	8647	168.00
4CX350FJ/8904	140.00	6156	110.00	8683	95.00
4CX600J/8809	835.00	6159	13.85	8877	465.00
4CX1000A/8168	242.50*	6159B	23.50	8908	13.00
4CX1000A/8168	485.00	6161	325.00	8950	13.00
4CX1500B/8660	555.00	6280	42.50	8930	137.00
4CX5000A/8170	1100.00	6291	180.00	6L6 Metal	25.00
4CX10000D/8171	1255.00	6293	24.00	6L6GC	5.03
4CX15000A/8281	1500.00	6326	P.O.R.	6CA7/EL34	5.38
4CW800F	710.00	6360/A	5.75	6CL6	3.50
4D32	240.00	6399	540.00	6DJ8	2.50
4E27A/5-125B	240.00	6550A	10.00	6DQ5	6.58
4PR60A	200.00	6883B/8032A/8552	10.00	6GF5	5.85
4PR60B	345.00	6897	160.00	6GJ5A	6.20
4PR65A/8187	175.00	6907	79.00	6GK6	6.00
4PR1000A/8189	590.00	6922/6DJ8	5.00	6HB5	6.00
4X150A/7034	60.00	6939	22.00	6HF5	8.73
4X150D/7609	95.00	7094	250.00	6JG6A	6.28
4X250B	45.00	7117	38.50	6JM6	6.00
4X250F	45.00	7203	P.O.R.	6JN6	6.00
4X500A	412.00	7211	100.00	6JS6C	7.25
5CX1500A	660.00	7213	300.00*	6KN6	5.05
KT88	27.50	7214	300.00*	6KD6	8.25
416B	45.00	7271	135.00	6LF6	7.00
416C	62.50	7289/2C39	34.00	6LQ6 G.E.	7.00
572B/T160L	49.95	7325	P.O.R.	6LQ6/6MJ6 Sylvania	9.00
592/3-200A3	211.00	7360	13.50	6ME6	8.90
807	8.50	7377	85.00	12AT7	3.50
811A	15.00	7408	2.50	12AX7	3.00
812A	29.00	7609	95.00	12BY7	5.00
813	50.00	7735	36.00	12JB6A	6.50

NOTE \* = USED TUBE

NOTE P.O.R. = PRICE ON REQUEST

"ALL PARTS MAY BE NEW, USED, OR SURPLUS. PARTS MAY BE SUBSTITUTED WITH COMPARABLE PARTS IF WE ARE OUT OF STOCK OF AN ITEM.

NOTICE: ALL PRICES ARE SUBJECT TO CHANGE WITHOUT NOTICE.

For information call: (602) 242-3037

**Toll Free Number**  
**800-528-0180**  
**(For orders only)**

"All parts may be new or surplus, and parts may be substituted with comparable parts if we are out of stock of an item."

**MHz electronics**

PRICES SUBJECT TO CHANGE WITHOUT NOTICE

# "FILTERS"

## COLLINS Mechanical Filter #526-9724-010 MODEL F455Z32F

455KHZ at 3.2KHz wide. May be other models but equivalent. May be used or new, \$15.99

### ATLAS Crystal Filters

5.595-2.7/8/LSB, 5.595-2.7/LSB	
8 pole 2.7KHz wide Upper sideband. Impedence 800ohms 15pf In/800ohms 0pf out.	19.99
5.595-2.7/8/U, 5.595-2.7/USB	
8 pole 2.7KHz wide Upper sideband. Impedence 800ohms 15pf In/800ohms 0pf out.	19.99
5.595-.500/4, 5.595-.500/4/CW	
4 pole 500 cycles wide CW. Impedance 800ohms 15pf In/800ohms 0pf out.	19.99
9.0USB/CW	
6 pole 2.7KHz wide at 6dB. Impedance 680ohms 7pf In/300ohms 8pf out. CW-1599Hz	19.99

### KOKUSAI ELECTRIC CO, Mechanical Filter #MF-455-ZL/ZU-21H

455KHz at Center Frequency of 453.5KC. Carrier Frequency of 455KHz 2.36KC Bandwidth.	
Upper sideband. (ZU)	19.99
Lower sideband. (ZL)	19.99

### CRYSTAL FILTERS

NIKKO	FX-07800C	7.8MHz	\$10.00
TEW	FEC-103-2	10.6935MHz	10.00
SDK	SCH-113A	11.2735MHz	10.00
TAMA	TF-31H250	CF 3179.3KHz	19.99
TYCO/CD	001019880	10.7MHz 2pole 15KHz bandwidth	5.00
MOTOROLA	4884863B01	11.7MHz 2pole 15KHz bandwidth	5.00
PTI	5350C	12MHz 2pole 15KHz bandwidth	5.00
PTI	5426C	21.4MHz 2pole 15KHz bandwidth	5.00
PTI	1479	10.7MHz 8pole bandwidth 7.5KHz at 3dB, 5KHz at 6dB	20.00
COMTECH	A10300	45MHz 2pole 15KHz bandwidth	6.00
FRC	ERXF-15700	20.6MHz 36KHz wide	10.00
FILTECH	2131	CF 7.825MHz	10.00

### CERAMIC FILTERS

AXEL	4F449	12.6KC Bandpass Filter 3dB bandwidth 1.6KHz from 11.8-13.4KHz	10.00
CLEVITE	TO-01A	455KHz+-2KHz bandwidth 4-7% at 3dB	5.00
	TCF4-12D36A	455KHz+-1KHz bandwidth 6dB min 12KHz, 60dB max 36KHz	10.00
MURATA	BFB455B	455KHz	2.50
	BFB455L	455KHz	3.50
	CFM455E	455KHz +-5.5KHz at 3dB, +-8KHz at 6dB, +-16KHz at 50dB	6.65
	CFM455D	455KHz +-7KHz at 3dB, +-10KHz at 6dB, +-20KHz at 50dB	6.65
	CFR455E	455KHz +-5.5KHz at 3dB, +-8KHz at 6dB, +-16KHz at 60dB	8.00
	CFU455B	455KHz +-2KHz bandwidth +-15KHz at 6dB, +-30KHz at 40dB	2.90
	CFU455C	455KHz +-2KHz bandwidth +-12.5KHz at 6dB, +-24KHz at 40dB	2.90
	CFU455G	455KHz +-1KHz bandwidth +-4.5KHz at 6dB, +-10KHz at 40dB	2.90
	CFU455H	455KHz +-1KHz bandwidth +-3KHz at 6dB, +-9KHz at 40dB	2.90
	CFU455I	455KHz +-1KHz bandwidth +-2KHz at 6dB, +-6KHz at 40dB	2.90
	CFW455D	455KHz +-10KHz at 6dB, +-20KHz at 40dB	2.90
	CFW455H	455KHz +-3KHz at 6dB, +-9KHz at 40dB	2.90
	SFB455D	455KHz	2.50
	SFD455D	455KHz +-2KHz, 3dB bandwidth 4.5KHz +-1KHz	5.00
	SFE10.7MA	10.7MHz 280KHz +-50KHz at 3dB, 650KHz at 20dB	2.50
	SFE10.7MS	10.7MHz 230KHz +-50KHz at 3dB, 570KHz at 20dB	2.50
	SFG10.7MA	10.7MHz	10.00
NIPPON	LF-B4/CFU455I	455KHz +-1KHz	2.90
	LF-B6/CFU455H	455KHz +-1KHz	2.90
	LF-B8	455KHz	2.90
	LF-C18	455KHz	10.00
TOKIN	CF455A/BFU455K	455KHz +-2KHz	5.00
MATSUSHIRA	EFC-L455K	455KHz	7.00

### SPECTRA PHYSICS INC., Model 088 HeNe LASER TUBES

POWER OUTPUT 1.6MW,	BEAM DIA. .75MM	BEAM DIR. 2.7MR	8KV STARTING VOLTAGE DC
68K OHM 1WATT BALLAST	1000VDC +-100VDC	At 3.7MA	\$59.99

### ROTRON MUFFIN FANS Model MARK4/MU2A1

115 VAC	14WATTS	50/60CPS	IMPEDENCE PROTECTED-F	88CFM at 50CPS	\$ 7.99
105CFM at 60CPS	THESE ARE NEW				

# MHz electronics

PRICES SUBJECT TO CHANGE WITHOUT NOTICE

**Toll Free Number**  
**800-528-0180**  
**(For orders only)**

"All parts may be new or surplus, and parts may be substituted with comparable parts if we are out of stock of an item."

For information call: (602) 242-3037



# HEWLETT PACKARD SIGNAL GENERATORS

606A	50KHz to 65MHz in 6 bands +-1% Output level adjustable 0.1uV to 3V into 50 ohms. Built-in crystal calibrator. 400-1000Hz modulation.	\$ 650.00	616B	Same as above but later model.	\$ 600.00
606B	Same as above but has frequency control feature to allow operation with HP 8708A Synchronizer.	\$1100.00	618B	3.8 to 7.6GHz range, with calibrated output and selection of pulse-FM or square wave modulation.	\$ 600.00
608C	10MHz to 480MHz, 0.1uV-1V into 50 ohms, AM, CW, or pulse modulation, calibrated attenuator.	\$ 500.00	618C	Same as above but later model.	\$2200.00
608D/TS510	10MHz to 420MHz, 0.1uV-0.5V into 50 ohms, +-0.5% accuracy, built-in crystal calibrator, AM-CW or pulse output.	\$ 375.00	620A	7 to 11GHz range, with calibrated output and selection of pulse-FM or square wave modulation.	\$ 750.00
608E	Improved version of popular 608C. Up to 1V output. Improved stability, low residual FM.	\$1450.00	620B	Same as above but later model.	\$2200.00
608F	10MHz to 455MHz in 5 bands +-1% frequency accuracy with built-in crystal calibrator. Can be used with HP 8708A Synchronizer. Output continuously adjustable from .1uV to .5V into 50 ohms.	\$1100.00	626A	10 to 156Hz, 10mw output power with calibrated output and pulse-square wave or FM modulation.	\$4200.00
612A	450-1230MHz, 0.1uV-0.5V into 50 ohms, calibrated output.	\$ 750.00	8708A	Synchronizer used with 606B, 608F. The synchronizer is a phase-lock frequency stabilizer which provides crystal-oscillator frequency stability to 430MHz in the 608F signal generator. Phase locking eliminates microphonics and drift resulting in excellent frequency stability. The 8708A includes a vernier which can tune the reference oscillator over a range of +-0.25% permitting frequency settability to 2 parts in 10 to the seventh. Provides a very stable signal that satisfies many critical applications.	(With HP 606B or 608F) \$ 350.00 (Without) \$ 450.00
614A	900-2100MHz with many features including calibrated output and all modulation characteristics.	\$ 500.00	EMC-10	ELECTROMETRICS EMC-10 RFI/EMI RECEIVER Low frequency analyzer covering 20Hz to 50KHz frequency range. Extendable to 500 KHz in wideband mode.	\$2500.00
616A/TS403	Direct reading and direct control from 1.8 to 4.2GHz. The H.P. 616A features +-1.5dB calibrated output accuracy from -3127dBm to -dBm. The output is directly calibrated in microvolts and dBm with continuous monitoring. Simple operation frequency diode accuracy is +-1% and stability exceeds 0.005%/C change in ambient temperature. Calibrated attenuator is within +-1.5dB over entire output band. 50 ohm impedance unit has internal pulse modulation with rep rate variable from 40 Hz to 4KHz, variable pulsewidth 1 to 10uSec and variable pulse delay (3 to 300uSec). External modulating inputs increase versatility.	\$ 375.00	NF-105F	Empire Devices Field Intensity Meter Has NF-105/TA, NF-105/TX, NF-105/T1, NF-105/T2, NF-105/T3. Covers 14KHz to 1000MHz.	\$2100.00

ALL EQUIPMENT CARRY A 30 DAY GUARANTEE.  
EQUIPMENT IS NOT CALIBRATED.

UNEX LABORATORIES THS-2 FLEX100M HEADSET.

these headsets come with data to hook up to a 100M radios and many other equipment.  
Perfect for Airplanes, Helicopters, Mobile Radios, or Just the Telephone.  
These Are Factory New In Sealed Boxes. Limited Supply Only \$69.95

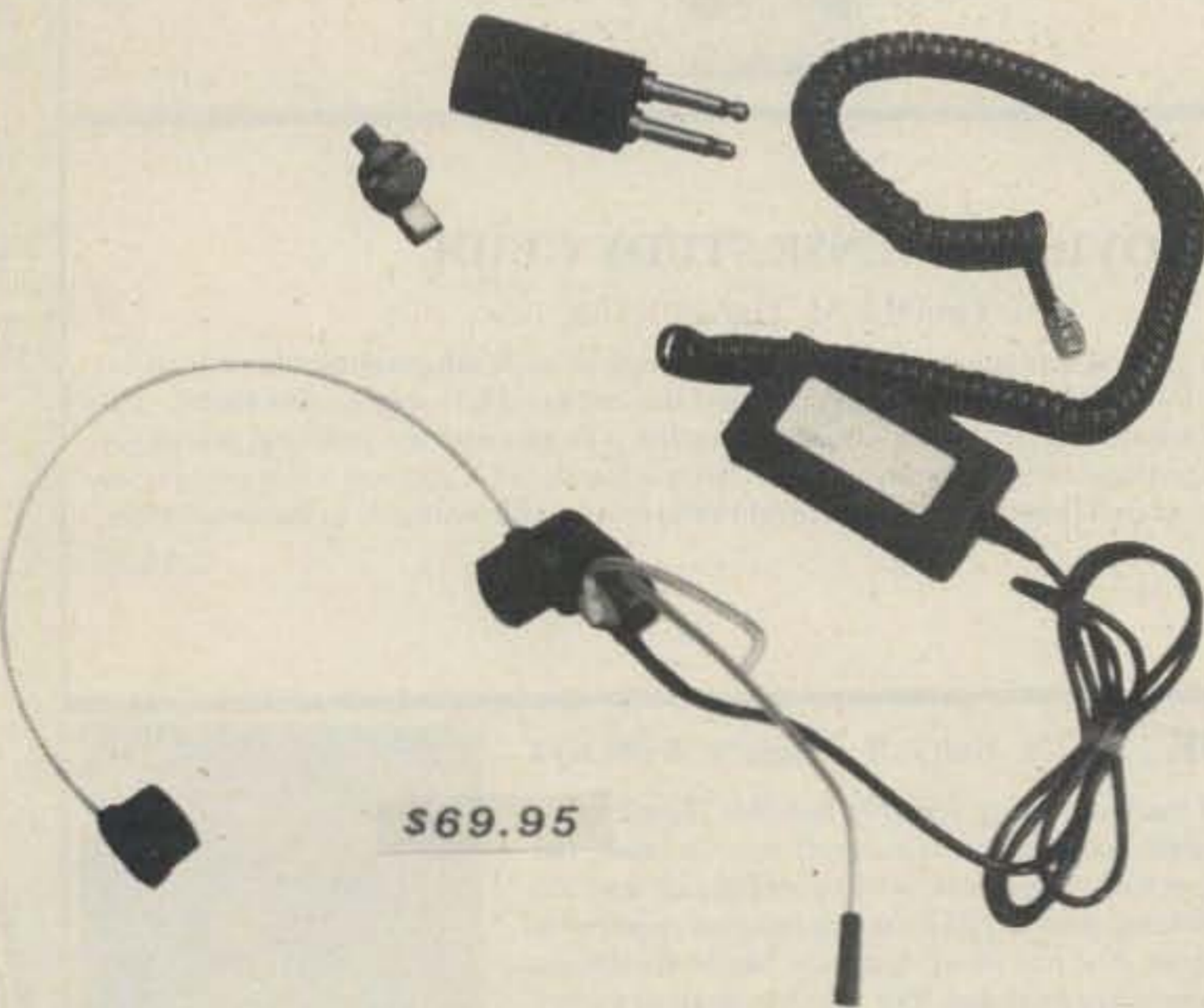

\$69.95

#### ORDERING INSTRUCTIONS

**DEFECTIVE MATERIAL:** All claims for defective material must be made within sixty (60) days after receipt of parcel. All claims must include the defective material (for testing purposes), our invoice number, and the date of purchase. All returns must be packed properly or it will void all warranties.

**DELIVERY:** Orders are normally shipped within 48 hours after receipt of customer's order. If a part has to be backordered the customer is notified. Our normal shipping method is via First Class Mail or UPS depending on size and weight of the package. On test equipment it is by Air only, FOB shipping point.

**FOREIGN ORDERS:** All foreign orders must be prepaid with cashier's check or money order made out in U.S. Funds. We are sorry but C.O.D. is not available to foreign countries and Letters of Credit are not an acceptable form of payment either. Further information is available on request.

**HOURS:** Monday thru Saturday: 8:30 a.m. to 5:00 p.m.

**INSURANCE:** Please include 25¢ for each additional \$100.00 over \$100.00. United Parcel only

**ORDER FORMS:** New order forms are included with each order for your convenience. Additional forms are available on request.

**POSTAGE:** Minimum shipping and handling in the US, Canada, and Mexico is \$2.50 all other countries is \$5.00. On foreign orders include 20% shipping and handling.

**PREPAID ORDERS:** Order must be accompanied by a check.

**PRICES:** Prices are subject to change without notice.

**RESTOCK CHARGE:** If parts are returned to MHZ Electronics due to customer error, customer will be held responsible for all extra fees, will be charged a 15% restocking fee, with the remainder in credit only. All returns must have approval.

**SALES TAX:** Arizona must add 5% sales tax, unless a signed Arizona resale tax card is currently on file with MHZ Electronics. All orders placed by persons outside of Arizona, but delivered to persons in Arizona are subject to the 5% sales tax.

**SHORTAGE OR DAMAGE:** All claims for shortages or damages must be made within 5 days after receipt of parcel. Claims must include our invoice number and the date of purchase. Customers which do not notify us within this time period will be held responsible for the entire order as we will consider the order complete.

OUR 800 NUMBER IS STRICTLY FOR ORDERS ONLY  
NO INFORMATION WILL BE GIVEN. 1-800-528-0180.

**TERMS: DOMESTIC:** Prepaid, C.O.D. or Credit Card

**FOREIGN:** Prepaid only, U.S. Funds—money order or cashier's check only

**C.O.D.:** Acceptable by telephone or mail. Payment from customer will be by cash, money order or cashier's check. We are sorry but we cannot accept personal checks for C.O.D.'s.

**CONFIRMING ORDERS:** We would prefer that confirming orders not be sent after a telephone order has been placed. If company policy necessitates a confirming order, please mark "CONFIRMING" boldly on the order. If problems or duplicate shipments occur due to an order which is not properly marked, customers will be held responsible for any charges incurred, plus a 15% restock charge on returned parts.

**CREDIT CARDS:** WE ACCEPT MASTERCARD VISA AND AMERICAN EXPRESS.

**DATA SHEETS:** When we have data sheets in stock on devices we do supply them with the order.

**MHZ** electronics



For information call: (602) 242-3037

2111 W. CAMELBACK ROAD  
PHOENIX, ARIZONA 85015

Toll Free Number  
800-528-0180  
(For orders only)

"All parts may be new or surplus, and parts may be substituted with comparable parts if we are out of stock of an item."

# WAYNE GREEN BOOKS

## KILOBAUD KLASROOM

by George Young and Peter Stark

Makes learning electronics fun and easy. First published as a series in *Kilobaud Microcomputing*, the book combines the learning of essential theory with practical, hands-on experience. The course begins with basic electronic projects and culminates in the construction of your own programmable microcomputer. The direct instructional methods of authors Young & Stark make KILBAUD KLASROOM a simple way for you to acquire a solid background in digital electronics.

BK7386 (419 pages).....\$14.95



## THE SELECTRIC INTERFACE by George Young

You need the quality print that a daisy wheel printer provides but the thought of buying one makes your wallet wilt. The SELECTRIC™ INTERFACE, a step-by-step guide to interfacing an IBM Selectric I/O Writer to your microcomputer, will give you that quality at a fraction of the price. George Young, co-author of *Kilobaud Microcomputing* magazine's popular "Kilobaud Classroom" series, offers a low-cost alternative to buying a daisy wheel printer. The SELECTRIC INTERFACE includes: step-by-step instructions, tips on purchasing a used Selectric, information on various Selectric models, including the 2740, 2980, and Dura 1041, driver software for Z80, 8080, and 6502 chips, tips on interfacing techniques. With The SELECTRIC INTERFACE and some background in electronics, you can have a high-quality, low-cost, letter-quality printer. Petals not included.

BK7388 (125 pages).....\$12.97

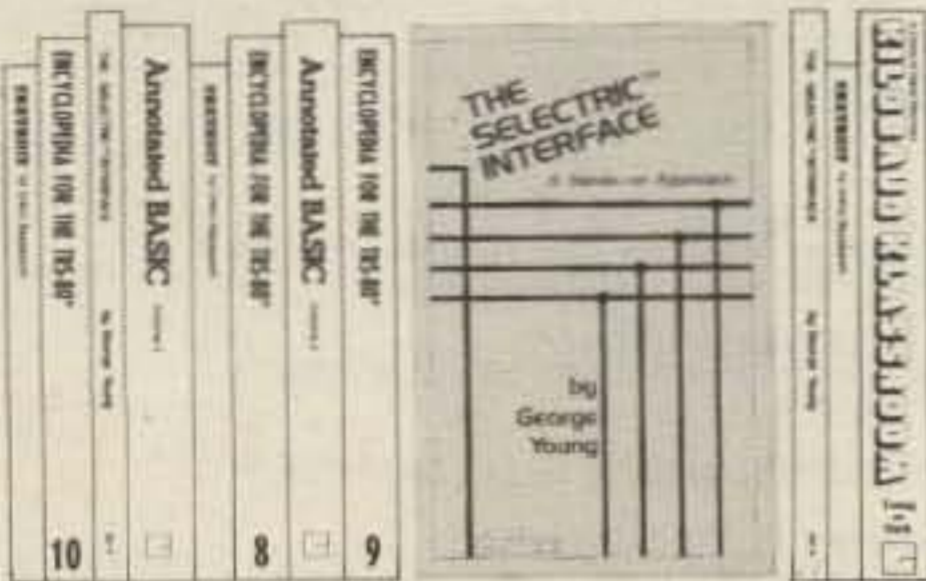

## GENERAL LICENSE STUDY GUIDE

By Timothy M. Daniel N8RK

This is the complete guide to the General License. Learning rather than memorizing is the secret. This is not a question-and-answer guide that will gather dust when the FCC issues a new test. Instead, this book will be a helpful reference, useful long after a ham upgrades to General. Includes up-to-date FCC rules and an application form. Order yours today and talk to the world.

SG7358 (87 pages).....\$6.95

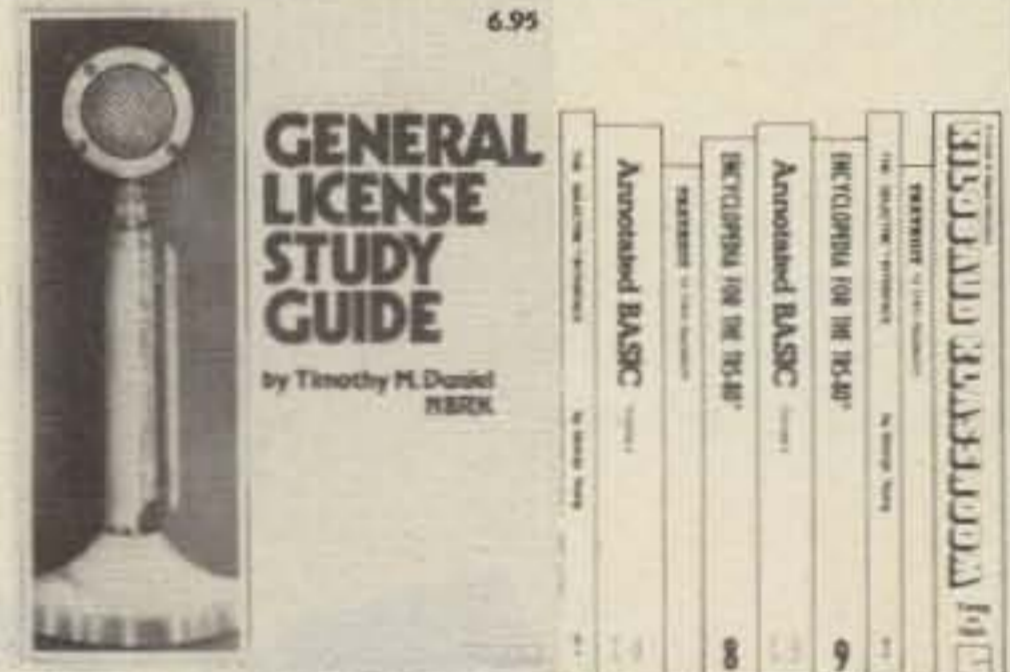

## NOVICE LICENSE STUDY GUIDE

By Timothy M. Daniel N8RK

Here is the most up-to-date novice guide available. It is complete with information about learning Morse code, has the latest FCC amateur regulations and the current FCC application forms. This guide is *not* a question/answer memorization course but rather it emphasizes the practical side of getting a ham license and putting a station on the air. It reflects what the FCC expects a Novice to know without page after page of dull theory. The most current information still available at last year's price.

SG7357 (98 pages).....\$4.95

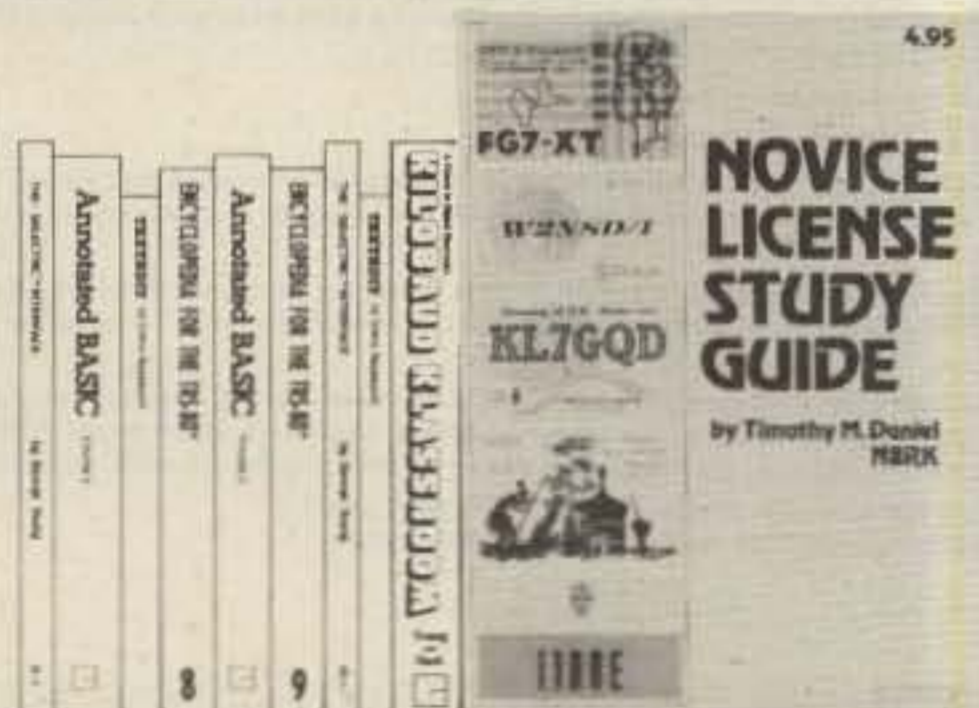

## THE NEW WEATHER SATELLITE HANDBOOK by Dr. Ralph E. Taggart WB8DQT

Here is the completely updated and revised edition of the best-selling *Weather Satellite Handbook*—containing all the information on the most sophisticated and effective spacecraft now in orbit. Dr. Taggart has written this book to serve both the experienced amateur satellite enthusiast and the newcomer. The book is an introduction to satellite watching, providing all the information required to construct a complete and highly effective ground station. Not just ideas, but solid hardware designs and all the instruction necessary to operate the equipment are included. For the thousands of experimenters who are operating stations, the book details all procedures necessary to modify their equipment for the new series of spacecraft. Amateur weather satellite activity represents a unique blend of interests encompassing electronics, meteorology and astronautics. Join the privileged few in watching the spectacle of earth as seen from space on your own monitoring equipment.

BK7383 (132 pages).....\$8.95



FOR TOLL-FREE ORDERING CALL 1-800-258-5473  
WAYNE GREEN BOOKS•PETERBOROUGH NH 03458

Itemize your order on a separate piece of paper and mail to Wayne Green Books, Att: Sales, Peterborough, NH 03458. Be sure to include check or detailed credit card information. (Visa, MC or AMEX accepted.) No C.O.D. orders accepted. All orders add \$1.50 for the first book, postage and handling; \$1.00 each additional book; \$10.00 per book foreign air mail. Please allow 4-6 weeks after publication for delivery. Questions regarding your order? Please write to Customer Service at the above address.

# A STAR IS BORN...



*RUN has arrived for your Commodore 64 and VIC-20 computers.*

RUN, the exciting new monthly that takes you beyond your instruction manual. RUN, packed with current information, entertaining programs, sage advice, and pure fun. RUN takes you from

- beginning BASIC to advanced graphics.
- candid product reviews to exciting new programs to type in and use.
- games to applications to informative tutorials.

Information. Entertainment. Advice. Fun... RUN has it all and for only \$19.97 per year. Subscribe today and get a 13th issue FREE with pre-payment by check or credit card.

*Catch a rising star... RUN.*

Start your subscription sooner by calling toll-free  
1-800-258-5473

Commodore 64 and VIC-20 are registered trademarks of Commodore Business Machines, Inc.

# RUN

Send me a subscription to RUN for only \$19.97 per year. I understand that with payment enclosed or credit card order, I will receive a FREE issue for a total of 13 issues for \$19.97.

- Check/MO     MC     VISA     AE  
 Bill me \$19.97 for 12 issues.

Card # \_\_\_\_\_ Exp. Date \_\_\_\_\_

Signature \_\_\_\_\_

Name \_\_\_\_\_

Address \_\_\_\_\_

City \_\_\_\_\_ State \_\_\_\_\_ Zip \_\_\_\_\_

Canada & Mexico \$22.97/1 year only, US funds drawn on US bank.  
Foreign Surface \$39.97/1 year only, US funds drawn on US bank.  
Foreign airmail, please inquire. Please allow 6-8 weeks for delivery.

33NC6

RUN • PO Box 954 • Farmingdale, NY 11737



# THE SELECTRIC™ INTERFACE

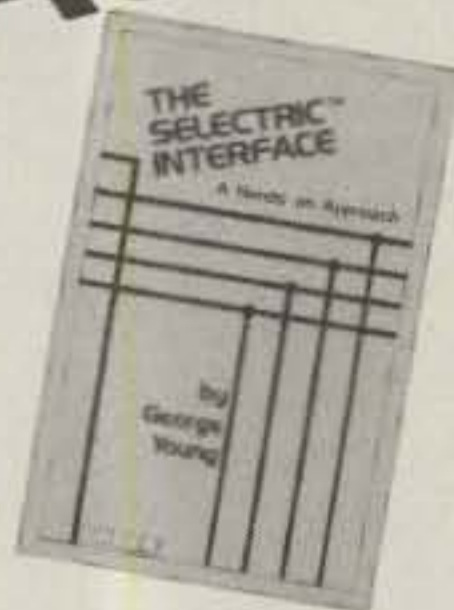

## Daisy wheel quality without daisy wheel expense.

You need the quality print that a daisy wheel printer provides but the thought of buying one makes your wallet wilt. *The Selectric™ Interface*, a step-by-step guide to interfacing an IBM Selectric I/O Writer to your microcomputer, will give you that quality at a fraction of the price. George Young, co-author of *Microcomputing* magazine's popular "Kilobaud Classroom" series, offers a low-cost alternative to buying a daisy wheel printer.

*The Selectric™ Interface* includes:

- step-by-step instructions
- tips on purchasing a used Selectric™
- information on various Selectric™ models, including the 2740, 2980, and Dura 1041
- driver software for Z80, 8080, and 6502 chips
- tips on interfacing techniques

With *The Selectric Interface* and some background in electronics, you can have a high-quality, low-cost, letter-quality printer. Petals not included.

Credit card orders call TOLL-FREE 1-800-258-5473. Or mail your order with payment plus \$1.50 shipping and handling to: Wayne Green Inc. Attn: Retail Book Sales, Peterborough, NH 03458.

Dealer inquiries invited.

ISBN 0-88006-051-4

128 pages

**\$12.97**

Yes, I want **Selectric Interface** (BK7388). Enclosed is \$12.97 per copy plus \$1.50 for shipping and handling.

MASTER

VISA

AMEX

Card # \_\_\_\_\_ Expires \_\_\_\_\_

Signature \_\_\_\_\_

Name \_\_\_\_\_

Address \_\_\_\_\_

City \_\_\_\_\_

State and Zip \_\_\_\_\_

All orders shipped UPS if complete street address is given.

33NB6S

# HAM HELP

I am looking for the service and instruction manuals for the CDE HAM III/CD 44 rotor, manufactured by Cornell-Dubilier. I will pay copying and postage costs.

Karl Mesquita Leite PS7KM  
Caixa Postal 385  
59000 Natal, RN  
Brazil

Can anyone help me find the service manual or any other information on the Galaxy III transceiver? It was made by World Radio Labs some years back. I also need a base or mobile power supply for the Galaxy III.

James E. Crawford KD5YD  
PO Box 643  
Lovington NM 99260

I am trying to interface my VIC-20 with my ham rig and would like any software or hardware information.

SFC Skip Barley KA4ROY/13  
167 Signal Company  
APO NY 09221

I have a hand-held made by Westinghouse Air Brake Co., model RPN-150. I would like service information and assistance in converting it to 2 meters.

Mike Antio KA8RIJ  
9940 Hubert  
Allen Park MI 48101

I need the service manual or schematics for a Sonar 40 transceiver. I will pay copying and postage costs.

Alvaro Alberto P. Miranda  
R. Joaquim Borges, 706  
13300 ITU-SP, Brazil

I want to convert my 9-V broadcast-band radio to receive between 5.4 and 16 MHz. Does anyone have any suggestions?

Kevin Neal  
Rt. Box 221A  
Flippin AR 72634

For a CB conversion project, I need the schematic for a Hy-Gain 2710X.

Kenneth Aston  
650 La Seda Rd., Sp. 3-A  
La Puente CA 91744

I need the service manual and schematic for the Bearcat 250 scanner. I will make a copy of the original and return.

C. Frazier K9FWF/4  
PO Box 972  
Windermere FL 32786

I am trying to use Motorola HT batteries for other projects, but I can only draw 20 mA before tripout. Is this proper?

G. C. La Grange W5AKQ  
3188 E. Circle Dr.  
Baytown TX 77521

### SIGNAL GENERATORS

#### RECONDITIONED AND LAB CALIBRATED

- AN/URM-25 MILITARY SIG GEN, RANGE 10 KHZ THRU 50 MHZ, AM/CW, MODULATION 400/1000 HZ, CALIBRATED OUTPUT. \$285.00
- PRECISION 50 OHM STOP ATTENUATOR \$285.00
- AN/URM-26 MILITARY SIG GEN RANGE 4 MHZ THRU 405 MHZ, 400/1000 HZ MODULATION, CALIBRATED OUTPUT, SMALL COMPACT SIZE \$285.00
- TS-510/U MILITARY SIG GEN, RANGE 10 MHZ THRU 420 MHZ, OUTPUT VOLTAGE .5V TO 1V, MODULATION 400/1000 HZ AM/CW OR PULSE, SAME AS HP-608D \$345.00
- HP-614 SIG GEN, RANGE 900 MHZ THRU 2100 MHZ, AM/PULSE MODULATION CALIBRATED OUTPUT, IDEAL FOR AMATEUR 1.2 GHZ, MICROWAVE OR AIRCRAFT RADIO REPAIR \$345.00
- SG-557/URM-52 MILITARY SIG GEN, RANGE 3.8 GHZ THRU 7.8 GHZ, AM/PULSE CALIBRATED ATTENUATOR, MILITARY EQUIVALENT TO HP-618A, IDEAL FOR SATELLITE OR MICROWAVE REPAIR \$345.00
- TS-418/URM-49 RANGE 400 MHZ THRU 1000 MHZ, AM/CW OR PULSE MODULATION, CALIBRATED ATTENUATOR \$225.00
- TS-419/URM-64 RANGE 900 THRU 2100 MHZ, CW OR PULSE MODULATION, CALIBRATED ATTENUATOR \$225.00
- SG-13/U AIRCRAFT VOR/ILS MILITARY SIG GEN, RANGE 108 THRU 135.9 MHZ AND 329.9 TO 335 MHZ, OUTPUT SIGNALS INCLUDE VOR, LOC AND GLIDESLOPE AND 1000 CPS, SAME AS COLLINS 479T-2, OPERATES FROM 28 VDC AT 3 1/2 AMPS BENCH POWER SUPPLY OR AIRCRAFT BATTERY, IDEAL FOR AIRCRAFT RADIO REPAIR \$285.00
- SG-66/ARM-5 AIRCRAFT OMNI SIG GEN, RANGE 108 MHZ THRU 132 MHZ, CALIBRATION OUTPUT AND MODULATION IDEAL FOR ALIGNMENT OF AIRCRAFT VOR RECEIVERS, MILITARY VERSION OF ARC H-14A \$245.00
- JERROLD 900A SWEEP GENERATOR, RANGE 0.5 THRU 1200 MHZ, 0.5 TO 400 MHZ SWEEP WIDTH, OUTPUT FLAT -5DB TO 800 MHZ, 1.5 DB TO 1200 MHZ, BUILT-IN RF DETECTOR \$325.00
- MARCONI TF-1066B AM/FM SIG GEN, RANGE 10 MHZ THRU 470 MHZ, INTERNAL FM OF 1 AND 5 KHZ WITH 100 KHZ VARIABLE DEVIATION, AM MODULATION OF 1 AND 5 KHZ, CALIBRATED OUTPUT, HAS MANY EXCELLENT FEATURES \$550.00
- HP 608E SIG GEN, RANGE 10 MHZ THRU 480 MHZ, CALIBRATED OUTPUT, PRECISION ATTENUATOR, INTERNAL AND EXTERNAL AM, CRYSTAL CALIBRATOR \$850.00
- MOTOROLA T-1034 FM SIG GEN, RANGE 25-54 MHZ, 130-175 MHZ, 400-470 MHZ AND 890-960 MHZ, VARIABLE OUTPUT FROM 0.1 MV TO 100,000 MV, CALIBRATED ATTENUATOR \$385.00

WE SHIP BEST WAY, SHIPPING CHARGES COLLECT, 30-DAY MONEY-BACK GUARANTEE. SEND CHECK, VISA OR M/C. PHONE BILL SLEP, 704-524-7519.



## Slep Electronics Company

P.O. BOX 100, HWY. 441  
OTTO, NORTH CAROLINA 28763

✓ 367

We now have available a bunch of goodies too good to bypass. Items are limited so order today

**MINI KITS - YOU HAVE SEEN THESE BEFORE NOW HERE ARE OLD FAVORITE AND NEW ONES TOO. GREAT FOR THAT AFTERNOON HOBBY.**

## FM MINI MIKE

A super high performance FM wireless mike kit! Transmits a stable signal up to 300 yards with exceptional audio quality by means of its built in electret mike. Kit includes case, mike, on-off switch, antenna, battery and super instructions. This is the finest unit available.

FM-3 Kit **\$14.95**  
FM-3 Wired and Tested **19.95**

### Color Organ

See music come alive! 3 different lights flicker with music. One light each for, high, mid-range and lows. Each individually adjustable and drives up to 300 W runs on 110 VAC

Complete kit, ML-1 **\$8.95**

**Video Modulator Kit**  
Converts any TV to video monitor. Super stable, tunable over ch. 4-6. Runs on 5-15V, accepts std. video signal. Best unit on the market! Complete kit, VD-1 **\$7.95**

**Led Blinky Kit**  
A great attention getter which alternately flashes 2 jumbo LEDs. Use for name badges, buttons, warning panel lights, anything! Runs on 3 to 15 volts. Complete kit, BL-1 **\$2.95**

**Super Sleuth**  
A super sensitive amplifier which will pick up a pin drop at 15 feet! Great for monitoring baby's room or as general purpose amplifier. Full 2 W rms output, runs on 6 to 15 volts, uses 8-45 ohm speaker. Complete kit, BN-9 **\$5.95**

**CPO-1**  
Runs on 3-12 Vdc 1 wall out. 1 KHZ good for CPO Alarm, Audio Oscillator. Complete kit **\$2.95**

### FM Wireless Mike Kit

Transmits up to 300' to any FM broadcast radio, uses any type of mike. Runs on 3 to 9V. Type FM-2 has added sensitive mike preamp stage.

FM-1 kit **\$3.95** FM-2 kit **\$4.95**

### Whisper Light Kit

An interesting kit, small mike picks up sounds and converts them to light. The louder the sound, the brighter the light. Includes mike, controls up to 300 W, runs on 110 VAC.

Complete kit, WL-1 **\$6.95**

### Tone Decoder

A complete tone decoder on a single PC board. Features 400-5000 Hz adjustable range via 20 turn pot, voltage regulation, 567 IC. Useful for touch-tone burst detection, FSK, etc. Can also be used as a stable tone encoder. Runs on 5 to 12 volts. Complete kit, TD-1 **\$5.95**

### Universal Timer Kit

Provides the basic parts and PC board required to provide a source of precision timing and pulse generation. Uses 555 timer IC and includes a range of parts for most timing needs.

UT-5 Kit **\$5.95**

### Mad Blaster Kit

Produces LOUD ear shattering and attention getting siren like sound. Can supply up to 15 watts of obnoxious audio. Runs on 6-15 VDC.

MB-1 Kit **\$4.95**

### Siren Kit

Produces upward and downward wail characteristic of a police siren. 5 W peak audio output, runs on 3-15 volts, uses 3-45 ohm speaker. Complete kit, SM-3 **\$2.95**

### 50 Hz Time Base

Runs on 5-15 VDC. Low current (2.5mA). Min. month accuracy. TB-7 Kit **\$5.50**  
TB-7 Assy **\$9.95**

# PARTS PARADE

## IC SPECIALS

### LINEAR

301	\$ .35
324	\$1.50
380	\$1.50
555	\$ .45
556	\$1.00
565	\$1.00
566	\$1.00
567	\$1.25
741	10/\$2.00
1458	\$ .50
3900	\$ .50
3914	\$2.95
8038	\$2.95

### TTL

74S00	\$ .40
7447	\$ .65
7475	\$ .50
7490	\$ .50
74196	\$1.35

### SPECIAL

11C90	\$15.00
10116	\$ 1.25
7208	\$17.50
7207A	\$ 5.50
7216D	\$21.00
7107C	\$12.50
5314	\$ 2.95
5375AB/G	\$ 2.95
7001	\$ 6.50

### CMOS

4011	\$.50
4013	\$.50
4046	\$1.85
4049	\$.50
4059	\$9.00
4511	\$2.00
4518	\$1.35
5639	\$1.75

### FERRITE BEADS

With info and specs **15/\$1.00**  
6 Hole Balun Beads **5/\$1.00**

### READOUTS

FND 359 4" C.C.	\$1.00
FND 507/510 5" C.A.	1.00
MAN 72/HP7730 33" C.A.	1.00
HP 7651 43" C.A.	2.00

### TRANSISTORS

2N3904 NPN C-F	15/\$1.00
2N3906 PNP C-F	15/\$1.00
2N4403 PNP C-F	15/\$1.00
2N4410 NPN C-F	15/\$1.00
2N4916 FET C-F	4/\$1.00
2N5401 PNP C-F	5/\$1.00
2N6028 C-F	4/\$1.00
2N3771 NPN Silicon	\$1.50
2N5179 UHF NPN	3/\$2.00
Power Tab NPN 40W	3/\$1.00
Power Tab PNP 40W	3/1.00
MPP 102/2N5484	\$ .50
NPN 3904 Type T-R	50/\$2.50
PNP 3906 Type T-R	50/\$2.50
2N3055	\$ .80
2N2646 UJT	3/\$2.00

**25 AMP 100V Bridge \$1.50 each**

**Mini-Bridge 50V 1 AMP 2 for \$1.00**

### Resistor Ass't

Assortment of Popular values - 1/4 watt. Cut lead for PC mounting. 1/2" center, 1/4" leads, bag of 300 or more. **\$1.50**

### Switches

Mini toggle SPDT **\$1.00**  
Red Pushbuttons N.O. **3/\$1.00**

### Earphones

3" leads, 8 ohm, good for small tone speakers, alarm clocks, etc. **5 for \$1.00**

### Mini 8 ohm Speaker

Approx 2" diam Round type for radios, mike etc. **3 for \$2.00**

### Slug Tuned Coils

Small 3/16" Hex Slugs turned coil 3 turns **10 for \$1.00**

### CAPACITORS

TANTALUM Dipped Epoxy	ALUMINUM Electrolytic	DISK CERAMIC
1.5 uF 25V 3/\$1.00	1000 uF 16V Radial <b>\$ .50</b>	01 16V disk <b>20/\$1.00</b>
1.8 uF 25V 3/\$1.00	500 uF 20V Axial <b>\$ .50</b>	1 16V <b>15/\$1.00</b>
.22 uF 25V 3/\$1.00	150 uF 16V Axial <b>5/\$1.00</b>	001 16V <b>20/\$1.00</b>
	10 uF 15V Radial <b>10/\$1.00</b>	100 pF <b>20/\$1.00</b>
		047 16V <b>20/\$1.00</b>

### Crystals

3 579545 MHZ	\$1.50
10 00000 MHZ	\$5.00
5 248800 MHZ	\$5.00

### AC Adapters

Good for clocks, nicad chargers, all 110 VAC plug one end.  
8.5 vdc @ 20 mA **\$1.00**  
16 vac @ 160mA **\$2.50**  
12 vac @ 250mA **\$3.00**

### Solid State Buzzers

small buzzer 450 Hz 86 dB sound output on 5-12 vdc at 10-30 mA. TTL compatible **\$1.50**

### AC Outlet

Panel Mount with Leads **4/\$1.00**

### Audio Prescaler

Make high resolution audio measurements, great for musical instrument tuning, PL tones, etc. Multiplies audio UP in frequency, selectable x10 or x100, gives .01 HZ resolution with 1 sec gate time! High sensitivity of 25 mv, 1 meg input z and built-in filtering gives great performance. Runs on 9V battery, all CMOS.  
PS-2 kit **\$29.95**  
PS-2 wired **\$39.95**

### 600 MHz PRESCALER

Extend the range of your counter to 600 MHz. Works with all counters. Less than 150 mv sensitivity, specify -10 or -100

Wired, tested, PS-1B **\$59.95**  
Kit, PS-1B **\$44.95**

### 30 Watt 2 mtr PWR AMP

Simple Class C power amp features 8 times power gain. 1 W in for 8 out, 2 W in for 15 out, 4W in for 30 out. Max output of 35 W, incredible value, complete with all parts, less case and T-R relay.  
PA-1, 30 W pwr amp kit **\$22.95**  
TR-1, RF sensed T-R relay kit **6.95**

MRF-238 transistor as used in PA-1 8-10db gain 150 mhz **\$11.95**

### Power Supply Kit

Complete triple regulated power supply provides variable 6 to 18 volts at 200 ma and +5 at 1 Amp. Excellent load regulation, good filtering and small size. Less transformers, requires 6.3 V 1 A and 24 VCT.  
Complete kit, PS-3LT **\$6.95**

RF actuated relay senses RF (1W) and closes DPDT relay. For RF sensed T-R relay TR-1 Kit **\$6.95**

### OP-AMP Special

BI-FET LF 13741 - Direct pin for pin 741 comp but 500,000 MEG input z, super low 50 pa input current, power drain.  
**50 for only \$9.00**

78MG	\$1.25
79MG	\$1.25
723	\$ .50
309K	\$1.15
7805	\$1.00

### Regulators

7812	\$1.00
7815	\$1.00
7905	\$1.25
7912	\$1.25
7915	\$1.25

**Shrink Tubing Nubs**  
Nice precut pcs of shrink size 1" x 1/4" shrink to 1/8". Great for splices **50/\$1.00**

**Mini TO-92 Heat Sinks**  
Thermalloy Brand **5 for \$1.00**  
To-220 Heat Sinks **3 for \$1.00**

**Opto Isolators - 4N28 type \$1.50 ea.**  
**Opto Reflectors - Photo diode + LED \$1.00 ea.**

**Molex Pins**  
Molex already precut in length of 7. Perfect for 14 pin sockets. **20 strips for \$1.00**

**CDS Photocells**  
Resistance varies with light, 250 ohms to over 3 meg **3 for \$1.00**

# 73 INTERNATIONAL

from page 82

the 60-year mark this year. They are M. W. Coutts of Auckland and W. M. (Soupy) Groves W5NW, whose original US call in 1923 was U5NW, according to the OTC Directory.

Arthur (Jumbo) Godfrey ZL1HV, retiring president of NZART, was made a Life Member of the Association at the Annual Conference at Dunedin. Jumbo was also recently appointed a Director of IARU Region III Association in the place of Tom Clarkson ZL2AZ, who retired from the position.

Honors: Tom Clarkson ZL2AZ was hon-

ored by Her Majesty Queen Elizabeth in her New Zealand Birthday Honors List, being awarded the medal of Ordinary Member of the Order of the British Empire (M.B.E.) for his services to amateur radio. Tom has had a long association with ham radio since he was first licensed in 1925; he has been NZART President, an NZART Councillor, a foundation Director of IARU Region III Association, and a Life Member of NZART. The recognition by the Queen in her Birthday Honors is well deserved.

Changes to amateur-radio frequency allocations in ZL from August 1, 1983, have been issued by the regulatory body, the New Zealand Post Office. The main

changes are the extension of Grade II licenses and Novice licenses and an extension of the 160-meter band.

Grade II licensees may now operate the 10-meter band between 28 MHz and 29.70 MHz, as well as the other bands previously allocated. The Novice operators have also been allocated a segment of the 10-meter band between 28.10 and 28.60 MHz. The extension of the 160-meter band, which now covers 1800 to 1959 kHz, will be of benefit to Grade I and Grade II operators.

Another change introduced by the NZ Post Office has been the deletion of the Modes of Emission from the Frequency Allocation List. They have placed the responsibility on NZART to set the band plans for each band, based on IARU recommendations, and on all of us to ensure that the mode of emission employed is compatible with other band users and that the bandwidth of the emission is not excessive and does not interfere with oth-

ers. The NZART Frequency Management Working Group has produced a draft proposal for the New Zealand band plan which is in line with the modes of emission that are in use now (the time of writing this is July), and basically there are no changes, just a shift of responsibility in the allocation and implementation of the modes of emission.

The new 18-MHz and 24-MHz bands are still in the pipeline, but there has been a small change in the 10-MHz band. It is now open from 10.10 to 10.15 MHz for Grade I operators only.

There are many alterations in the VHF and UHF bands; nine new bands are being added above 47 GHz as well as many new segments for the Amateur Satellite Service, which corrects the near-tragic outcome of the 1971 WARC Space Conference when meager provision was made for the Amateur Satellite Service. Provision has also been made for the use of certain bands for international traffic at a time of natural disaster. This is a new provision for many countries as a result of WARC-79 Resolution 640, but it is an amateur-radio function that NZART has always supported.

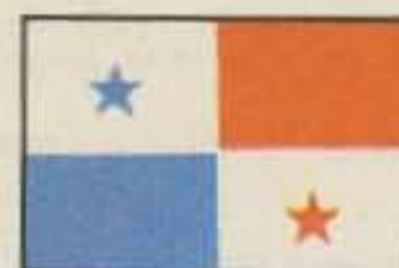

## PANAMA

Miss Dayra Z. Chang HP1AZC  
Apartado 6-1175  
El Dorado  
Panama, Panama

From L. O. Mathieu HP1ALX: Any radio amateur who visits the city of Panama would be very happy with the courtesy and the friendly treatment that radio amateurs offer in this country.

It can be a great surprise for a visitor to see that such a small city with just a little more than half a million inhabitants has been able to produce many repeaters in order to offer better service and communications to radio amateurs. We have in Panama various organizations of radio amateurs which we should mention. Liga Panamena de Radioaficionados has the leadership in Panama because the majority of radio amateurs throughout the Republic are members. We would also like to mention Radio Club de Panama, another outstanding organization, and also Asociacion de Radioaficionados and Club Experimentadores de Colon. There is another organization that we would like to bring to your attention; it is the Club Geminis de Panama. All of its members are also part of the firefighters division of Panama, and as radio amateurs they have been one of the most outstanding clubs in Panama. Finally, I should mention the Canal Zone Amateur Radio Association, an organization that was founded when the United States was administering the Canal Zone territory. Most of the members of this club are US citizens, and it is one of the most active clubs, especially on HF.

With this information, I feel that I have presented a general view of amateur radio in the Republic of Panama, which offers three classes of licenses. Class A is for those radio amateurs who have technical capacity in the electronics field and have passed the correspondent test in addition to the Morse-code and the general-theory exams. Class B is for those who pass only the theory and Morse-code exams. Finally,

## AZDEN

PCS-300 142-150MHZ 3W 8 MEM. HANDHELD..265.95  
PCS-4000 142-150MHZ 25W 16 MEM. MOBILE..265.95

## BUTTERNUT ANTENNAS

2MVCV 2 METER TROMBONE..5/8 WAVE.....29.95  
2MVCV-5 2 METER SUPER TROMBONE.....34.50  
HF6V 10-90M & 30M TRAP VERTICAL.....106.75  
HF6VX AS ABOVE IN SMALLER BOX.....122.00  
TBR-160 160 METER ADD ON KIT FOR HF6V..45.00

## CUSHCRAFT

32-19 144-148MHZ 19 ELEMENT BEAM.....88.41  
AV-4 10,15,20,40M TRAP VERTICAL.....88.41  
AV-5 10,15,20,40,80M TRAP VERTICAL.....95.00  
10-3CD 10M 3 ELEMENT SKY WALKER BEAM.....88.00  
15-3CD 15M 3 ELEMENT SKY WALKER BEAM.....108.85  
15-4CD 15M 4 ELEMENT SKY WALKER BEAM.....115.65  
20-3CD 20M 3 ELEMENT SKY WALKER BEAM.....184.00  
20-4CD 20M 4 ELEMENT SKY WALKER BEAM.....258.50  
40-2CD 40M 2 ELEMENT SKY WALKER BEAM.....272.00  
AMS-147 146-148MHZ MOBILE MAGNET MOUNT..27.95  
ATS-147 146-148MHZ MOBILE TRUNK MOUNT..27.95  
A147-11 146-148MHZ 11 ELEMENT BEAM.....44.25  
A147-20T 144-147 MHZ 20 ELEMENT BEAM.....81.65  
ARX2B 134-164MHZ RINGO RANGER II.....34.00  
A144-11 144MHZ 11 ELEMENT BEAM.....44.25  
A144-10T 145 MHZ 10 ELEMENT TWIST BEAM.....47.60  
A144-20T 145 MHZ 20 ELEMENT TWIST BEAM.....68.00  
214B 146-148MHZ 14 ELEMENT BEAM.....74.80  
214FB 144,5-148MHZ 14 ELEMENT BEAM.....74.80  
CALL FOR PRICES ON OTHER CUSHCRAFT PRODUCTS

## DAIWA/MILLER

CS-201 2 POS. HEAVY DUTY COAX SWITCH..19.85  
CS-401 4 POS. HEAVY DUTY COAX SWITCH..61.25  
CN-520 1.8-60MHZ SWR/POWER METER.....58.95  
CN-620B 1.8-150 MHZ SWR/POWER METER.....103.00  
CN-630 140-450MHZ SWR/POWER METER.....121.00  
CN-720B 1.8-150 MHZ SWR/POWER METER.....145.00  
CNA1001 10-80M AUTOMATIC ANT. TUNER...295.00

## ROTORS & CABLES

HD-73 ALLIANCE HEAVY DUTY ROTOR.....89.00  
U100 ALLIANCE LIGHT DUTY ROTOR.....42.00  
HDR-300 HYGAIN SUPER HEAVY DUTY ROTOR..425.00  
B610 8 CONDUCTOR ROTOR CABLE..PER FT.0.17  
9091 MINI R88 (R88-1).....PER FT.0.16  
9095-100 R88 SUPERFLEX W/FL..259.100FT..29.80  
4063 RG-215 MIL-SPEC COAX.....PER FT.0.28

## HY-GAIN

TH7DXS 10,15,20M 7 ELEMENT BEAM.....335.00  
TH3JRS 10,15,20M 3 ELEMENT BEAM.....140.00  
HQ-2 10,15,20M 2 ELEMENT QUAD.....259.00  
V2-S 2M 5/8 WAVE 3DB GAIN COLLINEAR..34.00  
66-B5 6M 6 ELEMENT BEAM.....106.00  
5DB0 10-80M TRAP DOUBLET.....104.00

## KDK 2 METER RADIOS

FM-2030 143-149MHZ 25W 11 MEMDRY.....265.95

## MINI-PRODUCTS

HQ-1 6,10,15,20M MINI QUAD.....129.50

## MACO POWER SUPPLIES

2006 8AMP SURGE, 6AMP INT., 4AMP CONT..46.00  
2010 12AMP SURGE, 10AMP INT., 6AMP CONT..55.25  
2020 24AMP SURGE, 20AMP INT., 12AMP CONT..69.00  
2030 36AMP SURGE, 30AMP INT., 18AMP CONT..100.00

## MFJ PRODUCTS

MFJ-103 12/24 HOUR CLOCK.....31.45  
MFJ-202 RF NOISE BRIDGE.....51.00  
MFJ-262 1000W DRY DUMMY LOAD.....55.00  
MFJ-311 154-158MHZ CONV. FOR 2M SYN.....41.95  
MFJ-481 50 CHARACTER MEMORY KEYS.....76.00  
MFJ-494 SUPER KEYBOARD 50 CHAR. MEMORY..235.00  
MFJ-496 AS ABOVE WITH 250 CHAR. MEMORY..285.00  
MFJ-722 SUPER SSB/CW FILTER.....58.75  
MFJ-941C ANTENNA TUNER/SWR METER 1:4BAL..75.50  
MFJ-989 3KW ANTENNA TUNER LOADED.....277.00  
MFJ-16010 RANDOM WIRE TUNER.....33.50  
CALL FOR PRICES ON OTHER MFJ PRODUCTS

## MIRAGE AMPLIFIERS

B23 2M FM/SSB/CW 2 IN 30 OUT.....75.50  
B108 2M FM/SSB/CW 10 IN 80 OUT.....151.00  
B1016 2M FM/SSB/CW 10 IN 160 OUT.....235.00  
B3016 2M FM/SSB/CW 30 IN 160 OUT.....201.55  
D1010 430-450MHZ 10 IN 100 OUT.....275.95  
MP1 1.8-30MHZ SWR/WATT METER.....100.00  
MP2 50-200MHZ SWR/WATT METER.....100.00

## TEMPO RADIOS & AMPS

\*\*\*\*\*SUPER SPECIAL\*\*\*\*\*  
S-1 144-148MHZ 1.5W HANDHELD.....239.95  
S-1T S-1 WITH 12 KEY TONE PAD.....259.95  
PRICE ON S-1 & S-1T INCLUDE 5/8 WAVE SUPER  
STICK II & RUBBER DUCK WHILE SUPPLY LASTS  
\*\*\*\*\*  
S-15 140-150MHZ SW 3 MEM. HANDHELD..255.00  
S-15B 150-160MHZ EXPORT MODEL.....307.00  
S-15T S-15 WITH 16 KEY TONE PAD.....274.00  
S-15TB S-15B WITH 16 KEY TONE PAD.....322.50  
ACH-15 AC QUICK CHARGER FOR S-15.....52.80  
CC-15 LEATHER CASE FOR S-15.....22.50  
BP-15 SPARE BATTERY FOR S-15.....25.75  
HM-15 SPEAKER MIKE FOR S-15.....30.50  
S-30 30 WATT AMP FOR 2M HANDHELDS..80.00  
S-80 80 WATT AMP FOR 2M HANDHELDS..135.00

## TEN-TEC

(NEW) TENTEC 2M HANDHELD.....270.00  
ARGOSY 10W/100W SSB/CW 10-80M W/30M..510.00  
CORSAIR 200W SSB/CW 10-160M W/WARC...999.00  
HERCULES 1KW AMP WITH 115/230 VAC P/S..1595.00

## VOCOM PRODUCTS

20025-2W 2M FM AMP 2 IN 25 OUT.....65.00  
20050-2W 2M FM AMP 2 IN 50 OUT.....96.00  
20100-2W 2M FM AMP 2 IN 100 OUT.....154.00

## WILSON BY MACO

SY-33 10,15,20M 3 ELEMENT BEAM.....194.00  
SY-36 10,15,20M 6 ELEMENT BEAM.....259.00  
33-6M 40 METER ADD ON FOR ABOVE.....67.95  
WV-1A 10-40M TRAP VERTICAL.....69.00  
GR-1 GROUND RADIAL KIT FOR WV-1A.....27.00

CALL FOR QUOTES ON  
OTHER RELATED PRODUCTS  
FOB ORIGIN

Amateur  
Equipment,  
Accessories  
& Antennas.  
Export Anywhere

2317 Vance Jackson Rd.  
San Antonio TX 78213

(512) 733-0334

(Toll free number 800-531-5405)



COD Available

Hours: 8:30 a.m. to 5:00 p.m. Monday thru Friday  
9:00 a.m. to 2:00 p.m. Saturday - CST  
Prices subject to change without notice.

ALL ITEMS ARE  
GUARANTEED OR SALES  
PRICE REFUNDED.  
PRICES F.O.B.  
HOUSTON  
PRICES SUBJECT TO  
CHANGE WITHOUT  
NOTICE  
ITEMS SUBJECT TO  
PRIOR SALE.



# MADISON Electronics Supply

## KENWOOD

TS930S ..... The best in its class  
TS430S Survivor of the Armadillo Run  
FM430 ..... 49.00  
Filters ..... 60.00  
We'll install accessories at no charge  
and check out the rig.  
TS530S ..... 639.00  
MC60A ..... 79.00  
NEW TS780 VHF-UHF TW4000A  
FC-10 Controller

**ALPHA 76PA** ..... \$1690.00  
**BENCHER ZA1A** ..... 17.00  
ZA2A ..... 21.00  
**SAMS CB Photofacts (stock only)** ..... 2.00  
**TENTEC 2591 Handie Talkie** ..... 279.00  
Corsair ..... 1025.00  
Argosy ..... 519.00  
**AMPHENOL PL259 silverplate** ..... 1.25  
UG176 ..... .30  
831J double female ..... 2.00  
82-61 N male ..... 3.00  
**ALPHA DELTA MACC**  
Transitrips ..... -10% stock  
**VALOR 1/4 + 5/8 Mag Mount**  
2M Ant ..... 25.00  
**BUGCATCHER All-band ant coil** ..... 45.00  
Single-band coils ..... 39.00  
**JANEL, WELZ, SHERWOOD,**  
**FOX TANGO** ..... 10% off  
**DRAKE TR5** ..... 599.00  
**SANTEC ST7T** ..... 230.00  
**SIGNAL ONE Milspec 1030** ..... 4995.00  
**AEA MM2** ..... 149.00  
CK2 ..... 129.00  
KT2/KT3 ..... 99.00 ea.  
**HAL ST6K** ..... 229.00  
**TOKYO HYPOWER**  
HC200 Tuner ..... 89.00  
HC2000 Tuner ..... 289.00  
HL10160V Amp ..... 289.00  
HL30160V Amp ..... 249.00  
**KDK 2030 2MFM** ..... 259.00  
**SANTEC ST144µP** ..... 279.00  
ST440µP ..... 289.00  
ST7T ..... 230.00

**MAXON 49S**  
TX FM Headset Vox ..... 39.95 ea.  
**SHERWOOD/WELZ** ..... 10% off list  
**ROCKWELL KWM380** ..... 3995.00  
**COAX SEAL QSL holder** ..... 2.00  
**BENCHER ST2**  
Chrome single lever ..... 45.00  
**BIRD 43 & elements** ..... Stock  
**JERSEY SPECIALTY RG213** ..... 29c/ft.  
RG8X ..... 14c/ft.  
450 ohm open wire ..... 20c/ft.  
**AMPHENOL PL259 silverplate** ..... 1.25  
**VAN GORDON Dogbone insulator** ..... 50c  
**WORLD RADIO TV handbook** ..... 17.50  
**VIBROPLEX** ..... 10% off list  
**BELDEN CABLE 9258 RG8x** ..... 19c/ft.  
8214 RG8 foam ..... 40c/ft.  
8237 RG8 ..... 36c/ft.  
8235 300 Ohm kW twinlead ..... 20c/ft.  
8000 14 Ga. stranded ant. .... 12c/ft.  
8267 RG213 ..... 49c/ft.  
8448 rotorcable ..... 29c/ft.  
9405 heavy rotor cable ..... 49c/ft.  
9888 ..... 70c/ft.

**PARTS**  
TCG 2.5A/1000 PIV epoxy diode ..... 19c  
Sprague 500 pF/30kv  
doorknob capacitors ..... 16.00  
1000pF/500V Feedthru ..... 1.95  
CDE .001/20kV ..... 1.95  
6"x9" copper board ..... 2.00  
Resistors 1/4, 1/2, 1, 2 Watt ..... 10c ea.  
Caps to 1MFD, 100V ..... 25c ea.  
**USED** - Subject to prior sale  
**COLLINS 75A4** ..... 295.00  
75S1 ..... 200.00  
32S1/AC ..... 350.00  
**DRAKE TR4C/AC4** ..... 395.00  
RV4C ..... 100.00  
**ALPHA 374** ..... 1200.00  
**KENWOOD TS520S (gem)** ..... 395.00  
**RF POWER LABS**  
A1000, C500X demos ..... 995.00  
**COLLINS KWS1/75A4 parts** ..... Call  
75S1/32S1 Parts ..... Call

## COMPUTERS

### PACKAGES

**#1 AEA CP1, VIC 20 Computer, Kantronics  
Hamssoft, with cables to fit your radio** \$325.00  
**#2 Above Package**  
with Kantronics Hamtext ..... 375.00  
**#3 MFJ 1224, Kantronics Hamssoft, VIC 20  
Computer, and cables for your radio** 225.00  
**AEA AMTOR + CW Receive** ..... 579.00  
**IRL FSK500** ..... 269.00  
FSK 1000/1020A AFSK ..... 575.00  
**AEA CP1** ..... 199.00  
**KANTRONICS interface** ..... 139.95  
**MFJ 1224** ..... 79.95  
10% off on Software in Stock

## YAESU

FT980 Transceiver  
(Best receiver in HF) ..... 1299.00  
FT77 ..... 499.00  
FT726R ..... 699.00  
accessories in stock  
FT208RA ..... 269.00

hy-gain

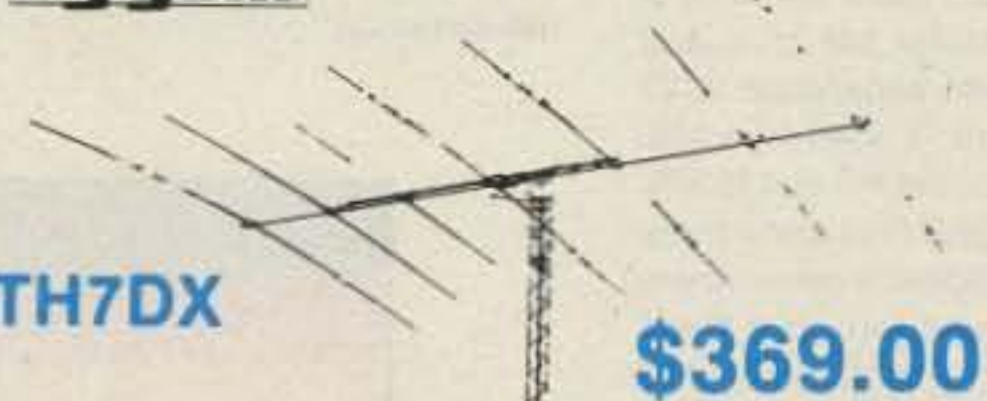

TH7DX

\$369.00

NEW



ICOM IC-37  
25W 220 Rig

TENTEC 2591  
Handie Talkie

\$279.00



YAESU

FT-757

NEW Medium Price  
\$829.00 Retail

General coverage receiver, CW filter, AM/FM  
Module, Microphone, Full break-in CW, Keyer  
FC 757 Automatic Antenna Tuner  
FP757 AC Supply  
Available shortly

## SSTV ROBOT

800 (limited) ..... 447.00  
1200C ..... 1139.00  
450C/800C each ..... 789.00  
400C Kit ..... 469.00  
800C Kit ..... 155.00

## ANTENNAS

DB+Enterprises 2 element QUAD  
in stock ..... \$275.00  
HF6V ..... 125.00  
2M CV-5 ..... 39.00  
6BTV ..... 139.00  
G7 144 ..... 108.00  
TH7DXS ..... 369.00  
7-10 Kit ..... 79.95  
Explorer 14 ..... 279.00  
HD73 ..... 99.00  
Ham4 ..... 199.00  
B&W AV25 10-80 vert ..... 85.00  
A3 ..... 219.00  
A4 ..... 289.00  
V2S Oscar ..... 39.00  
435 16TB ..... 58.00  
144-20T twist ..... 74.00  
ARX2B ..... 38.00  
HG52SS Hygain/Telex 52' self supporting  
crank-up tower to hold 9.5 sq ft at 50 mph  
Rotor mount inside top section. Nested ht  
20.5 feet ..... 939.00

## Big LCD Clock



\$29.95 + \$1.50 shipping.

GMT/Local twin display,  
black frame with large,  
easy-to-read display  
(.6" high)  
Batteries included.

## HAM TAGS

\$12.95 +  
\$1.50 shipping.



**DON'S CORNER:** Our Hurricane Alicia left us with a  
batch of wet antenna boxes (usable antennas inside).  
One of the windows blew out right over the antenna  
department. Take the lowest nationally advertised  
price you can find, deduct 20%, add suitable shipping  
or call us with your charge card & we'll check stock for  
you. Items are subject to prior sale, but we got a bunch  
of them!  
We have a great line-up of repair techs. The crew  
looks like this:  
Tech #1 Kenwood, Icom, Yaesu VHF-UHF + the new  
digitals  
Tech #2 Older tube Kenwoods, Yaesus and older  
transistor HF's  
Tech #3 Drake, C lines, Swan, Galaxy, Tempo  
Tech #4 S line and KWM2  
Tech #5 KWM 380 and ETO ALPHA  
**Madisonnote:** The first Saturday of each month we  
have a sidewalk sale. Bring your surplus and try to sell  
it to fellow amateurs.

1508 McKINNEY  
HOUSTON, TEXAS 77010

\*CALL FOR QUOTES  
713-658-0268

We stock what we advertise, and much more.  
TOLL FREE-ORDERS ONLY  
1-800-231-3057

we have Class C for those who pass only the general-theory exam. This license cannot be renewed and expires after one year. Non-Panamanian citizens also can obtain these licenses if there is mutual agreement between the two countries.

Panama is a country where the radio amateurs are well appreciated because they have always been hard-working people in emergencies and catastrophes of any nature.



## POLAND

Jerzy Szymczak  
78-200 Białogard  
Buczka 2/3, Poland

### EQUIPMENT

The rapid development in radio communications makes radios become out of date quickly, and it is difficult to win contests without the latest gear. In countries where there are hundreds of thousands of hams, many manufacturers compete with one another to sell more and more advanced equipment.

But in Poland, where there are only 12,000 or so hams, the situation is quite different. If they have the money, Polish hams buy American- or Japanese-made products. But if that is not the case, they construct their transmitters themselves. Individual construction is nearer to the spirit of amateur radio than buying ready-made gear; in the past, designing and building stations contributed significantly to the advancement of the state of the art. At any rate, no Polish plant makes radios for hams, and very few amateurs can buy gear from abroad.

So how do they shift for themselves? Radio amateurs belonging to the Polish Scouts Association have some opportunities to obtain gadgets from military stores. Most often, they are given obsolete gear needing repair. Other hams find schematics of transceivers in magazines such as *Radio Electrician*, and some hams publish their ideas.

Recently, the bulletin of the PRAA (Polish Radio Amateurs Association) contained details of a 5-band shortwave receiver, a 10-MHz heterodyne receiver, and a frequency synthesizer. In bulletin no. 4, there is a description of a new version of vfo and a mixer. Usually, the lack of parts makes building foreign designs impossible. In technical magazines, one occasionally comes across information on Polish parts. For example, in May it was announced that new 9-MHz SSB filters are being produced. These substitutes for the renowned XF-9B are being made by Omig, which will also be making PP-9-A1, PP-9-A2, and PP-9-A3 filters.

As you can see, things look rather gloomy, but the Technical Commission of the PRAA has worked out a plan for improvement in the near future. It was decided to put up more measuring laboratories which will enable hams to convert military surplus and test transceivers manufactured in Poland. For example, Zwus will soon be manufacturing an AM heterodyne receiver, a reflectometer, an electronic switch, and the 12 AVQ aerial. The Technical Commission will get professional equipment which is no longer in use and will distribute it to radio amateurs

through the PRAA District Departments. To discover the needs of radio amateurs, two polls were conducted and published in the bulletin of the PRAA. One of the polls referred to the general needs and finances of Polish hams. Every ham in the survey answered questions relative to his wants and needs in components, conductors, cables, sub-assemblies, and test equipment. Additional polls will ask about needs for services, documentation, and technical literature.

The Technical Commission appealed to all radio amateurs for cooperation and asked all industrial electronics plants to begin producing the basic equipment. We hope that as a result of Poland's economic reforms, some plants might say yes.



## SWEDEN

Rune Wande SM9COP  
Frejavagen 10  
S-155 00 Nykvarn, Sweden

### SATELLITE-REPEATER COLLISION

The European (Region 1) frequency allocation on 2 meters is 144.0-146.0 MHz, only half of the 2-meter band in America (Region 2). A rapidly-growing ham population using 2-meter repeaters has emphasized the need for more repeater channels.

In Sweden, as well as in the other Region 1 countries, there are only 10 repeater channels, designated R0 through R9. Here we usually say only the repeater output frequency, contrary to common US practice to say both the input and output frequencies, e.g., 21/61 for 146.21 in and 146.61 out. Our channel separation is 25 kHz and repeater input is always -600. Channel R0 is 145.600 and R9 is 145.825. All Japanese 2-meter gear is made in three versions, one for the home market where no repeaters are allowed (yet), one E-version for Europe, with limited frequency coverage but with a 1750-Hz tone oscillator as repeater-opener, and one A-version for America.

With the Phase IIIB satellite up and active, severe interference is expected within the repeater coverage for channels R8 and R9, 145.800 and 145.825 MHz respectively.

### Solutions

The widely-discussed solution to this problem is to abandon channels R8 and R9. This would mean a remaining maximum of only eight repeaters in a wide area in order not to cause unnecessary interference. Those living in densely-populated areas in the US and elsewhere who can easily access twenty or more repeaters can imagine the problem. There is heavy opposition against moving repeaters 1 MHz lower, i.e., into the 144-MHz band segment, which furthermore is against the Region 1 band plan.

What else? Well, the probable solution will be repeaters on so-called X-channels, i.e., channels split by 12.5-kHz separation. The industry already has European versions of 2-meter equipment capable of this new channel separation. However, interference from repeater channels on both sides is to be expected with existing equipment having a frequency swing designed for 25-kHz separation. In the beginning, repeater traffic on 145.800 and 145.825 MHz will be shared with satellite

traffic, but these two frequencies will probably be abandoned eventually.

### QRZ VS. CQ

Or, what's wrong with an old-fashioned CQ call? We sure live in a rapidly changing world. However, sometimes you hesitate and think for a while. Habits change; language changes as well as usage. Dialing across the bands, especially during an SSB contest, gives you a chance to observe the operating techniques used. In such a contest, you more and more often hear "QRZ Contest," and a regular "CQ Contest" is getting rare. According to the Q-code abbreviations, QRZ? means "Who is calling me?" Many of those using QRZ instead of CQ should never get a QSO if the answering station would respect what QRZ? stands for! Is maybe the feeling of being a "big gun" driving us to change old practice? Who will admit that they have to call others? No, probably it is higher status giving the impression that others are always calling them. Would you call this radio-amateur psychology?

### DX BULLETIN

SK3SSA is one of many stations transmitting bulletins for radio amateurs in Sweden. This bulletin station is operated by Lars SM3AVQ and transmits in RTTY. There are other SSA bulletin stations on both HF and VHF, on CW, SSB, and FM. Through voluntary efforts by a few dedicated hams in Scandinavia, we can enjoy the superb weekly "DX Bulletin" issued by the Southern New England DX Association. In Denmark, OZ1DJY picks up the RTTY bulletin on 20 meters at midnight local time. During the week, he retransmits it to SM3CFV, who sees to it that the "DX Bulletin" can be added to the domestic "SSA Bulletin" on RTTY each Sunday morning on 80 meters. An excellent service where RTTY is the perfect mode of transmission.



## WEST GERMANY

Ralf Beyer DJ3NW  
Opferkamp 14  
3300 Braunschweig  
West Germany

### TELEGRAPHY

A lot has been written and said in support of or against CW. But the net outcome is that there is no significant sign of shrinking CW activity, and the CW enthusiasts are getting more organized in order to promote CW. Their arguments are numerous, e.g., better utilization of the frequency spectrum, minimal equipment needs, last chance if everything else fails, and so on. The argument I like best is "CW is fun," and so do many who contribute to the promotion of CW.

Various groups and clubs have been formed in order to support CW. All of them have a common denominator in their by-laws: Telegraphy (CW) is considered the process of mental coding and decoding of information in Morse code—no machines like keyboards and CW readers are allowed. Assistance is offered to all who are interested in learning the code, and adherence to the recommendations of IARU and the regulations of the respective national radio society is mandatory.

Typical activities of the German "Activity Group Telegraphy—DL" (AGCW-DL),

for example, are rag-chewing, QRP experiments, CW training courses on the air, CW bulletins, contests, awards, and regular meetings. This group has about 1000 members. The individual national AGCWs in Europe are members of the European CW Association (EUCW), a multi-national organization. Everybody interested in the promotion of CW is invited to join the AGCWs, and no particular proficiency level is required. Foreign hams may apply for an associated membership in AGCW-DL, which is free of charge. The point of contact is Ilse Mueller DL5MAI, Stoffelsberg 3, D-8860 Noerdlingen, Federal Republic of Germany.

The High Speed Club (HSC) founded in 1951 is another CW group. It follows the same fundamental guidelines mentioned earlier but requires some personal achievement in CW by its members. In order to join HSC, one should be able to complete a CW QSO of 30 minutes duration at 25 wpm with solid copy and excellent keying. Five recommendations by HSC members confirming this achievement and 8 IRCs are all you need to apply for membership. Again, membership is free of charge. Therefore, do not confuse HSC with groups using similar logos and charging annual fees.

The HSC is also a member of EUCW and has more than 1100 members in 48 countries. Its club station, DL0HSC, is active on all bands and issues the special DOK number, HSC, for the DLD award. The point of contact is Ernst Manske DL1PM, Ansgarstrasse 14, D-2105 Seevetal 11, Federal Republic of Germany.

"Outrageous" may be your comment regarding a speed of 25 wpm. But there are thousands of hams who communicate regularly at this and even higher speeds comfortably. And there is much more in store. Once you have mastered 40 wpm, you may join the Very High Speed Club (VHSC) administered by PA0DIN, D. J. Hoogma, Schoutstraat 15, 6525 XR Nijmegen, The Netherlands. And in case you are looking for further challenges, ask ON5ME about the super and extremely high speed clubs, SHSC and EHSC! In any case, being a high speed fan or not, it is fun to celebrate the art of CW, to promote it by good operating practices, to give a hand to those who want to participate, and eventually to join one of the groups signaling "CW spoken here."



## TAIWAN

Tim Chen BV2A/BV2B  
PO Box 30-547  
Taipei, Taiwan  
Republic of China

### FLASH

The Chinese Telecommunications Authority has finally approved the request of Italian hams to operate their rigs and calls followed by BV portable. So far, there is no further information received from the ARI about their boys' departures and arrivals. They are required to contact CRA (China Radio Association) for necessary arrangements in this regard.

It has also been learned that permission will be given to a PA ham to be the second operator in the BV2A if he holds a valid and equivalent license issued by his government to operate on 14 and 21 MHz.



# WORLD CLASS

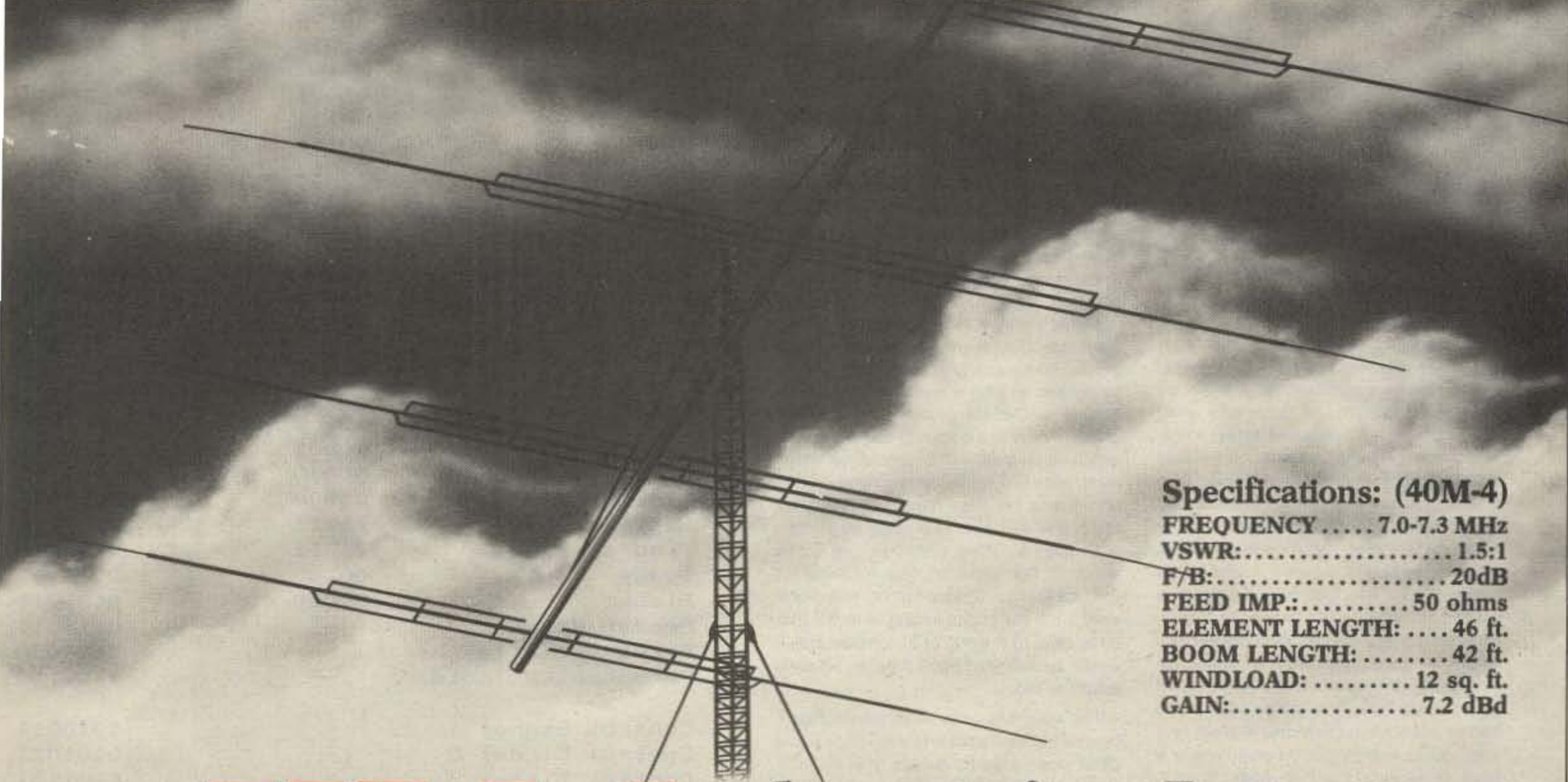

**Specifications: (40M-4)**  
 FREQUENCY ..... 7.0-7.3 MHz  
 VSWR:..... 1.5:1  
 F/B:..... 20dB  
 FEED IMP.:..... 50 ohms  
 ELEMENT LENGTH: .... 46 ft.  
 BOOM LENGTH: ..... 42 ft.  
 WINDLOAD: ..... 12 sq. ft.  
 GAIN:..... 7.2 dBd

## **KLM** electronics, Inc. *Full Line Performance*

The incredible performance of the World Class KLM 40M-4 is used by many DX'ers as a "Standard of Comparison" in Competitive Antenna Equipment.

Obviously, not everyone needs this type of Awesome performance, but its nice to know that the same performance proven design theory and quality construction have been carried over into our full line of quality antennas for all frequency ranges.

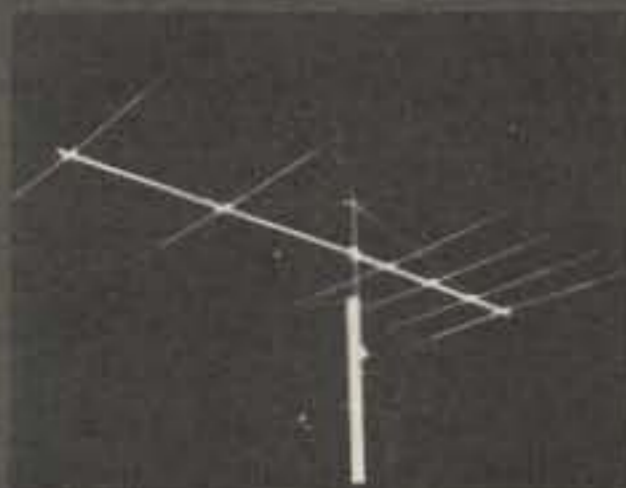

**Specifications: (20M-6)**  
 BANDWIDTH: ... 13.9-14.4 MHz  
 VSWR:..... 1.5:1  
 F/B..... 35 dB  
 FEED IMP.:..... 50 ohms  
 ELEMENT LENGTH: .... 37 ft.  
 BOOM LENGTH: ..... 57 ft.  
 WINDLOAD:..... 12.8 sq. ft.  
 GAIN:..... 11 dBd

*And there's more!*

See your local dealer or write to KLM, Electronics,  
 P.O. Box 816, Morgan Hill, CA 95037.

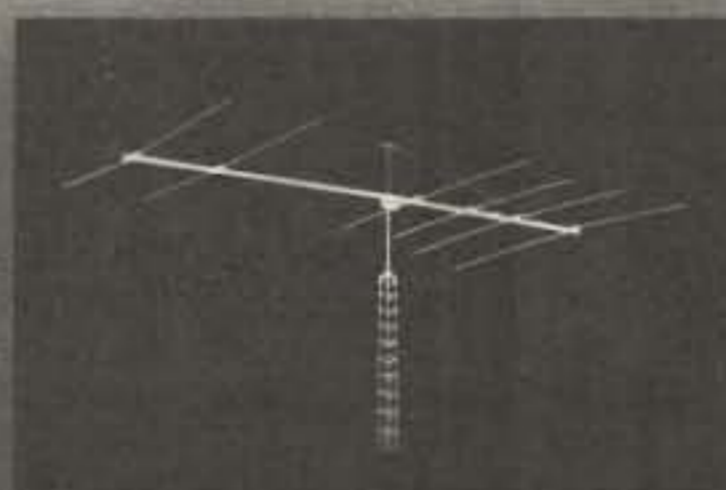

**Specifications: (30M-3)**  
 BANDWIDTH:... 10.1-10.150 MHz  
 VSWR:..... 1.5:1  
 F/B..... 20 dB  
 FEED IMP.:... 50 ohms unbal.  
 ELEMENT LENGTH: .... 35'6"  
 BOOM LENGTH: ..... 24'3"  
 WINDLOAD: ..... 7 sq. ft.  
 GAIN: ..... 7.0 dB

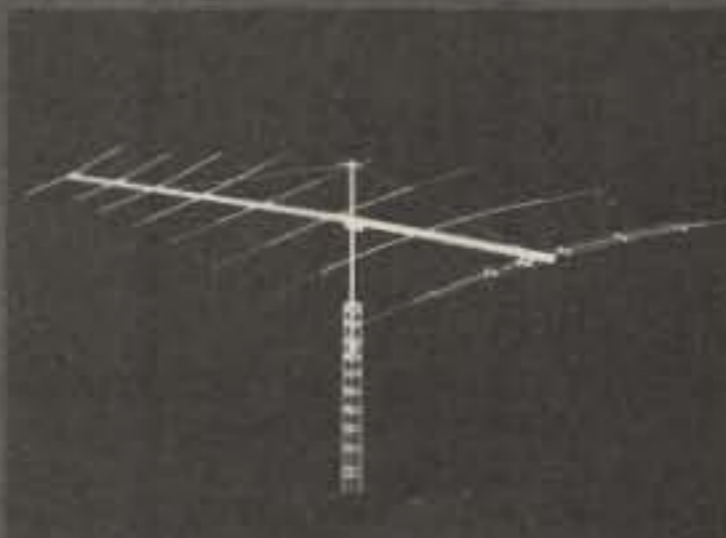

**Specifications: (15M-6)**  
 BANDWIDTH: ... 21.0-21.5 MHz  
 VSWR:..... 1.5:1  
 F/B: ..... 30 dB  
 FEED IMP.:..... 50 ohms  
 ELEMENT LENGTH: .... 25 ft.  
 BOOM LENGTH: ..... 36 ft.  
 WINDLOAD:..... 8.5 sq. ft.  
 GAIN:..... 10.5 dBd

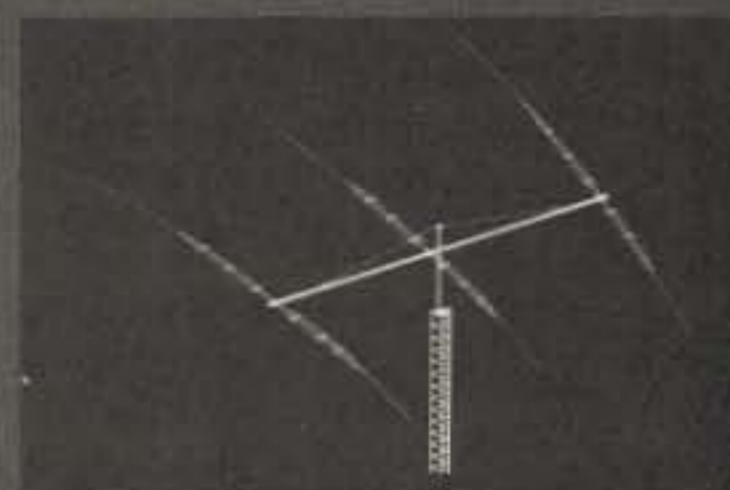

**Specifications:**  
**(7.2/10-30-7LPA)**  
 BANDWIDTH: .. 7.2/10-30 MHz  
 VSWR: ..... 2:1 typical  
 F/B:..... 10/15  
 FEED IMP.:... 50 ohm unbal.  
 ELEMENT LENGTH: .... 46 ft.  
 BOOM LENGTH ..... 42 ft.  
 WINDLOAD: ..... 12 sq. ft.  
 GAIN..... 3/7 dBd typical

# RTTY LOOP

Marc I. Leavey, M.D. WA3AJR  
6 Jenny Lane  
Pikesville MD 21208

Ever play this game? Take one letter—let's say "V". Well, that is either the first few bars of Beethoven's fifth or a common test signal on CW. Two letters? How about those two, back there—CW; or, being involved with radioteletype, we could use its test signal, RY. Three letters? That's easy—FSK. And four letters can be either AFSK or, you asked for it, RTTY! But how about five letters? This month we will take a look at five of the hottest letters to hit RTTY, and they spell AMTOR.

Let's start out by dropping back a bit and examining some of the fundamentals of radioteletype communications. As we have noted before, the commonly used RTTY code is the five-level Murray, sometimes called Baudot, code. Each letter is represented by a unique five-bit code, with most of the codes doubling to represent a figure or punctuation, by use of a shift into a second character set. One of the basic problems with this scheme is that in the world of radio, interference is a given. It is easy to see what would happen to a character code if any of the five bits were randomly changed from mark to space, or vice versa—the resulting character would be incorrect. Now, it might be possible to find or correct the character in plain text copy, using sophisticated computers or a good proofreader; but in code groups, data, or weather reports this would be impossible.

Various schemes have been devised to allow for error correction of bit-mangled characters. One technique, used with the American Standard Code for Information Interchange (ASCII), is to add a "parity" bit at the end of the character code. This extra bit is set at either a space (0) or mark (1), determined by the number of marks or spaces within the character code. The end result is to produce either an odd or even number of set (mark) bits. The result is termed odd, or even, parity, respectively.

Used over closed systems, this parity bit gives a remarkable improvement in accuracy. The receiving station is set up to reject any character in which the parity is not correct, and initiate a request for the sending station to repeat the letter or group. Just how this request is accomplished varies with the system, and since we will be getting into a parallel system with AMTOR later, I will not go into computer details here.

The problem with the parity bit is that if multiple bits are messed up, as might well

happen with a noise burst, the computed parity may still be correct. Another, more sensitive, technique for error correction is needed for radioteletype, particularly on high-frequency, noise-prone circuits. Devised for commercial telex circuits, a system for Teleprinter Over Radio (TOR) has been established as an international standard. When adapted for amateur use, this system, which goes by many proprietary names, is called AMTOR. In order to error-proof the system as much as possible, a seven-unit code is used. Rather than depend on one parity bit, however, only combinations of four marks and three spaces are used. Thus, inverting one or more bits is highly unlikely to produce another recognizable (four-mark, three-space) code group. Additionally, code groups should be chosen so that a one-bit change or inversion would not produce a legitimate group. This is analogous to the Gray code, which is a modified binary code which eliminates ambiguity by removing one-bit transitions between digits. Of the total 128 codes available to a seven-bit system (2 to the 7th), there are 35 unique codes which fit the above criteria. Allowing for the fact that a standard Murray teleprinter uses all of the codes available to the five-bit code (2 to the 5th, or 32, characters), it would appear that such a seven-bit code would do nicely.

The resultant code is shown in Fig. 1, comparing the familiar Murray code to the CCIR code used in various TOR circuits. Observant individuals will notice that there are three Control Signal codes given after the 35 noted above, and that these do resemble some other of the codes used for letters. Well, these codes are used in a rather special fashion, which I shall be going into, and are unlikely to be confused with the letter codes when used in that way.

If all we had right now were the seven-bit codes for each letter, with some means of built-in error correction, that would be nice, but there is more. Imagine two operators talking to each other, using any mode you please, sending traffic. Now these are exceptionally well-trained operators, and at the end of each line of the message the sending station breaks for a confirmation. A quick QSL is issued to confirm receipt of each line, or a SAY AGAIN or IMI (CW for "?") is used to request a repeat of a garbled line. The sending station obeys the receiving station's request 100% of the time, and no errors are ever made in a message again. Of course, if the sending station did not hear the receiving station's answer, he would respond with "WHAT?"; the receiving sta-

Letters	Figures	Murray	AMTOR
A	-	11000	1110001
B	?	10011	0100111
C	:	01110	1011100
D	\$	10010	1100101
E	3	10000	0110101
F	!	10110	1101100
G	&	01011	1010110
H	stop	00101	1001011
I	8	01100	1011001
J	'	11010	1110100
K	(	11110	0111100
L	)	01001	1010011
M	.	00111	1001110
N	,	00110	1001101
O	9	00011	1000111
P	0	01101	1011010
Q	1	11101	0111010
R	4	01010	1010101
S	bell	10100	1101001
T	5	00001	0010111
U	7	11100	0111001
V	;	01111	0011110
W	2	11001	1110010
X	/	10111	0101110
Y	6	10101	1101010
Z	+	10001	1100011
Carriage Return		00010	0001111
Line Feed		01000	0011011
Letters Shift		11111	0101101
Figures Shift		11011	0110110
Space		00100	0011101
Blank		00000	0101011
Repeat Request		-	0110011
Permanent A (alpha)		-	1111000
Permanent Z (beta)		-	1100110
Control Signal 1		-	1010011
Control Signal 2		-	0101011
Control Signal 3		-	1001101

Fig. 1.

tion, presuming he did not get the last block, would send "SAY AGAIN", to which the sending station would respond either "WHAT??" or "SAY AGAIN WHAT?" and the whole thing would go around again. You get the picture.

With people on each end, the whole thing could be resolved with one quick sentence or so. But if we are going to automate this thing, a better form is needed. That is where those Control Signals come in. After some experimentation, it was formulated that the receiving station should respond to each received block with Control Signal 1 (CS1) and CS2 alternately. Thus, receipt of a duplicate Control Signal by the sending station indicates non-receipt. If the sending station does not receive the receiving station's response, it sends a request for signal repetition (RQ) instead of more data. The third Control Signal, CS3, is used to transfer assignment of the sending- and receiving-station status to the other station. In this way, either station can send or receive, alternately, with the other station concurrently confirming receipt.

So what we have at this point is a system which allows the receiving station to tell if the information received is valid, and to automatically request a repeat from the sending station if it is not. But we have done this at the expense, if you will, of two more bits of data to be sent per character. Now, if we are talking about "standard" 60-wpm RTTY, where each data pulse is 21 ms long, this would lengthen each character, now composed of seven data pulses, a start pulse, and a stop pulse, by about 25%, slowing the rate of

transmission to a dismal (in this computer age) 45 wpm. Snore city!

Well, the way to deal with this is by eliminating those start and stop pulses, and speeding the whole thing up anyway so that the error correction becomes less a hindrance, and essentially transparent. Now, let me back up for a bit to explain. Conventional, if I may call it that, RTTY is known as a "start-stop," or asynchronous, system. That means that each character is an entity unto itself, starting and stopping within carefully defined limits. The system may idle for an indeterminate length of time, with a new character arriving at any time, heralded by a start pulse and ending with a stop pulse, which itself merges into the idle state. Contrast that with a synchronous system, where each character is assigned a precise time slot for its existence. By synchronizing clocks at the sending and receiving end, it is possible to eliminate the start and stop pulses by presuming that a character will be sent during a certain window of time, only. Clearly, loss of synchronization between sending and receiving stations will reduce a signal sent synchronously to garble, but there are ways of minimizing these problems.

So what do we now have? A synchronous, error-correcting way of sending RTTY which can be made to look like Murray, but which can far exceed the older system's reliability. In January we will look into AMTOR some more, and I would appreciate any of you using the technique penning me a note letting me know what you think of it. Next month, our December shopping list, a regular feature of RTTY Loop.

## MULTI-BAND SLOPERS

160, 80, and 40 meters

Outstanding DX performance of slopers is well known. Now you can enjoy 2 or 3 band BIG-SIGNAL reports! Automatic bandswitching • Very low SWR • Coax feed • 2kw power • Compact • Ground or tower feed • Hang from any support 25 ft. high or higher • Easy to install • Very low profile • Complete instructions • Immediate shipment • Check ok

3 BAND SLOPER - 160, 80, & 40 Meters - 60 ft. long \$ 43.00 frt. p.p.d.

2 BAND SLOPER - 80 & 40 Meters - 41 ft. long \$ 30.00 frt. p.p.d.

3-BAND NO TRAP DIPOLE, 160, 80, & 40M - 113ft. long \$ 66.00 frt. p.p.d.

2-BAND NO TRAP DIPOLE, 80, & 40M - 84ft. long \$ 49.00 frt. p.p.d.

FOR ADDN'L INFO on these and other unique antennas: send SASE

W9INN ANTENNAS  
BOX 393-S MT. PROSPECT, IL 60056



## Stuck with a problem?

Our TE-12P Encoder might be just the solution to pull you out of a sticky situation. Need a different CTCSS tone for each channel in a multi-channel Public Safety system? How about customer access to multiple repeater sites on the same channel? Or use it to generate any of the twelve tones for EMS use. Also, it can be used to access Amateur repeaters or just as a piece of versatile test equipment. Any of the CTCSS tones may be accessed with the TE-12PA, any of the audible frequencies with the TE-12PB. Just set a dip switch, no test equipment is required. As usual, we're a stickler for fast delivery with a full 1 year warranty.

Output level flat to within 1.5db over entire range selected. Immune to RF.

Powered by 6-30vdc, unregulated at 8 ma.  
Low impedance, low distortion, adjustable sinewave output, 5v peak-to-peak.  
Instant start-up.

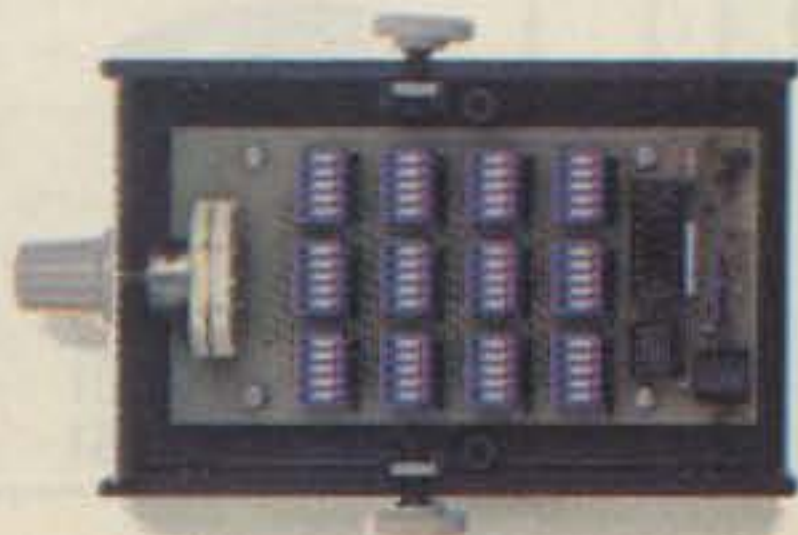

### TE-12PA

67.0 XZ	85.4 YA	103.5 1A	127.3 3A	156.7 5A	192.8 7A
71.9 XA	88.5 YB	107.2 1B	131.8 3B	162.2 5B	203.5 M1
74.4 WA	91.5 ZZ	110.9 2Z	136.5 4Z	167.9 6Z	
77.0 XB	94.8 ZA	114.8 2A	141.3 4A	173.8 6A	
79.7 SP	97.4 ZB	118.8 2B	146.2 4B	179.9 6B	
82.5 YZ	100.0 1Z	123.0 3Z	151.4 5Z	186.2 7Z	

- Frequency accuracy,  $\pm 1$  Hz maximum  $-40^{\circ}\text{C}$  to  $+85^{\circ}\text{C}$
- Frequencies to 250 Hz available on special order.
- Continuous tone

### TE-12PB

TEST-TONES:	TOUCH-TONES:	BURST TONES:
600	697 1209	1600 1850 2150 2400
1000	770 1336	1650 1900 2200 2450
1500	852 1477	1700 1950 2250 2500
2175	941 1633	1750 2000 2300 2550
2805		1800 2100 2350

- Frequency accuracy,  $\pm 1$  Hz maximum  $-40^{\circ}\text{C}$  to  $+85^{\circ}\text{C}$
- Tone length approximately 300 ms. May be lengthened, shortened or eliminated by changing value of resistor

**\$89.95**

15

**COMMUNICATIONS SPECIALISTS**

426 West Taft Avenue, Orange, California 92667  
(800) 854-0547/California: (714) 998-3021



# PRECISION PROCESSING



The E-CLIPS Model III

Provides total dynamic range control with very low distortion

- Selectable processing modes—envelope compression or peak limiting
- Variable high and low frequency response equalization
- Five segment LED display
- Easy to install and use with any transmitter/transceiver

Introductory price—\$189.95 ppd.

For brochure with complete technical specifications contact:

**ANALOG TECHNOLOGY**

P.O. Box 8964 • Fort Collins, CO 80525 ✓109



M/C  
Visa

\$129.95

## NEW! HF WATTMETER

- Digital Resolution (0.1 or 1 Watt)
- Wideband (160 through 10 meters)
- Wide range (QRP to 1999 Watts)
- Detachable (RF Sampler un-plugs)
- Battery Saver turns off minutes after RF disappears
- Price includes—Readout, HF Sampler, battery, VSWR nomogram and complete schematics.
- 90 day warranty

✓219

write or call:

e-tek P.O. Box 625, Marietta, OH 45750  
1-(614)-374-2280



## YOU EARNED YOUR CALL!

NOW DISPLAY IT PROUDLY  
IN A TOP QUALITY  
LACOSTE-TYPE KNIT SHIRT.

ONLY \$14.00 With your call in rich embroidery.

\$1.50 extra for first name. Choose from 10 great colors: rust, cream, brown, green, yellow, navy, lt. blue, aqua, white, and black.



Adult sizes only S-M-L-XL Club and dealer inquiries invited. Please add \$2.00 for P/H. Make check or money order payable to:

**Coin Int'l Inc.**

2305 N.W. 107 Ave.

Miami, Fl. 33172 ✓13



Allow 4 weeks for delivery Fl. residents add sales tax

## PROPAGATION PREDICTIONS

ON YOUR HOME COMPUTER!

DATE: 15 NOVEMBER  
10.7-CM FLUX: 118 SUNSPOT NR: 68  
FM: W3N1Z MILLERSVL MD 39-05N 076-37W  
TO: COPENHAGEN DENMARK 55-40N 012-30E  
DISTANCE: 6476 KM = 4024 MI = 3497 NM  
BEARING: 042

UT	MUF	UT	MUF
0000	9.1	1200	19.0
0100	8.9	1300	19.3
0200	8.8	1400	19.2
0300	8.7	1500	18.9
0400	8.6	1600	18.2
0500	8.5	1700	17.1
0600	8.5	1800	15.3
0700	8.4	1900	11.0
0800	8.6	2000	10.4
0900	8.5	2100	10.0
1000	13.5	2200	9.6
1100	17.1	2300	9.3

- For VIC-20 (std. or expanded), COMMODORE 64, & PET/CBM
- Cassette or Disk, only \$18.95 ppd.

**PROCAST**

P.O. Box 682, Dept. H  
Millersville, MD 21108

✓38

## ICOM OWNERS

MAJOR AUDIO BREAKTHROUGH

The ICOM 700 series have MIC pre amps built into their mics. Regular mics can't be used. The NEW EQ 200 P EQUALIZER has a pre amp built-in, allowing favorite mics to be used with ICOM. See July '82 QST, CQ, 73 reviews on microphone equalizer.

Makes All Mics Sound Great



EQ200P

APPROVED ✓59  
BY ICOM  
USER'S GROUP

\$59.95

+ \$3. shipping

**HEIL, LTD.**

Write For Catalog

Marissa, IL 62257

(618)295-3000

## Subscription Problem?

73 does not keep subscription records on the premises, therefore calling us only adds time and doesn't solve the problem.

Please send a description of the problem and your most recent address label to:

**73** Amateur Radio's  
Technical Journal

Subscription Dept.

PO Box 931

Farmingdale, NY 11737

Thank you and enjoy your subscription.

## KSG TECHNOLOGIES

High Technology at Reasonable Prices

Announcing the board all HAMS have awaited:

The KSG TECHNOLOGIES RCW-1 RTTY/CW board

- Exclusively built for the TRS-80\* Color Computer using ABRAMS RTTY/CW SOFTWARE
- Adaptable to other computers — write your own software
- One 4" x 6" board has all you need for Abrams package: Active Filter Demodulator (both mark and space) RTTY AFSK modulator CW Decoder with variable threshold CW Relay keyer Regulated on-board supplies for all above functions
- Etched and drilled glass epoxy board
- Parts easy to find
- Includes instructions, layout, schematic, parts list

For those who bought FACIT 4555 printers from MHZ Electronics and would like to PRINT LOWERCASE LETTERS KSG Technologies' FPM-1 kit is for you:

- Enables the Facit 4555 printer to print lowercase letters
- 96-character ASCII standard (expanded from 64)
- Optimized for good recognition
- Easy installation in minutes...no traces cut
- Complete kit of parts and detailed instructions
- 90-day written warranty

RCW-1 (Bare Board Only) \$20.00 postpaid

RCW-1K (Board and Parts Kit) \$125.00 postpaid

FPM-1 (Completely Assembled and Tested) \$35.00 postpaid

For additional information write to:

**KSG TECHNOLOGIES** ✓114

900 5TH WAY • PLEASANT GROVE, AL 35127

Check or Money Order Only. No Visa, MasterCard or Phone Orders Please — Allow three weeks delivery.

TRS-80\* is a product of Radio Shack (Tandy Company)

## California Antenna Systems

Antenna Alternatives for the Radio Amateur

### Introducing

**HOT DIPPED GALVANIZED TOWERS**

**TRI-STACK** Stacking Towers, 10' to 120'  
TS10 - 40' side supported package, all hardware complete - \$299. \*

**TRI-TEL** Telescoping Crank-up Towers

TT237 - 37' self support, 9 sq ft - \$499. \*

TT354 - 54' self support, 9 sq ft - \$799. \*

We have a full line of major brand antennas and accessories. Call for discount price quotes.

**FREE 2 Meter JAYBEAM** -

Choice of LW5/2M 5 el. yagi or UGP/2M ground plane with Tower purchase, offer limited. Our way of saying "Thanks"!

\*Terms: Certified Check or M.O. with order. Prices FOB Shingle Springs, CA 95682. Freight collect. Allow 2 to 6 weeks delivery. Calif. Residents add 6% Tax. Prices subject to change without notice.

6020 Windy Ridge Road  
Shingle Springs, California 95682 ✓53  
Telephone (916) 677-9540



## NEW! MULTI-CHANNEL MICROWAVE

Complete Antenna Systems from \$69.95

Full 800 Mhz Range  
Tune 1.9-2.7 Ghz  
Includes all ITFS Channels

DEALERS WANTED

COD's and Credit Card Orders call TOLL FREE

1-800-247-1151

**GALAXY** ✓178

**ELECTRONICS**  
6009 N. 61 Avenue  
Glendale, AZ 85301  
1-602-247-1151



**THE  
BEST PLACE  
To Look For  
New & Used  
Equipment  
Buy-Sell-Trade  
Our 4th Year**



## NUTS & VOLTS MAGAZINE

PO BOX 1111-G • PLACENTIA, CA 92670  
(714) 632-7721 ✓137

JOIN THOUSANDS OF READERS  
NATIONWIDE, EVERY MONTH

U.S.A. SUBSCRIPTIONS

\$ 7.00 - 1 YR. 3RD CLASS MAIL

\$12.50 - 1 YR. 1ST CLASS MAIL

\$25.00 - LIFETIME - 3RD CLASS

With Free Classified Ad

## HAM & SWL SOFTWARE

Send and receive CW or RTTY with these programs and your TRS-80 Model I or Model III computer. **NO HARDWARE OR TU IS REQUIRED!!** All I/O is done via the cassette ports and cable. Results rival hardware/software combinations sold by others. Write or call WD9ECD for details or to order.

- WOODALL SOFTWARE -  
P.O. BOX 284 ✓107  
Plainfield, IN 46168  
(317) 271-2565 (Eves & Sat)

### CIRCUIT BOARD SALE

RS-232C Serial Line Monitor  
LED indicators show activity and polarity of the 7 most common signals. DB-25 male and female connectors mount directly on circuit board to form a compact 2" x 3" unit. Mounts in series with your RS-232C cable. Kit includes all parts, directions and tips for use. Commercial quality, double sided fiberglass board with plated through holes. Assembled and tested (SLM-1) . . . . . 29.95  
Kit (SLM-1K) . . . . . 21.95  
Board only (SLM-1NB) . . . . . 6.95

Power Supply Board  
Provides +5, +12 and -12 volts at 1 amp for your ham radio project. Uses 78xx series positive voltage regulators. Needs 2 transformer windings, 18-24 volts (1 center tapped). 3.50" x 4.50"  
Assembled and Tested (PS-1) . . . . . 21.95  
Kit Less Xfms (PS-1K) . . . . . 16.95  
Board only (PS-1NB) . . . . . 4.95

STD Bus Mother board  
Single-sided fiberglass mother board. An excellent foundation for your STD bus computer. Mounts 12 of our 56 pin connectors. Provide your own card cage and save hundreds of dollars. 3.80" x 7.00"  
Mother Board (MB-1) . . . . . 15.95  
Connectors (C56-125-ST) . . . . . 3.00  
MB-1 and 12 connectors (MB-SPC) . . . . . 45.00

Please add \$2.00 per order shipping and handling. CA residents include tax.

Esoteric Engineering Incorporated  
PO Box 33682, San Diego, CA 92183 ✓29  
(619) 569-7868



PRESERVE

73 WITH



BINDERS & FILE CASES.

Keep your issues of 73 Magazine handy and protected in handsome and durable library file boxes or binders. Both styles are bound in red leatherette with the magazine logo stamped in gold.

File boxes: each file box holds 12 issues, with spines visible for easy reference.

\$5.95 each, 3 for \$17.00, 6 for \$30.00

Binders: each binder holds 12 issues and opens flat for easy reading.

\$7.50 each, 3 for \$21.75, 6 for \$42.00

(USA postage paid. Foreign orders must include \$2.50 per item.)

Please state years desired (1977 to 1984).

Send check or money order to:

Jesse Jones Box Corp., P.O. Box 5120, Philadelphia, PA 19141; please allow 6 to 8 weeks for delivery.

Sorry, no C.O.D. or phone orders.

**BUY! SELL! TRADE!**  
COMPUTER & HAM EQUIPMENT

COMPUTER®

TRADER

**ANNUAL  
SUBSCRIPTION  
\$15.00**

Low Ad Rates — Mailed Monthly  
Foreign Subscriptions - \$30.00 Year  
FREE 50 Word Classified Ad with Subscription Order

COMPUTER TRADER®

Chet Lambert, W4WDR  
1704 Sam Drive • Birmingham, AL 35235  
(205) 854-0271

Sample Copy — \$1.00

## WARC for FT-101

Modernize any model of the original FT-101 Series by adding *all three* WARC bands for RX and TX!

- Use 10 MHz now; be ready for the others.
- Increase resale value of your rig.
- Easy installation, detailed instructions.
- Includes all crystals, relays, etc.
- Tested, fool-proof design for all but 'ZD.

FT-101 WARC Kit #4N . . . . . **ONLY \$25.**  
Shipping \$3 (Air \$5). Florida sales tax 5%.

GO FOX TANGO — TO BE SURE!



Order by Mail  
or Telephone

For other great Yaesu modifications get the top-rated FT Newsletter. Still only \$8 per calendar year (US), \$9 Canada, \$12 Overseas.

**FOX TANGO CORPORATION**

Box 15944 S. W. Palm Beach, FL 33416  
(305) 683-9587 ✓95

## AZDEN PCS-4000

2 METER TRANSCEIVER  
AND PCS-300 2M TALKIE

We'll Beat Any Price in This Issue

10 AMP Regulated Supply  
10 AMP Continuous \$52.

Service Manuals ✓249

PCS 4000  
\$9<sup>00</sup>

300-3000  
\$5<sup>00</sup> EACH

Order 24 hours a day (215) 884-6010  
FREE UPS N.P.S. Inc. WA31FQ  
1138 BOXWOOD RD. JENKINTOWN, PA 19046

### CABLE CONVERTER SALE

MAGNAVOX FV-25 - 26 CHANNEL WITH  
REMOTE CONTROL - VHF-MIDBAND-  
SUPERBAND - REG \$59.95 - NOW \$49.95

JERROLD JSX-3DIC - 36 CHANNEL  
WITH IN BAND GATED SYNC  
DECODER - REG \$209.95 - NOW \$149.95

JERROLD SB-3 - IN BAND GATED  
GATED SYNC DECODER - USE WITH  
ANY CONVERTER WITH OUTPUT ON  
CHANNEL 3 - REG \$149.95 - NOW \$99.95

UHF BLOCK CONVERTER - CONVERTS  
MIDBAND AND SUPERBAND  
TO UHF - REG \$39.95 - NOW \$26.95

SEND \$1.00 (REFUNDABLE) FOR CATALOG

ADD \$4.25 SHIPPING/HANDLING  
FOR EACH UNIT ORDERED

NYS ADD SALES TAX -C.O.D.'S OK

24 HOUR ORDER LINE  
(607) 962-7313

ORDER DIRECT FROM -

TAYCO COMMUNICATIONS  
R3-146A NARROWS CREEK ROAD ✓183  
CORNING, NEW YORK 14838

## UHF POWER AMP

AM-6155/GRT (ITT 3212) 225-400 Mhz RF amp,  
50W output from 4-10W  
input using Eimac  
X651Z; silver-plated  
cavity in removable  
drawer. Requires 115/  
230 VAC & 20 VDC.  
7x19 1/2x18", 75 lbs.  
sh. Used-not tested, excellent condition: **\$149.50**

R-392 RECEIVER, 0.5-32 Mhz AM-  
CW in 32 bands; mechanical digital  
tuning. 2-4-8 Khz bandwidth; 100 Khz  
calibrator. 25 tubes; requires 24 VDC  
5 amps. 11 1/2x14 1/2x11", 60 lbs. sh.  
Used-reparable, **\$135.** Chkd., **\$200.**  
Manual, partial repro: **\$15.** LS-166  
speaker, **\$10.95.** 24 VDC 6 AMP  
Supply, for R-392 — no connector, used: . . . . . **\$25.**

TEKTRONIX 516 DUAL TRACE SCOPE, DC-15  
Mhz response with 5" CRT. Sensitivity 0.05-20 v/div  
and Sweep 0.2 usec-2 sec/div calibrated; Square-  
wave Calibrator 0.05-100 volts. Requires 115 VAC  
60 Hz. 13 1/2x9 3/4x21 1/2", 50 lbs. sh. Used-  
reparable . . . . . **\$165.** Checked . . . . . **\$225.**  
Prices F.O.B. Lima, O. • VISA, MASTERCARD Accepted.  
Allow for Shipping • Send for New FREE CATALOG '83  
Address Dept. 73 • Phone: 419/227-6573

**FAIR RADIO SALES** ✓22  
1016 E. EUREKA • Box 1105 • LIMA, OHIO • 45802

# NEW LOW-NOISE PREAMPS RECEIVING CONVERTERS TRANSMIT CONVERTERS

New low-noise microwave transistors make preamps in the 0.9 to 1.0 dB noise figure range possible without the fragility and power supply problems of gas-fet's. Units furnished wired and tuned to ham band. Can be easily retuned to nearby freq.



Models LNA( ), P30, and P432 shown

Model	Tunable Freq Range	Noise Figure	Gain	Price
LNA 28	20-40	0.9 dB	20 dB	\$39.95
LNA 50	40-70	0.9 dB	20 dB	\$39.95
LNA 144	120-180	1.0 dB	18 dB	\$39.95
LNA 220	180-250	1.0 dB	17 dB	\$39.95
LNA 432	380-470	1.0 dB	18 dB	\$44.95

## ECONOMY PREAMPS

Our traditional preamps, proven in years of service. Over 20,000 in use throughout the world. Tuneable over narrow range. Specify exact freq. band needed. Gain 16-20 dB. NF = 2 dB or less. VHF units available 27 to 300 MHz. UHF units available 300 to 650 MHz.

- P30K, VHF Kit less case \$14.95
- P30C, VHF Kit with case \$20.95
- P30W, VHF Wired/Tested \$29.95
- P432K, UHF Kit less case \$18.95
- P432C, UHF Kit with case \$24.95
- P432W, UHF Wired/Tested \$33.95

P432 also available in broadband version to cover 20-650 MHz without tuning. Same price as P432; add "B" to model #.

## HELICAL RESONATOR PREAMPS



Our lab has developed a new line of low-noise receiver preamps with helical resonator filters built in. The combination of a low noise amplifier similar to the LNA series and the sharp selectivity of a 3 or 4 section helical resonator provides increased sensitivity while reducing intermod and cross-band interference in critical applications. See selectivity curves at right. Noise figure = 1 to 1.2 dB. Gain = 12 to 15 dB.

Model	Tuning Range	Price
HRA-144	143-150 MHz	\$49.95
HRA-220	213-233 MHz	\$49.95
HRA-432	420-450 MHz	\$59.95



Models to cover every practical rf & if range to listen to SSB, FM, ATV, etc. NF = 2 dB or less.

	Antenna Input Range	Receiver Output
<b>VHF MODELS</b>	28-32	144-148
Kit \$44.95	50-52	28-30
Less Case \$39.95	50-54	144-148
Wired \$59.95	144-146	28-30
	145-147	28-30
	144-144.4	27-27.4
	146-148	28-30
	144-148	50-54
	220-222	28-30
	220-224	144-148
	222-226	144-148
	220-224	50-54
	222-224	28-30
<b>UHF MODELS</b>	432-434	28-30
Kit \$54.95	435-437	28-30
Less Case \$49.95	432-436	144-148
Wired \$74.95	432-436	50-54
	439.25	61.25

**SCANNER CONVERTERS** Copy 72-76, 135-144, 240-270, 400-420, or 806-894 MHz bands on any scanner. Wired/tested Only \$79.95.

**SPECIAL FREQUENCY CONVERTERS** made to custom order \$119.95. Call for details.

## SAVE A BUNDLE ON VHF FM TRANSCEIVERS!

FM-5 PC Board Kit - ONLY \$159.95 complete with controls, heatsink, etc. 10 Watts, 5 Channels, for 6M, 2M, or 220



Cabinet Kit, complete with speaker, knobs, connectors, hardware. Only \$59.95

**REPEAT OF A SELLOUT!**

While supply lasts, get \$59.95 cabinet kit free when you buy an FM-5 Transceiver kit. Where else can you get a complete transceiver for only \$159.95?

For SSB, CW, ATV, FM, etc. Why pay big bucks for a multi mode rig for each band? Can be linked with receive converters for transceive. 2 watts output.

	Exciter Input Range	Antenna Output
For VHF, Model XV2 Kit \$79.95 Wired \$119.95 (Specify band)	28-30	144-146
	28-29	145-146
	28-30	50-52
	27-27.4	144-144.4
	28-30	220-222*
	50-54	220-224
	144-146	50-52
	50-54	144-148
	144-146	28-30

	Exciter Input Range	Antenna Output
For UHF, Model XV4 Kit \$99.95 Wired \$149.95	28-30	432-434
	28-30	435-437
	50-54	432-436
	61.25	439.25
	144-148	432-436*

\*Add \$20 for 2M input

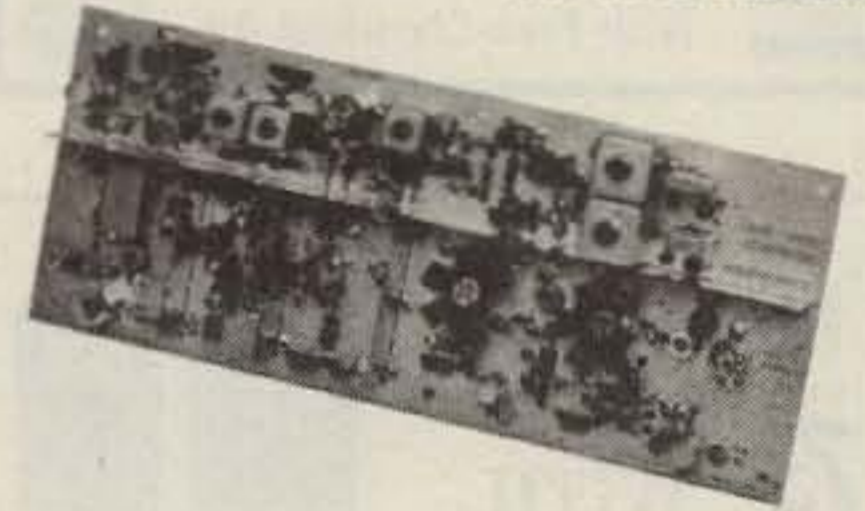

**VHF & UHF LINEAR AMPLIFIERS.** Use with above. Power levels from 10 to 45 Watts. Kits from \$69.95.

## LOOK AT THESE ATTRACTIVE CURVES!

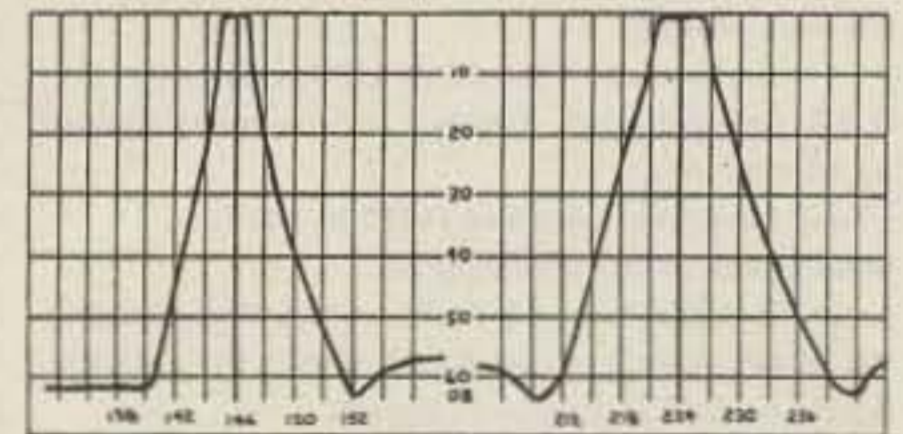

R144 & R220 Front Ends, HRA 144/220, & HRF-144/220

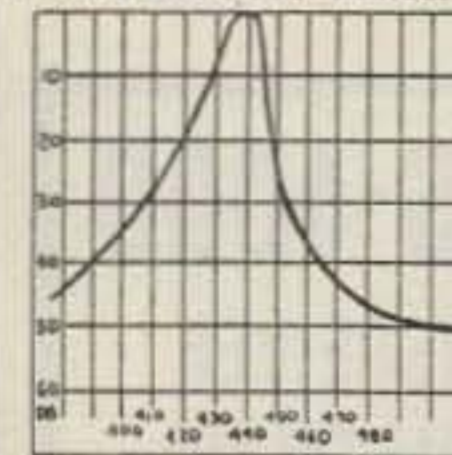

R451 Receiver Front End

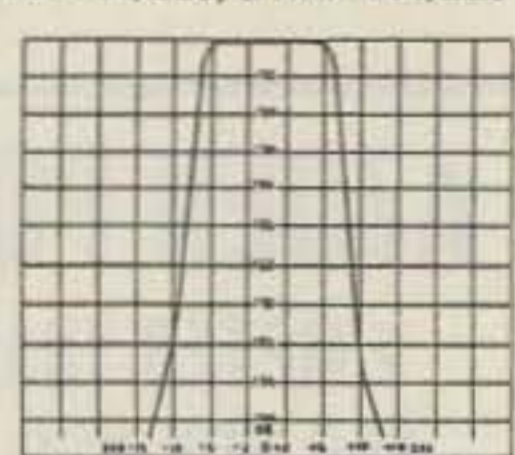

Rcvr I-F Selectivity

Typical Selectivity Curves of Receivers and Helical Resonators.

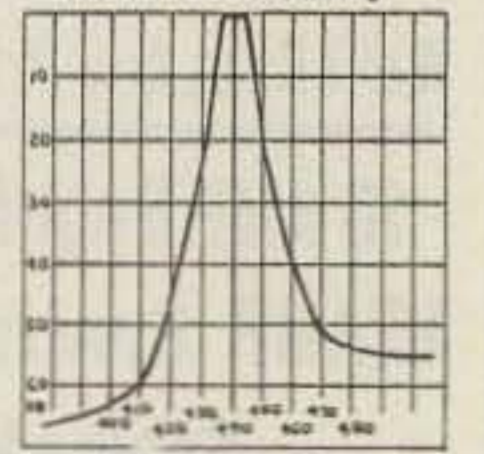

HRA-432, HRF-432

- Call or Write for **FREE CATALOG** (Send \$1.00 or 4 IRC's for overseas mailing)
- Order by phone or mail • Add \$2 S & H per order (Electronic answering service evenings & weekends)
- Use VISA, MASTERCARD, Check, or UPS COD.

# hamtronics, inc.

65-X MOUL RD. • HILTON NY 14468  
Phone: 716-392-9430

Hamtronics is a registered trademark

**AT LAST —  
YOU CAN AFFORD!  
A REPEATER**

For years, Hamtronics® Modules have been used by individual hams and manufacturers to make repeaters. Now, in the Hamtronics tradition of top quality and superb value, we are proud to offer a complete repeater package.



**JUST LOOK AT THESE PRICES!**

Band	Kit	Wired/Tested
6M, 2M, 220	\$595	\$745
440	\$645	\$795

Both kit and wired units are complete with all parts, modules, hardware, and crystals.

**CALL OR WRITE FOR COMPLETE DETAILS.**

Also available for remote site linking/crossband & 10M.

**FEATURES:**

- SENSITIVITY SECOND TO NONE; TYPICALLY 0.15  $\mu$ V ON VHF, 0.3  $\mu$ V ON UHF.
- SELECTIVITY THAT CAN'T BE BEAT! BOTH 8 POLE CRYSTAL FILTER & CERAMIC FILTER FOR GREATER THAN 100 dB AT  $\pm$  12KHZ. HELICAL RESONATOR FRONT ENDS. SEE R144, R220, AND R451 SPECS IN RECEIVER AD BELOW.
- OTHER GREAT RECEIVER FEATURES: FLUTTER-PROOF SQUELCH, AFC TO COMPENSATE FOR OFF-FREQ TRANSMITTERS, SEPARATE LOCAL SPEAKER AMPLIFIER & CONTROL.
- CLEAN, EASY-TUNE TRANSMITTER; UP TO 20 WATTS OUT.

**HIGH QUALITY MODULES FOR  
REPEATERS, LINKS, TELEMETRY, ETC.**

**INTRODUCING —  
NEW 1983 RECEIVERS**

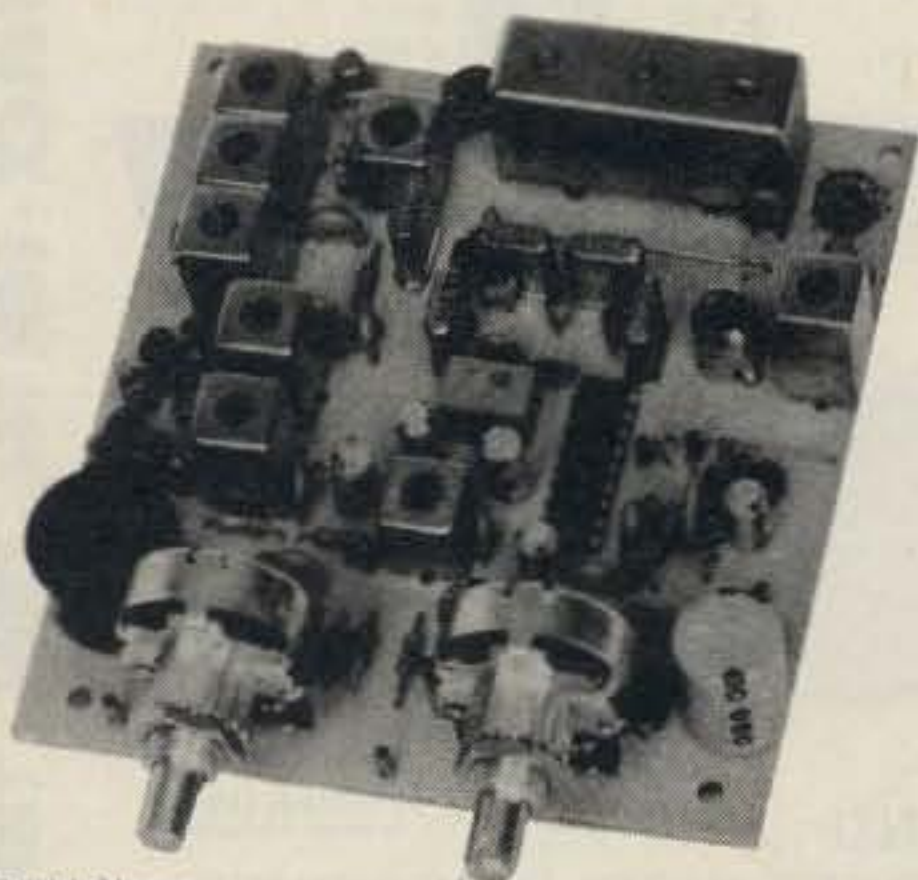

R144 Shown

- **R144/R220 FM RCVRS** for 2M or 220 MHz. 0.15 $\mu$ V sens.; 8 pole xtal filter & ceramic filter in i-f, helical resonator front end for exceptional selectivity (curves at left). AFC incl., xtal oven avail. Kit only \$119.95
- **R451 FM RCVR** Same but for uhf. Tuned line front end, 0.3  $\mu$ V sens. Kit only \$119.95.
- **R76 FM RCVR** for 10M, 6M, 2M, 220, or commercial bands. As above, but w/o AFC or hel. res. Kits only \$109.95. Also avail w/4 pole filter, only \$94.95/ kit.
- **R110 VHF AM RECEIVER** kit for VHF aircraft band or ham bands. Only \$84.95
- **R110 UHF AM RECEIVER** for UHF uses, including special 259 MHz model to hear SPACE SHUTTLE. Kit \$94.95

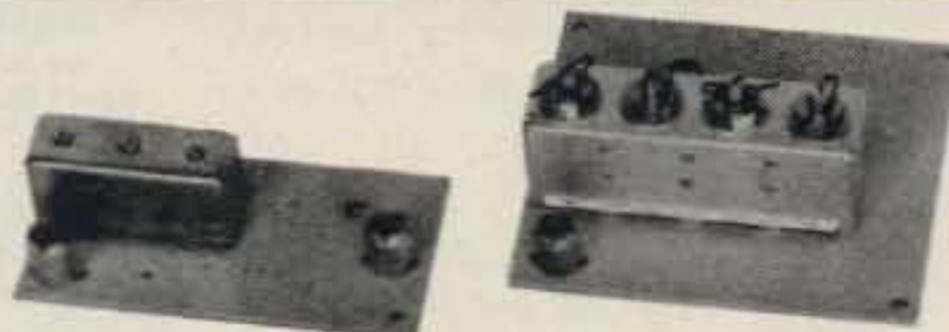

- **HELICAL RESONATOR FILTERS** available separately on pcb w/connectors.

HRF-144 for 143-150 MHz \$34.95  
HRF-220 for 213-233 MHz \$34.95  
HRF-432 for 420-450 MHz \$44.95

(See selectivity curves at left.)

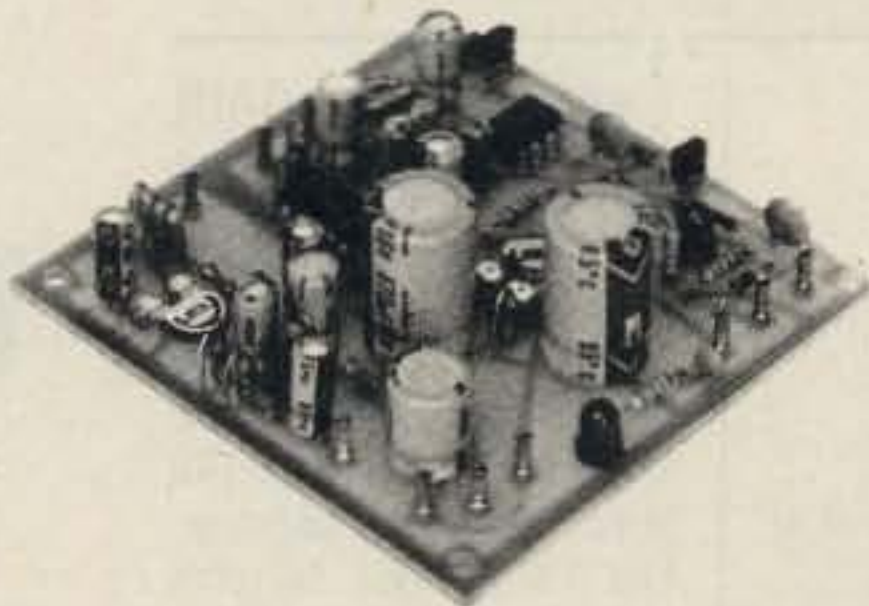

- **COR KITS** With audio mixer and speaker amplifier. Only \$29.95.
- **CWID KITS** 158 bits, field programmable, clean audio. Only \$59.95.
- **DTMF DECODER/CONTROLLER KITS.** Control 2 separate on/off functions with touchtones®, e.g., repeater and autopatch. Use with main or aux. receiver or with Auto-patch. Only \$89.95.
- **AUTOPATCH KITS.** Provide repeater autopatch, reverse patch, phone line remote control of repeater, secondary control via repeater receiver. Many other features. Only \$89.95. Requires DTMF Module.
- **A16 RF TIGHT BOX** Deep drawn alum. case with tight cover and no seams. 7 x 8 x 2 inches. Only \$18.00.

**TRANSMITTERS AND  
ACCESSORIES**



- **T51 VHF FM EXCITER** for 10M, 6M, 2M, 220 MHz or adjacent bands. 2 Watts continuous. Kits only \$59.95



- **T451 UHF FM EXCITER** 2 to 3 Watts on 450 ham band or adjacent. Kits only \$69.95.
- **VHF & UHF LINEAR AMPLIFIERS.** Use on either FM or SSB. Power levels from 10 to 45 Watts to go with exciters & xmtg converters. Kits from \$69.95.

**hamtronics®**

ANTENNA SPECIALISTS • AVANTI • ARAAL PUBS • AMECO • BASH • BEARCAT • BENCHER • B&W • BIRD • CALBOOK • COMMUNICATIONS  
 SPECIALISTS • CUSHCRAFT • DRAKE • HAM KEY • HUSTLER • HY-GAIN • ICOM • KANTRONICS • LARSEN • MFJ • MORGAIN • PANASONIC • RAMSEY • SHURE • SONY • TELEX • TENCOR • TRAC • TRANSCOM • VAN GORDON • VOKOM

**SPECIALISTS • CUSHCRAFT • DRAKE • HAM KEY • HUSTLER • HY-GAIN • ICOM • KANTRONICS • LARSEN • MFJ • MORGAIN • PANASONIC • RAMSEY • SHURE • SONY • TELEX • TENCOR • TRAC • TRANSCOM • VAN GORDON • VOKOM**

**POPULAR VALUES FROM SPECTRONICS!**

**SAVE \$\$\$**

**AM/FM/AIR/PSB/2 METERS!**

**ONLY \$69.95**  
plus \$2.00 UPS

**THE NEW PANASONIC RF-1405 HAS IT ALL!**

Portability and practicality are built right in to this newest Panasonic receiver, not to mention **LOW PRICE!**

- AC/DC power
- AM 525-1610 KHz.
- FM 88-108 MHz.
- AIR 108-136 MHz.
- PSB 136-174 MHz.



**Put Your Computer "On-The-Air"**

**The Interface™**

List \$149.95  
\$189.95

Plus \$3.00 Shipping



Your personal computer becomes a complete CW/RTTY/ASCII send and receive terminal with **The Interface** linking it to your transceiver.

If you own an Apple II or Apple II Plus, Atari 400 or 800, TRS-80 Color Computer, or VIC-20, **The Interface** will put your computer "On-The-Air".

Software for each system features split screen display, buffered keyboard, status display, and message ports. Attach any Centronics compatible printer for hard copy. Software is available, on diskette for the Apple and program boards for the others, at additional cost.

Apple diskette	Atari board	VIC-20 board	TRS-80C board	TI-99 board	VIC-20 Hamtext	Commodore 64 Hamtext
\$29.95	\$49.95	\$49.95	\$59.95	\$99.95	\$99.95	\$99.95

**KEN-TEC 24-HOUR DIGITAL MILITARY TIME ALARM CLOCK**

REPEATING 9-MINUTE DROWSE ALARM CAN BE USED FOR STATION I.D. REMINDER

**\$19.95**  
PLUS \$1.50 UPS

- 7" Red LED Numerals
- 24-Hr. Memory Alarm
- 1-Year Warrantee
- Drowse Control
- Dark Brown Walnut Grain
- 2 1/4" H x 6 1/4" W x 3 1/4" D



**"easy-talk'r" VOX PORTABLE TRANSCEIVER**

**\$49.95**  
plus \$3.00 shipping

- Up to 1/2 mile FM Transmitting
- "Hands free" VOX operation
- Light weight—less than 9 Oz.



**B&W PORTABLE APARTMENT ANTENNA**

**\$43.75**  
plus \$2.00 shipping

Quick, easy-mounting. Tunes 2, 8, 10, 15, 20 and 40 meter Amateur bands, plus SW BC bands in some ranges. 360 watts SSB/CW. 22 1/2" whip extends to 57" 14" mount. Includes 5 base loading coils. Weighs less than 2 lbs.



**FAMOUS "EAVESDROPPER" SW RECEIVING ANTENNA**

**\$59.95**  
plus \$3.00 shipping (Cont'l U.S.)



**ICOM HEADQUARTERS**

ICOM IC25A

**NEW! IC3AT (220 MHz) IC4AT (440 MHz)**

ICOM IC2A, IC2AT

- Compact
- Quality Construction
- Versatile
- Affordable
- Wide Range of Accessories Available

**CALL FOR PRICE & AVAILABILITY**



Valuable aid for Amateur use in antenna installation, tuning/pruning, field day, etc., plus hundreds of applications in home business, sports and recreation. Uses 9 volt battery (not supplied.)

**AMECO PREAMPS**

add \$3.00 shipping (Cont'l USA only)

Model PLF-2	\$52.95
Model PLF-2E (240V)	\$57.95
Model PT-2	\$79.95
Model PT-2E (240V)	\$84.95



**REPLACEMENT NICAD FOR WILSON/YAESU**

**\$26.95**  
plus \$2.00 shipping

Fits Wilson Mark II, and Mark IV plus Yaesu FT-207, 500 MAH, 11.7 V. Nickel-Cadmium.



**SUB-AUDIBLE TONE HEADQUARTERS**

ENCODERS plus \$2.00 shipping EACH (Cont'l USA only)

**\$29.95**

We stock Communications Specialists SS 32 and SS-32M encoders for most any mobile or hand-held applications including the very popular Icom Handhelds.

**MORGAIN MULTI-BAND ANTENNAS**

Add \$5.00 for shipping (Cont'l U.S.A.)

80-40HD/A 80/40 Mtr bands (69)	99.00	75-10HD/A 75/40/20/15/10 Mtr (66)	126.95
75/40HD/A 75/40 Mtr bands (66)	94.50	80-10HD/A 80/40/20/15/10 Mtr (69)	132.00



**FAMOUS AVANTI THRU-GLASS MOBILE ANTENNA**

**\$32.95**  
plus \$3.00 shipping

mounts on glass and transmits and receives through the glass. Extremely low VSWR is achieved by adjusting special tuning slug on matching network inside the vehicle. Can be easily removed for car washes without special tools.

The Avanti On-Glass is the first two-way communications antenna that



**NEW! 2.8 dbd GAIN BASE ANTENNA**

**\$15.00** Please add 2.00 shipping any qty

Here's an inexpensive, omni-directional, 144-148 MHz. 1/2 wave antenna. Fits 1 1/4" mast, 50 ohm impedance. A real problem solver!



**SONY VALUES!**

ICF-4800

**6-BAND POCKET WORLD RECEIVER**

- 6-band pocket world receiver—SW 1-5, plus MW
- Extremely compact and lightweight—palm sized!
- SW band spread dial—easy tuning • Tuning indicator

**9-BAND ICF-7600A \$109.95**  
plus \$2.00 UPS



**TO ORDER:** CALL OR WRITE. MASTER CARD, VISA, MONEY ORDERS, PERSONAL CHECKS TAKE 3 WEEKS TO CLEAR, ACCEPTED. INTERNATIONAL ORDERS WELCOME, PLEASE REQUEST PRO FORMA INVOICE. ILLINOIS RESIDENTS ADD 6% SALES TAX.

**HOURS:** MON. THRU WED. 9:30-6:00, THURS-FRI. 9:30-8:00, SAT. 9:30-3:00

**STOP BY AND VISIT WHEN IN THE CHICAGOLAND AREA!!**



**SPECTRONICS, INC**  
1009 GARFIELD ST. OAK PARK, IL. 60304

PHONE  
**(312) 848-6777**





**ramsey**

# the first name in Counters!



## 9 DIGITS 600 MHz \$129<sup>95</sup> WIRED

The CT-90 is the most versatile, feature packed counter available for less than \$300.00! Advanced design features include: three selectable gate times, nine digits, gate indicator and a unique display hold function which holds the displayed count after the input signal is removed! Also, a 10MHz TCXO time base is used which enables easy zero beat calibration checks against WWV. Optionally, an internal nicad battery pack, external time base input and Micro-power high stability crystal oven time base are available. The CT-90, performance you can count on!

**SPECIFICATIONS:**

Range: 20 Hz to 600 MHz  
 Sensitivity: Less than 10 MV to 150 MHz  
 Less than 50 MV to 500 MHz  
 Resolution: 0.1 Hz (10 MHz range)  
 1.0 Hz (60 MHz range)  
 10.0 Hz (600 MHz range)  
 Display: 9 digits 0.4" LED  
 Time base: Standard-10.000 MHz, 1.0 ppm 20-40°C.  
 Optional Micro-power oven-0.1 ppm 20-40°C  
 Power: 8-15 VAC @ 250 ma

**PRICES:**

CT-90 wired, 1 year warranty	\$129.95
CT-90 Kit, 90 day parts warranty	
AC-1 AC adapter	109.95
BP-1 Nicad pack + AC Adapter/Charger	3.95
OV-1, Micro-power Oven time base	12.95
External time base input	49.95
	14.95

## 7 DIGITS 525 MHz \$99<sup>95</sup> WIRED



**SPECIFICATIONS:**

Range: 20 Hz to 525 MHz  
 Sensitivity: Less than 50 MV to 150 MHz  
 Less than 150 MV to 500 MHz  
 Resolution: 1.0 Hz (5 MHz range)  
 10.0 Hz (50 MHz range)  
 100.0 Hz (500 MHz range)  
 Display: 7 digits 0.4" LED  
 Time base: 1.0 ppm TCXO 20-40°C  
 Power: 12 VAC @ 250 ma

The CT-70 breaks the price barrier on lab quality frequency counters. Deluxe features such as, three frequency ranges - each with pre-amplification, dual selectable gate times, and gate activity indication make measurements a snap. The wide frequency range enables you to accurately measure signals from audio thru UHF with 1.0 ppm accuracy - that's .0001%! The CT-70 is the answer to all your measurement needs, in the field, lab or ham shack.

**PRICES:**

CT-70 wired, 1 year warranty	\$99.95
CT-70 Kit, 90 day parts warranty	
AC-1 AC adapter	84.95
BP-1 Nicad pack + AC adapter/charger	3.95
	12.95

## 7 DIGITS 500 MHz \$79<sup>95</sup> WIRED



**PRICES:**

MINI-100 wired, 1 year warranty	\$79.95
AC-Z Ac adapter for MINI-100	3.95
BP-Z Nicad pack and AC adapter/charger	12.95

Here's a handy, general purpose counter that provides most counter functions at an unbelievable price. The MINI-100 doesn't have the full frequency range or input impedance qualities found in higher price units, but for basic RF signal measurements, it can't be beat! Accurate measurements can be made from 1 MHz all the way up to 500 MHz with excellent sensitivity throughout the range, and the two gate times let you select the resolution desired. Add the nicad pack option and the MINI-100 makes an ideal addition to your tool box for "in-the-field" frequency checks and repairs.

**SPECIFICATIONS:**

Range: 1 MHz to 500 MHz  
 Sensitivity: Less than 25 MV  
 Resolution: 100 Hz (slow gate)  
 1.0 KHz (fast gate)  
 Display: 7 digits, 0.4" LED  
 Time base: 2.0 ppm 20-40°C  
 Power: 5 VDC @ 200 ma

## 8 DIGITS 600 MHz \$159<sup>95</sup> WIRED



**SPECIFICATIONS:**

Range: 20 Hz to 600 MHz  
 Sensitivity: Less than 25 mv to 150 MHz  
 Less than 150 mv to 600 MHz  
 Resolution: 1.0 Hz (60 MHz range)  
 10.0 Hz (600 MHz range)  
 Display: 8 digits 0.4" LED  
 Time base: 2.0 ppm 20-40°C  
 Power: 110 VAC or 12 VDC

The CT-50 is a versatile lab bench counter that will measure up to 600 MHz with 8 digit precision. And, one of its best features is the Receive Frequency Adapter, which turns the CT-50 into a digital readout for any receiver. The adapter is easily programmed for any receiver and a simple connection to the receiver's VFO is all that is required for use. Adding the receiver adapter in no way limits the operation of the CT-50, the adapter can be conveniently switched on or off. The CT-50, a counter that can work double-duty!

**PRICES:**

CT-50 wired, 1 year warranty	\$159.95
CT-50 Kit, 90 day parts warranty	
RA-1, receiver adapter kit	119.95
RA-1 wired and pre-programmed (send copy of receiver schematic)	14.95
	29.95

## DIGITAL MULTIMETER \$99<sup>95</sup> WIRED



**PRICES:**

DM-700 wired, 1 year warranty	\$99.95
DM-700 Kit, 90 day parts warranty	
AC-1, AC adaptor	79.95
BP-3, Nicad pack + AC adapter/charger	3.95
MP-1, Probe kit	19.95
	2.95

The DM-700 offers professional quality performance at a hobbyist price. Features include: 26 different ranges and 5 functions, all arranged in a convenient, easy to use format. Measurements are displayed on a large 3 1/2 digit, 1/2 inch LED readout with automatic decimal placement, automatic polarity, overrange indication and overload protection up to 1250 volts on all ranges, making it virtually goof-proof! The DM-700 looks great, a handsome, jet black, rugged ABS case with convenient retractable tilt bail makes it an ideal addition to any shop.

**SPECIFICATIONS:**

DC/AC volts: 100uV to 1 KV, 5 ranges  
 DC/AC current: 0.1uA to 2.0 Amps, 5 ranges  
 Resistance: 0.1 ohms to 20 Megohms, 6 ranges  
 Input impedance: 10 Megohms, DC/AC volts  
 Accuracy: 0.1% basic DC volts  
 Power: 4 'C' cells

### AUDIO SCALER

For high resolution audio measurements, multiplies UP in frequency.

- Great for PL tones
- Multiplies by 10 or 100
- 0.01 Hz resolution!

\$29.95 Kit \$39.95 Wired

### ACCESSORIES

Telescopic whip antenna - BNC plug.....	\$ 7.95
High impedance probe, light loading.....	15.95
Low pass probe, for audio measurements.....	15.95
Direct probe, general purpose usage.....	12.95
Tilt bail, for CT 70, 90, MINI-100.....	3.95
Color burst calibration unit, calibrates counter against color TV signal.....	14.95

### COUNTER PREAMP

For measuring extremely weak signals from 10 to 1,000 MHz. Small size, powered by plug transformer-included.

- Flat 25 db gain
- BNC Connectors
- Great for sniffing RF with pick-up loop

\$34.95 Kit \$44.95 Wired

ramsey electronic's, inc.



2575 Baird Rd. Penfield, NY 14526

PHONE ORDERS  
 CALL 716-586-3950

TERMS: Satisfaction guaranteed. Examine for 10 days; if not pleased return in original form for refund. Add 5% for shipping insurance to a maximum of \$10. Overseas add 15% COD add \$2. Orders under \$10 add \$1.50. NY residents add 7% tax.

# DEALER DIRECTORY

## Culver City CA

Jun's Electronics, 3919 Sepulveda Blvd., Culver City CA 90230, 390-8003. Trades 463-1886 San Diego, 827-5732 (Reno NV).

## Fontana CA

Complete lines ICOM, DenTron, Ten-Tec, Mirage, Cubic, Lunar, over 4000 electronic products for hobbyist, technician, experimenter. Also CB radio, landmobile. Fontana Electronics, 8628 Sierra Ave., Fontana CA 92335, 822-7710.

## San Jose CA

Bay area's newest Amateur Radio store. New & used Amateur Radio sales & service. We feature Kenwood, ICOM, Azden, Yaesu, Ten-Tec, Santee & many more. Shaver Radio, Inc., 1378 So. Bascom Ave., San Jose CA 95128, 998-1103.

## New Castle DE

Factory Authorized Dealer! Yaesu, ICOM, Ten-Tec, KDK, Azden, AEA, Kantronics, Santee. Full Line of Accessories. No Sales Tax in Delaware. One mile off I-95. Delaware Amateur Supply, 71 Meadow Road, New Castle DE 19720, 328-7728.

## Boise, ID

Rocky Mountain area's newest ham dealer. Call RJM first for AEA, Azden, KDK, Ten-Tec, Butternut, Cushcraft, and more! RJM Electronics, 4202 Overland, Boise, ID 83705. 343-4018.

## Preston ID

Ross WB7BYZ has the Largest Stock of Amateur Gear in the Intermountain West and the Best Prices. Call me for all your ham needs. Ross Distributing, 78 So. State, Preston ID 83263, 852-0830.

## Ann Arbor MI

See us for products like Ten-Tec, R. L. Drake, Dentron and many more. Open Monday through Saturday, 0830 to 1730. WB8VGR, WB8UXO, WD8OKN and W8RP behind the counter. Purchase Radio Supply, 327 E. Hoover Ave., Ann Arbor MI 48104, 668-8696.

## Hudson, NH

Look!—Hams, SWLs, and Experimenters: Parts, Books, Gear, Antennas, Towers. Call for quotes. Polcari's ELECTRONICS CENTER, 61 Lowell Road (Route 3A), Hudson, NH 03051, 883-5005.

## Albany, New York UPSTATE NEW YORK

KENWOOD, ICOM, TEN-TEC, Belden, Cushcraft, Larsen, Hustler, ARRL, Hy-Gain, B&W, MFJ, Mirage. New and Used equipment. Serving the amateur community since 1942. Adirondack Electronics, Inc., 1991 Central Avenue, Albany, New York 12205, 456-0203 (One mile West of Northway exit 2W).

## Columbus OH

The biggest and best Ham Store in the midwest featuring Kenwood and other quality products with working displays. We sell only the best. Authorized Kenwood Service. Universal Amateur Radio Inc., 1280 Aida Dr., Reynoldsburg (Columbus) OH 43068, 966-4267.

## Stigler, OK

TI99/4-4A Basic, Extended Basic, Assembly Language Programs. CW Transceiver, CW Practice, DX, 1010, WAS, SSTV, Hamkid's Programs. AC5D Computer Programs, Box 368, Stigler, OK 74462 967-2034.

## Scranton PA

ICOM, Bird, Cushcraft, Beckman, Fluke, Larsen, Hustler, Antenna Specialists, Astron, Avanti, Belden, W2AU/W2VS, AEA, Vibroplex, HamKey, Amphenol, Sony, B&W, Coax-Seal, Cover Craft, J.W. Miller/Diawa, ARRL, Ameco, Shure. LaRue Electronics, 1112 Grandview St., Scranton PA 18509, 343-2124.

## Mountaintop PA

### WILKES-BARRE AREA

VHF/UHF Equipment & Supplies—From HT's to kW Amplifiers, Transverters, VHF/UHF Microwave Linear Amplifiers, GaAsFET Preamps, OSCAR Equipment, Low Noise preamps, Antennas, Power Supplies. From: ICOM, Lunar, Microwave Modules, UHF Units/Parabolic, Mutek, SSB Electronics, AR-COS, Astron, F9FT-Tonna, Tama, KLM, Mirage, Santee, Tokyo Hy-Power. Two stamps for catalog. The VHF SHOP, Dept. S, RD4, Box 349, Mountaintop PA 18707, 868-6565.

## Dallas TX

IBM PC/Apple aftermarket products; hobbyists' electronics project kits: \$50.00 complete modem kit, subscription/satellite TV decoder kits, EPROM programmer/duplicator, popular memory IC testers, data sheets, application notes, and more than 6000 parts in stock. Semiconductors, discretes, video products, tools... Please write for your free literature/catalog. Independent Electronics, 6415-06 Airline Rd., Dallas TX 75205.

## Baltimore/Washington

Avantek transistors, amplifiers, oscillators and LNAs. Coaxial cable and connectors. Blonder Tongue dealer with Microwave laboratory. Applied Specialties, Inc., 10101G Bacon Drive, Beltsville, Maryland 20705. Wash. 595-5393, Balt. 792-2211. 7:30 a.m. to 6:00 p.m. Monday thru Friday.

## DEALERS

Your company name and message can contain up to 25 words for as little as \$150 yearly (prepaid), or \$15 per month (prepaid quarterly). No mention of mail-order business or area code permitted. Directory text and payment must reach us 60 days in advance of publication. For example, advertising for the Jan. '84 issue must be in our hands by Nov. 1st. Mail to 73 Magazine, Peterborough NH 03458. ATTN: Nancy Ciampa.

# PROPAGATION

J. H. Nelson  
4 Plymouth Dr.  
Whiting NJ 08759

## EASTERN UNITED STATES TO:

	GMT:	00	02	04	06	08	10	12	14	16	18	20	22
ALASKA	14	7	7	7	3A	3A	3A	7	14	21	21A	21	
ARGENTINA	14	7	7	7	7	7	14A	21A	21A	21A	21A	21	
AUSTRALIA	21	14	7B	7B	7B	7B	7B	14B	14	14A	21	21A	
CANAL ZONE	14	7	7	7	7	7	14	21	21A	21A	21A	21	
ENGLAND	7	7	3A	3A	7	7B	14	21A	21A	21	14	7	
HAWAII	21	14	7	7B	7	7	7	7B	14	21A	21A	21	
INDIA	7	7B	7B	7B	7B	7B	14	14A	14	14B	14B	7B	
JAPAN	14	7B	7B	7B	7B	7	7	7B	7B	7B	14B	21	
MEXICO	14A	14	7	7	7	7	7	14	21A	21A	21A	21	
PHILIPPINES	14	7B	7B	7B	7B	7B	7B	7B	14B	14B	14B	14	
PUERTO RICO	14	7	7	7	7	7	14	21	21A	21A	21A	21	14A
SOUTH AFRICA	14	7	7	7	7B	14	21	21A	21A	21A	21A	14A	
U. S. S. R.	7	7	3A	3A	7	7B	14	21A	14	7A	7B	7	
WEST COAST	14A	14	7	7	7	7	7	14	21A	21A	21A	21	

## CENTRAL UNITED STATES TO:

ALASKA	14A	7A	7	7	3A	3A	3A	7	14	21	21A	21A	
ARGENTINA	14A	7A	7	7	7	7	14A	21A	21A	21A	21A	21A	
AUSTRALIA	21A	14A	7A	7B	7B	7B	7B	7B	14	14A	21	21A	
CANAL ZONE	14	14	7	7	7	7	7A	21	21A	21A	21A	21A	
ENGLAND	7	7	3A	3A	7	7B	14B	21	21A	21	14	7	
HAWAII	21A	14	7A	7	7	7	7	7	14	21A	21A	21A	
INDIA	7	14B	7B	7B	7B	7B	7B	14	14	14B	14B	7B	
JAPAN	21	14B	7B	7B	7B	7	7	7	7B	7B	14B	21	
MEXICO	14	7A	7	7	7	7	7	14	21	21	21A	21	
PHILIPPINES	21	14	7B	7B	7B	7B	7B	7	14B	14B	14	14A	
PUERTO RICO	14	14	7	7	7	7	14	21	21	21A	21A	21	
SOUTH AFRICA	14	7	7	7	7B	7B	14	21	21A	21A	21A	14A	
U. S. S. R.	7	7	3A	3A	7	7B	7B	14A	14	7B	7B	7B	

## WESTERN UNITED STATES TO:

ALASKA	14A	14	7	3A	3A	3A	3A	7A	14A	21	21A		
ARGENTINA	21A	14	7	7	7	7	7B	21	21A	21A	21A	21A	
AUSTRALIA	21A	21A	14	14	14B	7B	7B	7B	14	14A	21	21A	
CANAL ZONE	21	14	7	7	7	7	7	21	21A	21A	21A	21A	
ENGLAND	7B	7	3A	3A	7	7B	7B	14B	21A	21	14	7B	
HAWAII	21A	21	14	7A	7	7	7	7	14	21A	21A	21A	
INDIA	14	14	7B	7B	7B	7B	7B	14	14B	14B	14B	14B	
JAPAN	21A	21	14B	7B	7B	7	7	7	7B	14	21A		
MEXICO	14A	14	7	7	7	7	7	14	21A	21A	21A	21	
PHILIPPINES	21A	21	14	7B	7B	7B	7B	7	14	14	14	21	
PUERTO RICO	14	14	7	7	7	7	7	14	21A	21A	21A	21A	
SOUTH AFRICA	14	7	7	7	7B	7B	7B	14	21	21A	21A	14A	
U. S. S. R.	7B	7	3A	3A	7	7B	7B	14	14	7B	7B	7B	
EAST COAST	14A	14	7	7	7	7	7	14	21A	21A	21A	21	

A = Next higher frequency band may also be useful.

B = Difficult circuit this period.

First letter = night waves. Second = day waves.

G = Good, F = Fair, P = Poor. \* = Chance of solar flares.

# = Chance of aurora.

NOTE THAT NIGHT WAVE LETTER NOW COMES FIRST.

## NOVEMBER

SUN	MON	TUE	WED	THU	FRI	SAT
		1	2	3	4	5
		F/F	F/G	G/G	G/G	G/G
6	7	8	9	10	11	12
P/F*	F/F	G/G	G/G	G/G	F/G	F/G
13	14	15	16	17	18	19
F/G	F/G	F/G	G/G	G/G	F/G	G/G
20	21	22	23	24	25	26
G/G	G/G	G/G	G/G	F/G	F/G	F/G
27	28	29	30			
F/F	F/F	F/F	P/F*			

# FT-230R: QUITE A SIGHT! (AND EASY TO SEE, TOO!!)

Sporting an all-new Liquid Crystal Display, the FT-230R is Yaesu's high-performance answer to your call for a very affordable 2 meter mobile rig with an easy-to-read frequency display! The FT-230R combines microprocessor convenience, a sensitive receiver, a powerful yet clean transmitter strip, and the new dimension of LCD frequency readout. See your Authorized Yaesu Dealer today — and go home with your new FT-230R!



- LCD five-digit frequency readout with night light for high visibility day or night.
- Two VFOs for quick QSY across the band.
- Ten memory slots for storage and recall of favorite channels.
- Selectable synthesizer steps (5 kHz or 10 kHz) in dial or scanning mode.
- Priority channel for checking a favorite frequency for activity while monitoring another.
- Unique VFO/Memory Split mode for covering unusual repeater splits.
- Up/Down band scan plus memory scan for busy or clear channel. Scanning microphone included in purchase price.
- Full 25 watts of RF power output from extremely compact package.
- Built-in automatic or manual tone burst.
- Optional synthesized CTCSS Encode and Decode boards available.
- Lithium memory backup battery with estimated lifetime of five years.
- Now available: FT-730R  
10 watt 440-450 MHz FM Mobile Transceiver

**And don't forget! Yaesu has a complete line of VHF and UHF handheld and battery portable transceivers using LCD display!!!**

FT-208R  
FM Handheld  
2 Meters

FT-708R  
FM Handheld  
70 cm



FT-290R - 2 Meters  
SSB/CW/FM Portable

FT-690R - 6 Meters  
USB/CW/AM/FM Portable

FT-790R - 70 cm  
SSB/CW/FM Portable  
430-440 MHz

Price and Specifications Subject To  
Change Without Notice or Obligation

**YAESU** <sup>83</sup>  
**The radio.**



482R

# "DX-traordinary."



Superior dynamic range, auto. antenna tuner, QSK, dual NB, 2 VFO's, general coverage receiver.

## TS-930S

The TS-930S is a superlative, high performance, all-solid state, HF transceiver keyed to the exacting requirements of the DX and contest operator. It covers all Amateur bands from 160 through 10 meters, and incorporates a 150 kHz to 30 MHz general coverage receiver having an excellent dynamic range.

Among its other important features are, SSB slope tuning, CW VBT, IF notch filter, CW pitch control, dual digital VFO's, CW full break-in, automatic antenna tuner, and a higher voltage operated solid state final amplifier. It is available with or without the AT-930 automatic antenna tuner built-in.

### TS-930S FEATURES:

- **160-10 Meters, with 150 kHz-30 MHz general coverage receiver.**  
Covers all Amateur frequencies from 160-10 meters, including new WARC bands, on SSB, CW, FSK, and AM. Features 150 kHz-30 MHz general coverage receiver. Separate Amateur band access keys allow speedy band selection. UP/DOWN bandswitch in 1-MHz steps. A new, innovative, quadruple "UP" conversion, digital PLL synthesized circuit provides superior frequency accuracy and stability, plus greatly enhanced selectivity.
- **Excellent receiver dynamic range.**  
Receiver two-tone dynamic range, 100 dB typical (20 meters, 50-kHz spacing, 500 Hz CW bandwidth, at sensitivity of 0.25  $\mu$ v, S/N 10 dB), provides the ultimate in rejection of IM distortion.
- **All solid state, 28 volt operated final amplifier.**  
The final amplifier operates on 28 VDC for lowest IM distortion. Power input rated at 250 W on SSB, CW, and FSK, and at 80 W on AM. Final amplifier protection circuits with cooling fan, SWR/Power meter built-in.
- **CW full break-in.**  
CW full break-in circuit uses CMOS logic IC plus reed relay for smooth, quiet operation. Switchable to semi-break-in.

- **Automatic antenna tuner, built-in.**  
Covers Amateur bands 80-10 meters, including the new WARC bands. Tuning range automatically pre-selected with band selection to minimize tuning time. "AUTO-THRU" switch on front panel.
- **Dual digital VFO's.**  
10-Hz step dual digital VFO's include band information. Each VFO tunes continuously from band to band. A large, heavy, flywheel type knob is used for improved tuning ease. T.F. Set switch allows fast transmit frequency setting for split-frequency operations. A=B switch for equalizing one VFO frequency to the other. VFO "Lock" switch provided. RIT control for  $\pm 9.9$  kHz.
- **Eight memory channels.**  
Stores both frequency and band information. VFO-MEMO switch allows use of each memory as an independent VFO, (the original memory frequency can be recalled at will), or as a fixed frequency. Internal Battery memory back-up, estimated 1 year life. (Batteries not Kenwood supplied).
- **Dual mode noise blanker ("pulse" or "woodpecker").**  
NB-1, with threshold control, for pulse-type noise. NB-2 for longer duration "woodpecker" type noise.
- **SSB IF slope tuning.**  
Allows independent adjustment of the low and/or high frequency slope of the IF passband, for best interference rejection. HIGH/LOW cut control rotation not affected by selecting USB or LSB modes.
- **CW VBT and pitch controls.**  
CW Variable Bandwidth Tuning control tunes out interfering signals. CW pitch controls shifts IF passband and simultaneously changes the pitch of the beat frequency. A "Narrow/Wide" filter selector switch is provided.
- **IF notch filter.**  
100 kHz IF notch circuit gives deep, sharp, notch, better than -40 dB.
- **Audio filter built-in.**  
Tuneable, peak-type audio filter for CW.
- **AC power supply built-in.**  
120, 220, or 240 VAC, switch selected (operates on AC only).

- **Fluorescent tube digital display.**  
Six digit readout to 100 Hz (10 Hz modifiable), plus digitalized sub-scale with 20-kHz steps. Separate two digit indication of RIT frequency shift. In CW mode, display indicates the actual carrier frequency of received as well as transmitted signals.
- **RF speech processor.**  
RF clipper type processor provides higher average "talk-power," improved intelligibility.
- **One year limited warranty on parts and labor.**
- Other features:**
  - SSB monitor circuit, 3 step RF attenuator, VOX, and 100-kHz marker.
- Optional accessories:**
  - AT-930 automatic antenna tuner.
  - SP-930 external speaker with selectable audio filters.
  - YG-455C-1 (500 Hz) or YG-455CN-1 (250 Hz) plug-in CW filters for 455-kHz IF.
  - YK-88C-1 (500 Hz) CW plug-in filter for 8.83-MHz IF.
  - YK-88A-1 (6 kHz) AM plug-in filter for 8.83-MHz IF.
  - SO-1 commercial stability TCXO (temperature compensated crystal oscillator). Requires modifications.
  - MC-60A deluxe desk microphone with UP/DOWN switch, pre-amplifier, 8-pin plug.
  - TL-922A linear amplifier (not for CW QSK).
  - SM-220 station monitor (not for pan-adapter).
  - HS-6, HS-5, HS-4, headphones.

More information on the TS-930S is available from all authorized dealers of Trio-Kenwood Communications, 1111 West Walnut Street, Compton, California 90220.

# KENWOOD

...pacesetter in amateur radio



Specifications and prices are subject to change without notice or obligation.