

73 Magazine

for Radio Amateurs

- 24 **The Italian Freq Generator**
—from Bologna to you..... K7YZZ
- 28 **Happiness is a WE-800**
—proud owner loves his Wilson..... K3JML
- 32 **Explore the World of VLF**
—with this simple converter..... W3QVZ
- 34 **The S.H.A.F.T.**
—special tuning gadget for sightless
hams..... K5CW
- 38 **A Remotely-Tuned Matchbox**
—ultimate operating ease..... W4PSJ
- 44 **Diodes of the Dead**
—eavesdrop on the great beyond..... K5JRN
- 46 **Building an Economy Receiver**
—junk box, here I come!..... WB4NEX
- 50 **The ST-5 Plus**
—improvements on a favorite TU..... K5QY
- 52 **Build a \$10 Digital Thermometer**
—hundreds of uses..... McClellan
- 56 **CB to 10**
—part XVI: a CW conversion..... W4GBB
- 58 **Try a Little KISS**
—you'll love it..... K8AO
- 62 **Autotrak II**
—chase OSCAR with ease..... W9CGI
- 78 **The Twofer**
—double-duty IDer logic..... K3JML
- 80 **Adam-12 Revisited**
—a scanner unscrambler..... N8AMR/4
- 84 **Digital RTTY Is Simple**
—easy as 01, 10, 11..... WB5NYX
- 86 **Take the Pledge**
—a no-compromise console..... K3MPJ
- 90 **Two Meter Tone Alert**
—keep everyone on call..... WA3ENK
- 94 **Sneaky Car Security System**
—an alarming article..... WB8SWH/W8VL
- 100 **Design-a-Notcher**
—automated filter values..... WA4HUU
- 102 **The Cosmac Connection: Part 1**
—computerized CW..... VE3CWY
- 108 **Noise Bridge BASICS**
—computer-optimized radiation..... N6RY
- 114 **The Morse Master**
—convert your computer friends to
hamdom..... WB9TNW
- 120 **The MINI-MOUSE Key**
—perfect companion to the MINI-MOS
keyer..... WA6EGY
- 124 **One Step Further**
—PTTR instead of PTT..... Staff
- 126 **Hooray for LC Filters!**
—simplest is sometimes best..... Ogushwitz
- 128 **The Soft Touch Keyer**
—send CW with no moving parts..... WA3PKU
- 132 **SOS! Ship in Trouble!**
—life and death on 20 meters..... W1BNN
- 138 **Minicontests**
—get 'em involved!..... Stocking, W0VM
- 139 **Are Your Op Amps Opping?**
—try this IC helpmate..... W3KBM
- 140 **Major League TT Controller**
—15 digits, 40 devices, 100 bucks..... K3NCL
- 156 **CB to 10**
—part XVII: SBE and Pace rigs..... K3SZN
- 172 **Electronics Education by Mail Order**
—successful student reports..... N6UE
- 178 **Time-Domain Reflectometry**
—to check out your transmission
lines..... Staff
- 184 **High Seas Adventure—Ham Style**
—part IV..... WA6FEI

TEMPO
FM Transceiver - S1

8000

channels in the palm of your hand

Tempo presents the S1 SYNCOM
...the world's first
synthesized 800
channel hand held
transceiver



Shown with accessory touch tone pad

Top view, showing controls

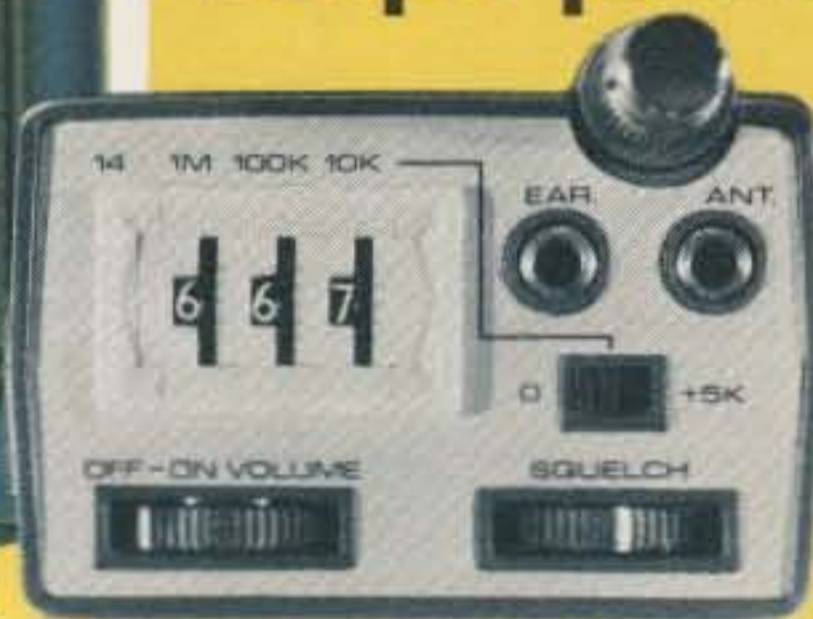

This amazing pocket sized radio represents the year's biggest breakthrough in 2-meter communications. Other units that are larger, heavier and are similarly priced can offer only 6 channels. The SYNCOM'S price includes the battery pack, charger, and a telescoping antenna. But, far more important is the 800 channels offered by the S1.

The optional touch tone pad shown in the illustration adds greatly to its convenience and we have available a 30 watt solid state power amplifier designed to give the SYNCOM S-1 the flexibility of operating as a mobile and base station as well.

SPECIFICATIONS

Frequency Coverage: 144 to 148 MHz
Channel Spacing: Receive every 5 kHz transmit simplex or ± 600 kHz
Power Requirements: 9.6 VDC
Current Drain: 17 ma - standby 400 ma - transmit
Batteries: Ni-cad battery pack included
Antenna Impedance: 50 ohms
Dimensions: 40 mm x 62 mm x 165 mm (1.6" x 2.5" x 6.5")
RF Output: Better than 1.5 watts
Sensitivity: Better than .5 microvolts

SUPPLIED ACCESSORIES

Telescoping whip antenna, ni-cad battery pack, charger.

OPTIONAL ACCESSORIES

Touch tone pad, tone burst generator, CTCSS sub-audible tone chips
Rubber flex antenna.

Price ... \$349.00 (or with touch tone pad ... \$399.00)

Tempo also offers a complete line of solid state power amplifiers, pocket receivers, the FMH-2, 5 & 42 portables, the VHF/ONE PLUS mobile transceiver, and the FMT-2 & FMT-42 remote control mobile transceiver. All available from Tempo dealers throughout the U.S. Call or write for full information.

11240 W. Olympic Blvd., Los Angeles, Calif. 90064 213/477-6701
931 N. Euclid, Anaheim, Calif. 92801 714/772-9200
Butler, Missouri 64730 816/679-3127

Henry Radio

Prices subject to change without notice.

THE SWITCH IS ON!

Not only is the big move to switch to the Wilson Mark Series of Mini-Hand-Held Radios, but now the switch is on the Mark!

Wilson Electronics, known for setting the pace in 2m FM Hand-Helds, goes one step beyond!

AT NO EXTRA CHARGE: all Mark Series Radios now will include a switch for you to control the power of operation. This will enable you to use the high power when needed, then later switch to low power to conserve battery drain for extended operation.

IN ADDITION: all Mark Series Radios now have an LED Battery Condition Indicator conveniently mounted on the top plate. A quick peek will reassure you of a charged battery in the radio.

Wilson hand-helds have been known world-wide for exceptional quality and durable performance. That's why they have been the best selling units for years.

Now the Mark Series of miniature sized 2-meter hand-helds offers the same dependability and operation, but in an easier to use, more comfortable to carry size . . . fits conveniently in the palm of your hand.

The small compact size battery pack makes it possible to carry one or more extra packs in your pocket for super extended operation time. No more worry about loose cells shorting out in your pocket, and the economical price makes the extra packs a must.

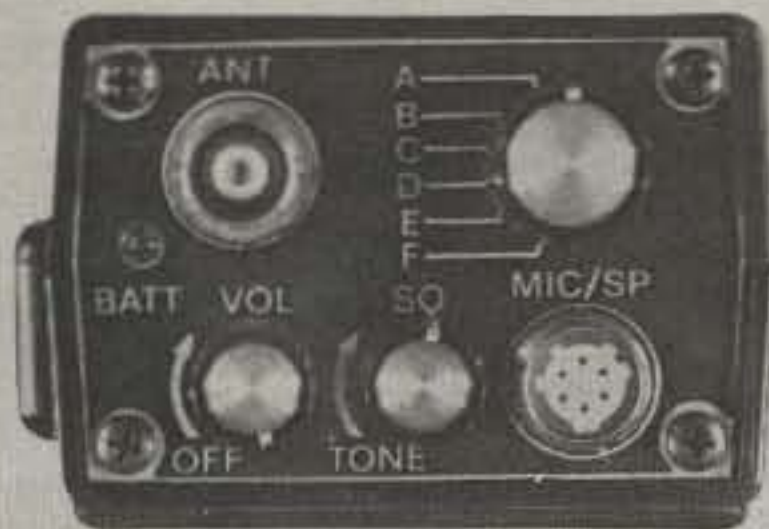

Conveniently located on top of the radio are the controls for volume, squelch, accessory speaker mike connector, 6 channel switch, BNC antenna connector and LED battery condition indicator.

Optional Touch Tone™ Pad available.

To obtain complete specifications on the Mark II and Mark IV, along with Wilson's other fine products, see your local dealer or write for our Free Amateur Buyer's Guide.

— NOW SWITCHABLE —

MARK II: \approx 1 & 2.5 watts

MARK IV: \approx 1 & 4.0 watts

SPECIFICATIONS

- Range: 144-148 MHz
- 6 Channel Operation
- Individual Trimmers on TX and RX Xtals
- Rugged Lexan® outer case
- Current Drain: RX 15 mA
TX - Mark II: 500 mA
TX - Mark IV: 900 mA
- 12 KHz Ceramic Filter and 10.7 Monolithic Filter included.
- 10.7 MHz and 455 KHz IF
- Spurious and Harmonics: more than 50 dB below carrier
- BNC Antenna Connector
- .3 Microvolt Sensitivity for 20 dB Quieting
- Uses special rechargeable Ni-Cad Battery Pack
- Rubber Duck and one pair Xtals 52/52 included
- Weight: 19 oz. including batteries
- Size: 6" x 1.770" x 2.440"
- Popular accessories available: Wall Charger, Mobile Charger, Desk Charger, Leather Case, Speaker Mike, Battery Packs, and Touch Tone™ Pad.



Illustrated is Wilson's BC-2 Desk Top Battery Charger shown charging the Mark Series Unit or the BC-4 Battery Pack only.

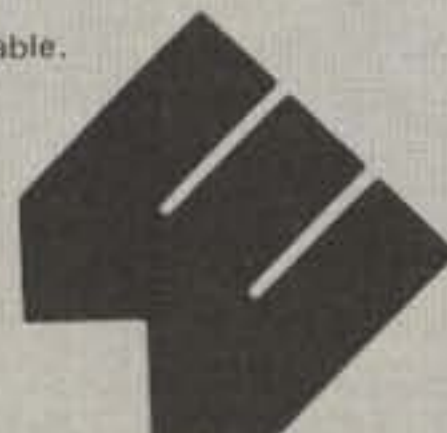

Consumer Products Division

**Wilson
Electronics Corp.**

4288 South Polaris Avenue • P. O. Box 19000 • Las Vegas, Nevada 89119

Telephone (702) 739-1931 • TELEX 684-522

Staff

EDITOR/PUBLISHER
Wayne Green W2NSD/1

EXECUTIVE VICE PRESIDENT
Sherry Smythe

ASSISTANT PUBLISHER
Jeffrey D. DeTray WB8BTH/1

ADMINISTRATIVE ASSISTANT
Dotty Gibson

MANAGING EDITOR
John C. Burnett

ASSISTANT MANAGING EDITOR
Susan G. Philbrick

NEWS EDITOR
Gene Smarte WB6TOV/1

EDITORIAL ASSISTANTS
Elisabeth Blackmore
Cynthia Smith

BOOK PUBLICATIONS
Beth Weston

PRODUCTION MANAGER
Lynn Panciera-Fraser

ART DEPARTMENT

Craig Brown
Gayle Cabana
Bob Drew
Bruce Hedin
Carl Jackson
James Lamothe
Dion Owens
Noel R. Self WB1ARP
Robin M. Sloan

PRINTING
Gary Steinbach
Dan Morgan
Dwight Perry

PHOTOGRAPHY
Bill Heydolph
Tedd Cluff

TYPESETTING
Barbara J. Latti
Mary Kinzel
Holly J. Walsh
Sara Bedell

BOOKKEEPER
Knud E. M. Keller KV4GG/1

CIRCULATION
Barbara Block
Laura Barnicle

DATA ENTRY
Mary Kinzel
Denise Loranger

DIRECTOR OF MARKETING
Robert R. LaPointe

BULK SALES MANAGER
Judy Waterman

SHIPPING
Ethan Perry
Bill Barry
Michelle Walsh

RECEPTIONIST
Doni Jarvis

ASSOCIATES
Robert Baker WB2GFE
E. H. Barnett WB0IIX
Schley Cox WB9LHO
Tom DiBlase WB8KZD
Terry Fox WB4JFI
W. Sanger Green
Dave Ingram K4TWJ
Larry Kahaner WB2NEL
Joe Kasser G3ZCZ
Bill Pasternak WA6ITF
John Schultz W4FA
Waller Scott K8DIZ
Peter Stark K2OAW
Chuck Stuart N5KC
Bill Turner WA0ABI

COMPUTER PROGRAMMING
Richard J. Dykema

CUSTOMER SERVICE
Florence Goldman
Joyce Tarr
Ellen Blanchard

ADVERTISING
Aline Coutu
Marcia Stone
Bill York
Nancy Ciampa
Pat Theriault

W2NSD/1 NEVER SAY DIE

editorial by Wayne Green



SAM HARRIS W1FZJ

On page 8 of the September issue of 73, we printed a picture of Sam Harris and his wife Helen. Word arrived from his son, Pat, that Sam died in early November. VHFers will miss him.

For some reason, Sam and I clicked early on... I think it was around 1948 or so that we began to get into extended contacts on the low end of 75m. We both shared an interest in 75m DXing... in VHF... and in learning more about the anomalies of life. When I moved out

to Cleveland and became W8NSD in 1951, I visited Sam and Helen at their farm just east of Cleveland. Sam was W8UKS at that time. We talked just about every evening on 75m.

Later, when I became the editor of CQ in 1955, Sam signed on as VHF editor and did a splendid job. During those days, I occasionally had a chance to drive or fly (I had a plane then) up to visit him in Medfield, just outside of Boston, and sack out on his living room couch.

Sam was one of those who said what he thought of people, pulling few punches. I remember a luncheon with the president of National Radio, where this chap asked Sam what he thought of their new receiver. Sam told him in no uncertain terms what he thought of their overpriced, unstable, easily overloaded bomb.

We get so used to kids wearing beards these days that we tend to forget that it wasn't long ago when a man with a beard was an unusual sight. Sam always had a beard... might have been born with one, for all I know. I asked him if the stares on the street ever bothered him, and he said they did sometimes... made him wonder if his fly was open.

Sam was not a difficult man to deal with or understand once you grasped that amateur radio came first, second, and perhaps even third in his life. Helen got used to it early on, and brought him his meals and coffee at his operating desk. This preoccupation with hamming manifested itself in a way that was helpful to many of us: He had to have the loudest signal in the world on a band before he would get active on it.

The antennas and towers which this conviction brought about have appeared in many magazine articles. I once ran an article by Sam on his "contest 100-Watt amplifier." I still pull out that article when I want to collapse a visiting ham with laughter. The final actually ran about 7,000 Watts, and consisted of separate finals for each of the low bands (which were built into Sam's garage). The article was a spoof of the 100-Watt listings in QST contest results, where many hams



Sam Harris W1FZJ.

Continued on page 106

73 Magazine is published monthly by 73, Inc., Peterborough NH 03458. Subscription rates in the U.S. and Canada are \$18 for one year, and \$45 for three years. Outside the U.S. and Canada, write for rates. Second class postage paid at Peterborough NH 03458 and at additional mailing offices. Publication No. 700420. Phone: 603-924-3873. Microfilm edition—University Microfilm, Ann Arbor MI 48106. Entire contents copyright 1978 by 73, Inc. INCLUDE OLD ADDRESS AND ZIP CODE WITH ADDRESS CHANGE NOTIFICATION and send to 73, Inc., Peterborough NH 03458.

Instant recall.



Kenwood's TR-7600 with optional RM-76 Microprocessor Control Unit offers a new dimension in channel memory and scanning capability.

...and, it's a combination that's hard to beat if you're looking for optimum versatility in a 2-meter FM transceiver. Together, the TR-7600 and RM-76 offer you the following:

TR-7600 (only)

- Memory channel...with simplex or repeater (plus or minus 600 kHz transmitter offset) operation.
- Mode switch for operating simplex or for switching the transmit frequency up or down...or for switching the transmitter to the frequency you have stored in the TR-7600's memory (while the receiver remains on the frequency you have selected with the dual knobs).
- Select any 2-meter frequency.
- Even without the optional RM-76, the TR-7600 gives you full 4-MHz coverage (144.000-147.995 MHz) on 2 meters; 800 channels; dual concentric knobs for fast frequency change (100 kHz and 10-kHz steps); 5-kHz offset switch, and MHz selector switch...for desired band (144, 145, 146, or 147 MHz).
- Digital frequency display (large, bright, orange LEDs).

- UNLOCK indicator...an LED that indicates transceiver protection when the frequency selector switches are improperly positioned or the PLL has malfunctioned.
- 10 watts RF output (switchable to 1 watt low power).

TR-7600 WITH RM-76

- Store frequencies in six memories.
- Scan all memory channels.
- Automatically scan up the band in 5 kHz steps.
- Manually scan up or down in 5-kHz steps.
- Set lower and upper scan frequency limits.
- Reset scan to 144 MHz.
- Stop scan (with HOLD button).
- Cancel scan (for transmitting).
- Scan for busy or open channel.
- Select repeater mode (simplex plus transmit frequency offset, minus offset, or one memory transmit frequency).
- Select transmit offset (± 600 kHz / ± 1 MHz).
- Operate on MARS (143.95 MHz simplex only).



RM-76 MICROPROCESSOR CONTROL UNIT

- Display indicates frequency (even while scanning) and functions (such as auto-scan, lower scan frequency limit, upper scan limit, error, and call channel).
See the exciting new TR-7600 and optional RM-76 now at any Authorized KENWOOD Dealer!

Subject to FCC approval



KENWOOD
...pacesetter in amateur radio

TRIO-KENWOOD COMMUNICATIONS INC.
1111 WEST WALNUT/COMPTON, CA 90220

Editor:
Robert Baker WB2GFE
15 Windsor Dr.
Atco NJ 08004

CONTESTS

HUNTING LIONS ON THE AIR CONTEST

Starts: 1200 GMT,
January 13
Ends: 1200 GMT,
January 14

The contest is sponsored by Lions International and coordinated by the Lions Club of Rio de Janeiro (Arpoador), Brazil. Participation is open to all licensed radio operators except members of the contest committee. The contest will be separated into two sections, phone and CW, with points counting separately and participation allowed in both modes. All bands 80 through 10 meters may be used, with each station being contacted no more than once per band and mode. When contacts are made between Lions and Leos, the name of the Lions Club or Leo Club contacted should be noted in the log. Confirmation of contacts will be made by log comparisons.

SCORING:

QSOs within the same continent count 1 point each; between different continents, 3 points. Bonus points: 1 extra point for a QSO with member of a Lions or Leo Club and 5 extra points for a QSO with a member of the Rio de Janeiro (Arpoador) Lions Club. Contacts between members of the Arpoador Club will not count any bonus

points.

ENTRIES AND AWARDS:

Lions International will present first-, second-, and third-place awards in two categories—phone and CW. The first place winner in each category will receive a trophy, the second a medallion, and the third a plaque. The Lions Club of Rio de Janeiro will award additional vermilion award medallions to the fourth- through tenth-place winners. Each participant making more than 20 points will receive a special QSL from the Lions Club of Rio de Janeiro. Logs for each mode showing time and callsign should be sent to the contest committee no later than 30 days after the contest: Lions Club of Rio de Janeiro (Arpoador), Rua Souza Lima n. 310—Apt. 802, Rio de Janeiro 22.081, ZC-37 Brazil.

IAAH AIRLINE CONTEST

Starts: 1500 GMT Saturday,
January 27
Ends: 1500 GMT Sunday,
January 28

Sponsored by the International Association of Airline Hams (IAAH), this is their first annual contest open to all "airline hams" and non-members. Members of the IAAH may work both members and non-members, and vice versa. Certificates will be given to the top

3 scorers in each of the two categories (members and non-members). Multi-op counts as one station. General call is "CQ Air Contest," etc.

EXCHANGE:

Non-members, five: "non-member," consecutive serial number, signal report, state, province, or country.

Members, five (the same as for non-members), except: "member," IAAH roster number, 3-letter airport identifier (if applicable), flight number or aircraft number if station is "aeronautical mobile."

Please Note: Specific laws apply to hams operating their equipment from on board an aircraft. Please contact the IAAH for rules BEFORE doing this!

SCORING:

Score 4 points for "airport operations" such as W9XYZ/9 at O'Hare Airport; score 5 points for contact with an "aeronautical mobile"; all others score 1 point each. Then add the total number of points, including bonus points. Add the total number of multipliers (states, countries, and Canadian provinces) and multiply the total points by the total multiplier for the final score.

ENTRIES:

Submit all logs, separate logs for each band, to: Frank Sadilek WB9OUE, 3818 N. Newcastle Avenue, Chicago IL 60634. Deadline for submitted logs will be March 1.

SUGGESTED FREQUENCIES:

CW—3550, 7050, 14050, 21050, 28050, 50095.
SSB—3975, 7275, 14280, 21375, 28550, 50105.

Novice/Tech—3725, 7125, 21125, 28125.

FM—146.52 and/or 146.55 simplex; duplex through a repeater is permissible!

WORKED COLUMBIA AND GREENE COUNTIES AWARD

Offered by the Rip Van Winkle Amateur Radio Society of Columbia and Greene Counties, New York, the award is given for having two-way contacts by amateur radio with two stations in each of Columbia and Greene Counties, New York. Contacts may be on any band or mode, except that repeaters may not be used. Send log information and \$1.00 to: Rip Van Winkle ARS, PO Box 1028, Hudson NY 12534.

FRENCH CONTEST

CW

Starts: 0000 GMT,
January 27
Ends: 2400 GMT,
January 28
Phone

Starts: 0000 GMT,
February 24
Ends: 2400 GMT,
February 25

All contacts must be made on 160 meter CW (or 1,826 MHz for F stations). All entries must be single operator.

EXCHANGE:

RS(T) and QSO number.

SCORING:

Score 3 points for each F or overseas French department or territory contacted in your own continent (10 points if in another continent). Multipliers are each F department (95) and DA1/2 STN/FFA (F forces in DL),

Continued on page 197

CALENDAR

Jan 1*	ARRL Straight Key Night
Jan 6-7	ARRL CD Party—Phone
Jan 13	Hunting Lions on the Air Contest
Jan 13-14	ARRL CD Party—CW
	ARRL VHF Sweepstakes
Jan 27-28	ARRL Simulated Emergency Test
	French Contest—CW
	IAAH Airline Contest
Jan 28-29	Classic Radio Exchange
Feb 2-11	ARRL Novice Roundup
Feb 4 & 11	10-10 Net Winter QSO Party
Feb 10-11	QCWA QSO Contest—CW
Feb 17-19	Two-Land QSO Party
Feb 17-Mar 4	University of Cape Town Festival Station
Feb 24-25	French Contest—Phone
Mar 3-4	ARRL DX Competition—Phone
Mar 10-11	QCWA QSO Contest—Phone
Mar 17-18	ARRL DX Competition—CW
Apr 7-8	ARRL Open CD Party—CW
Apr 21-22	ARRL Open CD Party—Phone
	ARRL EME Contest
May 19-20	ARRL EME Contest
June 9-10	ARRL VHF QSO Party
June 23-24	ARRL Field Day

*described in last issue



New, Remotable 2meter Mobile!



ICOM's New IC-280

ICOM introduces its new 2 meter mobile radio with the detachable microprocessor control head, the **IC-280**. Bright, easy to read LED's and a new style meter grace the brushed aluminum "new look" front panel of the detachable control head, which provides memory and frequency control for the remotely mountable main section.

The **IC-280** comes as one radio to be mounted in the normal manner; but, as an option, the entire front one third of the radio detaches and mounts by its optional bracket and the main body tucks neatly away out of sight. Now you can mount your 2 meter mobile radio in places that seemed really tight before.

With the microprocessor head the **IC-280** can store three frequencies of your choice, which are selected by a four position front panel switch. These frequencies are retained in the **IC-280's** memory for as long as power is applied to the radio. Even



when power is turned off at the front panel switch, the **IC-280** retains its programmed memories; and when power is completely removed from the radio, the ± 600 KHz splits are still maintained!

Frequency coverage of the **IC-280** is in excess of the 2 meter band; and the new band plan (144.5-145.5 MHz repeaters) can easily be accommodated, since it was included in the **IC-280's** initial planning by the ICOM design team.

The main section of the **IC-280** puts you up to the minute with the latest state of the art engineering. The new **IC-280** includes the latest innovations in large signal handling FET front ends for excellent inter-modulation character and good sensitivity at the same time. The IF filters are crystal monolithics in the first IF and ceramic in the second, providing narrow band capacity for today and tomorrow's crowded operating conditions. Modular PA construction with broad band tuning provides full rated power across the full 2 meter band (plus a little).

All ICOM radios significantly exceed FCC specifications limiting spurious emissions.

Specifications subject to change without notice.

IC-280 Specifications: Frequency Coverage: 143.90—148.11 MHz Operating Conditions: Temperature: -10°C to 60°C (14°F to 140°F), Duty Factor: continuous Frequency Stability: ± 1.5 KHz Modulation Type: FM (F3) Antenna Impedance: 50 ohms unbalanced Power Requirement: DC 13.8V $\pm 15\%$ (negative ground) Current Drain: Transmitting: 2.5A Hi (10W), 1.2A Lo (1W), Receiving: 0.630A at max audio output, 0.450 at SQL ON with no signal Size: 58mm(h) x 156mm(w) x 228mm(d) Weight: approx. 2.2 Kg Power Output: 10W Hi, 1W Lo Modulation System: Phase Max. Frequency Deviation: ± 5 KHz Spurious Output: more than 60 dB below carrier Microphone Impedance: 600 ohms dynamic or electret condenser type, such as the SM-2 Receiving System: Double superheterodyne Intermediate Frequency: 1st: 10.695 MHz, 2nd: 455 KHz Sensitivity: 1 μv at S+N/N at 30 dB or better, Noise suppression sensitivity 20 dB, 0.6 μv or less Selectivity: less than ± 7.5 KHz at -6 dB, less than ± 15 KHz at -60 dB Audio Output: More than 1.5W Audio Output Impedance: 8 ohms

HF/VHF/UHF AMATEUR AND MARINE COMMUNICATION EQUIPMENT

DISTRIBUTED BY:



ICOM

ICOM WEST, INC.
Suite 3
13256 Northrup Way
Bellevue, Wash. 98005
11 (206) 747-9020

ICOM EAST, INC.
Suite 307
3331 Towerwood Drive
Dallas, Texas 75234
(214) 620-2780

ICOM CANADA
7087 Victoria Drive
Vancouver B.C. V5P 3Y9
Canada
(604) 321-1833

ou moons don't ever proofs
lousy manuscripts from bat
burca of ro k e i s of
you liard y no art in
I insist that you print ev
tell Ma Bell that she shou

LETTERS

DRAWBACK?

Your latest issue is the best yet, and one of the fattest I've ever seen. You're approaching Japanese *CQ ham radio* girth. The only drawback was your taking on the Chrysler Corp. I don't think ham radio needs any more powerful opponents and I for one wish you'd keep your printed opinions in the ham radio arena. There are certainly enough electronic foibles to aim your barbs at, aren't there? If you're running short, let me suggest DX list operations, blatant business phone patches, the FCC considering overseas religious missions to be business, and the FCC's inability to run a computer rather than be run by it.

David L. Bell W6AQ
Hollywood CA

PERISH THE THOUGHT!

After reading your editorial in the September issue of 73, I just had to let you know how strongly I agree with what you say about the ITU and WARC and the effect the deliberations of WARC may have on the future of amateur radio as we know it today.

The reason I can so readily agree with you is that I am familiar with the operations of the ITU and its associate agencies. My first participation was while I was a member of a Canadian R & D organization then up to my retirement in 1973 as a consultant with the Canadian Department of Communications (DOC). I think that many amateurs are not fully aware of what the ITU really is and what it does. The ITU, a specialized agency of the United Nations, has, among other activities, two very important consultative committees. One of these is the CCITT, the International Consultative Committee for Telephones and Telegraph. The other is the CCIR, the International Consultative Committee for Radio. It is my feeling that it was in the CCIR that we amateurs should have had most interest and this should have extended back for many years. As you indicated in your editorial, this committee deals in all areas of radio

telecommunications. These areas are divided into about a dozen study groups, such as for marine radio, radio astronomy, television, radio satellites, and, of course, radio telecommunications in all frequencies from the lowest to the GHz and up. It is also probably not known to many amateurs that the only recognized participants in these study groups are the official government representatives of the member United Nations countries. Each of these administrations may include in their delegation certain specialists by personally inviting them and also informing Geneva. It is easy to understand that in the aggregate these specialists probably include the world's most knowledgeable people in all areas of telecommunications. Unfortunately, only a very few of these are amateurs, although none was selected for this reason. There is no study group dealing in amateur radio.

In addition to the international study group meetings, most administrations held national meetings paralleling these SGs. These national meetings would be held in the interval between the international meetings to prepare the administrations for the next Geneva meeting. The discussions in the national meetings were highly technical. The participants came from all national fields and represented many manufacturers, telecommunication companies, the television industry, many users such as public utilities, police, and others. Only a few of these people would be part of the international delegation.

Unfortunately, so far as I was aware, there was little or no participation in these national meetings although the DOC had indicated that such participation was acceptable.

Participation for WARC does include a number of national meetings, but we must be aware that these are not technical meetings. The technical meetings of the CCIR provided the CCIR recommendations as contained in the Green books, which would of course lend weight to the WARC in its decisions. It can be seen that the work of WARC will not be supported by the many specialists that we saw in the CCIR, but rather by a

relatively few people that are directly concerned with the national policy. It is quite possible that many delegations will have no amateurs, and this a definite certainty in the delegates in those countries that do not now have any amateurs. It is also the case that some administrations that do permit amateur activity in their countries are somewhat indifferent as to amateur survival.

What I may not have brought out here is a fact that some amateurs are not fully aware of, and that is that all of the meetings of the ITU and its associated agencies are closed meetings. There is one and only one voice at these meetings, and that is of the official administrative voice of the United Nations current member countries.

It is difficult for me to understand how an almost "no face," an organization that has not actively participated in and identified itself in the technical area (the CCIR), can hope to justify its existence at a WARC meeting where it has no voice and where a number, too many, of the administrations either do not have or do not want amateurs. Not only that, but many administrations that are otherwise in favor of amateurs would have no scruples in subordinating this if it interfered with other national more pressing needs.

Probably I agree so fully with you because, like you, I have attended these meetings and thus could sense the direction in which they seemed to lead. I hope that we are both mistaken and that we will be able to enjoy amateur radio as we now know it for many more years. I would hate to have to go underground. Perish the thought!

As insurance against total insanity if we do lose out, I have infected myself with a counter-insanity. I am becoming active in the microcomputer field, having obtained a TRS-80. With the help of *Kilobaud*, I trust this new insanity will make me impervious to any bad news from WARC.

My best 73s and may your cassettes never become demagnetized so you will always be able to CLOAD!

H.F. Hannay VE7WO
Nanaimo BC
Canada

BLESSING IN DISGUISE

It looks like your brain is finally starting to soften up, Wayne. "Never Say Die" in the October, 1978, issue sounded like you've been experimenting with drugs more than radio.

Docket 20777 would have been the best thing for amateur radio since SSB. Not perfect, maybe, but a lot better than what we have now. CW is okay, but to devote over half our HF spectrum to it is nonsense. Why doesn't someone look at amateur radio as it really is, not as it once was or as they wish it would be.

If amateur radio is gutted by the ITU next year, it will be a blessing in disguise. The deregulation you (and I) want will be an overnight fact. Once the challenge of "illegal" operation is overcome, things like bandwidth, subbands, band-edge, mode, power, and class of license all fade into insignificance. It will be almost as much fun as Peterborough to New York in 2½ hours! QRP, indoor antennas, and inexpensive fun operating CW would be reborn, TVI and tower problems would be eliminated, and licensing hassles would be forgotten.

Banning amateur radio would be the best thing that ever happened to it. No one outside amateur radio cares about it one way or the other. The only outside interest we get is bad (towers and TVI). If we went underground, the towers and TVI would disappear. We would have more operating freedom than we've ever had. As long as our operations did not interfere with "outsiders" and thus generate complaints, the FCC would remain sound asleep, as they have been for decades. What happens if they wake up, you ask? That would take millions of dollars, money they don't have and aren't likely to get.

Besides that, amateur radio is big business, and if for no other reason, we won't lose a single kHz of HF spectrum at the ITU meeting. We might even gain a little. Satellite communication, and the VHF/UHF frequencies required for it, is where we are going to lose our shorts.

Robert Seeber
Littleton CO

P.S. One of these days you are going to wish you had your 240Z back. However, I wouldn't trade my 1974 B200 Dodge van for anything.

STIRRED BLOOD

Congratulations on your finest editorial yet, Wayne, in the October issue of 73.

Please bear with me, and I'll give you one more example of the stupidity of some of their hard and fast rules at the FCC.

In August, 1921, I took a written test and written code test from a Mr. Paul Ord, then assis-

tant radio inspector out of San Francisco. It was in Stockton CA, and I was a 12-year-old kid running errands for the men who built and operated KWG, and they believed it was to be the first commercial broadcasting station. I operated my own 1 kW rotary spark-gap transmitter and homemade receiver. My best DX was from near Stockton CA, to Bozeman MT. I had many friends ten years or so my senior, and they were always ready to answer my many questions.

My principal at the high school expelled me in my junior year because I was a bad boy for not studying my history, English, etc., and I was the least likely boy to succeed in this world!

I went to San Diego and joined the Navy. I taught radio classes and theory at the school for about one year and then went aboard the *USS Idaho* for the rest of my enlistment of four years. Aboard the *Idaho* less than one hour, the communications officer, Ensign Charles F. Horn, called me to his office. Could I make a new crystal-controlled oscillator, a 211 50-Watt tube followed by another 211 amplifier, work? Earlier, one of my seniors had explained how to "neutralize" an amplifier to prevent self-oscillation. It worked! The *USS Idaho* had the first rig that would work. The Bureau of Ships diagram had not included a system to neutralize the final! Ensign Charles Horn received all the credit, but he put me in charge of all radio maintenance, and I bought a folding cot and lived in the material repair shop.

From the US Navy, I went to work at KFSD broadcast station in San Diego, and my lifetime was devoted to the broadcast business—KFI, KTTV, KEYT-TV, KTTV, etc.

In 1925, I took my Commercial First Class test in San Francisco and was given a test covering arc and spark. No problem. So I still have my Commercial First Class Telegraph and Telephone licenses.

In 1934, I experimented with a copper toilet bowl float and stumbled upon what may have been the first cavity system. Professors at Cal Tech, Pasadena CA, at least thought so. I built one for a young student which was at about 300 MHz, with the antenna at the focal point of a 4-foot parabola which was made in the Cal Tech shops. A small "perch" was attached to the parabola at the focal point about one foot beyond the radiator and was used to study the effects of rf upon insects. As a result, the student obtained his master's degree.

Then came WWII and I was the first person to be interviewed on the west coast by Dr. Louis Redenour (a close friend of the young student at Cal Tech), who was recruiting research people to go to MIT and design radar systems. I professed to know nothing about radar. I was politely informed that he knew all about my past history, and that I was to prepare to leave for MIT the following day, *or else!*

At MIT, I soon learned that the country's leading physicists were really smart, but most did not know how to work with their hands.

I developed gun-pointing systems. They included the system for the black widow night fighter. Upon intercept of a "bogey," the pilot would throw the switch to automatic, sit back, and relax while the plane flew via radar-controlled autopilot to an intercept at about 1200 yards. The guns would automatically fire and the plane would start to follow the enemy toward the earth, at which point the pilot would throw the switch back to manual and fly away. I also developed the AN/APG-15 gun-pointing system for the tail gunner in B-29s. I outfitted five B-29s at Bedford Airport and took them to India with full crews and turned them over to Gen. Curtis Lemay. The first, second, and third nights out over Japan, one Jap fighter was shot down each night. The fourth day, they switched to kamikaze head-on attacks. (In the meantime, a contract had been let to build 10,000 AN/APG-15 systems! But we did not need them then!)

After the war, I went back into broadcasting. I designed and built the triband gamma match feed system for beams. Mr. Andy Andros called long distance after reading a small report in *QST* and wanted to know what I was going to do with the idea. I said "nothing" and that if he was interested, I would give him a written release. I did, and hence the "Hy-Gain Corp." Andy retired with ulcers; I'm fat and sassy.

I developed many other items such as antenna-measuring devices, a "better" noise bridge generator (73), etc.

So, to the point of my writing. About four years ago, after working full time to make a living, I decided to go to San Francisco and get my Extra Class license. I failed! I found that the years had caught up with me; I could not remember rules or sufficient math to answer the damned tricky Philly-lawyer's questions. My wife gently informed me she was well aware that my mind was not what it used to be! I walked out of the

examiner's office in San Francisco in tears. I went to the parking lot and sat in the car for an hour before starting home. What a *terrible shock!*

At a Las Vegas convention about three years ago, I spoke to Johnny Johnson about my plight. No sympathy. I informed him that I was damned fed up with such bureaucracy, and that I would henceforth operate in any portion of the ham bands I chose, and that I would see the FCC in a Federal Court if any action was taken against me. And I have operated to some extent when I hear a long-lost friend.

I'm an old devotee of Col. Claire Foster 6HM, and I have hated the ARRL gang ever since. Yes, I subscribed to *QST* for one year, and that will expire within a month or so. No more!

Soooo, your editorial in 73, October, 1978, stirred my blood, and I hope you can do some good. I've taken 73 steady since you first started.

My best wishes to you, and continued strength to fight.

Lloyd M. Jones W6DOB
Salinas CA

Thanks for taking the time to write, Lloyd. I enjoyed your letter.

Frankly, I don't blame Johnny for ignoring you. You can't fool me. That soft-in-the-head bit doesn't wash. You have no problem with remembering anything; you just don't want to bother boning up for that damned Extra Class exam. I don't blame you on that one. It will be a well-frozen-over hell before they get me down for that one.

But the fact remains that if you want to pass the Extra exam, you can. I'm willing to bet that you didn't do your homework on this one. Did you get my Extra Class book and read it? Of course you didn't.

It's a pity that someone doesn't do some research and do a good article on Col. Foster. Newer hams should know about him and his battles with the League. As I recall, he didn't really get mad at 'em until after Maxim had kicked the bucket. I suspect they were a lot better under Maxim. I've enjoyed all of the Maxim books and suspect that he and I would have been friends if I had come along 20 years sooner... or if he had lasted longer. I've also read a lot of Foster's editorials and they were right on the mark.

Keep it flying, Lloyd.—Wayne.

WHAT SAY, NSD?

I enjoy most of your editorial comments, in particular those

regarding the ARRL. The remarks are, for the most part, exactly my sentiments, even though I am a life member of the League.

It seems to me, though, that you are overlooking one of the most important parts of the best argument for having such an organization. That is the fact that, even though many of us do not like it, they, through a very powerful membership, do represent amateur radio in making the laws and regulatory features of our licensing bureau, the FCC.

If a move were to increase the membership of this so-called organization to a greater level, including all of the amateurs who feel that the League is an outmoded, poorly operated, antiquated-in-thinking organization, perhaps a majority could overthrow the present continuity of the ruling hierarchy within the League.

Oh yes, there will be many who say, "What good is a vote; they have it all tied up." Yep, that's right, but no one has tried to change it to my knowledge, just abide with it, and continue to gripe or bury their heads in the sand and accept what is recommended.

A great deal of good things have come the way of amateur radio by the gripe system. A lot of amateurs who do the griping started out as Novices and wouldn't have a license at all if it were not for the League, so they have some good things to show in the past.

It takes a good organizer to control a giant, but it can be done and the control should be from the support team. Radio amateurs, why not put your editorial efforts into reorganization. Wayne, you seem to be able to say what should be done.

I for one will give you my support monetarily and though further agitation for this type of idea. What say, Never Say Die?

Peter S. Meacham
Waltham MA

FIELD MARSHAL THURSTON

I have recently re-subscribed to 73 because I find your editorials very thought-provoking and usually pretty much to the point. I normally do not respond in writing to editorials, but I felt compelled to do so when I read about Mary Lewis W7QGP.

I have been a supporter of Mary for about four years. During this time I have gained a lot of respect for her leadership qualities in administering the amateur radio affairs of the state of Washington; for this

Continued on page 82



Canadian Amateur Radio Federation, Inc.

CALGARY HOSTS SECOND ANNUAL NATIONAL SYMPOSIUM

The second National Amateur Radio Symposium, convened by the Canadian Amateur Radio Federation, Inc., wound up its two-day session in Calgary on October 1.

The conference, hosted by the Calgary Amateur Radio Association under the auspices of the Amateur Radio League of Alberta, made several important recommendations to the senior officials of the DOC who attended, concerning the future of amateur radio in Canada.

The more than 80 participants included amateurs representing major organizations and individual operators from all call districts except VO1, VO2, and VY1.

After a pleasant Friday evening cocktail party, the four workshops got down to business for a full-day session on Saturday, followed by a banquet, and a Sunday half-day general assembly.

The workshop on Digital and Computer Communications examined the new no-code Digital Radio Operator's Certificate in detail. John da Silva, the DOC headquarters consultant, gave the group an overview of data communication concepts. Technical discussions followed on their applicability to amateur use and the need to establish interim standards and specifications for amateur "packet radio." Asynchronous FSK was recommended for initial use for 1200 baud or below, with synchronous PSK or other techniques for higher speeds. Format recommended was ASCII with packet length of 150 characters with amateur call signs for identification.

The working group made a number of other technical recommendations and has asked CARF to form a committee to devise protocol details.

Packet radio should be introduced slowly and deliberately, much the same as was single sideband, the group reported. The cost to amateurs should be minimal, and CARF will publish availability of surplus equipment. To get into packet radio should cost only about \$150, according to the group's moderator, Croft Taylor VE3OR.

Probably of more importance to most amateurs was the work of the group on WARC '79 who heard at first hand from Ed Ducharme, head of the DOC WARC '79 planning, the status

of Canadian plans as they affect amateurs. Adjustments to the Canadian position are still in progress with the objective of completing a position which will, in the view of the federal government, best meet the unique needs of Canadian radio users.

The DOC did not pursue the idea of a new band around 18 MHz because of what was termed "a lack of support from the amateurs," but is still proposing 10.1-10.3 MHz as a new band. Amateurs were advised that although the new frequency allocations may be decided upon in late 1979, it would be 1981 or 1982 before implementation of the changes would be effectively underway. The working group strongly urged the DOC to reconsider the lopping off of 200 kHz from 75 meters (3800-4000 kHz), although it would propose exclusive use for the remaining 3500 to 3800 segment.

The group was told that little world sympathy could be expected for any expansion of the present 40 meter band, but a proposal to reduce it to 6.9-7.1 MHz exclusive for amateur use could be a significant gain.

The exclusive slot for "packet radio" from 221-223 MHz came under fire and in both the working group and the general assembly, which heard and discussed all of the working group results, there was a unanimous reaction voiced to the DOC to let amateurs undertake their own band planning.

The DOC noted that it would consider providing space for ATV in other parts of the 420-450 MHz band other than those now authorized, because it proposes to reduce the band to 430 to 450 MHz.

The discussion in the WARC group covered a number of other frequency problems, details of which will be found in the symposium official report.

While WARC '79 will have a delayed impact on amateur operations, the recommendations of the workshop on regulations would have a more immediate effect, if adopted. It recommended elimination of the logkeeping requirement for mobile stations. The abolition of the FCC reciprocal permits for operating while in the U.S. is now being undertaken by the DOC. Special call signs, the group concluded, should be eliminated, and the DOC headquarters will survey the regional offices to see if this step should be taken.

Clarification of the wording of the recent DOC notice concerning the new "digital" certificate and the frequency schedules was requested, especially with regard to operation in the 220-225 MHz band.

The DOC stated that all amateurs may work in that band now as before, using the modes noted in the frequency schedules (most modes, with a slot exclusive for packet radio message formats).

Recommendations to bring regulations up to date were made, such as the abolition of the requirement for frequency- and modulation-measuring devices.

In reply to a workshop query, the DOC said that the procedure in an interference complaint when the amateur set was "clean," and all efforts on the part of the amateur to cooperate with the complainant have been rebuffed, is for the DOC to write to the complainant stating that it will take no further action.

The perennial problem of local government legislating on tower matters was discussed and the DOC noted that such authorities cannot prohibit the erection of duly-licensed radio station towers as it is an area of federal control. They can, however, impose structural and safety requirements. Amateurs who sign private agreements or leases with restrictions on towers or antennas have no recourse to the DOC.

The conclusions reached in the workshop considering "certificates and examinations" did not meet with the unanimous support accorded other workshop recommendations in the general assembly.

The novice certificate was turned down by the group and the assembly. The group recommended a 5 wpm code test for persons over 55. The majority of the general assembly did not accept the idea. A proposal to extend the principle of the present 10 meter phone endorsement to 160 meters in order to encourage activity on that band met a majority approval.

A recommendation was made that the DOC be relieved of the task of code examinations, which would be delegated to amateurs approved by the DOC. It was also recommended that amateur exams be held once a month instead of four times a year as is now in force. Both ideas met with the approval of the Sunday general assembly.

In view of the flexible policy of the DOC in examining handicapped persons (for which the group commended the Department), it was felt that no waiver

of examinations for the handicapped was necessary.

A move to restrict VHF phone privileges for new amateurs met with a mixed reaction from the general assembly, with about half for and half against the idea, which reflected the working group's tie "vote" in the matter.

In the general assembly, ideas were expressed that the present advanced exam be "upgraded" to reflect the state of the art, with more about VHF, UHF, and FM techniques.

Suggestions were advanced to issue the present station licenses and certificates in a card form in order to make them more practical to carry when operating mobile or portable.

A member of the general assembly noted that a "no-code" digital operator could use A1 according to schedule and suggested that Morse code for a "no-code" certificate was redundant. It was explained, however, that in this day and age, with modern technology, Morse could be sent by machine and received by machine.

Moderator for the symposium was Bill Wilson VE3NR, president of CARF. Moderators were Croft Taylor VE3OR for the Digital Workshop, Hugh Dollard VE7PB for Frequency Allocations, Art Davis VE6KT for Regulations, and Percy Crosthwaite VE5RP for Certificates and Exams. The senior DOC Regulatory Service Officer from headquarters in Ottawa was W. W. (Scotty) Scott. The DOC representatives from headquarters were Ed Ducharme, International Planning, John da Silva, DOC Systems Engineering Consultant, Vic Decloux, and Peter Fitzgerald. Regional and district offices were represented by Murray Watson, Bob Poirier, Jim Essex, Irwin Williams, Wes Garvin, and Larry Reid. Dr. Jack Belrose VE2CV represented the Federal Communications Research Center.

The meeting learned with regret that Dr. John deMendoza, Director-General of the DOC Telecommunications Regulatory Service, who has been instrumental in originating these symposiums, was unable to attend due to a last-minute change in plans.

The CARF executive and those who attended are indebted to the Calgary Amateur Radio Association and the Symposium Committee members (VE6EX, VE6GQ, VE6MX, VE6AMU, VE6SA, and VE6CJC) for the interesting and productive meeting. Thanks, too, to the City of Calgary, the Prov-

Continued on page 167

The Height of Quality:

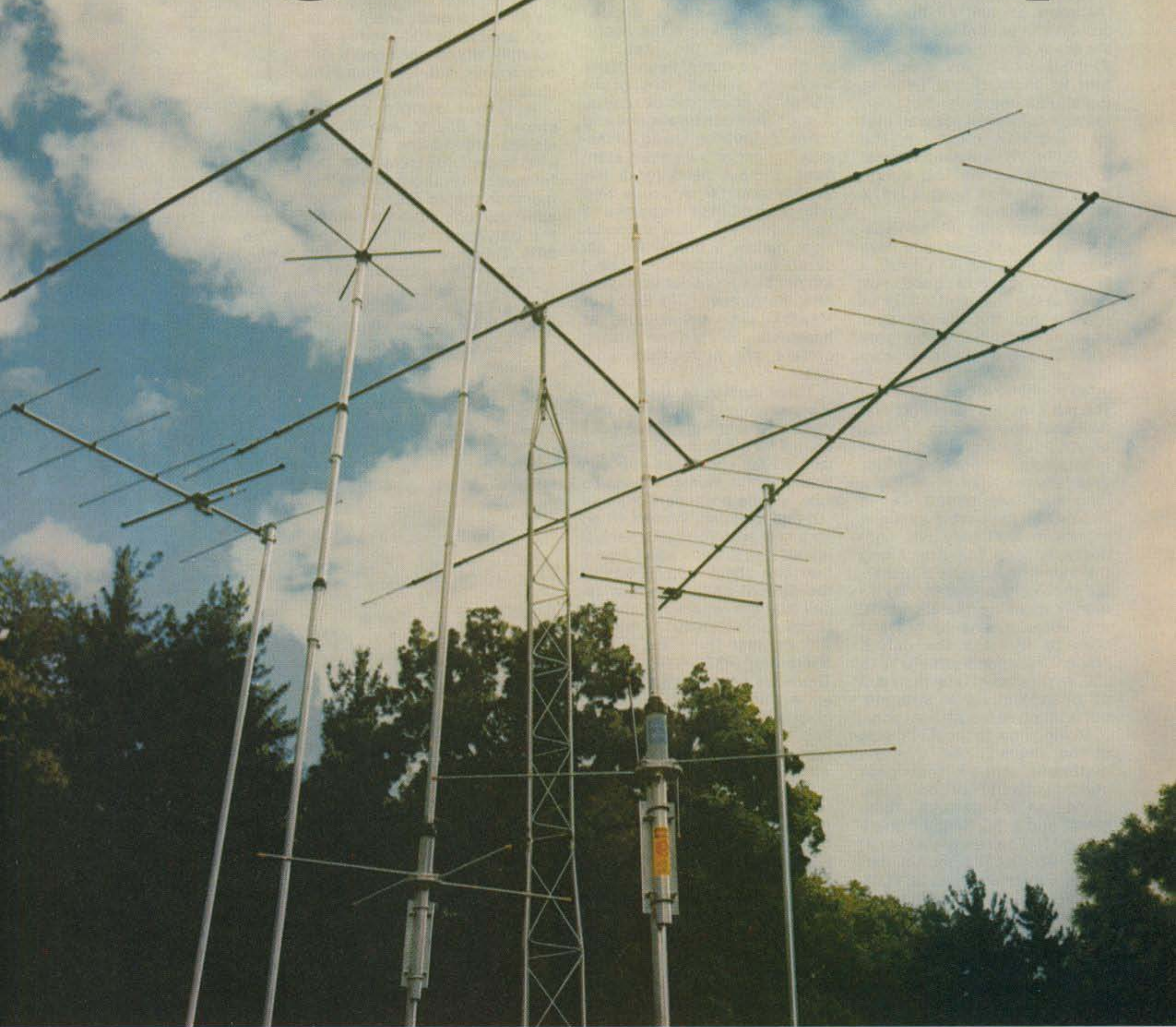

Hustler amateur fixed station antennas.

When you're transmitting and receiving around the globe, only the finest will do. Long distance communication demands the high quality you find in every Hustler antenna.

Hustler fixed station antennas have gained a world wide reputation of superior performance through

advanced design, precision construction, all-weather durability plus quality components such as all stainless steel hardware and heat treated seamless aluminum tubing.

When a Hustler amateur fixed station antenna goes up, you can be sure the very height of quality is reached.



Clearly the choice of those who know quality.

new·tronics corporation

15800 Commerce Park Dr. • Brookpark, Ohio 44142

RTTY Loop

Marc I. Leavey, M.D. WA3AJR
4006 Winlee Road
Randallstown MD 21133

With the cold of the Winter of '79 upon us, and all huddled around the pot-bellied stove in the shack (would you believe an IC heat sink?), my thoughts turn to aligning and peaking the equipment up for best performance. I try not to do all that by hand; it's rough on the manicure. What we will look at this month is the test equipment that helps keep a RTTY station on the air.

Let's start with the non-specialized, rf-type gear, and then work back to the TTY stuff. I hope you have a good swr meter in the line, or at least can ensure that the swr of your antenna remains reasonably flat. Notice that I say "remains." While that super quad might have been 1:1 when you put it up two years ago, one maniacal sparrow can destroy all your careful pruning. There is nothing a modern transmitter dreads more than spending a long key-down period, i.e., a RTTY transmission, fighting a high swr. Definitely not conducive to long final life! Along the same lines, your transmitter should have the facility to readily measure plate current, and some means to taper it down if it helps the output stage. Changing from 175 W to 100 W produces less than a 3 dB change in signal strength, but is much easier on the tubes.

Moving now to the RTTY side of the shack, I feel that the minimum station test gear should consist of only two items: an inexpensive multimeter and a ROTM/GV (run-of-the-mill/garden-variety) oscilloscope. The multimeter, usually referred to as a VOM, for Volts/Ohms/Milliamps, is extremely useful wherever static diagnostics are needed. This means, for example, in setting up the TTY loop to 60 mA, measuring the plate voltage or Vcc of a supply, or analyzing the terminations of an unknown piece of equipment, using the Ohms function. With the use of this rather cheap piece of gear, under \$20 from Radio Shack and others, you can perform most of the diagnostics needed to keep a RTTY

station up and on the air.

Where the VOM will let you down is when you have to measure some ac or audio component, or where you have to troubleshoot some digital logic. That's where the scope shines! Over the last few months we have seen many ways in which the plain ROTM/GV scope can be useful. Audio filters can be aligned and tones calibrated using Lissajous figures and a known standard, without need for a frequency counter. A scope tied onto the output of the mark and space filters of your demodulator makes a cheap and accurate tuning indicator. Again, I am not talking about an expensive instrument. Old Eicos or Heathkits that are sold at hamfests for ten or fifteen dollars are more than adequate.

There comes a time, however, when even this veritable wealth of test equipment fails you! There are many specialized RTTY items that you can spend your money on. Let's look at one and see if we can put one together. When setting up a new piece of equipment, it is useful to provide a test signal that can check out all bits of the Baudot code. You may recall that the letters R (01010 in binary) and Y (10101 in binary) will do just the trick if sent alternately (RYRYRYRYRY . . .). There are several ways to generate this signal. If one is a reasonably fast typist, and one half of a pair of twins, one can type the RYs on the keyboard while making the requisite adjustments. Unfortunately, most of us are not so blessed. A standard way to generate the RYs is by use of a short tape loop, running on the station's TD. With chadless tape, the tape may simply be overlapped, and the punched holes will interlock into a continuous tape. Punched-through tape must be glued together, but the result is the same—a continuous stream of RYs emanating forth.

With the advent of digital electronics, one feels that there must be a better way, and there is. Let's look in detail at the signal produced by an RY tape. Fig. 1 will help illustrate. First we'll send an R, including its start and stop bits, then the

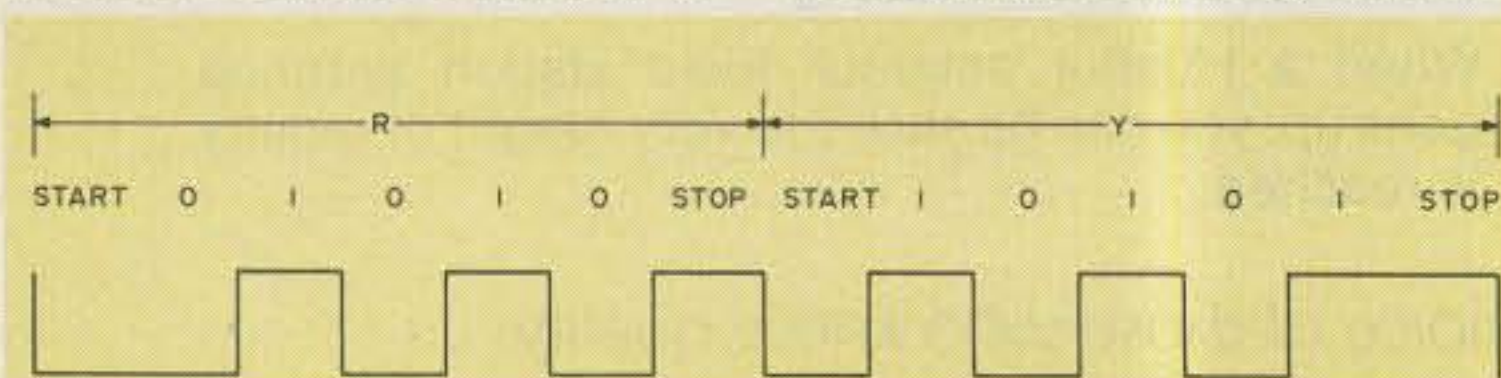

Fig. 1.

Y, with its delineators. Now string them all together and what have you got? Except for that stretched STOP pulse, it sure looks like a square wave, doesn't it? Don't you wonder if sending a square wave with 22 ms pulses would produce a string of RYs? Well, it will! Now, don't get me wrong, this is *not* the best way to generate an RY test signal, and it might not *always* work, and I absolutely would *not* send it out over the air, but, for around the shack, it can be helpful.

A rather simple circuit, shown in Fig. 2, can be designed around the 555 timer chip to generate the signal. The frequency is about 45 Hz (remember the 45.5 baud?) and, with the components shown, the duty cycle will be almost 50%. This means that mark and space will be about equal in length. The output of this circuit is TTL level, and how you use it is up to you. It can be

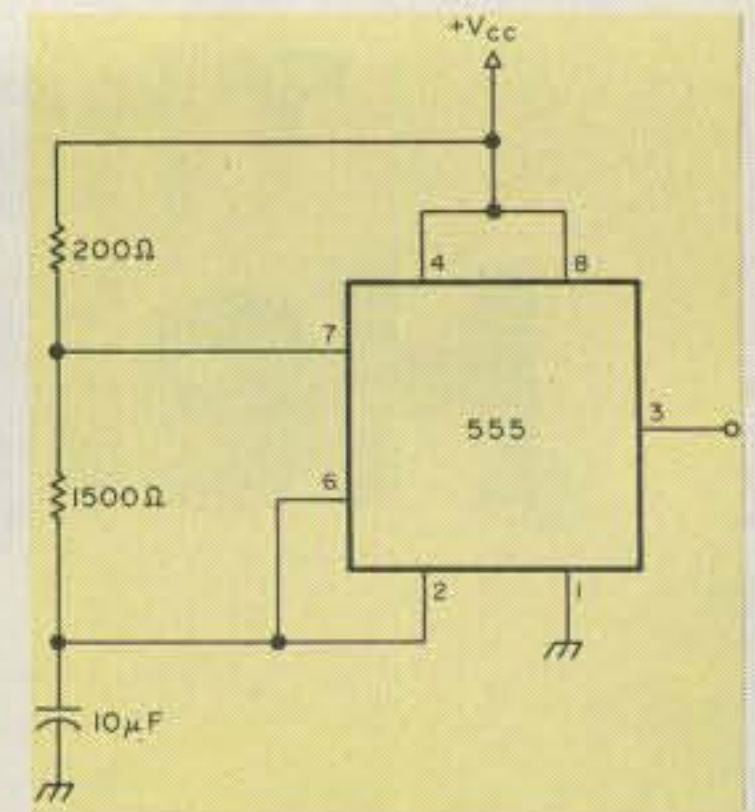

Fig. 2. 45-Hz generator.

used to drive an AFSK generator or through an optoisolator be inserted into your loop. Users of the ST-6 may be interested in the circuit of Fig. 3. This converter has a point which, when grounded, opens the loop, and the voltages are compatible with direct IC con-

Continued on page 191

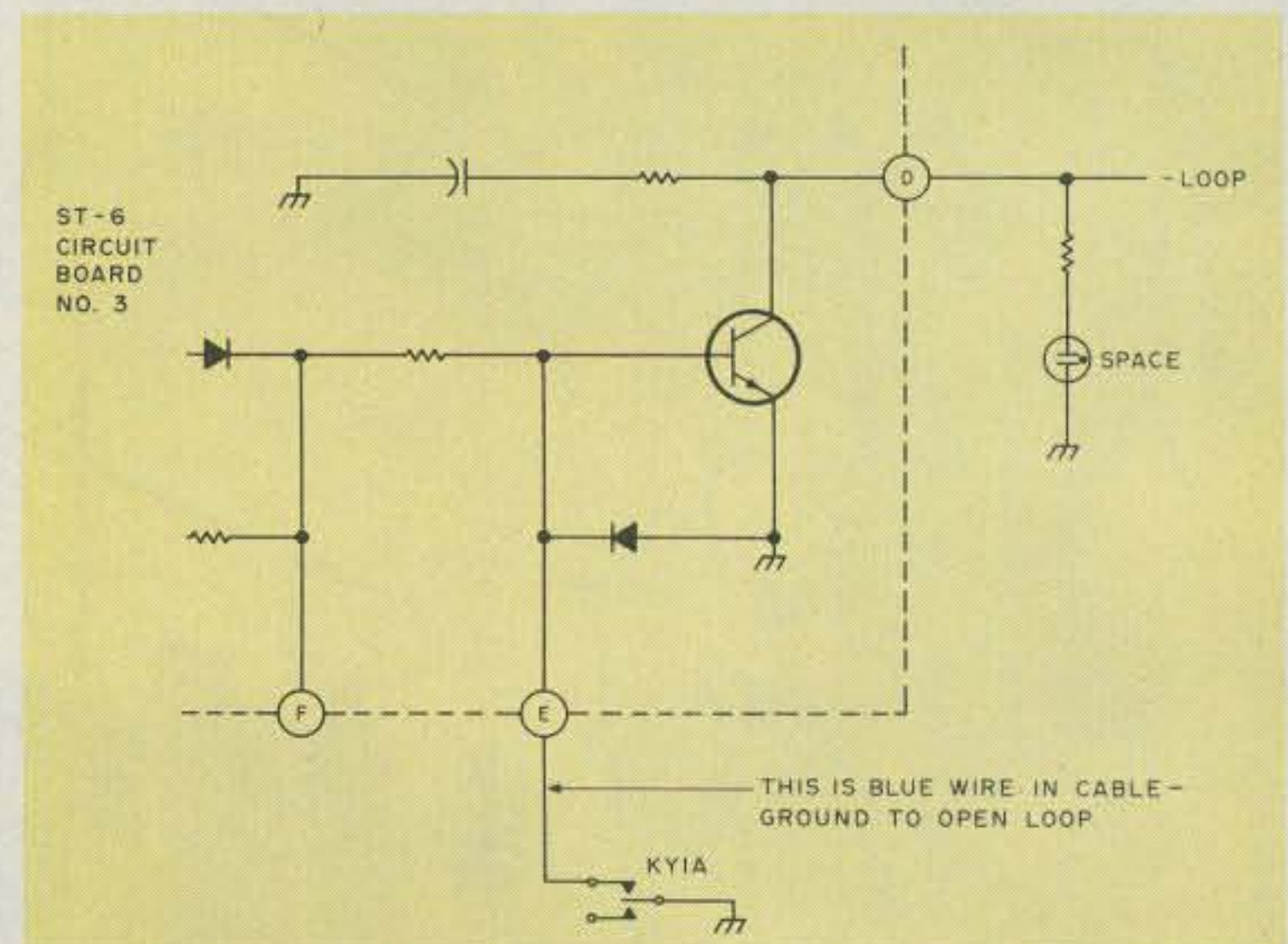

Fig. 3. ST-6 connection.

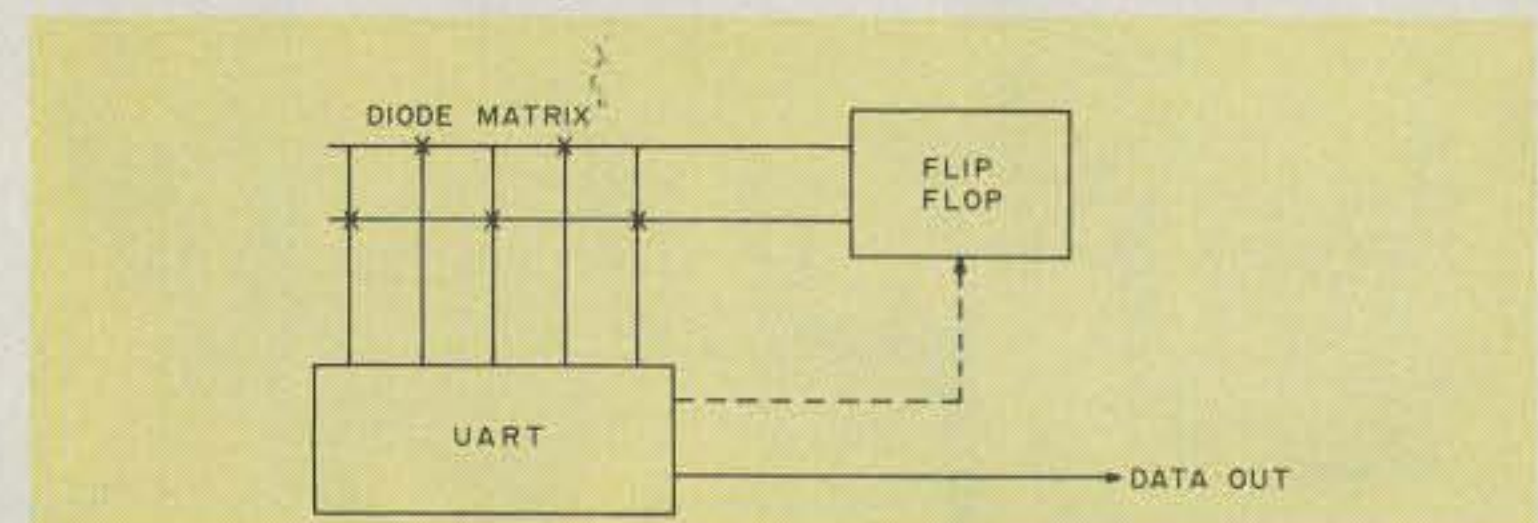

Fig. 4. Block diagram of "RY" generator.

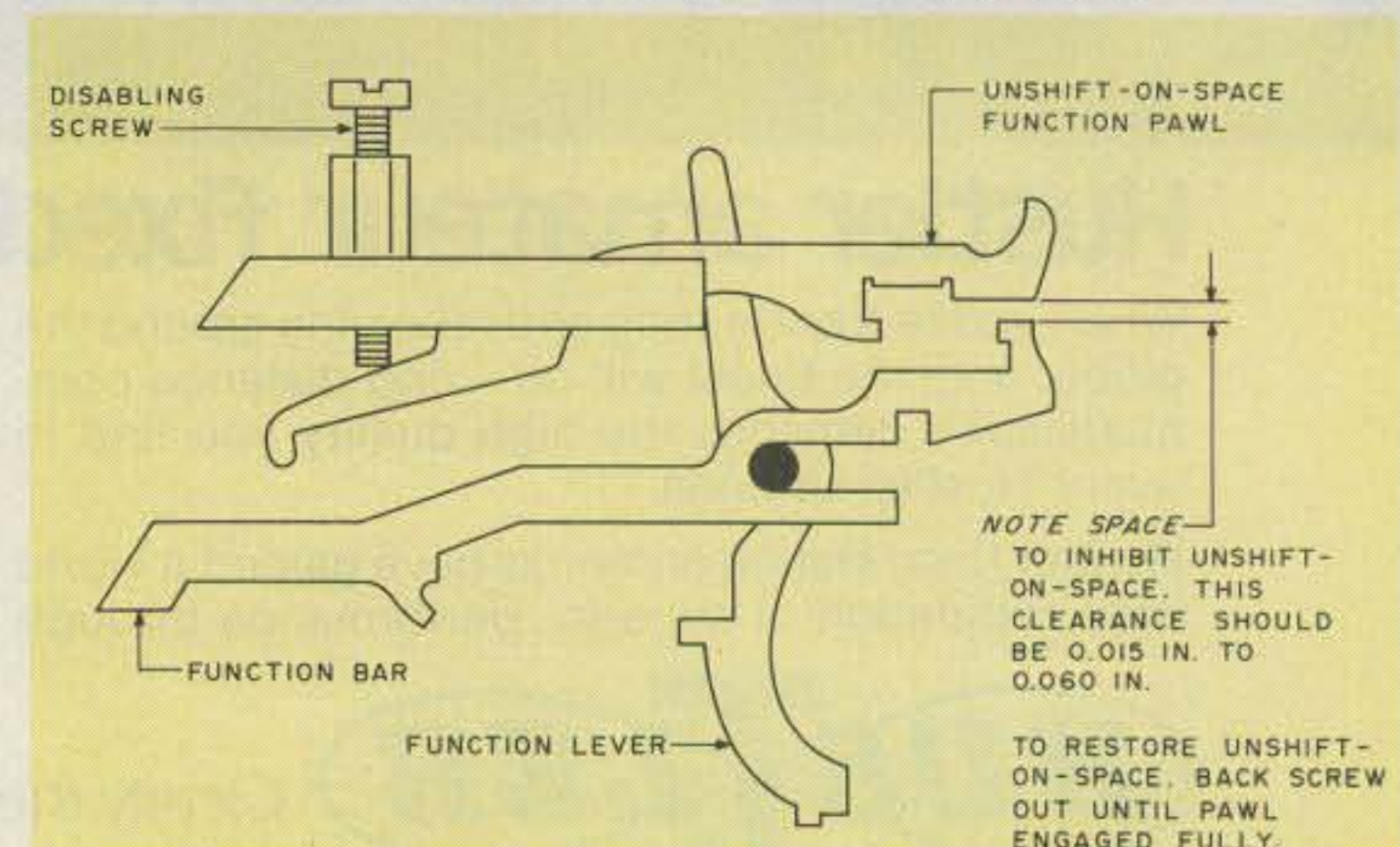

Fig. 5. Unshift-on-space for Model 28ASR.

Super Terminals with Hidden Features

Morse Tuning Indicator

Helps Improve copy of noisy RTTY signals

On Transmit ON OFF SYNCH IOLE

On Receive ON OFF UNSHIFT ON SPACE

Keyboard Transmit Modes LINE CONT

3 Standard Operating Modes ASCII BAUDOT MORSE

CW DETECT

ON OFF POWER

Clear Morse [CTRL-R]

Word Mode [CTRL-F]

Load ID Message [Shift-CTRL-P]

Activate ID Message

BAUDOT Blank

Correct Errors

Select Hidden Features with CTRL & Shift

Speed Change [CTRL-V]

Bell [CTRL-G]

Cursor Positioning For Editing

LTRS [Shift - ,]

FIGS [Shift - .]

Special Baudot Characters

"Quick Brown Fox..." Test Message [Shift-CTRL-O]

Page Mode Controls

Start of Text = CTRL-B

End of Text = CTRL-W

Transmit Text = CTRL-C



Year End Special!
DS-3000 V3
\$1425.00

For super operator convenience, Our keyboard works in MORSE, BAUDOT, and ASCII codes and controls the terminal, too. You can edit a message, program the HERE IS message, send the "QUICK BROWN FOX..." test message, change speeds, and change the terminal modes, all from the keyboard itself. In fact, the KOS (Keyboard Operated Switch) feature even turns the transmitter on and off from the keyboard. The DS-3000 KSR also features full-length 72 character lines (16 lines per screen), 5 speeds of BAUDOT and ASCII RTTY and Morse code from 1 to 175 wpm (Version 3), and word wrap-around to prevent splitting of words at the end of a line. When combined with the HAL ST-6000 Demodulator, you have the ULTIMATE in RTTY equipment.

DS-3000 KSR Version 3 (MORSE, BAUDOT, ASCII) \$1575.00
 DS-3000 KSR Version 2 (BAUDOT & ASCII only) \$1195.00

Write for our latest catalog & RTTY guide.

HAL COMMUNICATIONS CORP.
 Box 365
 Urbana, Illinois 61801
 217-367-7373



For our Overseas customers:
 see HAL equipment at:
 Richter & Co.; Hannover
 I.E.C. Interrelco; Bissone
 Vicom Imports; Auburn, Vic., Australia

New Products

THE NEW YAESU FT-227RA

If your two meter FM operation is largely mobile, you probably prefer a crystal rig which you can tune from channel to channel without taking your eyes off the road. Of course, you have to have a pretty good memory, better than mine, to remember what repeater is on what channel.

About a year ago, Yaesu introduced the FT-227 "Memorizer" which allowed you to select a channel and automatically return to it when desired.

Those folks at Yaesu know how to gild a lily, for they now have announced their FT-227RA. It is quite similar in appearance to the earlier model, which, by the way, is not being discontinued at this time, as it sells for less money. The "deluxe" version provides an expanded memory capability as well as is able to scan the entire band up or down as you choose. This dandy idea is accomplished by pressing the UP or DOWN button on the microphone. The scanner will search for a busy or clear channel, as desired, or will scan indefinitely until halted by a press of the PTT switch on the microphone. Because of the various functions performed by the microphone, it is a specially-designed unit and has a 6-pin connecting plug (supplied).

There are four memory positions in the FT-227RA. Three are for simplex frequencies, designated M1, M2, and M3, and one is for a repeater frequency, M4. By punching in your pet frequencies before you head for the freeway, you need not even bend over to read

the transceiver while driving, as it is now accomplished by the microphone buttons.

This makes it one of the safest of mobile radios. When you press the UP button on the mike, it will cause a shift of 10 kHz upwards, or vice versa, if you press the DOWN button. Holding the button down will cause the unit to continue scanning in either direction as just described.

If you place the scanning switch in the BUSY position, it will cause the scan to be halted whenever the squelch is tripped by a signal on the frequency being scanned. Placing the switch in the CLEAR position will cause the scan to be halted when the receiver is muted (no signal present). When the optional tone squelch is used, the scan will be halted according to the condition of the main squelch, not the tone squelch.

One may creep up or down the entire two meter band by 10-kHz steps simply by pressing the UP or DOWN button on the mike. Or, if you hold either button down, the scanning steps are automatic.

Frequency readout is by means of bright red LEDs which are easily seen in an automobile even on a bright sunny day.

Your pet repeater can be stored in the memory prior to use of the transceiver by storing the repeater uplink (input) frequency in channel M4, and then rotating the dial to the repeater downlink frequency. With the MR switch off, you will now be transmitting on the memorized frequency, but receiving on the dial frequency. Storing repeater or simplex frequencies does not entail getting into the "innards"

of the unit. It is simply a matter of dialing up what you want and pressing the memory button. Of course, this must be done, if you so choose to operate this way, each time the set is turned on, as the memory storage is not permanent.

The FT-227RA looks very much like the FT-227, with the exception of some added switches and buttons for the memory functions. You also have the usual 600-kHz up or down switch for normal repeater operation. A switch on the bottom of the unit allows you to operate with either of two power outputs, your choice of one Watt or ten Watts.

Tone squelch is offered as an optional accessory; it is a simple two-minute installation which can be made by anyone. With very few fellows and gals needing this feature, at least as the case is in California, it does shave the cost for the customer in a highly competitive market. Of course the FT-227RA has all the usual goodies we've come to expect in FM units, adjustable squelch control and an "S" meter that serves for the received as well as transmitted signal. The FT-227RA retains all of the niceties of the FT-227 while adding all those "Gee, I wish they'd have done this" items which you hear hams talk about after looking at a new piece of gear.

A mounting bracket is supplied for mobile use, as well as one to be used if you operate the equipment as a base station. The base station bracket slips under the transceiver to elevate the front of the unit. Power required is 13.8 V dc plus or minus ten percent. It will operate as a base station with the usual 12 V dc 3 Amp regulated power supply.

Operating the equipment is a pleasure, and once you have

the knack of it, it is about as safe a piece of transmitting gear as you can have in your car, as it does so many things which would otherwise require you to take your eyes off the road to accomplish. Say, come to think of it, why didn't Yaesu design this rig so that it would audibly tell you what frequency it was on? Then we wouldn't have to look at it at all.

As a final comment, Yaesu has announced that the FT-227RA may have four repeater memory channels if you desire. A conversion kit is now available and the mod is simple to do! *Yaesu Electronics Corp., 15954 Downey Ave., Paramount CA 90723, (213)-633-4007.* Reader Service number Y1.

Glenn Malme W6OJF
Downey CA

NEW AMATEUR LINEAR AMPLIFIER FROM DENTRON

DenTron Radio Company is proud to announce a revolutionary new linear amplifier for the amateur frequencies, the new GLA-1000. Powered by four D-50A (6LQ6) final amplifier tubes, the GLA-1000 is rated at 1200 Watts PEP SSB and 1000 Watts CW input with features like a reverse scale black-out multimeter for monitoring of critical currents and voltages, complete compatibility with any exciter or transceiver, front panel bypass, transmit indicator light, and a built-in relative power monitor for easy tune-ups. The GLA-1000 is super compact, ideal for portable or fixed operation, shipped set up for 117 V ac mains, and has 80 to 15 meter frequency coverage (covers most MARS frequencies just outside the amateur bands). FCC type acceptance has been granted. The GLA-1000 is now available at DenTron dealerships worldwide. *DenTron Radio Company, 2100 Enter-*



Yaesu's FT-227RA.



The GLA-1000 linear amplifier from DenTron.

prise Parkway, Twinsburg OH 44087. Reader Service number D15.

THE AED ELECTRONICS FT-227R SCANNER

I recently acquired an FT-227R 2 meter rig. While this is an excellent rig on its own merits, one of the major factors influencing me was the availability of a good, inexpensive scanner for it.

Within days of getting the rig, I got a scanner in kit form, and installed it in the rig. It worked very well—exactly as advertised. For my \$34.95 (plus \$1.50 for postage), I got a mailing pouch well-packed with goodies. There are some 35 components in all, including 2 ICs and a glass epoxy circuit board. Right off, I was favorably impressed by the double-sided board with silk-screened component locations. This impression was confirmed by the high quality parts and the inclusion of sockets for the ICs.

Assembly took me about three and a half hours. This may be the all-time slowest record for doing the job, but when I work inside a brand new half kilobuck (in Canada) radio, I work verrrry carefully!

The kit went together very easily, with no hassles. For a change, all of the parts fit where they were supposed to and the holes were drilled out to the right size. Other kit builders would be well advised to use a micropoint iron, as there are a lot of components packed into a small space. The circuit board measures about 1/2 inch by some four inches in length, so there's not a lot of room for error.

From the scanner board there are 11 wires going to various parts of the radio. The instructions are very clear, and there is no danger of putting the V+ to ground. The instructions themselves are much in the Heath tradition, well done and very clear. The only difference I noticed was that resistors are referred to by their values instead of by color. It's nice to know that someone still has confidence in us hams.

The scanner fits right inside the radio, along the side rail of the chassis as seen from the front. The only sign that the radio has been modified is the small toggle switch sticking out of the mike.

You could restore the unit to absolutely stock condition for the price of a new mike case. Instructions on how to modify the mike are included with the kit, along with the switch. For those who use the Drake TT mike, instructions are included for it as well. A nice touch, I thought, especially since I had one and used it with the 227R.

The kit comes with a complete schematic and board layout, so in the unlikely event that something goes wrong, a look at the circuit and a study of the theory of operation will make it easy to fix.

How does it work? Very well. It is, in fact, more of a sampler than a scanner as we usually know it. When you flip the switch on the mike to scan, it scans the band in 10-kHz steps until it locks onto a signal. It will then pause there for 3 seconds before it resumes scanning. This means that you can eavesdrop all over the band without lifting a finger. When you hear something interesting, you just flip the switch to the operate mode and the rig is ready to transmit.

This feature means that those repeaters which stay on the air using a tone to indicate that the timer has recycled won't cause your scanner to lock up on them. Both the frequency range and the delay are programmed by the user. You can cover the whole band or any portion of it in 1-MHz increments. Mine is set to cover from 146 to 148 MHz, as there is almost no activity below 146 here.

The scanner operates in conjunction with the digital readout of the 227R, so you always know where you are. If you disconnect the antenna, it takes about 8 seconds to go from 146 to 148 MHz. Once it hits the high limit, it starts back down again. The 227R has a very sensitive squelch circuit, so it locks up on any signal which is audible. Since the device uses CMOS circuits, it draws negligible current from the radio.

Frankly, AED Electronics makes a fine product. I have one of their scanners for the IC-22S in the car, and have been very satisfied with it. The new one for the 227R, with its digital readout, is even better. Locally, this rig has taken the market by storm, and almost everybody has a scanner as well. I've heard no complaints at all. My only concern is that AED Electronics can't be getting very rich selling so much product for this price. *AED Electronics Ltd., 750 Lucerne Road, Suite 120, Montreal, Quebec, Canada H3R 2H6.* Reader Service number A60.

Robert T. Rouleau VE2PY
Town of Mt. Royal
Quebec, Canada

Reprinted from the Canadian Amateur, October, 1978.

RF POWER LABS INTRODUCES MODEL V350 AMPLIFIER

RF Power Labs, Inc., is proud

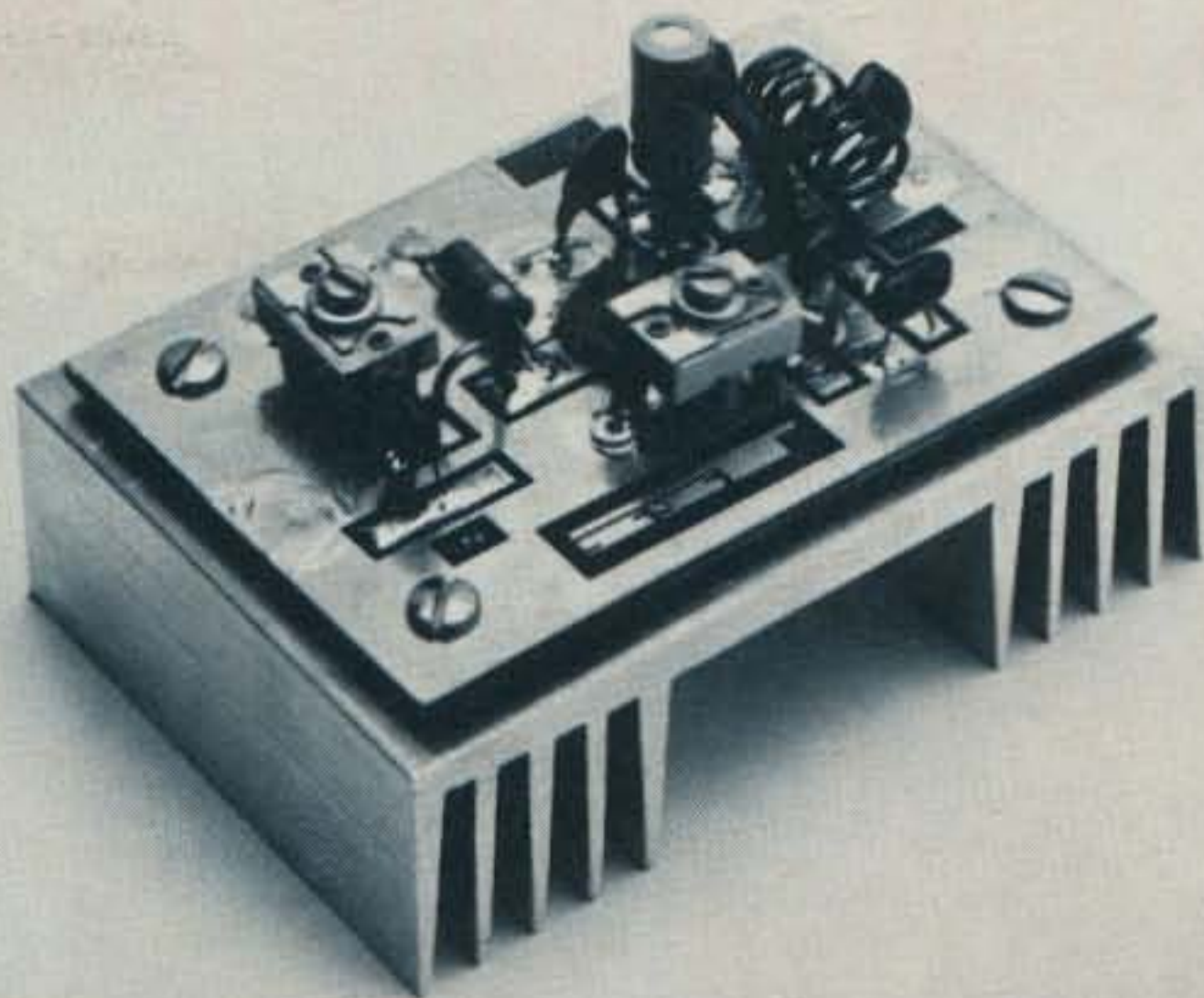

Two meter amplifier kit from SST.

to announce the release of their newest amplifier, Model V350. It is a 3/4-kilowatt dc-input all-mode VHF amplifier designed for base station and repeater use.

The V350 amplifier is designed for the radio amateur, but can be used on special orders over 5 MHz bandwidth, from 135 to 170 MHz. It is capable of producing more than 350 Watts of rf output power into 50 Ohms when driven with 10 to 15 Watts. The amplifier weighs only 52 pounds, including the built-in ac power supply.

For continuous duty operation, the F135 (115 V ac) or F235 (230 V ac) fan kit should be used.

For more information, contact *RF Power Labs, Inc., 11013-118th Place N.E., Kirkland WA 98033, (206)-822-1251.* Reader Service number R27.

SST A-1 2 METER AMPLIFIER KIT

SST Electronics has added a 2 meter amplifier kit to their line

of amateur radio equipment. The SST A-1 amplifier kit provides 15 Watts of output with 1 Watt in.

The SST A-1 includes everything necessary for a complete amplifier. A drilled G-10 epoxy solder-plated printed circuit board (2" x 3") makes assembly easy (approx. 1/2 hr.) with the comprehensive instructions. A large heat sink keeps the TRW power transistor cool. For ease of assembly, the coils used in the SST A-1 are pre-wound.

The SST A-1 is short- and open-protected—not damaged by high swr. Top quality components are used throughout. It is compatible with all 1-3 Watt 2 meter transceivers. The SST A-1 sells in kit form and also wired and tested. Instructions are included for a carrier-operated relay.

All SST products carry a 1-year unconditional guarantee and may be returned within 10 days for a full refund if you are not satisfied for any reason. To order, call (213)-376-5887 or

Continued on page 191



Model V350 all-mode VHF amplifier from RF Power Labs.

ARE YOU ON FREQUENCY?

BE ON FREQUENCY WITH DSI



MODEL 3600A .5PPM 17° - 37°C
\$199⁹⁵

- AUTO ZERO BLANKING
- AUTO DECIMAL POINT
- INCLUDES ANTENNA

SAVE SHOP COSTS WHEN ADJUSTING XTALS
 MEET YOUR QSO ON FREQUENCY EVERY TIME

The 3600A and 3550W Frequency Counters represent a significant new advancement, utilizing the latest LSI Design . . . which reflects DSI's ongoing dedication to excellence in instrumentation, for the professional service technician and amateur radio operator. Before you buy a DSI instrument you know what the specifications are. We publish complete and meaningful specifications which state accuracy over temperature and sensitivity at frequencies you need. And we guarantee those specifications in writing.

MODEL 3550W TCXO

\$149⁹⁵

- INCLUDES INTERNAL BATTERY HOLDER
- SAME AS 3600A LESS OVEN
- SEE SPECIFICATIONS BELOW

MODEL 3700 .2PPM 0° - 40°C
\$269⁹⁵

- AUTO ZERO BLANKING
- AUTO DECIMAL POINT
- INCLUDES ANTENNA

PORTABLE! TAKE IT TO THE MOUNTAINS OR
 USE IT MOBILE — TAKE IT WITH YOU ON FIELD DA

ALL NEW! ALL UNPARALLELED DSI QUALITY! The mod 3700 700MHz frequency counter features2 PPM 0° - 40°C proportional oven time base . . . Built in battery trick charger less batteries . . . Combined in a rugged (.125" thick aluminum cabinet makes the 3700 ideal for the communications industry, professional service technicians, and sophisticated amateur radio operators.

3600A OWNERS: Update your 3600A frequency counter to a 3700 includes2 PPM proportional oven, rugged .125" thick aluminum cabinet, order 3600-A - 3700. Unit must be returned to DSI factory for modification.

DSI — GUARANTEED SPECIFICATIONS — MADE IN USA

Model	Frequency Range	Accuracy Over Temperature	@ 146MHz	@ 220MHz	@ 450MHz	Number of Readouts	Size of Readouts	Power Requirements	Size
3700	50Hz - 700MHz	Proportional Oven .2 PPM 0° - 40°C	10MV	10MV	50MV	8	.5 Inch	115 VAC or 8.2 - 14.5VDC	3"H x 8"W x 6"D
3600A	50Hz - 600MHz	Oven .5 PPM 17° - 37°C	10MV	10MV	50MV	8	.5 Inch	115VAC or 8.2 - 14.5VDC	2 1/4"H x 8"W x 5"D
3550W	50Hz - 550MHz	1 PPM 65° - 85°F	25MV	25MV	75MV	8	.5 Inch	115VAC or 8.2 - 14.5VDC	2 1/4"H x 8"W x 5"D

— ALL UNITS ARE FACTORY ASSEMBLED, TESTED AND CARRY A FULL 1 YEAR WARRANTY —

- NO EXTRA COSTS •

FREE Shipping anywhere in U.S.A. and Canada.
 All other countries, add 10%.

Strongest warranty in the counter field.
 Satisfaction Guaranteed.

See Your Dealer or

Call Toll Free: (800) 854-2049
DSI INSTRUMENTS, INC.

California Residents, Call Collect: (714) 565-8402

VISA • MC • AMERICAN EXPRESS • CHECK • MONEY ORDER • COD

7914 RONSON ROAD, #G, SAN DIEGO, CA 92111

Model 3700 \$269.95

3600A - 3700 Factory Update (3600A Only)
 Includes Labor & Re-Calibration \$ 99.95

Model 3600A \$199.95

Model 3550W \$149.95

Option 03 20-Hr. Rechargeable
 Battery Pack \$ 29.95

DSI COMMUNICATIONS SERIES

1.3GHz — 1GHz — 700MHz



MODEL C1000 10Hz to 1GHz

- INCLUDES BATTERY PACK
- AUTO ZERO BLANKING
- AUTO DECIMAL POINT
- 10MHz TIME BASE

\$499⁹⁵

Accuracy . . . that's the operational key to this rugged advanced design Model C1000 1GHz frequency counter . . . a significant achievement from DSI. That's because you get1 PPM 0° to 40°C proportional oven time base . . . Built in 25DB preamplifier with a 60DB adjustable attenuator . . . x10 & x100 audio scaler which yields .01 Hz resolution from 10Hz to 10KHz equivalent to 10 sec. & 100 sec. Gate Time . . . Selectable .1 & 1 sec. time base and 50 ohms or 1 meg ohm input impedance . . . Built-in battery charging circuit with a Rapid or Trickle Charge Selector . . . Color keyed high quality push button operation . . . All combined in a rugged black anodized (.125" thick) aluminum cabinet. The model C-1000 reflects DSI's on going dedication to excellence in instrumentation for the professional service technician, engineer, or the communication industry.

MODEL C700 50Hz to 700MHz

- INCLUDES BATTERY PACK
- AUTO ZERO BLANKING
- AUTO DECIMAL POINT
- 10MHz TIME BASE

\$369⁹⁵

ALL NEW! All UNPARALLELED DSI QUALITY! The model C 700 700 MHz frequency counter features2 PPM 0° to 40° C proportional oven time base . . . 25db preamplifier with a 60db adjustable attenuator. Built in battery charger with a rapid or trickle charge selector . . . Combined in a rugged (.125" thick) aluminum cabinet makes the C700 ideal for the communication industry and professional service technician.

3600A OWNERS: Up date your 3600A frequency counter to a C 700 includes, new back board, .2PPM proportional oven, 25db preamplifier, rugged .125" thick aluminum cabinet, order 3600A-700. Unit must be returned to DSI factory for modification.

DSI — GUARANTEED SPECIFICATIONS — FACTORY ASSEMBLED — MADE IN USA

Model	Frequency Range	Proportional Oven Accuracy Over Temperature	50Hz To 75MHz	75MHz To 500MHz	500MHz To 1GHz	Number Of Digits	Size Of Digits	Power Requirements	Size
C700	50Hz to 700MHz	.2PPM 0° to 40°C	50MV	10MV	NA	8	.5 Inch	115 VAC-BATT 8 to 15VDC	3"H x 8"W x 6"D
C1000	10Hz to 1GHz	.1PPM 0° to 40°C	20MV	1MV	>50MV	9	.5 Inch	115VAC-BATT 8 to 15VDC	4"H x 10"W x 7½"D

— All Units Are Factory Assembled, Tested And Carry A Full 5 Year Limited Warranty —

FREE

Strongest warranty in the counter field.
Satisfaction Guaranteed.

FOR MORE INFORMATION

Call Toll Free: (800) 854-2049
DSI INSTRUMENTS, INC.

California Residents, Call Collect: (714) 565-8402

VISA • MC • AMERICAN EXPRESS • CHECK • MONEY ORDER • COD

7914 RONSON ROAD, #G, SAN DIEGO, CA 92111

Model C 700 **\$369.95**

3600A-700 Factory Update (3600A only)
Includes Labor & Re-Calibration **\$199.95**

Model C 1000 **\$499.95**

Opt. 01 1.3 GHz (C1000 only) **\$ 99.95**

Opt. 02 .05 PPM 10MHz Double Oven
0° to 50° C Time Base (C1000 only) **\$129.95**

Ant. 210 Telescopic Ant./BNC Adapter **\$11.95**



TS-1



TS-1JR



PE-2



SD-1

THE DAWNING

The age of tone control has come to Amateur Radio. What better way to utilize our ever diminishing resource of frequency spectrum? Sub-audible tone control allows several repeaters to share the same channel with minimal geographic separation. It allows protection from intermod and interference for repeaters, remote base stations, and autopatches. It even allows silent monitoring of our crowded simplex channels.

We make the most reliable and complete line of tone products available. All are totally immune to RF, use plug-in, field replaceable, frequency determining elements for low cost and the most accurate and stable frequency control possible. Our impeccable 1 day delivery is unmatched in the industry and you are protected by a full 1 year warranty when our products are returned to the factory for repair. Isn't it time for you to get into the New Age of tone control?

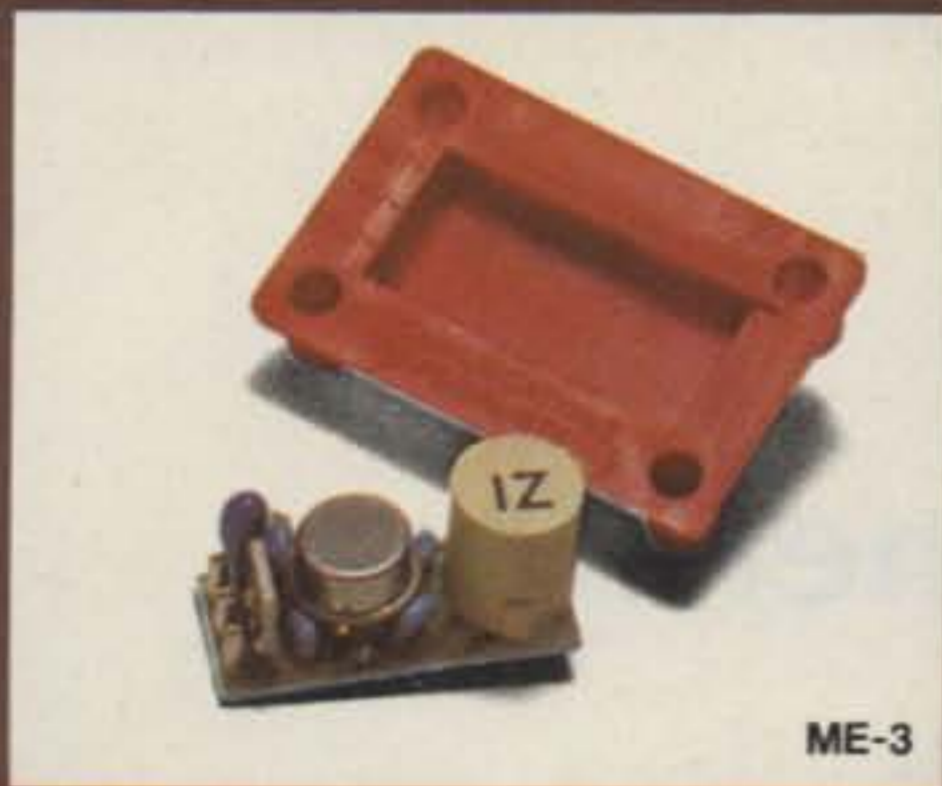

ME-3

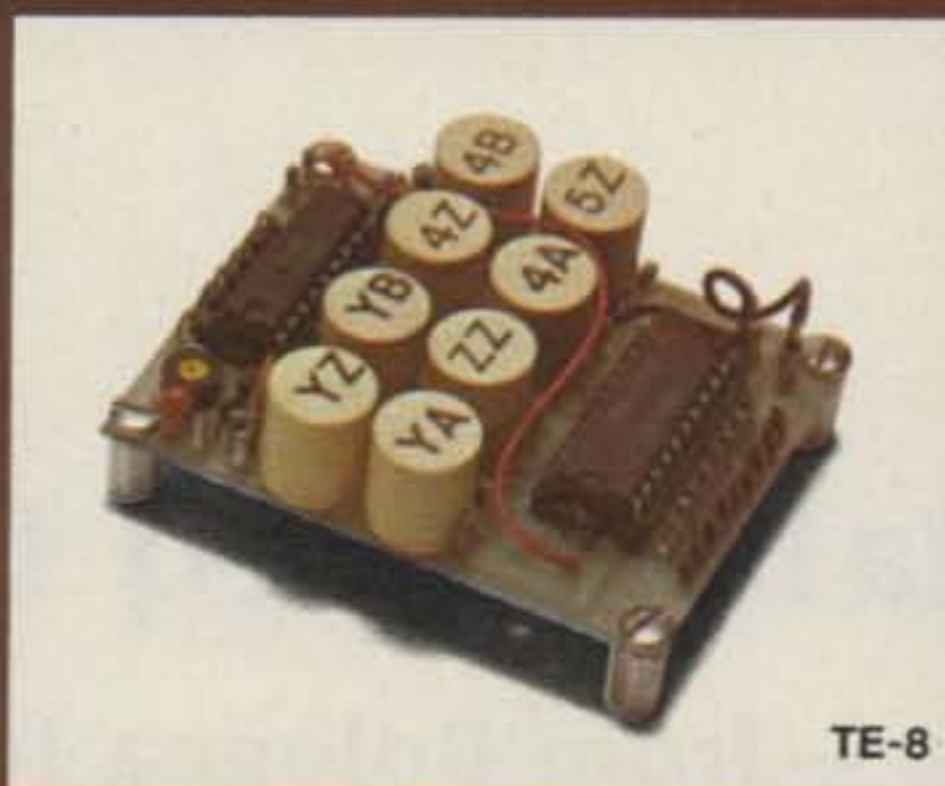

TE-8



TE-12

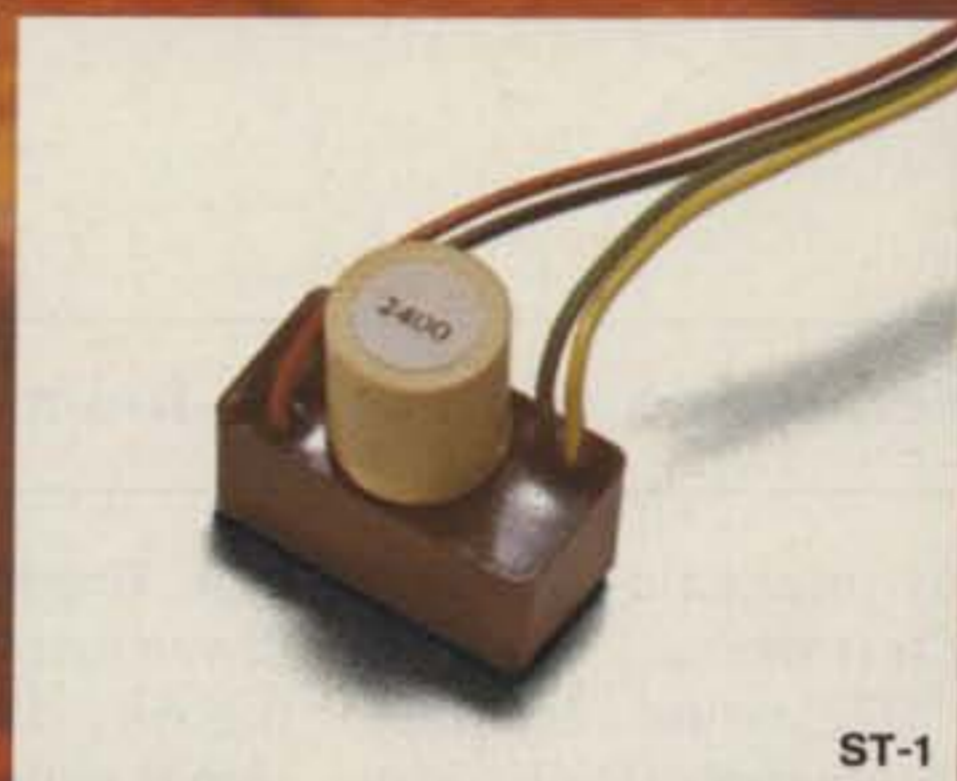

ST-1

OF A NEW AGE.

TS-1 Sub-Audible Encoder-Decoder • Microminiature in size, 1.25" x 2.0" x .65" • Encodes and decodes simultaneously • **\$59.95** complete with K-1 element.

TS-1JR Sub-Audible Encoder-Decoder • Microminiature version of the TS-1 measuring just 1.0" x 1.25" x .65", for hand-held units • **\$79.95** complete with K-1 element.

ME-3 Sub-Audible Encoder • Microminiature in size, measures .45" x 1.1" x .6" • Instant start-up • **\$29.95** complete with K-1 element.

TE-8 Eight-Tone Sub-Audible Encoder • Measures 2.6" x 2.0" x .7" • Frequency selection made by either a pull to ground or to supply • **\$69.95** with 8 K-1 elements.

PE-2 Two-Tone Sequential Encoder for paging • Two call unit • Measures 1.25" x 2.0" x .65" • **\$49.95** with 2K-2 elements.

SD-1 Two-Tone Sequential Decoder • Frequency range is 268.5 - 2109.4 Hz • Measures 1.2" x 1.67" x .65" • Momentary output for horn relay, latched output for call light and receiver muting built-in • **\$59.95** with 2 K-2 elements.

TE-12 Twelve-Tone Sub-Audible or Burst-Tone Encoder • Frequency range is 67.0 - 263.0 Hz sub-audible or 1650 - 4200 Hz burst-tone • Measures 4.25" x 2.5" x 1.5" • **\$79.95** with 12 K-1 elements.

ST-1 Burst-Tone Encoder • Measures .95" x .5" x .5" plus K-1 measurements • Frequency range is 1650 - 4200 Hz • **\$29.95** with K-1 element.



COMMUNICATIONS SPECIALISTS

426 West Taft Avenue, Orange, CA 92667
(800) 854-0547, California residents use: (714) 998-3021



The Italian Freq Generator

— from Bologna to you

A few years ago, this generator's qualities were found only in expensive, lab-type gear.

Louis I. Hutton K7YZZ
12235 S.E. 62nd Street
Bellevue WA 98006

During my recent visit to Sr. Franco Fanti I4LCF's ham shack, I was looking over his latest issues of an Italian elec-

tronics magazine called *CQ Elettronica*.¹ In the May, 1977, issue, I found a very interesting article on a phase locked digital signal generator.² I obtained a copy of that article and laboriously translated the major portion of it to get an idea of what the author, Sr. Mario Scarpelli I6THB, had to say regarding the

unit. This looked to me like it was just what I needed in the way of a home-brewed signal generator to replace my aging Heathkit AG-1 audio signal generator.

An undrilled, blank PC board was obtained through I4LCF,³ and a model was constructed in my shop. The generator provides a square wave

from 1 Hz to 9.999 MHz at a TTL output level. The signal may be switched on and off through the control input port.

Circuit Description

The digital signal generator consists of six basic components as shown in the block diagram (Fig. 4). The circuit is basically a phase locked loop design with the oscillator searching through its frequency spectrum until it finds the frequency selected in the programmable counter. At this point, the loop locks. To expand the range of the unit's frequency coverage, I6THB added a logic detector circuit that enables the voltage-controlled multivibrator to switch to a different frequency range by changing the value of the frequency-determining capacitor.

The reference oscillator consists of a 1 MHz crystal oscillator, X1 (7400), with three frequency dividers, X2, X3, and X4 (7490). The resulting output frequency of 1 kHz from the divider is



used as a reference signal in the phase detector, X13 (MC4044).

Four thumbwheel binary-coded decimal (BCD) switches are used in combination with four 74192s, X5, X6, X7, and X8, dividers to provide a programmable counter. The four 7400s, X9, X10, X11, and X12, are buffer/inverters to provide the proper TTL state to the inputs of the 74192 dividers. The thumbwheel switches cover an input range of from 0000 to 9999. The output from the programmable counter is connected to the phase detector, X13.

The frequency range logic detector consists of X15, X16, and X17. This circuit is connected to selected segments of the BCD switches so that, between 0000 and 3399, the VCM frequency-determining capacitor is 133 pF. From 3400 to 9999, the capacitor is reduced to 33 pF by the switching relay, RY-1.

The phase detector, X17 (MC4044), compares the reference oscillator signal with the output signal from the programmable divider and converts this to a dc voltage level proportional to the phase error. This error voltage is fed to the input of the VCM, X14 (MC4024), to drive or hold it to the frequency displayed on the thumbwheel switches.

The output of the VCM is connected to the input of the programmable counter to complete the phase locked loop circuit. The output signal is also connected to the input of the output frequency selectable divider chain consisting of X18, X19, X21, X22, X23, and X24 (7490). The MULTIPLY-BY selector switch is used to expand the digits appearing on the thumbwheel switches into the desired frequency. For example, 2125 appearing

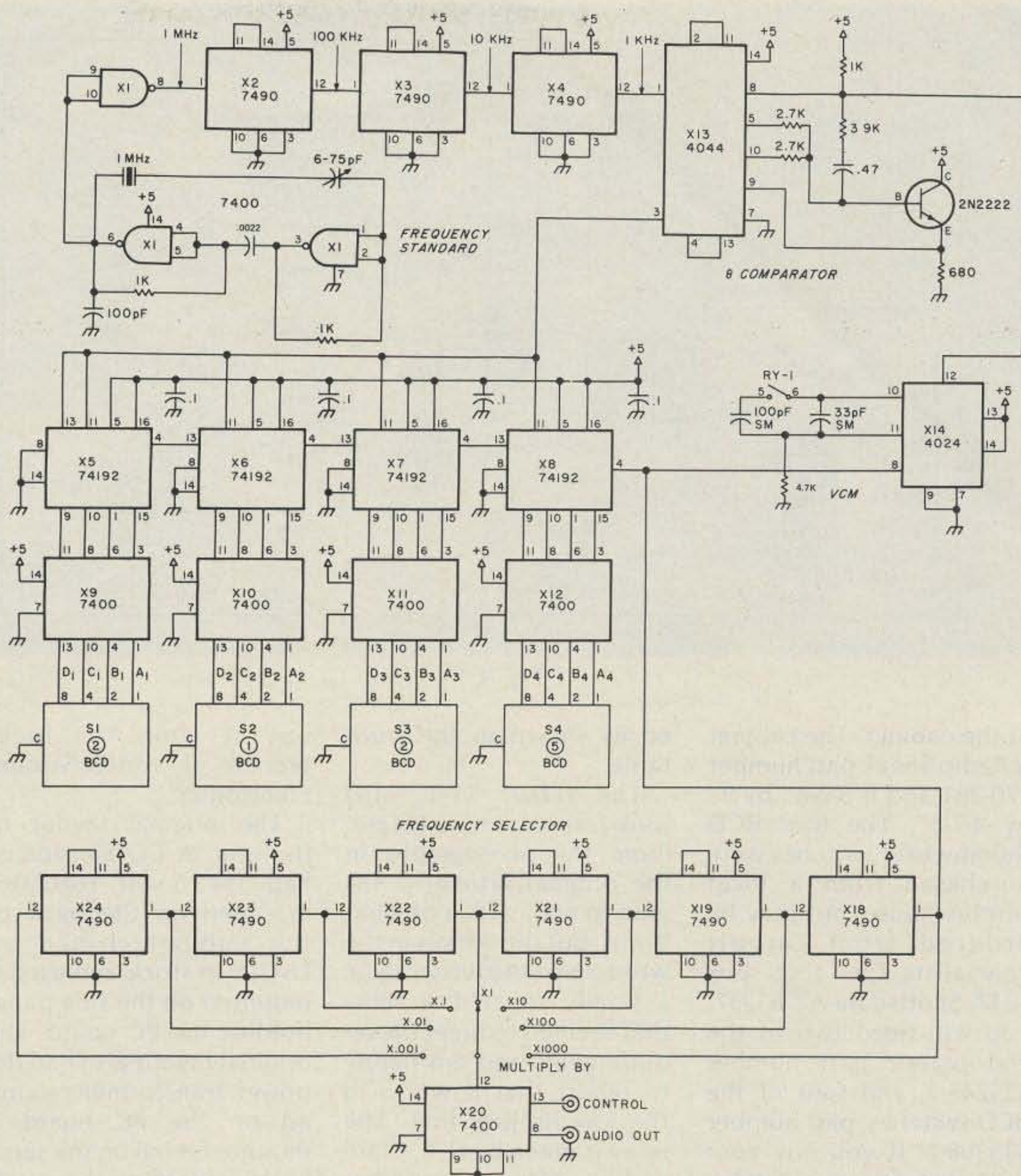

Fig. 1.

on the thumbwheel switches can, by proper MULTIPLY-BY selection, provide 2.125 MHz, 212.5 kHz, 21.25 kHz, 2125 Hz, 212.5 Hz, 21.25 Hz, or 2.125 Hz.

The control function is provided by the IC X20 (7400). Grounding the CONTROL input will inhibit the output. For example, if the CONTROL input were fed a square-wave signal of long time constant, the output would be keyed on and off depending upon the duty cycle of the signal on the CONTROL input.

Construction

The PC board I obtained from I4LCF was 8 by 5 inches and was not drilled. I

built two mounting brackets from aluminum to hold the board at right angles from the front panel

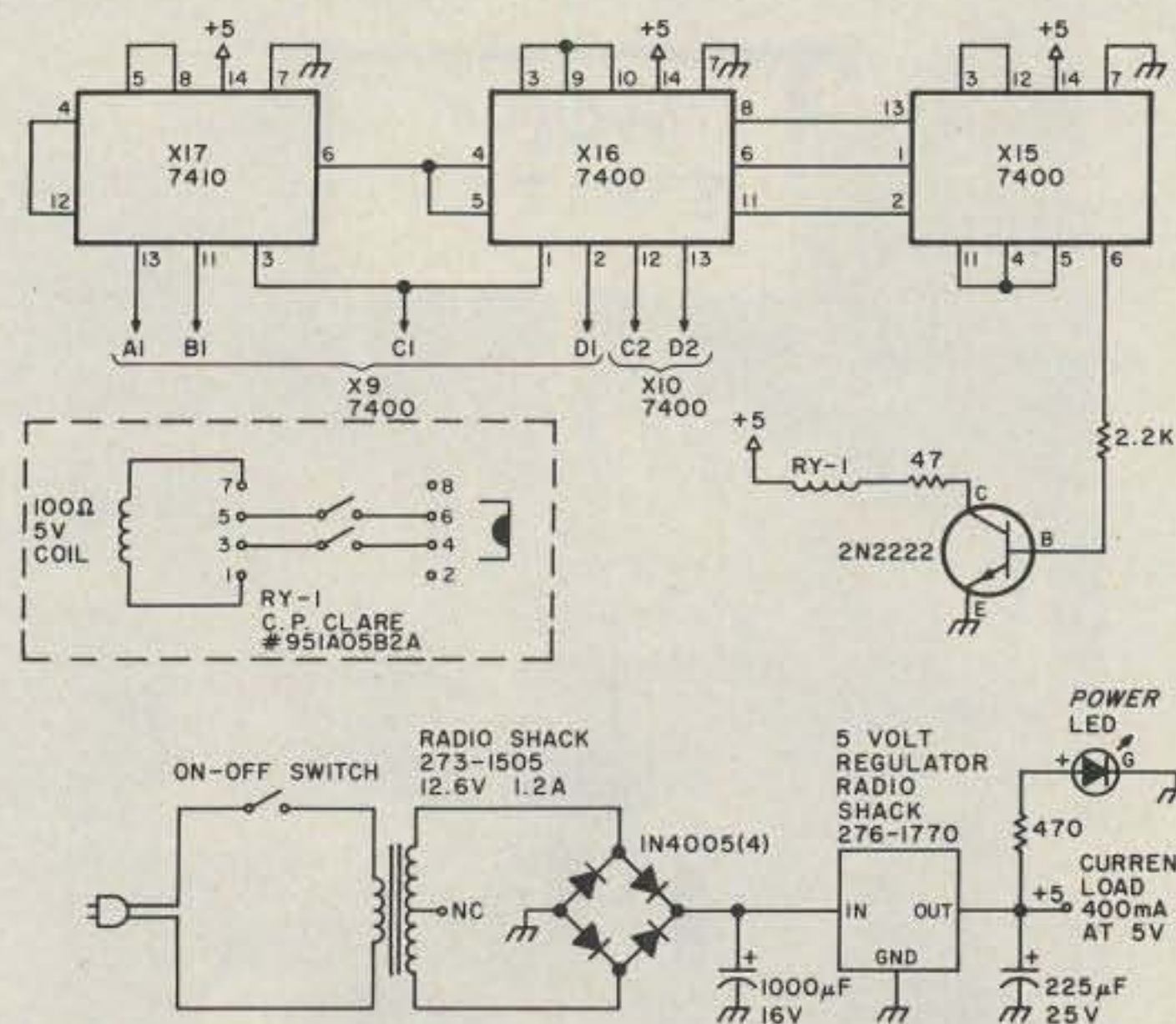

Fig. 2. Automatic switching circuit for VCM (top) and the power supply (bottom).

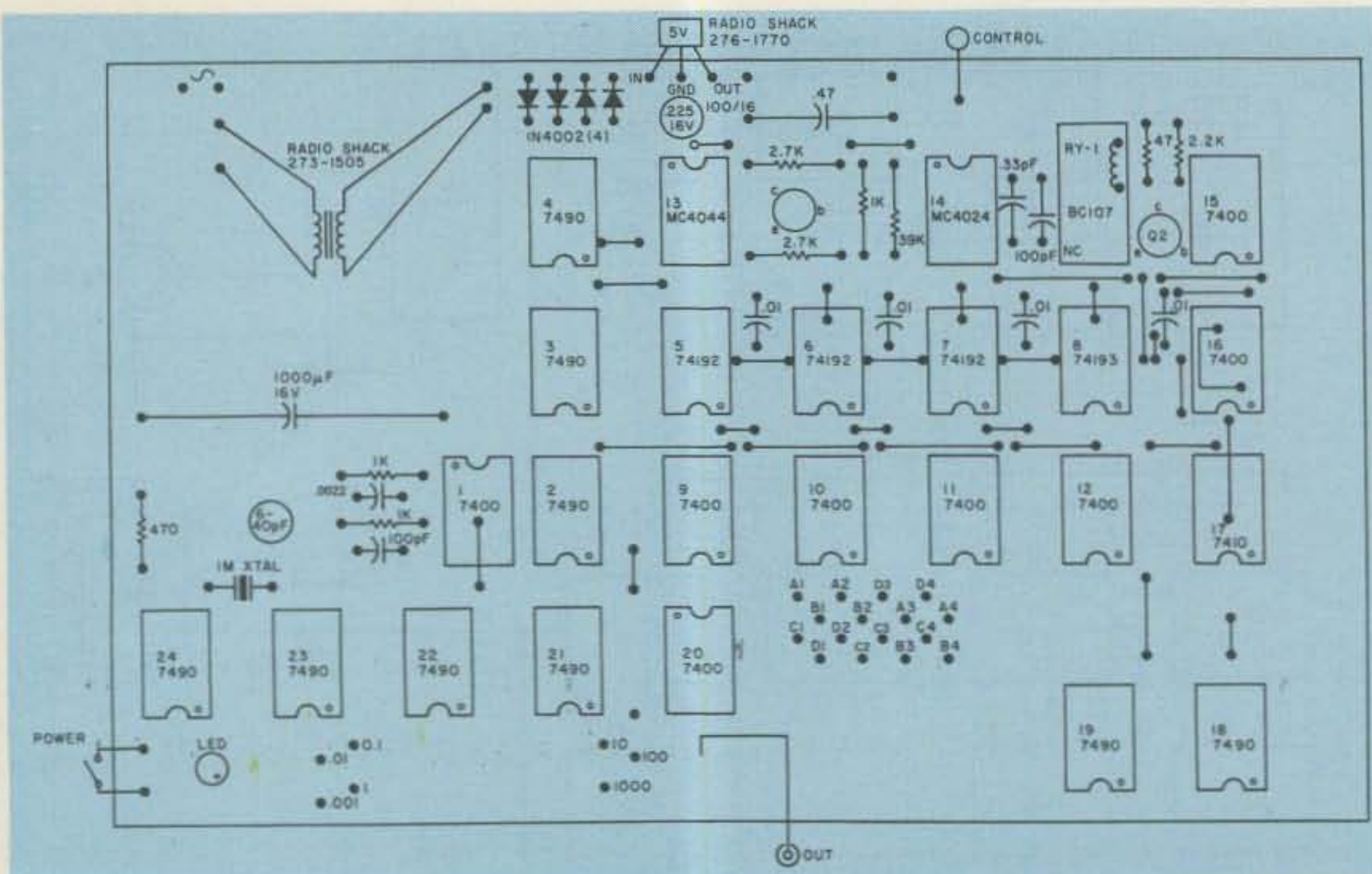

Fig. 3.

of the cabinet. The cabinet is Radio Shack part number 270-281 and is 5-7/8" by 9" by 4-7/8". The four BCD thumbwheel switches were purchased from a local surplus house, but may be ordered from Circuit Specialists Co., P.O. Box 3047, Scottsdale AZ 85257. You will need two of the end plates, part number 435245-2, and four of the BCD switches, part number 435308-2. If you buy your BCD switches at a surplus store, be sure they are cod-

ed as shown in the truth table.

The relay, RY-1, also took some doing to locate. From the photographs in the original article, I was able to get an idea of what it was, but the details in the write-up were pretty vague. I finally located a relay that seemed to meet the requirements and am happy to report that it works in the circuit just fine. The relay is made by C. P. Clare and is their part number 951A05B2A. I was able to

buy it from the local branch of Almac/Stroum Electronics.

The original layout of the unit in *CQ Elettronica* had the 5-volt regulator mounted on the back of the cabinet. I had an LM309 in stock and used it mounted on the side panel holding the PC board. The original layout also had the power transformer mounted on the PC board. I mounted mine on the same bracket holding the 5-volt regulator, as shown in the

photographs. The transformer is a bit oversized, as the circuit draws 400 mA at 5 volts.

After the PC board is drilled, the jumpers should be installed before the IC sockets are soldered to the board. The layout of the sockets, jumpers, and components is shown on the drawing. The HEPC3806P is the equivalent of the MC4044. The HEP3805 is the equivalent of the MC4024.

Testing of the finished unit was done in a series of steps as follows. When the board was wired, the IC for the 1 MHz oscillator was inserted along with the crystal. Power was applied, the 5-volt bus checked, and a scope probe connected to pin 1 of X1 to confirm that the oscillator was working. It was monitored on a communications receiver at 10 MHz to zero beat it with WWV.

Then the X2, X3, and X4 ICs were inserted, and, again, the power was applied. A counter was connected at each test point (pin 12 of the 7490) to be sure that the divider chain was working. Sure enough, I found that I had used a bad 7490 from my junk box.

Next, the MC4024, X14, was inserted and, again, the power applied. A counter was connected to pin 8 to be sure that the VCM was oscillating. It should be oscillating somewhere between 10 and 15 MHz. Ground pin 12 of the VCM and the frequency appearing on pin 8 should change from 10 to 15 MHz to around 3 MHz. That checks out the VCM frequency shift by varying the input voltage.

The relay, RY-1, is checked next. Install the remainder of the ICs, apply power, and, while using a VOM, monitor pins 5 and 6 on the relay for closure of contacts as the thumbwheel switch in the first

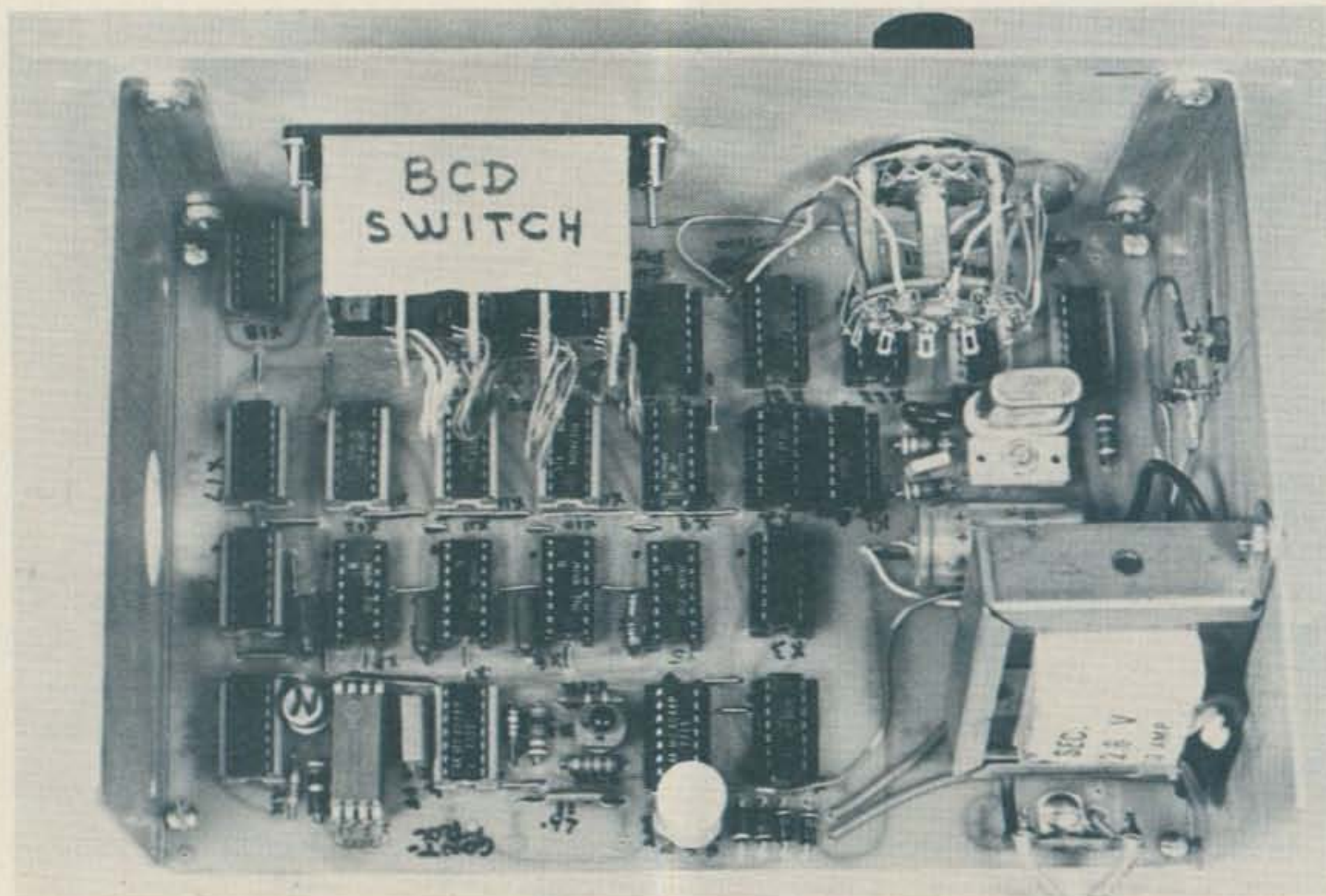

digit is switched from 3 to 4.

The final check made after assembly is to monitor, with a counter, the oscillator frequency as it appears at pin 1 of X18. Then follow that frequency down through the MULTIPLY-BY divider chain, looking at pin 1 to see if it has been divided by 10 at each stage of the divider.

It has been noted during testing that, when the unit is first turned on from a cold start, it takes about three minutes before the VCM settles down and is locked into the oscillator. The accuracy of the output frequency versus the digital thumb switch setting seems to be very good (plus or minus 1 to 2 Hz) on the audio ranges up to several hundred kHz. In the MHz range, it may be off as far as several hundred Hz, according to my counter readout, which is

still very acceptable for home-brewed equipment construction.

Conclusions

Although the unit as now constructed connects the output to a 7400 buffer, it was suggested in correspondence by I6THB to I4LCF that, if the builder wishes to provide more isolation and a better output load source impedance, an emitter follower circuit could be used with a 600-Ohm emitter resistor in the output. A transistor should be used that will handle up to 10 MHz signals.

I have had the unit in operation now for over ten months, and it has not given me any problems at all. Once the initial warm-up and lock-on has occurred, all that is required to get a particular frequency between 1 Hz and 9.999 MHz is to dial in

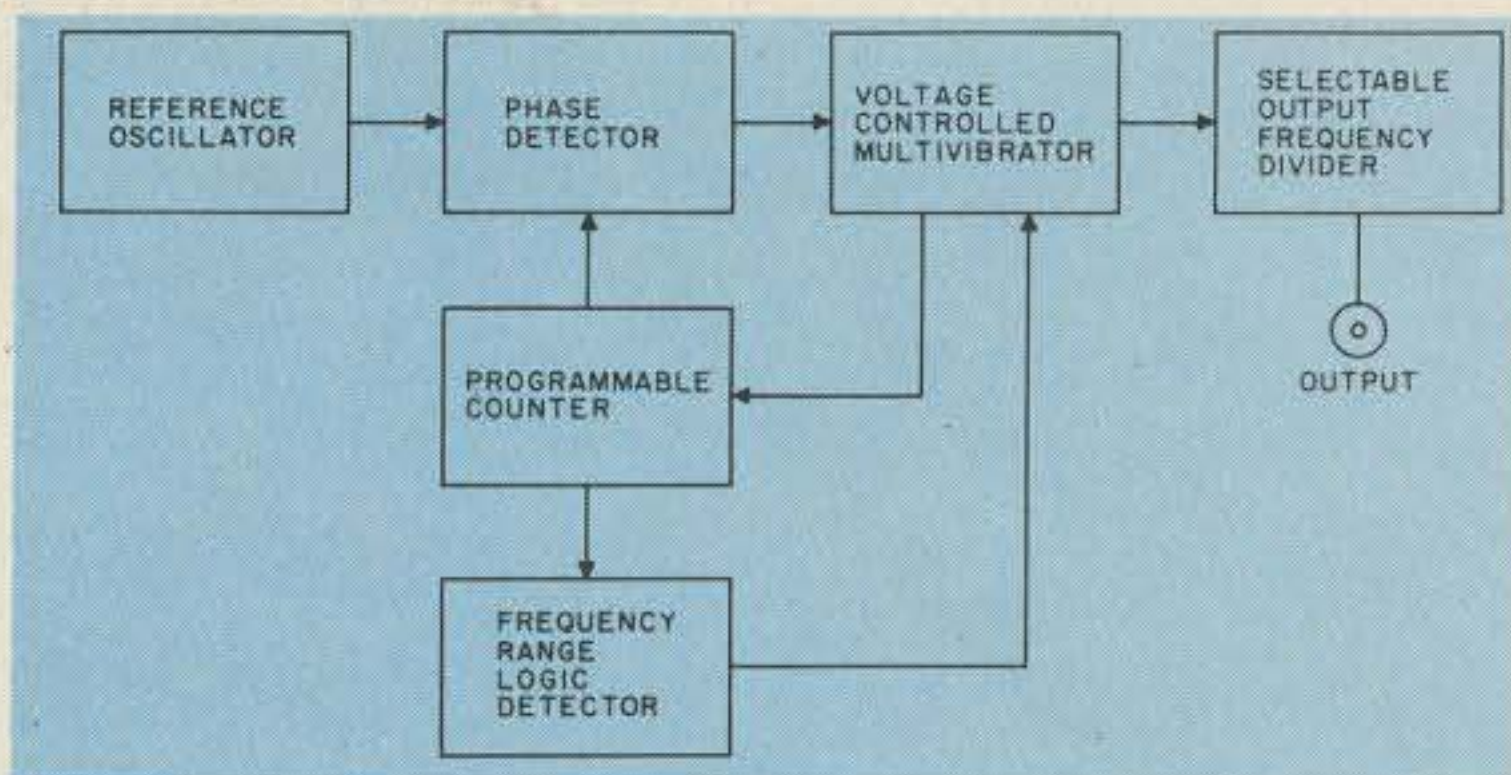

Fig. 4. Block diagram of the digital frequency generator.

the frequency.

I will try to answer questions from those who build this unit if I can and if they will please enclose a self-addressed stamped envelope. ■

References

1. *CQ Elettronica*, Via C. Boldrini, 22, Bologna 40121, Italy.
2. "Generatore di onde quadre a sintetizzatore di frequenze," Scarpelli, *CQ Elettronica*, Maggio, 1977, page 854.
3. PC boards obtainable from

Sr. Franco Fanti I4LCF, Via a Dallolio n. 19, Bologna 40139, Italy.

Thumb-wheel digit	BCD output			
	1	2	4	8
0	0	0	0	0
1	1	0	0	0
2	0	1	0	0
3	1	1	0	0
4	0	0	1	0
5	1	0	1	0
6	0	1	1	0
7	1	1	1	0
8	0	0	0	1
9	1	0	0	1

Table 1. BCD thumb switch truth table.

BLUEPRINT FOR FM MOBILE EXCELLENCE.

3 dBi GAIN.

5/8 WAVE 48" TAPERED STAINLESS STEEL WHIP.

FINGER TIP TUNING TO COVER 146-148 MHz AND NEW REPEATER SUB-BAND WITH MINIMUM VSWR.

TRIPLE CHROME PLATING.

PRECISION #18 COPPER COIL FOR MAXIMUM EFFICIENCY AND POWER HANDLING.

HANDSOME "90 L.B." MAGNET MOUNT TESTED TO 100 MPH, ALSO AVAILABLE WITH EASY-TO-USE TRUNK LIP MOUNT.

UPS SHIPPABLE
IN STOCK WITH DEALERS WORLDWIDE

cushcraft CORPORATION

P.O. BOX 4680 • MANCHESTER, NEW HAMPSHIRE 03108

If you expect to invest in a new ham antenna in the next 90 days, invest 15¢ postage to get Antenna Specialists' brand new, complete ham catalog today.

FREE decal just for fun!

Amateur Radio spoken here!

Name _____
Address _____
City _____ State _____ Zip _____

the antenna specialists co.

© "Stripes of Quality"

A62 a member of The Allen Group Inc.
12435 Euclid Ave., Cleveland, Ohio 44106
Export: 2200 Shames Drive, Westbury, L.I., New York 11590
Canada: A. C. Simmonds & Sons, Ltd.

Happiness is a WE-800

— proud owner loves his Wilson

If 2m FM is your bag, this is your rig.

*C. A. Kollar K3JML
1202 Gemini St.
Nanticoke PA 18634*

Recently, Wilson introduced a new concept in two meter FM rigs—the WE-800. This compact unit is an all-around synthe-

sized rig that can be used portable, mobile, or as a base. Its features include: 144 to 148 MHz coverage in 5 kHz steps, switchable 1- and 12-Watt output, 600 kHz up-down offset with two other positions available for other than 600

kHz, five priority channels on the front panel, and a meter light switch on the rear panel to conserve battery power.

After hunting around for a couple of months trying to locate a distributor who had one in stock, I finally

located one, ordered it, and eagerly awaited its arrival. When it arrived, I installed a newly-purchased and -charged set of nicads and turned it on. My first impression was that the received audio (emanating from the combination speaker/mike) sounded extremely hollow and tinny. Figuring that the effect was because of the small size of the speaker in the speaker/mike, I continued with the test somewhat disappointed, and made a call on the local repeater. The subsequent QSOs revealed that the transmit audio was full, crisp, and clear. Apparently, there were no transmit problems, although that hollow receive audio bothered me. After four or five short transmissions, my fears were realized when, upon releasing the mike button, I was bombarded with a raucous squeal. The received audio section was oscillating! I made a call to Wilson to explain the problem, and George Tennell advised me to ship it back. Wilson had it in the shop only one day and it was on



Fig. 1. Front panel.

its way back. If it wasn't for the twenty-four days it took UPS to get it to and from Nevada from Pennsylvania (bad news), it would have taken me a lot less than the nearly four weeks it was gone to get it back.

After carefully unpacking the repaired unit, I turned it on and listened to a QSO in progress on the local repeater. I was pleasantly surprised at the nice audio coming from the speaker/mike. What a difference! Leaving the unit on and monitoring all day wore the batteries down pretty well, but there was no trace of audio oscillation. Wilson had done a great repair job on the radio. I've had it a month now and the WE-800 still performs beautifully. My enthusiasm for this unit prompted me to write this review.

Front Panel Switches

Frequency selection is accomplished by a three position digi-switch which can be seen in the photo located at the left of the front panel. This unit covers 144 to 148 MHz in five kHz steps (10 kHz/step on the digi-switch, plus an extra five thrown in by flipping the kHz toggle to 5). Additionally, a six-position switch located on the right side of the panel can be used to choose five "priority" channels which will be used frequently. With the switch in the "dial" position, any frequency dialed in on the digi-switch will be heard. In positions A through E, any one of five preprogrammed channels will be activated. Please note at this time that the receive frequency is always dialed in on the digi-switch, or programmed in on the six-position channel switch. Transmit frequency is offset up or down from the receive frequency or made

the same as the receive frequency by operating the R/U-S-R/D toggle. R/U is used for 147 MHz repeaters, S for simplex, and R/D for 146 MHz repeaters. With the frequency coverage of the WE-800, you will have instant access to any repeater which may start up in the new repeater sub-band.

Programming priority channels is accomplished with diodes. See Fig. 2. As you can see, channel E is programmed for 147.18 (MHz—4, 2, and 1; 100 kHz—1; 10 kHz—8; and 1 kHz—0). 1N914 or equivalent diodes are recommended but, whatever you use, they *must* be small. The programming board is tiny and unless the diodes are small, they won't fit. Also, a subminiature soldering iron is a must. Without one, you wind up with as many solder bridges as solder joints.

The Hi-Off-Lo switch is operative only when using an external power source. When on internal batteries, either the Hi or Lo position will give you 1-Watt output. When on an external power source, the switch becomes operative, and selection of 1- or 12-Watt power levels is possible.

Rear Panel Switches

The rear panel switches are slide switches which provide a number of functions as will be explained. However, there is one big problem with them—they protrude too far from the chassis. I found that whenever the back of the radio brushed against something during normal use, the switches would be moved to some position I didn't want. I had the radio only two hours when I solved that problem by snipping off 3/8 of their length with a pair of diagonals. I've had no problems since that time and can still operate the switches easily.

The antenna select

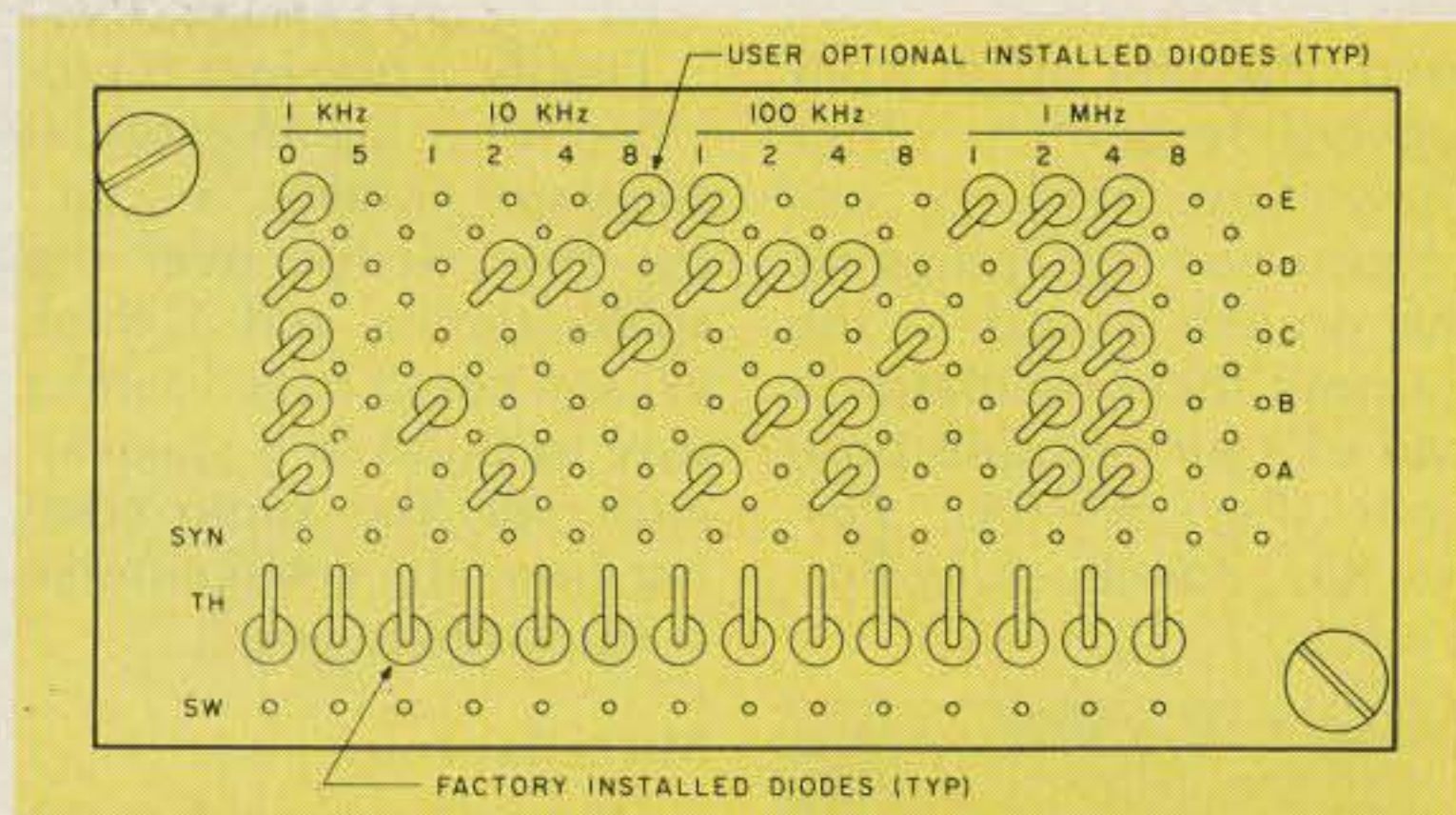

Fig. 2. Diode matrix frequency programming board (viewed from the top).

switch is the switch mounted nearest the SO-239 connector on the rear panel. See Fig. 3. This handy switch allows you to select from an antenna connected to the BNC connector on the front (rubber ducky, etc.), or from an antenna connected to the SO-239 on the rear. This comes in handy when going from portable or mobile to base.

The lamp switch in the "on" position illuminates the S/RF meter on the front panel for easy meter viewing. When on internal batteries, it can be kept off to prolong battery life. Power consumption is reduced considerably with the light off in standby. Squelched receive current with the light off is 50 mA and with the light on is 110 mA.

The power switch lets you select from an external power source or internal nicads or enables you to charge your batteries from whatever you have connected to the external power connector (power supply, cigarette lighter, etc.). The problem with this arrangement is the inability to monitor while charging batteries. This is a

distinct disadvantage because it puts your radio completely out of service for 12 hours in order to recharge your batteries. I guess this isn't too bad if you can make certain your batteries go dead only before you're ready to go to bed. The other disadvantage is the design of the "charging system" itself. No provision has been made for current limiting, so if your batteries are very low, and you charge them from your cigarette lighter or power supply, the batteries draw a hellacious amount of current for a while until they charge high enough to begin drawing a reasonable amount of current. Back to the drawing board on this feature, Wilson! See Fig. 4.

The RPT switch with positions marked "600 kHz," "A", and "B" is a nice feature of this rig. This switch controls how much the transmit frequency is offset from the receive frequency you have set up on the front panel. In the 600 kHz position, the standard repeater offset is utilized. In positions A and B, any one of two other transmit offsets chosen by you is

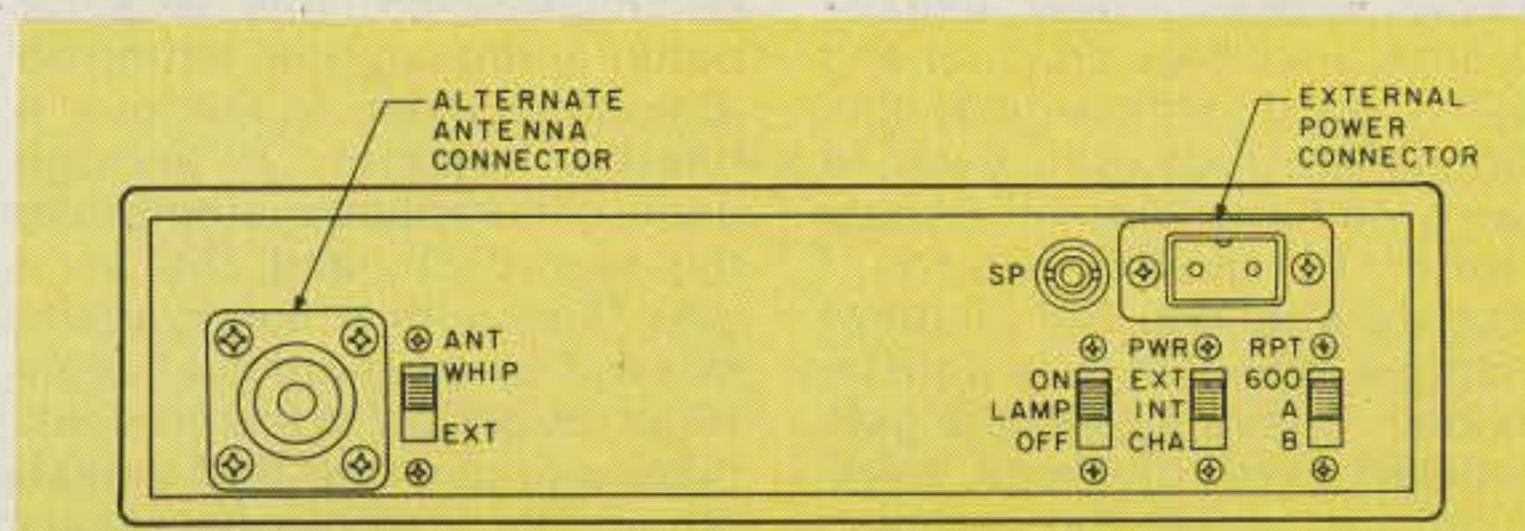

Fig. 3. Rear panel.

used. Transmit offset from receive frequency other than 600 kHz is accomplished by plugging the proper crystal in the transmit local oscillator in one of four possible positions (Pos. A—R/U; Pos. A—R/D; Pos. B—R/U; Pos. B—R/D).

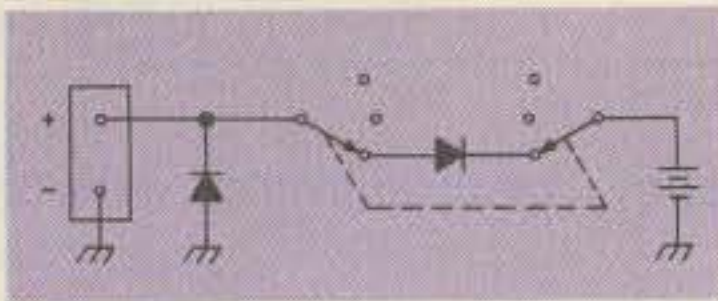

Fig. 4. Charge circuit.

Finally, a rear jack is provided for using an external speaker. Frankly, I can't get too excited over the speaker/mike and I think Wilson could have found a way to build in a speaker. However, the audio coming from the speaker/mike is surprisingly good.

Miscellaneous

Wilson's approach to the low-power position is to incorporate a separate 12-Watt amp which is

switched in only when external power is used (if the Hi/Lo switch is in Hi). This was a wise approach and accounts for the low (290 mA) current drawn when operated in the 1-Watt position. This is a much better scheme than used in some other multi-power rigs which force a 10-Watt amplifier stage to run at 1 Watt, with resulting higher current drain resulting in lower efficiency. A 50-mA squelched-receive-current

battery life is approximately 6 hours when monitoring a repeater of normal activity.

Conclusion

All in all, for someone looking for a 2 meter rig they can use portable, mobile, or base, the WE-800 is a wise choice. It has all the features you're looking for in a 2 meter synthesized rig, plus small size. It should provide years of enjoyment. ■

Looking West

from page 21

own users and say "to hell" with everyone else. The fallacy of this lies in the fact that making an open system into a private system will not make our jammer go away. He does not need the "secret tone" to jam—only the ability to capture the repeater receiver without the tone, which in effect shuts down the receiver. He won't be repeated, but neither will any user. A definitely ineffective solution.

The best suggestion to date came to me in a two-part conversation I recently had with NBC News correspondent Roy Neal K6DUE. It started one night on the phone and was completed the following week in Roy's office at the famous NBC peacock factory in Burbank. Roy's job has him traveling more than most of us, and therefore he is in a position to evaluate things that we might never get to see firsthand. Roy has some definite feelings on this subject, and his views make a lot of sense to me.

Roy's basic philosophy is that the big cities, where the real problems manifest themselves, should take a look at how the more rural areas operate. In most non-urban areas, repeaters are calling channels, places all amateurs monitor while they await a call. Should they be paged by some fellow amateur, they usually choose a simplex channel and QSY. Only under marginal conditions are repeaters used to carry on long-winded discussions. In the "outlands," repeaters serve the distinct purpose for which they were intended. It is rare that one gets jammed, and in those infrequent instances, the jamming is never given any form of

recognition.

The big cities are another story altogether. Hour after hour, repeaters are tied up with useless conversation between groups of amateurs living within simplex range of each other or between mobiles half a mile apart conversing through a repeater twenty miles away. It's rare when you hear one station take another to a simplex channel to continue a QSO. It's not uncommon to hear stations a mile or two apart break an existing conversation in order to obtain the system for their own QSO—when they have no need for relay communication whatsoever.

Roy therefore feels that the best way to frustrate a would-be jammer is to simply go away when the repeater gets jammed. Don't fight it—that only gives the intruder the audience he seeks. Simply take your QSO off to another repeater or (preferably) to simplex. If your area is being heavily harassed by the jamming crowd, stay off the repeater(s) and thus take away their audience. Even if the jammer catches on and takes to harassing you on simplex, a carefully arranged schedule between you and those with whom you wish to speak will frustrate the life out of the sickies in our society. Even if it's necessary to purchase an amplifier to ensure constant communication, this is a far better approach than sitting on a repeater trying to talk over a healthy jammer. If enough users of harassed systems take this approach, and the band gets filled with simplex, a jammer will be very hard put to continue his antics. In the process, many will discover that repeaters are not always a necessary means with which to communi-

cate. In fact, I spend more time talking to Roy on simplex than via any mountaintop box. Try it—it really works!

THE .76ERS

A noted local amateur recently said to me: "At least the .76ers had class!" He was referring to the mid-1960s, when a group known as the ".76ers" ruled southern California FM with a "tongue-in-cheek iron thumb." That was the pre-repeater era, when only a handful of hams inhabited two meters and even fewer machines existed. Over a period of years, the .76ers had developed jamming into an art form. But being jammed was part of being a .76er, and all on the "inside" looked at it as part of the fun. (The FCC took a far different view, however.) Much of what went on on 146.76 back then was recorded for posterity in a series of articles that appeared in various publications over the years. The series was called "The Chronicles of .76," and was written by Ken Sessions K6MVH. I understand that for anyone interested in knowing what it was like back then, the series is "must" reading.

The .76ers jammed because jamming was part of being a .76er. To them it was not malicious, but just part of their lifestyle. They abided by their own unwritten rules as to who,

what, why, and how. While outsiders continually chastised them for their actions, they just ignored it all and kept on having "fun." You and I would probably have been appalled if we had tuned in on .76 in those days, but our life-styles and backgrounds were totally different and we would have judged what we heard in a different light.

I mention .76 for a few reasons. First, while you and I might have judged the .76ers' actions to be improper, one clear fact is that they never went out of their way to be malicious in the sense that they would venture away from .76. There were a few occasions, but they were very rare indeed. If you happened to venture into their spectral territory, you were fair game, but if you did not like .76 and stayed away, they could have cared less about you. The only time they jammed a repeater was when one would try to set up shop on .16/.76. To this day, though many have attempted to establish such a system in the Los Angeles/San Diego rf corridor, not one has ever lasted more than a day or two. The remnants of the .76ers remain a viable force today, still strong enough to keep .76 simplex. They remain very low-key, but are far from having dissolved into oblivion.

Happy New Year!

Corrections

In my article "PCs Are Easy" (December, 1978), line 3 of column 4 on page 271 should better have read: "After the full-size positive . . ."

Brian E. McArthur VE3CGE
Brampton, Ontario

There is one minor error in the diagram on page 188 of

"Build the Brute" (November, 1978). The gate of the SCR is shown looking at the 8 uF capacitor discharged by a 470-Ohm resistor through the 14-volt zener. The anode of S1 should also be connected to the positive output of the supply.

Raymond W. Brandt N9KV
Janesville WI

BOARDS INSIDE CABINET

- 1 CARR OSC unit
- 2 VOX unit
- 3 AF unit
- 4 IF unit
- 5 Filter unit
- 6 Noise Blanker/RF Processor
- 7 Rectifier unit
- 8 Rectifier unit
- 9 Power XFMR
- 10 Final Amplifier unit
- 11 VCO unit
- 12 TUNE control
- 13 PLL unit
- 14 RF unit
- 15 Counter Display unit
- 16 FM unit

FT-901DM

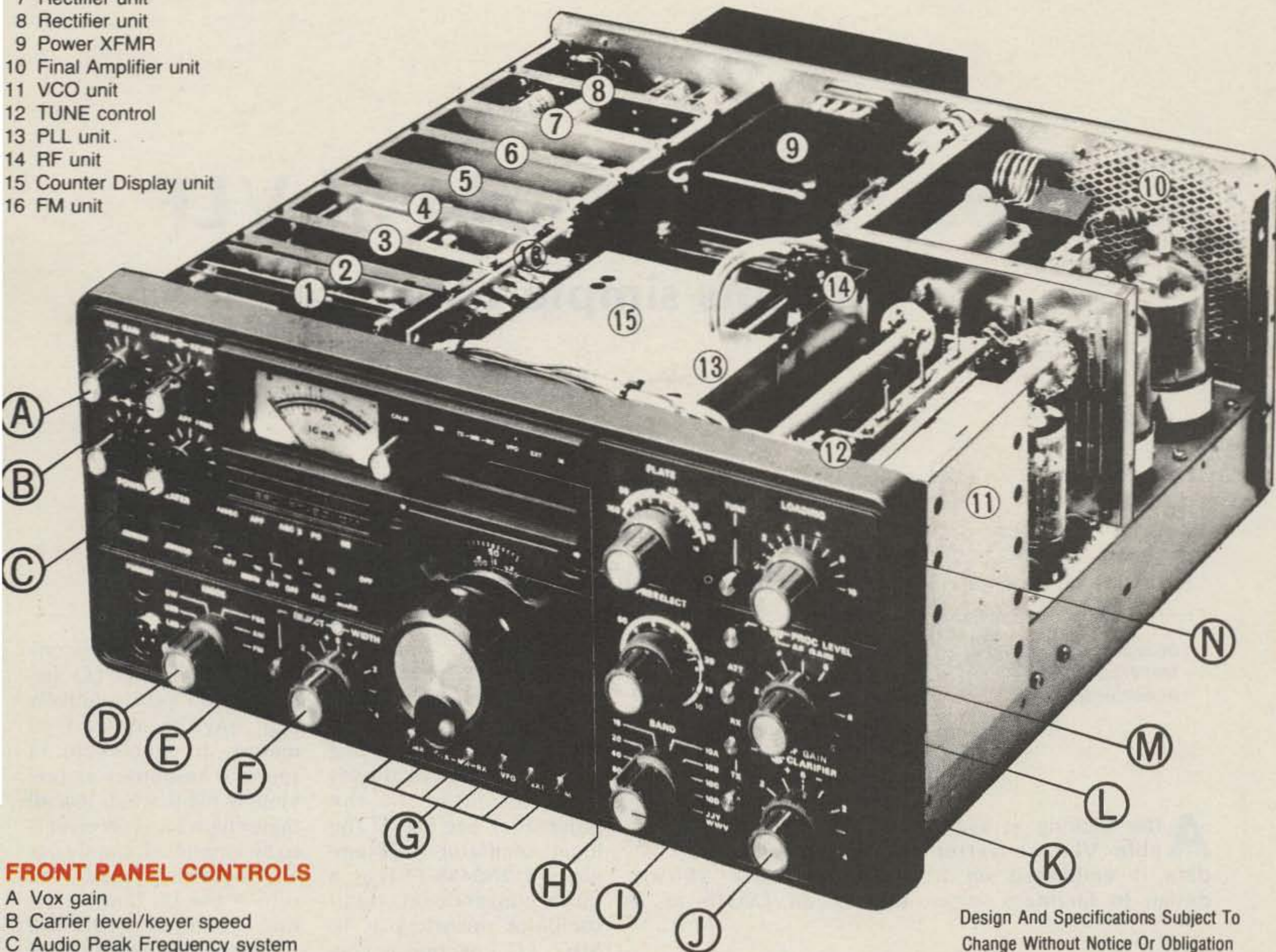

FRONT PANEL CONTROLS

- A Vox gain
- B Carrier level/keyer speed
- C Audio Peak Frequency system
- D MODE switch (SSB, CW, FSK, AM, FM)
- E Crystal calibrator/Noise blanker
- F Rejection tuning/variable IF passband tuning
- G Frequency memory system
- H Digital plus analog frequency readout
- I Band switch (160-10 meters + WWV/JJY receive)
- J Clarifier control
- K RX/TX Clarifier selector
- L RF Processor level
- M RF attenuator
- N TUNE control (Places transmitter in "TUNE" condition for ten seconds, then returns to "receive" condition to protect final tubes from excessive key-down time)

Design And Specifications Subject To Change Without Notice Or Obligation



THE SYMBOL OF TECHNICAL EXCELLENCE

YAESU The smart radio

YAESU ELECTRONICS CORP., 15954 Downey Ave., Paramount, CA 90723
(213) 633-4007

YAESU ELECTRONICS CORP., Eastern Service Ctr., 9812 Princeton, Glendale Rd., Cincinnati, OH 45246

1C78



Explore the World of VLF

— with this simple converter

A broadband preamp makes this unit tick.

Donald T. Morar W3QVZ
3663 Hipsley Mill Rd.
Woodbine MD 21797

After looking at available VLF converter data, I embarked on a design to facilitate some

VLF listening. Because it was convenient relative to the communications receiver that I planned to use the converter with, a 10 MHz i-f was picked. This removed the i-f far from many possible sources of i-f feedthrough.

The circuit shown utilizes an LM318 as a

broadband op amp, providing greater than 8 dB gain from 20 kHz up to 400 kHz. The mixer utilized is a 40673 MOSFET containing internal protective diodes (not indicated in the schematic). See Fig. 1. The local oscillator (LO) employs a 2N5458 FET as a rather conventional crystal oscillator operating at 10 MHz. LO injection is controlled by C_{inj} and tuning by C_t , although, of course, there is some interaction between the two capacitors.

I used a low-frequency signal generator with calibrated output, and I adjusted C_{inj} for best sensitivity with a very weak signal generator output, while maintaining the LO frequency at 10 MHz. The receiver used had a tuning range from 10 to 10.6 MHz, yielding a converter tuning range from zero beat to 600 kHz. Other appropriate frequencies could be employed to accommodate the particular receiver

to be used. It is recommended that the LO frequency be kept relatively high, say, at at least 40 meters, to ameliorate i-f spurious responses as previously mentioned. If a 40 meter ham band receiver is to be employed, simply use a 7.0 MHz crystal and retune the LC tank in the drain circuit of the 2N5458 FET. It may be necessary to add a bit of fixed capacitance in parallel with the existing 3-30 picofarad trimmer in order to tune down to 7.0 MHz.

The lower frequency limit of usability is, at present, about 10 kHz because of the 10 MHz LO feedthrough into the receiver. I think that a new layout would have to be made to further preclude this problem. A two-section low-pass filter is utilized on the input to the LM318 to preclude cross-modulation with strong signals in the broadcast band and above. The filter rolls off 6 dB by 500 kHz and is 20 dB down



Photo A. Front panel, showing antenna input on left, 10 MHz out in the upper right, and 12 V dc input in the lower right. A tunable i-f output was added after this picture was taken (see the schematic). The tunable inductance core shaft was brought out as an operating control slightly to the right of the rf gain control. It can be seen in Photo C.

at 750 kHz.

The converter was tried with several antenna arrangements. The most satisfactory was a 1000-foot longwire antenna that terminates in the shack. It still left much to be desired, so a separate antenna coupler was assembled. See Photo C. This greatly improved the reduction of cross-modulation and converter-usable sensitivity. Even with the low-pass filter at the converter input, strong local stations in the broadcast band plus local 100 kHz loran signals would cause objectionable cross-modulation problems without the antenna coupler.

I am also working on a fixed tuned TRF receiver for receiving WWVB, wherein a double-shielded tuned rotatable 27"-radius loop will be employed.

With the antenna coupler indicated in Photo C, it was possible to receive WWVB at 60 kHz at this location with an S-meter reading of S9, indicating an input in the vicinity of 20 microvolts. Without the antenna coupler, it was not possible to hear WWVB at all due to spurious responses about either side of 60 kHz. The converter requires 12 volts at 12 mA.

As can be seen from the accompanying photos, the converter is built on a 3½" x 6" single-clad phenolic board, utilizing vector mini-clip pins pushed into the holes of isolated copper pads, produced by an isolated-pad-Drill-Mill tool. See Photo B. The converter is housed in a Bud CU-247 Econo-box, with dimensions of 7-25/64" x 4-45/64" x 2-7/32". The antenna coupler is in a separate box, since it came as an afterthought and would have made the dimensions and layout of the converter unduly large anyway.

Fig. 1. shows the antenna coupler converter and Ken-

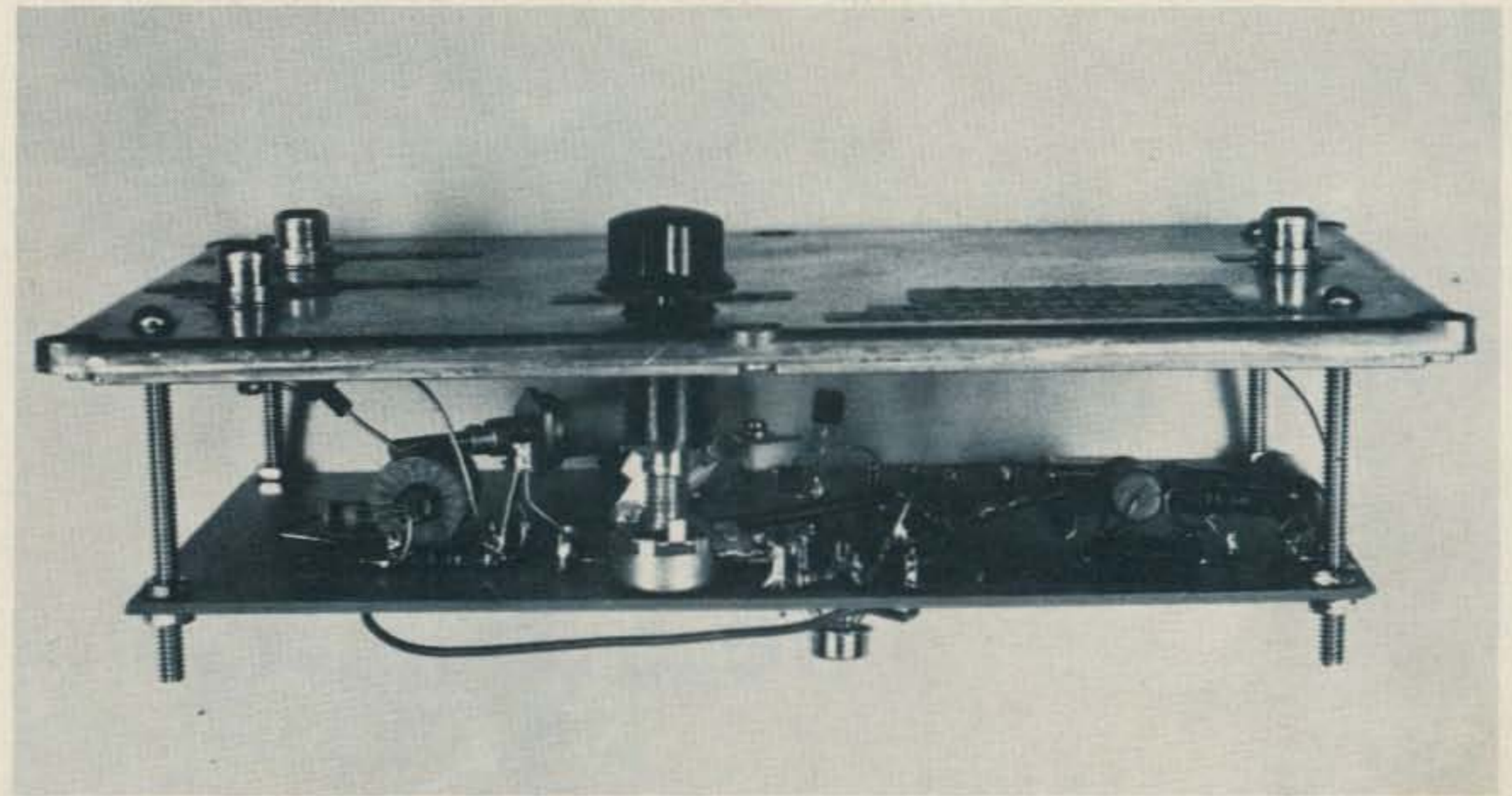

Photo B. Side (open view) of the converter showing the copperclad board and vector mini-clip construction described in the text.

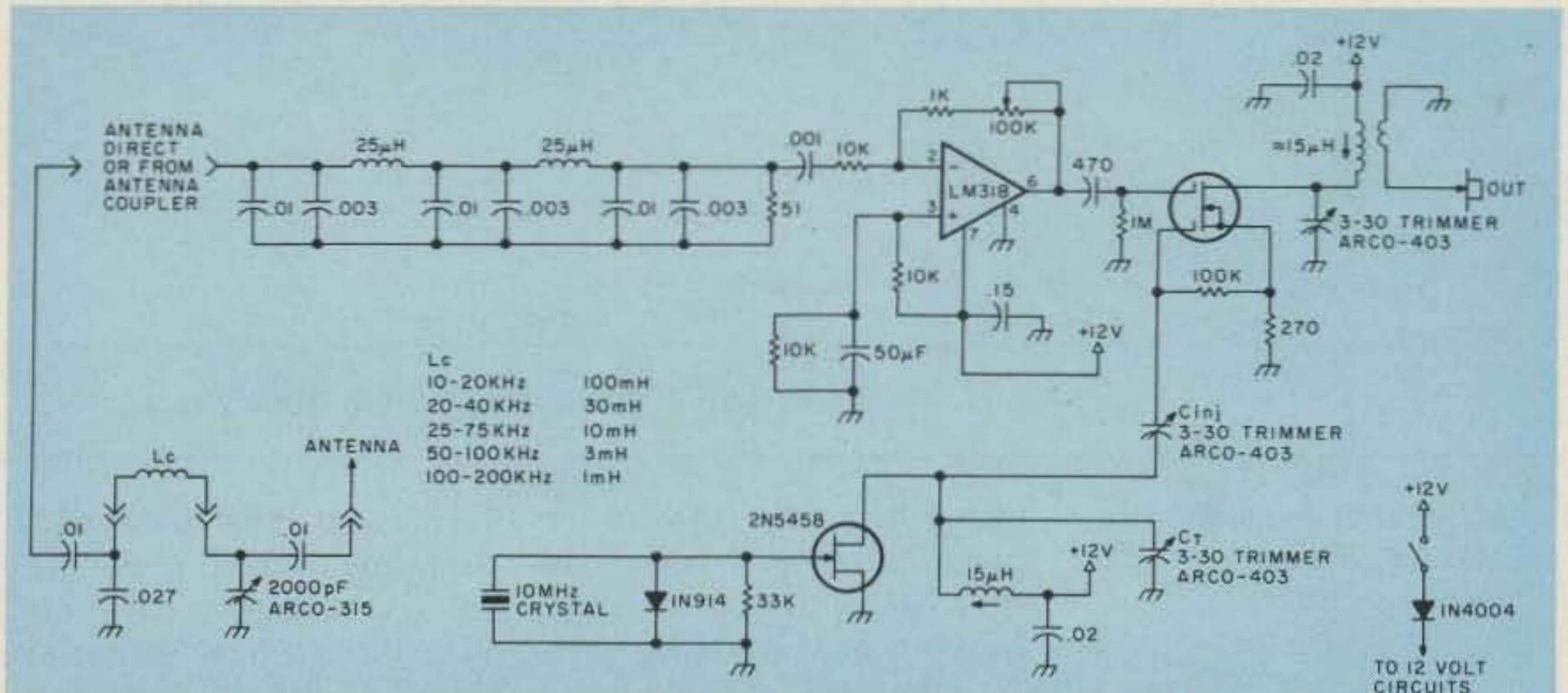

Fig. 1. VLF converter.

wood R599 receiver set up and connected to the 1000-foot longwire antenna which is 60 feet high. The antenna coupler was built in a 3" x 5" x 7" minibox, Bud CU3008. See Photo C. Coils were mounted on the selector switch so as to be as mutually perpendicular to each other as possible to minimize magnetic coupling. The Arco-type 315 compression capacitor has a range of 2525 pF tight and 1200 pF at 3 turns open. Using the inductances indicated, satisfactory tuning was obtained from 20 kHz to 200 kHz. Above 200 kHz, the converter had plenty of gain connected directly to the antenna without the coupler. Cross-modulation was not a problem in this region, either. ■



Photo C. The converter set up with the Kenwood R599 receiver. The antenna coupler can be seen at the top above the converter.

The S.H.A.F.T.

— special tuning gadget for sightless hams

You don't have to see to believe.

Burton H. Syverson K5CW
3401 Garner Lane
Plano TX 75023

Recently, a sightless ham friend of mine remarked that he had ruined the final amplifier tubes in his transmitter by

exceeding the maximum plate current. I am sure that being unable to tune his own gear must be very frustrating. Like most hams, I remembered several articles relating to tuning aids for the blind. As luck would have it, a search of my old magazines did not yield much in-

formation. The idea of a voltage-controlled oscillator is not exactly new, but it is hard to beat. What articles I found, however, used this idea to tune for maximum or minimum indication.

Not finding what I desired, the search for a method of reading discrete values of current or voltage began. The method decided upon involves the comparison of a variable voltage source calibrated in percent of the full scale voltage drop of the moving coil of the meter (Fig. 1). Application of the voltage-controlled oscillator is used to indicate balance. I call the unit to be described "The S.H.A.F.T." This stands for the Sightless Ham's Aid For Tuning.

Safety is always the prime consideration in the design of any electronic gear to be used by blind operators. In order to assure the equipment case was grounded, ac opera-

tion is used. The connecting cables carry ground to the frame of the equipment whose meter is being monitored. When readings are desired using a multimeter, the shield of the connecting cable is used as an electrostatic shield only, because of the nonmetallic case. For the operator's safety, use of a multimeter should be restricted to resistance and low voltage measurements.

One of the features of this unit is that it can be used with three different meters (i.e., multimeter, plate current meter, or ratiometer). Operation of the unit is quite simple. Referring to the schematic diagram (Fig. 2), it will be noted that zener diode CR1 holds the voltage of battery B1 at 3.9 volts. This is applied to a series resistance network so that the voltage drop from the lower end of control R14 to the junction of R13 and R22 is approximately 40



millivolts. This is something less than the full-scale voltage developed across the moving coil of most meters. By use of control R14 and switch SW2, any voltage between zero and 40 millivolts may be obtained. This voltage is fed into the inverting input of an operational amplifier on IC U1. Control R14 is calibrated from zero to 10% and switch SW2 in 10% steps from 0 through 90. The settings are additive. Voltage from the moving coil of the meter to be read is fed in jack J1 through 2-conductor shielded cord to switch SW1A which selects control R1, R2, or R3. R1, R2, and R3 are used to adjust the full-scale meter voltage to the 100% setting of the R14 and SW2. The voltage across R10 is fed into the noninverting input of the same operational amplifier. The output of the amplifier is fed into null detector Q1. Q1 causes unijunction oscillator Q2 to increase in frequency whenever the output of the operational amplifier crosses zero volts. The output of the oscillator is connected to a second operational amplifier which serves as an audio amplifier. Note: The jumper connected from C2 to terminal 1 of U1 may be replaced with a suitable resistor if the constructor feels the audio level is excessive.

Due to the dc nature of the unit, the mechanical layout of parts is not critical. The size of the etched circuit board was chosen to accommodate its being fastened to the back plate of a 4" x 5" x 6" Bud cabinet (Fig. 3). Others may choose a larger cabinet for ease of construction. In my unit, switches SW1 and SW2 are rated at 1500 V dc breakdown and need not be insulated. However, control R14 is sub-mounted on a

piece of vectorboard 2½" x 5" with enough clearance that the speaker frame (also on the vectorboard) does not touch the front panel. All parts (other than those on the etched board, and C3, F1, J1, and T1) are mounted on the vectorboard. Difficult to mount parts are held in place by epoxy cement. marking of the panel is done with embossed tape. Print wheels for embossed-tape writers are available with Braille symbols. Switch SW2 should be marked as shown on the schematic. Control R14 markings may be dots of nail polish with the zero and ten percent points identified with embossed tape. The in-between points may be determined with an ohmmeter connected from the contact arm to the lowest-voltage terminal of R14.

To put the unit in operation, connect a voltmeter (set to read 10 volts) across

resistor R7 on the etched circuit board. Connect the meter you wish to use to input jack J1 through a

suitable cable. Set R14 and switch SW2 to zero percent. With the power cord plugged in, operate switch

Parts List

- B1—3 type AAA cells in Keystone 169 holder
- C1, C2—1 uF, 25 V capacitor
- C3—.05 uF, 20 V capacitor
- C4 through C6—200 uF, 25 V capacitor
- C7—50 uF, 25 V capacitor
- CR1—1N4730, 3.9 V zener
- CR2, CR3—50 piv silicon diode
- D1 through D4—1N34A diode
- F1—3AG, 1 Amp fuse
- J1—¼" 3-circuit phone jack
- Q1—2N706 or equivalent
- Q2—2N2160 unijunction transistor
- R1 through R3—100k pot, Mallory type MTC 15L1
- R4, R7—1.5k, ¼ W resistor
- R5, R8, R10—47k, ¼ W resistor
- R6—3.3k, ¼ W resistor
- R9, R12—47 Ω, ¼ W resistor
- R11—470 Ω, ¼ W resistor
- R13—100k, ¼ W resistor
- R14—Mallory type UA12L 100 with plastic shaft
- R15 through R22—100 Ω, ½ W, 5% resistor
- R23—10k pot, Mallory type MTC 14L1
- SW1—4-pole, 4-position Stentite rotary switch, Centralab #2515
- SW2—1-pole, 10-position Stentite rotary switch, Centralab #2503
- T1—small 6.3 V ac transformer, 1500 V insulation
- T2—small output transformer, 2k primary to voice coil
- U1—Texas Instruments SN72747 IC
- Speaker—3" PM speaker with 4 Ω voice coil
- Misc.—cabinet, power cord, connecting cables to meters and assorted hardware

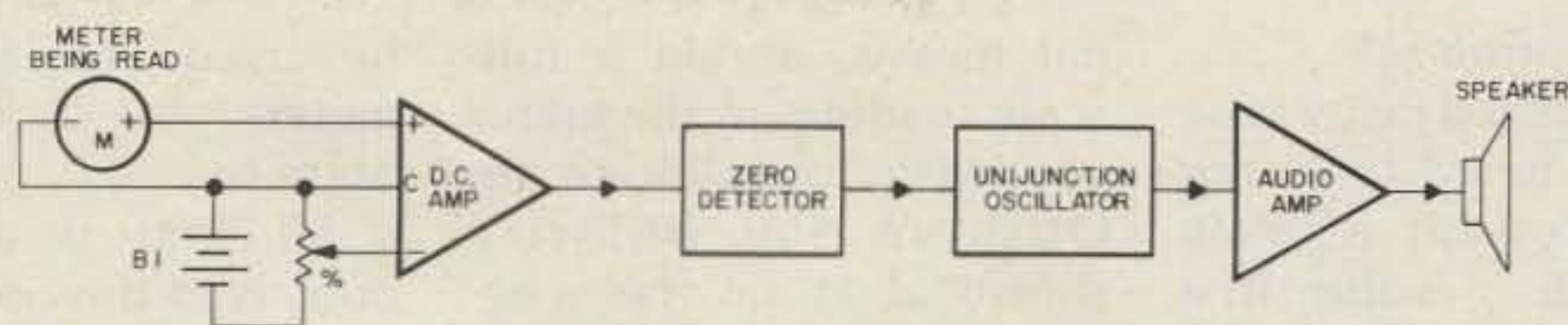

Fig. 1. Block diagram of the S.H.A.F.T.

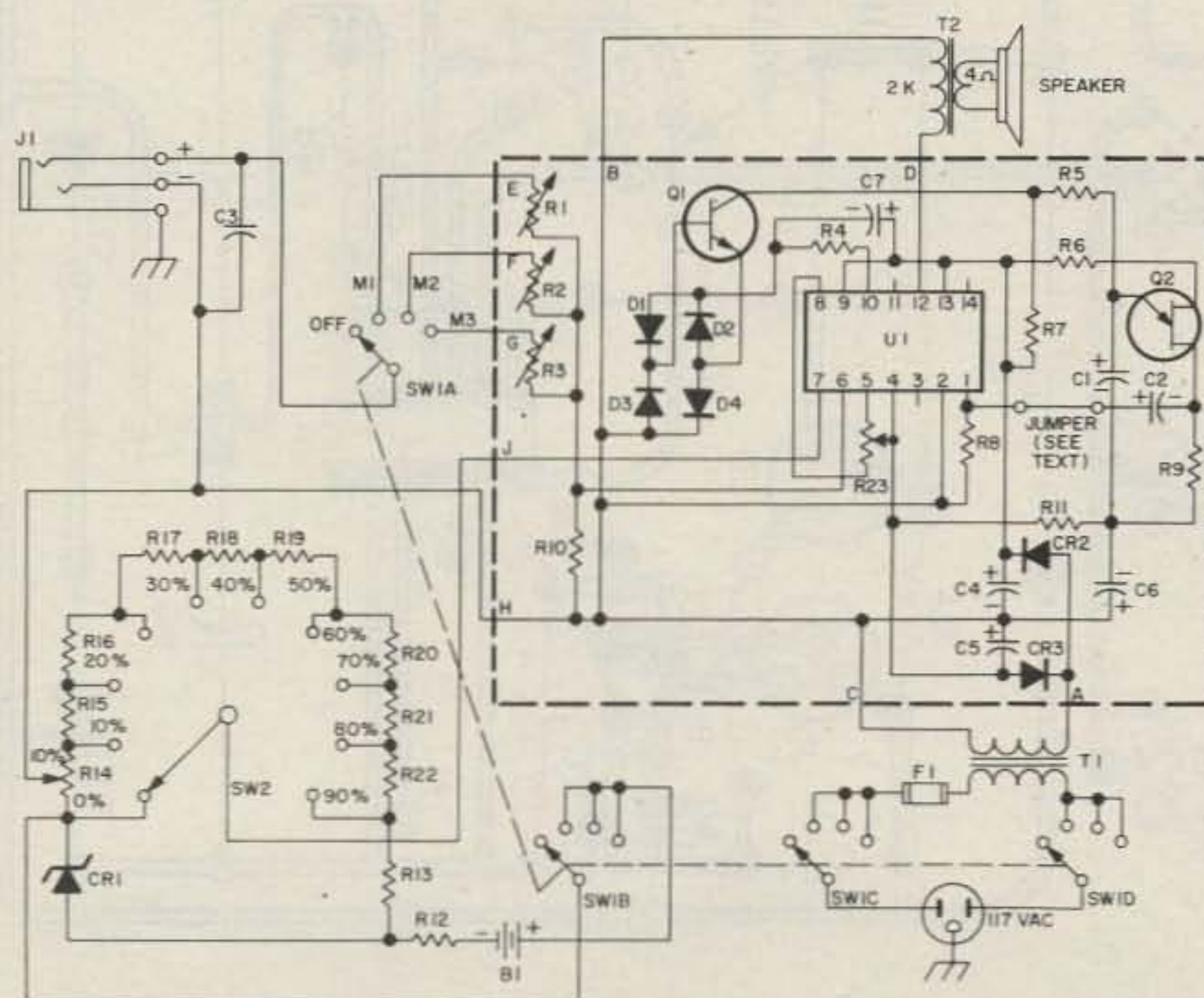

Fig. 2. S.H.A.F.T. schematic diagram.

SW1 to position M1.

A low-pitched raspy tone should be heard from the speaker. Resistor R5 may be reduced in value if a higher pitch is desired. I feel the shift in tone is more pronounced when a lower pitch is used. Adjust the offset control (R23) for minimum voltage drop across resistor R7. By exter-

nal means, obtain a full-scale reading on the meter you wish to calibrate to. Observe the polarity shown at J1 on the schematic. Set control R14 to 10% and switch SW2 to 90%. Slowly adjust R1 until a point is found where the pitch of the tone peaks. Tune for the highest pitch. The same method should

be used for any other meters you wish to calibrate to.

All that is necessary, now, is to provide the user with charts (in Braille) showing meter values versus percentage of the meter scale for each desired range. Due to the fact that meter scales are printed, the angular movement

does not necessarily track. As a result, it may appear that the user's ability to determine the reading is no better than 2 or 3%. My tests indicate at least half of this is due to tracking error of the meter. For this reason, it is safe to assume the Braille calibration for dc voltages is a straight line function (i.e., 80% equals 8 volts on the 10 V dc scale).

This unit was not intended for ac measurements in an effort to discourage the user from trying to make readings of the commercial power line. Should this feature be desired, it will be necessary to filter the input to the unit. This will undoubtedly upset the calibration of the meter's ac ranges.

The unit shown in the photograph is a prototype and the panel markings are not identical, though similar to those shown in the schematic (i.e., 90% on SW2 is 9). Space limitations make use of 1/2" tape difficult. However, the Braille characters are easier for the user to identify.

Since semiconductor devices can overload easily in rf fields, trouble may be encountered when the unit is used in close proximity to transmitters. The same lead filtering methods used for TVI prevention should help. As no single solution can be expected to cure all problems, it may require some experimenting to get normal operation under these conditions.

As with any idea, it can be improved upon. At present, this design appears to be a good compromise between results and cost. The enthusiasm of two of my blind ham friends for this device made the effort most gratifying. I hope this unit will provide a means for the sightless ham to enhance his independence and more thoroughly enjoy amateur radio. ■

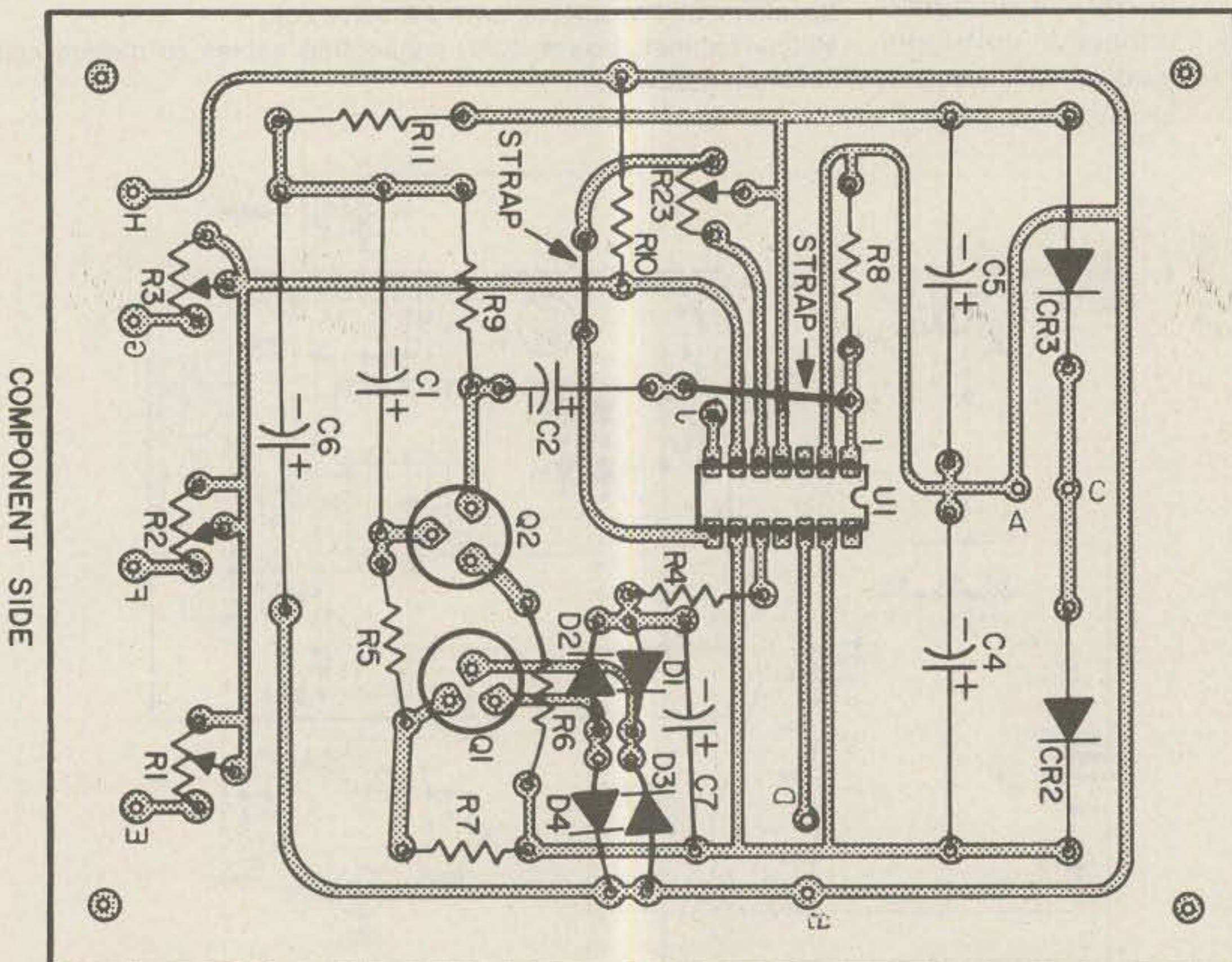
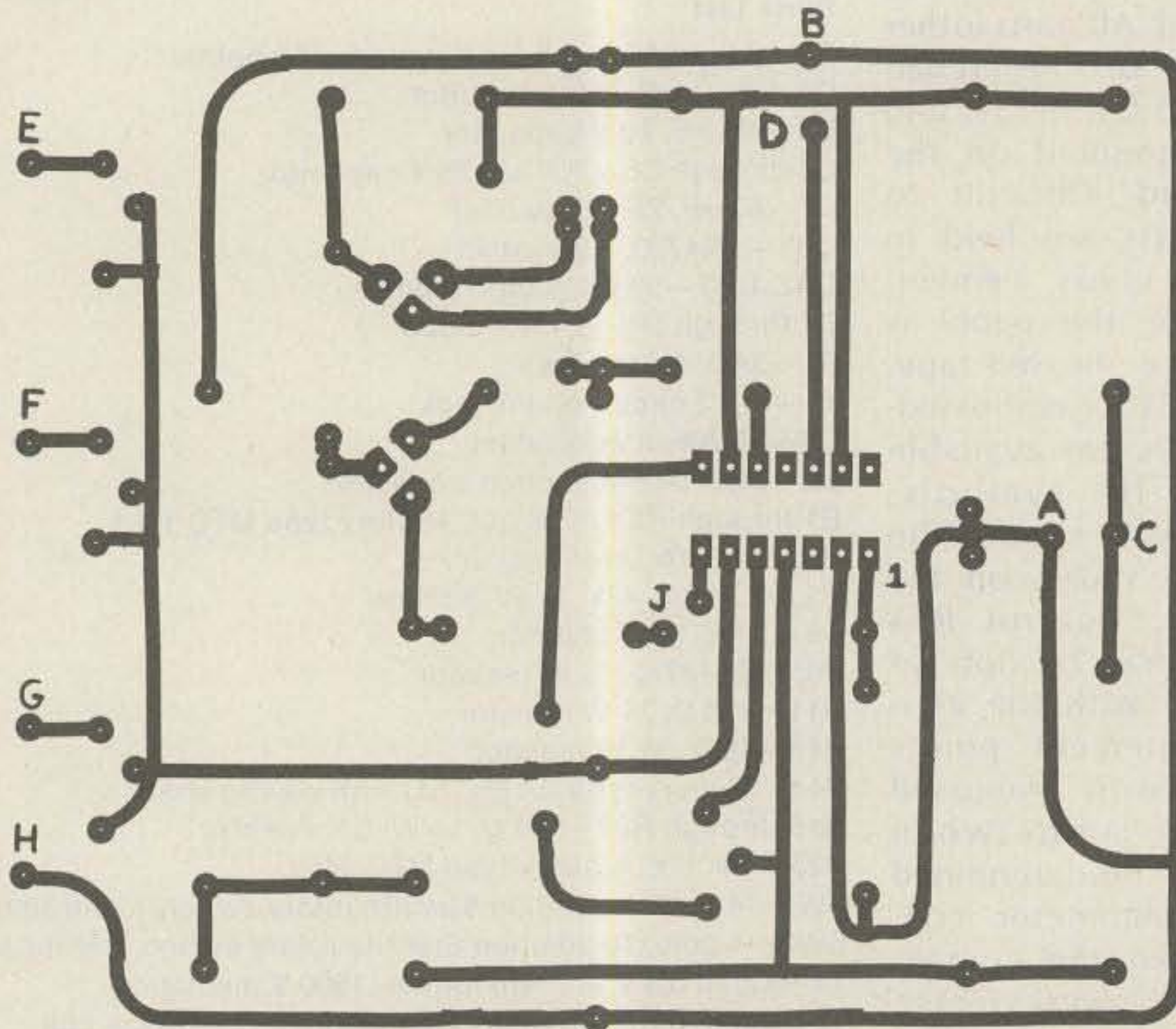
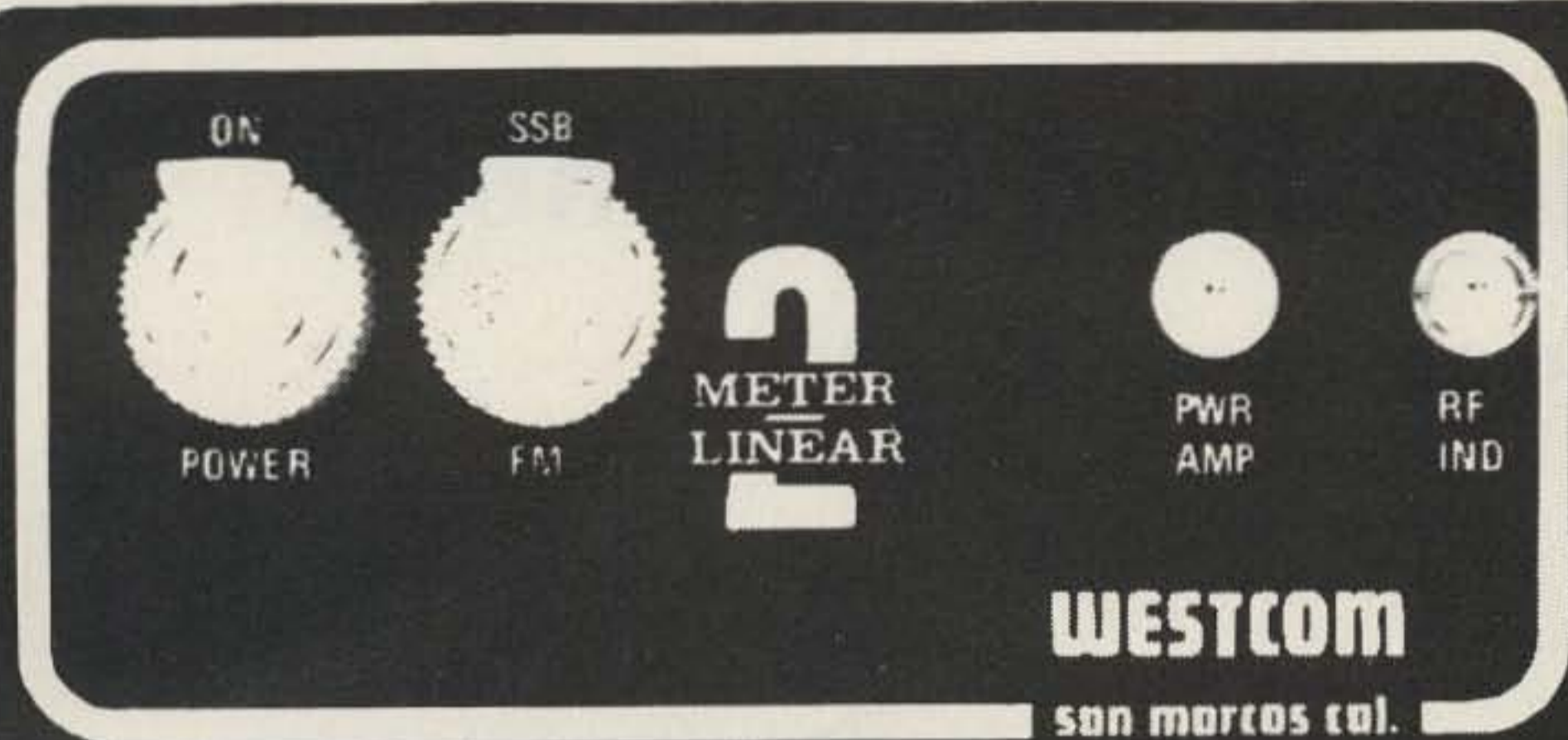

Fig. 3. PC board and component layout for the S.H.A.F.T.

BI-LATERAL



DIGS OUT THE WEAK SIGNAL AND BOOSTS THE POWER !!!

Now Westcom gives you twice the advantage... a low noise receiver preamplifier and an output power amplifier, all in the same package! No modification of your transceiver is required since it's all in one high performance, low cost unit. The low noise U310 J-FET yields 12dB gain, 2dB NF, and the receive amp may be used independent of power amp. This unit is a natural for OSCAR uplink or long haul weak signal TROPO work. Available in 90w or 125w

- An add-on unit, no internal connections or adjustments required to associated equipment
- Standard Amplifiers operate FM, Linear Models operate all modes: SSB, FM, AM, RTTY, CW
- Diffused emitter ballasting resistors achieve extreme ruggedness under severe operating conditions
- Withstands 20:1 VSWR under specified operating conditions
- "Microstrip" design provides high stability and optimum performance over wide bandwidth
- Factory adjusted, no tuning required
- Mobile mounting bracket included
- RF sensing T/R switching, adjustable drop-out delay (SSB/CW Mode)
- Remote keying capability
- Thermally coupled biasing
- Reverse Voltage protected
- Detachable fused power connector
- Conservatively rated with oversized heat sink
- Compact: 4 1/8 x 5 1/2 x 2 5/8
- Red LED indicators for monitoring DC and RF
- One year material and workmanship limited warranty

MODEL NO. (two meter)	INPUT POWER (watts)	MINIMUM OUTPUT W. (at max input)	MAXIMUM CURRENT 13.8 VDC	PRICE
FM Mode				
2m 15x70	5-15	70	8	\$119.95
2m 15x90	5-15	90	11	\$134.95
2m 25x125	10-25	125	18	\$164.95
All Mode-Linearized				
2m 15x70L	2-15	70	8	\$129.95
2m 15x90L	2-15	90	11	\$149.95
2m 25x125L	5-25	125	18	\$179.95
All Mode-Linearized with pre-amp				
2m 15x90BL	2-15	90	11	\$179.95
2m 25x125BL	5-25	125	18	\$209.95

* Linear; AM, CW, FM, SSB, RTTY. Linear models work well with low power transmitters of 2-3 watts to yield 30-40w output. Size: 4 1/8 x 5 1/2 x 2 5/8

If not available from your local dealer, contact:

WESTCOM

ENGINEERING ✓W17

1320 Grand Avenue San Marcos
California 92069 (714) 744-0728



It's easier

Dx'er
Contester • Trafficman
Ragchewer

Telex headphones and headsets make it easier to enjoy the hobby. Whether you prefer lightweight or full cushioned comfort, there's a high performance Telex product that will help make you a better operator. See yours...at better ham outlets everywhere, or write...

✓H4
hy-gain electronics
DIVISION OF TELEX COMMUNICATIONS, INC.

8601 NORTHEAST HWY. 6, LINCOLN, NE. 68505 U.S.A.
telephone: 402-467-5321, telex: 48-4324

Europe: 22, rue de la Legion-d'Honneur, 93200 St. Denis, France.
telephone: 820-98-46, telex: 63-0013

A Remotely-Tuned Matchbox

— ultimate operating ease

This system will tune your Matchbox from 300 feet away — or more.

Guy Black W4PSJ
12317 Hanger Road
Fairfax VA 22030

My shack is among those where the path between the operating position and the feedpoint of the antenna system poses some problems. So, I decided to locate a Johnson Matchbox in the garage, some 75 feet away, so I could use tuned feeders for a classic-dimensioned multiband antenna — 135 feet long centered with 42-foot feeders (see the older ARRL Handbooks). The rf path to the Match-

box is RG-8, and the problem is to tune and change bands on the Matchbox from the operating position.

I thought other hams would like to know how I did this, though I doubt that any would exactly duplicate the oddball collection of relays and motors that I obtained at trivial cost at various hamfest flea markets. It turns out that motorized tuning, bandswitching, tuner dial indicating, and a grounding switch for lightning protection can all be done with the commonly available 8-wire cable nor-

mally used for rotators.

I had kept my eye open for gear-head motors suitable for turning capacitors for a number of years and finally picked up a very assorted group which do the job. Any reversible motor with 2-20 rpm output and a reasonable torque capability can be used. A common type of 110 V ac motor has a starting capacitor that is connected between two of three motor connections, the third connection being connected to one side of 110 V ac and the direction of rotation being determined by connecting the

other side of 110 V ac to one side or the other of the capacitor.

Another common type of reversible ac motor has four connections, two of which are interchanged to change rotational direction. Dc motors with permanent magnet (PM) fields are generally reversible merely by reversing the polarity of the dc, though others — identifiable from connections — require reversing field or rotor connections.

One of the ac motors used was actually two motors on one shaft, each good for a different direction of rotation. This unit was made by the Merkle-Korff Gear Company and was so suitable for the purpose at hand that I contacted the company.¹ My motor was their type SG-25, now supplanted by model BF, and it turns out that the company has a national network of stocking distributors and can supply motors with various rotations down to one rpm with starting torques of 10-50 pound inches; torque is important, as the rotation of many big capacitors is a stiff job. These units are perhaps more appropriate to the intended function

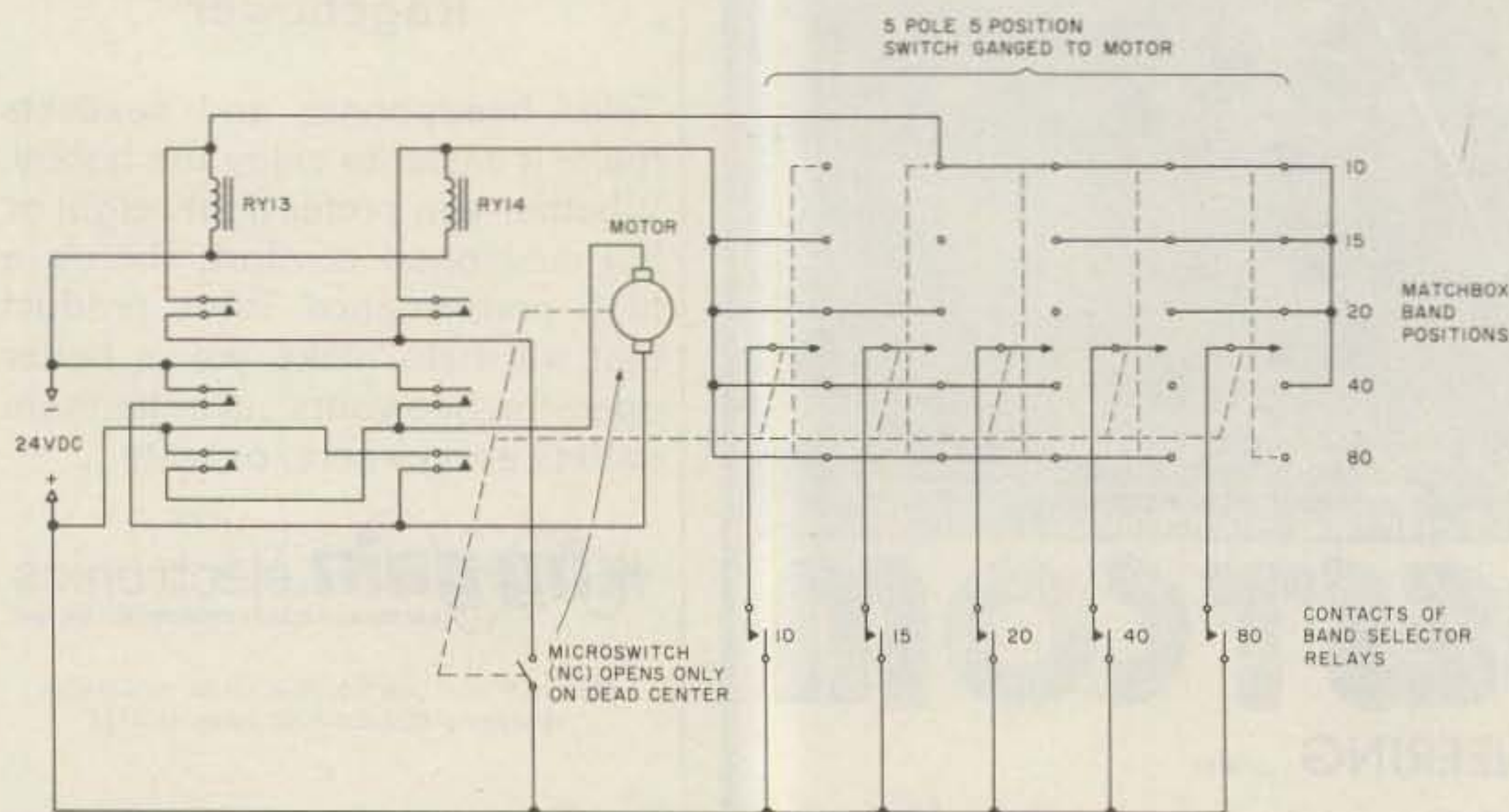

Fig. 1. Circuitry for motorized bandswitch.

than the more elegant instrument motors manufactured by Japan Servo Co. (subsidiary of Hitachi, Ltd.).²

The functions which I wished to operate remotely included turning two capacitors of the Matchbox and bandswitching to any of five bands. In addition, it turns out to be essential to have an indication at the operating position of the setting of the matching capacitor. If this is once set, a vswr bridge at the operating position can be used to find the proper setting of the tuning capacitor merely by rotating it (remotely) for minimum vswr. However, attempting to tune the Matchbox without information on the setting of the matching capacitor is hopeless.

In addition to controlling the Matchbox, I added two extra functions: an arrangement for grounding the tuned feeders for lightning protection (the need for this was learned the hard way) and provision for switching the coax from the Matchbox to another antenna, which will be for 160 meters in my case, but could be anything.

Photo A shows how I adapted an antique knife-blade-type power switch obtained from a local surplus dealer for antenna grounding. While two of the knife blades switch the tuned feeders, the third activates limit switches that restrict rotation of the knife blades to a 90-degree arc by shutting off the motor automatically when the desired connection is made. Duplicating this switch should be within the capability of many hams.

Photo B shows the activating unit for the Matchbox, connected to it by angle-aluminum arms to existing screw holes of the Matchbox, which has not been permanently modified in any way. In fact, it

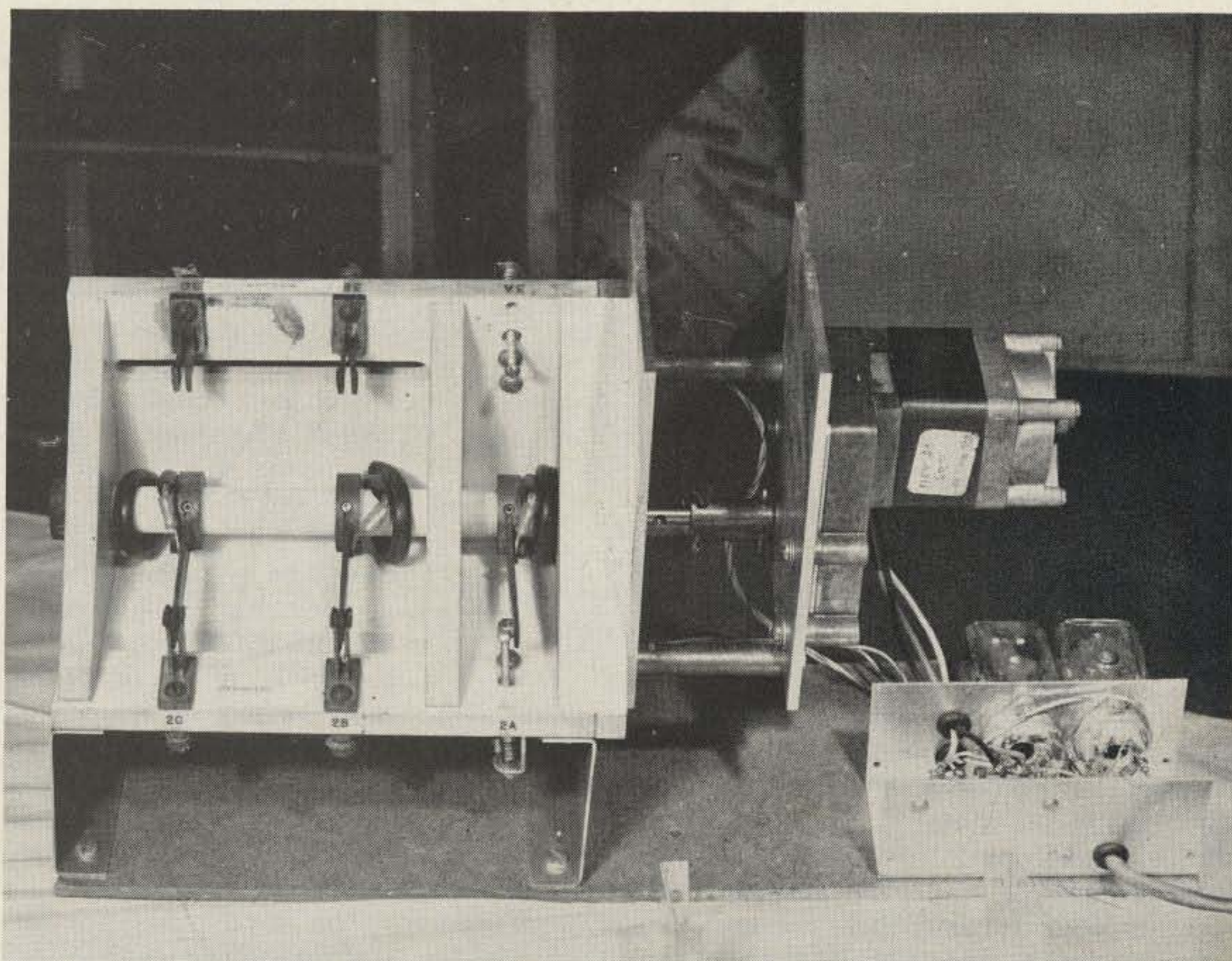

Photo A. Antenna grounding unit driven by reversible gear-head motor with limit switches to terminate rotation. Slack in the cotter pin holes lets the motor get up speed to overcome the torque required to turn the switch.

is a simple matter to detach this unit, say for Field Day, and restore the Matchbox to its original condition. What is seen is a PM-field, dc gear-head motor of uncertain vintage operating the tuning capacitor on the left, the dou-

ble Merkle-Korff motor on the right driving the matching capacitor via an internally-toothed belt (similar to an automotive timing belt), a selsyn indicator-transmitter for the matching capacitor, two boxes containing con-

trolling relays and other associated parts, and an assembly to take care of the bandswitching function. Dials have been replaced by bushings with projecting wire indicators, for use in local adjustment.

Now, as the tuning and

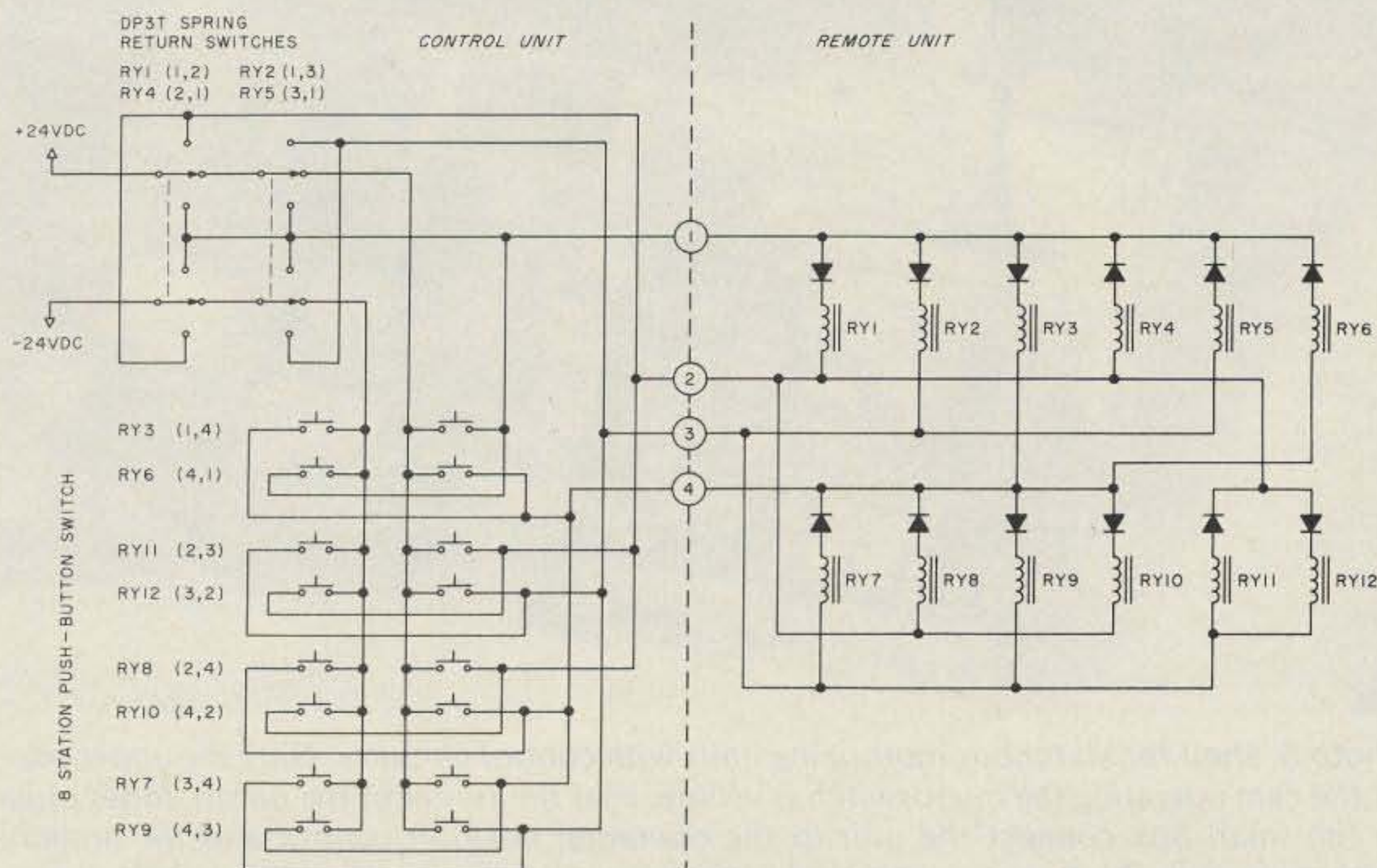

Fig. 2. Control of twelve relays using four-wire cable.

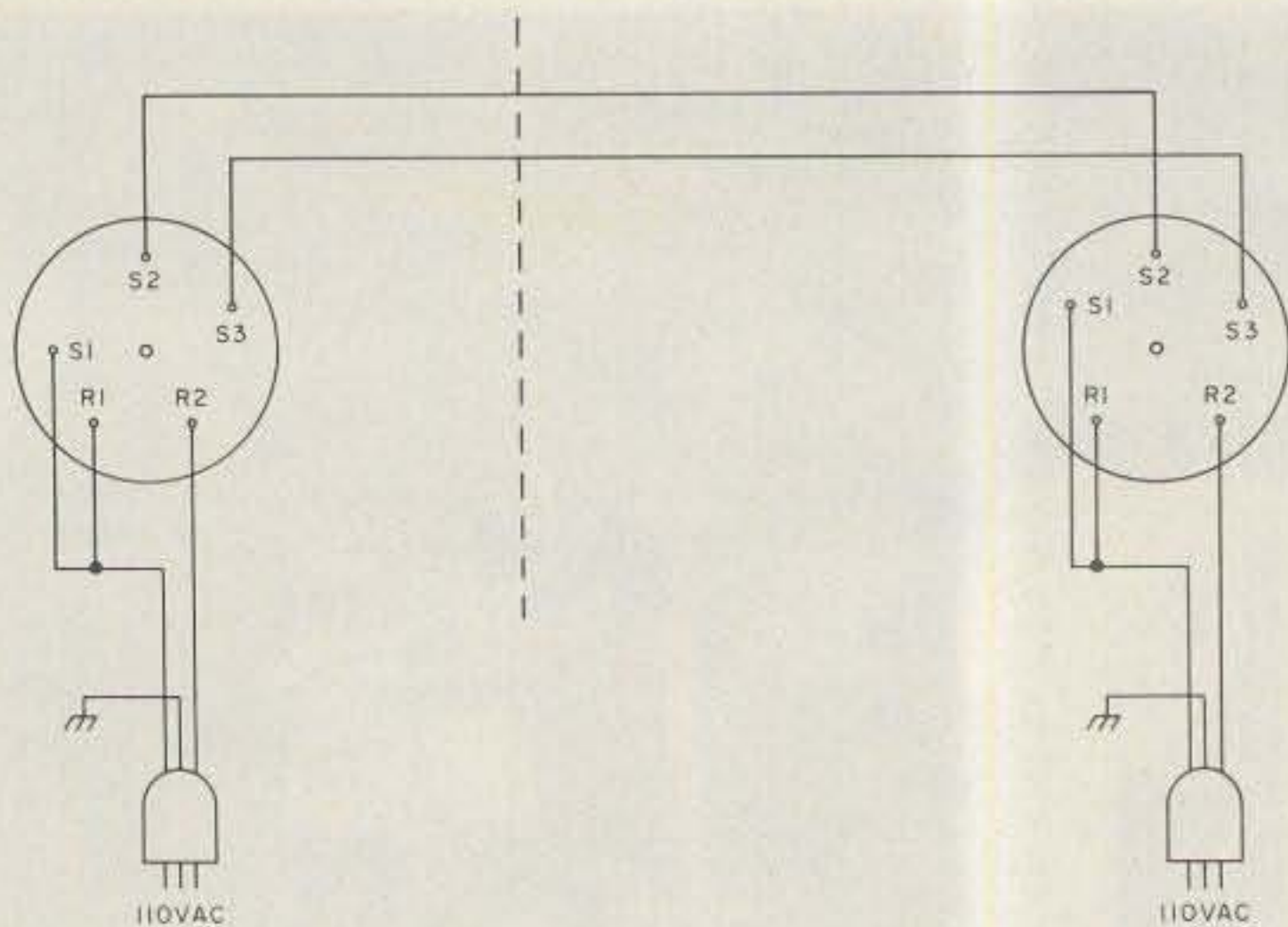

Fig. 3. Using household wiring to reduce to two the wires needed in a control cable for a synchronous transmitter-indicator.

matching capacitors can be rotated continuously, they present no problem for remote operating, but the bandswitching function requires a limit on rotation, and, further, the rotation must stop only when the switch is dead center on the desired set of

contacts. To accomplish this requires the large switch seen in the center of Photo B plus a very important cam-driven microswitch concealed behind the mechanism, and gears in a 1:12 ratio.

Here is how it works: The large switch (it need only

be a 5-pole, 5-position switch) is directly coupled to the Matchbox band selector switch. Both have 30-degree indexing. The common shaft is coupled into a 1:12 gear train which operates a cam that allows a microswitch to open only once in 30 degrees of rotation of the Matchbox band-switch and coupled 5-pole switch. The small PM-field dc motor that drives the bandswitch takes a rotational direction determined by one of two relays in the small box directly behind it. But, once the motor is in motion, the microswitch is closed — and thus keeps the relay closed — until it is opened because the bandswitch is dead center on some set of bandswitch contacts.

The circuit diagram for this function is given in Fig. 1. A contact (in this case, a relay contact pair) is

closed corresponding to the desired band to connect 24 V dc to the bank of 5 by 5 contacts. If some band other than the one to which the Matchbox happens to be set is desired, either RY-13 or RY-14 will be activated to connect the rotator motor for clockwise or counterclockwise rotation. Notice that two sets of contacts on each relay supply dc to the motor with opposite polarity. Once the 5-pole switch is off dead center of some switch position, the microswitch, being mechanically coupled to it, closes and holds the relay closed. Two conditions are required for rotation to stop: the selected bandswitch position has been reached and switch contacts are on dead center.

To accomplish complete remote control of the Matchbox and auxiliary grounding unit requires twelve functions: five Matchbox band positions; one auxiliary antenna in lieu of the Matchbox; tuning and matching capacitor rotation clockwise and counterclockwise; and antenna grounding and ungrounding. In addition, the position of the matching selsyn indicator must be transmitted to the operating position. To avoid the voltage drop in a long light-gauge wire, a 24 V dc supply and a source of 110 V ac were used at the Matchbox position, with the appropriate connections being made by a bank of 12 remotely activated relays. The simplest way, but most extravagant in its use of wire, would be to use an 18-wire control cable (including a ground return for the relays and five wires for the selsyn), but it is possible to reduce the number to four for controlling 12 relays and — provided 110 V ac is available at both Matchbox and operating position — two for the selsyn in-

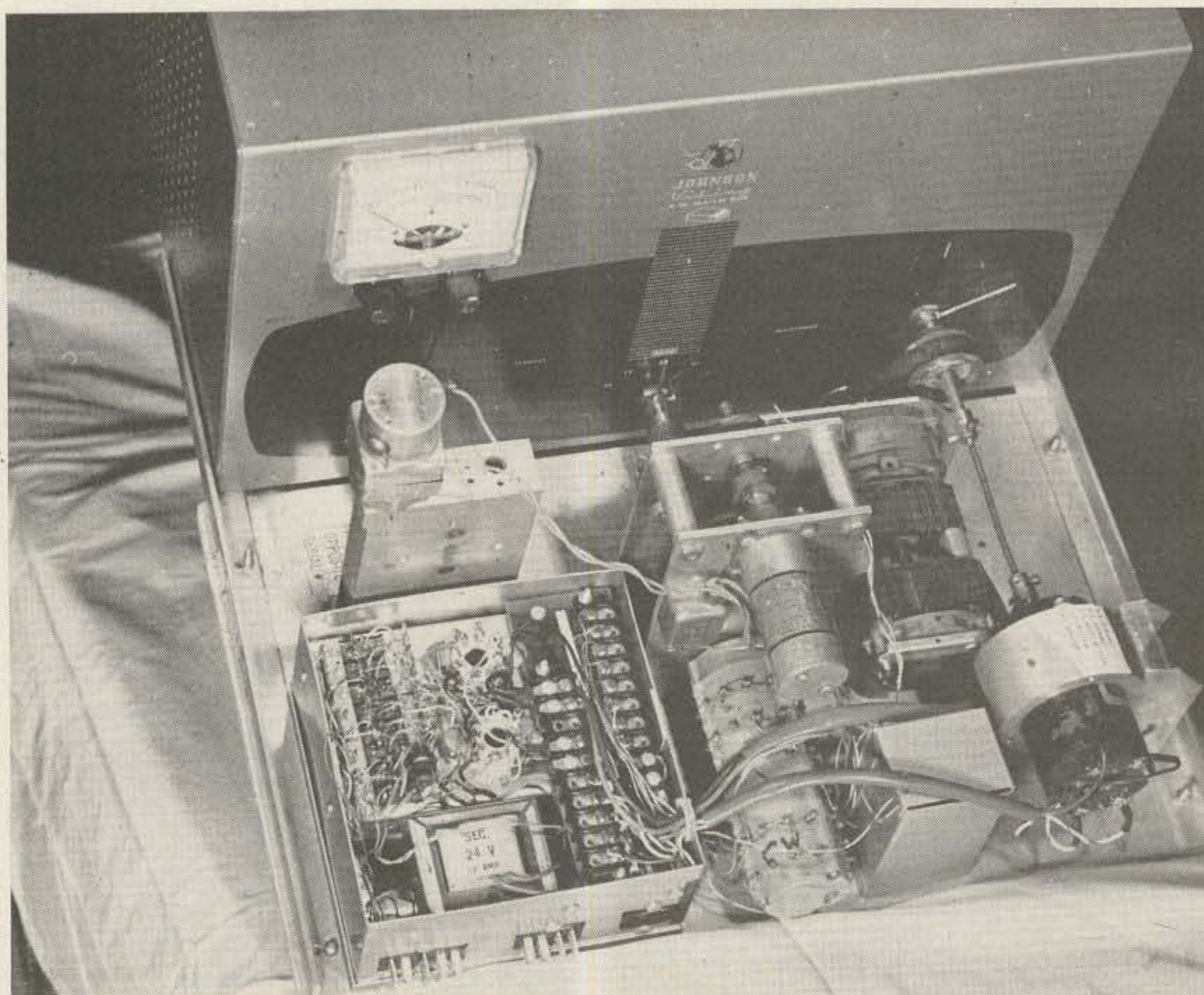

Photo B. Shelf for Matchbox motorizing units with control circuitry. Only the upper edge of the cam operating the microswitch is visible, near the center of the photo. Jones plugs in the small box connect the unit to the operating position control and the antenna grounding unit. By driving a matching capacitor with a timing-type belt, a shaft projection is available to drive the selsyn indicator.

dicator.

Fig. 2 shows how four wires can be used to operate 12 relays selectively. This circuit has been checked in breadboard, though not actually used in the pictured unit. The number of controllable relays has been doubled by using diodes such as 1N4004s so that each combination of wires one through four (e.g., 1-2; 1-3; 1-4; 2-3; 2-4; 3-4) can be used to select two relays. I plan to use a version of this for control of an EME set-up.

Note, however, that this arrangement permits, in general, any one wire to be used for only one relay at a time. It works for circuits that do not require continuous relay energization. For example, if you wished to turn off the ac power for the 24 V dc supply and the selsyn from the operating location, it would be necessary to use an impulse-type relay because, while the ac circuit is activated, none of the other relays can be used; it's one relay at a time.

The operating console control unit shown in Photo C uses an eight-position push-button switch of the locking type, and some consideration had to be given to this configuration. Band selection, matching capacitor setting, and tuning capacitor setting must be done non-simultaneously. This was ensured by using 2-pole, 3-position spring-return-to-center lever switches (Centralab # 1455s) for matching and tuning capacitor rotation. As shown in Fig. 2, operating either of these switches temporarily disconnects the push-button switch so that, temporarily, no power is applied to the respective relay and the center positions of the lever switches are in series. Note that a separate 24 V dc supply is in the control unit, though

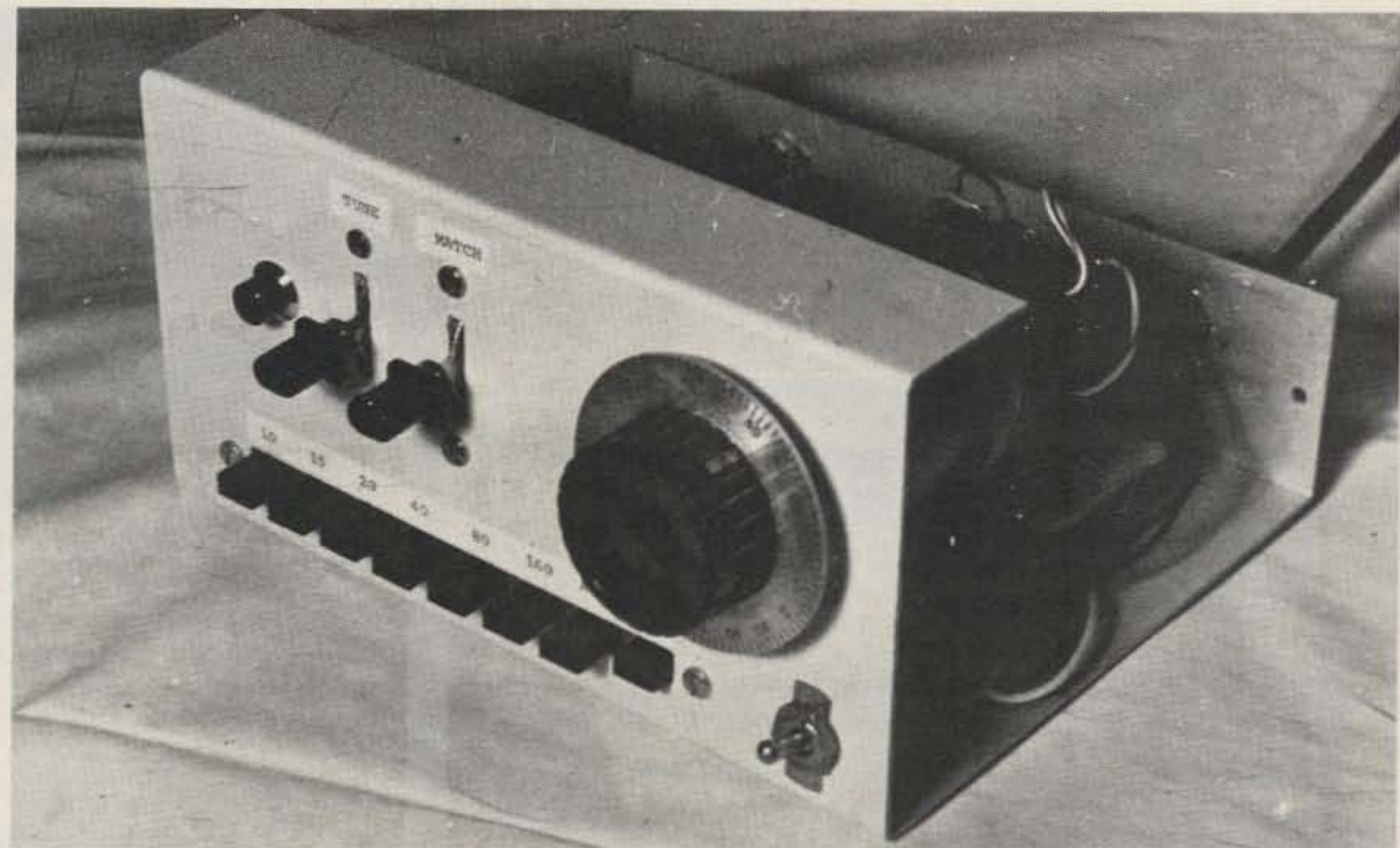

Photo C. Operating unit for remote control of antenna tuner, selection of antenna, and grounding of antenna for lightning protection. Dial is driven by a selsyn, which indicates the position of the matching capacitor. The unit is in a Ten-Tec MW-8 case.

the 24 V dc needed for relay operation could have been obtained via the otherwise unneeded last two wires of an eight-wire cable. For relay operation, voltage drop would not be a consideration, as the current drawn is very light.

As for the selsyn indicator, although conventionally five wires are used to connect the transmitter and indicator, all the textbooks show that the number can be reduced to four by using one common wire for rotor and field. But, if both indicator and transmitter are fed from the same household circuit, this circuit supplies two of the needed four wires and only two need be added in the control cable. It is possible that transmitter and indicator will be on opposite sides of a 220 V centertapped circuit, in which case rotor terminals will have to be reversed on one unit. Checking this idea out in breadboard verified that it worked, though it was not actually employed in the control unit pictured, which used a separate cable for the

selsyn. See Fig. 3. With the common 8-wire cable, two selsyn indications (azimuth and elevation) and control for up to 12 relays (tuning, gain, etc.) for an EME setup could be obtained, given ac power at the antenna.

A few small points complete the story. I chose to use miniature 24 V dc relays where current requirements were light — e.g., closing other relay contacts — but I used heavier relays for operating motors. Because the relay supply had very poor regulation, it stood at 38 volts when in use for miniature relays but it was drawn down to 24 V dc for the larger relays. A regulated 24 V dc supply might be neater. I added series resistors to limit current in the miniature relays. Transient suppressors (G.E. type MOV-750) were used across the coils of the bigger relays and the 24 V dc motors.

That's about it. I've thought of more sophisticated systems, such as tone-controlled systems using SE567 tone decoder ICs or some shift register arrangement. I've also con-

sidered other applications for simple remote control — for example, tuning and gain-setting in a pre-amplifier mounted at the top of a tower, or changing polarization on a moon-bounce or OSCAR antenna. As I've noted at several points, the circuit described is not the one used in the units pictured. This is because I built up the unit before figuring out how to minimize the number of connecting wires needed; however, all circuits diagrammed here have been checked out in breadboard form.

The collection of parts used and the construction are not what I'd use on a cost-plus government contract, but they are a good illustration of what is available at hamfest flea-markets, to make an off-beat project feasible at trivial cost. ■

References

1. Merkle-Korff Gear Co., 11500 W. Melrose Ave., Franklin Park IL 60131.
2. Available through Japanese Products Corporation, 7 Westchester Plaza, Elmsford NY 10523.

6 GOOD REASONS FOR BUYING A HAL-TRONIX FREQUENCY COUNTER

(1) 100% COMPLETE KIT, (2) EASY ASSEMBLY, (3) COMPLETELY ENCLOSED IN METAL CABINET, (4) IC SOCKETS USED THROUGHOUT FOR EASY TTL REPLACEMENT (5) EASY ON YOUR POCKET BOOK, AND (6) NO EXPENSIVE CHIPS TO REPLACE (EXAMPLE—IF YOU LOSE A DECODER, LATCH OR DRIVE IN A HAL-TRONIX COUNTER, THE AVERAGE COST OF REPLACEMENT OF THE LOW-COST TTLS IS LESS THAN \$1.00 EXCLUDING THE PRE-SCALE CHIP. IN SOME OF THE NEWER COUNTERS NOW BEING MARKETED BY MY COMPETITION, THEY ARE USING THE EXOTIC SINGLE CHIP AND WOULD COST YOU CLOSE TO \$30.00 TO REPLACE). THIS IS SOMETHING YOU SHOULD CONSIDER.



COMPLETE KITS: CONSISTING OF EVERY ESSENTIAL PART NEEDED TO MAKE YOUR COUNTER COMPLETE. **HAL-600A** 7-DIGIT COUNTER WITH FREQUENCY RANGE OF ZERO TO 600 MHz. FEATURES TWO INPUTS: ONE FOR LOW FREQUENCY AND ONE FOR HIGH FREQUENCY; AUTOMATIC ZERO SUPPRESSION. TIME BASE IS 1.0 SEC OR .1 SEC GATE WITH OPTIONAL 10 SEC GATE AVAILABLE. ACCURACY $\pm .001\%$, UTILIZES 10-MHz CRYSTAL 5 PPM.

COMPLETE KIT.....\$129

HAL-300A 7-DIGIT COUNTER WITH FREQUENCY RANGE OF ZERO TO 300 MHz. FEATURES TWO INPUTS: ONE FOR LOW FREQUENCY AND ONE FOR HIGH FREQUENCY; AUTOMATIC ZERO SUPPRESSION. TIME BASE IS 1.0 SEC OR .1 SEC GATE WITH OPTIONAL 10 SEC GATE AVAILABLE. ACCURACY $\pm .001\%$, UTILIZES 10-MHz CRYSTAL 5 PPM.

COMPLETE KIT.....\$109

HAL-50A 8-DIGIT COUNTER WITH FREQUENCY RANGE OF ZERO TO 50 MHz OR BETTER. AUTOMATIC DECIMAL POINT, ZERO SUPPRESSION UPON DEMAND. FEATURES TWO INPUTS: ONE FOR LOW FREQUENCY INPUT, AND ONE ON PANEL FOR USE WITH ANY INTERNALLY MOUNTED HALTRONIX PRE-SCALER FOR WHICH PROVISIONS HAVE ALREADY BEEN MADE. 1.0 SEC AND .1 SEC TIME GATES. ACCURACY $\pm .001\%$. UTILIZES 10-MHz CRYSTAL 5 PPM.

COMPLETE KIT.....\$109

ATTENTION RADIO CLUBS For club or group projects, request FREE information about our DISCOUNTS on any of the HAL-TRONIX kits. Discounts range from 10-25%, depending upon the quantity needed.

We are experienced in supplying kits in volume quantities to schools, laboratories, clubs, and common-interest groups. Nobody beats HAL-TRONIX quality and price. Just try us and see for yourself.



FROM
HAL-TRONIX

DELUXE 12-BUTTON TOUCHTONE ENCODER KIT utilizing the new ICM 7206 chip. Provides both VISUAL AND AUDIO indications! Comes with its own two-tone anodized aluminum cabinet. Measures only 2 3/4" x 3 3/4". Complete with Touch-Tone pad, board, crystal, chip and all necessary components to finish the kit.

PRICED AT.....\$29.95

For those who wish to mount the encoder in a hand-held unit, the PC board measures only 9/16" x 1 3/4". This partial kit with PC board, crystal, chip and components.

PRICED AT.....\$14.95

PRE-SCALER KITS

HAL 300 PRE.....\$19.95
(Pre-drilled G10 board and all components)

HAL 300 A/PRE.....\$24.95
(Same as above with preamp)

HAL 600 PRE.....\$34.95
(Pre-drilled G10 board and all components)

HAL 600 A/PRE.....\$39.95
(Same as above but with preamp)

ACCUKEYER (KIT) THIS ACCUKEYER IS A REVISED VERSION OF THE VERY POPULAR WB4VVF ACCUKEYER ORIGINALLY DESCRIBED BY JAMES GARRETT, IN QST MAGAZINE AND THE 1975 RADIO AMATEURS HANDBOOK. \$16.95

ACCUKEYER—MEMORY OPTION KIT THIS ACCUKEYER MEMORY KIT PROVIDES A SIMPLE, LOW COST METHOD OF ADDING MEMORY CAPABILITY TO THE WB4VVF ACCUKEYER. WHILE DESIGNED FOR DIRECT ATTACHMENT TO THE ABOVE ACCUKEYER, IT CAN ALSO BE ATTACHED TO ANY STANDARD ACCUKEYER BOARD WITH LITTLE DIFFICULTY. \$16.95

SHIPPING INFORMATION

ORDERS OVER \$15.00 WILL BE SHIPPED POSTPAID EXCEPT ON ITEMS WHERE ADDITIONAL CHARGES ARE REQUESTED. ON ORDERS LESS THAN \$15.00 PLEASE INCLUDE ADDITIONAL \$1.00 FOR HANDLING AND MAILING CHARGES. SEND SASE FOR FREE FLYER.



"HAL" HAROLD C. NOWLAND
WBZXH

HAL-TRONIX ✓H24

P. O. BOX 1101
SOUTHGATE, MICH. 48195
PHONE (313) 285-1782

SF

S-f Amateur Radio Services

(213) 837-4870

4384 KEYSTONE AVE., CULVER CITY, CA. 90230

the **W6TOG***

✓S33

RECEIVER MODIFICATION KITS

INCREASE SELECTIVITY • IMPROVE SENSITIVITY
LOWER INTERNAL NOISE

IMPROVE NOISE BLANKER OPERATION

COMBAT BLOCKING FROM LOCAL SIGNALS

TS-520 KIT	\$27.50	FT-101 SERIES KIT ...	\$32.50
TS-520S KIT	32.50	FR-101 SERIES KIT ...	34.50
TS-820 & 820S KIT ...	34.50	FT-301 SERIES KIT ...	34.50
R-599 A/D KIT	27.50	FT-901 SERIES KIT ...	34.50

EXPLICIT INSTRUCTIONS MAKE MODIFICATION A CINCH

IT'S MAGIC...

IT'S "MAGICOM"

PROCESSOR MODIFICATION KIT

IMPROVES AUDIO PUNCH

IMPROVES PROCESSED SPEECH QUALITY

Converts TS-820 / 820S speech processor from RF compressor to RF clipper \$27.50

RF speech processor for TS-520 / 520S \$42.50

The "MAGICOM" RF processor module provides up to 6dB increase in output with smooth, clean, non-distorted audio and more penetration for those pile-ups.

ENDORSED BY W6TOG AND BIG GUN DXers WORLD WIDE

the **W6TOG***

INTERNAL ELECTRONIC KEYS

FOR ALL AMATEUR TRANSMITTERS OR
TRANSCEIVERS USING GRID BLOCK KEYING

- No holes mounting with TS-820 Series
- Mounting options for TS-520, TS-520S, FT-101 Series, TR4 Series, T4X Series, T-599 Series and 32S Series.
- C-MOS DESIGN — Dot and dash memory — full iambic or manual operation.
- Simple installation \$49.50

THE S-F REJEKTOR FILTER

AN INTEGRATED CIRCUIT
ACTIVE BANDPASS FILTER
FOR PROCESSED RECEIVER AUDIO

- Separate active filter elements for CW and SSB audio output stage
- 8 ohm input and output impedance
- Headphone jack for convenience
- ON CW: from 500 hz to 100 hz, variable
 - ON SSB: 2 KHz fixed bandwidth
- Rejects unwanted signal better than 60 dB
 - Designed for today's transceivers or yesterday's older equipment \$49.50

*WELL KNOWN DXer WITH OVER 300 COUNTRIES CONFIRMED.

All prices postpaid - in Calif. add 6% sales tax - Mastercharge & Visa accepted
SATISFACTION GUARANTEED OR MONEY REFUNDED

SCR 1000

The Repeater of Your Dreams!

Available With Optional Features You've Only Dreamed About! Like -

- Full Autopatch, with or without reverse patch and "Landline" or Radio Remote Control of the Repeater.
- Radio and/or Landline TouchTone™ Remote Control of such repeater functions as HI/LO Power; Patch Inhibit/Reset; Switch ID Tracks; Repeater ON/OFF; PL ON/OFF, etc.
- 65 Wt. Transmitter!
- "PL"-CTCSS, HI/LO Pwr.; Multi-Freq.; Up to 4 different IDs; Automatic switching to "Emergency Power ID" when on battery pwr.
- Ultra-sharp 10 Pole Xtal Filter; Xmtr. Xtal oven—for the "ultimate" in stability.
- Timeout—Timer Reset Tone Annunciator
- And many other "custom-designed" options per your request—such as auxiliary receivers, radio links, etc. Please Inquire.

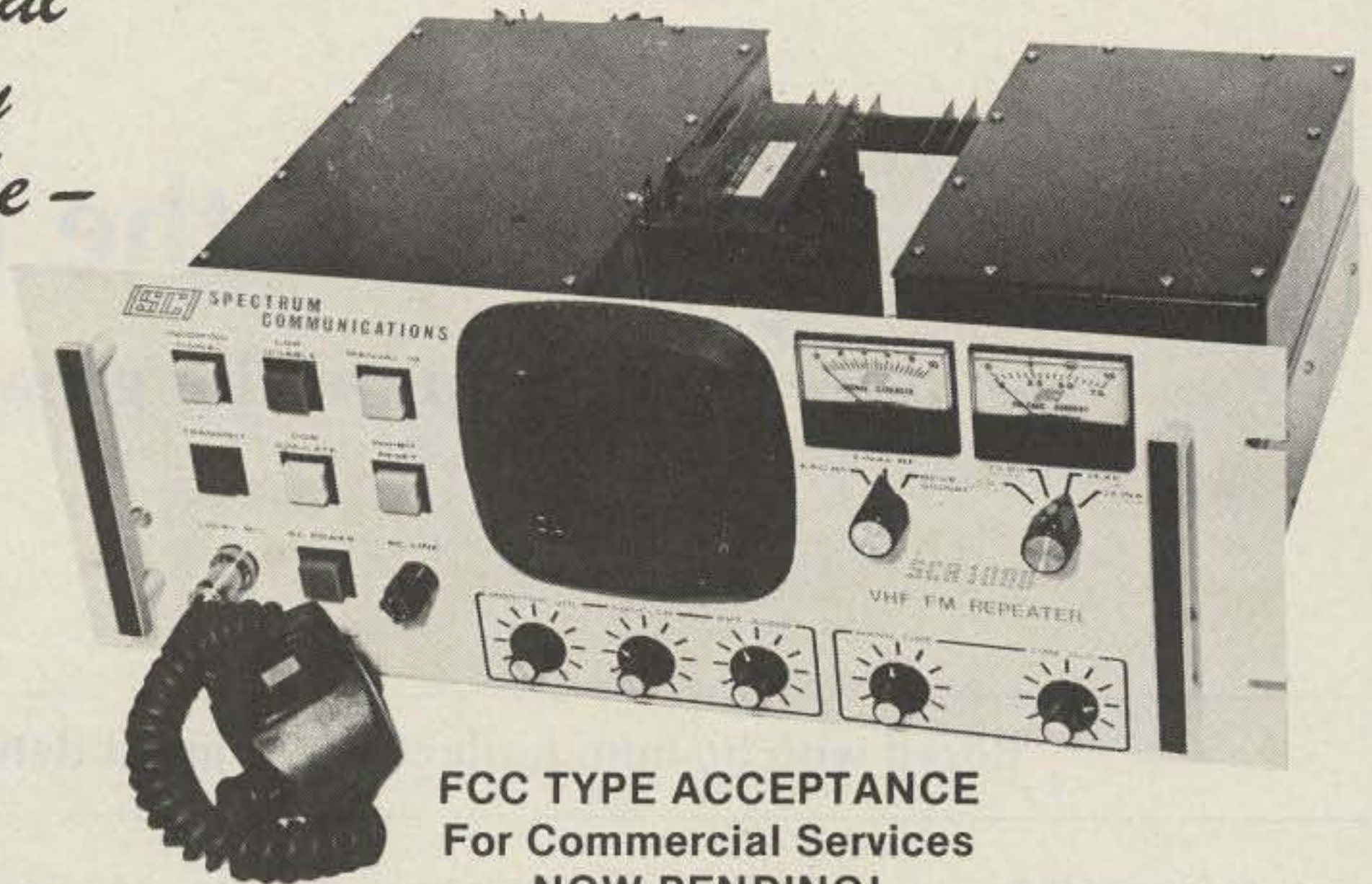

**FCC TYPE ACCEPTANCE
For Commercial Services
NOW PENDING!**

**2Mtr. & 220 MHz
(450 MHz Soon!)**



Rear chassis view of repeater with "RX & TX Assy."

Along with a complete line of Repeater System Accessories... such as: The Finest Duplexers, Cavities, Cabinets from 7" to 7', Antennas, "Hardline," Cables, etc.

The SCR1000—simply the finest repeater available on the market—absolutely TOP QUALITY throughout... and often compared to (lesser featured) units selling for 2-3 times the price! This is a 30 Wt. unit, with a very sensitive & selective receiver. Included is a built-in AC Supply, NEW Expanded Memory CW IDer, full metering and lighted status indicators/control push-buttons, crystals, local mic, etc.

Join the hundreds of very pleased Spec Comm customers world-wide who are using our gear—knowledgeable Amateur Radio groups, Commercial 2X Radio users, Military & Government Agencies, Red Cross, Universities, etc.

So, make your dream a reality... Call or write Spec Comm today! Give us all of your repeater system requirements—whether modest... or "Super Deluxe," and let us send you a quote.

The Spec Comm Repeater System... a sound, long-term investment—for those who demand the finest! Available only by direct factory order. Get your order in A.S.A.P.!

SCR 1000 Specifications

RF Output... 30 Watts typ.
Infinite VSWR proof
Sensitivity... 0.3uV/20dB Qt.
Selectivity-6dB @ ±6.5 kHz;
-75dB @ ±15 kHz;
-100dB @ ±30 kHz.
Includes 8 Pole Xtal Filt.
Sharper 10 Pole Filt.
Available.)

FEATURES

- Full Metering of critical levels.
- Front Panel Controls for timers & AF levels.
- Lighted push-buttons for control/test functions & status indicators
- State of the Art CMOS control logic & timers—No Relays!

- Exclusive Spec Comm MOS-FET/Hot Carrier Diode rcvr. front end—reduces "dense" & IM problems!
- Built-in AC Supply w/instant btry. switchover for emergency pwr.
- Supplied with ±.0005% precision xtals, local mic., & FL-6 Preselector.
- Built-in CW IDer—Low current draw, 250 bit PROM Memory! Adjustable speed, pitch, time, etc.
- Jacks Provided for Remote Control, Auto-Patch, DC out, AF in/out, COR Switch, etc.
- True FM—For Rpt. Audio so good, it "sounds like direct"!

Mobile/Portable/Base Transceivers also available! 5-25 Wt.; 2, 6, & 12 Chan.; 2M 220 MHz. Now in use in many Professional Communications Systems throughout the world! Write or call for further info.



180 DAY WARRANTY

SPEC-COMM REPEATER BOARDS, SUB-ASSEMBLIES & ACCESSORIES

**2M
&
220
MHz!**

- FL-6 Preselector. Rcvr. Front-End Filter/Preamp. Exc. rejection of strong "out of band" sigs. -60dB @ ±6 MHz \$85.00
- SCR100 Receiver Board. w/ xtal \$125.00
(9 Pole IF Filter + \$15.00)
(10 Pole IF Filter + \$25.00)
- SCR100 Receiver Assembly. SCR100 mounted in shielded housing..... \$195.00
- SCT110 Xmtr./Exciter Bd. 7 or 10 Wt. bd. \$135.00 w/xtal. BA-10 30 Wt. Amp. bd. & Ht. Sink..... \$51.95
- SCT110 Transmitter Assembly. SCT110 mounted in shielded housing.... \$199.95 (30 Wt. Amp. + \$68.00)
- CTC100 COR/Timer/Control Bd. \$35.00
- ID250 CW ID/AF Mixer Bd. Programmed \$65.00
- SCAP Autopatch Bd. \$225.00
- RPCM "Reverse Patch" & control bd. \$79.95
- TTC100 Touch Tone Control bd. 3 digit ON, 3 digit OFF..... \$85.00
- TRA-1 Timer Reset Annunciator Bd. \$20.95
- WP641 Duplexer. \$495.00

(Add \$3.75 ship/handling. PA residents add 6% tax.)

Send for Data Sheets!

See our December 73 Ad for more details!

EXPORT ORDERS—CONTACT HERE IN OUR INTERNATIONAL DEPARTMENT



SPECTRUM COMMUNICATIONS

1055 W. Germantown Pk., Norristown PA 19401 (215) 631-1710

Diodes of the Dead

— eavesdrop on the great beyond

Bored with ho-hum projects? This ghost detector will spook you!

Si Dunn K5JRN
3607 Binkley
Dallas TX 75205

Recently, in a Dallas bookstore, some eerie pink words suddenly glowed at me from shelves of psychic phenomena books: *Break Through—Electronic Communication With the Dead May Be Possible!*

In seconds, I was mesmerized. I paid \$2.25 plus tax and rushed home with my very own copy of Konstantin Raudive's "amazing study (more pink words on the cover) that reveals how tape recordings can suddenly become the medium for voices from the dead!"

You see, all you really need to eavesdrop on the conversations of the spirits, the good Latvian Dr. Raudive claims, is a tape recorder, supplemented—if you really want to get fancy—by a small handful of electronic parts obtainable from almost any Radio Shack or ham's junk box.

Here, at long last, was a psychic challenge I couldn't resist. I don't have much extrasensory perception (ESP), and I've never bent any keys or spoons with my brain. But I do

have a well-used Sony tape recorder and 24 years experience with radio parts and soldering guns. And I found, in my closet junk box, the parts to duplicate most of the psychic listening devices diagrammed in Raudive's treatise, recently imported to the American paperback market from the darkest corners of mysterious Europe.

In *Break Through*, Raudive describes three extremely simple techniques that he claims will record the voices of the dead and their messages from "beyond." And he includes transcripts—translated from Latvian, German, Russian and Swedish—of ghostly conversations that allegedly showed up on blank tapes.

In method one, you connect a sensitive microphone to your tape recorder, insert a blank tape, politely ask some of the dead-and-gone to speak to you, and sit quietly in your living room or ham shack. After a few minutes, you play back the tape and listen carefully for any messages.

It might help, incidentally, to be fluent in several tongues, since, Dr. Raudive claims, the spirits "speak in

an unmistakable rhythm and usually employ several languages in one sentence; the sentence construction obeys rules that differ radically from ordinary speech... (and) identification of the voices is... often a remarkably difficult task."

In method two, you tune an AM radio to a frequency clear of rock 'n roll and other earthly interferences and place the tape recorder's microphone near the radio's speaker. A clear channel in the vicinity of 200 meters (1500 kilohertz) is recommended, since this seems to be a medium wavelength favored by ghosts in Europe.

I elected, however, to go first to method three, the exotic "diode-recording" technique, because it requires a few radio parts, and the quality of the voices received from beyond, Dr. Raudive promises, is "nearest to those of ordinary human ones."

Curiously, the device I wired from Dr. Raudive's schematic looks exactly like a crystal radio, the kind I constructed from Cub Scout handbooks when I was a pre-Novice of 10. The only significant differences include the use of

a diode instead of a cat's whisker and hunk of galena and an antenna limited to no more than about three inches, instead of the traditional 100 feet.

Still, I didn't let suspicion stand in the way of experimentation. In science, anything is possible. If the dead want to address the living over crystal radios, I'll sure as heck listen.

As I soldered the last connections and readied my tape recorder, I considered the immense possibilities. Suppose I eavesdropped on a bitter argument between Babe Ruth and Plato? What if I received, live and direct from Franz Schubert, the finish to his *Unfinished Symphony*?

I might even hear the confused cries of all the souls lost in the Bermuda Triangle, if the skip was right. I would be able to write a new book: *Diodes of the Dead! Eavesdropping On Eternity With A Crystal Radio!* And while it sold millions from coast to coast, the *National Enquirer* would print excerpts and an interview, and movie producers would come to me in parades of limousines.

Raudive recommends taping for no more than 10

or 15 minutes at a time because "examination of voices received may take several hours."

Turning on the recorder, I felt my excitement sharpen as I read that "children and people with a musically trained ear have least difficulty in following the voices; military-trained radio operators achieve a high degree of accuracy, and, for some unknown reason, specialists of internal medicine and Catholic priests also seem to be able to discern the voices with relative success."

I'm no doctor or priest, but I can play a harmonica by ear. I was a Navy radio operator, and now I hold an Extra Class ham license. And some of my friends might argue that, at age 34, I'm still a bit of the old child. With qualifications like these, I might not even need a crystal radio to hear

Raudive's "voices."

The first 10-minute taping seemed to last forever. I carefully straightened the three-inch whip, tapped the tiny 1N914 diode and imagined all types of conversations flowing smoothly onto the tape. Ernest Hemingway might even offer from beyond to help me write, if I—in this world—would ghost his next novel.

Time at last to decode the first offerings from infinity, the dialogues of the dead, the jokes, the lessons, the exhortations from eternity. I rewound the tape and turned my ear expectantly to the first snaps, crackles, and pops emanating from the loudspeaker.

Nothing. Absolutely nothing but the electromagnetic void. Not even a static crash or whisper.

Desperately, I rechecked the wiring, rewound the tape, tried new tapes and methods one and two. But

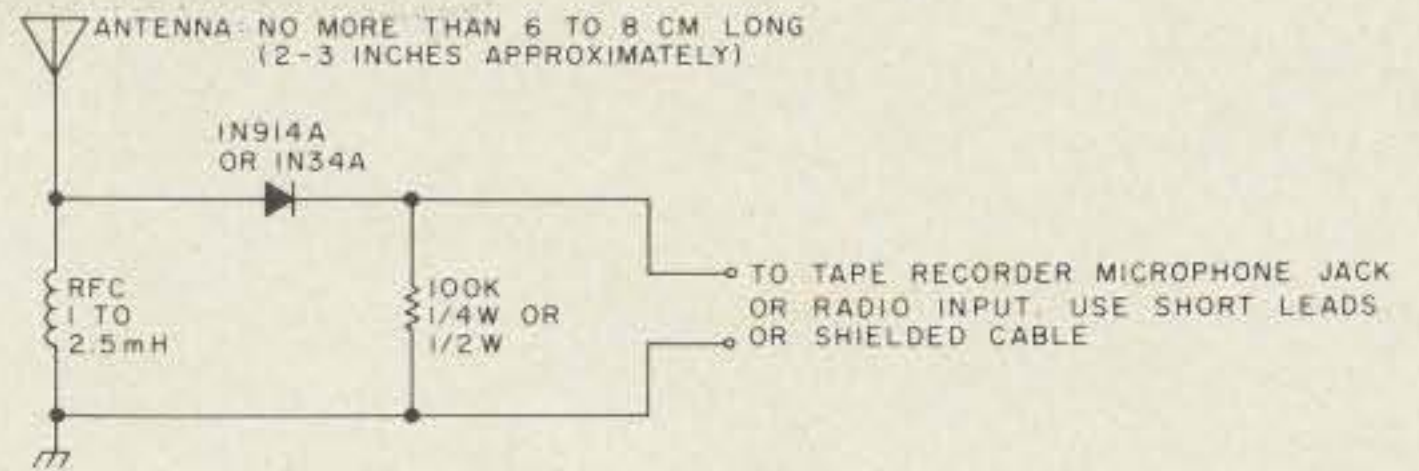

Fig. 1. Simple (too simple?) "voices of the dead" detector.

hour after hour, I heard nothing except the steady hissing of cheap cassettes and periodic moans and groans from the Sony's worn gears. At one point, the recorder stopped, as if seized suddenly by an unseen power. But it was only the batteries signaling that they were dead.

Sadly, I cast from my mind the outline for my best-seller. I threw Dr. Raudive's book into the pile to be sold soon at a used book store. But before I pitched the ghost detector into my junkbox, I hooked it to a 100-foot antenna and tried one

more taping.

Voices poured forth in a babble: news, weather, sports, music. Just as I had suspected, I had not found the Bermuda Triangle, but I had reinvented the crystal radio.

The ghosts of the world probably laughed when I sat down at my typewriter and confessed: "Writer fails to communicate with dead despite explicit instructions." But ask me if I care. The *National Enquirer* probably will call me anyway, and I think I hear a movie producer's limousine pulling into my driveway right now . . . ■

NEW MFJ Dual Tunable SSB/CW filter

lets you zero in SSB/CW signal and notch out interfering signal at the same time.

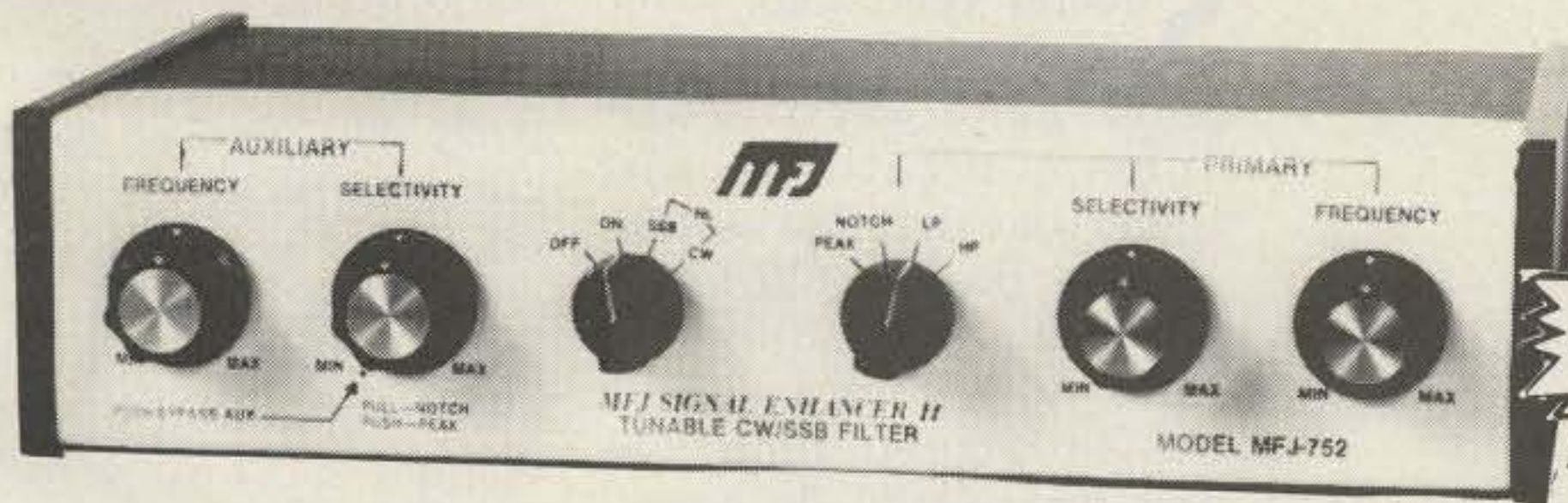

**Ham Radio's
Most Versatile Filter**

**BRAND
NEW**

\$79⁹⁵

The MFJ-752 Signal Enhancer is a dual tunable SSB/CW active filter system that gives you signal processing performance and flexibility that others can't match.

For example, you can select the optimum Primary Filter mode for an SSB signal, zero in with the frequency control and adjust the bandwidth for best response. Then with the Auxiliary Filter notch out an interfering heterodyne . . . or peak the desired signal.

For CW, peak both Primary and Auxiliary Filters for narrow bandwidth to give skirt selectivity that others can't touch. Or use Auxiliary Filter to notch out a nearby QSO.

The Primary Filter lets you peak, notch, low-pass, or highpass signals with double tuned filter for extra steep skirts. The Auxiliary Filter lets you notch a signal to 70 db. Or peak one with a bandwidth down to 40 Hz.

Tune both Primary and Auxiliary Filters from

300 to 3000 Hz. Vary the bandwidth from 40 Hz to almost flat. Notch depth to 70 db.

MFJ has solved problems that plague other tunable filters to give you a constant output as a bandwidth is varied. And a linear frequency control. And a notch filter that is tighter and smoother for a more effective notch.

Works with any rig. Plugs into phone jack. 2 watts for speaker. Inputs for 2 rigs.

Switchable noise limiter for impulse noise; trough clipper removes background noise.

Simulated stereo feature for CW lets ears and brain reject QRM. Yet off frequency calls can be heard.

Speaker and phone jacks. Speaker is disabled by phones. OFF bypasses filter. 110 VAC or 9 to 18 VDC, 300 ma. 10x2x6 inches.

Every single unit is tested for performance and inspected for quality. Solid American construction, quality components.

The MFJ-752 carries a full one year unconditional guarantee.

Order from MFJ and try it — no obligation. If not delighted, return it within 30 days for a refund (less shipping).

To order, simply call us toll free 800-647-1800 and charge it on your VISA or Master Charge or mail us a check or money order for \$79.95 plus \$3.00 for shipping/handling.

Don't wait any longer to use Ham Radio's most versatile filter. Order your MFJ Dual Tunable SSB/CW Filter at no obligation, today. ✓M52

MFJ ENTERPRISES, INC.
P. O. BOX 494
MISSISSIPPI STATE, MS 39762
CALL TOLL FREE . . . 800-647-1800
For technical information, order/repair status, in Miss., outside continental USA, call 601-323-5869.

Building an Economy Receiver

—junk box, here I come!

Broken radios and TVs are the mother lode for this project.

Tom McLaughlin WB4NEX
132 Bay Point Dr. NE
St. Petersburg FL 33704

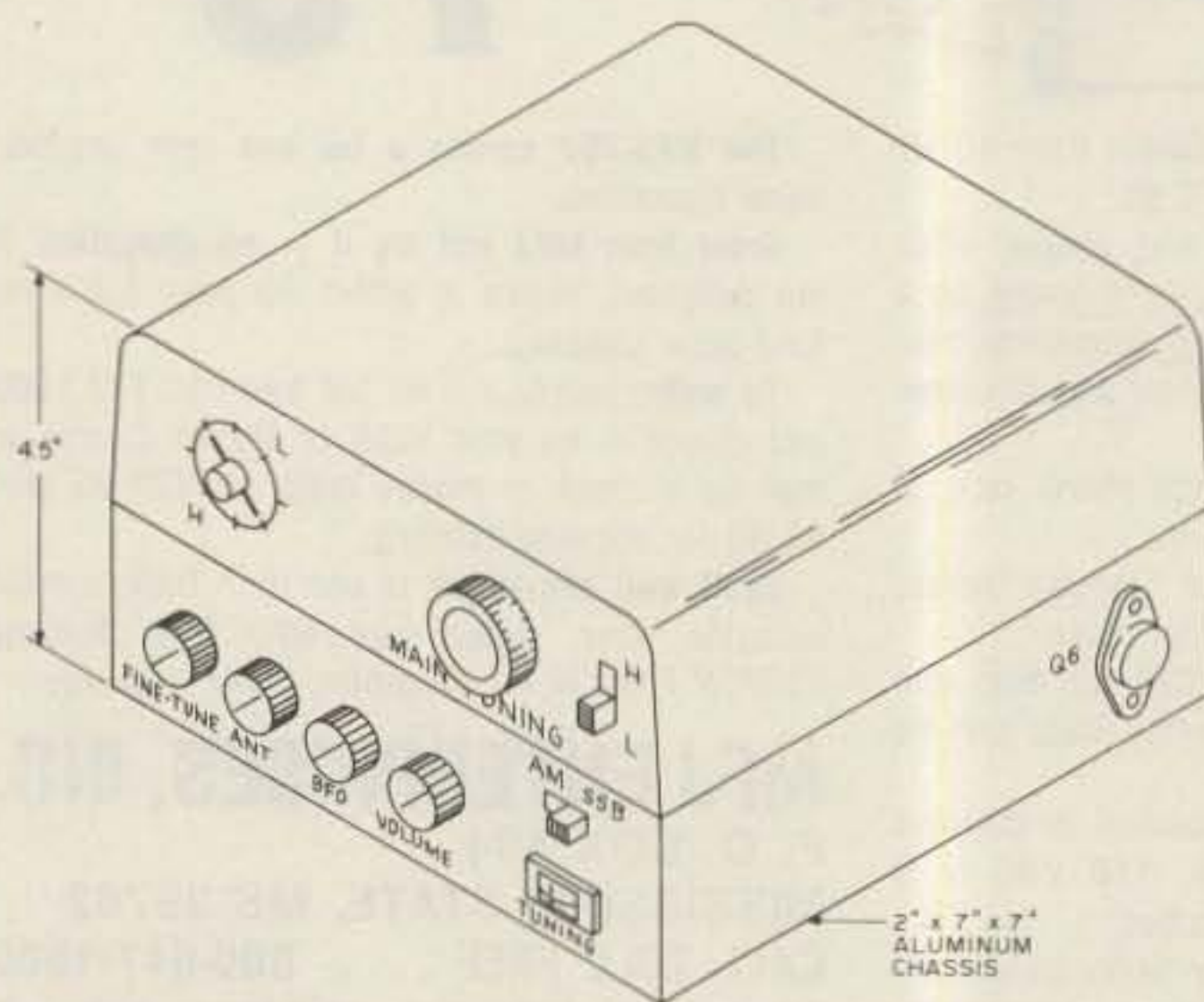

Fig. 1. Isometric view of the 6-15 MHz receiver.

Several years ago, I decided that I needed a good general-coverage "communications" receiver, one that had switchable bandwidth, CW filter, i-f and rf gain controls, etc. After looking for a while, I bought a used tube-type unit that would do everything except tune itself... ha.

I remember three or four occasions when I tuned the receiver to an AM broadcast station after warm-up, only to return a couple of hours later to find that the beast had moved itself up near the next station on the dial. This, of course, was an electronic and not a mechanical phenomenon and afflicted all bands. I worked on it for several months, but never did discover what was causing

the drifting.

After having been properly educated in general-coverage receivers, I decided that I would look for something cheaper, something that offered less chance of getting burned. I wanted a fairly sensitive transistor unit, good selectivity, bfo for receiving SSB, and coverage of international shortwave and 20 and 40 meters; all this should be for less than \$30 or so. I looked for quite a while. Obviously, I would have to build one myself.

Then along came the December, 1977, issue of 73, and in it was the article "Build A Useful HF Receiver." Essentially, that was the basis of my receiver, although I have greatly expanded and mod-

ified the circuit. My design uses a 120 V ac supply, bfo, adjustable i-f gain, and tuning meter; it can be modified to suit any particular need. The tuning range is limited only by personal preference and coil-winding ability. Even without going to extremes, there is less than 100-cycle drift after a twenty-minute warm-up, and adjacent channel rejection is good. You may want to add more tuned circuits in the rf section to improve image rejection, but, for my purposes, the circuit as shown is more than adequate.

Most of the components can be salvaged from broken radio and TV sets; the whole setup is based on using readily available stuff in order to keep the cost down. For example, I used the power transformer from a 12" black and white transistor TV I found in someone's garbage, the main tuning capacitor from an AM radio, some transistors from the AFT board out of a color TV, and the tuning meter from a smashed tape recorder. I had some pieces of scrap vectorboard which I used to make the subassemblies. After they were all working, I installed them in the chassis.

Rf Section

An NPN rf transistor, Q1, is used to isolate the antenna from the mixer stage; the NE-2 bulb is added to absorb any static discharges from the antenna. An FM trap and a 2 MHz high-pass filter are used to eliminate spurious signals. I recommend using these additions because of the high gain provided by IC1. Several high-power AM and FM transmitters nearby caused problems without the filtering. C6 on the FM trap should be adjusted to null out any FM stations coming through after the receiver is working.

Rf chokes for the 2 MHz

filter can very easily be obtained from a color TV; loads of them are used in the color circuitry. The coding is like resistors', except that two or three dots of color indicate the inductance as follows:

green + blue = 56 μ H
 red + black + brown = 200 μ H
 yellow + violet + white = 4.7 μ H.

I-f and Audio Section

The mixer stage is a dual-gate diode-protected MOSFET, Q2, followed by a Miller 8901-B 455 kHz i-f transformer. Oscillator injection is provided by the vfo which supplies about 1/2 to 1 volt rms. Although the Miller 8901-B is supposed to be followed directly by the 8902-B amplifier module, I decided to add a differential IC i-f amp, IC1, between the two in order to improve the sen-

- C1
- C2, C4
- C3
- C5, C6
- C7, C9
- C8, C10
- IC1
- IC2
- L_L
- L_H
- L_{OL}
- L_{OH}
- L_B
- Q1, Q3, Q4, Q5
- Q2
- Q6
- D1, D2
- ZD1, ZD2
- ZD3
- S1
- S2
- T1

Parts List

- AM BCB variable capacitor, air dielectric; (a) antenna section, 10-365 pF; (b) oscillator section, 7-115 pF
- variable capacitor, 5-50 pF (approximately) air dielectric
- variable capacitor, 1-7 pF (approximately), air dielectric; use one rotor and one stator plate, adjust spacing for desired tuning range.
- ceramic trimmer capacitor, 8-50 pF, N750
- ceramic trimmer capacitor, 5-25 pF, NPO
- ceramic trimmer capacitor, 3-12 pF, NPO
- CA3028A differential rf/i-f amp
- MC1306P integrated audio amp/preamp
- 14 turns #22 enamel wire closewound on 1/2" diameter slug-tuned form, red slug; tap at 1 1/4 turns from ground end
- 6 turns #22 enamel wire closewound on 1/2" diameter slug-tuned form, red slug; tap at 1 1/4 turns from ground end
- 31 turns #30 enamel wire closewound on 1/4" diameter slug-tuned form, red slug
- 14 turns #30 enamel wire closewound on 1/4" diameter slug-tuned form, red slug
- AM BCB tube-type radio oscillator coil
- 2N4124 silicon NPN rf transistor (or equivalent); many types will work
- 40673 dual-gate MOSFET, gate protected
- NPN power transistor, 10 Watts or more
- 1 Amp, 100 piv silicon rectifier diodes
- 8.2-volt, 1-Watt silicon zener diode
- 10.0-volt, 1-Watt silicon zener diode
- three-pole, two-position slide switch
- DPDT slide switch
- power transformer, 120 V ac primary; 35 V ac, .5-Amp secondary, c-t. (can also use 24 V ac).

8901-B and 8902-B i-f units, 455 kHz, made by J. W. Miller Co., Los Angeles.

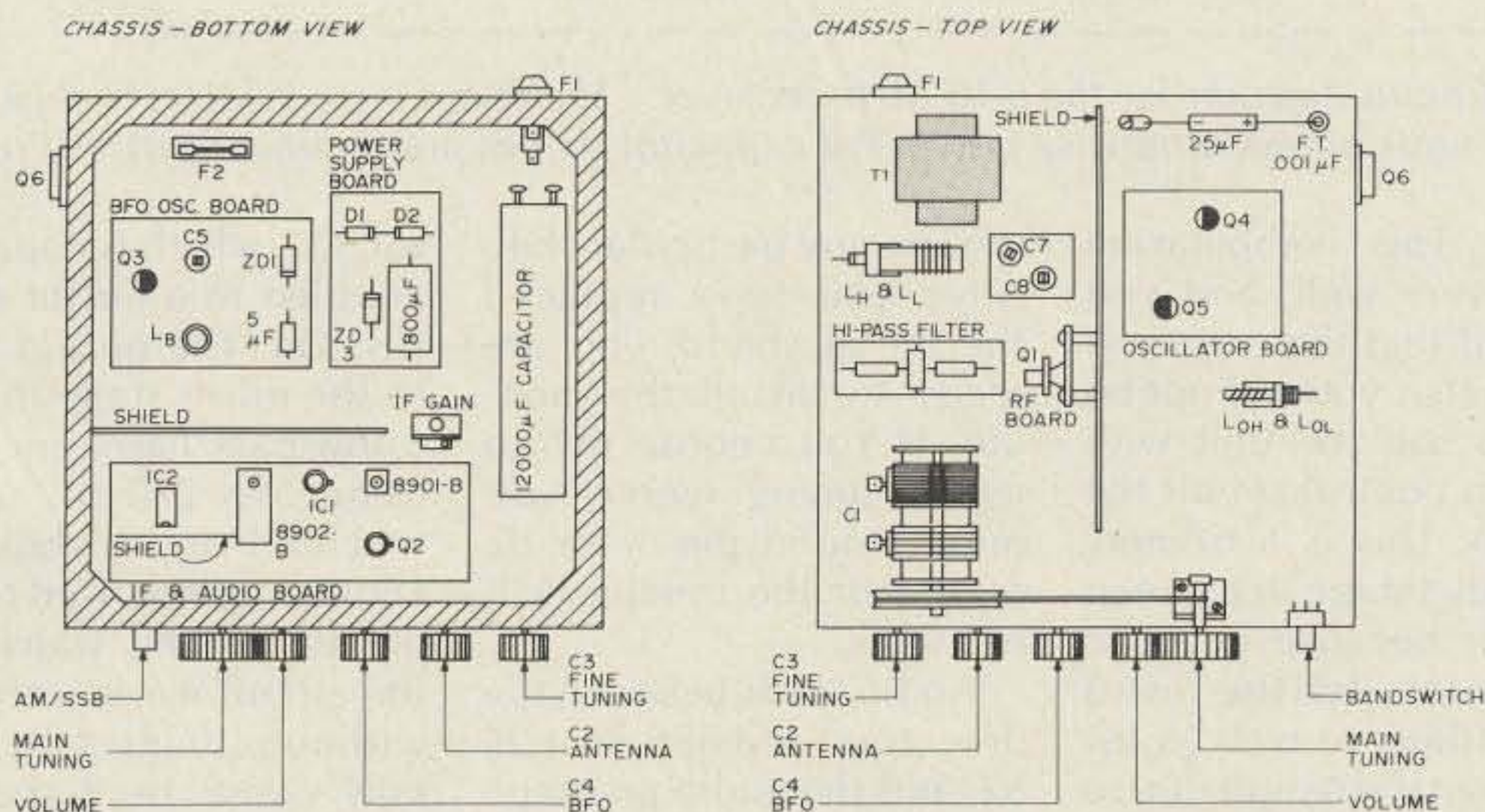

Fig. 2. Chassis and circuit board layout and component placement.

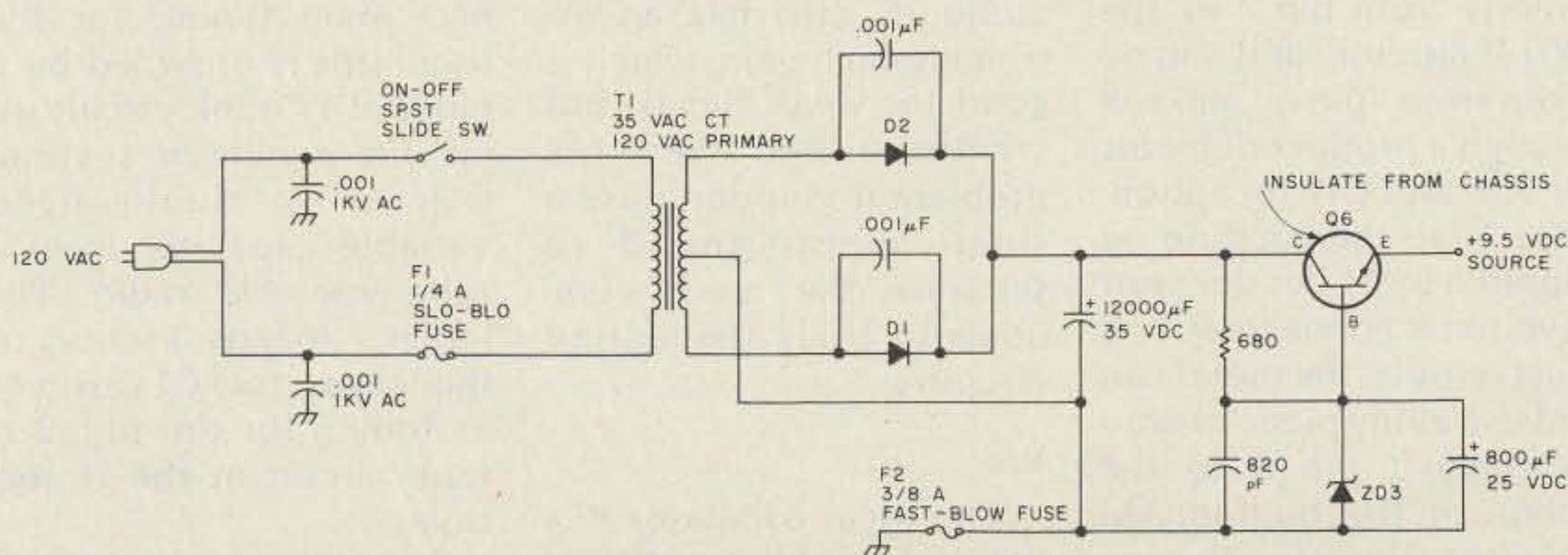

Fig. 3. +9.5-volt dc supply.

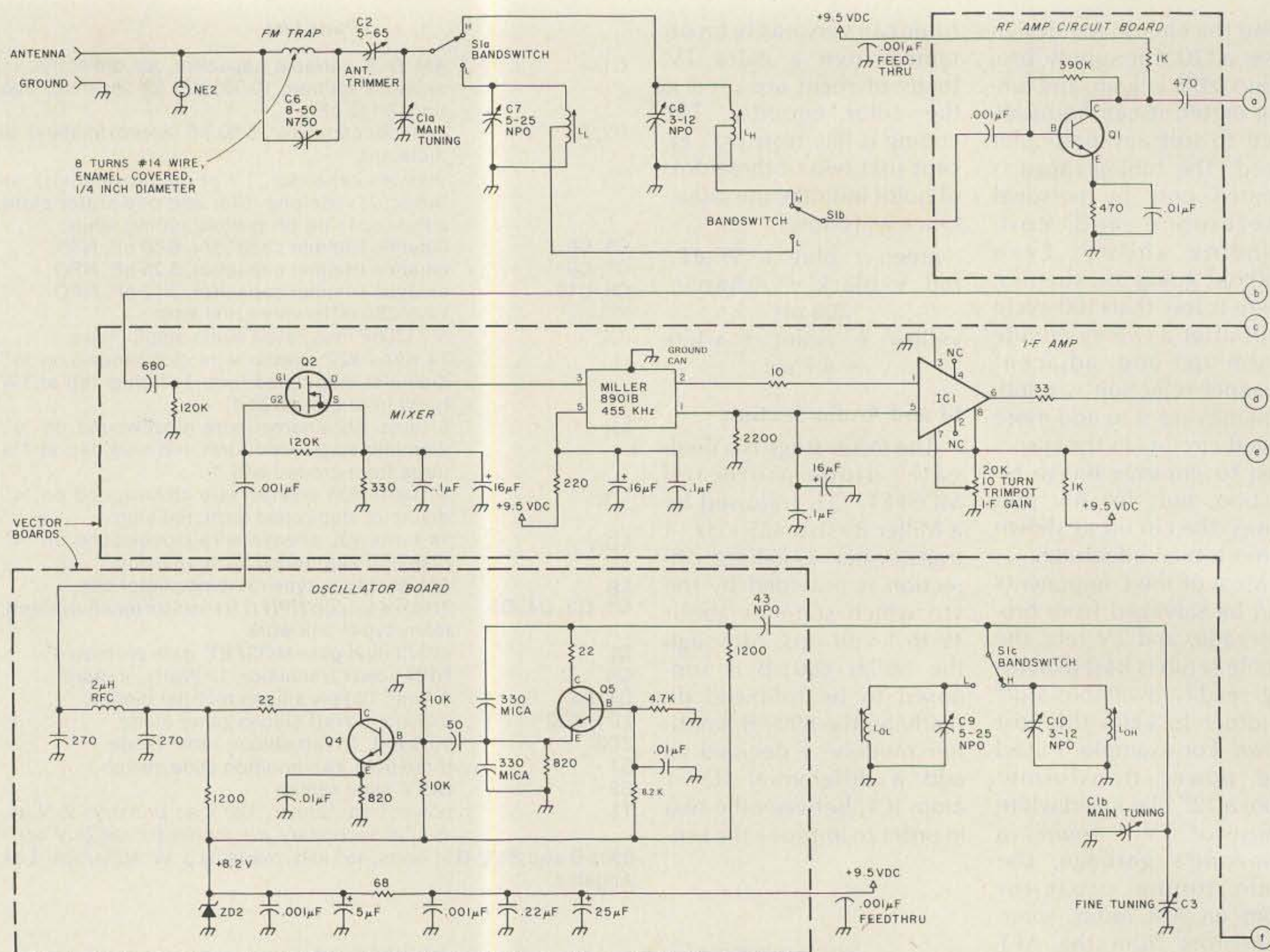

Fig. 4. Circuit diagram for the 6-15 MHz receiver. * See text. $L = 6-9$ MHz; $H = 9-15$ MHz. Electrolytic capacitors are 25-volt units unless otherwise noted. All capacitor values are in picofarads. All resistors are $\frac{1}{2}$ -Watt, 10% tolerance.

sitivity. This combination works very well, and you will find that the i-f gain is so high that you will not be able to use the unit with the gain control set all the way up. This is a tremendous advantage in a cheap receiver because you can compensate for the losses in the filters as well as for weak signal strength due to a lousy antenna.

Audio can be taken directly from pin 7 of the 8902-B module, or it can be taken from "pin 8" and run through a product detector for SSB and CW reception. Note that the module as supplied by Miller does not have pin 8 connected. You must remove the metal can and use a tiny piece of wire to connect pin 8 to the anode of the built-in AM detector. This is a very simple operation and does not

require any particular skill. After you have replaced the metal shield, you are ready to install the module. If you choose not to use a tuning meter, you must ground pin 5 for dc return, or the module will not work.

Audio leads between the detectors, AM-SSB switch, S2, and the audio preamp/amp, IC2, should be kept as short as possible. The audio IC also has an extremely high gain, which is good for weak signals but creates a bad feedback problem if you don't use a small metal shield to separate the input components from the output circuitry.

Vfo

The local oscillator is a two-stage setup consisting of a grounded-base oscilla-

tor, Q5, which is capacitor-coupled to a buffer amplifier, Q4. The output is fed to the mixer stage through a low-pass harmonic filter using two 270 pF capacitors and an rf choke. Rf chokes are not used to supply dc to the transistors; the circuit works very well without them and they may cause oscillation on two or more frequencies if they are used in this manner. Main tuning for the oscillator is provided by a parallel LC tank circuit using the oscillator section, C1_b, of a dual-ganged variable capacitor from a tube-type AM radio. The larger capacity section of this capacitor, C1_a, serves as tuning for the tuned rf tank circuit in the rf section.

It is important to use all the bypassing shown in the

diagram to keep rf out of the power supply and to keep audio from modulating the vfo. I had a good bit of trouble with this, and I finally eliminated all of it with the .22 uF and 25 uF capacitors in parallel across the feedthrough capacitor supplying dc to the vfo board.

Bfo

Good stability for sideband reception is provided by an NPN transistor in a Colpitts configuration. The oscillator coil, L_b, is from a tube-type AM radio oscillator circuit, also. You will have to pad this coil to get it down to 455 kHz. Two .003 uF disc ceramic capacitors connected as shown worked with the coil I used, but these may have to be altered slightly with other coils. The location of the

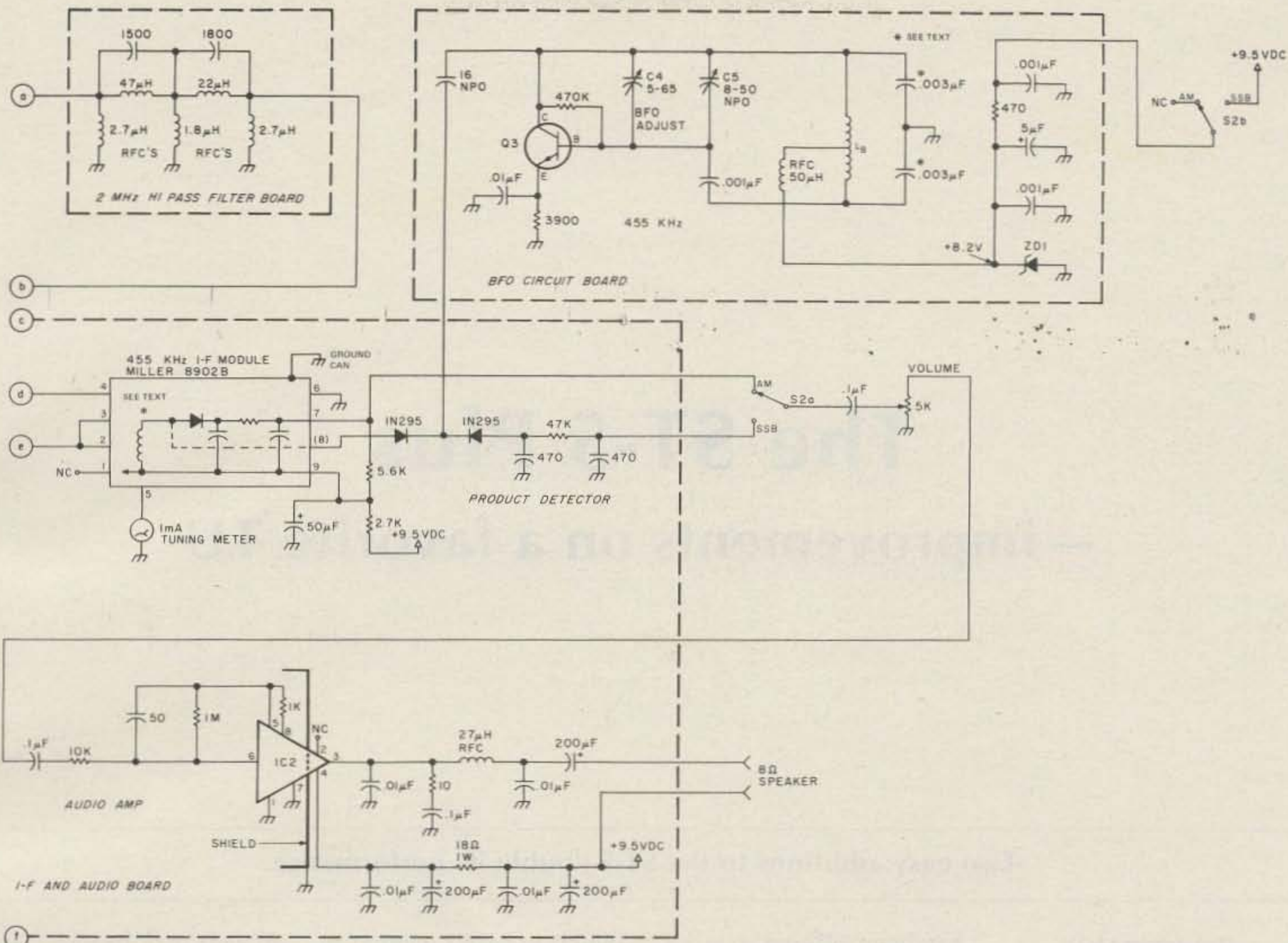

tap is not too critical because an rf choke is used here for dc feed. Once you have the oscillator working near 455 kHz, the bfo adjustment capacitor, C4, should be set to its midpoint and C5 should be adjusted so the oscillator frequency is at the center of the i-f bandpass. Then you can adjust C4 at the front panel for upper or lower

sideband.

Conclusion

Although this receiver is not a project for a beginner, it is really not complicated. A 15 MHz scope and a frequency counter were available to help get my unit working, but it is possible to finish up using only a high-Z voltmeter and rf probe, a general-purpose

rf generator, and a grid-dip meter. You can use the receiver i-f and audio sections to tell what the other stages are doing, so it's a good idea to make those sections first. Be sure to use all the electrolytic capacitors shown so there is no audio feedback through the power supply. Note that the stages are separated from each other ei-

ther by chassis placement or aluminum shields. ■

References

1. Edward M. Noll, *Second Class Radiotelephone License Handbook*, 1967 edition, p. 156.
2. *73 Magazine*, December, 1977, pp. 216-217.
3. *Ham Radio*, November, 1977, p. 14.
4. A.R.R.L., *Radio Amateur's Handbook*, 1969 ed., p. 191; 1977 ed., pp. 240, 278, 280.

«SWISS QUAD VHF SERIES»

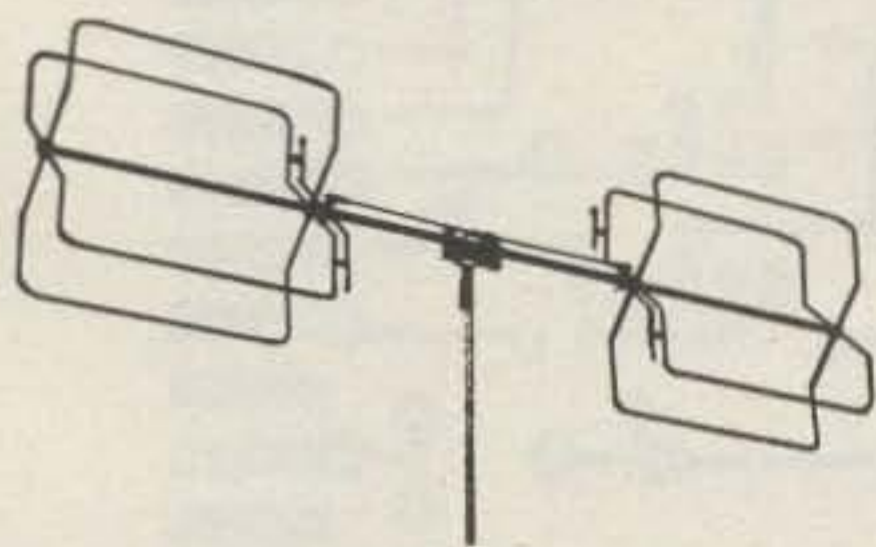

SO-22 TWO METER DUAL QUAD

ANTENNA GAIN AND FRONT-TO-BACK RATIO ARE WELL IMPROVED WHEN TWO ELEMENTS ARE DRIVEN AT ONE TIME WITH PHASE DIFFERENCE COMPARED TO A SINGLE DRIVEN ELEMENT SUCH AS A CONVENTIONAL QUAD OR YAGI. THE SO-22 PROVIDES THE OWNER WITH SUCH FEATURES. SIMPLE ASSEMBLY AND LIGHT WEIGHT.

THE 3F35DX BEAM IS FOR USE IN THE 10, 15 AND 20 METER AMATEUR BANDS. THIS IS A HIGH PERFORMANCE BEAM THAT MAKES USE OF A COMBINATION OF PARALLEL-FEED, FULL SIZE INDIVIDUAL DRIVEN ELEMENTS FOR EACH BAND. ALONG WITH THE USE OF HI-Q PARASITIC TRAPPED ELEMENTS. HIGH POWER RATING 3KW AND EXCELLENT VSWR ON EACH BAND.

WRITE OR CALL FOR PRICES AND INFORMATION.

DEALER INQUIRIES WELCOME

ALL ANTENNAS IN STOCK, FOB OKLAHOMA CITY, OKLA.

Multi Band Beam Super DX Series

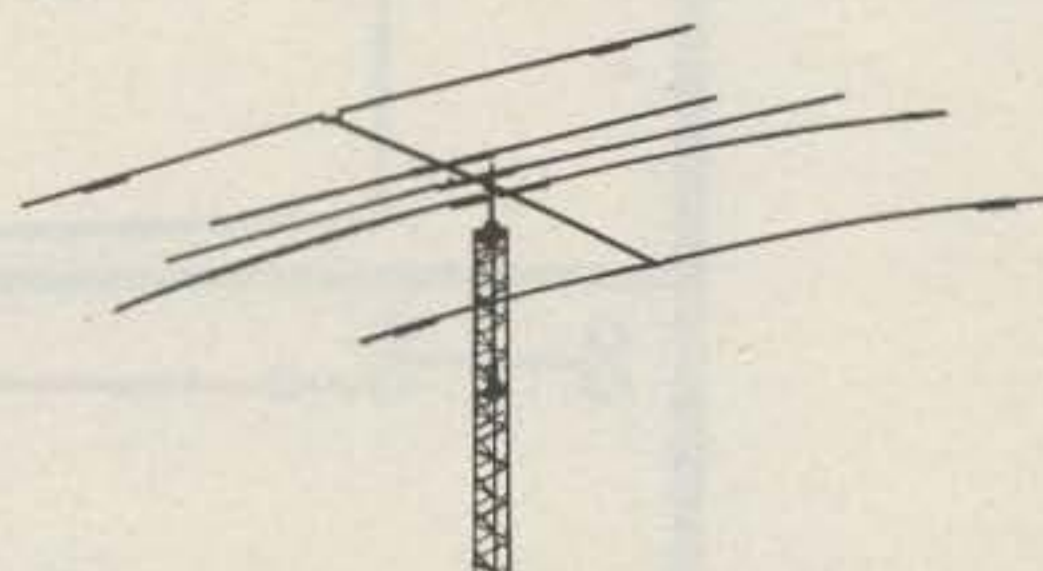

3F35DX MULTI BAND FIVE ELEMENT BEAM

BRODIE ELECTRONICS COMPANY

2537 Edgewood Drive
Moore, Oklahoma 73160
405-794-0406

✓ B42

The ST-5 Plus

— improvements on a favorite TU

Two easy additions to the ST-5 double its performance.

Dick Sander K5QY
110 Starlight Drive
Plano TX 75074

The ST-5 is a popular radioteletype (RTTY) terminal unit that has been around for a long time. It

has been offered as a kit, and many home brewers have built it from scratch. Unfortunately, I found that QRM on the HF bands easily wiped out the print on my ST-5. I made two modifications to improve its performance. First, I added a bandpass filter for 170 Hz shift (I included a bypass

switch in case I wanted to receive 850 Hz shift). The 170 Hz shift input filter is directly from the ST-6 terminal unit. Next, I added an automatic threshold detector which is described in *Ham Radio*, November, 1973 ("Variable Shift RTTY Terminal Unit," by K. Sueker W3VF). The im-

proved performance from these circuit modifications justifies the effort required to incorporate them.

To start, build the 170 Hz shift bandpass filter and automatic threshold detector on a printed circuit board. A printed circuit board for mounting and wiring the modifica-

Fig. 1. Printed circuit board; (a) foil side; (b) component side.

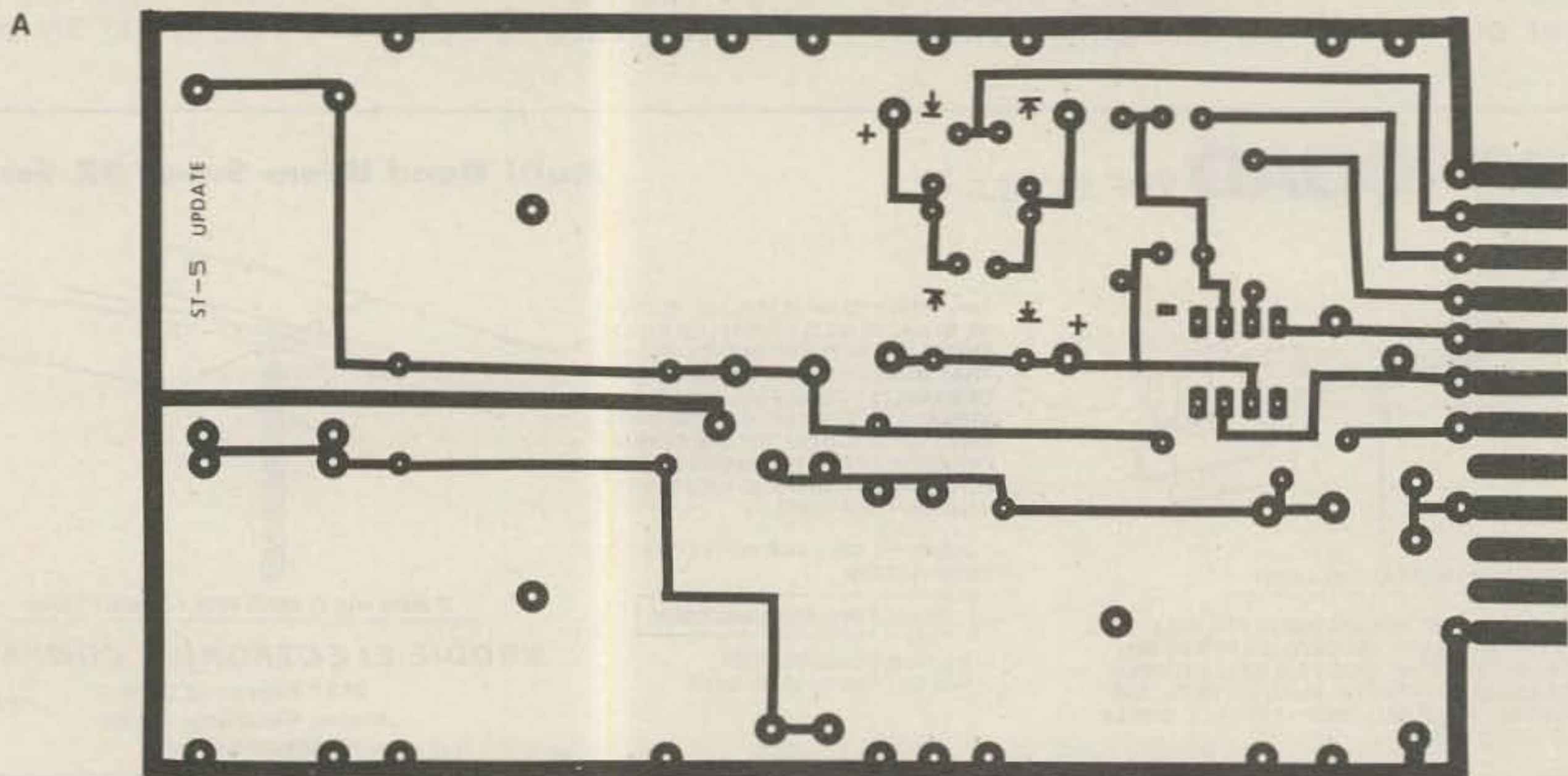

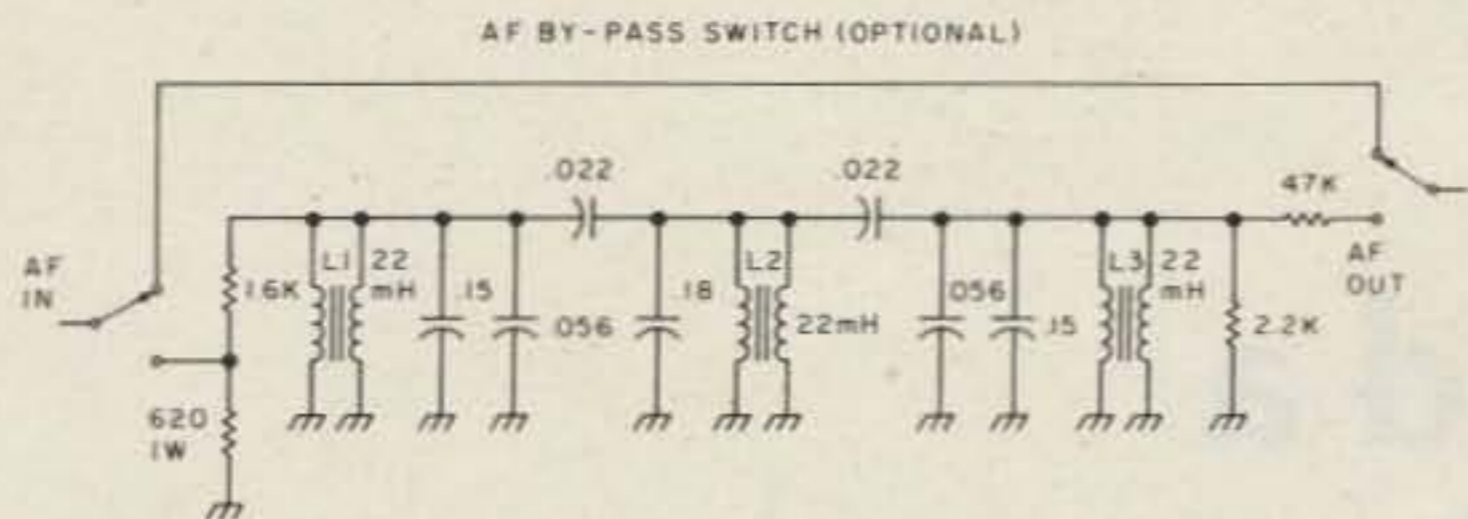

Fig. 2. 170 Hz shift input filter.

tions is shown in Fig. 1. A breadboard is fine if a printed circuit board is not desired. A schematic for the bandpass filter is shown in Fig. 2. The 22 mH toroids are 88 mH toroids with the parallel windings in proper phase (sleeved ends together).

After the detector-filter board is complete, tune the 170 Hz shift bandpass filter, and then wire the automatic threshold circuit into the ST-5. Tuning the 170 Hz shift input filter is not critical. However, addition of a small capacitance may be required to correct the likely high-frequency response of the filter. On the printed circuit board, extra holes are used for trimmer capacitors. Tune each toroid to 2195 kHz as follows:

1. Tune the first 22 mH toroid, L1, to 2195 kHz with the 0.15 uF, 0.056 uF, and 0.022 uF coupling capacitors shorted to ground.

2. Tune the second 22 mH toroid, L2, to 2195 kHz with the 0.18 uF and second 0.022 uF coupling capacitors shorted to ground.

3. Tune the third 22 mH toroid to 2195 kHz with the 0.056 uF and 0.15 uF capacitors.

4. Reinstall both 0.022 uF coupling capacitors from ground back to the proper toroid.

5. Wire the 170 Hz shift bandpass filter to the ST-5 input.

To wire the automatic threshold detector into the ST-5, make the following changes and see Fig. 4:

1. Remove the 100k and 91k resistors and 0.068 uF capacitor from existing circuit.

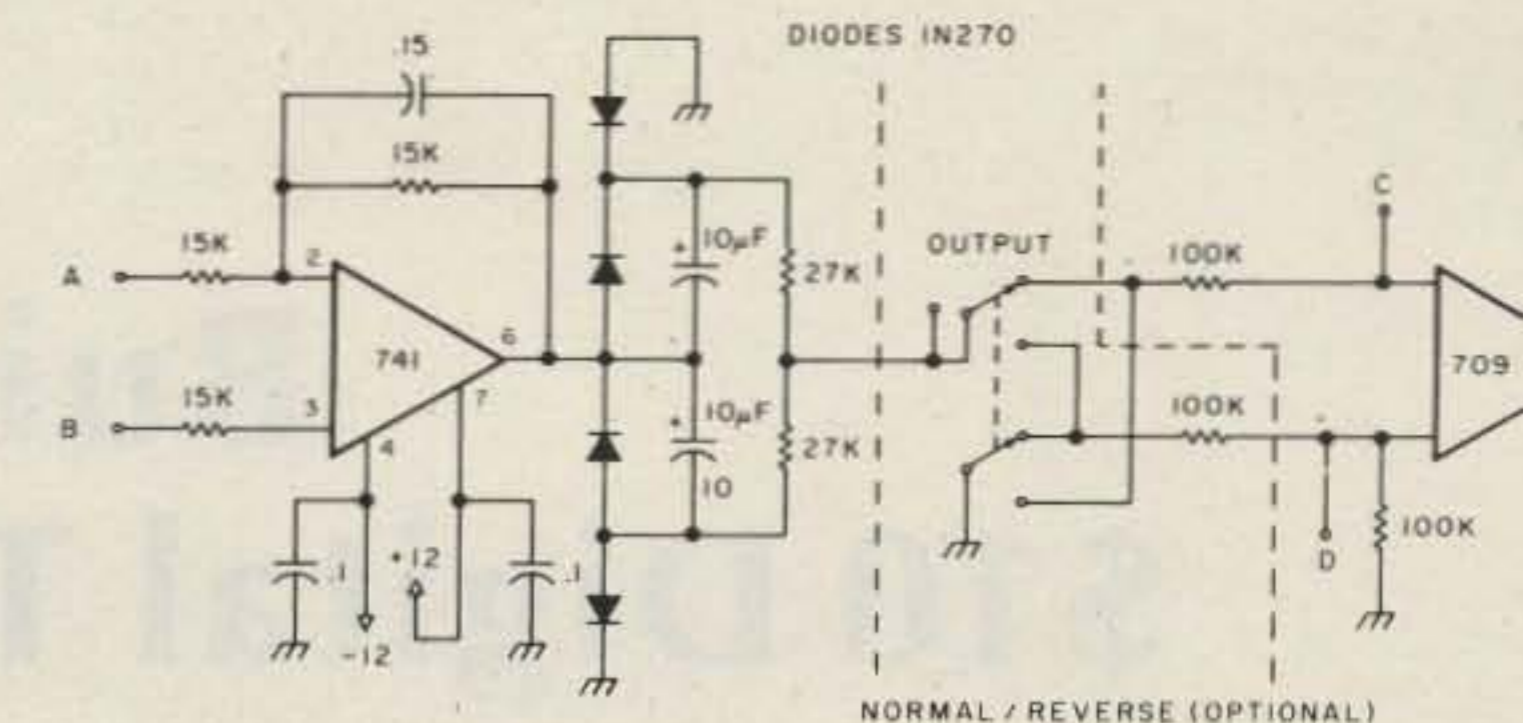

Fig. 3. Automatic threshold detector circuit, allowing copy of space keyed telemetry.

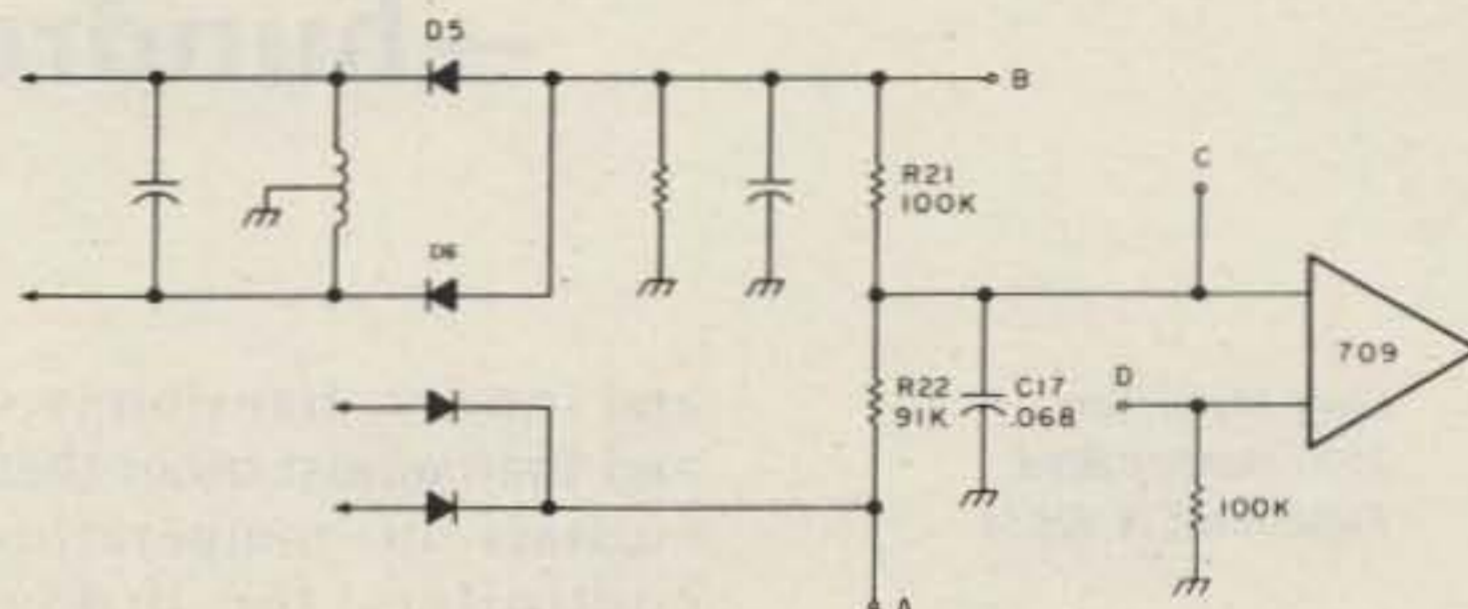

Fig. 4. Basic ST-5 discriminator.

2. Reverse the 1N270 diodes, D5 and D6.

3. Wire the automatic threshold detector into the ST-5 at points A, B, C, and D as shown in the schematic diagrams.

4. Wire the 741 operational amplifier to +12 and -12 V dc.

5. If desired, a NORMAL/REVERSE switch may be in-

stalled into the ST-5. See Fig. 3.

There are no adjustments required for the automatic threshold circuit. After both circuits are wired into the ST-5, you will find tuning a RTTY station is very easy and QRM will not interfere with the pictures you're trying to copy. ■

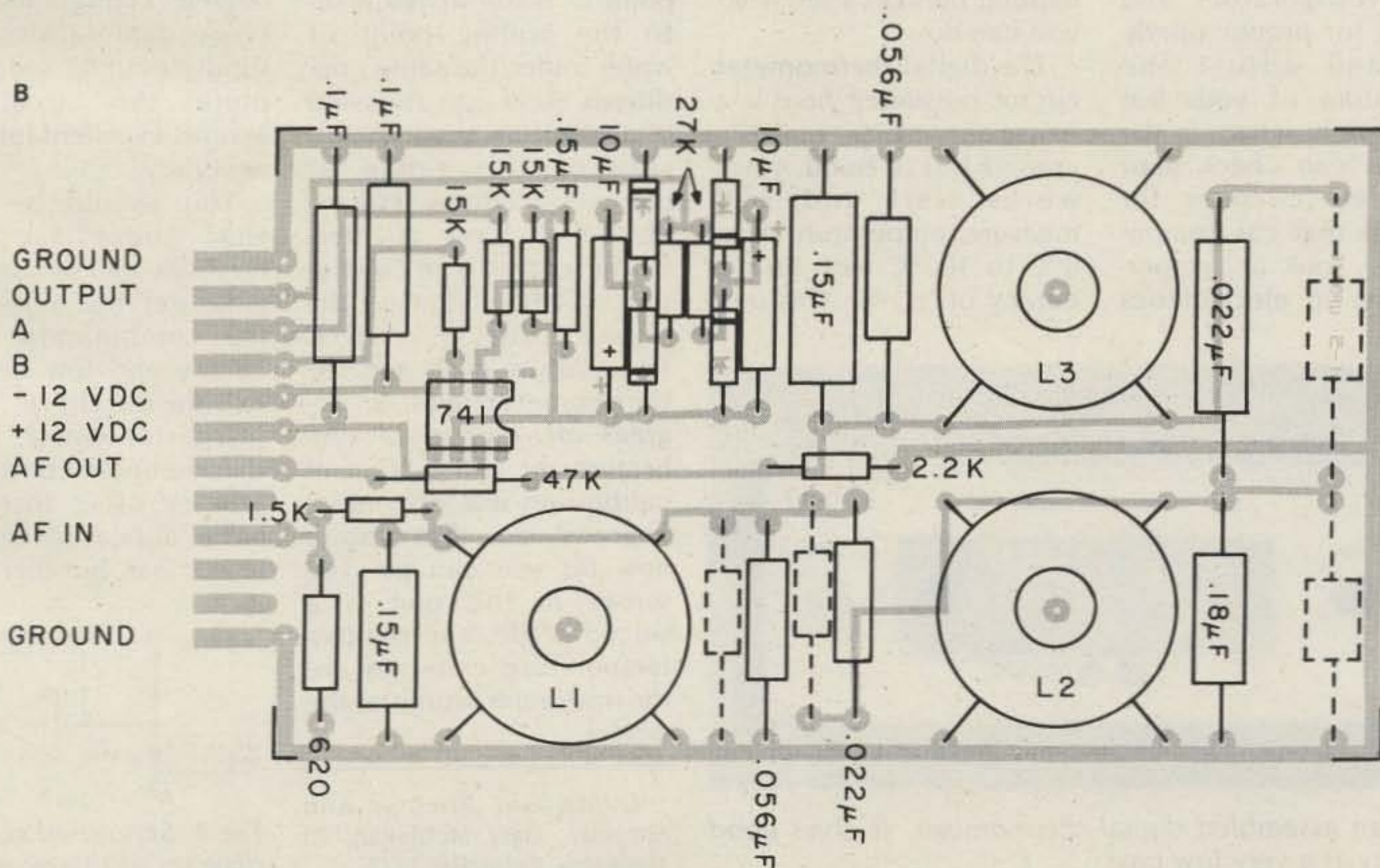

Build a \$10 Digital Thermometer

— hundreds of uses

Gary McClellan
2500 Harbor Blvd.
Fullerton CA 92634

You may not realize it, but a digital thermometer may be very useful around the home, lab, and shack. Besides using one to determine how hot or cold it is outside, and checking out cheap thermometers, you can do far more! For example, around the home, you can use a thermometer to check for heat loss (energy waste) in furnace and hot water heater insulation, check refrigerators and freezers for proper operation, and adjust the temperature of your hot water supply. Then, in the lab, you can check your home-brew circuitry for hot spots that cut component life, look at temperature rise in electrolytics

and power transformers, and then adjust other thermostats or temperature controllers for proper operation. In the shack, use one to check crystal ovens, check rf power transistors to see if more heat sinking is needed, and so on. Or, how about using a thermometer to monitor the heat sink temperature on your transmitter finals to prevent damage. This could sure cut down on those long QSOs! If you can't think up more or better ideas for a digital thermometer by now, you disappoint me! Let's see what you can do.

The digital thermometer circuit presented here is a low-cost unit, costing around \$10 to build, yet it works well and will measure temperature from 0°C to 100°C with an accuracy of $\pm 1^\circ\text{C}$. This unit

is really a companion to our model 101 DVM kit or MC-1405 DVM.* It puts out a dc voltage which is equal to the temperature in degrees centigrade. You may also use a 0-to-1-volt analog meter, or any digital multimeter if you wish. Calibration is fairly easy, too, and I have found a way to make it easier! There will be more on this, later.

The temperature limits of a thermometer are important, too. This one measures from 0°C to 100°C, or from the freezing point of water at sea level to the boiling point of water under the same conditions. You can measure temperatures slightly outside of this range at reduced accuracy. For example, I have a thermometer that is in calibration at 0°C. I dunked the probe into a -55°C temperature bath and the thermometer was 5 degrees off. I checked calibration at $+125^\circ\text{C}$ and calibration was off only 2 degrees! So that shows how far you can go. The sensor in this unit is a silicon diode, and the two temperature extremes are the maximum ratings of the diodes.

Fig. 1 shows a simplified schematic of the thermometer module. This unit is based on the fact that silicon diodes have the property of the junction voltage changing linearly with temperature. Actually, most solid-state devices have some sort of voltage change with temperature. In this case, a cheap 1N4148 diode will change 2.2 mV per degree centigrade. So all we have to do is bias the diode in the conducting mode, then amplify the signal and adjust it for a reading in degrees centigrade. A precision, dual-tracking power supply of ± 12 volts completes this circuit, and assures excellent long-term accuracy.

You should be aware that there are other methods of sensing temperature, but none offer the combination of accuracy and low cost. For example, there is the thermistor sensor. Lots of thermometer construction articles using thermistors have appeared in other magazines, but thermistors



Here's an assembled digital thermometer. It gives good accuracy at a very low cost.

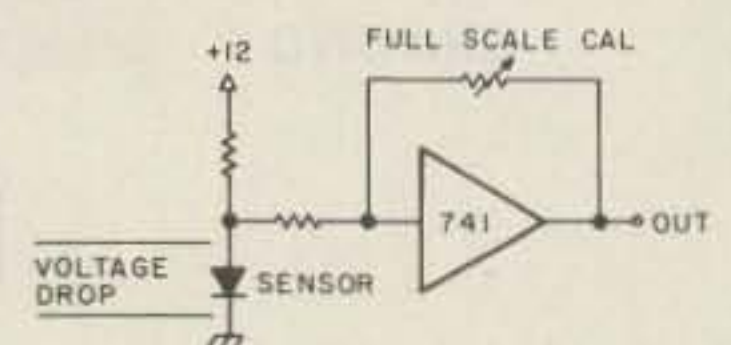

Fig. 1. Simplified schematic diagram of thermometer.

*"DVMs Get Simpler and Simpler," Gary McClellan, 73 Magazine, February, 1977.

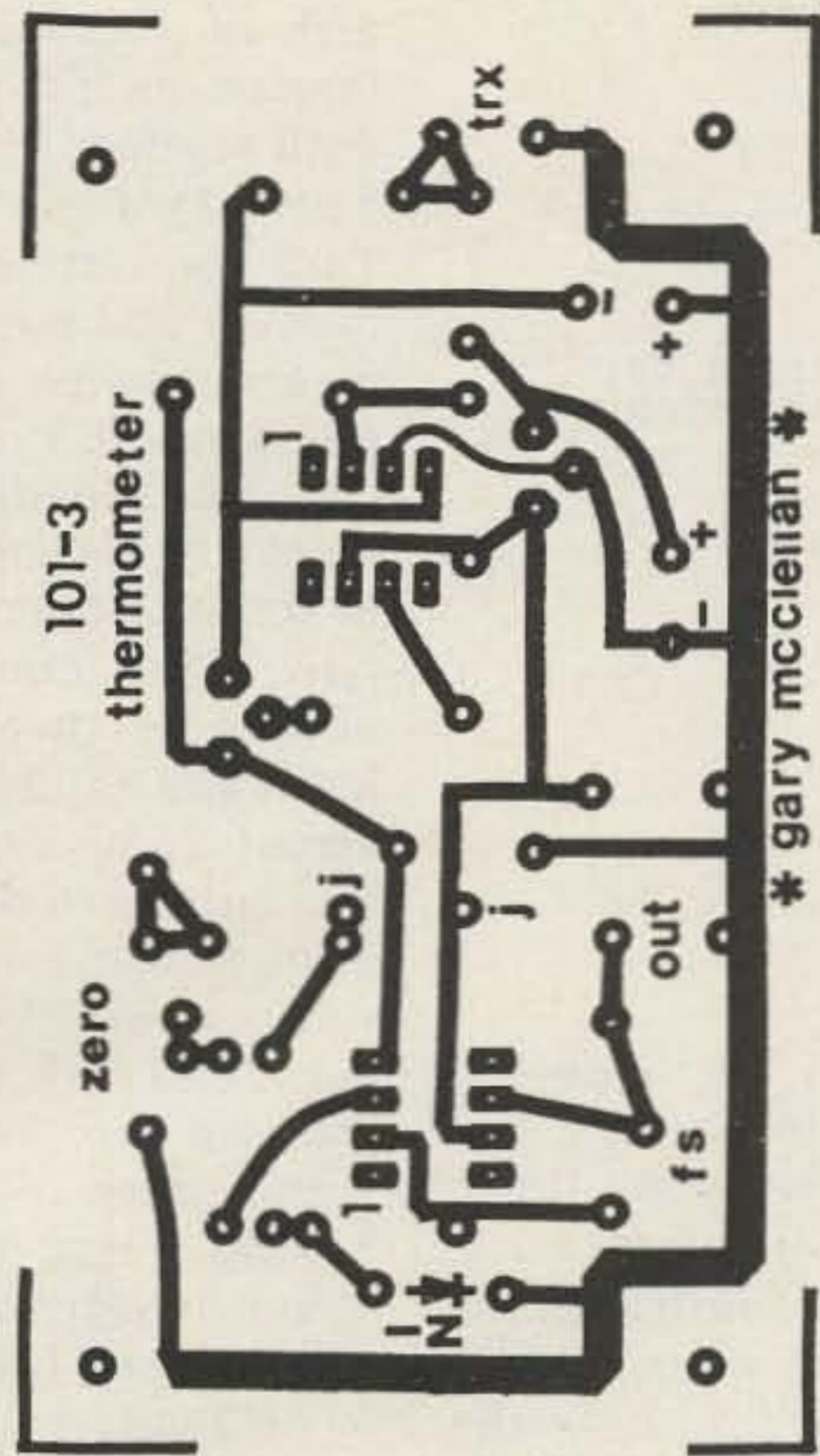
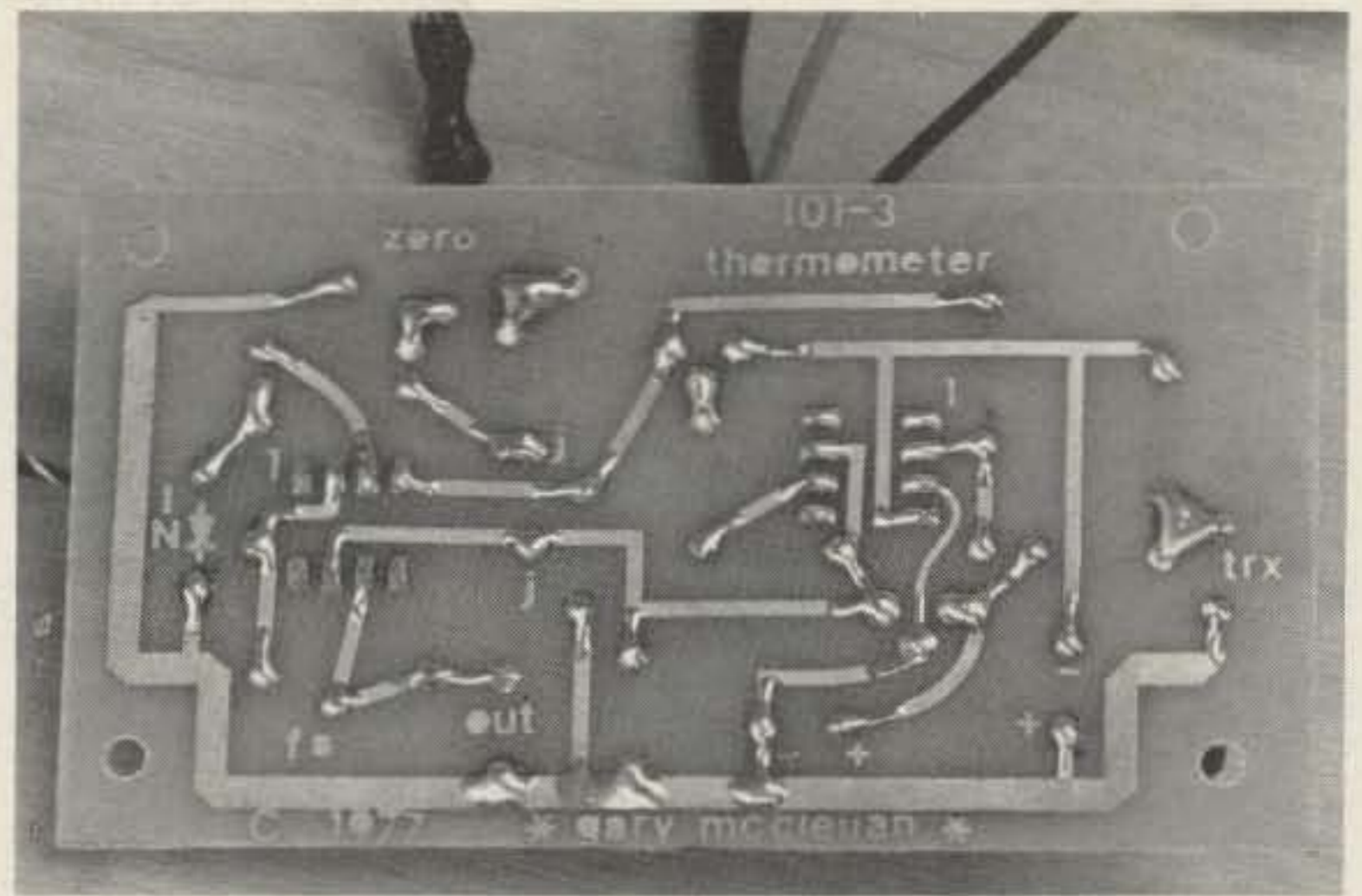

Fig. 2. PC board layout.

in the proper resistance ranges are usually hard to get and must be special ordered. Also, if you step on it or destroy it in some way, you must order another one and wait, wait, wait by the mailbox. Then you must recalibrate your box for the new thermistor. With my unit, if you break the diode, a new one costs only pennies and is readily available. You still have to calibrate your module, but a new sensor is easy to get. That's a big reason why I use diodes. I have accidentally broken sensors of both types, and I would much rather break a diode any day! Another type of sensor is the thermocouple. This is the original electronic sensor, and I'm sure most old-time people in the temperature measurement field will doff their hats at the mention of the word. This is just two pieces of wire (made of different materials) clipped together at one end. Thermocouples have the advantage of being able to measure a wide range of temperatures, and also they are interchangeable with-

out recalibration on a thermometer. One of the most popular thermocouples, the type K, or copper-constantin wire, has a temperature range of -270° to over $+600^{\circ}\text{C}$! Quite a difference from that diode. But thermocouple thermometers are much harder to build, and thus cost more. There are a good many \$300 boxes out there on the market. So, by



Underside of the thermometer circuit board.

now, you can see why I am using that diode as a sensor, and perhaps appreciate how it relates to the other sensors.

Construction of this project is easy. A full-size printed circuit layout is given to aid you (Fig. 2). Simply duplicate the board, drill it, and stuff it with the parts, an easy two-evening project. The complete schematic diagram is shown in Fig. 3.

After you have the board, you will want to scrounge the parts. Good sources for IC3 might include 73 advertisers. Another place is Active Electronics, PO Box 1035, Framingham MA 01701.

They have had them for 29 cents each plus postage. It's the same deal with the op amps. They do have a \$10 minimum order, but their prices on the 78L12 regulator is tops as I write this, so you may have to combine several projects' worth of parts to place an order. One very important thing: Do not use re-tested junk parts in this project. If you do, it probably won't stay in calibration. A word to the wise is sufficient. The next problem parts are the pots. I used surplus Beckman Instruments type 89PR10K for the 10k pot, and a Beckman type 89PR100K pot for the 100k unit. These are available from Beckman distribu-

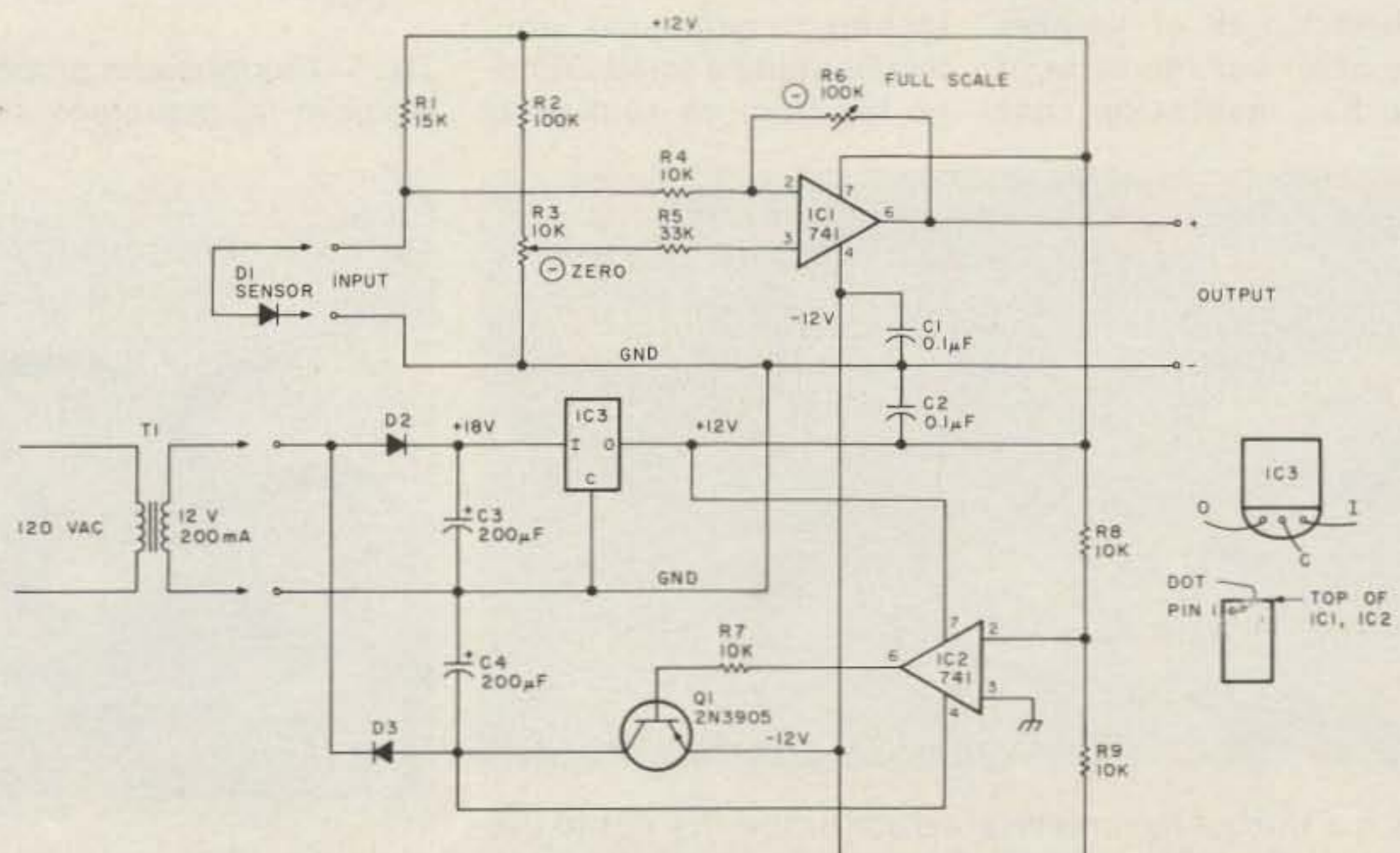

Fig. 3. Schematic diagram of Model 101-3 digital thermometer.

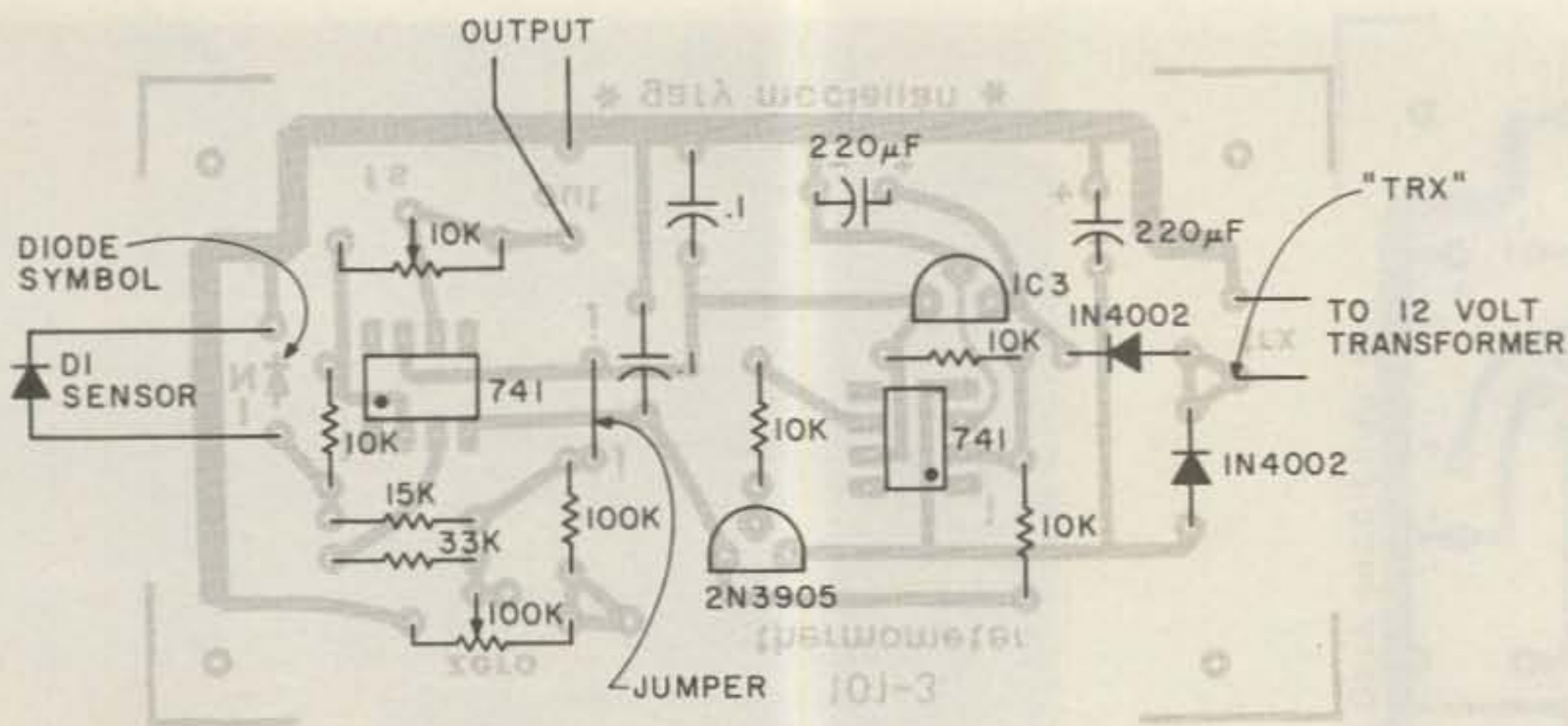

Fig. 4. Component layout. Don't forget the jumper!

tors, such as Fisher-Brownell here on the West Coast and others. They cost about \$1 each. If you can't find these pots, drop me a line. They are the 3/4-inch long rectangular, cermet units. Others will work, however.

The next step is obvious—build it! Just follow the Fig. 4 illustration and you will have no problems. After you are done, attach leads for the output, and connect the transformer. Then do the usual checks for wiring errors, etc.

The sensor deserves special comment. It is just a diode on the end of a 2-foot piece of wire. For best results, get Teflon[®] hookup wire. Number 24 stranded wire with Teflon will do fine. You could use a short length of speaker wire here, but this type of wire has insulation that

softens considerably at 100°C. Try not to use it—especially if you plan to do a lot of 100° measuring! Fig. 5 shows the details. There are several ways to construct the probe. A good universal probe can be made as shown by first slipping a 3-inch piece of Teflon tubing over the wires as a handle, then forming the diode leads and attaching them to the other leads. It might help to punch several holes along the edge of the tubing for the next step. Epoxy doesn't stick too well to Teflon. Finish up the general purpose probe by dipping it into epoxy. Cover up the end of the tube and let the epoxy set. You can make a special probe, such as for attaching to heat sinks, etc., by obtaining a small crimp-on lug from an auto parts

store. Epoxy the diode and wires inside the lug (insulate so they don't touch it) and you are all set.

After you finish with the wiring, plug in the transformer, and check the voltages on pins 7 and 4 of IC1. They should be plus and minus 12 volts respectively. Then measure the voltage across the input terminals. It should be around 0.5 to 0.6 volts. If not, reverse the input leads and recheck. If it is still not right, the sensor is bad.

Finish up with the calibration. First, prepare a

dish of cracked ice, and then return it to the freezer until needed. Also, heat up a pan of water until it boils. Turn your attention to the module and put your voltmeter between ground and pin 3 on IC1. Adjust R3 (zero) for a reading of 0.510 volts. The sensor should be at room temperature right now. Then connect your voltmeter to the output leads and adjust R6 (FS) for about 25°C or whatever the current room temperature is. These adjustments will put your thermometer in the ball park. Get out the cracked ice and place it within easy reach of the boiling water. Plunge the sensor into the ice and adjust R3 (zero) for 000 on the 1- or 2-volt scale of your meter. Then transfer the sensor to the boiling water, wait a minute until the meter settles down, and adjust R6 (FS) for a reading of 1000. Return the sensor to the ice, wait a minute for things to cool down, and readjust R3. Repeat with the boiling water and R6. For best results, do these steps at least 5 times. If

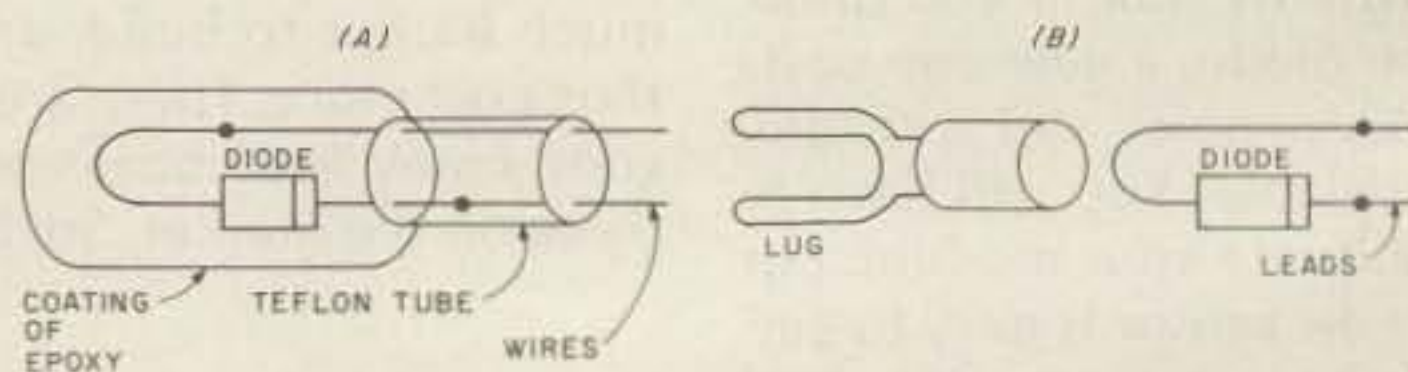
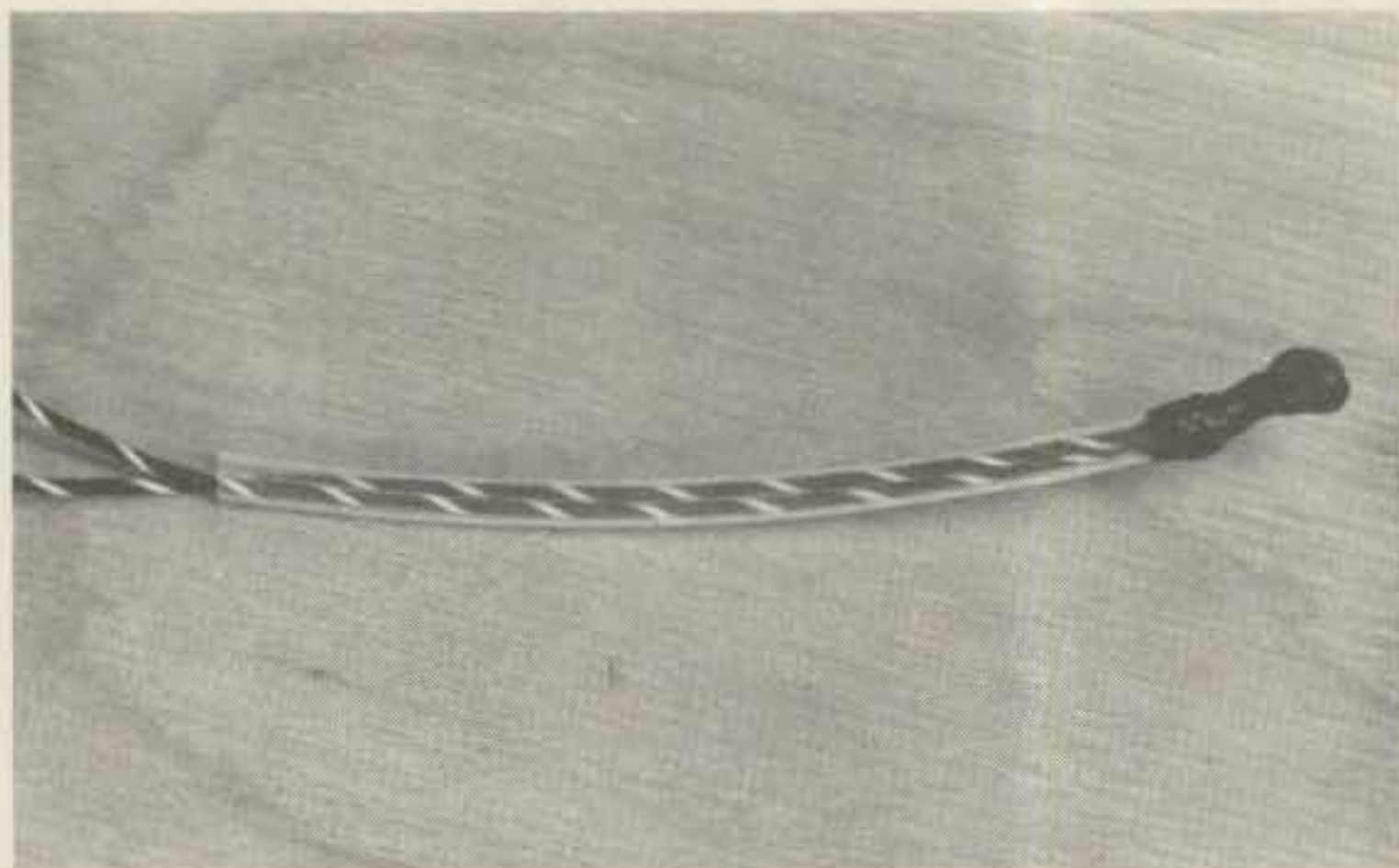
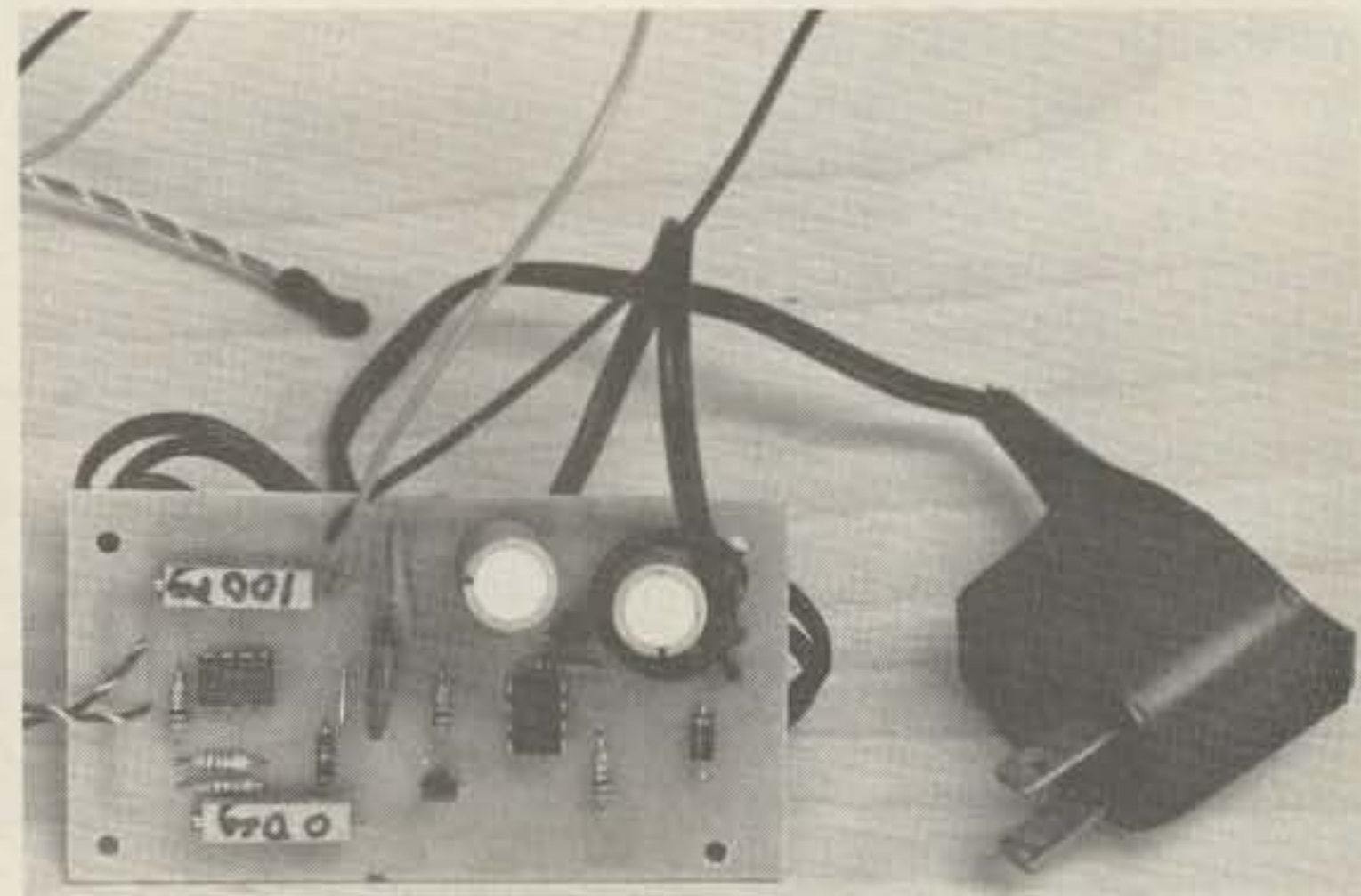

Fig. 5. Thermometer probe construction details: (a) general purpose, (b) mountable probe for heat sinks, etc.



This is a shot of the universal sensor probe. Try not to use as much epoxy over the diode as I did; the excess epoxy slows down response time.



Top view of the completed thermometer option. All that's needed is a digital voltmeter for operation.

you do, you will be within a few degrees of the correct temperature. For even better accuracy, use a well-calibrated commercial digital thermometer to compare with your thermometer.

Using your new thermometer is a snap! Simply touch the probe to the surface you want to measure. Then wait a minute or so for the temperature reading on your voltmeter to

stabilize (always use the 1- or 2-volt scale) and note the reading. Your meter will show, if it is digital, degrees and tenths of degrees. So 390 on the meter is 39.0°C, 1001 is 100.1°C, and so on.

Now that you have a thermometer, why not think up some more uses for it and let all of us know about it! How about solar heating applications? More ham radio applications, etc.? ■

Parts List

C1, C2	0.1 uF, disc capacitor
C3, C4	200-470 uF, 25 V electrolytic capacitor
D1	1N4148 diode
D2, D3	1N4002-1N4007 diodes (1 Amp)
IC1, IC2	LM741CN Op Amp (mini-DIP)
IC3	Fairchild-type 78L12, 100 mA voltage regulator
Q1	2N3905 PNP silicon transistor
R1	15k
R2	100k
R3	10k, 10-turn pot
R4, 7-9	10k
R5	33k
R6	100k, 10-turn pot
T1	117/12 V ac, 200 mA wall plug transformer
Misc:	Model 101-3 PC board, 16 Molex® pins, hookup wire

DX

from page 6

kHz at 1500Z is a good place to snag a few new ones. As with any net, listen until you understand the correct call-in procedure.

Congratulations to the new officers of the Iowa DX Association. Doug Byal W0SML is the president. Gary Letchford K0LUZ is VP, and Fred Benson K0AT is the secretary/treasurer. If you would like to join up, drop Fred a note in Cedar Rapids.

CO2FA notes that it takes four IRCs and 1¢ from his own pocket to purchase one air mail stamp. This is another case where one Yankee dollar is better for all concerned.

Often stations are heard signing /4U, and many have been wondering what exactly they count for in regard to DXCC. You can get DXCC credit for their actual location, and it helps if the QSL shows the exact QTH. This is straightforward, but sometimes confusing.

If you work any stations signing EI8H/, it will be a pirate. EI8H is for real, but someone has been using his call portable from such locations as PY0, GU, HV1, etc. All are phonies.

WA3HUP has been reported as having some VU2ANI/VU7ANI logs on hand. If you need a card, you might drop Mary Ann a line to see if she can help out. She has long been one of the top QSL managers around.

Jerry McManus, who operated 4W1GM back in 1975, says he received verbal permission to operate, but since that official was later assassinated, he is somewhat reluctant to try. Jerry feels that any present 4W1 operation would be open to question. Work 'em first, etc.

K5YY became seriously ill upon his return from Africa, and the QSL chore was delayed for a while. Remember this, if your card seems late in arriving.

During his VS6HK operation last September, W6MJE took a side trip and operated CR9AJ. These QSLs will be sent out automatically via the bureaus, so don't bother QSLing CR9AJ for contacts on September 20/21.

Tuvalu has been assigned the prefix block T2A to T2Z. VR8O will now be signing T2O.

If you still need a QSL for the last operation from Heard Island, VK0HM, in 1970, try W7PHO. Bill has all the logs.

4L0 calls are Russians operating north of the Arctic Circle.

Although the U.S. *Callbook* shows only about 20,000 JAs licensed, JARL figures show the total to be 359,005 as of last August. The discrepancy stems from the fact that, due to language problems, the *Callbook* must depend on individual Japanese amateurs to advise them of their QTHs.

At the IARU Region III meeting in Bangkok last October, VS6AW noted that there were some 350 Hong Kong Chinese waiting to take the written portion of the amateur exam in December and that many more were waiting for the next opportunity. Look for an influx of VS6s if everybody passes.

Speaking of the IARU Region III meeting, Fred Laun HS1ASD reports that there was a good turnout and lots of support for WARC '79.

The People's Republic of China responded to an invitation to attend the Region III conference by stating that since amateur radio activities had not yet been restored, it

would be difficult to send an observer. Read into that anything you wish. If Clipperton, Iraq, Somalia, and Bouvet, then why not China?

3F75 prefixes are being used by Panama stations through February 3, 1979, to celebrate the 75th anniversary of Panama's independence. HP1KC will sign 3F75KC, etc.

Jacky F6BBJ apparently ran into difficulties with his planned Abu Ail operation. But those in the know stay alert. You never can tell what the day will bring.

Speaking of staying alert, the Italians are hinting at big doings from ZA (Albania).

Apparently, lack of interest and some confusion over the new callsigns has caused the KS6 QSL bureau to fold. Local advice out of Samoa suggests you QSL direct wherever possible.

Several PY stations were planning a PY0 swing during December or early January, covering Fernando de Noronha, Rocas Atoll, St. Peter, and St. Paul. Rocas Atoll has a new autonomous administration and the PYs feel it should count as a new one. No doubt there will be more on this later.

4L0KR was a special call to mark the 350th anniversary of the city of Krasnoyarsk in central Siberia. QSL to UK0AAB.

Speaking of Siberia, UK9AAN has up a five over five on ten meters spaced ten meters apart on top of a 14 story building. UK9AAN is at the Ural Polytechnic Institute in Chelyabinsk.

The great New England Schrodtest attracted Father Moran 9N1MM along with PY1RO, to tell about the recent St. Peter and St. Paul operation, and well-known DXer Don Riebbhoff.

If you worked FH8DK and he said to QSL via WA6BJS, forget it. Herb says he is the QSL manager for no one.

Although K5OVC, subject of

our December DX Profile, was recently mentioned in a Personal Communications Foundation advertisement as having TVI problems, Lenny wants it known that everything is serene in Arkansas. The TVI problems were in New York when Lenny was W2OVC, and are now just a bad memory.

Many Pacific Ocean stations can be found on one or more of the nightly Pacific DX nets. P29JS invites stateside check-ins on 14222 from 0600Z. ZL1ADI holds forth on 14285 from 0530Z, and N2KW MCs the East-West Net on 14247 from 0430Z.

The new address for any future DX activity by VE3FXT is George Collins, Box 89, Lynden, Ontario L0R 1T0, Canada. Arrangements have been made to have the mail collected from the box daily and the QSLs processed. George also notes that his February, 1978, activity from H5 (Bophuthatswana) was actually from Thaba Nchu in the southern province of that country. Many feel that the present DXCC criteria will make this a separate country from the north province.

The sunspot count continues to climb beyond expectations. Many of those predicting an early doom for cycle 21 now say that it may prove to be one of the best ever. The real truth probably lies somewhere in between.

Larry LeKashman W9IOP, one of the founders of the CQ WW DX test, passed away recently, and the 1978 CQ WW test was dedicated to his memory.

The FT-101 that was shipped to YI1BGD by the Northern California DX Foundation is still being held by the SWISSAIR office there in Baghdad, with delivery efforts going to no avail. The airline wants \$250.00 to ship it back,

Continued on page 127

CB to 10

— part XVI: a CW conversion

Change one crystal and work the world legally with 5 Watts.

With three years of operating 10 meter QRP using converted CB rigs behind me, I decided to look for ways to monitor band openings by taking

advantage of the CW beacons around the world. At the same time, 10 meter CW sounded like a lot of fun. In order to accomplish these goals, I established

the following criteria which I wanted incorporated into the finished product:
 1. 10 meter beacon coverage;

2. CW transmit capabilities on both General and

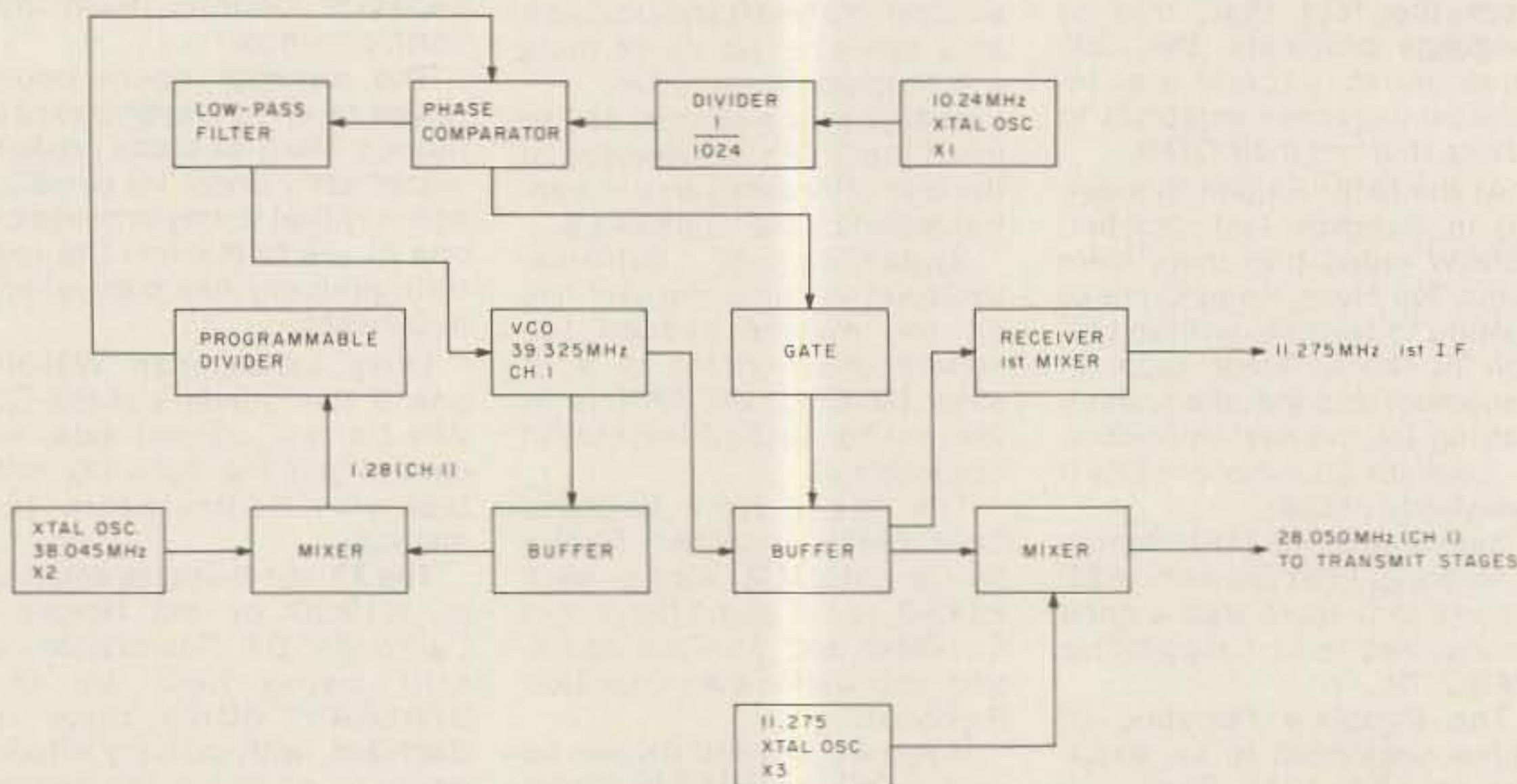

Ch.	f _o	f _{vco}	+ n
1	28.050	39.325	1.28
2	28.060	39.335	1.29
3	28.070	39.345	1.30
4	28.090	39.365	1.32
5	28.100	39.375	1.33
6	28.110	39.385	1.34
7	28.120	39.395	1.35
8	28.140	39.415	1.37
9	28.150	39.425	1.38
10	28.160	39.435	1.39
11	28.170	39.445	1.40
12	28.190	39.465	1.42
13	28.200	39.475	1.43
14	28.210	39.485	1.44
15	28.220	39.495	1.45
16	28.240	39.515	1.47
17	28.250	39.525	1.48
18	28.260	39.535	1.49
19	28.270	39.545	1.50
20	28.290	39.565	1.52
21	28.300	39.575	1.53
22	28.310	39.585	1.54
23	28.340	39.615	1.57

Fig. 1. Block diagram of phase-locked loop circuitry in the Sharp CB-800A with frequencies indicated for 10 meter coverage.

Table 1. $f_o + 11.275 = f_{vco}$; $f_{vco} - 38.045 = n$.

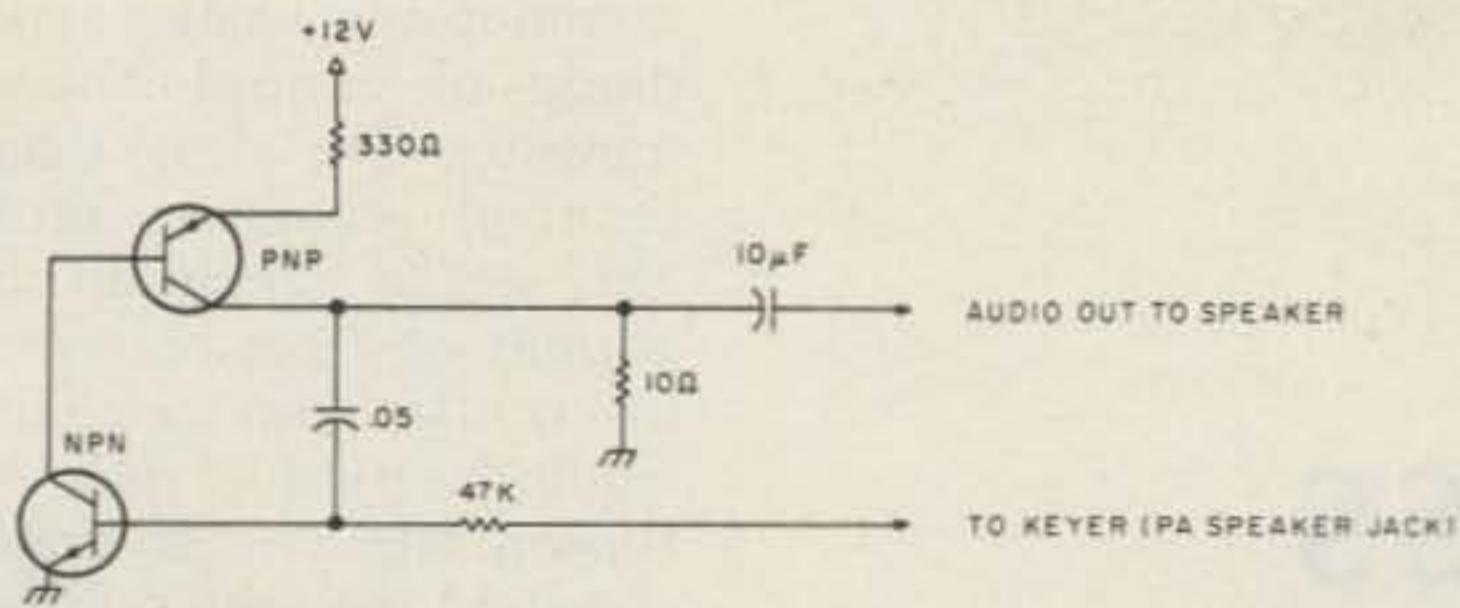

Fig. 2. Sidetone oscillator circuit. Transistors can be any general-purpose audio types. The .05 μ F capacitors may be changed to vary the tone.

Novice frequencies;

3. QRP operation of 5 Watts or less; and

4. price range between \$30 and \$40.

After researching the market, I decided on the Sharp model CB-800A phase-locked loop AM transceiver, which was readily available in my area for a price well under forty dollars.

An examination of the service manual for the CB-800A indicated that I would be able to meet the above goals. The frequency coverage I decided upon is shown in Table 1 with the beacon frequencies and identifications listed below:

Ch. 9	28.150	WA1EOB
Ch. 10	28.160	PY1CK
Ch. 11	28.170	ZL2MHF
Ch. 12	28.190	3B8MS
Ch. 12	28.190	DLØIGI
Ch. 13	28.200	JA1GY
Ch. 14	28.210	N4RD
Ch. 15	28.220	GB3CX

The first step in the conversion is to review the PLL frequency generation as shown in Fig. 1. As can be seen, the vco stage is the heart of the unit. In the original circuit, a vco frequency of 38.240 MHz was mixed with a received frequency of 26.965 MHz (Ch. 1) to produce a first i-f frequency of 11.275 MHz.

In the transmit mode, the vco output was mixed with an 11.275-MHz crystal oscillator to produce the 26.965-MHz transmit signal for channel 1. From this information, we can generate a formula to determine

the vco frequency to enable us to transmit and receive on 28.050 MHz for channel 1. Thus, $f_o + f_{i-f} = f_{vco}$, where f_o is the operating frequency and f_{i-f} is the frequency of the first i-f. With an operating frequency of 28.050 MHz for channel 1, the vco frequency must be changed to 39.325 MHz. It is very important, when converting a PLL circuit, that the original division factor for the programmable divider be maintained. As can be seen in Fig. 1, the division factor for channel 1 is 1.28. By changing the frequency of the original 36.960 MHz crystal (X2), we can do this. Thus, $f_{vco} - 1.28 = 38.045$ MHz, the new frequency of X2.

With the new 38.045 MHz installed, perform the following steps to align the PLL circuit:

1. Place the channel selector switch to channel 12.

2. Connect an rf voltmeter to C220 at the output of Q206, and tune T203 for maximum output at 38.045 MHz.

3. Disconnect the rf voltmeter.

4. Connect a frequency counter to TP206 at the output of the vco transistor, Q203, and tune T201 for 39.465 MHz.

5. Disconnect the frequency counter.

6. Connect an rf voltmeter to TP2 at the output of the vco buffer transistor, Q202, and tune T202 for maximum output at 39.465 MHz.

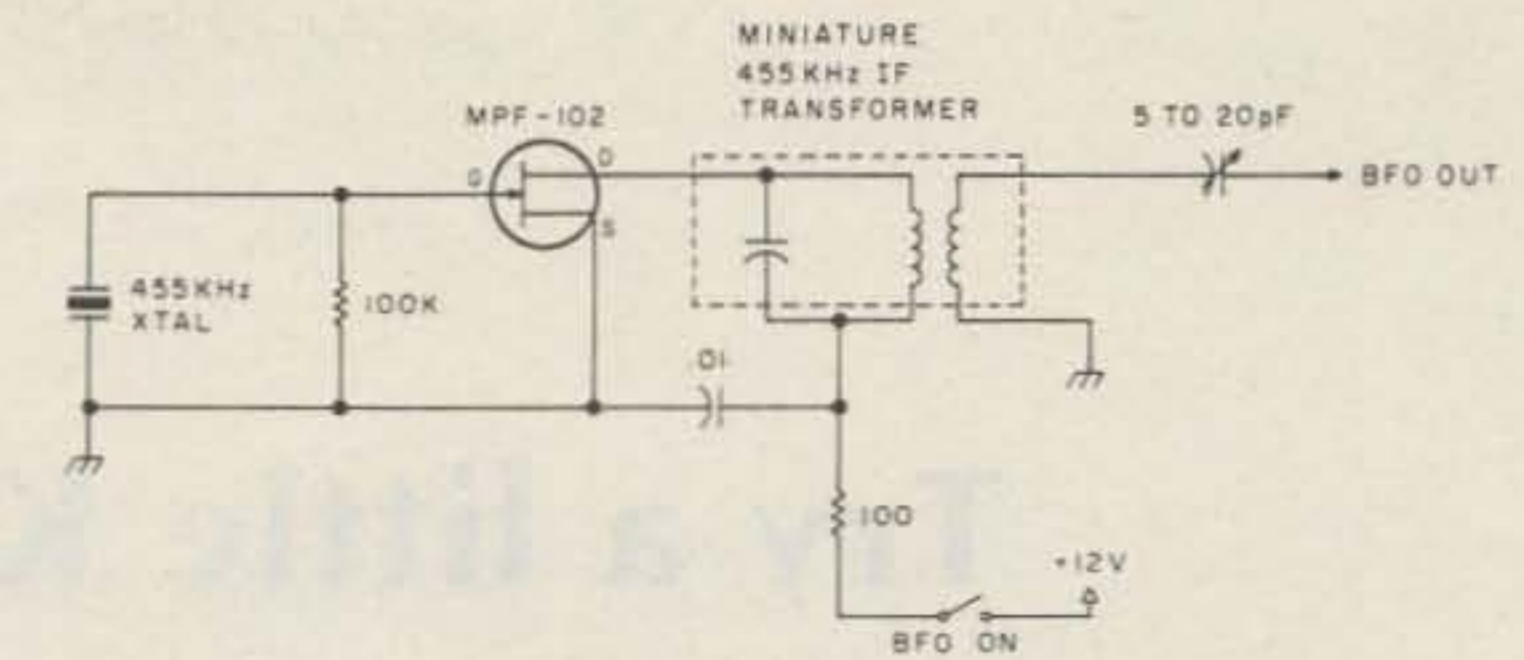

Fig. 3. 455-kHz bfo circuit.

7. Disconnect the rf voltmeter.

8. Connect a frequency counter to pin 15 of IC203, and verify the existence of a 1.42-MHz input signal.

9. Disconnect the frequency counter.

10. Measure the dc voltage at TP206. A voltage of approximately +2.7 indicates that the PLL circuit is locked. Zero indicates an unlocked condition.

This completes the PLL alignment. The receiver circuit alignment is as follows:

1. With the channel selector switch in the channel 12 position, connect a 28.190-MHz signal to the antenna jack.

2. Tune transformers T1, T2, and T3 for maximum S-meter indication.

3. Disconnect the signal generator.

This completes the receiver alignment. The transmitter alignment is as follows:

1. Connect a 50-Ohm dummy load to the antenna jack.

2. With the channel selector switch still in the channel 12 position, key the transmitter and tune T302, T303, T304, L302, and L303 for maximum rf output.

3. With a frequency counter, verify that the transmitted frequency is 28.190 MHz.

This completes the transmitter alignment, and you are now ready to make the necessary modifications for CW operation. The first step is to establish a method for keying the transmitter. This is ac-

complished by disconnecting the wiring to the existing PA switch located on the squelch control. Use this switch to energize the T-R relay in the CW mode. Unground the emitter resistor of Q303, the first rf amplifier in the transmitter, and connect it to the now-unused PA speaker jack. This will be the keyer connection. One word of caution: The ground side of the PA speaker jack is connected to the chassis. Before making any connections to the jack, break the connection to the chassis and connect the ground side of the jack to the circuit board ground.

The sidetone oscillator circuit shown in Fig. 2 and the receiver bfo circuit shown in Fig. 3 work very well and are small enough to fit inside the rig with no external mounting necessary. The output of the bfo circuit is high enough so that no direct connection to the receiver i-f is necessary. I simply positioned the wire from the bfo output across IC1, the receiver i-f circuit. Remember that in both the sidetone oscillator and the bfo circuit, ground connections are to the circuit board ground and not to the chassis ground.

Whether you decide to use the rig as a beacon monitor or a QRP rig, you will find it very enjoyable. I have had many contacts with it and all with good reports of CW quality.

So trade in your mic for a key and have fun on 10 meter CW! ■

Try a little KISS

— you'll love it

Reliable portable power has been right under your nose.

*J. Tom Badgett K8AO
400 Albemarle St.
Bluefield WV 24701*

Almost as familiar in hamdom as Murphy and his laws is the KISS formula: Keep It Simple, Stupid. When general considerations are at stake, most of us believe in KISS. It is when we pursue solutions to personal problems that we frequently lose sight of the fact that "simple" usually is best. Here's a case with some

general and specific lessons which may be of value.

I blew my bank account recently for an ultracompact cassette recorder with the ruggedness and frequency response I need as a writer. The Sony TC-150 worked beautifully from the beginning, but the carbon-zinc AA-cells didn't last through even the first interview. The company wanted nearly \$50 for rechargeable batteries and an automobile adapter, so I decided I might do some-

thing cheaper.

I solved the automobile converter problem first. The circuit in Fig. 1 reduces the vehicle's 12 volts to the six volts my recorder needs, gives excellent voltage regulation, smoothes out spikes and hash which might be generated by the electrical system, and provides recorder protection in the event of failure of any of the converter components. With junk-box parts, the total cost was around two dollars.

The circuit is a fairly

common one, using a zener diode to control a pass transistor. One of the three-terminal regulators probably would handle all the current of most recorders or similar devices and would be simpler still. As shown, the circuit draws about 12 mA with no load across C-D, so, if I forget to unplug the unit from my car's cigarette lighter, there's no real harm done.

Naturally I was concerned about the safety of my \$200 tape recorder, so, once I got the converter functioning, I shorted and opened leads while monitoring output voltage. Nothing I did produced excessive voltage at C-D. I had first experimented with a simple zener-resistor regulator, but found that such a circuit could deliver 12 volts to my six-volt recorder if the zener opened. With this circuit, an open zener simply will stop conduction through Q1. A shorted zener drops the output voltage to zero (and might blow a fuse in your car's electrical system). Should R1 short, the output voltage will rise a few tenths of a volt and probably cause excessive current to flow through VR1, but still no harm is done to the recorder. A short across any of the terminals of Q1 produces a slight rise in output voltage, but less than a one-volt increase was observed. Apparently the circuit is a safe one.

Obviously, it took some experimentation and breadboarding to get this circuit "perfected." Guys with more design experience could come up with a better circuit a lot quicker. But when I let KISS take over and studied the problem somewhat more objectively, I found another solution—one which made all that experimentation and design obsolete.

Even with the converter,



Here's some of the equipment I regularly power from a six-volt lantern battery. The keyer (left) is a Ten-Tec KR-1 paddle assembly with an Accu-keyer squeezed inside. My tape recorder is in the center, and on the right is a compact strobe I strap to my bicycle luggage carrier when I'm caught out after dark.

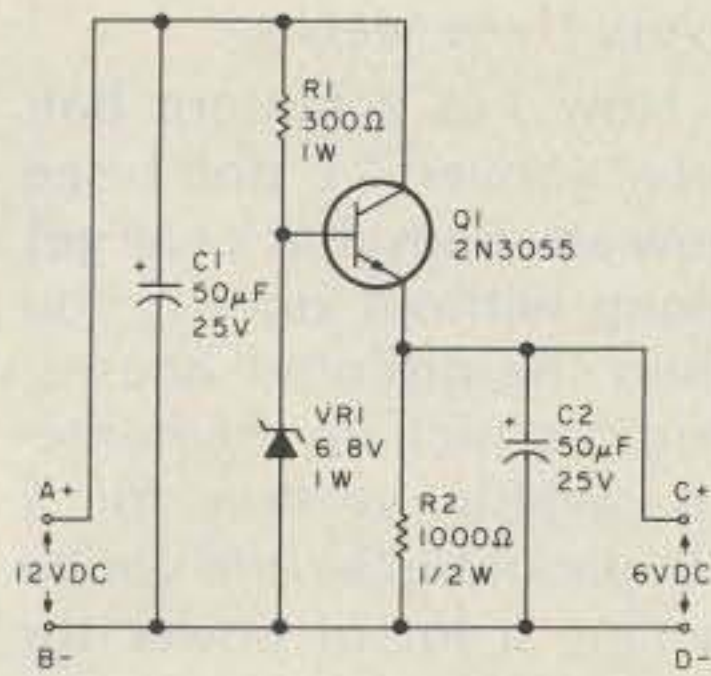

Fig. 1. Dc-to-dc converter.

I hadn't addressed the real problem: How can I have long-lasting battery power to record extensive interviews? Frequently I want to interview people outside, moving from room to room, or in an office situation where access to the mains isn't easy.

I checked several industrial and specialty battery suppliers for a rechargeable AA-cell which could deliver more than the 500 milliampere hours so commonly available. Apparently that's the largest AA-cell made and four of those will run my recorder less than three hours. It isn't unusual for my machine to run eight hours or more some days. Besides, these cells take anywhere from 5 to 12 hours to recharge, time I sometimes don't have in my business.

My recorder has an external dc input jack. I was using it with the ac converter in my office one day when the light dawned. I almost always carry the recorder in a small briefcase, so why must the power be self-contained? I found a plug to match the machine's dc input terminal and hooked it up to a six-volt lantern battery. I had found the (almost) ultimate long-life portable power supply.

These batteries are rated for about five Ampere-hours. My tape recorder draws 150 mA during playback and record and 300 mA with the motor stalled after rewind, a short-term condition. I was getting

over 30 hours of continuous use from each battery at a cost of less than two dollars. Since I was carrying the battery anyway, I no longer needed the automobile converter I had worked so hard to design.

Then other benefits became evident. This lantern battery with its power plug became a very useful bench supply. Cautiously at first, then with an increasingly cavalier approach, I began using the six-volt battery to power my five-volt circuits. I haven't found anything that couldn't take the slightly higher voltage with no harm. It is especially suited to power CMOS devices with their low power drain and wide voltage ratings.

I've improved the system now. I replaced the original dry battery with one of the new Gould rechargeables. With a charger, interchangeable screw terminals, and spring contacts, the battery costs around \$20, but it is worth it. Now when I build up a

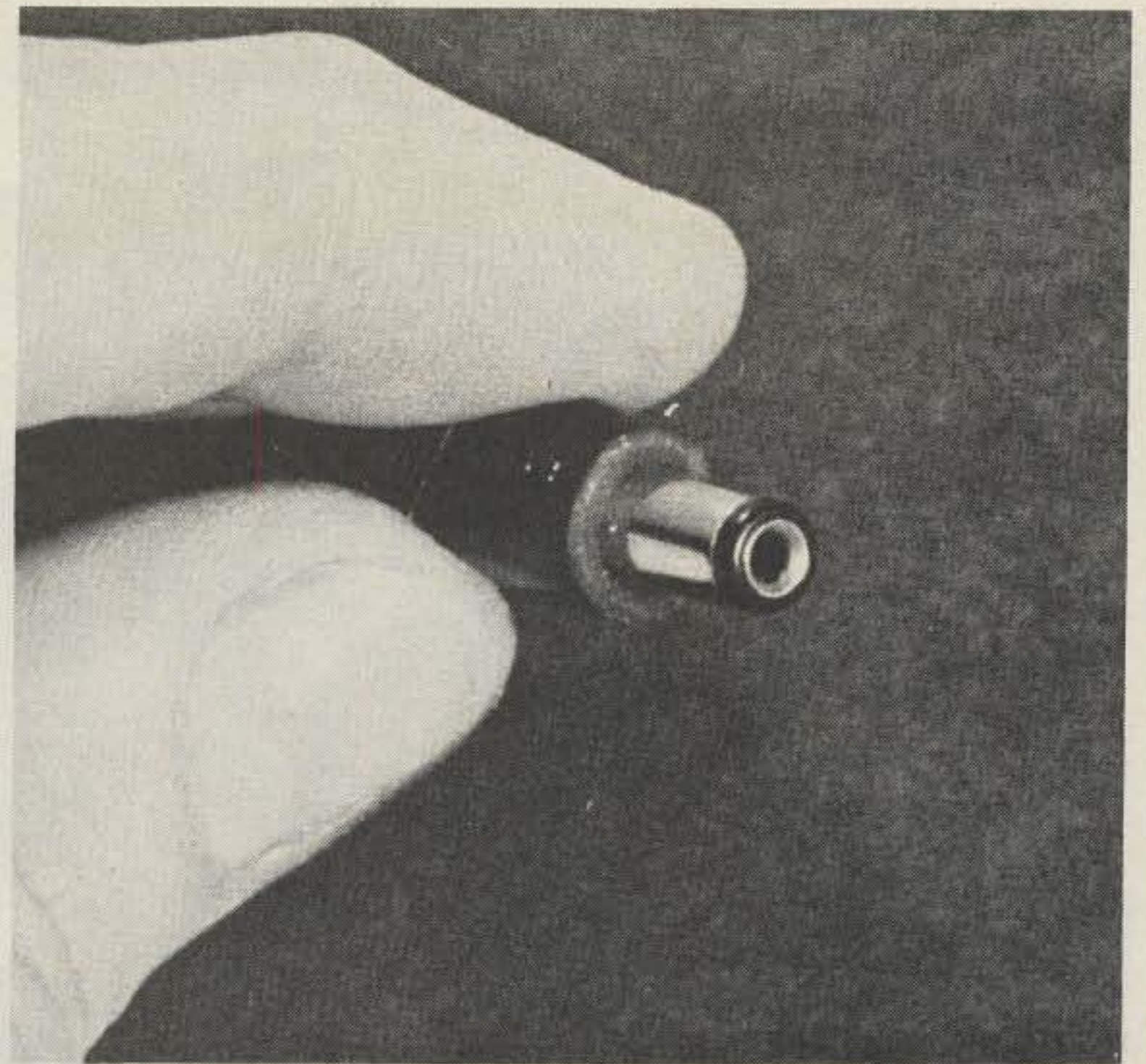

This tiny power plug attaches to lots of my ham equipment these days. Remember when wiring up one of these that the positive side is the outside of the barrel and the center conductor carries the negative current.

new project, I automatically install one of the little chassis-mount power plugs so common on tape recorders. They're available from Radio Shack and others for about four bits. They have an extra contact, so the in-

ternal supply (if one is installed) is disconnected when the external plug is inserted. Even with heavy recorder use and multiple uses around the shack, my six-volt rechargeable only has to be charged about

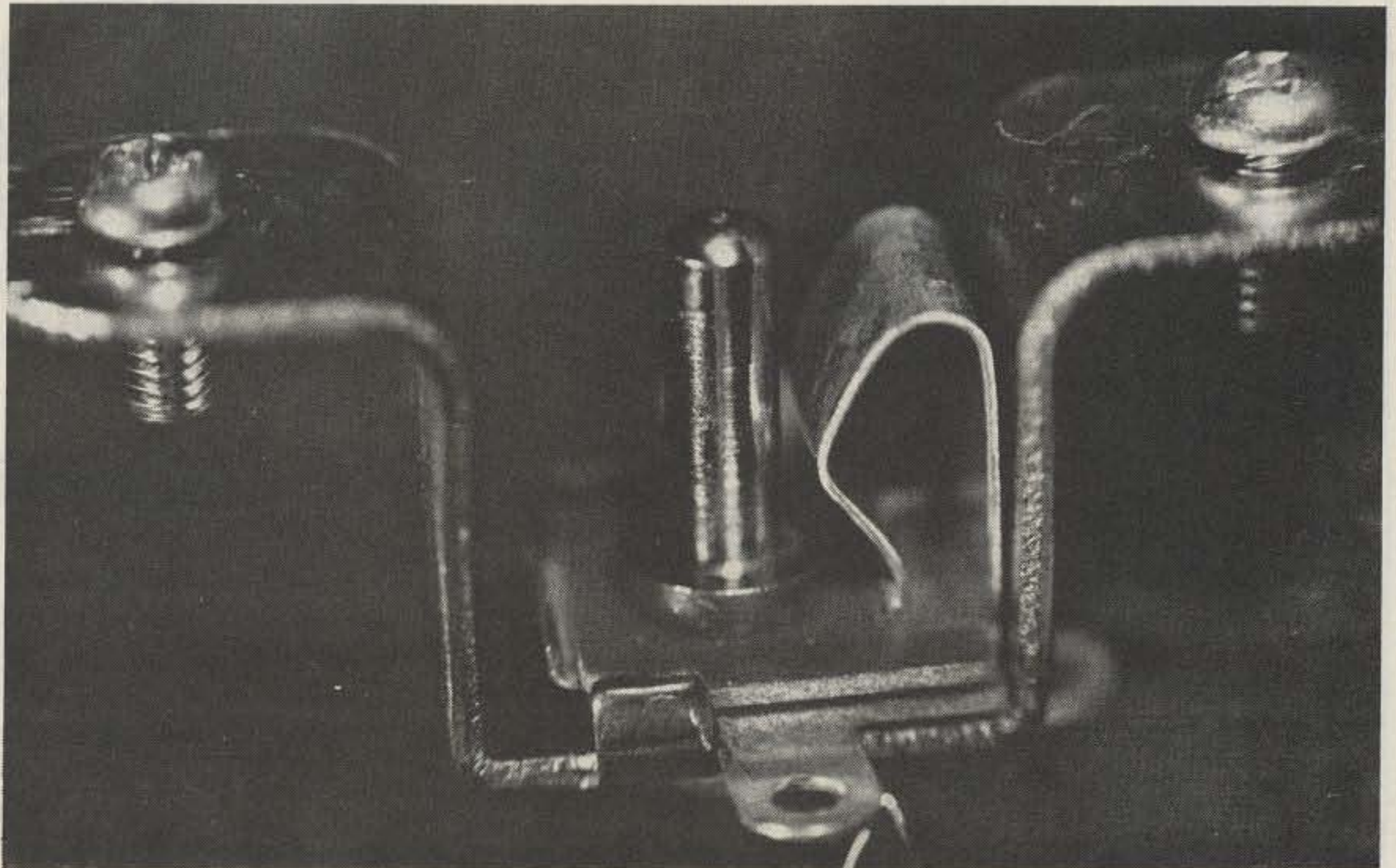

A close look at the chassis-mount jack that's going on more and more of my projects. Note the spring-type switch that can be used to disconnect an internal power supply. These jacks come with .085" or .097" diameter center posts. Most recorders use the smaller one, but I've found that some of the mating plugs can interface with either size. For some applications, you may have to isolate this jack from ground because the ground side is the positive side; the center post carries the negative current.



The ultimate in portable power: a six-volt, five Ampere-hour rechargeable battery. It comes with ac charger and interchangeable terminals for around \$20.

every three weeks.

Now I'm a lantern battery convert. I don't see how any ham shack can get along without one. If you shop the discount houses, you can pick up the nonrechargeable version for a couple of bucks and you're buying a lot of power for your money.

But for heavy use, I recommend the rechargeable battery as a better buy. Mine lasts so long I've given up using my ac converter altogether. In fact, I even use the battery with my recorder when I'm loading and dumping programs from my home computer.

Hardly a day goes by when I don't find some useful purpose for the six-volt lantern battery, and that always reminds me of the time I wasted solving my portable power problem until I KISSed it. ■



Swan 100MX

**ALLIANCE
ROTOR
SPECIAL**

HD 73 \$99.95



ICOM IC211

ATLAS • DRAKE • ICOM • SWAN • TEMPO • HY-GAIN • DENTRON • WILSON • STANDARD • KLM • CUSHCRAFT • B&W • PIPO • LARSEN • BENCHER • NYE • WESTCOM • ALLIANCE • MFJ • TELEX • NEW-TRONICS • FINCO • ROHN • WZAU • HAM-KEY • AND MANY MORE •

(((DISCOUNT PRICES ON ALL ABOVE ITEMS)))

Before you buy your next HAM RADIO—STOP—and take time to call us. We offer the lowest prices in the U.S.A. Charge it, VISA OR MASTERCARD, or we will ship C.O.D.

RON
(716) 235-7716

Mon-Fri 10 to 3
and 6 to 9

JIM
(716) 235-7540

**Amateur Radio
of Rochester, Inc.** ✓ A51

1185 Scottsville Rd. Rochester, New York 14624



**Germantown
Amateur
Supply,
Inc.**

MEMPHIS, TENNESSEE

NO MONKEY BUSINESS!

- (A) Complete Service Facilities
- (B) Good Deals on most Brands
- (C) Shipping within 24 Hours
- (D) All inquiries handled by Active Hams with over 20 years experience in ham radio

CALL TOLL FREE
1-800-238-6168

IN TENNESSEE, CALL 901-452-4276
MONDAY - SATURDAY 8:30-5:30
FOR YOUR SPECIAL.

Write: 3202 Summer Ave., Memphis, Tennessee 38112

Now you have a friend in the business!



Planning to purchase a new Transceiver?
or a new Amplifier —
or an Antenna?

Talk it over with your friends at Clegg!

Shopping for Price?
Looking for Reliable Service?
Want Professional Advice?

Your friends at Clegg offer all this, and more!

We want to be your Friend. Let us prove it! Call us today using our new departmentalized telephone system.

ORDERS AND QUOTES: TOLL FREE 1-800-233-0250
SERVICE DEPARTMENT: TOLL FREE 1-800-233-0337
ENGINEERING, PURCHASING, ADMINISTRATION
AND ACCOUNTING: 1-717-299-7221

Clegg

Communications Corp.
1911 Old Homestead Lane
Greenfield Industrial Park East
Lancaster, PA 17601

✓ C3

Autotrak II

— chase OSCAR with ease

With automated antennas, the OSCARs are at your doorstep.

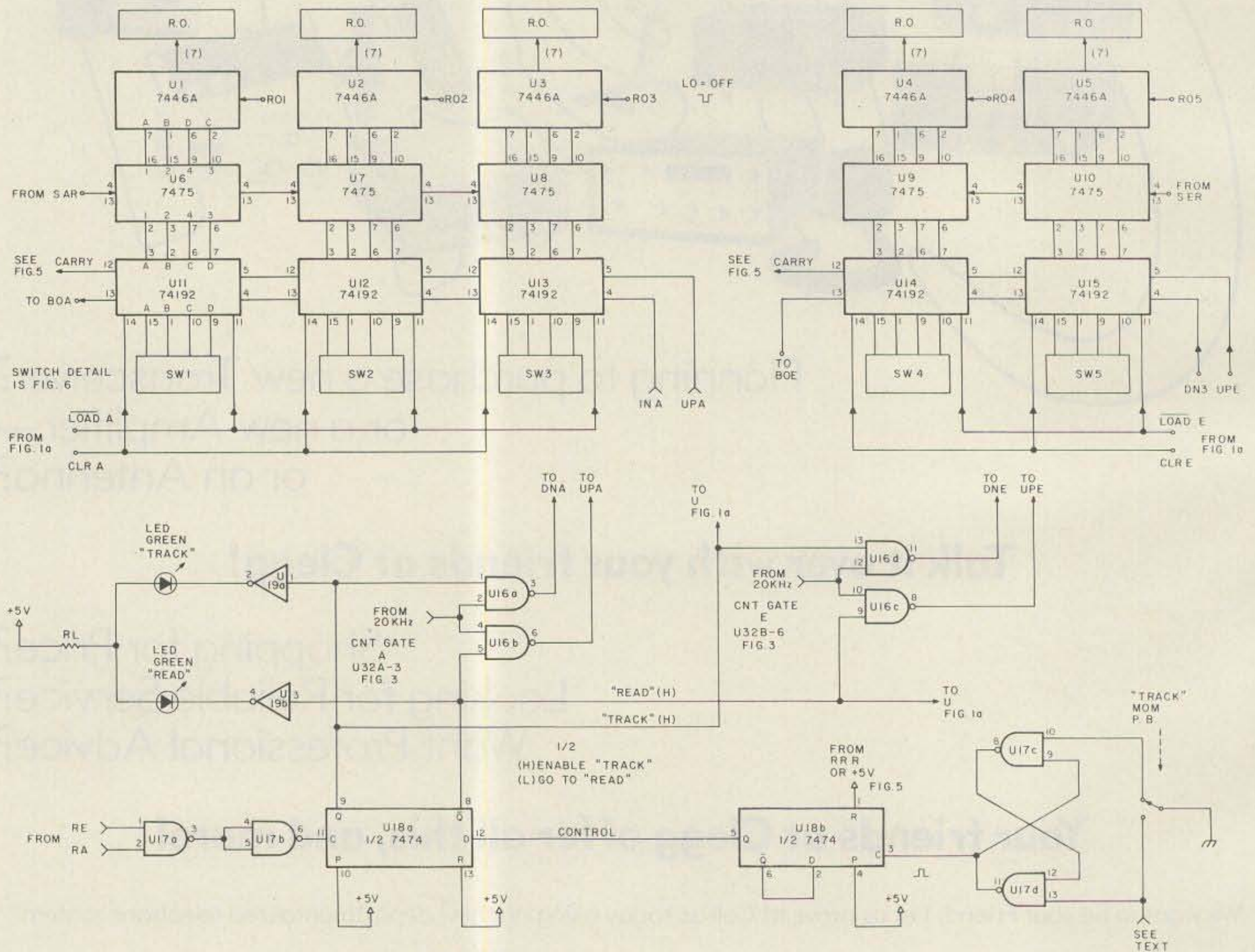

IC	Pin Vcc	Pin Gnd			
U1-5	16	8	U16-17	14	7
U6-10	5	12	U18	14	7
U11-15	16	8	U19	14	7

Fig. 1. Counter and read/track contents. U16—7400; U17—7400; U19—7406.

David J. Brown W9CGI
RR 5, Box 39
Noblesville IN 46060

As a follow-up to my original article on Autotrak (73 Magazine, July, 1977), this article will reflect what a year's change in overall use, my continued system development, and a lot of reading have done for the original system. "Had I only known then..." seems to be an adequate phrase because the new system is as different from the old as night and day are from one another.

The Autotrak II system performs the same chore of aiming celestial-type antennas (El-Az mounting) to chase such things as the moon or OSCAR, but does so with some vast improvements over the old system. Some of these are:

1. The BCD entry system from the antennas no longer needs the BCD or gray-code-encoded "wheels" of the Autotrak I, and, therefore, is easier to set up and adjust. It uses, instead, the 500-Ohm pot found in nearly all commercial rotators sold today—no BCD wheels and no extra control or sense wires!

2. The system has good resolution (crystal timebase) and is very temperature stable, as all systems electronics are indoors at a relatively constant temperature, as opposed to those which are outdoors at the antenna end.

3. There is a large reduction in hardware, especially if you leave off the "frills" of Fig. 5. If you don't want the automatic feature, but do want accurate setting (BCD switches) and digital readout (7-segment LEDs),

the circuit becomes even easier by eliminating most of Fig. 6.

4. My sincere thanks and credit are due to W6URH and his article in the November, 1977, issue of *Ham Radio* magazine. The article was on a digital locked receiver, but the counter scheme really got me thinking about its use in my Autotrak system. If you compare the two articles, you will no doubt see the striking similarities.

5. There was one major system fault which held up improvement until now. If you use any kind of pulse counting (ratchet wheel and microswitch at the antenna, etc.) system, the whole thing comes apart when you get to the counter part. If a ratchet were used, what would happen when you returned days later and turned power on? A memory, perhaps?—no, because of cost and constant power drain. Add that to a 90:1 change in elevation, or 360:1 change in azimuth, and vco's seem ruled out, too. But, in truth, they are not. You only have to use them properly, and the ratios suddenly become far less.

6. Finally, an idea I used in an earlier device to make a highly versatile tachometer circuit and a method used when counting low frequencies struck home. If you choose a good stable timebase of the right frequency as the "counts," or degrees, and allow the count gate time (period) to vary, a whole new picture develops. I have done just that on

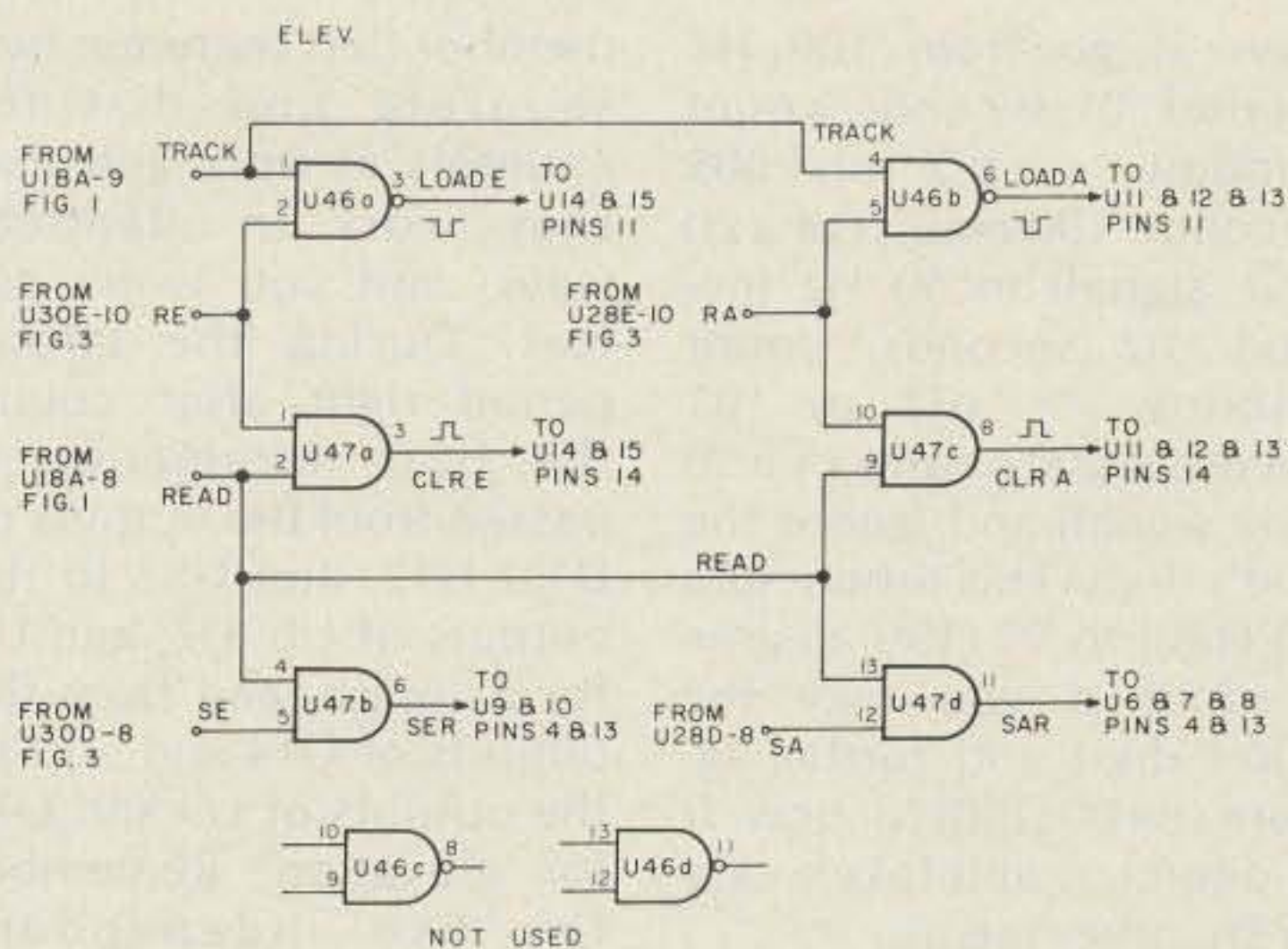

IC		Pin Vcc	Pin Gnd
U46	7400	14	7
U47	7408	14	7

Fig. 1(a).

Autotrak II. The timebase is a crystal-derived 20 kHz, or 1 pulse per 50 μ s. By making the window the right width, the right count occurs.

7. Further, I do run vco's for both elevation and azimuth. The 566 IC can easily change frequency 2:1 on the modulation input pin alone. By choosing the right frequency for the vco clocks and gating properly, 2:1 windows are formed which count just what you need for proper readout. The count is never zero. (I'll cover that better further into the article, but, for now, just be advised that that solves all my linearity and VLF-vco problems.)

Since a counter scheme started the whole ball rolling, that seems to be the logical place to begin my system explanation. If you consider just U11, U12, and U13, or U14 and U15 with the gating of U16, you have very simple 3- and 2-digit frequency counters, respectively. U16 is the count gate, and, for the moment, I will consider only up counting as you are used to seeing in frequency counters (U16b and c). As I mentioned, the same 20 kHz timebase frequency is applied to both the azimuth 3-digit and elevation

2-digit counters through U16. This is true in both up and down counting. The count gate window is formed by the externally generated frequency, much the same as period counting in a period/frequency counter is. Ignore the preload lines with SWs connected to them and the load lines' pin 11 for the moment. You have then a simple up counter that "reads" X number of 20 kHz pulses depending on the window period, which depends on the vco frequency, which in turn depends on the antenna position and 500-Ohm rotor pot.

The generation of timing I will cover in detail in discussing Fig. 3, so, for now, I'll just give a sequence. The gates produce a count period, then a strobe period, then a reset period, and, last, an unused period (x). The entire sequence is repeated over and over. The period of each window and the overall sample period is determined by the particular controlling vco. As an example, look over Table 1, and note that the elevation vco runs at 100 Hz for 00 degrees and 50 Hz for 100 degrees. In order not to have the vco ever have to go to a zero frequency, I decided to

have it go from 100 Hz (period .01 seconds, count window = $p/2$ or .005 seconds, 100 counts of a 20 kHz signal) to 50 Hz (period .02 seconds, count window = $p/2$ or .01 seconds, 200 counts of a 20 kHz signal) and ignore the 100's digit. This produces a 00 (100) to 99 (199) degree readout if you take the 100's digit and further ignore the 00 (200) for now. It is detected and taken care of by other means.

So the counter counts for the count period the proper number of counts representing a degrees position of the rotor pot. That's normal frequency counter operation. Re-

member that there are two separate and distinct counters at work and that they work in identical ways, and you won't get lost. During the strobe period right after count, the BCD information is passed from the outputs of U11, U12, and U13 to the outputs of U6, U7, and U8 for azimuth, and from the outputs of U14 and U15 to the outputs of U9 and U10 for elevation. Remember the two independent counters. The next period is reset, and, neglecting the how for now until we get to discussion of Fig. 1(a), this generates a clear (⌐) pulse for pins 14 of the counters. The up counter mode is

called the "read" mode because that is just what you do. The read mode counts the antenna position, and via U1, U2, and U3 for azimuth and U4 and U5 for elevation, displays it in the proper readout. That sums up the up counter/read mode. It is merely a "Where am I at?" function.

Still in Fig. 1, you have no doubt noticed that the 74192s possess a few lines and functions which are missing on the more familiar 7490/7493 family. These include the load line and preload lines connected to the SWs I had you ignore and a down counting function. Starting with the latter, in an up-count-only-

type IC, only one IC input is needed for two reasons—one, you are only counting one way, and two, the counter "knows" when it fills up (counts to 10 in a decade counter) to pass a 1 on to the next MSB counter as an up count or "carry" function. For the same reasoning, an up/down counter must have two inputs—one each to count each way, and two more to tell the next MSB to add a 1 or to subtract it. These further two lines are called "carry" and "borrow," respectively.

For the first down counter example, let's consider that all the SWs are decimal (0-9) reading and BCD output switches very common on the market today. You can set in a number desired (azimuth and/or elevation) in the 0-9 form you are used to using (ten-position switch), and the outputs are 4 BCD lines from each switch. When you connect these at the SW positions, BCD information for where you want to go is available to input on the preload lines of the 74192s. Since the down counting occurs in what I call the "track" mode, look at the bottom of Fig. 1 and I'll explain how to get to that mode.

To the far right of the schematic is a push-button momentary switch. Each time it is pushed, you change modes from read, to track, to read, etc. Pushing the push-button produces a clean TTL pulse out of U17d-11 to the U18b-3 clock input. U18b uses the leading edge of the pulse to put into the Q-output whatever is on the D-line at that time. The D-input, in this case, is merely the \overline{Q} -output of U18b-6. If U18b is in $\overline{Q} = 1$, then Q becomes 1, forcing \overline{Q} to 0. If U18b is in $Q = 1$, then $\overline{Q} = 0$, and Q becomes 0, forcing \overline{Q} to 1. It's a simple toggle switch. If this high in one mode

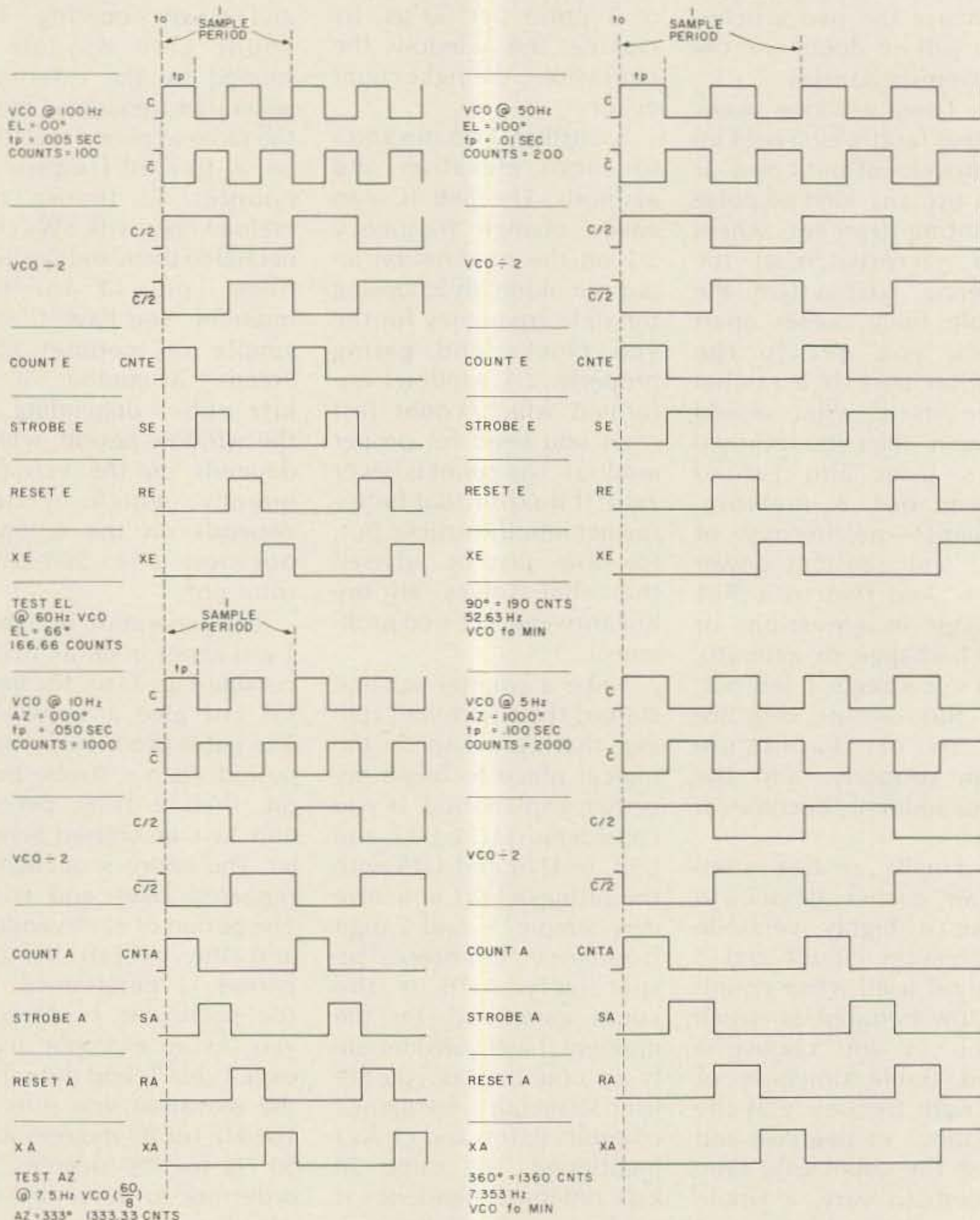

Table 1. Timing chart.

and low in the other mode were directly used to control the read/track mode changeover, all kinds of strange things could happen in counters, latches, and readouts. Remember, in a counter of any kind, timing is everything! I keep the strange things from happening by using the other half of U18 to determine when the mode change will occur in a sample period.

Start in the read mode you were in. A count period occurs (up counting the counters), and the strobes cause independent loading of the 7475 azimuth and elevation latches. Now, when both counters are in the reset period (data all locked up for the counters and readouts), and only then, does the U18a put the level on its D-input (output from U18b-5, high for track, low for read) onto its outputs by forcing its Q-output to go to D-level (input). When

U18a-9 (Q-output) is high, the \bar{Q} on U18b-8 is low. This enables the down counter gates and disables the up counter gates.

Since you are in the reset part of the sample period, the gating of Fig. 1(a) causes two things to happen. First, the strobe that has been causing the latches to pass data to the readout is disabled, causing the readouts to continuously display where you were when the mode button was pushed to the track mode. Also, the reset line is rerouted and used to cause a load command. The counters are no longer cleared, but rather preloaded in the reset period. As you are in the reset mode now, the contents of the BCD switches (SWs) are loaded into the counters directly, just as though you had counted to get there. Next comes the extra period (x) where nothing is done, and then it's on to a new sample period.

When the next sample period begins, the counters are already loaded with a number. Let's use azimuth and the SWs set at 180 (degrees—due south). Suppose further that the antennas were at 270 (degrees—due west). The display will remain locked up at a 270 readout during the entire track mode operation, since strobe is disabled then from getting to the latches. The gates have switched to down count, and the number 180 has been entered into the counters during reset (a load command when in track mode). The first operation of a new sample period is count, and so the counters begin counting down. Note that the count gate will be long enough to allow 270 counts to pass. This causes the MSB count-

er U11 to "underflow" and generate a borrow command normally used to steal a count from the next MSB counter. There is no such counter here, so it is used to operate other control circuitry we can now begin to cover in Fig. 2. Let's stay with the azimuth example.

The borrow pulse enters U20c-10 once for each sample period that the antenna readout numbers exceed the desired switch input numbers. Borrow is a negative-going pulse (\bar{B}) that causes a positive-going set condition on U20c-8 if it is not already set. The previous $\bar{R}A$ into U20d-12 assures this is the case. The leading edge of the positive-going sets condition clocks U22-3 and causes the \bar{Q} output U22-6 to go low. This low is used

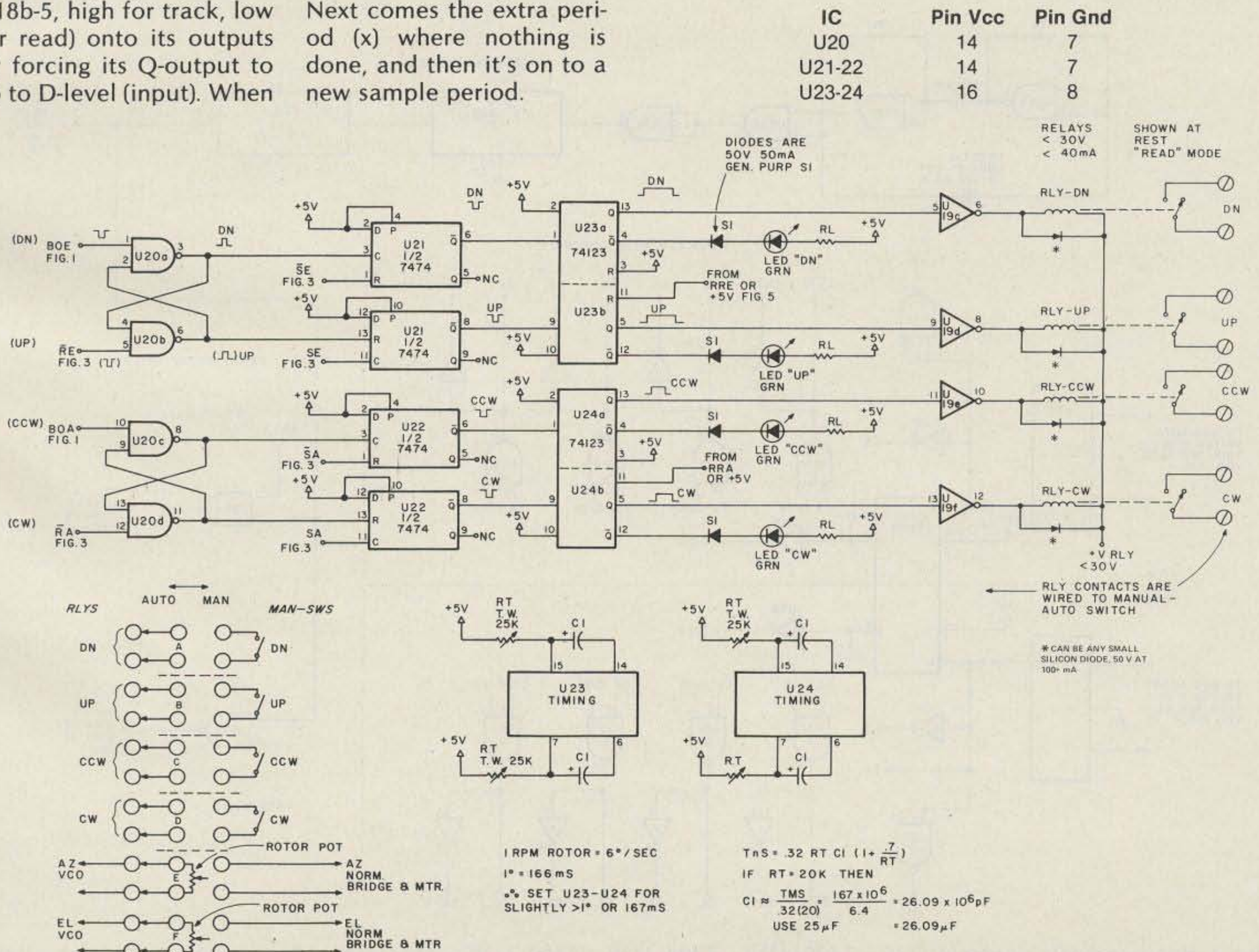

Fig. 2. Antenna control. C1 is tantalum capacitor 15 V; RT in k Ω ; C1 in pF. U20 = 7400.

to clock a one-shot, U24a, to output a positive-going pulse at U24a-13. This one-shot period is made longer than a 1-degree change in the rotor (or 166 ms) to give a carryover effect from degree to degree. Since this departs from the original author's ideas, here's why:

The original system used in a receiver used these output-pulsed lines from U21 and U22 to control devices which charged or discharged a capacitor whose dc voltage was used to control the vco of the receiver—hence it had digital afc. Since I am controlling relays and did not want them pulsing on and off rapidly at the sample

period rate, I use the one-shots to stretch the pulses into a long enough period to hold the relay closed from degree to degree. If triacs or the like were used and the rotator used did not object to pulsed power, the pulse stretchers would not be needed. Since I already had the relay panel in the Autotrak I system and didn't know the rotator motor's nature about pulsed power, I went my way.

In my example, the CCW relay would pull in. CCW refers to a top view of the antennas. CW does the exact opposite. In elevation, the up/down terms are self-explanatory, with 00

being straight ahead and 90 being straight up. CCW is the desired result in our example, and the antenna degrees begin decreasing with the sample period until the count just equals preload (180 = 180). At this time, no borrow pulse occurs. Due to the timing of gate U20 and the control lines to U21 and U22, this condition (=) causes no pulses out of either the CW or CCW part of U22—no pulses, one-shot period runs out, relay drops out, and antenna stops. How we get back to read and a proper display will be covered later.

Changing the example slightly, make the SWs the same 180, and change the original antenna position to 90 (degrees—due east). I am using large examples to show that several sample periods occur. For the

antenna to turn either way through 90 degrees of both examples takes about 15 seconds in the average 1 rpm rotator. This is many ms-type sample periods. When the antenna position in degrees is less than the desired SW input in degrees, the following occurs. First of all, you enter track mode the same way, and strobe disable, count-down enable, and preload take the place of clear. Track mode is the same for both ways of rotation, with only the down count result changing. If the 180 figure is preloaded into the counters during the first period of resets (load), then, during the next sample period first window (count), the counters will again count down. This time the count window only allows fewer counts to be counted down than the

IC	Vcc	Gnd
U25	14	7
U26-27	5	10
U28-29-30-31-32	14	7
U33	4	11

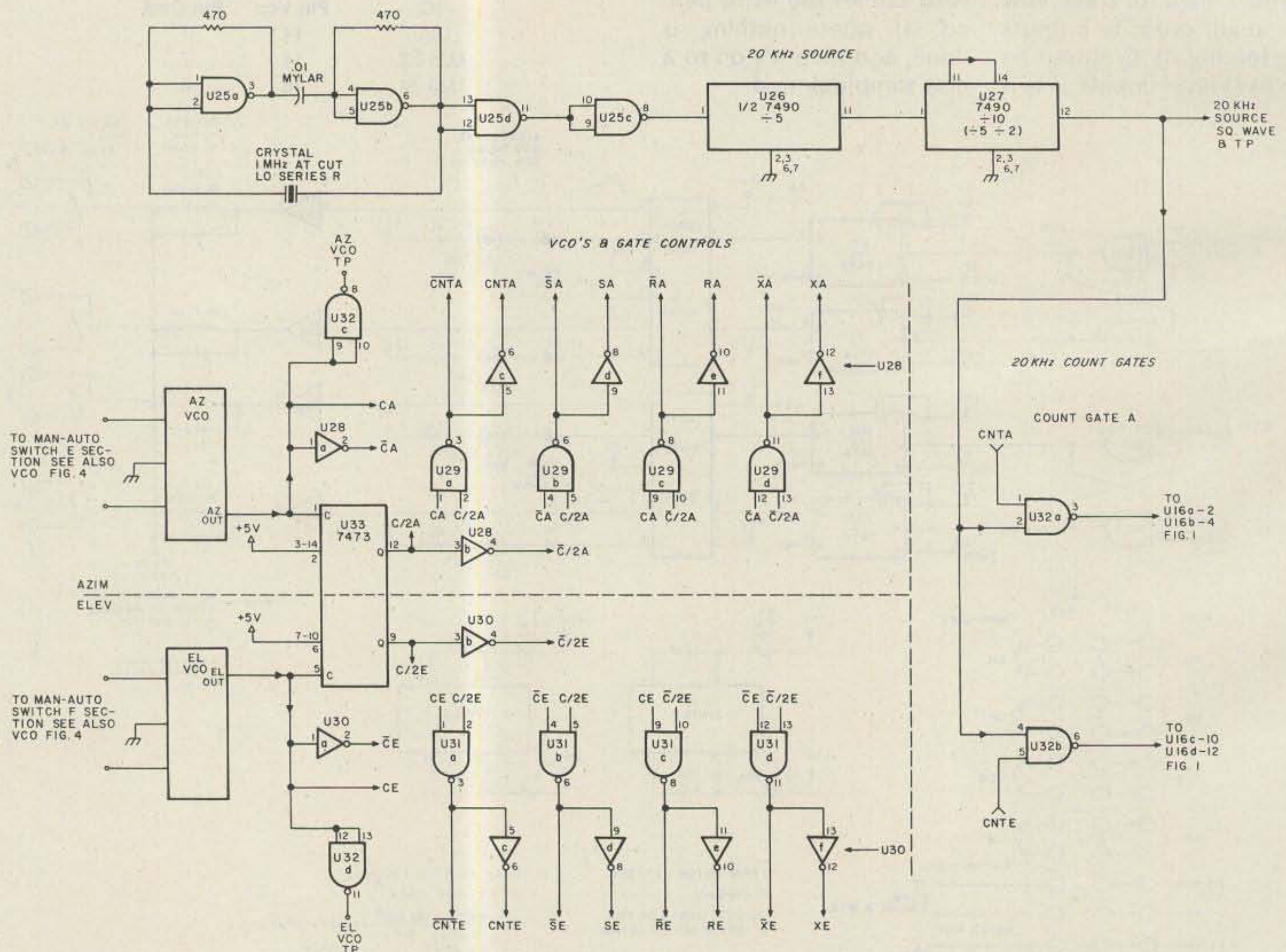

Fig. 3. Vco's and gate controls. U25—7400; U28—7404; U29—7400; U30—7404; U31—7400; U32—7400; U33—7473. 1/4 W film resistors.

preload figure, and no borrow pulse occurs. With U20d-11 now in the set (high) mode, the reset line U22-13 allows U22-8 to toggle low whenever a clock pulse comes along on U22-11. This happens during the strobe period following a countdown, and the leading edge of a pulse (strobe) toggles U22-8 low. The one-shot follows through as before, using U24b this time, which turns on the CW relay. CW is increase azimuth degrees, and the antennas drive toward 180 from their 90 start point. When 180 is reached, again the (=) exists and the antennas stop. Whenever the (=) exists and the track mode is entered, the timing of U20 and U22 is such that no relay pull-in occurs. That completes a run through for azimuth.

For elevation, exactly the same events occur, but on a 2-digit counter group.

It is as simple as that. What you have is a complete duplicate counter set for elevation from what an azimuth-only setup would be. For just that reason, you could very well build the azimuth-only version for normal on-the-ground communications not requiring elevation changes on the antennas. You cut everything just about in half except the read/track mode circuitry. You would have one 3-digit counter set, all the read/track circuit, half the antenna control (U20, U22, U24, and U19e and f), CW/CCW relays, one vco (azimuth), the same 20 kHz timebase, and whichever switch option you want from Fig. 6.

As usual, I have left for last the best and most important part of the explanation of Figs. 3 and 4. Fig. 4 is just a detail drawing of the vco part of Fig. 3. On Fig. 3, the easiest part to cover first is the timebase, and it

is very straightforward. A quite common TTL oscillator uses a 1 MHz crystal that you can trim by using one of the harmonics beat against WWV if you desire. I did not trim mine, so no trimmer is shown. Remember that you are dividing by 50, and, if you send any reputable crystal manufacturer the circuit schematic, the error in the crystal will more than likely be erased by the divide-by-50 process. Also, you have control over the count windows, so you can fudge things there for small errors if need be. I didn't have to, as the crystal I got, when plugged into the circuit, ran at 1.00000126 MHz (divided by 50 = 20.00002520 kHz). The error is further spread over all 20,000 Hz, and only a

small part (4000) is the maximum ever used. Resolution is resolution, but don't get ridiculous! The clock out is applied to the count gates as a fixed 20 kHz signal.

Jumping to Fig. 4 briefly, the vco's are quite standard use of the 566 vco, so I won't go into any more detail than the formulas and tips supplied on the figure. Suffice it to say that the elevation vco outputs 50 to 100 Hz, and the azimuth (due to an added divide-by-10) would put out 5 to 10 Hz were it not for the setup. That will be covered in the Fig. 4 notes and the calibration procedure.

Back on Fig. 3, and again using azimuth as our example, the 7+ to 10 Hz coming from the azimuth vco is applied to four places.

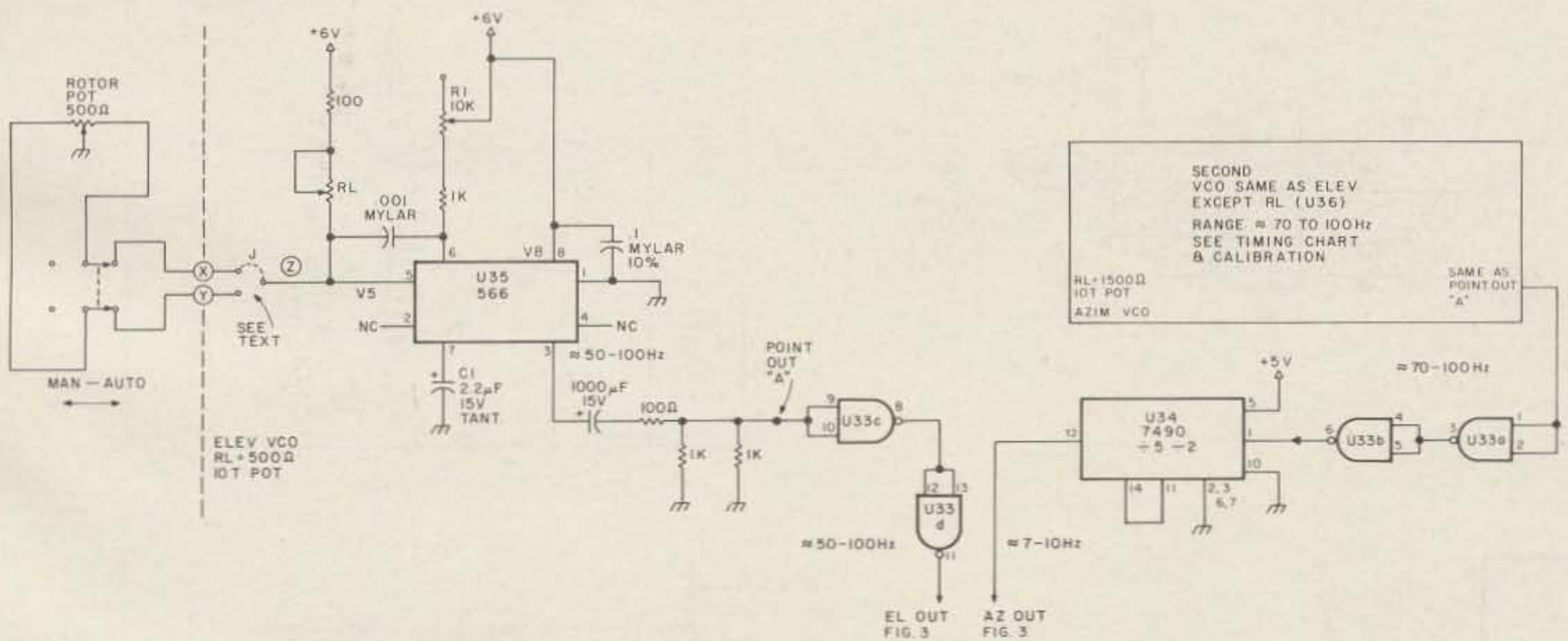

IC	Pin Vcc	Pin Gnd
U33	14	7
U34	5	10
U35-36	8	1

Fig. 4. All resistors are 1/2 Watt metal film for temperature stability, 5% tol. U33—7400; U34—7490; U35-36—566. Vco formulas: $f_o = 2(V_8 - V_5)/(R1C1)V_8$.

With V_5 gnd (by rotor pot) and RL_{EL} set at 400 Ω :

a. $f_o = 2(V_8)/(R1C1)V_8 = 2/R1C1$

With $V_5 + 3$ V (rotor pot set at 500 Ω) and RL_{EL} set at 400 Ω :

b. $f_o = 2(+6 - 3)/(R1C1)6 = 1/R1C1$

c. With R1 set at $\approx 9091 \Omega$ and $C1 = 2.2 \mu F$, $2/9091(2.2) \times 10^{-6} = 99.999 \text{ Hz} (\approx 100 \text{ Hz})$.

d. With R1 set at $\approx 9091 \Omega$ and $C1 = 2.2 \mu F$, $1/9091(2.2) \times 10^{-6} = 49.9995 \text{ Hz} (\approx 50 \text{ Hz})$.

e. For azim., R1C1 same, $RL = 1500 \Omega$, part a. same for 100 Hz $\therefore \div 10$ for 10 Hz frequency. Low frequency = 1360 counts $\times 1/20 \text{ kHz} = .068 \text{ sec}$. CNT a. For .068 sec. CNT, period = $2T$ (or 1 cycle) = .136 sec. $1/\text{period} = 7.3529412 \text{ Hz}$. That frequency = 73.529412% of 10 Hz. If $V_5 = 0 \text{ V}$ is 100% and $V_5 = 3 \text{ V}$ is 50%, $0 \text{ V} > V_5 < 3 \text{ V}$ is 73. . . . %. 73. . . . % of 6 V = 4.4117647 or $V_5 = 6 - 4.41 \dots = 1.5882353 \text{ V} = V_5$. $V_5/500 \Omega = 3.1765 \text{ mA}$. $V_{RL} = 4.41 \dots \therefore V_{RL}/I = RL_{total}$. $RL_{total} = 1388.89 \dots \Omega - \text{fixed } 100 \Omega = 1288.89$. Set RL at $\approx 1290 \Omega$ and follow calibration to trim.

U32c is merely a buffer whose function was not needed for anything else and whose output is a frequency counter test point (TP) for vco setup. The vco output becomes one of four gate primary signals, Ca, and, via inverter U28a, a second gate primary signal, $\bar{C}a$. Through a divide-by-2 stage, U33, the Ca signal becomes C/2a, and, via inverter U28b, the last primary gate signal $\bar{C}/2a$. These four commands are further gated in U29 to form four distinct and separate low periods during any sample period and, via the rest of the U28 inverters, the high period

inverses of the four periods. Not all are used, as you will see, but, when I build timebases and control circuits, I like to allow for future plans and expansion. As an example, the CNT a is not used, but it is what is detected, and it must be then inverted to get the CNT a needed. These gates and inverters are the cheapest TTL available, so "spend a bit more and keep versatility" has become my motto!

All the required signals for count (CNT), strobe (S), reset (R), and an extra (x) are formed in both polarities by U28 and U29. The elevation is a carbon copy

derived from the elevation vco frequency and is used to control the elevation counters and gates. (Incidentally, the little letter a denotes azimuth, and the letter e denotes elevation, just so you can follow the schematics more easily.)

At the proper time, the CNT a (\bar{a}) is applied to U32a-1 to pass 20 kHz to the azimuth read/track gate. The same goes for CNT e (\bar{e}) and the elevation read/track gate. And that's all there is to Fig. 3.

Fig. 5 contains circuitry that may prove necessary to some, options to others, and maybe crazy to yet a few more. I, quite frankly, did not use the "El stop" and "Az stop" circuits. They are preventative medicine. They form positive

electronic stops to avoid the almost nonexistent errors that can occur. Using the calculator inputs, I will explain with Fig. 6 the limits of the formulas and the calculator ICs I used. No answers over 90 degrees elevation or 359 degrees azimuth will occur anyway after the program is up and running right. On the manual switch entry version, in elevation, you only have enough switches to enter up to 99 degrees (two switches), so there's no problem, as 00 to 99 degrees are all legal commands in this system. In azimuth, you can only go from 000 to 360 degrees (mechanical stops), but the switches required (three switches) allow a manual entry of all that plus from 360 on up through 999 de-

IC		Pin Vcc	Pin Gnd
U43	7403	14	7
U44	7420	14	7
U45	7403	14	7

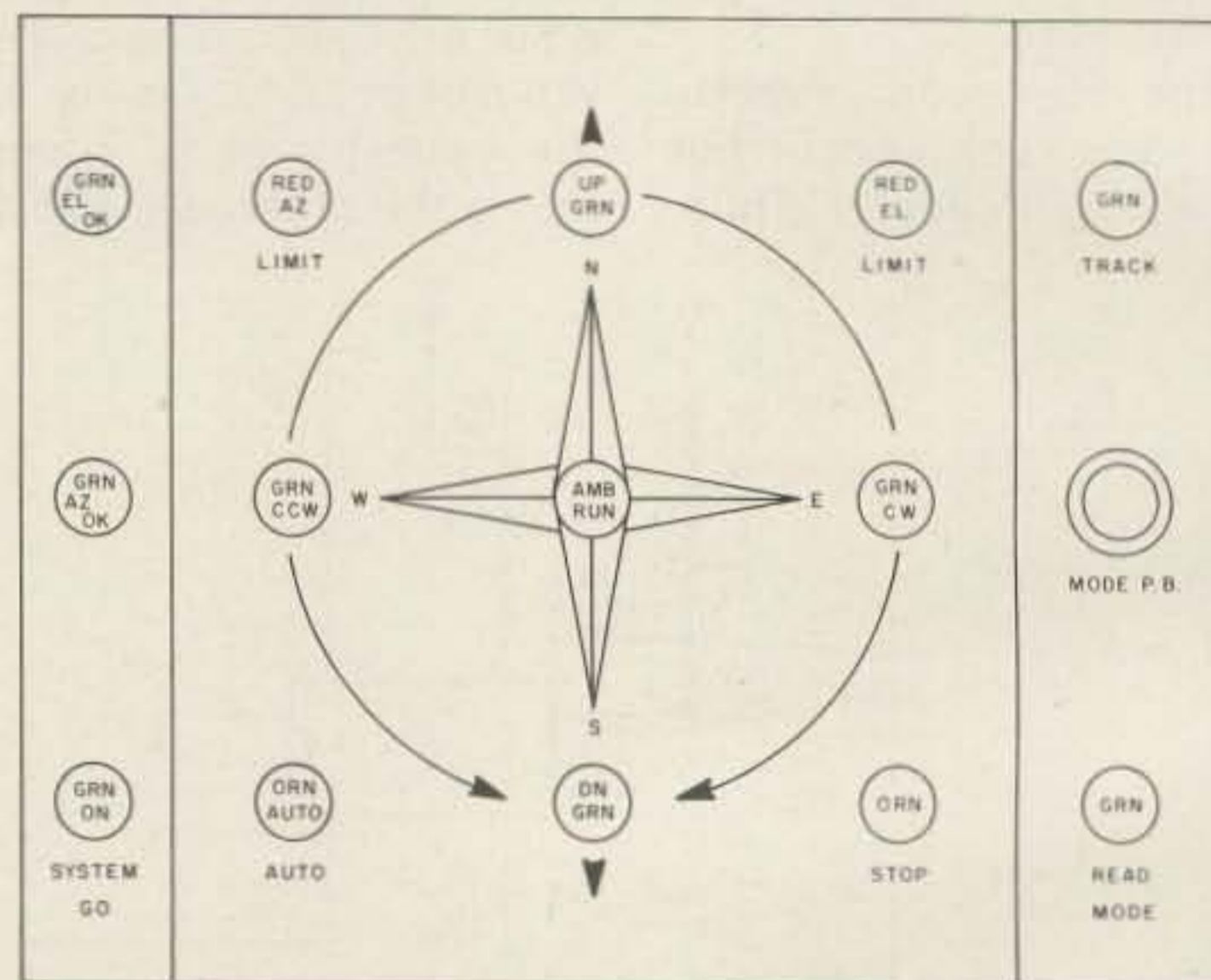
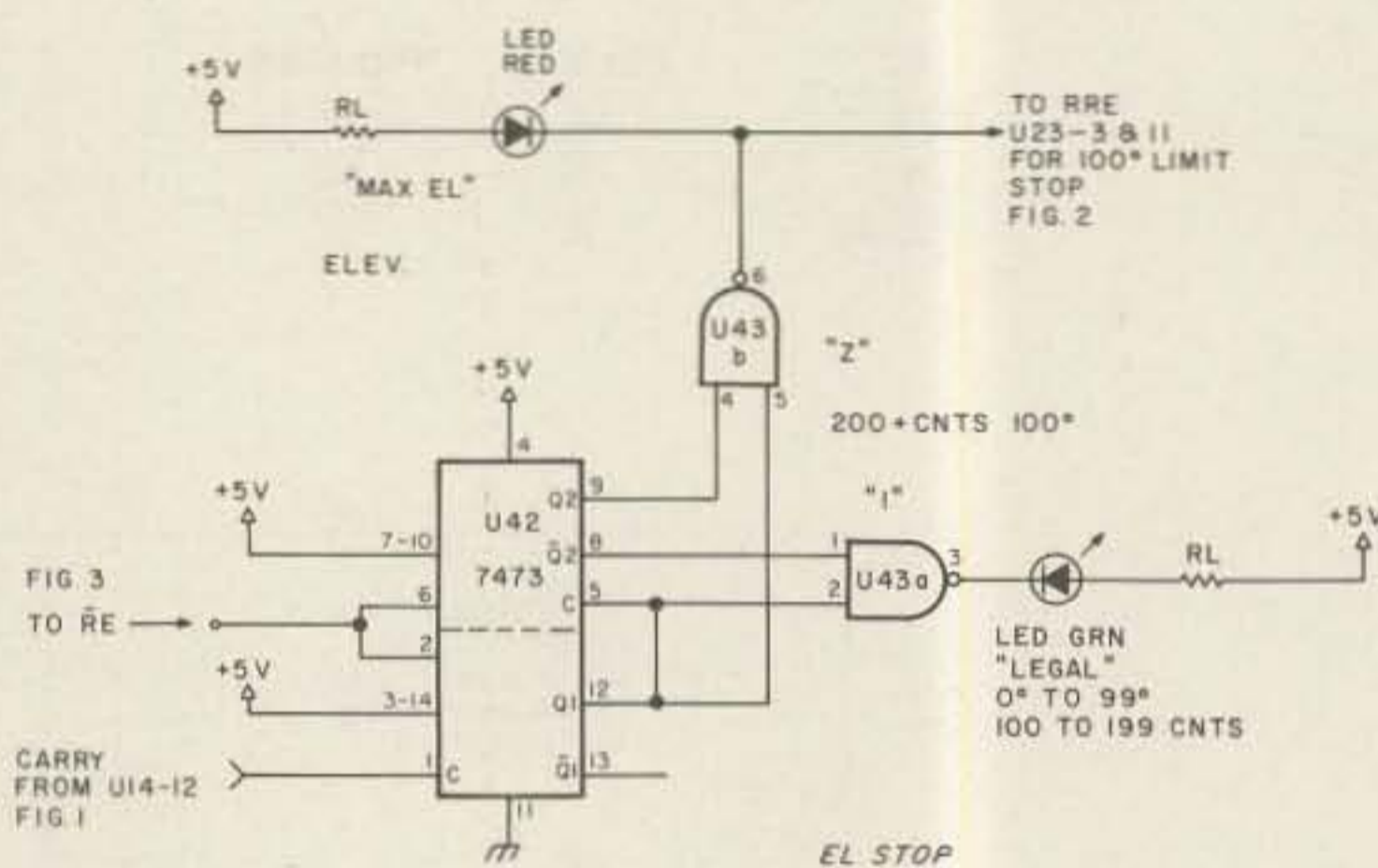

PARTIAL PANEL LAYOUT

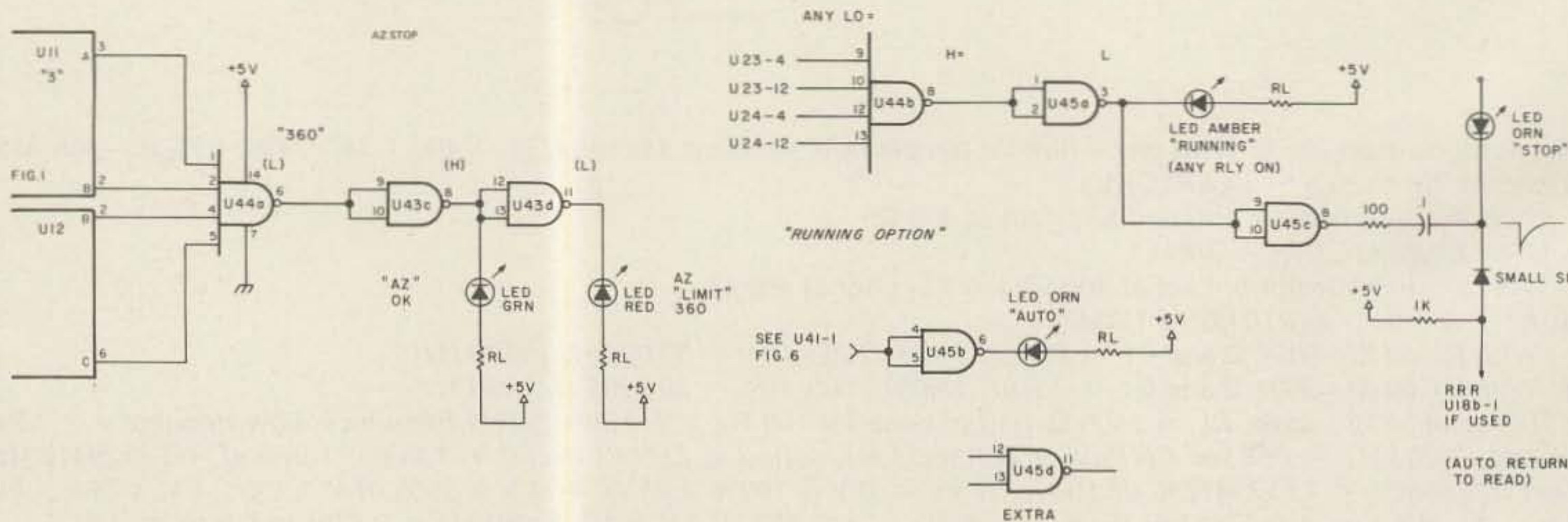

Fig. 5. Mechanical stops handle 350° stop, but, in automatic, the detector U44a-b also shuts off rotor ac via the CW relay and U24 off ($\bar{Q}s$). Handles false calculation data or error in SW entry, e.g., 400°.

grees. So either build the circuits, or watch your entries. If you don't build them, be sure to connect the RRe and RRa points of U23 and U24 (Fig. 2) to +5 volts.

If you add all the extra goodies, a suggested panel layout for a quick look and understanding is shown in Fig. 5. It is neat and quite usable in this fashion. I would include at least the LEDs of Fig. 2 for direction running, U45b if the auto entry of Fig. 6 is used, and the U44b and U45a "running" pair of IC parts.

U45c is nice if you want to automatically return to read mode when both antenna rotators reach their desired location. This isn't important in full automatic, because you won't be looking at the readouts at all except as a check if something suddenly goes afoul. U45c just puts a small reset pulse on the read/track line in place of your finger when all the U44b inputs return high. This drives U44b-8 low, U45a-1 and -2 low, U45a-3 high, the "running" LED off, U45c-9 and -10 high, and U45c-8 low. This causes a small negative-going pulse at the junction of the LED, the general-purpose silicon diode, and the .1 uF capacitor. This blinks the "stop" light (LED) and pulses the read/track line back to read via U18b-1. This allows the counter and readout to update to the new location in degrees.

Fig. 6 covers another option—a very, very useful one that started all of this automation. The 2-line to 1-line IC switches shown allow the preload entry to come from two separate places, depending on the position of the manual/auto switch controlling the select lines U37 to U41, pins 1. When grounded, pin 1 allows the ICs to pass the BCD data from S1 to S5 to SW1 to SW5, respectively.

In other words, you have direct entry by manual thumbwheel switches. If you don't want anything else, follow the notes of Fig. 6 and delete U37 to U41.

When pin 1 is high, it allows data to pass to the preload lines from a second source. This may be interesting to some just as a way to run one antenna from two "control heads," both of which would be thumbwheel switches. In my case, the data comes from other 7475 latches. At first, these were the entries like those used with Autotrak I. Now they are entries from a calculator device I put together and called a Calcuputer, for lack of a more descriptive term. It starts as a basic hand-held-type of RPN calculator by APF called a Mark 55. The calculator set of ICs is by Mostek, as are the MK50075N, MK50103N, and 50104N. I wrote a program (sequence) to follow OSCAR by punching in sequential keys on this calculator and cranking out answers. That then led to automating the whole

thing with a few more ICs. For the sake of explanation here, it boiled down to the answers for elevation (2 digits) and azimuth (3 digits) being dumped out on command to (5) latches, where they are held until needed.

I use a timer IC that outputs two control pulses 1 minute apart and staggered by 30 seconds. The sequence of operation is as follows: Pulse 1 (P1) occurs when I push a button exactly when OSCAR crosses the Equator (from published data). The Calcuputer has been given the Eqx longitude prior to this, been allowed to calculate the El-Az for T1 (Eqx plus 1 minute), and has outputted to the (5) latches. When the next pulse comes along 30 seconds later, it strobes this information into the preload lines and then triggers the read/track to track mode. Then, 30 seconds later at T2, the Calcuputer is started again and uses the new T = 2 minutes input for new answers which

are dumped out into the latches. This sequence is repeated over and over through the T maximum you choose.

I want to explain the other inputs as well. They can also be used to return the antennas to a preferred storage position when you are through operating (into the wind, toward town or a favorite DX direction, etc.) or even tied into the digital wind indicator, as I mentioned earlier in an article on digital wind instruments (*73 Magazine*, Nov., 1976, page 84).

For our small group of EME enthusiasts around the Indianapolis area, this dedicated input control method puts our repeater idea one step closer to remote control of my station antennas very accurately from a remote Indianapolis user's location.

The whole EME station at my QTH was designed around digital remote control, mainly because analog information is a bear to convey or compare. Speak-

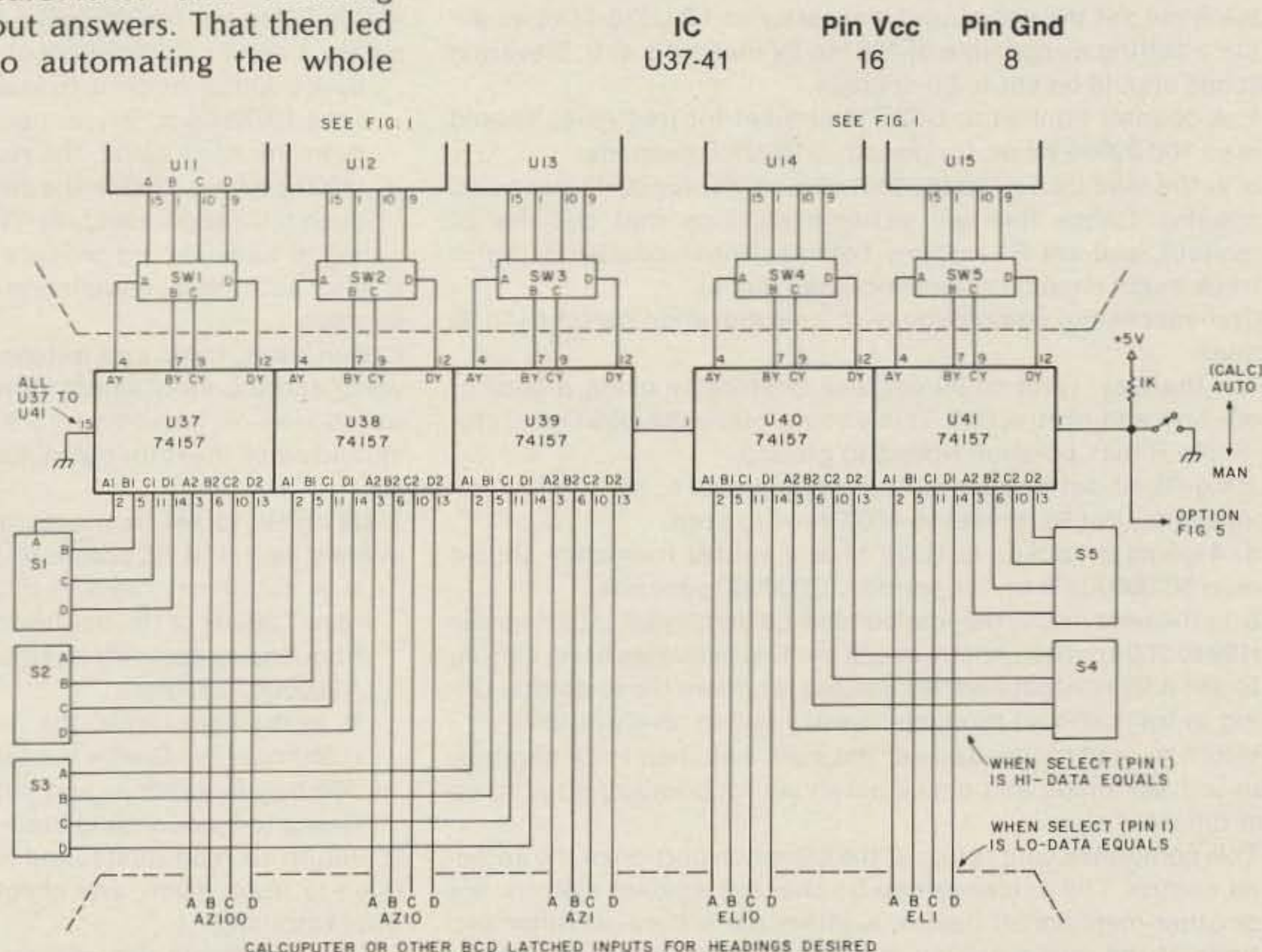

Fig. 6. S1 to S5 are read 0 to 9, BCD output T.W. switches. If manual SW only is desired, connect S1 to SW1, S2 to SW2, etc., and S1a to SW1a, S1b to SW1b, etc., and delete U37 to U41.

ing of digital, I fully believe EME should really pick up soon. Between the narrowband SSB article in a recent *QST* issue and another article on coherent CW which I was already working on (but confess I was not nearly so far along with), the modes of the future all point to narrower bandwidths and are almost always digital in nature. I give as my witness the above NBSSB and CCW examples, backed up by (digital) frequency synthesized receivers so you know exactly what frequency you are on, the (digital) very narrow tracking filters tuned by just adjusting a variable oscillator into them, and the forms of afc

tracking receivers such as that on which my hardware is based.

To close this article, may I issue a small challenge to all you dedicated remaining builders—especially the digital IC types? How about the feasibility (and it would seem to be very inexpensive even at TTL prices) of a fully digital transmit and receive system for weak signal work? (1) It should include a synthesis scheme for all the transmitter and receiver (transceive) operations. (2) All of the filters and band-pass (i-fs, bfo, etc.) devices should be digital tracking types. (3) It should have a lock or afc mode such as the one I started with here.

(4) It should be locked to, traceable to, or have a countdown scheme involving a reliable master oscillator determining the operating frequency (i.e., WWV, CHU, etc.). (5) The digital readout and display should go down to cycles or, at the very least, 10s of cycles is a must. (6) It should use coherent CW and very narrowband SSB or FM as modes, and the FM detector should be a digital pulse counting type (the FM for inherent AM noise immunity which even improves in a digital system as all transitions are saturating, eliminating AM just as a limiter does). (7) The transmitter should run class D (digital) switching

for fairly high power output out of low power devices (they are on or off and therefore dissipate little power themselves). (8) The class D goes for the audio outputs in the receiver as well. (9) Readout must employ mixing of hfo, lfo, and bfo oscillators to give an exact frequency out reading. (10) Oscillators should be vco's so that a dial input can be used.

Is this ten times an impossibility? Not on your life! All the above is available now and at a TTL-type of expense. Now who is going to be the first to build one? (P.S. If you think I'm just kidding, mine is half done!) ■

Table 2. Calibration/setup.

Use a well regulated +6 volts on vco sections and good quality parts. Vco elevation :: Rough set R1 = 8100 Ohms.

1. With RL rough set to around 400 Ohms, run elev. rotor and antennas to 00 degrees elev. This will be a mechanical rotor stop, so set it accurately using a level.
2. Measure X to ground and Y to ground and insert jumper between Z and the X or Y terminal that reads zero (0) Ohms to ground.
3. When Z to ground is zero Ohms, V5 is 0 volts, and the vco runs at its highest frequency (100 Hz), determined by the setting of R1. (This is the shortest gate period, thus 00 degrees—100 cnts.)
4. Use R1 to set the vco output frequency at TP U32d-11 to as accurate a setting as possible of 100 Hz, by method a or b. Elevation switches should be set to 00 degrees.
 - a. A counter hooked to U32d-11 and set for frequency should read 100.00000 Hz or, for period, .01000000 seconds.
 - b. In the read mode, the readout should display 00 degrees (100 counts). Check the two extreme settings that get the 00 readout, and set R1 midway between these points. Going to track mode should produce no relay pull-in.
5. After successful completion of (4.), set elevation switches to 99 degrees.
6. Run the elev. rotor to 99 degrees (preferably using a level or plumb bob and protractor). This should place the 500-Ohm rotor pot in the R max position from Z to ground.
7. Using RL to set frequency and method a or b, set the low frequency limit. Pot RL preset to 400 Ohms to start.
 - a. A counter hooked to U32d-11 and set for frequency should read 50.00000 Hz or, for period, .02000000 seconds.
 - b. In the read mode, the readout should display 99 or 00 degrees (199 to 200 counts). Again, check the two extremes of RL setting to get a 99 readout and set midway between these points. Going to track should produce no relay pull-in on elevation.
8. Return to read mode, and set the elev. switches to 90 degrees. Push to track mode and check antennas for pointing straight up after the rotor stop.

This completes calibration of the elevation portion of the antenna control. The antennas can be checked against a protractor or other mechanical device, weather permitting, at other settings. If the relays are mounted on a separate board and the board is mechanically "floated" (rubber grommets), then the pots should hold accuracy. If in doubt, a drop of nail polish or glue from the shaft to case will fix things up after calibration. Just be careful to use something that can be removed later if

need be, and get none down inside the pots.

The calibration of the azimuth portion follows the same general procedure. Set the Az switches to 000 degrees and R1 = 8100 Ohms.

1. With RL rough set at 1290 Ohms, run the azim. rotor and antennas to north through east (CCW). This is one of two mechanical stops and should be done accurately.
 2. Measure X to ground and Y to ground and insert a jumper between Z and the X or Y terminal that reads zero Ohms to ground.
 3. Same as elev. (shortest gate period).
 4. Use R1 to set the vco output frequency at TP U32c-8 to as accurate a setting as possible of 10 Hz, by method a or b.
 - a. A counter hooked to U32c-8 and set for frequency should read 10.00000 Hz or, for period, .10000000 sec.
 - b. In the read mode, the readout should display 000 degrees (1000 counts). Check the two extremes of R1 setting that produce this readout and set R1 midway between these points. Going to track should produce no relay pull-in.
 5. After successful completion of (4.), set azimuth switches to 360 degrees.
 6. Run azim. rotor and antennas to 360 degrees (north through west) and the mechanical stop. Check for true north, and, if not, run to true north (some rotors allow 360 + a few degrees). This should place the rotor pot in maximum Ohms to ground position at Z.
 7. Using RL to set frequency and method a or b, set the low frequency limit. Pot RL preset to 1290 Ohms to start.
 - a. A counter hooked to U32c-8 and set for frequency should read 7.3529412 Hz, but few digital counters can handle the low frequencies accurately, so use period and set RL for a period of .13600000 seconds.
 - b. In the read mode, the readout should display 360 degrees (1360 counts). Check the two extreme settings that produce a 360 degree readout and set R midway between these points. Going to track should produce no relay pull-in.
 8. Return to read mode, and set azim. switches to 180 degrees. Push to track mode, and check antennas for pointing due south after rotor stop.
- This completes the calibration of the azimuth portion of the antenna control. The antennas can be checked at the cardinal compass points N, E, S, W, N, weather permitting, by compass. The view from the ground is really accurate enough for most amateur work, anyway.

SST T-4 ULTRA TUNER

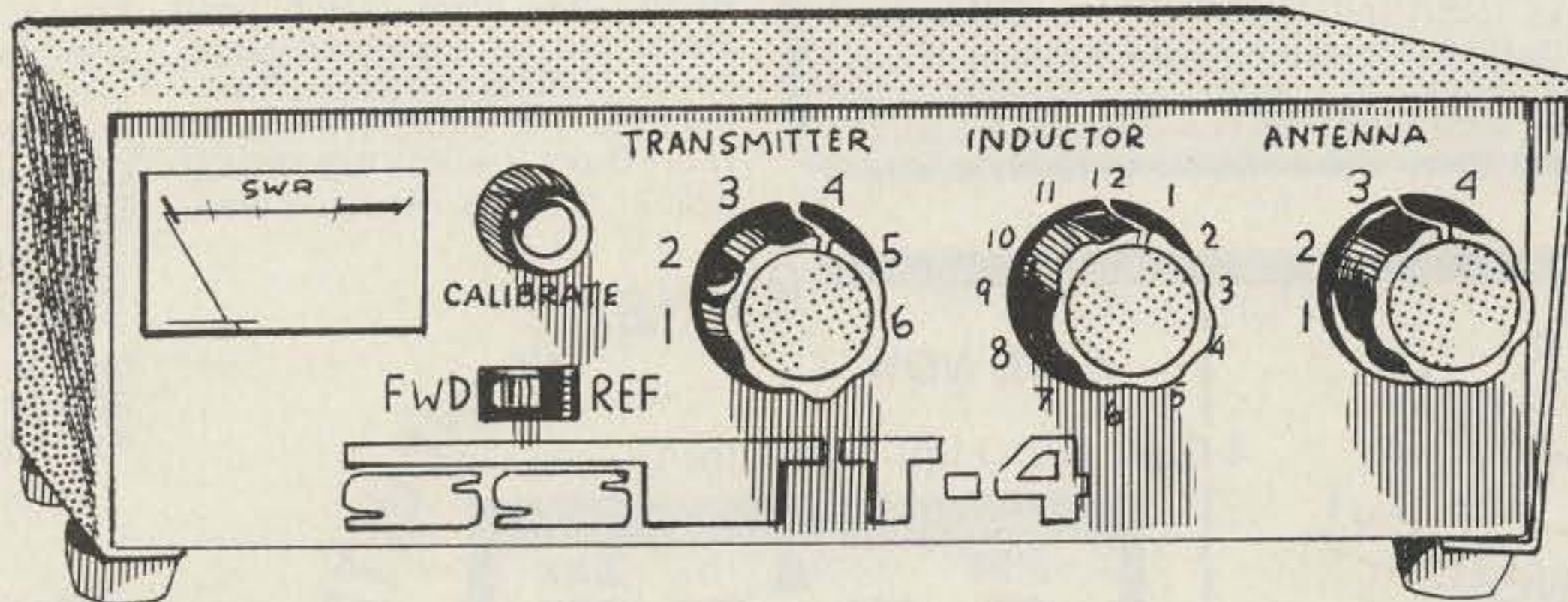

ULTRA TUNER DELUXE

The new SST T-4 Ultra Tuner Deluxe matches any antenna---coax fed or random wire on all bands (160-10 meters). Use it with your dipole, vertical, beam, etc. It works with any transceiver.

Tune out the SWR on your antenna for more efficient operation of your rig. One antenna can even be used for all bands. The SWR on mobile whips can be tuned out from inside your car.

An easy-to-read two color meter scale provides convenient indication of SWR for easy tuning. A back panel antenna switch allows you to select between two coax fed antennas, a random wire, or tuner bypass.

The SST T-4 Ultra Tuner Deluxe is compatible with any rig---solid state or tube. It's compact size (9" x 2-1/2" x 5") makes it ideal for mobile, portable, or home operation. Features an attractive bronze finished enclosure and exclusive SST styling.

Features:

- Matches any antenna - coax fed or random wire. 1.8-30 MHz.
- 300 watt **output** power capability.
- SWR meter.
- Antenna switch on back panel.
- Efficient tapped inductor.
- 208 pf. 1000v. capacitors for flexible, reliable operation.
- Johnson binding posts. Four SO-239 connectors.
- Made in USA.

Compare features, quality, and price---SST antenna tuners are your best value. This is our seventh year of manufacturing compact antenna tuners.

Available now at your SST dealer or order direct---information on following page.

✓ S10

only \$69.95

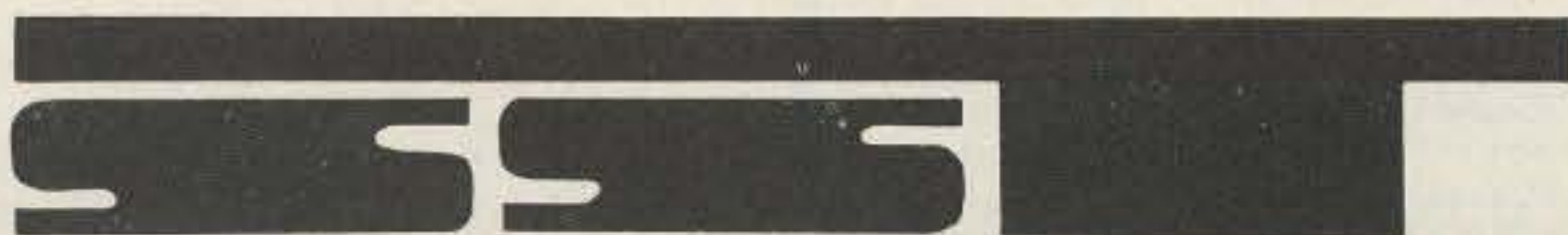

ELECTRONICS

P.O. BOX 1 LAWNSDALE, CALIF.
90260 • (213) 376-5887

JUST GETTING ON THE AIR?
See Adirondack for



- New Equipment
- Used Gear
- Friendly Advice

ADIRONDACK Radio Supply

185-191 West Main Street • P.O. Box 88
 Amsterdam, N.Y. 12010 Tel. (518) 842-8350
 Just 5 minutes from N.Y. Thruway - Exit 27

Social Events

**OAK PARK MI
 JAN 7**

The Oak Park Amateur Radio Club will hold its 10th annual swap & shop on Sunday, January 7, 1979, from 8:00 am to 3:00 pm, at Oak Park High School, Coolidge at 9½ Mile Road, Oak Park, Michigan. There will be expanded table space, parking and prizes. Talk-in on .52. For information, contact Dave Lefko WB8RGQ, 32252 12 Mile Road, Farm-

ington Hills MI 48018.

**SOUTH BEND IN
 JAN 7**

The Repeater Valley Hamfest Swap & Shop will be held on Sunday, January 7, 1979, at the New Century Center on US 31 in South Bend, Indiana. This event will be held indoors with food service available. An automobile museum and art center are in the same building. Tables are \$3.00. Talk-in on 146.13/.73, .34/.94, and .52/.52; 147.99/.39, .93/.33, .84/.24, and .69/.09. For information, contact Wayne Werts K9IXU, 1889 Riverside Drive, South Bend IN 46616; (219)-233-5307.

**RICHMOND VA
 JAN 14**

The Richmond Amateur Telecommunications Society will hold its Frostfest-II on January 14, 1979, at the Bon Air Community Center in Richmond, Virginia. Talk-in on .28/.88, .34/.94, and .52. There will be a technical symposium, a drawing, and a home-brewers' contest with two divisions, over 18 and under. FCC exams will be administered starting at 10:00 am. To take the exam, mail Form 610 at least five days prior to the Fest to the address below. Commercial exhibitors are by invitation only. There will be an indoor flea market with one table for \$2.50 and outdoor tailgate space for \$1.00. Admission is \$2.50. For information, contact the Richmond Amateur Telecommunications Society, PO Box 1070, Richmond VA 23208.

**WAUKESHA WI
 JAN 20**

The West Allis Radio Amateur Club, Inc., will hold its 7th annual midwinter swapfest on Saturday, January 20, 1979, starting at 8:00 am, at the Waukesha County Expo Center, Waukesha, Wisconsin. There will be food, beer, and prizes. Directions are as follows: I-94 to Waukesha Co. F, south to FT, west to Expo. Admission is \$1.50 in advance and \$2.50 at the door. Reserved tables are \$3.00 (until January 12). For information, send an SASE to WARAC, PO Box 1072, Milwaukee WI 53201.

**SOUTHFIELD MI
 JAN 21**

The Southfield High School Amateur Radio Club will hold its 14th annual Swap & Shop on Sunday, January 21, 1979, at Southfield High School, Southfield, Michigan, at 10 Mile and

OUR
 CATALOGUE
 WILL SAVE
 YOU MONEY!

**FREE
 CATALOG**

- RF CONNECTORS • ANTENNAS
- SWITCHES • TRANSFORMERS
- ETCHING KITS • RESISTORS
- HAM GEAR • CAPACITORS

P.O. BOX 2366 INDIANAPOLIS, IND. 46206

SAVE NOW!!

4-Digit 0.5" Liquid Crystal Display

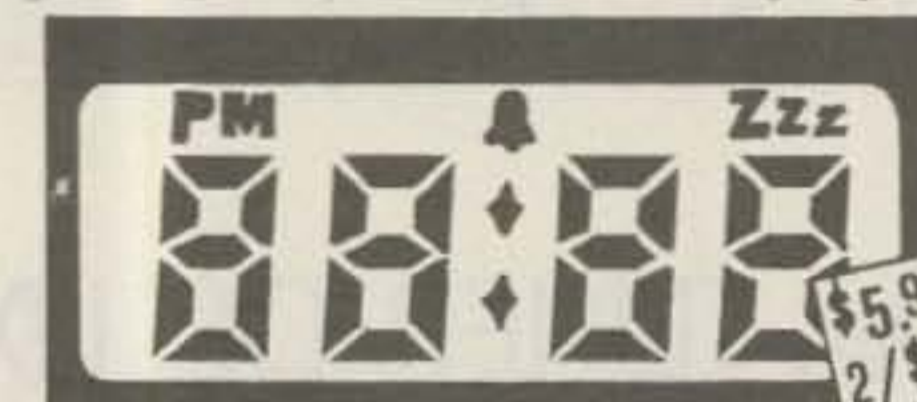

Includes Socket
 for Easy Mounting

Reflective type LCD display with snooze, alarm and PM indicators. Very low power requirements. Direct drive design needs only 4 to 10 VAC at 2 µA. Complete with socket and data sheet.

RAINBOW INDUSTRIES



THE FIRST CHOICE IN
REPEATER CONTROL

The Power and Flexibility of Microprocessor Technology

AUTOPATCH, REVERSE PATCH, SMART ID, ACCESS CODE
 MUTING, MORSE CODE ANNOUNCEMENTS, FLEXIBLE
 FUNCTION TIMEOUT, COURTESY TONE, LINKING,
 CONTROL OP. FUNCTIONS, TWELVE USER FUNCTIONS,
 ... AND MUCH MORE.

Call or write for specifications:

MICRO CONTROL SPECIALTIES (617) 372-3442

✓ M69

23 ELM PARK GROVELAND, MA. 01834

ALL BAND TRAP ANTENNAS!



PRETUNED - COMPLETELY ASSEMBLED -
 ONLY ONE NEAT SMALL ANTENNA FOR
 UP TO 6 BANDS! EXCELLENT FOR CON-
 GESTED HOUSING AREAS - APARTMENTS
 LIGHT - STRONG - ALMOST INVISIBLE!

FOR ALL MAKES & MODELS OF AMATEUR
 TRANSCEIVERS - TRANSMITTERS -
 GUARANTEED FOR 2000 WATTS SSB
 1000 WATTS CW. FOR NOVICE AND ALL
 CLASS AMATEURS!

COMPLETE AS SHOWN with 90 ft. RG58U-52 ohm feedline, and PL259 connector, insulators, 30 ft. 300 lb. test dacron end supports, center connector with built in lightning arrester and static discharge - molded, sealed, weatherproof, resonant traps 1"X6"-you just switch to band desired for excellent worldwide operation - transmitting and receiving! WT. LESS THAN 5 LBS.

- 160-80-40-20-15-10 bands 2 trap--149 ft. with 90 ft. RG58U - connector - Model 777BU . . . \$54.95
- 80-40-20-15-10 bands 2 trap --- 102 ft. with 90 ft. RG58U - connector - Model 998BU . . . \$49.95
- 40-20-15-10 bands 2 trap --- 54 ft. with 90 ft. RG58U coax - connector - Model 1001BU . . . \$48.95
- 20-15-10 bands 2 trap --- 26 ft. with 90 ft. RG58U coax - connector - Model 1007BU . . . \$47.95

SEND FULL PRICE FOR POST PAID INSURED DEL. IN USA. (Canada is \$5.00 extra for postage - clerical - customs - etc.) or order using VISA Bank Americard - MASTER CHARGE - AMER. EXPRESS. Give number and ex. date. Ph 1-308-236-5333 9AM - 6PM week days. We ship in 2-3 days. PRICES MAY INCREASE SO - ORDER NOW AND SAVE! All antennas guaranteed for 1 year. Money back trial! Made in USA. FREE INFO. AVAILABLE ONLY FROM.

WESTERN ELECTRONICS

Dept. A7-1

Kearney, Nebraska, 68847

Lasher. Admission is \$2.00. For information, send an SASE to Robert Younkers, 24675 Lasher Rd., Southfield MI 48034, or call (313)-354-8210.

**MIAMI FL
JAN 27-28**

The Dade Radio Club presents the 19th annual Tropical Hamboree and ARRL South Florida Convention on January 27-28, 1979, in Miami, Florida. Over one hundred exhibitor booths, a giant flea market, and several technical and group sessions will operate simultaneously in completely separate areas of the Flagler Dog Track Auditorium building. With the Convention immediately following the Miami Board Meeting, most Division Directors and HQ officials will be present for the ARRL general session. Extensive free parking, including overnight space for RVs, is

available on the grounds. Pre-registration is \$3.00; \$4.00 at the door. For up-to-date information, booth space, flea market table space, RV parking space reservations, and hotel rates, write DRC Hamboree, PO Box 350045, Riverside, Miami FL 33135.

**MANCHESTER NH
FEB 10**

The Interstate Repeater Society will hold its 3rd annual auction and hamfest on February 10, 1979, beginning at 9:00 am, at the Manchester Armory, across the Amoskeag Bridge from I-93, in Manchester, New Hampshire. There will be commercial exhibits, and the auction will be held rain or shine. Admission and parking are free. Talk-in on 146.52, 146.25/.85, and 224.86/223.46. For information, contact Gary A. Delong WB7NOH/KA1BCA, Interstate Repeater Society,

PO Box 94, Nashua NH 03061.

**MANSFIELD OH
FEB 11**

The Mansfield midwinter hamfest/auction will be held on February 11, 1979, in a heated building at the Richland County Fairgrounds in Mansfield, Ohio. There will be prizes and a flea market. Doors will open to the public at 8:00 am. Talk-in on 146.34/.94. Advance tickets are \$1.50; \$2.00 at the door. For information, contact Harry Fritchen K8HF, 120 Homewood, Mansfield OH 44906, or phone (419)-529-2801 or (419)-524-1441.

**LANCASTER PA
FEB 18**

The 7th annual Lancaster hamfest will be held on Sunday, February 18, 1979, at the Guernsey Sales Pavilion, US Rt. 30 & PA Rt. 896, Lancaster, Pennsylvania. Doors will open at 8:00 am and there will be a

prize drawing at 2:00 pm. Admission is \$3.00, and table reservations are \$2.00 in advance. There is a new, larger indoor flea market area. Food and soft drinks will be available. Talk-in on 146.01/.61. For further information, contact SERCOM, PO Box 6082, Rohrerstown PA 17603.

**MARLBORO MA
FEB 24**

The Algonquin Amateur Radio Club will hold its annual electronic flea market on Saturday, February 24, 1979, from 10:00 am to 4:00 pm, at St. Mary's School Hall on Broad Street in Marlboro, Massachusetts. There is easy access to the Hall from I-149 via Rt. 20 east. Seller setup is from 9:00 am to 10:00 am. Talk-in on .52. Sellers should contact Charlie W1BK at (617)-562-5622.

Continued on page 176

DISCOUNT SCANNERS

The Touch™



\$255.00 Prepaid USA Regency

CHECK, M.O., MASTERCHARGE, VISA

BAY-COM ✓B32

196 FRONT STREET
SCITUATE MA 02066
617-545-9700

Other Regency models at similar savings—send for list

...Mass. residents please add 5% tax...

FAST SCAN ATV

ALL YOU NEED IN ONE BOX



Show the shack, home movies, computer games, etc. Connect to the ant. terminals of any TV set, add a good 450 antenna, a camera, and you are there...

- 10 Watts peak RF output. Specify 434.0 or 439.25 MHz
- Subcarrier sound with plenty of mic gain for distance pick-up.
- 8 MHz bandwidth, high resolution necessary for computer alphanumeric and color.
- Tuneable converter covers 420 to 450. (Covers CH 2, 3)
- Contains AC to 12VDC regulated 3 AMP power supply.
- Only \$399.00 direct mail. Check, Money Order, VISA. Send S.A.S.E. for catalog of ATV Modules and PC Boards.

P.C. ELECTRONICS

Maryann 2522 PAXSON Tom
WB6YSS ARCADIA, CA 91006 W6ORG

FT-227 "MEMORIZER" OWNERS SCANNER KIT

- Selectable sweep width (up to full band)
- Scans *only* the portion of band you select
- Scans at the rate of 200 kHz per second
- Switch modification on mike allows you to scan past, or lock on, any occupied frequency
- Complete kit with detailed instructions
- Installs *inside* rig; no obtrusive external connections
- Rig can easily be returned to original condition whenever desired
- Scans to preset limits and reverses
- Automatic bypass of locked frequency in 3½ seconds unless you press lock-on switch

Kit \$34.95

Pre-assembled and tested \$54

Add \$1.50 Postage & handling

DEALERS INQUIRIES INVITED



ELECTRONICS ✓A60

750 LUCERNE RD SUITE 120 MONTREAL, QUEBEC
TEL. 514-737-7293 CANADA H3R 2H6

INVENTORY REDUCTION!

CDE T2X Tail Twister	\$224.95
Mosley CL 36 Antenna	259.95
KLM 420-470-14 Ant.	29.00
KLM 432-16 LB Ant.	54.95
KLM 420-470-27 Ant.	44.95
KLM 220-4 Bay Frame	76.00
KLM 2M-4 Bay Frame	192.00
KLM 432-4 153.06 in. Cable Set	12.00
KLM 420-2 2 Bay 108.58 in. Cable Set	12.00
KLM ECHO 70 432 Transceiver	419.00

universal amateur radio inc



1280 AIDA DRIVE
COLUMBUS, OHIO
(Reynoldsburg) 43068 ✓U6

ICOM IC-3PS Power Supply	\$ 89.00
ICOM IC-20L Linear Amplifier	84.95
ICOM Mobile Mtg. Bracket	
IC-502 • IC-202 • IC-213	10.95
ICOM Mobile Mtg. Bracket	
IC-221	12.00
Wilson WE 800 Portable	
Synthesized 2m. Transceiver	399.00
Fujinon CCTV Lens	
HF9A 1: 1.4/9	39.95
Tempo VHF/one plus	325.00
Mosley MPK3 TA33JR Power	
Conversion Kit	35.95
Mark II Wilson, Wall	
Charger & TT Pad	299.95



(614)-866-HAMS

All items subject to prior sale and are F.O.B. Reynoldsburg, Ohio

NEW FROM XITEX

\$95 MORSE TRANSCIEVER

SEND:

- 1 to 150 WPM (set from terminal)
- 32 character FIFO buffer with editing
- Auto Space on word boundaries
- Grid/Cathode key output
- LED Readout for WPM and Buffer space remaining

SERIAL INTERFACE:

- ASCII (110, 300, 600, 1200) or Baudot (45, 50, 57, 74) compatible
- Simplex Hi V Loop or T²L electrical interface
- Interfaces directly with the XITEX[®] SCT-100 Video Terminal Board; Teletypes[®] Models 15, 28, 33, etc.; or the equivalent



COPY:

- 1 to 150 WPM with Auto-Sync.
- Continuously computes and displays Copy WPM
- 80 HZ Bandpass filter
- Re-keyed Sidetone Osc. with on-board speaker
- Fully compensating to copy any 'fist style'

See your local dealer or contact XITEX[®] direct.

MC/Visa accepted

XITEX CORP.

13628 Neutron • P. O. Box 402110
Dallas, Texas 75240 • (214) 386-3859

MRS-100 CONFIGURATIONS:

- \$95 Partial Kit (includes Microcomputer components and circuit boards; less box and analog components)
- \$225 Complete Kit (includes box, power supply, and all other components)
- \$295 Assembled and tested unit (as shown)

Overseas Orders and dealer inquiries welcome

Sere-Rose & Spencer Electronics ✓S39

1465 WELLS STATION ROAD
MEMPHIS, TENN. 38108
PH (901) 683-9125—685-8461

Authorized Dealer

**DRAKE—ICOM—KENWOOD
REGENCY—TEMPO—DENTRON**

CALL OR WRITE
FOR BEST DEAL



CONNECTOR ASSORTMENT

\$25.00 **\$23.50** each
Postpaid lots of three

Includes: 5- PL259, 5- SO239, 5- UG175, 5- UG176, 2- PL258, 1- DM, 1- M358, 2- M359, 1- UG255, 1- UG273, 2- PL259PO, 1- 1021-20, 1- Lightning Arrestor.

Master Charge & Visa accepted / Send for Free Catalog

COAKIT ✓C21

P.O. Box 101-A Dumont, N. J. 07628
Circle C21 on Reader Service Card

Key Electronics

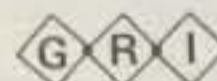

Full ASCII Professional Keyboard Kit, Model 756



Model 756 Keyboard Kit.....	\$64.95
Model 701 Plastic Enclosure.....	\$14.95
Model 702 Steel Enclosure.....	\$29.95
INTEGRATED CIRCUITS:	
SN76477N Complex Sound Gen.....	\$2.95 2/\$5.50
CA3140 Op Amp.....	.60
CA3240 Dual Op Amp.....	\$1.10
uA555 Timer.....	.45
SOCKETS:	
8 pin Low profile.....	15 8/\$1.00
14 pin Low profile.....	19 6/\$1.00
16 pin Low profile.....	22 5/\$1.00
Transistor Socket.....	12 10/\$1.00

FREE: CA3140 with orders of \$5.00 or more
Please include \$1.00 for postage and handling

N.Y.S. Residents Add 4% Sales Tax
Send to: **Key Electronics**
P.O. Box 3506
Schenectady, NY 12303 ✓K14

50 144 REPEATERS 220 450 Mhz

Hi Pro Mk I

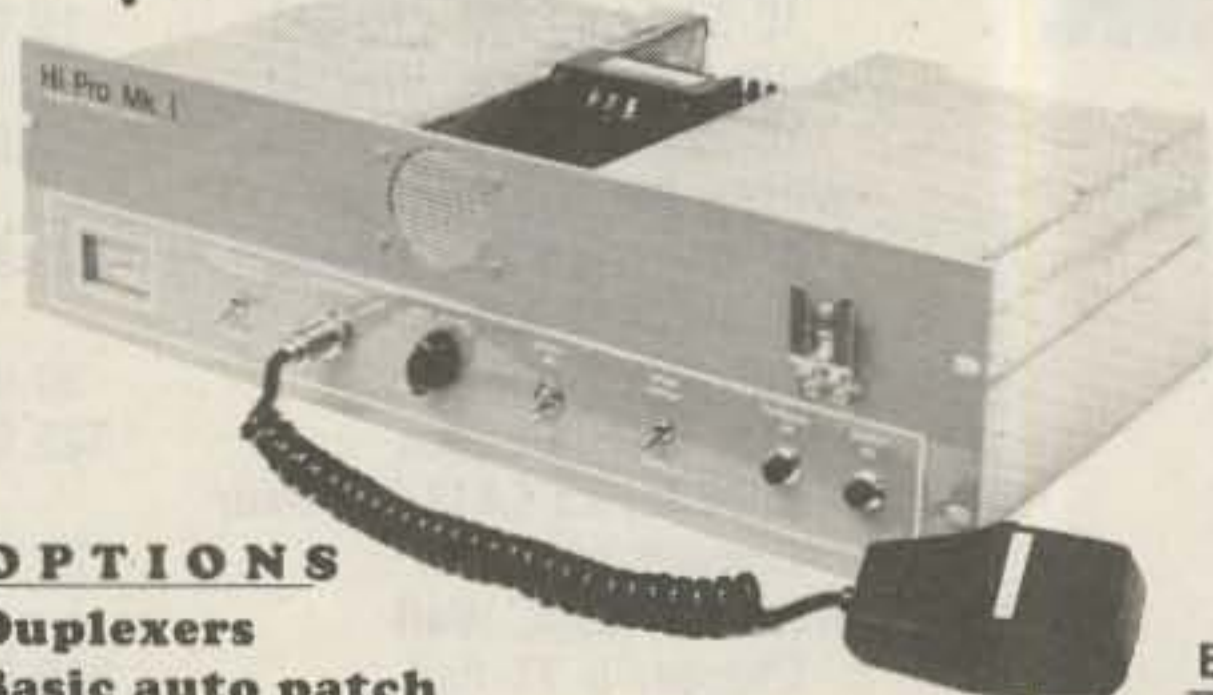

OPTIONS

- Duplexers
- Basic auto patch
- Matching cabinet
- .0005% High stability crystals

50 MHz \$789.95 450 MHz 799.95
144 + 220 MHz \$699.95

Now with courtesy
beep and beacon
capability

Available Separately:

COR Identifier: All on one board, programmable, Fully adjustable, time out (.5-7 min.), hang time (0-1 min.), identifier (1-10 min.), tone, speed, volume, L.E.D. outputs, low current drain CMOS logic, plugs for easy installation and removal plus much more. \$79.95

Basic Repeater \$499.95

2M 130-175 MHz Basic Repeater for 2 meters with all the features of the Hi Pro MkI less the power supply and front panel controls and accessories.

Maggiore Electronic Laboratory

PA Res. add 6% tax
PLUS SHIPPING

845 WESTTOWN RD. ✓M36
WEST CHESTER, PA. 19380 PHONE 215 436-6051

\$95 Stand Alone Video Terminal

αΒΓΔΕΖΗΘΙΚΛΜΝΞΟΡΡΟ123 0^+-%[]|←→↑↓
 !"#%&'()* +,-./012456789:;<=>?
 @ABCDEFGHIJKLMN OPQRSTUVWXYZ[\]^_`
 ~{|}~

SCT-100 FEATURES:

- 64 X 16 line format with 128 displayable characters
- Serial ASCII or BAUDOT with multiple Baud rates
- \$187 Assembled or \$157 Kit (Partial Kit \$95)
- Full cursor control with scrolling and paging
- On board power supply

Call or write today. MC/VISA accepted

XITEX CORP 13628 Neutron P. O. Box 402110
 Dallas, Texas 75240 (214) 386-3859
 X1
 Overseas orders and dealers inquiries welcome

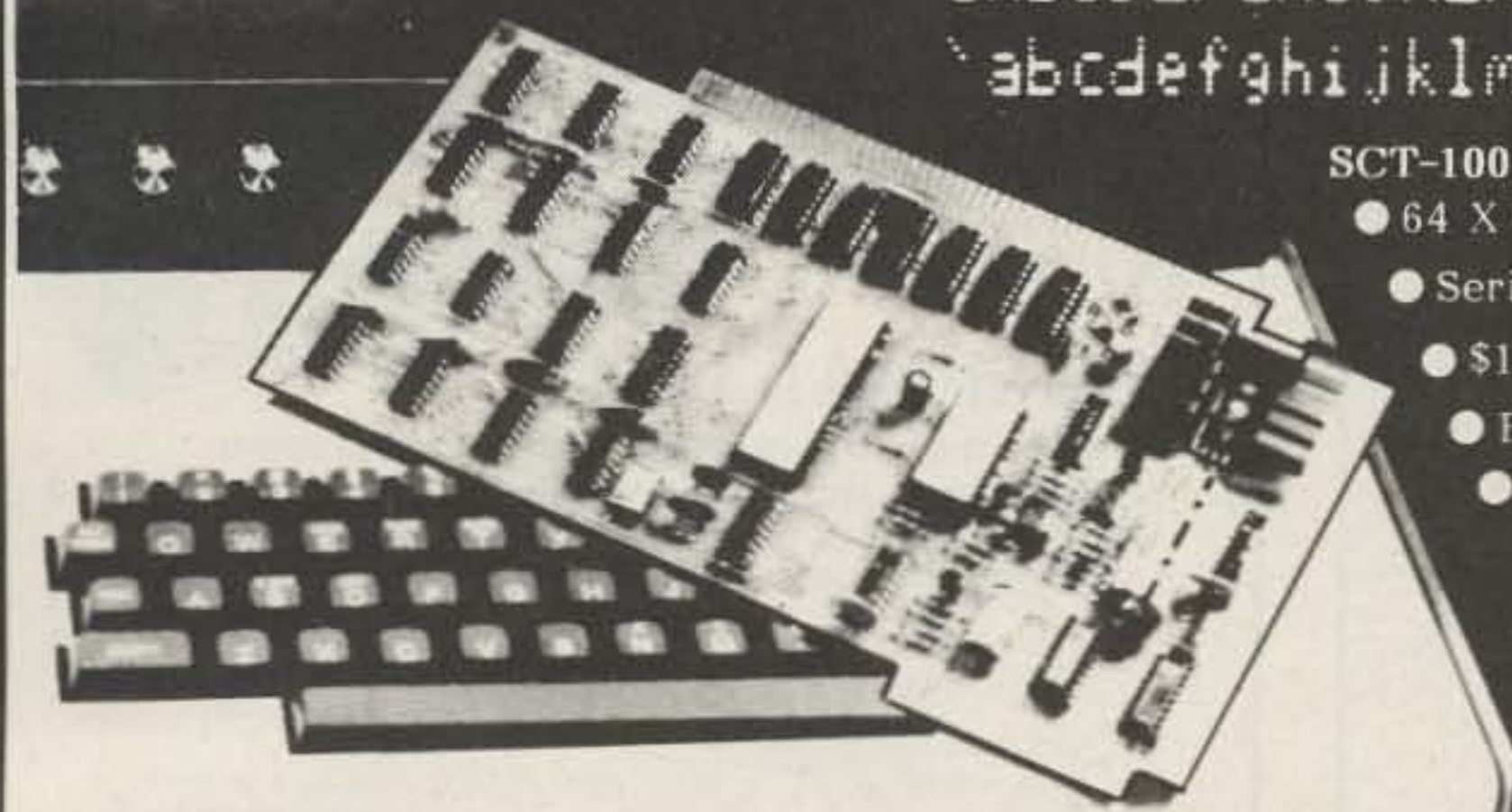

Trans Com ✓ T35

Tone Signaling Equipment
 Featuring the TG-1B Sub-Audible Tone Encoder
 Compatible with P.L., CG and other systems

Features:

- Low sine wave distortion of less than 1.5% THD
- Plug in tone element
- Excellent Temperature & frequency stability
- Low current draw using CMOS IC's
- Immunity to RF
- Two year warranty



Priced at \$27.95
 wired and tested
 with tone element

Also Available

Touch tone encoders from \$29.95, touch tone decoders and two tone sequential tone encoders and decoders.

Order from or for further information contact

Trans Com

P.O. Box 120, Addison, Illinois 60101 312-653-6724

AMATEUR TELEVISION ON 439.25 MHz

INTERESTED? ACTIVITY IS INCREASING EVERYWHERE YOU CAN GET ACTIVE IN YOUR AREA WITH OUR PRODUCTS -

- AM1B FSTV CONVERTER complete \$150.00
- AX10B FSTV TRANSMITTER complete \$385.00

CALL 812-336-4775, OR WRITE US, FOR COMPLETE DETAILS

APTRON LABORATORIES ✓ A6
 PO BOX 323
 BLOOMINGTON, INDIANA, 47401

Write for CATALOG

CRAMMED WITH GOV'T SURPLUS ELECTRONIC GEAR SEND 50¢ FOR HANDLING

- ARC-5 TRANSMITTER—with all tubes & crystal, brand new in original carton..... \$12.95
- SCR-522 TRANSMITTER/RECEIVER—100-156 mc., crystal controlled on 4 channels, in excellent condition with all tubes (18)..... \$28.50
- LM FREQUENCY METER—frequency range 125-20,000KC, operates on 12 or 24 V dc with tubes, crystal & original calibration book, ex. cond., checked out..... \$54.50
- AC POWER SUPPLY for above (original)..... \$22.50
- HEADSET, 2000 Ohms with 7' cord & PL-55 plug, new..... \$3.95
- HEADSET, low impedance with chamois cushions, 4' cord & plug ex. cond..... \$2.95
- RUGGED HEAVY DUTY CARBON HANDMIKE with cord & plug, new..... \$1.88
- All types of transmitting, receiving & special purpose tubes available. We invite your inquiries.

Terms: F.O.B. NYC. 25% deposit with order, balance COD or remittance in full. Subject to prior sale and price change.

G & G RADIO ELECTRONICS ✓ G20
 COMPANY 45-47 Warren St. (2nd floor)
 Ph. 212-267-4605 New York, N.Y. 10007

IN STOCK!

THE REVOLUTIONARY NEW YAESU 2-METER FM LINE

CPU-2500RK



"The Ultimate Rig"

Microprocessor controlled, 25 watt, keyboard-entry transceiver.

Amateur net \$585.00

FT-202R



"Best Buy" 2-meter hand-held. Compact, lots of extras.

Amateur net \$199.00

FT-227RA



"Full-Featured Plus." Four memories, Autoscan remotely controlled from mike. Tone burst.

Amateur net \$399.00

For immediate delivery, best price . . .

TOWER ELECTRONICS

✓ T44 24001 Alicia Parkway
 Mission Viejo, CA 92675
 Phone 714/768-8900



Hours:
 Tues thru Fri: 10 am - 7 pm
 Saturday: 9 am - 5 pm
 Sunday: Noon - 4 pm

Yaesu service and repair specialists.



January 27-28, 1979



ARRL Convention & 19th Annual TROPICAL HAMBOREE

FLAGLER DOG TRACK
67th AVE. W. NW. 31-11
Miami, Florida

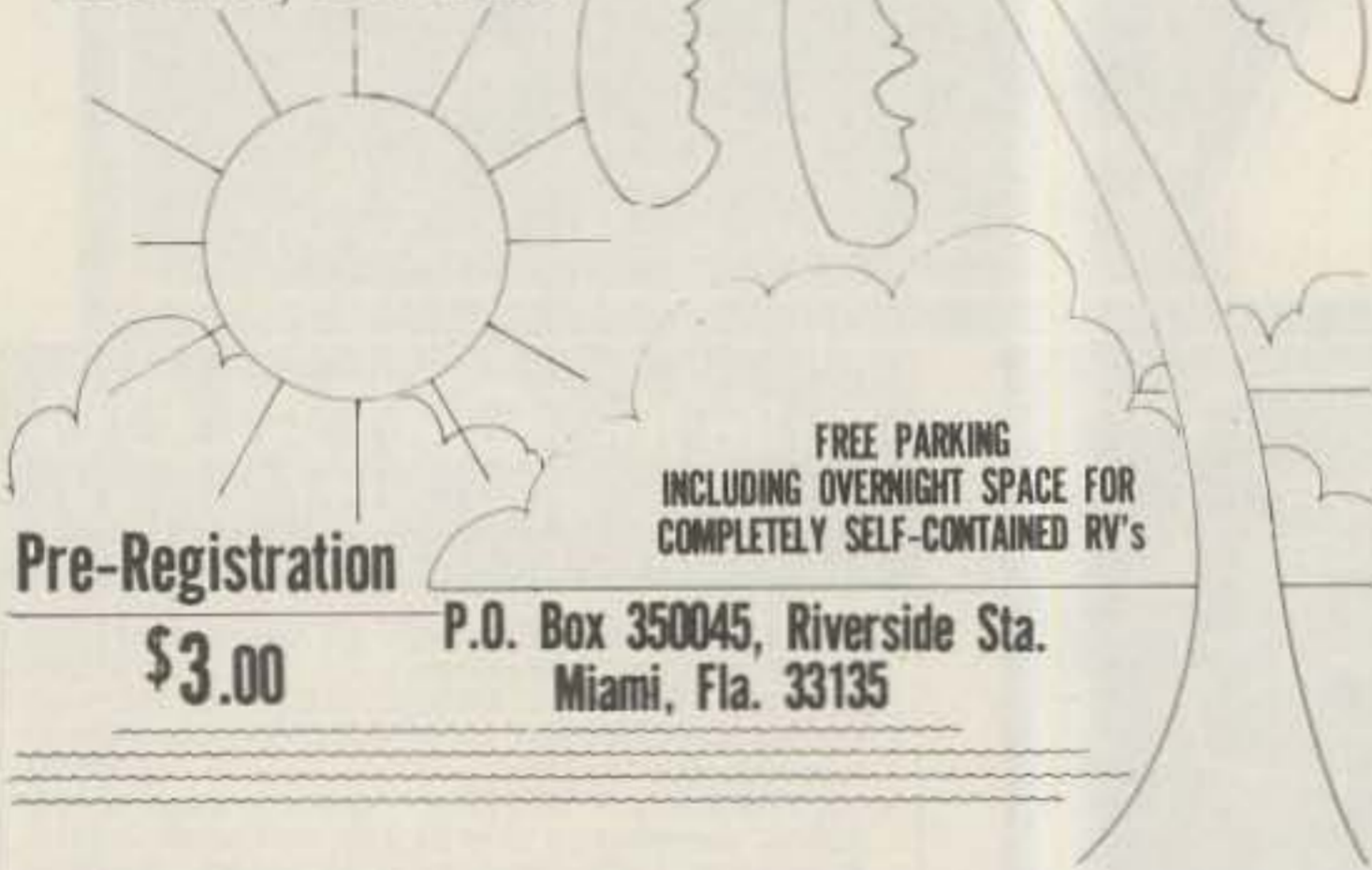

FREE PARKING INCLUDING OVERNIGHT SPACE FOR COMPLETELY SELF-CONTAINED RV's

Pre-Registration
\$3.00

P.O. Box 350045, Riverside Sta.
Miami, Fla. 33135

RTTY made easy

WITH THE NEW TU-170 TERMINAL UNIT



Connect to your receiver speaker, transmitter microphone jack, and teletype machine and you're on the air. State of the art design features make the TU-170 ideal for HF and VHF autostat operation.

- Proved 170 Hz shift active filter demodulator
- Stable audio frequency shift oscillator produces phase coherent sine wave tones
- Lighted tuning meter for easy tuning
- TTL compatible inputs and outputs for auxilliary equipment
- Current regulated loop keyer & power supply
- High level output for scope tuning
- Autostat with threshold control and solid state relay

TU-170 Kit 149.95 TU-170 Wired 219.95

Flesher products . . . the critics choice!



F5 **FLESHER CORP.**



P.O. Box 976, Topeka, Kansas 66601 (913) 234-0198

NEW CoaxProbe* NEW Coaxial RF Probe for Frequency Counters and Oscilloscopes That Lets You Monitor Your Transmitted Signal Directly From the Coax Line.

Only **\$12.95**
plus .50 postage

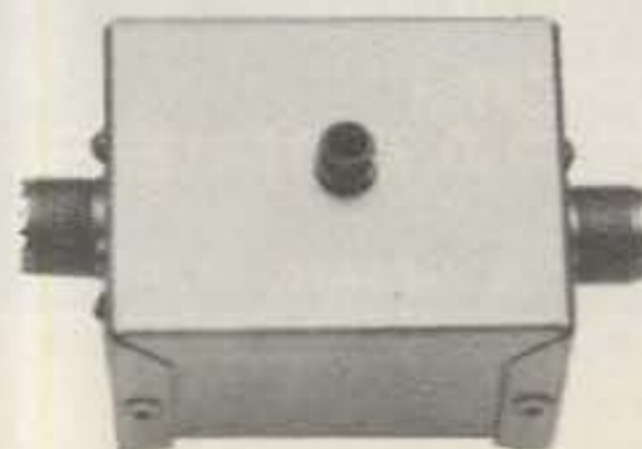

FINALLY! A RF PROBE that lets you connect into your coax cable for frequency measurements and modulation waveform checks directly from the transmitter.

JUST CONNECT THE CoaxProbe* into your transmission line and plug the output into the frequency counter or oscilloscope. Insertion loss is less than .2db so you can leave it in while you operate.

A NECESSITY IN ANY WELL-ORGANIZED HAM SHACK, the CoaxProbe* eliminates "jerry-rigging" and hassles when tapping into the coax line is desired.

A SPECIAL METHOD OF SAMPLING keeps output relatively constant with a wide variation of power. Power output of 8 watts gives .31v out, while 800 watts will give 1.8v out. (rms 3-30 mhz.) 2000 watts PEP rating too!

*Trademark of CoaxProbe Co. for rf sampling device.
© 1978 by CoaxProbe Co.

USE IT ON 2 METER RIGS TO ADJUST FREQUENCY. The CoaxProbe* has a range of 1.8 to 150 mhz.

MONITOR YOUR MODULATION WAVEFORM. With an oscilloscope of proper bandwidth, you can check your modulation for flat-topping, etc. Ideal for adjusting the speech processor.

NOW YOU CAN MONITOR SIGNALS when connected to the dummy load, eliminating unnecessary on-the-air radiation.

AVAILABLE FOR THE FIRST TIME TO AMATEURS. Try it for 10 days. If not satisfied, send it back for refund (minus shipping charges).

Order today from:

CoaxProbe Co. ✓ C110
P.O. Box 426, Portage, MI 49081
Michigan Res. Add 4% Sales Tax

The RUGGED



Dipole Antenna Connectors

Stand Up to Winter's Worst

- Black die-cast aluminum body
- Steatite insulators with welded eyebolts
- Flat-top or Inverted-V
- Handle full amateur power

Commercial quality / Amateur price

B&W At your B&W dealer.

Barker & Williamson, Inc. ✓ B23
10 Canal St. • Bristol, PA 19007
Telephone: (215) 788-5581

This NEW MFJ Versa Tuner II . . .

has SWR and dual range wattmeter, antenna switch, efficient airwound inductor, built in balun. Up to 300 watts RF output. Matches everything from 1.8 thru 30 MHz: dipoles, inverted vees, random wires, verticals, mobile whips, beams, balanced lines, coax lines.

MFJ LOWER PRICES!

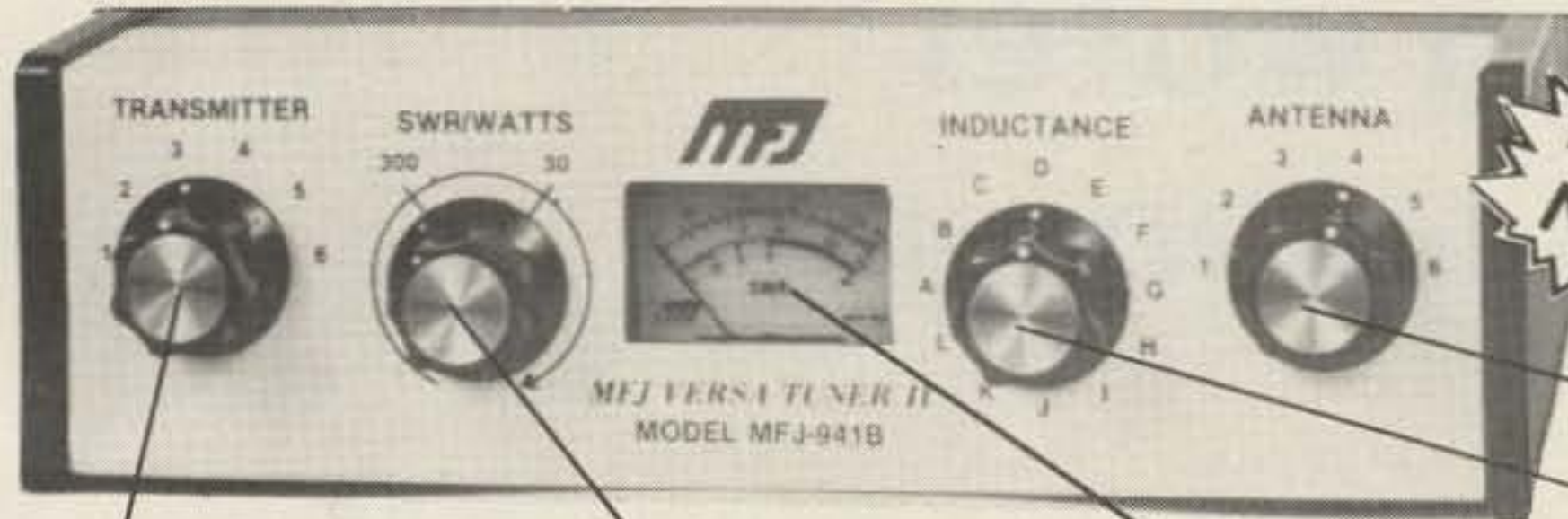

NEW, IMPROVED MFJ-941B HAS . . .

- More inductance for wider matching range
- More flexible antenna switch
- More sensitive meter for SWR measurements down to 5 watts output

NEW LOWER PRICE

\$79⁹⁵

Transmitter matching capacitor. 208 pf. 1000 volt spacing.

Sets power range, 300 and 30 watts. Pull for SWR.

Meter reads SWR and RF watts in 2 ranges.

Efficient airwound inductor gives more watts out and less losses.

Antenna matching capacitor. 208 pf. 1000 volt spacing.

Only MFJ gives you this MFJ-941B Versa Tuner II with all these features at this price:

A SWR and dual range wattmeter (300 and 30 watts full scale) lets you measure RF power output for simplified tuning.

An antenna switch lets you select 2 coax lines direct or thru tuner, random wire/balanced line, and tuner bypass for dummy load.

A new efficient airwound inductor (12 positions) gives you less losses than a tapped toroid for more watts out.

A 1:4 balun for balanced lines. 1000 volt capacitor spacing. Mounting brackets for mobile installations (not shown).

With the NEW MFJ Versa Tuner II you can run your full transceiver power output — up to 300 watts RF power output — and match your



ANTENNA SWITCH lets you select 2 coax lines direct or thru tuner, wire/balanced line, dummy load.

transmitter to any feedline from 160 thru 10 Meters whether you have coax cable, balanced line, or random wire.

You can tune out the SWR on your dipole, inverted vee, random wire, vertical, mobile whip, beam, quad, or whatever you have.

You can even operate all bands with just

one existing antenna. No need to put up separate antennas for each band.

Increase the usable bandwidth of your mobile whip by tuning out the SWR from inside your car. Works great with all solid state rigs (like the Atlas) and with all tube type rigs.

It travels well, too. Its ultra compact size 8x2x6 inches fits easily in a small corner of your suitcase.

This beautiful little tuner is housed in a deluxe eggshell white Ten-Tec enclosure with walnut grain sides.

SO-239 coax connectors are provided for transmitter input and coax fed antennas. Quality five way binding posts are used for the balanced line inputs (2), random wire input (1), and ground (1).

NEW 300 WATT MFJ VERSA TUNER II'S: SELECT FEATURES YOU NEED.

NEW MFJ-945 HAS SWR AND DUAL RANGE WATTMETER. NEW LOWER PRICE

\$69⁹⁵

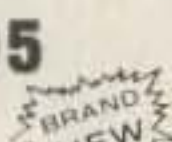

Same as MFJ-941B but less 6 position antenna switch.

NEW MFJ-944 HAS 6 POSITION ANTENNA SWITCH ON FRONT PANEL. NEW LOWER PRICE

\$69⁹⁵



Same as MFJ-941B but less SWR/Wattmeter.

NEW MFJ-943 MATCHES ALMOST ANYTHING FROM 1.8 THRU 30 MHz. NEW LOWER PRICE

\$59⁹⁵



Same as MFJ-941B, less SWR/Wattmeter, antenna switch, mounting bracket. 7x2x6 in.

ULTRA COMPACT 200 WATT VERSA TUNERS FOR ALL YOUR NEEDS.

MFJ-901 VERSA TUNER MATCHES ANYTHING, 1.8 THRU 30 MHz. NEW LOWER PRICE

\$49⁹⁵

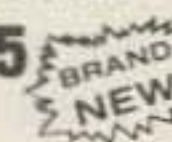

Efficient 12 position air inductor for more watts out. Matches dipoles, vees, random wires, verticals, mobile whips, beams, balanced lines, coax. 200 watts RF, 1:4 balun, 5x2x6 in.

MFJ-900 ECONO TUNER MATCHES COAX LINES/RANDOM WIRES. NEW LOWER PRICE

\$39⁹⁵

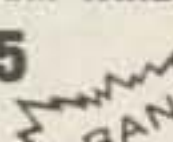

Same as MFJ-901 but less balun for balanced lines. Tunes coax lines and random lines.

MFJ-16010 RANDOM WIRE TUNER FOR LONG WIRES. NEW LOWER PRICE

\$29⁹⁵



1.8 thru 30 MHz. Up to 200 watts RF output. Matches high and low impedances. 12 position inductor. SO-239 connectors. 2x3x4 inches. Matches 25 to 200 ohms at 1.8 MHz. Does not tune coax lines.

For Orders

Call toll-free 800-647-1800

✓ M52 Order any product from MFJ and try it. If not delighted, return within 30 days for a prompt refund (less shipping).

Order today. Money back if not delighted. One year unconditional guarantee. Add \$2.00 shipping/handling. For technical information, order/repair status, in Mississippi, outside continental USA, call 601-323-5869.

Order By Mail or Call TOLL FREE 800-647-1800 and Charge It On



MFJ ENTERPRISES, INC.

P. O. BOX 494

MISSISSIPPI STATE, MISSISSIPPI 39762

✓ Reader Service—see page 227

The Twofer

— double-duty IDer logic

This circuit selects your CW IDer when a repeater is in use, and voice when it isn't.

C. A. Kollar K3JML
1202 Gemini Street
Nanticoke PA 18634

There is much to be said about the advantages and disadvantages of either a voice or CW ID. The best of two worlds would be to have both, with the right one selected automatically according to conditions on the repeater. For example, a CW-only ID

is standard in this area, but this approach quickly becomes ordinary and, after a while, no one listens to it anyway. This is demonstrated by the frequent calls on the repeater from transients asking if someone could tell them where it's located. This can be remedied by going to a voice ID which gives the repeater call, QTH, and any other pertinent information. The disadvantage to this approach is the disruptive effect a voice ID has on a QSO. It can get very confusing listening to two voices at the same time. The solution to this problem is the circuit shown in Fig. 1. It has been in use at WR3AGU at Mehoopany PA for about eighteen months and has worked fine.

This circuit gives your repeater "memory" capabilities. While a QSO is in progress, an enable signal is applied to your CW IDer

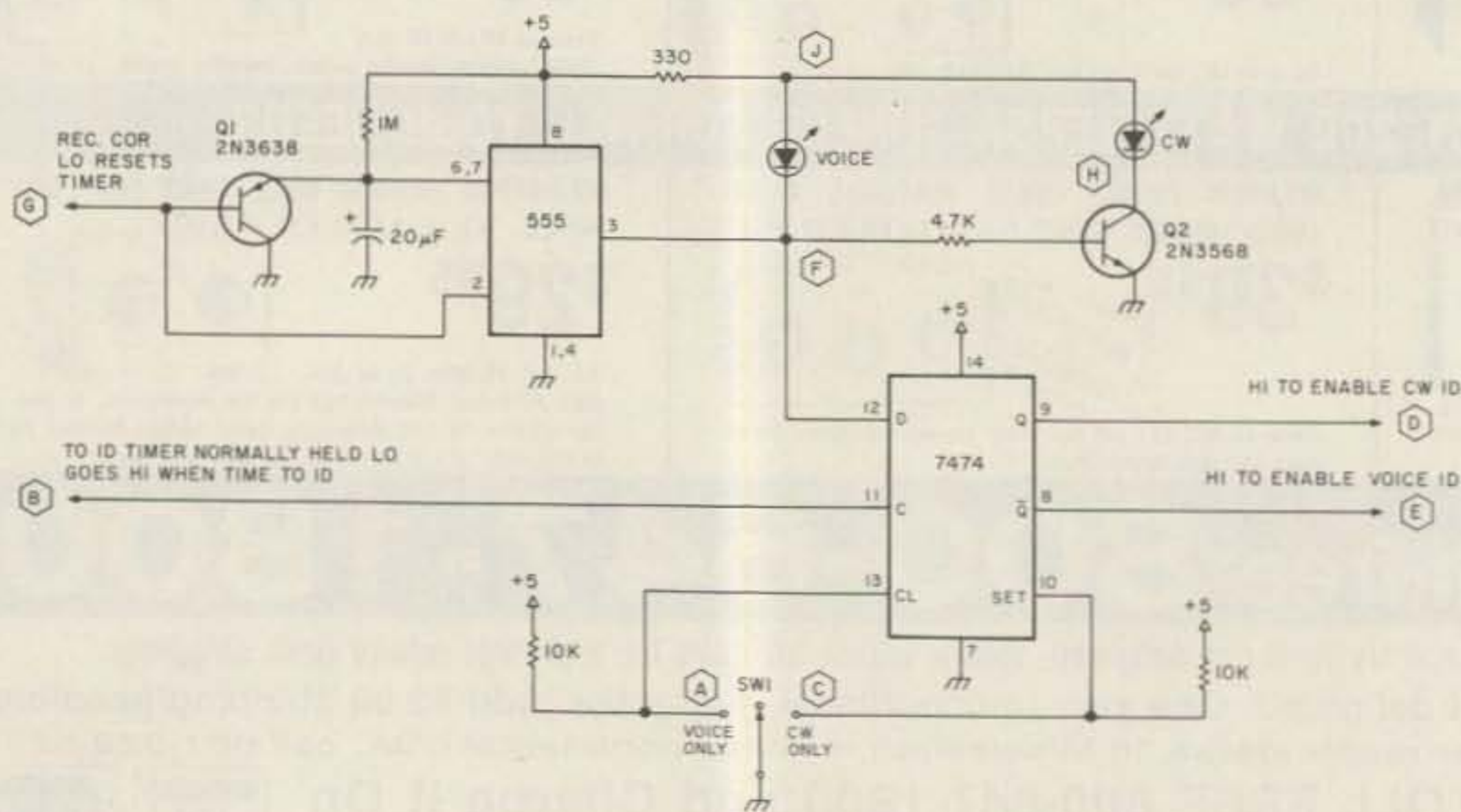

Fig. 1. Dual-ID logic schematic diagram.

which causes the ID to be given in CW only. When the repeater is not in use, when it is kerchunked, or when the last ID after a series of transmissions is given, the circuit will enable the voice IDer.

Operation

Referring to Fig. 1, the 555 timer chip and Q1 are set up as a retriggerable monostable. The 7474 is a dual-D flip-flop. In operation, point A is connected to the repeater COR line at a point that is normally high and goes low when a signal is received. If this is not possible (i.e., the only point easily accessible is a point which is normally low and goes high when a signal is received), a transistor or IC inverter can be used between point A and the base of Q1 and pin 2 of the 555 timer to give you the necessary inversion. Every time a signal is received, the 20 uF timing capacitor is discharged by Q1 and the 555 is reset. During this time, the 555's output (pin 3) goes high and will stay there for 20 seconds unless retriggered. Every time the receiver's COR indicates a received signal, the 555 is reset and retriggered for 20 more seconds. This high is applied to the base of Q2 through a limiting resistor making its collector go low. This lights the "CW" LED to let you know that this ID will come up next. The "voice" LED on pin 3 of the 555 will light only when it times out. This occurs only after about 20 seconds of repeater inactivity.

The information on pin 3 of the 555 is also presented to the D input of the 7474 flip-flop. The C (clock) input of the 7474 is connected to your repeater ID timer at a point which is normally low and goes high when it's time to ID. Again, if this is not possible

or inconvenient, an inverter will have to be used to provide the necessary inversion between the repeater timer and point B.

The 7474 works as follows: The info presented at the D input goes on to the Q output whenever the clock changes from low to high. The only time the output can change is when the clock goes positive. Changes on the D input are not passed on if the clock is held high or low. Information on the D input can be changed at any time. It is only its value at the instant of the positive clock edge (time to ID) that matters. This is what is entered into the flip-flop.

So, when it becomes time to ID, point B should go high. At this instant, the flip-flop checks its D input. If it is low (the 555 has timed out because of no repeater activity in the last 20 seconds), the low is passed on to the Q output and the Q output goes high enabling the voice ID. If your voice ID requires a low to enable, an inverter can be used after the Q output or the \bar{Q} output can be used to enable the voice ID and the Q output for the CW ID.

The last feature of this

ID selector is the use of S1, an SPDT switch with a center off position. With the switch in the off position, ID selection is completely automatic as described above. However, when put in the position where the clear input (pin 13) is grounded, the Q output goes low and the \bar{Q} output goes high and they both stay that way as long as the switch is in that position for a voice-only ID. Conversely, when in the position where pin 10 (set) is grounded, the flip-flop immediately goes into the state with Q high and

\bar{Q} low. This gives you a CW-only ID. This becomes very handy if it is necessary to remove either of the IDers for maintenance.

This ID selector will add a bit of "intelligence" and courtesy to your repeater's automatic operation and provide variety and relief from monotony to the ops who monitor your repeater consistently.

I'll be happy to help with any questions you may have regarding connection to your repeater if you will supply the necessary information and include an SASE. ■

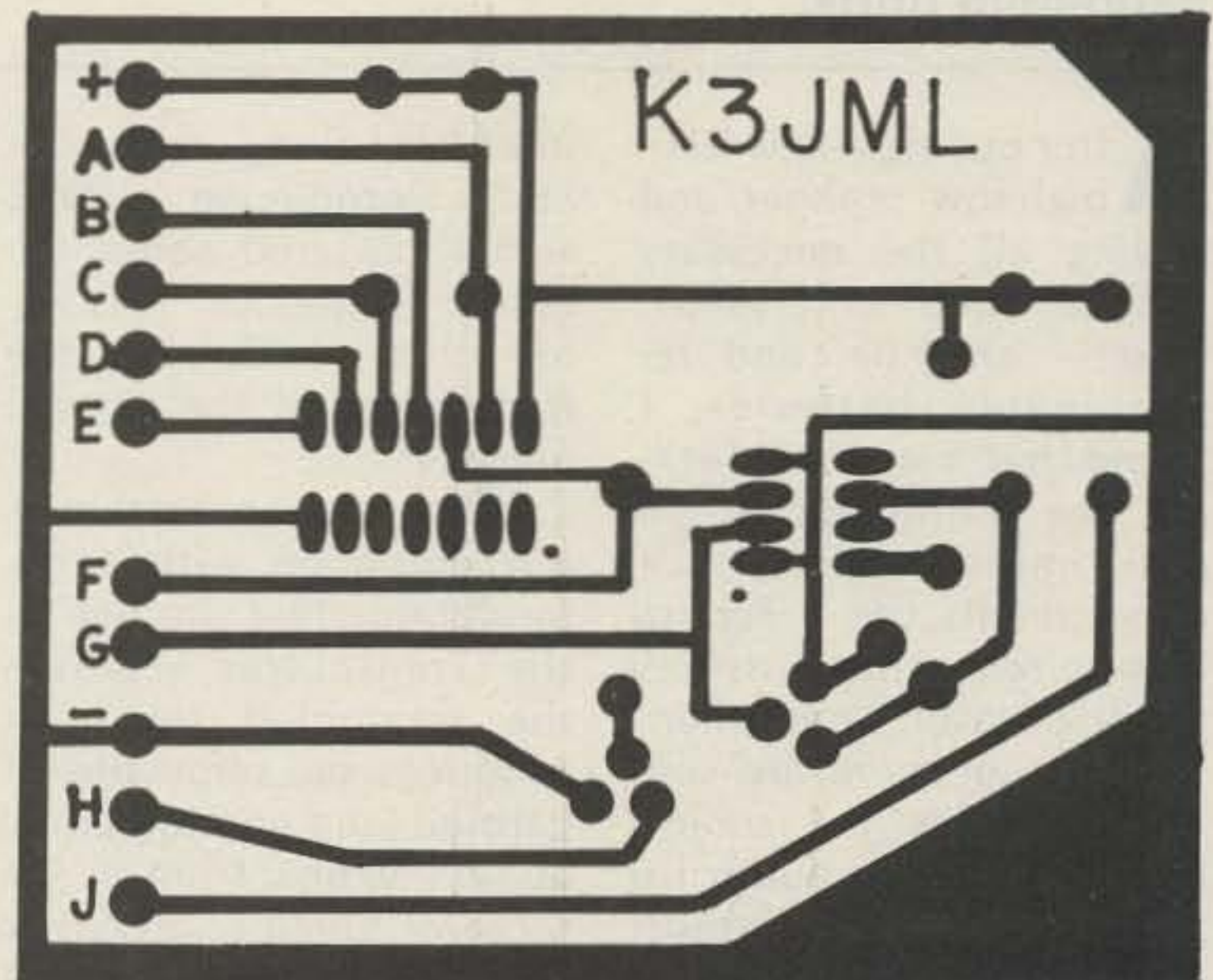

PC board (artwork by K3ETN).

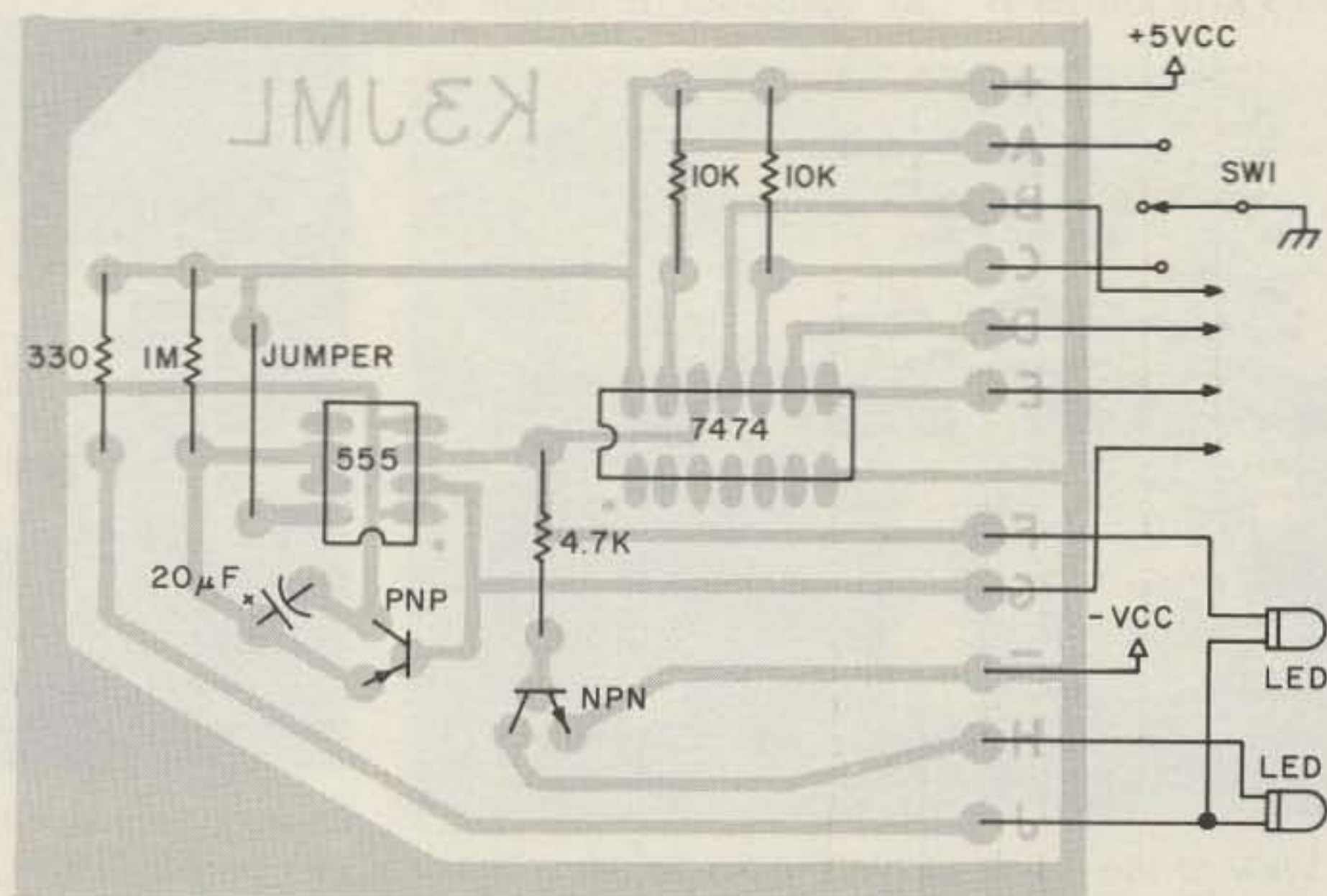

Component layout.

Adam-12 Revisited

— a scanner unscrambler

This simple circuit will decode the most common scramblers used, and is small enough to fit inside hand-held units.

After buying a new VHF high-low scanner and adding all the necessary options such as crystals, flexible antenna, and rechargeable batteries, I found that it was still lacking one useful option, an unscrambler. Many police departments use a scrambler on some transmissions for one reason or another.

Although there are several schemes for scrambling or encoding audio, by far the most common method is to feed the audio signal along with a carrier into a balanced modulator before transmission. Typically, a 2-3.5 kHz carrier is

injected along with the audio, producing a DSB signal centered about the carrier frequency. This signal then modulates the transmitter in the normal manner.

When a scanner that is not equipped with a demodulator like the one at the transmitter receives the scrambled signal, it produces the same sort of garbled (and unintelligible) audio you hear from an AM receiver tuned to a DSB or SSB signal. The fact that I could not receive the scrambled transmissions was enough to prompt me to construct a circuit to

recover the audio. I would like to remind anyone who builds one of these decoders, that, as with any other information you might obtain over your scanner, you cannot divulge the content of the transmissions.

The Circuit

I designed the circuit with the following conditions in mind:

1. The circuit must operate on the scanner's 6-volt battery supply.
2. The circuit must fit in the scanner with no external components.
3. The change from normal

to decode operation must be simple and quick.

The final demodulator uses a Signetics N5596 balanced modulator/demodulator. The pin designations in Fig. 1 refer to the 14-pin DIP package. The National Semiconductor LM1496 or an HEP6050G is also usable with no circuit modifications, but the pinouts are different. The carrier signal is supplied by IC2, a 555 timer. Potentiometer R1 is used to balance the demodulator (null out the carrier), with no audio input to the IC. R2 adjusts the frequency of

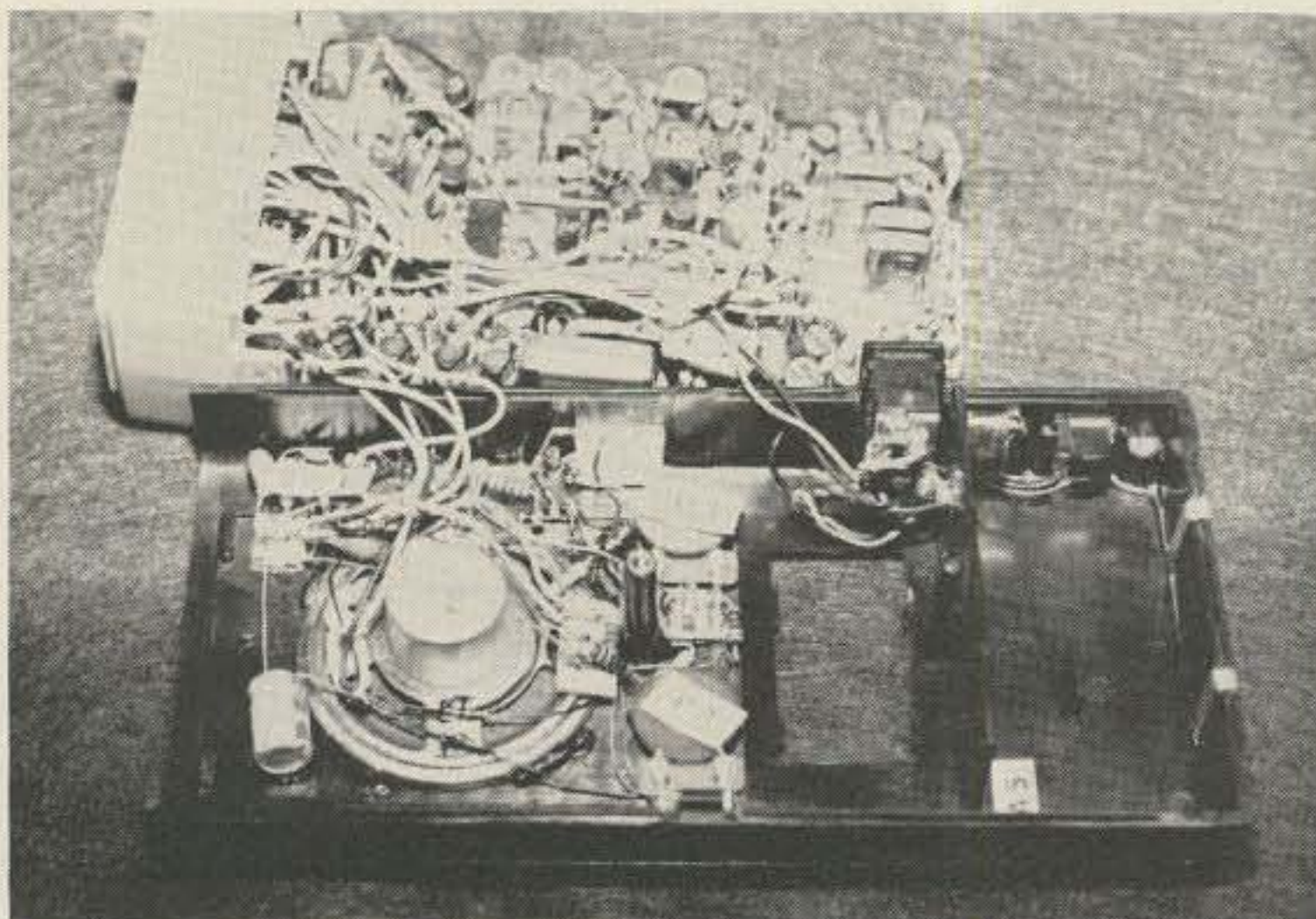

Photo A. View of the inside of the Pro-6 scanner with the decoder installed. Major components are secured to the case with glue.

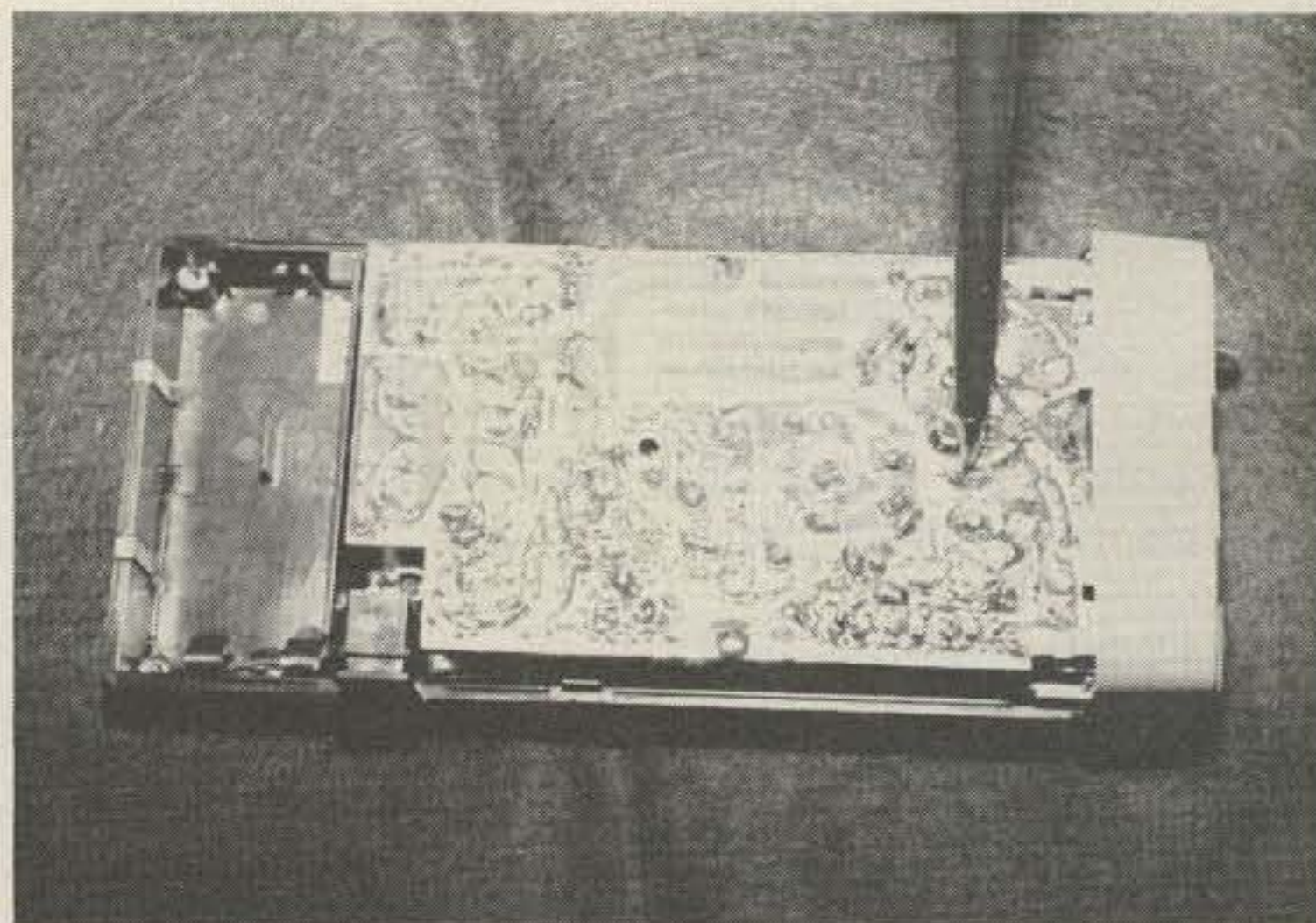

Photo B. View of the foil side of the Pro-6 PC board. The pen points to the point on the board where the volume control wire is disconnected and the decoder input and outputs are inserted.

the carrier generator. R2 must be set so that the frequency of the carrier matches the frequency of the carrier that was introduced at the transmitter. C1 must be selected to give the proper range of carrier frequencies in your use. Since most systems use a carrier frequency of from 2.0-3.5 kHz, C1 = .1 uF is a good choice in most cases (see Table 1). Use a good quality 5% capacitor for C1, as it basically determines the stability of the carrier generator.

Some systems use more than one carrier frequency. Usually these will be designated as Code 1, Code 2, Code Black, Code Yellow, etc. If this is the case in your area, you can add more than one R2 pot, as shown in Fig. 1. A slide switch can then select the proper frequency. If only one frequency is used, S2 may be eliminated, with pin 5 of the 555 connected directly to the wiper terminal of R2. S1 turns the demodulator on and off. I used one of the channel lockout switches on my scanner for S1 and thus did not have to mount any extra switches on the radio. Any general-purpose silicon NPN transistor will work for Q1. The audio input to the demodulator should be about 100 mV rms. This is available at the input to the volume control of most scanners.

Construction

My scanner is a Realistic Pro-6 VHF high-low by Radio Shack, so the photographs and details of the text apply to this particular radio. The circuit itself will

work with any scanner or monitor, but the component placement may have to be modified due to space considerations.

I originally planned to build the demodulator on a small printed circuit, but, after seeing how little space was available in the scanner, I had to resort to the less elegant point-to-point wiring method. Owners of the Pro-6 can see where to mount the major components by referring to Photo A.

To disassemble the scanner, remove the two screws at the bottom of the radio just below the battery pack. Now remove the back by squeezing the sides of the front half of the case about 3 inches from the bottom of the case. Once you have removed the back, take out the one screw in the middle of the printed circuit board and remove the front half of the case.

All parts of the demodulator mount in the front half of the case. The ICs are mounted by turning them upside down and securing them with a drop of glue. Be sure to identify lead number one on each IC before gluing it down. The ICs will be hard to remove once glued down, so I strongly suggest that you first construct the circuit on a protoboard if you have one.

Trimpots R1 and R2 should be mounted so that they can be adjusted with the scanner operating. I drilled out two of the "fake" holes in my scanner and mounted the pots behind them, so I could adjust them once the scanner

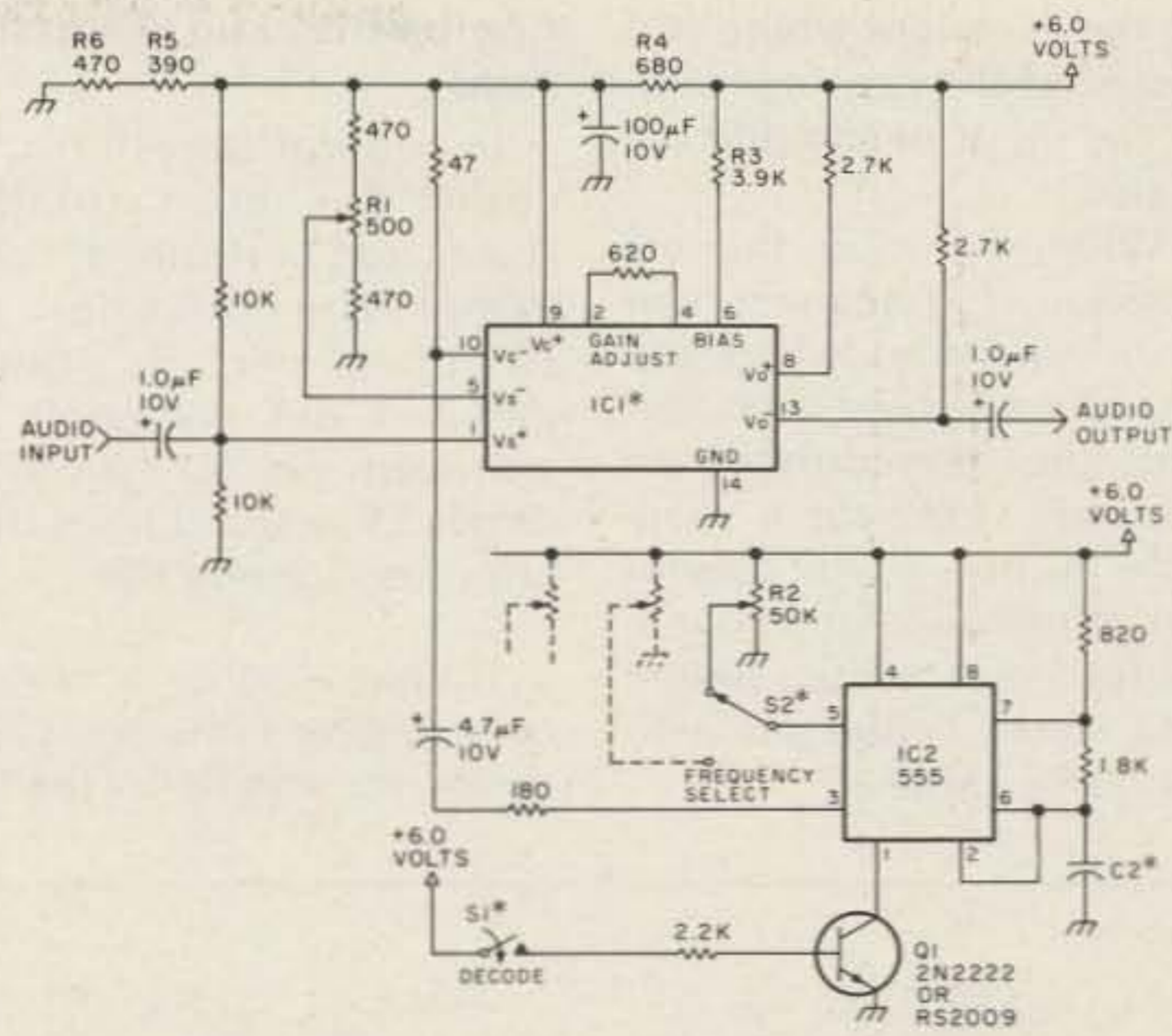

Fig. 1. Unscrambler schematic. IC1—N5596 14-pin DIP; LM 1496 or HEP6050G also suitable; see text. IC2—555 timer, 8-pin DIP. Q1—2N2222 or RS2009, NPN silicon general purpose. All fixed resistors 1/4 W, 10%. * = see text.

was assembled. After operating the scanner for a few weeks, I found the circuit to be stable enough so that adjusting the pots again was not necessary. Make the needed tie points by gluing small pieces of printed circuit board to the case. Be careful to mount the parts so that they do not interfere with the re-assembly of the case.

I used one of the channel lockout switches for S1. If you elect to do the same, refer to Fig. 3.

Testing and Adjustment

Once the circuit is complete, but before connecting the audio input and output to the scanner, you

should balance the demodulator. Connect an oscilloscope or high-impedance headphones to the output of the circuit, apply power, and turn the decode switch on. You should have a square wave on the oscilloscope or a tone on the headphones. Adjust R1 to null the carrier output.

If all was well in the previous step, you are ready to connect the demodulator. Unsolder the wire on the PC board going to the volume control. This is a green wire on the Pro-6. See Photo B for the proper location. Solder this wire to the output of the demodulator. Now connect a short wire from the point

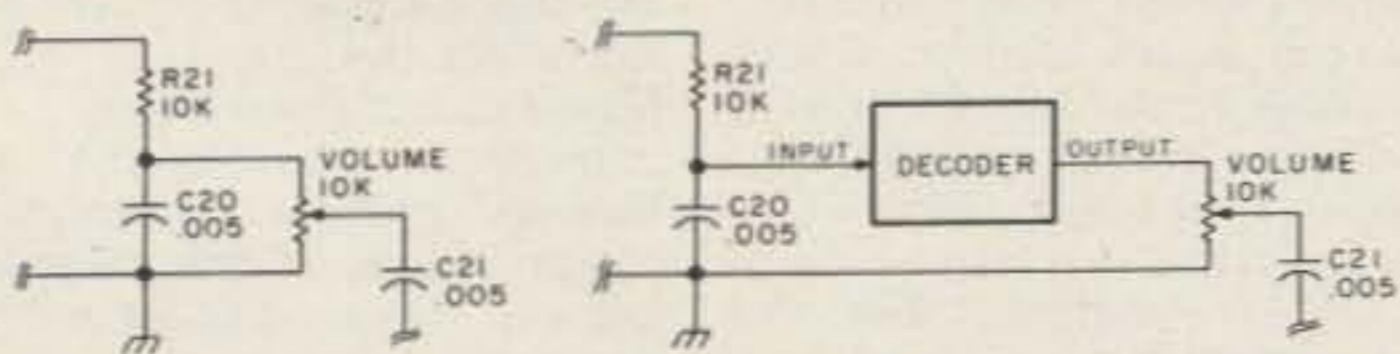

Fig. 2. Details of decoder input and output connections to the Pro-6 scanner. Other brands of scanners will have similar configurations.

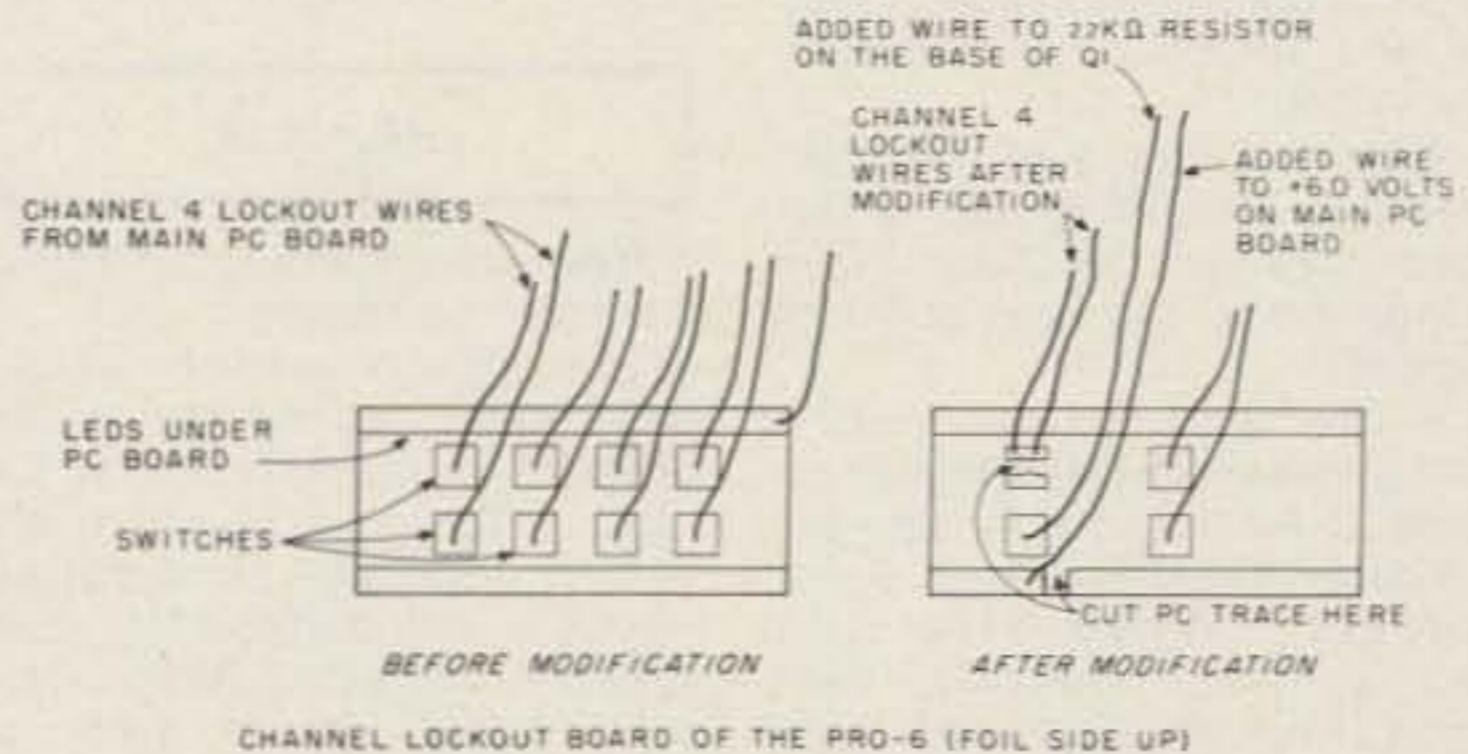

Fig. 3. Modifications to the channel lockout board of the Pro-6 to allow the channel 4 switch to be used as S1 of the decoder. Channel 4 of the scanner will always be active after the modification.

on the PC board where you removed the previous wire to the input of the demodulator.

When S1 is in the off position, the scanner will work normally. When you hear a scrambled message, turn the demodulator on and adjust R2 for a readable output. If you cannot get a low enough frequency for your needs, simply add some capacitance to C1, as in Table 1.

Comments and Conclusions

In operation, the decoder has been totally stable and performed well. When the decoder is switched off, it draws about 3 mA. When it is switched on, it typically draws 15 mA and has little effect on battery life.

If your scanner operates on a higher voltage, scale up R4, R5, and R6 by the %

Value of C1 (uF)	Carrier frequencies obtained (Hz)		
	Lowest	Center	Highest
0.10	1650	3500	6000
0.15	1000	2500	4000
0.20	800	2000	3000

Table 1. Selection guide for C1. Lowest, highest, and center frequencies of each range obtainable by adjusting R2 are given.

voltage increase (approximately) that you have above 6 volts; also adjust R3 to give 1.0 mA current

into pin 6.

I will be glad to answer any questions if an SASE is enclosed. ■

ou moons don't ever proof
lousy manuscripts from bat
bunch of rock...
you...
I insist that you print ev
tell Ma Bell that she shou

LETTERS

from page 11

reason, the BS that the ARRL has dished out to Mary has frustrated me.

Mary, as far as I know, started having trouble when she ran against W7PGY in the last director election. I don't know that Thurston was responsible for the mudslinging that Mary got, but he certainly benefited the most from it. If enough people had read between the lines, just maybe the election would have come out differently.

When the election for SCM came up, two people were nominated: W7QGP and W7IEU. The results of the election are obvious; Mary was disqualified. I have proof that Mary was disqualified after the fact. It seems that the people charged with looking after our best interests took it upon themselves to change the rules or by-laws so as to disqualify W7QGP; this caused W7IEU to win by acclamation.

After the fiasco of the SCM election, Mary filed suit in the court system out here. This brings me to the next point of interest.

A few months ago, notice was given in QST that elections were to be held for Northwest Division Director and Vice-Director. When after the deadline for nomination petitions had expired and only W7QGP and W7PGY had been nominated, the election was set aside until the litigation concerning the SCM election was settled. Meanwhile, the executive board (minus W7PGY)

voted to have W7PGY, his highness and not so exalted ruler of the Northwest Division, Mr. Thurston, act as a caretaker director until such time as the aforementioned litigation is resolved. So far, the litigation has gone on for almost 2 years now, and, by the looks of it, probably a couple more years.

Well, fellow members of the Northwest Division, it seems we are enslaved to the junta in Newington under direct command of Field Marshal Thurston. Heil! Heil! Long live the regime!!

I must close for now and pay homage to his excellency, W7PGY, on my knees bowing down towards Seattle.

**Phillip J. Kelly, Sr. WA7DKA
Vancouver WA**

P.S. I have remained a member of the ARRL for the sole reason that if any reasonable facsimile of a fair election is run, I want to be able to vote W7PGY out.

HR-13015

You are generally on top of things coming out of Washington which affect amateur radio, so I am somewhat surprised that I've read nothing in 73 (or in any other amateur publication) about a bill currently in Congress which could have an impact every bit as great as WARC. The bill is HR-13015, which was introduced last June by Lionel Van Deerlin (D-Cal.) and Lou Frey (R-Fla.). It is titled "The Communications Act of 1978" and is now moving

through the Committee on Interstate and Foreign Commerce, of which Van Deerlin is chairman.

The Van Deerlin-Frey bill has received a great deal of press among broadcasters because of the sweeping changes it would make in regulation of the radio/television broadcast industry. The point is to deregulate the broadcasters, and let free enterprise take its course. The bill also seeks to break up the Ma Bell/AT&T monopoly.

But HR-13015 would also affect amateurs. Amateur radio is not specifically mentioned in the bill, and that in itself is disturbing, since it would affect us so directly. The act, if passed, would repeal the Communications Act of 1934 entirely. It would eliminate the FCC, setting up a 5-member Communications Regulatory Commission in its place. There would also be an independent, policy-making arm of the executive branch known as the National Telecommunications Agency. The duties of the Commission and the Agency, as outlined in the bill, are primarily concerned with broadcasting, although the Commission would also regulate some "non-broadcast services" such as common carriers. Again, the Amateur Service is not mentioned. (Do they know something we don't?)

One interesting change in the bill would be the charging of license fees according to the amount of spectrum allocated. A TV broadcaster would be charged for his 6 MHz, while an AM broadcast station would only have to pay for 10 kHz, etc. In reading the bill, I can't determine if this same system would be applied to the "non-broadcast services," but can you imagine what a ham license would cost if it were? Our 420-450 MHz band alone would cost the same as five TV broadcast permits!

I think this legislation bears looking into by amateurs, and I'll be interested in reading further comments on it.

**Mark D. Johns WA0RGV
Iowa Falls IA**

DELETE THE DOWNLINK

I would like to express my opinion about the OSCAR-type ham satellites with downlinks into 10 meters now that the band is fully open for worldwide communications direct. It would seem that the time has come to turn off the OSCAR 10 meter downlink.

The reason for my position is that even 100 kHz is a lot to take out of the usable spectrum. Now that the Soviets have put up their two satellites, this has increased to 200 kHz, which seems to be forbidden territory for those wishing to make direct contacts.

The pass time over any given area may be good for only 15 to 20 minutes of acquisition, but now that near-normal direct skip prevails over such a wide area in all directions, it means that interference chances are many times greater because of the wider area a direct skip signal may cover.

There are several other factors that make OSCAR-type satellites unethical at this time, one being the large number of Civil Emergency Preparedness Stations which have been established on these frequencies since shortly after WWII, another being the many QRP stations which have been squeezed out of the lower portions of the band by high-powered activities there.

It is unfortunate that the Soviets chose to make their major output in the 10 meter band at this time of increasing good skip conditions.

I have suggested to AMSAT that if they lead the way now by

Continued on page 93

Midland's 13-510 Is One Great 2-Meter Mobile. Our 13-510A Is Even Better!



- NEW!** The 13-510A P.L.L. synthesizer delivers 1,200 frequencies between 143.00 and 149.00 MHz... the full 2-meter band, plus MARS.
- NEW!** The 13-510A will operate with up to a 6 MHz split between TX and RX frequencies.
- NEW!** The 13-510A microphone connector is pre-wired for your Touch-Tone® encoding microphone.
- NEW!** The 13-510A has a 7-pin accessory connector for your Touch-Tone® dial, tone-burst generator or discriminator meter. *Touch-Tone is a registered trademark of AT&T.
- NEW!** The 13-510A is compatible with available popular CTCSS continuous tone-coded squelch system accessories.
- NEW!** The 13-510A has 3 transmitter outputs: 1, 10 and 25 watts.

Midland's 13-510, with its commercial-type modular construction, earned its reputation as one tough 2-meter FM mobile. Now Midland has made the 13-510A an even more versatile performer!

The 13-510A P.L.L. synthesizer splits the 6 MHz spread between 143.00 and 149.00 into 600 discrete frequencies, and a 5 KHz up-shift delivers 600 more for a total of 1,200... shown directly on the digital display. In addition, there's access to 4 available offsets for repeater operation on ± 600 Hz with crystals supplied or up to 6 MHz spread with your crystals installed. Inside the 13-510A, there's a highly sensitive (0.3 μ V), highly selective (-70 dB at ± 15 KHz) dual conversion receiver with

dual gate MOSFET RF and mixer stages, crystal filter in the 1st IF, ceramic filter in the 2nd IF, and helical resonators in the RF amplifier.

The transmitter is conservatively rated for 25 watts output, switchable to 1 or 10 watts for repeaters, and uses direct FM modulation to deliver natural sounding audio.

Other features making Midland's 13-510A the one to look at include automatic protection circuit for the output transistor, internal DC filtering and polarity protection, a deep-finned heat sink for the power transistors, and electronic switching that needs no mechanical maintenance. Mobile mounting bracket, base stand and push-to-talk microphone are included.

CHECK OUR SPECS:

RECEIVER. Type: dual conversion superheterodyne. 1st IF frequency: 16.9 MHz. 2nd IF frequency: 455 KHz. Sensitivity: Less than 0.5 μ V for 20 dB quieting (0.3 μ V for 12 dB SINAD). Spurious response: -60 dB. Squelch threshold: Less than 0.3 μ V. Modulation Acceptance: ± 7.5 KHz. Selectivity: -70 dB at ± 15 KHz. Audio output power: 1.5 watts at 8 ohms.

TRANSMITTER. Outputs: 1, 10, 25 watts. Frequency deviation: Adjustable 3 - 16 KHz (normal 5 KHz). Audio input: 600 ohms. Modulation system: Direct FM. Spurious Radiation: Less than -60 dB below carrier.

GENERAL. Power: 13.8 volts DC, negative ground. Current drain: Transmit, 2 - 7 amps.; receive, 0.8 amps. average. Antenna impedance: 50 ohms. Unit size: 2-5/8" x 6-13/16" x 9-5/8". Unit weight: 6.6 lbs.

Want to know more? See your
Amateur Radio Dealer for Midland Quality

- P.L.L. "220" MOBILE
- CRYSTAL "220" MOBILE
- ANTENNAS & ACCESSORIES

... or write for free full-color brochures. ✓ M41

MIDLAND[®]
INTERNATIONAL

P.O. Box 1903, Kansas City, Missouri 64141

Digital RTTY Is Simple

— easy as 01, 10, 11

Copy wide- or narrow-shift RTTY with this digital converter.

Lately, I have become interested in getting on a local 2 meter repeater and working some radio-

teletype (RTTY). I have a 2 meter rig and an old Teletype™ unit, but getting the audio from the

speaker to the Teletype print magnet in a language it could understand was a problem. While doing

some research and trying to decide on one of the inexpensive RTTY converters described in different magazine articles, I thought how nice it would be to connect my digital frequency counter to the speaker of my receiver, display the frequency, and tell my Teletype unit, "When this display changes from 2125 to 2295, disconnect the power from the print magnet." Of course, there is no way that my counter was going to keep up with the rapid frequency shifts of radioteletype, but the idea stuck with me. It resulted in an inexpensive RTTY converter that is easy to build and operate.

The main element in getting a good copy on a Teletype is to turn the print magnet off and on at a

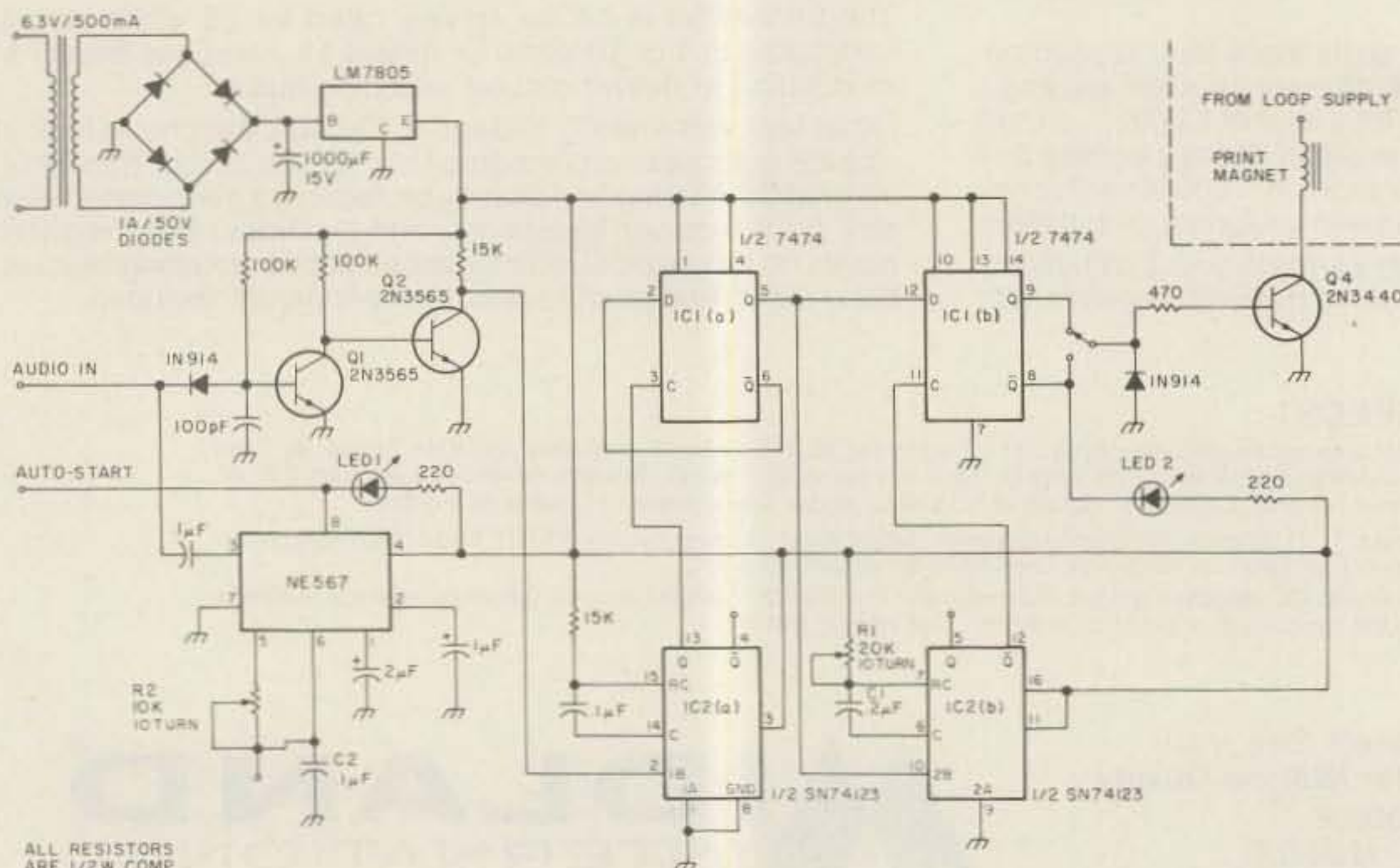

Fig. 1.

precise timing rate. A "mark" turns the magnet on; a "space" turns it off. At 60 wpm, the number of marks and/or spaces that occur during a 163 ms period tells the machine which character to print. A "space" is not the character you get when you hit the space bar, but it signifies that no current is being drawn by the loop.

I knew the first thing I needed was a square audio wave to clock the digital circuitry. After a few hours of building different squaring circuits, Q1, Q2 (Fig. 1) turned out to be the one with the best waveshape with the minimum output voltage required to obtain a square wave output.

Rather than use a method of counting the audio frequency, I decided that it would be easier and require less parts to measure the time between cycles. In order to do this, the first cycle has to turn on a timer and the next one turns it off. I used the popular divide-by-2 method using the SN7474 dual D-type flip-flop. The SN7474 can be used as a place to store data, also. When the SN7474 is clocked by a low-to-high voltage transition at its clock input, the voltage value of its data input (D) is moved to the "Q" output. The "Q" output is always the opposite of "Q". Data is referred to as a "1" being the higher voltage (4 V typically) and "0" being the lower voltage (.2 V typically). If the "Q" is connected to the "D" input, the "Q" output will be high on every other clock cycle because "Q" is always the opposite of "Q". This divides the clock frequency by two.

Now that "Q" is a "1" for one complete cycle of the input frequency, a reference pulse is needed to compare this time with. The SN74123 provides this pulse. The output of the SN74123 can be triggered

and the output pulse width can be set by an RC network. It also has a "Q" opposite of "Q".

There are two one-shots in an SN74123. One of them is used to help square the audio input. The RC time constant of this half is set for approximately 150 μ s.

The input circuit was designed to work with the speaker connected to the audio output used. Only 300 mV p-p is required to get a square audio wave out.

The audio input is squared and conditioned by Q1, Q2, and IC2(A). The "Q" output of IC2(A) is connected to the clock input of IC1(A). IC1(A) divides the input frequency by two. The high logic level at the "Q" of IC1(A) is now equal in time to the time it takes the input frequency to complete one cycle. With 2000 Hz at the input, the "Q" output of IC1(A) will be high for 500 μ s; at 2170 Hz, "Q" will be high for 460.8 μ s.

When "Q" of IC1(A) goes high, this clocks IC2(B), causing "Q" of IC2(B) to go low at the same time. The output pulse length of IC2(B) can be adjusted to a desired length by R1.

If the output pulse length of IC2(B) is set to 480 μ s and input frequencies of 2000 Hz for mark and 2170 Hz for space are used, the "Q" output of IC2(B) will be low for 480 μ s and will go high while "Q" of IC1(A), on mark, is still high. But it will go high after "Q" of IC1(A), on space, goes low. The low-to-high transition of "Q", IC2(B), clocks the "Q" of IC1(A) into "Q" of IC1(B). A "1" will always be clocked in for a mark and a "0" will be clocked in for a space, as shown by Fig. 2.

The "Q" or "Q" of IC1(B) can be selected for upshift (Q) or downshift (Q) and used to drive the loop switch, Q4. This out-

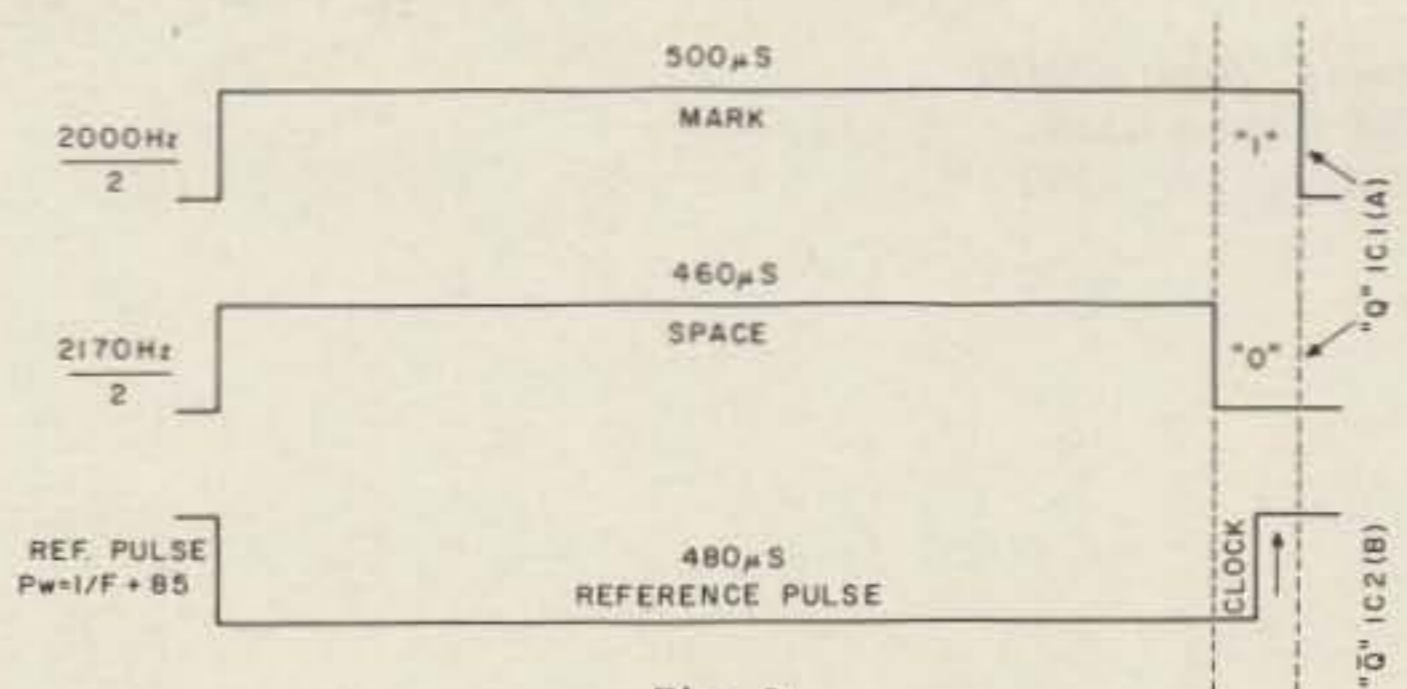

Fig. 2.

put could also be used to drive a UART.

The converter should be set to convert narrow shift. Then it will decode both wide and narrow shifts.

To adjust the converter, apply a 300-500 mV p-p audio signal at the desired mark frequency to the audio input. Connect a scope to "Q" of IC1(A), pin 5. This output should be a clean square wave at half the input frequency. Disconnect the scope and connect it to "Q" of IC2(B), pin 12. Adjust R1 until the low-level pulse width is equal to Pw. $Pw = 1/F + 85$, where Pw is the pulse width in seconds and F is the input mark frequency.

Disconnect the scope and connect it to the "Q" output of IC1(B). This output should be high. Adjust the input to the frequency of the space signal (mark frequency + 170 Hz for narrow shift). "Q" should be low. Shift the audio frequency from mark to space and back. The "Q" output should now shift with the input; 1 equals mark, 0 equals space. If the PLL tuning indicator is used, adjust the audio input to the mark frequency and then adjust R2 until LED1 turns on. Adjust R2 and find the center of the bandwidth of the PLL. The converter is now ready to convert up-, down-, narrow-, and wide-shift radioteletype.

Tuning is done by adjusting the bfo of the receiver and is not difficult. If the converter is to be used on 2 meters, it

should be aligned for the standard audio frequencies used in your area. LED2 will blink as a shift in frequency occurs and, if the PLL circuit is used, will also "unlock" randomly, especially on wide shift.

Some other input circuits could be used, such as an FET or Schmitt trigger, and some noise limiters and audio filters added, but they are not at all necessary to get a good copy from a good signal.

I built the converter with VHF RTTY in mind, but have used it to receive Teletype on the HF bands where noise and fading did cause problems. As long as the audio was decent and noise was at a minimum, the converter didn't miss a character.

The phase locked loop circuit using the NE567 was built as an autostart circuit, but makes a great aid for tuning.

For more information on the NE567 PLL, see the November, 1977, issue of *73 Magazine*. For more information on one-shots, see the February, 1977, issue of *73*. If you need to do some reading about radioteletype in general, read the September, 1977, issue of *73*.

I etched a 3" x 5" circuit board and had plenty of room on the board for the power supply. A breadboard or hand-wired circuit will work just as well.

The converter was housed in a Radio Shack cabinet no. 270-252. The LEDs are Radio Shack no. 276-026. ■

Take the Pledge

— a no-compromise console

This simple approach to building your final equipment features two-tiered, sloped construction.

Following a long history of futile attempts at misusing desks, adding table-top extenders, building shelves, and the like, I finally decided upon the pictured design for my amateur radio equipment console. Photo A illustrates the unit, complete with the following features:

1. a sloped top to aim the upper equipment down;
2. a sloped bottom to aim the lower equipment up;
3. a storage shelf for books, logs, parts, meters, etc.;

4. an inexpensive wood-grain contact paper finish; and
5. portability to sit atop any existing table or desk.

After estimating the costs to have it built from particle board covered with Formica™ by an acquaintance who is a part-time cabinet maker (\$350), or simply to purchase a metal workbench of similar style but less capacity (\$150), I made myself an offer that I couldn't refuse: "Do it yourself, but take your time and do it right, and the XYL will be on

your side forever!"

The total construction costs will be variable, mostly dependent upon your current supply of scrap lumber and hardware as follows:

1. two aluminum angles @ \$4.95
2. four T-braces @ 50¢
3. twenty feet wood-grain contact paper @ 59¢
4. screws, nails, glue, etc., for \$5.00
5. optional electrical outlets and lamp(s)
6. one and one-half sheets of plywood (4' x 8' x ½")

Begin to get the overall construction details clear in your mind by referring to Photo B and Fig. 1. The unit is four feet wide, by all the dimensions shown in Fig. 1. The dotted lines represent an internal barrier to keep things from getting lost in the very least accessible nooks and crannies. The shaded areas represent the internal supports needed for strength and stability.

I stress the use of plywood instead of particle board because of its lighter weight

and ease of maneuverability, its ability to accept screws and nails without fracturing, and its esthetic wood grain if you elect to give it a natural wood finish instead of using the contact paper option.

If you are not an experienced cabinetmaker, I recommend that you acquire and read the following literature before commencing the actual construction:

"How to Buy Plywood," *Popular Science*, Feb., 1977, page 122; "How to Work With Plywood," *Popular Science*, Mar., 1977, page 124; *NBS Voluntary Product Standard PS51-71, Hardwood and Decorative Plywood*, SD Catalog number C13.20/2:51-71, Government Printing Office, Washington DC 20402.

The first step towards construction is to pre-cut the following sizes of plywood. They can be cut most efficiently according to the diagrams in Fig. 2: 48" x 30" bottom plate, 48" x 18" bottom shelf, 48" x 12¾" bottom slope (20° cut), 48" x 24" top plate, 48" x 11¾" top shelf, 48" x 11" top slope (20° cut).



Photo A.

The slope pieces require angled edges if you don't want to use up all of your Plastic Wood™! The specified lengths include the extended edges of those angled cuts.

Next, precut the internal supports and sides from plywood, or from one-inch pine (the latter is recommended if it is available): 30" x 4½" bottom sides (two pieces), 22" x 5" top sides (two pieces), 6" x 4½" internal support (for bottom), 6" x 5" internal support (for top).

Refer to the details illustrated in Fig. 1 to make the angle of slope on the side pieces, and the 20° cut angle on the slope pieces.

Then, precut the miscellaneous parts as follows: 48" x 1" bottom rear ledge, 48" x 1¾" top front ledge, 47" x 4½" internal barrier (for the bottom). This internal barrier can be made of any material from plywood to plasterboard because it doesn't have to support any weight, it is not usually visible, and you're trying to build this console for next to nothing, aren't you?

Finally, you can go to your local building supply center to acquire the following items:

1. four-penny finishing nails (½ pound)
2. white glue (large bottle)
3. four 3-inch T-braces with mounting screws
4. two 8-foot lengths of ¾" angles of 1/8-inch aluminum
5. six #8 x 1" aluminum screws, bevel-head
6. six #6 x ½" aluminum screws, flat-head
7. miscellaneous electrical fixtures if you aren't reusing whatever you were using before you decided to build this project (I used two outlet strips with six outlets each, one for the top and one for the bottom); you may also want to install a small fluorescent lamp fixture

You are now ready to assemble the console. Remember to use an abundant application of glue at every point of contact. Then remember to wipe away the excess glue after the nails have been driven and countersunk. Since the glue is typically water soluble, all you need is a wet rag for this cleanup procedure.

Begin by building the structural portion of the top and bottom, by referring to Fig. 3. Attach the sides to the top and bottom plates by seating all pieces atop the plates. Then attach the internal supports in a similar manner, centered left to right, but secured three inches from the open edge. Now attach the internal barrier for the bottom section; its back side should be flush with the beginning of the downslope cut of the side pieces.

Complete the main sections by affixing the shelf pieces to the top and bottom. As you may have figured out by now, I've saved the best for last. The angle cuts of the slope pieces may have to be "fine tuned" for an acceptable fit due to your manufacturing tolerances. The best way to implement those adjustments is by eyeballing the fit and adjusting the angle of the cut until you're satisfied with your own craftsmanship. Now apply the front and rear ledges, and all the hard work is over. The tedious work now begins!

Take a few moments to smooth the edges and joints, to countersink all the nails, and to fill and sand all those countersunk nail holes, joint gaps, and surface imperfections. If it doesn't look and feel smooth at this point, you'll be disappointed later, especially if you opt for a natural finish.

It is now time to apply the finish of your choice. I decided to use contact paper because the scrap lumber I used didn't consist of all unfinished lumber. Also, I wanted to match the finish of



Photo B.

the low-boy filing cabinet, as well as other items already in the shack. Modern adhesives work well on a clean surface, so be sure you have removed all the sawdust possible with a tacky cloth before you start to apply the contact paper.

As alternatives, however, you may choose to stain it, then finish it with varnish or shellac, or to paint it, or to apply a veneer or a laminate, depending upon your needs, skills, and finances.

Once that finish is com-

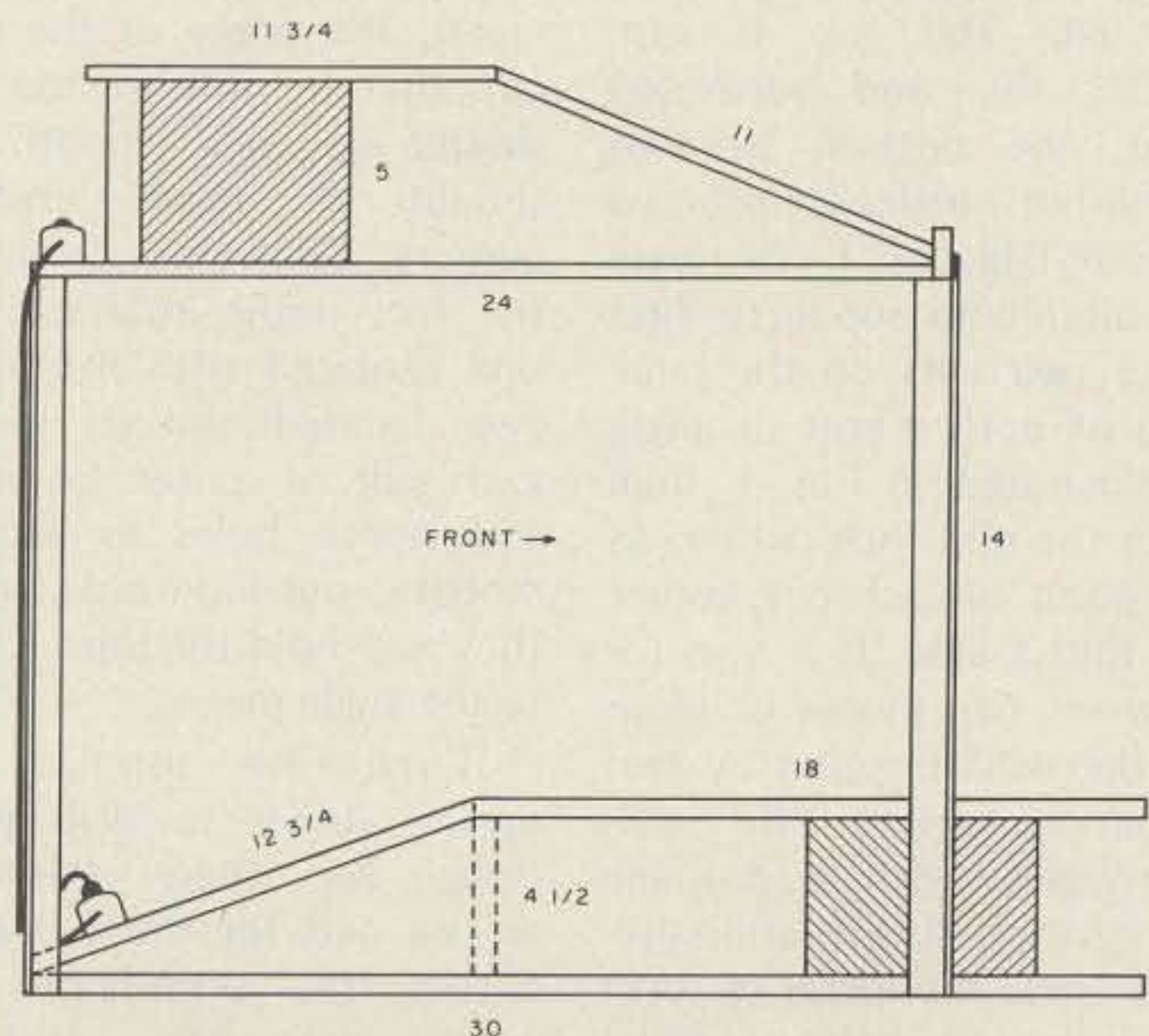

Fig. 1.

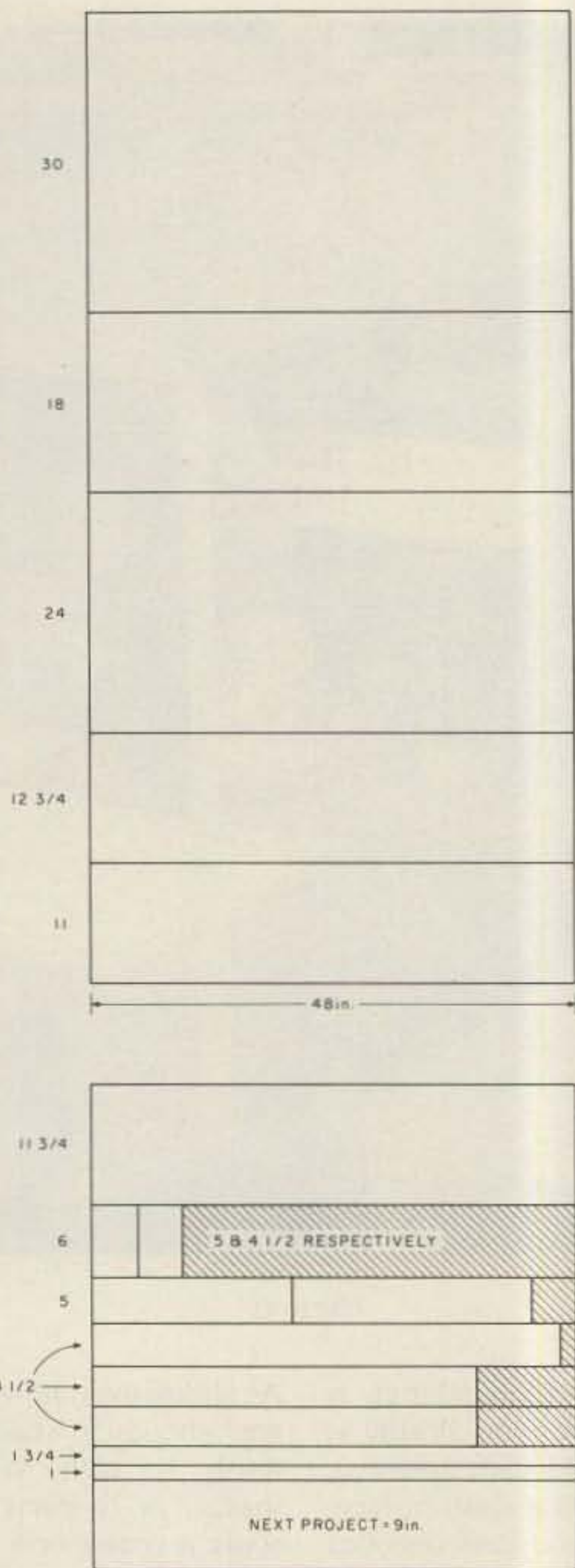

Fig. 2.

plete, the legs can be constructed. The top is supported by, and separated from, the bottom by two aluminum angles reinforced by four T-braces. To fabricate the aluminum supports, first make two cuts on the same edge of both pieces of angle as illustrated in Fig. 4, then scrap the nine-inch cutoff. At the point of each cut, secure the uncut side in a vise (or between two pieces of scrap lumber held together by two C-clamps). Heat the area thoroughly with a propane torch, then slowly and carefully bend the metal to form a right angle, taking special care not to crack the metal

on the bend. On each piece of metal, the edges of the two cuts that are now opened 90° should be filed smooth, as should the newly created corners. Drill three holes in the forty-eight inch section, one centered with the other two located sixteen inches each side of center. Counter-sink these holes to accommodate your flat-head screws; they will hold the top section to the angle pieces.

Turn the top section upside down to drill pilot holes for these flat-head screws and for the T-braces. Secure the aluminum supports with the flat-head screws, then install the

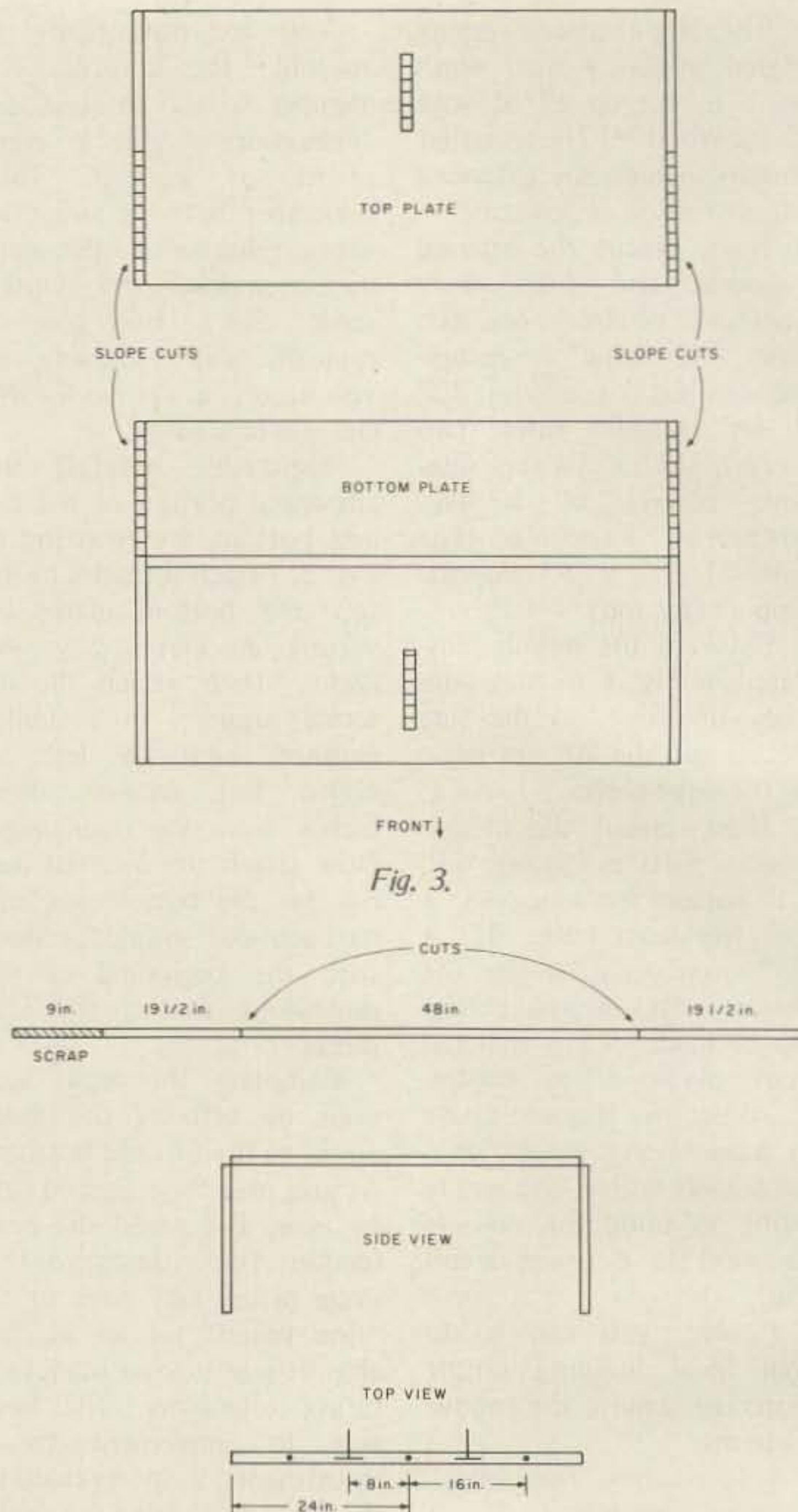

Fig. 3.

Fig. 4.

T-braces for additional strength, centered eight inches each side of center, as illustrated in Fig. 4.

Right side up, this assembly will wobble easily on these legs, but once secured to the bottom with three screws on each side, it will be sturdy enough to support a human being, let alone your kilowatt amplifier! That task is easily accomplished with two bevel-head screws in each front leg, and one in each rear leg.

Install your outlets at the rear of each section, and secure the feeder cable for the top strip to the back of a rear leg to hide it. If you

opted for a lamp, install it now, too.

Finally, sucker an accomplice . . . er, ahem . . . convince an able-bodied acquaintance to help you carry your creation from the woodshop to the ham shack, and lift it atop your old desk or table. If you used the contact paper finish, remember to be careful not to snag or to tear the plastic when you finally move in, connect, and check out your equipment. Now you may call in the boss for her approval.

Say, have you given any thought to building another console for your test equipment at the service bench? ■

It's Thomas Communications For Top Quality Equipment and Service

FREE

- Call Toll-Free 1-800-243-7765
- Retail Price Catalog
- Monthly Used Equipment List



YAESU
FT-7



YAESU
FT-901



ICOM
IC-701



DRAKE
TR-7



KENWOOD
TS-820S



YAESU
FT-227R



TEN TEC
544



PANASONIC RECEIVER
RF 4800



KENWOOD
TS-700SP

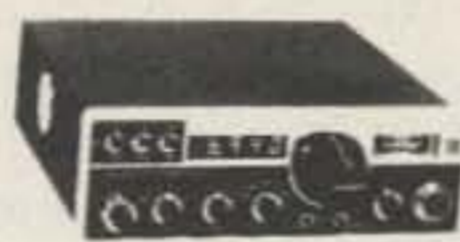

KDK
2015R



DENTRON
MLA-2500B



WILSON
MARK IV

OVER 50 BRANDS IN STOCK

- KENWOOD • SWAN • KDK • DENTRON
- MOSLEY • WILSON • YAESU • DRAKE
- LARSEN • BENCHER • KLM • BEARCAT
- B & W • DATONG • ICOM • PANASONIC
- ARRL PUBLICATIONS • ALLIANCE • BIRD
- CUSHCRAFT • TRAC • MICROLOG • CDE
- HAM KEY • MFJ • DAYBURN INSULATORS
- DSI • SAXTON • TEN TEC • REGENCY
- HUSTLER • ASTATIC • PIPO • AMCOMM
- AMECO • CALL BOOK • FINCO • TEMPO

★ NEW AND USED EQUIPMENT
"Get on our used equipment mailing list"

★ TRADES WELCOME
"The best allowances anywhere"
"We buy good used SSB gear"

★ FREE CATALOG
"Prices of all major manufacturers"

★ SAME DAY U.P.S. SHIPPING
"Just a phone call away"

★ COMPLETE RADIO SERVICE SHOP
• Fast Efficient Service • We Repair All Brands • All Work Guaranteed • Amateur Extra/First Class Licenses • Send Us Your Defective Equipment U.P.S. Collect • Free Shipping Both Ways If Work Is Done • Most Repairs Done & Shipped Within 7 Days

★ OUR FINE REPUTATION SPEAKS FOR ITSELF ★ "YOU SHIP IT — WE FIX IT"

**Call or write for
your super quote today!**

Connecticut Residents Call:
203-667-0811

95 Kitts Lane
Newington, Conn. 06111

"Near ARRL Headquarters"



**THOMAS
COMMUNICATIONS**

T34

OPEN MON.-FRI. 10-6 • THURS. 10-8 P.M. • SAT. 10-4

EASY DIRECTIONS: Rt. 15 South — 2 blocks past McDonald's (Berlin Turnpike)

Two Meter Tone Alert

— keep everyone on call

This system can provide emergency help at the dial of a "9".

Rodney A. Kreuter WA3ENK
R.D. #1, Box 27G
New Stanton PA 15672

Here in southwestern Pennsylvania, we have had our share of emergencies lately. The Johnstown flood and two hard winters have kept the local two meter repeaters from gathering dust. How-

ever, many hams, myself included, do not monitor these repeaters as much as we should because, many times, we are busy doing something and don't want to be interrupted by local rag chewing or routine traffic. Of course, I'm sure that there isn't a ham in our area who wouldn't drop whatever he was doing and man his station if he was needed.

The morning after Frank WB3HIY had found some stranded motorists in need of first aid for frostbite, Larry WA3YIR and I were discussing the use of the local repeater during times of emergency. Larry, who is the emergency coordinator for Westmoreland County, suggested that it would be very useful to have a type of tone alert similar to those used by fire com-

panies and ambulance services. Two meters is ideal for this, with its local coverage and fixed frequencies for repeaters. Since a great many hams now have touchtone™ pads for autopatch, it wouldn't be very difficult to use these to activate two meter monitors. All a person needs to do is access a repeater and touchtone in a certain code.

Since a fair number of repeaters now have autopatch, the tone alert decoders would have to be designed to ignore the tones used in making phone calls. The easiest and most reliable system of accomplishing this was to delay the output of the decoders so that the tones would have to be present for at least 4-6 seconds to trip the monitors. This doesn't mean that it can never trip during routine autopatch use, but anyone who holds a key down for that long needs help anyway.

The number 911 is the most often used telephone number for emergency service, so we decided to make our tone alert system activate when the number

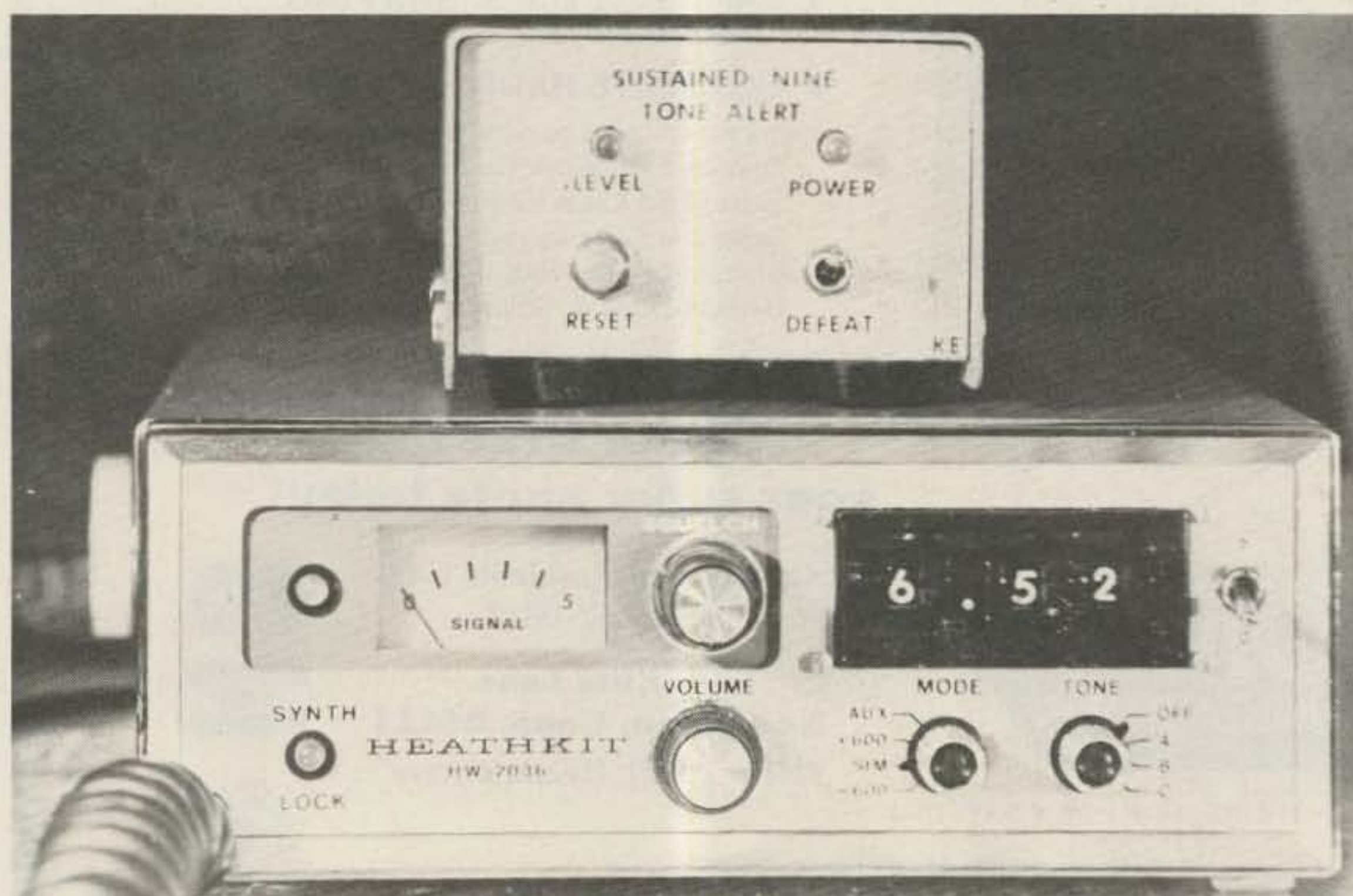

The system ready for operation.

9 is transmitted for longer than about 8 seconds.

Circuit Operation

In the monitor mode, audio is fed from the receiver to the 10-Ohm resistor, R1. R1 acts as a load for the audio amplifier and should match its impedance. If you don't know what the load impedance should be, use 10 Ohms.

The volume control on the receiver should be adjusted so that the LEDs light dimly when a set of tones is received. Since most LEDs have a turn-on threshold of about 1.7 volts, the audio voltage will be about 1.2 volts rms when the LEDs light. Resistors R3 and R4 divide this voltage down to about 100 mV, which is a voltage that the 567s seem to be happy with.

One more note on the volume control setting on the receiver: With the receiver pumping out 1.2 volts rms, the audio power delivered to the speaker when the tone alert activates will be about 200 mW. This is plenty for my ears. If your ears are different, do this:

1) Choose the audio power that you want;

2) Calculate the rms voltage for this power rating from $E = \sqrt{P \cdot 8}$ (assuming 8-Ohm speakers);

3) The new $R2 = [(1.4 \cdot E) - 1.7] / 0.01$ (R2 in Ohms); and

4) If you choose to use less than 200 mW, forget the above three steps. The LEDs won't light, so leave them out. Instead, adjust the volume controls so that you get 100 mV at the junction of R3 and R4. A scope or VTVM will suffice.

Since the LEDs limit the voltage to 1.7 volts peak, it won't be necessary to change R3 and R4 unless you opt for lower power. If you do want to use less than 200 mW, calculate the

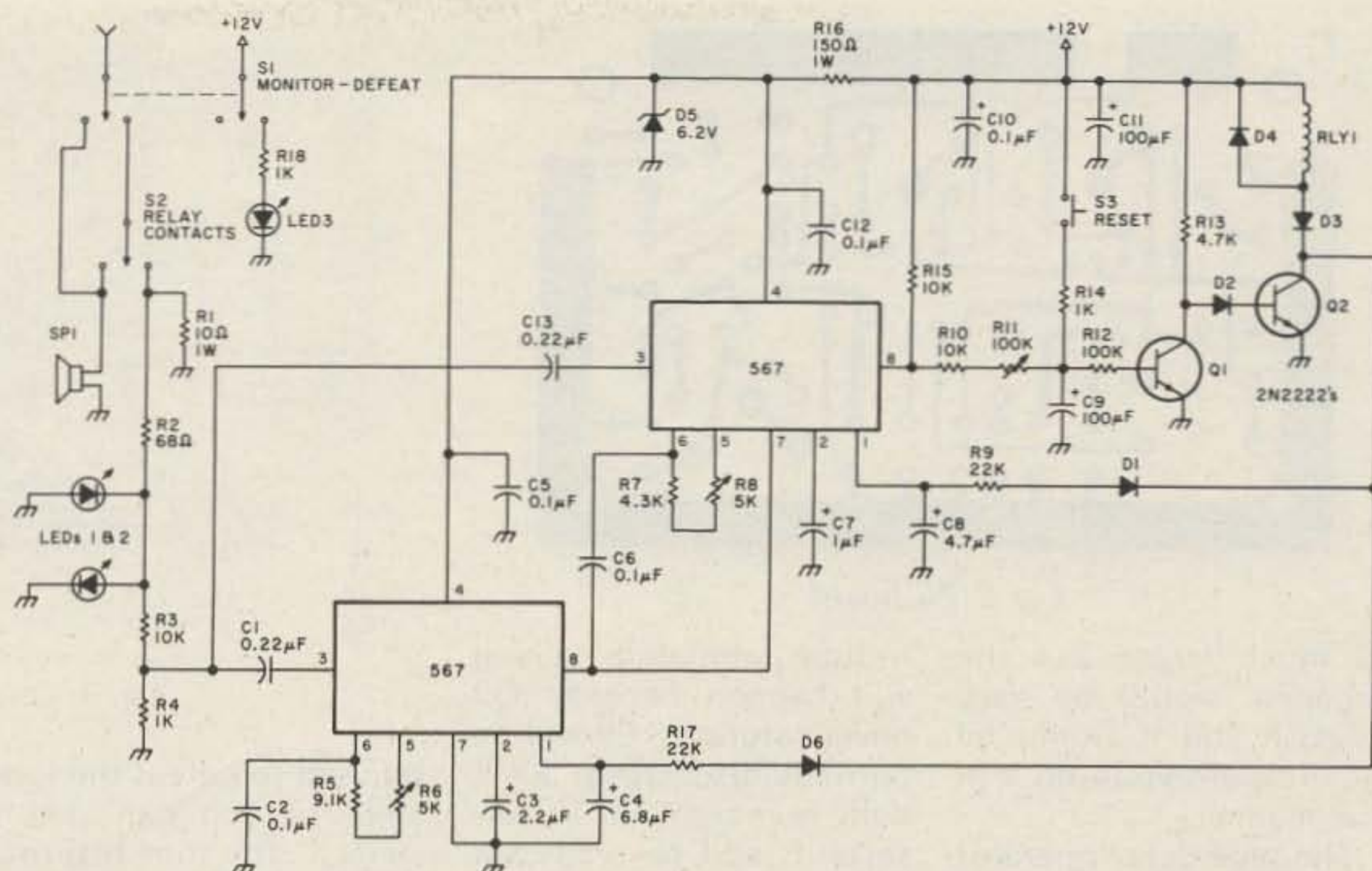

Fig. 1. S1 — monitor, defeat; S2 — relay contacts; S3 — reset.

new R3 from:

$$R3 = (10 \cdot E) - 1$$

(R3 in k Ohms)

Now that you have 100 mV feeding the 567s, you can proceed to more important matters.

As everyone knows, the tone for the number 9 consists of two tones, 852 and 1477 Hz. The load of IC1 is IC2. Therefore, IC1 is always drawing current from the power supply and "listening" for that 852 Hz

tone. IC2, on the other hand, isn't doing anything because IC1 controls its power supply and it won't have any source of current until IC1 "hears" 852 Hz. This saves current and provides the means of producing an output only when both tones are present.

When the tones representing the number 9 are received by the monitor, the output (pin 9) of IC1 saturates (goes from about

5 volts to 0.5 volts). Now IC2 has power and it "listens" for 1477 Hz. If 1477 is present, IC2's output also saturates and energizes the delay circuit, Q1 and Q2.

Capacitors C4 and C7 slow down the action of the tone decoders a little (0.5 to 1 second), but Q1 and Q2 provide most of the time delay. Additional time delay could be obtained by making C4 and

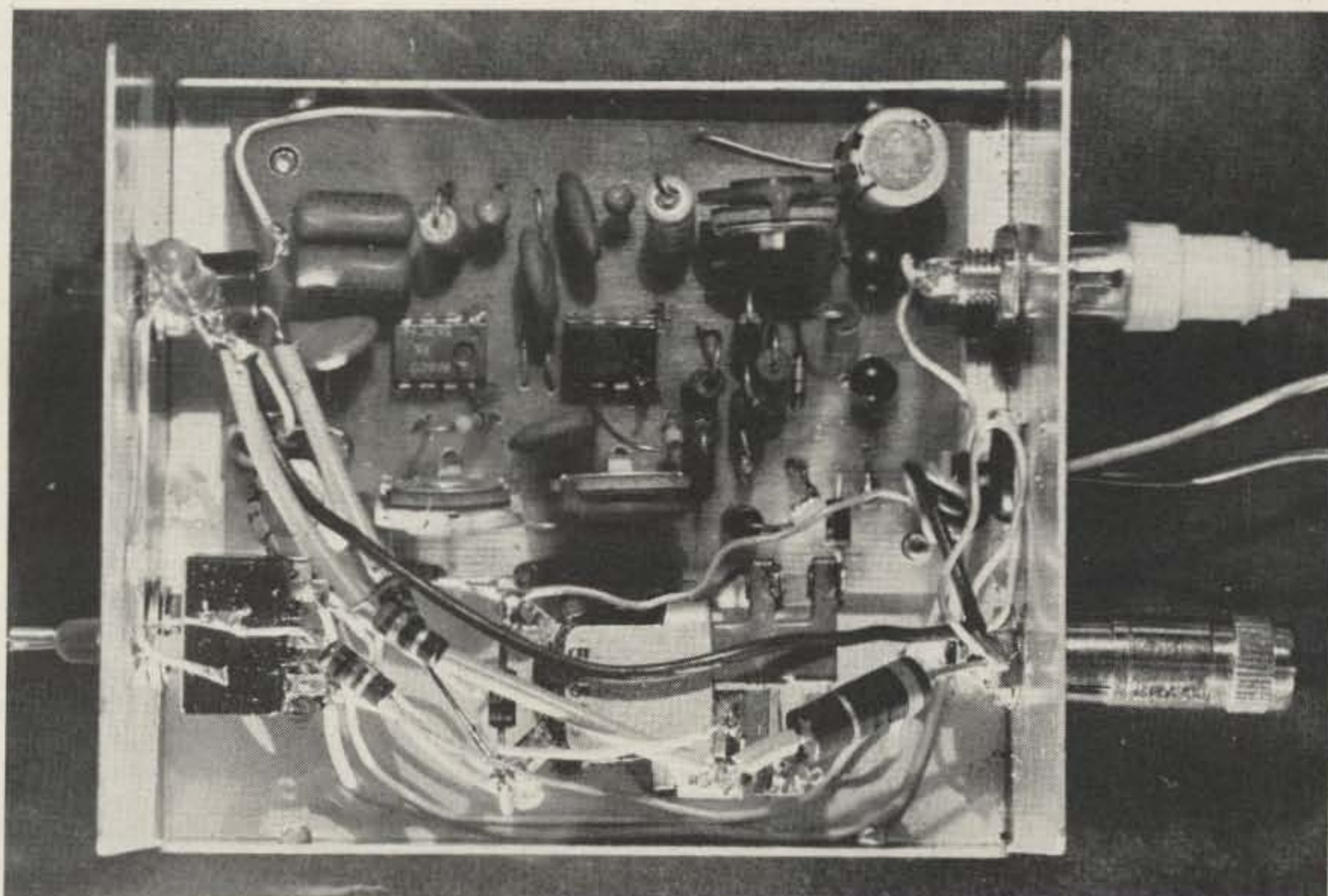

Inside view of the tone alert.

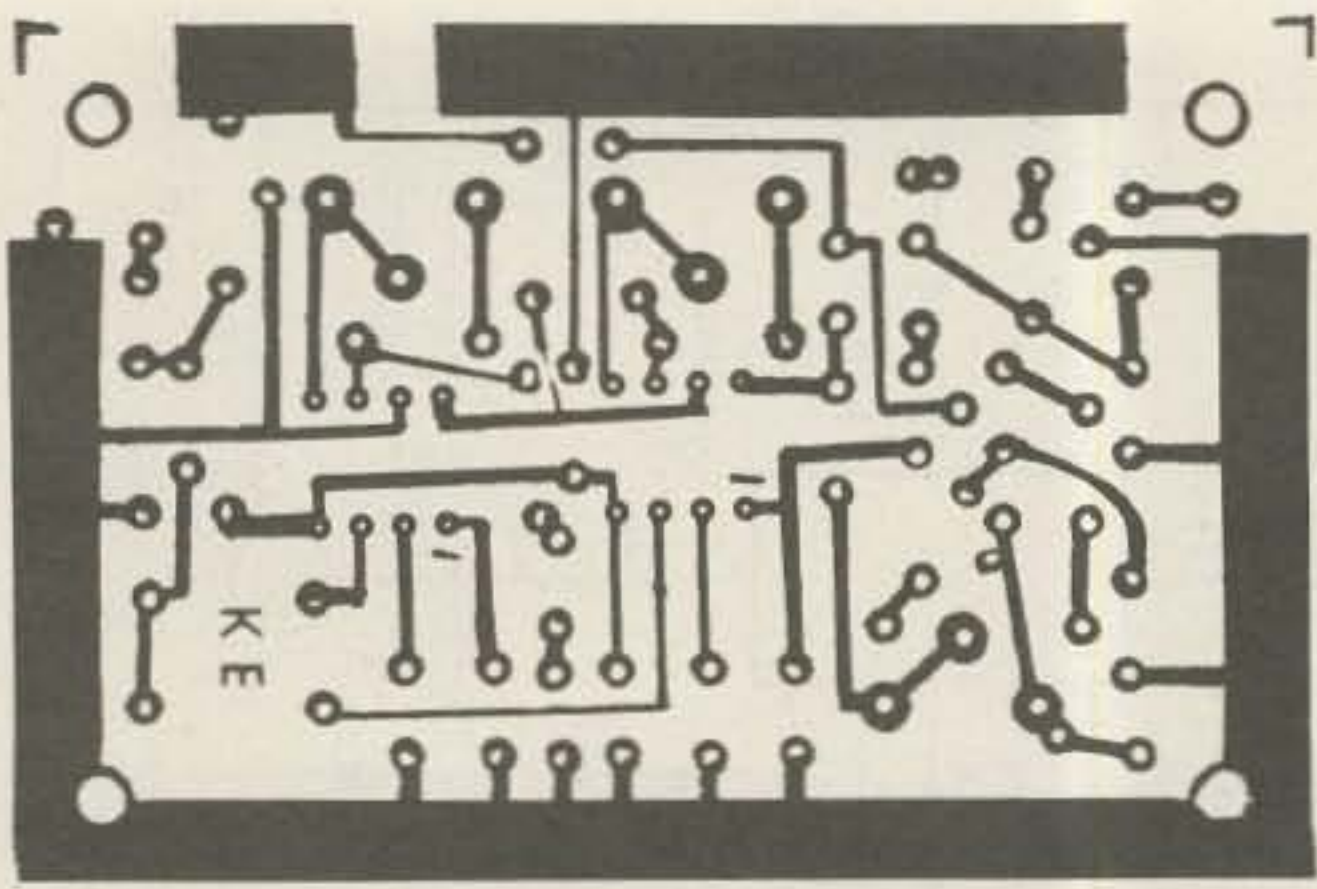

Fig. 2. PC board.

C7 much larger, but the decoders would be very sluggish and it would be more expensive to do it in that manner.

The time delay operates as follows. Initially, capacitor C8 charges to about 12 volts through resistors R10, R11, and R15. This causes Q1 to turn on and Q2 to turn off. When pin 8 of IC2 goes low, capacitor C8 begins to discharge through R10, R11, and R12. When it has almost completely discharged, Q1 turns off and Q2 turns on. This pulls in the relay and latches the circuit. Time delay is controlled by R11.

Resistor R9 and diode D1 provide the latching function for IC2. When Q2 finally saturates, pin 1 of IC2 is low. The voltage at pin 1 is then kept low by the diode and resistor. By applying a positive voltage to pin 1, the circuit is reset.

If the tones should end before the time delay times out, as in the case of a

routine autopatch, nothing will happen because Q2 never saturates. C8 will be partially discharged, but it will recharge in a few seconds and be ready for an alert.

Construction

The easiest method of construction is to use the artwork in Fig. 2 and make a printed circuit board. This would be especially useful if a club were to photographically produce a lot of boards. Perfboard construction could be used, since the circuit isn't very complex and layout is not critical.

Some components, such as the LEDs, relay, and speaker, were left off the board so that you can use any size components you might have. The relay should not draw any more than 150 mA. Mount the LEDs somewhere where you can see that the device is receiving the proper audio voltage.

A bypass switch (S1) can

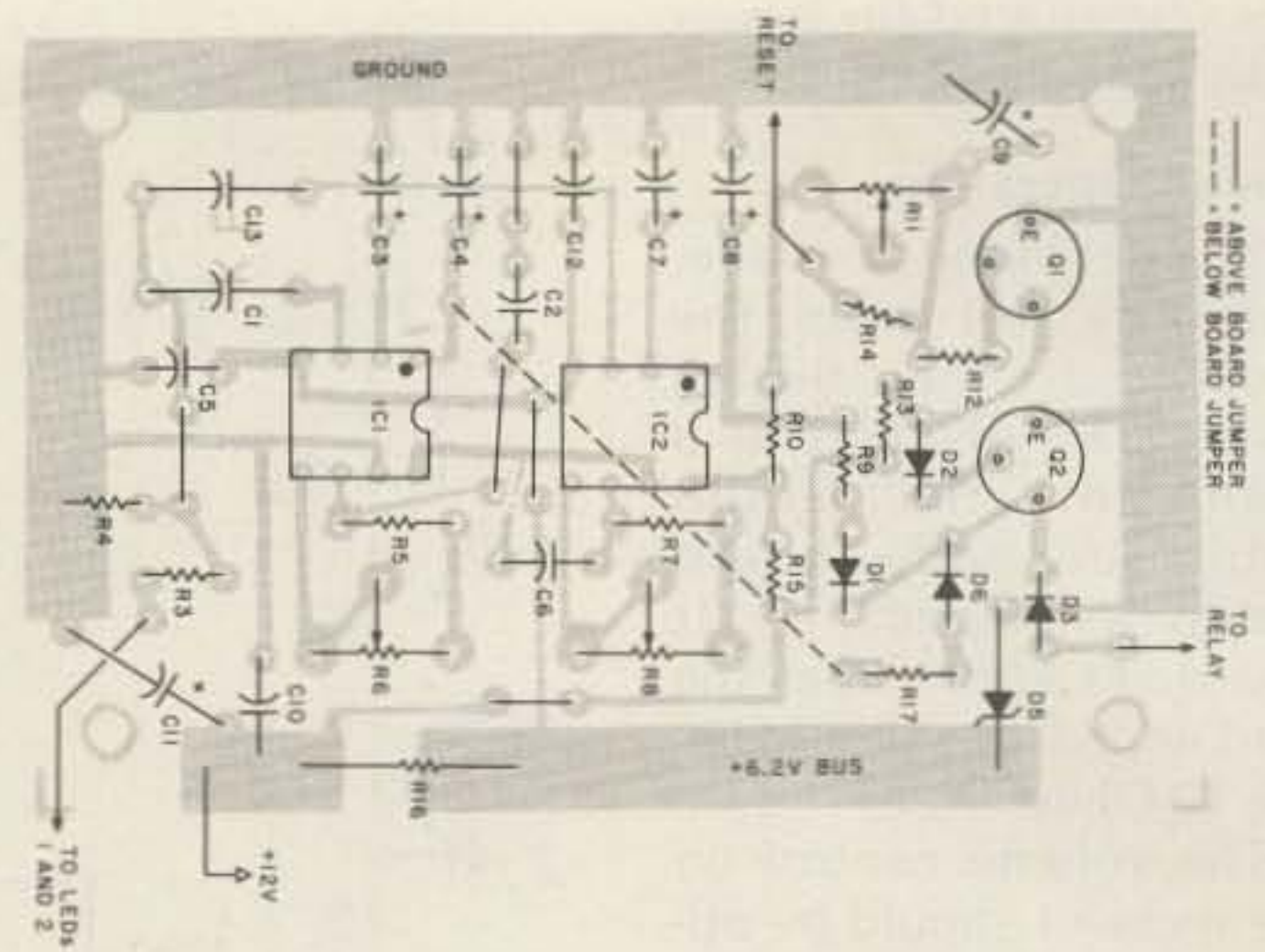

Fig. 3. Component layout.

be used to defeat the tone alert, or you can simply switch to the internal speaker of your rig.

Use the highest quality components that you can afford for this project. This device by its very nature might be called to work for months at a time without any testing. I would suggest that, if your local repeater group has nets every week, the monitors be tested before each net.

Use at least ½-Watt resistors unless otherwise marked. Capacitors should be at least 10-volt unless otherwise marked. Total cost of the tone alert should not be any more than about \$15 — junk box to the rescue!

Adjustment

Adjustment is not difficult, but it will take some time, mostly due to the fact that the decoders are a

little broad and a little slow to react.

Tune IC1 first. Turn R6 fully counterclockwise. Have someone transmit the tones for the number 9 (simplex, please). Apply power to the board, wait about 15 seconds, and then reset IC2. Adjust the volume on your receiver so that the LEDs just light.

Connect a voltmeter from pin 8 of IC1 to ground. Slowly turn R6 until the voltage falls from 5 volts to about 0.5 volts. Mark this point on the pot. Repeat the tuning with the pot initially in the clockwise position. The final setting of the pot will be midway between these two points. Have your friend pulse his pad — about 2 seconds on, 2 seconds off — and make sure the decoder falls each time.

Now proceed to IC2. Remember that IC1 must

Parts List

C1, C13	0.22 uF	R2	68Ω ½ W
C2, C5, C6, C10, C12	0.1 uF	R3, R10, R15	10k
C3	2.2 uF/16 V	R4, R14, R18	1k
C4	6.8 uF/16 V	R5	9.1k
C7	1 uF/16 V	R6, R8	5k trimpot vertical mount
C8	4.7 uF/16 V	R7	4.3k
C9, C11	100 uF/25 V	R9, R17	22k
D1, D2	1N914	R11	100k trimpot vertical mount
D3, D4	1N4001	R13	4.7k
D5	6.2-volt, 1-Watt zener	R16	150Ω 1 Watt
IC1, IC2	567 tone decoders	RLY1	12 volt SPDT relay 150 mA or less (see text)
LED1, LED2	red LEDs	S1	DPDT switch (power-defeat)
LED3	green LED	S2	relay contacts
Q1, Q2	2N2222 or similar	S3	N.O. push-button (reset)
R1	10Ω 1 Watt	SP1	8Ω speaker

be working before IC2 will operate. Perform the same type of adjustment using R8.

After you are certain that the pots are set correctly, epoxy, glue, wax, or nail polish them so that they cannot move. Adjust R11 for the proper amount of time delay. Six or seven seconds is okay.

One warning about the tones you use for adjustment. Be sure that your

friend has a good touch-tone pad.

Depending on what type of relay you might have available, you might do more than just switch in a speaker. A flashing light or tone, for example, might be switched in by an extra set of contacts.

Use

It comes to mind that a device such as this could be misused out of ex-

istence rather quickly. We are fortunate here in our area that we don't seem to have that problem.

To be really effective, as many hams as possible should know that a group of people in your area have these devices and are monitoring a certain repeater with them. It would be best if at least a few people on each repeater frequency have the tone alerts.

Another possibility that should not be overlooked is that alerts built for other tones could be used as a private line with friends or the XYL. A club could also have its own to alert members to cancellation of meetings or other business that would affect only those people.

Many thanks to Larry WA3YIR for his help with testing and printed circuit artwork. ■

ou moons don't ever proof
lousy manuscripts from bat
bunch of rock on
you liard y coart in
I insist that you print ev
tell Ma Bell that she shou

from page 82

deleting the 10 meter downlink, the Soviets may do likewise on their next venture.

AMSAT and associates should be congratulated for providing service into the 10 meter band during the low MUF, but now is the time to stop!

**Samuel H. Beverage W1MGP
North Haven ME**

MORE GROANING

To K4KI's informative article ("Silence Groaning Refrigerators") in the November, 1978, issue of 73 should be added several additional points to avoid problems he described. In addition to cleaning up bad connections in junction boxes, outlets and switches that show signs of overheating should be replaced. Appliances such as washers, refrigerators, garbage disposals, and air conditioners should be fed by separate circuits directly from the fuse or breaker panel. A common neutral as he describes in his article must be avoided! Balance the current draw on each side of the 220-volt service if possible; for example, if you operate 4 window air conditioners drawing 7 Amps at 117 volts, arrange separate direct wiring to each unit. At the fuse panel, two units should be connected between one of the 220-volt legs and neutral, and the other two between the opposite leg and neutral. If local building regulations do not permit you to work on your wiring in your

own home and if you are otherwise not qualified, find a competent electrician.

**William W. Muessig K4FD
Falls Church VA**

Mr. Muessig does not support his statement about running appliances directly to a fuse box using separate circuits by referencing the specific requirement of any recognized electrical codes. Three-wire systems have been developed for specific technical reasons. They have been in use for many years and are still being installed. As in any electrical power system, poor connections can be hazardous.

As electrical codes are quite complex and differ in various locations, the best thing to do is to check your code and see if your wiring conforms. One of the problems is that older houses may not conform to the latest codes, as the codes are often being changed and updated in many communities. Before making any changes, I would suggest learning the exact facts applicable to your own situation. A licensed electrical contractor will be able to inspect your wiring and suggest what changes would be desirable or required.

I am in full agreement with Mr. Muessig's excellent suggestion that any overheated items be replaced and bad connections corrected.—K4KI.

OOPS!

Oops! I'm only fifty-six and I certainly wasn't any child

wizard with electronics, but "fifty years a ham and long-time member of QCWA" is about the nicest thing anyone could say about me even if it isn't correct (see October, 1978, issue of 73, page 6)! My letter of July 24th providing you with the original artwork had reference to Larry Harvey N6LY for whom I did the sketch—he fits that description. He's the ham responsible for producing the fine printed program of the San Diego Convention and deserves recognition for a job "well done," most especially in view of the lack of help and cooperation which he had to overcome.

Keep the League's tender spots exposed to the stove, Wayne. The pages of 73 Magazine certainly give the amateur radio community much to think about and use in every facet of this great hobby. May your tribe increase—also your ad contracts and subscriptions!

**Paul Hower WA6GDC
La Mesa CA**

WE ASKED

You asked. I copied the 14 wpm tape you sent thirty times besides copying off the air—excuse me, thirty sides, fifteen times. Tuesday I got my General and Advanced licenses in one sitting.

So now send me the 21 wpm tape and the 6 wpm tape. Also, subscribe me again to 73.

**Glen Jacobs WB7CMZ
Eagar AZ**

GOLD STAR

The good guys still outnumber the bad guys in the mail-order business. In the spring of 1978, I ordered a gear set and service manual for a Lorenz Teletype™ machine over the telephone. I paid \$48.00, in advance, for the

order. The person accepting the order misunderstood and sent gears for a Model 15. I was advised the manual was not available from the advertiser. Subsequently, the advertiser had a machinist cut a pinion gear and I received my three made-to-order gears. I forgot about the manual. Recently, I received an unsolicited check for \$26.00 as refund on the manual not delivered. A gold star advertiser—Teletypewriter Communications Specialists, Berkeley Heights, New Jersey.

**George D. Loudon WB9GMF
Omro WI**

COMPUTER USER'S NET

There has been established a 2650 Computer User's Net every Thursday at 2330Z on a frequency of 3.993 MHz. The net is an informal net dedicated to the discussion of the 2650 in particular and personal computing in general. Most of the net participants are using the Central Data 2650 system and they are eager to talk to any and all.

The present net control station is Jerry Johnson WA3WZF, Fort Meade, Maryland, and it is hoped to expand the net to a 20 meter version also.

**Vincent Staffo WB2FYZ
Ilion NY**



Sneaky Car Security System

— an alarming article

The recent visit to my van by an "uninvited guest" gave me the impetus to start construction on a radio-controlled electronic locking and alarm system which I have contemplated building for some time. Most standard automotive alarms have

certain disadvantages, such as time-delay units which allow 30 or so seconds for entry. A professional thief can have the door to your car opened, radio out, and be halfway down the block before your siren goes off! Lock-actuated systems possess

the negative feature of having to punch a hole in the body of your car. They are also a dead giveaway to the "pro" as to what type of protection you are using. But my particular design utilizes a small battery-powered transmitter to activate and deac-

tivate the alarm/receiver, without any direct connection to your vehicle.

Almost all of the digital circuitry is from the CMOS family, which is a natural for automotive applications because of its wide supply voltage range, excellent thermal character-

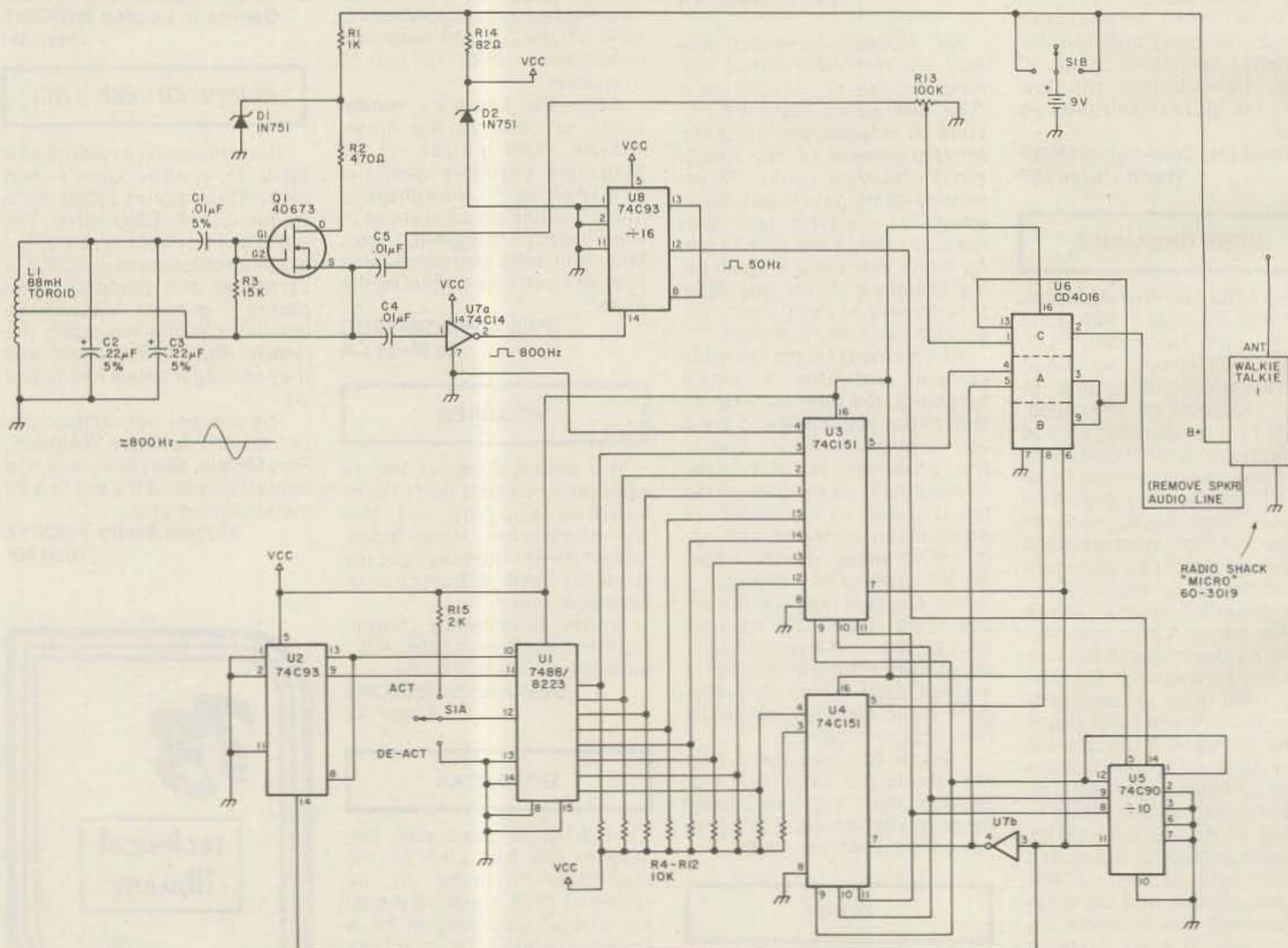
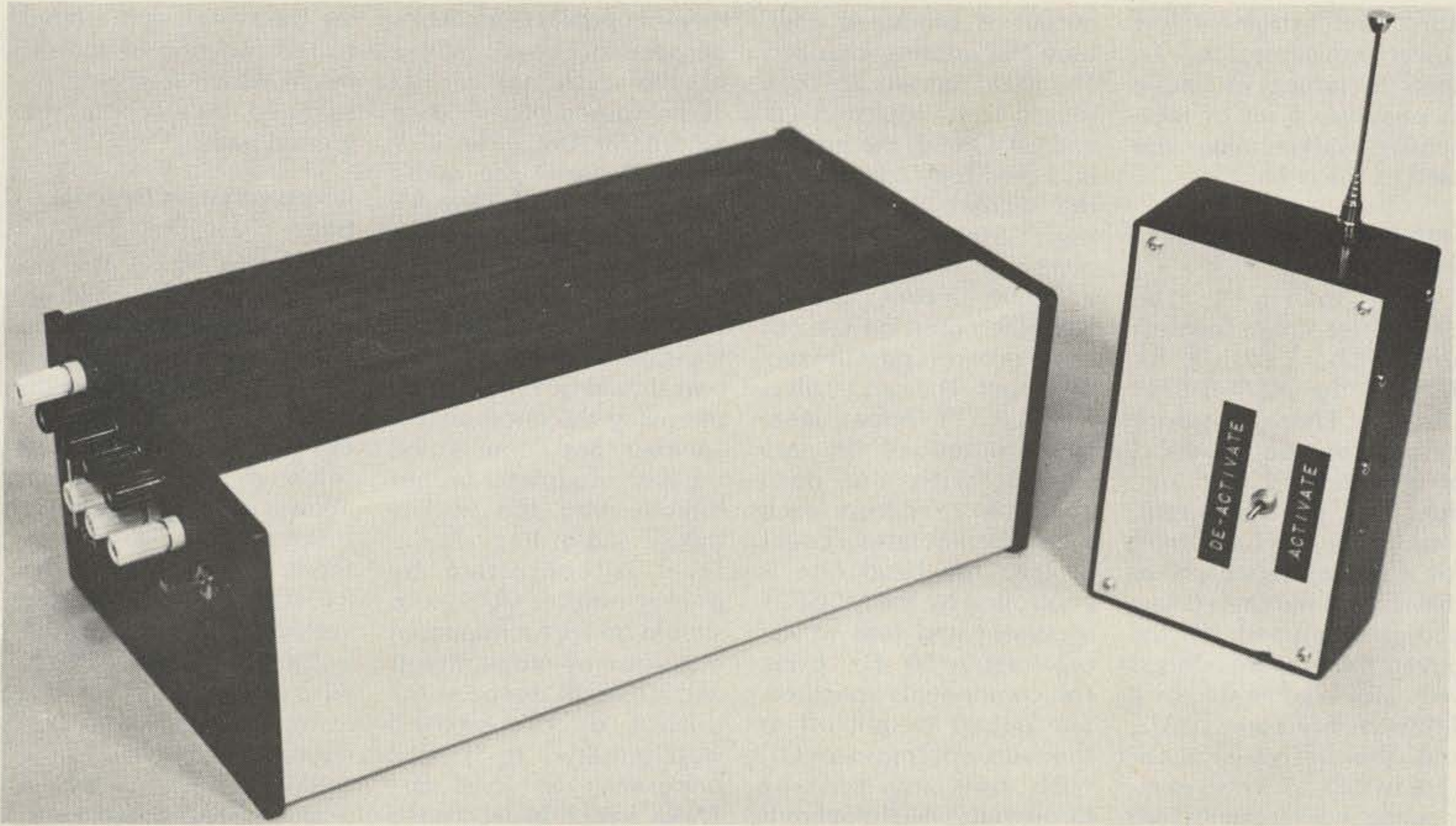

Fig. 1.



Receiver and companion transmitter.

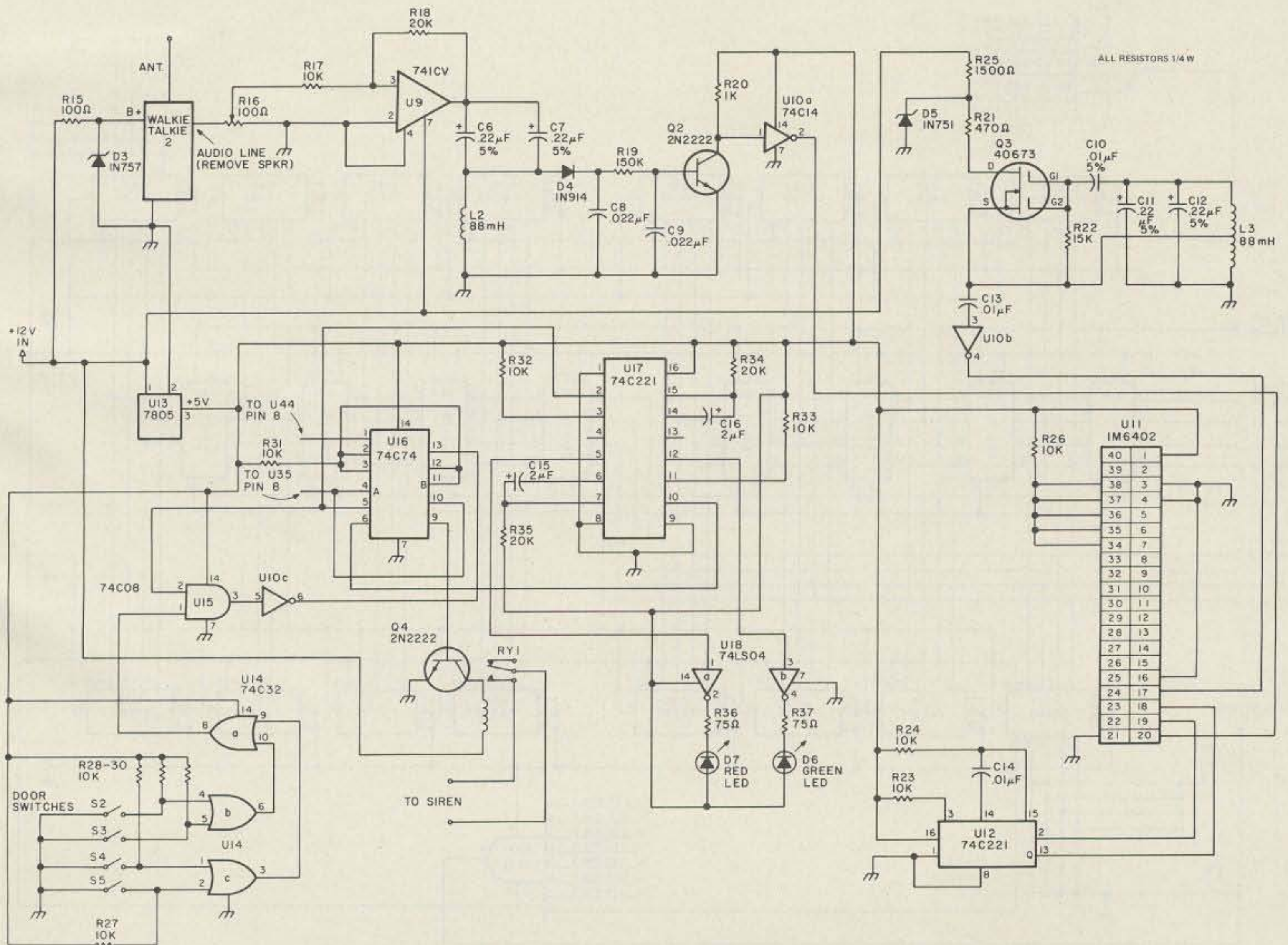

Fig. 2. Rx/logic control. All resistors are 1/4 Watt.

istics, and extremely low power consumption. To keep the project as simple as possible, a set of inexpensive walkie-talkies are used as the rf link.

Transmit System Description

Refer to Fig. 1. The transmitter logic centers around U1, a 32 x 8 bit ROM of the 7488 or 8223 variety. These memory chips can be bought, preprogrammed with random bits on the output, through the surplus market for a few dollars each, or they can be purchased new and programmed by the buyer. A four-word address sequence is generated by a 74C93 binary counter, U2, and the activate/deactivate switch, S1. The two remaining address lines are hard-wired to ground. A different eight-bit parallel

output is produced each time the address changes. The ROM outputs are then routed to multiplexers U3 and U4. On U3, the first bit is locked low, and, on U4, the second bit is locked high. Since the multiplexers are sequenced with a 74C90 decade counter (U5), the count on U4 will never progress past the second input. The end result is a ten-bit TTY format signal at the output of OR gate U6A/B, with the data changing 1 address each time U5 completes a count of ten. The baud rate is controlled by the MOSFET oscillator and runs at approximately 50 Hz using the components specified. The output is split off at the source of transistor Q1, with one leg passing through the 74C14 Schmitt trigger (U7) and divide-by-16 counter, U8, and

drives counter U5 at 50 bits per second. The second leg of the oscillator is the audio source for the data modulator U6C. The TTY signal controls the audio tone by producing ON/OFF keying in direct proportion to the digital data. The output of the analog switch is then used to modulate the transmit walkie-talkie. The unit should be modified by removing the microphone/speaker and connecting the data modulator output directly into the walkie-talkie audio line. Audio level is controlled by potentiometer R13 and should be set for minimum distortion by monitoring it with an oscilloscope at the output of the second walkie-talkie. It is also necessary to lock the TX/RX switch in TX. This is accomplished by removing the PTT button and bend-

ing the switch arm around to the foil side of the PC board where it should be soldered in place to the ground pad.

Receive System Description

Refer to Fig. 2. The encoded signal is picked up by walkie-talkie #2 with the audio tone level controlled by R16 and boosted by op amp U9. C6, C7, and L2 comprise a frequency selective network which allows only the 800 Hz tones to pass. D4 detects the signal, and C8, C9, and R19 filter it. Q2 clamps the voltage so that it can fire Schmitt trigger U10A, whose output is the restored digital data. This data is then applied to the serial input port of U11, a 5-volt UART. Clocking to U11 is provided by a second MOSFET oscillator,

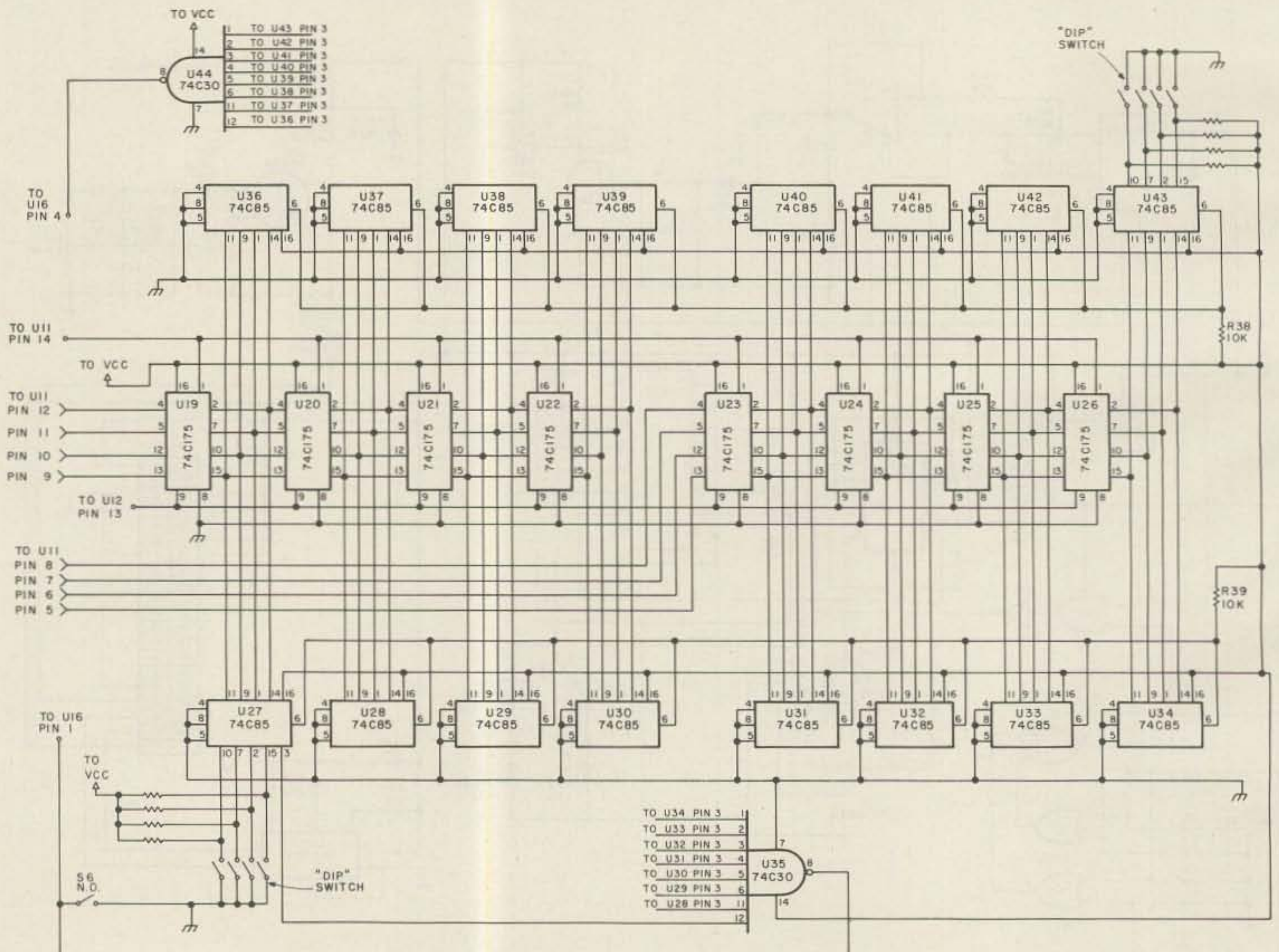

Fig. 3. 10k pull-up resistors and switches on all pins 10, 7, 2, and 15, ICs U36-U34.

Jan 1979

which is essentially the same circuit as the transmit oscillator. The output of the UART is a succession of eight-bit parallel words which are decoded by the circuitry in Fig. 3. The decoder provides a signal when it senses an "activate" command which sets flip-flop U16A. When the Q output (pin 5) goes high, it arms AND gate U15. At this time, if any of the other switches (S2-S5) are opened, the output of U15 will change state, causing U16B to latch, which turns on Q4, trips the relay, and sounds the alarm. Once U16B latches, it is not possible to reset it by merely closing the door. The turn-off command must come from the transmitter or from a reset switch hidden inside the vehicle. To ascertain that the receiver has actually picked up the activate command, a visual indication system is provided. When U16A arms, it triggers one-shot U17, which produces a half-second-wide pulse that blinks red LED D7. When U16A disarms, D6, a green LED, will also blink, indicating that the vehicle can be entered without setting off the alarm. These two LEDs can be mounted in an inconspicuous place near a window to aid visibility.

Decoder

Refer to Fig. 3. The eight-bit codes enter the shift register chain simultaneously through U19 and U23. Here they are clocked down the line by U12, which provides a pulse each time it recognizes that a valid word has been received by U11. U12 also produces the data reset command for U11. At this time, a constant comparison is being made by ICs U36 through U43 and U27 through U34, which comprise the respective activate and de-

activate command recognition circuits. Pre-selected values which match the activate and deactivate codes are set into the comparators by DIP switches. When the data at the shift register outputs is the same as those preselected values, the A = B outputs of the comparators will go high, and, when all eight go high concurrently, their associated NAND gates will go low, causing U16 to either set or reset. If no changes in coding are anticipated after the initial setup, it is not necessary to use the DIP switches. Instead, the codes can be hard-wired into the comparators. It's not even that difficult to change codes with this technique, especially if wire-wrap construction is used. As an added security measure, all the shift register clear lines are tied common and wired to the UART framing error flag output. In the event of noise, quite often the UART will output a random "word," but it also

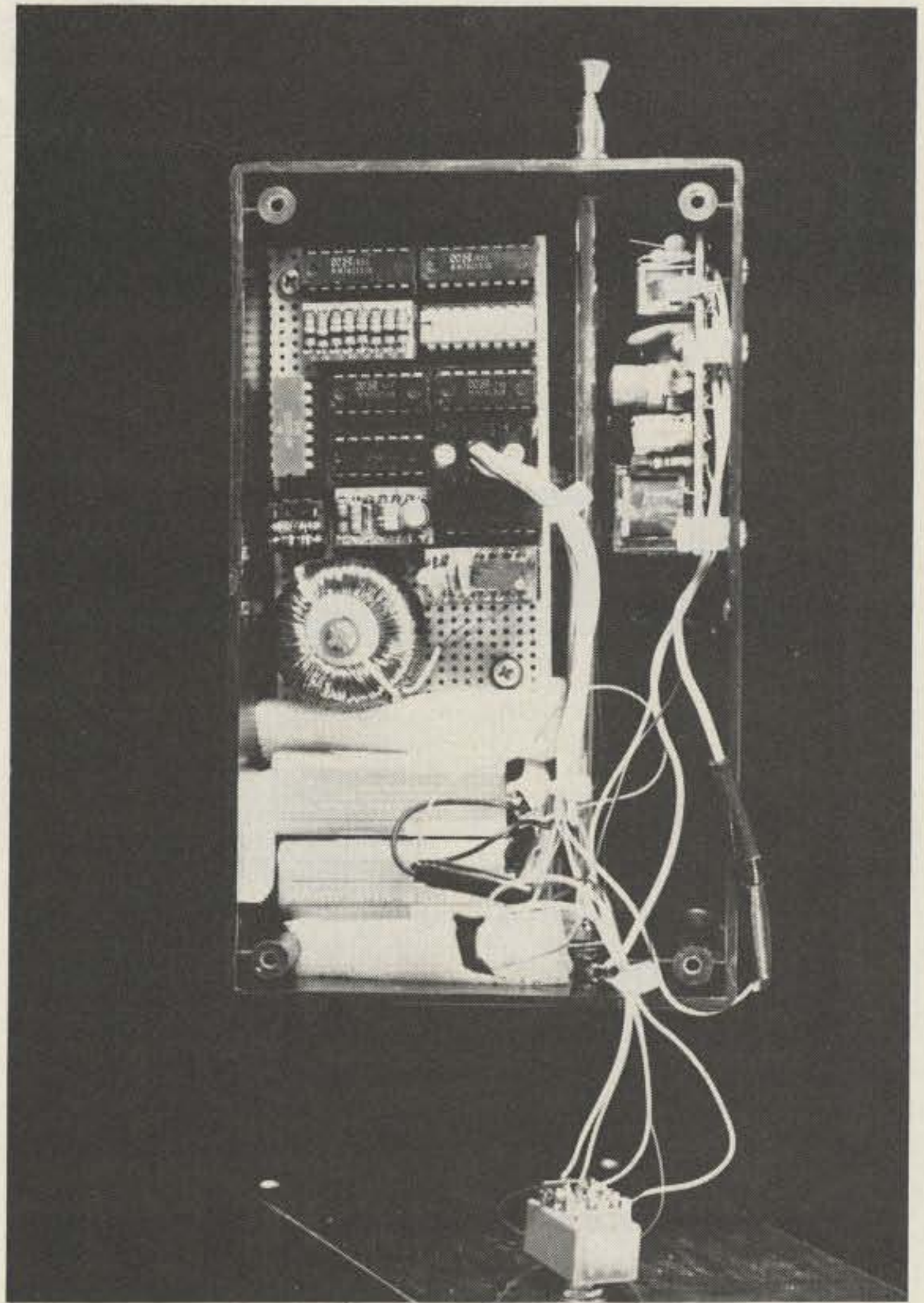

Interior view of transmitter. Digital section and batteries are on the left. Rf section is mounted on right wall.

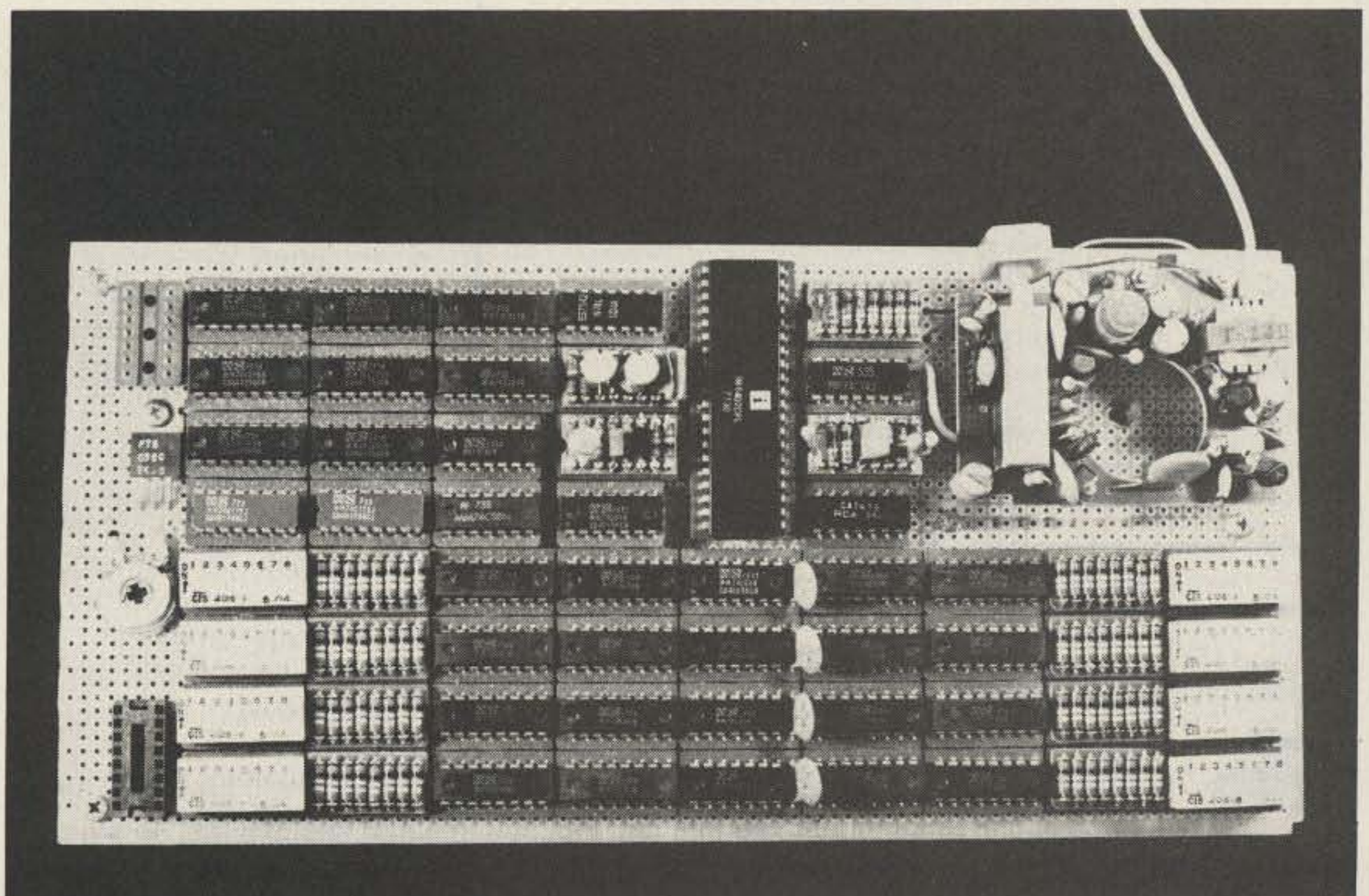

Receiver circuit board. Receive rf board is in the upper right-hand corner. To its left are the tone-to-data converter, UART, and shift register chain. The bottom half of the board contains the digital comparator and logic control circuits. I/O connectors are on the extreme left, upper and lower.

TIMETRAC

By Comus

the microcomputer-controlled
appointment clock

NEW
First Time Offer

— NOT A KIT —
Regular Price \$79.95
Introductory Offer by
HAL-TRONIX
only \$69.95



FEATURES:

- Sleek modern styling to complement any home or office decor.
- Tells the time.
- Tells the date and year.
- Up-timer to 60 minutes, 59 seconds with pause.
- Alarm to ring at the same time everyday.
- Daily appointment sets appointments for the next 23 hours, 59 minutes.
- Future appointments up to one year.
- Dimmer switch for display.
- Memory will hold up to 30 appointments.
- Lithium power cell to retain memory during power outage.
- Appointments entered out of chronological order will be stored in chronological order.
- Colon flashes once each second.
- A.M./P.M. indicator.
- Plugs into any wall outlet.
- Easy to read vacuum fluorescent display.
- Extremely accurate quartz crystal clock.

EFFICIENT. REMARKABLE.

TimeTrac sold and distributed by HAL-TRONIX. Dealers welcome.

Send 15¢ stamp or S.A.S.E. for information and flyer on other HAL-TRONIX products. To order by phone: 1-313-285-1782.



"HAL" HAROLD C. NOWLAND
WBZXH

HAL-TRONIX ✓ H24

P.O. Box 1101
Southgate, MI 48195

**SHIPPING
INFORMATION:**

ORDERS OVER \$15.00 WILL BE SHIPPED POSTPAID EXCEPT ON ITEMS WHERE ADDITIONAL CHARGES ARE REQUESTED. ON ORDERS LESS THAN \$15.00 PLEASE INCLUDE ADDITIONAL \$1.00 FOR HANDLING AND MAILING CHARGES.

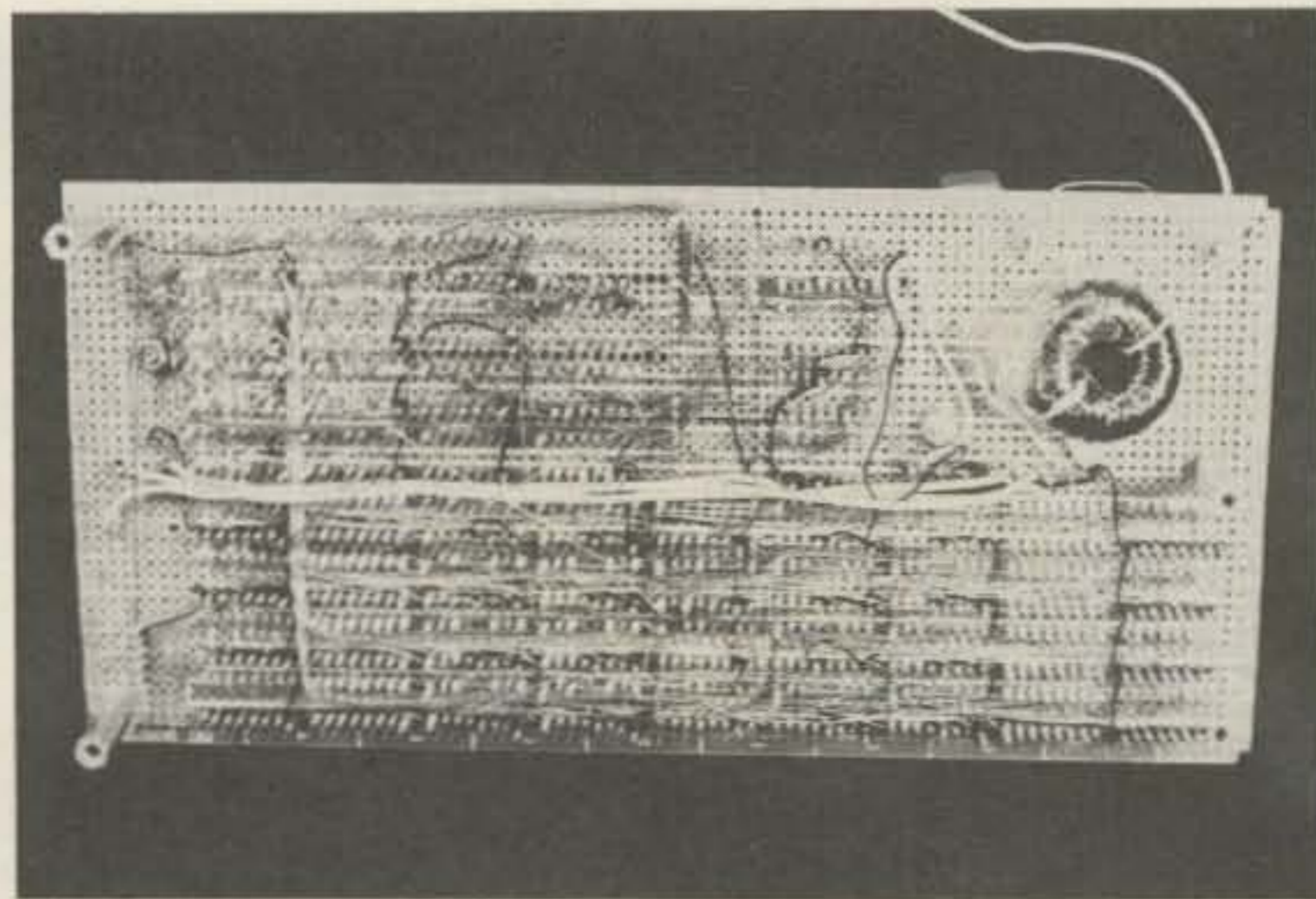

Rear view of receive board. Filter coil is in the upper left-hand corner.

recognizes that it was triggered from noise and will pulse the framing error flag high. This pulse will cause the shift registers to dump any erroneous data in them, thus decreasing the possibility of accidental activation or deactivation due to noise. Push-button switch S6 is used to manually reset the alarm by producing a negative-going pulse. The momentary short circuit across U35 will cause no harm to any circuitry.

Operation

It is only a matter of throwing the activate or deactivate switch and observing the receive indicator LEDs for proper operation. The transmitter is designed to send a continuous string of data, for the receiver only has to miss just one data bit for the commands to be ignored. It is better to send the data continuously and then turn the transmitter off after it has been verified that the command has been properly received.

Conclusions

Designed initially as an automotive protection system, the basic circuitry can be adapted to suit a host of other needs, such as home protection or as an automatic garage door opener. Power supply re-

quirements are extremely low. In the arm mode, about only 50 mA of current at 12 V dc is all that is needed. This suggests battery power as a primary or backup source which would sustain protection to, say, a house during a blackout — or if someone cut your ac lines!

There are so many variables present that it would be extremely difficult to try to "crack" the receiver by means other than what it was designed for. Transmission and modulation frequencies, data rate, and code combinations are just a few of the parameters which can be changed. At the other extreme, this particular unit was designed as a prototype, and the coding scheme is more complex than it really has to be. Eight bits per word, multiplied by four words for each command, results in 2^{32} possible code combinations (more than 4 billion)! If this much security is not needed, remove the wire from U2, pin 9 in the transmitter and ground it. This will result in only 2^{16} code possibilities (65536). However, U21, U22, U25, U26, U29, U30, U33, U34, U38, U39, U42, and U43 can all be deleted. Other ways to decrease complexity would be to use only a four-bit data word. ■

SUBSCRIBE TO KILOBAUD TODAY AND RECEIVE THIS \$5 BOOK FREE!!!

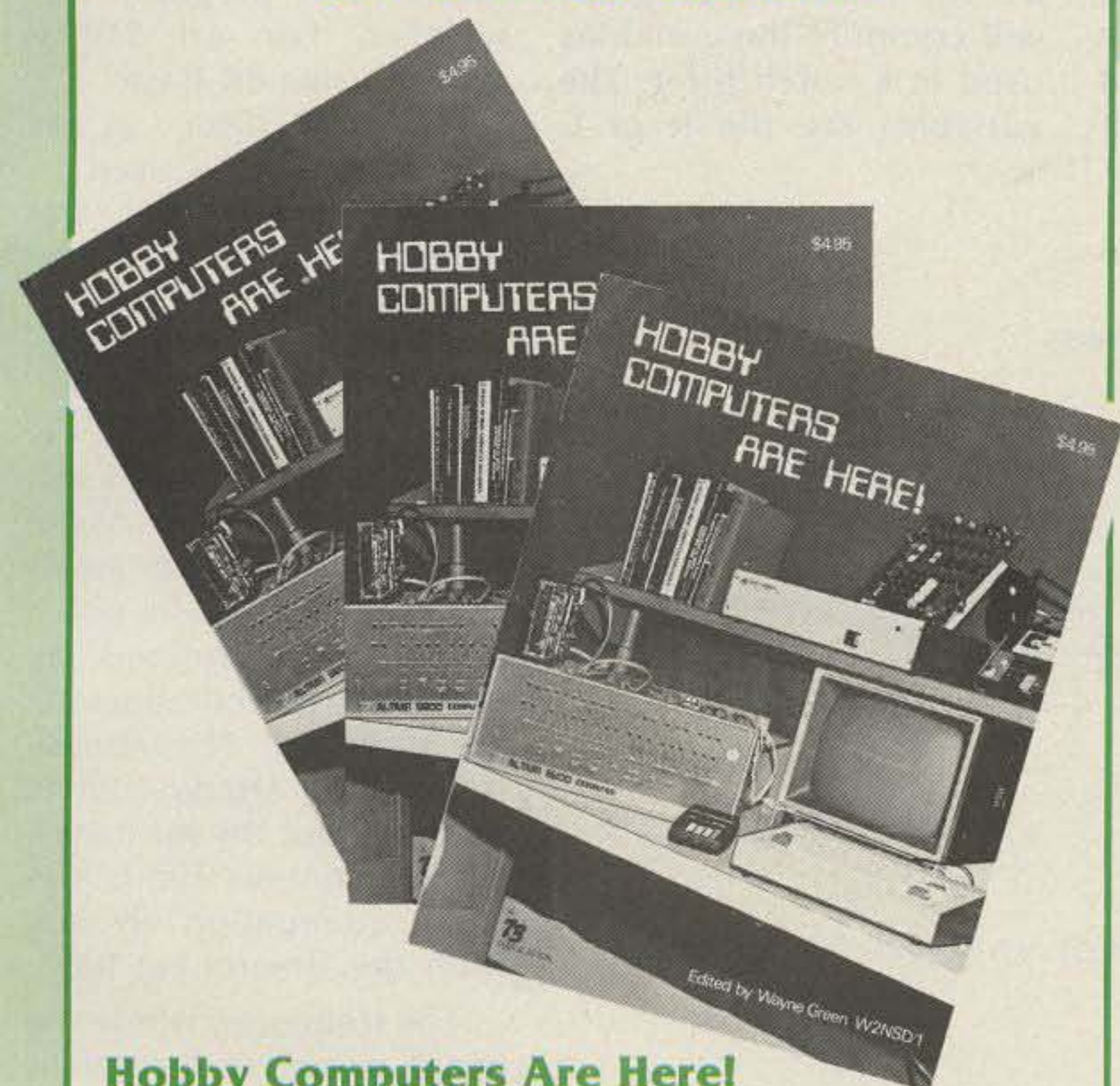

Hobby Computers Are Here!

... is for the beginner. It starts with the fundamentals of microcomputers ... shows how all of the basic parts of a computer system work ... gates, flip-flops, TTL logic, keyboards, video generators, I/O systems, CPUs. It's an entire basic education in microcomputing.

Subscribe to **Kilobaud**, the small computer magazine, this month and take advantage of this great offer. We'll send you one of the best-selling books in the computer field—**Hobby Computers Are Here**.

In addition, if at any time you wish to stop receiving **Kilobaud** for any reason, simply cancel, and we'll send you a full refund for all remaining issues. You keep the book.

However, we're betting that once you look at your first issue of **Kilobaud**, we'll have you for life. Because **Kilobaud** is written for beginners as well as experts, you'll quickly experience the euphoria of Microcomputer Madness—even if you think the S-100 bus is a means of mass transport.

You'll learn how to get started in microcomputing ... what to look for in equipment ... where to get the best programs ... how to improve your home ... make money in microcomputing ... and have more fun using a microcomputer.

You'll find that **Kilobaud** is an ever-expanding encyclopedia of microcomputing that guides you into previously uncharted territory ... gives you the skills that were only science fiction a few years ago ... and leads you through a fascinating world in which your life is more convenient, more exciting and just plain more fun.

And by mailing the card on this page now, you receive the book free and save on your trial subscription, with the understanding that you may cancel at any time, keep the free book, and receive a full refund at once for all remaining issues.

Why not experience the euphoria of Microcomputer Madness, starting with a free book? Mail the postage-paid form today. No need to send money now, we'll worry about that after you decide whether **Kilobaud** is as addictive as we say.

Toll Free Subscription Number (800) 258-5473

kilobaud

peterborough nh 03458

Design-a-Notcher

— automated filter values

Personal computers have been around for several years now and it appears that many of them spend most of their time playing games. I think we should start making them do some honest work for us. The following program will compute the variables used in a notch filter. The variables are the R or C

terms. The program was written for an SWTP system using 8K Basic.

A notch filter, as its name implies, is used to notch out a certain frequency. The desired frequency will be notched out and certain side frequencies will be attenuated. The number of side frequencies attenuated will depend on the depth of the notch and the sharpness of the notch itself. The notch depth is determined by how well the components are matched. Theoretically, infinite attenuation is possible, but the mismatch of components limits the total attenuation to less than the theoretical limit.

The frequency where the notch occurs is dependent on the values of the RC components in the following equation:

$$F_n = 1/2\pi RC$$

where F_n is the notch frequency.

To use the program, one must know the resistance of the source feeding the filter and the resistance of the load being fed by the filter. The filter works best when working into an open load, which is not practical, but it still does quite well with a load across the output if the load resis-

```

WHAT IS THE DESIRED NOTCH FREQUENCY
1000
WHAT IS THE DRIVING SOURCE RESISTANCE IN OHMS
600
WHAT LOAD (IN OHMS) IS THE FILTER FEEDING
10000

SELECT A VALUE FOR (R)

WHEN SELECTING R THE SOURCE & LOAD RESISTANCE MUST
BE CONSIDERED THE R SHOULD BE AT LEAST => THE SOURCE RESISTANCE
(R=>RS) AND R SHOULD BE 1/10 OR LESS THAN RL. THE RATIO
SHOULD BE RS<R<RL
1500
IS THIS A STANDARD VALUE OF (C)
YES
THE VALUE OF (R) IS 1500
THE VALUE OF 2C IS 2.12314224E-07
THE VALUE OF R/2 IS 750

THESE VALUES SHOULD BE ROUNDED TO THE NEAREST STANDARD
VALUES

WHAT IS THE DESIRED NOTCH FREQUENCY
6000
WHAT IS THE DRIVING SOURCE RESISTANCE IN OHMS
600
WHAT LOAD (IN OHMS) IS THE FILTER FEEDING
10000

SELECT A VALUE FOR (R)

WHEN SELECTING R THE SOURCE & LOAD RESISTANCE MUST
BE CONSIDERED THE R SHOULD BE AT LEAST => THE SOURCE RESISTANCE
(R=>RS) AND R SHOULD BE 1/10 OR LESS THAN RL. THE RATIO
SHOULD BE RS<R<RL
1500
THE VALUE OF C IS 1.7692852E-08

IS THIS A STANDARD VALUE (YES,NO)
NO

THE NOTCH VALUE DEPENDS ON THE ACTUAL VALUES OF
THE COMPONENTS IT IS DESIRABLE TO GET AS CLOSE AS
POSSIBLE TO THE ACTUAL VALUE OF C

TO CORRECT THIS WHAT IS THE NEAREST STANDARD VALUE
OF C
0.02
THE VALUE OF (R) IS 1326
THE VALUE OF 2C IS 0.04
THE VALUE OF R/2 IS 663

THESE VALUES SHOULD BE ROUNDED TO THE NEAREST STANDARD
VALUES
  
```

Sample runs.

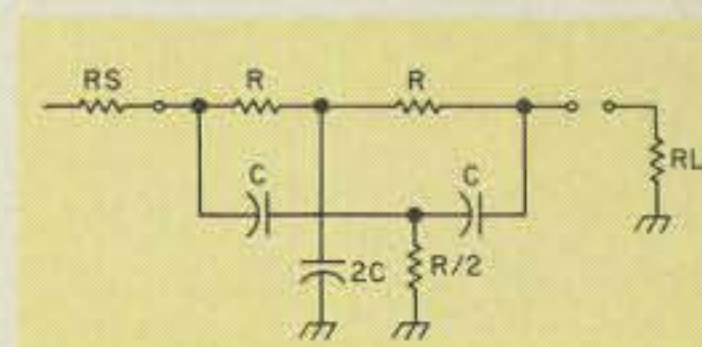

Fig. 1. Twin-T notch filter.

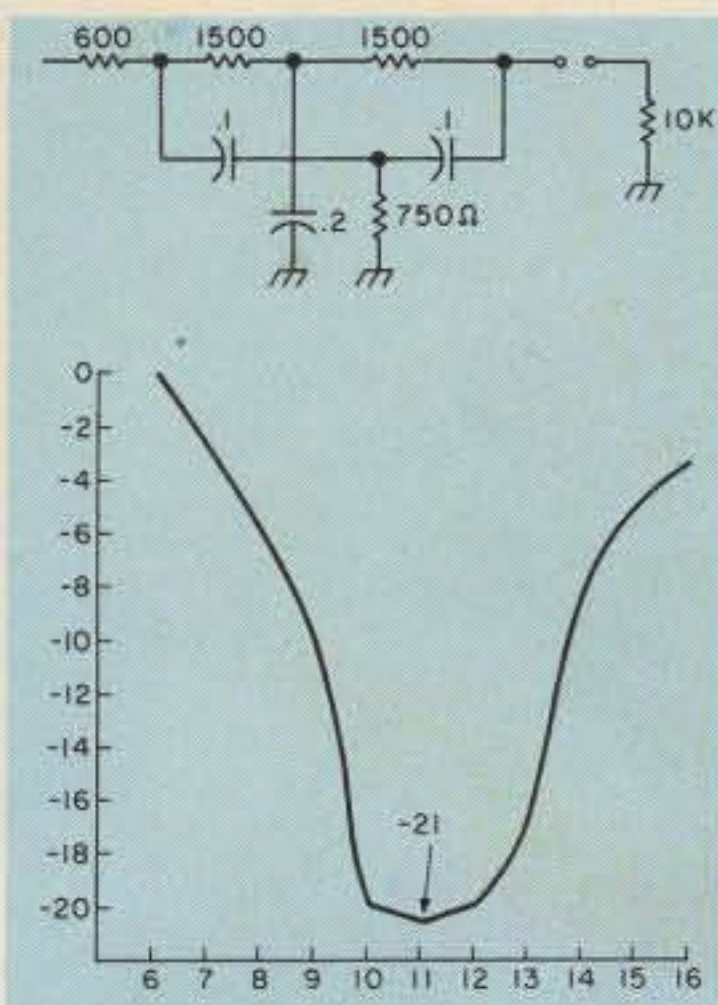

Fig. 2.

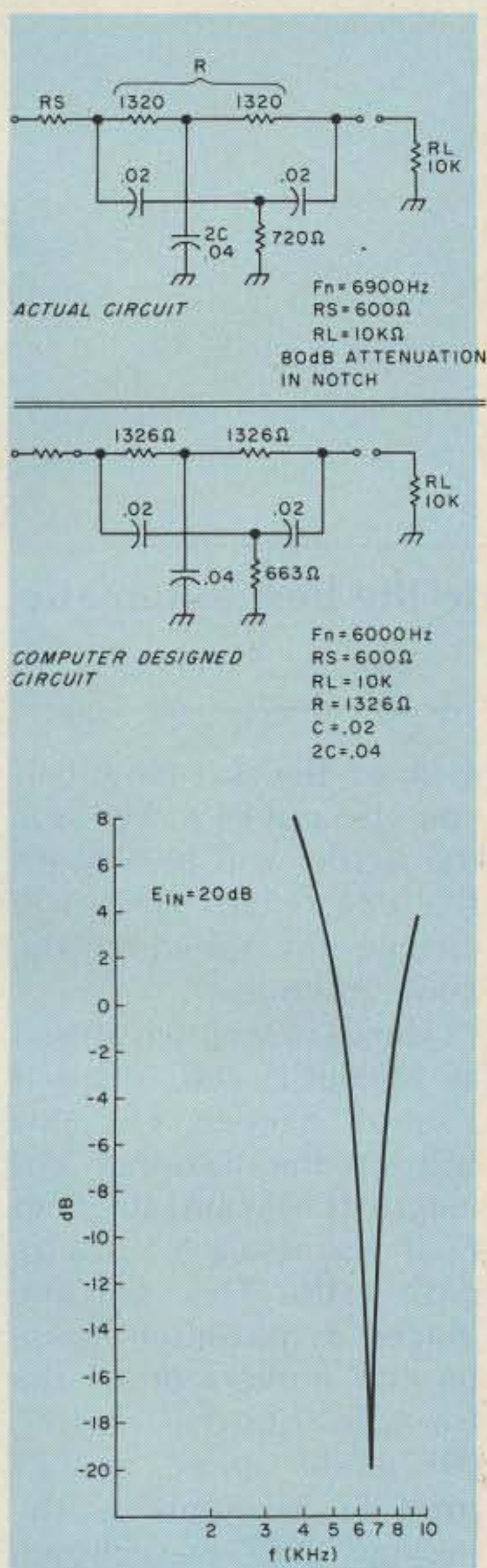

Fig. 3. A graph of a computer-designed notch filter. Note the closeness of the computer values and the values used in the actual circuit.

tance is high compared to the source resistance and the resistance in the notch circuit. For best results, the following ratio should be

adhered to: $RS < R < RL$.

Notch filters are popular, but their use is limited to frequencies below approximately 400 kHz, and they tend to have high attenuation and low selectivity. But, because of their simplicity, low cost, and ease of design, they are widely used.

The sample run of the

```

*
0100 PRINT "WHAT IS THE DESIRED "
0105 PRINT "NOTCH FREQUENCY ?"
0110 INPUT N
0111 IF N>450000 GOTO 600
0120 PRINT "WHAT IS THE DRIVING SOURCE "
0125 PRINT "RESISTANCE IN OHMS ?"
0130 INPUT R1
0140 PRINT "WHAT LOAD (IN OHMS) IS THE"
0145 PRINT "FILTER FEEDING ?"
0150 INPUT R2
0155 PRINT
0156 PRINT CHR$(16),CHR$(22)
0160 PRINT "SELECT A VALUE FOR (R) "
0161 PRINT
0163 PRINT "WHEN SELECTING (R), THE SOURCE "
0165 PRINT "AND LOAD RESISTANCE MUST BE "
0167 PRINT "CONSIDERED . THE(R) "
0168 PRINT "SHOULD BE AT LEAST"
0170 PRINT " =>THE SOURCE RESISTANCE (R=>RS) "
0172 PRINT " AND R SHOULD BE 1/10"
0175 PRINT "OR LESS THAN RL"
0180 PRINT "THE RATIO SHOULD BE RS<R<RL"
0185 INPUT R
0190 LET C=1/(6.28*N*R)
0194 PRINT CHR$(16),CHR$(22)
0195 PRINT "THE VALUE OF (C) IS ";C
0196 PRINT "IS THIS A STANDARD VALUE (YES,NO)"
0197 INPUT A$
0198 IF A$="YES" THEN 400
0220 PRINT "THE NOTCH DEPTH DEPENDS ON THE"
0230 PRINT "ACTUAL VALUES OF THE COMPONENTS"
0240 PRINT "IT IS DESIRABLE TO GET AS CLOSE AS POSSIBLE "
0245 PRINT "TO THE ACTUAL VALUE OF (C) "
0250 PRINT
0255 GOSUB 800
0260 PRINT CHR$(16),CHR$(22)
0270 PRINT "TO CORRECT THIS, WHAT IS THE "
0275 PRINT "NEAREST STANDARD VALUE OF (C) "
0280 INPUT C
0285 LET R3=1/(6.28*N*C*(1E-6))
0290 PRINT "THE VALUE OF (R) IS ";INT(R3)
0295 LET C2=2*C
0300 PRINT "THE VALUE OF 2C IS ";C2
0310 LET R4=R3/2
0320 PRINT "THE VALUE OF R/2 IS ";INT(R4)
0330 PRINT
0340 PRINT "THESE VALUES SHOULD BE ROUNDED TO THE NEAREST STANDARD VALUES"
0350 END
0400 LET R3=1/(6.28*N*C)
0410 GOTO 290
0600 PRINT "BE ADVISED THAT THE NOTCH"
0605 PRINT "FILTER IS NOT EFFECTIVE AT THE"
0610 PRINT " HIGHER FREQUENCIES "
0620 PRINT "DO YOU STILL WANT THIS HIGH A FREQUENCY (1=YES, 0=NO)"
0630 INPUT Z
0640 IF Z=1 THEN 120
0650 GOTO 100
0800 FOR I=1 TO 500
0803 NEXT I
0805 RETURN

```

Program listing.

program uses RS equal to 600 Ohms, RL equal to 10k Ohms, and a desired notch of 1 kHz.

Fig. 2 shows the circuit that the program developed. Note that it does not notch out at exactly 1 kHz. The reason for this is that with the values of .1 uF for C vice 1.0615 . . . , the value of R should be 1592 Ohms and $R/2$ should be

796 Ohms. I am reasonably sure that the notch would have been nearer 1 kHz if more exact values of R were used.

If you have need for a notch filter and use a computer that speaks BASIC, this program will allow you to play with different values and see how they affect the depth and sides of the notch. ■

The Cosmac Connection: Part 1

— computerized CW

With a few ICs and this program, your Cosmac microcomputer can imitate the best automatic keyers available.

A simple 90-byte program can turn your Cosmac microcomputer into an excellent automatic keyer for sending Morse code. It features automatic dash and dot completion, dash and dot memories, adjustable dash:dot ratio, automatic letter spacing, iambic or squeeze keying, and adjustable speed from 5 wpm to 80 wpm.

Equipment Required

You will need the Cosmac microcomputer fashioned around the CDP1802CD CPU by RCA. The program requires 90 bytes of memory. My computer was constructed according to the article which appeared in *Popular Electronics*, September, 1976. In addition, you will need some ICs and perhaps a transistor or relay in order to interface the computer with your transmitter. The program was written for a clock frequency of 1 MHz, but it

can be modified for other clock frequencies quite easily.

How the Program Works

After setting subroutine counters and memory pointers, the first thing the program does is convert the code speed entered via the keyboard into hexadecimal form. The program assumes the code speed will be less than 100 wpm. An example will illustrate the method best. Suppose you enter 35 as your desired speed. The program converts this to base 16 by repeatedly subtracting 10_{16} from it until the remainder is less than 10_{16} . In this case,

$$35_{16} - 10_{16} = 25_{16}$$

$$25_{16} - 10_{16} = 15_{16}$$

$$15_{16} - 10_{16} = 05_{16}$$

Each time a subtraction is performed, 0A is added to R1, and, finally, the remainder is added to R1. In this case $R1 = 0A + 0A + 0A + 05 = 23_{16}$. This com-

pletes the conversion, $35 \text{ wpm} = 23_{16}$.

Next, I derive a number which is proportional to the length of one dot. Since the length of a dot is inversely proportional to the code speed, I calculate $00F7/\text{code speed}$ in hex form and store the quotient in M(000A). This number sets the length of a timing loop in making a dot. Two times this number is used for letter spacing, and three times this number is used for the dash length. Actually, during execution of the program, a dot or dash is automatically followed by a space of one dot, and, if a letter space of two dots is added to this, you get effectively a letter space equal to the length of three dots.

Spaces were left at M(0048) and M(0049) to enable you to increase the length of the dashes. By inserting the instruction F4 at M(0048), the dashes will be

4 times the dot length. If you also put F4 at M(0049), the dashes will be 5 times the dot length. This will change the speed of the code, of course.

The dash length is stored in M(000C), and, since it cannot exceed FF, this restricts the maximum dot length at M(000A) to 1/5 of FF if you use a 1:5 dot-to-dash ratio. This, in turn, places a maximum value on the numerator of the formula quoted earlier, $00F7/\text{code speed}$ in hex form. So, summing up, the number 00F7 was chosen to allow code speeds as low as 5 wpm without exceeding a dash time of FF at M(000C). At M(0036), provision is made for changing this numerator to 01F7 or 02F7, if desired. This is useful when operation will consistently be at high code speeds and when finer resolution is required in the code speed. For example, with the program as

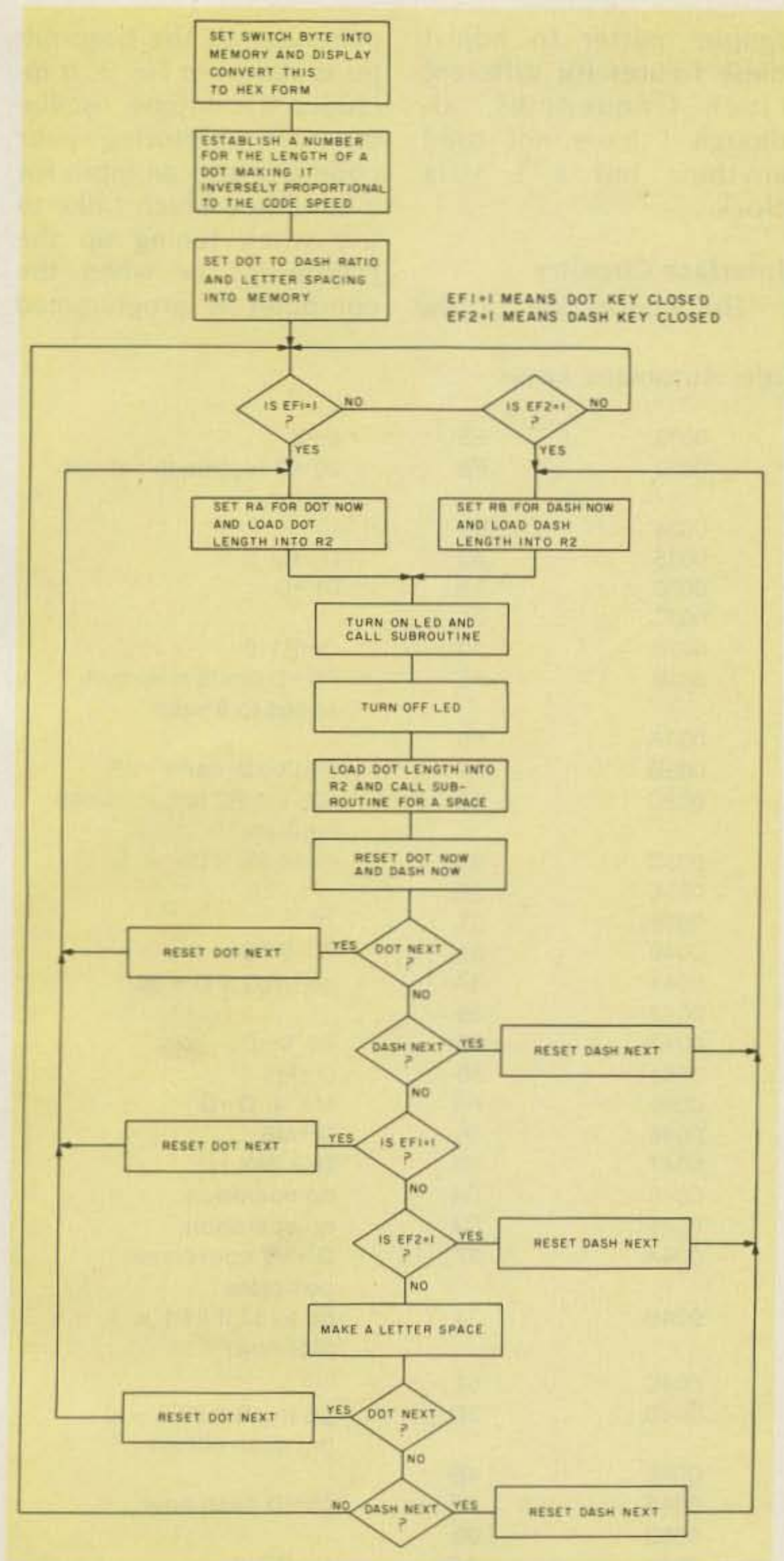

Fig. 1. Flowchart for automatic keyer.

is, you get the same speed of code whether you enter 25, 26, or 27 wpm. The speed changes at 28 wpm, but remains at this new speed whether you enter 28, 29, or 30. The problem is accentuated at very high speeds. For example, you get the same speed of code for all entries between 62 and 81 wpm.

The rest of the program is straightforward and is understood best by looking at the flowchart. The key is connected to $\overline{EF1}$ and $\overline{EF2}$.

Closing the dot side makes $EF1 = 1$. Closing the dash side makes $EF2 = 1$. The program periodically checks the status of these inputs, and the dots and dashes come out on the Q-line, which is interfaced with the transmitter as described later.

The subroutine in the program is simply a timed loop using registers R1 and R2. The initial value of R2 is set before entering the subroutine according to the length of delay re-

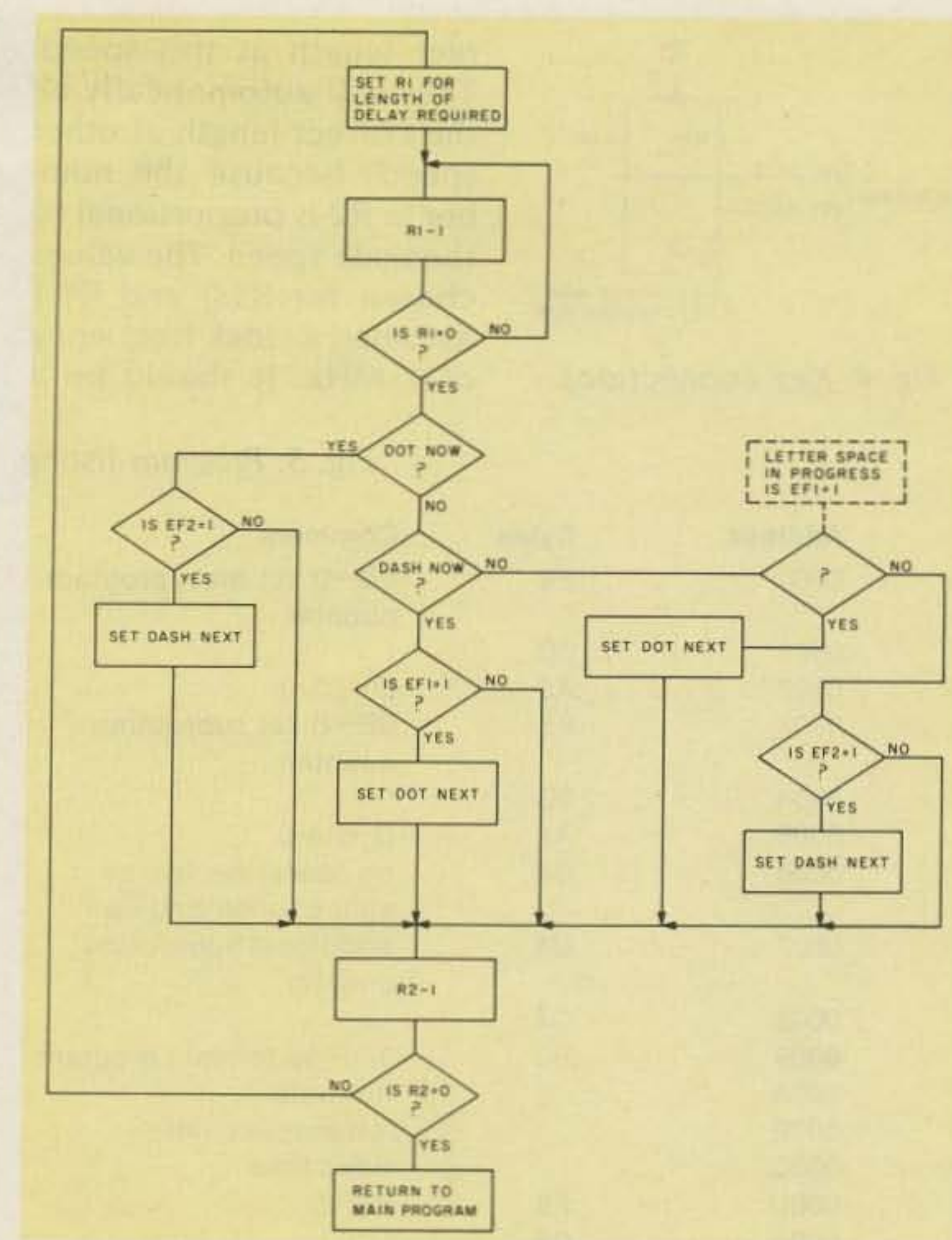

Fig. 2. Timed subroutine flowchart.

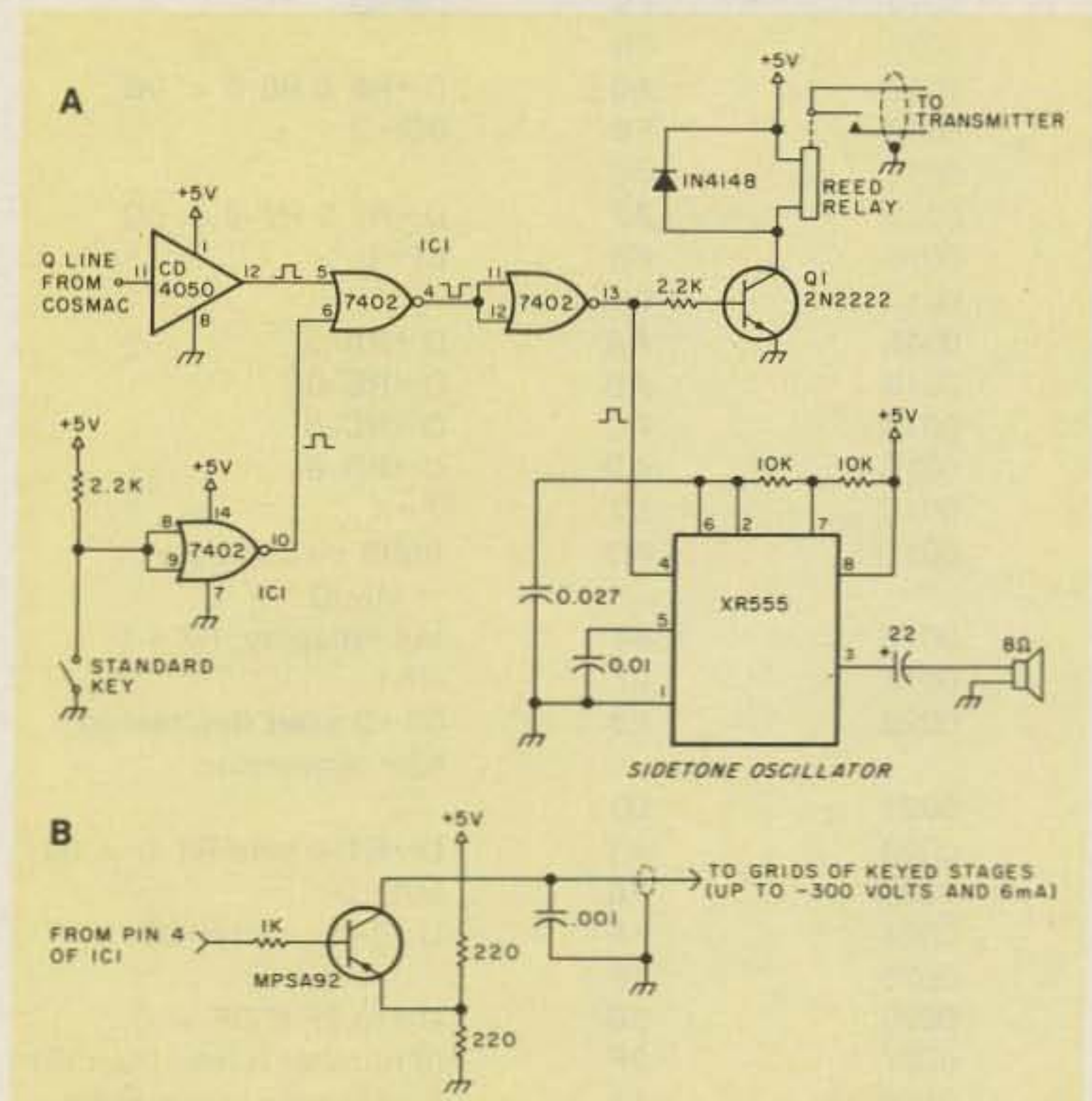

Fig. 3.(a) Interface between Cosmac and transmitter; (b) alternate circuit for rigs with grid-blocked keying eliminates relay and Q1.

quired, whether a dot, dash, or letter space is being generated. At a code speed of 24 wpm, you should get 10 dots per second. For a 1:3 dot:dash

ratio, the length of a dot at 24 wpm should be 50 ms. Accordingly, the values of R1.1 and R1.0 were set at M(009C) and M(009F) so that the dots are the cor-

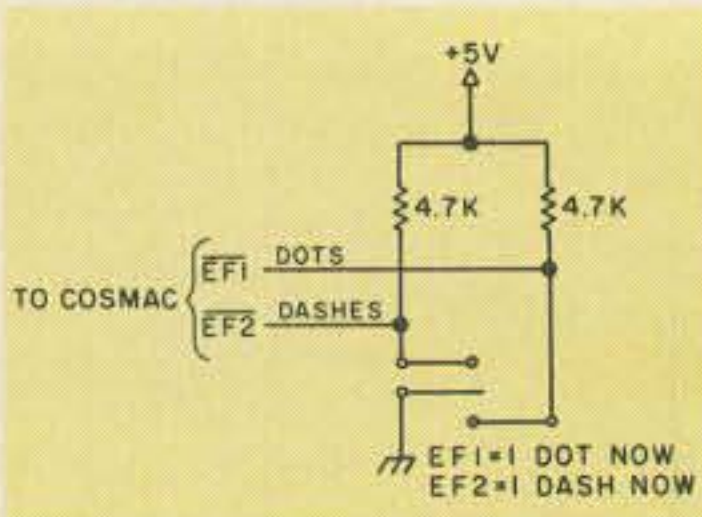

Fig. 4. Key connections.

rect length at this speed. They will automatically be the correct length at other speeds because the number in R2 is proportional to the code speed. The values chosen for R1.0 and R1.1 assumed a clock frequency of 1 MHz. It should be a

simple matter to adjust these figures for different clock frequencies, although I have not tried anything but a 1 MHz clock.

Interface Circuitry

The connection of the

computer to the transmitter is shown in Fig. 3. It includes a sidetone oscillator for monitoring your code and also an input for a hand key which I like to use when tuning up the transmitter or when the computer is programmed

Fig. 5. Program listing. Title: Automatic keyer.

Address	Bytes	Comment	Address	Bytes	Comment
0000	F8	0D→D set main program counter	0032	E5	5→X
0001	0D		0033	F8	00→D routine to set dot timing
0002	A3	D→R3·0	0034	00	
0003	F8	9B→D set subroutine counter	0035	A2	D→R2·0
0004	9B		0036	F8	01→D
0005	A4	D→R4·0	0037	01	
0006	C4	no operation; leaves space for setting up additional subroutine counter	0038	A1	D→R1·0
0007	C4		0039	F8	F5→D limits minimum speed to 5 wpm
0008	C4		003A	F5	
0009	D3	3→P go to main program	003B	F7	D-MX→D, carry→DF
000A		dot time	003C	12	R2 + 1 R2 accumulates quotient
000B		letter space time	003D	33	go to 3B if DF = 1
000C		dash time	003E	3B	
000D	F8	0A→D	003F	21	R1-1
000E	0A		0040	81	R1·0→D
000F	A5	D→R5·0 R5·0 = 0A	0041	3A	go to 39 if D ≠ 00
0010	F8	0B→D	0042	39	
0011	0B		0043	82	R2·0→D
0012	A6	D→R6·0 R6·0 = 0B	0044	55	D→M5
0013	F8	0C→D	0045	F4	MX + D→D
0014	0C		0046	56	D→M6
0015	A7	D→R7·0 R7·0 = 0C	0047	F4	D + MX→D
0016	F8	01→D	0048	C4	no operation
0017	01		0049	C4	no operation
0018	AA	D→RA·0	004A	57	D→M7 conversion complete
0019	AB	D→RB·0	004B	34	go to 57 if EF1 = 1 (dot now)
001A	AC	D→RC·0	004C	57	
001B	AD	D→RD·0	004D	3D	go to 4B if EF2 = 0 (no dash either)
001C	E7	7→X	004E	4B	
001D	6C	input switch byte → MX, D	004F	F8	00→D dash now
001E	64	MX→display, RX + 1	0050	00	
001F	27	R7-1	0051	AB	D→RB·0
0020	F8	00→D start decimal to hex conversion	0052	47	M7→D R7 + 1
0021	00		0053	27	R7-1
0022	A1	D→R1·0 sets R1·0 = 00	0054	A2	D→R2·0
0023	F0	MX→D	0055	30	go to 5D and make dash
0024	FF	D-10→D, carry→DF	0056	5D	
0025	10		0057	F8	00→D dot now
0026	3B	Go to 2F if DF = 0	0058	00	
0027	2F	(if number is less than 10)	0059	AA	D→RA·0
0028	57	D→M7 place remainder in M7	005A	45	M5→D R5 + 1
0029	81	R1·0→D	005B	25	R5-1
002A	FC	0A + D→D	005C	A2	D→R2·0
002B	0A	ADD 0A to R1	005D	7B	1→Q light on
002C	A1	D→R1·0	005E	D4	4→P call subroutine for a delay
002D	30	Go to 23	005F	7A	0→Q light off
002E	23		0060	45	M5→D R5 + 1
002F	81	R1·0→D	0061	25	R5-1
0030	F4	MX + D→D	0062	A2	D→R2·0
0031	55	D→M5 conversion complete	0063	D4	4→P call subroutine for delay = 1 dot
			0064	F8	01→D

0065	01		00A8	3D	go to BD if EF2 = 0
0066	AA	D→RA·0 reset dot now	00A9	BD	(no dash next)
0067	AB	D→RB·0 reset dash now	00AA	F8	00→D
0068	8C	RC·0→D	00AB	00	
0069	3A	go to 70 if D ≠ 00	00AC	AD	D→RD·0 set dash next
006A	70	(no dot next)	00AD	30	
006B	F8	01→D	00AE	BD	
006C	01		00AF	8B	RB·0→D dash now?
006D	AC	D→RC·0 reset dot next	00B0	3A	go to B9 if D ≠ 00
006E	30	go to 57 and make dot	00B1	B9	(if no dash now either)
006F	57		00B2	3C	go to BD if EF1 = 0
0070	8D	RD·0→D dash next?	00B3	BD	
0071	3A	go to 78 if D ≠ 00	00B4	F8	00→D
0072	78	(no dash next either)	00B5	00	
0073	F8	01→D	00B6	AC	D→RC·0 set dot next
0074	01	reset dash next	00B7	30	go to BD
0075	AD	D→RD·0	00B8	BD	
0076	30	go to 4F and make a dash	00B9	34	go to B4 if EF1 = 1
0077	4F		00BA	B4	
0078	34	go to 90 if EF1 = 1	00BB	35	go to AA if EF2 = 1
		and make a dot	00BC	AA	
0079	90		00BD	22	R2-1
007A	35	go to 95 if EF2 = 1	00BE	82	R2·0→D
		and make a dash	00BF	3A	go to 9B if D ≠ 00
007B	95		00C0	9B	
007C	46	M6→D, M6 + 1	00C1	30	go to 9A
		no dot or dash now	00C2	9A	end of subroutine
007D	26	R6-1			
007E	A2	D→R2·0			
007F	D4	call subroutine for			
		letter space			
0080	8C	RC·0→D dot next?			
0081	3A	go to 88 if D ≠ 00			
0082	88	no dot next			
0083	F8	01→D			
0084	01				
0085	AC	D→RC·0 reset dot next			
0086	30	go to 57 and make dot			
0087	57				
0088	8D	RD·0→D dash next?			
0089	3A	go to 4B if D ≠ 00			
008A	4B	no dash either			
008B	F8	01→D			
008C	01				
008D	AD	D→RD·0 reset dash next			
008E	30	go to 4F and make dash			
008F	4F				
0900	F8	01→D			
0091	01				
0092	AC	D→RC·0			
0093	30	go to 57 and make a dot			
0094	57				
0095	F8	01→D			
0096	01				
0097	AD	D→RD·0			
0098	30	go to 4F and make a dash			
0099	4F				
009A	D3	3→P return to main			
		program			
009B	F8	01→D start subroutine			
009C	01				
009D	B1	D→R1·1			
009E	F8	58→D fine adjustment			
		of dot length			
009F	58				
00A0	A1	D→R1·0			
00A1	21	R1-1			
00A2	91	R1·1→D			
00A3	3A	go to A1 if D ≠ 00			
00A4	A1				
00A5	8A	RA·0→D dot now?			
00A6	3A	go to AF if D ≠ 00			
00A7	AF				

R1, R2—part of timing loop and used for decimal to hex conversion
R3—main program counter
R4—subroutine counter
R5—memory pointer for dot length
R6—memory pointer for letter space
R7—memory pointer for dash length
RA = 00 if dot now RC = 00 if dot next
RB = 00 if dash now RD = 00 if dash next

Table 1. Register assignments.

as an automatic message generator instead of an automatic keyer. Fig. 4 shows the method used to connect the key to the computer.

If your transmitter is running more than a few Watts, you must be careful that your wiring does not pick up rf in the shack. If it does, it may upset the logic gates, and you'll find that, once the first dot or dash is sent, the transmitter might not shut off. This rules out any long dangling wires running across your desk in front of your transmitter! For best results, use a shielded enclosure and bypass the leads to the transmitter and key with 0.001 uF ceramic capacitors.

Using the Keyer

Enter the program shown and, before setting the computer to "run,"

enter the desired code speed from the front panel. Set the computer to "run," and your speed will be displayed on the hex display. To change the speed, just set the switches on the front panel to the new speed and flick the run switch off and then on. Some people find the automatic letter space a bit awkward at first, probably because their fist, like mine, has become a little sloppy over the years. To eliminate automatic letter spacing, enter the instruction C4 at M(007F). C4 means no operation, and the subroutine normally called at that location does not get called.

So, for your next QSO, try out this nifty keyer and tell the operator at the other end that he's talking to a computer! He'll have no excuse for not being able to read your fist. ■

W2NSD/1 NEVER SAY DIE

editorial by Wayne Green

from page 4

were running thousands of Watts in order to win the Sweepstakes contest and then taking the 100-Watt multiplier.

The saying that an antenna is not big enough unless the winter brings it down came from Sam. His Medfield home was surrounded by enormous towers with beams for all bands. Sam was one of the first to consistently get his signals

back from the moon on 144 MHz. This activity progressed to a couple of big dishes, and eventually were his ticket to working as an engineer at the world's largest dish at Arecibo, Puerto Rico.

Sam would never actually admit it, but I think my own activities in New Hampshire helped drive him out of the country. I mentioned his deep need to have the loudest signal on a band. Was it a coincidence

that shortly after I put up 336 elements on 2m on a mountain not far from 73 HQ that Sam moved to Arecibo?

At the time, Sam had been working for Microwave Associates, helping them sell his parametric amplifiers. Sam called me one day to say that he had been fooling with a very high gain amplifier on six meters and had gotten it working. Before this there had been some articles predicting that something like that might work but no one had ever built one. It not only worked, but it was so powerful that they were soon being added to virtually every US radar installation in the world.

Sam wrote an article for me on it, and it happened to be published in an April issue of the magazine. Many readers thought the concept so out-

rageous that the article must be an April Fool.

After Sam moved to Arecibo, he got the laboratory there interested in amateur radio moonbounce. I made a trip down to participate in the 1296 MHz moonbounce experiments. The dish had so much gain that the band sounded like 20 meters during a contest. That was an experience which will never be forgotten.

Getting time allocated on the big dish was so difficult that Sam started building his own fixed dish with a movable antenna pointing into it, a small replica of the big one. After he got this dish working well, he was loaded with so many laboratory uses for it that he seldom had time to get set up for ham moonbounce work.

We have so few pioneers such as Sam that we can ill afford to lose them. I would be hard put to name one other amateur who has done as much for amateur radio as Sam.

SEPTEMBER WINNER

Our readers religiously voted for Thomas R. Sundstrom W2XQ's article, "The SWL Bible," as the most popular in our September issue, so he will be receiving 73's \$100 bonus check for that month. Don't forget to use your Reader Service card ballot!

WRIST RADIOS

For those of you who have not been reading the more obscure technical journals, be advised that there is a strong move afoot to augment the present telephone system with a wrist radio which would work on about 5 GHz. This would run about 25 mW and would work through a series of satellites.

The radio would have an LED which would tell you when you were within working range of the satellite. This would be accomplished by the reception of

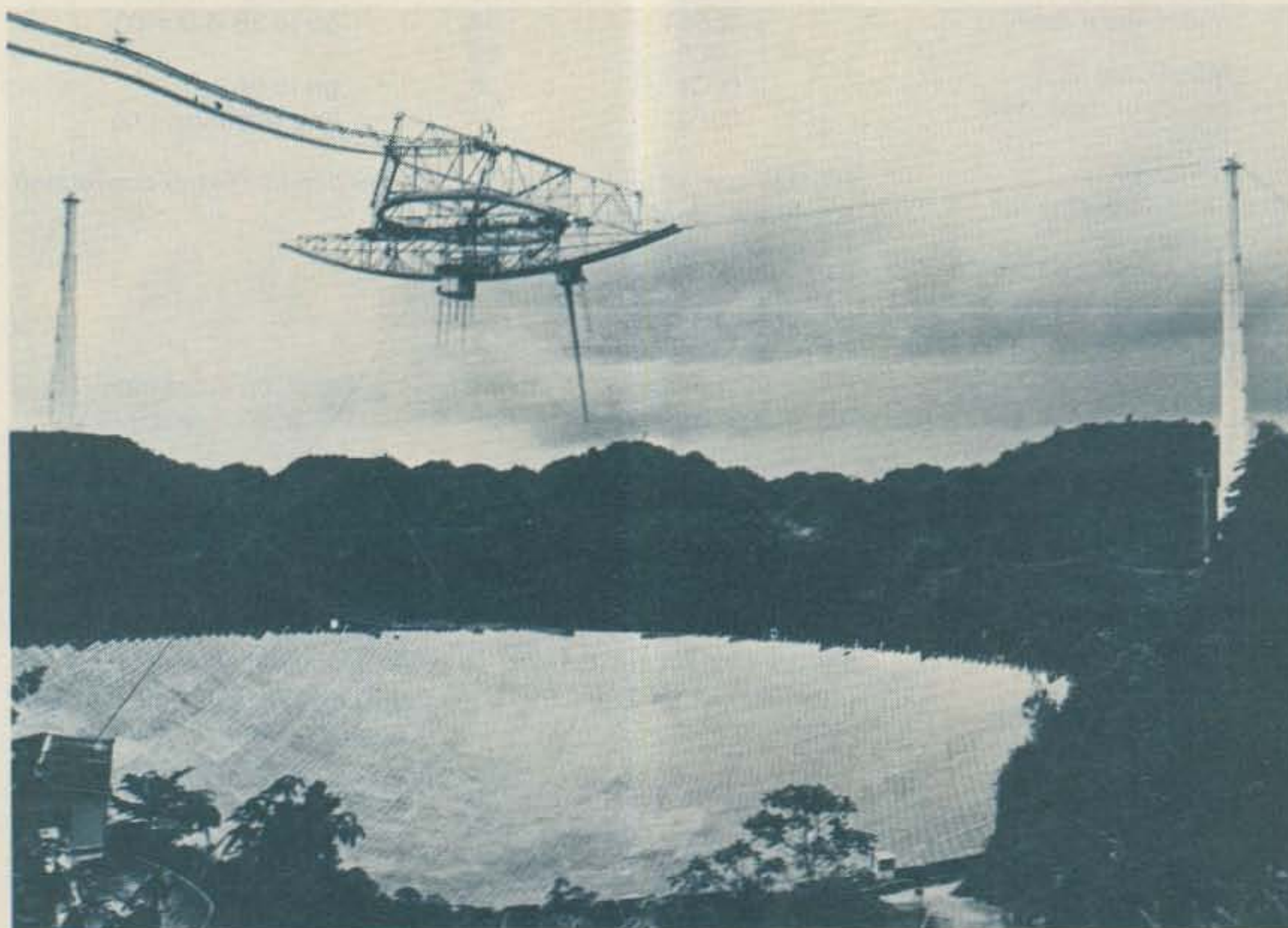

W1FZJ's dish at Arecibo.

Continued on page 110

WHEATON HAMFEST FEB 4

DUPAGE COUNTY FAIRGROUND

Sponsored by Wheaton Community Radio Amateurs, Inc. • Box QSL • Wheaton, IL 60187 • (312) 858-7388

1st prize

DRAKE TR-7

8 AM - 6 PM 147.54 talk in

ADMISSION: \$3 at door — \$2 advance (include s.a.s.e.)

Make checks payable to WCRA. Mail ticket order to:

Free Parking On Grounds
No Smoking in Heated Buildings
Police Service
Quality Refreshments
Hourly Prize Drawing
Winners Need Not Be Present

JIM OSBORNE WB9YRO

1518 Larry Lane W23

Glendale Heights, IL 60137

YOU ASKED FOR IT YOU GOT IT DSI QUIK-KIT®

550 MHZ COUNTER KIT Performance You Can Count On



OPERATES ON

- Batt 6-C Size
- DC 8.2 To 14.5 VDC
- AC Batt. Eliminator

\$99.95
MODEL 3550 KIT

DSI OFFERS THE BEST OF TWO WORLDS . . .

An unprecedented DSI VALUE . . . in a high quality, LSI Design, 550 MHZ frequency counter kit. And, because it's a DSI innovation, you know it obsoletes any competitive makes, both in price & performance. The basic 550 MHZ counter & time base are factory assembled, tested and burned-in. The problems of bad LEDs, IC's, capacitors, are a thing of the past with DSI QUIK-KIT®. But you can take pride in assembling the power supply, PC mounted selector switch, input connectors, and the final mechanical assembly of your 550 MHZ counter, into its' handsome cabinet. **GO WITH THE LEADER . . . BUY A DSI FREQUENCY COUNTER KIT. SAVE TIME & MONEY AND BE ASSURED IT WILL WORK THE FIRST TIME.**

SPECIFICATIONS

Time Base TCXO 1PPM 65° to 85° F
Frequency Range 50HZ to 550MHZ
Resolution 1HZ to 55MHZ, 10HZ to 550MHZ
Gate Time 1 second - 1/10 second
Sensitivity 25MV 150 & 250MHZ 75MV 550MHZ
Display Eight 1/2-inch LEDs
Input Two SO239 Connectors
Power 6C-Size Batt., 15HR, or 8.2VDC to 14.5VDC
Current 150 Ma standby 300 Ma operational

3550 KIT INCLUDES

- Pre-assembled, tested counter board
- Case, power supply, connectors, hardware
- Built-in prescaler & preamp
- Gate Light - Automatic Zero Blanking
- Automatic Decimal Point
- One to two hours assembly time
- One Year Warranty on all parts
- All new parts - not factory seconds or surplus

3550 Kit	\$99.95
T-101 Telescopic Antenna	3.95
AC-9 Battery Eliminator	7.95
Cigarette Lighter DC Adapter	2.95

TERMS: Orders to U.S. and Canada, add 5% to maximum of \$10.00 per order for shipping, handling and insurance. To all other countries, add 15% of total order. California Residents add 6% State Sales Tax.

SEE YOUR LOCAL DEALER
OR

CALL TOLL FREE (800) 854-2049

California Residents, Call Collect (714) 565-8402

DSI INSTRUMENTS, INC.

7914 Ronson Road No. G, San Diego, CA 92111

VISA • MC
AMERICAN EXPRESS
CK • MONEY ORDER
COD

Noise Bridge BASICS

— computer-optimized radiation

This program makes sense out of those funny readings on your noise bridge.

Terry A. Conboy N6RY
1231 Crestview Drive
San Carlos CA 94070

One of the most useful tools that the antenna experimenter can have is an antenna noise impedance bridge. This handy device allows you to find not only the resonant frequency and swr of an

antenna, but it also lets you find the actual impedance at the antenna, which is decidedly handy when adjusting matching networks. It is portable and does not require you to operate your transmitter to make measurements, which helps to reduce the already ridiculous QRM levels on the bands.

The only thing that is

particularly inconvenient about a noise bridge is making use of the indications that it gives. Unless you use a feedline which is a multiple of a half wavelength, the reading on the bridge is not the impedance at the antenna. It isn't very convenient to find the swr, either. The Smith chart is a very usable graphical tool which will allow you to find both the impedance at the antenna and the swr. There is a learning period on the Smith chart, and, even after you understand its use, it is still easy to make

silly errors and get the wrong answer. And, since it is a graphical method, there are small errors due to "eyeballing" the lines and circles. This isn't a serious problem, however, considering the accuracy of the bridges available to most amateurs.

The BASIC program given here does all of the dirty work for you. It will accept readings from any of three different types of antenna noise bridges and output the antenna impedance in series form ($R + jX$). It also gives the swr on the feedline. The only

A	Angle of complex antenna impedance in radians
B*	$Z \tan(P) + W$
C	Reactance or capacitance dial reading
D	Resistance dial reading
E	Range extension resistor value
F	Frequency in MHz
G*	$U \tan(P)$
H*	$Z - W \tan(P)$
K	Reflection coefficient
L	Feedline length in feet
M	Magnitude of complex antenna impedance
P	Electrical length of feedline in radians
Q*	$1/[(1/D^2) + (1/Y^2)]$
R	Series resistive component of antenna impedance
S	Swr
T*	$\tan(P)$
U	Series resistive component of impedance at bridge
V	Velocity factor of feedline
W	Series reactive component of impedance at bridge
X	Series reactive component of antenna impedance
Y	Parallel reactance at bridge
Z	Characteristic impedance of feedline
* Intermediate variable used for convenience	

Table 1. List of variables used.

Bridge type	All	All	P & B
Char impedance	50 ohms	50 ohms	50 ohms
Line length	83.6961'	68.4471'	157.89'
Velocity factor	0.69	0.79	0.66
Frequency	14.2	7.1	3.6
Omega-t			
resistance dial	20	100	---
Palomar			
resistance dial	20	100	60
reactance dial	0	0	3.49089
W6BXI/W6NKU			
resistance dial	20	100	165.625
capacitance dial	0	0	-50.0487
range extn. resistor	0	0	100
Antenna resistance	125	40	75
Antenna reactance	0	30	-25
Swr	2.5	2	1.76759

Table 2.

```

10 !FINDS REAL AND IMAGINARY PART OF ANTENNA IMPEDANCE
20 !AND SWR, GIVEN FEEDLINE DATA, MEASUREMENT FREQUENCY,
30 !AND READINGS FROM POPULAR NOISE BRIDGES.
40 !VERSION 3.02          2001 CHARACTERS
50 !07 MAR 1978          TERRY CONBOY N6RY
60 !
100 PRINT "TYPE O FOR OMEGA-T, F FOR PALOMAR,"
110 PRINT " OR B FOR W6BXI/W6NKU BRIDGE ";:INPUT A$
120 IF A$="O" THEN 200
130 IF A$="F" THEN 200
140 IF A$="B" THEN 200
150 GOTO 100
160 !
200 PRINT
210 PRINT "CHARACTERISTIC Z="";:INPUT Z
220 PRINT "LINE LENGTH (FT)="";:INPUT L
230 PRINT "VELOCITY FACTOR="";:INPUT V
240 IF V>1.0 THEN 230
250 !
300 PRINT
310 PRINT "FREQUENCY (MHZ)="";:INPUT F
320 IF F=0 THEN 1200
330 PRINT "RESISTANCE DIAL="";:INPUT D
340 IF D=0 THEN L=0.00001
350 !
400 IF A$="O" THEN GOSUB 800
410 IF A$="F" THEN GOSUB 900
420 IF A$="B" THEN GOSUB 1000
430 IF U>0 THEN 500
440 PRINT "NEGATIVE RESISTANCE!"
450 GOTO 300
460 !
500 P=(-6.38372E-3)*L*F/V
510 IF ABS(P)=F/2 THEN F=F+0.0001
520 T=SIN(P)/COS(P)
530 B=(Z*T)+W
540 G=Z-(W*T)

```

```

550 H=U*T
560 M=Z*SQR(((U+2)+(B+2))/((G+2)+(H+2)))
570 A=ATN(B/U)-ATN(H/G)
580 IF G<0 THEN A=A+PI
590 H=M*COS(A)
600 X=M*SIN(A)
610 PRINT "ANTENNA RESISTANCE="";R
620 PRINT "ANTENNA REACTANCE="";X
630 !
700 K=SQR(((R-Z)+2)+(X+2))/(((R+Z)+2)+(X+2))
710 IF K=1 THEN K=0.999999
720 S=(1+K)/(1-K)
730 PRINT "FEEDLINE V S W R ="";S
740 GOTO 300
750 !
800 !SUBR FOR OMEGA-T BRIDGE
810 U=D
820 RETURN
830 !
900 !SUBR FOR PALOMAR BRIDGE
910 U=D
920 PRINT "XL(+) OR XC(-)="";:INPUT C
930 IF C>70 THEN C=140-C
940 IF C<=-70 THEN C=-C-139.999
950 W=(2273.64/F)*C/(C+70)
960 RETURN
970 !
1000 !SUBR FOR W6BXI/W6NKU BRIDGE
1010 PRINT "CAPACITANCE DIAL="";:INPUT C
1020 IF C=0 THEN C=0.00001
1030 Y=(-159155)/(F*C)
1040 Q=1/(1/(D+2)+1/(Y+2))
1050 PRINT "RANGE EXTN RESIS="";:INPUT E
1060 U=(Q/D)-E
1070 IF U=0 THEN U=0.00001
1080 W=Q/Y
1090 RETURN
1100 !
1200 END

```

Fig. 1. Program listing.

assumption is that the feedline is lossless, which works out well in practice. Most feedlines used in the frequency range where the bridges are most useful do not have significant loss.

Of the three types of bridge which may be used with this program, the simplest is the resistance-only bridge, such as an Omega-t unit. These are very popular, but they will only give a deep null when the unknown impedance has a nearly zero reactive component. Often you can find only one or two nulls in a band. More nulls may be obtained if you add another chunk of feedline to the normal feeder. The nulls will then move to different frequencies. Be sure that you have a good null, or the output from the program will be in error.

Another popular commercial bridge is the one sold by Palomar Engineers. This bridge has a "reactance" dial in addition to the resistance dial. This dial varies a small series capacitance in the bridge circuit. (In fact, the dial is

really calibrated in picofarads, even though it is labeled "XC" and "XL".) Use of this dial should let you find a null for almost any impedance at any frequency. This wide range is a liability at times, though. A small error in reading the dial can give a fair amount of error, especially at lower frequencies. Notice that the program considers "XL" readings to be positive and "XC" readings negative.

The third type of bridge we'll call the W6BXI-W6NKU bridge, after the two hams who brought this circuit to a state of perfection.¹ It, too, has a variable capacitance, but the capacitor is connected in parallel in the bridge. The dial is calibrated in positive and negative picofarads. (A negative picofarad is what resonates the inductive reactance at the measuring port of the bridge.) These parallel-type bridges have a somewhat restricted range of reactances for which they will provide a null, particularly at lower frequencies. To extend the

measurement range, a coaxially-mounted resistor is placed in series with the feedline connection at the bridge. This improves the ratio of resistance to reactance and often permits nulling the bridge. The value of this range extension resistor must be input to the computer (zero Ohms if not used).

The program is broken up into nine sections. The "100" section lets you specify the type of bridge you are using. In the "200" part, you input the parameter of the feedline. Velocity factors greater than 1 are not allowed. (If you find a feedline with this characteristic, sell me part of it!) In section "300", the measurement frequency and resistance dial reading are input. If you input a zero frequency, it terminates the program run. If the resistance dial reading is zero (doubtful), the program substitutes 10 milliohms to avoid division by zero later.

Section "400" calls the subroutines needed for the type of bridge that you

have specified. These three subroutines input any other readings needed, make allowances for out-of-range values, and convert the readings to the series-equivalent impedance seen at the bridge end of the feedline. If a negative resistive component is present, the program bails out to prevent meaningless results.

In sections "500" and "600", the equivalent length of the feedline in radians is found and is used to transform the impedance at the bridge to the impedance at the antenna. This impedance is then printed. The last section of the main program, "700", computes the magnitude of the reflection coefficient and uses that to calculate the swr.

Table 1 lists the variables used and indicates what they represent. This may help you adapt to other languages or make modifications. If you are only interested in one of the three types of noise bridges, you can de-

lete the branches to the subroutines for the undesired types of bridges to shorten the program.

The only thing that might be a bit different about the Quodata BASIC compiler used on the PDP-8/e is that it doesn't allow for prompts as part of an "INPUT" statement. This was circumvented by using a "PRINT" statement followed by a semicolon to suppress the line feed.

To check for proper operation of the program, Table 2 shows three different sets of input data which will give nice round answers for most of the outputs. The inputs simulate feedline lengths at multiples of one-eighth wavelength. The six-digit input values should give outputs within one-tenth of an Ohm. Obviously you can't measure your antenna this accurately, but at

least you'll know the program won't interfere with your answers.

In actual use, don't be surprised if the swr that your noise bridge indicates is somewhat higher than your trusty old swr meter. The normal reflectometer-type swr meter usually reads optimistically, especially when it is not driven with a great deal of power. This is probably due to detector diode non-

linearity at low power levels.

With this program you can speedily optimize your radiating system. Take care that the switching noise from your CPU doesn't interfere with the noise nulls, or you might have to go back to the Smith chart! ■

Reference

1. R.A. Hubbs W6BXI and A.F. Doting W6NKU, "Improvements to the RX Noise Bridge," *Ham Radio*, February, 1977, p. 10.

W2NSD/1 NEVER SAY DIE

editorial by Wayne Green

from page 106

a guide signal from the satellite. In order to get the antenna gain needed to pick up these low-powered radios, the satellites would use 68 dB gain antennas, with about 7000 of them covering the country.

A study of the project has been made by NASA and their estimates of the cost for the use of the system run to about one cent per minute, about one-tenth that of Ma Bell's costs. The watches are estimated to

cost about \$10. It is hoped that the system will be operational in about ten years.

YOUR HAM DEALER

If you don't see *HR* and *HRH* magazines at your local dealer in the future, chalk it up to a stupid blunder. Dealers are really upset over this and are not only canceling their monthly copies of the magazines, but also are canceling advertising and even leaning on manufacturers to stop them from advertising.

How come all the uproar? It stemmed from an article which was full of bad advice for ham newcomers on buying rigs. One of the parts that really got to the dealers was the claim that dealers don't service new equipment, they just send it to the factory, so who needs a dealer to back up a new equipment purchase?

It was bad enough that someone wrote this baloney, but for a magazine to publish such rot seems inexcusable. The fact is that any reputable dealer has an enormous investment in test equipment so he can service ham gear and perform warranty service. Most test benches these days run from a minimum of \$35,000—and many double that. It takes two or three technicians to keep up with the service situation for most stores. The dealer knows that he *has* to provide this service if he is going to stay in business and keep his customers coming back.

What about factory service? Ask *me* about that, if you want your ears pinned back. I get most of my ham gear directly from the manufacturers or the importers since it is sent to me for evaluation. Obviously, they send me equipment which has been checked out and should be in pretty good shape. Despite this, at least one third of the equipment I get craps out within a few days and has to go back for service. It is a sorry fact of life that few manufacturers of ham gear put their equipment through the burn-in tests which most commercial equipment suffers. This means that early part failure happens *after* you get the rig instead of before.

This is by no means an indictment of the manufacturers. They are forced to cut corners on design, construction, and testing in order to be competitive in the ham market. If you look at almost identical commercial equipment made

by the same firms, you'll find that it costs half again as much in most cases. This is not because the manufacturers are making a bigger profit—it's because they are putting out a much better product, one which the customers are willing to pay for.

Few hams are equipped to deal with the aches and pains of modern high-density synthesized equipment... and even if we are game to spend a few days chasing some glitch, we feel that, dammit, the rig is under warranty, so why should we go through all that trouble.

Now, if you've bought the rig from a reputable dealer, all you have to do is get it back to him. In some cases, if the rig is still brand new and he has another, he may well give you another rig in its place. But at least he has the repair equipment and technicians to tackle the problem, plus the service data from the factory to help him quickly isolate the difficulty.

My own experiences with getting equipment repaired by the factories have occasionally been so bad that it is unbelievable. And if I can't get service from a manufacturer, how can *you*? I've had rigs come back to me two and three times either in worse shape than they went out or with no improvement whatsoever. I've had rigs take months to get fixed. There's one piece of equipment which is at the factory right now... and has been in and out of there for almost two years, with not one day working right in between. When I call to find out what is happening, I'm sure they put the rig to the back of the line again.

Sure, there are some factory service departments that are wonderful. But, on the other hand, there are some importers who do no service at all. If you can't get your rig fixed by your dealer, it will have to be sent to

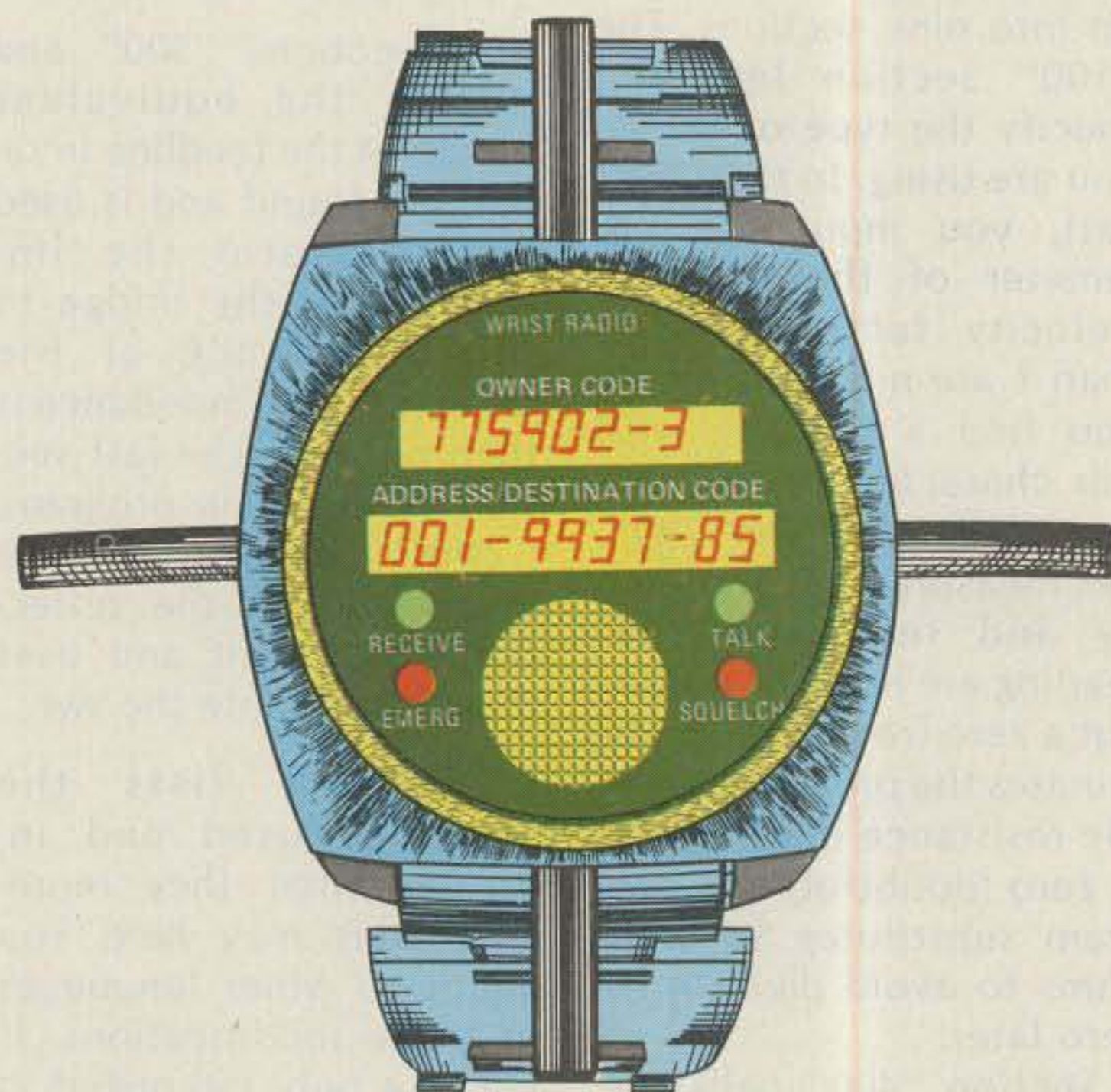

Illustration courtesy of *Microwave Systems News*; artwork by Hans-J. Wacker, Jr.

All New!

REAL·STATE·OF·THE·ART

DIGITAL INSTRUMENTATION FROM OPTOELECTRONICS, INC.

Designed and assembled at Ft. Lauderdale, Florida U.S.A.

TWO NEW AC-DC BATTERY PORTABLE COUNTERS

OPTO-8000.1A 10Hz to 600MHz Frequency Counter

- Precision TCXO time base 0.1PPM Stability 17-40°C • Super Sensitivity with preamps in both HI-Z & 50 Ohm inputs <10 mV to 150 MHz <50 mV @ 600 MHz
- Auto Decimal Point • Aluminum Case • Socketed IC's • Three position attenuator: X1, X10, X100 (avoids false counting)

- #OPTO-8000.1A Factory Assembled - 2 Year Guarantee \$329.95
- #OPTO-8000.1AK Kit Form - 1 Year Parts Guarantee \$279.95
- #NI-CAD-80 NI-CAD Battery Pack (Installs in case) \$ 19.95

OPTO-7000 10 Hz to 600 MHz Miniature Counter

- XTAL (TCXO) Time Base ±.08PPM/°C Standard • Aluminum Case • HI-Z & 50 Ohm inputs
- 1 Sec. & 1/10 Sec. Gate times • Auto Dec. Pt. • Built-in Prescaler and Preamps Standard

- #OPTO-7000 Factory Assembled - 1 Year Guarantee \$139.95
- #OPTO-7000K Kit Form \$99.95 #AC-70 AC Power Pak \$ 4.95
- #NI-CAD-70 NI-CAD Battery Pack and Charger Circuitry \$ 19.95
- #TCXO-70 Optional Precision TCXO Time Base 0.1PPM, 17-40°C \$ 79.95

CM-1000 Digital Capacitance Meter

- Featured Sept. 1978 Radio Electronics Magazine • Measures from 1 pf to 9999 ufd. • 4 Jumbo LED .6" Digits • Aluminum Case • Accuracy of .1 % less one digit

- #CM-1000 Factory Assembled \$179.95 #P-1000 Probe \$6.95
- #CM-1000K Kit Form \$129.95 #P-1000K Probe Kit \$3.95

T-100 Precision Thermometer

- For Use with Digital Voltmeter • Output: 10 mv per Degree • Switchable: Fahrenheit/Celsius

- Resolution to .01° with 4½ Digit Meter • Requires two 9V Batteries - not included

- #T-100 Factory Assembled & Calibrated \$59.95 #T-100K Kit Form \$39.95

- #D-450, Antenna, Rubber Duck, RF Pickup, 450 MHz \$12.50

- #D-146 Antenna, Rubber Duck, 146.MHz \$12.50

- #RA-BNC Right-Angle BNC Adapter for Above Antennas \$ 2.95

PROBES:

- #P-100 50 Ohm, 1X Direct Connection RF Probe 13.95

- #P-101 Lo-Pass, Attenuates RF at audio frequencies 16.95

- #P-102 HI-Z, 2X High impedance, general purpose 16.95



TERMS: Orders to U.S. and Canada add 5% to maximum of \$10.00 per order for shipping, handling and insurance. To all other countries, add 10% of total order. Florida residents add 4% state tax. C.O.D. Fee: \$1.00. Personal checks must clear before merchandise is shipped.



Factory Direct - Phone Orders
(305) 771-2050 • 771-2051



OPTOELECTRONICS, INC.
5821 N.E. 14th Avenue, Fort Lauderdale, Florida 33334

INSTANT SOFTWARE

TRS-80
4K
LEVEL I
16K
LEVEL II

Basic and Intermediate Lunar Lander

0001R Instant Software Inc., Peterborough NH 03458 USA See reverse for program information

INSTANT SOFTWARE

TRS-80
4K
LEVEL I
16K
LEVEL II

Space Trek II

0002R Instant Software Inc., Peterborough NH 03458 USA See reverse for program information

INSTANT SOFTWARE

TRS-80
4K
LEVEL I
16K
LEVEL II

Air Flight Simulation
by Dwight W. Meyer

0017R Instant Software Inc., Peterborough NH 03458 USA See reverse for program information

INSTANT SOFTWARE

TRS-80
4K
LEVEL I
16K
LEVEL II

Oil Tycoon
by Dwight W. Meyer

1802181 Copyright 1978 Instant Software Inc. #1978 See reverse for program information

INSTANT SOFTWARE

TRS-80
4K
LEVEL I
16K
LEVEL II

Golf Cross-Out
by Wilford Niepraschk
by David Dillehay

0009R Instant Software Inc., Peterborough NH 03458 USA See reverse for program information

INSTANT SOFTWARE

TRS-80
4K
LEVEL I
16K
LEVEL II

Ham Package I
Basic Electronic Formulas with Voltage Divider by Rick Morel
Basic Electronic Formulas with RLC Time Constants by Rick Morel
Dipole Antennas and Yagi Antennas by D. A. Lien

0007R Instant Software Inc., Peterborough NH 03458 USA See reverse for program information

INSTANT SOFTWARE

TRS-80
LEVEL I
16K

Cave Exploring Yacht Concentration
by Frank Rowlett

0010R Copyright 1978 Instant Software Inc. #1978 See reverse for program information

*IMP™ for TRS-80™

*Instant Micro Programs

Level I on one side—Level II on the other

● AIR FLIGHT SIMULATION by Dwight W. Meyer (for the TRS-80™) Your mission is to take off and land your aircraft without crashing. You're flying blind on instruments only. The flight starts with a full tank of fuel giving you approximately 50 miles of range. The computer constantly updates your air speed, compass heading and altitude. As you grow more sure of yourself in the pilot seat, you can fly a course against a map or do acrobatic maneuvers. \$7.95. Order no. 0017R.

● BASIC LUNAR LANDER/INTERMEDIATE LUNAR LANDER (for TRS-80™) Your automatic landing system has malfunctioned and you are forced to make a manual landing. Taking control at 15,000 feet, the pilot's success requires precise manipulation of the lunar lander's retro-rockets. After mastering the basic game, the able commander will be taxed by the difficult intermediate program. \$7.95. Order no. 0001R.

● SPACE TREK II (for the TRS-80™) This Space Trek game will challenge the most skillful and careful player. As commander of the Enterprise, you must defend the galaxy against enemy Klingon warships using your arsenal of phasers and photon torpedoes to best advantage. The Enterprise is also equipped with impulse power for moving within the quadrant, and warp power for jumping from quadrant to quadrant. \$7.95. Order no. 0002R.

● ELECTRONICS I by Rick Morel (for the TRS-80™). With this group of five programs you will be able to design coils for radio circuits, calculate the component values for tuned circuits, design preamplifiers using the LM-381 IC and timer circuits, either monostable or astable using the 555 timer IC.

Coils can be designed with the use of tables or special calculators, but they are difficult to use. This package has a coil designing program which is simple to use and the computer does all the work.

There is also a program for designing tuned circuits, audio or radio frequency—fixed or variable frequency.

The LM-381 program draws the circuit diagram and gives you the component values for your needs. It will calculate any unknown values for you. The two 555 programs do the same, giving you the diagrams for either one-shot timers or astable timing systems (clocks). It will do all the calculations for you, providing times or component values.

These programs are not only helpful around any workshop or lab, they also are wonderful for teaching the fundamentals of electronics to newcomers. \$7.95. Order no. 0008R.

● GOLF/CROSS-OUT by Wilford Niepraschk and David Dillehay (for the TRS-80™). Playing golf on a computer? You bet and frustrating, too. You have your choice of seven clubs—three irons, three woods, a chip and a putter. The program has 18 different fairways, each diabolically designed. You have to pick the right club and angle for hitting the ball or else you end up in the woods or a trap. The green calls for putting skill. The program has excellent graphics and you'll have a ball... golf ball. CROSS-OUT is the old peg puzzle, but in computer form. You have to jump pegs, removing each one jumped. The idea is to end up with but one peg, and that one in the middle hole. The program will rate your skill at the end of each try. \$7.95. Order no. 0009R.

● HAM PACKAGE I by Rick Morel and D. A. Lien (for the TRS-80™). This group of eight programs (we like to give you plenty) will be of frequent help to any experimenter or ham operator.

OHM'S LAW CALCULATIONS	SERIES CAPACITANCES
FREQUENCY VS REACTANCE	PARALLEL CAPACITANCES
SERIES RESISTANCES	DIPOLE DESIGN
PARALLEL RESISTANCES	YAGI DESIGN

These programs draw the circuits or antennas involved and let you fill in the pertinent data, giving you the dimensions, etc.

This series of programs is not only an excellent way to learn the fundamentals of electronics and the handling of simple formulas, they will also be of constant use in any workshop or hamshack. \$7.95. Order no. 0007R.

● OIL TYCOON by Dwight W. Meyer (for the TRS-80™) In this Oil Tycoon game you get to compete against a friend for the honor of being the wealthiest tycoon in the oil industry. Throughout the game you invest in research and development, explore for oil and drill with the hope of a successful strike. Not every well drilled will produce oil, and you have to rely on a geologist's report and your own instincts to come up with a gusher. There are also oil spills and blowouts to further complicate your rise to riches. \$7.95. Order no. 0023R.

● BEGINNER'S BACKGAMMON/KENO —by Fred Schild (for the TRS-80™). You will never be in need of a backgammon companion again! Schild's program is designed for the newcomer to the game, but the computer's steady play will challenge the careless expert. KENO is a popular Las Vegas gambling game. As in many games of chance, the odds are against you, but when you win you can win big. \$7.95. Order no. 0004R.

← **Level I only**

● CAVE EXPLORING/YACHT/CONCENTRATION three games by Frank Rowlett (for the TRS-80™) Cave Exploring is a game of trial, error, and exploration in which you search the inner chambers of a large cave looking for treasure while trying to avoid the dangerous creatures that guard the goods. Yacht is a two-player game based on the dice game of Yahtzee. The computer tosses the dice for you and automatically keeps score. Concentration is a computer version of the television game. Two players compete in trying to match the prizes hidden behind the twenty-five numbered squares that appear on the screen. \$7.95. Order no. 0010R.

ONLY \$7.95 ea.

Instant Software Inc.

Peterborough, New Hampshire 03458

603-924

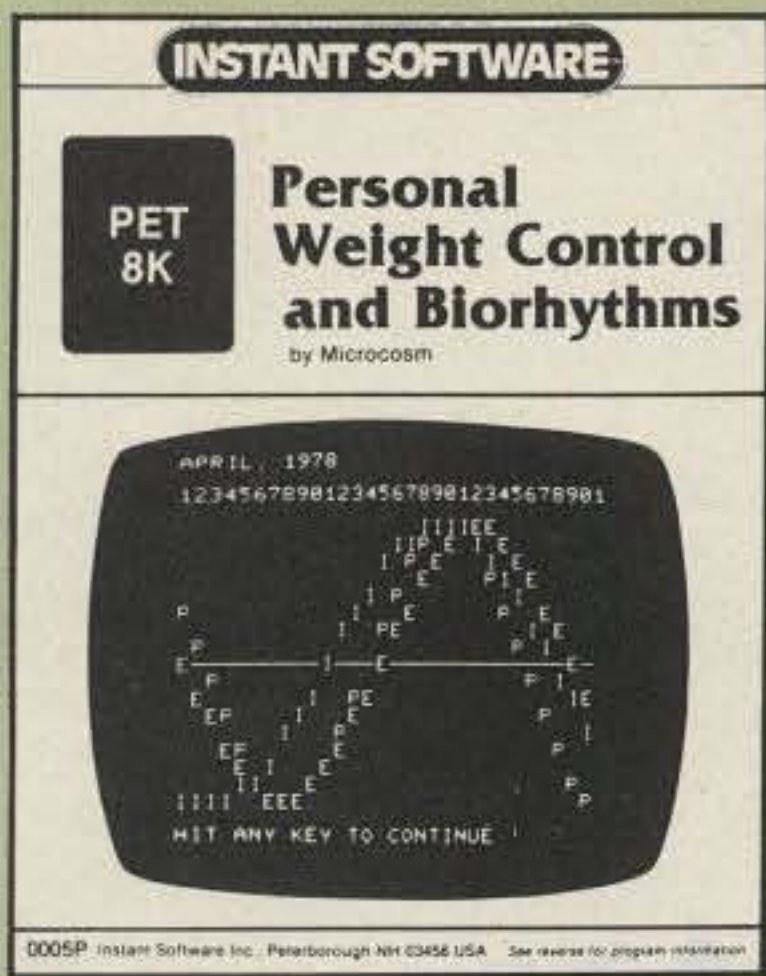

*IMPTM for APPLE



*IMPTM for PETTM

*Instant Micro Programs

● **DOW JONES**, by Robert Knez (for the PETTM) Dow Jones is a challenging stock-market game for up to six players. Players engage in the daily routine of buying and selling stock, while the computer flashes news bulletins that affect the market for better and worse. To increase the complexity of the game there is a high influence option that, when used, causes prices to change with each player's transactions. There is so much going on in this game you may feel like getting a little advice from a broker from time to time, and when you do, the computer is ready to assist you with a broker's prediction. \$7.95. Order no. 0026P.

● **PERSONAL WEIGHT CONTROL/BIORHYTHMS**—by Microcosm (for the PETTM) Here's a program that will let you chart any individual's biorhythm cycle, showing physical, emotional, and intellectual highs and lows. If your neighbors find out you've got it, they will never leave you in peace. **PERSONAL WEIGHT CONTROL** is a must for the diet-conscious. Once your ideal weight has been determined, the program will calculate the correct daily caloric intake necessary to reach your goal over a certain time period. \$7.95. Order no. 0005P.

● **MORTGAGE WITH PREPAYMENT OPTION/FINANCIER**—by Microcosm (for the PETTM) Before you go to the bank, calculate your mortgage payment schedule and find out what you can afford. You will learn how much prepayments save, and can easily compare the true costs of variations in interest. **FINANCIER** is actually three programs in one and is guaranteed to make you a financial wizard. In part I you'll learn to tell which investments will pay off. Part II calculates annual depreciation schedules, providing rates, amounts, and salvage values, which is great when tax time rolls around. The final section figures costs of borrowing, payment terms, and remaining balances on loans of all sizes. \$7.95. Order no. 0006P.

● **CASINO I** by Charles M. Stuart (for the PETTM). There are blackjack games galore, but not many of them are so dependable that you can use them to prepare to make your fortune at Vegas. This blackjack program is not only fun to play, it is also tutorial and allows you to play every combination which you could play at the MGM Grand Hotel in Las Vegas.

There are several systems which will beat the house at blackjack, but before you go investing your cash in a get rich quick attempt, try out your system on this program and see how it does in actual practice.

Roulette programs are more difficult to find, yet this is another very popular casino game—and one you'll want to get some experience with before you venture to go up against the professionals at Vegas. Remember that there are a lot of people who have worked out systems to beat the house at these games and they make a comfortable living going to Vegas every now and then to rebuild their fortunes.

This roulette program is tutorial and gives you the odds on each type of bet.

All you need is the expertise and a little luck to go along with it and you'll pay for your computer in no time. \$7.95. Order no. 0014P.

● **CASINO II** by Charles M. Stuart (for the PETTM). Yes, there are a lot of craps programs around—so why should you buy this one? The big difference is that this one is not just a crap game, it is also a tutorial program which will give you the odds on every type of bet so you can steer clear of the idiot bets that impoverish the unwary. Did you know that there are bets which give the house as little as 0.8% advantage? It takes precious little luck to overcome such a slight edge—but you have to know where to find these bets before you can use them.

If you use this program to get experienced with craps you should be able to walk away from any craps table a winner. Once you know what bets to make and are able thereby to take the best advantage of lucky streaks, betting lightly to wait through the lean times, you'll have quite an edge.

This program uses the exact rules used at the MGM Grand Hotel in Las Vegas, so you'll be playing under actual gambling house conditions. You should be able not only to pay for the program, but also for your computer system the next time you go to Vegas or Atlantic City. \$7.95. Order no. 0015P.

● **GOLF**, by Wilfred Niepraschk (for the APPLETM) This version of a computer golf game may soon rival its outdoor counterpart in popularity. It has an eighteen hole course with some pretty tricky fairways lined with trees, sand traps and water hazards. Players select from nine available clubs the club that can get them closest to the flag. Players also choose the angle of their stroke, but the computer is programmed to give them an occasional slice just to keep things interesting. \$7.95. Order no. 0018A.

*IMPTM assist for the Businessman

—4 tape set only \$29.95—



● **BUSINESS PACKAGE I**, The Small Business Accounting System by A. W. Brown (for the TRS-80TM). Is it possible to keep the books of a small business on such a simple and inexpensive computer system as the Radio Shack TRS-80? Indeed it is—and with the least expensive model: Level I and 4K of memory... that's all this series of programs requires. With The Small Business Accounting System you will be able to run off a list of your assets when you wish. You will be able to run a trial balance and profit and loss statement at will... rather than having to wait until the end of the year for your accountant to work this out. \$29.95. Order no. 0013R.

ONLY \$7.95 ea.

Instant SoftwareTM Inc.

Peterborough, New Hampshire 03458

603-924-3873

Cut along dotted line and mail today
or call during business hours—800-258-5473

Check Money Order VISA AMEX
 MasterCard Expiration date _____

Card No. _____

Name _____

Address _____

City _____ State _____ Zip _____

Signed _____

Instant Software Inc. Dept. 73
Peterborough NH 03458

Send me the following Instant Software:

Quantity	Catalog	Program name	Unit Cost	Total cost
			Shipping	\$1.00
			Total order	

The Morse Master

— convert your computer friends to hamdom

A novel use of the MID\$ function is only one feature of this relentless program.

William A. Thornburg WB9TNW
RR 2
Thompsonville IL 62890

There have been a few articles lately in the microcomputer literature concerning the creation of a radio network for the interchange of information. It has been mentioned that the amateur radio service would provide a natural environment in which to implement such a network.

For several years, amateurs all over the globe have been exchanging "files" in the form of slow scan television. These "files" are of a special nature, but they are still streams of data in the long view.

The ability to use radio for information exchange should be easy for the average computerist to develop. However, there are three major hurdles to

overcome.

The FCC must approve the use of ASCII in the amateur radio service. This, I hope, is a formality whose time will come. Secondly, there must be a set of hardware/software protocols developed, so we can dance to the same tune when using the system. There are some bright people working on this, and we will surely hear more about this in the future.

Last, but not least, one needs a license to operate a transmitter in the amateur radio service. A ham license is the key that unlocks the door to an entire world of adventure in amateur radio. To get a license, you must pass a written test and a code test. The international Morse code must be mastered at various levels of difficulty, corresponding to the different licenses.

Stop a minute and consider this combination. I

am sure serious computerists would be welcomed to the ranks of amateur operators and would find a niche in the amateur structure to enjoy this unique blend of electronic wizardry. I am also sure computerists would enjoy the unique experiences that only amateur radio has to offer. The potential for increased enjoyment is tremendous. Can you imagine discussing and swapping algorithms with a fellow ham computerist in Australia via the 20 meter ham band? How about accessing your computer by using your two meter hand-held radio and touchtone™ pad while cruising down the highway or fishing on some remote river? And, some of the brightest inhabitants of the Silicon Valley can be heard on the ham bands discussing the latest in hardware, software, and techniques. (I hear a lot of computer discussion in the advanced portion of the 20

meter band.) The list of possibilities is endless when you combine these two activities.

I repeat: To be a ham you must get a license; to get a license one must learn the code. The code is not the awesome obstacle that some make it out to be. It can even be a lot of fun. To further learn about the amateur licensing structure, I suggest the *73 Novice Study Guide* and the ham magazines. These can most often be found in the local radio store.

Now that your motivational fires are stirred up, let's look at the program about which this article was written.

This program is a drill which will help you to learn the Morse code. It spits out groups of 5 randomly-selected characters by sounding the proper Morse dit/dah patterns, and it can also print the letters on the video terminal.

My system is all Heathkit. I have the H-8 with 16K

of memory, the H-9 video terminal, the cassette tape recorder and I/O board, and Extended Benton Harbor BASIC.

In the Heath H-8 mainframe, there is a speaker. An audio tone is counted down from one phase of the system clock and applied to the speaker using appropriate control logic which provides a means to turn the "horn" on and off. The H-8 monitor normally uses this feature to provide audio feedback and signaling in conjunction with the front panel.

Placing the number 11210 in location 820110 turns on the tone, and a 24010 in location 820110 turns it off. This can be accomplished by using the "POKE" command, e.g., "POKE 8201,112" turns it on, and "POKE 8201,240" turns it off. By selectively turning the tone on and off

and providing the proper timing and spacing, the Morse code patterns can be formed.

The flowchart in Fig. 1 illustrates the main features of the program logic. Two nested FOR/NEXT loops control the timing between characters and between groups of 5 characters. Statements 131, 132, and 140 do the actual work of tone generation via subroutines. The inner loop and delay return a group of five characters. The outer loop provides a delay between groups of five characters.

A delay is created by a FOR/NEXT loop of the form "FOR I = 1 TO X: NEXT X". The timing parameter "X" is user-defined and is in arbitrary units of time.

Line 131 generates a pseudorandom number between 650 and 900, which

is stored in P3. Please note that P3/10, a number between 65 and 90, corresponds to the ASCII code for the letters of the alphabet. Therefore, the command "PRINT CHR\$(P3/10)" prints the actual letter (line 145).

Lines 650 to 900 constitute a conversion table and control is directed here as a function of the variable P3 and statement 132. A string code is placed in the string variable A\$. In Morse code, there are two sounds: the short sound "dit" and the long sound "dah". A dit is encoded by a "1" in the string. A dah is encoded by a "3". For example, if P3 comes up "650", A\$ is set as "13"; the ASCII code for an "A" is 65, and the Morse code is "dit dah". The letter "C" in Morse is "dah dit dah dit", and a 670 from the random number generator would cause the string "3131" to be placed in the variable A\$.

With A\$ charged with the proper string code, the subroutine at line 1000 produces the actual sounds. This subroutine examines each element in the string A\$ proceeding from left to right. If a "1" is encountered, a sound will be emitted whose duration is governed by the timing parameter "X". If a "3" is encountered, the sound emitted will be of length "T". There is also a delay after each sound governed by "X".

Stepwise examination of the string expression A\$ is accomplished by the MID\$ function. This is a very handy function, and its power in string or text processing is often needed. Consider the following: R\$=MID\$(A\$, I, J), where A\$="HI THERE". If we set I=4 and J=2, then R\$ becomes "TH". The string which is placed in R\$ starts with the Ith character and continues until there are J characters moved (in a left

to right fashion). If we use the construction: "FOR I=1 TO LEN(A\$): R\$=MID\$(A\$, I, 1)::NEXT I", then the individual elements of A\$ are placed one at a time in R\$, allowing action to be taken as a function of the instantaneous value of R\$.

Keep in mind that the timing parameters are in arbitrary units, and what is really important is the ratio. Normally, amateurs suggest a dit/dah ratio of 1/3. I have found that a dit length of 10 and a dah length of 35 sounds good to me. As this drill is intended for the beginner, this setup should remain constant. The time between characters should be fairly long at first, say around 300 to 400.

There is another delay provided between groups of five. This is to allow the user to look up at the video terminal and check to see if he has copied the last group correctly. Therefore, if the user has optioned to view the characters, a time longer than 500 should be used. When the user no longer needs this visual feedback, he can set this timing parameter equal to that for the intercharacter delay.

As was noted, this tone is actually a square wave of around 1 kHz that is fed to a tiny little speaker inside the H-8 cabinet. You shouldn't expect it to sound like a clean sine wave coming out of your stereo. The upper limit of speed is naturally set by the operating environment of the equipment and the software.

If you terminate program execution during tone output by the "Control C" command, it is possible that the system "horn" will be left on. To shut it off, issue the command "POKE 8201,240" in "command mode." Or, you could just start the program again.

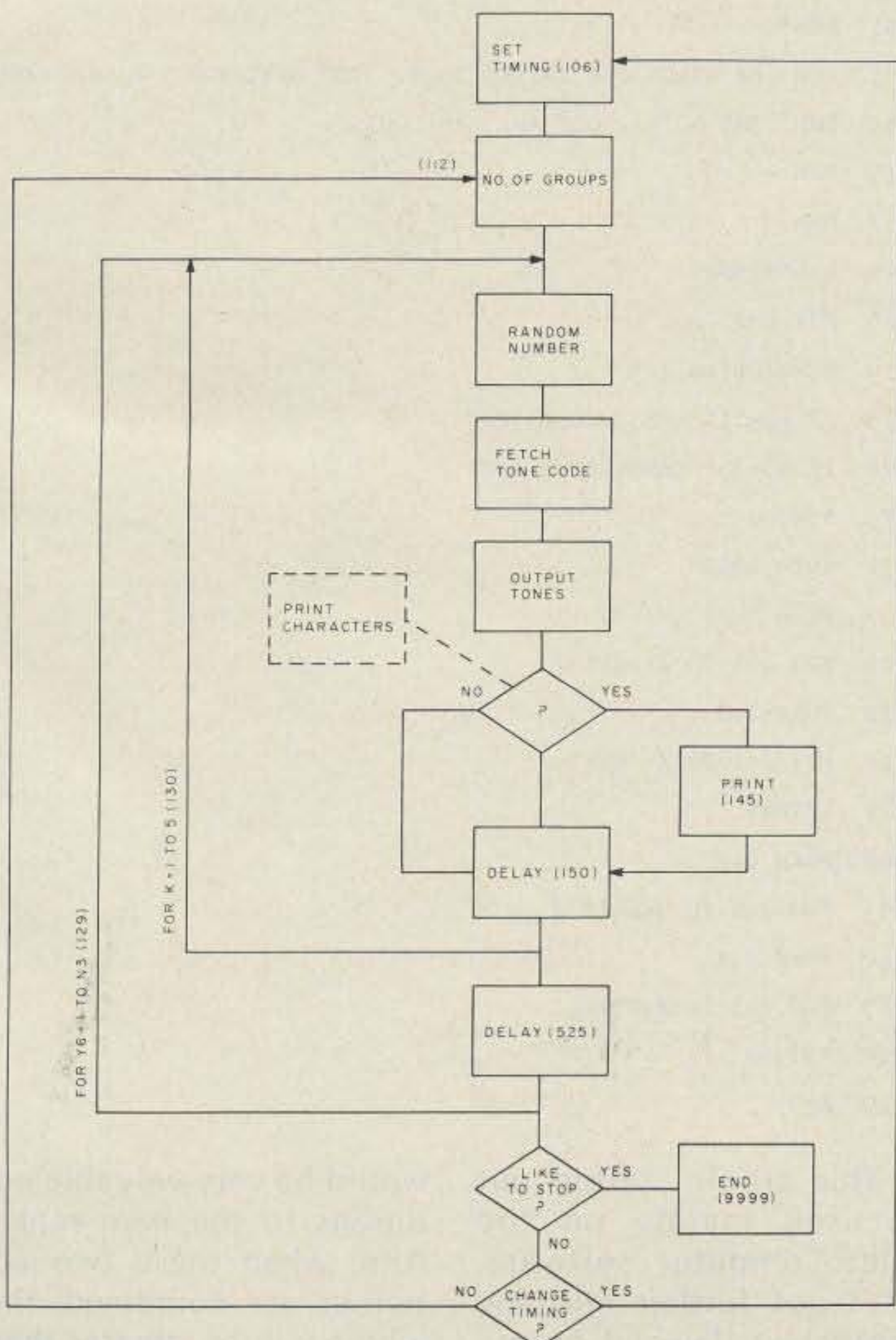

Fig. 1. Flowchart. Statement numbers are in parentheses.

Program listing.

```

50 REM *****
51 REM *
52 REM * CODE PRACTICE PROGRAM *
53 REM * WRITTEN BY WILLIAM A. THORNBURG *
54 REM * 2-13-78 *
55 REM *
56 REM *****
90 PRINT
91 PRINT "THIS PROGRAM SENDS MORSE CODE IN GROUPS OF FIVE."
100 G=8201
102 H=112
104 R=240
106 INPUT "INPUT THE LENGTH OF A DIT": X
108 INPUT "INPUT THE LENGTH OF A DAH": T
109 INPUT "THE TIME BETWEEN CHARACTERS": F7
110 INPUT "INPUT THE TIME BETWEEN GROUPS OF FIVE": G9
111 LINE INPUT "WOULD YOU LIKE TO SEE THE CHARACTERS?": A8$
112 INPUT "INPUT THE NUMBER OF GROUPS OF FIVE DESIRED": N3
113 PRINT
114 REM
115 REM
116 REM END OF INITIALIZATION CODE
117 REM
118 REM
129 FOR Y6=1 TO N3
130 FOR K=1 TO 5
131 P3=(INT(26*RND(1)+65))*10
132 GOSUB P3
140 GOSUB 1000
145 IF A8$="YES" THEN PRINT CHR$(P3/10);
150 FOR I=1 TO F7:NEXT I

500 NEXT K
501 PRINT
525 FOR M=1 TO G9:NEXT M
550 NEXT Y6
560 PRINT
561 LINE INPUT "WOULD YOU LIKE TO STOP?": W6$
564 IF W6$="YES" THEN GOTO 9999
565 LINE INPUT "WOULD YOU LIKE TO CHANGE SPEEDS?": E7$
566 IF E7$="YES" THEN GOTO 106
567 GOTO 112

640 REM P3 IS A PSEUDO-RANDOM NUMBER BETWEEN 650 AND 900
641 REM WHICH IS 10 TIMES THE ASCII CODE.
642 REM THE FOLLOWING ENCODES FOR THE LETTERS.
643 REM A "1" MEANS A DIT AND A "3" IS A DAH.
644 REM
650 A$="13":RETURN

660 A$="3111":RETURN
670 A$="3131":RETURN
680 A$="311":RETURN
690 A$="1":RETURN
700 A$="1131":RETURN
710 A$="331":RETURN
720 A$="1111":RETURN
730 A$="11":RETURN
740 A$="1333":RETURN
750 A$="313":RETURN
760 A$="1311":RETURN
770 A$="33":RETURN
780 A$="31":RETURN
790 A$="333":RETURN
800 A$="1331":RETURN
810 A$="3313":RETURN
820 A$="131":RETURN
830 A$="111":RETURN
840 A$="3":RETURN
850 A$="113":RETURN
860 A$="1113":RETURN
870 A$="133":RETURN
880 A$="3113":RETURN
890 A$="3133":RETURN
900 A$="3311":RETURN
950 REM
951 REM
952 REM A$ HOLDS THE LETTER CODE. THE NEXT ROUTINE GENERATES
953 REM THE ACTUAL DIT AND DAH SOUNDS.
954 REM
955 REM
1000 L=LEN(A$)
1005 FOR I=1 TO L
1010 R$=MID$(A$,I,1)
1015 IF R$="1" THEN GOSUB 1200
1020 IF R$="3" THEN GOSUB 1300
1025 NEXT I
1030 GOTO 1320
1200 POKE G,H
1205 FOR J=1 TO X:NEXT J
1210 POKE G,R
1215 FOR J=1 TO X: NEXT J
1220 RETURN
1300 POKE G,H
1305 FOR J=1 TO T:NEXT J
1310 POKE G,R
1315 FOR J=1 TO X:NEXT J
1320 RETURN
9999 END

```

As a person passes through the beginner stage, it is best to practice your code copy in a more realistic manner. The method that I found best

was a combination of 73's code practice cassette tapes and listening to the ARRL ham station's (W1AW) code practice sessions.

This article started out focused mainly on the microcomputer software. As I got further into the project, it dawned on me that computer enthusiasts

would be very valuable additions to the ham ranks. And, when these two activities are combined, the whole will be greater than the sum of its parts. ■

SWITCHES CRYSTALS CONNECTORS HEAT SINKS TEST CLIPS BOOKS KITS DIP JUMPERS CABLE ASSEMBLIES SWITCHES CRYSTALS CONNECTORS HEAT SINKS

Jim-pak[®] electronic components

One-Stop Component Center Authorized Distributors

SWITCHES CRYSTALS CONNECTORS HEAT SINKS TEST CLIPS BOOKS KITS DIP JUMPERS CABLE ASSEMBLIES SWITCHES CRYSTALS CONNECTORS HEAT SINKS

✓ J1

ALABAMA

- Cropwell
- Huntsville
- Mobile
- ALASKA**
- Anchorage
- ARIZONA**
- Flagstaff
- Fountain Hills
- Tempe
- Sierra Vista
- Yuma
- CALIFORNIA**
- Bellflower
- Berkeley
- Brea
- Buena Park
- Cypress
- El Monte
- Fontana
- Fullerton
- Glendale
- Harbor City
- Lake Tahoe, South
- Lancaster
- Long Beach
- Mission Viejo
- Modesto
- Modesto
- Monterey
- Morro Bay
- Oceanside
- Palmdale
- Palo Alto
- Pasadena
- Riverside
- Sacramento
- Sacramento
- Sacramento
- Salinas
- San Bernardino
- San Carlos
- San Diego
- San Fernando
- San Francisco
- San Francisco
- San Jose
- San Jose
- San Luis Obispo
- San Rafael
- Santa Barbara
- Santa Cruz
- Santa Maria
- Santa Monica
- Suisun City
- Sunnyvale
- Torrance
- Vallejo
- Van Nuys
- Ventura
- Walnut Creek
- Westminster
- Whittier
- Whittier
- COLORADO**
- Aurora
- Denver
- Denver
- Steamboat Springs
- CONNECTICUT**
- Bridgeport
- FLORIDA**
- Ft. Lauderdale
- Gainesville
- Lakeland
- Miami
- Oriando
- Pensacola
- Tampa
- Tampa
- GEORGIA**
- Atlanta
- HAWAII**
- Aiea
- Honolulu
- IDAHO**
- Boise
- Caldwell
- Idaho Falls
- ILLINOIS**
- Carbondale
- Evanston
- Evanston
- Granite City
- Groveland
- Mount Prospect
- Niles
- Oak Park
- Peoria
- Robinson
- Rockford
- Schaumburg
- INDIANA**
- East Chicago
- Hammond
- IOWA**
- Clinton
- Davenport
- Des Moines
- Indianola

- Tucker Bros.
- Industrial Electronic Supply
- Lafayette Radio Electronics
- Electronics Corp. of Alaska
- Jim's Audio & Stereo Repair
- P & C Communications
- Computerworld Inc.
- B & S Electronics
- Yuma Electronics
- Earl's Hobby Shop
- Al Lasher Electronics
- Century Electronics
- Ford Electronics
- SCR Electronics
- Kimball & Stark
- Fontana Electronics
- Orvac Electronics Inc.
- Eagle Electronics
- Buff's Electronics
- CalPine Electronics
- Consumer Electronics
- Scott Radio Supply Inc.
- Tower Electronics Corp.
- Computer Magic
- Pacific Radio
- Zackit
- Morro Bay Electronics
- Electronic Center
- Radio Shack A.S.C. Palmdale
- Zack Electronics
- Dow Radio Inc.
- Computer Center
- Heathkit Electronic Center
- The Radio Place
- Zackit
- Salinas Radio
- Inland Computer & Electronics
- J & H Outlet Store
- Radio Shack A.S.C. Mira Mesa
- San Fernando Electronics
- Zack Electronics
- Zenith Distributing Corp.
- Peninsula Electronic Supply
- Quement Electronics
- Mid-State Electronic Supply
- Electronics Plus
- Lombard Electronics
- Santa Cruz Electronics
- Caps Electronics
- Mission Control
- Byte Shop
- Sunnyvale Electronics
- SE Electronics
- Zackit
- Thrifty Electronics Supply
- Lombard's Electronics Inc.
- Byte Shop of Walnut Creek
- JK Electronics
- D & S Electronics
- Whittier Electronics Co.
- Com Co Electronics
- Amptec Inc.
- Mt. Coin Distributing Co.
- Norm's TV & Electronics
- Bridgeport Computer
- Computers For You
- Lafayette Radio
- Lakeland Specialty Electronics
- Herman Electronics
- Altair Computer Center
- Grice Electronics Inc.
- AMF Radio
- Microcomputer Systems
- Atlanta Computer Mart
- Delcoms Hawaii
- Integrated Circuit Supply
- Custom Electronics
- A-Gem Supply Inc.
- Audiotronics
- Lafayette Radio
- Itty Bitty Machine Co.
- Tri-State Electronic Corp.
- Computer Systems Center
- Moyer Electronics
- Tri-State Electronic Corp.
- Computer Land
- Spectronics Inc.
- Warren Radio Co.
- Radio Shack Associate Store
- Imperial Computer Systems
- Data Domain
- Acro Electronics Corp.
- Meade Electronics
- Bridge Elec. Computer Center
- Computer Store of Davenport
- Radio Trade Supply Co.
- Electronix Limited

KANSAS

- Kansas City
- Manhattan
- Wichita
- KENTUCKY**
- Lexington
- LOUISIANA**
- Baton Rouge
- Baton Rouge
- Baton Rouge
- Houma
- Metairie
- New Orleans
- MARYLAND**
- Baltimore
- Baltimore
- Baltimore
- Churchville
- La Vale
- Rockville
- Rockville
- Silver Spring
- Towson
- Towson
- Towson
- MASSACHUSETTS**
- Medford
- North Adams
- Waltham
- Worcester
- MICHIGAN**
- Ann Arbor
- Clawson
- Flint
- Grand Rapids
- Lansing
- Midland
- Mt. Clemens
- Muskegon

- Electronic Surplus Sales
- Communications Specialties Ltd.
- Amateur Radio Equipment Company
- Radio-Electronic Equipment Co.
- Davis Electronics Supply Co.
- Pelican Electronics
- Menard Electronics Inc.
- Pelican Electronics
- Pelican Electronics
- Wm. B. Allen Supply Co.
- Computers Unlimited
- Computer Workshop of Baltimore
- Everything Electronic
- Churchville Electronics
- J & M Electronics
- Computer Workshop
- Heathkit Electronic Center
- Computers Etc.
- Baynesville Electronics Inc.
- Computers Etc.
- Heathkit Electronic Center
- Tufts Electronics
- Electronics Supply Center
- Computer Mart Inc.
- RM Electronics Inc.
- Airway Electronic Communications
- Radio Supply & Engineering
- Hobby Electronic Center
- Micro Computer World
- Fulton Radio Supply Co.
- Computronix Corp.
- The Computer Store
- H.R. Electronics
- Northwest Radio of Duluth
- Heathkit Electronic Center
- Pal Electronics
- Heathkit Electronic Center
- Beckman Electronics
- Computer Country
- Computer Workshop of Kansas City
- Computer Country
- Conley Radio Supply
- Electronic Service & Distributing
- Art's Electronics
- Altair Computer Center
- Scott Electronic Supply Inc.
- Scott Radio Supply Corp.
- Heathkit Electronic Center
- Omaha Computer Store
- Century 23
- A. R. S. Communications Services
- Radio Shack Associate Store
- The Computer Emporium
- Hoboken Computer Works
- All-tronics
- Computer Corner of New Jersey
- Typetronic Computer Store
- Fort Orange Electronics
- Computer Tree Inc.
- Greylock Electronics
- Manhattan Electronics
- Com-Tech Electronics
- Trojan Electronics
- Am-Com Electronics
- The Computer Corner

NORTH CAROLINA

- Durham
- Greensboro
- Raleigh
- NORTH DAKOTA**
- Fargo
- Fargo
- OHIO**
- Bucyrus
- Cincinnati
- Cincinnati
- Columbus
- Dayton
- Reynoldsburg
- OKLAHOMA**
- Guymon
- Oklahoma City
- Tulsa
- OREGON**
- Albany
- Beaverton
- Coos Bay
- Medford
- Ontario
- Portland
- Salem
- PENNSYLVANIA**
- Drexel Hill
- Erie
- Greensburg
- Hershey
- Murrysville
- Phoenixville
- Pittsburgh
- Pittsburgh
- Wilkesbare
- York
- RHODE ISLAND**
- Cranston
- Pawtucket
- TENNESSEE**
- Chattanooga
- Clarksville
- Cookeville
- Knoxville
- Memphis
- Memphis
- Nashville
- Nashville
- Oak Ridge
- TEXAS**
- Amarillo
- Dallas
- Houston
- Houston
- Houston
- Houston
- San Antonio
- UTAH**
- Provo
- Salt Lake City
- Salt Lake City
- VIRGINIA**
- Alexandria
- Alexandria
- Charlottesville
- Hampton
- Norfolk
- Richmond
- Richmond
- Roanoke
- Springfield
- Virginia Beach
- WASHINGTON**
- Everett
- Kennewick
- Longview
- Pasco
- Richland
- Seattle
- Seattle
- Seattle
- Seattle
- Spokane
- Tacoma
- WEST VIRGINIA**
- Morgantown
- Morgantown
- Ripley
- Wheeling
- WISCONSIN**
- West Allis
- Olson Electronics
- Futureworld
- Byte Shop
- Byte Shop of Raleigh
- The Computer Company
- S & S Electronics
- Mead Electronics
- Digital Design
- Heathkit Electronic Center
- Heathkit Electronic Center
- Altair Computer Center
- Universal Amateur Radio
- Sound Service
- Bits, Bytes & Micros
- High Technology
- Oregon Ham Sales
- Norvac Electronics
- Herrick Electronix
- Portland Radio Supply
- Miller Electronics
- Portland Radio Supply
- Computer Pathways
- Kass Electronic Distributors
- Warren Radio
- M. Leff Radio Parts Co.
- Microcomputer Systems Inc.
- Computer Workshop of Pittsburgh
- Stevens Electronics
- Heathkit Electronic Center
- Tydings Company
- Hamlane Electronics
- G.Y.C. Company
- Jabbour Electronics City
- Jabbour Electronics City
- William's Data Comp Division
- Masstronics
- Wagon's Stereo Center
- Byte Shop
- Bluff City Electronics
- Sere-Rose & Spencer Electronics
- Eddie Warner's Parts Co.
- Electra Distributing Co.
- Computer Denn
- Computer Encounters Inc.
- CompuShop
- Altair Computer Center
- CompuShop
- Interactive Computers
- Sherman Electronics Supply Inc.
- Alpine Electronic Supply Co.
- Best Distributing
- Computerland of Salt Lake
- Computer Hardware Store
- Computers Plus Inc.
- Heathkit Electronic Center
- Lafayette Radio
- Lafayette Radio
- Avec Electronics Corp.
- Avec Electronics Corp.
- Computers-To-Go
- The Computer Place
- Computer Workshop of North Virginia
- Heathkit Electronic Center
- ABC Communications
- C & J Electronics
- Progress Electronics
- Riverview Electronics
- C & J Electronics
- ABC Communications
- Amateur Radio Supply
- C-Com
- Empire Electronics
- Personal Computers
- Northwest Radio Supply
- The Computer Corner
- Electro Distributing Co.
- Thompson's Radio Shack
- Lafayette Radio
- The Computer Shop
- CompuShop Alberta Ltd.
- Home Computer Centre
- Wang's Microcenter
- NewBear Computing Store
- Redigetek, S.A.
- Sonitel, S.A.
- Tropelco, S.A.
- Inter-trade (PTE) Ltd.
- Systems Technology Ltd.

New! **Jim-pak** KITS
electronic components

**Regulated Power Supply
JE200 5V-1amp \$14.95**

- * Uses LM309K
- * Heat sink provided
- * P.C. board construction
- * Provides a solid 1 amp @ 5V
- * Size: 3 1/2" x 5" x 2" high
- * Includes components, hardware & instructions

MINNESOTA

- Duluth
- Hopkins
- Minneapolis
- St. Paul
- MISSOURI**
- El Dorado Springs
- Florissant
- Kansas City
- St. Louis
- MONTANA**
- Billings
- Bozeman
- Great Falls
- NEBRASKA**
- Lincoln
- Lincoln
- North Platte
- Omaha
- Omaha
- NEVADA**
- Las Vegas
- NEW JERSEY**
- Bayville
- Bricktown
- Cherry Hill
- Hoboken
- Paterson
- Pompton Lake
- Ramsey
- NEW YORK**
- Albany
- Endwell
- Kingston
- New York
- Rensselaer
- Troy
- Utica
- White Plains

JIM-PAK[®] • 1021 HOWARD AVENUE, SAN CARLOS, CALIFORNIA 94070 • (415) 592-8097

QUALITY and SERVICE SAME DAY SHIPMENT

TRANSISTORS, ETC.

type	case	VCE	Ic	PD	Ft	HEP*	each	ten
MPSA10	NPN	T092	40V	.1A	.3W	50MHz	72¢	\$3.50
MPSU52	PNP	T0202	40	1.5	1.0	150	\$3031	.30
MPSU56	PNP	"	60	1.0	5.0	50	"	.35
MPSA55	PNP	T092	40	.5	.5	50	70¢	.25
2N2222	NPN	T092	30	.8	.5	250	73¢	.30
2N2322	SCR	T0-5	25V	1 AMP	.2ma	gate 1		.40
2N2324	SCR	T0-5	100	1 AMP	.02ma	"		4.00
2N2325	SCR	T0-5	150	1 AMP	.2ma	"		.45
2N2907	PNP	T018	40	.6	.4	200	52	.35
2N3440	NPN	T0-5*	250	1.0	10.0	50	\$3021	.60
2N3565	NPN	T0106*	30	.2	.3	40	55	.15
2N3639	PNP	T092	12	.1	.2	350	57	.20
2N3640	PNP	T0106*	15	.2	.2	400	57	.15
2N3646	PNP	T0106*	15	.2	.2	400	50	.15
2N3704	NPN	T092	30	.8	.3	100	735	.40
2N3903	NPN	T092	40	.2	.3	300	736	.20
2N3904	NPN	T092	40	.2	.3	300	736	.20
2N4248	PNP	T092	40	.1	.2	40	715	.15
2N4250	PNP	T092	40	.1	.2	50	57	.25
2N4400	NPN	T092	40	.2	.3	200	736	.15
2N4437	NPN	T0106	30	.5	.2	250	736	.20
2N5138	PNP	T0106	30	.1	.2	30	52	.20
2N5172	NPN	T092	25	.1	.2	120	56	.25
2N5210	NPN	T092	50	.05	.3	80	728	.30
2N5910	PNP	T0106	20	.1	.3	700	52	.30
2N5964	NPN	T092	150	.1	.5	100	50005	.25
016P1	NPN	T099	12 (high gain lo-per DARL.)					.20
D40C1	NPN	T0220*	30	5	6	DARLINGTON		.30
D41D1	NPN	T0220	30	1.0	6	150	53027	.35
D44H5	PNP	T0220	60	10.0	50			.50
RC4105	PNP	T0220						.35
MJE1091	"	T0220	60	5.0	70	PWR DARLINGTON	1.25	10.00
MJE1100	NPN	T0220	60	5.0	70	PWR DARLINGTON	1.25	10.00
TIP31A	NPN	T0220*	60	3.0	40M			.40
2N6101	NPN	T0220	80	10.0	75			.60
2N4304	N CHANNEL FET	T0106 CASE	5Vn	HEP802				.35
40327	NPN	T0-5	300	1.A	5W			.40

* house number - we guarantee that the device sold is identical to the 26 number specified. PNP numbers from ZEP 1111.
* leads are cut and formed for PC mount.

TRANSISTOR BONANZA

\$6 per 100 - \$50 per 1000

PRIME TO-18 PLASTIC TRANSISTORS FROM A MAJOR SEMI HOUSE. THESE ARE FIRST GRADE DEVICES WITH CUT AND FORMED LEADS AND MARKED WITH A HOUSE NUMBER. THESE ARE NOT BARNUM REJECTS... PNP AND NPN AVAILABLE WE WILL SHIP 50/50 ON ANY MIX WITH 50 PEEK PER TYPE MINIMUM.....

14 PIN GOLD PLATED WIRE WRAP 3 LEVEL SOCKETS.....

35¢ each
25 for \$7.50
100 for \$25



DIP TRIMMER
12 TURN 1/4" x 1/4" 5K or 200K only mfg. DALE
\$1.50 TEN FOR \$4

ZERO CROSSING SWITCH
A.C. powered 14 pin DIP IC used to trigger TRIAC devices...RCA CA3079
60¢ ea \$5- ten

1/2 WATT RESISTORS
10 ea. - 390, 1.8k, 3.9k, 6.8k, 11k 43k, 68k, 200k - 5 percent tol.
80 FOR \$4

BISTABLE RELAY
SPST 6VDC 200 ohm coils 1 amp, 20 watt IC contacts Long life (1x10E+3) oper. High speed (500 Hz) Hermetically sealed
3/8x3/8x3/4" \$2.95 ea

OPTO ISOLATOR
FCD820 6PIN DIP WILL DRIVE A TTL GATE WITH TEN MA LED CURRENT
69¢ ea ten \$6

Ge or Si SIGNAL DIODES
High quality, marked computer grade signal diodes. Leads trimmed for PCB mounting....
40 for \$2

POTTER BRUMFIELD
TYPE NIP RELAY 4PIN 300V 24VDC 500 ohm
please specify coil required.
\$1.60

VARO SEMICONDUCTOR
EPOXY BRIDGE RECTIFIERS 10 AMP 50V VJ048
SUPER SAVER
.90 ea. 10 for \$7.50 100-\$65

DIODE ARRAY
10 IN914's
25¢ each
10 - \$2.25

ELEC-TROL 12 vdc REED RELAY
440-ohm coil
4 dpst n.o.
1.1" x 1.1" x 1.1" CONTACTS
79¢ ea. 10 - \$6

direct LINE (916) 334 2161 TOLL-FREE TELEPHONE SERVICE

24 HOURS A DAY 7 DAYS A WEEK
\$15 minimum order
order DIAL: 800 423 2355 EXT 307
Any Time Day or Night (California Residents Please Dial 800-232-2161)
PHONE ORDERS CAN ONLY BE CHARGED TO MASTER CHARGE OR VISA/BANKAMERICARD

SPECIALS

uA776	programmable operation amplifier	\$1.00
F706BPC	Fairchild 5W audio per. amp. 14 pin DIP w/ integral heat sink	1.25
AM-1	Motorola MPC6070 1W audio amp (mini)	.40
LM386	low voltage audio per. amp. (mini)	1.00
MM5058	1024 bit static shift register (mini)	1.50
2504T	Sig. dyn. 1024 bit shift * (70-99)	.75
747	dual 741 operational amplifier DIP	.50
723	0-40V precision variable regulator DIP	.50
CD4011	CMOS gate	.19
CD4025	CMOS gate	.19
MC1303	stereo preamp (DIP)	1.00
LS1412	Lambda 12V 3A reg. (pulled out of computer board sockets) full spec. devices	3.95
7402	quad two input TTL NOR gate (DIP)	.12
7430	eight input NAND gate (DIP)	.13
7492	divide by twelve counter (DIP)	.30

BABYLON ELECTRONICS BOX 41778 4811 MYRTLE SACRAMENTO, CA 95841

JAN CRYSTALS HOLD THE FREQUENCY

- CB
- CB standard
- 2 meter
- Scanners
- Amateur Bands
- General Communication
- Industry
- Marine VHF
- Micro processor crystals

easy to charge

Send 10¢ for our latest catalog Write or phone for more details
2400 Crystal Drive
Ft. Myers, Florida 33901
all phones (813) 936-2397

THE BEST

ICOM 701 YAESU FT-901 DRAKE TR-7

TOP OF THE LINE. NUMBER ONE. IF YOU'RE THE TYPE OF PERSON THAT WILL SETTLE FOR NOTHING LESS, WE'VE GOT WHAT YOU'RE LOOKING FOR. TOP OF THE LINE FROM THE THREE TOP LINES. AND WE OFFER MORE THAN JUST THE RIGS—SUPER SERVICE AFTER THE SALE. CALL US SOON FOR A QUOTE ON YOUR NEXT RIG.

ORDER TOLL FREE!
800-845-6183

G.I.S.M.O.
2305 CHERRY ROAD
ROCK HILL, S.C. 29730

JANUARY SPECIALS

HY-GAIN		
TH6DX 6 element tribander	\$195.00
TH3MK3 3 element tribander	158.50
TH3R Low Power Beam	104.00
1BAVT/WB 10-80 Meter Vertical	70.00
Others—Write		
MOSLEY		
TA-33 3 element tribander	\$169.95
TA-33R Low Power Beam	129.00
CL-33 3 element tribander	199.00
CL-36 6 element tribander	249.95
Others—Write		
CUSHCRAFT		
ATB-34 4 element tribander	\$195.95
A147-11 11 el. 2 M. Beam	26.50
A147-22 22 el. 2 M. Beam	73.95
ARX-2 Ringo Ranger 2M	27.95
ROTORS		
Ham III	\$117.00
T2X Tailtwister	217.00
Alliance HD-73	99.00
WILSON		
System One	\$209.00
System Two	167.00
SAXTON WIRE & CABLE		
See Sept. Issue		

COMMUNICATIONS SERVICES

326A WEST MAIN STREET
PHILADELPHIA MS 39350
PHONE: 601-656-5345
HOURS: 8-5 Mon-Fri.

Send stamp for price list or \$1 check for full line catalog. \$1 refundable on first order. We ship only to 50 states. All shipping is FOB.

3 YEARS WARRANTY!

EXACT Replacements for
SYLVANIA
ECG Transistor-Diodes-ICs

ECG#	ECG#	ECG#	ECG#	ECG#	ECG#		
100	94	163	5.95	220	1.72	289	.88
101	.98	164	5.75	221	1.90	290	.98
102	.96	165	6.95	222	1.99	291	1.99
102A	.98	171	1.37	223	2.79	292	2.26
103	1.05	172A	.72	224	5.06	293	1.08
103A	1.11	175	1.62	225	4.34	294	1.14
104	1.06	176	2.06	226	1.67	295	2.02
105	2.27	177	.49	228	1.38	297	1.13
106	.80	179	5.69	229	1.06	298	1.13
107	.79	180	5.88	230	3.60	299	2.02
108	.89	181	4.65	231	3.96	300	2.02
121	2.15	182	3.35	232	.70	302	2.80
123	.69	183	3.63	233	.74	306	2.80
123A	.79	184	1.37	234	.72	307	2.57
124	1.53	185	1.70	235	2.45	308	7.65
126	1.16	186A	1.46	236	5.75	309K	3.27
127	4.60	187A	1.46	237	5.07	310	7.65
128	1.37	188	1.59	238	7.95	311	2.13
129	1.56	189	1.59	239	3.02	312	1.13
130	1.95	190	1.85	241	1.71	313	1.00
131	1.98	191	2.07	242	1.90	314	7.85
132	1.01	192	.96	276	8.72	315	2.01
133	1.14	193	1.04	278	2.36	316	2.74
152	1.43	194	.82	279	5.85	317	24.20
153	1.85	195A	2.67	280	5.06	318	20.60
154	1.85	196	1.98	281	6.35	319	1.11
155	2.02	197	1.89	282	4.24	320	26.00
157	1.43	198	1.89	283	6.32	321	7.65
158	1.08	199	.59	284	7.35	322	1.80
159	.86	210	1.37	285	7.99	323	3.53
160	1.43	211	1.56	288	5.75	324	3.53
161	.98	218	3.08	287	.69	325	27.50
162	5.75	219	4.36	288	.74	326	.96

- R-U-S-H, All Orders Shipped Same Day Received
- FREE Freight on all prepaid orders
- EXCLUSIVE 3 YEAR CONDITIONAL WARRANTY!
- NO Min. Order-Quantity Discounts Available
- Exact ICs & Diodes In Stock
- Longer Hours Mon-Sat 9a-10p, Sun 1-7p
- Call or write today—to place your order (518)-465-3367

Communications & T.V. Unlimited
Dept 73, 17 Washington St., Rensselaer, N.Y. 12144
DISTRIBUTOR INQUIRIES INVITED
T.V.-C.B.-AMATEUR RADIO-STEREO-MONITORS-
ELECTRONIC PARTS ✓C105

MFJ INTRODUCES A NEW Tunable SSB/CW Filter

Instantly zero in SSB/CW signals with tunable peak, notch, lowpass filter. MFJ has solved problems that plague other tunable filters.

MFJ improves tunable filter . . . constant output as BW is varied, linear freq. control, tighter notch.



BRAND NEW \$59⁹⁵

Instantly zero in a SSB/CW signal and eliminate QRM. The MFJ-751 Signal Enhancer is a tunable SSB/CW active filter.

You can select an optimum mode, zero in with the frequency control and adjust the bandwidth for best response.

Peak, notch or lowpass signals with double tuned filter for extra steep skirts.

Tune frequency from 300 to 3000 Hz. Vary bandwidth from 40 Hz to flat. Notch to 70 db.

Peak for CW, SSB, AM, SSTV, RTTY. Notch rejects QRM. Lowpass removes hiss, splatter.

Hear off frequency calls with simulated stereo.

MFJ has solved problems that plague other tunable filters to give constant output when bandwidth is varied, linear frequency control, and tighter, smoother notch.

Works with any rig. Plugs into phone jack. 2 watts for speaker. Phone and speaker jacks. Speaker disables when phones are used. 110

VAC, or 9-18 VDC, 300 ma. 5x2x6 inches.

Order from MFJ and try it — no obligation. If not delighted, return it within 30 days for a refund (less shipping). The MFJ-751 is unconditionally guaranteed for one year.

To order, simply call us toll free 800-647-1800 and charge it on your VISA or Master Charge or mail us a check or money order for \$59.95 plus \$2.00 for shipping and handling.

Don't wait any longer to zero in signals and eliminate QRM. Order your MFJ Signal Enhancer at no obligation, today.

MFJ ENTERPRISES, INC.

P. O. BOX 494 ✓M52
MISSISSIPPI STATE, MS 39762
CALL TOLL FREE . . . 800-647-1800
For technical information, order/repair status, in Miss., outside continental USA, call 601-323-5869.



TWO METER CRYSTALS

LIFETIME GUARANTEE! NOW ONLY \$8.00 A PAIR!

Make/Model _____

Xmit. freq. _____

Rec. freq. _____

Name _____

Address _____

City _____ State _____ Zip _____

Bill: MC Visa Amex

Credit Card # _____

Exp. date _____

Signature _____



Power Range	Frequency Bands (MHz)					
	2-30	25-60	50-125	100-250	200-500	400-1000
1 watt	—	5A	5B	5C	5D	5E
10 watts	—	10A	10B	10C	10D	10E
25 watts	—	25A	25B	25C	25D	25E
50 watts	50H	50A	50B	50C	50D	50E
100 watts	100H	100A	100B	100C	100D	100E
250 watts	250H	250A	250B	250C	250D	250E
500 watts	500H	500A	500B	500C	500D	500E
1000 watts	1000H	1000A	1000B	1000C	1000D	1000E
2500 watts	2500H	—	—	—	—	—
5000 watts	5000H	—	—	—	—	—

MODEL 43 \$125.00
Elements (Table 1) 2-30 MHz 45.00
Elements (Table 1) 25-1000 MHz 38.00
Carrying case for Model 43 & 6 elements 27.50
READ RF WATTS DIRECTLY! (Specify Type N or SO239 connectors)

Send for our new catalog!
\$3.00 shipping charge
order • NO C.O.D.s!
TUFTS
Radio Electronics
209 S Mystic Ave
Medford MA 02155
1(800) 225-4428
(617) 395-8280

electronic calculators

LIST	HAM NET	TEXAS INSTRUMENTS ELECTRONIC CALCULATORS
\$299.95	\$269.95	T.I.-59, 960 STEP PROGRAMMABLE SCIENTIFIC
124.95	112.45	T.I.-58, 480 STEP PROGRAMMABLE SCIENTIFIC
59.95	53.95	T.I.-57, 150 STEP PROGRAMMABLE SCIENTIFIC
49.95	44.95	T.I.-55, 32 STEP PROGRAMMABLE SCIENTIFIC
59.95	53.95	T.I. PROGRAMMER, CONVERTS DECIMAL/OCTAL/HEX
69.95	62.95	T.I. MBA, SUPER PROGRAMMED FINANCIAL
LIST	HEWLETT-PACKARD ELECTRONIC CALCULATORS	
\$750.00	\$675.00	H.P.-97, 224 STEP PROG SCIENTIFIC PRINT/VISUAL
450.00	405.00	H.P.-67, 224 STEP PROG SCIENTIFIC
275.00	247.50	H.P.-19C, 98 STEP PROG SCIENTIFIC PRINT/VISUAL
175.00	157.50	H.P.-29C, 98 STEP PROG SCIENTIFIC
175.00	157.50	H.P.-10 BASIC HAND HELD PRINTER VISUAL
325.00	292.50	H.P.-91, PREPROGRAMMED SCIENTIFIC PRINT/VISUAL
100.00	90.00	H.P.-33E, 49 STEP PROG SCIENTIFIC
80.00	72.00	H.P.-32E, PREPROGRAMMED SCIENTIFIC WITH STAT
60.00	54.00	H.P.-31E, PREPROGRAMMED SCIENTIFIC
495.00	445.50	H.P.-92, PREPROGRAMMED FINANCIAL PRINT/VISUAL
120.00	108.00	H.P.-38E STEP PROGRAMMABLE SUPER FINANCIAL
75.00	67.50	H.P.-37E, PREPROGRAMMED FINANCIAL

WE STOCK ALL HEWLETT-PACKARD CALCULATOR SOFTWARE AND ACCESSORIES

SEND ME THE CALCULATOR(S) INDICATED BELOW. COMPLETE WITH INCLUDED ACCESSORIES, INSTRUCTIONS, AND MANUFACTURERS WARRANTY. I UNDERSTAND THAT IF I AM NOT COMPLETELY SATISFIED, I MAY RETURN IT WITHIN 10 DAYS FOR A COMPLETE REFUND (LESS SHIPPING)

MODEL(S) _____ QUANTITY _____ AMOUNT ENCLOSED \$ _____

WE HONOR _____ VISA _____ MASTERCARD _____ MONEY ORDERS _____ COD

ADD \$2.00 FOR POSTAGE AND HANDLING. PLEASE ALLOW 10 DAYS FROM DATE OF RECEIPT OF ORDER FOR DELIVERY. TEXAS RESIDENTS ADD 5% SALES TAX.

CARD NUMBER _____ EXPIRATION DATE _____

FULL NAME _____ CALL _____

STREET _____ CITY _____ STATE _____ ZIP _____

MORE LITERATURE MODEL(S) _____

*****DEALER INQUIRIES INVITED*****



MAIL TO: 6810 LARKWOOD
HOUSTON, TEX 77074
ATTN: STEVE, WA5OEN
PHONE: A.C. (713) 777-2673

The MINI-MOUSE Key

— perfect companion to the MINI-MOS keyer

WA6EGY reveals the secret ingredients of his funny-looking key.

When my article on the MINI-MOS keyer appeared in the August, 1976, issue of 73, many readers were puzzled by the funny-looking dual-paddle key that was shown in the photos together with the keyer. Several wrote me and inquired about the key which

they thought was "built up from scraps of PC board." So, forthwith, I will reveal the secret ingredients of this mystery key, which, because of its mouse-grey, ear-shaped plastic paddles, may be referred to as the MINI-MOUSE key.

A straight key is actually nothing more than a con-

tact that makes and breaks a keying circuit. If need arises, any contact can be pressed into service for this purpose. Some readers might remember that dramatic scene in the movie classic "Union Pacific" where the hero (was it John Wayne?) taps out the life-saving code message by hitting his gun barrel against the downed telegraph wire. To build a reliable, easy-to-use dual-paddle key, however, is another story. The necessary low-friction bearings, lockable stops, and tension springs normally make the construction of such a key a project beyond the capabilities of the average ham. While several good dual-paddle keys are available from manufacturers advertising in 73, none were small enough to be used with the MINI-MOS keyer. For this reason, a matching key was designed. In the design, great care was exer-

cised to use only materials and tools that are readily available to the average ham. A close-up of the key is shown in the photo.

The material used for the construction of the key was G-10 (fiberglass epoxy) circuit board, single-sided, with a measured thickness of .046 inches. This board, which was surplus material, is somewhat thinner and more flexible than the more common 1/16 inch PC board. One starts by cutting parts 1, 8, 6a, 6b, 4a (twice), and 4b (twice) from the board according to the dimensions shown in Fig. 1. By drilling and filing, or with a fine jigsaw, one then cuts the slot in parts 4a, leaving only about 1/16 of an inch of material at the edge. These sections will later act as a flexible "hinge" around which the paddles pivot and, thus, solve the problem of the bearings. Next, parts 4a-4b and 6a-6b are laminated

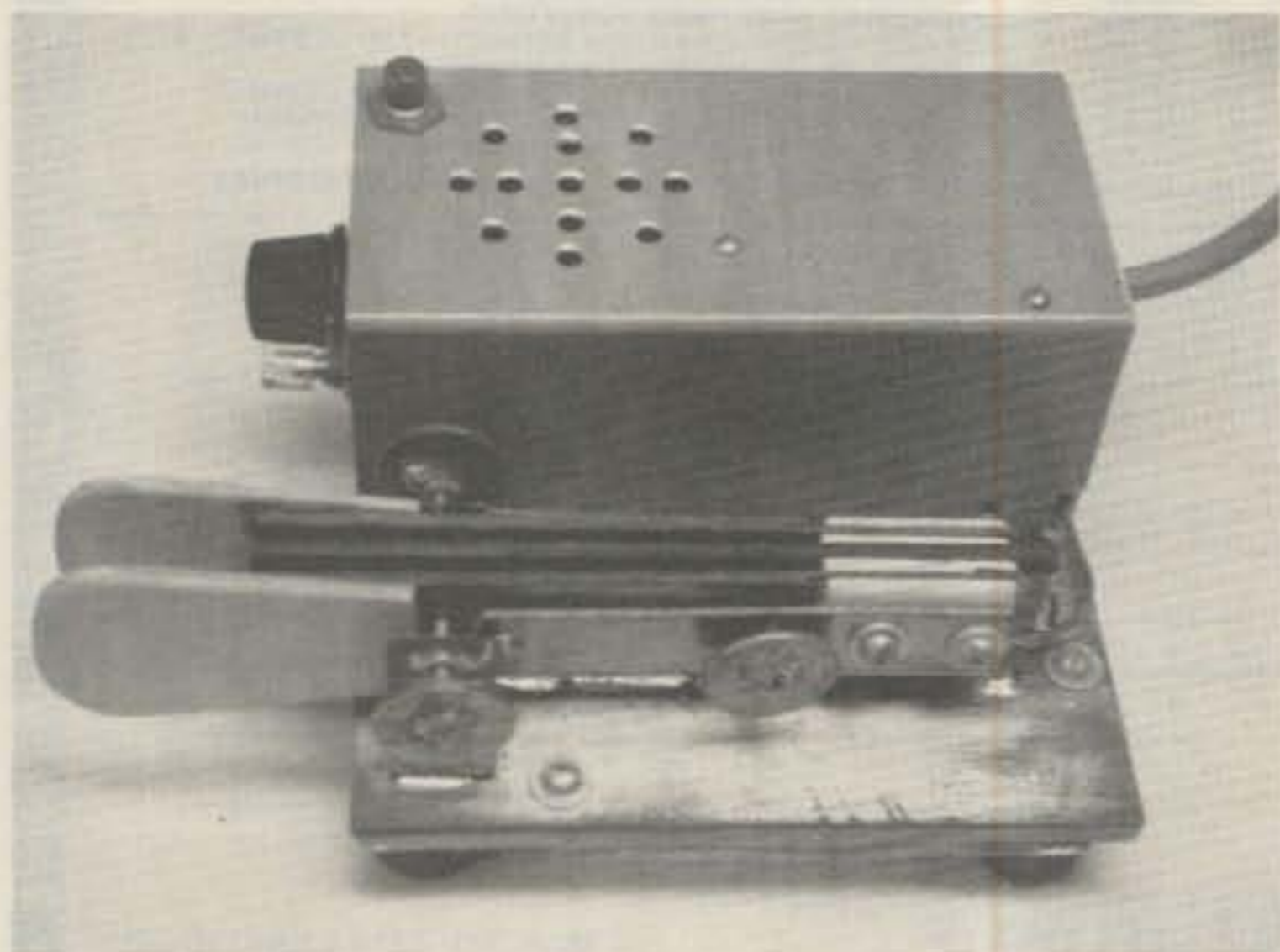

Close-up view of the MINI-MOUSE key mounted with the MINI-MOS keyer on a common base plate.

together (foil sides out) as indicated by the dotted lines in Fig. 2, using contact cement. As indicated in Figs. 1 and 2, the foil on both sides of part 6 is cut 1/4 of an inch from the edge by removing a narrow strip. This can be done with a router, cross-feed table on a drill press, bit of a high-speed hand tool, or even with the blade of a hacksaw. Then one corner of the part is notched according to the dimensions shown in Fig. 1.

Next, the position for hole "Y" on part 4b and holes "U", "V", and "X" on parts 4b and 8 are marked according to the dimensions shown in Fig. 1. Parts 2 (four each) and 3 (two each) are cut from any kind of suitable plastic of the correct thickness. Next, all parts (with the exception of parts 3) are stacked together in the sequence shown in the "explosion" drawing, Fig. 2. Parts 4 and 6 should line up at the front edge, with all other parts lining up with parts 4 at the rear with part 6 protruding by about 1/4 of an inch. The whole stack is tightly clamped together or, if no suitable clamps are available, it is wrapped tightly with wire or clear plastic adhesive tape. While making sure that the corners of the stack remain lined up, holes "U" and "V" are drilled using a No. 33 drill. After the first hole has been drilled, a 4-40 screw is inserted through the hole, which helps keep

the stack from moving while the second hole is drilled. Then hole "Y" is drilled, which serves the purpose of lining up the contact rivets when they are soldered in place. The diameter of hole "Y" should be chosen to center the part of the contacts protruding on the side of the spring opposite the contact surface. Next, part 1 is removed from the stack of parts and, using the screws in holes "U" and "V" to keep everything lined up, hole "X" is drilled using a No. 42 drill. Then the stack is separated and hole "X" enlarged to a diameter of about 1/4 of an inch in parts 4 and 6; but not in part 8. The contacts, part 5, are soldered in place on parts 4 and 6, using the holes to line them up, and the same is done with nut 15 on part 8. Parts 3 are cemented to part 4, as shown in Fig. 2, again using contact cement. Make sure part 3 does not cover part 4 by more than 3/4 of an inch. Parts 4 will later be pulled out by "springs" 1 and 8 respectively, with the help of linkage 10. This linkage, a short piece of flexible stranded wire or copper braid, is soldered to part 4 in the appropriate location; the other end will be connected later. Then part 6 is soldered to the ground plate along its center line, making sure the two parts are positioned perpendicular to each other, with the notch of part 6 lined up with the

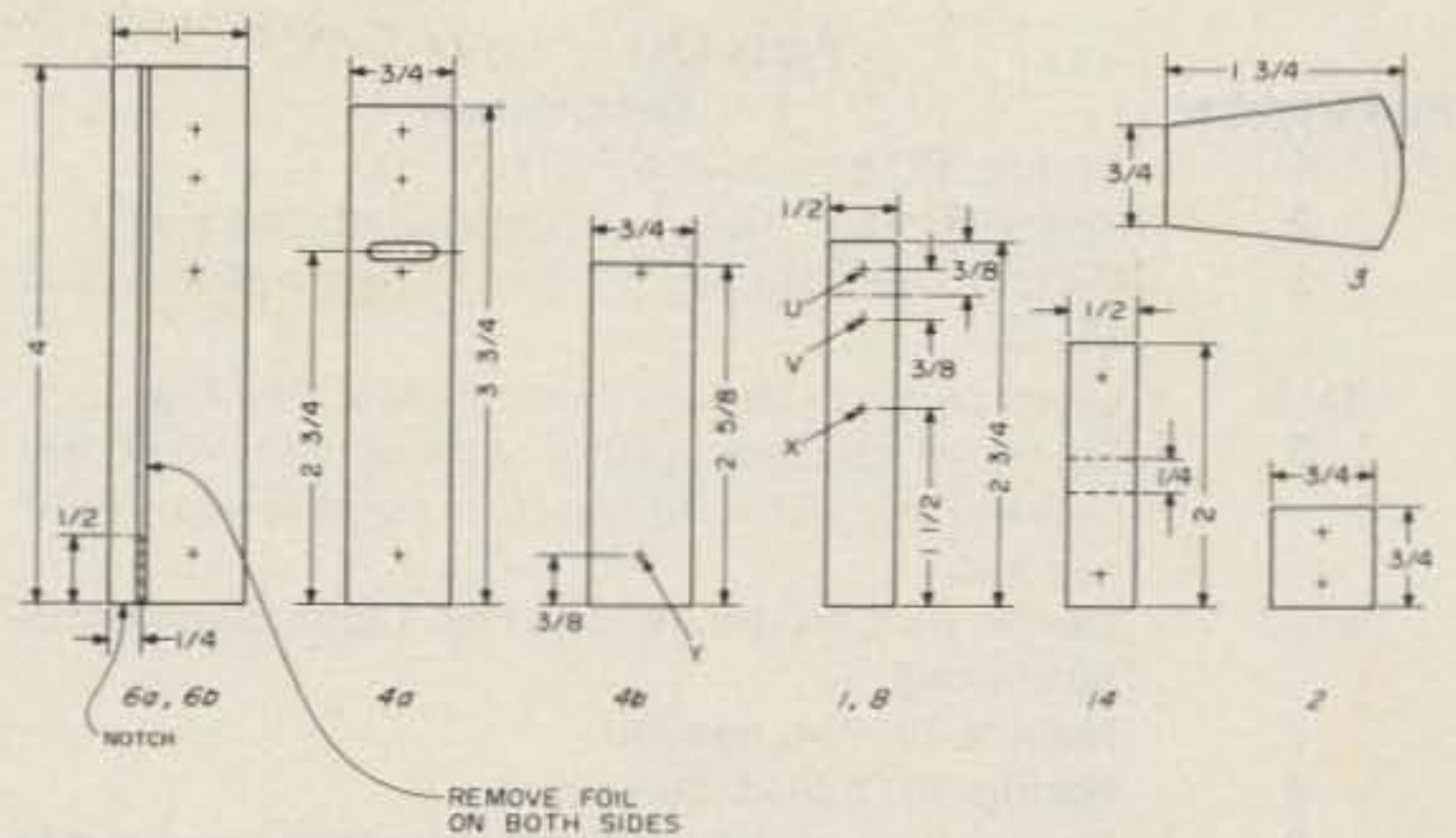

Fig. 1. Dimensions for most parts. For details of the materials to be used, see parts list.

edge of part 4.

Now, everything is ready for the final assembly. If one wants to protect the beauty of the MINI-MOUSE key permanently, however, one has to keep the copper foil on the PC board from tarnishing. First, the contacts and all places where one must solder during assembly will have to be masked with patches of masking tape. Then all parts are sprayed with several coats of a clear plastic lacquer. Before the final assembly, the setscrews 9 are prepared. Knurled discs of exactly the correct size in a handsome copper-nickel alloy are available from the U.S. Mint for the price of 10 cents each. To drill a hole through the center of the dime, however, and to solder the 2-56 screw in place, might be the most difficult task of the construction project.

Using a larger drill bit or a sharp knife, one removes a ring-shaped section of

the foil around holes "U" and "V" on both sides of part 6 and on parts 4a and 4b. This prevents the screws from shorting out the foil on the parts. These foil surfaces on part 6 will be connected to the dot and dash terminals of the keyer by lengths of wire which are soldered to the foil at the rear end of part 6. The negative supply voltage, -Vss, will be connected to the foil surfaces of parts 4a and 4b which face part 6. This arrangement has the effect that the foil surfaces of parts 4, which, for rf, shield the dot and dash contacts and, thus, reduce the effect of stray rf fields. The connection to the foil of parts 4 can be made by inserting a U-shaped strip of copper foil between parts 4 and 2, which connects both parts 4, and then soldering the -Vss connection to this foil.

All parts can now be stacked as shown in Fig. 2 and, after checking that the contacts line up properly, the compression nuts and screws can be tightened. The thumb-screw inserted through nut 15 should pass through

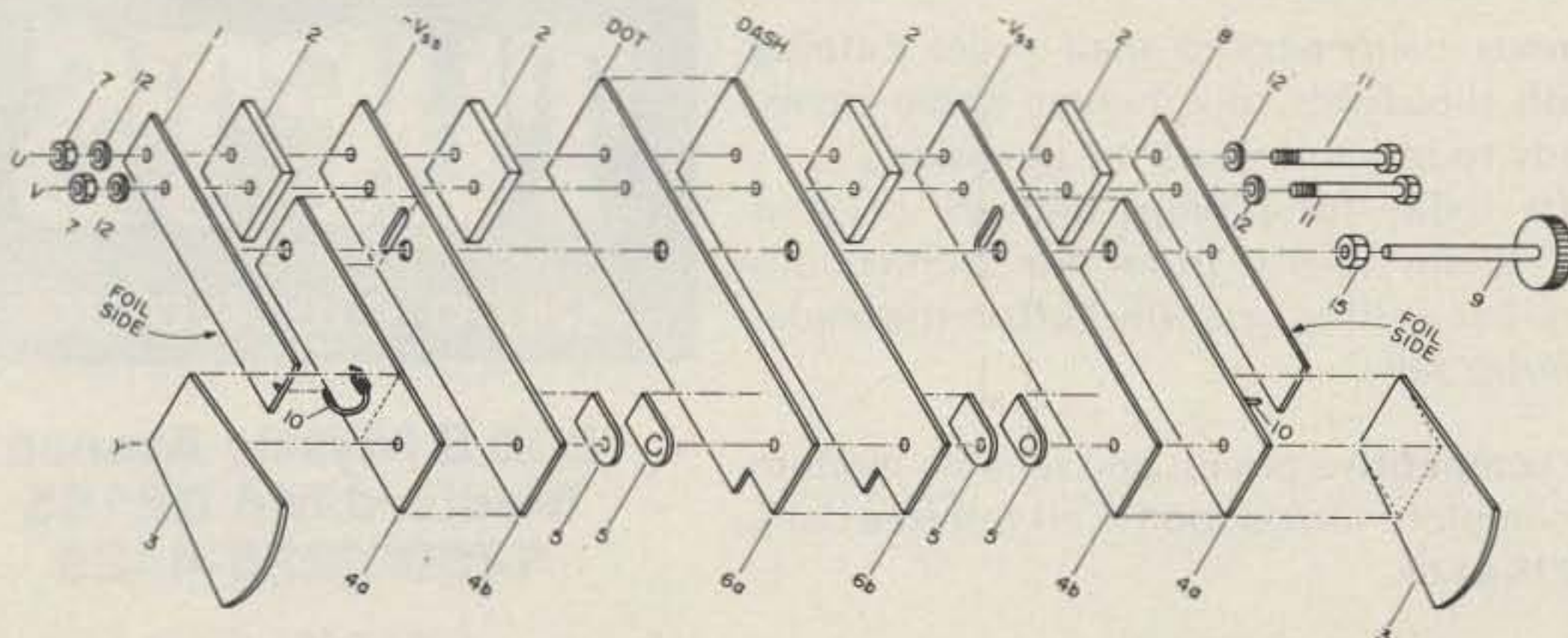

Fig. 2. This "explosion drawing" shows how the many parts fit together.

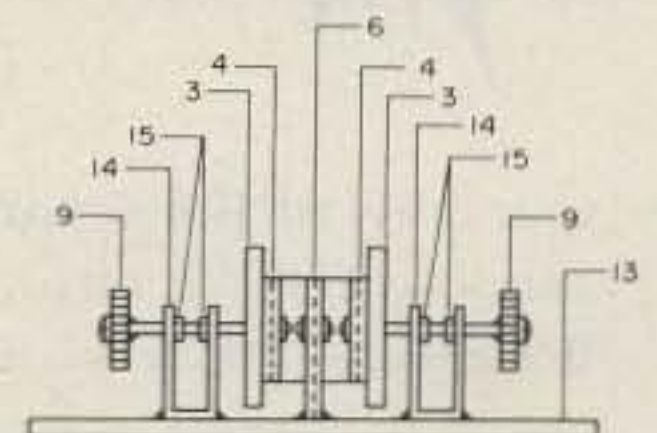

Fig. 3. Front view of the key.

Part Number	Parts List Description
1	Spring, PC board. See Fig. 1.
2	Spacers, 1/16" plastic. Four needed. See Fig. 1.
3	Paddle, 1/8" plastic or wood. Two needed. See Fig. 1.
4a, b	Lever parts, PC board. Two needed. See Fig. 1.
5	Pieces of contact springs with contact rivet, approximately 1/2" long, cut from surplus relay. Four needed.
6a, b	Center part, PC board. See Fig. 1 and assembly instructions.
7	Nuts, 4-40. Two needed.
8	Spring, PC board. See Fig. 1
9	Screw, 2-56 x 3/4" with thumbscrew head made from dime with hole drilled through center and soldered to screw. Three needed.
10	Stranded copper wire or fine braid. Two pieces about 3/4" long needed.
11	Screw 4-40 x 3/4". Two needed.
12	No. 4 washer. Four needed.
13	Base plate, PC board, 2" x 4".
14	Metal strip, brass or tinfoil cut from can. See Figs. 1 and 3. Two needed.
15	Nut, 2-56. Five needed.

part 6 and both parts 4 without touching, and should contact only part 1. This screw is tightened slightly until parts 1 and 8 begin to spread. Then the linkages 10 are cut to length and soldered to

parts 1 and 8.

Next, the brackets 14 (Fig. 3) for the stop-screws have to be prepared. They are bent according to the dotted lines in Fig. 1, and the locations for the holes are marked so that they

line up with the centerline of part 6 when the brackets are soldered to the ground plate. The holes are drilled, and two No. 2 nuts are soldered to the inside of the brackets. With the thumbscrew inserted, the brackets are then soldered to the ground plate in such a way that the setscrews can touch parts 4 without rubbing against parts 3 and 1, or 8, respectively.

Fig. 3 shows the key as viewed from the paddles. This completes the assembly of the key. The ground plate is mounted to some suitable base, either alone or together with the keyer as shown in the photo. The contact clearance can be adjusted separately by the thumbscrews in the U-shaped brackets. If these screws tend to turn on their own, unscrew them from one of the nuts, spread the bracket slightly, and turn the screws back in against the force of the bracket,

which acts as a brake. The stiffness of the paddles can be controlled with the screw that spreads parts 1 and 8.

One word of warning for operators who are used to Vibroplex-type semiautomatic keys: The MINI-MOUSE key works best with little contact clearance and minimal stiffness of the paddles, a characteristic it has in common with the FYO-key (now sold by HAL Communications Corporation). If the key is hit hard, as you would do with a Vibroplex key, you can get contact bounce and erroneous code elements. Once you are used to the different feel, however, you can operate the key with nothing more than a very slight finger movement, and you will find that the MINI-MOUSE key, together with the MINIMOS keyer, greatly reduces operator fatigue and keying errors. ■

WHEATON HAMFEST FEB 4

DUPAGE COUNTY FAIRGROUND

Sponsored by Wheaton Community Radio Amateurs, Inc. • Box QSL • Wheaton, IL 60187 • (312) 858-7388

8 AM - 6 PM 147.54 talk in **ADMISSION: \$3 at door — \$2 advance (include s.a.s.e.)**

Make checks payable to WCRA. Mail ticket order to:

1st prize
DRAKE TR-7

Free Parking On Grounds
No Smoking in Heated Buildings
Police Service
Quality Refreshments
Hourly Prize Drawing
Winners Need Not Be Present

JIM OSBORNE WB9YRO
1518 Larry Lane ✓ W23
Glendale Heights, IL 60137

free

Our famous value-packed mail order catalog filled with thousands of Amateur Radio items. Now ready to roll and yours for the asking... Call **Tufts** today for prompt delivery of your Amateur Radio needs from our tremendous inventory. Let us show you why **Tufts** is the leader in mail order sales.

Our crew of **100% hams**, very **competitive** prices, and reliable modern service facilities ensure your complete satisfaction. Call **toll free** daily 9-9 and Saturday 9-6. **1-(800) 225-4428**.

TUFTS

Radio Electronics

**209 S Mystic Avenue
Medford MA 02155
1-(800)225-4428**

1-(617)395-8280

Clegg is Amplifier Headquarters!

**IF YOU WANT A BIG BIG SIGNAL,
AT A LOW LOW PRICE ...**



DENTRON DTR-2000 L



DRAKE L-4B



MIRAGE B10B



ALPHA 76 SERIES



DENTRON CLIPPERTON L



DENTRON MLA-2500 B

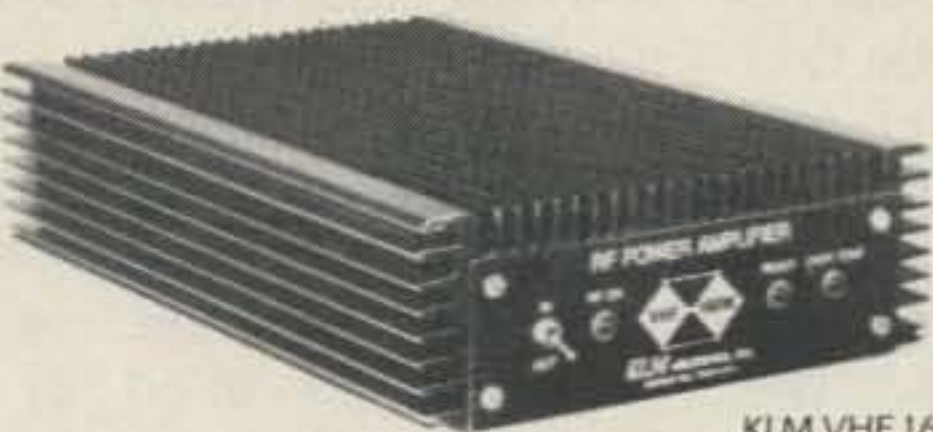

KLM VHF 160

**...CHOOSE FROM
ONE OF THE LARGE
SELECTION OF
AMPLIFIERS AT CLEGG.**

QUOTES • ORDERS
1 (800) 233-0250
SERVICE DEPT.
1 (800) 233-0337
MAIN OFFICE
1 (717) 299-7221

And—let us fill your antenna requirements:

- Towers, Masts & Hardware
- Rotators & Cables
- Coax & Connectors
- HF, VHF, UHF Beams & Mobile Antennas
- Multi-Band Dipoles
- Traps & Baluns

✓ C3

Clegg

Communications Corp.
1911 Olde Homestead Lane
Greenfield Industrial Park East
Lancaster, PA 17601

One Step Further

— PTTR instead of PTT

If you can push to talk, you can push to receive.

There are some amateurs who prefer a leisurely style of operating, even while mobile, instead of machine-gun-like exchanges. In such a case, the old push-to-talk button on a microphone can become a bit of a nuisance to hold down. VOX operation is, of course, a solution, but then, if one pauses to think a bit, the VOX relay will drop out. To hold relays in, one can produce a bunch of "aah"s, but it hardly makes for a pleasant sound.

A better solution was found years ago in the use of latching relays. These relays close (or open) when they are momentarily energized and then perform the opposite operation when they are again momentarily energized. So one achieves a push-to-talk and push-to-receive mode of operation where both

"pushes" are just momentary depressions of the microphone button.

All it takes is some simple IC circuitry which can be used with any transceiver to provide push-to-talk, push-to-receive operation. The circuits are made up of low-cost, readily available ICs which I had on hand. Undoubtedly, the circuitry can be made even more simple by those who like to optimize IC circuitry.

The basic solid-state replacement circuit for the old latching relay is shown in Fig. 1. In this case, it is one half of a dual J-K flip-flop IC. The circuit is wired so that each time pin 1 is momentarily grounded, the outputs of pins 14 and 15 change state. Once "set," they hold their state until pin 1 is momentarily grounded again. Pin 15 is

shown driving a transistor switch which, in turn, operates a relay. The transistor switch and relay are only necessary if one wants to build the unit so it is universally usable with any transceiver. In a great many cases, the transistor switch and relay may not be necessary. Depending on the voltage present on the PTT line in a given transceiver, it is often possible to tie pin 14 or 15 directly to the PTT line or to use just the transistor switch without the relay.

The 1k resistor and the switch are shown in dotted lines in Fig. 1 because, although theoretically the circuit should be complete as shown, it would prove to be erratic in actual operation. This is due to the fact that the PTT switch exhibits contact bounce. The effect of this bounce is shown in Fig. 2. Both on "make" and "break," the switch will actually cycle on and off for several milliseconds before it comes to rest in its final state. The J-K flip-flop

would try to follow these switch changes, and the final outcome would be a random switching action.

Two simple "debouncing" circuits are shown in Fig. 3. These circuits will present positive switching action to the J-K flip-flop, although the switches which activate them exhibit contact bounce.

The circuit of Fig. 3 is extremely simple, has a very positive response, and utilizes a simple 7400 IC. Its disadvantage is that it requires an SPDT-type PTT switch. The leaf-spring switches in many mobile-type microphones do have the necessary contacts and an extra conductor in the microphone cord. So, in this case, the circuit can be easily implemented.

If only a simple PTT switch is available, the circuit of Fig. 3 can be used. In this case, one section of the 7414 is used as a Schmitt trigger. The resistor and capacitor form a time constant that lasts slightly longer than the duration of the contact

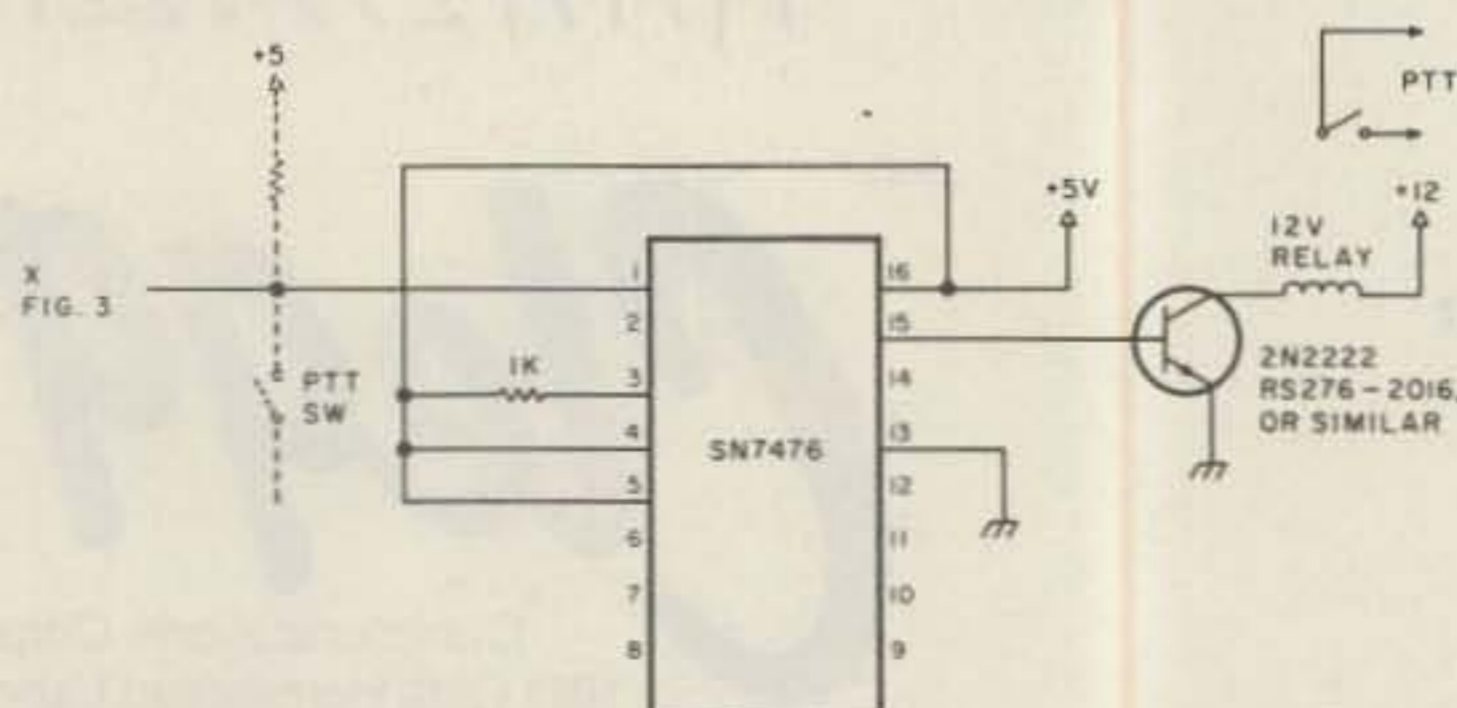

Fig. 1. One half of a 7476 dual J-K flip-flop is used as a latching circuit.

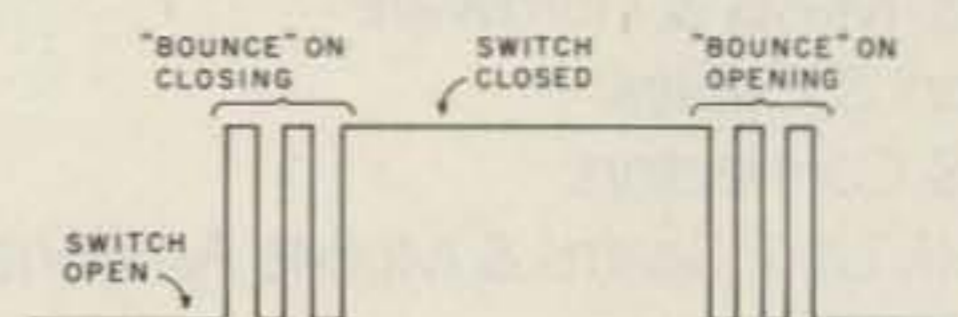

Fig. 2. An illustration of the contact bounce which occurs to some degree with any mechanical switch.

bounce from the switch. Although the values shown should suffice, if the action is not positive with any given PTT switch, one might try lowering the resistance value or using a larger size capacitor.

Depending on the number of conductors available in the microphone cord, it might be possible to place the necessary circuitry in the microphone case. If not, the circuit can be assembled on a piece of small perforated board stock. Simple point-to-point wiring can be used since there is nothing critical about the layout of the components. The voltages to the ICs need not be regulated. The required 5 volts can be obtained by using a series 200-Ohm trim-type potentiometer from a 12-volt source. Adjust the potentiometer from its maximum value

until 5 volts is measured at pin 16 on the 7476 IC.

There are two ancillary circuits that one might want to consider. Probably the most important is some positive indicator that the transceiver has been placed in the transmit mode, if this does not already exist on a given transceiver. If the receiver is squelched, there is the danger that one might not notice that the transceiver has been left in, or accidentally placed in, the transmit mode. Any sort of positive indicator will do, such as a lamp operated from some line or circuit that is active during transmit. A nice touch, if one has the necessary conductor available in the microphone cord, is an LED indicator in the microphone case itself.

One might wish to add a bypass switch to the circuit so one can go back to or-

dinary PTT operation. It is not really necessary, however, since the push-to-talk, push-to-receive circuitry can be activated just as fast as one can momentarily depress the PTT button. But, there might be some circumstances when one is making a particularly long series of very short communications exchanges where the push-to-talk, push-to-receive operation can become tiresome.

The current drawn by the circuitry will be that typical for TTL logic devices. For small hand-held transceivers, this current could be a good fraction of that drawn by the transceiver itself in a squelched receive condition. So, one would have to weigh the advantage of putting the circuitry in such a unit against the increased current drain. Of course, for mobile and home station transceivers,

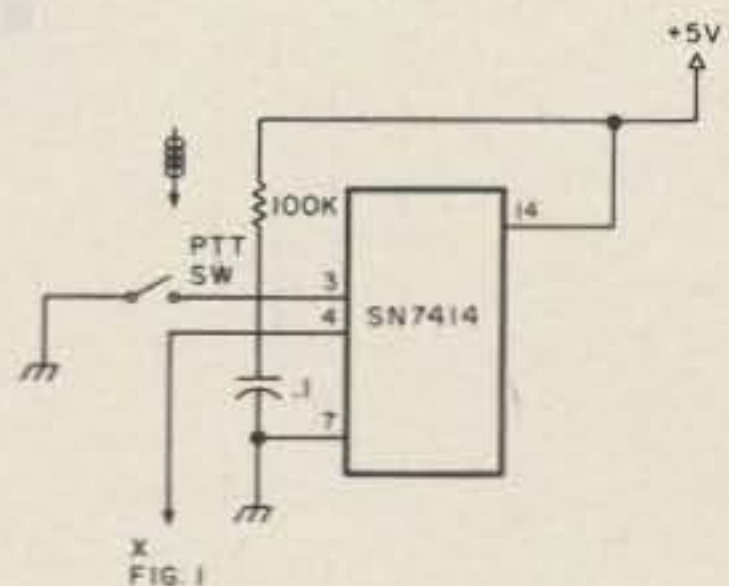
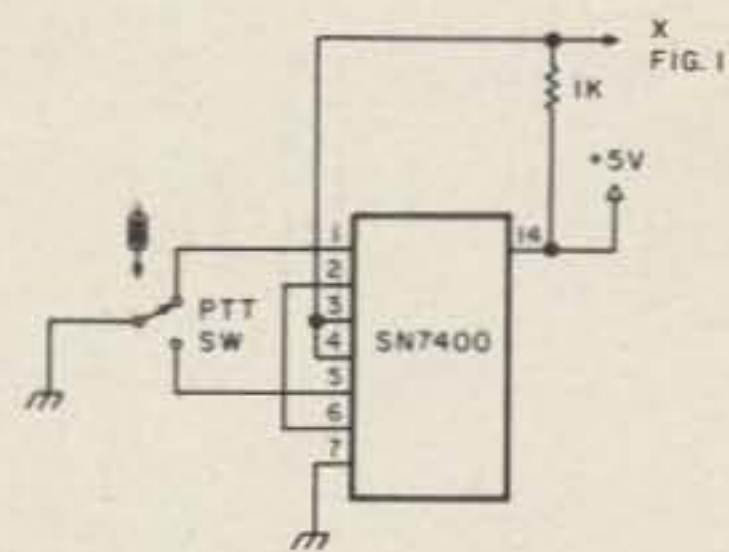

Fig. 3. Two circuits which can be used before the circuit of Fig. 1 to eliminate the effects of contact bounce.

the increased current drain should be insignificant as far as the operation of a transceiver is concerned. ■

SLEP SPECIALS

RADIO RECEIVERS, TRANSCEIVERS

- R-390/URR Receiver, tunes 500 kHz through 30.5 MHz, digital tuning, dual rf, audio filters, 19" rack mount, 115 V/60 Hz. \$495.00
- R-390A/URR Receiver, tunes 500 kHz thru 30.5 MHz digital tuning, mechanical filters, 19" rack mount, 115 V/60 Hz. 595.00
- R-389/URR VLF Receiver, tunes 15 kHz thru 1500 kHz, 19" rack mount, digital tuning, 115 V/60 Hz. 550.00
- HAMMARLUND SP-600JX Receiver, tunes 500 kHz thru 54 MHz, 19" rack mount, 115 V/60 Hz. 375.00
- R-388/URR Receiver, military version of the 51J-3, tunes 500 Hz to 30.5 MHz, 19" rack mount, 115 V/60 Hz. 375.00
- R-392/URR Receiver, tunes 500 kHz thru 32 MHz digital tuning, mechanical filters, in cabinet size 11-1/2" H x 14" D x 11" L, takes 28 volts dc - 5 Amps to operate . . . 275.00
- COLLINS RT-594/ARC-38A Aircraft Transceiver 2.0 thru 25 MHz, synthesized channels 35, 250 (20 preset), 100 Watts PEP SSB, FSK AM, CW, size 24" L x 15-1/2" W x 7-3/4" H, weight 65 lbs., requires 28 volt dc power supply 145.00
- MODEL VOX-2 technical material corp variable frequency oscillator tuneable 2 thru 64 MHz oven controlled, 115 V/60 Hz. 85.00

TEST EQUIPMENT

- COLLINS 479T-2 VOR/ILS Signal Generator 108-135.9 MHz and 329.3-335 MHz, output signals include VOR, LOC, glideslope & 1000 CPS operated 28 V dc portable or bench power source 225.00
- TS-510A Signal Generator, military version of HP608D, 10-420 MHz AM, CW, Pulse, built-in calibrator 425.00
- TS-497/URR Signal Generator, 2-400 MHz, 100,000 Microvolts, calibrated output, 400, 1000, Hz modulation 225.00
- AN/URM-25 Signal Generator, 10 kHz thru 50 MHz, AM/CW, MOD 400 & 1 kHz, rf output 0-2 V, or 0-.1 V precision 50 Ohm stop attenuator 285.00
- SG-12 FM Signal Generator, 20-100 MHz in 5 bands, rf output .5 uV to .5 V, deviation 0-100 kHz in 3 ranges, internal modulations 185.00
- SG-3 FM Signal Generator 50-400 MHz in 3 bands, rf output .1 to .1 V, variable 50 Ohm attenuator, deviation 0-150 kHz in 3 ranges, internal modulation, 385.00
- HP 302A Wave Analyzer, 125.00
- TS-1079/U SPECTRUM ANALYZER range 0-30 MHz in 6 bands, 5" crt display, 8 sweep widths from .15 to 30 kHz sweep rate 1 sec. to 10 sec. Has fast sweep mode for rapid tuning, dynamic range 60 dB, solid state 385.00
- ARM-5A military version of the ARC H-14 OMHI signal generator 285.00
- TS-1100/U Transistor Test Set, portable, perfect for testing transistors 65.00
- SG-24/TRM-3 Sweep Generator 265.00
- HP717A Klystron Power Supply 65.00
- HP-100D Frequency standard Generator 10 Hz, 100 kHz, 1 kHz, built-in scope. 85.00

All equipment shop tested, satisfaction guaranteed or money refunded. Send check, M.C. or VISA, FOB Otto, NC, phone (704) 524-7519.

SLEP ELECTRONICS COMPANY
P.O. Box 100, Hwy. 441, Dept. 73
OTTO, NORTH CAROLINA 28763

✓ S4

BRITT'S

2-Way Radio Service

✓ B29

2508 North Atlanta Road
Belmont Hills Center
Smyrna,
Georgia 30080
Phone (404) 432-8006

North Georgia's
only
Authorized
Yaesu Dealer

Yaesu	Kenwood
Mosley Antenna	Vibroplex keys
Cush-Craft	B & W
Rohn-Tower	Dentron
C.D.E. Rotors	Hustler
Shure	United Clocks and tuners
Call Books	ARRL Books
M F J	Saxton

TPL 2 Meter Amplifiers

Complete service facilities

Call toll free 1-800-241-9961

Hooray for LC Filters!

— simplest is sometimes best

Design a simple filter and a useful control circuit to go with it.

Howard L. Ogushwitz
19 Storrs Heights Road
Storrs CT 06268

With names like Chebyshev, Butterworth, M-Derived, Maximally Flat, or Minimum Ripple, it is sometimes difficult to decide just how to pick a filter, particularly one that will pass or reject a small band of low frequencies. Well, why not use an LC circuit, since it is quite stable and simple to make?

The difficulty with the tuned LC circuit, of course, is that it is usually too sharp to pass or stop a band of frequencies, and has to be loaded (resistively) to reduce the Q. Fig. 1 shows the series (a) and parallel (b) forms of this circuit, along with a generalized impedance curve (c),

which shows how the impedance of the circuit changes with frequency and Q.

Another problem with this network is that as the notch or center frequency of the band of frequencies we would like to pass or stop is lowered, the necessary values of L and C become very large. Just calculate, for a center frequency of 160 Hz, the values of L and C for a series-tuned LC circuit using the following formula: $f = \frac{1}{2\pi\sqrt{LC}}$, where f = frequency in Hz, L = inductance in Henrys, and C = capacitance in farads. You will see why the parts can't be nicely fitted on a printed circuit board. In this age of miniaturization, it is difficult to even see a resistor, capacitor, or amplifier!

Don't despair—a circuit known as the Twin-T Filter

will not only fit on the board, but is extremely simple to design. The circuit layout is shown in Fig. 2.

All you have to know in order to design this network to "stop" or at least attenuate a particular frequency is the following set of relations: $C1 = 2C2$, $R1 = 2R2$, and $f = \frac{1}{2\pi R1C2}$. For example, suppose we want to design the filter to have a center frequency of 160 Hz. By rewriting $f = \frac{1}{2\pi R1C2}$ as $R1C2 = \frac{1}{2\pi f}$, we find $R1C2 = 1/6.28(160) = 0.000995$. Since there are an infinite number of ways to multiply R1 and C2 in order to get the value 0.000995, we have to narrow things down a bit. A simple way to do this is to pick a large value for C that is available in a small physical size, such as a high K (dielectric constant) ceramic-type capacitor. Let's try .01 microfarads ($.01 \times 10^{-6}$ farads). Using this value, we find that $R1 = 9.95 \times 10^{-4}/.01 \times 10^{-6} = 9.95 \times 10^4 \approx 100k$ Ohms.

Therefore, with $C2 = .01$ uF, then $C1 = 2C2 = .02$ uF and $R2 = R1/2 = 50k$ Ohms. Using these values, with small ceramic capaci-

tors and 1/4-Watt resistors, we can produce a filter that will pass all frequencies except those directly around the center frequency of 160 Hz. This is a notch filter.

Let's assume that we want to stop all frequencies, but we would like to pass the frequency of 160 Hz. The op amp circuit outlined in Fig. 3 does this with good stability.

This is a negative feedback circuit, which means that the output of the amplifier is added to the input such that the input to the amplifier is reduced. The amount of feedback is controlled by the feedback network, which in our case is the Twin-T filter. Since this network passes all frequencies except a small band of frequencies around the design center (160 Hz), the feedback is large at all these frequencies, and the input to the amplifier will, therefore, be very small. This means that the output will be very low. In the region of 160 Hz the feedback is almost zero, so the output becomes large.

In other words, if we attach an audio oscillator to the input of this circuit, and slowly increase the frequency starting at about 10

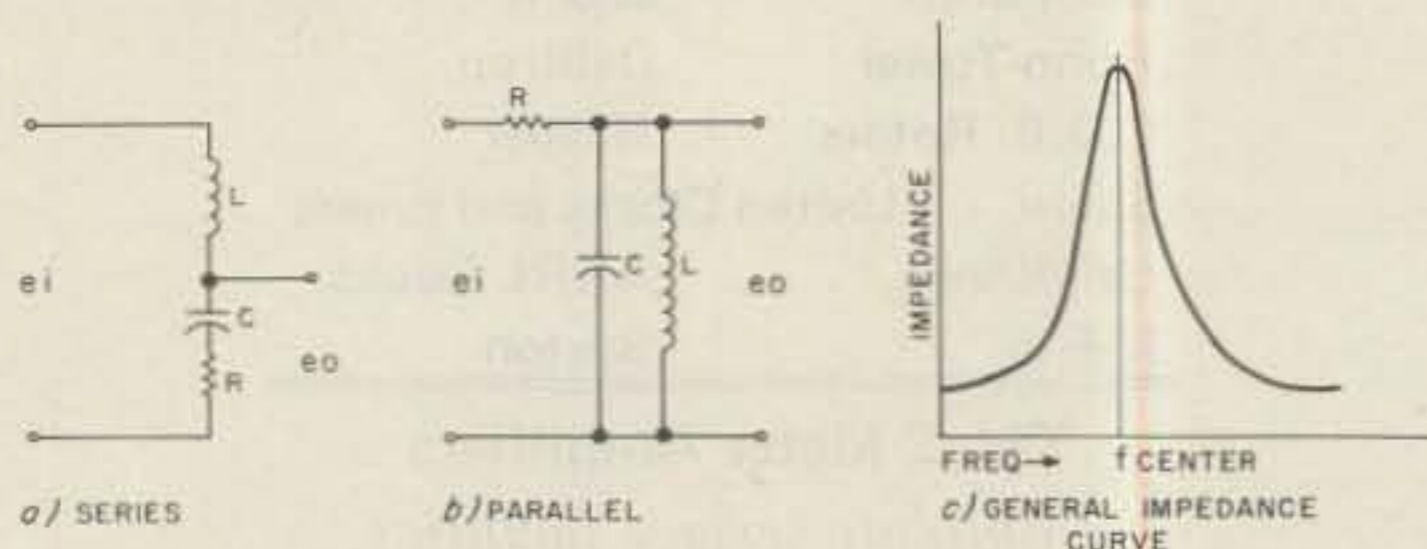
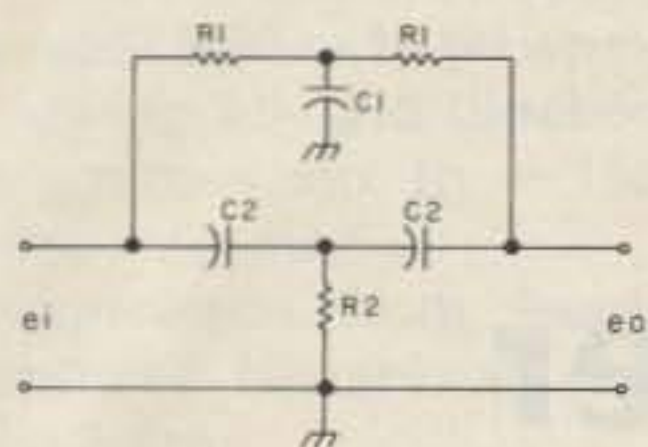

Fig. 1. Series (a) and parallel (b) tuned circuits with generalized impedance curve (c).

Hz, we will get no output until the dial reads from about 130 to about 190 Hz, with the signal peaking at 160 Hz. As the frequency is increased further, the output will again drop to zero.



2. Twin-T filter schematic diagram.

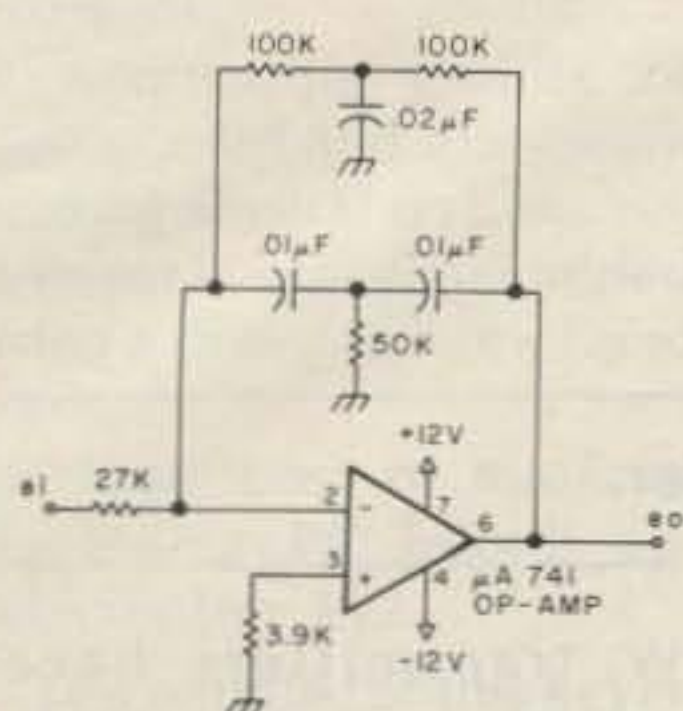

Fig. 3. 160-Hz bandpass filter schematic diagram.

This is similar to the general tuning curve of the LC circuit shown in Fig. 1(c).

This circuit was used in a tone-operated slide viewer that a friend asked me to build for him. The tape recorder that he used to

provide the narrative for each slide, as it was shown by the projector, contained a tone of 160 Hz which occurred at the end of each narration. A microphone near the speaker picked up the tone, which was then amplified, and this oper-

ated a relay which caused the slide mechanism to insert a new slide. This circuit is shown in Fig. 4, and it should be self-explanatory. With a little ingenuity, many uses can be devised for this simple filter. ■

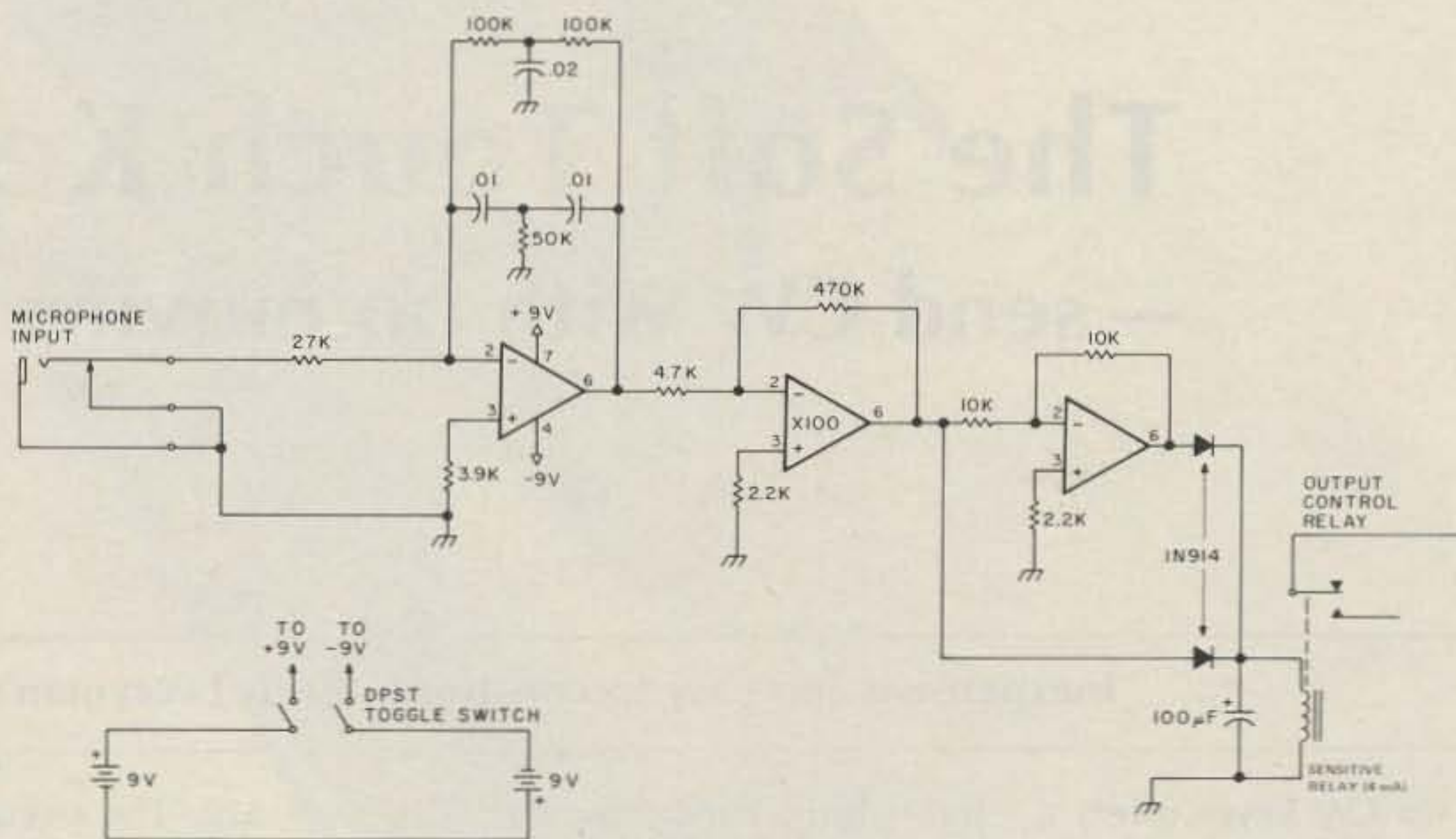

Fig. 4. Automatic slide-advance system using a 160-Hz Twin-T filter for cueing from a tape recorder speaker.

DX

from page 55

and unless some decision is made soon by the Iraqi officials, that may be the end result.

HB9MX reports that he hit bedrock in the mountain of Clipperton QSLs and is now answering QSLs as they come in. As of the end of September, he had answered 19,298 QSLs. 15,812 were returned direct by air mail, with the remainder going via the various bureaus. 852 cards were rejected because they were not in the log. If you still don't have your Clipperton QSL, you can now get an immediate response from Kurt Bindschedler, Strahleggweg 28, 8400 Winterthur, Switzerland.

Australian Novices, recognizable by the letter N immediately following their district number in their callsign, are allowed to run ten Watts on CW and thirty Watts on SSB. They operate in the following subbands: 28100-28550, 21125-21150, and 3525-3625 on CW, and 28100-28600, 21150-21200, and 3525-3625 on SSB.

9V1TT is apparently the only XYL active in Singapore. She is the XYL of 9V1TP.

Ownership of Abu Ail, once considered unclaimed, seems to be a bone of contention between France and Djibouti. If it is owned by Djibouti, then it is just another offshore island. But if Abu Ail belongs to France, then it would be a separate DXCC country.

FH8CY should become a bit more available now that the Northern California DX Foundation has donated an FT-101 and outboard vfo. This was the rig used by K5YY on his recent African swing.

The efforts of the Northern California DX Foundation have put many new ones in the pockets of the deserving DXers. Drop them a line at PO Box 717, Oakland CA 94604, to see how you can get in on the fun.

DJ9ZB is publishing a large, plastic-bound QSL book which lists a large number of QSL Managers. It contains some 50 pages of listings, and is a great aid for the serious DXer. Order from DJ9ZB, Carl-Kistner Str. 19, D-7800 Freiburg, West Germany.

If you still need cards from the SV0WZ stay on Rhodes, try WB3JRL.

Well, that about covers the DX front for this month. We want to again thank the *West Coast DX Bulletin*, the *LIDXA*

Bulletin, and *WorldRadio News* for much of the preceding information. We also want to thank all you readers who have sent reports and photos. Keep them coming, and we will see you again next month.

Ham Help

This letter is in regard to the article "Rejuvenate A Pawnee," in the October, 1978, issue. I liked the way K4GRT and W4IEV laid out the modifications and diagrams—even I could follow them. I would like to know if someone else will do the same sort of article on the Hallicrafters SR-42 2 meter AM

rig, as that is what I have and I would like to put it on 2 meter FM.

If an article is not possible, is it possible that someone would modify it for me at a reasonable price? Thanks.

Wilbert R. Farris N5ADL
Rt. 4, Box 169-B
Denham Springs LA 70726

Corrections

Please note the following corrections to my article "The Classic Kilowatt," which appeared in the November, 1978, issue: On page 226, column 2, line 9, should read: "3 dB weaker than a large." On page 228, column 2, line 17 should read: "output power is 700 Watts." (It is assumed that the reader realizes that the amplifier is loaded into a dum-

my load for these measurements.) On page 229, column 1, lines 12 through 14, should read: "are 1500 volts at 700 mA on 20 meters, producing 700 Watts output." (This power was measured using a Drake W4 wattmeter while feeding a nonradiating dummy load.)

Dave Ingram K4TWJ
Birmingham AL

turned off. C2 charges positive through D1 until U1A switches negative once again. The period that C2 is charging positive is the space, and, at the end of the space, the circuit stabilizes unless another dot or dash is triggered.

The speed control provides biasing for U1A (note that this bias is different during a character than during a space because R9 is tied to the output of U1A). R4 determines how fast C2 charges positive during the production of a space following a character. If R17 and R20 are adjusted to make dashes equal to 3 spaces and dots equal to 1 space, then this weight will be true at any speed.

Capacitors are used liberally to bypass rf energy so that there is no interference from the transmitter. Care must be taken to ground the keyer, or problems might still

arise with rf feedback, especially at high power levels.

I have been using this keyer for several years and find it very enjoyable. Keying is effortless and is ideal for extended operation such as during contests. This mechanism should also be useful to persons

with certain types of handi-caps that restrict motion. A 9-volt transistor battery will power the keyer for a long time and makes portable operation practical. With mechanical paddles as expensive as they are, this keyer provides an excellent alternative because it can be built complete

with keying mechanism for less than most paddles on the market. Information and PC boards are available from the author. I would like to express my appreciation to Bruce Robinson and John Coken, fellow students at Temple University, for help in preparing this article. ■

Parts List

U1	LM339 quad voltage comparator
Q1	2N4888 PNP
D1-D9	silicon small signal diodes (50 piv, 50 mA)
C1, C5, C6, C7	100 pF
C2	0.1 or 0.047 uF
C3, C8, C9	0.001 uF
C4	10 uF
R12, R24	10k
R9	39k
R25	47k
R3, R6, R7, R8, R11, R21, R22, R23	100k
R19	220k
R4	470k
R20	500k
R5, R10, R14, R15, R17, R18	1 megohm
R1, R13	1.8 megohm
R2, R16	5.6 megohm
S1	2-pole, 3-position rotary switch

QSO Tape and QXX Tape for the new exams.



only \$4.95

Kantronics QSO Tape and QXX Tape

Get prepared!

To pass the new FCC code exams, you'll need to identify unusual names, places, antenna heights, rig types and a variety of other items garnered from simulated QSOs.

Now you can really study for the new exams with the Kantronics QSO Tape and QXX Tape! Our C-60 QSO Tape cassette sends simulated "on-the-air" transmissions at 7½, 10, 13 and 15 WPM. (Also available in a "13 WPM only" version.) The QXX Tape speeds you on to 20, 23 and even 26 WPM!

Both cassettes generate sharp, crisp code to exact Morse specifications, just as the FCC does. There's no better way to study for the new FCC exams!

KANTRONICS

The Lightweight Champs.

1202 East 23rd Street
Lawrence, Kansas 66044
We accept Visa, Master Charge, check, and money orders. Phone: 913-842-7745

COMPLETELY FREE-STANDING, TELESCOPING TOWERS.



PUT IT RIGHT WHERE YOU WANT IT. With one hand, raise the tower from 21' to as high as 55'. Find exactly the right receiving level from CB, Ham or TV. When you want to adjust your antenna, install a new one, or pull maintenance, crank it down again. No more climbing up in the sky to repair or replace antennas. With the exception of our breakover models, this is the most convenient tower you can buy.

BREAKOVERS—THE ULTIMATE IN CONVENIENCE—Our breakovers not only telescope, they lie down for you. One man can crank it down, then lay it down, so your feet never have to leave the ground, even on our tallest towers.

TOTALLY FREE-STANDING. No guy wires, no brackets, our towers are designed to withstand 60 mile winds, with 50 pounds rotor and antenna with a vertical area of 6 square feet.

TOWER CONSTRUCTION. We make it out of the finest materials available. Our steel is thicker and heavier—our towers themselves are two or three times heavier than comparable towers on the market. Weight runs about 165 pounds for our 40' towers, 350 pounds for 55'. Several design innovations are used to make Tele Tow'r the strongest, most reliable tower.

ONE-PIECE PRICE. When you buy one of these towers, you get the whole tower ready to install. No accessory charges, no extra costs for guy wire, base plates, etc. And even our complete one-piece price is considerably lower than any comparable tower on the market.

Concrete sleeves available for Model 40s and Model 55s. By using sleeves you can move tower to another location and all you leave is the sleeve in concrete.

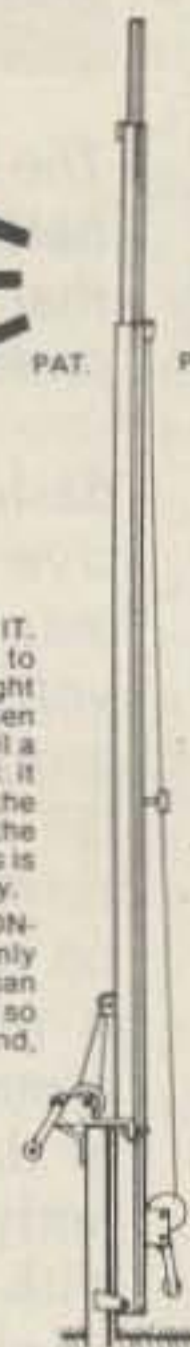

40' MODELS
Model 40 (extends from 21' to 40')
Breakover Model 40

(extends from 23' to 40' with breakover at ground level)

55' MODELS
Model 55 (extends from 21' to 55')
Breakover Model 55

(Extends from 23' to 55' with breakover at ground level)

TELE-TOW'R MFG. CO., INC.

P.O. Box 3412 • Enid, Oklahoma 73701
405-233-4412

IF YOU'VE READ ONE, YOU HAVEN'T READ

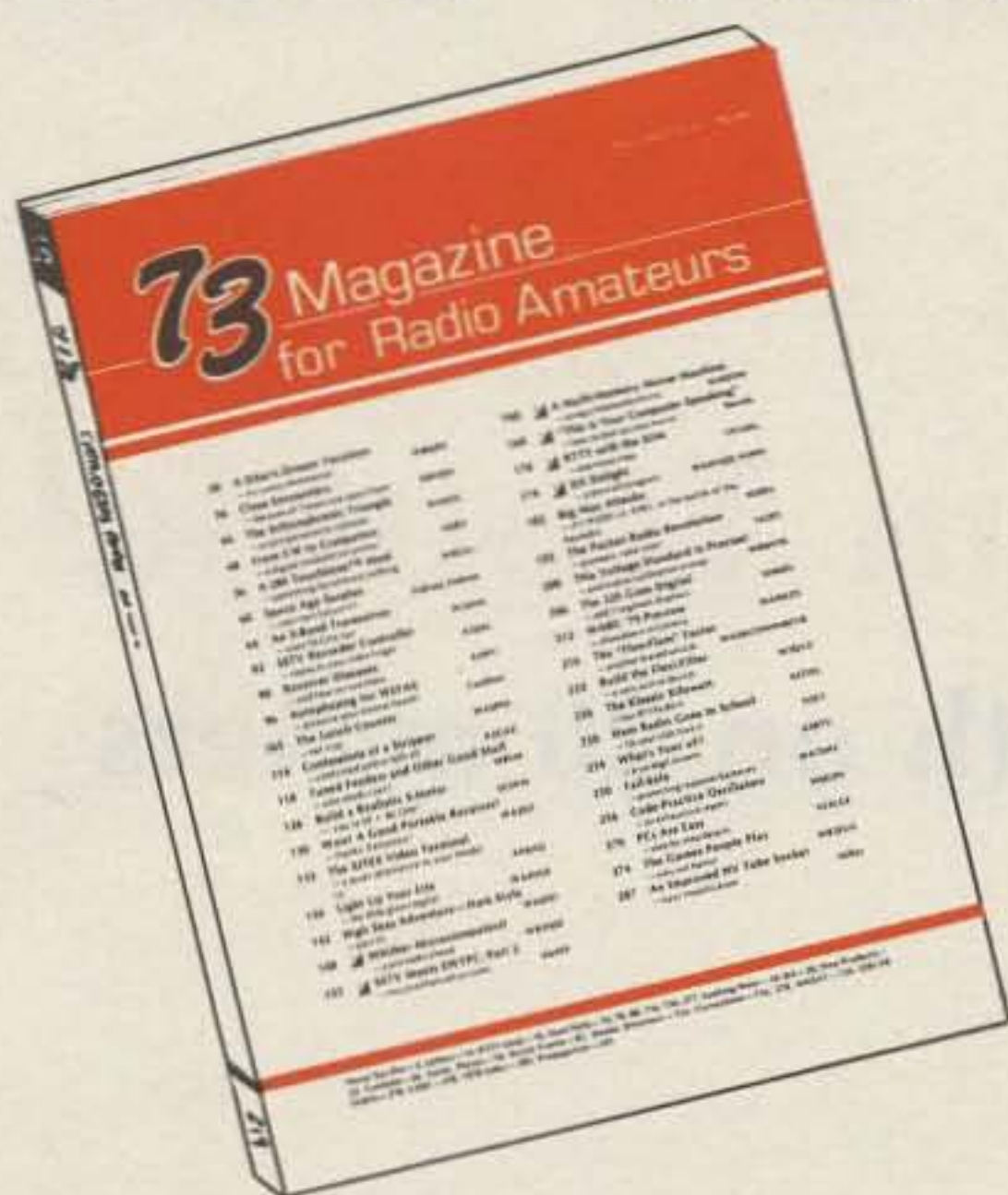

THEM ALL . . .

Ever notice how other magazines published in the field of radio electronics are just like the ones before them—same old subjects, same predictable views, same old editorials?

Each issue of **73** is an entirely new book: over 225 pages including over 40 articles of new material each month, separate and special, unlike all that have come before it. **73** led the way in developing the use of solid-state circuitry and was the first to promote SSTV, radioteletype, computer applications for radio communications, and single sideband, to name a few. In addition, the staff of **73** is working on another scoop that you won't want to miss.

In one issue you might find building projects and information on antennas, moonbouncing, and mountaintopping. In the next issue you might read about computers, radioteletype, traffic handling, and satellites.

More Quantity—More Quality

This is a hefty magazine, with more articles each month than any two of the other ham magazines combined, and we pay more for an article than any other ham magazine.

You get what we pay for!

The only thing that every issue of **73** has in common is quality, and we take pride in delivering them to you, pride in providing the latest developments in the field, pride in helping you enjoy your hobby, and pride in covering subjects the rest of the ham media ignore.

So try a year with us at **73**; you'll be surprised at the amazing variety. You've got nothing to lose, but plenty to gain. If, after you've read your first copy, or even your 11th, you're not completely satisfied with **73**, if you don't feel that **73** is as good a magazine as you can buy anywhere, we'll refund your money on all remaining issues. So start your subscription by dropping the attached postage-paid card in the mail today. You pay only \$18—40% off the current newsstand price for 12 issues, or save 50% on a three-year subscription for \$45. Please allow 60 days for shipment of first copy.

No need to send money now; we'll bill you later.

SOS! Ship in Trouble!

— life and death on 20 meters

When a ship sinks in the Caribbean, it's the U.S. Coast Guard and Air Force to the rescue.

John M. Murray WIBNN
4 Kenwood Circle
Bloomfield CT 06002

Imagine listening in on a real SOS situation involving a ship sinking at sea! Purely by chance, I tuned in on just such an urgent drama in August, 1977, on 20 meters.

With no fanfare, suddenly there was a loud voice at about 14.252 kHz. "This is the U.S. Coast Guard at Portsmouth, Virginia. Emergency... Emergency! A clear frequency is requested. A ship has been reported by an amateur operator as sinking in the Caribbean. HP3422—do you read me?"

Of all times for it to happen, my tape recorder was out of order. I could only listen and try to remember, jotting down a few notes.

"HP3422—this is the U.S. Coast Guard. Do you read me?"

Smack on frequency but weakly came the reply,

"Yes, here's HP3422. We're sinking. Eleven feet of water in the hold. Thirteen persons aboard. This is a ham operator on the bridge with battery power. Ship's transmitter and electrical power gone. We have 11 life preservers. Again, 13 of us aboard..."

"What is your position? Give us your coordinates so we can notify Homestead Air Force Base in Florida. A rescue plane can be sent out, if it's within their range."

"Thank you. It will have to be fast. The captain says we have maybe an hour and a half before going down."

"Roger. This is Portsmouth Coast Guard. Stand by!"

"Hello, HP3422," came another loud voice, "this is Potomac Coast Guard at Washington, D.C. We have notified Homestead Air Force Base in Florida to ready a rescue plane to proceed to your position when we know it. What is

your position?"

"The Captain says we're about 17-15 north, 78-58 west, but there may be a discrepancy because the last time we plotted our position was the day before yesterday, and we believe our compass is faulty." He repeated the position coordinates several times at CG request.

HP3422's signal had dropped way down at this point, probably due to atmospheric conditions. The time was approximately 10:50 am, DST. As could be expected about that moment, with things getting more urgent, a bland voice cut in, "CQ twenty... calling twenty for Hoboken, New Jersey. This is WA5 Bing-Bang-Boom (or something like that). Is anyone around there?"

Fortunately, the directional CQ went on for only a few moments, and was quickly followed by the Portsmouth Coast Guard again: "Please QSY off this frequency immediately.

This is the U.S. Coast Guard in emergency contact. A clear frequency is requested!"

Again the WA5: "What is the emergency? This is an amateur band."

The CG operator was in no mood to argue. "Please do as I say." He then continued, "HP3422, please give me your vessel's name and type. What other life-saving gear have you aboard?" The CG signal was enormously strong and would probably override any ham competition. As he stood by, HP3422's very weak signal, fading in and out, was again audible. "Name is *Hippopotamus*, registered in Panama. Cargo vessel, about 200 feet. We're in ballast now. Grey, with much rust." The signal then stopped abruptly.

As close as I could figure it with the National Geographic Mercator Chart and an 18-inch globe, Homestead to the disaster area would be a flight of

MADISON ELECTRONICS SUPPLY, INC.

1508-B McKINNEY • HOUSTON, TEXAS 77002

713/658-0268

KENWOOD — TR7600A

Beat the high cost of Deluxe 2 meter operation



Remote Controller (option)

- Stores • Scans
- Reads Out Frequency

(CALL FOR QUOTE)



MICROWAVE MODULES LTD



MML 144/100, 100 WATT 144 MHz LINEAR POWER AMPLIFIER

- 80 Watts Minimum Output
- Fully Protected Against Poor Load VSWR, Overheating and Excessive or Reverse Supply Rails
- Equipped with RF VOX and Manual Override
- Supplied with Power Lead and All Connectors

**CALL FOR FAST QUOTES
SPECIAL ORDERS WELCOME**

TERMS: All prices FOB Houston. Prices subject to change without notice. All items Guaranteed. Some items subject to prior sale. Send letterhead for Amateur dealers price list. Texas residents add 6% tax. Please add postage estimate.

W5GJ, W5MBB, K5AAD, N5JJ, W5IMJ, AG5K, WD5EDE, K5ZD, WD5ABR, WA5TGU, WD5BDX, WB5AYF, K5RC, K5BGB.

Have A Nice Day!
DLA.

WINTER WONDERS

OMNI-J & heavy duty magnet mount complete	\$49.95
TRIEX W-51 FT Self Support Tower (Reg. \$825.00)	
Your Cost (F.O.B. California)	\$725.00
Tonna F9FT Antennas 144/16el	\$79.95
RIW 432/19el	\$59.95
KLITZING VHF-UHF Amplifiers	
2M 10W In — 100W OUT	\$198.00
432 10W In — 50 W Out	\$198.00
BIRD 43 & Slugs, UPS Paid	Stock
Microwave Modules 432-28S, UPS Paid	\$329.00
Telrex TB5EM, In Stock	\$415.00
NEW Palomar Engr. Transceiver Preamp	\$89.50
Bencher Paddles ... \$39.95; Chrome	\$49.95
ETO 76 Amplifiers	Stock
Lunar 6M-2M-220 In Line Preamps	\$49.95
Lunar 2M Amp 10-80 with Preamp, UPS Paid	\$189.95
Janel QSA-5	\$41.95
CDE HAM-3 ... \$129.00; HAM-X	\$249.00
VHF Engrs. blue line amps	Stock
Cetron 572B	\$27.95
Raytheon 572B	\$24.95
Motorola HEP 170	\$0.29 ea.
Mallory 2.5A/1000 PIV Epoxy Diode	\$0.19 ea.
Aerovox 1000PF/500V Feed thru	\$1.95
GE 6146B or 8950	\$7.95
Technical books: AMECO, ARRL, Sams, TAB, Rider, Radio Pub., Callbook, Cowan, many others	Call
NEW BELDEN 9405 (2#16) (6#18) 8 wire Rotor Cable, heavy duty for long runs	\$0.26/ft.
8448, Std. 8-wire Rotor	\$0.16/ft.
9888, double shield RG8 Foam	\$0.39/ft.
8214, RG8 Foam	\$0.25/ft.
8237, RG-8	\$0.21/ft.
8267, RG-213	\$0.25/ft.
Amphonol Silver Plate PL259	\$0.59
TIMES 1/2" Foam Hardline \$0.60/ft.	Connectors \$15.00 ea.
7/8" Hardline \$1.50/ft.	Connectors \$25.00 ea.
BERKTEK RG-8X, 52 ohm, KW	\$0.16/ft.
Consolidated HD-18 Ga. Galv. Tower, 10 Sec.	\$29.95
Robot "Slow Scan" Now In Stock	Call
Alliance HD73 Rotor	\$109.95
Teletower - self support - 55 ft/w breakover	\$499.00

LATE SPECIAL: All FINCO Amateur Antennas — 10% off list in stock

THIS MONTH'S SPECIAL ICOM IC280 — \$395.00 DENTRON GLA1000 Amplifier — \$319.00

16 ELEMENTS — F9FT — 144 MHz

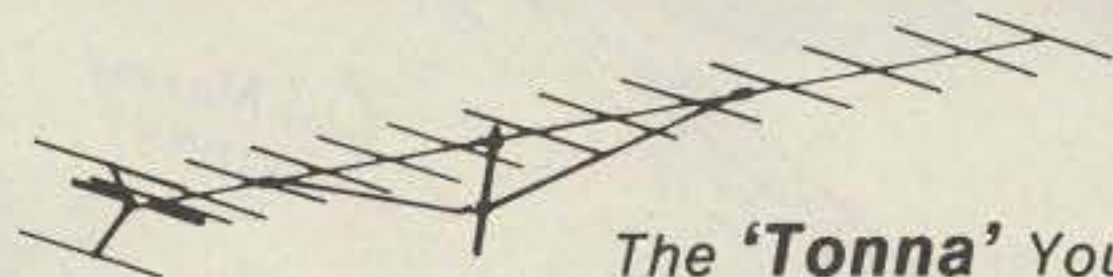

The 'Tonna' You've been hearing about

144/146 MHz SWR 1.2:1
50 ohms Wt. 4.4 kg.
length 6.4 m. Horiz./Vert.
Side lobe attenuation 60 dB
Horizontal aperture 2 x 16° (-3 dB)
Vertical aperture 2 x 17° (-3 dB)

\$79.95

9 Element 144-146	\$39.95
4 Element 144-146	\$32.95

MADISON ELECTRONICS SUPPLY, INC.

1508-B McKINNEY • HOUSTON, TEXAS 77002

713/658-0268

✓ M35



some 775 miles, allowing a deviation eastward through the Windward Passage between the eastern end of Cuba and the tip of Haiti. Otherwise, to take the direct Great Circle route would churn up quite a bit of air space over Cuba, possibly blowing sparks from an angry cigar and setting a beard on fire. The ship was foundering in 3,000 feet of shark-infested ocean about 75 miles due south of Cap Carcasse, Haiti.

"This is Air Force rescue plane. I repeat—what life-saving gear do you have aboard? What color are your life preservers?"

"Hello, Air Force rescue plane. This is HP3422. Thank you for calling." I could hear some other voices in the background of HP3422's signal, one yelling, "This is the captain speaking. All we have is a life raft of planks lashed to four oil drums."

At times there were considerable time lags be-

tween transmissions. Well over an hour sped by. Presumably, military direction finders and radar were being used, but so far no mention of them had been made over the air. Also, there was no explanation of how the ship got in such dire straits. No storm reports were given, nor word about why they didn't have at least one lifeboat.

Another voice cut in: "This is Homestead to HP3422. Please give us a

long count so we can get a better DF bearing on you. Repeat it several times. OK?"

HP3422 proceeded to give several long counts, then stood by with, "Is that enough? Did you get a reading? Our bow is dropping deeper!"

Before the plane could answer, a new signal appeared on frequency. "This is experimental research ship *Aquarius*. We're some 300 miles from HP3422's approximate position. Can we be of help?"

"Air Force Rescue here. Negative. You're too far away. Thank you. Stand by. HP3422, I say again, what color are your life preservers and oil drums? Over."

"This is HP3422. Preservers, planks, and drums are grey."

"That'll be hard to see. Visibility is very poor, less than a mile at my altitude. I hope I can find you. This is going to be a tough one."

Homestead then gave the rescue plane a DF bearing which altered his course only slightly. Apparently, the sinking ship's position report was not as faulty as had been implied.

Suddenly, HP3422 was on the air again weakly. "The Captain's given the order to abandon ship. Water in hold now at 14 feet. When I go over the side, I'll have to cut loose from my antenna. Visibility here not too bad, maybe three miles. Almost a cloudless sky. Hazy. Oh, yes, there's a single big thunderhead about a mile due west of us. A huge one, only one in sight. Over."

The Air Force plane's signal snapped back on. "Great! I see it . . . about five miles from me. Correcting my course immediately."

"Good! This will be my last transmission. We see your plane. Over and out."

That was the last I heard

**If you ever worked a repeater...
Chances are, it was one of these!**

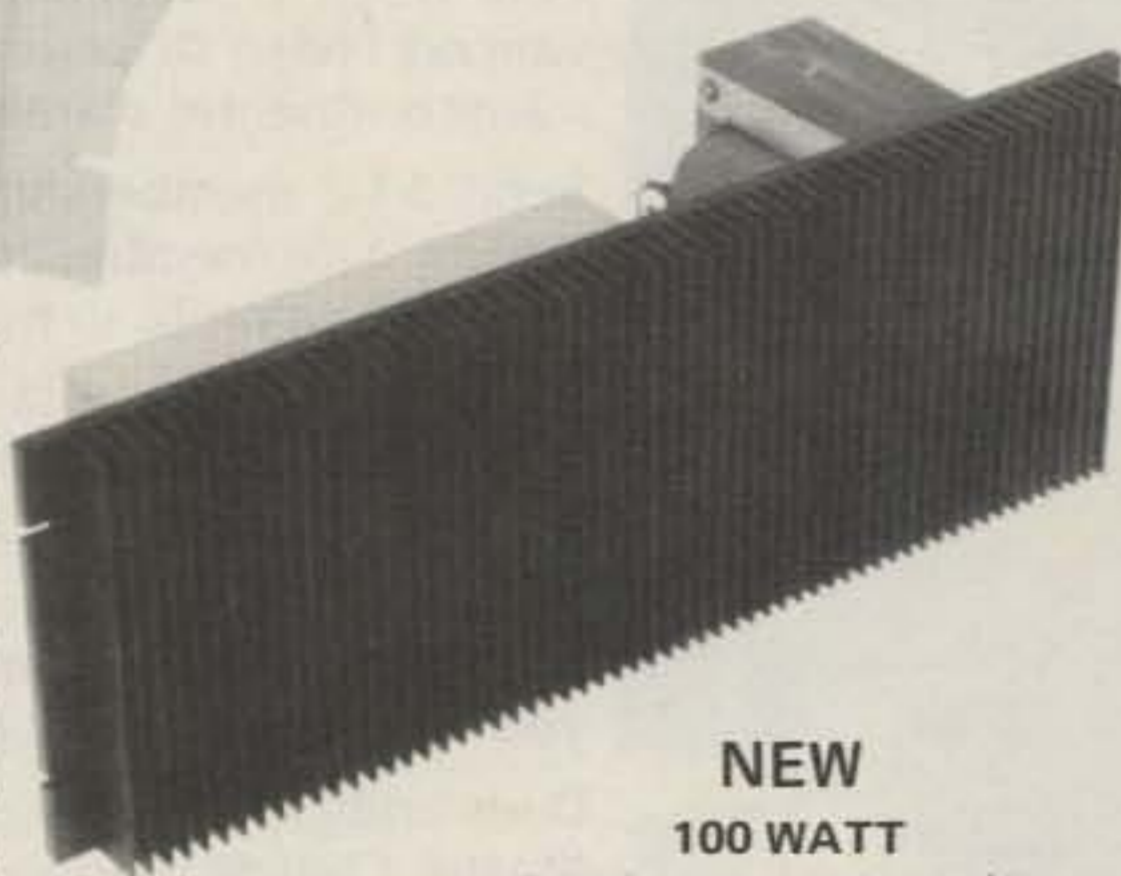

Self contained, all solid state repeaters. Conservatively rated, high quality components, assure excellent reliability. Careful consideration has been given to both interfacing and control flexibility.

- RPT 50B, RPT 144B or RPT 220B Kit \$499.95
- RPT 432B Kit 579.95
- RPT 50B, RPT 144B or RPT 220B factory wired and tested 799.95
- RPT 432B factory wired and tested 849.95

**NEW
100 WATT
REPEATER AMPLIFIER**

AVAILABLE AT THESE DEALERS:

CALIFORNIA

C & A Electronic Enterprises, Carson, CA 90745, Ph. 213-834-5868
Tele-Com Electronics, San Jose, CA 95121, Ph. 408-274-4479
Zackit Corporation, Vallejo, CA 94590, 707-644-6676

COLORADO

A.E.S. Communications, Wes-Com, Colorado Springs, CO 80909,
Ph. 303-475-7050

FLORIDA

Amateur Electronic Supply, Orlando, FL 32803, Ph. 305-894-3238
N & G Distributing, Miami, FL 33126, Ph. 305-592-9685
VHF/JAX, Orange Park, FL 32073, Ph. 904-264-7176

GEORGIA

Creative Electronics, Marietta, GA 30065, Ph. 800-241-4574

ILLINOIS

Klaus Radio, Peoria, IL 61614, Ph. 309-691-4840
Spectronics, Oak Park, IL 60304, Ph. 312-848-6777

IOWA

Bob Smith Electronics, Fort Dodge, IA 50501, Ph. 515-576-3886

MASSACHUSETTS

Tufts Radio Electronics, Medford, MA 02155, Ph. 617-395-8280

MICHIGAN

Adams Distributing, Detroit, MI 48228, Ph. 313-584-4640
The Ham Shack, Kentwood, MI 49508, Ph. 616-531-1976

MINNESOTA

PAL Electronics, Minneapolis, MN 55412, Ph. 612-521-4662

MISSOURI

Alpha Electronic Labs, Columbia, MO 65201, Ph. 314-449-1362

NEBRASKA

Communications Center, Lincoln, NE 68504, Ph. 402-466-3733

NEVADA

Communications Center West, Las Vegas, NV 89106, Ph. 702-647-3114

NEW YORK

Barry Electronics, New York, NY 10012, Ph. 212-925-7000
Delmar Electronics, W. Babylon, LI, NY 11704, Ph. 516-420-1234
VHF Communications, Jamestown, NY 14701, Ph. 716-664-6345

OHIO

Universal Amateur Radio, Reynoldsburg, OH 43068, Ph. 614-866-4267

OKLAHOMA

Derrick Electronics, Broken Arrow, OK 74012, Ph. 918-251-9923

PENNSYLVANIA

LaRue Electronics, Scranton, PA 18509, Ph. 717-343-2124

SOUTH DAKOTA

Burghardt Amateur Center, Watertown, SD 57201, Ph. 605-886-7314

TEXAS

AGL Electronics, Dallas, TX 75234, Ph. 214-241-6414
Madison Electronics Supply, Houston, TX 77002, Ph. 713-658-0268

VIRGINIA

Radio Communications, Roanoke, VA 24016, Ph. 703-342-8513

WASHINGTON

A-B-C Communications, Seattle, WA 98155, Ph. 206-364-8300

WISCONSIN

Amateur Electronic Supply, Milwaukee, WI 53216, Ph. 414-442-4200

CANADA

Bytown Marine Ltd., Ottawa, Ontario, Can. K2H 7V1, Ph. 613-820-6910
Traeger Distributors, Richmond, BC, Can. V6X 2A7, Ph. 604-278-1541

Vhf engineering ✓V5

DIVISION OF BROWNIAN ELECTRONICS CORP.

320 WATER STREET / BINGHAMTON, NEW YORK 13901 / PHONE 607-723-9574

Prices and specifications subject to change without notice. | Export prices slightly higher.

of HP3422. But the Air Force plane resumed transmission. "Hello, Homestead. Hard to believe! I've just passed over the spot where the ship went down. Great swirl of water and quite a bit of deck debris. Much bubbling—but have spotted the raft. Will make another pass directly and drop them our rescue craft. Over to you."

That was it. A few minutes later, the plane came on again briefly, re-

ported that his rescue raft, with first aid, food, clothing, radio, etc., had landed with a hell of a splash very close to the shipwrecked mariners. Then, to my utter frustration, the pilot made one final transmission. "OK Homestead, am switching to the military frequency for follow up instructions. Thank you, hams!" And he was gone. I had no way of knowing what that military frequency was. My trans-

ceiver was limited in that setting to the 20 meter ham band. Obviously, the rescue craft's radio would be on the new frequency.

It was not clear whether the rescue plane was sent out from Florida, or whether Homestead had notified Guantanamo or one of the NASA activities in the area. Either of the latter might have meant a much shorter flight, and may well have been what happened.

In any event, it will be of

much interest to me to learn any further details which some listener, or even the military operators involved, might have on this near-disaster.

The fact that there was a happy ending seems almost certain. However, I failed to hear a single word about it on the radio or on the tube, or even see a tiny item on the subject in newspapers or magazines, let alone in our ham radio publications. ■



There's a new, eighth OSCAR satellite in orbit, and the AMSAT team helped put it there! Your help is needed for future satellites. Join AMSAT and support the new, advanced Phase III series of OSCARs, engineered to provide communications over transcontinental distances for hours at a time.

Send \$10 membership dues to AMSAT, P.O. Box 27, Washington, D.C. 20044. Life membership is available for a tax-deductible donation of \$100 or more, payable in quarterly installments if you wish.

Phase III satellite solar cells may be sponsored for \$10 each, and we'll send you a certificate specifying the cells you are sponsoring.

For a tax-deductible contribution of \$1,000 or more, we'll even inscribe your name on a plaque to be placed in orbit aboard the Phase III spacecraft for posterity, and we'll send you a replica honoring your contribution.

Dues and contributions may be charged to VISA or Master Charge. Phone us at (202) 488-8649.

Radio Amateur Satellite Corporation
P.O. Box 27, WASHINGTON, D.C. 20044
AMSAT
AMSAT MEMBER

Code Made Easy.

If you want to master code, get the Pickering Codemaster.

Pickering Codemaster is the proven set of instruction tapes. In fact, we've sold tens of thousands over the last 12 years. And the reasons are simple. Our tapes are easy to learn. Easy to use. Complete. And reliable.

But don't take our word for it. Ask any ham. Or better yet, order a set and see for yourself.

CM-1 Beginner (Novice Class)

A complete course in code is on the tape. Practice at 5, 7 and 9 WPM. The tape includes code groups and punctuation.

CM-1½ Intermediate (General)

No instruction, just practice. ½ hour at 11 WPM, 1 hour at 14 WPM, and ½ hour at 17 WPM. It includes both coded groups and straight text.

CM-2 Advanced (Extra-Class)

Mostly straight text, some coded groups. 1 hr. at 20 WPM, ½ hr. each at 25 and 30 WPM. For real QRQ, play this tape at twice speed!



EACH SET IS TWO HOURS LONG

	SPECIFY	7" REEL (3¼ IPS)	CASSETTE (C-120)
Single tape price	\$ 7.95		
Any two; save \$1.90	\$14.00	<input type="checkbox"/>	<input type="checkbox"/>
All three; save \$4.85	\$19.00	<input type="checkbox"/>	<input type="checkbox"/>
		<input type="checkbox"/>	<input type="checkbox"/>

Special rates to code classes on request, retail inquiries welcome.

Postage paid SP 4th class in USA

1st class and Canada, Mexico add \$1.00 per reel, 50¢ per cassette

Name _____ Call _____

Street or PO # _____

City _____ State _____ Zip _____

Total enclosed or charge to MASTER CHARGE or VISA Account: \$ _____
or C.O.D.

Charge card No. _____ expires _____

Clip out and send to: PICKERING CODEMASTER CO., PO BOX 396 D,
PORTSMOUTH, RI 02871

In a hurry? Call (401) 683-0575 R.I. residents add 6%.

Pickering Codemaster. ✓ P44
Your key to code.

CT-50 FREQUENCY COUNTER



**Outstanding
Performance
at an
Incredible
Price**

DESCRIPTION: The CT-50 is a versatile and precision frequency counter which will measure frequencies to 60 MHz and up to 600 MHz with the CT-600 option. Large Scale Integration, CMOS circuitry and solid state display technology have enabled this counter to match performance found in units selling for over three times as much. Low power consumption (typically 300-400 ma) makes the CT-50 ideal for portable battery operation. Features of the CT-50 include: large 8 digit LED display, RF shielded all metal case, easy pushbutton operation, automatic decimal point, fully socketed IC chips and input protection to 50 volts to insure against accidental burnout or overload. And, the best feature of all is the easy assembly. Clear, step by step instructions guide you to a finished unit you can rely on. Use the order blank below or call us direct and order yours today!

SPECIFICATIONS:

Frequency range: 5 Hz to 65 MHz, 600 MHz with CT-600
 Resolution: 10 Hz @ 0.1 sec gate, 1 Hz @ 1 sec gate
 Readout: 8 digit, 0.4" high LED, direct readout in MHz
 Accuracy: adjustable to 0.5 ppm
 Stability: 2.0 ppm over 10° to 40° C, temperature compensated
 Input: BNC, 1 megohm/20 pf direct, 50 ohm with CT-600
 Overload: 50VAC maximum, all modes
 Sensitivity: less than 25 mv to 65 MHz, 50-150 mv to 600 MHz
 Power: 110 VAC 5 Watts or 12 VDC @ 400 ma
 Size: 6" x 4" x 2", high quality aluminum case, 2 lbs
 ICS: 13 units, all socketed
 CT-600: 600 MHz prescaler option, fits inside CT-50
 CB-1: Color burst adapter, use with color TV for extreme accuracy and stability, typically 0.001 ppm

OPTIONS:

CB-1 option: The CT-50 time base may be locked to an external frequency standard. The television networks maintain extremely accurate atomic based frequency standards to maintain color tint on TV programs. These standards are typically accurate to one part in 10 to the 12. By locking the CT-50 to one of these network standards, we are able to get super accuracy. The CB-1 adapter interfaces a standard color TV receiver to the CT-50 so that one can take advantage of the TV network frequency standards. The CB-1 requires connection to a color television for operation.

CT-600 option: The CT-600 prescaler option enables the CT-50 counter to measure frequencies as high as 600 MHz with sensitivity in the 20 to 150 mv range, depending upon frequency. Typical sensitivity at 150 MHz is 25 mv. The CT-600 mounts on the same PC board as the CT-50, no extra boxes or PC boards are required. The scaler utilizes a state of the art ECL IC chip and two transistor pre-amplifier, thus eliminating the need for external pre-amp devices.



CT-50, 60 MHz Counter Kit \$89.95
CT-50 WT, 60 MHz counter, wired, tested 159.95
CT-600, 600 MHz prescaler option
 for CT-50, add 29.95

ACCESSORIES

DC probe, direct input, general purpose type \$12.95
 High impedance probe, does not load circuit 15.95
 Low pass probe, used when measuring audio 15.95
 High pass probe, reduces low freq pickup 15.95
 VHF flexible rubber antenna, BNC connector 12.95
 Color burst adapter, for calibration, high accuracy 14.95
 typically 0,001 ppm accuracy, stability

ramsey electronics

Box 4072 Rochester NY 14610 (716) 271-6487

Ramsey Electronics		VISA	master charge	78
Box 4072 716-271-6487				
Rochester, NY 14610		✓ R8		
Quantity	Description	Price		
Shipping, handling, insurance		\$5.00		
N.Y. state residents, add tax				
Total				
Name _____				
Address _____				
City _____ State _____ Zip _____				

Minicontests

— get 'em involved!

A little local competition can be a great source of fun — and new members.

Would your amateur radio club like to have a fun activity that will attract new members? If so, challenge another club to a "minicontest." Such a contest will provide behind-the-mike and contest logging experiences for all participants.

In planning a minicontest, the time and station location should be such that the greatest number of people can observe the station in operation. (A shopping mall, a public park, or a school lobby are possibilities.) As much publicity as possible should precede the contest.

In a recent minicontest between the amateur radio clubs of the Principia College (Elsah, Illinois) and the Principia High School (St. Louis County, Missouri),¹ the following format was devised by the clubs' officers. This information was duplicated and given to the members of both clubs.

Inter-Campus QSO Party

Purpose: To create interest in amateur radio on both of our campuses and to unite the campuses in

friendly competition.

Rules: Each campus will operate a portable radio station using a transceiver without a linear amplifier. The contest will be held on November 12th for a period of three hours from the first contact. Starting time will be about 11:00 am. We should encourage as many non-hams as possible to get involved.

Logs need to include the following information: Time of the QSO, call of the station worked, its operator's name, and the state of the station. The name of any unlicensed operator of our station making the contact should also be entered. Only one contact per station per band counts.

Scoring: Count one point per contact by a licensed operator, or two points if the operator is unlicensed. Each unlicensed operator will be permitted to make only five contacts. Each state worked will be used as a multiplier. After the contact points have been multiplied by the number of states, add on bonus points: 2 points when an

operator communicates with his home state, and 15 points if a phone patch is completed or a message delivered to a third party.

Observations at the high school station in the November 12 contest illustrate a minicontest in action. The station was located along the route between the dormitories and the dining room. All students would be sure to see it on their way to lunch. A temporary antenna was installed on the roof. Two bamboo fishpoles taped together supported a 32-foot wire for the vertical half of the antenna. The other half of the antenna was another 32-foot wire slanting down towards the roof. The antenna was fed by 60 feet of twinlead connected to an antenna tuner. The antenna loaded beautifully on both 40 and 20 meters. The sponsor of the club, WBØVOE, supplied a Yaesu FT-101E transceiver and lumber to support the fishpoles. An "old-timer" (and long-time field day "supervisor")² supplied the antenna, the antenna tuner, and the two-letter call (WØVM). A sign with the station call

and its phonetic equivalent, "whiskey zero victor mike," was posted where all participants and visitors could see it.

The first contact was made with the college station WA9NYN (Illinois). The second contact was made with the father of the college club's sponsor (Minnesota). The next two contacts were in Ohio and Tennessee. What a good start! Four contacts in four different states! The first 19 contacts were made on 40 meter SSB. The remaining contacts were made on 20 meter SSB. All in all, the high school club made 32 contacts in 19 states.

Nine unlicensed students made contacts under the supervision of the two licensed operators. In the middle of the contest, a much appreciated contact was made with WA2RBN, the South Queens Boys Club in New York City. The father of one of the participants was in New York City on business. This student sent a message to his dad via the hotel where he was staying. Another student from New York City also sent a message to his family.

During the QSO with the Boys Club station, one of the student operators innocently used the expression "ten four." The club's sponsor immediately took the microphone and apologized for the use of "such language." This incident provided a good opportunity to explain the differences between CB and ham radio. As one student put it, "using CB lingo in an amateur radio QSO is like

wearing old patched-up blue jeans to a formal dance."

Circumstances gave the high school club what could be called an "unfair advantage" in the contest. A Missouri QSO contest was on at the time, and "CQ contest, W0VM, St. Louis, Missouri" brought many answers. The two-letter call also helped. Although the high school club made more points

than the college club, both clubs really won. All participants (some of whom were YLs) had fun, and each club has new members as a result of the minicontest. One of the new high school members has taken the Novice examination and is eagerly waiting for his license to arrive. When Field Day comes around in June, these two clubs are planning to join forces and

enter a class 1-A station in the "big contest."

Your amateur radio club could benefit from a minicontest. Why not challenge another club, have a minicontest, and enjoy the fun? ■

References

1. Private boarding schools managed by a nonprofit organization, the Principia Corporation.
2. See "A Field Day to Remember," *73 Magazine*, June, 1969, page 44.

Allan S. Joffe W3KBM
1005 Twining Road
Dresher PA 19025

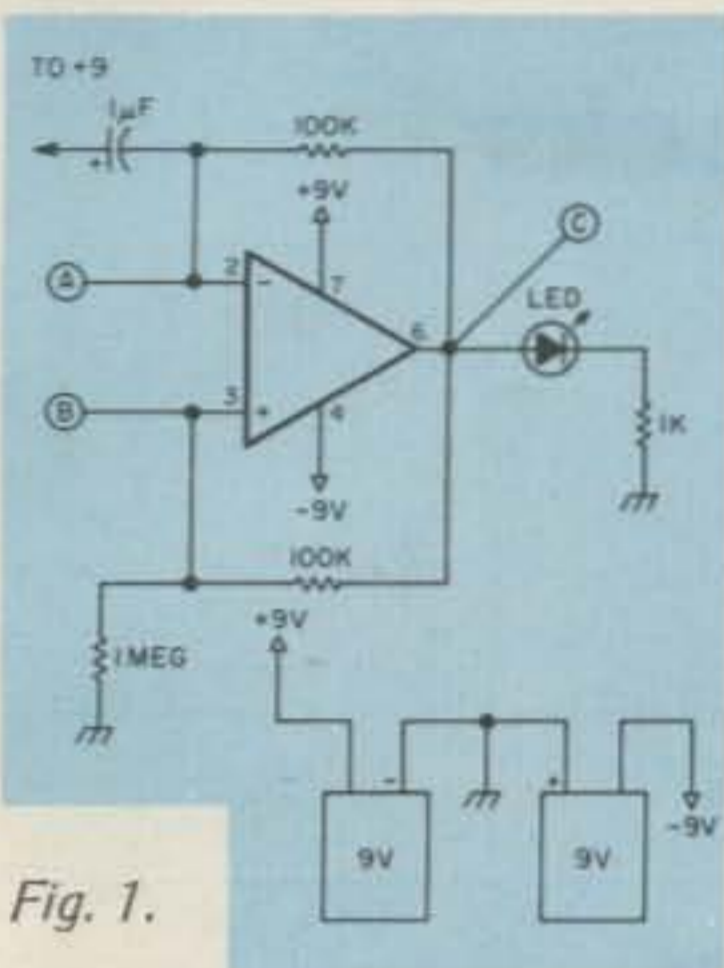

Fig. 1.

Are Your Op Amps Opping?

— try this IC helpmate

Here are two small shack helpmates, simple and inexpensive, but very handy. The first one has been around in many forms. Fig. 1 shows it is an astable multivibrator that will blink the LED about one flash per second if a mini-DIP op amp with typical 741 pinouts is plugged into the socket. The self-contained nine-volt batteries should give shelf life, as the drain is both minimal and infrequent. Some of the similar pinout units are the 301, 307, 318,

and 844.

A second unit was constructed to allow testing of dual units in mini-DIP packages and 14-pin units, either dual or single.

This is identical electrically but differs physically. Fourteen test point jacks are arranged around a 14-pin socket, and each socket pin is wired to one of the jacks.

Five test leads with clips are brought out to connect to the proper pins, depending on the device packaging. Two of these are the plus and minus nine volts. The other three connect to points A, B, and C in the schematic of the mini-DIP tester. Simply determine where the clip leads should go according to the unit to be tested. Clip the leads to the

appropriate test point jacks, and insert the IC. If the LED blinks, the device is okay. The mini-DIP version needs no battery switch. The second device only needs a switch if you believe in Murphy's law that says, "When in storage on the shelf, if two leads do touch, they will be the battery leads." ■

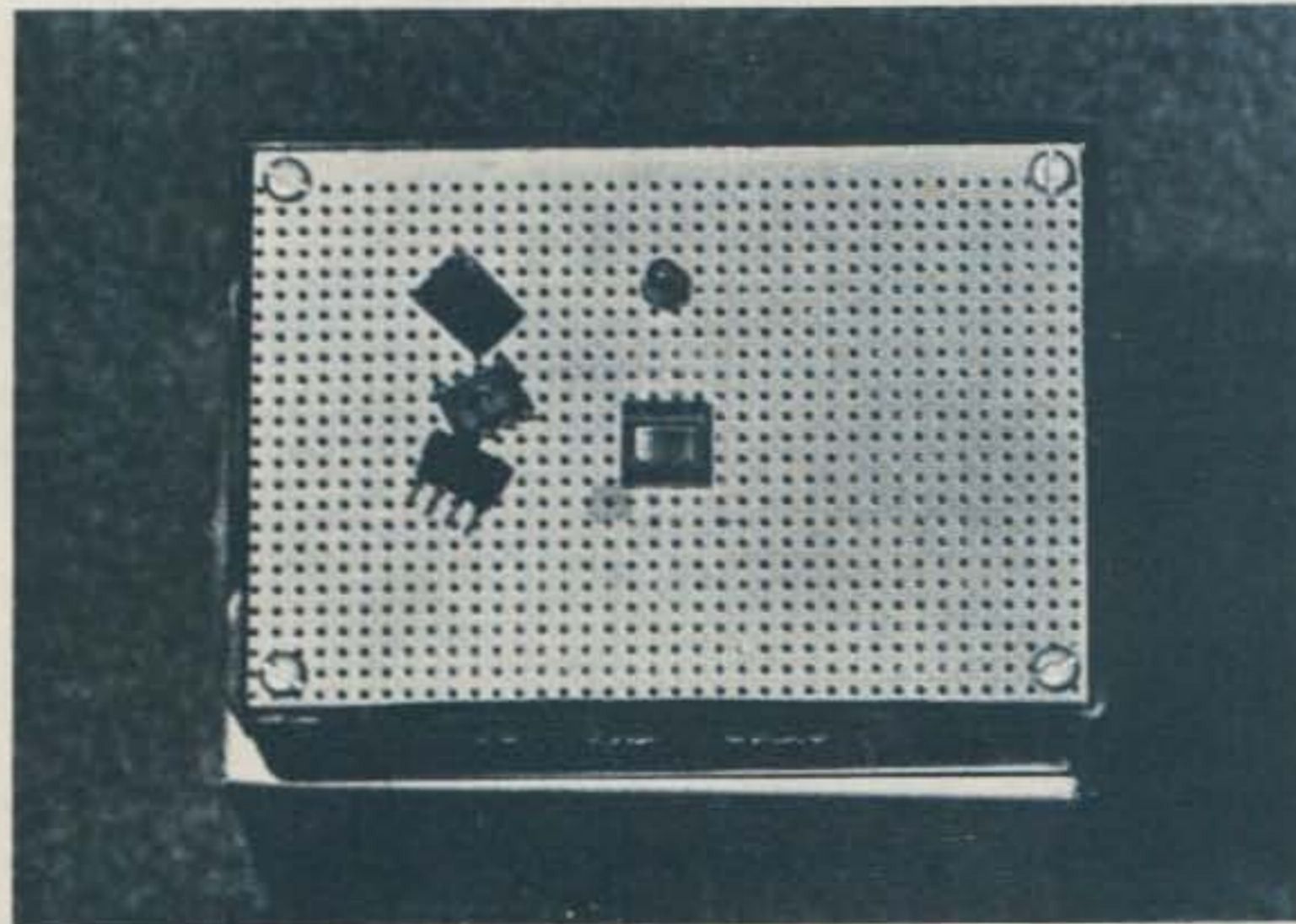
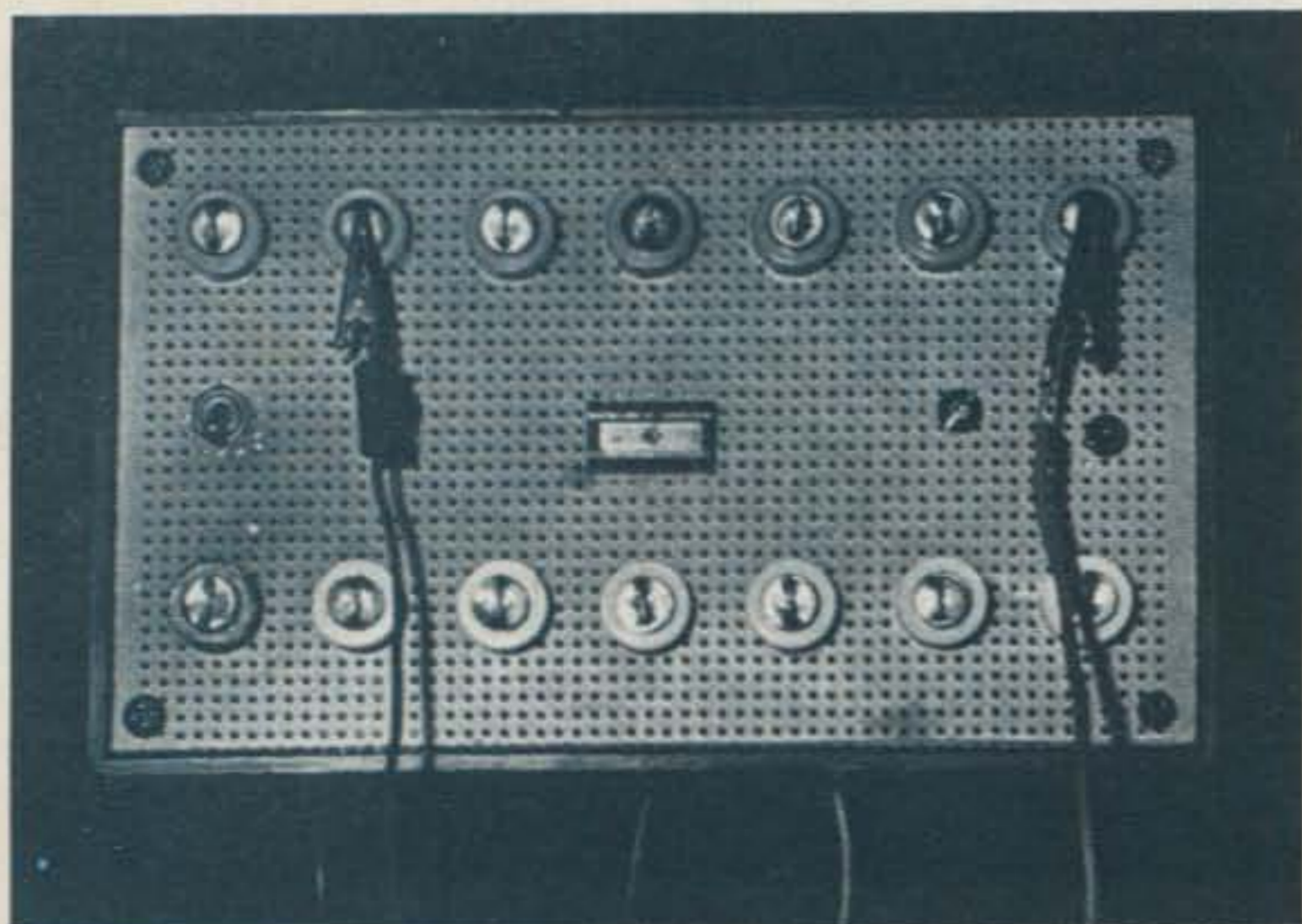

Major League TT Controller

— 15 digits, 40 devices, 100 bucks

Now's the time for a high-performance control system.

Photos by James Sevast K3IMH

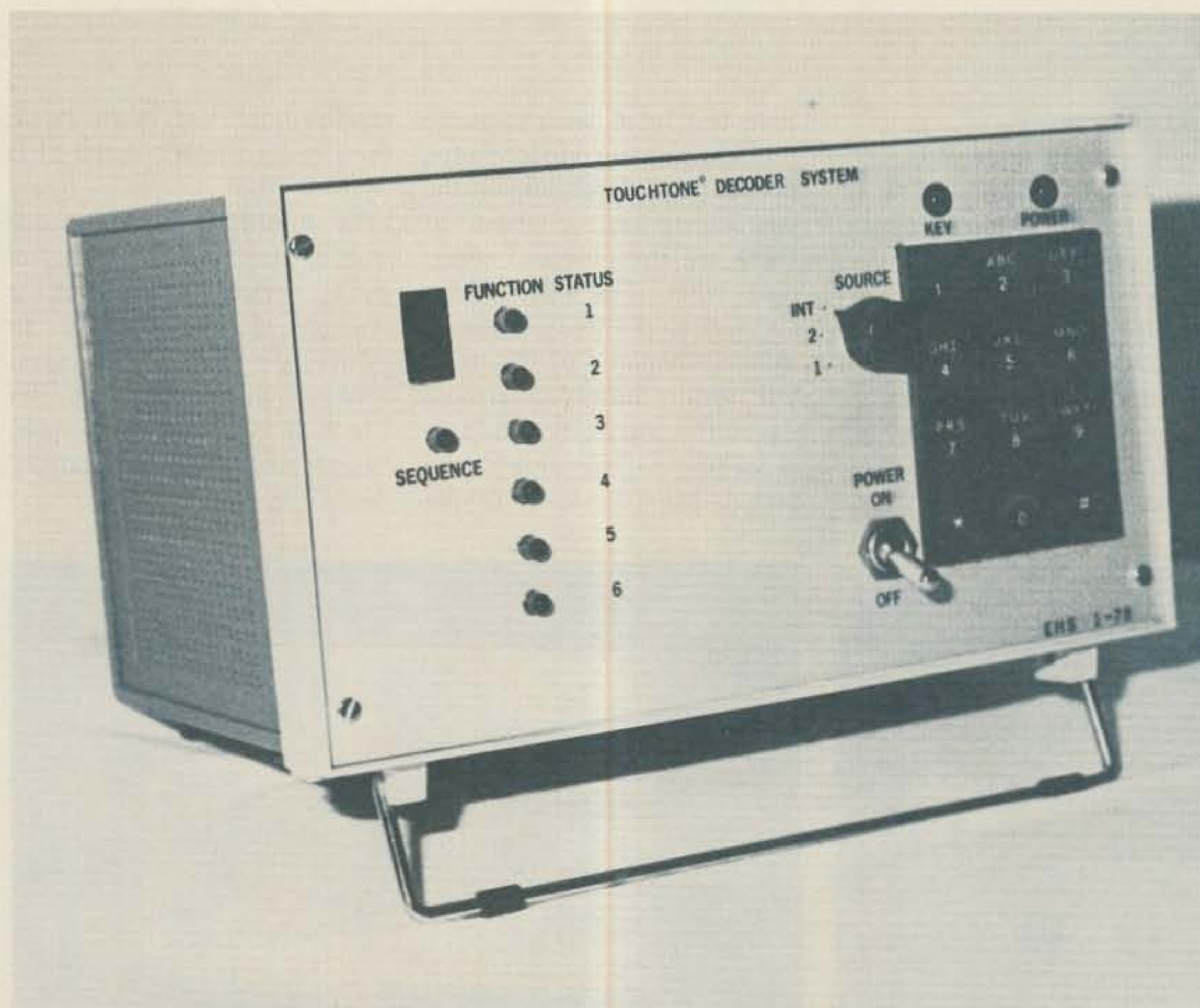

Front view of system. The system is housed in a 5" × 9" × 6" cabinet. The source selector switch selects as input the internal touchtone pad or one of two external sources. The "key" LED is turned on by a key of the pad being depressed.

The radio amateur has been using dual-tone multifrequency (DTMF) touchtone™ signalling to remotely control electrically activated devices for some time. Detection circuitry has evolved from bulky LC tone filters to phase-locked-loop tone detectors to the most recent development, an MOS/LSI integrated circuit that shrinks the size of circuitry, simplifies construction, and yields substantially improved DTMF detection performance.

Since the two meter repeater explosion started, I have had the pleasure, and occasional frustration, of building four 2 meter repeaters, three of which have limited-capability phase-locked-loop-based DTMF supervisory control circuitry. When I saw this new IC, I decided the time was right to develop a general-purpose, flexible, high-performance expandable control system that could be used at a repeater site, or in the shack, to turn

almost anything on or off remotely.

The system that has evolved can be programmed to respond to a user's access code of up to 15 digits and can control up to forty devices. Access code and control codes can easily be changed at any time by changing the system's programmable read only memories (PROMs). Cost is reasonable. Even with an empty junk box, you should be able to reproduce the system for under \$100.

General Description

Referring to Fig. 1, audio from a receiver or other source of DTMF tones is applied to a high-tone group preprocessor and a low-tone group preprocessor. The preprocessors consist of multistage active bandpass filters that provide a minimum of 32 dB separation between the high-tone group (1209 Hz, 1336 Hz, 1477 Hz) and the low-tone group (697 Hz, 770 Hz, 852 Hz, 941 Hz). Included in the preprocessor are digital comparators that change the analog tones into digital pulse trains for input into the DTMF detector.

The DTMF detector consists of a Collins Rockwell CRC-8030 MOS/LSI integrated circuit. Fig. 2 is a block diagram of the 8030. Using a unique (patent pending) digital filter algorithm, the 8030 processes the incoming high and low tones, recognizes when a valid touchtone digit is being sent, and provides a user-selectable two-of-eight output or 4-bit binary output that identifies the digit received. High stability is assured by a crystal-controlled time-base.

The DTMF detector is followed by a sequence detector which determines if the proper access code has been received. The sequence detector, after de-

tecting a valid access code, responds to the next digit as a command to activate or deactivate a particular control function. The sequence detector is capable of being programmed to recognize an access code consisting of as little as one digit up to a maximum of fifteen digits. It can control from one to nineteen on-off functions or up to forty pulsed functions. Circuitry for five on-off functions and one pulsed function will be described in detail.

The output interface has drivers that can power relays or other external dc circuitry. The open collector transistor outputs can sink up to 300 mA and can sustain voltages of up to

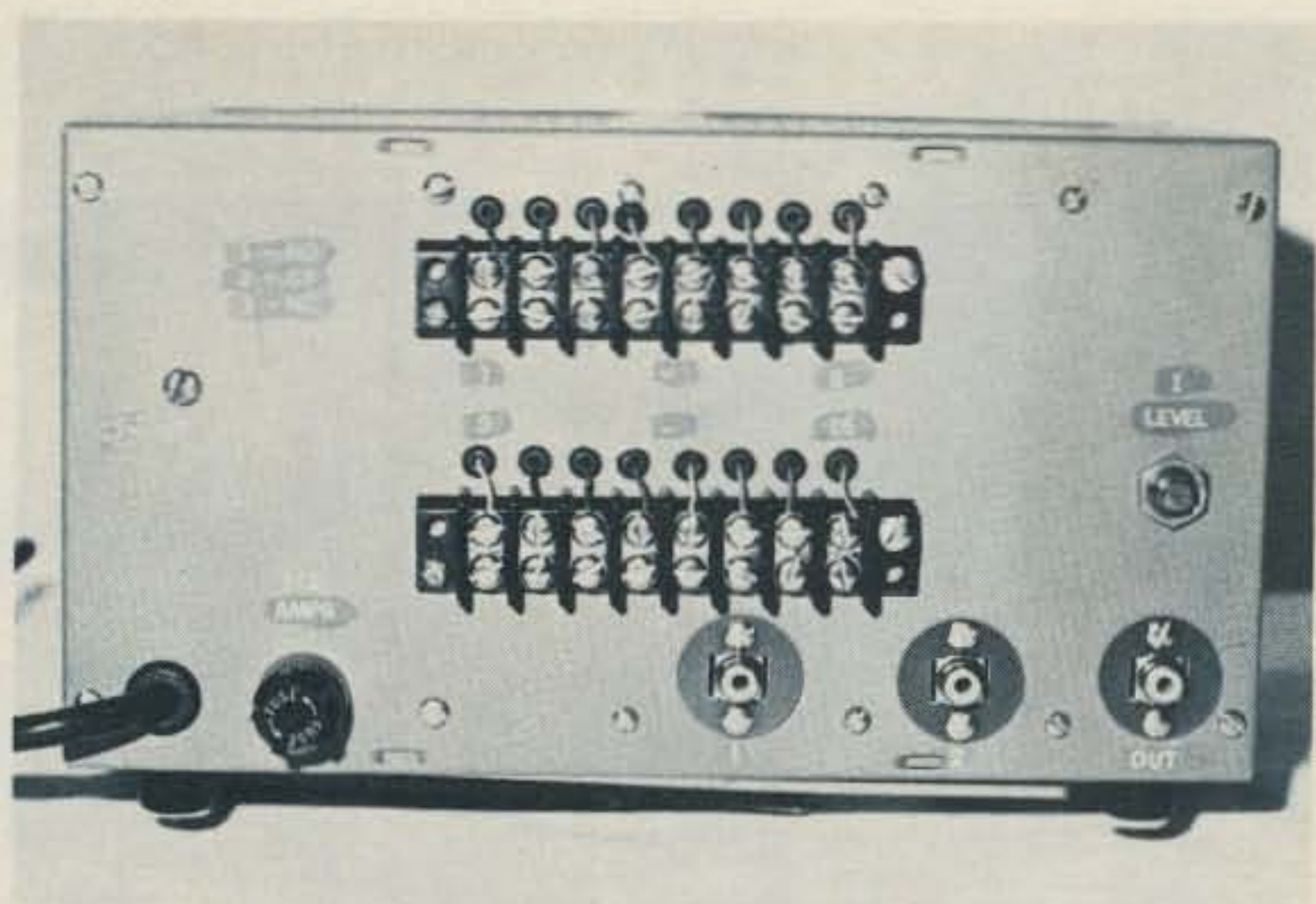

Rear view of the system. Relay contacts are brought out to terminal strips for easy connection to external devices being controlled. Jacks are provided for the two input sources and audio output from the touchtone pad. A level control was included for source #1.

30 V dc.

The status display shows if the incoming digit se-

quence corresponds to the access code, which digit is being received, and which

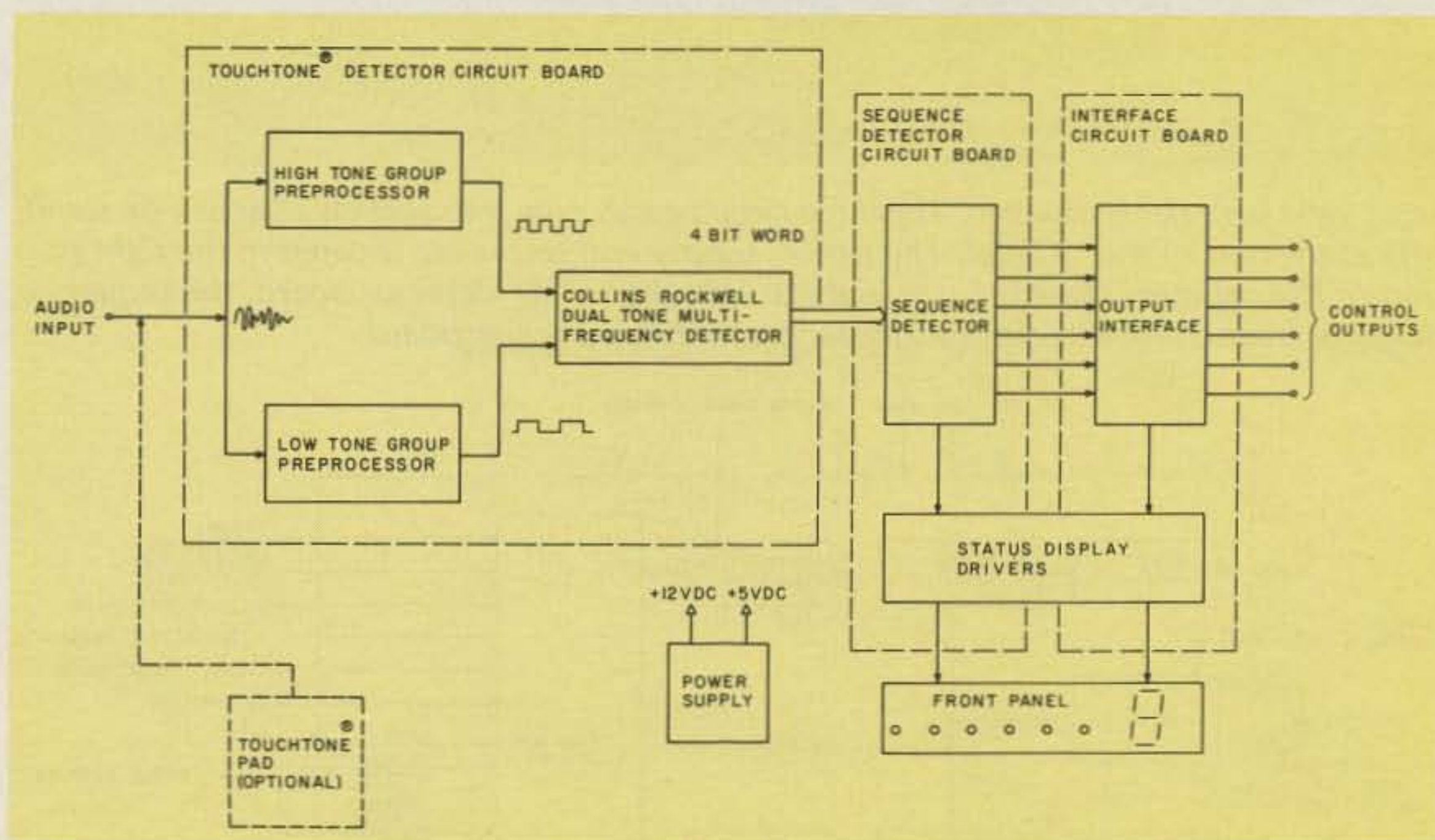
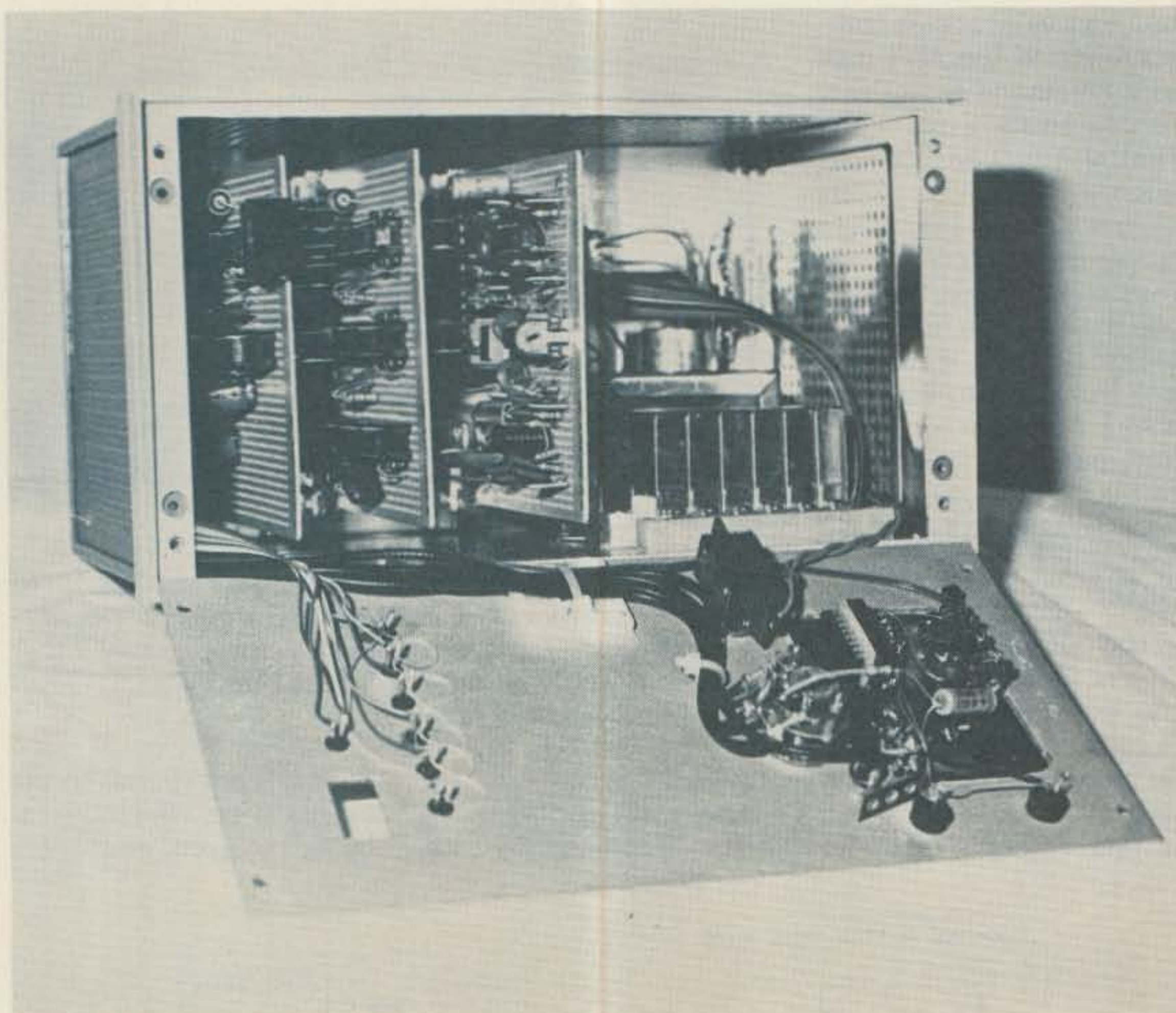

Fig. 1. Block diagram of the touchtone control system.

TOUCHTONE [®] DIGIT	DTMF DETECTOR WORD								BINARY COUNTER				PROM OUTPUT BITS (NOTE 2)								
	MSB				LSB				PROM ADDRESS												
	8	4	2	1	8	4	2	1	A7	A6	A5	A4	A3	A2	A1	A0	O1	O2	O3	O4	
ACCESS CODE	2	7	0	3	1	0	0	1	0	0	0	0	0	0	0	0	0	1	0	0	0
						0	1	1	1	0	0	0	0	0	0	0	1	1	0	0	0
						1	0	1	0	0	0	1	0	0	0	1	1	1	0	0	0
						0	0	1	1	0	0	1	1	0	0	1	1	1	0	0	0
						0	0	0	1	0	1	0	0	0	1	0	0	1	0	0	0
CONTROL DIGITS	9	0	*		1	0	0	1	0	1	0	1	0	1	0	1	0	0	0	1	
					1	0	1	0	0	0	1	0	0	1	0	1	0	0	1	0	
					1	0	1	1	0	1	0	1	0	1	0	1	0	1	0	0	

Table 1. PROM #1 (U9) programming chart. Notes: 1 — The access code is determined by the addresses within the box. Any access code can be chosen by appropriate address selection when the PROM is programmed. Access code 2-7-0-3-1 is shown. 2 — All other PROM outputs are left unprogrammed (binary 0).



Front view with panel lowered. The three circuit cards plug into sockets attached on stand-offs at the rear of the cabinet. The power supply and relays are located in the right portion of the cabinet. The cards are, right to left, the DTMF detector board, the sequence detector board, and the output interface and display driver board.

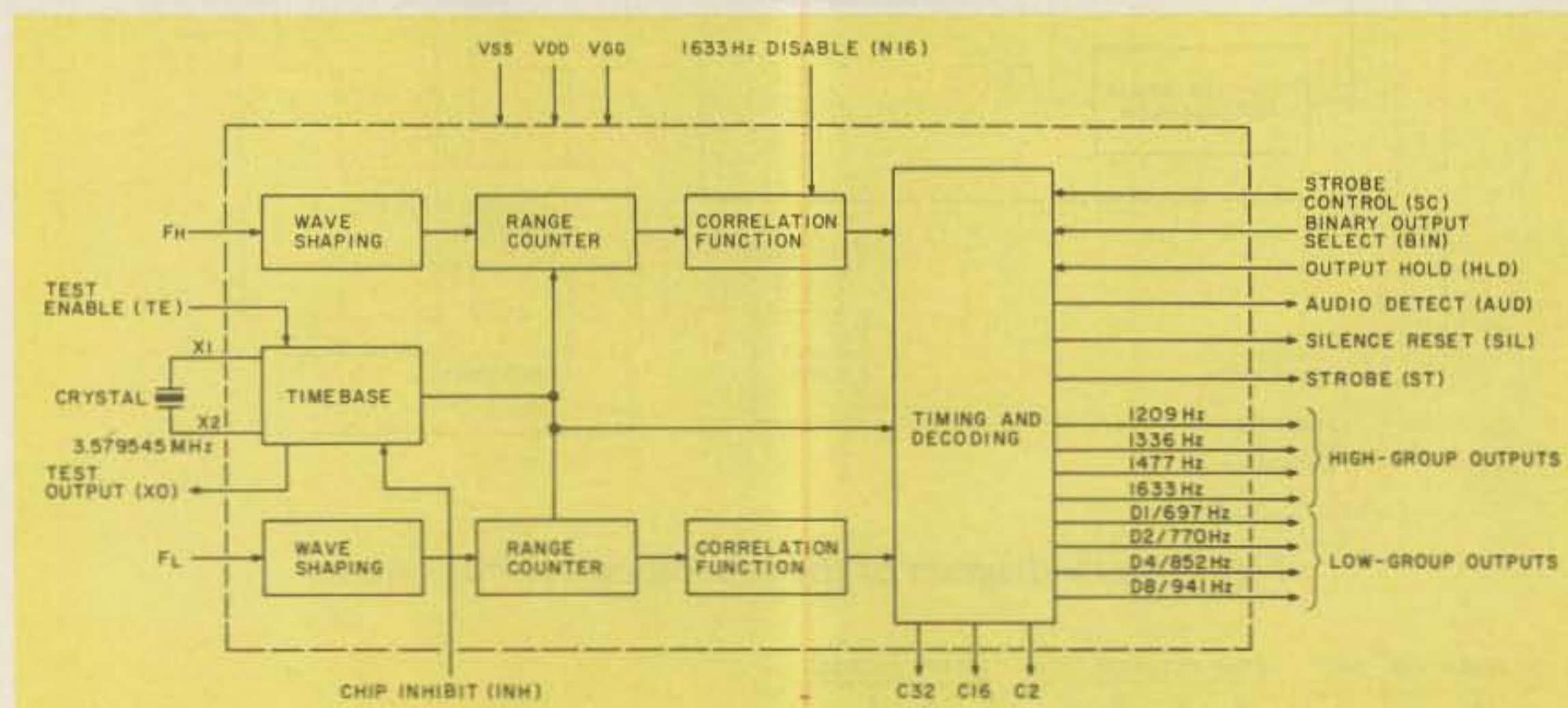

Fig. 2. CRC-8030 block diagram (from CRC-8030 data sheet, pg. 2, Fig. 3).

functions are on or off.

I elected to include an optional touchtone pad in my system for local control. When not in use for local control, the pad drives my two meter transmitter.

Tone Group Preprocessor

The tone group preprocessor circuitry is shown in Fig. 3. 100 milli-

volts peak-to-peak audio is coupled into the high- and low-tone group bandpass filters through gain control potentiometers. The gain control potentiometers permit individual adjustment of gain of the high-tone group and low-tone group filters to compensate for "twist," which is the term used to describe differences in the level of

the high group and low group outputs from the user's receiver. The filters consist of four active bandpass stages. Trimpots are provided for each filter stage so that the stage can be tuned to the proper frequency. In addition to filtering, the active stages provide gain so that an incoming tone is amplified to 6 volts peak-to-peak at the

filter output.

An LM339 comparator converts the sinusoidal output from the group filter into a digital pulse train. A trimmer potentiometer, R_c , permits adjustment of the comparator reference voltage so that the comparator output is logic low when DTMF tones are not being received. Note that mylar™ capacitors are used in the bandpass filters to minimize filter drift with temperature.

DTMF Detector

Fig. 4 shows the circuitry for the DTMF detector. The CRC-8030 has numerous inputs and outputs, which give the device great flexibility.

In this application, I have selected the binary output format rather than two of eight and thus have grounded the binary select pin, Bin. Likewise, I am using a 12-digit touchtone pad rather than a 16-digit pad and have, therefore, grounded the "1633" pin which defeats the reception of these additional control digits. The strobe control selection pin, Sc, is also grounded, which ensures that the detector only responds to high quality input signals. This reduces the probability that voice or noise signals from the receiver will cause the chip to falsely identify the presence of a control signal.

Outputs include a 4-bit binary word, a strobe signal that indicates when a valid tone pair has been received, and a silence reset signal that continually pulses when valid tone pairs are not being received.

The CRC-8030 can be operated from a single or dual power supply. When operated from a single 5-volt dc power supply, as I have elected to use, the outputs are only capable of driving LPTTL or CMOS.

CD-4049 CMOS-to-TTL buffers interface the detector to the remainder of the circuitry.

Preprocessor/Detector Construction

As can be seen in the photograph, the high- and

low-tone group preprocessor circuitry and the dual-tone multifrequency detector fit nicely on a single 4" x 4½" circuit board. The preprocessor circuitry operates from a +12-volt dc power supply. I have included on the circuit board

an LM340-5 voltage regulator that provides the +5 volts dc for the CRC-8030 chip.

If you are fortunate enough to have a microcomputer in your radio shack, you could utilize this single card to convert

DTMF tones into a 4-bit binary word for input to your microcomputer. Sequence decoding and control could be programmed by appropriate software. If you don't have a microcomputer, the following "computer-like" circuitry

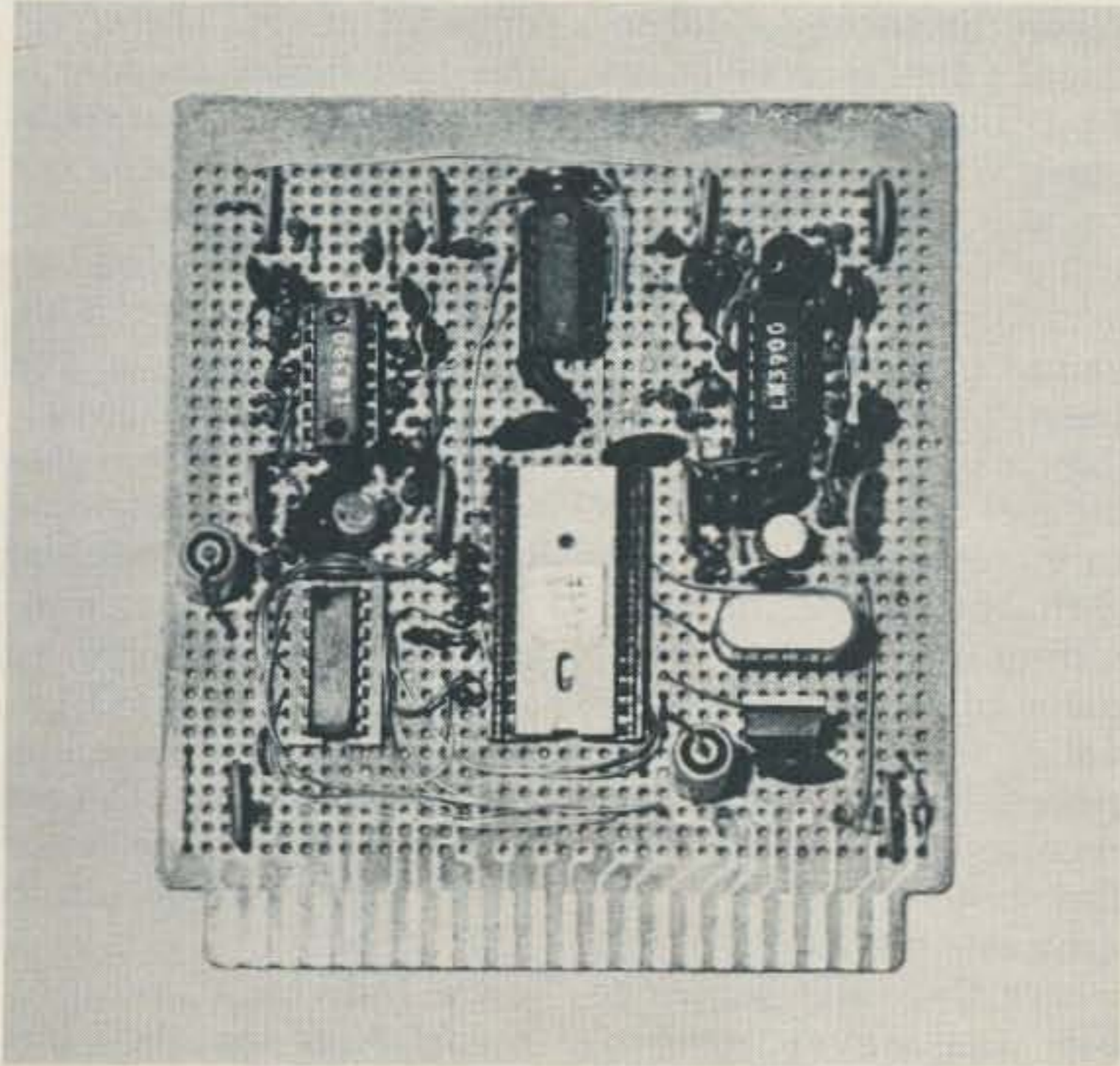

DTMF detector circuit board.

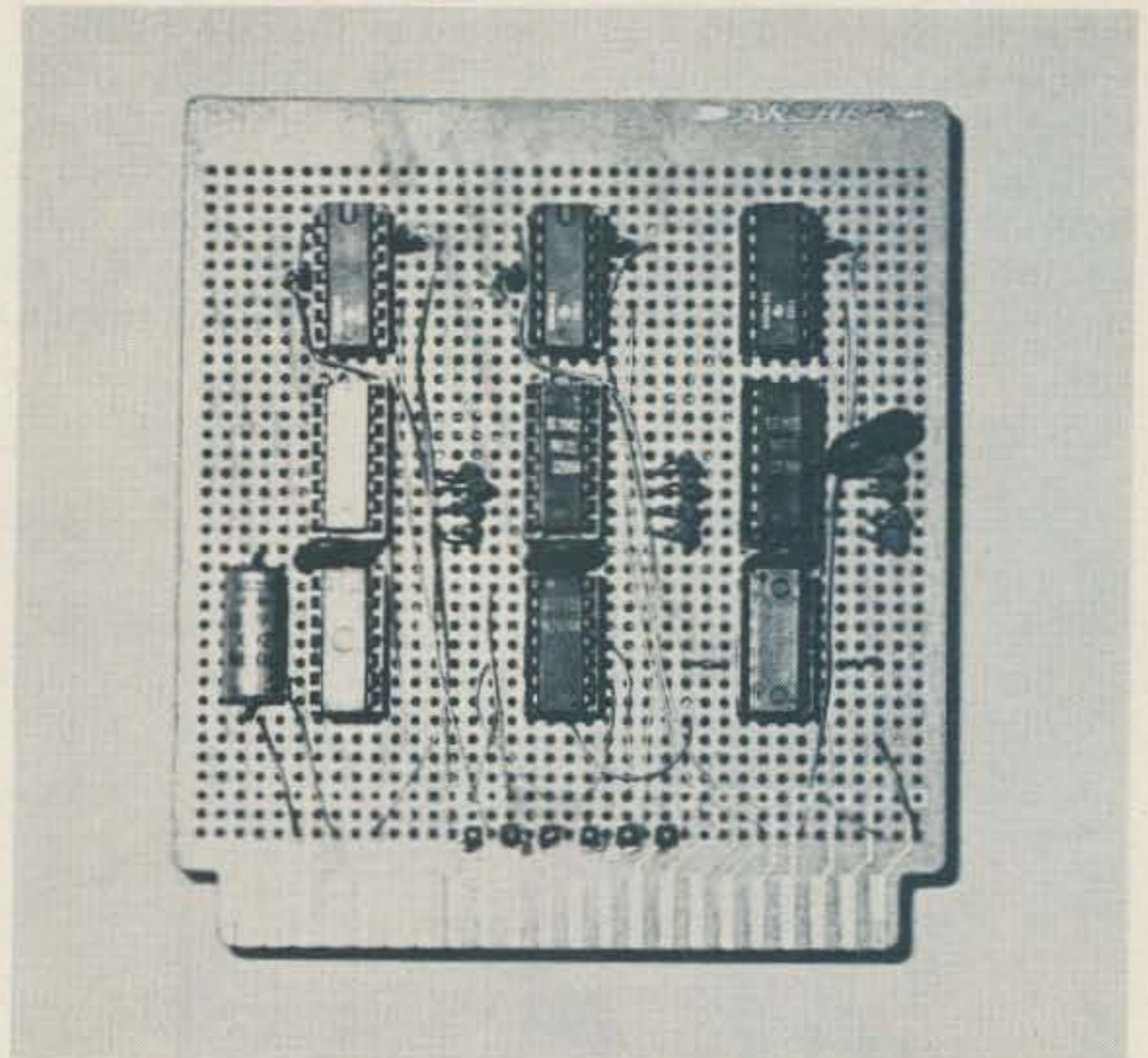

Sequence Detector Board.

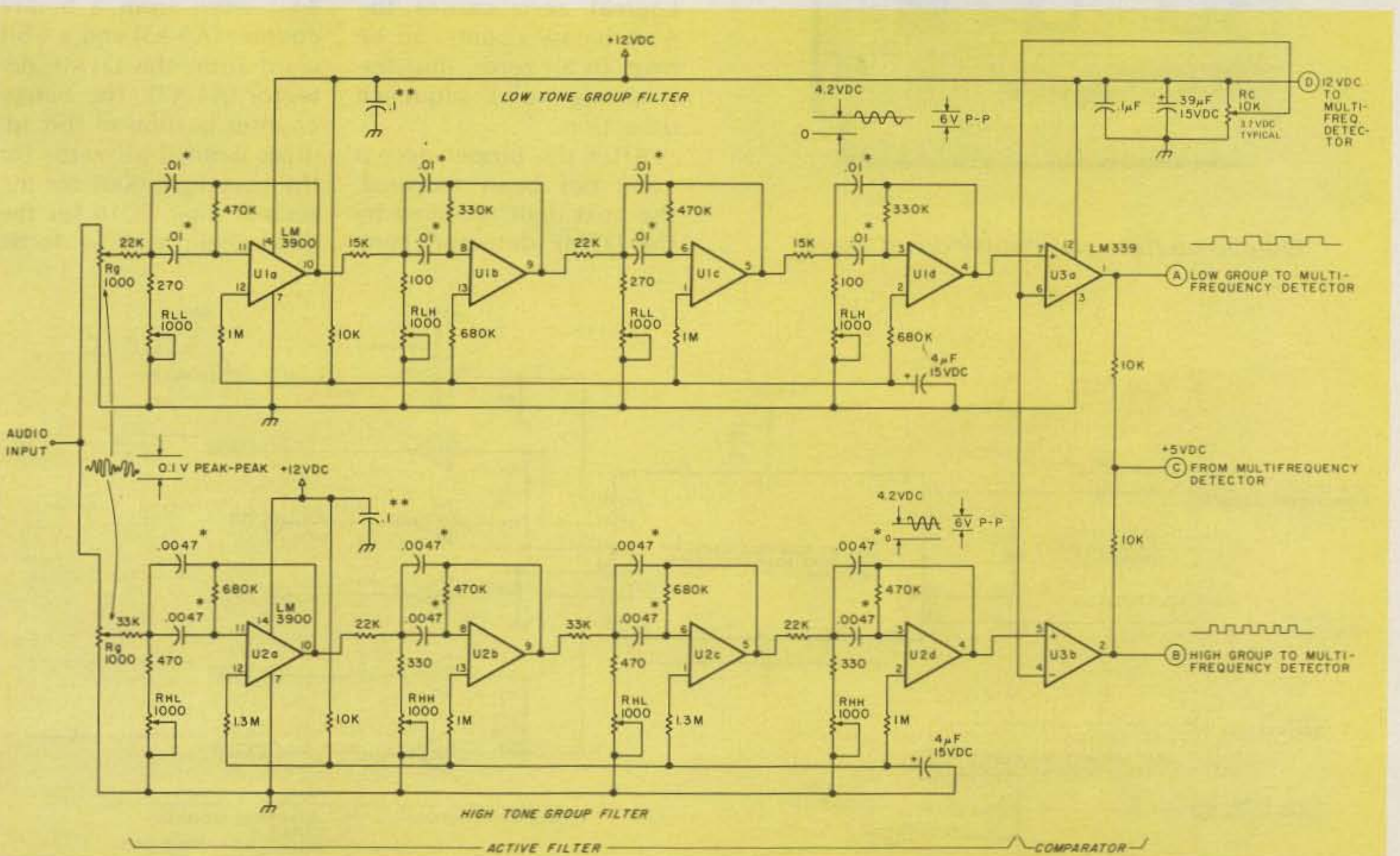

Fig. 3. High- and low-tone group preprocessor circuitry. * Mylar™, 10%; ** located close to associated LM3900; all resistors ¼ Watt; all capacitors uF.

will do the job.

Sequence Detector

The heart of the sequence detector consists of three 4-bit by 256-word programmable read only memories (PROMs). To address the 256 words of the PROMs, an 8-bit address is required. Referring to Fig. 5, this 8-bit address is provided by a 4-bit binary counter and the 4-bit word from the DTMF detector circuitry previously described. PROM #1, com-

combined with PROM #2 and PROM #3, provides eleven control bits that are used to activate or deactivate control functions.

Detection of a valid access code occurs as follows: Initially, the 4-bit binary counter outputs are all 0. When a digit is received by the DTMF detector, its 4-bit binary word combines with the binary counter word to produce a PROM address. One output bit of PROM #1 is called the valid sequence

bit. If the digit received by the DTMF detector is the first one in the access code sequence, the PROM #1 output accessed by the 8-digit address will contain a binary 1 for the valid sequence bit. This bit causes the 4-bit binary counter to increment by one count. When the second valid sequence digit is received, its 4-bit binary word, combined with the 4-bit binary counter which is now 0001, will also address a location in PROM #1 where the valid sequence digit has been preprogrammed to logical one. In this way, the binary counter continues to increment and combine with the DTMF detector output to address different parts of PROM #1 where valid sequence bits are stored. If an invalid digit is received, it, combined with the binary counter, addresses a part of PROM #1 where the valid sequence bit was never preprogrammed to logical one and is, instead, zero. Logical zero causes the 4-bit binary counter to be reset to all zeros, thus terminating valid sequence detection.

After the proper access code has been received, the next digit received by the DTMF detector, com-

combined with the counter circuit, addresses a location in PROM #1, #2, or #3 where a word was preprogrammed to activate an appropriate control bit.

When the control digit is received, the PROM #1 location addressed does not have the valid sequence bit set. Therefore, the 4-bit binary counter is again reset to zero and further control cannot occur unless the proper access code is again received.

Table 1 provides additional information on the programming of PROM #1. Study of this table will give you a better understanding of how the access code and control bits are programmed. For example, an access code of 2-7-0-3-1 is shown. You could use any digit combination. The access code could be fewer digits or more digits (up to 15), depending on your own individual requirements. Note that the 8 bits of the PROM address (A0-A7) are made up of a 4-bit word from a binary counter (A0-A3) and a 4-bit word from the DTMF detector (A4-A7). The binary counter portion of the address word is all zeros for the first digit, 0010 for the second digit, 0010 for the third digit, and so forth.

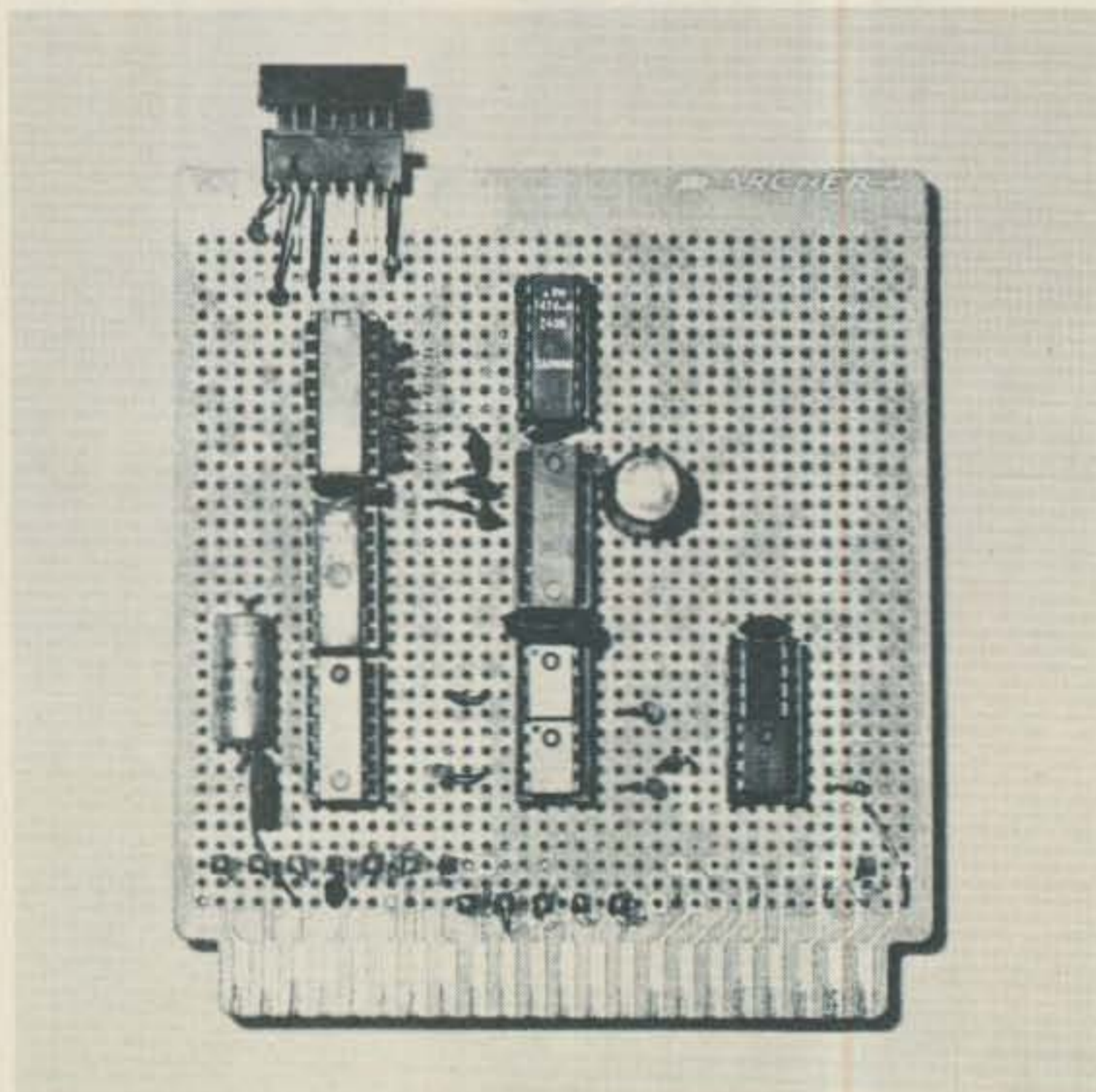

Output interface and display driver board.

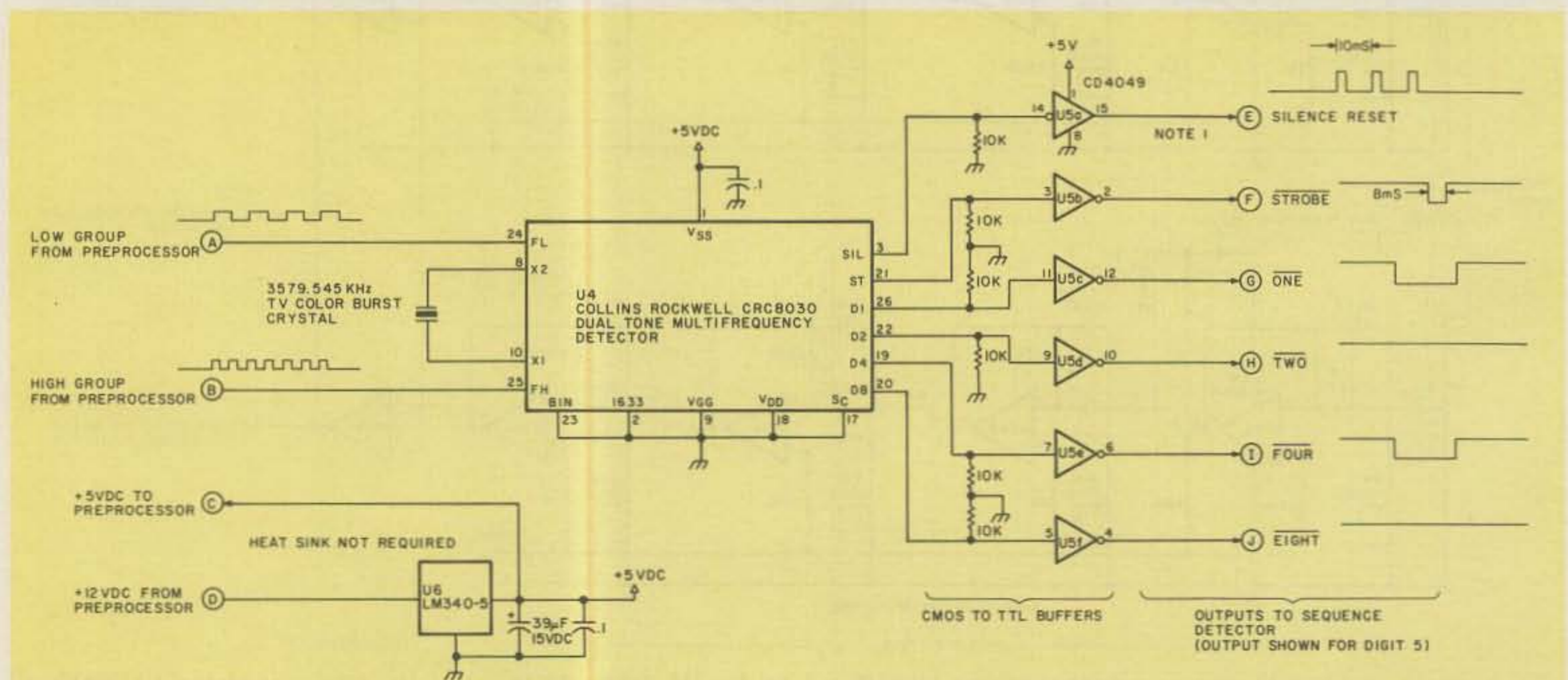

Fig. 4. Dual-tone multifrequency detector. Note 1 — buffer can drive two TTL loads maximum.

The remaining 4 bits of the address are a function of the access code as shown.

PROM #1, which initially has all of its output bits unprogrammed at zero, is programmed at the five access code addresses shown to have output bit 0, to be 1. The control digits represent the last digit sent in a sequence, and, therefore, the binary counter portion of the PROM address would be 0101 as shown, representing the sixth digit received. I have programmed PROM #1 to respond to the control digits 9, 0, and *. These addresses are used in the PROM programming process to set output bits 0₂, 0₃, and 0₄ to logical one as shown. Note that the output bit 0₁ (valid sequence bit) is set to 0 for these addresses, which will cause the circuitry to recognize that the end of a valid sequence has occurred.

Since 1 bit of PROM #1 is used as the valid sequence bit, only 3 bits remain to activate control functions. To have additional control functions, additional PROMs must be added. Tables 2 and 3 give the programming instructions for PROM #2 and PROM #3, respectively. Since PROM #1 contains all of the information for determining if a valid access code has occurred, the other two PROMs need only be concerned with providing additional control bit outputs. As in PROM #1, when a control digit is received, the binary counter is 0101 as shown. The remainder of the address is determined by the control digit (1, 2, 3, 4, 5, 6, 7, and 8). These addresses are the only words in PROMs #2 and #3 that have any output bits set. Since no information related to the access code is required in PROM #2 or #3, any change in the access code only requires programming one new PROM (PROM #1).

Sequence Detector Circuitry

The sequence detector circuitry is shown in Fig. 6. The six signals from the DTMF detector are further buffered by a 7404 hex inverter. This provides adequate drive to address up to 10 PROMs. The PROMs, Signetics 82S129s, were chosen for their ready availability and their low cost. The PROMs are tri-state; 270-Ohm resistors from the output pins to ground ensure that the following TTL circuitry can be properly driven.

The 7493 binary counter is incremented by the trailing edge of the strobe pulse. After the incoming digit has gone away, the silence reset signal will begin to pulse and will reset the binary counter to zero if the 7474 D flip-flop is not set. The flip-flop will be set, thus disabling silence reset from resetting the binary counter, if the digit received was part of the access code. The valid sequence bit only exists for the duration of the strobe pulse. It is stretched by the 0.1 uF capacitor, 270-Ohm resistor parallel combination, so it is still present when the D flip-flop is clocked by the trailing edge of the strobe pulse. An LED connected to the Q output of the flip-flop lights if a valid sequence is being received. As long as the LED is on, the sequence is valid.

The outputs from the PROMs are pulses of duration equal to the strobe pulse. RS flip-flops consisting of 7402 NAND gates store the control instructions. For example, function 1 is activated by a 1 on PROM #3 output line 0₄. Function 1 is deactivated by a 1 on PROM #3 output line 0₃. From Table 2, you can see that this corresponds to a digit 1 setting the flip-flop and a digit 2 resetting the flip-flop. Again, these digits represent the last digit to be transmitted in a control sequence. LEDs are connected to the flip-flops to show the status of the various control functions.

Note that output 0₂ of PROM #1 is not connected to a flip-flop. The pulse that occurs on this output line is used to activate a one-shot that will be described later.

The sequence detector circuitry fits on a 4" x 4 1/2" circuit board, as shown in the photograph.

The sequence detector could be used for other than DTMF applications. For example, a key pad connected to this sequence detector would make a great electronic combination lock. You would have to include in your key pad circuitry something to generate the strobe and silence reset signals and some gates to convert the 2-of-8 output that is typical of most pads

to 4-bit binary.

Output Interface

The output interface is shown in Fig. 7. Functions 1 through 5 are buffered by 75452 peripheral drivers which are capable of sinking up to 300 milliamps with collector-to-emitter voltages as high as 30 volts dc. A 400-milliwatt maximum power dissipation for each transistor must be observed.

In my unit, I elected to have the transistors drive some miniature 24-volt dc relays which I had in the junk box. These relays have a set of normally-open and normally-closed contacts which give me great flexibility in interfacing; I can control both ac- and dc-operated devices. Relays have the further advantage of assuring electrical isolation of the devices being driven from the control system. If you elect to drive relays, include the 1N4002 diodes, which will keep the back EMF from the relay coil from getting back into the circuitry.

Function 6 is a pulse produced by a 74123 one-shot which I arbitrarily adjusted to provide a one-second contact closure at the output. The 100 uF capacitor connected to the 74123 can be changed in value to lengthen or shorten the contact closure time.

Status Display

Also shown in Fig. 7 is

TOUCHTONE DIGIT	DTMF DETECTOR WORD BINARY COUNTER								PROM OUTPUT BITS (NOTE 1)			
	8	4	2	1	8	4	2	1	01	02	03	04
	PROM ADDRESS											
	A7	A6	A5	A4	A3	A2	A1	A0				
CONTROL DIGITS	5	0	1	0	1	0	1	0	1	0	0	0
	6	0	1	1	0	0	1	0	1	0	0	0
	7	1	1	1	1	0	1	0	1	0	0	0
	8	1	0	0	0	0	1	0	1	0	0	0
CONTROL DIGITS	1	0	0	0	1	0	1	0	1	0	0	0
	2	0	0	1	0	0	1	0	1	0	0	0
	3	0	0	1	1	0	1	0	1	0	0	0
	4	0	1	0	0	0	1	0	1	0	0	0

Table 2. PROM #2 (U10) programming chart.

Table 3. PROM #3 (U11) programming chart. Note: All other PROM outputs are left unprogrammed (binary 0).

the circuitry for the MAN-7 front panel LED indicator. The MAN-7 is driven by a 7447 decoder/driver. Inputs to the decoder/driver

are latched by the 7474 D flip-flops. The display circuitry is straightforward, with one exception. The 7447 normally responds to

all inputs at logic 0 as representing the decimal digit 0. The output of the DTMF detector for the digit 0 is binary 1010. A 7420 NAND gate decodes the presence of binary 1010 and clears the four flip-flops so that the LED display will truly represent the presence of the digit 0.

your access code is being sent. It is also useful in determining if a user's touchtone pad is functioning properly. For example, using this display, I quickly found out that one of my touchtone pads was not transmitting the digit 6 correctly. Without it, I would have suspected the control system rather than the touchtone pad.

The LED display cannot represent properly the two control digits, * and #. For *, the LED display will show a small backward C. For #, the display will show a small u. All the numerical digits are displayed correctly.

The output interface and status display circuitry easily fits on a 4" x 4 1/2" circuit board, as shown in the photograph.

Power Supply

The LED digit display is optional; it is not really needed for proper functioning of the system. It does allow you to see if

A 117-volt power supply is shown in Fig. 8. In addition to supplying voltages for the control system, it also provides necessary voltages to the PROM blast-

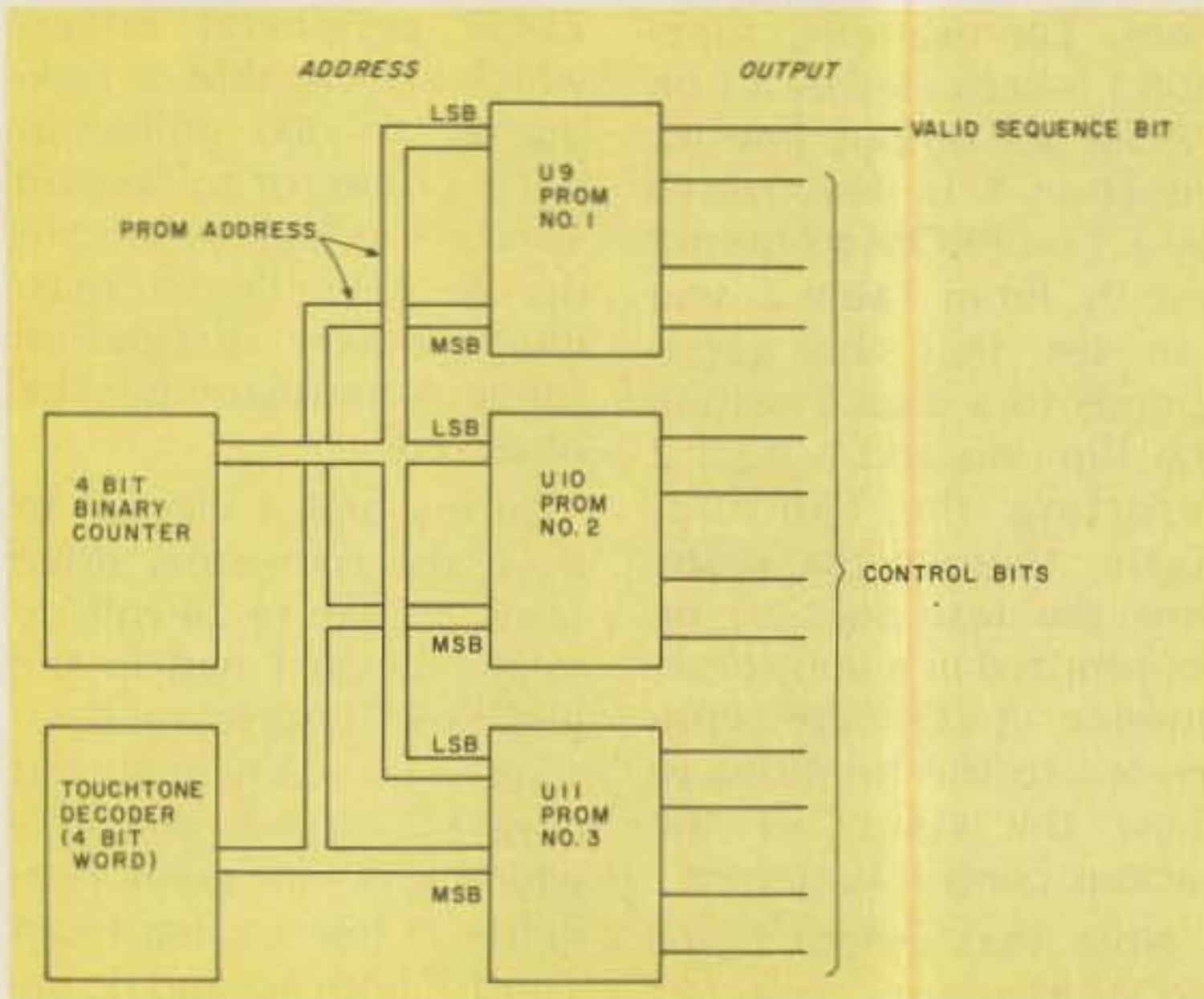

Fig. 5. PROM addressing.

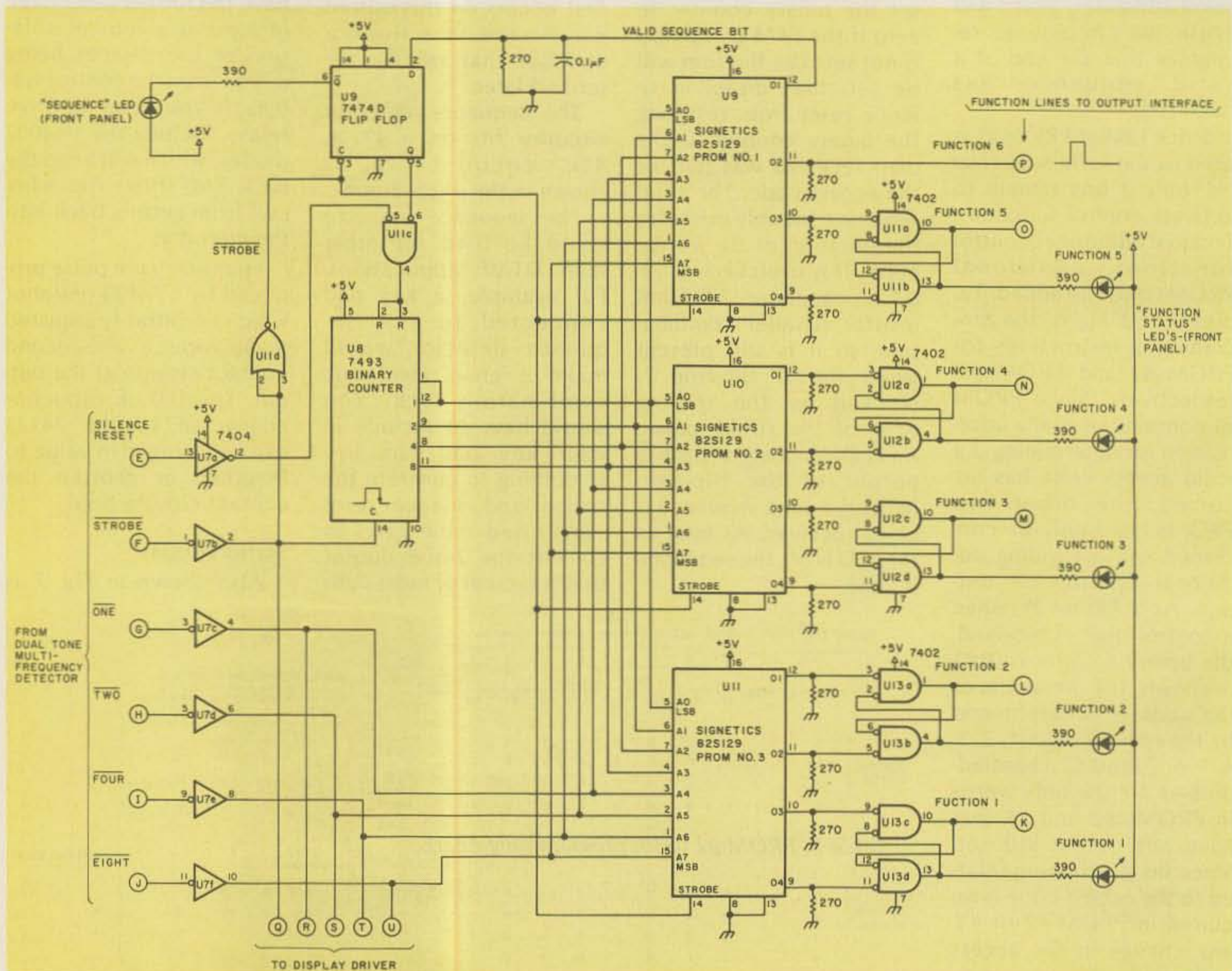

Fig. 6. Sequence detector. See text for PROM programming instructions. Bypass each IC power pin with 0.1 uF capacitor. Bypass +5 V input to circuit card with 39 uF 15 V dc capacitor.

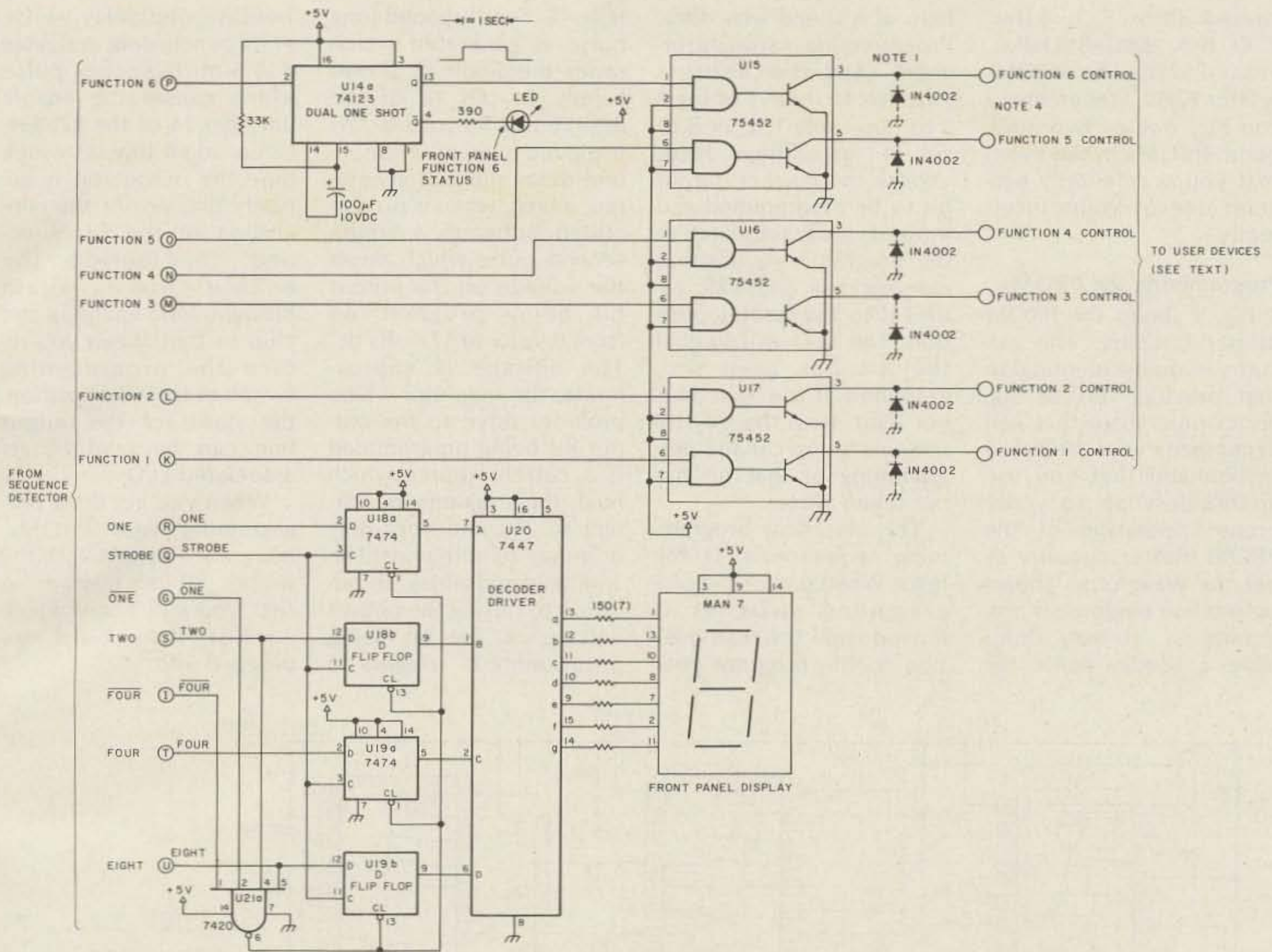

Fig. 7. Output interface and display driver circuitry. Notes: 1 — Output transistors are 30 V dc maximum voltage, 300 mA maximum current, 400 milliwatts maximum power dissipation. 2 — Bypass each IC power pin with 0.1 uF capacitor. 3 — Bypass +5 V dc input to circuit card with 39 uF, 15 V dc capacitor. 4 — Diodes are optional; required when driving inductive load such as a relay.

er (to be described shortly).

Construction

The construction is well illustrated by the photographs. The touchtone detector circuit board was wired point-to-point, whereas the other circuit boards used wire-wrapped sockets and interconnections were made by wire-wrap.

Most of the parts are readily available from distributors that advertise in this magazine. One part deserves special note. The CRC-8030 DTMF detector can be purchased from your local Hamilton Avnet Electronics distributor or can be purchased directly from Rockwell Collins, 4311 Jamboree

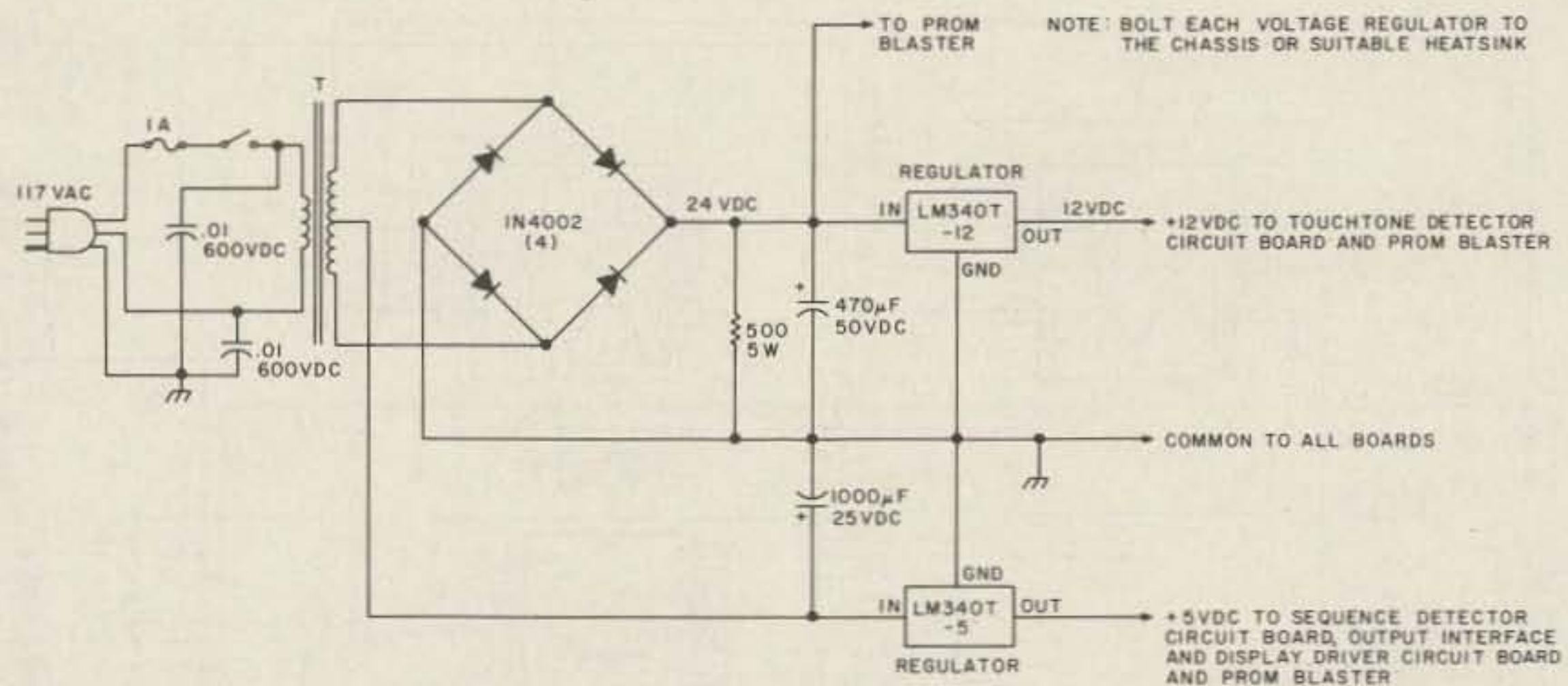

Fig. 8. Power supply. Transformer T — 117 V ac primary, 18 V ac center-tap secondary at 1 Amp minimum.

Boulevard, Newport Beach, California 92663, Attention: Component Sales.

The CRC-8030 represents the only expensive part in

this entire system, selling for \$42 (plastic) as of January, 1978. While relatively expensive, it provides one heck of a lot of performance. Prices will

probably drop rapidly as these chips are produced in quantity, so you should check the current price before ordering.

The PROMs can be pur-

chased from S.D. Sales, P. O. Box 28810-B, Dallas, Texas 75228. The PROMs sell for \$2.50. I recommend you buy one or two additional PROMs in the event that you accidentally program one of yours incorrectly.

Programming the PROMs

Fig. 9 shows the PROM blaster circuitry. This circuitry is almost identical to that provided in the Signetics data sheet that will accompany your PROMs. I recommend that you use an oscilloscope to verify proper operation of the PROM blaster circuitry as per the waveforms shown before you begin your programming. If you don't have a scope, enlist the

help of a friend who does. Programming is straightforward. Set the address switches to logic 1 or logic 0 as per Table 1, 2, or 3 to set up an address. Next, choose the correct output bit to be programmed and move its program switch to the programming position momentarily and then return it to the display position. The LED will light if the bit has been programmed. If the light does not light, then the bit still remains at logic 0 and programming of that bit has not taken place.

The electrical programming sequence is as follows: When one of the programming switches is moved from the read position to the program position, a 5-millisecond-long pulse is generated which

raises the 5-volt dc power supply to pin 16 of the 82S129 to 8.75 volts dc. At the same time, a 1-millisecond delay pulse is generated, which, when it is completed, activates a 3-millisecond pulse which raises the voltage on the output bit being programmed from 0 volts to 17 volts dc. The voltage is approximate; the regulator which provides drive to the output bit being programmed is a current source which holds the programming current to 200 milliamps plus or minus 20 milliamps. The 3-millisecond pulse, in addition to raising the output voltage of the bit being programmed, triggers a

1-millisecond delay which, at its conclusion, activates a 1.5-millisecond pulse which causes the enable line, pin 14 of the 82S129, to be taken low, at which time the output bit is actually blasted. At the conclusion of the 5-millisecond time period, the enable line is again brought low, enabling the chip so that, when you return the programming switch to the read position, the status of the output line can be read by its associated LED.

When you get done programming your PROMs, mark each PROM with the proper PROM number so that you will know which socket it should be plugged into.

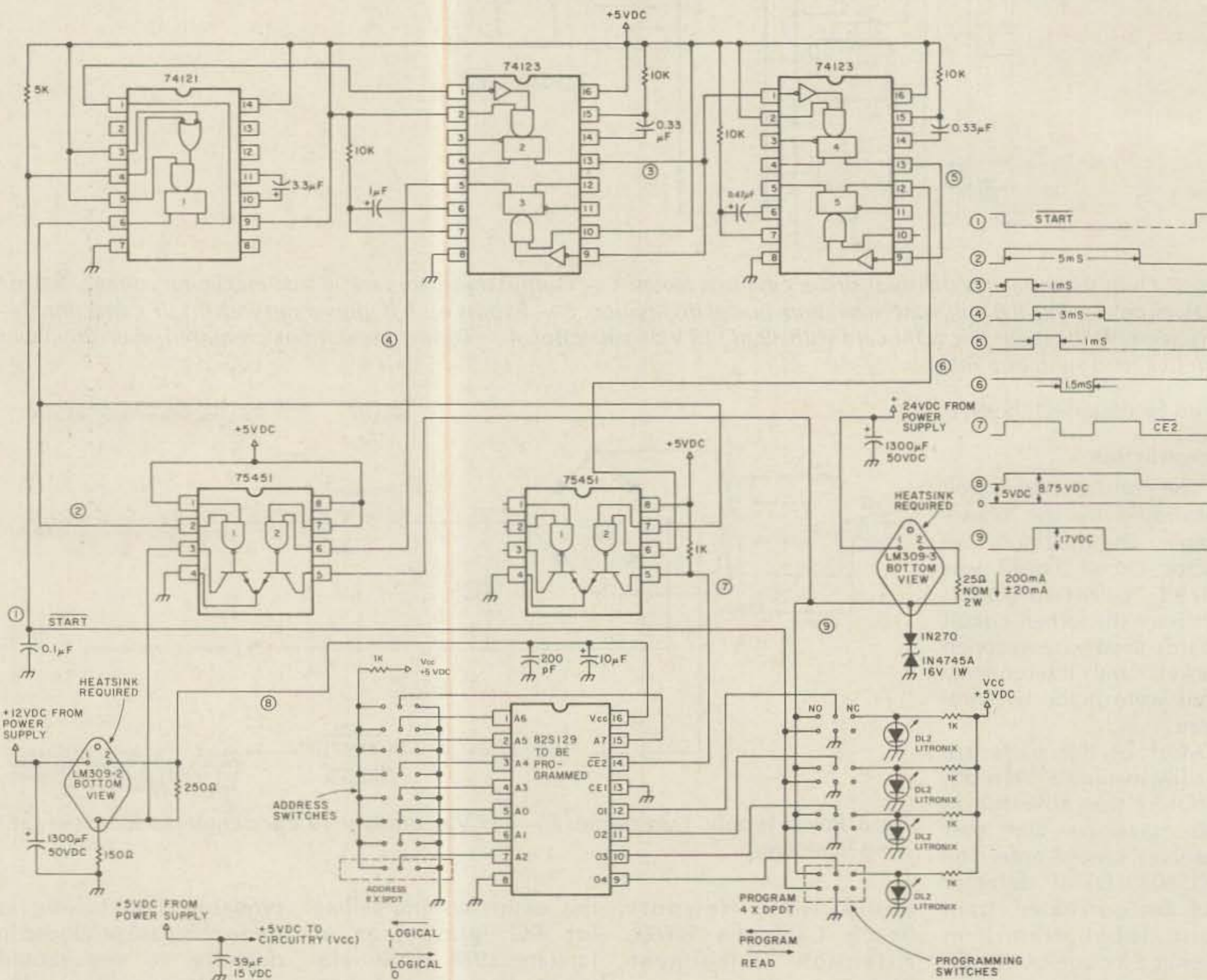

Fig. 9. PROM blaster circuitry. Notes: 1—All resistors 1/4 Watt unless otherwise indicated. 2—All capacitors are uF unless otherwise indicated.

Adjustments

The only adjustment required to your touchtone control system is the alignment of the preprocessor circuitry. Refer to Fig. 3 and proceed as follows. Connect the audio input to your source of touchtone signals. Verify with an oscilloscope that the audio level at the wiper arm of the two gain pots, Rg, is 100 millivolts peak-to-peak. Beginning with the low-tone group, generate a 697-Hz tone by depressing both digits 1 and 2 on your touchtone pad. While observing the output signal at the first amplifier, U1a, on an oscilloscope, adjust R_{LL} for maximum signal. Next, move your oscilloscope to the output of U1b, generate a 941-Hz tone by depressing the digit 0 and the digit * on the touchtone pad, and adjust R_{LH} for maximum signal. Returning to the 697-Hz tone, adjust the R_{LL} associated with U1c for maximum signal at the output of U1c. Returning to the generation of the 941-Hz signal, adjust R_{LH} associated with U1d while observing the output of U1d. Repeat the adjustment sequence while observing the output at U1d. Adjust the potentiometers as necessary to get uniform response to the 697-Hz tone, the 941-Hz tone, and the two tones in between, 770 Hz and 852 Hz. If the circuitry is working properly and is properly aligned, you should observe voltage levels at the output of U1d as shown in Fig. 3.

The high-tone group filter is aligned in a similar way, with the R_{HLS} adjusted for a maximum output from the 1209-Hz tone (digits 1 and 4 held down simultaneously) and the R_{HHS} adjusted for a maximum from the 1477-Hz tone (digits 3 and 6 held down simultaneously). After alignment of the band-

pass filters is completed, go back and adjust the gain pots, Rg, so that the voltages at the output of U1d and U2d are equal.

Next, using a voltmeter or an oscilloscope, adjust the voltage at the wiper arm of pot Rc to 3.7 volts dc. This should correspond to 0.5 volts dc lower than the dc voltage at the output of U1d and U2d. Next, observe the output of U3a and U3b on an oscilloscope while depressing digits on your touchtone pad. The signals observed should look very similar to square waves with timing between pulses a function of the tone frequency being received.

Extending Performance

The system can be easily extended to control more than the six functions that I have described. To do this, additional circuitry must be added and a method to address these additional control functions is required. The additional circuitry consists of adding more 82S129 PROMs, function flip-flops (7402s), and appropriate output circuitry. Each additional PROM will permit you to control two or more on-off functions or four one-shot functions. The binary counter and hex inverter that buffers the signals from the DTMF detector will drive up to 10 PROMs.

Access to these additional functions is obtained as follows: Note that the # digit on the touchtone pad has thus far not been used. Program your #1 PROM so that, when the digit # is depressed as the next digit after the access code, none of the control bits are set to logic 1, but the valid sequence bit continues to be logic 1. Now program your additional PROMs so that they will respond to the next digit received. If you want additional control digits beyond this, then program

your #1 PROM so that additional control functions can be accessed by the access code followed by #, #, and then the control digit, etc.

The unused digit # can be used for other functions. For example, if each of the members of your radio club had one of these units connected to his receiver, he could have it disable his speaker unless someone dials his access code followed by the appropriate digit to turn his speaker on. However, in an emergency, you might like to activate all of the club members' speakers simultaneously. Perhaps you have chosen a 5-digit access code with the first 2 digits unique to your club and the last three digits to identify the club member. By programming the PROM that activates the speaker to also respond to the first two digits followed by the #, with # programmed to set the speaker control bit, you could activate all club members' radios by the club identification number followed by the #. Normal function of the control system would not be affected. If you understand at this point how the PROMs are programmed, you should have little trouble determining the PROM address and output bit that should be programmed to permit this capability.

Another use for the # digit might be to turn on or off all of your devices at once. In this case, you would program the PROMs so that, at the conclusion of your access code, receipt of the # would cause all of the bits of all of the PROMs that reset flip-flops to be programmed for logic 1. Again, normal operation would not be affected.

These are probably just a few of the ways that the performance of this control system can be en-

hanced. The use of inexpensive PROMs permits you to try all sorts of ideas without the need to rewire circuitry.

Conclusion

I have described a small, easily reproduced, flexible and extendable touchtone control system that can be used to control any electrically-activated device remotely. Performance of this device has been most gratifying. I have had it operating for several months on my two meter receiver, and I have yet to experience any false decoding. I am using a five-digit access code. The system responds reliably and rapidly to touchtone signals, with a performance that parallels what you expect of a commercial touchtone telephone.

In the last ten years, DTMF detector circuitry has evolved from LC filters to 567 phase locked loops to, now, the CRC-8030 DTMF detector. With our rapid growth in IC technology, I am sure the 8030 will someday be obsolete, but replacing it will give the semiconductor manufacturers a hard act to follow. ■

References

1. National Semiconductor Corporation Linear Applications, volume 1, 1976, *Designing RC Active Filters* (with the LM3900 quad "Norton" amplifier), paragraph 6.4, "A single amplifier bandpass active filter," pages AN7-15 through AN7-16.
2. J. H. Everhart WA3BXH, "Toward a More Perfect Touchtone Decoder," 73, November, 1976, pages 178-181.
3. Rockwell-Collins CRC-8030 MOS/LSI dual-tone multifrequency detector data sheet. Rockwell International, 4311 Jamboree Boulevard, Newport Beach, California 92663.
4. M. Hammad, Rockwell-Collins application note CRC-8030, *Telephone DTMF Telephone Receiver*, January, 1977, Rockwell International, Newport Beach, California.

CALL TOLL FREE 1-800-633-3410

Long's suggests MFJ

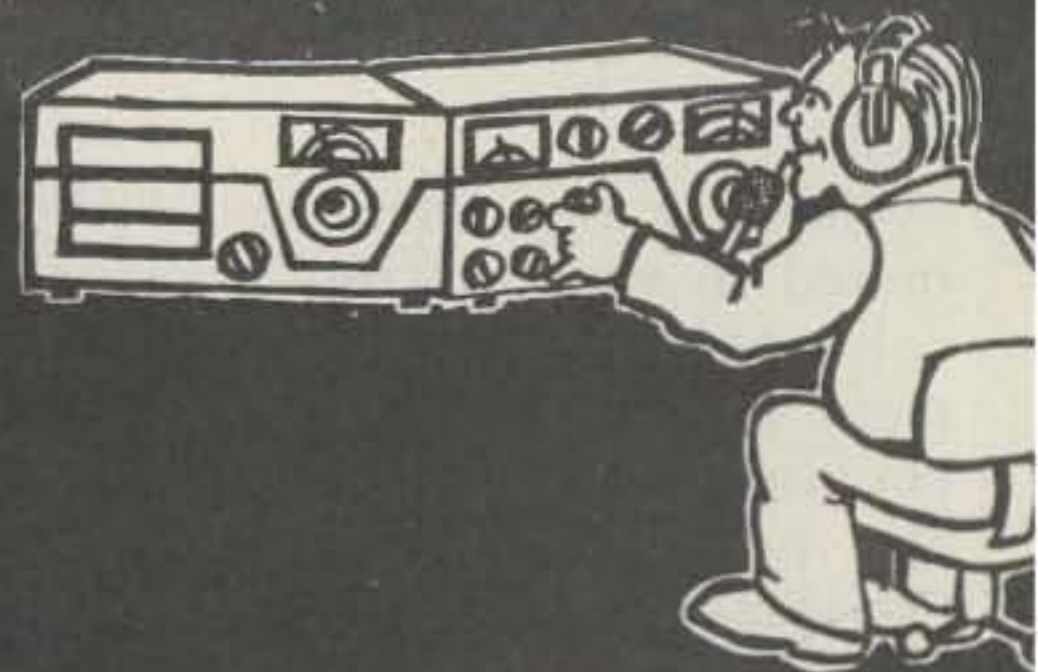

MFJ Grandmaster Keyer

A keyer with memory. Has speed control 8 to 50 WPM, LED to show which memory is in use and when it ends, has record and playback control, and has up to twelve 25 character messages plus a 100, 75, 50, or 25 character messages.

139.95 Call for yours today.

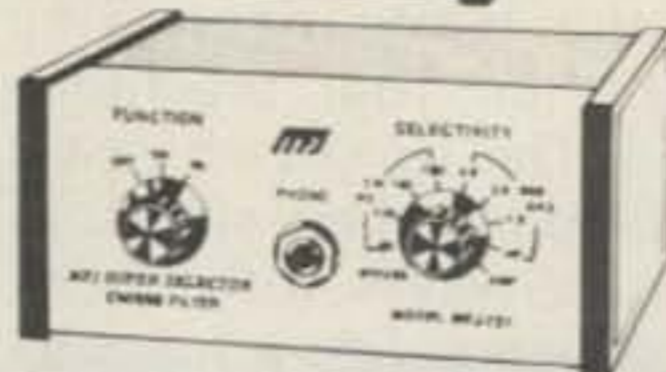
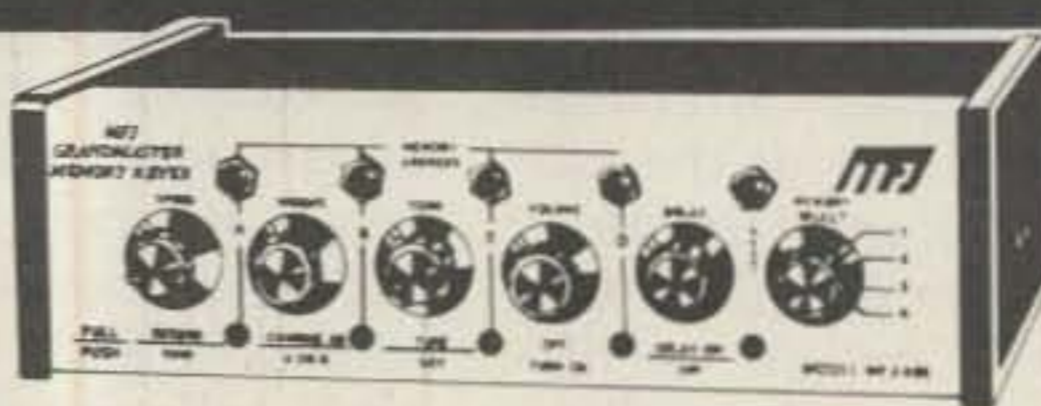

MFJ 721 Super selector CW/SSB filter

This new filter gives you 80 Hz BW, steep SSB skirts, noise limiting, 2 watts for the speaker, select your bandwidth, and has an 8 pole active IC filter.

59.95 Call for yours today.



MFJ-941 Versa Tuner II

MFJ's new Versa Tuner II has: • SWR • Dual rane wattmeter • Antenna switch • Efficient airwound inductor • Built-in 1:4 balun • Up to 300 watts RF output • Transmitter & antenna matching capacitors: 208 pf. 1000 V spacing.

79.95 Call for yours today.



MFJ 400 econo keyer

Speed 8 to 50 wpm pull-to-tune, adjustable sidetone and volume. Internal weight control lets you adjust dot-dash space ratio. Dot memory. May be used with squeeze key for iambic operation.

39.95 Call for yours today.



MFJ-202 RF noise bridge

Adjust your antenna quickly for maximum performance. Measure resonant frequency, radiation resistance and reactance. Has exclusive range extender and expanded capacitance range (+ 150 pf) for extended measuring range. Uses 9 V battery.

49.95 Call for yours today.

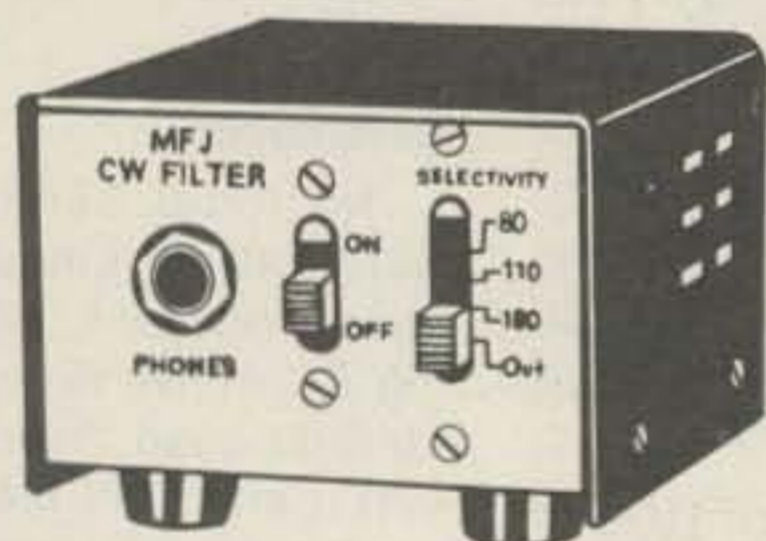

MFJ CWF-2BX super CW filter

The MFJ CW filter has: • Selectable band width: 80, 110, 180 Hz • 60 dB down one octave from center frequency of 750 Hz for 80 Hz BW • Reduces noise 15 dB • 9 V battery • Plugs in between receiver and phones • 8-pole active IC filter.

29.95 Call for yours today.

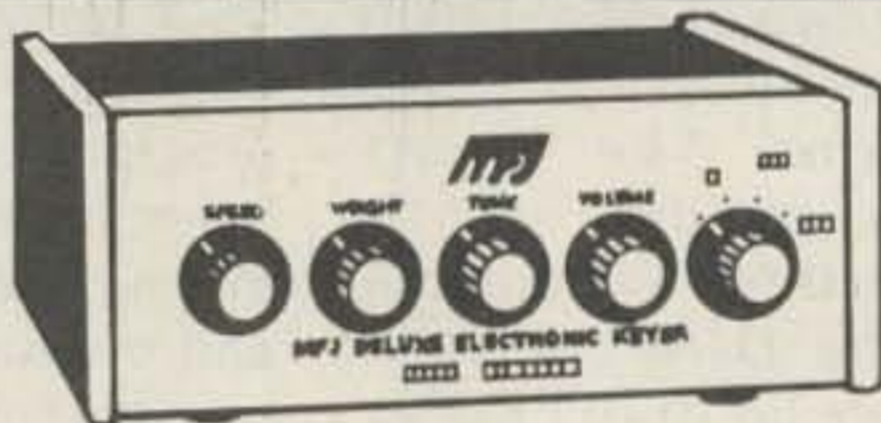

MFJ 8043 IC deluxe keyer

8043 IC features: • 4-way sending: iambic, automatic, semi-auto, & manual • iambic squeeze key operation • Semi-auto "bug" operation provides auto dots & manual dashes • Dot memory: self-completing dots & dashes • Totally RF proof • Solid-state keying • Weight & tone control • Optional squeeze key shown: only 29.95.

69.95 Call for yours today.

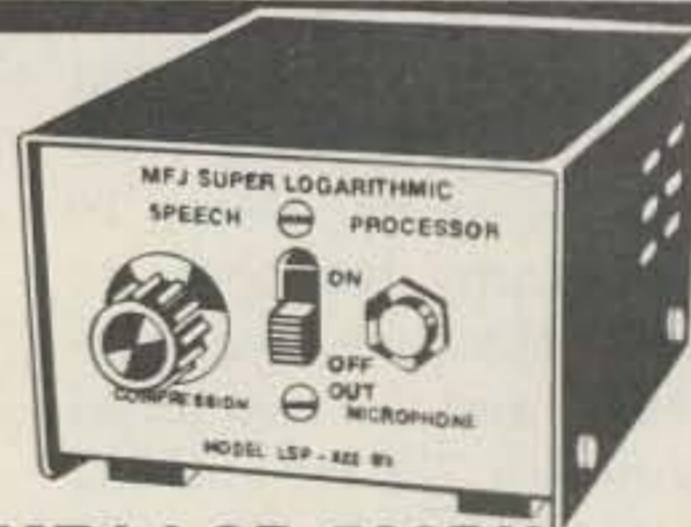

MFJ-LSP-520BX logarithmic speech processor

Up to 400% more RF power. Plug the unit in between mic. and transceiver and it's "solid copy OM". • 30 dB dynamic range IC log amp and 3 active filters give clean audio • RF protected • Uses 9V battery • Has 3 conductor, 1/4" phono jacks for input & output.

59.95 Call for yours today.

Remember, you can Call Toll Free: 1-800-633-3410 in the U.S.A. or call 1-800-292-8668 in Alabama for our low price quote. Store hours: 9:00 AM til 5:30 PM, Monday thru Friday.



Long's Electronics

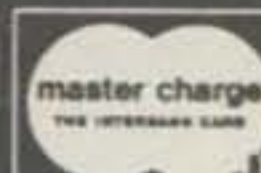

MAIL ORDERS: P.O. BOX 11347 BIRMINGHAM, AL 35202 • STREET ADDRESS: 2808 7TH AVENUE SOUTH BIRMINGHAM, ALABAMA 35233

Long's suggests DENTRON

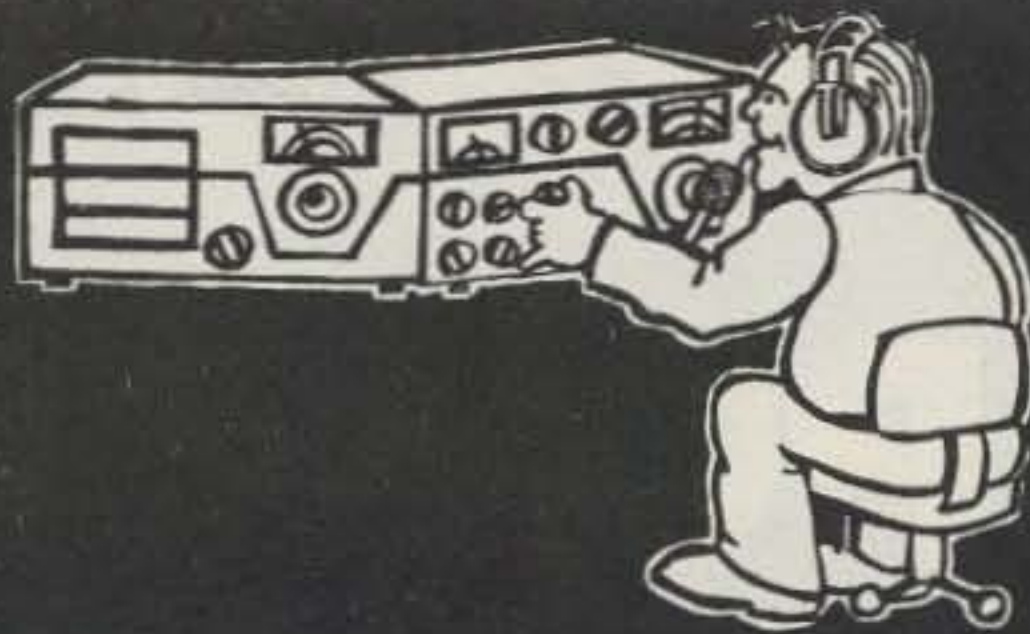

CALL TOLL FREE 1-800-633-3410

DENTRON DTR-2000L Precision linear amplifier

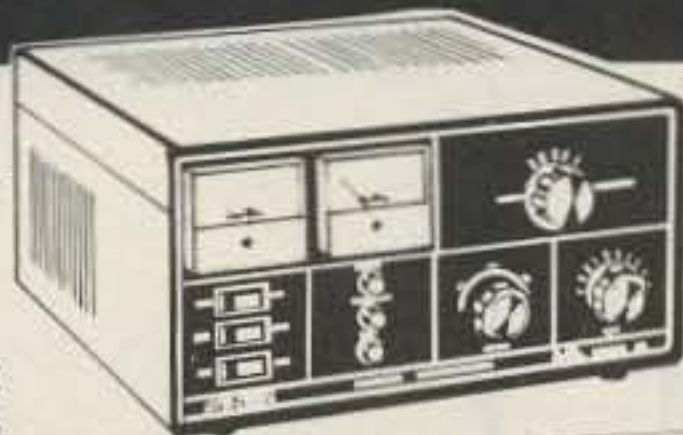

Features range from a Broadcast proven 8877 tube to a continuous duty built-in power supply with a vacuum impregnated power transformer. Cooling is EIMAC spec. forced air, dual metering and more. Freq: 15-160 meter bands — 1.8-23.50 MHz. 2000W P.E.P.

1099.50 Call for quote.

DENTRON MLA-2500B linear amplifier

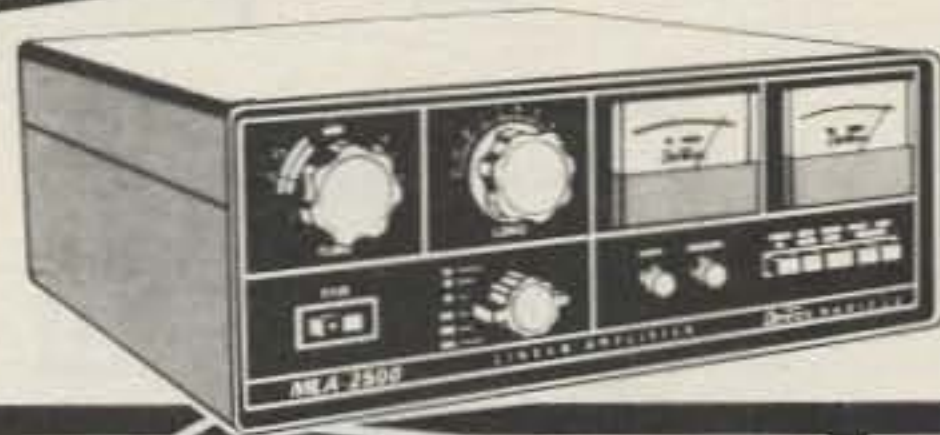

The world famous MLA-2500B has the EIMAC 8875 work horse finals, self-contained continuous duty power supply, full complement metering and controls from the front panel, plus new High-Low power switching. Freq. range: 1.8 MHz-21 MHz. 2000 W. P.E.P.

899.50 Call for quote.



DENTRON MT-3000A antenna tuner

The MT-3000A is Dentron's ultimate tuner. Tunes 3 coax, random wire and balanced feed system, just select the one. Handles in excess of 3KW PEP • Built-in 50 ohm-250W dummy load • Dual watt meters • 3 core heavy-duty Balun.

349.50 Call for quote.



DENTRON MT-2000A antenna tuner

An economical, full power tuner designed to handle virtually any type of antenna. Features: • Continuous tuning 1.9 to 30 MHz • Handles a full 3 KW PEP • Front panel coax bypass switching • Built-in 3-core balun. Front panel grounding switch.

199.95 Call for quote.



DENTRON Super Tuner Plus

1000 watt CW and 1200 watt SSB, continuous tuning from 1.8 to 30 MHz, selectable antenna functions, alternate output, and coaxial tuning.

149.50 Call for quote.

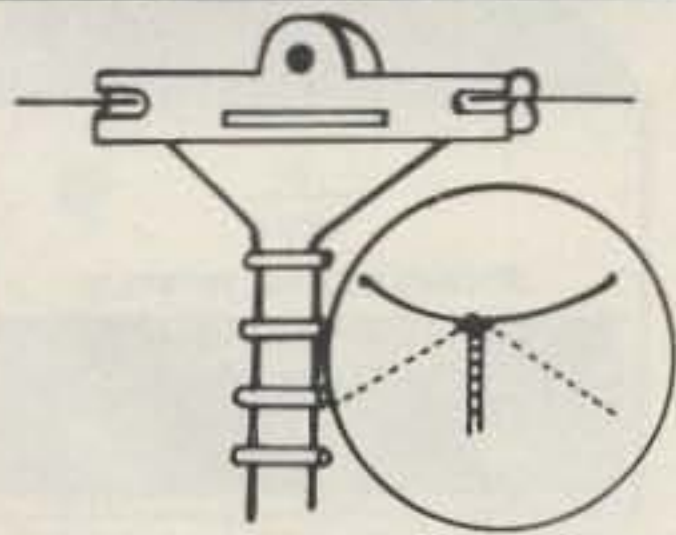

DENTRON All Band Doublet antenna

- Has a total length of 130 feet (14 ga. stranded copper) • Center fed through 100 ft. of 470 ohm PVC covered balanced transmission line • Assembly complete • Tune 10 thru 160 with one antenna • (Requires antenna tuner).

24.50 Call for yours today.



DENTRON Big Dummy Load

Tune-up off the air with Dentron's Big Dummy Load. A full power dummy load, it has a flat SWR, full frequency coverage from 1.8 to 300 MHz. A high grade industrial cooling oil is furnished with the unit. Fully assembled and warrantied. Help cut out the QRM factor NOW!

29.50 Call for yours today.



DENTRON Clipperton L

160 thru 15 meters, 2000 watts PEP on SSB, 1000 watts DC on CW, RTTY, or SSTV, covers most MARS frequencies just outside Ham bands, and easily changed 117V or 234V AC 50-60 Hz.

599.50 Call for quote.

Remember, you can Call Toll Free: **1-800-633-3410** in the U.S.A. or call **1-800-292-8668** in Alabama for our low price quote. Store hours: 9:00 AM til 5:30 PM, Monday thru Friday.

VISA

Long's Electronics

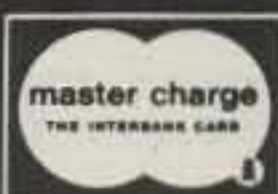

CALL TOLL FREE 1-800-633-3410

Long's suggests

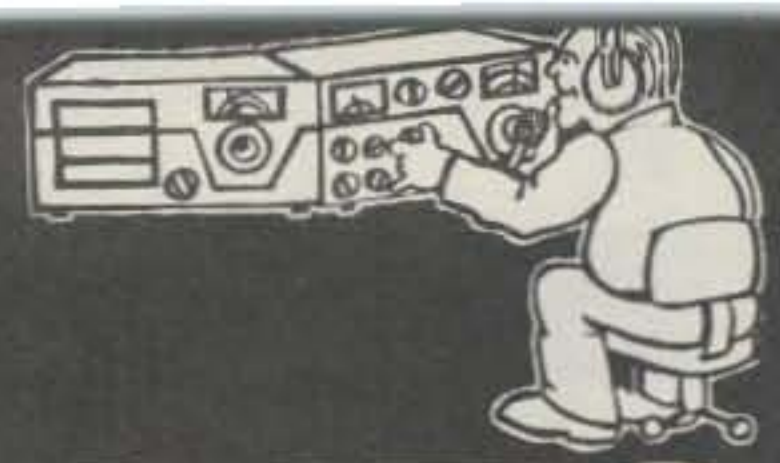

POWER SUPPLIES

INNERSPACE IPS 30 M analog amp.

Has an output voltage of 3-14 VDC, continuous current: 20, power req. 110-130 VAC 50/60 Hz, DC output fuse 30A, primary fuse 10A, and has meters.

289.95 Call for quote.

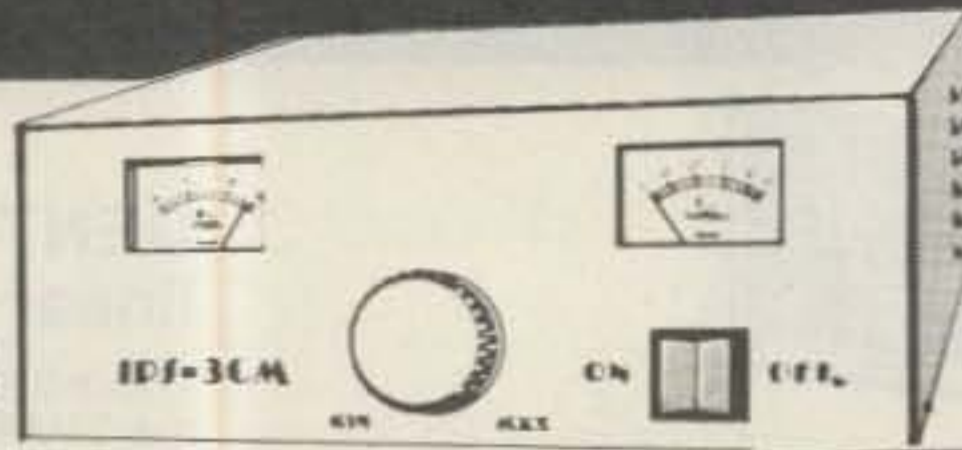

INNERSPACE IPS 30 D digital amp.

Has an output voltage of 3-14 VDC, continuous current 20, primary fuse 10A, DC output fuse 30A, power req. 110-130 VAC 50/60 Hz, and has a digital readout.

349.95 Call for quote.

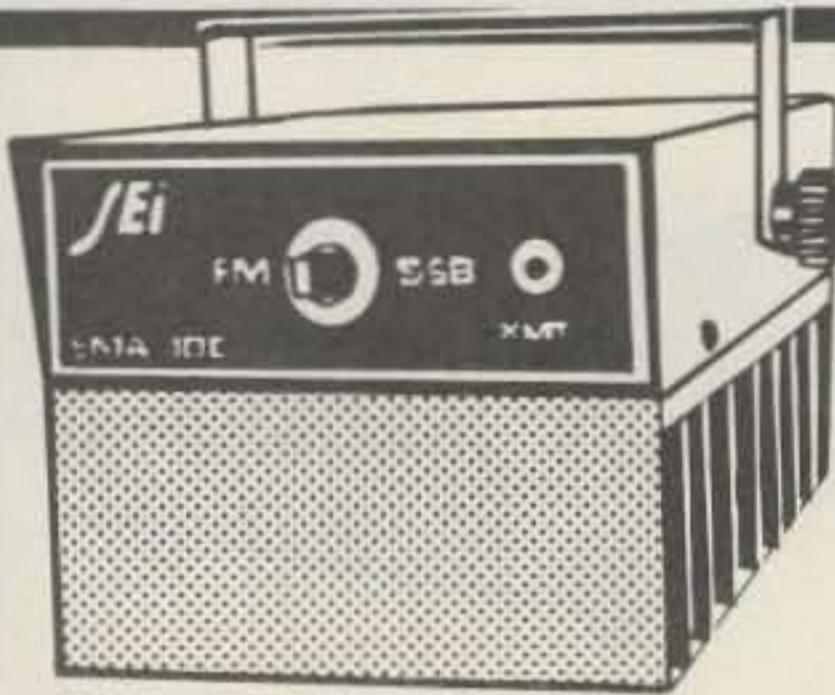
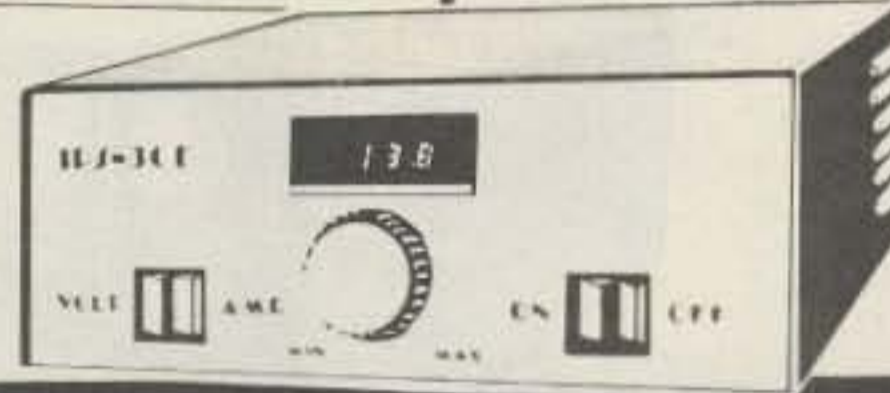

SEI SMA-100 FM or SSB 2 meter mobile amp

Power output: 15 watts input = 75 watts output typical, max. drive 25 watts FM, 20 watts PEP SSB, VSWR protection, complete with mobile mounting bracket, supply voltage 13.6 VDC.

199.95 Call for quote.

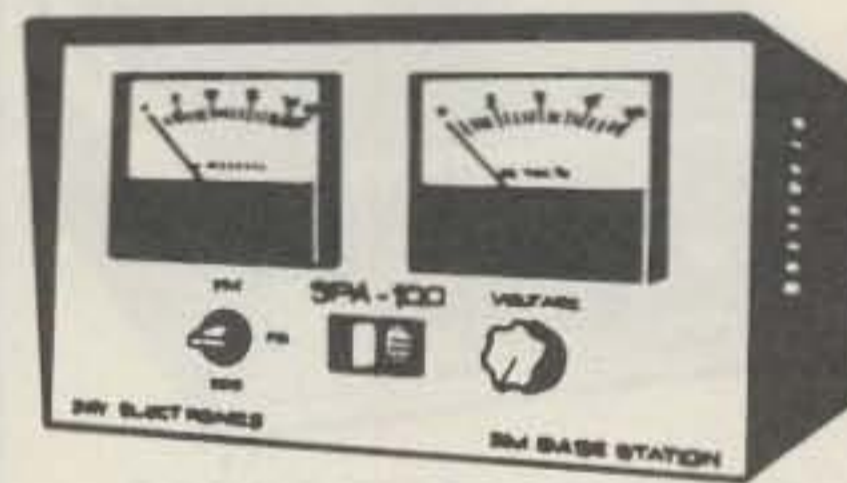

SEI SPA-100 2 meter power amp & supply

Power supply output: voltage adjustable (3VDC-14VDC), 10 amps DC continuous current, Amp. power output 15 watts in/75 watts out typical, max. drive 25 watts, bias selectable, FM or SSB.

399.95 Call for quote.



SEI SPS-10 regulated power supply

Without a meter, this unit has an output voltage of 13.6 VDC ± .3VDC, current limit 12 amps, continuous current 10 amps, auto. current limiting, overvoltage protection, and short circuit protection.

111.95 Call for quote.



NPC 108RM regulated power supply

Converts 115 VAC to 13.6 DC ± 200 millivolts. 8 amps continuous, 12 amps max. All solid state. Features dual current overload & overvoltage protection. Great for mobile Ham radio 2 meter AM-FM-SSB transceivers. Can be used to trickle-charge 12V car batteries.

99.00 Call for quote.



NPC 109R regulated power supply

Converts 115 volts AC to 13.6 volts DC ± 200 millivolts, 10 amps continuous, 25 amps max., all solid state, dual current overload, overvoltage and thermal protection.

159.95 Call for quote.



NPC 104R regulated power supply

Converts 115 VAC to 13.6 DC ± 200 millivolts. Handles 4 amps continuous and 6 amps max. Solid-state. Excellent where DC stability is important such as small Ham or CB rigs, or 8 track car stereos. Use to trickle-charge 12V car batteries.

49.95 Call for yours today.

Remember, you can Call Toll Free: **1-800-633-3410** in the U.S.A. or call **1-800-292-8668** in Alabama for our low price quote. Store hours: 9:00 AM til 5:30 PM, Monday thru Friday.



Long's Electronics



MAIL ORDERS P.O. BOX 11347 BIRMINGHAM, AL 35202 • STREET ADDRESS: 2808 7TH AVENUE SOUTH BIRMINGHAM, ALABAMA 35233

Long's suggests ACCESSORIES

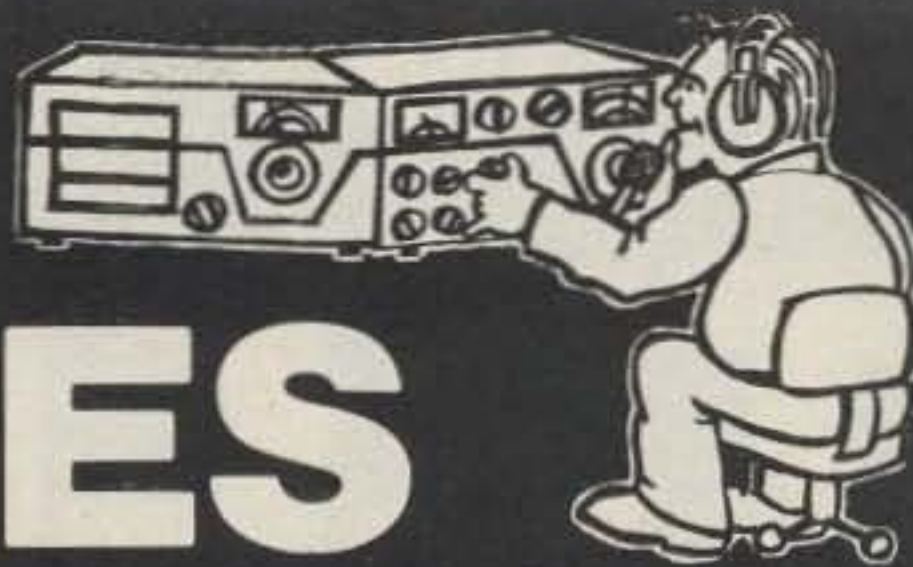

CALL TOLL FREE 1-800-633-3410

BIRD MODEL 43 ThruLine® watt meter

50 ohms nominal impedance. VSWR with UHF connectors 1.05 max • Expanded scales of 25, 50 & 100 permits direct reading from 100 Mw to 10,000 watts.

125.00 Call for yours today.



BIRD plug-in elements

Frequency Bands in MHz

Power range	2-30	25-60	100-250	200-500	400-1000
5W		5A	5C	5D	5E
10W		10A	10C	10D	10E
25W		25A	25C	25D	25E
50W	50H	50A	50C	50D	50E
100W	100H	100A	100C	100D	100E
250W	250H	250A	250C	250D	250E
500W	500H	500A	500C	500D	500E
1000W	1000H	1000A	1000C	1000D	1000E
2500W	2500H				
5000W	5000H				

H-Elements (2-30 MHz) **44.00 ea.**

A-C-D-E-Elements (25-1000 MHz) ... **38.00 ea.**

AEA AD-1 automatic dialer

You get 18 numbers from a 1-2 punch. Make quick and safe auto-patch calls. The AD-1 features: Key-Pad programmable memory, built-in speaker, MOS microprocessor. Crystal controlled & mates with virtually all FM transceivers.

129.95 Call for quote.



ANTLER A-280 2m mobile antenna

The A-280 is as close to the ideal antenna as you can get. Features:

- Precision tuned coil
- 47" tapered 17-7 stainless steel whip
- VSWR: less than 1.3
- Certified 3 dB gain
- Magnetic mount has roof-top stability to withstand winds up to 100 MPH.

39.95 list price. Call for quoted.



CDE Ham III antenna rotor

The Ham III rotor sets new levels of rotor performance! Snap action switched wedge brake & rotational controls brings pinpoint accuracy to any directional beam. New motor and brake designs, offering pre-brake action stronger lock-in place action, make the Ham III ideal for in-tower mounting.

159.95 Call for quote.



BENCHER Model BY-1 lambic keyer paddle

This is the ultimate paddle. It has adjustable contact point spacing, wide tension adjustment, self adjusting needle bearings, solid silver contact points, precision-machined components, and a heavy textured black base with non skid feet. Model BY-2 has a polished chrome base. 49.95

39.95 Call for yours today.



SWAN SWR-1A power meter and SWR bridge

Frequency range: 3.5 to 150 MHz • Compact and light weight for portable or mobile use • Capable of handling 1,000 watts RF and measures 1:1 to infinity VSWR.

29.95 Call for yours today.



YAESU QTR-24 world clock

Features world time at a glance. Time in any principal city or time zone can be coordinated with local time on a 24-hour basis. The Time Zone Hour Disc automatically retains the correct time. Uses one "C" battery.

35.00 Call for yours today.



Remember, you can Call Toll Free: **1-800-633-3410** in the U.S.A. or call **1-800-292-8668** in Alabama for our low price quote. Store hours: 9:00 AM til 5:30 PM, Monday thru Friday.

VISA

Long's Electronics

master charge
THE OFFICIAL CARD

CALL TOLL FREE 1-800-633-3410

Long's suggests

TELEX

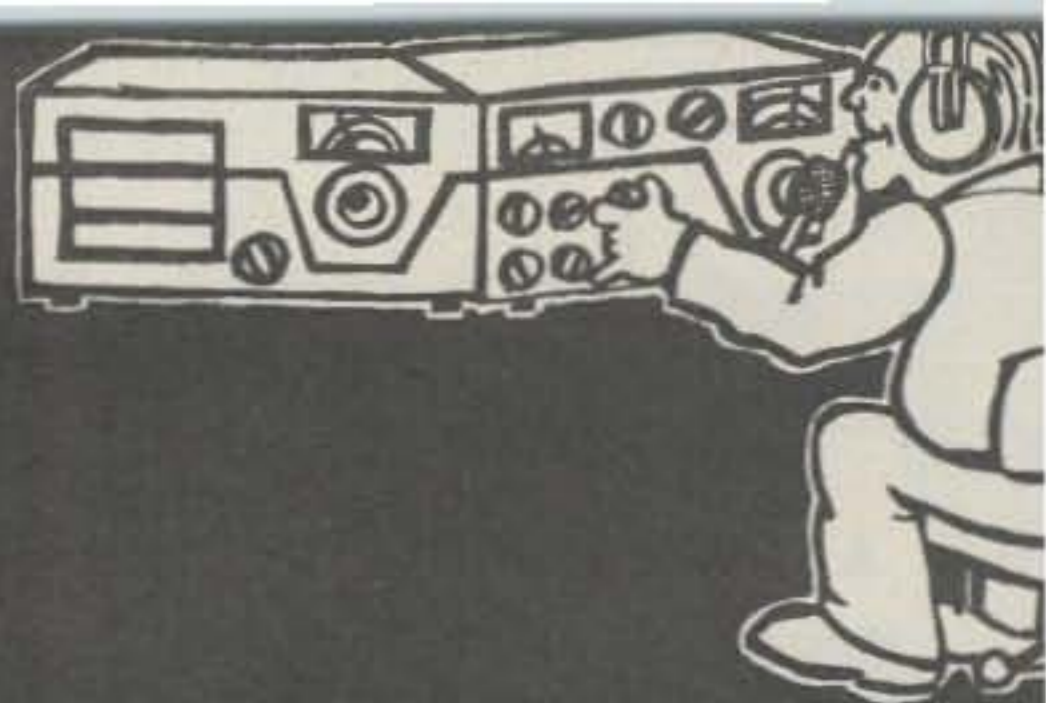

TELEX CM-1320 headset

This is Telex's best headset. It's the top of the line with a ceramic, boom microphone, high impedance 50K, and the hchoice of DX-peditions. Don't wait. Order today.

71.70 Call for yours today.



TELEX CM 1320-S single earpiece headset

If you prefer a single earpiece headset, choose this top quality one. This has a ceramic, boom microphone, high impedance, mobile operation, and a choice of DX-peditions.

57.25 Call for yours today.

TELEX CB-1200 Mobile "FM"

VHF House or Mobile-high performance audio on transmit and receive. Fet amplifier, low Z microphone. Earphone 8 ohms — in-line PTT.

59.95 Call for yours today.



TELEX HMC-2 lightweight headphones

These headphones are feather-weight aluminum. The underchin tone arms direct signals into the ear. Great for contests. 1.2 ozs., 100-3000 hz., low impedance, and 8-20 ohms.

13.85 Call for yours today.

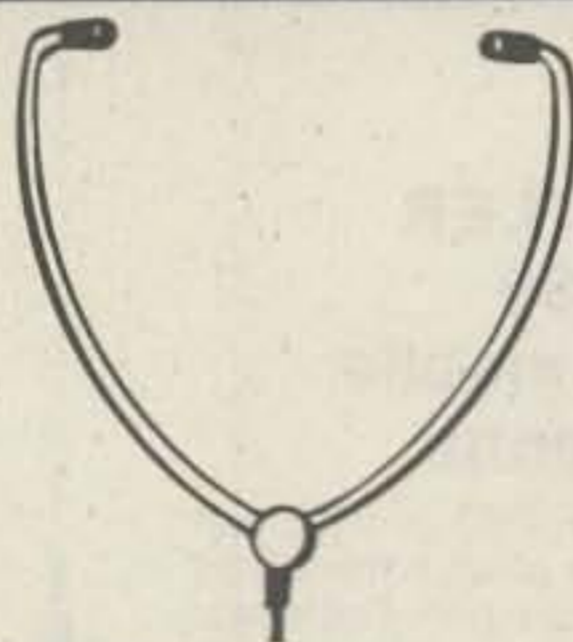

TELEX CM-1210 headset with microphone

Ceramic, 50,000 ohms. Ideal for traffic nets.

59.75 Call for yours today.



TELEX ProCom I Electret mobile microphone

"Broadcast quality" — "clarity and crispness," describe the audio of the electret. Useable in low impedance. 1.4 volt battery (included) also powers and 10dB amplifier.

19.95 Call for yours today.



TELEX HTC-2 lightweight headphone

Lightest dual driver headset. Choice of the "pros" who must wear them for hours. 1.6 ounces, 100-3,000 Hz. Low impedance, 8-20 ohms.

22.00 Call for yours today.



TELEX HFC-91 lightweight headphone

Ultra-light underchin headphone. Accoustic delay of 1 millisecond enhances intelligibility on CW or SSB. Low impedance 8-20 ohms. Shaped response 100-3,000 Hz, 1.5 ounces.

8.95 Call for yours today.

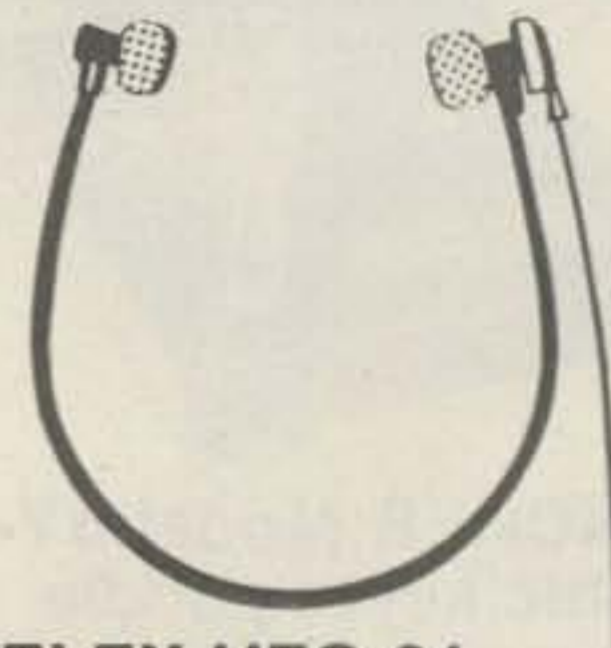

Remember, you can Call Toll Free: **1-800-633-3410** in the U.S.A. or call **1-800-292-8668** in Alabama for our low price quote. Store hours: 9:00 AM til 5:30 PM, Monday thru Friday.



Long's Electronics



MAIL ORDERS. P.O. BOX 11347 BIRMINGHAM, AL 35202 • STREET ADDRESS: 2808 7TH AVENUE SOUTH BIRMINGHAM, ALABAMA 35233

Longs suggests

ANTENNAS



CALL TOLL FREE 1-800-633-3410

HY-GAIN TH6DXX The Ultimate tribander

Gain 8.7 dB • Front-to-back ratio 25 dB • SWR (at resonance) less than 1.5:1 • Number of elements 6 • Frequency 10, 15, and 20 meters • Longest element 31.1' • Boom length 24' • Wind load at 80 m.p.h., 207 lbs. • Surface area 8.09 sq. ft. Balun BN-86 recommended 15.95.

296.95 list. Call for quote.

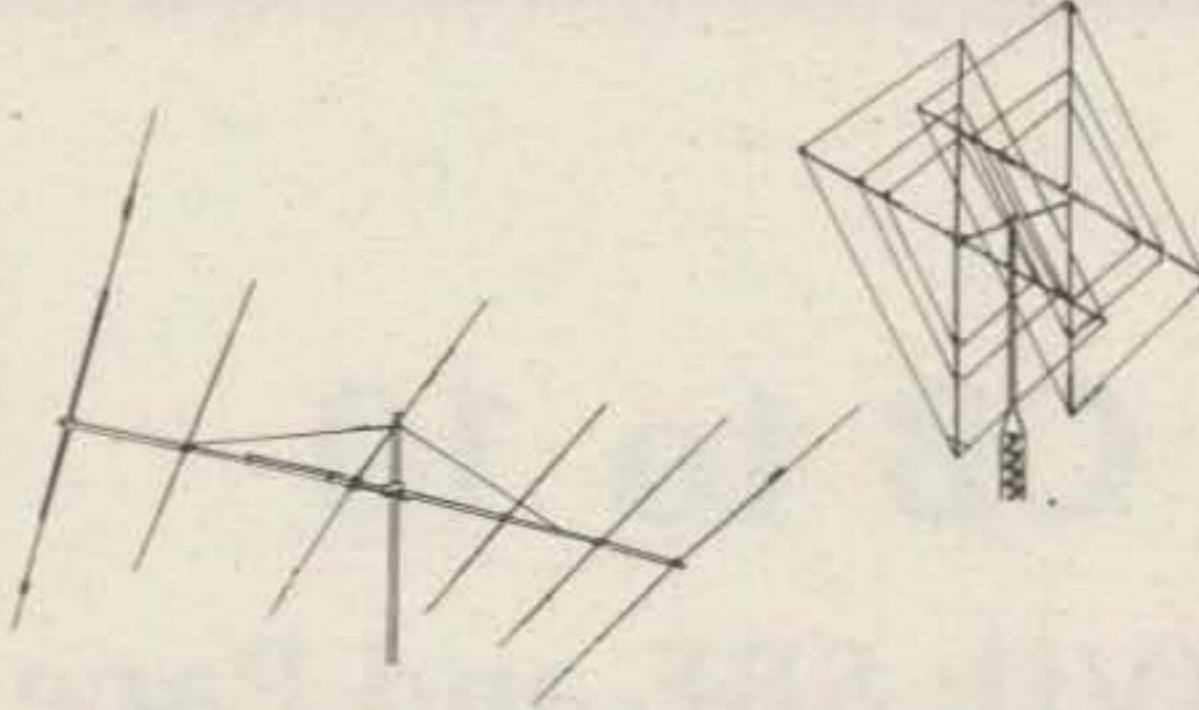

HY-GAIN 244 tri-band quad antenna

2-element Hy-Quad for 20, 15 & 10 meters. Horizontally polarized spreaders have Cyclocac® insulators. Full-wave element loops require no tuning stubs, traps, loading coils or baluns & delivers 8.5 dB gain.

229.95 Call for quote.

WILSON SYSTEM I 10, 15, 20 meter tribander

A DX'er's delight! A full 26' boom with 4 active elements on 20 meters. 4 operational elements on all 3 bands. Gain: 10 dB, F/B ratio: 20-25 dB. Surface area 8.6 sq. ft. Longest element 26'7". Balun BN-86 optional 16.95.

274.95 list price. Call for quote.

WILSON SYSTEM 2 10, 15, 20 meter tribander

A tribander featuring gain 8.5, 4-elements, 14-21-28 MHz, VSWR 1.5:1, boom length 18'6", longest element 26'7", surface area 6.15 sq. ft. and F/B ratio 20-25 dB.

219.95 list. Call for quote.

CUSHCRAFT ARX-2 2m antenna

Three 1/2 waves in phase and a 1/8 wave matching stub. Extremely low angle of radiation for better signal coverage. Turnable over a broad freq. range. Matched to 52 ohm coax.

32.95 Call for yours today.

HUSTLER 4-BTV vertical antenna

The 4-BTV HF fixed station four bander features 10, 15, 20, and 40 meter coverage, switching or matching devices not required, RM 75 option may be added for 75 meter coverage, 21'5" long, 2000 watts PEP power rating, bandwidth SWR 1.6:1 or better at band edges. Guaranteed easy assembly.

99.95 Call for quote.



CUSHCRAFT ATV5 trapped vertical antenna

Five band operation on 80 thru 10 meters, high Q traps are optimized for wide operating bandwidth, instructions provided for adjusting resonance to preferred part of band, built-in coaxial conn., hgt. 293", 2000 watts PEP on all bands. The ATV-4 is for 4 band use. List Price 89.95.

109.95 List. Call for quote.



CUSHCRAFT A147-11 2m antenna

The 11-element antenna is rated at 1000 watts with direct 52 ohm feed and PL-259 connectors. Boom length 144 ins. Longest element 40 ins. Gain/F/B ratio dB: 13.2/28. Freq. 146-148 MHz. Wind area 1.21 sq. ft.

34.95 Call for yours today.

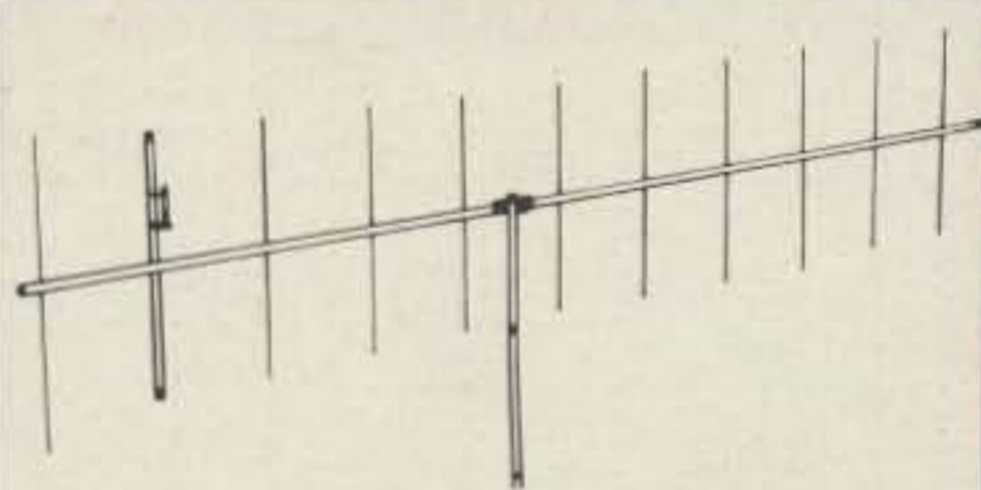

Remember, you can Call Toll Free: 1-800-633-3410 in the U.S.A. or call 1-800-292-8668 in Alabama for our low price quote. Store hours: 9:00 AM til 5:30 PM, Monday thru Friday.

VISA

Long's Electronics



CB to 10

— part XVII: SBE and Pace rigs

Easy conversions mean happy QRP mobiling.

Larry Fletcher K3SZN
PO Box 188
Churchton MD 20733

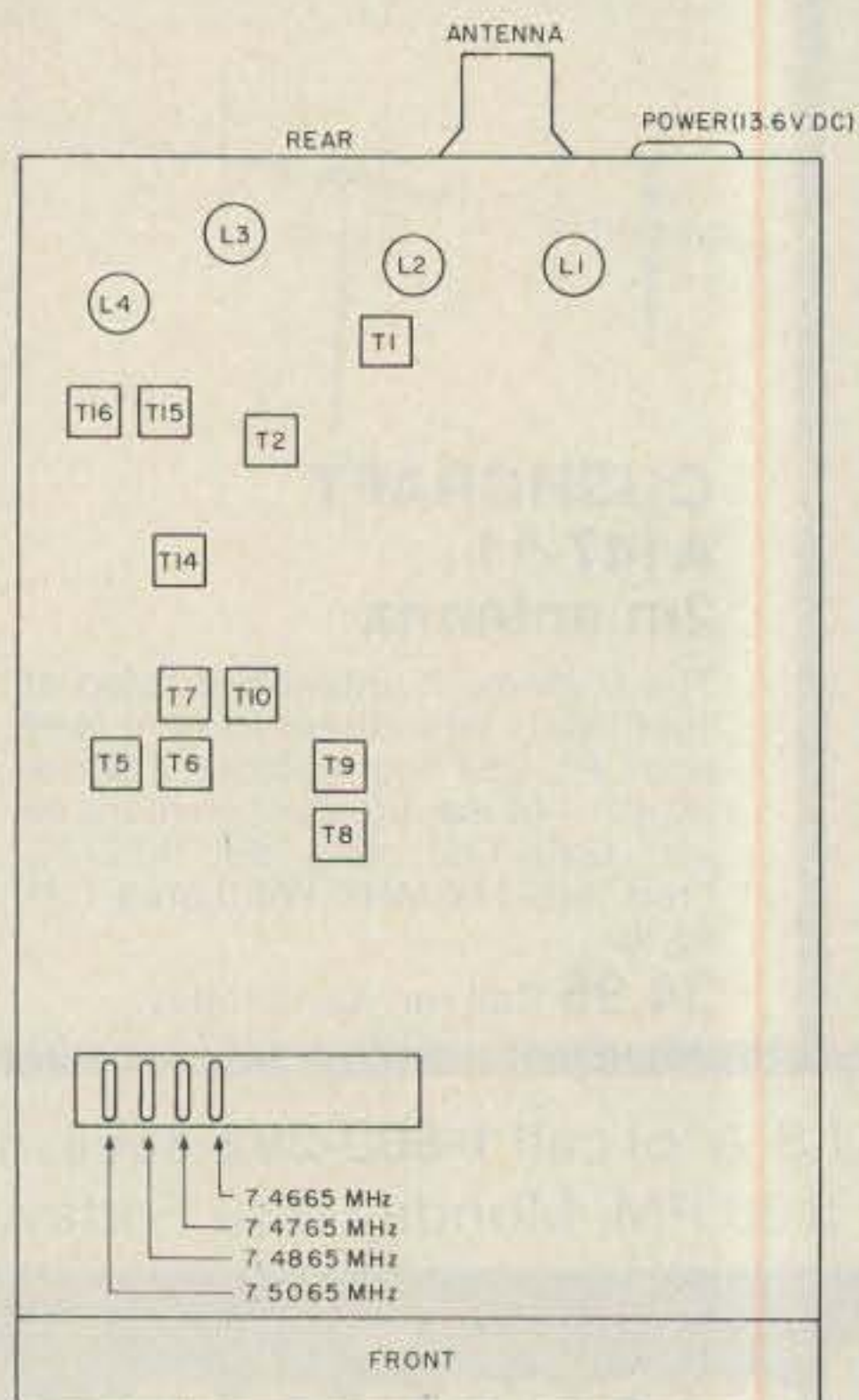

Fig. 1. SBE Sidebander III (SBE-18CB).

One of the easiest projects I have undertaken as an amateur and also one of the most rewarding has been the conversion of 23-channel CB rigs to 10 meters. I first converted an SBE "Sidebander III" a week before Christmas, 1977, and, with very little actual time on the air, worked eleven states and Europe from my car! I was hooked.

I have always found the 10 meter band to be friendly, and, although 5 Watts input power may not seem like much to some readers, it sure packs a punch in that delightful world of 28 MHz. Rather than fear the "big guys" on 10 meters, as some authors have suggested, my rig starts off at 28.510 MHz as channel 1, resulting in the band plan listed in Table 1. This hot little rig has performed so well that I have set myself a goal of "WAS 10 meter

QRP mobile" for this year, which I have every confidence of reaching.

I have since converted, and helped others in this area to convert, AM and SSB CB rigs of various other manufacture. One thing I have learned and would like to stress here is that "conversion" from 11 to 10 meters is easy. The only parts swapping required is the change in crystals. Once the crystals have been changed, only straightforward realignment of the oscillator, mixer, and rf portions of the rig affected by the frequency change is necessary. That is, no i-f alignment or alignment of those oscillator sections using the original crystals is necessary. Furthermore, the little realignment that is required can be accomplished with the barest minimum of test equipment. I estimate that ninety percent of all

YAESU ANNOUNCES THEIR SENSATIONAL COMPUTER AGE CPU-2500R/K 2-METER 25 WATT TRANSCEIVER



Again, Yaesu, THE RADIO, takes a giant step forward with their computer age 4-bit Central Processor Unit controlling the Phase Locked Loop. It allows selection of 800 PLL channels with touch button station selection built into the optional keyboard mike . . . **PLUS** automatic scan, up or down across the entire 2 meter band . . . **PLUS** four memory channels . . . **PLUS** optional tone squelch encoding . . . **PLUS** tone burst . . . **PLUS** high SWR and reverse voltage polarity protection . . . **PLUS** 3/25 watts of power . . . **PLUS** fixed ± 600 KHz offsets . . . **PLUS** programmable offsets . . . **PLUS** tone pad microphone option . . . **PLUS** bright 3/8" LED six digit frequency display and another LED for memory display . . . and much more.

The CPU-2500R/K is a space age radio for discriminating amateurs utilizing the latest solid state techniques and it's on your dealer's shelf today!

Price And Specifications Subject To
Change Without Notice or Obligation



YAESU *The radio.*

YAESU ELECTRONICS CORP., 15954 Downey Ave., Paramount, CA 90723 • (213) 633-4007
YAESU ELECTRONICS Eastern Service Ctr., 9812 Princeton-Glendale Rd., Cincinnati, OH 45246

23-channel CB rigs now available can be converted using only a 12-volt power supply, a piece of wire a few feet long (2 or 3 feet suffices, used as a signal source for oscillator/receiver mixer/receiver alignment), a cheap CB wattmeter or other output power indicator, and a 5-Watt dummy load (52-Ohm resistor, 5 Watt, or less, if properly heat sunk). A frequency counter or friend with a calibrated receiver permits certain refinements regarding netting and checking SSB "clarifier" ranges once the basic tune-up has been completed.

Practical Conversion Hints

First, I recommend that anyone undertaking this project either purchase or borrow the Sams *Photofacts* covering the CB to be converted. The *Photofacts* provides a readable circuit diagram, parts locator guides, and alignment procedures which can be easily adapted to the new frequency.

Secondly, avail yourself of a good set of properly-fitting nonmetallic alignment tools. The cores of many of the inductors/transformers in the typical CB rig are small and very fragile. Use a properly fitting tool and do not force it. A broken core usually jams in the form and is extremely difficult to remove without damaging the inductor or transformer. I broke the core in the synthesizer oscillator transformer in a Claricon CB and spent two hours on one conversion which should normally have taken less than fifteen minutes!

Finally, some cores are sealed in place at the factory using either a soft wax or a thin cement. For those cores sealed with wax, apply a small amount of heat to the wax to liquify it, us-

ing the tip of a soldering iron, while gently rocking the core back and forth with the alignment tool until the core loosens. For those cores sealed with cement, carefully chip away the cement using a small, sharp blade such as an X-Acto™ tool. These cements are more difficult to deal with than the wax, but are also not as commonly used.

Choosing a Band Plan

For those of you converting a sideband CB and looking for DX contacts, design your band plan to cover the lower 300 kHz of the phone band. I start with 28.510 MHz as channel 1, which keeps me comfortably away from the band edge. You will find plenty of action there!

For AMers, most of the activity I have observed is above 28.8 MHz. This is as it should be, because AM and SSB are not truly compatible. AM activity is still a little sparse, but should grow rapidly as the band conditions continue to improve and the number of CB conversions increases.

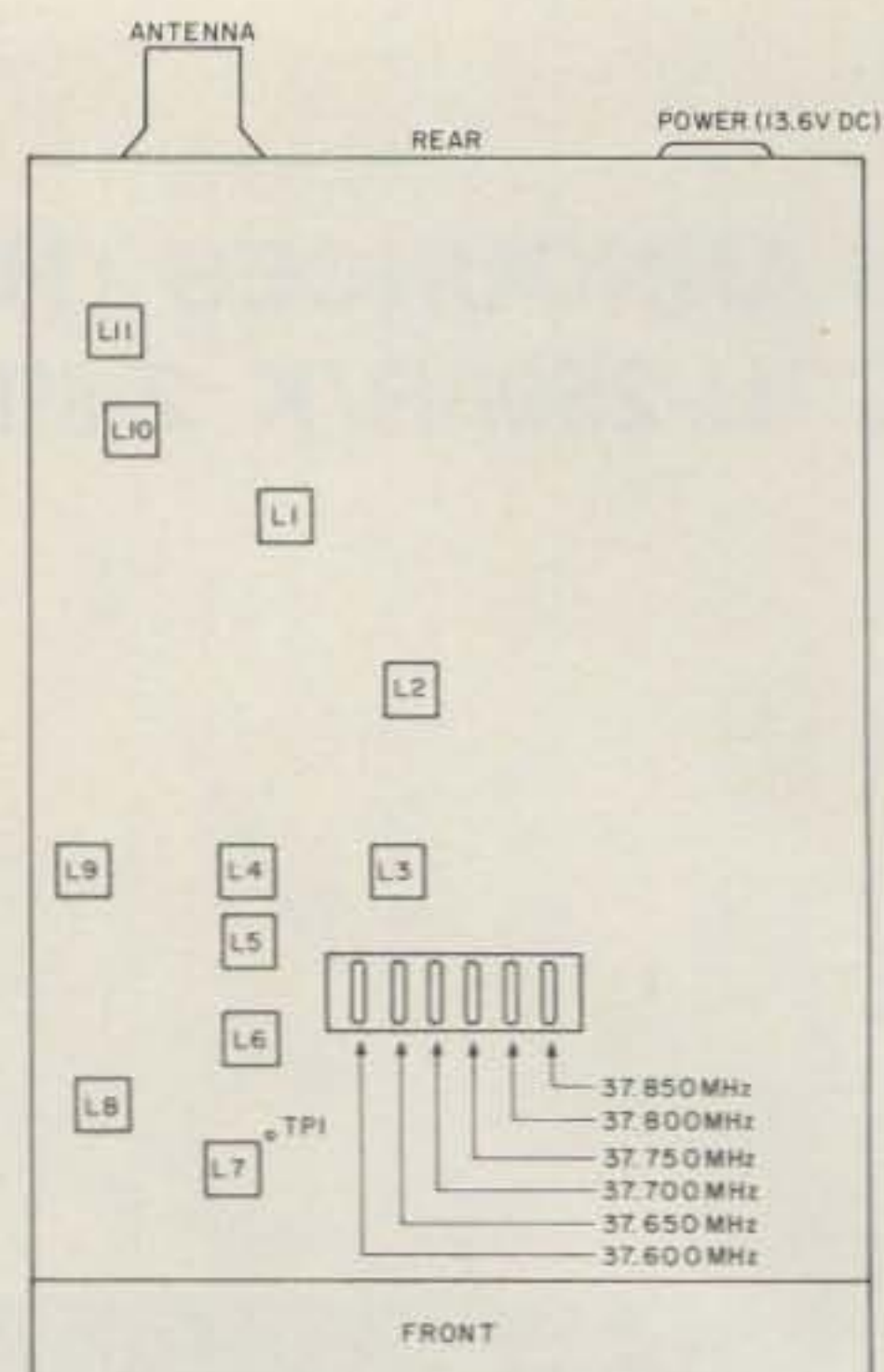

Fig. 2. Pace 123A.

Prior to my first AM conversions, several proposed band plans were in the literature. Unfortunately, none of these offered much in the way of either rationale or authoritative-ness, so my first conversions started with 28.8 MHz as channel 1. I now favor the so-called "73 band plan" (see Wayne Green's editorial in the

February, 1978, issue of *73 Magazine*). Although this plan offers no special magic over others I have seen, it has the support of the media (*73 Magazine*) and, for that reason, has a fighting chance of being generally adopted. The 73 band plan frequencies are exactly 2 MHz above their CB counterparts, with channel 1 being 28.965

Channel #	CB frequency	Original crystal	New crystal	10m frequency
1	26.965 MHz	7.4665 MHz	9.0115 MHz	28.510 MHz
2	26.975 MHz	7.4765 MHz	9.0215 MHz	28.520 MHz
3	26.985 MHz	7.4865 MHz	9.0315 MHz	28.530 MHz
4	27.005 MHz	7.5065 MHz	9.0515 MHz	28.550 MHz
5	27.015 MHz			28.560 MHz
6	27.025 MHz			28.570 MHz
7	27.035 MHz			28.580 MHz
8	27.055 MHz			28.600 MHz
9	27.065 MHz			28.610 MHz
10	27.075 MHz			28.620 MHz
11	27.085 MHz			28.630 MHz
12	27.105 MHz			28.650 MHz
13	27.115 MHz			28.660 MHz
14	27.125 MHz			28.670 MHz
15	27.135 MHz			28.680 MHz
16	27.155 MHz			28.700 MHz
17	27.165 MHz			28.710 MHz
18	27.175 MHz			28.720 MHz
19	27.185 MHz			28.730 MHz
20	27.205 MHz			28.750 MHz
21	27.215 MHz			28.760 MHz
22	27.225 MHz			28.770 MHz
blank				
23	27.255 MHz			28.800 MHz

Table 1. SSB band plan.

You're just a few digits away from name brand radio equipment - AT DISCOUNT PRICES!

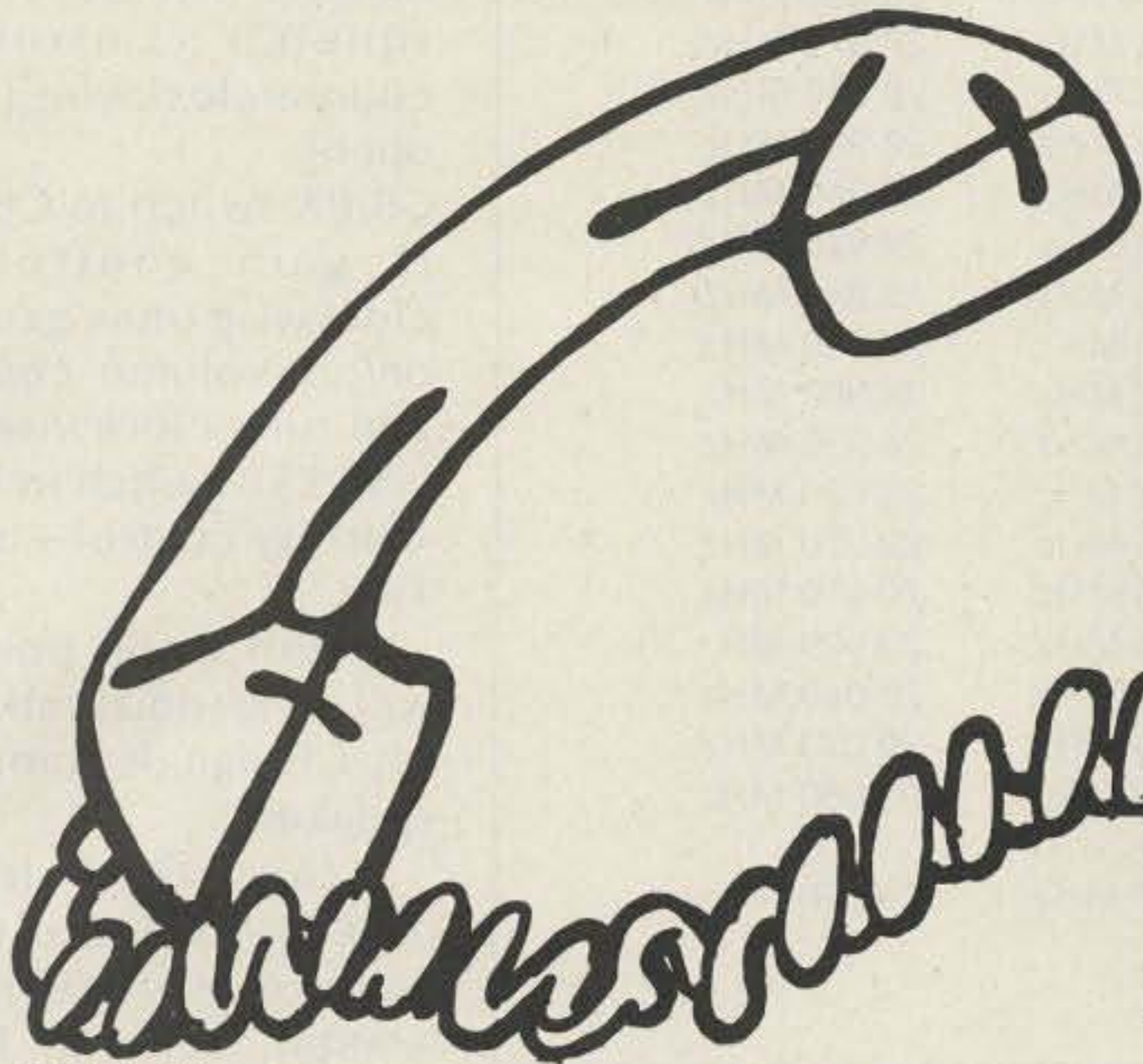

CALL TOLL FREE

1-800-228-4097
Communications Center

443 N 48th Street
Lincoln, Nebraska 68504
In Nebraska Call (402) 466-8402

1-800-634-6227
**Communications Center
West**

1072 N. Rancho Drive
Las Vegas, Nevada 89106
In Nevada Call (702) 647-3114

YAESU
KENWOOD
DRAKE
ICOM
STANDARD
EDGE COM
KDK
PANASONIC

DENTRON
HY-GAIN
MOSLEY
CUSHCRAFT
WILSON
HUSTLER
LARSEN
BENCHER

TAYLOR
SWAN
TEMPO
TEN-TEC
MIDLAND
CDE
AUTEK
MIRAGE

E.T.O. ALPHA
VHF ENGINEERING
BERK-TEK CABLE
CONSOLIDATED TOWER
SAY
SHURE
TELEX
ROBOT-SSTV

We carry all major lines of Antennas at Discount Prices

look

OUR NEW HOURS at Lincoln store only

look

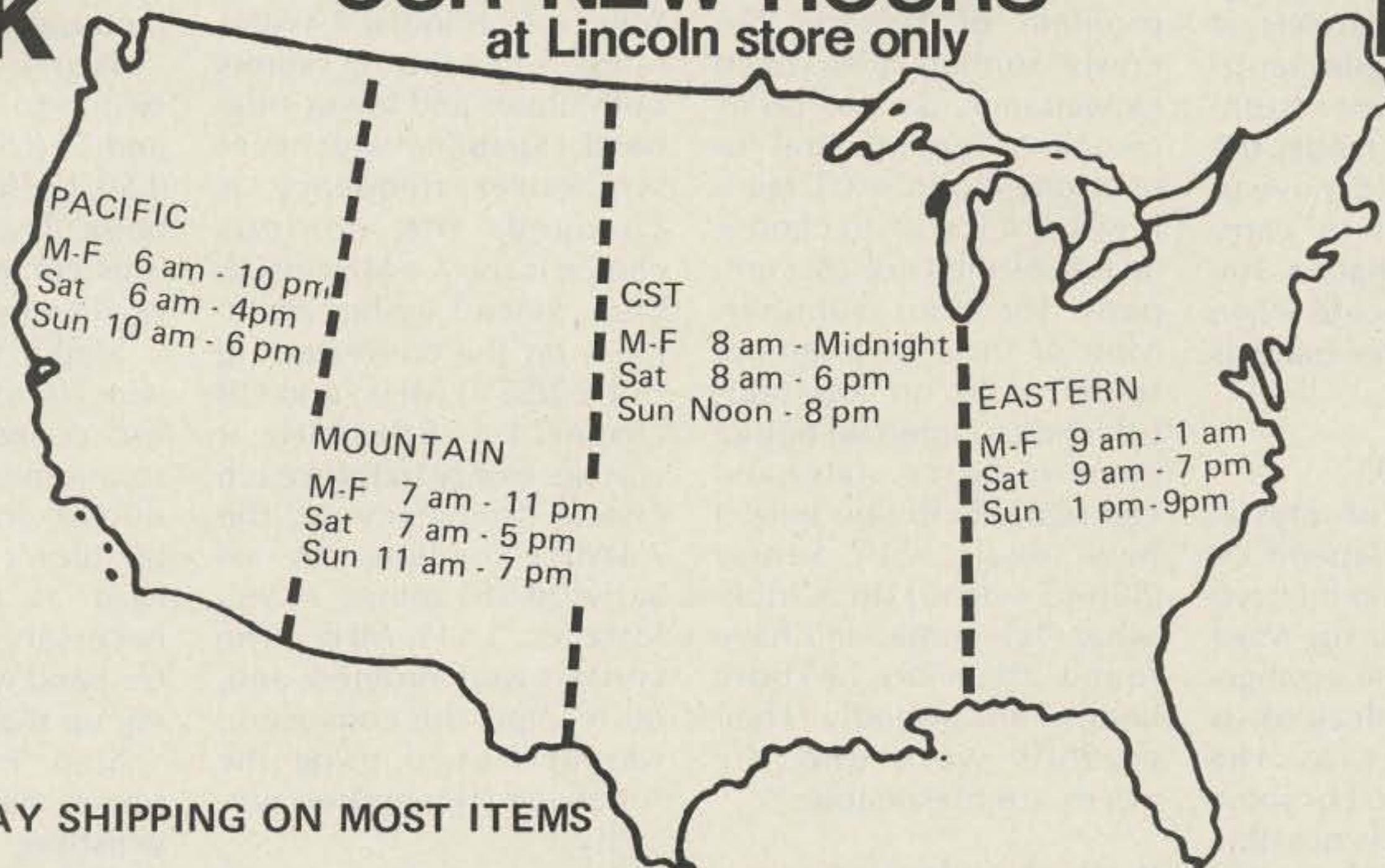

SAME DAY SHIPPING ON MOST ITEMS

1-800-228-4097

Communications Center

443 N. 48th, Lincoln, Nebraska 68504

In Nebraska Call (402) 466-8402



Channel #	CB frequency	Original crystal	New crystal	10m frequency
1	26.965 MHz	37.600 MHz	39.435 MHz	28.800 MHz
2	26.975 MHz	37.600 MHz	39.435 MHz	28.810 MHz
3	26.985 MHz	37.600 MHz	39.435 MHz	28.820 MHz
4	27.005 MHz	37.600 MHz	39.435 MHz	28.840 MHz
5	27.015 MHz	37.650 MHz	39.485 MHz	28.850 MHz
6	27.025 MHz	37.650 MHz	39.485 MHz	28.860 MHz
7	27.035 MHz	37.650 MHz	39.485 MHz	28.870 MHz
8	27.055 MHz	37.650 MHz	39.485 MHz	28.890 MHz
9	27.065 MHz	37.700 MHz	39.535 MHz	28.900 MHz
10	27.075 MHz	37.700 MHz	39.535 MHz	28.910 MHz
11	27.085 MHz	37.700 MHz	39.535 MHz	28.920 MHz
12	27.105 MHz	37.700 MHz	39.535 MHz	28.940 MHz
13	27.115 MHz	37.750 MHz	39.585 MHz	28.950 MHz
14	27.125 MHz	37.750 MHz	39.585 MHz	28.960 MHz
15	27.135 MHz	37.750 MHz	39.585 MHz	28.970 MHz
16	27.155 MHz	37.750 MHz	39.585 MHz	28.990 MHz
17	27.165 MHz	37.800 MHz	39.635 MHz	29.000 MHz
18	27.175 MHz	37.800 MHz	39.635 MHz	29.010 MHz
19	27.185 MHz	37.800 MHz	39.635 MHz	29.020 MHz
20	27.205 MHz	37.800 MHz	39.635 MHz	29.040 MHz
21	27.215 MHz	37.850 MHz	39.685 MHz	29.050 MHz
22	27.225 MHz	37.850 MHz	39.685 MHz	29.060 MHz
blank				
23	27.255 MHz	37.850 MHz	39.685 MHz	29.020 MHz

Table 2. AM band plan.

MHz. At least two manufacturers (Standard and Bristol) have adopted the plan and presently market 40-channel 10 meter rigs.

A coordinated band plan offers many exciting possibilities for the channelized rigs. For example, moving mobile operation could be greatly simplified by designating certain channels as calling channels, similar to marine VHF operation. Once contact is made, the participants could move to another channel to carry on the QSO. Beacon stations would indicate when and to where the band is open.

Crystal Selection

Your choice of crystal frequency will depend on your band plan and the crystal lineup in your rig. Most rigs follow a 6-4-4 arrangement where the deck of six crystals serves as the master oscillator. For some sideband rigs, it is possible to retain both upper and lower sideband capability by changing only four crystals, while others require changing six crystals (it is assumed here that you are

converting for a full 23-channel capability). Your *Photofacts* will indicate what crystal frequencies are used and how they are mixed to obtain the channel frequencies.

Once you have selected which crystals you wish to change and the frequencies of the new crystals, the problem of figuring the crystal formula arises (load capacitance, parallel/series resonant, fundamental or overtone mode, etc.). Here is where it is wise to choose an established crystal company for your supplier. Most of these keep an up-to-date file on amateur, CB, and commercial equipment using crystals, and can really help you here. I have dealt with Sentry (800-654-8850) in Chickasha, Oklahoma, and have found them to be both helpful and friendly. Their crystals work and the prices are reasonable.

By-the-Numbers Conversion

The following describes a step-by-step approach for converting some example CB rigs, using the bare

bones of test equipment. It is the technique I now use and it works!

SBE "Sidebander III" — This is the first rig I converted and the one that is going to win me WAS. The rig uses two synthesizer oscillators, one switching six crystals in the 11.7-MHz range and one switching four crystals in the 7.4-MHz range. Since this rig retains both upper and lower sideband capability whichever synthesizer frequency is changed, the obvious choice is the 7.4-MHz oscillator. Since I wished channel 1 on the converted rig to be 28.510 MHz, and CB channel 1 is 26.965 MHz, it was necessary to raise each crystal frequency in the 7.4-MHz oscillator by exactly 28.510 minus 26.965 MHz or 1.545 MHz. The crystals were ordered, and, on receipt, the conversion was performed using the following step-by-step procedure:

Step 1: Remove cover from the rig and connect to 12-volt power supply.

Step 2: Plug in microphone (necessary for this rig to receive), and attach

piece of wire to center terminal of antenna connector.

Step 3: Preset all controls as follows: channel switch to channel 1; noise limiter switch off; squelch control fully counterclockwise (squelch open); CB/PA switch to CB; rf gain control fully clockwise (max gain); on/off volume control on and fully clockwise; USB/LSB switch in USB; clarifier control — any position.

Step 4: Apply power (you will hear noise and possibly CB signals coming over speaker).

Step 5: Remove 7.4665-MHz crystal and replace with 9.0115-MHz crystal. See Fig. 1. Noise over speaker will greatly diminish with this operation.

Step 6: Using appropriate alignment tools, tune T5 and T6 (synthesizer mixer), T7 (USB buffer), and T1 and T2 (receiver rf amp) for maximum noise level over speaker (this completes all necessary alignment to receive 10 meters on upper sideband).

Step 7: Switch USB/LSB switch to LSB and tune T8 and T9 (LSB mixer) and T10 (LSB buffer) for maximum noise level over speaker (this completes the receiver alignment).

Step 8: Remove piece of wire from antenna connector, connect power meter to antenna connector, and dummy load to power meter (don't use antenna as load as this creates unnecessary QRM on 10 meter band while you are tuning up the transmitter).

Step 9: Depress microphone button, and, while whistling into the microphone at as steady a level as possible, tune T14, T15, T16, L4, L3, L2, and L1 for maximum indicated power output (this rig operates sideband only, and it must

RADIO EQUIPMENT DOESN'T GROW ON TREES—

But C & A ELECTRONICS offers super values that will make you think it does—

SUPER VALUE NO. 1

Purchase the compact ICOM IC701 HF Synthesized Transceiver with matching Power Supply and Microphone for\$1,719.00

and receive a brand new, ICOM IC 215 15-channel FM Portable/Mobile Transceiver including accessories (\$250.00 value)

FREE



SUPER VALUE NO. 2

- Wilson Mark IV Hand Held\$259.95
1.5W & 4.5W (switchable)
- 2 Crystals—.52/.52no charge
- BP4 Battery Pack24.95
- WC14 Wall Charger15.95
- Rubber Duck Antennano charge

Amateur Net \$300.85

Super Value Price \$271.00

Optional TTP Touchtone Pad
(installed at time of purchase)61.95



This is a limited offer!

TO ORDER:

**Super Value No. 1
Super Value No. 2**

or

Quotes On All Your Amateur Needs

call

800-421-2258

FOR OUR TOLL FREE NUMBER
(Out of California)



C&A Electronic Enterprises

Distributors of Commercial and Amateur Radio Equipment
22010 S. Wilmington Ave., Suite 105
Carson, CA 90745
(213) 834-5868 (California residents)

be modulated to obtain any power output).

Step 10: Replace the remaining 37-MHz crystals with their 10 meter counterparts, set the channel switch to channel 13, and repeat steps 2 through 9 (this "centers" the alignment over the band span of the rig).

Step 11: Button up the rig; it is ready to go on the air!

Pace 123A—This is an AM rig I converted to operate with 28.8 MHz as channel 1, resulting in the band plan listed in Table 2. The rig uses a master synthesizer oscillator that switches six crystals in the 37.8-MHz range. I purchased replacement crystals having frequencies 28.8 minus 26.965 MHz, or 1.835 MHz higher than their counterparts. The steps for this conversion were as follows:

Step 1: Remove cover from the rig and connect to

12-volt power supply.

Step 2: Attach piece of wire to center terminal of antenna connector (the rig will receive without the microphone being plugged in).

Step 3: Preset all controls as follows: channel switch to channel 1; LCL/DIST switch to DIST; squelch control fully counterclockwise (squelch open); CB/PA switch to CB; on/off volume control on and fully clockwise.

Step 4: Apply power (you will hear noise and possibly CB signals coming over speaker).

Step 5: Remove 37.600-MHz crystal and replace with 39.435-MHz crystal. See Fig. 2. Noise over speaker will greatly diminish with this operation.

Step 6: Using appropriate alignment tools, tune L3 (synthesizer oscil-

lator) and L1 and L2 (receiver rf amp) for maximum noise level over speaker (this completes all necessary alignment to receive 10 meters).

Step 7: Remove piece of wire from antenna connector, connect power meter to antenna connector, dummy load to power meter, and plug in microphone.

Step 8: Depress microphone button and carefully tune L4, L5, and L6 (transmit mixer), and L7, L8, L9, L10, and L11 for maximum indicated power output. (The tuning of L4 through L6 is a bit tricky since you will have little or no output power to go by until these three are in tune. Turn the cores in a little at a time until an indication is obtained. If you have a VTVM or scope, observing the transmit buffer emitter voltage at TP5 makes things easier. The emitter voltage rises as you

approach proper tuning.)

Step 9: Replace the remaining 7-MHz crystals with their 10 meter counterparts, set the channel switch to channel 13, and repeat steps 2 through 8 (again, to "center" the rig alignment).

Step 10: Button up the rig; it is ready to go on the air!

The Pace 113 uses a board identical to the Pace 123A, and the conversion procedure is therefore identical. I have used this approach with each rig I have converted, and, if done carefully, the final result is as good as if done with a laboratory full of instruments.

In closing, 10 meter band openings are becoming more and more frequent and lasting longer and longer each time. The converted CB rig gives you an easy in to QRP operation and a dandy mobile rig that is easy to operate. ■

NEW MFJ *DELUXE* Versa Tuner II

\$119.95 buys you one of the world's finest 300 watt antenna tuners with features that only MFJ offers, like . . . dummy load, SWR, forward, reflected power meter, antenna switch, balun. Matches everything from 1.8 thru 30 MHz: coax, random wires, balanced lines.



*MFJ's Best Versa Tuner II . . .
Solid American Quality*

\$119⁹⁵

This is MFJ's best Versa Tuner II. And one of the world's finest 300 watt (RF output) tuners.

The MFJ-949 *Deluxe Versa Tuner II* gives you a combination of quality, performance, and features that others can't touch at this price . . . or any price.

PERFORMANCE: You can run your full transmitter power output — up to 300 watts RF output — and match your transmitter to any feedline from 1.8 thru 30 MHz whether you have coax, balanced line or random wire.

FEATURES: A 200 watt 50 ohm dummy load lets you tune up for maximum performance.

A sensitive meter lets you read SWR with only 5 watts and both forward and reflected power in two ranges (300 and 30 watts).

A flexible antenna switch lets you select 2 coax lines direct or thru tuner, random wire or balanced line and dummy load.

A large efficient airwound inductor 3 inches in diameter gives you plenty of matching range and less losses for more watts out.

1:4 balun, 1000 volt capacitors. SO-239 coax connectors. Binding post for balanced line, random wire, ground. 10x3x7 inches.

QUALITY: Every single unit is tested for performance and inspected for quality. Solid American construction, quality components.

The MFJ-949 carries a full one year unconditional guarantee.

Order from MFJ and try it — no obligation. If not delighted, return it within 30 days for a re-

fund (less shipping).

To order, simply call us toll free 800-647-1800 and charge it on your VISA or Master Charge or mail us a check or money order for \$119.95 plus \$3.00 for shipping/handling.

Don't wait any longer to tune out that SWR and enjoy solid QSO's. Order your *Deluxe Versa Tuner II* at no obligation, today. ✓M52

MFJ ENTERPRISES, INC.

P. O. BOX 494

MISSISSIPPI STATE, MS 39762

CALL TOLL FREE . . . 800-647-1800

For technical information, order/repair status, in Miss., outside continental USA, call 601-323-5869.

INTRODUCING THE TET MODULAR ANTENNA TOWERS

Ideal for ground or roof mounts.
Modular, portable, extremely rugged.

- One man assembly and installation
- Light weight
- High quality aluminum alloy
- High stability

Finally here are strong, sturdy antenna towers that are simple to assemble, light weight, strong and can be used on your roof top, or packed up and used in the field.

Available in three models: 11½', 18' and

25'. The 11½ foot model has base and one tower module; the 18 foot has two tower modules; and the 25 foot model contains three tower modules.

We also handle the TET line of HB 9 Series, Yagis and Swiss Quads.

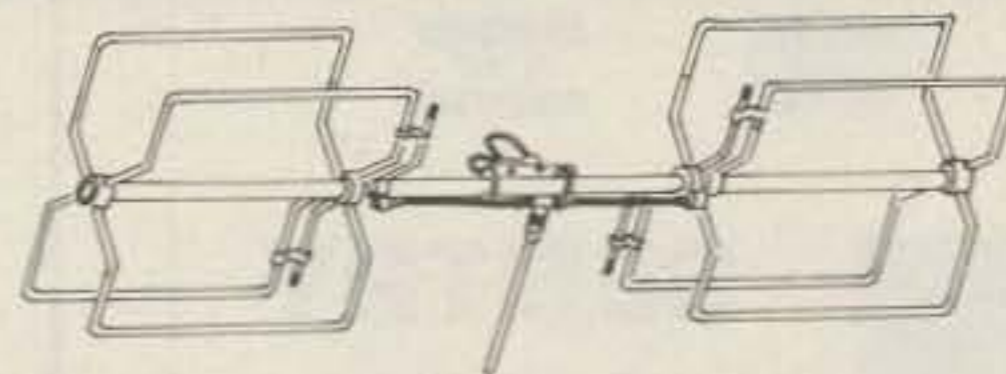
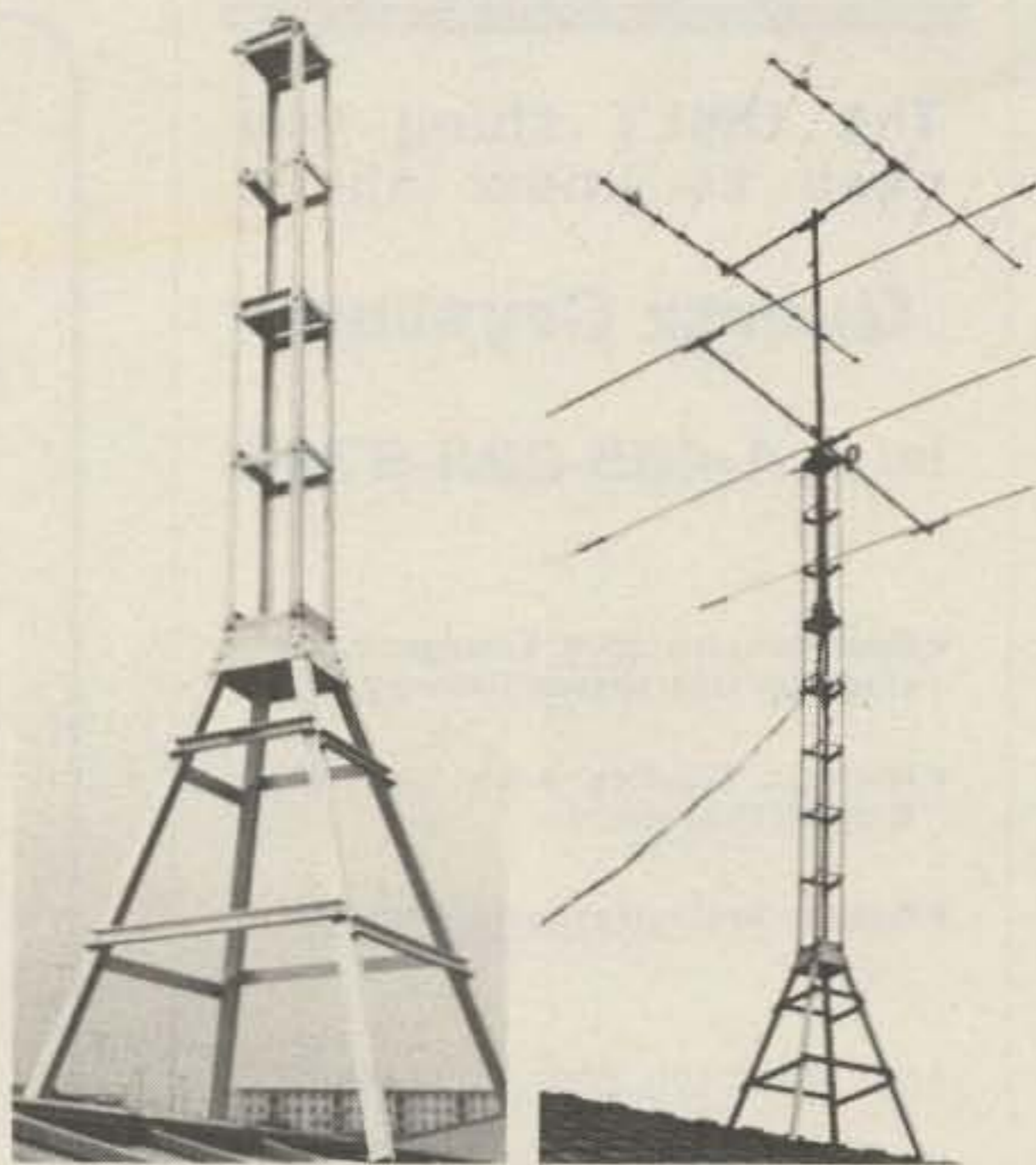

**CALL FOR
BEST
PRICE!**

**M & M RF,
DISTRIBUTORS
(714) 299-9741**

**ORDER
DIRECT FOR
IMMEDIATE
DELIVERY**

Exclusive U.S. distributors for

KEN PRO ROTATORS



KR 400—Designed for 360° rotation. Rated to support up to 200 kg or 440 lbs. Read out tolerance ± 5 degree maximum. Waterproof terminal block in rotators.

KR 500—Designed for 180° rotation. Brake holds up to 2000 kg/cm (1750 lbs/inch) torque.

KR 600—Designed for 360° rotation. Brake holds up to 4000 kg/cm (3470 lbs/inch) torque.

KR 2000—Designed for 360° rotation. Brake holds up to 10,000 kg/cm (8680 lbs/inch) torque.

We also stock the complete line of Lunar Amplifiers and Pre Amplifiers.

M & M RF DISTRIBUTORS

3360 Sports Arena Blvd. • San Diego, CA 92110 • (714) 299-9741

The **ONLY** thing you need to know about

Quartz Crystals

is: **1-405-224-6780**

• **Best delivery plus Emergency Service with Guaranteed Delivery**

• **Highest Quality with gold MIL-C-3098 Process**

• **Ask for Sentry Technology Manual**

And, order Toll Free 1-800-654-8850

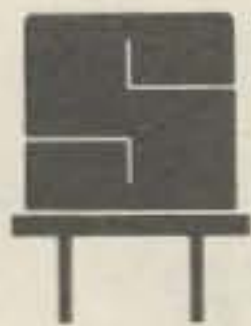
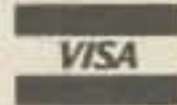

SENTRY

✓ S3 Crystal Park
Chickasha, Oklahoma
73018

3/4 KILOWATT DC INPUT ALL MODE VHF AMPLIFIER

SPECIFICATIONS:

Frequency Range	: 144-148MHz; No Tuning
Power Output, Max.	: 350 to 400 Watts
Circuitry	: Fully Transistorized
Modes of Operation	: AM-FM-SSB-CW-RTTY
Duty Cycle	: Continuous Duty
Gain, Typical:	
8 Watts Input	: 300 Watts Output
12 Watts Input	: 350 Watts Output
15 Watts Input	: 400 Watts Output
Primary Wiring	: Built-in AC Power Supply, 115/230 VAC
T/R Switching	: Built-in 1KW Coaxial T/R Relay
Spurious	: 60dB down all Harmonics 60dB down all Spurious
Power Output Select	: 10 Watts (LOW) or 350 Watts (HIGH)
Metering, Lighted	: Front Panel All Mode Set Indicator
Cooling	: Convection SSB and CW Model F135 or F235 required for continuous FM operation
Temperature Control	: Built-in Thermo-Switch for Fan Control
Auxiliary Output	: + 13 Volt at 3 Amperes on Rear Panel
Design Layout	: Hinged Amplifier and Heatsink Top Assembly for easy Accessibility and Service
Weight	: 52 pounds; 24 kilograms
Size (W x H x D)	: 17 x 8 x 13"; 432 x 203 x 330 mm
Mounting	: Bench Mounting, Rubber Bumpers Rack Mounting, 19" Adaptor Kit (OPTIONAL)
Connectors	: SO-239-UHF
USA Price	: \$895.00 FOB Factory

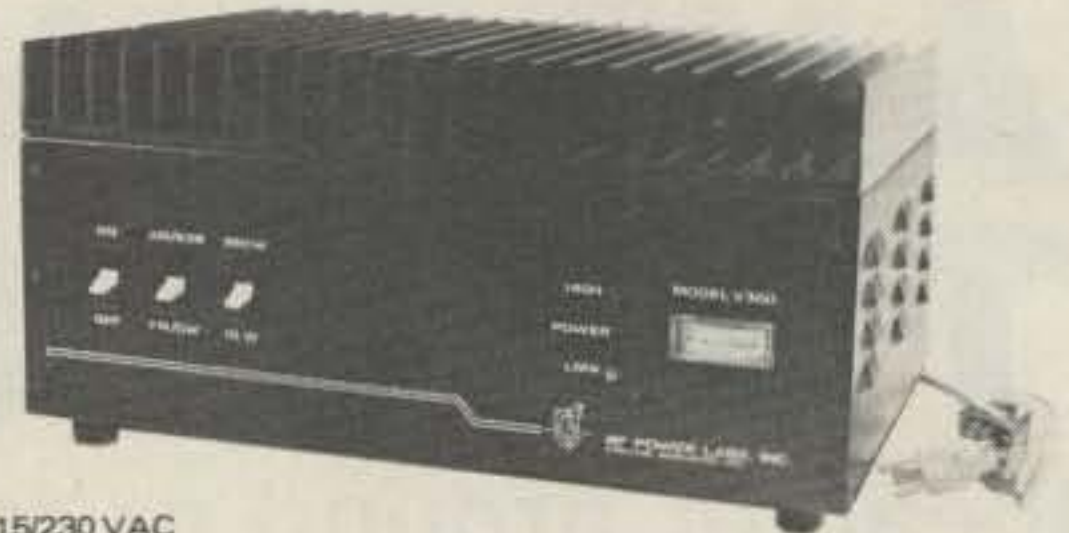

MODEL: V350

**FOR BASE STATION
&
REPEATER USE**



RF POWER LABS, INC. ✓ R27

11013-118th Place N.E. • Kirkland, Washington 98033 • Telephone: (206) 822-1251 • TELEX No. 32-1042



QUASAR VIDEO TAPE RECORDER SALE!



We are constantly testing ham and other electronic equipment for review in 73 Magazine. In order to be able to keep this not inexpensive project going we have to sell off the equipment used for test. Most of it has been used for a few days and is in every way as good as new. In many cases it is better than new since 95% of the equipment failures come within the first few hours of operation.

In this case we are running a series of tests of VTR systems, using them for regular, ham TV, SSTV, and even micro-computer programming tests. One of the best we've found so far is the Quasar system, but we still have to go on and test the RCA, JVC, and many other systems . . . so our Quasar is up for sale. We paid well over \$1,000 for the Quasar . . . used it for a few days and have gone on to test more systems.

Quasar VTR System special like new \$675.

73 MAGAZINE
Peterborough NH 03458

Major Credit Cards Accepted.

The only REALLY NEW 80-10 meter vertical design in 20 years!

Completely automatic bandswitching 80 through 10m [160-10m with optional TBR-160 add-on unit.]

Low V.S.W.R. over entire 40, 20, 15, & 10m bands plus ANY 60-100 KHZ segment of 80/75 m. NO ANTENNA TUNER NEEDED! ENTIRE 26 ft. length active on 80, 40, 20, & 10m with full 1/4 wave resonance on 15 m for greater bandwidth & superior DX performance. Ground, roof, or tower mount- no guys needed.

HIGHEST QUALITY CONSTRUCTION & WORKMANSHIP THROUGHOUT. HIGH STRENGTH ALUMINUM ALLOY AND FIBERGLASS DESIGN. Complete with 1-1/8 in. O.D. tubular mounting post, RG-11/U matching line, and connector for PL-259. Use any length of 50-52Ω coax.

V.S.W.R. at resonance: 1.5:1 or less; all bands.
Power rating: Legal limit SSB/CW 40-10m; 1200 W. P.E.P./500 W. CW on 80/75m.

AT YOUR DEALER OR DIRECTLY FROM

**BUTTERNUT
ELECTRONICS CO.** ✓ B31

ROUTE ONE DEPT. 4
LAKE CRYSTAL, MN. 56055
PHONE 507-947-3126

OTHER MODELS, TOO! FREE INFORMATION.



15m trap



80m coil

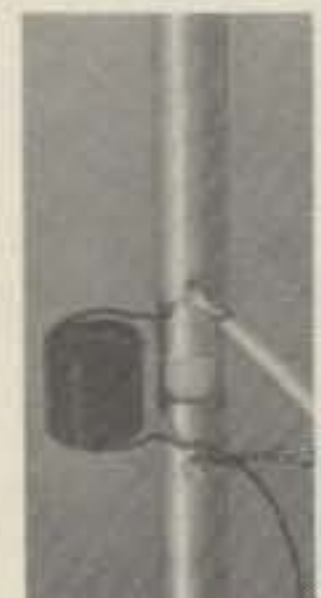

Base

Model HF5V-II **\$98.00** PPD. IN CONT. USA [BY UPS].
MN. RESIDENTS ADD TAX.

CALL **RUSH** TOLL FREE
ELECTRONICS, INC.

1-800-251-0264

TENN. RESIDENTS 1-615-764-0831

AUTHORIZED DEALERS FOR

YAESU	ROHN TOWERS
DENTRON	LARSEN
CUSHCRAFT	TURNER
WILSON	CDE
HY-GAIN	HUSTLER
CES	KDK
BENCHER	VIBROPLEX
ATRONICS	ALLIANCE
	TEMPO

AND MORE...

ALSO: THE APPLE II PERSONAL
COMPUTER SYSTEM

CALL OR WRITE FOR THE
BEST PRICES

ON AMATEUR EQUIPMENT

RUSH
ELECTRONICS, INC.

✓R21



SOUTH'S FASTEST GROWING AMATEUR STORE

1315 BLUFF CITY HWY., BRISTOL, TN. 37620

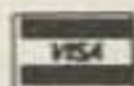

NEW



DENTRON
SUPER TUNER
PLUS
Reg. 149.50 \$135.00

SUPER TUNER PLUS
A full 1000 watts CW and
1200 watts SSB power
handling capacity.

CURTIS LSI's
help you



speaK
MORSE

- ★ 8044; Keyer-On-A-Chip* (Replaces 8043) . \$14.95
Apr '75 HR, Feb '76 OST, Radio Hdbk '75, Apr Hdbk '77-78
- ★ 8044-3; IC, PCB, Socket, Manual 24.95
- ★ 8044-4; Semi-Kit 54.95
- ★ 8045; Morse Keyboard-On-A-Chip IC . . . 59.95
- ★ 8045-1; IC, PCB, FIFO, Sockets, Manual . . 89.95
- ★ 8045-2; Semi-Kit 159.95
- ★ 8046; Instructokeyer-On-A-Chip IC . . . 49.95
- ★ 8046-1; Semi-Kit 79.95
- ★ 8047; Message Memory-On-A-Chip IC . . 39.95
- ★ 8047-1; IC, PCB, RAM, Sockets, Manual . . 69.95

(add \$1.75 on above for postage and handling)

- EK-430; CMOS Keyer* (Feb '76 OST) 124.95
- IK-440A; Instructokeyer* (Mar '76 OST) 224.95

*now with dash memory as standard

System 4000 Ham Computer (see Jan '78 OST) (write)

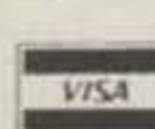

Curtis Electro Devices, Inc.
Dept. S (415) 964-3136
Box 4090, Mountain View, CA 94040



MFJ INTRODUCES A NEW 24 HOUR DIGITAL CLOCK

with HUGE 1-5/8 inch digits that you can keep set to GMT.
Alarm and snooze functions let you use it as an ID Timer.
Assembled, too!



\$29⁹⁵

BRAND
NEW

MFJ Enterprises brings you a new 24 hour digital alarm clock with HUGE 1-5/8 inch orange 7 segment digits that you can see clear across the room.

This one is strictly for your ham shack, one that you can leave set to GMT. No more mental calculations to get GMT.

Use the alarm to remind you of a SKED or with the snooze function as an ID timer to buzz you in 8 minute intervals.

A constantly changing kaleidoscopic pattern indicates continuous operation.

Beige. 2-1/4 x 4-1/8 x 8-3/4 inches. UL listed. Requires 120VAC, 60Hz.

Order from MFJ and try it — no obligation. If not delighted, return it within 30 days for a re-

fund (less shipping). One year limited warranty by MFJ Enterprises.

To order, simply call us toll free 800-647-1800 and charge it on your VISA or Master Charge or mail us a check or money order for \$29.95 plus \$2.00 for shipping and handling.

Don't wait any longer to enjoy the convenience of a "Hams Only" clock. Order today.

MFJ ENTERPRISES, INC.

P. O. BOX 494 ✓M52

MISSISSIPPI STATE, MS 39762

CALL TOLL FREE 800-647-1800

For technical information, order/repair status, in Miss., outside continental USA, call 601-323-5869.

2 METER CRYSTALS MANY IN STOCK

FOR THESE RADIOS ON
STANDARD ARRL REPEATER
FREQUENCIES

- | | |
|--------------------------------|----------------------|
| Clegg HT-146 | Regency HR-212 |
| Drake TR-22 | Regency HR-2B |
| Drake TR-33 (rec only) | Regency HR-312 |
| Drake TR-72 | Regency HR-2MS |
| Genave | S.B.E. |
| Heathkit HW-2021
(rec only) | Sonar 1802-3-4, 3601 |
| Heathkit HW-202 | Standard 146/826 |
| Icom/VHF Eng | Standard Horizon |
| Ken/Wilson | Swan FM 2X |
| Lafayette HA-146 | Tempo FMH |
| Midland 13-505 | Trio/Kenwood |
| Regency HR-2 | Trio/Kenwood TR2200 |
| | Trio/Kenwood TR7200 |

\$3.95 EACH — IN QUANTITIES
OF 10 OR MORE, \$3.50 EACH

Certified check or money order only —

ROLIN DISTRIBUTORS

P.O. Box 436 ✓R15
Dunellen NJ 08812

MFJ INTRODUCES NEW SUPER CW/SSB FILTERS

This new MFJ-721 Super Selector CW/SSB Filter gives you 80 Hz BW, steep SSB skirts, noise limiting, 2 watts for speaker plus more.



BRAND NEW \$59⁹⁵

This New MFJ-721 Super Selector CW/SSB Filter gives you a combination of performance and features available only from MFJ:

- Razor sharp 80 Hz non-ringing CW filter
- Steep skirt SSB filter
- Selectable peak and trough noise limiting
- Plugs in phone jack
- Two watts for speaker
- Simulated stereo reception
- Inputs for 2 rigs
- Speaker and phone jacks
- Auxiliary 2 watt amplifier, 20 dB gain.

The CW filter gives you 80 Hz bandwidth and extremely steep skirts with no ringing for razor sharp selectivity. Lets you hear just one CW signal on the crowded Novice bands.

Bandwidth is selectable: bypass, 80, 110, 150, 180 Hz. Response is 60 dB down one octave from center freq. for 80 Hz BW. Center freq. is 750 Hz. Up to 15 dB noise reduction.

8 pole active IC filter. Low Q cascaded stages eliminates ringing. Hand matched components.

The SSB filter dramatically improves readability by optimizing audio bandwidth to reduce

sideband splatter, remove low and high pitched QRM, hiss, static crashes, background noise, and hum.

Makes listening for long periods pleasurable and less fatiguing. Ideal for contest and DX.

IC active filter includes 375 Hz highpass cut-off plus selectable lowpass cutoffs at 2.5, 2.0, 1.5 KHz (36 dB per octave rolloff).

Switchable automatic noise limiter for impulse noise; trough clipper removes background noise.

For Simulated Stereo, the raw signal goes to one ear and the filtered signal to the other. The signal appears in both ears and the QRM in only one. The ears and brain reject QRM yet off-frequency calls can be heard. Requires stereo phones.

Switch selects one of two rigs. OFF position connects speaker to rig. Speaker disables when phones are used. Requires 9 to 18 VDC, 300 ma. max. 5x2x6 inches. Optional AC adapter is \$7.95. Order yours now.

This New MFJ-720 Deluxe Super CW Filter gives you 80 Hz BW, no ringing, 2 watts out.

Same 8 pole Super CW Filter as in MFJ-721. 80 Hz BW, extremely steep skirts with no ringing for razor sharp selectivity. Selectable BW: 80, 110, 180 Hz. Center freq. 750 Hz. Automatic noise limiter. Plugs in phone jack to drive speaker to 2 watts. 2x4x6 in. Requires 9-18 VDC, 300 ma. max. Optional AC adapter, \$7.95.

BRAND NEW \$44⁹⁵



These MFJ active filters are the most copied in Industry.

CWF-2BX MFJ SUPER CW FILTER



SBF-2BX MFJ SSB FILTER



\$29⁹⁵ each

But performance is not copied. Only MFJ hand selects components so the center frequency of each CW stage is within one Hz of each other.

CWF-2BX and the SBF-2BX are the same CW and SSB filter as in the MFJ-721 but less speaker amplifier and noise

limiter. Plugs in rig to drive phones or connect between audio stage for full speaker operation. Uses 9 V battery. 2x3x4 inches.

**For Orders, Call Toll Free
800-647-1800**

ORDER TODAY BY MAIL OR CALL TOLL FREE 800-647-1800 AND CHARGE IT ON VISA OR MASTER CHARGE. Order any product from MFJ and try it. If not delighted, return it within 30 days for a prompt refund (less shipping). One year unconditional guarantee. Add \$2.00 shipping/handling. For order/repair status, in Mississippi and outside continental USA, call 601-323-5869.



MFJ ENTERPRISES, INC.
P. O. BOX 494 MISSISSIPPI STATE, MISSISSIPPI 39762 M52

IC Keyer

The World's Greatest
Sending Device



**Adjustable to
Any Desired Speed**

Now available from Palomar Engineers — the new Electronic IC KEYSER. Highly prized by professional operators because it is **EASIER, QUICKER, and MORE ACCURATE.**

It transmits with amazing ease **CLEAR, CLEAN-CUT** signals at any desired speed. Saves the arm. Prevents cramp, and enables anyone to send with the skill of an expert.

SPECIAL RADIO MODEL

Equipped with large specially constructed contact points. Keys any amateur transmitter with ease. Sends Manual, Semi-Automatic, Fully Automatic, Dot Memory, Dash Memory, Squeeze, and Iambic — **MORE FEATURES** than any other keyer. Has built-in sidetone, speaker, speed and volume controls, **BATTERY OPERATED**, heavy shielded die-cast metal case. Fully **ADJUSTABLE CONTACT SPACING AND PADDLE TENSION.** The perfect paddle touch will **AMAZE** you.

Every amateur and licensed operator should know how to send with the IC KEYSER. **EASY TO LEARN.** Sent anywhere on receipt of price. Free brochure sent on request.

Send check or money order. IC KEYSER \$97.50 in U.S. and Canada. Add \$3.00 shipping/handling. Add sales tax in California.

Fully guaranteed by the world's oldest manufacturer of electronic keys.

ORDER YOURS NOW!

Palomar Engineers
Box 455, Escondido, CA. 92025
Phone: [714] 747-3343

FCC

Reprinted from the Federal Register.

MAKING SPECIAL CALL SIGNS AVAILABLE TO STATIONS LICENSED TO AMATEUR EXTRA CLASS OPERATORS

AGENCY: Federal Communications Commission.

ACTION: Second Report and Order.

SUMMARY: The Commission is terminating its proposal to allow Amateur Extra Class licensees to request certain types of specific call signs.

EFFECTIVE DATE: Nonapplicable.

ADDRESSES: Federal Communications Commission, Washington, D.C. 20554.

FOR FURTHER INFORMATION:

Contact Mr. Joseph Johnson, FCC

1919 "M" Street NW., Washington, D.C. 20554, 202-632-7175.

SUPPLEMENTARY INFORMATION: See attached document.

In the matter of amendment of part 97 to make special call signs available to stations licensed to Amateur Extra Class operators. (Docket 20092; See 41 FR 17734).

Adopted: October 19, 1978.

Released: October 26, 1978.

By the Commission:

1. A Notice of Proposed Rule Making in the above captioned matter was released on July 2, 1974. In that Notice, the Commission proposed to amend Part 97 of the rules to permit Amateur Extra Class licensees to request any

available specific unassigned call signs for their primary and/or secondary stations. It was also proposed to discontinue the availability of "in memoriam" call signs, i.e., call signs requested by Amateur club stations for the purpose of honoring a deceased member.

2. On April 22, 1976 the Commission adopted a First Report and Order in this proceeding which adopted in part the proposals made in the Notice. Specifically, Amateur Extra Class licensees were permitted to request specific "two-letter" all signs, (call signs consisting of a single or double letter prefix, a digit, and a two letter suffix); action was deferred on permitting licensees to request specific "three-letter" call signs, (call signs consisting of a single or double letter prefix, a digit, and a three letter suffix). On March 11, 1977, the Commission released a Notice of Proposed Rule Making in Docket 21135 which, among other things, proposed to delete from

the rules the provisions adopted under Docket 20092 which permitted Amateur Extra Class licensees to obtain specific call signs of their choice. On February 23, 1978, a First Report and Order in Docket 21135 was released which adopted this proposal. This action was taken because of the additional workload imposed by the call sign program. In amending its rules, the Commission provided that, henceforth, all call signs would be assigned systematically, with the details of the system to be announced.

3. In light of our experience with the call sign provisions adopted under Docket 20092, we see not further usefulness in continuing that proceeding. Therefore, It is ordered that Docket 20092 is terminated effective immediately.

FEDERAL COMMUNICATIONS COMMISSION,
WILLIAM J. TRICARCIO,
Secretary.



Canadian Amateur Radio Federation, Inc.

from page 12

GRS HAS SYMPOSIUM, TOO

For some of the DOC headquarters people attending the amateur symposium, it was the second weekend in a row devoted to radio users. At a National GRS Symposium held in Ottawa on September 21, the DOC unveiled a plan for 100 new GRS ("CB") channels in

ince of Alberta, Dome Petroleum Limited, the Amateur Radio League of Alberta, and the Canadian Imperial Bank of Commerce, for their financial assistance and support.

the 900 MHz area. In a speech for the Minister of Communications, (parliamentary assistant) Crawford Douglas of the DOC forecast that the GRS would evolve into a sophisticated technology which could be integrated with telephone and computer systems. Good news for amateurs was the fact that Dr. John deMercado, head of the Regulatory Service, stated, in answer to the GRS complaint that they were often blamed for TVI in poorly designed sets, that the first well-shielded sets would be on the market next

year. This move would be of little significance in solving the problem for the GRS and amateurs for 4 or 5 years.

Better news still was the fact that in Mr. Douglas's speech, when reference was made to the fact that the DOC was considering 900 MHz for the GRS, there was no reference to the use of the 220 MHz band for this purpose. CARF sources in the U.S. forecast that an October 12th meeting of the FCC would also kill the idea of 220 MHz for the CB.

OSCAR Orbits

The listed data tells you the time and place that OSCAR 7 and OSCAR 8 cross the equator in an ascending orbit for the first time each day. To calculate successive OSCAR 7 orbits, make a list of the first orbit number and the next twelve orbits for that day. List the time of the first orbit. Each successive orbit is 115 minutes later (two hours less five minutes). The chart gives the longitude of the day's first ascending (northbound) equatorial crossing. Add 29° for each succeeding orbit. When OSCAR is ascending on the other side of the world from you, it will descend over you. To find the equatorial descending longitude, subtract 166° from the ascending longitude. To find the time OSCAR 7 passes the North Pole, add 29 minutes to the time it passes the equator. You should be able to hear OSCAR 7 when it is within 45 degrees of you. The easiest way to determine if OSCAR is above the horizon (and thus within range) at your location is to take a globe and draw a circle with a radius of 2450 miles (4000 kilometers) from your QTH. If OSCAR passes above that circle, you should be able to hear it. If it passes right overhead, you should hear it for about 24 minutes total. OSCAR 7 will pass an imaginary line drawn from San Francisco to Norfolk about 12 minutes after passing the equator. Add about a minute for each 200 miles that you live north of this line. If OSCAR passes 15° east or west of you, add another minute; at 30°, three minutes; at 45°, ten minutes. Mode A: 145.85-.95 MHz uplink, 29.4-29.5 MHz downlink, beacon at 29.502 MHz. Mode B: 432.125-.175 MHz uplink, 145.975-.925 MHz downlink, beacon at 145.972 MHz.

OSCAR 8 calculations are similar to those for OSCAR 7, with some important exceptions. Instead of making 13 orbits each day, OSCAR 8 makes 14 orbits during each 24-hour period. The orbital period of OSCAR 8 is therefore somewhat shorter: 103 minutes.

To calculate successive OSCAR 8 orbits, make a list of the first orbit number (from the OSCAR 8 chart) and the next thirteen orbits for that day. List the time of the first orbit. Each successive orbit is then 103 minutes later. Due to incorrect tracking information obtained during the early days of OSCAR 8, the equator crossing times contained in most published charts are in error. To correct this error, multiply the orbit number by 0.00205 minutes and add

Oscar 7 Orbital Information				Oscar 8 Orbital Information			
Orbit	Date (Jan)	Time (GMT)	Longitude of Eq. Crossing °W	Orbit	Date (Jan)	Time (GMT)	Longitude of Eq. Crossing °W
18884Q	1	0121:40	81.2	4203A	1	0034:53	50.9
18896	2	0021:00	66.1	4217A	2	0040:05	52.2
18909X	3	0115:17	79.7	4231X	3	0045:18	53.5
18921	4	0014:38	64.5	4245A	4	0050:31	54.9
18934	5	0108:55	78.1	4259A	5	0055:43	56.2
18946	6	0008:15	62.9	4273J	6	0100:56	57.5
18959	7	0102:32	76.5	4287J	7	0106:09	58.8
18971Q	8	0001:52	61.4	4301A	8	0111:21	60.1
18984	9	0056:09	75.0	4315A	9	0116:34	61.4
18997X	10	0150:26	88.6	4329X	10	0121:46	62.8
19009	11	0049:47	73.4	4343A	11	0126:59	64.1
19022	12	0144:04	87.0	4357A	12	0132:12	65.4
19034	13	0043:24	71.8	4371J	13	0137:24	66.7
19047	14	0137:41	85.4	4385J	14	0142:37	68.0
19059Q	15	0037:01	70.3	4398A	15	0004:35	43.5
19072	16	0131:18	83.9	4212A	16	0009:48	44.9
19084X	17	0030:39	68.7	4426X	17	0015:00	46.2
19097	18	0124:56	82.3	4440A	18	0020:13	47.5
19109	19	0024:16	67.2	4454A	19	0025:25	48.8
19122	20	0118:33	80.7	4468J	20	0030:38	50.1
19134	21	0017:53	65.6	4482J	21	0035:50	51.4
19147Q	22	0112:10	79.2	4496A	22	0041:03	52.7
19159	23	0011:31	64.0	4510A	23	0046:15	54.1
19172X	24	0105:48	77.6	4524X	24	0051:27	55.4
19184	25	0005:08	62.5	4538A	25	0056:40	56.7
19197	26	0059:25	76.1	4552A	26	0101:52	58.0
19210	27	0153:42	89.6	4566J	27	0107:05	59.3
19222	28	0053:02	74.5	4580J	28	0112:17	60.6
19235Q	29	0147:19	88.1	4594A	29	0117:29	62.0
19247	30	0046:39	72.9	4608A	30	0122:42	63.3
19260X	31	0140:56	86.5	4622A	31	0127:54	64.6

the result to the equator crossing time as printed in the chart. For example, the published time for orbit number 3352, the first equatorial crossing on November 1, 1978, is 0018:50 UTC. Thus, for orbit number 3352, the corrected equatorial crossing time would be:

$$\begin{aligned} \text{Corrected time} &= 0018:50 + (3352 \times 0.00205 \text{ minutes}) \\ &= 0018:50 + (6.8716 \text{ minutes}) \\ &= 0025:42.3 \end{aligned}$$

The longitude figures contained in the OSCAR 8 chart are virtually unaffected by this tracking error. The chart gives the longitude of the day's first ascending equatorial crossing. Add 26° for each succeeding orbit. To find the time OSCAR 8 passes the North Pole, add 26 minutes to the time it crosses the equator. OSCAR 8 will cross the imaginary San Francisco-to-Norfolk line about 11 minutes after crossing the equator. Mode A: 145.85-.95 MHz uplink, 29.4-29.50 MHz downlink, beacon at 29.40 MHz. Mode J: 145.90-146.00 MHz uplink, 435.20-435.10 MHz downlink, beacon at 435.090 MHz.

MESSAGE MEMORY KEYS



\$69.95

Features:

- Advanced CMOS message memory
- Two (50 char. each) message storage
- Repeat function
- Records at any speed—plays back at any speed
- Longer message capacity
Example: send CQ CQ CQ DX de WB2YJM WB2YJM K—then play second message on contact—de WB2YJM QSL NY NY 579 579 Paul Paul K
- Use for daily QSOs or contests

PLUS:

- State-of-the-art-CMOS keyer
- Self completing dots and dashes
- Both dot and dash memory
- Iambic keying with any squeeze paddle
- 5-50 wpm
- Speed, volume, tone, tune and weight controls
- Sidetone and speaker
- Low current drain CMOS battery operation—portable
- Deluxe quarter-inch jacks for keying and output
- Keys grid block and solid state rigs
- **WIRED AND TESTED FULLY GUARANTEED—LESS BATTERY**

\$36.50



NEW!

Features CMOS Electronic Keyer

- State-of-the-art-CMOS circuitry
- Self completing dots and dashes
- Dot and dash memory
- Iambic keying with any squeeze paddle
- 5-50 WPM
- Speed, volume, tone controls, side tone and speaker

- Low current drain CMOS battery operation
- Deluxe quarter inch jacks for keying and output
- Handsome eggshell white base—woodgrain top
- Compact and portable 1-7/8 x 4-1/4 x 6-1/4
- Grid block keying
- Wired and tested—fully guaranteed—less battery

NEW!



FEATURES:

- Twin paddle squeeze key
- Extra heavy base—non-skid feet
- Adjustable contact spacing
- Touch tension—comfort keying
- Smooth friction free paddle movement
- Handsome crinkle finish base and rich red paddles
- Five way binding posts
- Use with Trac CMOS keyer or any keyer

TRAC - KEY

\$25.95

AT YOUR DEALER OR SEND CHECK OR MONEY ORDER.

plus \$2.00 s/h
NY res. add tax

TRAC

ELECTRONICS, INC
1106 RAND BLDG.
BUFFALO NY 14203

T18

TRS-80 OWNERS

Send-Receive RTTY & CW



- Automatic send & receive: RTTY & CW
- Complete hardware and software package
- Connects to your TRS-80 User Port and the key/headphone jacks of your rig
- Ten message memories—255 char. each
- Keyboard buffer—allows typing ahead
- Uses built-in PLL or external TU
- Morse trainer—random 5 letter words
- Includes hardware, cassette & manual

\$99. KIT

\$129. WIRED

- PET version available, 69.95 kit 99.95 wired

Write or call for detailed brochure

MICROTRONICS

P.O. Box 747 (S) Keyes, CA 95328

(209) 634-8888 / 667-2888

California residents add 6% tax



M48

CALL TOLL FREE

1-800-228-4097
Communications Center
 443 N 48th Street
 Lincoln, Nebraska 68504
 In Nebraska Call (402)466-8402

1-800-634-6227
Communications Center
West
 1072 N. Rancho Drive
 Las Vegas, Nevada 89106
 In Nevada Call (702)647-3114

Antenna Sale!

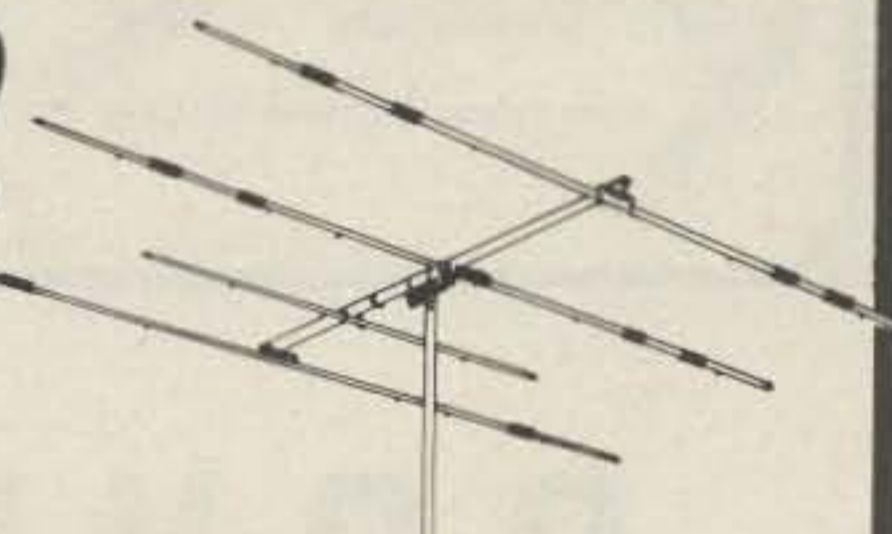

18HT

	HY-GAIN	Regular	Special
TH6-DXX	Super Thunderbird	\$296.95	\$ 209.95
TH3-MK3	3 ele. 10, 15, 20 Mtr. beam	219.95	179.95
Hy-Quad	2 ele. Quad 10, 15, 20 Mtr.	229.95	199.95
TH3-Jr.	3 ele. 10, 15, 20 Mtr. beam	144.50	129.95
18 HT	Hy-Tower 10-80 Mtr. Vertical	299.95	259.95
14AVQ/WB	10-40 Mtr. Trap Vertical	67.00	57.00
18AVT/WB	10-80 Mtr. Trap Vertical	97.00	84.95
205 BA	5 ele. "Long John" 20 mtr.beam	289.95	249.95
203	3 ele. 2 Mtr. beam	14.95	
205	5 ele. 2 Mtr. beam	16.95	
208	8 ele. 2 Mtr. beam	24.95	
214	14 ele. 2 Mtr. beam	31.95	

MOSLEY

Classic 33	3 ele. 10, 15, 20 Mtr. beam	304.75	219.95
Classic 36	6 ele. 10, 15, 20 Mtr. beam	392.75	289.95
TA-33	3 ele. 10, 15, 20 Mtr. beam	264.00	199.95
TA-36	6 ele. 10, 15, 20 Mtr. beam	392.75	289.95
TA-33 Jr.	3 ele. 10, 15, 20 Mtr. beam	197.00	149.95
TA-40KR	40 Mtr. add on	119.50	89.95

CUSHCRAFT

ATB-34	4 ele. 10, 15, 20 Mtr. beam	259.95	209.95
ARX-2	2 Mtr. Ringo Ranger	36.95	32.95
A147-20T	2 Mtr. Twist	59.95	52.95
A144-10T	10 ele. Twist 2 Mtr.	39.95	32.95
A144-20T	20 ele. Twist 2 Mtr.	59.95	52.95
A147-11	11ele. 146-148 MH2	34.95	30.95
A147-22	Power Pack 22 ele.146-148 MH2	99.95	88.95
A432-20T	430 -436 MH2 20 ele. TWIST	54.95	49.95
ATV-4	10,15,20,40 MTR Vertical	89.95	79.95
ATV-5	10,15,20,40 MTR Vertical	109.95	94.95

HUSTLER

4BTV	10-40 Mtr. Trap Vertical	99.95	82.95
RM-75	75 Meter Resonator	16.95	14.50
RM-75s	75 Meter Super Resonator	31.95	27.50
G6-144-A	6 db. 2 Mtr. Base Colinear	79.95	64.95
G6-144B	7 db. 2 Mtr. Base Colinear	119.95	99.95

WILSON

System One	5 ele. 10, 15, 20 Mtr. beam	274.95	239.95
System Two	4 ele. 10, 15, 20 Mtr. beam	219.95	189.95
System Three	3 ele. 10,15,20 MTR beam	179.95	159.95
WV-1 Vertical	10-40 MTR Vertical	79.95	69.95

CDE ROTORS

Ham III \$125.00 T2X Tail Twister \$225.00

CUSHCRAFT
ATB-34

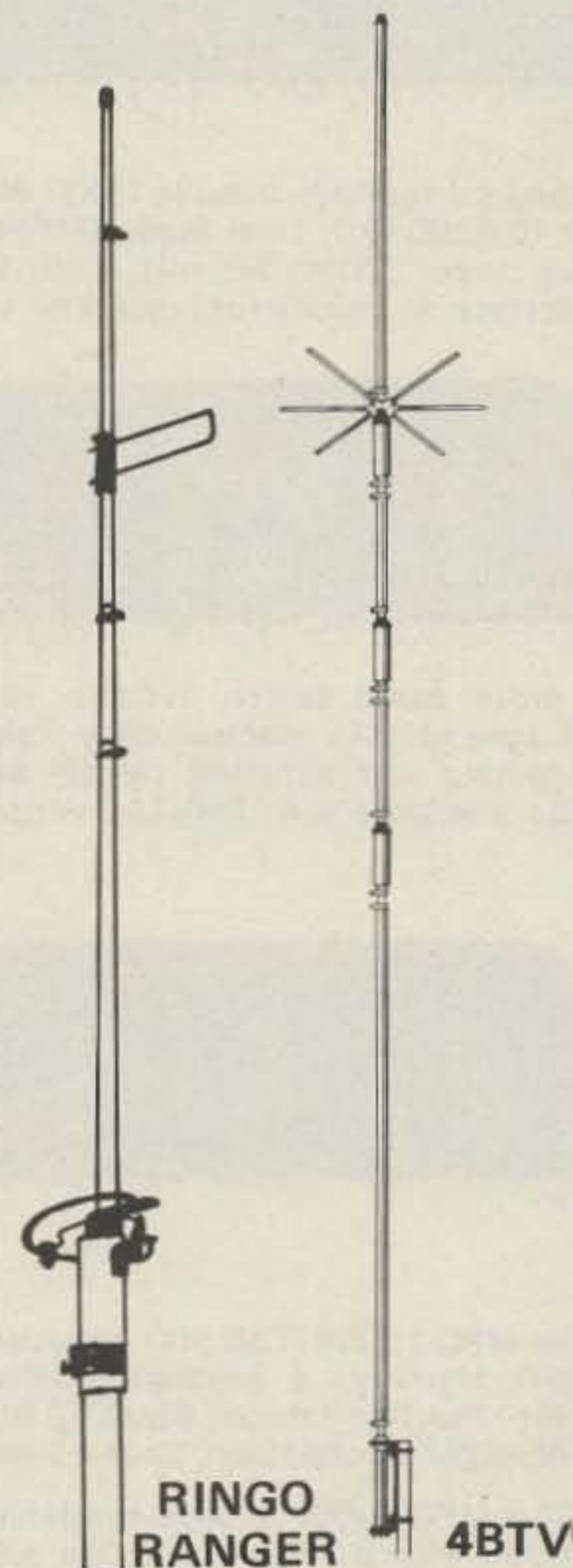

RINGO
RANGER 4BTV

**We carry all major brands of ham radios
 AT DISCOUNT PRICES**

Yaesu — Kenwood — Drake — ICOM — Dentron —
 Ten-Tec — Swan — Tempo — Midland — E.T.O. — Wilson

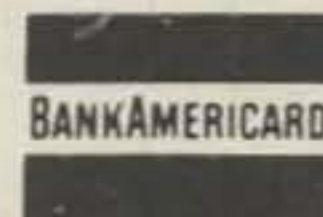

... at last ...
your shack organized!

A beautiful piece of furniture — your XYL will love it!

\$149.95 S-F RADIO DESK

Deluxe - Ready to Assemble

Designed with **angled** rear shelf for your viewing comfort and ease of operation.

FINISHES: Walnut or Teak Stain.
 Also available in Unfinished Birch, \$134.95

Additional Information on Request.
 Checks, Money Orders, BankAmericard
 and Master Charge Accepted.

F.O.B. Culver City. (In Calif. Add 6% Sales Tax.) ✓ S33

S-F AMATEUR RADIO SERVICES

4384 KEYSTONE AVENUE • CULVER CITY, CALIF. 90230 — PHONE (213) 837-4870



DOVETRON



MPC-1000C

Multipath Correction
 In-Band Diversity &
 AFSK Tone Keyer

Amateur Net: \$545.00

Standard features include CONTINUOUSLY tuneable Mark and Space channels (1000 Hz to 3200 Hz), Dual Mode (MARK or FSK) Autostart and internal high level neutral loop keyer (20 to 60 ml). Both EIA and MIL FSK outputs are provided for direct interface to microprocessor and video terminal peripherals.



MPC-1000CR

Signal Regeneration &
 Speed Conversion

Amateur Net: \$645.00

A front panel switch permits internal TSR-200 Signal Regenerator-Speed converter assembly to electronically "gear-shift" between 60, 67, 75 and 100 WPM. All incoming and outgoing signals are regenerated to less than 0.5% bias distortion. Also available with DIGITAL Autostart (TSR-200D): Amateur Net: \$695.00



MPC-1000R/- TSR-500

Dual UART Regeneration,
 Speed Conversion, 200
 Char. Memory, Word Cor-
 rection & DIGITAL
 Autostart

Amateur Net: \$895.00*

The MPC-1000R/TSR-500 provides Preloading and Recirculation of the 200 character FIFO Memory, a keyboard-controlled Word Correction circuit, Variable Character Rate, Tee Dee Inhibit, Blank/LTRS Diddle, a Triple Tone-Pair AFSK Tone Keyer and a Character Recognition/Speed Determination DIGITAL (DAS-100) Autostart mode.

*The MPC-1000R is also available without a TSR assembly and functions as a MPC-1000C with a Triple Tone-Pair AFSK Tone Keyer. This "Basic-R" permits future expansion with a TSR-100, TSR-200, TSR-200D or TSR-500 by simply lifting the lid and plugging in the appropriate TSR assembly: Amateur Net (Basic-R): \$595.00

Your QSL will bring complete specifications, or call: 213-682-3705.

✓ D23



627 FREMONT AVENUE
 (P. O. BOX 267)
 SOUTH PASADENA, CA. 91030

R-853/URR AM-FM BROADCAST RECEIVER

Made by Jetronic.
 Slide-Rule tuning;
 6" x 9" Speaker,
 and nine Tubes.
 Walnut-Finished
 pressboard con-
 struction; 115 VAC
 60 Hz or 220 VDC.
 12 1/4 x 16 x 8"; Sh.
 Wt. 15 lbs. Used, Repairable ...



\$19.95

DUMONT 304 SCOPE



With big 5" CRT. DC to 100 KHz band-width;
 usable to 300 KHz. 100 MV full scale vert.
 sensitivity. Sweep: 2-30,000 Hz. Input im-
 pedance: 2 megohms paralleled by 50 pf. 115/
 230 VAC 50-400 Hz: 9x13 1/2 x 19"; 65 lbs. sh.
 wt. (Shipped via truck.) Used, repairable with
 good trace: \$49.95

MANUAL, partial reproduction: \$8.50

SPECIAL! 1978 ARRL RADIO AMATEUR'S HANDBOOK ... \$4.50

All Prices F.O.B. Lima, Ohio. Please Allow for Shipping.
 Use your VISA or Mastercharge cards.

Write for our big 36 page catalog. ✓ F1

Address Dept. 73 • Phone 419/227-6573

FAIR RADIO SALES

1016 E. EUREKA • Box 1105 • LIMA, OHIO • 45802

CIRCUIT BOARDS

- REPEATER CONTROL
- COMPUTER PROJECTS
- SENSITIZED BLANKS
- NEGATIVES/POSITIVES
- PROTO-TYPE BOARDS
- PARTS KIT
- CUSTOM ETCH/DRILL
- RCA 1802 MP BOARDS
- CIRCUIT BOARD DESIGN
- PROGRAMMING PADS
- ART MASTER PREPARATIONS

We can supply many of the items you need
 to make a p-c board. Send SASE + 25 cents
 for catalog.

O.C. Stafford ✓ S50

Electronic Service and Development
 427 S. Benbow Rd.
 Greensboro, NC 27401
 919-274-9917 DAY/NITE
 Serving Amateurs Around the World

NEW ELECTRONIC PARTS

Brand name, first line components. Stocked in
 depth. 24 hour delivery. Low prices and money
 back guarantee on all products we carry.

STAMP BRINGS CATALOG

SPECIALS

KEYBOARD ENCLOSURES

SIX SIZES	W	D	H	PRICE
	14"	8.3"	3"	\$15.20
	17"	8.3"	3"	18.35
	20"	8.3"	3"	19.25
	14"	11.3"	3"	16.50
	17"	11.3"	3"	18.80
	20"	11.3"	3"	20.75

Blue base, specify white or black top.

MAGNA-LITE JR
 ONLY
 \$5.79



SEEK FOR
 • Printed Matter/reading
 • Electronics — Design, Production & Inspection
 • Robotics — Engineers, Technicians, Diagnostics
 • Laboratory & Research

RTTY

UT4 SPEED CVTR BOARD
 KIT \$109.95
 BOARD ALONE \$18.95
 AUTO CW ID KIT \$37.90

SHIPPING
 INCLUDED
 IN PRICE

Daytapro Electronics, Inc.

Formerly NuData Electronics ✓ D35
 3029 N. WILSHIRE LN. ARLINGTON HTS. ILL. 60004
 PHONE 312-870 0555

HAMTRONICS USED GEAR • TEST EQUIPMENT • SPECIALS

30-DAY GUARANTEE ■ 90-DAY FULL CREDIT TRADE-IN ■ FREE SHIPPING VIA UPS ONLY

Limited quantities. First come, first served. (if weight or size exceeds UPS max., we will ship freight collect)

<p>Allied</p> <p>AX-190 Receiver \$159</p>	<p>TR-222 Meter 140 T-4X Transmitter 339 TR-722 Meter FM 225 AC-4 AC Supply 95 TR-4-C Transceiver 449 CC-1 Console CPS-1 Supply SC-2 Conv SC-6 Conv SC-1 Calibrator The above all assembled complete pkg. Only \$200</p>	<p>HT-37 Transmitter 159 HT-40 Transmitter 49 SX-99 Receiver 99 SX-117 Receiver 189 SR-150 Xcvr 259 SR-160 Xcvr 159 SX-146 Receiver 175 HT-44 Transmitter 159 SX-111 Receiver 149 SX-122 Receiver 249 S-36 UHF Receiver 125</p>	<p>Johnson</p> <p>T-1KW Matchbox/SWR \$195 Courier Linear 139 Ranger I Transmitter 85 Ranger II Transmitter 139 Valiant I Transmitter 129 Invader 2000 Xmitt 495</p>	<p>Standard</p> <p>SRC-146 HT \$149 826 M Trnscvr 195 SRC-144 395 SRC-851T 250</p>	<p>Tempo</p> <p>Tempo one Xcvr \$299 AC One Supply 79 FMH 2M H.T. 149 CL-220 Trnscr 220 MC 179 FMH 2M w/Talkle 149</p>	
<p>Ameco</p> <p>PV-50 \$ 9 CN-50 29 CN-144 39 TX-62 79 621 VFO 45</p>	<p>Dycomm</p> <p>10-0 2 M Ampl \$125 35-0 401N 110 Out 130 470-25 450 MC 120 P-1416 16 Amp Supply 95</p>	<p>Hammarlund</p> <p>HQ-110 A VHF Receiver \$189 HQ-110C Receiver 119 HQ-110AC Receiver 149 HQ-145X Receiver 169 HQ-170C Receiver 159 HQ-180 Receiver 379 HQ-215 Receiver 259 SP-600 Receiver 179 HX-50 Transmitter 169</p>	<p>Kenwood</p> <p>T-599 Transmitter \$289 R-599 Receiver 289 TS-520 Tranc 429 QR-666 259 QR-666 Receiver 239 TV 502 Transvertor 179</p>	<p>Swan</p> <p>700-CX Xcvr \$459 260 Cygnet 289 279 Cygnet 329 500 Xcvr 299 500 CX Xcvr 389 117-XC AC Supply 95 14X DC Module 39 MK II Linear 475 KK VI 6 Meter 550 250 C 6M Xcvr 349 FM 2X2M Xcvr 169 FM-1210A 2M 249 350 Transceiver 269 350C Xcvr 299 600R Receiver 339 600T Transmitter 399 410 VFO 79</p>	<p>Ten Tec</p> <p>PM-3 Trnscr \$ 49 Argonaut Xcvr 199 KR-40 Keyer 79 RX-10 Receiver 49 S-30 Signalizer 29 Triton II 479</p>	
<p>B&W Waters</p> <p>Nuverfor 2+6 Conv. \$ 75 6100 SSB Xmitter 395 670 SSB Adaptor 39 Co-Dax Keyer 95</p>	<p>Eico</p> <p>720 Transmitter \$ 49 722 VFO 39 730 Modulator 39</p>	<p>Heathkit</p> <p>SB-300 Receiver \$199 SB-301 Receiver 229 HR-10-B Receiver 69 SB-303 Receiver 269 SB-220 Linear Amp 449 SB-102 Trivcvr 379 DX-60B Transmitter 69 HW-32 Transmitter 85 HW-100 Transceiver 249 SB-100 Transceiver 299 SB-401 Transmitter 249 SB-101 Transceiver 349 SB-650 Digital Freq. Display 149 HW-30 Twoer 29 Also Sixer 29 H-10 Monitor 69 VHF-1 Seneca 79 HW-12 Transmitter 75 HP-23 AC Supply 49 HP-23B AC Supply 59 HW-202 2M FM Xcvr 159 SB-620 Spectrum Analyz 120 SB-102 Xcvr 369 SB-610 Scope 95 HA-20 6m Linear 125 SB-634 Console 175 SB-604 Spkr 29.50 SB-644 VFO 129.50 SB-230 Linear 359 SB-104 Transceiver 625</p>	<p>Knight</p> <p>T-60 Transmitter \$ 39 r-100 Receiver 59 TR-108 Trancur 2M 79</p>	<p>Lafayette</p> <p>HA-800 Receiver \$ 89 HP-350 Receiver 149 HE-45 Transceiver 49</p>	<p>Yaesu</p> <p>FT-401 Xcvr \$499 FRDX 400SD Rec 325 FT 2 Auto 2M FM 249 FT-101B Xcvr 549 FL-2100B Linear 295 FV-101 VFO 79 101E Xcvr Demo 695</p>	
<p>Central Electronics</p> <p>100V Transmitter 325 MM-2 Scope 69 20-A SSB Adaptor 79</p>	<p>Eimac</p> <p>AF-67 Transmitter \$ 45 PMR-8 Receiver 79</p>	<p>Midland</p> <p>509 H.T. \$149</p>	<p>Millen</p> <p>92200 Transmatch \$149 90651-A Grid Dipper 95</p>	<p>National</p> <p>NC-270 Receiver \$119 NC-300 Receiver 129 NCX-5 Transceiver 279 NCX-5MKII Trnscvr 299 NC-303 Receiver 199 AC-500 AC Supply 69 NCX-500 Transceiver 199 NCX-3 Transceiver 169 NC-190 Receiver 149 NC-105 Receiver 69</p>	<p>Test Equipment Bargains</p> <p>Boonton "Q" Meter \$295 Tektronix 5140 249 Tektronix 545A 950 5 3/54A Plug-in wide band preamp . . . 75 Hickok 695 Generator 69 Bendix BC221 Freq Meter 39 Polarad Spectrum Analyzers A84T. . . 1695 Hewlett Packard 400C 75 Precision E-400 Signal Generator. . . . 125 Electro Impulse Spectrum Analyzer . . 395 Dyna/Sciences Model 330 Digital Multimeter 195 Hewlett Packard 4905A Ultra Sonic Detector 550 Hewlett Packard 120A Scope 250 TS-323/UR Frequency Meter 175 Hewlett Packard 4910B Open Fault Locator 650 Bird Mod 43 80 General Radio 650A 150 Measurements Mod 80 195 Nems Clark 1400 495 Ballantine 300H 175 PACO Scope Mod-S-50 75 Singer FM-10C 3495 Simpson 260 V.O.M. 49.50</p>	
<p>Clegg</p> <p>22'er FM \$129 66'er 6M Xcvr 115 99'er 6M Xcvr 59 Interceptor BRCUR 275 Ant Pre Amp 22 All Bander 69 HT-146 125 2 Vess 259 FM-27-B Xcvr 325</p>	<p>Genave</p> <p>GTX22M FM \$165 GTX-200 2M FM 149</p>	<p>Regency</p> <p>HR-2B 2M FM \$169 HR-220 FM 220 MC 185 AR-2 2M Amplifier 85 HR-25 2M FM 225 HR-6 Meter FM 189</p>	<p>SBE</p> <p>SB-34 Transceiver \$249 SB-33 Transceiver 189 SB-144 2M FM 175 SBZ-LP Linear 179</p>	<p>Collins</p> <p>75 A4 Receiver \$395 7553B Receiver 695 7551 Receiver 349 KWM-2 Xcvr 595 3251 Xmitter 349 PM-2 AC Supply 95 516 F2 AC Supply 139 312B5 Console 425 361D2 Mount 29</p>	<p>Globe/Galaxy</p> <p>VHF 6+2 Transm \$ 39 Chief Transmitter 39 Galaxy III Xcvr 159 Galaxy V Xcvr 189 Galaxy V Mk II 239 GT-550 Xcvr 279 GT-500A Xcvr 329 AC-400 Supply 79 FM-210 2M FM 95</p>	<p>ICOM</p> <p>IC-21 2M FM Xcvr \$299 IC-230 Demo 369 IC-22A 2M FM Xcvr 185 IC-30A 432 MCFM 269</p>
<p>Drake</p> <p>2A Receiver \$149 2B Receiver 189 2AQ SPKR QMULT 29 R4 Receiver 289 R4-B Receiver 349 R4-C Receiver 399 MS-4 Speaker 19 2NT Transmitter 125 2NT Transmitter 99 TR-6 695</p>	<p>Gonset</p> <p>Com II 2M \$ 75 Com II 6M 69 Com IV 2M 129 GC-105 2M 115 G-28 Xcvr 149 G-50 Xcvr 149</p>	<p>Hallicrafters</p> <p>S-108 Receiver \$ 99 SX-101 Receiver 159 HT-32 Transmitter 179 HT-32B Transmitter 269 SX-99 Receiver 79 SX-115 Receiver 349</p>	<p>DRAKE</p> <p>TR33C</p>	<p>Midland</p> <p>92200 Transmatch \$149 90651-A Grid Dipper 95</p>	<p>DRAKE</p> <p>TR4CW - \$799.00</p>	



ICOM IC22S
Regular \$299, save \$50; buy an ICOM IC22S for \$299 (no trades) and take a \$50 credit for another purchase.

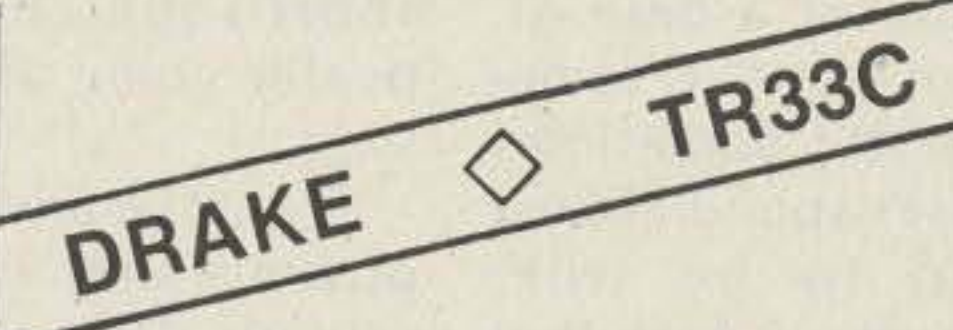

DRAKE TR33C
Regular \$229, save \$30; buy a Drake TR33C for \$229 (no trades) and take a \$30 credit for another purchase.



MIDLAND 13-510
Regular \$399, save \$50; buy a Midland 13-510 for \$399 (no trades) and take a \$50 credit for another purchase.



KENWOOD
TS820 \$ 919.00
TS80S \$1098.00



YAESU
FT101E - 799.00
FT101EE - 759.00
FT101EX - 699.00



DRAKE
TR4CW - \$799.00

MAIL & PHONE ORDERS WELCOMED. BANK AMERICARD ACCEPTED. ALL UNITS GUARANTEED

HAMTRONICS

DIVISION OF

Trevoze Electronics

4033 BROWNSVILLE ROAD
TREVOSE, PA. 19047
Telephone: Toll Free:
(215) 357-1400 1 800-523-8998
(215) 757-5300

Electronics Education by Mail Order

— successful student reports

A trade school extension course may be your ticket to a ticket.

R.S. Isenson N6UE
4168 Glenview Drive
Santa Maria CA 93454

Have you ever wondered, while reading the advertising for electronics courses, what it would be like to take one? In common, the schools, institutes, or whatever they call themselves, emphasize the "goodies" that come

with the course: 25-inch color TV sets, quadraphonic stereos, digital computers, various types of mouth-watering test equipment, and even transceivers. It's almost a case of, "If you can name it, someone offers it!" Sometimes the promises sound almost too good to be true, yet you sort of feel that most, if not all, of the heavily advertised correspondence schools must

have fairly decent integrity. They must, in one way or another, meet their advertising claims or the post office would grab at them like an alligator on a short-squelch-tailed repeater going after a wind-bag.

From the advertising, it's obvious that some of the schools offer Heathkits as the hardware inducements. Others claim to offer kits of their own design. If it's the former, the Heath catalog spells out the specifications for the would-be student. If it isn't, it could be pretty tough to assess the hardware unless someone else who's taken the course broadcasts his experience. The latter is what this article is all about: my experiences with and impressions of one of the correspondence courses, and my personal, nonprofessional assessment of the "main goody," the CONAR 452 2 meter transceiver.

Late in 1976, NRI (The National Radio Institute, Washington, DC) announced a new communications/electronics course that held out, for me, a double appeal. First, their advertising promised that, if one pursued the course to its conclusion, he would be able to pass the FCC Commercial First Class Radio/Telephone examination, or his money would be refunded. Second, the pièce de résistance of the home study course was a digital, phase-locked-loop, synthesized 2 meter transceiver.

Having a requirement, at that time, for a Commercial First Class ticket, and knowing full well that I needed some motivation—like a significant financial commitment—to keep my nose in the books, the NRI course made a lot of sense. The fact that my 2 meter FM capability consisted of a clobbered together,

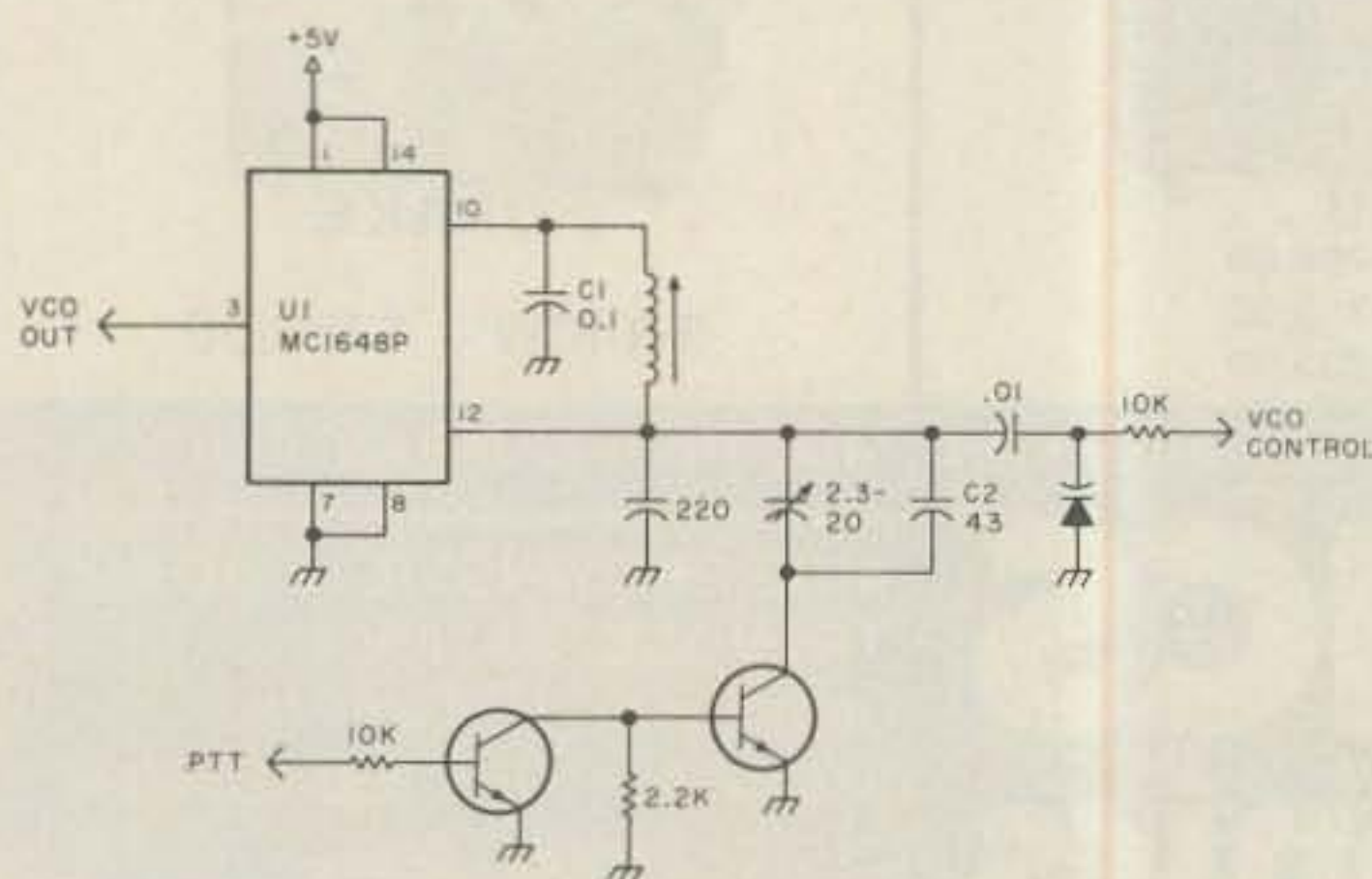

Fig. 1. Voltage-controlled oscillator.

many-times-recycled VHF Engineering transmitter strip, and a salvaged Pace HF/VHF scanner, didn't make the synthesized rig any less appealing. So I signed the contract form, letting myself in for a reasonably solid educational experience as well as a lot of aggravation and a bit of exasperation. Ye who seek the first and would avoid the latter, read on!

NRI advertises that the student sets his own pace. The hard rock truth is that this isn't necessarily so, particularly if, as in my case, the student plans to get through the course in less than six months. Perhaps a 12 to 18 month schedule is more in keeping with the Institute's gearing. That impedance mismatch accounted for a considerable part of my unhappiness, but far from all of it. The real heartburn was caused by the very much delayed delivery of significant parts of the 2 meter transceiver.

NRI, and probably every one of the other correspondence schools, sends kit hardware to the students in subassembly portions. The student assembles the hardware in that packet, conducts some prescribed experiments on or with it, mails to the school the answers to some questions pertaining to the experiments, and waits for the school to make the next move. Receipt by the school of the set of answers supposedly triggers the next shipment. Three "training kits" contain the hardware for the CONAR 2 meter transceiver. Five months transpired between the time that I mailed the answers to questions on the first kit and I received the third kit; five months, a number of protesting letters, and a couple of cross-country telephone calls spells "exasperation" to me.

I learned, after receiving



Photo A. CONAR 452 2 meter synthesized transceiver. CONAR 380 power supply.

the third kit, that the fault wasn't all NRI's. The Institute had been caught up in the April 15, 1977, "Purity of Emission" FCC regulation change (Part 97.73). NRI had to rework the final and output filter to meet the 60 dB spurious emission limit in order to get FCC type approval. Had the Institute only said something about their problems when I first started complaining, some aggravation could have been avoided. If there's a lesson to be learned from all of this, I guess it's threefold: Don't try to get through an extension course in a hurry, don't be in a hurry to sign up for a newly offered course, and don't expect a correspondence school to be sensitive to student personnel problems.

The academic program was found to be reasonably comprehensive, touching on almost every significant facet of communications/electronics. The proclaimed objective of the course is preparation for the FCC Commercial First

Class radiotelephone license. Therefore, it wasn't surprising to see primary attention focused on entertainment and commercial communications equipment rather than amateur gear. Similarly, concern with FCC regulations is for parts other than Part 97 (Amateur Radio Services). The technical level is trade school rather than university. That is, high school algebra is all one needs for the mathematical background.

The "Complete Communications/Electronics" course consists of 57 lessons, each including a short multiple-choice test, a set of 14 supplemental study guides, each with a pamphlet containing a number of FCC-type questions designed to prepare the student for the Commercial Class license, and ten hardware kits. The kits include a TVOM, a modern version of a breadboard with built-in power supplies and provisions for quickly setting up prototype circuits of discrete

components or ICs, a 6- to 7-MHz digital frequency counter, a crude but practical antenna test facility, a regulated power supply, and the 2 meter transceiver.

The antenna range can be a useful addition to any ham shack.

After completing the NRI prescribed antenna modeling and tests, I used mine to try out scale models of various low-band antenna configurations, the full-size versions of which could be fitted into the backyard of the home QTH. That exercise resulted in the gaining of some interesting antenna insight, and the empirical design of a much improved (for me) 75 and 40 meter antenna system. But that's another story!

In short, except for the difficulty in attaining my desired time schedule, the course was interesting and fun. Anyone completing it should have no difficulty with the technical portion of any FCC commercial or amateur licensing exami-

nation. The ham need only brush up on the legal aspects of Part 97 and get his code speed up to go right through to an Extra Class ticket. So much for my impression of the academics. Now on to the CONAR 452 2 meter transceiver.

Photo A shows the rig along with the ac power supply furnished as part of the course. The transceiver isn't small. It measures 4" high \times 8 $\frac{1}{4}$ " wide \times 11 $\frac{1}{2}$ " deep, as compared to, for example, the 2 $\frac{3}{4}$ " \times 8 $\frac{1}{4}$ " \times 9-7/8" of the Heathkit HW-2036A, and the latter is no pygmy. It weighs about one ounce less than the HW-2036A's 6.25 lbs. The front panel is fairly clean, with a seven-segment LED display for receiver frequency. Additional LED displays indicate transmitter offset status, phase-locked-loop status, and the 5-kHz increment. As a real boon for under-dash mounting, it has a front-panel-mounted speaker. Much of the size of the NRI rig is attributable to a design concept resulting in outstanding accessibility. This is one of the easiest pieces of electronic gear to work on that I've seen since germanium replaced the vacuum.

Photo B shows the transceiver with its top cover

removed and with the receiver board extended. Each of the other four boards can be extended, one at a time, for test or alignment purposes. Front and rear panels (Photo C) swivel out on the assembly screws to afford access to components mounted on those panels.

The transmitter has a switch-selected high/low power option. As measured with a ThruLine wattmeter to a matched dummy load, low rf power out was between 2.5 and 3 Watts across a selected 2-MHz portion of the 2 meter band. In the high-power position, the rf output varied between 19.5 and 20 Watts over the same 146-to 148 MHz portion of the band. On-the-air reports were good. The rig has a clean, natural sound.

For the receiver, a 0.5-microvolt signal was crudely measured to be the squelch threshold. A 4-microvolt signal into the antenna terminal resulted in absolutely full quieting. Numbers aside, the CONAR 452 offers an adequate receiver with acceptable sensitivity and selectivity. It has double conversion i-fs, 10.7-MHz and 455-kHz, with crystal filtering or control on each. It has, however, a couple of de-

sign weaknesses, the first of which took an embarrassing number of hours to identify and reduce.

Remember my comment about the clever layout that permitted the front and rear panels to be swung out for component accessibility? The design is great for maintenance, but it doesn't afford a very good electrical path between the end panels and the main chassis. NRI neglected the latter point. The volume control and squelch control potentiometers are both "grounded" to the front panel. The result, at least in my rig, was a ground loop that, in turn, furnished enough feedback to drive the LM380 audio amplifier into oscillation at the volume setting needed to override my "VW-type QRN." After much fumbling and groping, the problem was identified and reduced by adding a grounding strap from the front panel to the main chassis and running a separate wire from the bottom side of the two potentiometers to a clip fastener that was added to the audio board. The clip fastener was used to retain the flexibility of board removal.

The other audio problem results from the configuration of the top and bottom covers. These rather large, unsupported, flat metal surfaces find their resonant frequencies low in the audio band. At high volume settings, they tend to vibrate noisily! Some strips of electrician's rubber tape applied so as to provide pressure contacts between the top cover and the internal baffles of the housing (Photo B) help some, but don't eliminate the problem.

Assembly of the transceiver was straightforward. Most of the components mount on one or another of the five PC boards. The instruction manuals

are very similar to those of Heath. A few errors were spotted, and there were a few examples of things being done the hard way. The kits were short a few components, though nothing significant—a couple common resistors and some discaps. I had all of the necessary replacements in the junk box. Comments on the discrepancies, textual and component, were sent to NRI, and the missing parts were received by return mail. The other comments may well have been reduced to errata notes. The parts shortages and assembly instruction errors are just part of the price one pays for being in a hurry to try a newly announced kit, I guess!

For some reason, NRI chose to use 1/2-Watt and larger resistors. This undoubtedly adds to the size and weight of the transceiver without offering any obvious compensation unless it's lowered parts cost.

A multiple component problem in the voltage controlled oscillator of the PLL synthesizer almost drove me up that proverbial wall! The digital, phase-locked-loop synthesizer is the well known, circa 1970, Motorola circuit. Finding it in a transceiver that supposedly was a 1976 design was a bit disappointing. In light of all the CMOS one- and two-chip synthesizers that have reached the market in the last few years, it's difficult to understand why NRI opted for the power-hungry, high-part-count TTL approach, unless it was the lower cost of TTL and its relative immunity to static discharge. The first indication of trouble was the observation that the MC1648 voltage-controlled oscillator had two modes of operation. At random, it would oscillate at nominally 24 MHz, where it should have, or at about 43 kHz. If power was



Photo B. CONAR 452 transceiver with top cover removed and receiver board extended.

applied to the transceiver and the vco went into the low-frequency mode, it would remain there until something upset it, such as flicking power off and back on. Once I was aware of the phenomenon, it was easy enough to tell when the vco was in the wrong mode—the loop-unlock warning lamp would remain on! The precise frequency of oscillation in either mode could be varied by adjusting the tank coil (Fig. 1). This, of course, pointed to the chip as the part at fault. Additionally, in the desired 24-MHz mode, the oscillator was very unstable, drifting slowly up and down with peak frequency excursions sometimes exceeding 300 kHz. For all practical purposes, the set was inoperable.

Replacing the 14-pin DIP MC1648, a nasty job because it's soldered to the PC board, eliminated the low-frequency oscillation mode, but didn't affect the drift problem. The latter was finally reduced to a tolerable level by replacing, one by one, every frequency-determining component in the vco circuit. Replacing the 43-pF silver mica used to offset the vco in the receive mode (Fig. 1.) helped considerably, but not enough. The 43 pF is an odd value. I didn't have one, so I used the more common 47 pF. It worked fine.

Final stabilization of the vco required replacing a 0.1 μ F discap with a polystyrene capacitor of the same value. In the circuit diagram, it looks like a simple bypass capacitor, and why it should make a difference is anyone's guess. In fact, replacing it was a desperation move; everything else had already been tried!

There's much sentiment against using ICs for vcOs. Describing the new 11C85 PLL synthesizer in the No-

vember-December, 1977, issue of Fairchild's *Journal of Semiconductor Progress*, Eric Breeze said, "After considering the stringent vco requirements... it was concluded that discrete components offer more flexibility and better performance than anything that could be built on a chip." After hours and hours of fighting that vco stability problem, I can only say, "Hear! Hear!" As long as the MC1648 was involved, there was no way that I could visualize the full role played by that discap or the possibilities of its interactions. I suspect that this circuit will cause NRI considerable heartburn!

The TTL phase-locked-loop synthesizer and the LED readouts are significant contributors to the power appetite of this transceiver. In the receive mode, it takes about 1.5 Amps at 13 V. In the transmit mode, I measured about 2.5 Amps drawn in the low-power mode and about 5 Amps in the high-power mode.

In my judgment, another questionable choice of components was the T-R relay (Photo C). The relay is open framed and is mounted at the rear of the unit between the louvers in the top and bottom covers. Every time the PTT switch is closed, a field is created around that relay. Particularly in the dusty vehicular environment for which this type of rig is intended, that field will attract an oil and dirt film to the contact points. The relay should be replaced with an enclosed type. Hopefully, NRI will see fit to offer a more suitable, compatible replacement. I'll be pleased to pay a reasonable price for one.

On the positive side, in addition to the excellent mechanical layout, NRI has built in several nice features. Recall that 6- to



Photo C. Top cover removed to show swing-out panels and T-R relay.

7-MHz digital-frequency counter? Bet you wondered what good that could be for aligning a 2 meter rig, didn't you? Well by cleverly making use of the decade-dividing circuit that's part of the 10-MHz reference-frequency oscillator, NRI divides the receiver and transmitter simplex and offset frequencies from their 23- to 24-MHz range down to a figure that's 1/10th of that. The latter is easily handled by the little counter.

Rf and i-f alignment are accomplished by using an already-present, harmonic-rich, 1-MHz TTL square wave as a signal source. It's a clever concept and permits a surprisingly good alignment. I double checked with a fairly elegant sweep generator and a wideband scope. Improvement in performance, if any, resulting from the more elaborate alignment technique, wasn't obvious.

The synthesizer is supposed to cover 400 channels, that is, any 2 MHz of the 4-MHz band in 5-kHz increments. Actually, it retains lock through almost 3 MHz of the 4. This may change as components age.

The power supply shown in Photo A has a variable voltage output—5 volts to

about 15 volts. NRI rates it a 4-Amp steady load to 6 Amps with a 50% duty cycle. The heart of the power supply is the relatively new Fairchild 78GKC 4-lead TO3. Fairchild rates the device at 5 Amps. The supply is very well regulated and should be a welcome addition to any bench, as well as serve as an ac supply for the transceiver when it's in the shack.

I understand that the transceiver and the power supply are available from NRI in kit form, independent of the entire communications/electronics course. It's quite clear that the design engineers on the CONAR 452 transceiver were very cost-conscious. If NRI passes these savings along to the kit buyer, this 2 meter rig could be a very good buy.

Some weaknesses have been identified, but the fixes were described. Having debugged the transceiver, it's going to be a very adequate mobile rig, and I'll stack up its performance against anyone else's rig. That's about all I can say for it.

Finally, I didn't get a chance to test NRI's money-back guarantee. I got my First Class Commercial radiotelephone ticket, with radar endorsement, on the first try! ■

Social Events

from page 73

LAPORTE IN FEB 25

The LaPorte Amateur Radio Club will hold its winter hamfest on Sunday, February 25, 1979, at the LaPorte Civic Auditorium, LaPorte, Indiana. There is a \$1.00 table charge. Donation is \$2.00 at the gate. Talk-in on .01/.61 and .52. For more information, contact LARC, Box 30, LaPorte IN 46350.

AKRON OH FEB 25

The Cuyahoga Falls Amateur Radio Club will hold its annual electronic equipment auction and flea market on Sunday, February 25, 1979, at North High School, Akron, Ohio, from 9:00 am to 4:00 pm. Tickets are \$2.00. You may bring your own tables, and there will be some available for \$2.00 each. There will be refreshments, prizes, and a grand prize of a Triton IV. There is easy access to the high school on the Tallmadge Avenue off-ramp and the North

Expressway (Rt. 8). Talk-in on 146.52 and 146.04/.64. For details, write CFARC, PO Box 6, Cuyahoga Falls OH 44222, or phone Bill Sovinsky K8JSL at (216)-923-3830.

DAVENPORT IA FEB 25

The Davenport Radio Amateur Club will hold its hamfest on February 25, 1979, at the Masonic Temple in Davenport, Iowa. Admission is \$2.00 in advance, \$2.50 at the door. Refreshments and tables will be available. Talk-in on .28/.88 and .52. For further information, send an SASE to John S. Birmingham WB0QCC, 2022 Brown St., Davenport IA 52804.

LIVONIA MI FEB 25

The Livonia Amateur Radio Club would like to announce that the 9th annual LARC Swap 'n Shop will be held on Sunday, February 25, 1979, from 8:00 am to 4:00 pm, at the new location of Churchill High School in Livonia MI. Tables, door prizes, refreshments, and free parking

will be available. Talk-in on 146.52 simplex. Reserved table space of 12-foot minimum is available. For further information, send an SASE to Neil Coffin WA8GWL, c/o Livonia Amateur Radio Club, PO Box 2111, Livonia MI 48151.

VIENNA VA FEB 25

The Vienna Wireless Society will hold its annual Winterfest on Sunday, February 25, 1979, at the Vienna Community Center, Vienna, Virginia. There will be tables, sales, prizes, food, and frostbite tailgating. Doors open at 6:30 am for vendors and 8:00 am for the general public. Admission is \$3.00, including one prize ticket; \$2.00 for an extra prize ticket and \$1.00 for frostbite tailgating. Preteens with parents are free. Tables range from \$2.00 to \$5.00, depending on the quantity. Reservations close on February 15, 1979. For reservations, contact Carroll N. Guin, 7533 Oak Glen Court, Falls Church VA 22042. For information, contact the Vienna Wireless Society, PO Box 418, Vienna VA 22180.

VERO BEACH FL MAR 17-18

The Treasure Coast Hamfest will be held on March 17-18, 1979, at the Vero Beach Community Center, Vero Beach, Florida. Activities will include prizes, drawings, and a QCWA luncheon. Admission is \$3.00 per family. Talk-in on 146.13/.73, 146.52/.52, and 222.34/223.94. For information, write PO Box 3088, Vero Beach FL 32960.

WAUKEGAN IL MAR 25

The Libertyville and Mundelein Amateur Radio Society will hold its second annual Lamarsfest on Sunday, March 25, 1979, at the J. M. Club, 708 Greenwood Ave., Waukegan, Illinois. Doors will open at 7:00 am. There will be plenty of free parking, door prizes, and a large indoor flea market for radio and electronic items. Tables will be available at \$4.00 each. Advance tickets are \$1.50; \$2.00 at the gate, with children under 10 free. Hot lunch will be available and there will be plenty of commercial exhibits and demonstrations. Talk-in on 146.94. For further information, write LAMARS (include SASE, please) at 1226 Deer Trail Lane, Libertyville IL 60048, or call (312)-367-1599.

MUSKEGON MI MAR 30-31

The Muskegon Area Amateur Radio Council is sponsoring the ARRL Great Lakes Division

Convention and Hamfest at the Muskegon Community College in Muskegon, Michigan, on March 30-31, 1979. This event will feature manufacturers' exhibits, technical forums, and a large swap shop. Ample parking and dining facilities are available. Friday evening at the Muskegon Ramada Inn, there will be a "Ham Hospitality" with libation courtesy of the MAARC and a Wouf Hong initiation. For additional information, contact MAARC, PO Box 691, Muskegon MI 49443, or H. Riekels WA8GVK, (616)-722-1378/9.

UPPER HUTT NZ JUNE 1-4

The 1979 Annual Conference of the New Zealand Association of Radio Transmitters will be held on June 1-4, 1979, at Upper Hutt, New Zealand. Visitors are welcome to attend this conference. For registration forms, contact the Secretary, 1979 Conference Committee, PO Box 40-212, Upper Hutt NZ.

LOUISVILLE KY JUN 29-JUL 1

The Louisville Area Computer Club will hold its 4th annual Computerfest™ 1979 from June 29 through July 1, 1979, at the Bluegrass Convention Center, Louisville, Kentucky. Activities include a flea market, seminars, and exposition, as well as activities for the entire family. Seminar and exposition admission is \$4.00. Pre-registered Ramada Inn guests (\$29.00, single; \$34.00, double) receive free admission. For advance mail information, write Computerfest '79, Louisville Area Computer Club, PO Box 70355, Louisville KY 40270, or phone Tom Eubank, Chairman, at (502)-895-1230.

GEORGETOWN IL SEP 1-2

The 1979 Danville, Illinois, Area Hamfest will be held on September 1-2, 1979, at the Georgetown, Illinois, fairgrounds, located ten miles south of Danville on Illinois Rt. 1. Gates open at noon on Saturday for vendors to start setting up their displays. Gates open to the general public at 6:00 am Sunday. Facilities will consist of a large enclosed building 50 x 150 feet with electrical hookups available at no charge. Please bring your own tables and chairs and power cords. Outside space is also available at a \$2.00 per person gate charge. Overnight camping on the fairgrounds is available at \$5.00 per vehicle. For information, contact Bob Wilson K9RBW, c/o Illiana Repeater Systems, Inc., PO Box "G", Catlin IL 61817.

Ham Help

I live close to an AM radio station and will be moving even closer to another one. I use an old army surplus receiver for shortwave and cannot use it at all when that station is on the air. Could anyone give me information on an article, or a copy of one, that would help me build a filter to filter out the broadcast station? Thank you very much.

Terry D. Wright WB8UPO
525 South Downing St.
Piqua OH 45356

I need a diagram or information on a "CHIBA" model CPF12 6-channel 2m hand-held transceiver with 16/76, 34/94, and 94 simplex built-in crystals.

Jung Y. Lem KB6BO
5222 Coringa Dr.
Los Angeles CA 90042

Does anyone have any information or a schematic on a Poly-Comm "B" 29-MHz transceiver? I will buy manual for above or pay for a copy. Thank you.

Peter J. St. Arnaud
PO Box 695
Lowell MA 01853

I need information about ter-

minal antennas for satellite TV. Any info about suppliers for these kits would be greatly appreciated. Thanks.

Steve Hutchens
Rt. 1 Box 186C
Boonville NC 27011

I would like to add electronic switching to my TS-520S so that I might have full break-in on CW. If possible, I would like to leave the VOX circuit intact for SSB operation, but I would sacrifice that for the full break-in feature. I wonder if anyone has made this modification?

Dick Arnold WD8RZB
22901 Schafer
Mt. Clemens MI 48043

I have been working on my ticket and collecting equipment. I read where a Gonset Super 6, when used with a modified BC-453, makes a good receiver. I bought a Super 6 but now I need to know what voltages to hook up to the brown, red, orange, and white wires. I also need to know how to adjust the coils and trimmers. I will gladly reimburse mailing and duplicating expenses. Thank you.

Keith L. Brown
2537 Starling Rd.
Arnold MO 63010

Clegg is...



...ICOM Headquarters

No one else offers as diversified a transceiver line as ICOM, and no one else can fill your ICOM needs better than Clegg!

Take your pick for your favorite mode and band:

IC-701 160-10 meters, Synthesized, Solid State Digital readout, 200 watt PEP input.

IC-211 144-148 MHz, Synthesized, FM/USB/LSB/CW Digital readout, 10 watt output Solid State. 13.8 VDC and 115 VAC operation.

IC-245/SSB 144-148 MHz, Synthesized, FM/USB/CW digital readout, 10 watts output, Solid State Multi-Mode Mobile.

IC-280 143.9-148.11, Microprocessor controlled memory. 1 and 10 watt FM'er. Remote controllable.

IC-30A 440-450 MHz FM, 22 Channels, 10 watts

IC-202S 2 Meter SSB Portable

IC-502 6 Meter SSB/CW Portable

IC-215 2 Meter FM Portable

IC-402 432 MHz SSB/CW Portable

Call us today for information on the ICOM of your choice. Take advantage of our new departmentalized telephone system to assure the fastest possible service.

ORDERS & QUOTES: TOLL FREE 1-800-233-0250

SERVICE DEPARTMENT: TOLL FREE 1-800-233-0337

ENGINEERING, PURCHASING, ADMINISTRATION

AND ACCOUNTING: 1-717-299-7221

Looking for a different brand? Clegg also stocks all other major product lines including Dentron, Alpha, Yaesu, Drake, Wilson, KLM, Hustler and MFJ, and—of course—Clegg transceivers.

Call Clegg for best price

Clegg

✓ C33

Communications Corp.
1911 Old Homestead Lane
Lancaster, PA 17601

Time-Domain Reflectometry

— to check out your transmission lines

This added dimension simplifies the location of an antenna system fault.

When the band seems dead or, worse yet, when the band sounds alright but you can't make contacts as usual, how often have you wondered about the condition of your antenna system? This is certainly one of the more frustrating feelings an amateur experiences, especially if parts of the antenna system are not visible from the operating position.

There are many methods that can be used to check an antenna system. A simple ohmmeter reading, especially if the ohmmeter used has good resolution in the low Ohms range, is useful for antenna systems which form a closed dc loop for measurement purposes.

The measurement of swr at the transmitter end of the transmission line remains one of the most basic and useful of measurements in the average situation, although there are circumstances where swr readings can be misleading. For instance, depending on the attenuation of the transmission line involved at a given frequency, the swr read at the transmitter end of a transmission line will be lower than that existing at the transmission line/antenna interface. Theoretically, the swr at the transmitter end could look perfect while there was no antenna connected to the

other end of the transmission line. No practical situation would normally approach this condition, however.

Even if an swr reading indicates that something has changed in the antenna system, it does not give any information as to what might be at fault or where the fault might be located. "Time-domain reflectometry" is a rather impressive term for a transmission line measurement technique that can provide information on the nature and location of faults on a transmission line. In the commercial world, the equipment needed to make measurements using this technique can be sophisticated and expensive. The results can also be impressive — like being able to isolate a fault to a specific connector or almost down to the foot in an extensive cable TV distribution system.

The general improvement in quality of the test gear available even in the average ham shack, due to

modern ICs, etc., makes the basic use of the technique interesting to explore for HF to VHF antenna system checks. Two basic items of test gear are necessary to implement the technique: a fast-rise-time square-wave generator and a broadband oscilloscope. (If a suitable square-wave generator is not available, a perfectly useful home-brew unit using only two ICs is described later.) The oscilloscope used should have a frequency response of 10 MHz or more, but some of the newer low-cost oscilloscopes which have a flat response to 5 MHz and a usable response up to several MHz more are also quite satisfactory for basic measurements (e.g., the Heath IO-4560 oscilloscope at \$120). Older oscilloscopes with restricted frequency responses can also be used in many circumstances, but with varying results.

In simple terms, time-domain reflectometry works like a radar signal on a transmission line. The

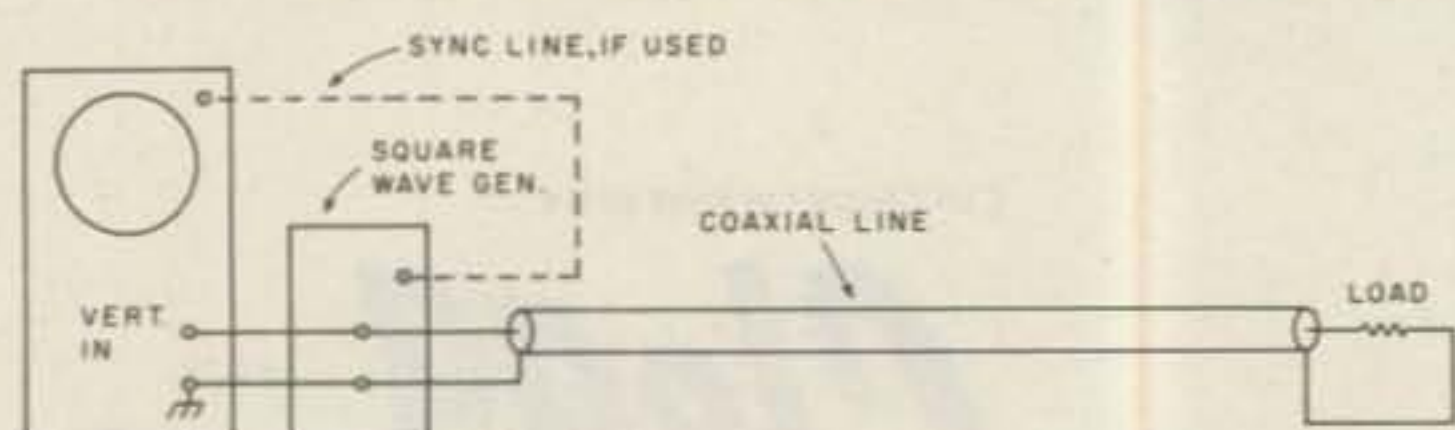

Fig. 1. Basic test setup for time-domain reflectometry. A fast-rise-time square-wave generator and a broadband oscilloscope are the basic test instruments needed.

square-wave generator sends out the necessary "pulse," and the scope is used to obtain a picture of the results. Problems on the transmission line or with the line termination will produce discontinuities on the oscilloscope display. The location of the problem is determined by knowing the speed at which the signal travels down the line and then noting where (time-wise on the horizontal sweep of the scope) a discontinuity occurs. With good equipment, one can calculate quite accurately the location of faults (opens, shorts, etc.) on the line, but this is not necessary in the average amateur installation. After having made a few good "signatures" of what the transmission line system looked like when it was known to be in good condition, and then comparing them to oscilloscope "signatures" when a problem occurs, one can be readily guided to the approximate location of a fault.

Fig. 1 shows the setup for measurement. The output of the square-wave generator is connected directly to the vertical input of the oscilloscope and to the coaxial line being tested. The connection should be as short as possible and preferably directly to the oscilloscope terminals. The square-wave generator to be described later can, in fact, be constructed compactly enough to fasten directly on the vertical input terminals of many oscilloscopes using binding posts or via a T-connector for oscilloscopes with a BNC- or UHF-type input connector.

It may seem a little difficult at first to understand why anything meaningful would be displayed on the oscilloscope with the square-wave generator output connected directly to

the oscilloscope's input terminals. One may think the coaxial line just acts as a capacitor across the oscilloscope terminals. The key to the situation is to remember that the voltage step produced by the start of the square wave requires a finite time to travel down the coaxial line (the speed of light times the velocity factor of a specific cable). Therefore, the square-wave frequency used must be chosen taking into consideration the length of the coaxial line under test if a meaningful display is to be obtained. If the positive portion of the square wave lasts long enough time-wise so that it is not completed before the length of time needed for the voltage step to travel down a given length of coaxial cable, any discontinuities in the line produce a reflection which travels back to the oscilloscope terminals. The reflected voltage adds or subtracts to the positive portion of the square wave which the oscilloscope is displaying and the pattern will change.

For instance, in Fig. 2(a), the coaxial line is terminated in a resistive load which matches the line. The square wave traveling down the line encounters no discontinuities, and so the oscilloscope display is essentially a square wave. In Fig. 2(b), the line is terminated in a load resistance which is less than the line impedance. The square wave, when it reaches the termination, is partly reflected back and, when it reaches the oscilloscope terminals, subtracts from the positive portion of the square wave the oscilloscope is trying to display. The display, therefore, is altered as shown. If the load resistance were higher than the line impedance, the reflected voltage would add to the displayed voltage.

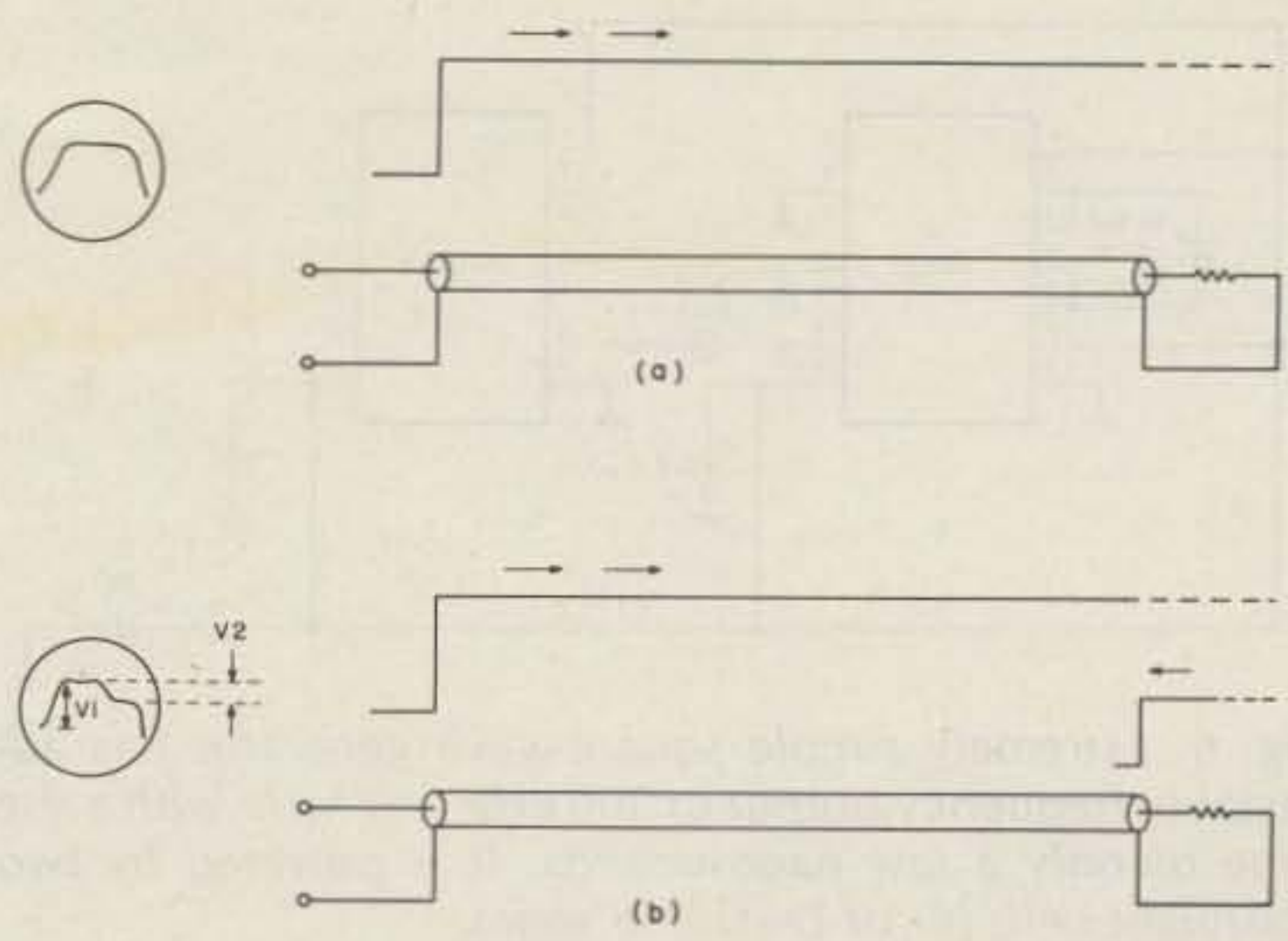

Fig. 2. The concept of a voltage step traveling down a line (a) and then part of that step being reflected back from an improperly matched load (b) is the basis for time-domain reflectometry.

The square-wave frequency used should be low enough to allow the reflection produced by a fault, even at the extreme end of the line, time enough to travel back to the oscilloscope terminals before the positive portion of the square wave is completed. On the other hand, the frequency shouldn't be lower than necessary or else resolution as to where a fault lies will be lost. One can calculate the optimum frequency for a given type of line, but it is rarely necessary to get so precise. Fig. 3 presents a rough guide as to the square-wave frequency one should use for given

lengths of ordinary coaxial line.

If you have, or can borrow, two lengths of coaxial cable each at least 50 feet in length and the same impedance, I would suggest that the circuit of Fig. 1 be tried out. Use a resistor equal to the line impedance, and resistors lower and greater in value than the line impedance to terminate the line. Also, short and/or terminate the junction of the two sections of cable with various resistors.

Most amateurs do not believe the technique works until they try it out in this fashion. The idea of a reflection actually travel-

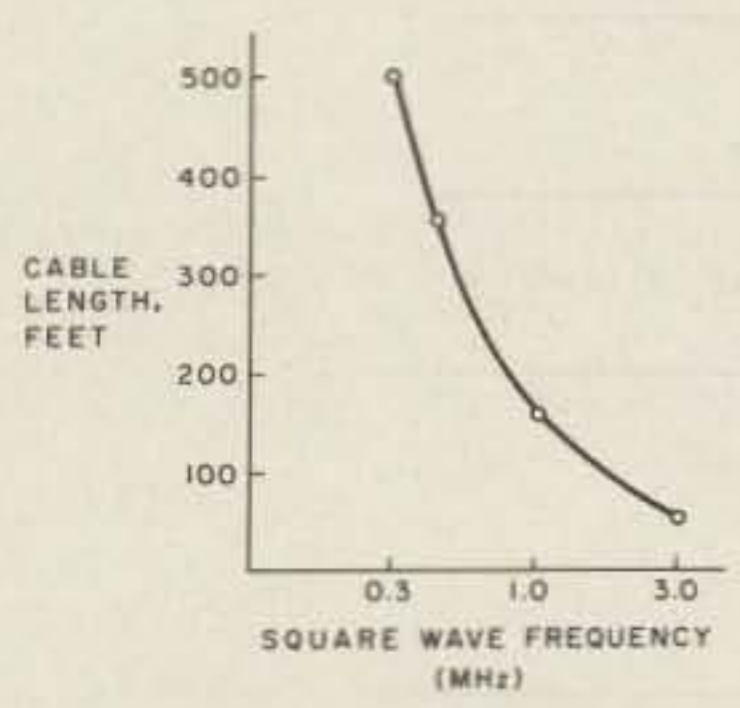

Fig. 3. This graph shows approximately what generator frequency to use when testing different lengths of line. Using a variable frequency generator, the generator frequency is actually adjusted for the best oscilloscope display.

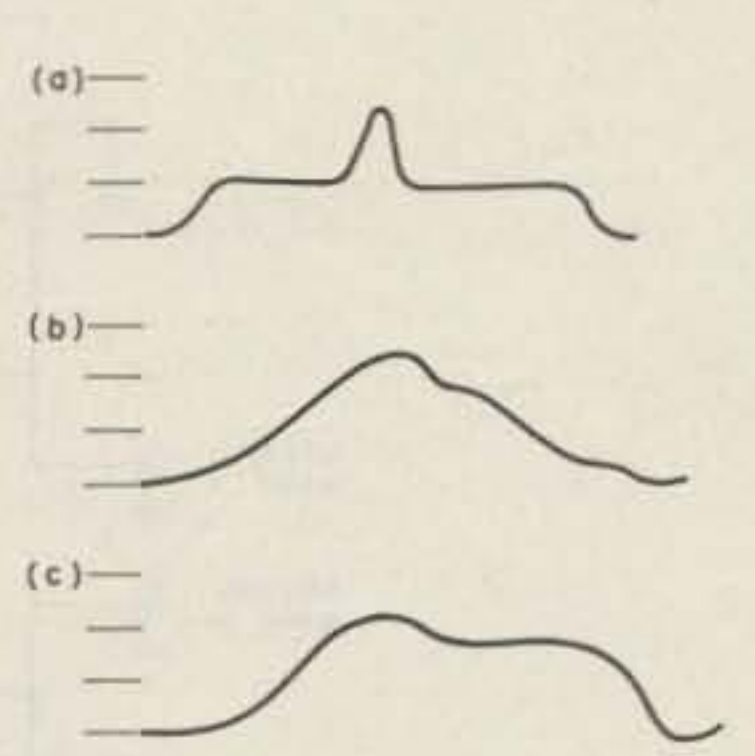

Fig. 4. These are some actual oscilloscope patterns obtained. (a) shows a line with a short circuit in the center of its run. (b) and (c) are discussed in the text and show the effect of an antenna fault.

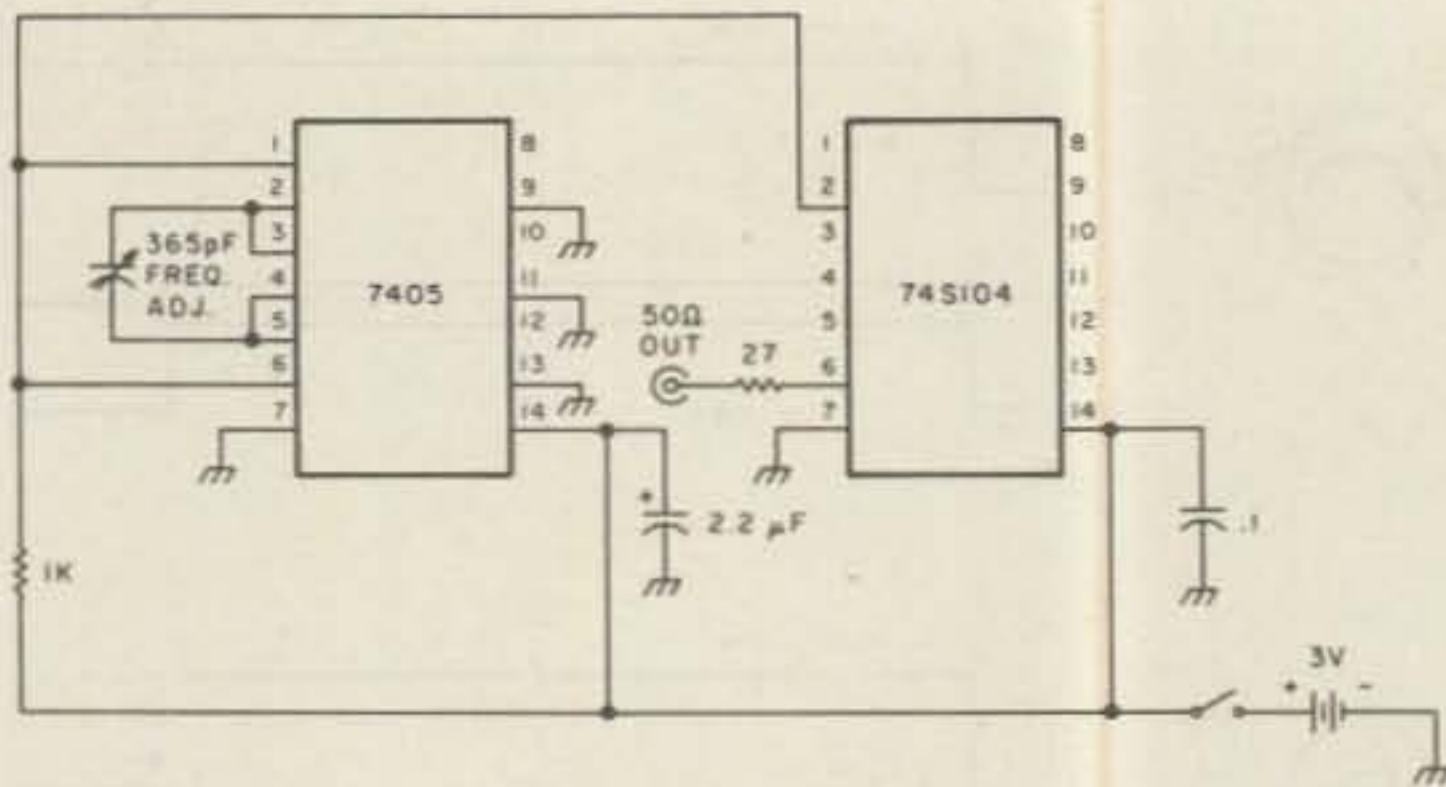

Fig. 6. Extremely simple square-wave generator has adjustable frequency output of 300 kHz to 3 MHz with a rise time of only a few nanoseconds. It is powered by two flashlight cells (C- or D-size) in series.

ing back up a line from a mismatched load is sometimes a difficult idea to grasp. The oscilloscope patterns one obtains depend upon the quality of the equipment used, but they should duplicate that of Fig. 2(a) for a properly-terminated line, that of Fig. 2(b) for a line terminated in a low-value load resistor, and that of Fig. 4(a) for a line terminated in its correct load resistance but with a short in the middle of the line. Obtaining an exact display is not so important as noting how sensitive the display is to changes in load terminations and to faults which take place at different places along the line.

If one can obtain a very

sharp display, it will be noted that the display of Fig. 2(b) can be related to the load swr. V_2 is the reflected voltage amplitude and V_1 is the incident voltage amplitude. The swr is $(V_1 + V_2)/(V_1 - V_2)$. For instance, if V_1 is 2 volts and V_2 is 0.5 volts, the swr is 1.67. This type of display can be very useful for classroom situations where swr must be explained, and especially when you must make the point that terminating a transmission line in its characteristic impedance is important in most cases.

Applying the measurement technique to an actual antenna system produces more complex oscilloscope displays because

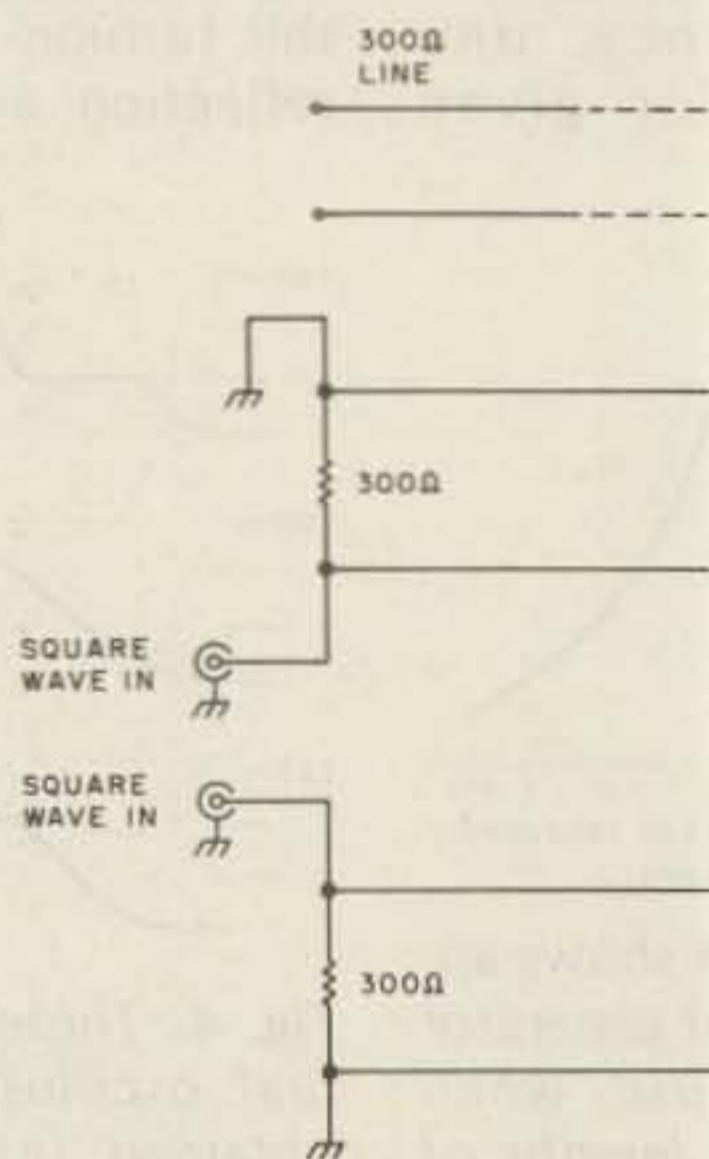

Fig. 5. Systems using a balanced line can be checked also. The line is terminated by a resistor as shown and then the square-wave signal applied alternatively to either side of the line. The balance of the line is also checked by this method.

of the reactances involved. But the technique can still be very useful if one is consistent with a test setup — that is, using the same length of test leads, square-wave frequency, amplitude, etc. One should obtain an oscilloscope "signature" of the antenna system as measured from the transmitter end when the antenna system is known to be in good order. If possible, a few faults should be simulated to see how the oscilloscope display changes. The actual faults, if they take place, will be relatively easy to identify. For instance, Fig. 4(a) shows the display obtained on a given antenna system when the transmission line was terminated in a dummy load but shorted in the center of its run. Fig. 4(b) shows the display of an antenna system using a multiband trap antenna but with two lengths of coaxial cable of the same impedance but different type (RG-58 and RG-8) hooked together to form a single transmission line. Fig. 4(c) shows the change in the display when one of the antenna loading coils was partially shorted to duplicate a fault in the antenna. The change in swr at the terminal end, as measured with a conventional swr meter, was barely noticeable in this case, although the oscilloscope display change was easily noticed. Again, it deserves some emphasis to note that the oscilloscope display obtained with any given antenna system will be unique depending on the system and the test equipment being used.

For those amateurs who use a balanced transmission line/antenna system, the measurement technique described can still be used. For instance, if one uses a 300-Ohm transmission line system, the line is terminated at the transmitter end as shown in Fig. 5,

and the square wave signal is alternatively applied to both sides of the line. Faults in the system will be displayed in the same manner as for a coaxial system when testing either side of the balanced line. The oscilloscope pattern obtained when testing either side of the balanced line should be the same if no faults are present and acts as a check on the true symmetry of the balanced system.

The purpose of the measurement technique described is to discover faults in an antenna system, either along the transmission line or in the transmission line termination — the antenna. One, therefore, has to start with a matched condition at the square-wave generator/coaxial line terminus, or else a confusing oscilloscope display will be obtained. Any sort of mismatch will cause a reflection in the system under test, and the reflection will bounce back and forth between mismatched or fault points in the system. Thus, if the square-wave generator/coaxial line end is not properly matched, a reflected voltage from a mismatched load will be reflected up the transmission line again once it meets the square-wave generator/coaxial line mismatch. Fortunately, this situation is easily prevented. The output of the square-wave generator being used, assuming its output impedance is at least several hundred Ohms, should be terminated in a resistor equal in value to the characteristic impedance of the line being tested (usually 50 or 70 Ohms).

If one does not have a suitable square-wave generator, the one shown in Fig. 6 is simple to build and very versatile. It utilizes a 7405 as an oscil-

lator and a 74S140 as an output/buffer. The square waves produced have the necessary fast rise time, and the 360 pF variable capacitor (a standard BC type) will allow varying the output frequency from about 300 kHz to 3 MHz. So a variety of transmission line lengths can be tested. The oscillator should be constructed in a metal enclosure and is simply powered by two 1.5 cells of either the C or D variety.

The 27-Ohm series resistor from pin 6 of the 74S140 has already been chosen, in conjunction with the internal output impedance of the 74S140 section being used, to provide the correct terminating impedance for a 50-Ohm coaxial system. No further terminating resistor is necessary when the generator output is connected to an oscilloscope and a 50-Ohm coaxial line.

The use of a simple time-

domain reflectometry setup to check an antenna system can prove to be of definite value, especially when swr readings give rise to doubt as to the condition of an antenna system. The usual swr meter reading is taken only at a definite point in the transmission line/antenna chain and it reflects conditions only at the point where the swr meter is inserted. Granted, the swr meter reading even at a

fixed point in an antenna system is influenced by conditions throughout the antenna system. But there is no way to tell from the swr meter reading alone where a fault might have taken place in the total transmission line/antenna system. The oscilloscope display of the time-domain reflectometry method provides that extra dimension that makes locating a fault in an antenna system significantly easier. ■

W2NSD/1 NEVER SAY DIE

editorial by Wayne Green

from page 110

the factory . . . and the factory is in Japan, so rots of ruck.

If you've priced shipping charges lately, you know another reason why there is much to be said for buying from you local dealer. Normally, the dealer picks up the charges from the factory to his place. If you buy from a dealer who has no service, you'll usually have to pick up the freight charges to and from the factory service department . . . and figure two weeks for shipping (at least).

The article suggested getting bids for ham gear and accepting the lowest bid. Some hams have been using the WATS line numbers for this already. There has been a growing number of cases in which some crafty people have set up as dealers, published a WATS number, and undercut everyone else on price. As Barnum said, there's a sucker born every day. These "dealers" seldom have much in stock, but they "can get it for you immediately." The manufacturers tend to fill orders from the better paying dealers first and, if anything is left over, fill the orders from these operators last. This means you can easily go several months waiting for delivery, while the dealer has your money.

Getting bids on ham gear will quickly put you in touch with dealers who are waiting for you with "bargains." The markup on ham gear is very small to start with, seldom running more than 25%. It takes all of

this to run a store, prepay for equipment, carry out warranty service, etc. For every percent you manage to cut off that figure, you are laying yourself open to getting screwed. The lower the price, the more the chance that you are the one who is going to take the licking.

Sure, a dealer operating out of his cellar or garage, with no gear in stock, no employees, and no service, can sell very cheap. But you have to wait for the factory to honor his order for a drop shipment direct to you. This means you pay those shipping charges. It also usually means extended waits, no matter what the promises were on the phone.

The dealers were more than a little upset over a ham magazine promoting cutthroat selling, a practice that could quickly drive legitimate dealers out of the ham business. In the longer run, it could encourage manufacturers to start selling directly to the ham, a practice which at first has the seeming benefit of cutting out the middleman and bringing prices down. The fact is that every experiment with this form of selling has forced prices right back up because customer service gets to be an ogre and the need for local dealers becomes imperative.

In general, the rule is that the more discount you get, the longer you may have to wait and the more of an orphan you'll buy when it comes to problems. If you have infinite patience and are equipped with a good test lab and a lot of ex-

perience in working with the latest equipment, it may be worth your while to shave a few percentage points off the purchase price. Good luck.

AVUNCULAR ADVICE

Newcomers to amateur radio have a lot of catching up to do. Frankly, it takes years of forgetting most of what you read and much of what you hear to develop the learned ignorance of many old-timers. You can hear them pontificating on 75m long into the nights, often operating in groups and thus reinforcing their misinformation.

Well, the esoterics of radioteletype and slow scan television are still mysteries to the beginner, perhaps awed by his own bewilderment and the appearance of mastery by hams heard over the air. Take heart, pre-Novice, all is not as it seems. The buzzwords of amateur radio will soon be yours to cow family and friends, and your gradual understanding of electronics will be both a delight and a temptation to one-up CBers.

It is difficult, when surrounded by the delights of modern electronics, not to try to skimp on fundamentals. A partial understanding of some articles in 73 can give people false security, which can cause great harm later on when the lack of understanding of fundamentals assures that nothing is really thoroughly understood. You need a firm foundation in electricity, magnetism, motors and generators, etc.

One of the purposes of the Novice Class FCC exam is to encourage people to study basics. The FCC exam series is very well designed to carry the beginner right on through the steps of understanding which will make it possible to deal with more advanced technical concepts. The 73 Study Guides have everything you need to know to start from scratch and work your way up to mastering

electronics to the level where you should be able to pass a First Class Commercial FCC exam . . . and certainly have no trouble with the Amateur Extra exam, even with some of the very tricky questions the FCC throws at you.

Yes, the FCC resorts to tricks. I get a lot of complaints about this and some would-be amateurs get so angry about it that they want to take the FCC into court. Unfortunately, this is a losing battle, for the FCC has a whole bevy of staff lawyers, so the whole thing costs them nothing. Further, judges tend to be very wary of going against the government . . . that's where their promotions come from. The government generally has to really screw things up before they can lose a case. This means that you'll have to endure the warped minds which put together the ham exams and just figure that you'll have to allow a 10% margin for FCC bias.

The best response to FCC trickery is to come to their exams as over-prepared as you can. Be sure that you can pass the code test in a breeze, otherwise you may still be uptight when you get to the written part of the ritual and not be able to throw your full weight into it. If there is any code course even close to giving you the confidence of the 73 series, I'm honestly not aware of it . . . and if I were, you can be sure that I would make the 73 tapes even better.

On tape number four of the 73 Novice theory series, I discuss the questions on typical Novice exams. If anyone who has used these tapes has ever failed the exam, this has been kept a secret from me . . . and I would find it hard to believe in the face of the thousands of enthusiastic letters I've received from survivors.

Continued on page 190

The LEADER In the Northwest!



ATLAS • ICOM • KENWOOD • YAESU

Come to **ABC Communications** today for the best solution to your particular communication requirements, whether they be Amateur, Two-way Business Band, VHF Marine or Police Scanner.



ATLAS Transceiver 210X
80 thru 10M



DENTRON MT-3000A
Deluxe Tuner

ATLAS Transceiver 215X (not shown)
160 thru 15M

DENTRON 160-10 AT (not shown)
Super Tuner



KENWOOD Transceiver
TS-820S 160 thru 10M



KENWOOD Transceiver
TS-520S 160 thru 10M



KENWOOD 2M FM
TR-7400A

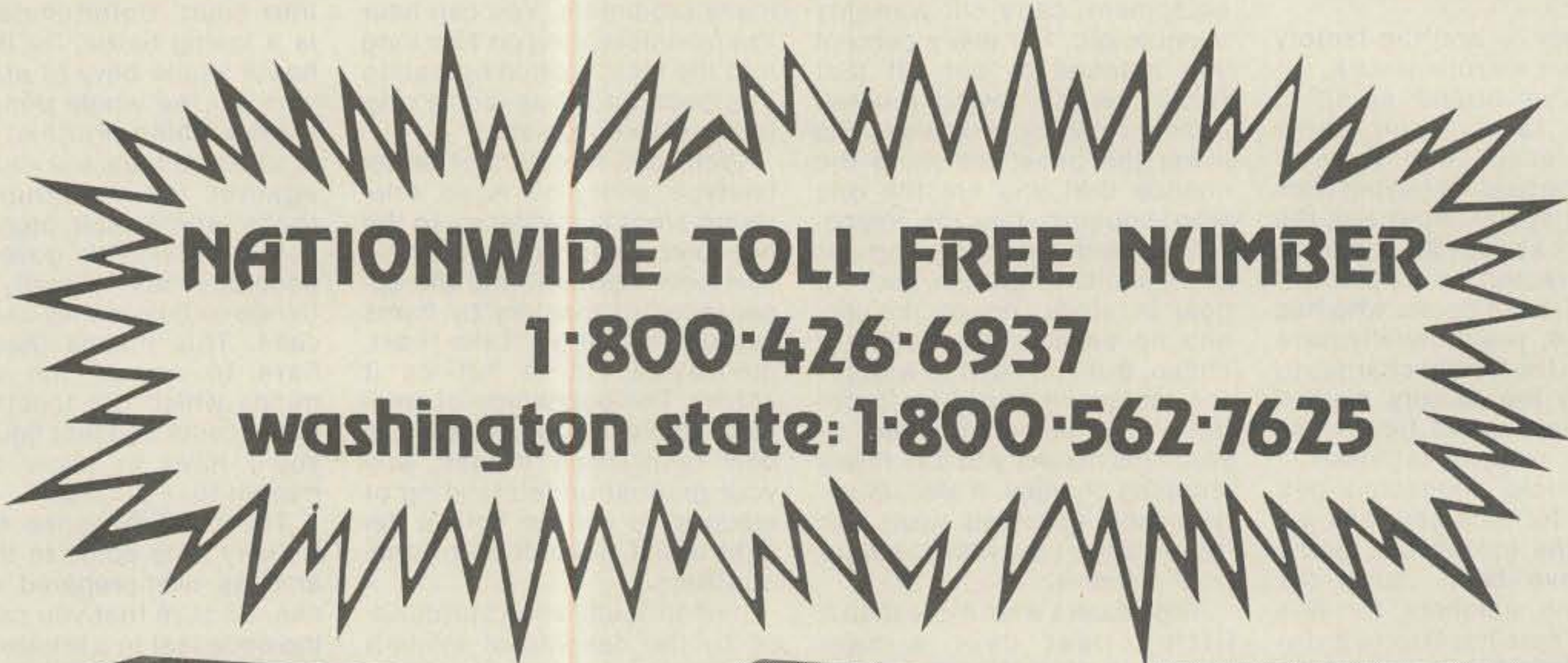

ICOM Transceiver 2M FM
SSB IC 211



ICOM Transceiver 2M FM IC 245



YAESU 901 DM



YAESU HF SSB 160 thru 10M
FT 101F or FE



✓ A46

17550 15TH AVE. N.E. • SEATTLE, WASH. 98155 • (206) 364-8300

We also handle Wilson, Cushcraft, Hy-Gain, Antenna Specialists, KLM, etc.

Attention Washington residents: Come on in for excellent service in our complete Communications Repair Shop.

Write or call for SPECIAL tower, rotor, antenna package! Tri-Ex, Rohn, Wilson Towers. Shipping Info: F.O.B. Seattle via UPS, truck, or parcel post.

Washington residents add sales tax.

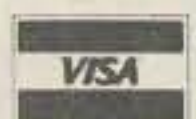

Other locations: (Walk-in customers only) • Bellevue — 12001 N. E. 12th • Everett — 4610 Evergreen Way • Open Mon. thru Sat.

Bearcat® 250 Features:

- **50 Channels/5 banks**—Program 50 frequencies from infinite frequency combinations. Designate certain banks for specific types of activity, for example, use bank 1-10 for Police, 11-20 for Secret Service, 21-30 for Drug Enforcement Agencies, etc.
- **5-Band Coverage**—Includes Low and High VHF bands, UHF and 2 meter plus 3/4 meter amateur bands. With special programming techniques, this unit can monitor additional frequencies not published in factory specifications.
- **Self-Destruct**—In case your scanner falls into enemy hands, you can electronically erase up to 64 frequencies in storage memory with only two key strokes.
- **Search/Store**—"Hands-off" automatic search operation that locates and "remembers" active frequencies.
- **Search/Recall**—Used in conjunction with search, displays frequencies found in search/store sequence.
- **Communications Electronics™**—quality control approval rating #1. Our highest quality grade for technologically sophisticated equipment.
- **Crystalless**—Without ever buying a crystal, you can select from all local frequencies by simply pushing a few buttons.
- **Priority**—Samples programmed priority frequency on channel 1 every 2 seconds regardless of other scanner operations—important for professionals who must monitor a certain frequency.
- **Time**—Brilliant digital LED clock—will display hours, minutes and seconds. Extremely accurate!
- **Count**—Frequency "traffic analysis" may be easily recorded to keep track of potentially hostile forces. Automatically counts numbers of transmissions on each channel to determine the most active frequencies.
- **Non-Volatile Memory**—No batteries required to retain memory, even when scanner is unplugged. MNOS integrated circuit utilized for memory.
- **Scrambler/Tape Audio Output**—Top secret cryptographic messages may be received and decoded by connecting the Bearcat 250's audio output jack to a correctly keyworded decrypting device, even if it utilizes the National Bureau of Standards, Data Encryption Standard.
- **Small Size**—The Bearcat 250's small physical size lends itself to government monitoring applications. When used with a battery power supply and a tape recorder, the Bearcat 250 may be easily concealed in an attache case for unattended, unobtrusive surveillance.
- **Auxiliary**—On/Off control of auxiliary equipment (tape deck, alarm, light, motor) when transmissions occur on programmed channels. Now, law enforcement agents can activate a tape recorder by remote control when a "body mike" transmission is received.
- **Speed**—Choice of either 15 or 5 channels per second scan speed for closer monitoring of desired frequencies.
- **Limit**—Sets the upper and lower frequencies of the user controlled search range.
- **Birdie-Lockout**—Avoid annoying scanner "lockup" during search mode. Scanner will skip over any programmed birdies!
- **Search Direction**—Determines in which direction search goes for faster return to desired frequencies.
- **Direct Channel Access**—Move directly to desired channel without stepping through all channels.
- **Automatic Squelch**—Factory-set squelch automatically blocks out unwanted noise.
- **Decimal Display**—Shows frequency and channel number as well as programmed function.
- **Deluxe Keyboard**—Makes frequency and feature selection easy for simple programming.
- **Patented Track Tuning**—Receive frequencies across the full band without adjustment. Circuitry is automatically aligned to each frequency monitored.
- **Selective Scan Delay**—Adds a two-second delay to prevent missing transmissions when "calls" and "answers" are on the same frequency.
- **Extended Frequency Coverage**—With special programming techniques, the Bearcat 250 can monitor 125-146 MHz, and 399-420 MHz in addition to the normal frequencies, without special modifications.
- **Simple Programming**—Simply punch in on the keyboard the frequency you wish to monitor.
- **Space Age Circuitry**—Custom integrated circuits... a Bearcat tradition in scanning radios.
- **Rolling Zeros**—This Bearcat exclusive tells you which channels your scanner is monitoring.
- **UL Listed/FCC Certified**—In addition to the #1 rating from **Communications Electronics™**, the UL and FCC certification assures you of quality design and manufacture.

The new **Communications Electronics Bearcat® 250** is an incredible scanning radio offering the scanning professional and the knowledgeable scanning enthusiast more monitoring capabilities, more frequency versatility, than any other scanning monitor available today.

It uses patented Bearcat integrated circuitry, so there's never a crystal to buy. With pushbutton ease, up to 50 channels can be programmed in five banks of ten channels each. The keyboard is easy to comprehend, simple to use. All functions are instantly displayed in bright LED numbers and letters.

All programmed frequencies and pertinent scan instructions are memorized in an electronic memory that operates even when the unit is unplugged from wall power—there is no need for batteries.

Not only will the Bearcat 250 capture more scanning action, it will "remember" where and how often it heard that action. Now it's easy to identify which frequency is used most often. It will search automatically through a selected frequency range and memorize in its search memory up to 64 active frequencies. To determine what frequencies were found during the search store mode, simply push the recall button and they will be displayed one at a time. Press the enter key and any of these frequencies is entered automatically into the scan memory.



As low as **\$259.00**
in quantities below

Bearcat® 250 Specifications

Frequency Reception Range	
Low Band	32-50 MHz
VHF Band	146-174 MHz
UHF Band	420-512 MHz
Extended frequency range	
<i>With special programming techniques the Bearcat 250 will also cover the following frequencies with a reduction in sensitivity:</i>	
VHF Band	125-146 MHz
UHF Band	399-420 MHz
Scanner Dimensions	
27.0 cm Wide x 7.6 cm High x 19.4 cm Deep (10 3/4" Wide x 3" High x 7 3/4" Deep)	
Scanner Weight	
2.27 Kilograms (5 pounds)	
Shipping Weight	
3.18 Kilograms (7 pounds)	
Power Requirements	
<i>(Note: 220 Volt AC Export model may be available April, 1979)</i>	
110-130 V ac, 60 Hz, 15 Watts	
12-15 V dc, 8 Watts	
Audio Output	
At least 2.0 Watts rms	
Antenna	
Telescoping (supplied)	
Scan Rate	
15 or 5 channels per second	
Sensitivity	
0.4 microvolts for 12dB SINAD on VHF bands, UHF band slightly less	
Selectivity	
Better than: -60dB @ ±25 KHz	
Audio Quality	
The BC-250's audio is more noise-free and suffers less distortion than the Bearcat 210 by a margin of 10 dB or more.	
Image Rejection	
The Bearcat 250 rejects image frequencies by at least 8 dB better in all bands than the Bearcat 210.	
Connectors	
External antenna and speaker, AC & DC Power, Auxiliary control output, tape audio output	
Accessories	
Vehicle mounting bracket and hardware, AC & DC power cords	

The **Communications Electronics™ Bearcat 250** even has an automatic count function that remembers how often any or all programmed frequencies were activated by transmissions while scanning. This will help you determine the value of your frequency selections. The Bearcat 250 will literally search and seize active frequencies.

An important feature for professionals who must monitor a specific frequency is the priority channel, Channel 1. If desired, whatever frequency is programmed for this channel will be sampled every two seconds anytime the set is turned on.

THE INCREDIBLE, NEW BEARCAT® 250 SCANNER.

LEADING THE WAY TO REAL EXCITEMENT

The Bearcat 250 has an auxiliary output feature which can be programmed to actuate external devices such as a light, alarm, motor, etc.

ONE-YEAR LIMITED WARRANTY

With your Bearcat 250, we will send all accessories, a complete set of **simple operating instructions** and a one-year limited warranty. If service is ever required, just send your receiver to one of our approved national service centers. When you purchase your scanner from **Communications Electronics**, you're buying from the world's leader in no-crystal scanners. We've sold more synthesized scanners than any other company.

NO OBLIGATION 31 DAY TRIAL

Test our Bearcat 250 for 31 days before you decide to keep it. If you do, you'll own the most sophisticated and technologically advanced scanner in the world. If for any reason you are not completely satisfied, return it in new condition with all accessories in 31 days, for a courteous and prompt refund (less shipping charges).

ADVANCED YET UNCOMPLICATED

Besides all the advanced features that put the **Communications Electronics™ Bearcat 250** light years ahead of any other scanning radio, it has the superior engineering and "standard" features that have made Bearcat the greatest selling scanner in America. Bearcat's patented track tuning insures full band coverage for maximum reception. And a single electronically switched antenna eliminates the need for an additional low band antenna. A detailed service manual is also available for \$15.00 postpaid.

BUY WITH CONFIDENCE

The **Communications Electronics™ Bearcat 250** is an extraordinary scanning instrument. It provides virtually any scanning function that the most professional monitor could require. The Bearcat 250 lets those who need to know, know more. To **get the fastest delivery** of your super synthesized Bearcat 250, send or phone your **order directly** to our Bearcat Scanner Distribution Center. Mail orders to: **Communications Electronics**, Box 1002 - Department WG12, Ann Arbor, Michigan 48106 U.S.A. Send \$319.00 plus \$5.00 for U.P.S. shipping or \$9.00 for U.P.S. air shipping (Michigan residents please add 4% sales tax). Foreign orders invited at a slightly higher cost. International customers, please read special shipping information (in our catalog) before ordering. Further price discounts are available to quantity buyers. Suggested list price is \$399.95 but you can get 6 Bearcat 250's @ \$309.00, 12 units @ 299.00, 24 units @ \$289.00, 48 units @ \$279.00, 96 units @ \$269.00, 252 units and up @ 259.00. Add \$15.00 for each 6 scanners ordered for U.P.S. U.S. ground shipping. Add \$195.00 shipping charge for each 6 scanners, on international shipments, or write for a pro-forma invoice. If you have a Master Charge or Visa card you may call and **order toll free 800-521-4414** to place a credit card order. If you are outside the U.S. or in Michigan dial 313-994-4444. All order lines at **Communications Electronics™** are staffed 24 hours.

Since this Bearcat scanner is the most popular unit ordered through our Scanner Distribution Center, you must **order your Bearcat 250 today** at no obligation, to assure prompt delivery.

Autoprogramming™ Scanner Distribution Center™ and CE logos are trademarks of Communications Electronics™. Bearcat® is a registered trademark of Masco Corporation of Indiana. Copyright ©1978 Communications Electronics™

COMMUNICATIONS ELECTRONICS™ ✓ C5

Box 1002, Ann Arbor, Michigan 48106 U.S.A.



ORDER YOUR BEARCAT 250 TODAY!

High Seas Adventure — Ham Style

— part IV

W6YO's odyssey ends, as the *Yankee Trader* finally returns home.

*James E. Seidel WA6FEI
1066 N. Westside St.
Porterville CA 93257*

Jules Wenglare W6YO set sail aboard the *Yankee Trader* from Freeport, the Bahamas, on February 15, 1977, for a ten-month around-the-world cruise. His westerly circumnavigation of the globe, his search for adventure in strange and exotic ports of call, and his operation of amateur radio, both at sea and on land, were partly covered in the last three issues of 73. Now, here in part IV you will venture with him during the final

seven weeks of the most enjoyable and exciting trip anyone could ever experience.

In the tape recording Jules made after leaving Cape Town, South Africa, he said: "The seas are picking up here. We're kind of rolling a little. Let's see . . . the weather is overcast with the wind blowing whitecaps. The swells are five to ten feet high. They are good size, but we haven't had any rough weather yet. Can't do much about it. It's 1700 miles to St. Helena, around seven to ten days, one of our longer crossings . . ."

Jules was looking for-

ward to meeting the ZD7 hams when he arrived. He hoped to obtain permission to operate amateur radio from the island.

The bands were very good at sea, and he made many contacts. He talked to Mac ZS1LK, whom he had met back in Cape Town, and Gordon ZS2MI, on Marion Island. Another QSO was with Bill ZD7SD and Sybil ZD7SS on St. Helena. He requested information about obtaining a license, and everything seemed favorable.

The *Trader* arrived at Jamestown, St. Helena, at 6:00 am, Saturday, October 29, and Bill ZD7SD, who

was born on the island, came aboard to meet Jules. Later, they went ashore and headed downtown to a government office. Jules filled out some papers, and the governor's secretary asked him what call he would like to have. ZD7YO, of course. It took about a half hour, and the call was issued. The actual license was picked up later after having been signed by the governor of the island.

Jamestown is a very quaint and old rustic city with all the charm one would expect. Bill's home was located about 800 feet up the side of a mountain. "What a view," said Jules.

"You look out right over the ocean, back about a half mile, but at a fairly steep angle."

They hooked up Jules's equipment (along with Bill's rig) and set everything up for split frequency operation. The bands were checked but nothing was coming in, so they went for a sightseeing ride in the country. Jules said, "It was very beautiful—all lush and green here on the southern half of the island."

They later went back to the *Trader* and, for Bill, Jules got the fiberglass poles and spiders for the quad antenna I mentioned in part I which never got installed. They returned to Bill's home and got on the air. The first contact was with Rudy W3CXX at 1903 UT (7:00 pm local time). The fifth contact was with John W6UZ, back in good old Delano, Jules's hometown.

One of the contacts made was with Archie K4IBO, Miami, where Jules had stayed a couple of weeks before this world trip began. "It was really something," Jules commented, "to work Archie. First time since somewhere in the South Pacific. It was really a surprise."

Jules worked many friends, both on 15 and 20 meters. Most of the contacts were on SSB during the CQ DX contest—mostly split frequency, but some transceiver operation. At times, the bands didn't open up very well and no contacts were made. He did make close to 300 contacts as ZD7YO, with the final contact at 1613 UT the following day: a PY1. It was another successful ham operation from a country where he had less than 36 hours to visit.

One of the places he visited was what they call "Jacob's Ladder." He climbed to the top of this 699-step stairway that goes

straight up from Jamestown on the side of a hill. It's really steep and was built years ago. The ladder is very famous, with cement steps about 10" high and a cast iron plate for railings and sides. "It's all bolted down to the solid rock hillside," Jules said, "at about a 45-degree angle."

Jules said it was quite a climb, but he and another *Trader* passenger went all the way to the top after a few rest stops. He said that the local boys slide down the rail. It was really a sight to see.

Bill took Jules to Napoleon's exile home. They went through the garden and the five or six room home and saw the room where Napoleon had died. A French flag flew inside the compound there on a British island. Jules said that this could be classified as a new country under the circumstances. The five-acre historical sight belongs to France ex-

clusively, as a tribute to Napoleon.

Jules finally had to leave St. Helena, and Bill and Sybil bid him farewell at the dock as the air horns aboard the *Trader* sounded. Jules said, "It was another memorable stop. One of the rare islands of the world."

The day after leaving St. Helena, it was Halloween. Many of the passengers aboard the *Trader* dressed up in all sorts of attire. One young lady was dressed up as a "gas pump." She had a large paper bag with numbers painted on it slipped over her head, and carried a black hose around to simulate the hose and nozzle of the pump. Many unusual costumes were worn to celebrate Halloween.

The bands were pretty good about four days out to sea. Jules worked Dixie KG6JIO and Dave KØWIQ/DU2 (Clark AFB, the Philippines), and Father Denny P29CC even arranged for

them to work ZD7SD for a new country. He had some tremendous signals coming in, with some good openings.

Remember the around-the-world yacht race I mentioned in part III? Well, Jules wrote another short piece about it for issue #10 of the *Trader Tales* newsletter.

"The *Yankee Trader* could have been taken as the 'mother ship' of the world's most elite blue-water racing yachts competing in the Whitbread Round-the-World while all were resting in Cape Town.

"The racers are sailing in an easterly circumnavigation, while we are cruising westerly. Our paths will 'cross' in the Atlantic, off the eastern tip of Brazil.

"The *Traderites* met the crew members of the sleek yachts while bending elbows at one of the finest yacht clubs in the world. This famous world yacht race started at Portsmouth, England, August 27, and

Photos by Jules Wenglare W6YO



Left to right: Bill ZD7SD and Sybil ZD7SS on St. Helena Island, with Jules W6YO. Jules operated here as ZD7YO for a short but successful DXpedition.

will end there sometime in April, Cape Town being the first of three stops. The second leg is expected to be the roughest, crossing the southern Indian Ocean to Auckland, New Zealand, in an area known as the 'Roaring Forties,' so close to the Antarctic that they may encounter icebergs. It is interesting to mention that their main communications are dependent on amateur radio 'ham' operators. Aboard the yacht *B and B Italia*, crew member Henry and his station I2NSX have been in contact with several hams—mainly with Gordon ZS2MI on Lonely, isolated Marion Island, which South Africa staffs with a small group of weather professionals and one radio operator. This station will furnish the yachts vital wind directions and iceberg warnings.

"Gordon and Henry asked for my assistance in relaying weather and position reports at times when they could not copy each other (and I could) while we were heading to and away from St. Helena."

It was a pretty smooth

crossing to Recife, a big seaport on the eastern tip of Brazil. Upon arrival, Jules called Fred PY7AZQ in Olinda, a nearby town, and made arrangements to meet him at the dock. Well, something happened and Fred didn't make it.

Sometime later, Jules took a bus to Olinda in hopes of finding him. No such luck; he couldn't find the house. On the way back to Recife by bus, he saw a ham antenna, got off the bus, and checked the house only to find that no one was there. He showed Fred's address to a cab driver, and about five minutes later the cab pulled up in front of Fred's home. The only one there was a babysitter, so Jules left a note for him and returned to Recife.

The following day, Fred, his wife, and daughter came to the ship and met Jules. They all took a taxi back to Fred's home for a visit. While there, Jim PY7BXC and Xavier PY7DA came over to meet him. He had a very enjoyable stay.

Jules was invited to a breakfast the following morning to celebrate a

very special occasion. It was to do honor to Vic PY7AN, who was celebrating 40 years as an amateur radio operator.

Jules met Alex PY7PO when he was picked up at 5:30 am Saturday and taken to the special celebration. When they arrived, a large crowd had already assembled. "There were about 15 to 20 people there," Jules said. "One fellow was shooting off skyrockets. Boy, did they go off with a big bang way up high. There were 40 of these rockets. One for each year." Jules also mentioned that two buglers were playing to add a little extra color to an already happy event.

Jules saw Vic's ham room and setup. He had a number of awards and certificates on the wall. The antenna was rotated with a car steering wheel, as the turning shaft went straight up through the roof.

Another location visited was the local radio club, where Jules met a few more hams. The club had a nice station set up, with a large number of QSL cards on display. He said he was only there for about an hour.

One of the more interesting visits was at the home of Plinio PY7ACQ, a very active ham. "He went four times to Fernando de Noronha Island (PYØ), and made two trips to St. Peter and St. Paul's Rocks (PYØ). Just amazing. That evening he showed us 8 mm movies of them."

The films Jules saw showed the difficulty of getting on these rocks and setting up a ham DXpedition. He said it was a very good presentation. It was the first official ham operation from the rock islands (where they had to operate under pretty poor conditions). "It was an endurance check, that's for sure," commented Jules.

After a week of exten-

sive activity in Recife, the *Trader* set sail at about 7:40 am on November 14. "I got on the air," mentioned Jules, "but there wasn't too much to work yet. I finally did have some contacts later that afternoon and evening. Even handled a few patches the first night out."

A couple of contacts were made with hams in Trinidad. He lined up some meetings for when he arrived. It's always nice to have talked by radio with someone you've never seen before and then meet him in person a few days later.

The seas were very smooth and calm almost all the way to Trinidad. Several of the passengers even saw a couple of extremely large killer whales. They came very close to the ship, and estimates were that they were over 30 feet in length. It was another acrobatic show at sea.

Remember those three novice students I mentioned Jules giving code practice to? Well, the birth of three new "ham" operators was reported by him.

Jules had Russell W4LAS in Virginia Beach send three tests to him in Recife. He picked them up at the post office and reported that Ted, George, and Roland passed their code test while crossing the Atlantic, and took their Novice FCC exam between Recife and Trinidad. Hopefully, all three received their ham tickets.

The *Trader* anchored in Trinidad late in the afternoon, quite some distance out in the harbor. On shore, Jules called Mike 9Y4UA, who works at the U.S. Embassy. He later went to the Embassy and met Mike and another ham from Caracas, but he doesn't remember his call. He also met Rusty 9Y4RH, whom he had talked to on the air.

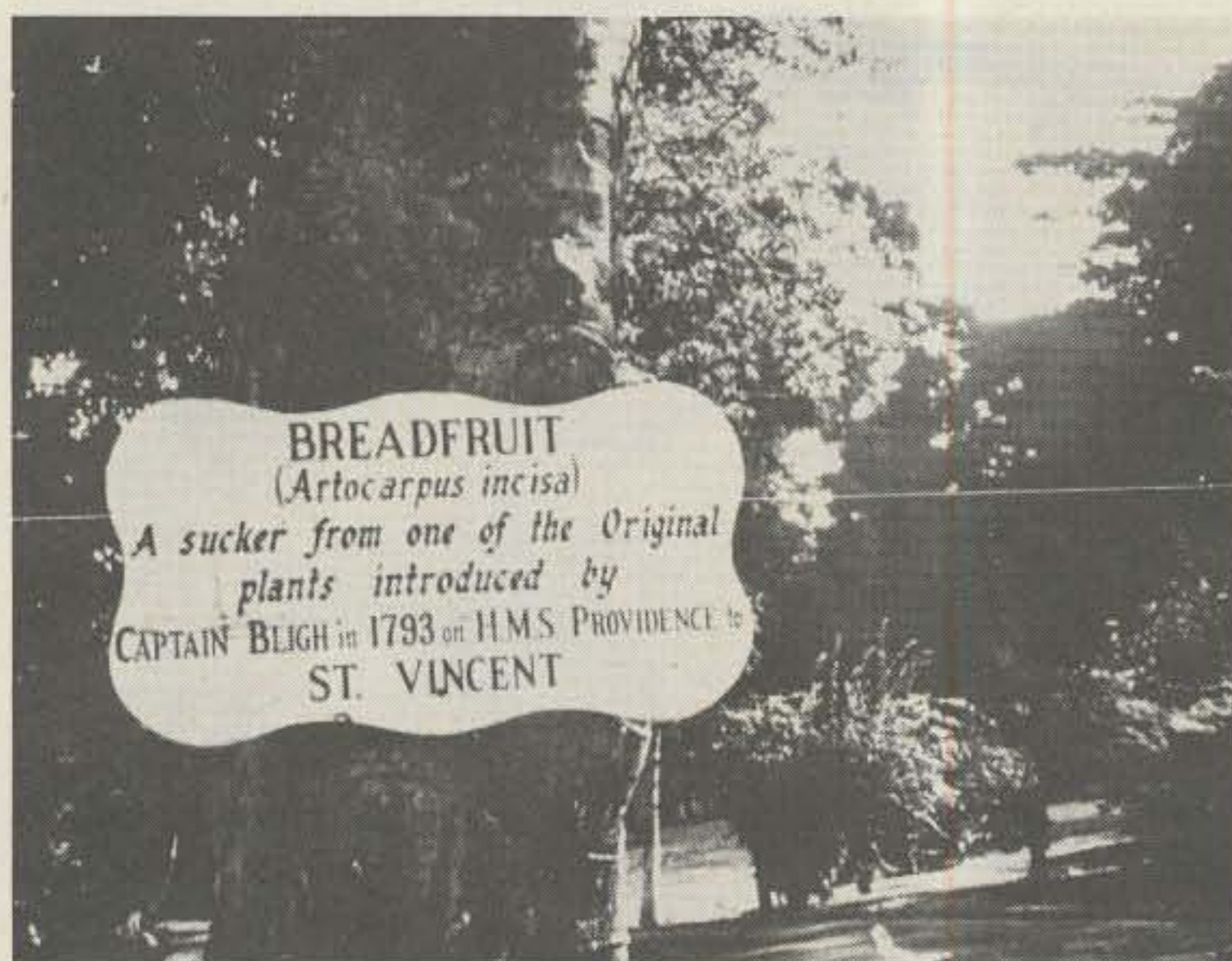

"Mutiny on the Bounty" in 1789—and the resultant children of mutiny on Pitcairn Island—was fact. Ask Tom Christian VR6TC. Captain Bligh with the *Bounty's* breadfruit cargo never arrived in the West Indies. Captain Bligh and HMS *Providence*, loaded with breadfruit plants, did—some four years later, as the plaque and tree indicate, here on St. Vincent Island.

Jules spent Thanksgiving Day on Trinidad, and talked amateur radio while enjoying lunch with Carl 9Y4OV and Rusty. Thanksgiving dinner was very well enjoyed aboard the *Trader*. It was a complete turkey dinner with all the trimmings.

About a half-hour drive from Port-of-Spain is the Omega Navigational Aid Station, which Jules visited. It is on 10.2 and 13.6 kHz. The antenna system is strung across the valley between two 1000-foot peaks.

Jules said it is a reasonably nice transmitter setup, "coaxfed with large vacuum relays which switch the resonance of the antennas from one frequency to the other by a difference of 3.4 kHz. They have huge 20-foot diameter coils with motor-driven slugs to keep the antennas tuned. Stations like this are in Norway, Liberia, Hawaii, North Dakota, Reunion Island, Argentina, and Japan, in addition to this one on Trinidad."

The *Trader* set sail for St. George's Grenada Island on November 26. The following day, the ship arrived, having gone a distance of 103 miles.

On Grenada, Jules visited an old telegraph museum display. There was a tape show showing how telegraph messages were sent. He said, "There were two keys side by side, which were used to send the code. It was very interesting."

He met Leroy J3AI at a restaurant and then visited his home overlooking the harbor.

After a very short stop, the ship left for Carriacou, an island north of Grenada. While here, he said he ate an apple that had fallen from a tree. He only took a couple of bites, and soon after, his mouth and throat began to burn. Someone



From the left are Alex PY7PO, Jimmy PY7BXC, Plinio PY7ACQ, Vic PY7AN, and Jules W6YO. These are only four of the many hams Jules met during his visit to Recife, Brazil.

told him later that the apple was poisonous. This toxic apple has been known to be fatal to small children.

His throat was really burning by the time he got back to the ship. "It felt like I had drunk Tabasco sauce," Jules commented. It was about three days before his throat got back to normal.

The trip from Hillsboro, Carriacou, to Kingstown, St. Vincent Island, was made in about six hours. While sailing there, an event took place which many people would like to accomplish: The *Trader*, along with her passengers, crossed their outboard course at 0430 hours on November 30, 1977, and had now circumnavigated the globe—a sail of 29,346 miles in a little over nine months.

While on St. Vincent, Jules met and went to the home of Bill VP2SQ. His radio shack is built on top of his home. While checking his log, Jules found that Bill had just recently worked Frank W6KPC on 15 meters, as well as several other hams Jules knew personally. He said that Bill also worked 2 meters and on occasion gets into Trinidad, over 100 miles away.

It was in the year 1787 that *HMS Bounty* left England bound for Tahiti

to collect and transport breadfruit plants to the West Indies. It is history that there was continued abuse and almost brutal treatment of the crew by Capt. William Bligh.

Some 16 months later, on the morning of April 28, 1789, with the *Bounty* laden with over a thousand breadfruit plants, the 23-year-old Master's Mate, Fletcher Christian, and a number of the crew mutinied against Capt. Bligh. Bligh and eighteen loyal seamen were cast adrift in an open boat and managed to sail that overladen craft 3,618 miles over almost uncharted waters, reaching the island of Timor in 41 days. Fletcher Christian and his fellow mutineers threw all the breadfruit plants overboard and sailed back to Tahiti.

Mr. Christian, along with eight other mutineers, six Tahitian men, and twelve Tahitian women, sailed the Pacific in search of a secure home. On January 15, 1790, they located and went ashore on uninhabited Pitcairn Island. This island, nearly two centuries later, is now the home of Thomas Coleman Christian VR6TC, great-great-great grandson of Fletcher Christian.

Captain Bligh eventually returned to England, and a

few years later completed his task and transported breadfruit plants to the West Indies. Here on St. Vincent, Jules saw a breadfruit tree that grew from a shoot planted from an original plant brought there by Captain Bligh after the mutiny on the *Bounty*. There is a plaque in front of the tree telling of its origin.

Bill took Jules sightseeing all around the island. After a very enjoyable day together, Bill took Jules back to the dock and they bid farewell; the ship was scheduled to leave shortly.

The trip from St. Vincent to Dominica was made overnight. When Jules arrived, he met Austin VP2DAJ. Jules had talked to Austin some nine months earlier via amateur radio when the *Trader* was in this area at the beginning of its world cruise. Their eyeball QSO was short due to the fact that Jules was on the island only one day. Jules took in a few of the sights and went back to the ship.

On Friday morning, December 2, the *Trader* anchored in English Harbor, Antigua. After Jules went ashore, he saw some more of those small apples that had caused him so much misery. This time he only looked.

While walking around,

Jules saw a triband beam and inquired at the home. It was the residence of Jim VP2AB, who invited him in for a visit and a look at his ham room.

Jim later took Jules out of town about ten miles to see a high-powered short-wave broadcast station, a very modern up-to-date station only about a year

old. Jules was given a tour of the station by Bob VP2AZB. He was there for about three hours.

The *Trader* left the island of Antigua about midnight, after a twelve-hour visit, and headed for St. Barthelemy Island (St. Bart's). The ship arrived shortly after Jules got off watch.

In the harbor was the

Polynesia, a four-mast windjammer of Windjammer Cruises. This is one of the ships that takes one-week cruise tours into the West Indies.

Jules didn't do much here other than look around and take pictures. He said, "I just sat under a nice shady tree and admired the beach and everything about 150 to 200 feet down below. There was a group of boys and girls playing with a frisbee down on the half-mile-long beach. It was very peaceful up there..."

The ship left that afternoon and arrived at St. Martin Island that evening for a two-day stay. While walking in town, Jules saw what at first he thought was a rotary dipole. "It seemed funny with traps on it," Jules said. It turned out to be a triband antenna. The director and reflector had come off during a windstorm. He inquired at the home, but the ham wasn't in.

Jules said, "This was the first place I saw with big American cars. I saw more Cadillac and Lincoln taxis than I have anywhere in my life. Amazingly, they were all new ones!"

Jules mentioned that on these islands camera film is very expensive, about \$10 for a roll of 110 or 35mm. So, if you happen to be making plans for a trip into this area, take along a good supply of film—or money.

Jules met Vince PJ7VL, who works at the weather station on St. Martin. He knows many of the hams Jules knows. They even had a chance to get on the air for a few stateside contacts on Vince's rig.

The following day, Jules had a cold, so he stayed aboard ship. There wasn't much else to see ashore, so he just relaxed a little.

The *Trader* left that evening, and the following day tied up to a buoy at Saba Island. With only a

few hours there in port, Jules couldn't do much. A quick tour of the area and back to the ship. The next stop was the island of Tortola in the British Virgin Island group.

While at sea, Jules got on the air and talked to John 4S7JD in Sri Lanka, the ham he met back a few months ago. He also worked into ZL-land and talked to several old friends in California.

They finally arrived at Road Harbor, Tortola, on December 7. Jules took a cab into town, where he met Art VP2VJ, the radio inspector for the island. During their conversation, Jules asked, "Is it any trouble to get a license here?" Art said, "No, you want one now?" He said Art just started to fill out the papers for him. Jules was issued the call of VP2VEF.

Art told Jules that Bob Denniston WØDX, ex-ARRL president, now VP2VL, owns the Smuggler's Bay Inn here on the island. Art tried to get ahold of Bob by phone, but couldn't locate him. After Jules returned to the *Trader*, he had some visitors. Art had finally located Bob, and they came aboard for a visit.

Jules met Bob over 20 years ago and had even worked him on the air from Crete and many other places in years past. They all talked about DX and the old times during their visit in Jules's cabin.

When Jules got on the air as VP2VEF, the first contact was with Ed W7ZJ, a friend of his. Jules heard him on the air and gave him a call. He was told to "stand by." Ed was very surprised when he found out that it was actually Jules W6YO.

After the *Trader* stopped at one more island, St. Thomas Bay, Virgin Gorda, she left the area and headed for the Bahamas. Jules said, "On our way we crossed right over the Puer-

QTH _____

W6YO/VR 6

Ex- W8DVS W8OSL W4LIU TA3AA W3SPI VP9BM KP4AIO W4VOF
DX- Peditions FK8OSL SV6AA SV7AA AR8AR Y14LIU YVOAB

CONFIRMING QSO ON SSB CW R _____ S _____ T _____ Freq _____ MC
DATE _____ / _____ 1977 _____ GMT

73.....Jules Wenglare
W6YO Home QTH

QSL by _____ 1416 7th Ave., Delano, CA. 93215 USA

DZAOUDZI
MAYOTTE ISLAND
FRENCH COMORO ISLANDS

FHØYO

DX-PEDITION by W6YO and WA4CWG Sept. 26 & 27, 1977
ATLAS 210X and YEASU FT-101E with vertical dipoles.

QSO _____ Jules Wenglare

St. Helena I.

ZD7YO

OPERATION OCT. 29 AND 30, 1977.
FT 101 ATLAS 210X TRAP DIPOLE

CONFIRMING SSB CW QSO. _____ GMT
_____ MHZ. HOME CALL W6YO 73

QSL MGR. W6BVM JULES WENGLARE

Of the 53 stops Jules Wenglare W6YO and the Yankee *Trader* made, three locations issued him a license to operate amateur radio. The first was on Pitcairn Island (VR6). The second was Mayotte Island (FHØYO), followed by St. Helena Island (ZD7YO). With these special calls, he made over 900 contacts, thanks to the countries and the officials who appreciate amateur radio and made it possible.

to Rican Trench, the deepest place in the Atlantic Ocean, nearly five and a half miles deep. As we passed the eastern reaches of the Grand Turks Islands, we had sailed 30,000 nautical miles.

"We were enjoying nice warm weather all along for months on end, it seemed. While listening to the radio news, we heard that the east coast was having blizzards and subfreezing temperatures. Then, on December 11, southeast of San Salvador, where Columbus made his first landfall and where we had hoped to visit for the second time, we were hit by a weather front that made us shiver. The storm that followed for two days kept things sliding off the tables at meal times and made walking difficult anywhere. For the second or third time on the trip, the ladies were missing their meals.

"Since leaving the Virgin Islands, it was great to make final contact with 4S7JD, VK4MW, ZS1ER, ZD7SD, 9Y4OV, and even Helen HC2HV, all of whom we had 'eyeballed' along the trip. Our contact with the ship's doctor's daughter, Jay WA2JBY, was achieved after many attempts and frustrations.

"We arrived in the busy port of Nassau on the morning of December 12. There were two large cruise ships in, and we were hardly noticed among the crowded shopping streets of a colorful city.

"Again, I mailed off over 20 copies of the *Trader Tales*, our monthly newspaper, to friends around the world and in the States.

"I did find a ham, Verne C6ANR, ex-VP7NR, who runs a nice men's clothing shop in town." The ship departed on the second day and headed for Freeport, the Bahamas, where, Jules said, "We ar-

rived at 1400 zulu on the 14th of December, the place we departed 303 days ago..."

Jules said, "It was most gratifying to get all the weather data, phone patches, and just FB QSOs with so many hams around the world. The maritime mobile and other nets who give priority to sea-going hams certainly are a wonderful group of 'hams.' I've realized that this is the best system of communications for the smaller ships and yachtsmen.

"To get back to the U.S. mainland with all my gear, I was fortunate to have arranged over the air to sail back in a small luxury sloop of one of the passengers who only went as far as Singapore, but now was waiting in Freeport to pick up his many souvenirs and diving equipment left on the *Yankee Trader*.

"Three of us from the ship, with our belongings—one fellow had an 18-foot outrigger canoe from Tahiti—left at 4:00 am and hit strong head winds all the way to Bimini. We were constantly getting spray all over us up on the deck where we all took two-hour 'wheel watches.' After a needed rest in Bimini and some spearfishing for lobster and a good dinner, we set sail across for Miami, still going against strong winds and rough seas.

"It was great seeing the bright lights of Miami Beach reflecting on the horizon. We arrived practically at downtown Miami at 11:00 pm, where our skipper called the customs and immigration people, who came right over.

"I finally wound up packing close to 500 pounds of souvenirs, clothes, radio gear, and related stuff at the QTH of Bill WA4VOI, who was one of my main contacts around the world."

Jules shipped his belong-

ings by truck back to California and caught a plane himself. He arrived at his home in Delano on the evening of December 23, 1977, and was warmly greeted by his wife, Lyla. Christmas came two days later.

Jules had planned on taking Lyla with him on this world cruise, but she decided that he would have more time for amateur radio activities if he went alone. They kept in contact with each other with phone patches provided for Jules by other hams. While he was gone, her sister came all the way from Australia and stayed with her for a very long vacation. Lyla is also from Australia.

I spent many hours with Jules going over the manuscripts for this article and selecting the many slides used for the photos to go with it. I only wish that every piece of information he gave me could have been used here in print, but unfortunately they all couldn't. I tried to hit the highlights at each stop and bring out the most interesting activities. I sincerely hope I did justice to such an extraordinary adventure.

I asked Jules a few questions about the trip which were not covered in any of the tapes. Here are part of the answers.

Of the 1,070 hours on Jules's transmitter's hour meter, he averaged 3½ hours each day while at sea. He spent 163 days in port (53 stops) and 139 days at sea. There were 3,600-plus QSOs, of which over 900 were made while on shore. He had over 125 "eyeball" QSOs with other hams on every continent of the world.

What location was the most enjoyable? "Cape Town, South Africa." He said the cleanest spot was the "Maldives." Of all the hams he met, the three that top the list were (and

I'll put these in alphabetical order) Tom Christian VR6TC, Pitcairn Island; Father Dave Reddy CE0AE, Easter Island; and Bill Stevens ZD7SD, St. Helena Island.

Jules sailed 30,759 nautical miles aboard the *Yankee Trader*, a tough, rugged, and highly seaworthy vessel. The *Trader* was built in 1930 by the Spear Engineering Co., Norfolk, Virginia. It was originally commissioned by the U.S. Coast and Geodetic Survey as an oceanographic research vessel. Her original name was the *Hydrographer*. She has assisted in charting the world's major bodies of water, including the Arctic and Antarctic Oceans. During WWII, she served in the Pacific. When a new oceanographic research vessel was built in the mid-60s, she was renamed *Yankee Trader* and converted to become part of the Windjammer fleet.

Constructed of nickel iron, the *Trader* is considered to be an exceptionally strong, stable vessel. She has twin diesel electric engines generating 1500 hp each. She has a single screw (propeller), 11 feet in diameter. Her registered tonnage is 1180. Her cruising speed is a variable 10 knots, with a range of 18,000 miles.

To embark on a 10-month around-the-world cruise to strange and exotic ports of call is true adventure. If you take amateur radio and put the two together, you have the greatest sea experience and personal search for adventure ever possible. I experienced this great adventure when I wrote about it. You went along while reading it. But for Jules Wenglare W6YO, the experience was reality, for he took amateur radio aboard the *Trader* with him and lived it—at the four corners of the globe. ■

W2NSD/1 NEVER SAY DIE

editorial by Wayne Green

from page 181

WHAT SHOULD YOU BUY?

One of the curses which can drive a beginner to drink is the reluctance to spend a lot of money on equipment. The result of this is that many Novices get on the air with junk and find amateur radio a terrible experience. They have trouble separating signals and lose contacts to interference a lot. The obvious answer is to spend a little more and get something first rate in the way of a receiver.

You don't have to buy new equipment, but, on the other hand, you'll regret it if you go too far back and load up with an old tube-type receiver. Moderation is the watchword... old, but not too old. Just about any rig with solid state except for the final transmitter stages and made within the last ten to twelve years should provide you with a usable station. Get the very best you can, so you don't have to cope with drift, adjacent channel garbage, wide i-fs, etc.

Not to put flea markets and auctions down, but I seldom see anything I'd recommend buying at these low-end debris exchanges. Oh, you *can* luck out, but I look more for gadgets and parts at these affairs than for rigs. A better source of a rig is to join the nearest ham club and let the members know you are in the market. If it is any size club, some of the members will be wanting to update their shack with the newest gear and be looking for a good home for their old stuff. This means you'll have a better handle on the history of the equipment and probably some help in service when the inevitable happens.

Another possibility is your nearby ham dealer. Now I don't necessarily mean for you to run down and shop from the used ham gear shelf, which is probably rather scantily occupied most of the time. Used equipment doesn't last long in a store. I suggest you check over the used gear to see if they have what you really want. If not, talk with the owner of the store and explain what you are looking for and suggest that he keep an eye open for it as a trade-in on some new gear. This can be to both your and his ad-

vantage. If he knows he has a good fast sale for something, he can offer a little more for it... and he won't have to mark it up as much since it won't be taking up space and costing him money to keep in inventory.

But what about the ads in ham magazines for used equipment where hundreds of old sets are advertised? As far as I know, this is more of a come-on than anything else. Your chances of actually finding one of those advertised rigs in stock is slight. One more warning, while I'm at it. I had a chap working for me one time who had been with one of the major ham stores. He swore that the equipment which they had been selling as "reconditioned" went out of the store without ever being plugged in to see if it would work.

WHAT ABOUT THE CODE?

One of the more unfortunate aspects of the Morse code is that it is mandatory for a ham license. If a knowledge of the code were optional, I'm convinced that a lot more hams would use it and enjoy it. But, since there is no choice, don't let the code be a big deal... it isn't, if you manage to get started the right way.

There are some incredibly bad systems for learning the code. Sams had probably the worst I've ever seen... the sight and sound method, I think they called it. I wonder if anyone ever managed to learn the code with that. The age-old ARRL system of gently increasing speeds has lost us hundreds of thousands of prospective hams. If it hadn't been for the Sams system, I would make the claim that it would take a truly deviant mind to come up with a more frustrating and failure-prone system for teaching the code than the ARRL has been pushing for about 50 years.

Some recent experiments with students starting with high-speed code have confirmed earlier tests. The fact is that it takes very little longer to start right out at 13 words per minute than at five. In fact, there are more and more students starting out at 20 words per minute and able to pass the FCC exam with just three or four days of intense practice.

Four-year-old kids, barely able to write, even in block let-

ters, have been passing the code test. How many of you are willing to admit that a four-year-old can outperform you... even a *smart* four-year-old? Learning code has nothing to do with brains, as you'll discover when you meet a few hams and find out what a wide range of intelligence is involved. Some hams may have been a little hard of hearing when brains were handed out and said, "Trains? They make me sick... no, thanks."

The code system that works the fastest and will give you the confidence you need to beat the bastards is on the 73 code cassettes. I dislike putting in that commercial, but I guess it's necessary because every now and then I talk to a club where they are using the ARRL materials and driving people crazy. It just isn't fair... and being an ARRL-affiliated club doesn't mean you have to take it out on defenseless students.

ANTENNAS

Until the day comes when you go the truly practical route with a 73-foot tower and a good quality three-element beam... and find that you have a signal into any spot in the world where a DX operator chances to pop up... you'll go through what most of the rest of us have—continual experimenting with various antennas. Sure, the tower, rotor, and beam are expensive... and it will spoil all the fun of being ground into dust in DX pileups, of losing contact in the QRM with that 50th state just as he was about to get your call letters... and of other growth-promoting traumas. Perhaps you won't really appreciate a good antenna system unless you apprentice with dipoles, longwires, and such for a few years.

Not that dipoles are all that bad on the lower bands. You can get a dipole to plunk a signal almost anywhere in the world if you put it in a good spot and then fill it with a good solid signal. I had the thrill of hearing my own dipole putting through an S-9 signal into Australia on 75 meters one night while I was operating from VK3ATN. *That* was exciting!

YOUR EXPERIENCES?

It's been a long time since I first braved the ham bands... and they were sure different then. With very few exceptions, everyone had to use crystals for frequency control, so the standard mode for operating was to go on the air, call CQ, and then tune the band for a call. Forty meters was a CW band, but then about 90% of the ham contacts in those days were made on CW. The 100 kHz wide 20m phone band was pret-

ty well filled up with big signal stations... and a phone kilowatt in those days cost on the order of \$20,000, so you didn't casually buy one. The other Class A phone band was 75m and it, too, was pretty well taken up with about six or seven nets of kilowatt phone stations. The band was 100 kHz wide and each net took 10 kHz of this, leaving very little for the 50-Watt average ham.

The great unwashed hung out on 160m... the Class B band. There were no commercial transmitters then, so most rigs were copied out of *Radio* magazine or *QST*. *Radio* had the better projects by a wide margin.

How about writing about some of your own experiences? I'll bet you've had some which would strike a familiar cord with other readers. And perhaps you have some good advice on rigs, antennas, QSLing, etc.

ARRL VS. WOMEN

A couple of months ago I brought up the matter of Mary Lewis W7QGP and her battle with the League. Mary was disqualified for the post of SCM unfairly, she thought, so she took the League to court over this. The real battle seemed to be over Mary's threat of becoming the very first woman director of the League. She is the only person running against the incumbent Thurston. The League position has been clearly explained to Mary: No way will there ever be a woman director.

Mary won the first big battle when the case came up in court and the judge ruled 100% for Mary. Firstly, he said that the League should have charged Mary for the mailing list if that was a problem, and should not have disqualified her for the post of SCM. Then he went on to say that the League should stop stalling on the director election and proceed with it. The League maneuver on this apparently was to postpone the election as long as possible, allowing their yes-man Thurston to remain in power in the interim.

My mail has been heavy with compliments for Mary and bad-mouthing for Thurston, who apparently has given a great many Pacific area hams the idea that he holds them in great contempt. Every one of the readers has asked not to be identified for fear of reprisals by Thurston or the League.

If we should lose amateur radio next year, we will have only ourselves to blame for permitting directors like Thurston and his ilk to refuse to put capable people into office at HQ.

RTTY Loop

from page 14

nections. This figure shows you how to do it. This point is also useful for those of you working on computer transmitting routines who have to key the loop from the computer.

Now, as mentioned, this is far from an ideal way to produce a string of RYs. In fact, since the need arises to automatically send text like "THE QUICK BROWN FOX JUMPED OVER THE LAZY YELLOW DOG 1234567890 TIMES" (the sentence containing all letters of the alphabet for those of you who just joined us), or IDs like "DE WA3AJR," it would be nice to have a circuit that could be set up to put that out. A block diagram of such a circuit is shown in Fig. 4. What we are going to do is encode what we want to send on a diode matrix, and then put it out using parallel-to-serial conversion. I know, you all are saying, "There he goes with that

computer stuff again!", but I promise, no computer. Everything we will do will be with hardware, and I hope to explain it well enough that it is clear. If not, it's my fault! We'll get into it next month.

Turning to the *vox populi*, we'll take some overseas correspondence this month. Sgt. Gary Kohtala HL9TG/WA7NTF is looking for information in general on RTTY. Well, Gary, that's what we're here for. While you're stationed overseas, you may want to look into the MARS program. This has been a particularly fruitful source of RTTY gear for the ham in the service, and many a serviceman has come into amateur radio through contact with a MARS station. For those of you who don't know what I'm talking about, MARS is the Military Affiliate Radio System, and, while it is not as active as it was during the Vietnam "conflict," many hams still maintain

regular net schedules to keep up the morale of our servicemen across the globe. Much of the traffic handled is on RTTY, only they call it RATT, and equipment is frequently available to the amateur willing to invest a small part of his time and get a big return—in more than one way.

Bernard Malandain 3D2BM writes that his Model 28ASR is equipped with downshift-on-space, a feature that is annoying when trying to copy groups of figures in weather broadcasts. Although he has studied the manuals, he states that he is unable to disable this function. Well, Fig. 5 is reproduced rather loosely from the Teletype Corporation's manual for the 28, Volume 1, Fig. 5-56. You can see that tightening the disabling screw will prevent the pawl from engaging the function lever and prevent downshifting-on-space. If this is not clear, at least I have pointed you in the right direction. Bernard also needs information on synch gears for the 28 to run on the 50-Hz current they have there, and the 84018 and 84019 gears for his Model 15 on the

same current. Readers with information may write me or send it to him, at Box 590, Suva, Fiji.

Several readers have written with questions regarding the new Microlog RTTY units. The October, 1978, issue of 73 carried a nice review by K3CMY of his unit, and I will refer you all to that article for details. I met with the makers of the unit about a month back and had a chance to see it in action. Very impressive! Unfortunately, the data they were going to rush me has not materialized as yet, so I can say little other than what I have gathered by talking to users of the system. One problem that has cropped up in one station was rf overload of the device, shutting it down when the transmitter was keyed. I don't know if this is swr- or frequency-dependent, but I would be on the lookout for this sticky wicket.

Next month, we will look into the circuit for sending that RY or BROWN FOX painlessly, and maybe even understand how it works. Meanwhile, I look for your input to tell me what you want to see in RTTY Loop!

New Products

from page 17

mail to SST Electronics, PO Box 1, Lawndale CA 90260. Reader Service number S10.

HEATH ANNOUNCES FIRST COMPUTERIZED WEATHER STATION

Heath Company, the world's largest manufacturer of electronic kits, announces the availability of its new ID-4001 computerized weather station. The microprocessor-based ID-4001 indicates time, indoor and outdoor temperatures, wind speed and direction, and barometric pressure on an upright display panel utilizing large LED readouts. It will also display average wind speed and automatically calculate wind chill factor as well. The ID-4001's memory allows instant recall of date and time of maximum and minimum temperatures, date and time of wind gusts, and the date and time of maximum and minimum barometric pressure. It can even indicate the barometric pressure's rate of change per hour and tell if it is rising or falling. The ID-4001's 6-digit time/date display shows time in hours, minutes, and seconds, and the date in month and day. The time/date can be displayed alternately, or either may be

displayed continuously. The 12-hour time format has an ampm indicator. A 2-digit display shows wind speed in mph, kph, or knots. A 16-indicator wind vector display identified by compass points and radial degrees indicates wind direction. The thermometer display indicates indoor or outdoor temperature in degrees F or C with + or - signs. A 4-digit display shows barometric pressure in inches of mercury or millibars. Separate indicators show rising or falling pressure. Kit and assembled versions of the ID-4001 are available.

For more information about the ID-4001, send for a free copy of the latest Heathkit catalog. Write Heath Company, Dept. 350-730, Benton Harbor MI 49022. Reader Service number H5.

NEW 2 METER FM MOBILE TRANSCEIVER WITH MEMORY FEATURES OPTIONAL MICROPROCESSOR CONTROL UNIT

The TR-7600 2 meter FM mobile transceiver with memory, and an optional RM-76 microprocessor control unit, which provides six memories and various scanning functions, have been introduced by Trio-Kenwood Communications, Inc.

The TR-7600 provides full

4-MHz coverage (800 channels) on 2 meters and includes a memory channel. It operates on simplex (same transmit and receive frequencies) or repeater (plus or minus 600-kHz transmitter offset) modes. Furthermore, the memory can be used to provide a transmit frequency for accessing a repeater with a non-standard frequency pair.

The TR-7600 also features a digital frequency display with large, bright, orange LEDs. Another LED, called an "unlock" indicator, shows transceiver protection when the frequency selector switches are improperly positioned or the PLL has malfunctioned. Selecting frequencies with the TR-7600 is fast and easy with its

dual concentric knobs, 5-kHz offset switch, and MHz selector switch.

Power output is switchable between 10 Watts and 1 Watt (adjustable from 1 to 10 Watts). The TR-7600 is ideal for mobile use and comes with the MC-30S noise-canceling dynamic microphone. The compact transceiver measures only 6-7/16 inches wide, 2-7/16 inches high, and 9-3/16 inches deep.

The optional RM-76 microprocessor control unit allows the TR-7600 to perform many interesting new functions. Using the RM-76 keyboard, the amateur can select any 2 meter frequency (including MARS on 143.95 MHz simplex), store frequencies in six memories, automati-



First computerized weather station from Heath.

Jan 1979



The Kenwood TR-7600 2m mobile transceiver.

cally scan up the band in 5-kHz steps, manually scan up or down in 5-kHz steps, set lower and upper scan frequency limits, scan for busy or open channel, reset scan to 144 MHz, stop scan, cancel scan (for transmitting), and select repeater mode (simplex, plus or minus 600-kHz or 1-MHz transmit frequency offset, or one memory transmit frequency).

The RM-76's digital display indicates frequency (even while scanning) and functions (such as autoscans, lower scan frequency limit, upper scan limit, error, and call channel).

The TR-7600 was scheduled to be available by late November, 1978. The RM-76 microprocessor control unit will be available by the end of January, 1979. *Trio-Kenwood Communications, Inc., 1111 West Walnut Street, Compton CA 90220.*

**MIRAGE B108
VHF POWER AMPLIFIER
WITH BUILT-IN RX PREAMP**

Mirage Communications is proud to introduce its new 2 meter solid state amplifier—

the B108.

The B108 represents a new generation of all-mode amplifiers for VHF use. It incorporates operation features that have not been available before in a single amplifier.

The B108 is designed to operate on AM, FM, SSB, or CW, with a power output of at least 80 Watts for 10 Watts input.

A built-in receive preamp is standard. The preamp utilizes a J310 FET in the latest low-noise circuit design. It provides at least 10 dB of gain and a 2-2.5 dB noise figure. The preamp may be operated with or without the power amp being turned on.

Also standard is a rear panel connector, providing remote control operation. An optional remote head, the RC-1, is available with either a 6-foot or 18-foot cable.

Keying is provided by the internal rf sensing circuit, or the unit may be keyed from the external transmitter.

For SSB operation, the relay dropout delay is fully adjustable.

The B108 will strengthen the



Mirage's B108 VHF power amplifier.

transmitter output, providing crisp, clear communications. The built-in receiver preamp will really help pull in the weak signals.

For further details, contact your local dealer or *Mirage Communications, PO Box 1393, Gilroy CA 95020, (408)-847-1857.* Reader Service number M75.

**TELE-TOW'R BREAKOVER
MODEL 55 TOWER**

My impression at first sight of the Tele-Tow'r Breakover Model 55 can be expressed in one word: unprepossessing. And that's precisely what I was looking for!

While it may be mighty nice to have a couple of 120-footers with big monobanders on top in the backyard, I've never been fortunate enough to live where I could get away with putting up anything like that. For me, reality has meant striking a compromise between what the zoning laws, neighbors, and my budget would permit, and the performance I would like to have.

Actually, during the first few months after moving to New Hampshire, I did quite well with a variety of dipoles and random wires. But I knew that if I was going to be able to take advantage of improving conditions on 10, 15, and 20 meters, I'd need beams and a good tower to hold them. I also needed a tower to be able to properly evaluate occasional antennas and other items for 73's New Products column.

Surveying my present location, I concluded that I could probably maintain a reasonable state of peace with my neighbors and still attain a useful degree of performance with a tower in the 40- to 60-foot range. Another requirement would be that the tower be as inconspicuous as possible. The tower should be of the telescoping, tiltover type, so that work on it or the rotor and antenna could be done from the ground. It should also be fully self-supporting.

After looking over various manufacturers' ads and literature, I decided that the Tele-Tow'r Breakover Model 55 would definitely bear further investigation. A careful study of the literature and a phone conversation with one of the owners of Tele-Tow'r convinced me that the Breakover Model 55 was just what I was looking for. And if I had any lingering doubts, they were dispelled at my first sight of the tower as it was being unloaded from the freight truck.

The Breakover Model 55 may be quite unprepossessing in appearance, especially at first glance, but behind its slim, clean lines lie lots of engineer-

ing skill and design innovations—as well as quality materials and workmanship. One of the most attractive things about the tower is that it comes truly complete and ready to install—nothing else is needed.

Tele-Tow'r does offer one accessory item that, while not required for a complete tower installation, can be mighty convenient—particularly if there's a possibility you may want to move your tower at some future date. The item is a tubular steel sleeve into which the tower's base, or breakover riser section, can be slipped instead of setting it directly in concrete. By using the mounting sleeve, you can simply lift the riser section out and carry it away to another location. Otherwise, you're stuck with the choice of digging it out of a 2' x 2' x 3' block of concrete or of leaving it behind and buying a new section.

Try lifting the riser section or the telescoping main part of the tower and you'll instantly gain an appreciation of the solid, rugged construction of the Breakover Model 55. The main part of the tower weighs 300 pounds and is made of three different-sized sections of steel pipe and tubing. The largest section is steel pipe with an outside diameter of 4 inches and .234-inch wall thickness. Next comes a section of steel tubing with an outside diagonal measurement of 2½ inches and a wall thickness of .188 inches. The third section is 10-gauge steel tubing with a 2-inch outside diameter. The winches, the 3/16-inch aircraft control cables, and other fittings are all of excellent quality and workmanship, and are capable of providing years of troublefree service.

The toughest and most time-consuming part of installing the Breakover Model 55 was digging the hole and pouring the concrete for the base. In my own case, I quickly discovered why New Hampshire is called the Granite State. Everywhere I attempted to dig in the area I had chosen for the tower, I ran into stones and small boulders. Eventually I got the job done, but I came away with some beautiful blisters from swinging a pick for the better part of an hour.

Once the hole was dug, things proceeded very smoothly. I had decided to use the accessory mounting sleeve, so it was slipped onto the breakover riser base section and the assembly was placed in the hole. After pouring the concrete, I used a carpenter's level to check that the riser section was level, and left it for a couple of days while



Radio World



CENTRAL NEW YORK'S FASTEST GROWING HAM DEALER



DRAKE TR7-DR7



YAESU FT225RD

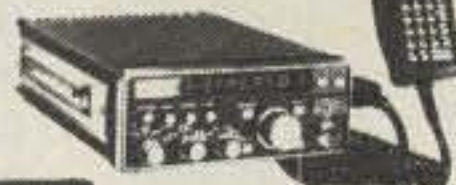

YAESU CPU-2500RK



ICOM IC-701



YAESU FT-901DM

Featuring Yaesu, Icom, Drake, Atlas, Ten-Tec, Swan, Dentron, Pace, Palomar, Alda, Midland, Wilson, KDK, MFJ, Microwave Module, Standard, Tempo, Astron, KLM, Hy-Gain, Mosley, Larsen, Cushcraft, Hustler, Mini Products, Universal and Tristao Towers. We service everything we sell! Write or call for quote. You Won't be Disappointed. We are just a few minutes off the NYS Thruway (I-90) Exit 32

CALL TOLL-FREE ONEIDA COUNTY AIRPORT TERMINAL BUILDING
1-800-448-7914 ORISKANY, NEW YORK 13424

Bob Warren
WA2MSH K21XN

NY STATE RESIDENTS CALL 315-337-2622 or 315-337-0203



**RTTY
made
easy**

TU-170 kit...\$149.95
wired...\$219.95

State of the art design features make the TU-170 ideal for HF and VHF autostart operation at an unchallenged price.

- SIZE: 7 1/4" W x 3 1/4" H x 7 1/2" D
- Proved 170Hz shift 3 stage active filter demodulator
- Lighted tuning meter for easy tuning
- Current regulated loop keyer and power supply
- Autostart with threshold control and solid state relay
- Stable audio frequency shift oscillator, produces phase coherent sine wave tones
- TTL compatible inputs and outputs for auxiliary equipment
- High level output for scope tuning

FLESHER CORP.

P.O. Box 976

Topeka, Kansas 66601

(913) 234-0198 ✓ F5



BEWARE!!

Aluminum towers are not usually as strong as steel towers — ask for engineering facts before purchasing any tower. Aluminum towers, in most cases, are one-half as strong as steel towers within the same price range.

Notice Paid For By Unarco-Rohn ✓ U2

(Advertisement)

FREE!

**NEW
CATALOG OF
HARD-TO-FIND
PRECISION
TOOLS**



Jensen's new 144-page catalog is jam-packed with more than 3000 quality items. Your single source for hard-to-find precision tools used by electronic technicians, scientists, engineers, instrument mechanics, schools, laboratories and government agencies. This wanted catalog also contains Jensen's world-famous line of more than 40 tool kits. Plus 10 pages of useful "Tool Tips" to aid in tool selection. Send for your free copy today! ✓ J7

JENSEN TOOLS & ALLOYS
1230 SOUTH PRIEST DRIVE • TEMPE, AZ. 85281

FLY YOUR RUBBER DUCKY !!

Get off the trunk lid and into the best location on the car... the center of the roof! Tests have proven that the low profile quarter-wave whip, or the rubber-ducky from a Handy-Talky, outperforms a 5/8 whip on the trunk. Take advantage of the super ground plane by converting to the FLYING-DUCKY magnetic mount. Although designed specifically for use with a H-T, it can be used with any mobile rig. Ten second installation.

FLYING-DUCKY magnetic mount consists of:

- Chrome-plated super magnet (holds 50 lbs.)
- Compatible coax plugs furnished to match rig requirements. Specify BNC, F type, PL259-SO239. For TNC Wilson type add \$3.
- Coax cable 105 in. long.

FLYING DUCKY MOUNT AND CABLE... \$13.95
 QUARTER WAVE WHIP
 (specify connector) \$ 5.95
 RUBBER DUCKY to match
 (specify connector) \$ 7.95

Pace-Traps
✓ P15

Box 234
Middlebury CT 06762
(203) 758-9228



The model 820 portable digital capacitance meter from B&K Precision.

the concrete set.

With the breakover riser section in place and the concrete set, completion of the installation took 15 minutes or less. The first step was to position the tower with winch downward and base against the riser section. The tower was then secured to the riser with a $\frac{3}{4}$ x 6-inch bolt and nut. Next, the pulley was removed from its housing near the bottom of the tower, the winch on the riser section was released, and the cable was looped over the pulley. The pulley was then reinstalled in its housing and the pulley shaft bolt tightened securely. The tower was then cranked into the upright position and a $\frac{3}{8}$ -inch U-bolt was installed just below the level of the winch on the riser section, securing the tower to the base.

Fully extended, and without an antenna, the Breakover Model 55 looks more like a flagpole than an antenna tower, something that can be a tremendous asset in a residential neighborhood. The towers come with a silver finish, but you can easily paint them another color or colors to help them blend more effectively with their surroundings, something quite a few owners are apparently choosing to do. In my own case, I think I'll paint the bottom section green, to blend with nearby evergreens, and make the upper portion sky blue.

The Breakover Model 55 is designed to withstand 60 mph winds with 50 pounds of rotor and antenna with a vertical area of 6 square feet when fully extended to 55 feet. With the same loading, the tower will withstand 70 mph winds when cranked down to 45 feet. And, of course, for added safety in high winds or icy conditions or simply when it is not in use, the

tower can be cranked down to 23 feet. If you wish, coax and rotor cables can be run inside the tower. Just drill an appropriate-sized hole and feed the cables through, making sure they retract and extend with the tower.

The tower's designers have incorporated a number of interesting and innovative features, including the patented guiding and cable systems and safety stop. The use of round to square to round steel pipe and tubing also contributes to greater ease and safety of operation. While several of the tower's most interesting and important features are internal and of a proprietary nature, thus precluding any detailed description, they clearly help to make the Breakover Model 55 a product of superior quality and performance. I'm mighty glad I chose one for my personal use.

Tele-Tow'r makes four different models. The Breakover Model 55 (extends from 23 to 55 feet) and the Breakover Model 40 (extends from 23 to 40 feet) are telescoping, break over at ground level, and are fully self-supporting. The Model 55 (extends from 21 to 55 feet) and Model 40 (extends from 21 to 40 feet) are telescoping and fully self-supporting. Prices are \$618.46 for the Breakover Model 55 and \$411.80 for the Breakover Model 40. The Model 55 sells for \$442.97 and the Model 40 goes for \$242.15. The accessory sleeve is \$35.10 for the 40-foot models and \$45.90 for the 55-foot models.

The towers and accessory sleeves are available from selected dealers or direct from Tele-Tow'r Mfg. Co., PO Box 3412, Enid OK 73701, (405)-233-4412. Reader Service number T52.

Morgan W. Godwin W4WFL
Peterborough NH

LOW-COST PORTABLE DIGITAL CAPACITANCE METER ANNOUNCED BY DYNASCAN

Dynascan Corporation has just announced the introduction of the B&K Precision model 820 portable digital capacitance meter. The 820 is a compact instrument capable of measurement over the wide capacitance range of 0.1 pF to 1 farad. Accuracy is said to greatly exceed the tolerance of most capacitors. The unit features a bright 4-digit LED display for easy reading in laboratories, product lines, or field applications.

The capacitance of virtually any capacitor can be measured quickly and accurately with the 820. Because the accuracy of this unit greatly exceeds the tolerance requirements of most users, required values can be "hand-selected." Matched capacitors can also be singled out for use in bridge circuits and other critical applications.

The 820 allows quick measurement of unmarked capacitors or verification that a capacitor is within tolerance. Virtually any type of capacitor can be measured, from miniature disks to pole-mounted power types. Even the small amounts of capacitance encountered in cable or switches can be measured.

For production line applications, the 820 is an excellent means of pretesting critical capacitors or accurately adjusting trimmer capacitors. The simplicity of operation allows even untrained workers to be quickly instructed in proper operation. To facilitate fast incoming component sorting and selection, slot-type front panel lead-insertion jacks are used. The slot jacks eliminate the time-wasting step of guiding a capacitor lead into the type of small lead-insertion holes commonly found on other instruments.

In classroom applications, the 820 can be used to verify capacitor network calculations by measuring the actual value of a network. The operation of a variable capacitor can also be demonstrated, as can the effects of heat or cold on a capacitor.

The B&K Precision model 820 comes with a 26-page detailed manual. Optional accessories include the BP-28 rechargeable battery pack, the BC-28 charger, and the LC-28 carrying case. The 820 is now available for immediate delivery at local B&K Precision distributors. For additional information, contact B&K Precision, Sales Department, 6460 West Cortland Street, Chicago IL 60635, (312)-889-9087. Reader Service number B45.

HAMTRONICS' VHF LINEAR AMPLIFIERS

One of the best and least expensive ways I know of getting started on VHF/UHF, or of expanding your capabilities if you're already active on those frequencies, is with the growing line of Hamtronics kits. Two of the more recent kits are the model LPA 2-45 and LPA 8-45 two-meter linear power amplifiers. The LPA 2-45 is designed to amplify the 2 Watts PEP output of the Hamtronics XV2 Transmitting Converter or the T50 FM Exciter or any other 2-Watt two-meter rf power source to 45 Watts PEP. As a linear, it may be used on any mode, including SSB, CW, AM, and FM. The LPA 8-45 is designed to boost the 8-10 Watt output of the popular two-meter multimode transceivers or other rigs in that power range to 45 Watts PEP. Both models use the same circuitry, with the exception that the first two stages are omitted in the LPA 8-45. Input and output impedance is 50 Ohms. Power requirement is 13.6 V dc at 8 to 10 Amps. The amplifiers may be tuned to any frequency in the 140 to 175 MHz range, and have a passband of 2 MHz.

One of the first things you notice when unpacking the kit is that the power transistors and PC board have been pre-assembled for you so that the proper spacing, heat-sink compound application, and transistor stud torque are taken care of for you. It's a nice touch and makes the project go more quickly and easily. The transistors are the latest, emitter-ballasted, high-gain types, and are operated well below their full output capability to remain in the linear range. Impedance matching is done with high Q, discrete coil-capacitor-tuned circuits to aid signal purity.

Construction is simple and straightforward. Although the instructions are not of the detailed step-by-step type, they are more than adequate for anyone who has done a bit of home brewing or kit building and who reads them over carefully a couple of times before starting. In fact, building the LPA 8-45 is very much like working from a well-written magazine construction article. Coil winding and special parts mounting procedures are fully detailed, and even I got through the process without any problems or delays. Either model makes an easy and enjoyable afternoon or evening project.

Alignment is very simple. Just connect the input to a two-meter rf source of the appropriate power rating. Connect a VTVM or VOM to the test point pad on the PC board and



The Message Memory Keyer from Trac.

apply moderate drive and B+. Then tune the six trimmer capacitors alternately for maximum output. Continue increasing the drive slightly and repeaking the capacitors until maximum output is achieved (about 10 Amps maximum current drain). Of course, during normal operation you would not drive the amplifier to its limit. However, for alignment, you want to tune for absolute maximum output to establish the proper load for the PA transistors for best linearity on SSB.

The amplifier has an rf output meter detector circuit that may, if desired, be used as an aid during normal operation. A VTVM or VOM, or even a sensitive panel microammeter, may be used to monitor output. An ammeter in the B+ line is another handy operating indicator.

T/R switching of the antenna is not provided for. If a single antenna is to be used with the amplifier and a receiver, some form of coax relay or other method of switching suitable for use in the 144-MHz range must be provided.

Current drain of the amplifier at full output is 8 Amps for the LPA 8-45. If the unit is used in a mobile application, or powered by anything other than a well-regulated and protected power supply, an outboard filter is recommended for hash and transient filtering and reverse polarity protection.

If desired, the amplifier may be mounted to a panel with screws in the left- and right-hand edges of the heat sink. It may be mounted with standoffs to clear the components, or a cutout can be made in the rear panel to clear the PC board and the heat sink then mounted flush to the panel. However the unit is mounted, the fins should be in free air to allow for good convection cooling.

The amplifier has not only given a big boost to my two-meter signal, but it's also provided the satisfaction of building a useful piece of equipment without the hassle of having to round up all the individual bits and pieces needed for such a project. And best of all, at \$109.95 for the LPA 2-45 and \$89.95 for the LPA 8-45, plus \$2.00 per kit for postage, they're affordable. Both models are also available for 6 meters. Heavy-duty versions, rated for 100% duty cycle, are \$15.00 more. There is also a 15-Watt amplifier for six and two meters and 220 MHz. The standard version, model LPA 2-15, sells for \$59.95, and the heavy-duty version is \$69.95, plus \$2.00 postage per kit.

Hamtronics kits may be ordered by mail or phone. VISA and Mastercharge cards are accepted. A handy pocket-size free catalog describing all of the Hamtronics kits plus a useful selection of hard-to-find components, antennas, etc., is available on request. *Hamtronics, Inc.*, 65 Moul Road, Hilton NY 14468. (716)-392-9430. Reader Service number H16.

Morgan W. Godwin W4WFL
Peterborough NH

TRAC MESSAGE MEMORY KEYER

Trac Electronics, Inc., has introduced a new completely CMOS state-of-the-art Message Memory Keyer. Containing all CMOS integrated circuitry, the Message Memory Keyer contains two-message capacity. Each message has expanded 512-bit memory capacity (50 characters, approximately). The keyer can record at any speed and the messages may be replayed at the same or any other speed. A unique repeat function allows the operator to repeat the message played, as in calling CQ. The heart of the Message Memory

is a 1024 x 1 bit CMOS random access memory chip. The all-CMOS unit is virtually rf-proof. In addition to the dual message functions, the keyer contains both dot and dash memory keying, iambic keying, 5-50 wpm, speed, volume, tune, tone, and weight controls, as well as a sidetone with speaker. The unit keys both negative and positive keyed rigs. Available direct from *Trac Electronics, Inc.*, 1106 Rand Building, Buffalo, New York 14203, or at most dealers throughout the U.S. and Canada. Reader Service number T18.

RADICAL NEW TOTALLY CONCEALED UHF ANTENNA INTRODUCED BY ANTENNA SPECIALISTS

A new UHF communications antenna designed for total concealment yet offering performance comparable to external mobile antennas has been announced by The Antenna Specialists Co., major producer of land mobile antennas and accessories. The new model ASP-1000 covert antenna is similar in design concept to antennas utilized for jet aircraft (A/S is also a major supplier of avionic antennas).

Producing a vertically-polarized radiation pattern, this cavity-backed slot antenna is constructed of rugged reinforced aluminum with an iridite finish. Included is a silver-plated matching network enclosed in a protective cover.

Two screwdriver tuning adjustments allow for precise tuning of the antenna to the required operating frequency.

With performance comparable to an antenna mounted externally, the new ASP-1000 is configured to fit precisely into the space inside an automobile trunk originally designed for mounting a 6" x 9" rear deck speaker. The antenna mounting holes mate with those provided for the speaker and the antenna matches exactly the 6" x 9" oval cutout.

Rf power rating is 125 Watts continuous, bandwidth is 5 MHz minimum, and nominal impedance is 50 Ohms. The ASP-1000 covers the 406 to 512 MHz range. For further information, contact *The Antenna Specialists Co.*, 12435 Euclid Avenue, Cleveland OH 44106. Reader Service number A62.

WV-1 WILSON VERTICAL TRAP ANTENNA

No bandswitching is necessary with the new WV-1 antenna. It is an excellent low-cost 10-40 meter vertical that offers an electrical quarter wavelength and a low angle of radiation. Advanced design assures a low swr on each band.

For more information, see your favorite dealer, or contact *Wilson Electronics Corporation, Consumer Products Division, PO Box 19000, Las Vegas NV 89119*. Reader Service number W2.

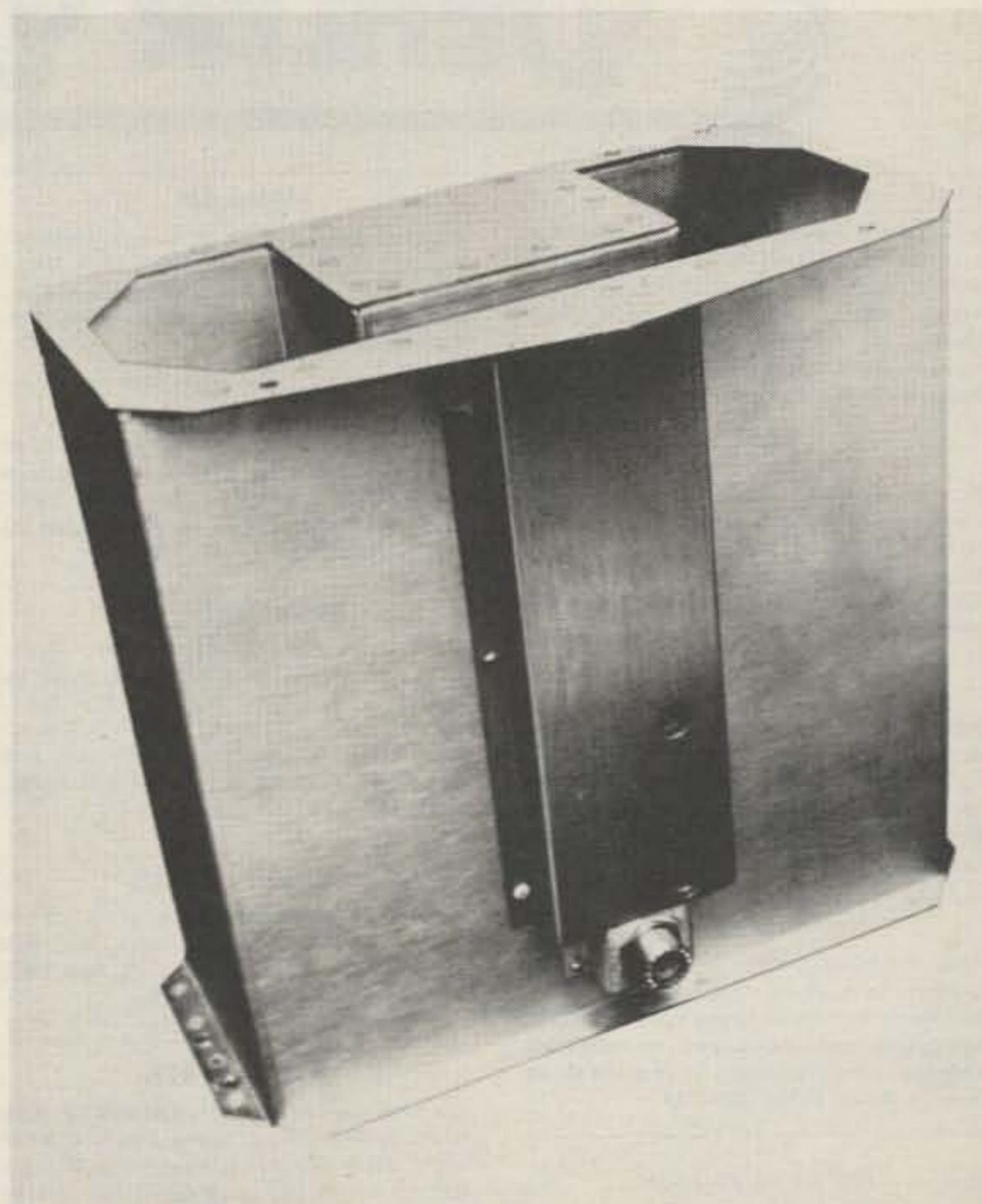

New concealed UHF antenna from Antenna Specialists.

WHERE ELSE
BUT DAVIS?



600 MHz Mini Counter at \$149⁹⁵!

All Davis Frequency Counters deliver highest quality at low cost. But Series 7200 plug-in or battery-powered Mini Counters are truly minimal cost, general purpose instruments that sacrifice no basic performance characteristics. No other counter offers such superior features at Mini Counters' prices. One year warranty on assembled units, 90-day on kit components.

2 MODELS: Kit \$149.95 Assembled \$199.95
 • All Metal Cabinet • 115 V or 12 V operation
 • 8 Digit .4" LED Display • Selectable Gate Times, .1 & 1 sec.
 • Crystal Time Base (1 ppm after cal.)

OPTIONS: Portable w/Ni-Cad Battery (Built-in Charger) \$39.95
 Crystal Oven (1 ppm 10 to 50°C) \$39.95 Handle \$5.00

Order direct from factory. Add \$3.00 for shipping, \$1.00 extra for C.O.D., and 7% sales tax in N.Y. State. Payment by certified check, money order, Master Charge, VISA. Credit-rated company P.O. accepted. Money back guarantee if returned in good condition in 10 days. Kits returnable only unassembled.

For more information, request FREE DESCRIPTIVE LITERATURE, or for in-depth preview, send \$3.00 for 32-page INSTRUCTION MANUAL. Detailed, illustrated. Credited against purchase of either unit.



✓ D10 DISTRIBUTOR INQUIRIES INVITED
 Affordable quality is the Davis difference.

DAVIS ELECTRONICS
 636 Sheridan Drive, Tonawanda, N.Y. 14150 • 716/874-5848

CUSTOM TRANSFORMERS

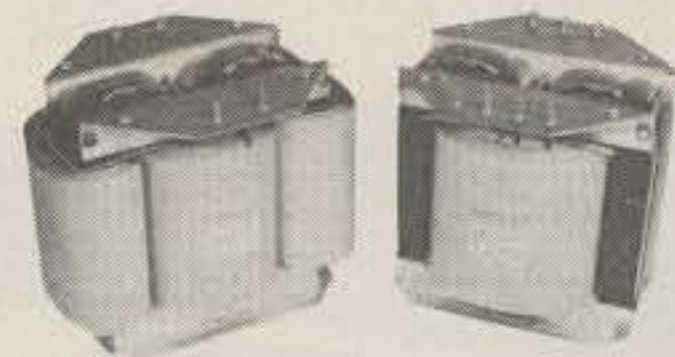

HEAVY DUTY REPLACEMENT TRANSFORMERS

ALPHA A77D Power	\$135	HEATH DX-100 Modl	\$ 95
BTI LK-2000 Plate	\$135	HEATH HX-10 Power	\$ 95
COLLINS 30S-1 Power	\$215	HEATH SB-220 Plate	\$125
COLLINS KWS-1 Plate	\$135	HENRY 2K Plate	\$150
COLLINS 516F-2 Power	\$ 95	HENRY 2K-2 Power	\$155
DENTRON 160-10L Power	\$125	HENRY 2K-4 Power	\$165
DRAKE L4B Plate	\$165	HENRY 3K-A Plate	\$165
GONSET GSB-100 Power	\$ 95	HENRY 3K-A DC Choke	\$ 85
GONSET GSB-201 Power	\$135	EFJ T-BOLT Plate	\$125
H-CRAFTERS HT-32 Power	\$ 95	EFJ 500 Modulation	\$ 95
H-CRAFTERS HT-37 Power	\$ 95	EFJ 500 DC Choke	\$ 75
HEATH DX-100 LV Power	\$ 95	NATL NCL-2000 Plate	\$125

OFF-THE-SHELF SPECIALS

PLATE XFMR:	2400 VAC @ 1.5A ICAS 220/240 PRI-4 1LB	\$150
PLATE XFMR:	3000 VAC @ 1.5A CCS 230 PRI-60LB	\$195
PLATE XFMR:	3000 VAC @ 0.7A ICAS 115/230 PRI-27LB	\$115
PLATE XFMR:	3500 VAC @ 1.0A ICAS 115/230 PRI-4 1LB	\$150
PLATE XFMR:	4000/4600 VAC @ 1.5A ICAS 230 PRI-60LB	\$195
PLATE XFMR:	6000 VCT @ 0.8A CCS 115/230 PRI-4 1LB	\$150
FILMT XFMR:	5.0 VCT @ 30A 117 PRI-9.5LB	\$ 30
FILMT XFMR:	7.5 VCT @ 21A 117 PRI-9.5LB	\$ 30
FILMT XFMR:	7.5 VCT @ 55A 115/230 PRI-14.6LB	\$ 65
FILMT XFMR:	7.5 VCT @ 75A 115/230 PRI-20.2LB	\$ 95
FIL CHOKE:	30 AMP Bifilar Wound on 1/2"x7" rod	\$ 9
DC CHOKE:	8.0 Henries @ 1.5 AMP DC 4 1LB	\$150
SWG CHOKE:	5-30 Henries @ 1.0 AMP DC 23LB	\$100

ALL TRANSFORMERS & CHOKES GUARANTEED FOR 24 MONTHS
 Many others also available. Write for free list or quote on any custom transformer, choke, or saturable reactor.

Peter W. Dahl Co. ✓ D6

4007 Fort Blvd. • El Paso, Texas 79930
 Telephone (915) 566-5365 or (915) 751-4856



DEALER DIRECTORY

Fontana CA

We carry the following: ICOM, Midland, Amcom, DenTron, KLM, Swan, Drake, Ten-Tec, Wilson, SST, MFJ, Hy-Gain, Lunar, Nye-Viking, B&W, Redi-kilowatt, Cush Craft, Mosley, Big Signal, Pipo, etc. Full Service Store **Fontana Electronics**, 8628 Sierra Ave., Fontana CA 92335, 822-7710.

Santa Clara CA

Bay area's newest Amateur Radio store. New & used Amateur Radio sales & service. We feature Kenwood, ICOM, Wilson, Yaesu, Atlas, Ten-Tec & many more. **Shaver Radio**, 3550 Lochinvar Avenue, Santa Clara CA 95051, 247-4220.

Denver CO

Experimenter's paradise! Electronic and mechanical components for computer people, audio people, hams, robot builders, experimenters. Open six days a week. **Gateway Electronics Corp.**, 2839 W. 44th Ave., Denver CO 80211, 458-5444.

New Castle DE

Paul WA3QPX, Rob WA3QLS—Serving amateurs in southern New Jersey, Delaware, and Maryland with the largest stock of amateur equipment and accessories in Delaware. **Delaware Amateur Supply**, 71 Meadow Road, New Castle DE 19720, 328-7728.

Tell them you saw
their name in 73

Boise ID

Alliance, Amcom, CIR, Cushcraft, Dentron, Edgcom, ICOM, Hustler, KDK, MFJ, NPC, NYE, SST, Ten-Tec, Wilson. **Custom Electronics**, 1209 Broadway, Boise ID 83706, Bob W7SC 344-5084.

Preston ID

Ross WB7BYZ, has the Largest Stock of Amateur Gear in the Intermountain West and the Best Prices. Call me for all your ham needs. **Ross Distributing**, 78 So. State, Preston ID 83263, 852-0830.

Bloomington IL

Retail—wholesale distributor for Rohn Towers—antennas by Cush Craft, Antenna Specialists, KLM, Wilson, Hy-Gain. Transceivers by Tempo, Regency, Wilson, Amcom. Also business and marine radios. **Hill Radio**, 2503 G.E. Rd., Bloomington IL 61701, 663-2141.

Terre Haute IN

Your ham headquarters located in the heart of the midwest. **Hoosier Electronics, Inc.**, 43B Meadows Shopping Center, P.O. Box 2001, Terre Haute IN 47802, 238-1456.

Littleton MA

The ham store of N.E. you can rely on. Kenwood, ICOM, Wilson, Yaesu, DenTron, KLM amps, B&W switches & wattmeters, Whistler radar detectors, Bearcat, Regency, antennas by Larsen, Wilson, Hustler, GAM. **TEL-COM**

Inc. Communications & Electronics, 675 Great Rd. Rt. 119, Littleton MA 01460, 486-3040.

Laurel MD

We stock Drake, Ten-Tec, Wilson, ICOM, DenTron, Tempo, Hy-Gain, Midland, Mosley, Hustler. 40-page ham catalog available for \$1.00 (refundable with 1st purchase)—write for cash quote! **The Comm Center, Inc.**, Laurel Plaza, Rte. 198, Laurel MD 20810, 792-0600.

St. Louis MO

Experimenter's paradise! Electronic and mechanical components for computer people, audio people, hams, robot builders, experimenters. Open six days a week. **Gateway Electronics Corp.**, 8123-25 Page Blvd., St. Louis MO 63130, 427-6116.

Camden NJ

X-Band (& other frequencies) Microwave Components & Equipment, Laboratory Grade Test Instruments, Power Supplies, 1000's in stock at all times, BUY & SELL all popular makes—HP, GR, FXR, ESI, Sorensen, Singer, etc. **Lectronic Research Labs**, 1423 Ferry Ave., Camden NJ 08104, 541-4200.

Syracuse NY

We Deal, We Trade, We Discount, We Please! Yaesu, Kenwood, Drake, ICOM, Ten-Tec, Swan, DenTron, Midland, Cush Craft, KLM, Hy-Gain, etc. Complete 2-way service shop! **Ham-bone Radio (div. Stereo Repair Shop)** 3206 Erie Blvd. East, Syracuse NY 13214, 446-2266.

Syracuse-Rome-Utica NY

Featuring: Yaesu, ICOM, Drake, Atlas, DenTron, Ten-Tec, Swan, Tempo, KLM, Hy-Gain, Mosley, Wilson, Larsen, Midland Southwest Technical Products. You won't be disappointed with equipment/service. **Radio World, Oneida County Airport-Terminal Building**, Oriskany NY 13424, 337-2622.

Cleveland OH

Need service on your late model or old time equipment? We service all makes and models. Rates \$19.96 hr. Call or write. **Communications World, Inc.**, 4788 State Rd., Cleveland OH 44109, 398-6363.

Souderton PA

Tired of looking at ads ??? Come and try our new and used equipment yourself—personal advice from our staff's 60 years combined ham experience. **Electronic Exchange**, 136 N. Main St., Souderton PA 18964, 723-1200.

Port Angeles WA

Mobile RFI shielding for elimination of ignition and alternator noises. Bonding straps. Components for "do-it-yourself" projects. Plenty of free advice. **Estes Engineering**, 930 Marine Drive, Port Angeles WA 98362, 457-0904.

DEALERS: Your company name & message can contain up to 25 words for as little as \$150 yearly or \$45 quarterly (prepaid). No mention of mail order business or area code permitted. Text & payment must reach us 45 days in advance. The deadline for the April issue is Feb. 18th. Mail to 73 Magazine, Peterborough NH 03458, ATTN: Aline Coutu.

CONTESTS

from page 8

all DUF countries as per the diploma of the Union F List, 9 Belgian provinces (2 letters), DA2 STN/FBA (Belgian forces in DL), 22 cantons of Switzerland (2 letters), and all other Francophone countries—LX, 40, OD, 3B, 9Q, 9U, 9X, HH, VE2. French stations will give their department number after the call. Example: F6ZZZ/67 and FFA will give DA.../FFA. Final score is the sum of the QSO points times the sum of multipliers. Send logs and summary sheet to the REF Traffic Manager, 2, Square Trudaine, 75009 Paris, France.

CLASSIC RADIO EXCHANGE

Starts: 2000 GMT Sunday, January 28

Ends: 0300 GMT Monday, January 29

Sponsored by the Southeast ARC, K8EMY, Cleveland OH, the contest is open to all. Object is to restore, operate, and enjoy older equipment with like-minded hams. A classic radio is any equipment built since 1945 but at least 10 years old, an advantage, but not required in the exchange. Exchange your name, RST, QTH, receiver and transmitter type (home brew send PA tube, i.e., "6L6"), and other interesting pleasantries. The same station may be worked with different equipment combinations, and on each mode on each band. CW call is "CQ CX." Phone call is "CQ EXCHANGE." Non-contestants may be worked for credit. Suggested frequencies: CW—up 60 kHz from low band edges; phone—3910, 7280, 14280, 21380, 28580; Novice/Tech—3720, 7120, 21120, 28120. Listen to 10 meters on the quarter hour, 20 on the half hour, 15 on the three-quarter hour.

SCORING:

Add the numbers of different transmitters, receivers, states/provinces/countries contacted for each band. Multiply by total number of QSOs. Multiply that total by the Classic Multiplier: total years old of all transmitters and receivers used, three QSOs minimum per unit. For transceivers, multiply years old by two.

ENTRIES:

Please send logs, comments, anecdotes, etc., to Stu Stephens K8SJ, 2386 Queenston Road, Cleveland Heights OH 44118. Include an SASE for results and a copy of the *Classic Radio Newsletter*.

MINNESOTA—ST. LOUIS COUNTY AWARD

This award is issued for having contacts with three stations in St. Louis county, Minnesota, with no date, mode, or frequency restrictions. The award is also available to SWLs on a "heard" basis. Do not submit QSL cards; send log information, \$1.00, and two 15¢ stamps to: Wilderness Ham Radio Operators, Certificate Manager, Ron Heruth WA0WNV, 321 Wyandotte Rd., Hoyt Lakes MN 55750.

BEATA OPERATION

A Dominican ham radio group affiliated with the Dominican Radio Club is concentrating its efforts on trying to offer its country and the world the possibility of working for the first time the HI1 prefix. Beata Island is a restricted area, a military restricted area under the administration of the Dominican Marine Corps. As of October 19, the activity was scheduled for January 25-28 and the group will include: Waldo HI8WPC, Max HI8MVF, Joe HI8JAG, Mike HI8MRF, Tim HI8MFP, and Carlos HI8XPT.

No stations other than the above-mentioned are authorized to work the HI1 prefix. If any call was made prior to the date of this DXpedition, it would not be valid. A weekly

bulletin will be issued until the exact day of the DXpedition, containing interesting information about the island and the operation. Suggestions or in-

MINNESOTA
ST. LOUIS COUNTY

AWARD



formation can be requested at: Beata Operation Public Relations, HI8MFP, Box 2191, Santo Domingo, Dominican Republic, West Indies.

THE 73 BAND PLAN

Channel	Freq.(MHz)	
1	28.965	... Listening & calling
2	28.975	... Autocall monitoring
3	28.985	... County hunting—not rag chew
4	29.005	... Beacon monitoring
5	29.015	
6	29.025	... Rag chewing (lowest)
7	29.035	
8	29.055	
9	29.065	
10	29.075	
11	29.085	
12	29.105	
13	29.115	
14	29.125	
15	29.135	
16	29.155	
17	29.165	
18	29.175	
19	29.185	... Repeater channel
20	29.205	... RTTY
21	29.215	... Oscar coordination
22	29.225	
23	29.255	... SSTV
24	29.235	
25	29.245	... Repeater
26	29.265	... Repeater
27	29.275	... Repeater
28	29.285	
29	29.295	
30	29.305	
31	29.315	
32	29.325	
33	29.335	
34	29.345	
35	29.355	
36	29.365	
37	29.375	
38	29.385	
39	29.395	
40	29.405	... Oscar listening

THE 73 MAGAZINE 10 METER AWARDS

The return of vigorous solar activity means that 10 meters is once again a band to be reckoned with. Ol' Sol's 11-year cycle of sunspot production is about to hit a peak, with the result that QRP 10 meter DX is possible.

Now's the perfect time to convert that old CB rig to 10. American Crystal Supply makes a variety of simple and inexpensive conversion kits, or you can do-it-yourself from the articles in 73. True appliance operators can purchase ready-made rigs from Bristol Electronics or Standard Communications. To give you an added incentive, 73 is offering two nifty Certificates of Achievement for 10 meter channelized communications.

For domestic types, there is the 10-40 Award. This one should be pretty easy—just work 40 of the 50 states. The DX Decade Award goes to DXers who work 10 or more foreign countries with a channelized 10 meter rig. We have endorsement stickers, too—the whole bit.

To give everyone an equal shot at award #1, only contacts made October 1, 1978, or after will be valid.

Well, don't just sit there. Get out your soldering iron, order some crystals, and put that CB rig on 10. This is going to be fun, so don't miss out!

RULES

1) All contacts must be made in the 10 meter amateur band using channelized AM equipment. Both converted Citizens Band equipment and commercially-produced units may be used.

2) To be eligible for award credit, all contacts must be made October 1, 1978, or after.

3) The 10-40 Award is available to applicants showing proof of contact with stations in at least 40 of the 50 United States. A special endorsement sticker will be available to those working all 50 states.

4) The DX Decade Award is available to applicants showing proof of contact with at least 10 foreign countries. Endorsement stickers will be awarded for 25, 50, 75, and 100 countries.

5) A log of stations worked, with the date, time, and type of equipment used for each contact, must be submitted when applying for each award or endorsement.

6) Each application for an award or endorsement must be accompanied by a signed statement that all claimed contacts are valid. No QSL cards need be sent, but they must be in the possession of the applicant.

7) To cover costs, a fee of \$5.00 must accompany each application for the 10-40 or DX Decade Award. The fee for endorsement stickers will be \$2.00 each.

8) All award applications should be mailed to: Chuck Stuart N5KC, 5115 Menefee Drive, Dallas TX 75227.

**SERVING
HAMS
BETTER!**

*North ... south ...
east ... west*



Bob Ferrero, W6RJ/K6AHV, Jim Rafferty, N6RJ
other well known hams give you courteous,
personalized service.

All leading brands ...
in-depth stocks ...
new/used gear.

NOW...FREE PHONE!

**800
854-6046**

CALIF. CUSTOMERS PLEASE CALL OR VISIT STORES LISTED BELOW

**PLUS FREE SHIPMENT
ALL ITEMS U.P.S. (Brown).**

CALL US FOR SPECIAL PRICES ON:

- ALDA • ALLIANCE • ALPHA • AMECO • ATLAS • BIRD •
- CDE • COLLINS • CUSHCRAFT • CURTIS • DENTRON •
- DRAKE • EIMAC • HUSTLER • HY-GAIN • ICOM •
- KENWOOD • KLM • MFJ • MOSLEY • PALOMAR • ROHN •
- ROBOT • SHURE • SWAN • TELEX • TEMPO • TEN-TEC •
- TRISTAO • TELREX • TRI-EX • WILSON • YAESU • more.

KENWOOD!

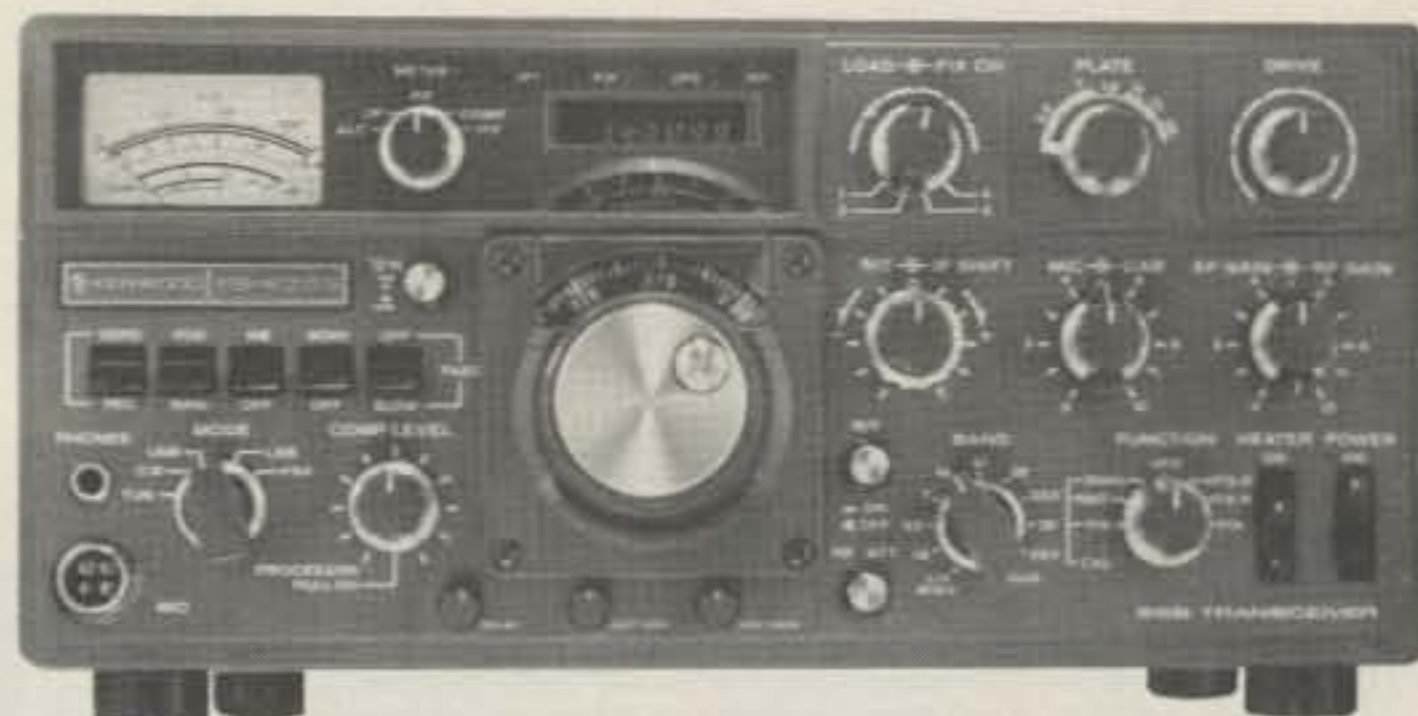

DRAKE!



ICOM!



YAESU!



✓ H31

ANAHEIM, CA. 92801

2620 W. La Palma
(714) 761-3033, (213) 860-2040
1 mile east Knotts Berry Farm

SAN DIEGO, CA. 92123

5375 Kearny Villa Road
(714) 560-4900
Highway 163 & Clairemont Mesa Blvd.

BURLINGAME, CA. 94010

999 Howard Avenue
(415) 342-5757
5 miles south on 101 from S.F. Airport.

VAN NUYS, CA. 91401

6265 Sepulveda Blvd.
(213) 988-2212
San Diego Fwy. at Victory Blvd.

**HAM
RADIO
OUTLET™**

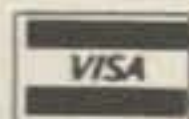

OVER THE COUNTER (Mon. thru Sat. 10 AM to 5:30 PM)

MAIL ORDER, Phone, Write.

SAVE \$25.00

Model 8100 Frequency Counter Kit

- Range: 20Hz to 100MHz
- High Sensitivity
- Resolution to 0.1Hz

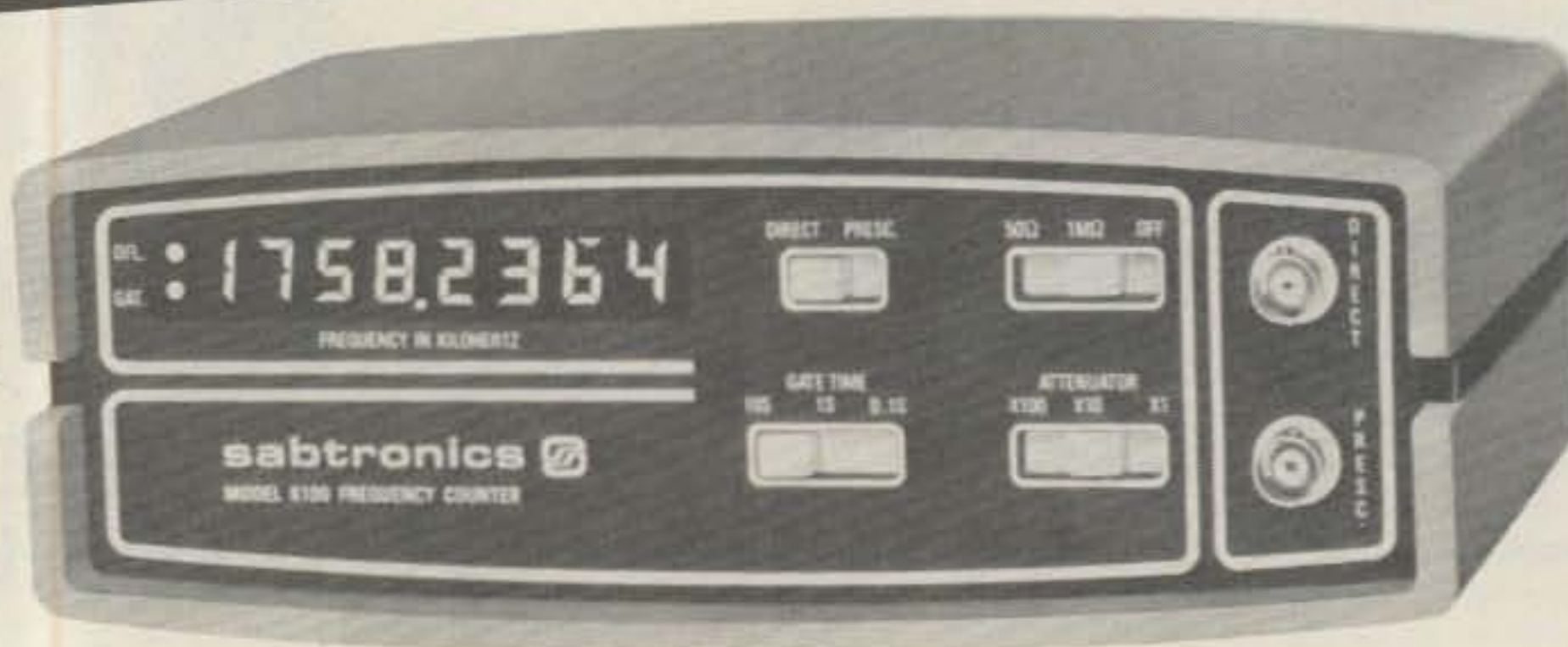

Now you can forget about price/performance trade-offs when you select a frequency counter. In Sabtronics' Model 8100 kit you get all the characteristics of superior performance at a low, affordable price.

This frequency counter, employing LSI technology, has the performance and input characteristics you demand: guaranteed frequency range of 20Hz to 100MHz (10 Hz to 120MHz typical); selectable hi/lo impedance; superior sensitivity; selectable resolution and selectable attenuation. Plus an accurate time base with excellent stability.

An 8-digit LED display features gate activity indicator, leading zero suppression and overflow indicator. You would expect to find all these features only on high-priced instruments — or from Sabtronics' advanced digital technology.

BRIEF SPECIFICATONS:

- Frequency Range: 20Hz to 100MHz guaranteed. (10Hz to 120MHz typical)
- Sensitivity: 15mV RMS, 20Hz to 50MHz (10mV typical); 25mV RMS, 50MHz to 100MHz (20mV typical)
- Selectable Impedance: 1MΩ / 25pF or 50Ω
- Attenuation: X1, X10 or X100
- Accuracy: ±1Hz plus time base accuracy
- Aging Rate: ±5ppm/yr.
- Temperature Stability: ±10ppm, 0°C to 40°C
- Resolution: 0.1Hz, 1Hz, 10Hz selectable
- Display: 8-digit LED, overflow indicator, gate activity indicator
- Overload Protection
- Power Requirement: 9-15 VDC @ 330mA



Model 2000, 3½ Digit DMM Kit

- 5 Functions, 28 Ranges
- Basic DCV Accuracy: 0.1% ± 1 Digit

The amazing Sabtronics 2000 is the choice of both professionals and hobbyists. It's the only portable/bench DMM that offers so much performance for such an astonishing low price.

You get basic DCV accuracy of 0.1% ± 1 digit; 5 functions giving 28 ranges; readings to ±1999 with 100% overrange; overrange indication; input overload protection; automatic polarity; and automatic zeroing.

The all-solid-state Model 2000 incorporates a single LSI circuit and high-quality components. Our clear, step-by-step manual simplifies assembly. Complete kit includes a rugged high-impact case ideal for both test-bench and field use.

BRIEF SPECIFICATIONS:

- DC volts in 5 ranges: 100 µV to 1kV
- AC volts in 5 ranges: 100 µV to 1kV
- DC current in 6 ranges: 100 nA to 2A
- AC current in 6 ranges: 100 nA to 2A
- Resistance: 0.1Ω to 20MΩ in 6 ranges
- AC frequency response: 40 Hz to 50kHz
- Display: 0.36" (9.1mm) 7-segment LED
- Input Impedance: 10MΩ
- Size: 8"W × 6.5"D × 3"H (203 × 165 × 76 mm)
- Power requirement: 4.5-6.5 VDC · 4 "C" cells (not included).

Special Offer! Save \$25.00*

If you order both the frequency counter and DMM kits now, you pay only \$144.90 including shipping and handling. You save \$25.00 off the combined regular low price of \$169.90. Order both kits now. This special offer good for a limited time only.

*Special offer good in USA only.

Making performance affordable. ✓S27

sabtronics

13426 Floyd Circle · Dallas, Texas 75243
Telephone 214/783-0994

Sabtronics International Inc. 13426 Floyd Circle Dallas Tx 75243 "73-1"

Yes, I want to take advantage of your special \$25.00-off offer.*
Please send _____ Model 8100 and Model 2000 kit(s) for only \$144.90 total including shipping and handling \$ _____

Please send _____ Model 8100 Frequency Counter kit(s) @ \$89.95 ea \$ _____
Shipping and handling \$ 5.00/unit* \$ _____

Please send _____ Model 2000 DMM kit(s) @ \$69.95 ea \$ _____
Shipping and handling \$ 5.00/unit* \$ _____

Texas residents add sales tax \$ _____
Total enclosed \$ _____

Check Money Order Charge my Master Charge Visa _____
Exp. Dt. _____
Acc. No. _____

Name _____

Address _____

City _____ State _____ Zip _____

*USA only. CANADA: \$6.50. FOREIGN: \$19.00 AIRMAIL.

(Cut on dotted line and keep next to your radio equipment)

(Cut on dotted line and keep next to your radio equipment)

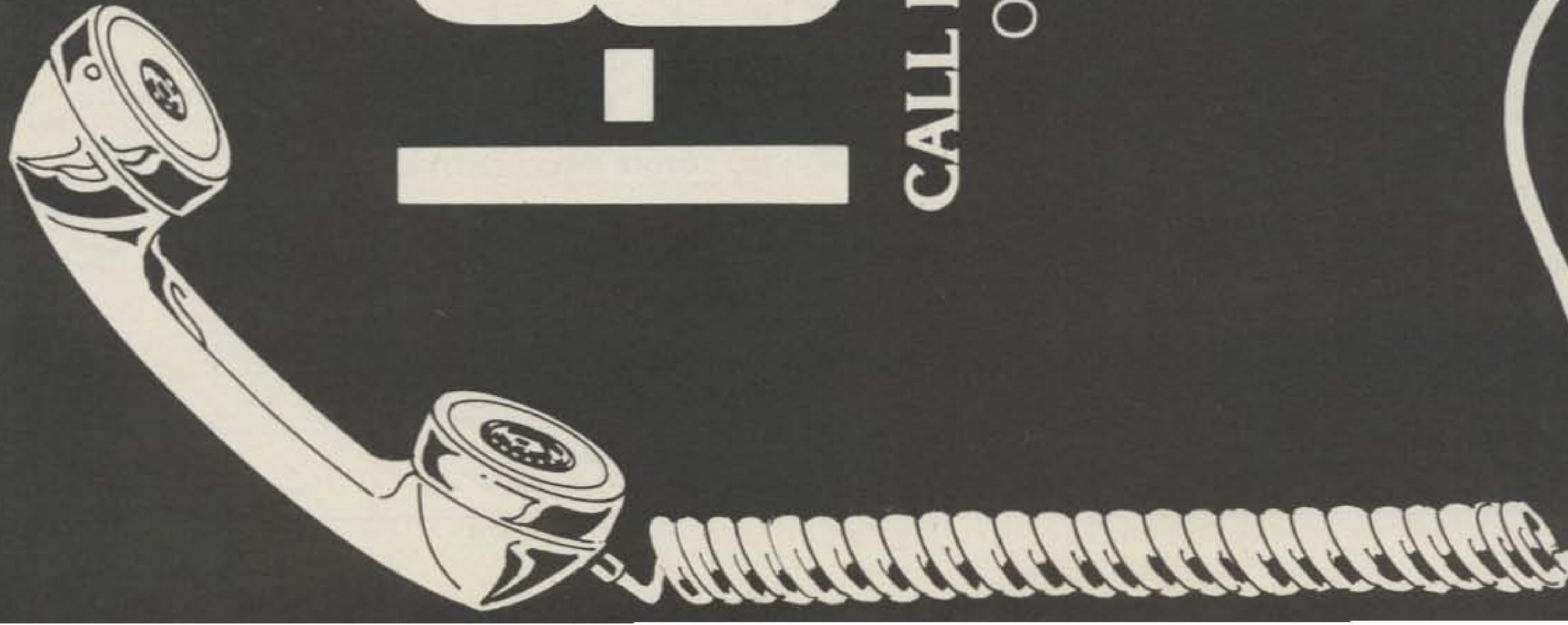

Call our toll-free number first

... and it's the last call you'll have to make!

(NO CHARGE TO CALLING PARTY)

1-800-325-3030

CALL FOR THE BEST PRICE AND FAST DELIVERY

ON THE FOLLOWING LINES:

ATLAS
COLLINS
DENTRON
DRAKE
HY GAIN

ICOM
INFO-TECH
KENWOOD
MOSLEY
STANDARD

SWAN
TEMPO
TEN-TEC
WILSON
YAESU

... AND MANY OTHERS.



HAM RADIO CENTER

8340-42 Olive Blvd. P.O. Box 28271 St. Louis, MO 63132



GALLIUM PHOSPHIDE L.E.D.
Provides Higher Intensity Than Regular LED's; T1-3/4 Dome (Red Diffused) AND Part #114R 1-99...22¢ 100+...20¢ We stock the full line of AND L.E.D.'s

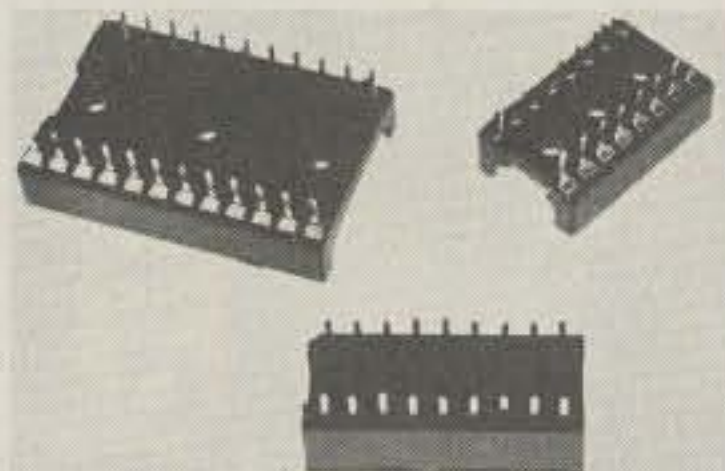

DIP SOCKET SPECIALS

16 Pin Low Profile Solder Tab 1-49 50+
20¢ 15¢
18 Pin Standard Height Solder Tab 25¢ 20¢
24 Pin Low Profile Solder Tab GOLD 60¢ 55¢

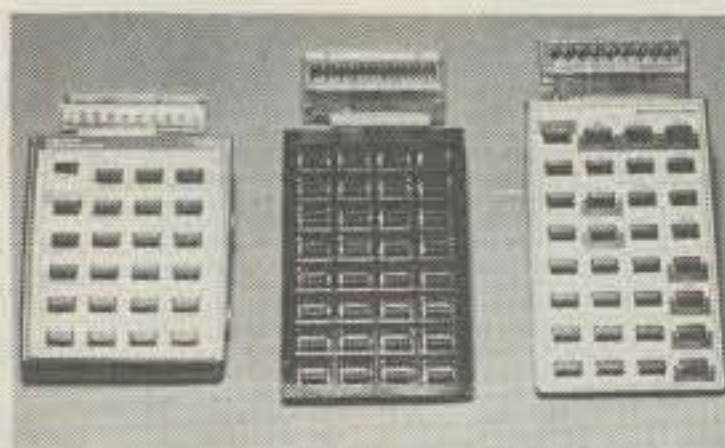

CALCULATOR GUTS Experimenter's delight. Each keyboard includes a monolithic calculator chip and a display. These are rejects. It might be something simple to repair or it could be very nasty. At this price, who cares! 9 volt. \$1.50 ea. 3/\$3.00.

CLOCK DISPLAY National Semi. 6 Digit Multiplexed Display; .33" Characters (Common Cathode). A REAL BUY AT JUST \$1.00.

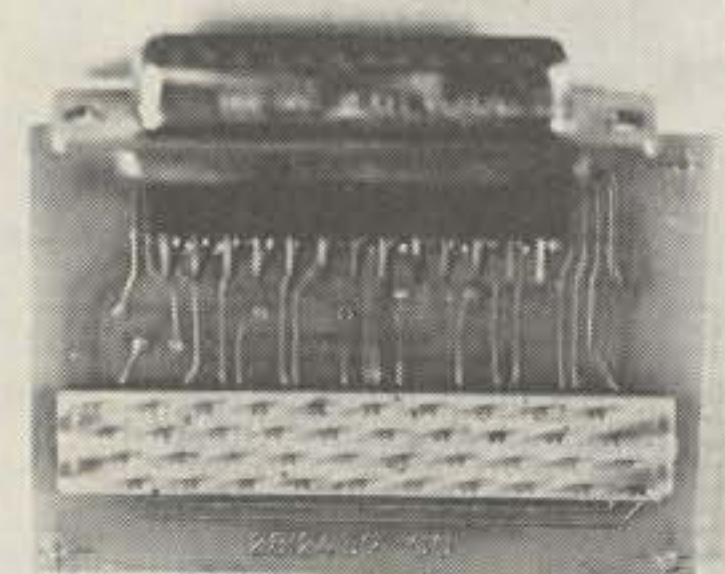

DB-25 FEMALE CONNECTOR
A unique assembly originally adapting the RS232 Type Connector to flat cable. \$1.50 each or 2/\$2.50.



INSTRUMENT/CLOCK CASE KIT Perfect for your opto projects. Solid aluminum construction with real walnut sides. O.D. 5-3/8" by 5-3/8" by 2". \$6.95 ea.



EDGE CARD CONNECTOR
Cinch Jones 10/20 Pins .156 Spacing PC Mount 85¢

M-M Electronic Sales ✓ U8

A division of **united products Corporation**

Corp. Hdqts., 2322 1st Ave., Seattle, Wash. 98121 • (206) 682-5025



LINE PRINTER HAMMER DRIVER BOARD Each board contains approx. 130 each #MJE800 (Silicon Darlington NPN hfe 750, 1.5A). About \$130.00 worth, over 100 1N4001 diodes, plus support chips. The whole package is yours for only \$14.95. HURRY, WE DON'T EXPECT THESE TO LAST VERY LONG!

EUROPEAN 220V LINE CORD
Building something for export? Then you might need this. 40¢ ea. 10/\$3.00.

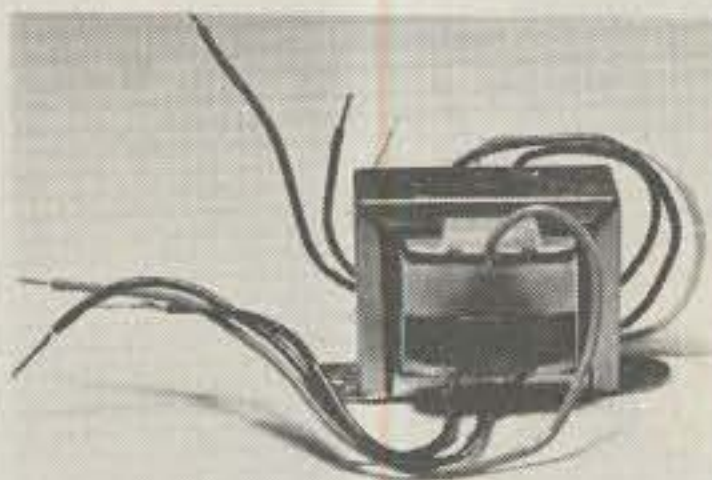

TRANSFORMER Pri. 110 VAC Sec. 11.2 and 5 VCT @ 1 amp. 95¢ ea.



TRANSFORMER P-C mount. pri. 110 VAC Sec. 12:6 @ 1 amp. \$1.25 ea.



CLOCK DISPLAY NATIONAL SEMICONDUCTOR 6 digit multiplexed display. 1/2" characters. (Common anode) A real buy at just \$1.00 ea.



5 FUNCTION L.C.D. CAR CLOCK Wait no longer. We brought the price down on L.C.D.s. This is not a kit. It comes completely assembled, ready for you to easily install in the dash of your car, boat, or R.V. 5 functions, providing hours- minutes- seconds- month and day. Power is provided from a simple pen light cell which will service for about 2 years. Night lighting is through connection to your existing dash lights. Time accuracy to 4 seconds per month. You won't need a magnifying glass to see the time, either. This beauty boasts a big 1/2" character display. Which, incidentally, has passed the temperature extremes encountered in an automobile. Battery not included. \$24.95

FAIRCHILD #78H05 Pos. 5V 5 Amp Regulator (TO-3) NET \$11.00; Your Cost \$1.95 or 2/\$3.00

FLAT CABLE CONNECTOR
Female 34 Pin Socket 50¢ each

PLASTIC PARTS BOX A nice little hinged-top box for storing all your small parts. O.d. 6 3/4" by 3 3/4" by 2". 75¢ ea. 10/\$5.00.

COMPUTER POWER SUPPLY TRANSFORMER PRI. 110/220 Vac; SEC. 12.1V @ 9A, 44.0V @ 2.5A, 12.9V @ 2.0 A, 12.9 V @s 3.2 A. Only \$14.95 ea.

EDGE METER 100-0-100 ua 1/2" by 1 1/16". Compare with other meters costing \$6.00. ONLY \$2.00 ea. Why pay more?

CALCULATOR BUBBLE DISPLAY BRAND NEW pocket calculator displays. Ranging from 6-9 digit. Your luck \$1.25 ea. 3/\$3.00

KEYBOARD HOBBY BAG Compare, then really save with our calculator hobby bag assortment. Each one contains 3 calculator keyboards. All this for only \$1.75.

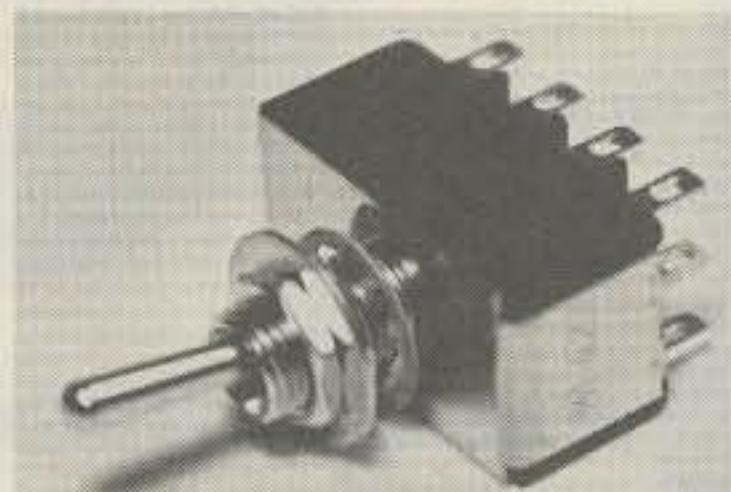

TOGGLE SWITCH J.B.T. #JMT 423, Subminiature 4 P.D.T. 5 amp. @ 125 VAC. LIST PRICE \$5.95. YOUR PRICE \$1.11 ea.



REPEAT OF A SELL-OUT A complete 12 hour digital clock. Some are manufacture line rejects, some are returns, and some are just scratched. Features: hours- minutes- alarm- snooze alarm. Parts value alone would equal \$20.00, you pay only \$6.00 ea.

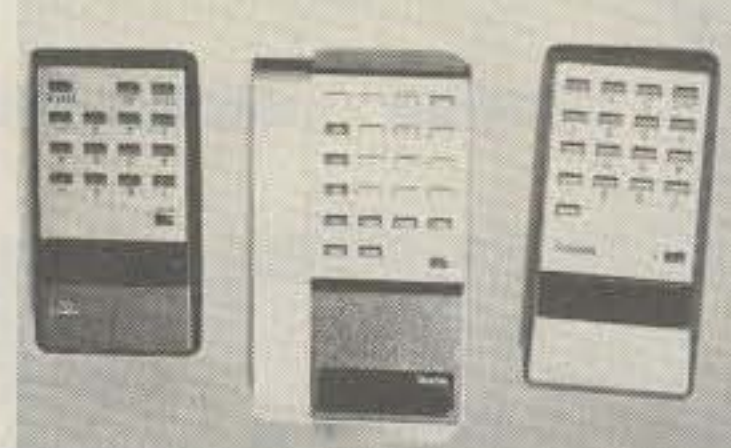

DEFECTIVE CALCULATORS Well, some are and some are not. We can't afford the time to test them. \$2.50 ea. Batteries not included. 2/\$4.00

#30 KYNAR Blk., Brn., Red., Or., Yel., Grn., Blu., Vio., Gry., Wh. We will do our best to ship the color you specify. To ensure prompt delivery of your order we will substitute colors should we be temp. out, unless you specify otherwise. \$2.36 per hundred foot spool; \$14.16 per thousand foot spool; Multiples of 100' only.

Call us for quotes on larger quantities.

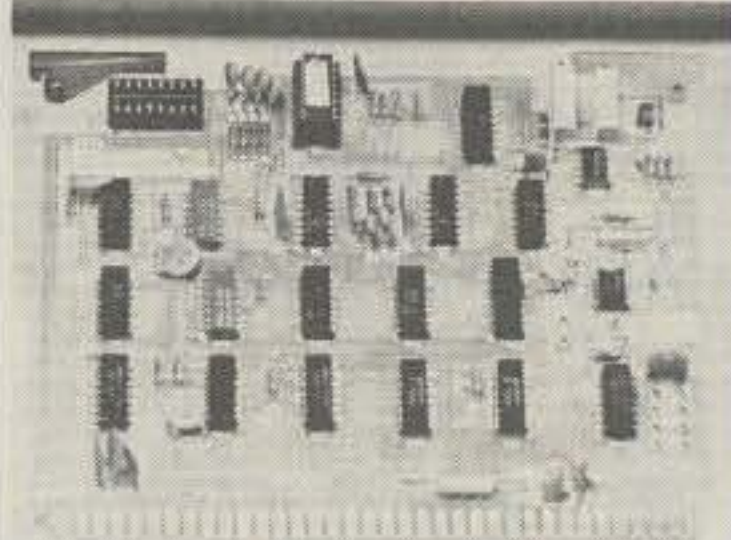

PARTS BOARDS A great way to buy parts on a budget. We guarantee your money's worth. ONLY \$1.00 ea.



CAPACITORS

Capacitance	Voltage	Style	Price
1000uf	25 VDC	P-C	25¢
220uf	25 VDC	P-C	25¢
2000uf	25 VDC	AXIAL	50¢
40/40	150 VDC	AXIAL	45¢
1uf	15 VDC	AXIAL	19¢
.018	100 V	MYLAR	25¢
.001	100 V	MICA	11¢
.01		DISC	7¢
.02		DISC	6¢
.1		DISC	9¢

CLAIREX PHOTO CELLS These have a real USEFUL range to them. Any project involving control from ambient light levels will utilize this photo cell. Light resistance 1K. Fast response. .156 Diameter. 75¢ each or 2/\$1.00.

ROTRON WHISPER FAN #WR2H1 3 Blade 4" Diameter 75CFM 115VAC. NET \$17.00 YOUR PRICE \$9.95 Wait now, these are not pull-outs or something like that, these are new!

KEYBOARD SWITCH ASSEMBLIES Spring contact type 6/\$2.00 (Which enables you to re-assemble 3 complete groups of 4 switches.)

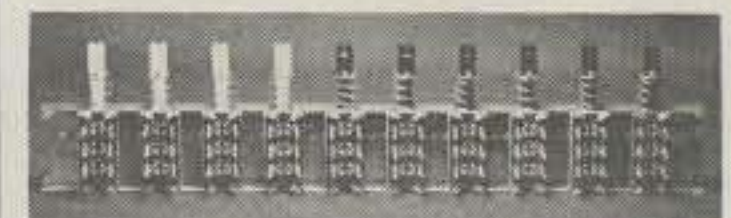

10 STATION PUSH BUTTON SWITCH ASSEMBLY 4 Push-On/Push-Off, 6 Ganged Push-On/Push-Off DPDT \$2.50 Each.

SELECTED VALUES

These items are chosen from our vast inventory of industrial quality components: Extruded heat sink 10 7/8" by 2 1/4" by 5/8"..... \$1.49
500 Ohm P-C mount trimmer..... 20¢
Line cord #18 ga 6'..... 25¢
74LS175 Quad D flip-flop..... 50¢
S.P.D.T. sub-min slide switch..... 40¢
S.P.S.T. P-C SWITCH..... 20¢
ACID BRUSH..... 10¢
SMITH #8523 SPACER .5 by #8 hole..... 5¢
2 cond. #24 spiral wrap shld. cable ... 10¢
14 PIN DIP HEADER ... 35¢

For Master Charge/Visa Orders Use Our TOLL FREE HOT LINE: 1-800-426-0634 for areas outside Washington (incl. Alaska & Hawaii)

O.E.M.'s WELCOME



Terms: All orders shipped promptly. Minimum order \$5.00. Telephone orders accepted. All orders shipped UPS or PP. Add 5% extra for shipping & handling. Washington state residents add additional 5.4% sales tax. Master Charge & Visa cards accepted. Money orders & your personal or company check are welcome. Funds made payable in U.S. currency only. No C.O.D. orders. Your satisfaction is guaranteed on all merchandise purchased. All merchandise subject to prior sale. Open account to govt. agencies & publicly funded schools.

Store Hours M-F 9-6 • SAT 9-5

BULLET ELECTRONICS

P.O. Box 1944ZE Dallas, TX. 75219 (214)823-3240

MK-05 MINI MOBILE CLOCK

The smallest and best priced mobile clock kit on the market. Designed to be a mobile clock from the ground up. There has been no compromise on quality.

FEATURES:

- Quartz crystal timebase
- Toneid & zener noise & overvoltage protection
- Magnified, 15", 6 digit LED readout
- Complete with pretable 24 hr. alarm
- 9-14 VDC @ 40 to 60 mA
- Readouts can be suppressed
- EASY, QUICK ASSEMBLY
- All components required included (you supply the speaker)
- Top quality drilled and plated PC boards

12.95

Clock board: 2.8" x 2"
Readout board: 2.3" x .75"

UNIVERSAL SOUND EFFECTS BOARD

HAVE YOU EVER WISHED YOU COULD DUPLICATE THE SOUND OF A STEAM TRAIN OR A PHASOR GUN? HOW ABOUT GUNSHOTS, WHISTLES, SIRENS, BARKING DOGS AND OTHER SOUND EFFECTS? NOW YOU CAN WITH OUR PROGRAMMABLE SOUND EFFECTS KIT. IT USES THE NEW 28 PIN T.I. SOUND SYNTHESIZER CHIP, SN75477 AND SUPPORT CIRCUITRY. 5 TO 12VDC IS REQUIRED TO GIVE APPROX. 1/4 WATT OF AUDIO OUTPUT. WE PROVIDE THE P.C. BOARD, PARTS AND INSTRUCTIONS ALONG WITH A CHART TO PROGRAM SOME COMMON SOUNDS. USE YOUR IMAGINATION TO CREATE ORIGINAL SOUND EFFECTS.

ORDER: SE-01 16.95(Less Spkr.)

YOU'VE SEEN IT ON QUALITY STEREO GEAR



DPDT Toggle
ALCO CST-622
3A @ 125V

49

MC1468 POSITIVE VOLTAGE REGULATOR

1 AMP COMPLETE SPECS AND APPLICATIONS SHOW HOW TO BUILD FIXED OR VARIABLE POWER SUPPLIES FROM 3 TO 50VDC DRIVE EXTERNAL SERIES PASS FOR CURRENT TO 30 AMP

1.25 EA.
10/10.00
HOUSE #

25A
100V
SCR

Perfect for battery chargers, switching supplies, crowbars, etc.

1.95

739 FAIRCHILD



DUAL LOW NOISE AUDIO PRE-AMPLIFIER

89¢ 2/1.69

HOUSE # PNP POWER

TO-18
75 WATTS
10 VDC @ 10 AMPS
IDENTICAL TO 2N2904 1.00

MPF131 N-CHANNEL DUAL GATE MOSFET

DESIGNED FOR AMPLIFIER AND MIXER APPLICATIONS TO 300 MHz. PLASTIC CASE. UNITS ARE HOUSE NUMBERED WITH SPECS.

50¢

FANTASTIC SOUND EFFECTS CHIP

THIS 28 PIN MARVEL CONTAINS A LOW FREQUENCY OSCILLATOR, VCO, NOISE OSCILLATOR, ONE SHOT, MIXER AND ENVELOPE CONTROL. WITH 8 PAGE MANUAL. 5 TO 8VDC

3.95

EMITTER RESISTORS

HARD TO FIND VALUES!

.1 ohm @ 5W
.25 ohm @ 5W
YOUR CHOICE...
7/1.00

LM3900 QUAD NORTON AMP

WE BOUGHT A LARGE QUANTITY OF THESE HOUSE NUMBERED PARTS AT A BARGAIN PRICE THAT ALLOWS US TO SELL THEM AT A LOW LOW

39¢

IL-1 OPTO ISOLATORS

BY LITHONIX 6 PIN DIP STANDARD PINOUT. LED-TRANSISTOR COMBINATION.

50¢ WHILE THEY LAST!

WIREWRAP Wire

30 Gauge
KYNAR[®] Insulat.
500 FT
4.50

MJ2900 - MJ1000

COMPLEMENTARY PNP, NPN DARLINGTON POWER TRANSISTORS. 8 AMPS. WE SUPPLY A SCHEMATIC TO BUILD A HIGH POWER (20W) LOW DISTORTION AUDIO AMP WITH ONLY ONE ADDITIONAL TRANSISTOR AND A DOZEN INEXPENSIVE COMPONENTS. TO-3 CASE STYLE. BUY A PAIR FOR

\$3.00!

6 DIGIT ZULU CLOCK KIT

At last a clock for HAMS. Designed with large bright LED digits to enhance your shack. The unit is a pleasure to assemble and so easy on the budget! You get top quality parts and plated PC Boards. The unique design of the board set eliminates the headaches of running wires between clock and readout board. As a bonus the unit has a switchable timer that can be reset to zero without disturbing real time. Elapsed time in minutes and seconds up to 25 minutes. Six full sized FND510 readouts and colors making viewing easy from across the room. Does NOT use the old style 5314 chip. **DUE TO A SPECIAL PURCHASE WE HAVE A LIMITED QUANTITY.**

We Promised!

COMPLETE ZULU CLOCK KIT

Includes: All components, plated, drilled PC Boards, large easy to read instructions, and AC transformer. Clock board: 2 3/4" X 4 3/4". Readout Board: 1 1/2" X 4 1/4".

16.00

24 Hr. Format Only
Hand made solid hardwood case for the Zulu Clock. Includes ruby front filter and back panel.

6.95

WARBLE ALARM Kit

A fun EASY kit to assemble that emits an ear piercing 10 watt dual tone scream. Resembles European siren sound. Great for alarms or toys. Operates from 5-12VDC at up to 1 amp (using 12VDC @ 8 ohm speaker). Over five thousand have been sold. All parts including PC board, less speaker.

2.50

FND510 694

COMMON ANODE READOUT CHARACTER LIMIT 24 PER CUSTOMER!

LED'S JUMBO RED 5/89
GREEN 4/89
MEDIUM RED .15
GREEN .16
YELLOW .16

1.5V 10-30 MA

MC1351P FM-IF AMP AND DISCRIMINATOR



USED IN FM & TV SOUND CIRCUITS. REQUIRES MINIMUM EXTERNAL COMPONENTS. 14 PIN DIP. DIRECT REPLACEMENT FOR HEPC 6960, EC3, 748 AND MANY OTHERS. HOUSE # WITH SPECS

50¢

MC3301P HOUSE

4 OF AMPS IN ONE PACKAGE. USES SINGLE SUPPLY (4 TO 28VDC). INTERNALLY COMPENSATED. SIMILAR TO MC3401, BUT HIGHER GAIN.

69¢

NEVER A SWEETER METER!

Beautiful American made panel meters are a snap to install. Huge 3 1/2" wide dials are easy to read. You would expect to pay more for each than we get for the pair! MATCHED SET 0-15VDC, 0-30ADC

12.95 Set

MK-03A CLOCK/TIMER KIT

Features 24 hour Zulu time and up to 24 hours of elapsed time on the same set of six digit LED readouts. Totally independent operation of both functions. Clock has pre-settable alarm with 10 minute snooze. Timer has reset, hold, and count functions. Full noise and overvoltage protection. 24 hour only. Readouts has dimmer feature or they can be turned off without disturbing the clock or timer. Timebase included (.01% accuracy). Because of the many options and mounting considerations the case and switches are not included. Switches are standard types. Will fit inside standard aircraft instrument case.

9-14VDC

28.95

POWER SUPPLY KIT PS-14

- Better than 200MV load and line regulation
- Foldback Current Limiting
- Short Circuit Protected
- Thermal Shutdown
- Adjustable Current Limiting
- Less than 1% ripple.
- 15 amps 11.5 to 14.5V
- All parts supplied including heavy duty transformer.
- Quality plated fiberglass PC board.

REVIEWED IN 7/78 73 MAG.

15A CONT. 20A INT. 42.95

OVERVOLTAGE PROTECTION KIT 6.95

Provides cheap insurance for your expensive equipment. Trip voltage is adjustable from 3 to 30 volts. Overvoltage instantly fires a 25A SCR and shorts the output to protect equipment. Should be used on units that are fused. Directly compatible with the PS-12 and PS-14. All electronics supplied. Drilled and plated PC board. (Order OVP-1)

MOBILE CLOCK CALENDAR KIT

Same as everybody sells digital clock kits. However we have the only low cost DIGITAL CLOCK / CALENDAR for Mobile operation. We provide quality printed: through hole boards and step-by-step instructions, parts overlays and schematics. This clock has many features and we supply all the parts but a small speaker. Fantastic for car, boat or Van.

- 1.01% ACCY
- Large 4 DIGIT LED display with AM/PM indicators
- 100% noise and overvoltage protection for mobile use
- Auxiliary output with drive relay or TRIAC to control external equipment
- 5% Wet 1/4 2310
- 48VDC ignition
- blanking turns off readouts when not in use
- resettable alarm with Snooze
- Special "Sleep Timer"

23.50 NO CASE

12 VAC XFMR for 110 VAC 1.50
24 Hour Format add 2.00

CAPACITORS

SMALL SIZE!

- 2000 MFD @ 16 VDC RADIAL 3/1.00
- 500 MFD @ 35VDC 5/1.00 AXIAL
- 200 MFD @ 25VDC 7/1.00 AXIAL
- 1 MFD @ 20VDC DISC CERAMIC 15/1.00
- .022 @ 100VDC Mylar 8/1.00
- .22 @ 50VDC Mylar 6/1.00
- 1.5mfd @ 400VDC Mylar 4/1.00
- 1mfd @ 35V Tant Axial 6/1.00
- .47mfd @ 35V Tant Axial 6/1.00
- 2.2mfd @ 35V Tant Axial 6/1.00
- .22mfd @ 20V Dio Tant 4/1.00
- .33mfd @ 10V Dio Tant 4/1.00

ZENER GRAB BAG

A very nice assortment of 1/4, 1/2 & 1W zeners. Voltage ranges are from 2.7 to 30 VDC. Most have house # but we provide a cross over list to standard numbers. A great buy for any shop. 12 different types.

69¢

- NO COD'S
- ADD 5% FOR SHIPPING
- ORDERS UNDER \$10.
- SEND CHECK OR MONEY
- TEX RESIDENTS ADD 5% TAX
- ADD .75 for HANDLING
- ORDER OR CHARGE CARD NO.
- FOREIGN ORDERS ADD 10%.

PHONE ORDERS ACCEPTED ON VISA & MC

COPYRIGHT 78

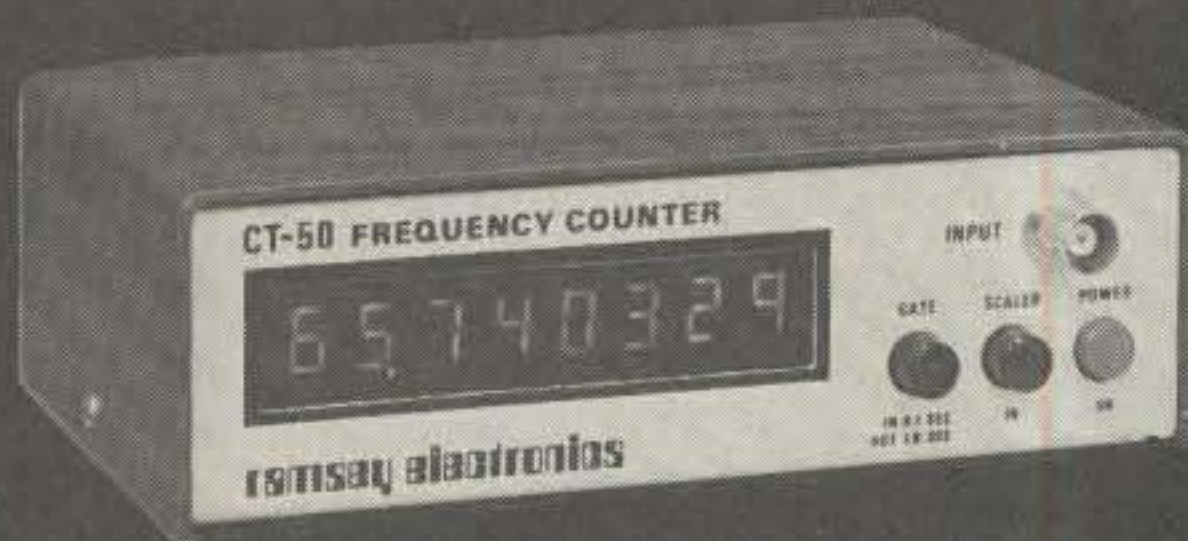

FREQUENCY COUNTER KIT

Outstanding Performance

Incredible Price

\$89⁹⁵

CT-50

SPECIFICATIONS:

Frequency range: 6 Hz to 65 MHz, 600 MHz with CT-600
Resolution: 10 Hz @ 0.1 sec gate, 1 Hz @ 1 sec gate
Readout: 8 digit, 0.4" high LED, direct readout in mHz
Accuracy: adjustable to 0.5 ppm
Stability: 2.0 ppm over 10° to 40° C, temperature compensated
Input: BNC, 1 megohm / 20 pf direct, 50 ohm with CT-600
Overload: 50VAC maximum, all modes
Sensitivity: less than 25 mv to 65 MHz, 50-150 mv to 600 MHz
Power: 110 VAC 5 Watts or 12 VDC @ 400 ma
Size: 6" x 4" x 2", high quality aluminum case, 2 lbs
ICS: 13 units, all socketed

The CT-50 is a versatile and precision frequency counter which will measure frequencies to 60 MHz and up to 600 MHz with the CT-600 option. Large Scale Integration, CMOS circuitry and solid state display technology have enabled this counter to match performance found in units selling for over three times as much. Low power consumption (typically 300-400 ma) makes the CT-50 ideal for portable battery operation. Features of the CT-50 include: large 8 digit LED display, RF shielded all metal case, easy pushbutton operation, automatic decimal point, fully socketed IC chips and input protection to 50 volts to insure against accidental burnout or overload. And, the best feature of all is the easy assembly. Clear, step by step instructions guide you to a finished unit you can rely on.

Order your today!

CT-50, 60 MHz counter kit	\$89.95
CT-50WT, 60 MHz counter, wired and tested	159.95
CT-600, 600 MHz scaler option, add	29.95

CB-1, Color TV calibrator-stabilizer	\$14.95
DP-1, DC probe, general purpose probe	12.95
HP-1, High impedance probe, non-loadin	15.95

CAR CLOCK

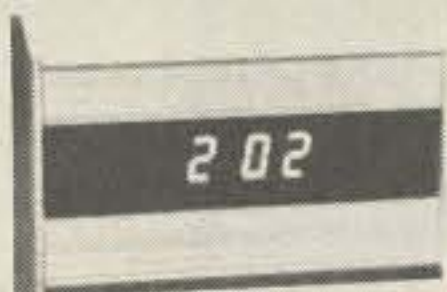

The UN-KIT, only 5 solder connections

Here's a super looking, rugged and accurate auto clock which is a snap to build and install. Clock movement is completely assembled—you only solder 3 wires and 2 switches, takes about 15 minutes! Display is bright green with automatic brightness control photocell—assures you of a highly readable display, day or night. Comes in a satin finish anodized aluminum case which can be attached 5 different ways using 2 sided tape. Choice of silver, black or gold case (specify)

DC-3 kit, 12 hour format	\$22.95
DC-3 wired and tested	\$29.95
110V AC adapter	\$5.95

OP-AMP SPECIAL

741 mini dip	12/\$2.00
B1-FET mini dip, 741 type	10/\$2.00

VIDEO TERMINAL

A completely self-contained, stand alone video terminal card. Requires only an ASCII keyboard and TV set to become a complete terminal unit. Two units available, common features are: single 5V supply, XTAL controlled sync and baud rates (to 9600), complete computer and keyboard control of cursor, Parity error control and display. Accepts and generates serial ASCII plus parallel keyboard input. The 3216 is 32 char. by 16 lines, 2 pages with memory dump feature. The 6416 is 64 char. by 16 lines, with scrolling, upper and lower case (optional) and has RS-232 and 20ma loop interfaces on board. Kits include sockets and complete documentation.

RE 3216, terminal card	\$149.95
RE 6416, terminal card	189.95
Lower Case option, 6416 only	13.95
Power Supply Kit	14.95
Video/RF Modulator, VD-1	6.95
Assembled, tested units, add	60.00

FM MINI MIKE KIT



A super high performance FM wireless mike kit! Transmits a stable signal up to 300 yards with exceptional audio quality by means of its built in electret mike. Kit includes case, mike, on-off switch, antenna, battery and super instructions. This is the finest unit available.

FM-3 kit	\$12.95
FM-3 wired and tested	16.95

Under dash car clock



12/24 hour clock in a beautiful plastic case features: 6 jumbo RED LEDs, high accuracy (1 min / mo.), easy 3 wire hookup, display blanks with ignition, and super instructions. Optional dimmer automatically adjusts display to ambient light level.

DC-11 clock with mtg bracket	\$27.95
DM-1 dimmer adapter	2.50

CALENDAR ALARM CLOCK

The clock that's got it all! 6-5" LEDs, 12/24 hour, snooze, 24 hour alarm, 4 year calendar, battery backup, and lots more. The super 7001 chip is used. Size: 5x4x2 inches.

Complete kit, less case (not available)	
DC-9	\$34.95

PRESCALER



Extend the range of your counter to 600 MHz. Works with any counter. Includes 2 transistor pre-amp to give super sens, typically 20 mv at 150 MHz. Specify +10 or +100 ratio.

PS-1B, 600 MHz prescaler	\$59.95
PS-1BK, 600 MHz prescaler kit	49.95

30 Watt 2 mtr PWR AMP

Simple Class C power amp features 8 times power gain, 1 W in for 8 out, 2 in for 15 out, 4 W in for 30 out. Max. output of 35 W, incredible value, complete with all parts, less case and T-R relay.

PA-1, 30 W pwr amp kit	\$22.95
TR-1, RF sensed T-R relay kit	6.95

CLOCK KITS



our Best Seller your Best Deal

Try your hand at building the finest looking clock on the market. Its satin finish anodized aluminum case looks great anywhere, while six 4" LED digits provide a highly readable display. This is a complete kit, no extras needed, and it only takes 1-2 hours to assemble. Your choice of case colors: silver, gold, bronze, black, blue (specify).

Clock kit, 12/24 hour, DC-5	\$22.95
Clock with 10 min. ID timer, 12/24 hour, DC-10	27.95
Alarm clock, 12 hour only, DC-8	24.95
12V DC car clock, DC-7	27.95

For wired and tested clocks add \$10.00 to kit price.

Hard to find PARTS

LINEAR ICs	REGULATORS
301	78MG
324	723
380	309K
380-8	7805
555	78L05
556	7905
566	7812
567	7912
1458	7815
3900	50
CMOS ICs	TTL ICs
4011	74S00
4013	7447
4046	7475
4049	7490
4518	74196T
5369	1.35
TRANSISTORS	SPECIAL ICs
2N3904 type	11C90
2N3906 type	10116
NPN 30W Pwr	4511
PNP 30W Pwr	5314
2N3055	5375AB
UJT 2N2646 type	7001
FET MPF102 type	4059 + N
UHF 2N5179 type	7208
MRF-238 RF	17.95
SOCKETS	LEDs
8 pin	Jumbo red
14 pin	Jumbo green
16 pin	Jumbo yellow
24 pin	Mini red
28 pin	Micro red
40 pin	BiPolar
FERRITE BEADS	
With info, specs	15/1.00
6 hole balun	5/1.00

Ramsey's famous MINI-KITS

FM WIRELESS MIKE KIT

Transmits up to 300' to any FM broadcast radio, uses any type of mike. Runs on 3 to 9V. Type FM-2 has added sensitive mike preamp stage



FM-1 kit	\$2.95
FM-2 kit	\$4.95

VIDEO MODULATOR KIT

Converts any TV to video monitor. Super stable, tunable over ch. 4-6. Runs on 5-15V, accepts std. video signal. Best unit on the market!

Complete kit, VD-1	\$6.95
--------------------	---------------

SUPER SLEUTH

A super sensitive amplifier which will pick up a pin drop at 15 feet! Great for monitoring baby's room or as general purpose amplifier. Full 2 W rms output, runs on 6 to 15 volts, uses 8-45 ohm speaker.



Complete kit, BN-9	\$5.95
--------------------	---------------

COLOR ORGAN/MUSIC LIGHTS

See music come alive! 3 different lights flicker with music. One light for lows, one for the mid-range and one for the highs. Each channel individually adjustable, and drives up to 300W. Great for parties, band music, nite clubs and more.

Complete kit, ML-1	\$7.95
--------------------	---------------

TOPE DECODER

A complete tone decoder on a single PC board. Features: 400-5000 Hz adjustable range via 20 turn pot, voltage regulation, 567 IC. Useful for touch-tone decoding, tone burst detection, FSK, etc. Can also be used as a stable tone encoder. Runs on 5 to 12 volts.



Complete kit, TD-1	\$5.95
--------------------	---------------

POWER SUPPLY KIT

Complete triple regulated power supply provides variable -5 to 18 volts at 200 ma and +5V at 1 Amp. Excellent load regulation, good filtering and small size. Less transformers, requires 6.3V @ 1 A and 24 VCT.



Complete kit, PS-3LT	\$6.95
----------------------	---------------

LED BLINKY KIT

A great attention getter which alternately flashes 2 jumbo LEDs. Use for name badges, buttons, warning panel lights, anything! Runs on 3 to 15 volts.

Complete kit, BL-1	\$2.95
--------------------	---------------

WHISPER LIGHT KIT

An interesting kit, small mike picks up sounds and converts them to light. The louder the sound the brighter the light. Completely self-contained, includes mike, runs on 110VAC, controls up to 300 watts.

Complete kit, WL-1	\$6.95
--------------------	---------------

SIREN KIT

Produces upward and downward wail characteristic of a police siren. 5W peak audio output, runs on 3-15 volts, uses 3-45 ohm speaker.

Complete kit, SM-3	\$2.95
--------------------	---------------

ramsey electronics

BOX 4072, ROCHESTER, N.Y. 14610

PHONE ORDERS CALL (716) 271-6487



TERMS: Satisfaction guaranteed or money refunded. COD, add \$1.50. Minimum order, \$6.00. Orders under \$10.00, add \$.75. Add 5% for postage, insurance, handling. Overseas, add 15%. NY residents, add 7% tax.

SSB TRANSMITTING CONVERTERS

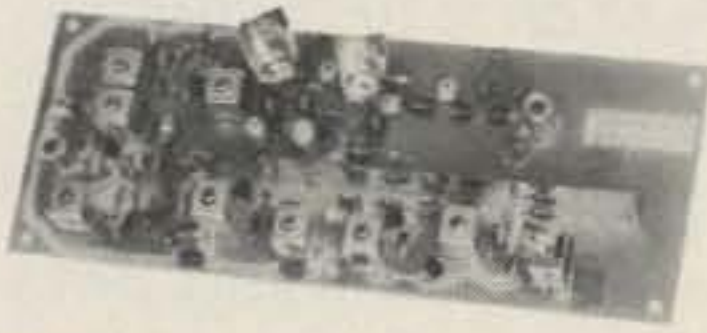

FEATURES:

- Linear Converter for SSB, CW, FM, etc.
- A fraction of the price of other units
- 2W p.e.p. output with 1 MW of drive
- Use low power tap on exciter or attenuator pad
- Easy to align with built-in test points

Frequency Schemes Available:

MODEL	INPUT (MHz)	OUTPUT (MHz)
XV2-1	28-30	50-52
XV2-2	28-30	220-222
XV2-3	28-30	222-224
XV2-4	28-30	144-146
XV2-5	28-29	145-146
XV2-6	26-28	144-146

ONLY \$59.95!

VHF RECEIVING CONVERTERS

LET YOU RECEIVE OSCAR AND OTHER EXCITING SIGNALS ON YOUR PRESENT HF RECEIVER!



MODEL	RF RANGE	I-F RANGE
C28	28-32MHz	144-148MHz
C50	50-52	28-30
C144	144-146	28-30
C145	145-147	28-30
C146	146-148	28-30
C110	Aircraft	26-30
C220	220-222	28-30
C222	222-224	28-30
Special	Inquire About Other Ranges	

ONLY \$34.95

FAMOUS HAMTRONICS PREAMPS

let you hear the weak ones!

Great for OSCAR, SSB, FM, ATV. Over 10,000 in use throughout the world on all types of receivers.

P9 Kit \$12.95
P14 Wired \$24.95



Specify Band When Ordering

- Deluxe vhf model for applications where space permits • 1-1/2 x 3" • Models avail to cover any 4 MHz band in the 26-230 MHz range • 12 Vdc
- 2 stages • Ideal for OSCAR • 20 db gain
- Diode transient protection • Easily tunable



P8 Kit \$10.95

P16 Wired \$21.95

Specify Band

- Miniature vhf model for tight spaces - size only 1/2x2-3/8" • Models avail to cover any 4 MHz band in the range 20-230 MHz • 20 db gain • 12V

P15 Kit \$18.95

P35 Wired \$34.95



- Covers any 6 MHz band in UHF range of 380-520 MHz
- 20 db gain • 2 stages • Low noise

VHF Linear PA's

- Use as Linear or Class C PA's • For XV-2 Xmtg Converters, T50 Exciters, or any 2W Exciter

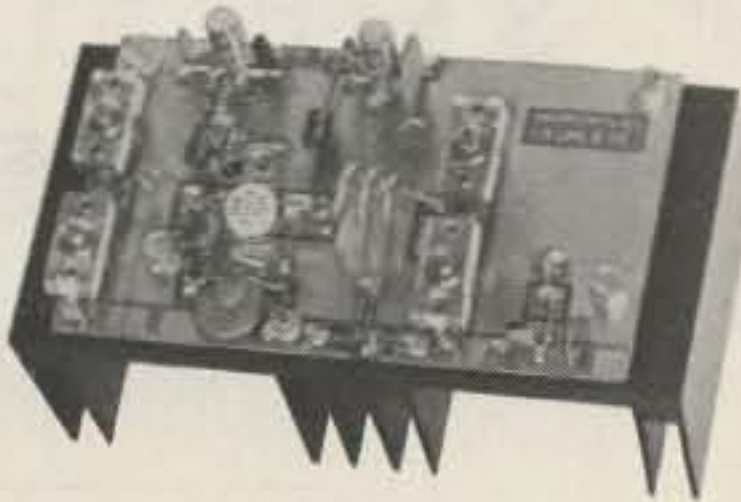

LPA 2-15 Kit \$59.95

- 15W out (linear) or 20W (class C) • Solid State T/R Switching • Models for 6M, 2M, or 220 MHz

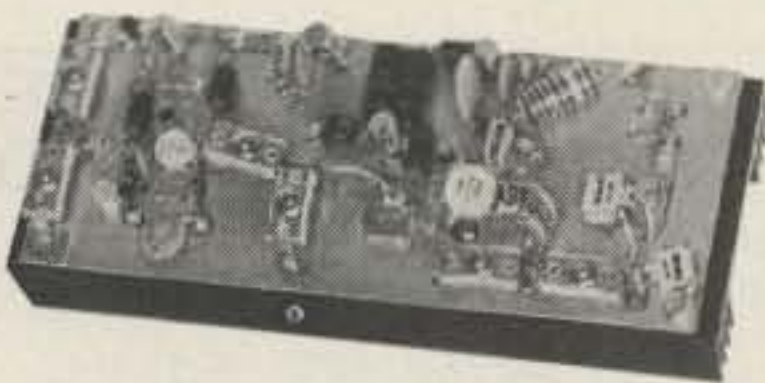

LPA 2-45 Kit \$109.95

- 45W out (linear) or 50W (class C)
- Models for 6M or 2M

LPA 8-45 Kit \$89.95
For 2M, 8-10W in, 45W out

UHF RECEIVING CONVERTERS



MODEL	RF RANGE	I-F RANGE
C432-2	432-434	28-30MHz
C432-4	432-436	144-146
C432-5	435-437	28-30
C432-7	427.25	61.25
C432-9	439.25	61.25
Special	Inquire About Other Ranges	

ONLY \$34.95

A9 Extruded Alum Case with BNC's for above Converters (Optional) ... \$12.95

VHF & UHF FM RECEIVERS

- ★ NEW GENERATION RECEIVERS
- ★ MORE SENSITIVE ★ MORE SELECTIVE (70 or 100 dB)
- ★ COMMERCIAL GRADE DESIGN
- ★ EASY TO ALIGN WITH BUILT-IN TEST CKTS
- ★ LOWER OVERALL COST THAN EVER BEFORE



R70 6-channel VHF Receiver Kit for 2M, 6M, 10M, 220 MHz, or com'l bands..... \$69.95
Optional xtal filter for 100 dB adj chan 10.00



R90 UHF Receiver Kit for any 2 MHz segment of 380-520 MHz band..... \$89.95

NEW FM/CW EXCITER KITS

BUILD UP YOUR OWN GEAR FOR MODULAR STATIONS, REPEATERS, & CONTROL LINKS
• Rated for Continuous Duty • Professional Sounding Audio • Built-in Testing Aids



T50 Six Channel, 2W Exciter for 2M, 6M, or 220 MHz (Specify band)..... \$49.95

T50U Six Channel, 1W Exciter for 430-450 MHz uhf operation \$49.95

▶ Ask For Free Catalog ◀

IT'S EASY TO ORDER!

CALL OR WRITE NOW FOR FREE CATALOG OR TO PLACE ORDER!

PHONE 716-392-9430. (Electronic answering service evs & weekends)

Use credit card, c.o.d., check, m.o.

Add \$2.00 shipping & handling.

IN CANADA, order from Communications Plus, 3680 Cote Vertu; St-Laurent, Quebec or phone 514-337-7255. Add 38% to cover duty, tax, and exchange.

Note New Address and Phone No.

hamtronics, inc.

65A MOUL RD · HILTON, NY 14468

--Dealer Inquiries Invited--

T80 UHF POWER AMP

- Broadband PA • No Tuning Required • Class C PA
- 430-470 MHz
- 13-15W Out
- 200 mW Drive



Model T80-450
\$79.95
Wired & Tested

NATIONAL SEMICONDUCTOR JUMBO CLOCK MODULE

**MA1008D
BRAND NEW!**

ASSEMBLED,
NOT A KIT!

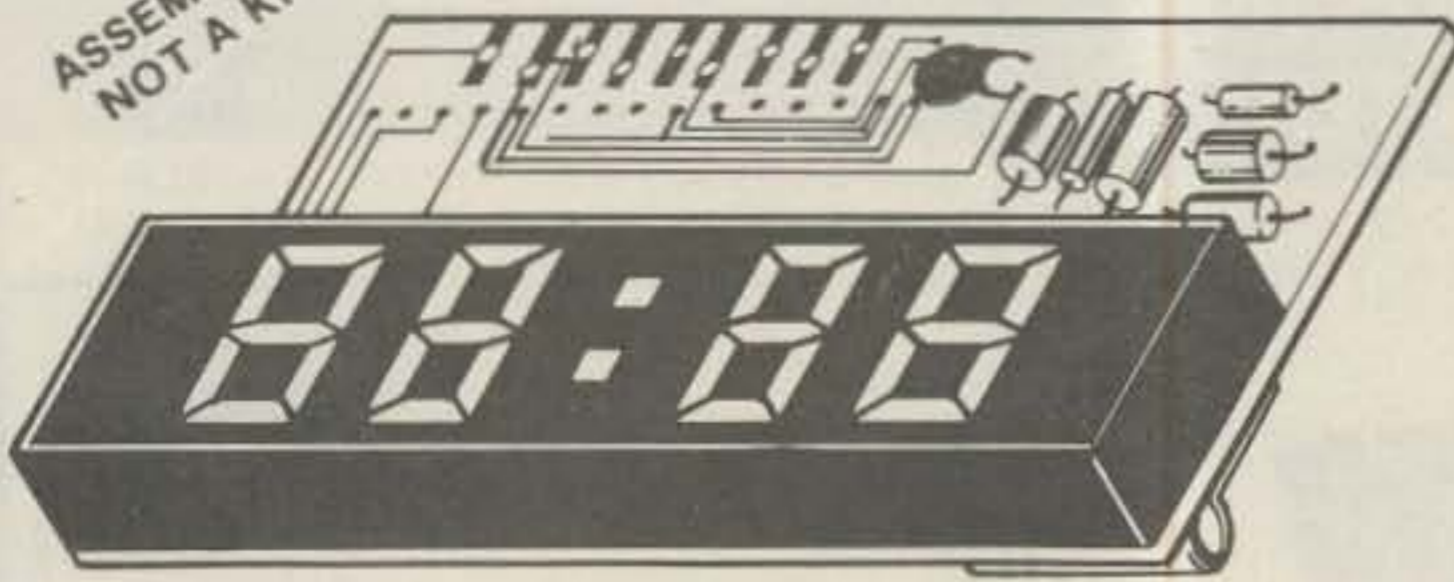

\$7⁹⁵

REG. \$9.95

FEATURES:

- ★ FOUR JUMBO 1/2 INCH LED DISPLAYS
- ★ 24 HR REAL TIME FORMAT
- ★ 24 HR ALARM SIGNAL OUTPUT
- ★ 50 OR 60 Hz OPERATION
- ★ LED BRIGHTNESS CONTROL
- ★ POWER FAILURE INDICATOR
- ★ SLEEP & SNOOZE TIMERS
- ★ DIRECT LED DRIVE (LOW RFI)
- ★ COMES WITH FULL DATA

**ZULU
SALE!**

PERFECT FOR USE
WITH A TIMEBASE.

**COMPARE AT UP TO TWICE
OUR PRICE!**

MANUFACTURER'S CLOSEOUT!

I.F. TRANSFORMERS — VARIABLE INDUCTORS



YOUR CHOICE

6 FOR \$1

MICROMINI-SIZE

We bought a load from a very large manufacturer of COM. gear!
Please order by part #

- #5009-011: 7 TO 1.3 UH VARIABLE INDUCTOR (C.T.)
- #5006-008: 455 KHZ IF TRANSFORMER
- #5015-009: 27 MHZ RF TRANSFORMER (C.T. PRI.)
- #5015-007: 4.3 MHZ IF TRANSFORMER

NOTE: The 5009-011 Variable Inductor can also be used as a 10.7 MHZ I.F. by using a 240 PF CAPACITOR

**GENERAL INST. DUAL MOS-FET
GATE**



MPF-131. HIGH FREQUENCY.
DIODE PROTECTED GATES!
DEPLETION MODE. VDS-35V
N-CHANNEL. YFS-10,000
uMHOS LOW NOISE.

10 FOR \$3.95 **2 FOR \$1**

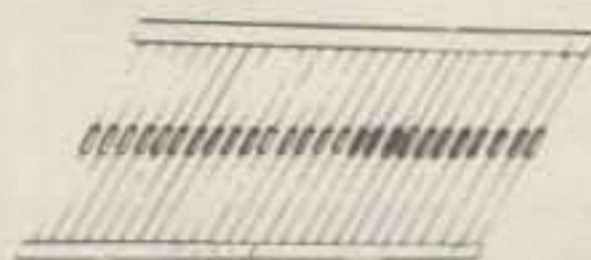

1N4148 DIODE SALE!

FULL LEADS! BRAND NEW!
COMPUTER MFG. SURPLUS

100 FOR \$2 1000 FOR \$17.50

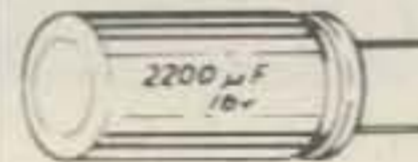

FILTER CAP

2200 MFD 16WVDC
BY PANASONIC. SMALL SIZE.

FRESH! **3 FOR \$1.25**

**VARIABLE
INDUCTOR #2**

By Seimens. Pot Core Style.
50 To 75 MH. High Q.

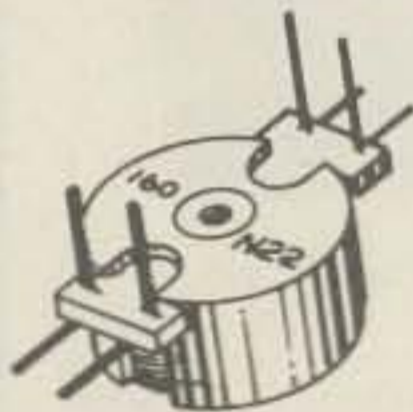

75¢

GE NICAD!

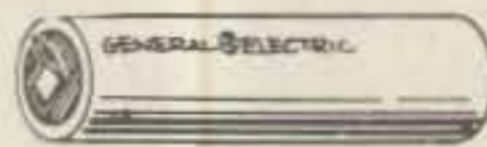

GE Ni-Cad Battery Pack
3 Cell pack, gives 4 volts
at 900MAH. Brand new,
factory fresh. Each cell is
2/3 "C" size. **\$2.95.**

Buy 3 packs (12 volts)
for \$6.95. Limited stock!

COMPLEMENTARY POWER TRANSISTORS

SILICON NPN AND PNP. TO-220 CASE.

VCEO - 40V PD - 30 WATTS

FOR AUDIO POWER AMPS, ETC.

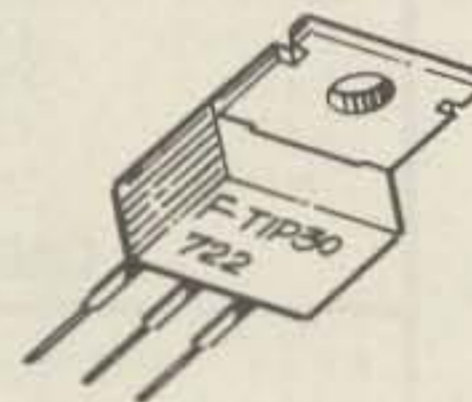

TIP29 - NPN
TIP30 - PNP

YOUR
CHOICE
3 FOR \$1

EXPERIMENTER CRYSTALS

- #1 — 262.144 KHZ — 1.25
- #2 — 4.444 MHZ — 1.25
- #3 — 64.000 KHZ — 1.49
- #4 — 300.000 KHZ — 1.25
- #5 — 4.00 MHZ — 1.75
- #6 — 49.710 KHZ — 1.49

ELECTROLYTIC CAP SPECIAL

Factory Fresh! Small Size.
100 MFD 16 WVDC



6 FOR \$1
30 FOR \$3⁹⁵

**FAIRCHILD PNP
"SUPER TRANSISTOR"**

2N4402. TO-92 Plastic. Silicon PNP
Driver. High Current. VCEO-40 HFE-50
to 150 at 150 MA. FT-150 MHZ. A super
"BEEFED-UP" Version of the 2N3906.

8 FOR \$1

FAIRCHILD RED LED LAMPS

#FLV5057. Medium Size. Clear Case. RED EMITTING. These are not
retested off-spec units as sold by some of our competition. These are
factory prime, first quality, new units.



"WE BOUGHT 250,000 PCS."

10 FOR \$1¹⁹
50 FOR \$4⁹⁵

VOLTAGE SUPPRESSORS

By Midwest. #67D5010. Silicon Carbide Varistors. These units grab
voltage transients, spikes, surges, etc. For use on AC or DC in the
range of 12 to 28 Volts. Small Size: .5 Inch Disc with radial leads. For
use across transformer secondaries, relays, etc. More rugged and
reliable than silicon devices. Rated at 30 WATT-SEC. .25 WATT
CONT. Perfect for use on AC operated clocks and instruments.

SPECIAL PURCHASE: 3 FOR \$1

Digital Research Corporation
(OF TEXAS)

P.O. BOX 401247 GARLAND, TEXAS 75040 (214) 271-2461

TERMS: Add 30¢ postage, we pay balance. Orders under \$15 add 75¢
handling. No C.O.D. We accept Visa, MasterCard, and American Express
cards. Tex. Res. add 5% Tax. Foreign orders (except Canada) add 20% P & H.
90 Day Money Back Guarantee on all items.

16K EPROM CARD-S 100 BUSS

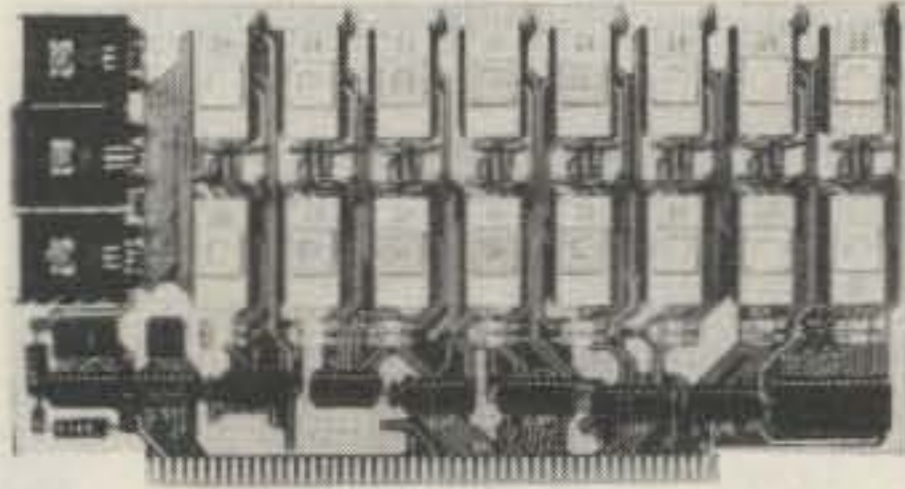

\$59.95
KIT

OUR
BEST
SELLING
KIT!

USES 2708's!

Thousands of personal and business systems around the world use this board with complete satisfaction. Puts 16K of software on line at **ALL TIMES!** Kit features a top quality soldermasked and silk-screened PC board and first run parts and sockets. All parts (except 2708's) are included. Any number of EPROM locations may be disabled to avoid any memory conflicts. Fully buffered and has WAIT STATE capabilities.

OUR 450NS 2708'S
ARE \$8.95 EA. WITH
PURCHASE OF KIT

ASSEMBLED
AND FULLY TESTED
ADD \$25

8K LOW POWER RAM KIT-S 100 BUSS

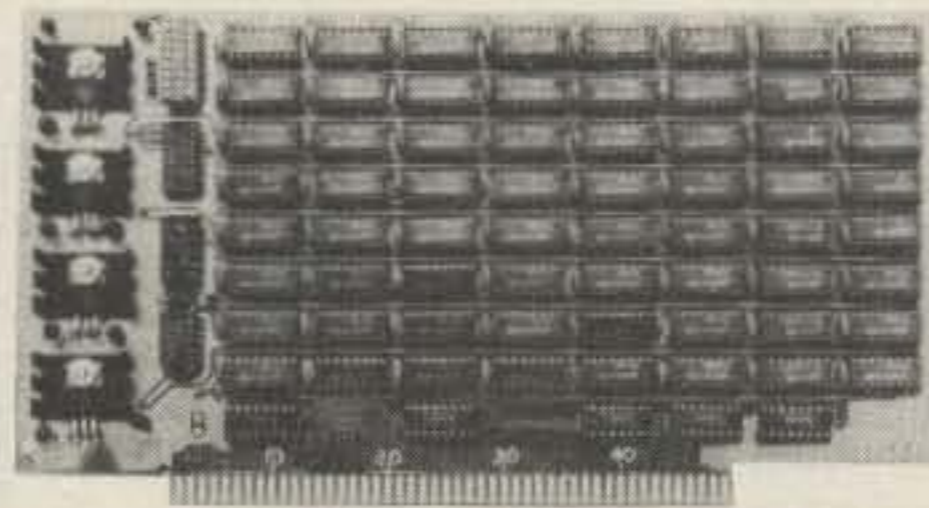

\$129 KIT

Use 21L02
450 NS RAMS!

Thousands of computer systems rely on this rugged, work horse, RAM board. Designed for error-free, NO HASSLE, systems use.

KIT FEATURES:

1. Doubled sided PC Board with solder mask and silk screen layout. Gold plated contact fingers.
2. All sockets included.
3. Fully buffered on all address and data lines.
4. Phantom is jumper selectable to pin 67.
5. FOUR 7805 regulators are provided on card.

Blank PC Board w/Documentation
\$29.95
Low Profile Socket Set...**13.50**
Support IC's (TTL & Regulators)
\$9.75
Bypass CAP's (Disc & Tantalums)
\$4.50

ASSEMBLED AND FULLY
BURNED IN ADD \$30

16K STATIC RAM KIT-S 100 BUSS

\$295 KIT

FULLY
STATIC, AT
DYNAMIC PRICES

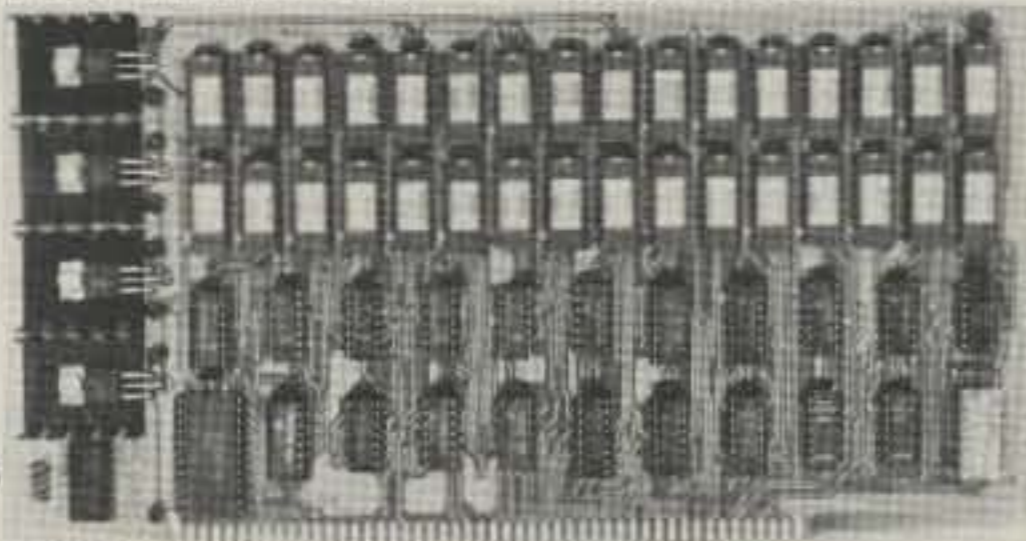

WHY THE 2114 RAM CHIP?

We feel the 2114 will be the next industry standard RAM chip (like the 2102 was). This means price, availability, and quality will all be good! Next, the 2114 is FULLY STATIC! We feel this is the ONLY way to go on the S-100 Bus! We've all heard the HORROR stories about some Dynamic Ram Boards having trouble with DMA and FLOPPY DISC DRIVES. Who needs these kinds of problems? And finally, even among other 4K Static RAM's the 2114 stands out! Not all 4K static Rams are created equal! Some of the other 4K's have clocked chip enable lines and various timing windows just as critical as Dynamic RAM's. Some of our competitor's 16K boards use these "tricky" devices. But not us! The 2114 is the ONLY logical choice for a trouble-free, straightforward design.

KIT FEATURES:

1. Addressable as four separate 4K Blocks
2. ON BOARD BANK SELECT circuitry (Cromemco Standard). Allows up to 512K on line!
3. Uses 2114 (450NS) 4K Static Rams.
4. ON BOARD SELECTABLE WAIT STATES.
5. Double sided PC Board, with solder mask and silk screened layout. Gold plated contact fingers.
6. All address and data lines fully buffered.
7. Kit includes ALL parts and sockets.
8. PHANTOM is jumpered to PIN 67.
9. LOW POWER: under 2 amps TYPICAL from the +8 Volt Bus.
10. Blank PC Board can be populated as any multiple of 4K.

BLANK PC BOARD W/DATA—\$33

LOW PROFILE SOCKET SET—\$12
SUPPORT IC'S & CAPS—\$19.95

ASSEMBLED & TESTED—ADD \$30
2114 RAM'S—8 FOR \$69.95

16K STATIC RAM KIT SWTPC (SS-50) 6800 BUSS

USES 2114
4K RAMS!

\$295
COMPLETE KIT

WHY PAY MORE
FOR FINNICKY
DYNAMIC BOARDS?

At last an affordable static RAM board for this popular buss. Quality PC Board with solder mask and silk-screen. Fully buffered with plenty of bypassing for reliable operation. FOUR ON-BOARD REGULATORS.

16K DYNAMIC RAM CHIP

16K X 1 Bits. 16 Pin Package. Same as Mostek 4116-4 250 NS access. 410 NS cycle time. Our best price yet for this state of the art RAM. 32K and 64K RAM boards using this chip are readily available. These are new, fully guaranteed devices by a major mfg.

8 FOR \$89.95

VERY LIMITED STOCK!

NOT ASSOCIATED
WITH
DIGITAL RESEARCH
OF CALIFORNIA,
THE SUPPLIERS OF
CPM SOFTWARE.

450 NS! **2708 EPROMS**
Now full speed! Prime new units from a major U.S. Mfg. 450 N.S. Access time. 1K x 8. Equiv. to 4-1702 A's in one package.

~~\$15.75 ea.~~

\$9.95

~~4 FOR \$50.00~~

PRICE CUT

NATIONAL SEMICONDUCTOR JUMBO CLOCK MODULE



\$6.95

2 FOR \$13

(AC XFMR \$1.95)

- MA1008A
BRAND NEW!
- FEATURES:
- FOUR JUMBO 1/2 INCH LED DISPLAYS
 - 12 HR REAL TIME FORMAT
 - 24 HR ALARM SIGNAL OUTPUT
 - 50 OR 60 Hz OPERATION
 - LED BRIGHTNESS CONTROL
 - POWER FAILURE INDICATOR
 - SLEEP & SNOOZE TIMERS
 - DIRECT LED DRIVE (LOW RFI)
 - COMES WITH FULL DATA

COMPARE AT UP TO TWICE
OUR PRICE!

MANUFACTURER'S CLOSEOUT!

ASSEMBLED! NOT A KIT!

ZULU VERSION!
We have a limited number of the 24 HR Real
Time version of this module in stock
#MA1008D — \$9.95

PERFECT FOR USE
WITH A TIMEBASE.

WESTERN DIGITAL UART

TR1602A. PIN FOR PIN SUB FOR
AY5-1013 AND TMS6011.

FOR SERIAL I/O



\$2.99 EACH

SURPLUS SPECIAL

SALE!
1N4148 DIODES. SILICON.
Same as 1N914. New,
factory prime, Full Leads.
100 FOR \$2
1000 FOR \$17.50

New! REAL TIME
Computer Clock Chip
N.S. MM5313. Features
BOTH 7 segment and
BCD outputs. 28 Pin
DIP. **\$4.95 with Data**

Z-80 PROGRAMMING MANUAL

By MOSTEK, or ZILOG. The most detailed explanation ever on the working of the Z-80 CPU CHIPS. At least one full page on each of the 158 Z-80 instructions. A MUST reference manual for any user of the Z-80. 300 pages. Just off the press.

\$12.95

8212 I/O CHIP

8 BITS. 8080 or Z-80
SUPPORT CHIP. 24 PIN
CHIP. NEW BY N.E.C.

SPECIAL: \$2.25 EACH

MOTOROLA 7805R VOLTAGE

REGULATOR. Same as standard 7805
except 750 MA output. TO-220. 5VDC
output.

44¢ each or 10 for \$3.95

Digital Research Corporation

(OF TEXAS)

P.O. BOX 401247 • GARLAND, TEXAS 75040 • (214) 271-2461

✓ D20

TERMS: Add 30¢ postage. we pay balance. Orders under \$15 add 75¢ handling. No C.O.D. We accept Visa, MasterCard and American Express cards. Tex. Res. add 5% Tax. Foreign orders (except Canada add 20% P & H 90 Day Money Back Guarantee on all items.

ECONORAMS from CompuKit™

TRS-80 CONVERSION KIT: \$109, 3/\$320

Please note our kit is guaranteed for 1 year, includes DIP shunts, and uses 250 ns chips for 4 MHz operation should you upgrade your machine to the new, higher speeds. Promotes a 4K TRS-80 to 16K, or populates the Memory Expansion Module — our novice level instructions show you how. Also suitable for APPLE memory expansion.

HEATH H8 COMPATIBLE 12K X 8 STATIC MEMORY BOARD: "Packer Bill" Special \$200



Econoram VI™ is fully static, and comes with sockets and bypass capacitors pre-soldered in place for easy assembly. Now you can add Econoram performance to the H8 buss. Assembled/tested: \$270

RF POWER TRANSISTORS

- 2NRF-1 2 GHz. Pd max 3.5W, Pout min @ 2 GHz 1.0W, Pin 310 mW, efficiency @ 2 GHz 30%, round shape, similar to RCA 2N5470. \$4.95
- 2NRF-2 2 GHz. Pd max 8.7W, Pout 2.5W, Pin 300 mW, efficiency 33%, cross shape. Similar to RCA TA8407. \$5.95
- 2NRF-3 2 GHz. Pd 21W, Pout 5.5W, Pin 1.25W, efficiency 33%, cross shape. Similar to RCA 2N6269. \$6.95
- 2NRF-4 2 GHz. Pd 29W, Pout 7.5W, Pin 1.5W, efficiency 33%, cross shape. Factory selected prime 2N6269. \$7.95

Also available: FET-6, house numbered General Instrument type 631 dual gate MOSFET. Ideal for RF amp and mixer applications, with very low noise figure. 200 MHz. 3/\$2.00

THE ECONORAM FAMILY

The ECONORAM™ family of static memory offers high performance at low cost. All boards are static, low power/high speed, fully buffered, and backed with a 1 year limited warranty. Available in 3 forms: **unit** (sockets, bypass caps pre-soldered in place); **assembled/tested**; or qualified under our **Certified System Component** high-reliability program (200 hour burn-in, 4 MHz operation over full temp range, exchange if failure occurs within 1 year of invoice date). Send for our flyer for additional information on these fine memories, or better yet, visit your local computer store.

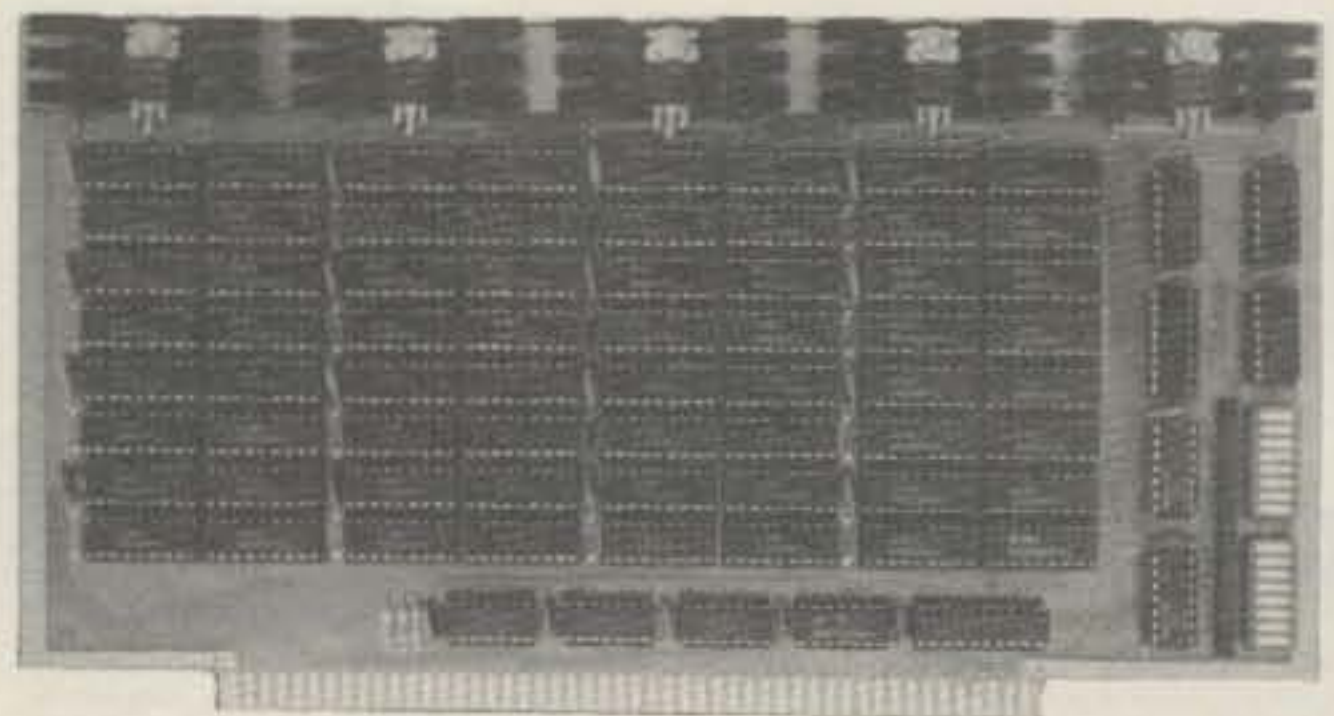

Name	Buss	Unkit	Assm	CSC
8K Econoram II™	S100	\$139	\$159	N/A
16K Econoram IV™	S100	\$279	\$314	\$ 414
24K Econoram VII™	S100	\$445	\$485	\$ 605
32K Econoram X™	S100	\$599	\$649	\$ 789
32K Econoram XI™	SBC	N/A	N/A	\$1050
32K Econoram IX™	Dig. Group	\$650	N/A	N/A

All of the above use reliable, hassle-free static technology.

SPECIAL: LM317 adjustable positive regulator.
\$2.25. Limited quantities.

GODBOUT

BILL GODBOUT ELECTRONICS
BOX 2355, OAKLAND AIRPORT, CA 94614

TERMS: Add \$1 to orders under \$15; allow 5% shipping, excess refunded. Cal res add tax. VISA®/Mastercharge® (\$15 min) call (415) 562-0636, 24 hrs. COD OK with street address for UPS.

FREE FLYER: Our flyer is printed in glorious black and white on 40 pages of the cheapest paper we could find. The plot is far from absorbing, but what a cast of characters! ICs, kits, passive components, books, Vector products, and some specials that are so special we don't dare put them in an ad. Yours free for the asking, or, end us 41¢ in stamps for 1st class delivery.

7400 TTL table listing various integrated circuit part numbers and their prices. Includes sub-sections for 7400, 7401, 7402, 7403, 7404, 7405, 7406, 7407, 7408, 7409, 7410, 7411, 7412, 7413, 7414, 7415, 7416, 7417, 7418, 7419, 7420, 7421, 7422, 7423, 7424, 7425, 7426, 7427, 7428, 7429, 7430, 7431, 7432, 7433, 7434, 7435, 7436, 7437, 7438, 7439, 7440, 7441, 7442, 7443, 7444, 7445, 7446, 7447, 7448, 7449, 7450, 7451, 7452, 7453, 7454, 7455, 7456, 7457, 7458, 7459, 7460.

20% Discount 100 pcs combined order 25% -1000 pcs combined order

C/MOS table listing various CMOS integrated circuit part numbers and their prices. Includes sub-sections for CD4000, CD4001, CD4002, CD4003, CD4004, CD4005, CD4006, CD4007, CD4008, CD4009, CD4010, CD4011, CD4012, CD4013, CD4014, CD4015, CD4016, CD4017, CD4018, CD4019, CD4020, CD4021, CD4022, CD4023, CD4024, CD4025, CD4026, CD4027.

74C00 table listing various 74C00 series integrated circuit part numbers and their prices. Includes sub-sections for 74C00, 74C01, 74C02, 74C03, 74C04, 74C05, 74C06, 74C07, 74C08, 74C09, 74C10, 74C11, 74C12, 74C13, 74C14, 74C15, 74C16, 74C17, 74C18, 74C19, 74C20.

LINEAR table listing various linear integrated circuit part numbers and their prices. Includes sub-sections for LM106H, LM109, LM109B, LM109C, LM109D, LM109E, LM109F, LM109G, LM109H, LM109I, LM109J, LM109K, LM109L, LM109M, LM109N, LM109P, LM109Q, LM109R, LM109S, LM109T, LM109U, LM109V, LM109W, LM109X, LM109Y, LM109Z.

74LS00TTL table listing various 74LS00TTL series integrated circuit part numbers and their prices. Includes sub-sections for 74LS00, 74LS01, 74LS02, 74LS03, 74LS04, 74LS05, 74LS06, 74LS07, 74LS08, 74LS09, 74LS10, 74LS11, 74LS12, 74LS13, 74LS14, 74LS15, 74LS16, 74LS17, 74LS18, 74LS19, 74LS20, 74LS21, 74LS22, 74LS23, 74LS24, 74LS25, 74LS26, 74LS27, 74LS28, 74LS29, 74LS30, 74LS31, 74LS32, 74LS33, 74LS34, 74LS35.

Vigilite Electronic Home Security Timer advertisement featuring a diagram of the device and a photo of the installed unit. Part Number VGL-1, Price \$39.95 ea.

DISCRETE LEDs advertisement listing various LED part numbers and prices. Includes sub-sections for 200, 250, 280, 300, 350, 380, 400, 450, 500, 550, 600, 650, 700, 750, 800, 850, 900, 950, 1000.

DISPLAY LEDs advertisement listing various display LED part numbers and prices. Includes sub-sections for MAN 1, MAN 2, MAN 3, MAN 4, MAN 5, MAN 6, MAN 7, MAN 8, MAN 9, MAN 10, MAN 11, MAN 12, MAN 13, MAN 14, MAN 15, MAN 16, MAN 17, MAN 18, MAN 19, MAN 20, MAN 21, MAN 22, MAN 23, MAN 24, MAN 25, MAN 26, MAN 27, MAN 28, MAN 29, MAN 30.

RCA LINEAR advertisement listing various RCA linear integrated circuit part numbers and prices. Includes sub-sections for CA3013T, CA3020T, CA3035T, CA3039T, CA3046N, CA3059N, CA3060N, CA3080T, CA3081N.

IC SOLDERTAIL - LOW PROFILE (TIN) SOCKETS advertisement listing various IC socket part numbers and prices. Includes sub-sections for 8 pin LP, 14 pin LP, 18 pin LP, 20 pin LP, 14 pin ST, 16 pin ST, 18 pin ST, 24 pin ST, 8 pin SG, 14 pin SG, 18 pin SG, 24 pin SG, 8 pin WW, 14 pin WW, 18 pin WW, 24 pin WW.

1/4 WATT RESISTOR ASSORTMENTS - 5% advertisement listing various resistor part numbers and prices. Includes sub-sections for ASST. 1, ASST. 2, ASST. 3, ASST. 4, ASST. 5, ASST. 6, ASST. 7, ASST. 8R.

Jameco Electronics advertisement featuring the company logo, phone number (415) 592-8097, and address: 1021 HOWARD AVENUE, SAN CARLOS, CA 94070.

TELEPHONE/KEYBOARD CHIPS advertisement listing various chip part numbers and prices. Includes sub-sections for AY-5-9100, AY-5-9200, AY-5-9500, AY-5-2376, HD0165, 74C922, ICM7045, ICM7205, ICM7207, ICM7208, ICM7209.

NMOS READ ONLY MEMORIES advertisement listing various ROM part numbers and prices. Includes sub-sections for MCM6571, MCM6574, MCM6575, TL074CN, TL494CN, TL496CP, 11C90, 95H90, 4N33, MK50240, DS0026CH, TL308, MMS320, MMS330, LD110/111.

LITRONIX ISO-LIT 1 advertisement listing various photo transistor opto-isolator part numbers and prices. Includes sub-sections for SN 76477, SOUND GENERATOR, TV GAME CHIP AND CRYSTAL.

EXAR advertisement listing various EXAR integrated circuit part numbers and prices. Includes sub-sections for XR205, XR210, XR215, XR220, XR225, XR230, XR235, XR240, XR245, XR250, XR255, XR260, XR265, XR270, XR275, XR280, XR285, XR290, XR295.

DIODES advertisement listing various diode part numbers and prices. Includes sub-sections for 1N4001, 1N4002, 1N4003, 1N4004, 1N4005, 1N4006, 1N4007, 1N4008, 1N4009, 1N4010, 1N4011, 1N4012, 1N4013, 1N4014, 1N4015, 1N4016, 1N4017, 1N4018, 1N4019, 1N4020.

SCR AND FW BRIDGE RECTIFIERS advertisement listing various SCR and bridge rectifier part numbers and prices. Includes sub-sections for C360, C38M, 2N2328, MDA 980-1, MDA 980-3.

TRANSISTORS advertisement listing various transistor part numbers and prices. Includes sub-sections for C10681, MPSA05, MPSA06, TIS97, TIS98, 40409, 40410, 40673, 2N918, 2N2219A, 2N2221A, 2N2222A, 2N2222 Plastic, 2N2298, 2N2299, 2N2300, 2N2301, 2N2302, 2N2303, 2N2304, 2N2305, 2N2306, 2N2307, 2N2308, 2N2309, 2N2310, 2N2311, 2N2312, 2N2313, 2N2314, 2N2315, 2N2316, 2N2317, 2N2318, 2N2319, 2N2320, 2N2321, 2N2322, 2N2323, 2N2324, 2N2325, 2N2326, 2N2327, 2N2328, 2N2329, 2N2330, 2N2331, 2N2332, 2N2333, 2N2334, 2N2335, 2N2336, 2N2337, 2N2338, 2N2339, 2N2340.

CAPACITOR CORNER advertisement listing various capacitor part numbers and prices. Includes sub-sections for 50 VOLT CERAMIC DISC CAPACITORS, 100 VOLT MYLAR FILM CAPACITORS, +20% DIPPED TANTALUMS (SOLID) CAPACITORS, MINIATURE ALUMINUM ELECTROLYTIC CAPACITORS.

CAPACITOR CORNER advertisement listing various capacitor part numbers and prices. Includes sub-sections for 47.50V, 50.00V, 55.00V, 60.00V, 65.00V, 70.00V, 75.00V, 80.00V, 85.00V, 90.00V, 95.00V, 100.00V, 105.00V, 110.00V, 115.00V, 120.00V, 125.00V, 130.00V, 135.00V, 140.00V, 145.00V, 150.00V, 155.00V, 160.00V, 165.00V, 170.00V, 175.00V, 180.00V, 185.00V, 190.00V, 195.00V, 200.00V, 205.00V, 210.00V, 215.00V, 220.00V, 225.00V, 230.00V, 235.00V, 240.00V, 245.00V, 250.00V, 255.00V, 260.00V, 265.00V, 270.00V, 275.00V, 280.00V, 285.00V, 290.00V, 295.00V, 300.00V, 305.00V, 310.00V, 315.00V, 320.00V, 325.00V, 330.00V, 335.00V, 340.00V, 345.00V, 350.00V, 355.00V, 360.00V, 365.00V, 370.00V, 375.00V, 380.00V, 385.00V, 390.00V, 395.00V, 400.00V, 405.00V, 410.00V, 415.00V, 420.00V, 425.00V, 430.00V, 435.00V, 440.00V, 445.00V, 450.00V, 455.00V, 460.00V, 465.00V, 470.00V, 475.00V, 480.00V, 485.00V, 490.00V, 495.00V, 500.00V, 505.00V, 510.00V, 515.00V, 520.00V, 525.00V, 530.00V, 535.00V, 540.00V, 545.00V, 550.00V, 555.00V, 560.00V, 565.00V, 570.00V, 575.00V, 580.00V, 585.00V, 590.00V, 595.00V, 600.00V, 605.00V, 610.00V, 615.00V, 620.00V, 625.00V, 630.00V, 635.00V, 640.00V, 645.00V, 650.00V, 655.00V, 660.00V, 665.00V, 670.00V, 675.00V, 680.00V, 685.00V, 690.00V, 695.00V, 700.00V, 705.00V, 710.00V, 715.00V, 720.00V, 725.00V, 730.00V, 735.00V, 740.00V, 745.00V, 750.00V, 755.00V, 760.00V, 765.00V, 770.00V, 775.00V, 780.00V, 785.00V, 790.00V, 795.00V, 800.00V, 805.00V, 810.00V, 815.00V, 820.00V, 825.00V, 830.00V, 835.00V, 840.00V, 845.00V, 850.00V, 855.00V, 860.00V, 865.00V, 870.00V, 875.00V, 880.00V, 885.00V, 890.00V, 895.00V, 900.00V, 905.00V, 910.00V, 915.00V, 920.00V, 925.00V, 930.00V, 935.00V, 940.00V, 945.00V, 950.00V, 955.00V, 960.00V, 965.00V, 970.00V, 975.00V, 980.00V, 985.00V, 990.00V, 995.00V, 1000.00V, 1005.00V, 1010.00V, 1015.00V, 1020.00V, 1025.00V, 1030.00V, 1035.00V, 1040.00V, 1045.00V, 1050.00V, 1055.00V, 1060.00V, 1065.00V, 1070.00V, 1075.00V, 1080.00V, 1085.00V, 1090.00V, 1095.00V, 1100.00V, 1105.00V, 1110.00V, 1115.00V, 1120.00V, 1125.00V, 1130.00V, 1135.00V, 1140.00V, 1145.00V, 1150.00V, 1155.00V, 1160.00V, 1165.00V, 1170.00V, 1175.00V, 1180.00V, 1185.00V, 1190.00V, 1195.00V, 1200.00V, 1205.00V, 1210.00V, 1215.00V, 1220.00V, 1225.00V, 1230.00V, 1235.00V, 1240.00V, 1245.00V, 1250.00V, 1255.00V, 1260.00V, 1265.00V, 1270.00V, 1275.00V, 1280.00V, 1285.00V, 1290.00V, 1295.00V, 1300.00V, 1305.00V, 1310.00V, 1315.00V, 1320.00V, 1325.00V, 1330.00V, 1335.00V, 1340.00V, 1345.00V, 1350.00V, 1355.00V, 1360.00V, 1365.00V, 1370.00V, 1375.00V, 1380.00V, 1385.00V, 1390.00V, 1395.00V, 1400.00V, 1405.00V, 1410.00V, 1415.00V, 1420.00V, 1425.00V, 1430.00V, 1435.00V, 1440.00V, 1445.00V, 1450.00V, 1455.00V, 1460.00V, 1465.00V, 1470.00V, 1475.00V, 1480.00V, 1485.00V, 1490.00V, 1495.00V, 1500.00V, 1505.00V, 1510.00V, 1515.00V, 1520.00V, 1525.00V, 1530.00V, 1535.00V, 1540.00V, 1545.00V, 1550.00V, 1555.00V, 1560.00V, 1565.00V, 1570.00V, 1575.00V, 1580.00V, 1585.00V, 1590.00V, 1595.00V, 1600.00V, 1605.00V, 1610.00V, 1615.00V, 1620.00V, 1625.00V, 1630.00V, 1635.00V, 1640.00V, 1645.00V, 1650.00V, 1655.00V, 1660.00V, 1665.00V, 1670.00V, 1675.00V, 1680.00V, 1685.00V, 1690.00V, 1695.00V, 1700.00V, 1705.00V, 1710.00V, 1715.00V, 1720.00V, 1725.00V, 1730.00V, 1735.00V, 1740.00V, 1745.00V, 1750.00V, 1755.00V, 1760.00V, 1765.00V, 1770.00V, 1775.00V, 1780.00V, 1785.00V, 1790.00V, 1795.00V, 1800.00V, 1805.00V, 1810.00V, 1815.00V, 1820.00V, 1825.00V, 1830.00V, 1835.00V, 1840.00V, 1845.00V, 1850.00V, 1855.00V, 1860.00V, 1865.00V, 1870.00V, 1875.00V, 1880.00V, 1885.00V, 1890.00V, 1895.00V, 1900.00V, 1905.00V, 1910.00V, 1915.00V, 1920.00V, 1925.00V, 1930.00V, 1935.00V, 1940.00V, 1945.00V, 1950.00V, 1955.00V, 1960.00V, 1965.00V, 1970.00V, 1975.00V, 1980.00V, 1985.00V, 1990.00V, 1995.00V, 2000.00V, 2005.00V, 2010.00V, 2015.00V, 2020.00V, 2025.00V, 2030.00V, 2035.00V, 2040.00V, 2045.00V, 2050.00V, 2055.00V, 2060.00V, 2065.00V, 2070.00V, 2075.00V, 2080.00V, 2085.00V, 2090.00V, 2095.00V, 2100.00V, 2105.00V, 2110.00V, 2115.00V, 2120.00V, 2125.00V, 2130.00V, 2135.00V, 2140.00V, 2145.00V, 2150.00V, 2155.00V, 2160.00V, 2165.00V, 2170.00V, 2175.00V, 2180.00V, 2185.00V, 2190.00V, 2195.00V, 2200.00V, 2205.00V, 2210.00V, 2215.00V, 2220.00V, 2225.00V, 2230.00V, 2235.00V, 2240.00V, 2245.00V, 2250.00V, 2255.00V, 2260.00V, 2265.00V, 2270.00V, 2275.00V, 2280.00V, 2285.00V, 2290.00V, 2295.00V, 2300.00V, 2305.00V, 2310.00V, 2315.00V, 2320.00V, 2325.00V, 2330.00V, 2335.00V, 2340.00V, 2345.00V, 2350.00V, 2355.00V, 2360.00V, 2365.00V, 2370.00V, 2375.00V, 2380.00V, 2385.00V, 2390.00V, 2395.00V, 2400.00V, 2405.00V, 2410.00V, 2415.00V, 2420.00V, 2425.00V, 2430.00V, 2435.00V, 2440.00V, 2445.00V, 2450.00V, 2455.00V, 2460.00V, 2465.00V, 2470.00V, 2475.00V, 2480.00V, 2485.00V, 2490.00V, 2495.00V, 2500.00V, 2505.00V, 2510.00V, 2515.00V, 2520.00V, 2525.00V, 2530.00V, 2535.00V, 2540.00V, 2545.00V, 2550.00V, 2555.00V, 2560.00V, 2565.00V, 2570.00V, 2575.00V, 2580.00V, 2585.00V, 2590.00V, 2595.00V, 2600.00V, 2605.00V, 2610.00V, 2615.00V, 2620.00V, 2625.00V, 2630.00V, 2635.00V, 2640.00V, 2645.00V, 2650.00V, 2655.00V, 2660.00V, 2665.00V, 2670.00V, 2675.00V, 2680.00V, 2685.00V, 2690.00V, 2695.00V, 2700.00V, 2705.00V, 2710.00V, 2715.00V, 2720.00V, 2725.00V, 2730.00V, 2735.00V, 2740.00V, 2745.00V, 2750.00V, 2755.00V, 2760.00V, 2765.00V, 2770.00V, 2775.00V, 2780.00V, 2785.00V, 2790.00V, 2795.00V, 2800.00V, 2805.00V, 2810.00V, 2815.00V, 2820.00V, 2825.00V, 2830.00V, 2835.00V, 2840.00V, 2845.00V, 2850.00V, 2855.00V, 2860.00V, 2865.00V, 2870.00V, 2875.00V, 2880.00V, 2885.00V, 2890.00V, 2895.00V, 2900.00V, 2905.00V, 2910.00V, 2915.00V, 2920.00V, 2925.00V, 2930.00V, 2935.00V, 2940.00V, 2945.00V, 2950.00V, 2955.00V, 2960.00V, 2965.00V, 2970.00V, 2975.00V, 2980.00V, 2985.00V, 2990.00V, 2995.00V, 3000.00V, 3005.00V, 3010.00V, 3015.00V, 3020.00V, 3025.00V, 3030.00V, 3035.00V, 3040.00V, 3045.00V, 3050.00V, 3055.00V, 3060.00V, 3065.00V, 3070.00V, 3075.00V, 3080.00V, 3085.00V, 3090.00V, 3095.00V, 3100.00V, 3105.00V, 3110.00V, 3115.00V, 3120.00V, 3125.00V, 3130.00V, 3135.00V, 3140.00V, 3145.00V, 3150.00V, 3155.00V, 3160.00V, 3165.00V, 3170.00V, 3175.00V, 3180.00V, 3185.00V, 3190.00V, 3195.00V, 3200.00V, 3205.00V, 3210.00V, 3215.00V, 3220.00V, 3225.00V, 3230.00V, 3235.00V, 3240.00V, 3245.00V, 3250.00V, 3255.00V, 3260.00V, 3265.00V, 3270.00V, 3275.00V, 3280.00V, 3285.00V, 3290.00V, 3295.00V, 3300.00V, 3305.00V, 3310.00V, 3315.00V, 3320.00V, 3325.00V, 3330.00V, 3335.00V, 3340.00V, 3345.00V, 3350.00V, 3355.00V, 3360.00V, 3365.00V, 3370.00V, 3375.00V, 3380.00V, 3385.00V, 3390.00V, 3395.00V, 3400.00V, 3405.00V, 3410.00V, 3415.00V, 3420.00V, 3425.00V, 3430.00V, 3435.00V, 3440.00V, 3445.00V, 3450.00V, 3455.00V, 3460.00V, 3465.00V, 3470.00V, 3475.00V, 3480.00V, 3485.00V, 3490.00V, 3495.00V, 3500.00V, 3505.00V, 3510.00V, 3515.00V, 3520.00V, 3525.00V, 3530.00V, 3535.00V, 3540.00V, 3545.00V, 3550.00V, 3555.00V, 3560.00V, 3565.00V, 3570.00V, 3575.00V, 3580.00V, 3585.00V, 3590.00V, 3595.00V, 3600.00V, 3605.00V, 3610.00V, 3615.00V, 3620.00V, 3625.00V, 3630.00V, 3635.00V, 3640.00V, 3645.00V, 3650.00V, 3655.00V, 3660.00V, 3665.00V, 3670.00V, 3675.00V, 3680.00V, 3685.00V, 3690.00V, 3695.00V, 3700.00V, 3705.00V, 3710.00V, 3715.00V, 3720.00V, 3725.00V, 3730.00V, 3735.00V, 3740.00V, 3745.00V, 3750.00V, 3755.00V, 3760.00V, 3765.00V, 3770.00V, 3775.00V, 3780.00V, 3785.00V, 3790.00V, 3795.00V, 3800.00V, 3805.00V, 3810.00V, 3815.00V, 3820.00V, 3825.00V, 3830.00V, 3835.00V, 3840.00V, 3845.00V, 3850.00V, 3855.00V, 3860.00V, 3865.00V, 3870.00V, 3875.00V, 3880.00V, 3885.00V, 3890.00V, 3895.00V, 3900.00V, 3905.00V, 3910.00V, 3915.00V, 3920.00V, 3925.00V, 3930.00V, 3935.00V, 3940.00V, 3945.00V, 3950.00V, 3955.00V, 3960.00V, 3965.00V, 3970.00V, 3975.00V, 3980.00V, 3985.00V, 3990.00V, 3995.00V, 4000.00V, 4005.00V, 4010.00V, 4015.00V, 4020.00V, 4025.00V, 4030.00V, 4035.00V, 4040.00V, 4045.00V, 4050.00V, 4055.00V, 4060.00V, 4065.00V, 4070.00V, 4075.00V, 4080.00V, 4085.00V, 4090.00V, 4095.00V, 4100.00V, 4105.00V, 4110.00V, 4115.00V, 4120.00V, 4125.00V, 4130.00V, 4135.00V, 4140.00V, 4145.00V, 4150.00V, 4155.00V, 4160.00V, 4165.00V, 4170.00V, 4175.00V, 4180.00V, 4185.00V, 4190.00V, 4195.00V, 4200.00V, 4205.00V, 4210.00V, 4215.00V, 4220.00V, 4225.00V, 4230.00V, 4235.00V, 4240.00V, 4245.00V, 4250.00V, 4255.00V, 4260.00V, 4265.00V, 4270.00V, 4275.00V, 4280.00V, 4285.00V, 4290.00V, 4295.00V, 4300.00V, 4305.00V, 4310.00V, 4315.00V, 4320.00V, 4325.00V, 4330.00V, 4335.00V, 4340.00V, 4345.00V, 4350.00V, 4355.00V, 4360.00V, 4365.00V, 4370.00V, 4375.00V, 4380.00V, 4385.00V, 4390.00V, 4395.00V, 4400.00V, 4405.00V, 4410.00V, 4415.00V, 4420.00V, 4425.00V, 4430.0

DIODES/ZENERS				SOCKETS/BRIDGES				TRANSISTORS, LEDS, etc.					
1N914	100v	10mA	.05	8-pin	pcb	.20	ww	.35	2N2222	NPN (2N2222 Plastic .10)			.15
1N4005	600v	1A	.08	14-pin	pcb	.20	ww	.40	2N2907	PNP			.15
1N4007	1000v	1A	.15	16-pin	pcb	.20	ww	.40	2N3906	PNP (Plastic - Unmarked)			.10
1N4148	75v	10mA	.05	18-pin	pcb	.25	ww	.75	2N3904	NPN (Plastic - Unmarked)			.10
1N4733	5.1v	1 W Zener	.25	22-pin	pcb	.35	ww	.95	2N3054	NPN			.35
1N753A	6.2v	500 mW Zener	.25	24-pin	pcb	.35	ww	.95	2N3055	NPN 15A 60v			.50
1N758A	10v	"	.25	28-pin	pcb	.45	ww	1.25	T1P125	PNP Darlington			.95
1N759A	12v	"	.25	40-pin	pcb	.50	ww	1.25	LED Green, Red, Clear, Yellow				.15
1N5243	13v	"	.25	Molex pins .01 To-3 Sockets				.25	D.L.747	7 seg 5/8" High com-anode			1.95
1N5244B	14v	"	.25	2 Amp Bridge 100-prv				.95	MAN72	7 seg com-anode (Red)			1.25
1N5245B	15v	"	.25	25 Amp Bridge 200-prv				1.95	MAN3610	7 seg com-anode (Orange)			1.25
									MAN82A	7 seg com-anode (Yellow)			1.25
									MAN74A	7 seg com-cathode (Red)			1.50
									FND359	7 seg com-cathode (Red)			1.25

C MOS		- T T L -									
4000	.15	7400	.10	7473	.25	74176	.85	74H72	.35	74S133	.40
4001	.15	7401	.15	7474	.30	74180	.55	74H101	.75	74S140	.55
4002	.20	7402	.15	7475	.35	74181	2.25	74H103	.55	74S151	.30
4004	3.95	7403	.15	7476	.40	74182	.75	74H106	.95	74S153	.35
4006	.95	7404	.10	7480	.55	74190	1.25			74S157	.75
4007	.20	7405	.25	7481	.75	74191	.95	74L00	.25	74S158	.30
4008	.75	7406	.25	7483	.75	74192	.75	74L02	.20	74S194	1.05
4009	.35	7407	.55	7485	.55	74193	.85	74L03	.25	74S257 (8123)	1.05
4010	.35	7408	.15	7486	.25	74194	.95	74L04	.30		
4011	.20	7409	.15	7489	1.05	74195	.95	74L10	.20	74LS00	.20
4012	.20	7410	.15	7490	.45	74196	.95	74L20	.35	74LS01	.20
4013	.40	7411	.25	7491	.70	74197	.95	74L30	.45	74LS02	.20
4014	.75	7412	.25	7492	.45	74198	1.45	74L47	1.95	74LS04	.20
4015	.75	7413	.25	7493	.35	74221	1.00	74L51	.45	74LS05	.25
4016	.35	7414	.75	7494	.75	74367	.75	74L55	.65	74LS08	.25
4017	.75	7416	.25	7495	.60			74L72	.45	74LS09	.25
4018	.75	7417	.40	7496	.80	75108A	.35	74L73	.40	74LS10	.25
4019	.35	7420	.15	74100	1.15	75491	.50	74L74	.45	74LS11	.25
4020	.85	7426	.25	74107	.25	75492	.50	74L75	.55	74LS20	.20
4021	.75	7427	.25	74121	.35			74L93	.55	74LS21	.25
4022	.75	7430	.15	74122	.55			74L123	.85	74LS22	.25
4023	.20	7432	.20	74123	.35	74H00	.15			74LS32	.25
4024	.75	7437	.20	74125	.45	74H01	.20	74S00	.35	74LS37	.25
4025	.20	7438	.20	74126	.35	74H04	.20	74S02	.35	74LS38	.35
4026	1.95	7440	.20	74132	.75	74H05	.20	74S03	.25	74LS40	.30
4027	.35	7441	1.15	74141	.90	74H08	.35	74S04	.25	74LS42	.65
4028	.75	7442	.45	74150	.85	74H10	.35	74S05	.35	74LS51	.35
4030	.35	7443	.45	74151	.65	74H11	.25	74S08	.35	74LS74	.35
4033	1.50	7444	.45	74153	.75	74H15	.45	74S10	.35	74LS86	.35
4034	2.45	7445	.65	74154	.95	74H20	.25	74S11	.35	74LS90	.55
4035	.75	7446	.70	74156	.70	74H21	.25	74S20	.25	74LS93	.55
4040	.75	7447	.70	74157	.65	74H22	.40	74S40	.20	74LS107	.40
4041	.69	7448	.50	74161	.55	74H30	.20	74S50	.20	74LS123	1.00
4042	.65	7450	.25	74163	.85	74H40	.25	74S51	.25	74LS151	.75
4043	.50	7451	.25	74164	.60	74H50	.25	74S64	.15	74LS153	.75
4044	.65	7453	.20	74165	1.10	74H51	.25	74S74	.35	74LS157	.75
4046	1.25	7454	.25	74166	1.25	74H52	.15	74S112	.60	74LS164	1.00
4049	.45	7460	.40	74175	.80	74H53J	.25	74S114	.65	74LS193	.95
4050	.45	7470	.45			74H55	.20			74LS367	.75
4066	.55	7472	.40							74LS368	.65
4069/74C04	.25										
4071	.25										
4081	.30										
4082	.30										
MC 14409	14.50										
MC 14419	4.85										
4511	.95										
74C151	1.90										

9000 SERIES		LINEARS, REGULATORS, etc.									
9301	.85	95H03	1.10	MCT2	.95	LM320T5	1.65	LM340K15	1.25	LM723	.40
9309	.35	9601	.20	8038	3.95	LM320T12	1.65	LM340K18	1.25	LM725N	2.50
9322	.65	9602	.45	LM201	.75	LM320T15	1.65	LM340K24	1.25	LM739	1.50
				LM301	.45	LM324N	1.25	78L05	.75	LM741 (8-14)	.25
				LM308 (Mini)	.95	LM339	.75	78L12	.75	LM747	1.10
				LM309H	.65	7805 (340T5)	.95	78L15	.75	LM1307	1.25
				LM309K (340K-5)	.85	LM340T12	.95	78M05	.75	LM1458	.65
				LM310	.85	LM340T15	.95	LM373	2.95	LM3900	.50
				LM311D (Mini)	.75	LM340T18	.95	LM380 (8-14 PIN)	.95	LM75451	.65
				LM318 (Mini)	1.75	LM340T24	.95	LM709 (8, 14 PIN)	.25	NE555	.35
				LM320K5 (7905)	1.65	LM340K12	1.25	LM711	.45	NE556	.85
				LM320K12	1.65					NE565	.95
										NE566	1.25
										NE567	.95

MICRO'S, RAMS, CPU'S, E-PROMS			
74S188	3.00	8214	8.95
1702A	4.50	8224	3.25
MM5314	3.00	8228	6.00
MM5316	3.50	8251	8.50
2102-1	1.45	8255	8.50
2102L-1	1.75	8T13	1.50
2114	9.50	8T23	1.50
TR1602B	3.95	8T24	2.00
TMS 4044	9.95	8T97	1.00
		2107B-4	4.95
8080	8.95	2708	9.50
8212	2.95	Z80 PIO	8.50

INTEGRATED CIRCUITS UNLIMITED

7889 Clairemont Mesa Boulevard, San Diego, California 92111
(714) 278-4394 (Calif. Res.)

All orders shipped prepaid No minimum
Open accounts invited COD orders accepted

Discounts available at OEM Quantities California Residents add 6% Sales Tax
All IC's Prime/Guaranteed. All orders shipped same day received.

24 Hour Toll Free Phone 1-800-854-2211 American Express / BankAmericard / Visa / MasterCard

SPECIAL DISCOUNTS

Total Order	Deduct
\$35 - \$99	10%
\$100 - \$300	15%
\$301 - \$1000	20%

STUDENTS & TEACHERS WITH YOUR ORDER, SEND PROOF OF YOUR STATUS AND RECEIVE 5% OF YOUR PRESENT ORDER AS A CREDIT CERTIFICATE YOU CAN USE ON YOUR NEXT ORDER.		FREE SOCKETS WITH PURCHASE OF ANY OF THESE I.C.'s.		8080 SYSTEM 8080A 5.95 8212 3.75 8214 8.95 8216 3.50 8224 4.80 8226 4.75 8228 7.25 8238 8.25 8251 9.45 8253 21.50 8255 10.75 8257 20.50 8259 20.50	CPU's cont. 8008 8.95 8035 19.95	PROG. LOGIC ARRAYS 82S100 11.95 82S101 11.95	S-100 MOTHER BOARD — 8 Slot Kit 69.00 S-100 32K STATIC MEMORY BOARD ALL BURNED IN AND TESTED 650ns 599.00 450ns 735.00 ultra low power 200ns 875.00 S-100 EDGE CARD CONNECTORS MAXI KEYBOARD — 53 Keys 19.95 MAXI KEYBOARD — 74 Keys 33.95 KEYPAD — 16 key x-y matrixed 1.95 KEYPAD — 20 key x-y matrixed 2.95 WIRE WRAP POSTS 2 level 100/3.95 4 level 100/4.95 WIRE WRAP SOCKET PIN 100/7.95 TAPE READER — 12 level — includes both 29.00 IR sources and pickups MAKE YOUR OWN PAPER TAPE READER 1/10" SPACED PHOTO TRANSISTORS 10/9.50 REED RELAY — TTL compatible 1.89 SOLID STATE RELAY — micro reed actuated for total isolation 3.95 CRYSTAL FILTERS — 455 Kc miniature single section 1.95 dual section 2.95 PRECISION THERMISTORS YSI-BEAD — 1% 5000 OHM 2.95 GLASS BEAD — 1% 15000 OHM 2.95 GLASS BEAD — 1% 200 OHM 2.95 CYLINDRICAL — 01% 3.95 POWER THERMISTOR — positive temperature coefficient 20-2500 OHM 2.95 D/A CONVERTER — NE5008 (8 bit) 7.95 D/A CONVERTER — DAC 01-SH (6 bit) 6.95 PHOTO DIODE — super fast 0.5ns 3.95 IR DETECTOR — super sensitive 4.95 READ OUTS — MULTI DIGIT LCD-3 1/2 dig. 4"-4.95 3 1/2 dig. 3" 1.95 LED 17"-3 dig. 1.25 — 6 dig. 3.95 — 8 dig. 4.95 PHOTO DEVICES—DIODES, XSTR'S, DARLINGTONS 2N5771 - 1.25 FPT100A .79 MD1 1.95 H-38 - 3.25 MRD-250 - 1.95 LASCR 1.95 HIGH VOLTAGE TRANSISTORS 2SC1358 100W-1400V-5A TO-3 7.95 BUY698 110W-800V-10A TO-3 5.95 W905 100W-500V-5A Plastic 4.95 362-4 20W-500V-1A Plastic 2.25 338-7 20W-350V-1A Plastic 1.50 HIGH VOLTAGE DIODES UNMARKED 1500V at 1 AMP 10/1.99 EG 250 2500V at .35 AMP .95 HV60EL 6000V at 25 ma 1.95 SUBMINIATURE 20,000V at 100 ma 2.95 CARBIDE DRILL BITS AND ROUTER BITS for P.C. board work — MIXED SIZES OUR MIX — DRILLS 10/12.95 100/95.00 OUR MIX — ROUTERS 10/15.95 100/125.00					
CHRISTMAS SPECIAL OF 5% OFF EFFECTIVE ON ALL ORDERS MAILED BEFORE DECEMBER 25, 1978.				RAM 7489 2.95 3101 3.95 8225 2.95 2101-1 2.95 2101-2 3.25 2101A-4 3.25 2102-2 1.50 2102L1 1.95 82S10 4.95 82S11 4.95 5101L-3 11.95 2107 3.95 TMS4060 3.95 UPD411 3.95 4200A 9.95 2114 200ns 13.50 2114 450ns 10.95 2114 650ns 6.25 4116 200ns 18.50 4116 300ns 17.50 4116 450ns 13.50	CLOCK CHIPS MM5311 7.95 MM5312 4.95 MM5313 7.95 MM5314 4.95 MM5315 7.95 MM5316 4.50 MM5375 5.95 TMS3834 6.95 CT7001 6.50	8080 SYSTEM 6800 16.95 6810 7.20 6820 7.95 6821 8.50 6850 8.95 6852 11.95 6860 9.95 6862 13.75	8080 SYSTEM 8223 2.95 82S23 3.75 82S126 5.95 82S129 6.95 82S131 7.25 6306-1 6.95 93427 5.95 03604 11.95 2616 50.00 1702A 4.95 2708 12.95 2716-5V 46.95	7000 SYSTEM 9900 66.00 9901 23.75 9902 19.50 9980 54.00 9981 54.00	6800 SYSTEM 6502 14.95 6520 12.75 6522 12.50 6530 17.50	9900 SYSTEM 1802 24.00 1821 19.50 1822 20.25 1824 13.50 1852 13.75 1856 11.75 1857 11.76 1861 20.00	8080 SYSTEM 2650 19.95 2901 19.95 PACE 19.00 SC/MP 14.95	PROG'S CHARACTER GENERATORS 2513 UC 7.95 2513 LC 7.95 2516 7.95 5240 7.95 MM6571A 9.95 KEYBOARD ENCODER AYS-2376 14.95 UARTS AYS-1012 8.95 AYS-1013 8.95 TR-1602 9.95 TMS6011 8.95 FIFO'S 3341 7.95 1502E 10.95
PRESCALER - 250 MHZ complete \$23.95 PRESCALER - 650 MHZ complete \$49.95 11C90 - PRESCALER CHIP 650 mc \$19.95	OPTO ISOLATORS 1. MCT2 \$.79 2. MOC1000 \$.89 3. 4N-26 \$.95 4. CL1422 CLAIREX PHOTO MODULE (USE AS VOLTAGE VARIABLE RESISTOR—40 MEG OHM TO 40 OHM—MILLION TO ONE RATIO—OR USE AS VERY HIGH VOLTAGE OPTO ISOLATOR) \$1.49	SOLID STATE RELAY • 400 V at 3 AMPS • TTL COMPATIBLE • MICRO REED ACTUATED TO MINIMIZE CHANCES OF AC POWER SPILLOVER INTO LOGIC CIRCUITS \$3.95	REFLECTIVE PHOTO COUPLERS TIL-139 LED INTO PHOTO TRANSISTOR \$2.95 ROC100 INCANDESCENT INTO CDS CELL— 20 MEG OHM OFF RESISTANCE \$1.95	CHEAPER BY THE 100 LEDS- (HP AXIAL-RED) 100/8.95 LEDS- (MINI-RED) 100/9.95 LEDS- (JUMBO-RED) 100/13.95 LEDS- (DUAL COLOR) 100/59.00 1N4001- (50V-1 AMP) 100/ 4.95 1N4148- (SWITCHING DIODE) 100/ 3.95 2N4303- (N-JFET) 100/21.95 2N3392- (PRIME-NPN LOW NOISE) 100/ 9.95	AUDIO POWER AMPS SINGLE TDA-2020-20 Watt \$9.95 S11020H-20 Watt \$10.50 S11130H-30 Watt \$12.50 STK-50 -50 Watt \$18.95 STEREO STK433-5 Watts per channel \$6.95 STK435-7 Watts per channel \$9.95 STK437-10 Watts per channel \$11.95 STK439-15 Watts per channel \$13.95 STK441-20 Watts per channel \$16.95							

RADIO SHACK® TRS-80™ COMPUTER SERVICE AND MODIFICATION

BE FIRST TO TURN YOUR TRS-80 INTO A SUPER MACHINE

1. Keyboard and Video Mod

ADD RAM FOR LOWER CASE CHARACTERS AND CLEAN UP HORIZONTAL SMEAR (SEND YOUR TRS-80 MICROCOMPUTER ONLY)
PARTS AND LABOR \$59.00

2. Install 16K Memory

JUST SEND US YOUR TRS-80 MICROCOMPUTER AND WE DO THE REST.
16K OF MEMORY AND LABOR \$189.00

3. Level 2 plus 1 Mod

WE INSTALL YOUR LEVEL 2 SO YOU KEEP LEVEL 1 AND CAN USE IT BY JUST FLIPPING A SWITCH. (SEND LEVEL 2 WITH YOUR TRS-80)
\$69.00

4. Clock Mod

INCREASE YOUR PROCESSING SPEED BY 30%. WITH THIS OPTION YOU CAN SWITCH-SELECT BETWEEN THE FASTER 2.66MHZ CLOCK RATE AND 1.77MHZ.
INSTALLATION, PARTS AND LABOR \$49.00

5. Serial Printer Interface Mod

OPERATE CRYSTAL CONTROLLED TTY WITH LEVEL 1 OR 2. WE INSTALL SWITCH SELECTABLE BAUD RATES OF 75, 110, 137.5, 150, 300, 600, 1200, 2400, 4800, 9600 OR EXTERNAL EIA RS232 AND CURRENT LOOP OUTPUT.
PARTS AND LABOR \$119.00

6. Mini Floppy Mod

YOU PROVIDE EXPANSION INTERFACE AND WE'LL INSTALL A PERTEC F D 200 MINI FLOPPY.
PARTS AND LABOR (PERTEC F D 200 MINI FLOPPY INCLUDED) FOR ONLY \$425.00

SPECIALS!! DO MORE THAN ONE MOD AND SAVE

MODS 1, 2, 3, 4 AND 5 \$449.00
 MODS 1 AND 2 \$234.00
 MODS 2 AND 3 \$243.00
 16K MEMORY, PARTS AND INSTALLATION DATA \$159.00

SEND TRS-80 KEYBOARD ONLY!!

RETURN SHIPPING:
 FROM ENGLAND ADD \$30.00 FOR AIR, \$9.50 SURFACE MAIL
 FROM JAPAN ADD \$35.00 FOR AIR, \$8.50 SURFACE MAIL

REPAIR—WE WILL REPAIR ANY ORIGINAL TRS-80 MICROCOMPUTER OR ONE OF OUR MODIFICATIONS.

ALL PARTS AND LABOR \$69.00

NOTE: THIS IS AN INDEPENDENT SERVICE EFFORT NOT AFFILIATED WITH RADIO SHACK® OR TANDY CORPORATION.

ALL WORK GUARANTEED UNCONDITIONALLY FOR 1 YEAR
TERMS FOR TRS-80 WORK: WE ACCEPT ONLY TRS-80 MICROCOMPUTERS! SHIP YOUR TRS-80 MICROCOMPUTER TO US, INSURED AND SUITABLY PACKAGED AND WE WILL RETURN SAME FREIGHT COLLECT. ALL FACTORY SEALS MUST BE INTACT. ANY UNIT WHOSE SEALS HAVE BEEN TAMPERED WITH WILL BE SHIPPED BACK IMMEDIATELY. MODS 1, 2, 4 AND 5 SEND TRS-80 MICROCOMPUTER ONLY. MOD 3 SEND YOUR TRS-80 MICROCOMPUTER AND LEVEL 2. MOD 6 SEND TRS-80 AND EXPANSION INTERFACE. **NORMAL TURN AROUND TIME IS UNDER 10 DAYS WITH CERTIFIED FUNDS**

F. REICHERT SALES

✓R25

DROP INTO ONE OF OUR LOCATIONS

1110 E. GARVEY AVE.
 W. COVINA, CA 91790
 (213) 967-3846

- \$20 MINIMUM ORDER
- FREE UPS DELIVERY ON U.S. ORDERS ONLY—OR BY SURFACE MAIL IF SPECIFIED.
- MONEY BACK GUARANTEE (MOS & LED DEVICES EXCLUDED)
- UNDER 8 HOUR PROCESSING ON MONEY ORDERS & CASHIER'S CHECK.

- SORRY! NO COD'S, P.O.'S OR CREDIT CARDS
- CALIF. RES. ADD 6% SALES TAX
- CANADA, PUERTO RICO & U.S. POSSESSIONS ADD U.S. \$3.50. ALL OTHERS ADD U.S. \$7.00.
- U.S. FUNDS ONLY.

LOS ANGELES
 (213) 967-4611

LMN ELECTRONICS
 1042 E. GARVEY AVE.
 WEST COVINA, CA

PORTLAND
 (503) 646-4044

WIZARD OF PARTS
 8225 S.W. CIRRUS DR.
 BEAVERTON, OREGON

DENVER
 (303) 573-5214

ELECTRONIC LOLLIPOP
 5643 N. BROADWAY, DENVER
 (I-25 & 58th AVE.)

ASSOCIATED RADIO ^{A50}

8012 CONSER BOX 4327
OVERLAND PARK, KANSAS 66204

913-381-5900



CALL US WITH YOUR REQUIREMENTS



AMERICA'S #1 Real Amateur Radio Store

TRADE SELL BUY



**SEND \$1.00 FOR OUR CURRENT CATALOG OF
NEW AND RECONDITIONED EQUIPMENT.**

***ALSO WE PERIODICALLY PUBLISH A LIST OF
UNSERVICED EQUIPMENT AT GREAT SAVINGS.
A BONANZA FOR THE EXPERIENCED OPERATOR.
TO OBTAIN THE NEXT UNSERVICED BARGAIN LIST,
SEND A SELF ADDRESSED STAMPED ENVELOPE.**

7294 N.W. 54 STREET
MIAMI, FLORIDA 33166

SURPLUS ELECTRONICS CORP. ✓ S43

PHONE: (305) 887-8228

TWX: 810-848-6085

WHOLESALE - RETAIL

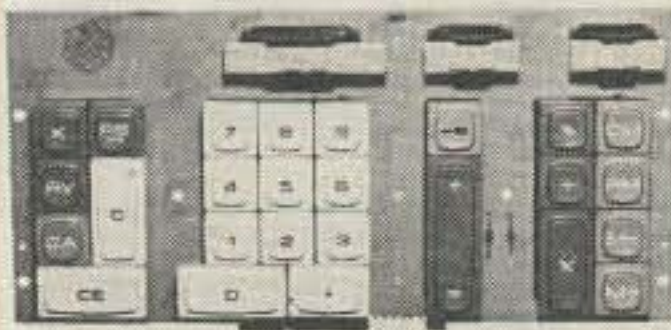
<p>PL 259's QUALITY AMERICAN MADE 10/\$5.00 100/\$35.00 50/\$40.00 1000/\$300.00</p>		<p>E. F. Johnson Desk Top Microphone Ceramic Element/High Imp \$20.00 ea While They Last</p>		<p>IC SOCKETS Cambion Gold Plated Wire Wrap 14 pin .35 ea 10/\$3.00 16 pin .38 ea 10/\$3.30</p>											
<p>SURPRISE PACKAGE Resistors, Caps, Semis, Pots, Relays, etc. We guarantee it to be \$25.00 worth of material. Every package is different. \$5.00</p>		<p>TEXAS INSTRUMENT KEYBOARD \$1.95 ea., 5 for \$8.00 10 for \$13.95</p>  <p>Has 3 slide switches—28 different keys—keypads removable by removing 4 screws.</p>		<p>MODEN CABLE 50' cable contains 13 # 22 ga. wire DB-25p with DB-51226-1 cover on one end \$6.50 ea 10/\$50.00</p>											
<p>White Porcelain Egg Insulator 1 1/2" x 1" 50¢ ea 3 for \$1.25</p>		<p>MINI TOGGLE SW C&H SPDT \$1.00 ea 6/\$5.00</p>		<p>12 Udc RELAY SPST 35 Amp Contacts Open Frame Rugged, great for mobile use \$4.50 ea 5/\$20.00</p>		<p>New Dry Nickel-Cadmium Battery 2 1/4" x 2 3/4" x 8 3/4" General Electric 12.0 Volts dc @ 4.0 Amp hrs. \$19.95 while they last.</p>									
<p>Neon Panel Light 110 Vac Amber, w/ built in resistor & wire leads—3 for \$1.50</p>		<p>WIRE WOUND RESISTORS .1 Ohm—5 W .10 Ohm—10 W @ 15¢ each</p>		<p>PANEL METERS 2 1/4" x 2 1/4" also 2 1/4" x 3" 10-0-10 dc Amps \$4.00 ea 0-20 dc Volts 25-0-25 dc Volts 2 for \$7.00 0-25 dc Volts 0-50 ac Volts -Shunt Required-</p>		<p>CB SPECIAL Complete brand new printed circuit board assembly with all parts. Used in all Hygain 40 channel CB Transceivers. Fits many other manufactures units also. Board dimensions 6" x 6 1/2" 1-9—7.50 ea 10-50—6.50 ea 50-100—6.00 ea 100-up—5.50 ea</p>		<p>MUFFIN FANS 3 Blades, 110 Vac, 4 3/4" sq. Removed from equipment—Excellent condition—\$4.95</p> <p>"New" Muffin Fans 3 Blades-110 Vac, 4 3/4" sq. \$9.95</p>							
<p>CMOS RCA CD 4012 AE Dual 4 in Nand Gate 6/\$1.00 100/\$10.00 50/\$6.00 1000/\$80.00</p>		<p>12 Vdc RELAY SPST Open Frame 5 Amp Contacts Mfg-Magnecraft \$1.50 ea 4/\$5.00</p>		<p>POLYFOAM COAX—50 OHM Equal to RG174 \$4.95/100' Low Loss Polyfoam Coax Cable</p>		<p>TRIMMER CAPS Small enough to fit in your watch— 3.5 to 20 pF 5 to 30 pF 7 to 40 pF \$.75 ea., 2 for \$1.25 5 for \$3.00</p>									
<p>D Cell Nicad mfg. by G. E. 2.50 ea 1.2 volts 3.5 amp hrs. cat No. 41B004 AD08G5</p>		<p>Coax Connectors UG-273/U BNC-F/UHF-M 2.50 UG-255/U BNC-M/UHF-F 3.00 UG-146A/U N-M/UHF-F 4.50 UG-83B/U N-F/UHF-M 4.50 UG-175 RG-58 Adapt. .20 UG-176 RG-59 Adapt. .20</p>		<p>New Boxer Fans 5 Blades 110V ac 4 3/4"—\$11.95</p>		<p>JOY STICK For TV games and hi fi with four, 100K pots 2 3/4" X 2 3/4" X 1" with 1" handle—\$3.95</p>									
<p>Computer Grades 23,200 uf @ 50 Vdc 3.00 ea 3" diam x 4 1/2" high G. E.</p>		<p>GOLD PLATED CARD EDGE CONNECTORS</p> <table border="1"> <tr> <td colspan="2"> <p>Double Row/Wire Wrap .100</p> <p>25 pins \$3.49 ea 10/\$30.00 30 pins \$3.96 ea 10/\$32.00 50 pins \$5.43 ea 10/\$45.00</p> </td> <td colspan="2"> <p>Double Row/Solder Eyelet .156</p> <p>6 pins \$1.10 ea 10/\$9.00 15 pins \$1.55 ea 10/\$12.50 22 pins \$2.08 ea 10/\$17.00 43 pins \$3.66 ea 10/\$30.00</p> </td> <td colspan="2"> <p>22 pins/Double Row/Dipped Solder .156</p> <p>\$2.08 ea 10/\$17.00</p> </td> <td colspan="2"> <p>22 pins/Double Row/Wire Wrap .156</p> <p>\$2.44 ea 10/\$19.00</p> </td> </tr> </table>						<p>Double Row/Wire Wrap .100</p> <p>25 pins \$3.49 ea 10/\$30.00 30 pins \$3.96 ea 10/\$32.00 50 pins \$5.43 ea 10/\$45.00</p>		<p>Double Row/Solder Eyelet .156</p> <p>6 pins \$1.10 ea 10/\$9.00 15 pins \$1.55 ea 10/\$12.50 22 pins \$2.08 ea 10/\$17.00 43 pins \$3.66 ea 10/\$30.00</p>		<p>22 pins/Double Row/Dipped Solder .156</p> <p>\$2.08 ea 10/\$17.00</p>		<p>22 pins/Double Row/Wire Wrap .156</p> <p>\$2.44 ea 10/\$19.00</p>	
<p>Double Row/Wire Wrap .100</p> <p>25 pins \$3.49 ea 10/\$30.00 30 pins \$3.96 ea 10/\$32.00 50 pins \$5.43 ea 10/\$45.00</p>		<p>Double Row/Solder Eyelet .156</p> <p>6 pins \$1.10 ea 10/\$9.00 15 pins \$1.55 ea 10/\$12.50 22 pins \$2.08 ea 10/\$17.00 43 pins \$3.66 ea 10/\$30.00</p>		<p>22 pins/Double Row/Dipped Solder .156</p> <p>\$2.08 ea 10/\$17.00</p>		<p>22 pins/Double Row/Wire Wrap .156</p> <p>\$2.44 ea 10/\$19.00</p>									

TERMS: All material guaranteed • If for any reason you are not satisfied, our products may be returned within 10 days for a full refund (less shipping). Please add \$3 for shipping and handling on all orders. Additional 5% charge for shipping any item over 5 lbs. COD's accepted for orders totaling \$50.00 or more. All orders shipped UPS unless otherwise specified. Florida residents please add 4% sales tax. Minimum order \$15.00.

EQUIPMENT / COMPONENTS / WIRE & CABLE / ACCESSORIES

GET YOUR

NEW 1979

Published December 1st, 1978

RADIO AMATEUR CALLBOOKS

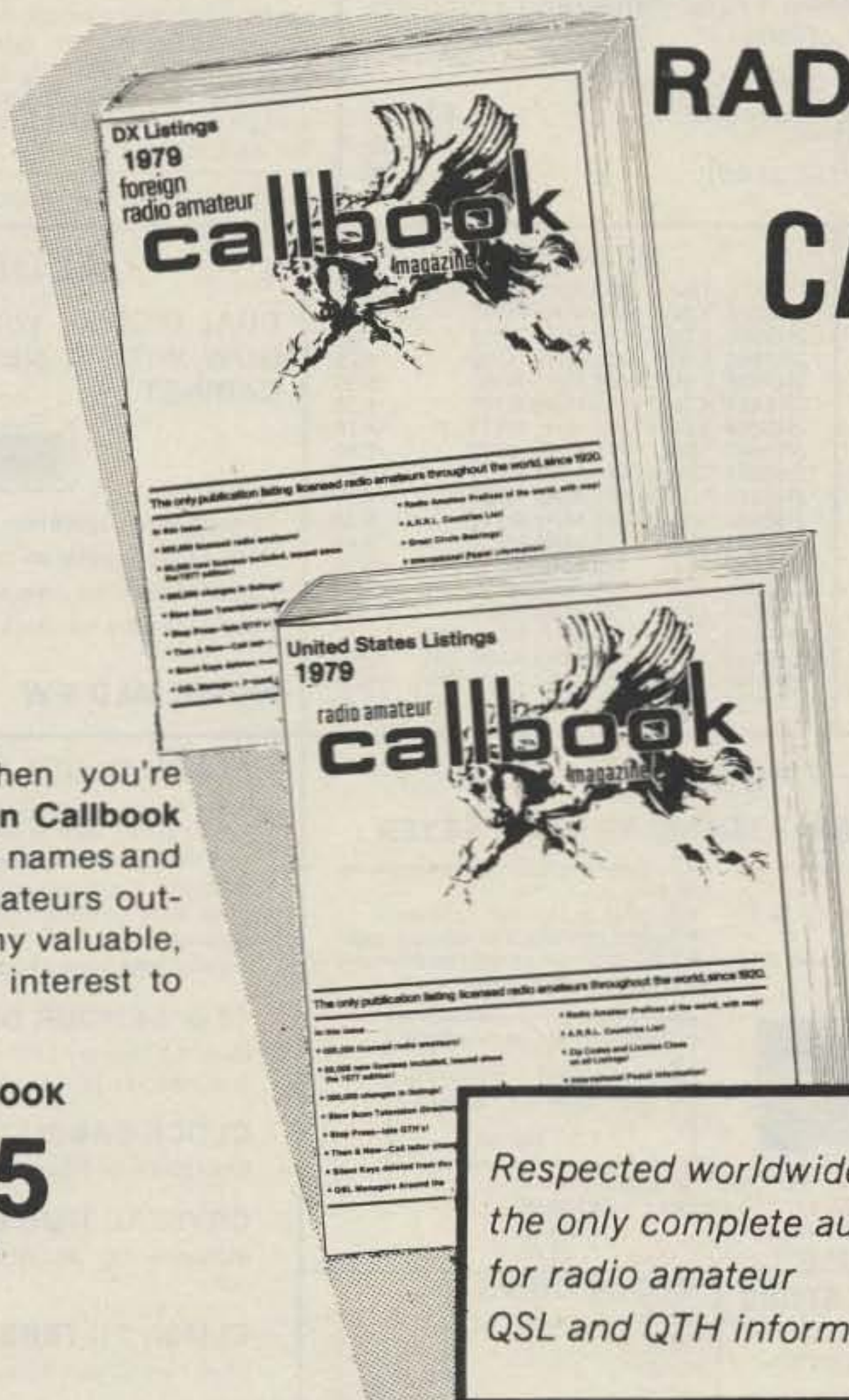

Specialize in DX? Then you're looking for the **Foreign Callbook** with over 280,000 calls, names and addresses of radio amateurs outside the USA plus many valuable, additional features of interest to the DX'r.

FOREIGN CALLBOOK
\$14.95
PLUS SHIPPING

The **U.S. Callbook** has over 350,000 W & K listings. It lists calls, license classes, names and addresses plus the many valuable back-up charts and references you come to expect from the **Callbook**.

UNITED STATES CALLBOOK

\$15.95
PLUS SHIPPING

*Respected worldwide as
the only complete authority
for radio amateur
QSL and QTH information.*

See your favorite electronics dealer for the latest issue or order direct from the publisher using handy order form.

Payment in U.S. funds must be sent directly to publisher not through a bank.

**Radio
Amateur** ✓R1
callbook, INC.

925 SHERWOOD DRIVE
LAKE BLUFF, ILLINOIS 60044

ORDER FORM

Item	Price Each	Shipping	Total Price
<input type="checkbox"/> U. S. CALLBOOK	\$15.95	\$1.75	\$17.70
<input type="checkbox"/> FOREIGN CALLBOOK	\$14.95	\$1.75	\$16.70

Illinois residents only add 5% sales tax _____

Name _____

Address _____

City _____

State _____ Zip _____

TOTAL _____

Charge my: Visa Card Master Charge

Card No. _____ Expiration Date _____

Dept. B

Signature _____

ALDELCO ELECTRONIC CENTER

AT LAST!!! A PROFESSIONAL LOOKING CAR CLOCK CABINET FOR THE MA1003 CAR CLOCK MODULE

OVERVOLT 12

Crow Bar circuit protects Transceivers & Tape Decks from runaway power supply voltage that can zap expensive components. OV 12 causes fuse in Power Supply to blow if voltage exceeds preset level (approx. 16 to 18 volts). Rated at 25 Amperes. **\$ 7.95**
 Model OV5. Protects 5 Volt circuits. Triggers at 7.5 Volts **\$8.95**
 Other units available at 3.3 to 100 Trigger Voltages **\$10.95 ea**

THE LUNCH COUNTER



Build a 600 MHz 6 Digit Frequency Counter. We supply 3 PC Boards, Silk Screened Front Panel and complete Instructions **Only \$12.50**

Chips used in Counter
 11C90 Prescaler **\$14.50**
 74C925 **9.95**
 F9368 (2 used) **ea 3.95**

Measures
 3-5/8" Wide
 2-1/8" High
 1-15/16" Deep



ONLY \$5.95

PERFECT FOR VANS AND RECREATIONAL VEHICLES

ATTRACTIVE IMPACT RESISTANT ABS BLACK PLASTIC CABINET WITH CHROME TRIMMED FRONT. HAS REMOVABLE WOOD GRAIN INSERT THAT WILL MATCH OR COMPLIMENT MOST AUTO INTERIORS. CAN BE INSTALLED "IN DASH" OR MOUNTED ON DASHBOARD TOP OR BOTTOM WITH SUPPLIED BRACKET. CONTROL SWITCHES CAN BE MOUNTED REMOTE OR AS SHOWN.

MA1003 National Car Clock Module with 3 push switches **\$17.95**

AEC 1074 50Watt
 @ 30 MHz **\$21.15**
 AEC 1076 75Watt
 @ 50 MHz **\$24.00**
 both cases 500 4LFL

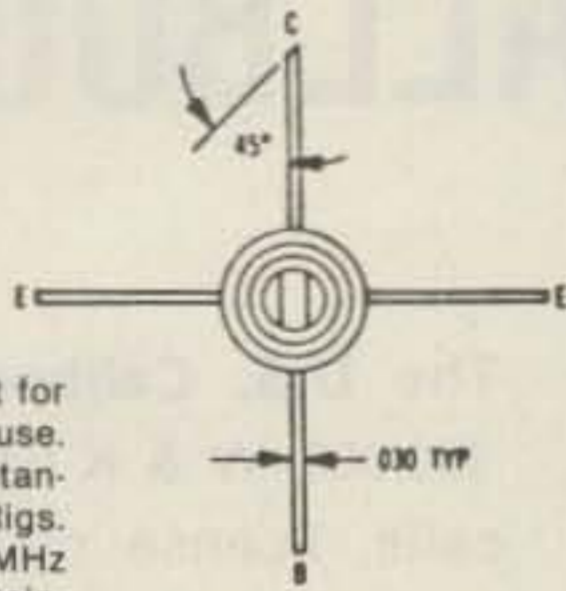

AEC 1158

Hard to find replacement for VHF Mobile & Marine use. Successfully used in Standard and other VHF Rigs. Rated 12 Watts at 200 MHz 12.5 Volts with 5.3 DB Gain. Heat Sink stud (8/32) isolated from leads. **Only \$12.30**

RF DEVICES

2N2876	18W	200 MHz TO60	\$12.35
2N3375	3.0W	400 MHz TO60	5.60
2N3553	2.5W	175 MHz TO39	1.40
2N3866	1.0W	400 MHz TO39	1.25
2N3926	7.0W	175 MHz TO60	6.30
2N4427	1.0W	175 MHz TO39	1.35
2N5589	3.0W	175 MHz MT71	4.75
2N5590	10W	175 MHz MT72	7.80
2N5591	25W	175 MHz MT72	10.25
2N5913	1.75W	175 MHz TO39	1.70
2N6080	4.0W	175 MHz MT72	5.40
2N6081	15W	175 MHz MT72	8.45
2N6082	25W	175 MHz MT72	10.95
2N6083	30W	175 MHz MT72	12.30
2N6084	40W	175 MHz MT72	16.30
2N6094	4.0W	175 MHz X106 PNP	6.60
2N6095	15W	175 MHz X106 PNP	8.50
2N6096	30W	175 MHz X106 PNP	10.35
2N6097	40W	175 MHz X106 PNP	20.00

ALDELCO KITS

DUAL DIGITAL 12/24 HOUR CLOCK KIT NOW WITH A NEW WALNUT GRAIN WOOD CABINET

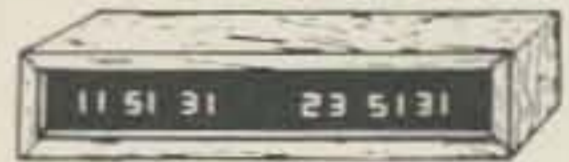

Features:
 12 or 24 Hour Operation on either clock
 Each Clock separately controlled
 Freeze feature for time set
 Easy assembly for clock and cabinet

BIG 0.5 LEDs

MODEL ALD 5-W **ONLY \$49.95**

LEDS

Monsanto MAN 72 Red LED Readout .300" High, Common Anode. **ONLY \$.89**

Monsanto MV5053 JUMBO LED and Holder **only .25**
 LED Holders.....10
 Jumbo Red LED 8 for \$1.00
 Jumbo Green, Orange or Yellow LED 5 for \$1.00

FETS

MPF102	55
2N3819	35
2N5457	50
2N5458	50
2N5459	55
2N5485	50
2N5486	72

DARLINGTON

MPSA 13	80
MPSA 14	40
2N5306	50
SCR	
C 106A	55
C 106B	65
C 122B	85

— THE MIMIC —

PROGRAMMABLE IAMBIC MEMORY KEYS

- Four memory inputs, sixty letters each
- Five minutes of memory @ 10 wpm
- Operates on 110 V ac and 8-16 vdc
- Triggered clock for memory recording
- Built-in side tone monitor
- Speed control 5 to 40-plus wpm
- Two to three times the memory of nearest competitor



Comes in attractive light blue cabinet measuring 2 1/2" high x 4" wide x 5" deep.

KIT ONLY \$79.95

Kit with set of paddles \$104.95
 Assembled unit 99.95
 Paddles only 29.95

VOLTAGE REGULATORS

TO220 Package	
Positive \$1.00	Negative \$1.25
7805	7905
7806	7906
7808	7912
7812	7915
7815	

CLOCK CHIPS

5313	3.49
5314	3.49
5316	3.95
5375	3.95
CT7001	6.95

2200 MFD 16 volt
 Radial Cap 3 for 89¢

ALARM CLOCK KIT

6 Big 0.5 LED Displays * On Board AC Transformer * 12 Hour Format with 24 Hour Alarm * Snooze Feature * Elapsed Timer. Timer feature makes this Popular in Broadcast Stations. It's a natural for cars, boats and campers when used with optional crystal time base. Fits our standard cabinet. **\$19.95**
 Crystal time base when purchased with clock. **\$2.95**

12 or 24 HOUR DIGITAL CLOCK KIT

Uses 0.5 Display LED, 5314 Clock Chip. Freeze feature for accurate set, fits our standard cabinet. **ONLY \$18.95**

CLOCK CABINETS

Woodgrain or black leather **ea. \$4.95**

CRYSTAL TIME BASE KIT

Includes PC Board, Crystal, all parts and instructions. **\$4.95**

CLOCK FILTERS

Blue, Red, Green, Amber or Smoke **\$.60**

Blinky Flasher Kit

PC board, 555 & all parts works on 9 volts. Mouse button—**\$1.00**

DIGITAL MULTIMETER & THERMOMETER

3 1/2 Digit—5 ranges on each function AC/DC .2 Volts to 2000 Volts Current 2 Microamps to 2 Amps Resistance 2000 Ohms to 2 Megohms. Includes PC Board, ICL7107 Chip and all parts. **Only \$49.95**

SPECIAL RF TRANSISTOR

3 Watts 175 MHz
 2N5589 **\$3.75**

SPECIALS

MC1458P	29
555 Timer	3 for \$1.00
4011	23

CRYSTAL SOCKETS

HOLDS 8 HC25U \$.59
 Single HC25U 29

144 MHz 10 Watts
 RF Transistor
 2N5590 **\$5.50 ea.**



NEW!

Tunable 420 MHz
 Fast Scan TV
 Converter

Receive Fast Scan Amateur TV in the 420 to 450 MHz Band with any TV set. Low noise, high gain rf Amp with Varactor tuned input and outputs. Built in AC supply. Comes in two tone walnut & beige cabinet measuring 1 7/8" x 4 1/4" x 4 1/8". Factory wired with 2 year guarantee. **\$59.95**

ADJUSTABLE POWER SUPPLY KITS

5-15 Volts 500 MA	\$6.95
12-28 Volts 500 MA	6.95

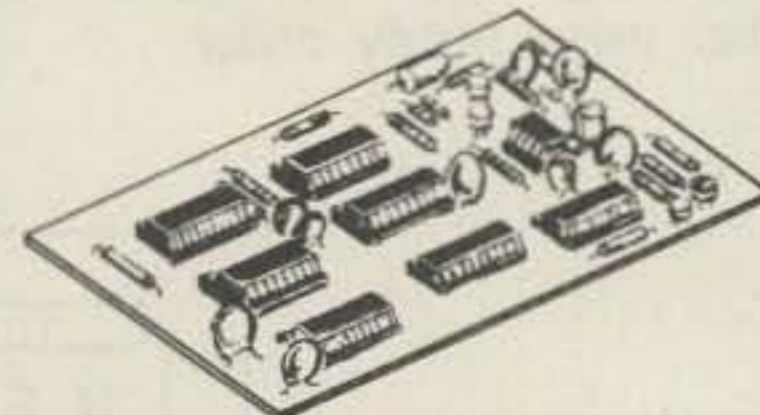

THE VERY POPULAR TOPE ACCUKEYER KIT

- Self Completing Dots & Dashes
- Iambic Operation
- Single Dot & Dash Memories
- Provision for attachment of 256 or 512 Bit Memory for DX or Contest work

Revised version of the Accukeyer featured in the ARRL Handbook. Has more logical IC Layout and ON Board sidetone Oscillator. Includes PC Board, TTL ICs, 555 Timer, IC Sockets, Switch, Speaker, Transistors, capacitors and resistors. Requires 5VDC. **ONLY \$19.95**

ACCUKEYER MEMORY KIT

Simple low cost Memory Kit. Uses 2 programmable 1101 Memory chips. Provides 2 canned messages of 30 Characters each. Adaptable to Handbook and other Accukeyers. Includes PC board (same size as accukeyer board) and all parts. Requires 5VDC, 9VDC. **\$19.95**

ALDELCO

✓ A2

2789A MILBURN AVE, BALDWIN, N.Y. 11510
 516-378-4555

Add 6% shipping. Add \$1.00 for orders under \$10.00. Out of U.S.A. add 15% shipping and certified check or money order in U.S. funds.

NEW!

Synthacoder 509



Ask about Group Purchases

ONLY
\$129⁹⁵
postpaid

E12 Take Command of 220 MHz!

The Synthacoder 509 represents the first of a totally new generation of frequency synthesizers, based on the latest advances in CMOS-LSI techniques. "Matrix Modules", which contain programming diodes, make adding new channels a cinch. Simply snip the leads on the diodes not needed, plug it in, and you are **On The Air!** Our unique interface design allows you to use your existing crystal positions even though the synthesizer has been installed. The Synthacoder is also easily adapted for **Scanning** and **External Frequency Control**. To sum it up—We are sure that you will find the new Synthacoder 509 **Everything You Want** in a 220 MHz synthesizer—And at a **Price Comparable to Crystals!**

- * SIMPLE TO INTERFACE - Three wires and no holes!
- * FULL COVERAGE - 220-225 MHz in 20 KHz steps
- * MATRIX PROGRAMMABLE - No more crystals
- * EXCLUSIVE "MATRIX MODULES" - Program in seconds
- * FULL MODE CONTROL - Simplex, Repeater, Reverse
- * LOW POWER CMOS - Draws only 60 ma
- * FULLY ASSEMBLED AND CALIBRATED - Not a kit
- * FITS MIDLAND, COBRA, and CLEGG 220 MHz transceivers

Engineering Specialties

P.O. BOX 2233
1247 COMMERCIAL AVENUE
OXNARD, CA 93030
(805) 486-0817

731

- I'LL BITE! Please send more info.
 I'M HOOKED! Please RUSH my Synthacoder.

YES, I would like to purchase a Synthacoder for my 220 radio. Enclosed please find my \$129.95 (Price includes postage and handling). California residents add 6% sales tax.

\$ _____ enclosed: Check Money Order
Please charge my Master Charge BankAmericard
Credit card # _____
Interbank # _____
Expiration date _____
Signature _____



Name _____ Call _____
Address _____
City _____ State _____ Zip _____



SEMICONDUCTORS SURPLUS

S63

2822 North 32nd Street/Unit -1 Phoenix, Arizona 85008 (602) 956-9423

We accept checks, MasterCard, and Visa

Prices subject to change without notice

R.F. CONNECTORS

SO-239	49
PL-259	59
UG-175	39
M-358	1.95
M-359	2.00
PL-258	2.00
UG-88E/U	89
UG-492A/U	2.00
UG-306B/U	2.00
UG-290A/U	99
UG-274/U	2.00
UG-260B/U	1.10
UG-273/U	2.50
UG-201A/U	2.50
UG-58/U	1.99
UG-491A/U	2.25
UG-260/U	99
UG-1094/U	89

FERRITE BEADS

12/.89 or 100/4.00

TOROIDAL CORES

T-37-6 6/1.00 25/4.00 50/6.00
100/10.00

TOROIDAL CORES

T-30-2 & T-30-12 5/1.00

1N914/1N4148

30/1.00 or 120/3.00

2C39/7289 TUBES

\$4.00 each or 10/\$35.00

TRIMMERS 5-80PF

45¢ each or 10/ 3.50 or
100/25.00

CHOKE (U252) 2.5MH 150 MA 30 MHZ

2/\$1.00

TRIMMER CAPS

Small enough to fit in your
watch 3.5-11 pf 75¢ each or
10/\$6.00

RG-174 52 OHM COAX MADE BY H.P.

\$5.00/100 ft.

MINIATURE SWITCHES

SPST ON-ON 3/1.00 Used

F.E.T.S

MPF4391	.75 or 10/6.50
MPF112	.69 or 10/5.50
MPF102	.43 or 10/3.50
40673	1.39 or 10/10.00
3N128	1.35 or 10/10.00
2N5248	.60 or 10/4.50
MPF131	.60 or 10/5.00
2N4303	.45 or 10/3.50
2N3958	2.95 each
MFE2000	.90 or 10/8.00
MFE2001	.99 or 10/8.00
MFE2008	4.20 or 10/36.00
MFE2009	4.80 or 10/39.00
MFE3002	3.35 each
MMF-5	5.00 each
MFE120	1.00 or 10/8.50
2N3436	2.25 each
2N4416	1.00 each
MFE131	1.05 each

PISTON CAPS 1.2-10 PF

75¢ each or 10/5.50

LM566V VCO Function Generator

99¢ each

LM340T-5 & LM340T-12

75¢ each

1500PIV 1.5 AMPS RECTIFIERS

10/1.50

SEMTECH MINISTIC, HIGH VOLTAGE RECTIFIERS

SFMS 20K 20,000 PIV
500ma \$1.99 each

MOTOROLA I.C.s

MC4024P & MC4044P \$3.27 ea.

HEP 170 2.5 AMPS

1000PIV 10/2.00 or
100/14.50

MOTOROLA R.F. AMPS

MC1550G 1.50 each
MC1590G 6.90 each

NEW WHISPER FANS

115 VAC \$9.95 each

POTTER & BRUMFIELD RELAYS

12VDC 4PDT 3Amps 2.95
12VDC SPDT 25Amps 5.95
12VDC 2PDT 3Amps 1.99
12VDC 4PDT 25Amps 6.99

DRAKE LOW PASS FILTERS

TV-42-LP TV-3300-LP
100W Max. 1000W Max.
30 MHz \$9.95 30 MHz \$19.95

TUBES

2E26	5.00
3B28	5.00
4X150A	15.00
4CX250B	24.95
4CX250R	29.95
4CX250F	26.00
6146	3.99
6146A	5.25
6146B	6.25
6146W	6.95
6360/A	7.95
6907	35.00
6939	5.96
7289	9.95
7984	6.95
8072	45.00
8106	1.75
8560A/AS	30.00
8950	5.95
6KD6	4.65
6LQ6/6JE6	6.20
811	6.00
811A	10.95
717A	8.00
572B/T160L	29.00
4-400AX	39.95
4-125A	20.00
4CX15000A	150.00
8437	250.00
7007/6166A	600.00
3-500Z	69.00

R.F. TRANSISTORS

2N2857	1.80
2N2857JAN	2.35
2N2947	16.00
2N3375	6.00
2N3553	1.80
2N3818	5.50
2N3866	1.05
2N3866JAN	3.14
2N3866JANTX	4.25
2N3925	6.00
2N3948	2.00
2N3950	26.00
2N3960	4.70
2N4072	1.70
2N4427	1.24
2N4877	2.57
2N4957	2.50
2N5108	3.90

R.F. Transistors, con't.

2N5109	1.55
2N5179	59
2N5589	4.00
2N5583	5.00
2N5590	6.00
2N5591	10.00
2N6080	5.00
2N6081	6.00
2N6082	10.75
2N6083	12.00
2N6084	13.00
2N6095	10.00
2N6097	27.00
MRF502	99
MRF8004	69
SS2548	75
40281	10.90
40282	11.90

BRIDGES 25 AMPS 500PIV

\$2.99 each

ROTRON FEATHER FANS

Factory Fresh Type 213
230VAC 20W Max. \$12.95

MUFFIN FANS, REMOVED

from new equipment \$6.95

TEKTRONIX SCOPES

545/CA Plug-in \$499.95
HP Model 651A Test Oscilla-
tor \$299.95

ELECTRO/DATA PANORAMIC RECEIVER PLUG-IN UNIT

Model PN1011, will work in
Tektronix Scopes and will make
into Spectrum Analyzers. 1000
to 12,000 MHz \$299.95

LINEAR I.C.s

LM308H	1.00
LM309K	1.00
LM380N-14	60
LM301V	30
LM301H	30
LM1458V	50
LM304H	79
LM307V	35
LM310H	2.00
LM312	1.75
LM555V	49
LM555H	5.00
LM318H	1.00
LM324N	1.00

RADIO BOOKSHOP

LICENSE STUDY GUIDES & TAPES

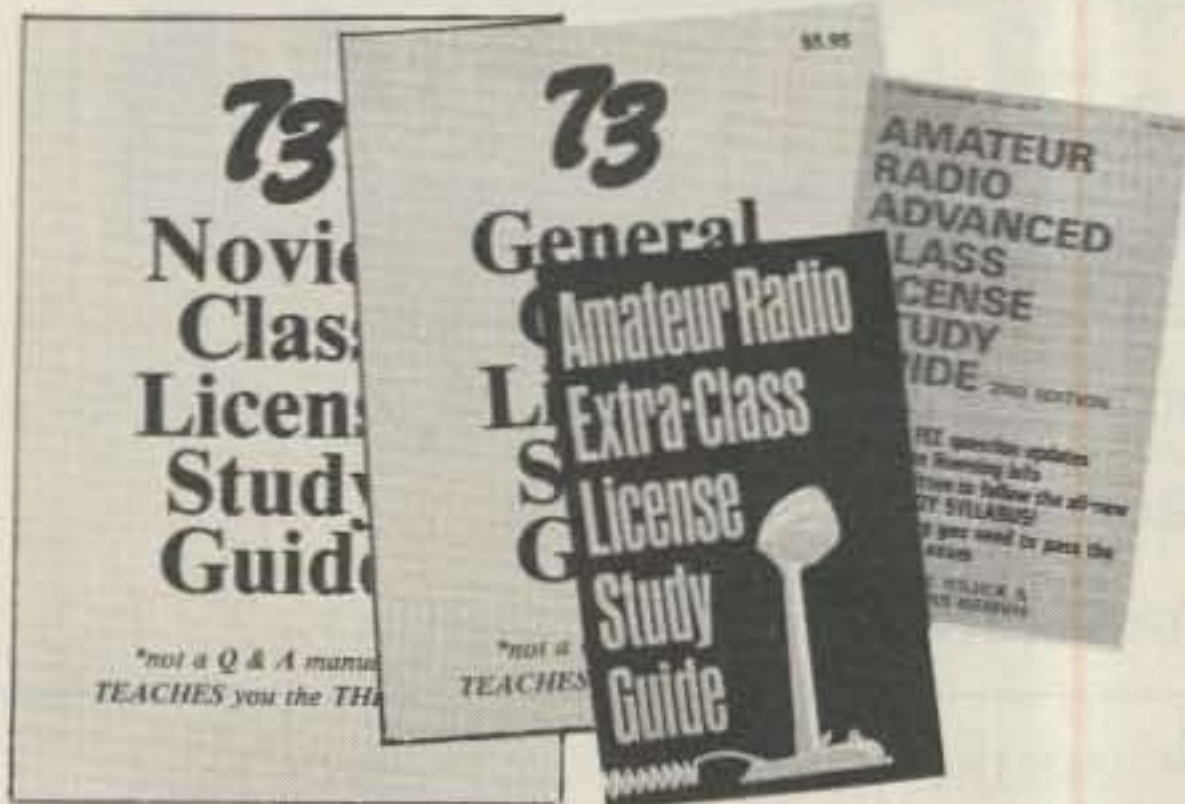

● **NOVICE STUDY GUIDE—SG7357**—Here is a completely new study guide and reference book for the potential ham. This is not a question/answer memorization course. Electronic and radio fundamentals are presented and explained in an easy-to-understand fashion, preparing the beginner for the Novice exam. Includes the latest FCC amateur regulations, as well as application forms. Easily the best path into the exciting world of ham radio! \$4.95.*

● **GENERAL CLASS STUDY GUIDE—SG7358**—A complete theory course for the prospective General or Technician. This reference explains transistor, amplifier, and general radio theory, while preparing the Novice for the "big" ticket. After getting your ticket, you'll use this guide again and again as an electronic reference source. Not a question/answer guide that becomes dated when the FCC updates the amateur exams. \$5.95.*

● **ADVANCED CLASS STUDY GUIDE—SG1081**—Ready to upgrade your license? To prevent retaking the FCC theory exam, you need the 73 Advanced theory guide. SSB, antenna theory, transmitters, and electronics measuring techniques are covered in detail in this easy-to-follow study guide. Special modes and techniques, such as RTTY, are also treated. An engineering degree is *not* necessary to master Advanced theory—try this book before visiting the examiner's office! \$5.95.*

● **EXTRA CLASS LICENSE STUDY GUIDE—SG1080**—Before going for your 1 x 2 call, it pays to be a master of the Extra class electronic theory. This study guide is the logical extension of the 73 theory course. All the theory necessary to pass the exam is presented. Antennas, transmission lines, swr are discussed, as well as noise, propagation, and specialized communication techniques. This book is not a classroom lecture or memorization guide, but rather a logical presentation of the material that must be *understood* before attempting the Extra exam. Save yourself a return trip to the FCC and try the 73 method first! \$5.95.*

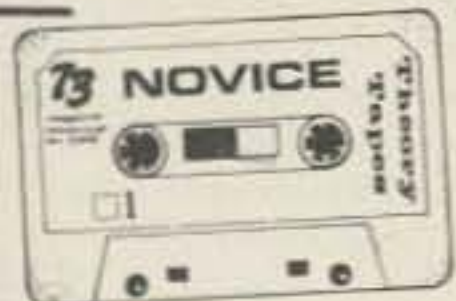

NOVICE THEORY TAPES Startling Learning Breakthrough

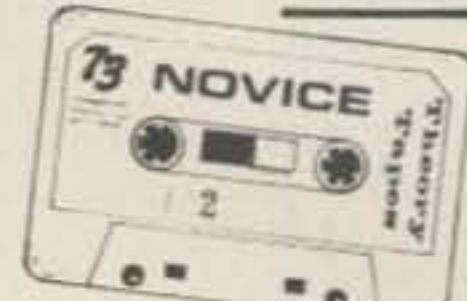

● **NOVICE THEORY TAPES—CT7300**—Startling Learning Breakthrough. You'll be astounded at how really simple the theory is when you hear it explained on these tapes. Three tapes of theory and one of questions and answers from the latest Novice exams give you the edge you need to breeze through your exam. 73 is interested in helping get more amateurs, so we're giving you the complete set of our tapes for the incredibly low price of **ONLY \$15.95.***

Scientists have proven that you learn faster by listening than by reading because you can play a cassette tape over and over in your spare time—even while you're driving! You get more and more info each time you hear it.

You can't progress without solid fundamentals. These four hour-long tapes give you all the basics you'll need to pass the Novice exam easily. You'll have an understanding of the basics which will be invaluable to you for the rest of your life! Can you afford to take your Novice exam without first listening to these tapes? Set of 4—\$15.95.*



SSTV

● **SLOW SCAN TELEVISION TAPE—CT7350**—Prize-winning programs from the 73 SSTV contest. Excellent for Demo! \$5.95.*

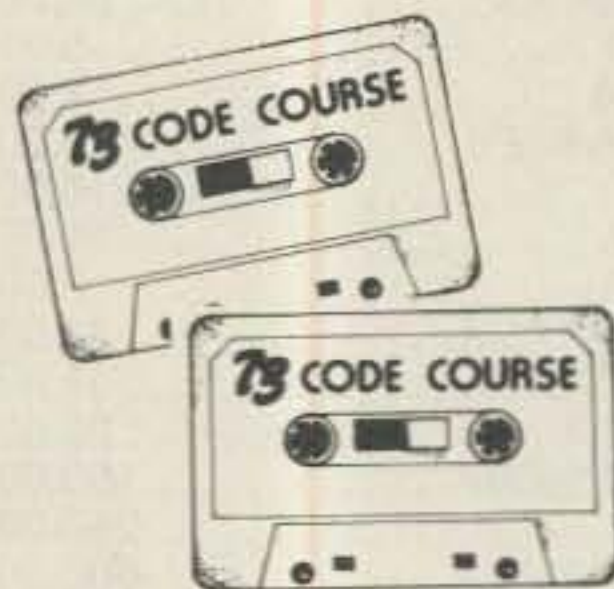

73 CODE SYSTEM TAPES

code, sent at the official FCC standard (no other tape we've heard uses these standards, so many people flunk the code when they are suddenly—under pressure—faced with characters sent at 13 wpm and spaced for 5 wpm). This tape is not memorizable, unlike the zany 5 wpm tape, since the code groups are entirely random characters sent in groups of five.

"COURAGEOUS"

20+ WPM—CT7320—Code is what gets you when you go for the Extra class license. It is so embarrassing to panic out just because you didn't prepare yourself with this tape. Though this is only one word faster, the code groups are so difficult that you'll almost fall asleep copying the FCC stuff by comparison. Users report that they can't believe how easy 20 per really is with this fantastic one hour tape.

"THE CANADIAN"

10+ WPM—CT7310—73 hasn't forgotten the Canadian hams—our 10 WPM tape prepares you to breeze through your country's licensing exams. Like the other code groups, the tape is not memorizable and, once mastered, provides a margin of safety in the actual text situation.

"OUTRAGEOUS"

25+ WPM—CT7325—This is the tape for that small group of overachieving hams who wouldn't be content to simply satisfy the code requirements of the Extra Class license. It's the toughest tape we've got and we keep a permanent file of hams who have mastered it. Let us know when you're up to speed and we'll inscribe your name in 73's CW "Hall of Fame."

Any Four Tapes For \$15.95! *
\$4.95 Each! *

"GENESIS"

5 WPM—CT7305—This is the beginning tape for people who do not know the code at all. It takes them through the 26 letters, 10 numbers and necessary punctuation, complete with practice every step of the way using the newest blitz teaching techniques. It is almost miraculous! In one hour many people—including kids of ten—are able to master the code. The ease of learning gives confidence to beginners who might otherwise drop out.

"BACK BREAKER"

13+ WPM—CT7313—Code groups again, at a brisk 13 per so you will be at ease when you sit down in front of the steely-eyed government inspector and he starts sending you plain language at only 13 per. You need this extra margin to overcome the panic which is universal in the test situations. When you've spent your money and time to take the test, you'll thank heavens you had this back-breaking tape.

"THE STICKLER"

6+ WPM—CT7306—This is the practice tape for the Novice and Technician licenses. It is made up of one solid hour of

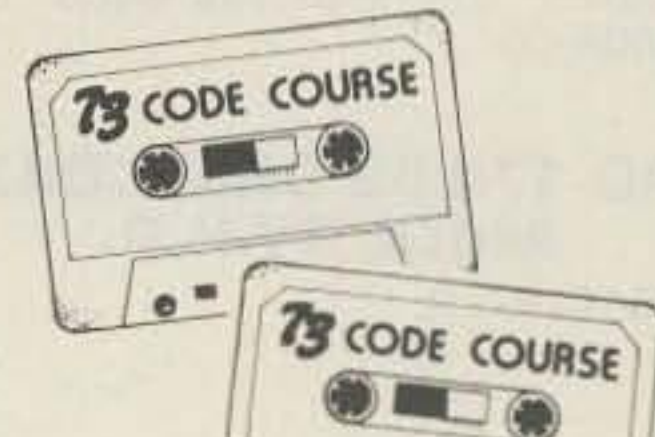

73 Radio Bookshop • Peterborough NH 03458. Be sure to include check or detailed credit card information.
* Add \$1.00 handling charge for orders under \$10.00. Note: Prices subject to change on books not published by 73 Magazine.

FOR CUSTOMER SERVICE CALL 603-924-6132

RADIO BOOKSHOP

73 TECHNICAL LIBRARY

● **BEHIND THE DIAL**—BK7307—By Bob Grove. Get more fun out of shortwave listening with this interesting guide to receivers, antennas, frequencies and interference. \$4.95.*

● **THE CHALLENGE OF 160**—BK7309—is the newest book in the 73 technical library, dedicated to 160 meter operating. Si Dunn provides all necessary information to get started on this unique band. The all-important antenna and ground systems are described in detail. The introduction contains interesting photos of Stew Perry's (the King of 160) shack. This reference is a must for new and experienced "Top Band" operators. Price: \$4.95.*

● **IC OP-AMP COOKBOOK**—BK1028—by Walter G. Jung. Covers not only the basic theory of the IC op amp in great detail, but also includes over 250 practical circuit applications, liberally illustrated. 592 pages, 5½ × 8½, softbound. \$12.95.*

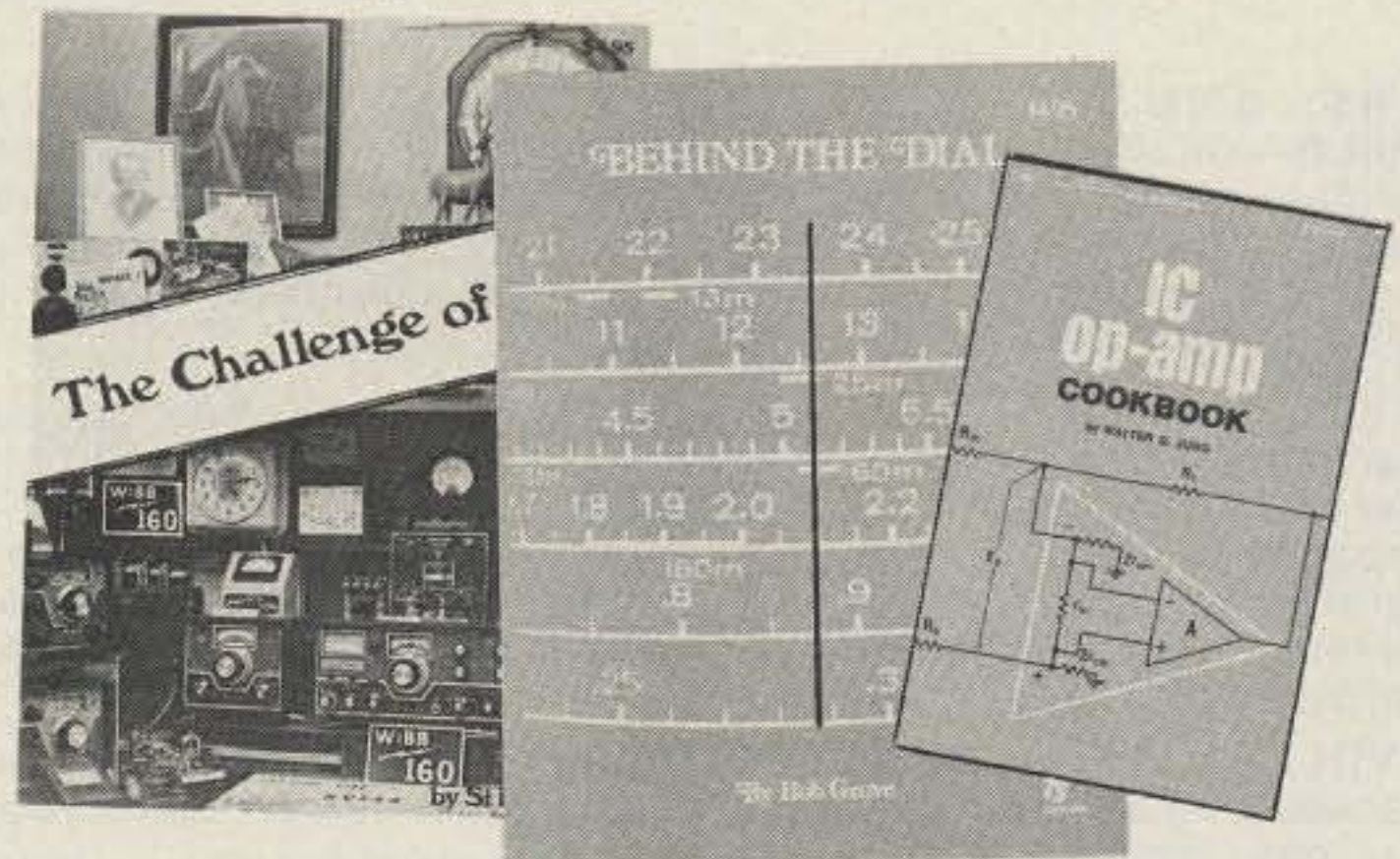

● **INTRODUCTION TO RTTY**—BK7380—A beginner's guide to radioteletype including teletypewriter fundamentals, signals, distortion and RTTY art. You can be a RTTY artist! A 73 publication. \$2.00.*

● **THE NEW RTTY HANDBOOK**—BK7347—is a new edition and the only up-to-date RTTY book available. The state of the art has been changing radically and has made all previous RTTY books obsolete. It has the latest circuits, great for the newcomer and expert alike. \$5.95.*

● **PROPAGATION WIZARD'S HANDBOOK**—BK7302—by J. H. Nelson. When sunspots riddled the worldwide communications networks of the 1940's, John Henry Nelson looked to the planets for an answer. The result was a theory of propagation forecasting based upon interplanetary alignment that made the author the most reliable forecaster in America today. The book provides an enlightened look at communications past, present, and future, as well as teaching the art of propagation forecasting. \$6.95.*

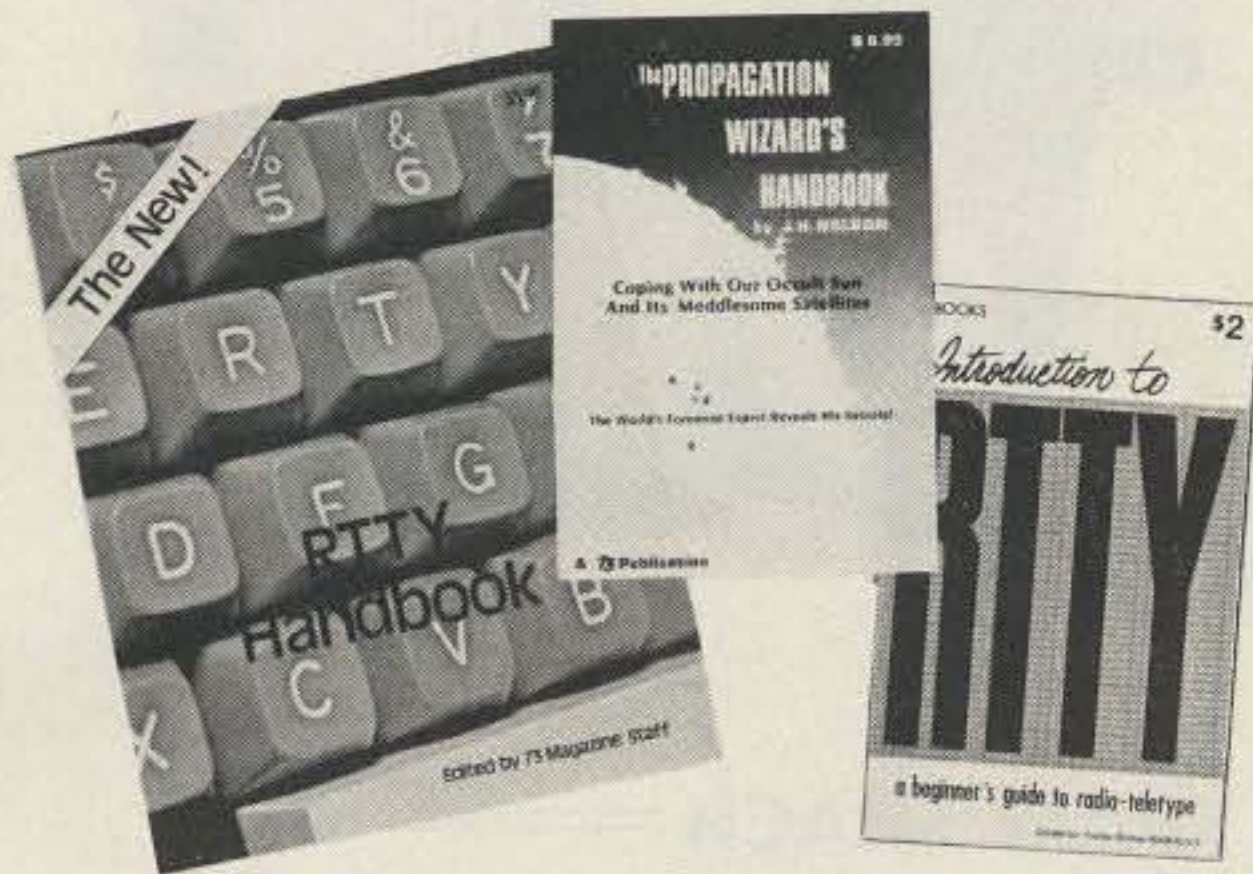

● **SSB . . . THE MISUNDERSTOOD MODE**—BK7351—by James B. Wilson. Single Sideband Transmission . . . thousands of us use it every day, yet it remains one of the least understood facets of amateur radio. J. B. Wilson presents several methods of sideband generation, amply illustrated with charts and schematics, which will enable the ambitious reader to construct his own sideband generator. A must for the technically-serious ham. \$5.50.*

● **SSTV HANDBOOK**—BK7354(hardcover), BK7355(softcover)—This excellent book tells all about it, from its history and basics to the present state-of-the-art techniques. Contains chapters on circuits, monitors, cameras, color SSTV, test equipment and much more. Hardbound \$7.00, softbound \$5.00.*

● **WEATHER SATELLITE HANDBOOK**—BK7370—Simple equipment and methods for getting good pictures from the weather satellite. Antennas, receivers, monitors, facsimile you can build, tracking, automatic control (you don't even have to be home). Dr. Taggart WB8DQT. \$4.95.*



ANTENNAS



● **73 DIPOLE AND LONG-WIRE ANTENNAS**—BK1016—by Edward M. Noll W3FQJ. This is the first collection of virtually every type of wire antenna used by amateurs. Includes dimensions, configurations, and detailed construction data for 73 different antenna types. Appendices describe the construction of noise bridges, line tuners, and data on measuring resonant frequency, velocity factor, and swr. \$5.50.*

● **73 VERTICAL, BEAM AND TRIANGLE ANTENNAS**—BK1069—by Edward M. Noll W3FQJ. Describes 73 different antennas for amateurs. Each design is the result of the author's own experiments covering the construction of noise bridges and antenna line tuners, as well as methods for measuring resonant frequency, velocity factor, and standing-wave ratios. 160 pages. \$5.50.*

● **VHF ANTENNA HANDBOOK**—BK7368—The NEW VHF Antenna Handbook details the theory, design and construction of hundreds of different VHF and UHF antennas . . . A practical book written for the average amateur who takes joy in building, not full of complex formulas for the design engineer. Packed with fabulous antenna projects you can build. \$4.95.*

73 Radio Bookshop • Peterborough NH 03458. Be sure to include check or detailed credit card information.

* Add \$1.00 handling charge for orders under \$10.00. Note: Prices subject to change on books not published by 73 Magazine.

FOR TOLL FREE ORDERING CALL 1-800-258-5473

RADIO BOOKSHOP

TEST EQUIPMENT

● **RF AND DIGITAL TEST EQUIPMENT YOU CAN BUILD**—BK1044—Rf burst, function, square wave generators, variable length pulse generators—100 kHz marker, i-f and rf sweep generators, audio osc, af/rf signal injector, 146 MHz synthesizer, digital readouts for counters, several counters, prescaler, microwave meter, etc. 252 pages. \$5.95.*

● **VOL. I COMPONENT TESTERS**—LB7359—... how to build transistor testers (8), diode testers (3), IC testers (3), voltmeters and VTVMs (9), ohmmeters (8 different kinds), inductance (3), capacity (9), Q measurement, crystal checking (6), temperature (2), aural meters for the blind (3) and all sorts of miscellaneous data on meters... using them, making them more versatile, making standards. Invaluable book. \$4.95.*

● **VOL. II AUDIO FREQUENCY TESTERS**—LB7360—... jam packed with all kinds of audio frequency test equipment. If you're into SSB, RTTY, SSTV, etc., this book is a must for you... a good book for hi-fi addicts and experimenters, too! \$4.95.*

● **VOL. III RADIO FREQUENCY TESTERS**—LB7361—Radio frequency waves, the common denominator of Amateur Radio. Such items as SWR, antenna impedance, line impedance, rf output and field strength; detailed instructions on testing these items includes sections on signal generators, crystal calibrators, grid dip oscillators, noise generators, dummy loads and much more. \$4.95.*

● **VOL. IV IC TEST EQUIPMENT**—LB7362—Become a troubleshooting wizard. All you need to know about pulse, audio and sync generators, frequency counters, digital component testers, logic probes and more! Plus a cumulative index for all four volumes of the 73 Test Equipment Library. \$4.95.*



THE WELL-EQUIPPED HAM SHACK



● **NEW REPEATER ATLAS OF THE ENTIRE WORLD**—BK7345—150% as big as any list ever available—nearly 900 more repeaters listed. New improved maps show the locations by frequency of every repeater in the States. Only \$1.95.*

● **QSL CARDS**—73 turns out a fantastic series of QSL cards at about half the cost of having them done elsewhere because they are run as a fill-in between printing books and other items in the 73 Print Shop. 250 Style W—QW0250—for \$8.95*; 500 Style W—QW0500—for \$13.95*; 250 Style X—QX0250—for \$8.95*; 500 Style X—QX0500—for \$13.95*; 250 Style Y—QY0250—for \$8.95*; 500 Style Y—QY0500—for \$13.95.*

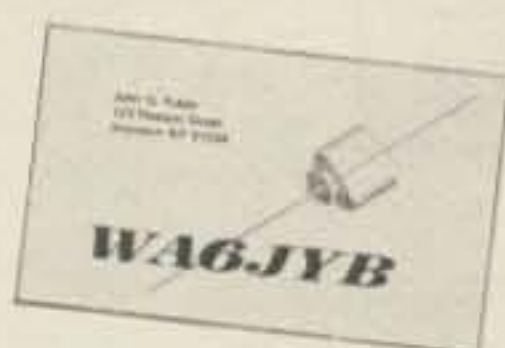

Style X



Style W



Style Y

● **73 MAGAZINE BINDERS**—Preserve and protect your collection for your lifetime! There's no excuse for lost issues when you have these handsome red binders with gold lettering. Order 1—BN1001—for \$6.50*; 2 or more—BN1002—for \$6.00 each.*

● **BACK ISSUES**—Complete your collection—many are prime collectibles now, classics in the field! A full collection is an invaluable compendium of radio and electronics knowledge! \$2.00 each*, or 5 for \$5.00.*

● **LIBRARY SHELF BOXES**—These sturdy white, corrugated, dirt-resistant boxes each hold a full year of 73 or Kilobaud. With your order, request self-sticking labels for any of the following: 73, Kilobaud, CQ, QST, Ham Radio, Personal Computing, Radio Electronics, Interface Age, and Byte. Order 1—BX1000—for \$2.00*; order 2-7—BX1001—for \$1.50 each*; order 8 or more—BX1002—for \$1.25 each*.



73 Radio Bookshop • Peterborough NH 03458. Be sure to include check or detailed credit card information.
* Add \$1.00 handling charge for orders under \$10.00. Note: Prices subject to change on books not published by 73 Magazine.

FOR CUSTOMER SERVICE CALL 603-924-6132

Radio Bookshop

● **SSB... THE MISUNDERSTOOD MODE** —BK7351—by James B. Wilson. Single Sideband Transmission... thousands of us use it every day, yet, it remains one of the least understood facets of amateur radio. J. B. Wilson presents several methods of sideband generation, amply illustrated with charts and schematics, which will enable the ambitious reader to construct his own sideband generator. A must for the technically-serious ham. \$5.50.*

● **PROPAGATION WIZARD'S HANDBOOK** —BK7302—by J. H. Nelson. When sunspots riddled the worldwide communications networks of the 1940's, John Henry Nelson looked to the planets for an answer. The result was a theory of propagation forecasting based upon interplanetary alignment that made the author the most reliable forecaster in America today. The book provides an enlightened look at communications past, present, and future, as well as teaching the art of propagation forecasting. 6.95.*



● **A GUIDE TO HAM RADIO**—BK7321—by Larry Kahaner WB2NEL. What's Amateur Radio all about? You can learn the basics of this fascinating hobby with this excellent beginner's guide. It answers the most frequently asked questions in an easy-going manner, and it shows the best way to go about getting an FCC license. A Guide to Ham Radio is an ideal introduction to a hobby enjoyed by people around the world. \$4.95.*



● **VOLUME IV—IC TEST EQUIPMENT**—LB7362—it's easy and fun to build your own test equipment with ICs! Here in this fourth volume of the 73 TEST EQUIPMENT LIBRARY are 42 home construction projects for building test equipment to work with your ham station and in servicing digital equipment. Counters, scalars, frequency standards, synthesizers, logic probes... JUST ABOUT EVERYTHING you need and can build with ICs. \$4.95.*

73 Radio Bookshop • Peterborough NH 03458. Be sure to include check or detailed credit card information.

* Add \$1.00 handling charge for orders under \$10.00. Note: Prices subject to change on books not published by 73 Magazine.

THE 73 RADIO BOOKSHOP ORDER FORM

Qty.	Cat.#	Description	Unit Price	Total

Add \$1 shipping & handling for orders under \$10:

Merchandise total:

SUBSCRIBE!

- 73 One year—73: \$18* 3 years—73: \$45*
 Kilobaud One year—KB: \$18* 3 years—Kilobaud: \$45*
 Life Sub (73/KB) \$195** New Sub Renewal Subscription total: _____

*U.S. & Canada only

**U.S. only

Enclosed _____ Check Money order

Bill my: Visa Master Charge American Express

Credit card # _____ Expiration date _____

Signature _____

Name _____

Address _____

City _____ State _____ Zip _____

Total subscription &/or merchandise:

73
magazine
peterborough nh 03458

For Toll Free Ordering : (800) 258-5473

(coupon expires in 60 days)

S1A

FOR TOLL FREE ORDERING CALL 1-800-258-5473

**21,560
pages.**



**That's the size of the world's
most comprehensive guide to
the subject of ham radio:
18 years of 73 Magazine.**

The back issues of 73 are a gold mine of interesting articles. Unlike the other magazines, which fill their pages with activity reports, there's little to go stale in 73. You'll find pioneering articles on SSTV, FM, repeaters, ICs, and computers. Even the editorials are fun as Wayne Green's dire predictions, like the debacle of incentive licensing, have come to pass.

Clip the coupon below and send for 73's new back issue catalogue. Treat yourself (or a friendly ham) to some fun, and a fantastic bargain to boot.

YES! Rush me 73's FREE Back Issue Catalogue!

Name _____

Address _____

City _____ State _____ Zip _____

51

73 magazine
PETERBOROUGH NH 03458

IS HARD COPY STORAGE A PROBLEM?



73, as thick as it is, is more like a floppy when it comes to standing on the bookshelf. Try the 73 Library Shelf Boxes, . . . sturdy corrugated white dirt resistant cardboard boxes which will keep them from flopping around. We have self-sticking labels for the boxes, too, not only for 73, but also for *Kilobaud* . . . and for *CQ*, *QST*, *Ham Radio*, *Personal Computing*, *Radio Electronics*, *Interface Age*, and *Byte*. Ask for whatever stickers you want with your box order. They hold a full year of 73 . . . or *Kilobaud*. Your magazine library is your prime reference, keep it handy and keep it neat with these strong library shelf boxes . . . One box is \$2.00, 2 boxes are \$3.00 and eight boxes are \$10.00. Be sure to specify which labels we should send. Have your credit card handy and call our toll-free order number 800-258-5473, or use the order card in the back of the magazine and mail to:



PROPAGATION

by
J. H. Nelson

EASTERN UNITED STATES TO:

GMT: 00 02 04 06 08 10 12 14 16 18 20 22

ALASKA	14	7A	7	7	7	7	7	7	7	7A	14	21A	21
ARGENTINA	14	7A	7	7	7	7	14	21	21A	21A	21A	21	
AUSTRALIA	21	14	7B	7B	7	7	7	14B	14	14	21	21A	
CANAL ZONE	14	7	7	7	7	7	14	21	21A	21A	21A	21	
ENGLAND	7	7	7	7	7	7B	14	21A	21A	14	7B	7	
HAWAII	21	14	7B	7	7	7	7	7B	7A	21	21A	21A	
INDIA	7	7	7B	7B	7B	7B	14B	14	14B	7B	7B	7	
JAPAN	14A	7B	7B	7	7	7	7	7	7B	7B	7B	14	
MEXICO	14	7	7	7	7	7	7	14	21	21A	21A	21	
PHILIPPINES	14	14	7B	7B	7B	7B	7	7	7B	7B	7B	7B	
PUERTO RICO	14	7	7	7	7	7	14	21	21	21A	21	14	
SOUTH AFRICA	14	7	7	7	7B	7A	21	21A	21A	21A	21	14	
U. S. S. R.	7	7	7	3A	7	7B	14	14A	14	7B	7B	7	
WEST COAST	21	14	7	7	7	7	7	14	21	21A	21A	21A	

CENTRAL UNITED STATES TO:

ALASKA	21	14	7	7	7	7	7	7	7A	14	21A	21	
ARGENTINA	14A	14	7A	7	7	7	7	14	21	21A	21A	21A	
AUSTRALIA	21A	14	7B	7B	7	7	7	7B	14	14	21	21	
CANAL ZONE	21	14	7	7	7	7	7	14	21A	21A	21A	21	
ENGLAND	7	7	7	7	7	7	7B	14	21A	14	7B	7	
HAWAII	21A	14	7B	7	7	7	7	7	7A	21	21A	21A	
INDIA	7B	7A	7B	7B	7B	7B	7B	14B	14B	7B	7B	7B	
JAPAN	21	14	7B	7	7	7	7	7	7	7B	7B	14	
MEXICO	14	7A	7	7	7	7	7	14	21	21	21A	21	
PHILIPPINES	21	14	7B	7B	7B	7B	7	7	7	7B	7B	14	
PUERTO RICO	14	7A	7	7	7	7	14	21	21	21A	21A	21	
SOUTH AFRICA	14	7	7	7	7B	7B	14	21	21A	21A	21	14	
U. S. S. R.	7B	7	7	3A	7	7B	7B	14	14	14B	7B	7B	

WESTERN UNITED STATES TO:

ALASKA	21	14	7	3	3	3	3	3	7	14	21	21	
ARGENTINA	21A	14	14	7	7	7	7	14	21	21	21A	21A	
AUSTRALIA	21A	21A	14	7B	7	7	7	7	7A	14	21	21	
CANAL ZONE	21	14	7	7	7	7	7	14	21	21A	21A	21A	
ENGLAND	7B	7	7	7	7	7	7B	7B	14A	14A	7B	7B	
HAWAII	21A	21A	14	7	7	7	7	7	7A	21	21A	21A	
INDIA	7B	14	7B	7B	7B	7B	7B	7	14B	7	7B	7B	
JAPAN	21A	14	7B	7	7	7	7	7	7	7	7B	14	
MEXICO	21	14	7	7	7	7	7	7A	21	21A	21A	21	
PHILIPPINES	21A	21	7A	7B	7B	7	7	7	7	7B	7B	14	
PUERTO RICO	14	7A	7	7	7	7	7	14	21	21A	21A	21	
SOUTH AFRICA	14	14B	7	7	7B	7B	7B	14	21	21A	21A	14	
U. S. S. R.	7B	7	7	3A	7	7B	7B	14B	14B	7B	7B	7B	
EAST COAST	21	14	7	7	7	7	7	14	21	21A	21A	21A	

- A = Next higher frequency may also be useful
- B = Difficult circuit this period
- F = Fair
- G = Good
- P = Poor
- SF = Chance of solar flares

January

sun	mon	tue	wed	thu	fri	sat
	1 G	2 G	3 G/SF	4 P/SF	5 F	6 F
7 F/SF	8 P/SF	9 P	10 F	11 G	12 G	13 G
14 G	15 G	16 G	17 F	18 G	19 G	20 G
21 F	22 F	23 F/SF	24 F/SF	25 F	26 G	27 G
28 G	29 G	30 G	31 G			

MOVING?

Let us know 8 weeks in advance so that you won't miss a single issue of 73 Magazine. Attach old label where indicated and print new address in space provided. Also include your mailing label whenever you write concerning your subscription. It helps us serve you promptly. Write to:



- Address change only
- Extend subscription
- Enter new subscription
- 1 year \$18.00
- Payment enclosed (1 extra BONUS issue)
- Bill me later

If you have no label handy, print OLD address here.

AFFIX LABEL

Name _____ Call _____

Address _____

City _____ State _____ Zip _____

print NEW address here:

Name _____ Call _____

Address _____

City _____ State _____ Zip _____

S179

READER SERVICE

A46 ABC Communications..... 182	G26 G & G Radio Electronics Co.... 75	R1 Radio Amateur Callbook, Inc.. 215
A1 Adirondack Radio Supply..... 72	G22 G.I.S.M.O..... 118	* Radio World..... 193
A24 Adva Electronics..... 218	G4 Godbout Electronics..... 208	R10 Rainbow Industries..... 72
A60 AED Electronics..... 17, 73	* HAL Communications Corp.... 15	R8 Ramsey Electronics..... 137, 204
A2 Aldelco..... 216	H24 Hal-Tronix..... 42, 98	R25 F. Reichert & Sales..... 211
A51 Amateur Radio of Rochester... 60	H2 Ham Radio Center..... 201	R27 RF Power Labs, Inc..... 17, 164
* Amsat..... 136	H31 Ham Radio Outlet..... 199	R15 Rolin Distributors..... 165
A62 Antenna Specialists..... 27, 195	H16 Hamtronics, NY..... 194, 205	R21 Rush Electronics..... 165
A6 Apron Laboratories..... 75	H8 Hamtronics, PA..... 171	S27 Sabtronics..... 200
A50 Associated Radio..... 212	H26 Hartwell's Office World..... 119	S63 Semiconductors Surplus..... 219
B1 Babylon Electronics..... 118	H5 Heath..... 191	S3 Sentry..... 164
B23 Barker-Williamson..... 76	H3 Henry Radio..... CII	S39 Sere-Rose & Spencer Elec.... 74
B32 Bay-Com..... 73	H4 Hy-Gain Electronics..... 37	S33 S-F Amateur Radio Ser.... 42, 170
B45 B&K Precision..... 194	I1 ICOM..... 9	S4 Slep Electronics Co..... 125
B29 Britt's 2-Way Radio..... 125	I32 Instant Software..... 112, 113	S8 Spectrum Communications... 43
B42 Brodie Electronics Company... 49	I9 Integrated Circuits, Unltd.... 210	S10 SST Electronics..... 17, 71
B8 Bullet Electronics..... 203	J1 Jameco Electronics..... 117, 209	S50 O.C. Stafford Electronics.... 170
* Butternut Electronics Co.... 164	J2 Jan Crystals..... 118	S43 Surplus Electronics..... 214
C88 C & A Electronic Enterprises... 161	J7 Jensen Tools & Alloys..... 193	T52 Tele-Tow'r Mfg. Co., Inc.. 130, 192
C3 Clegg..... 61, 123, 177	K13 Kantronics..... 130	* Ten-Tec..... 7
C21 Coakit..... 74	* Kilobaud..... 99	T34 Thomas Communications.... 89
C110 Coax Probe Co..... 76	* Kenwood..... CIV, 5	T48 Tower Electronics Corp.... 75
C105 Communications & TV Unltd.. 119	K14 Key Electronics..... 74	T18 Trac Electronics, Inc.... 168, 195
C58 Communications Ctr, NE. 159, 169	L9 Long's Electronics..... 150-155	T35 Trans Com..... 75
C5 Communications Electronics. 183	M35 Madison Electronics Supply.. 133	T3 Tufts Radio Electronics. 119, 122
C89 Communications Services... 118	M36 Maggiore Electronic Lab.... 74	U2 Unarco-Rohn..... 193
C6 Communications Spec..... 22, 23	M52 MFJ Entrp.45, 77, 119, 162, 165, 166	U8 United Products..... 202
C90 Curtis Electro Devices..... 165	M69 Micro Control Specialties... 72	U6 Universal Amateur Radio Service, Inc..... 73
C67 Cushcraft..... 27	M48 Microtronics..... 168	V5 VHF Engineering..... 135
* Dade County Hamfest..... 76	M41 Midland International..... 83	W17 Westcom Engineering..... 37
D6 Peter W. Dahl Company..... 196	M75 Mirage..... 192	W18 Western Electronics..... 72
D10 Davis Electronics..... 196	M76 M & M RF Distributors..... 163	W23 Wheaton Hamfest..... 122
D35 Daytapro Electronics, Inc.... 170	N2 New-Tronics..... 13	W2 Wilson Electronics..... 3, 195
D15 Dentron..... 16	O3 Optoelectronics, Inc..... 111	X1 Xitex..... 74, 75
D20 Digital Research Corp.... 206, 207	P15 Pace-Traps..... 193	Y1 Yaesu Elec. Corp.. CIII, 16, 31, 157
D23 Dovetron..... 170	P30 Palomar Electronics..... 21	From 73 pages..... 131, 220-226
D25 DSI Instruments..... 18, 19, 107	* Palomar Engineers..... 166	
E12 Engineering Specialties..... 217	P41 P.C. Electronics..... 73	
F1 Fair Radio Sales..... 170	P44 Pickering Codemaster Co.... 136	
F5 Fleisher Corporation..... 76, 193	P2 Poly Paks..... 213	
G12 Germantown Amateur Supply. 60	Q3 Quest Electronics..... 198	

*Reader Service inquiries not honored. Please contact advertiser directly.

BOOKS, ETC.

BK1016 73 DIPOLE & LONG WIRE ANTENNAS..... \$ 5.50	QW0500 QSL CARDS—STYLE W—500..... \$13.95
ST0000 73 BACK ISSUE..... \$ 3.00	QX0250 QSL CARDS—STYLE X—250..... \$ 8.95
ST2500 73 BACK ISSUES—25 OUR CHOICE..... \$10.00	QX0500 QSL CARDS—STYLE X—500..... \$13.95
ST0500 73 BACK ISSUES—5 YOUR CHOICE..... \$ 5.00	QY0250 QSL CARDS—STYLE Y—250..... \$ 8.95
ST1000 73 BACK ISSUES—10 YOUR CHOICE..... \$12.00	QY0500 QSL CARDS—STYLE Y—500..... \$13.95
ST2501 73 BACK ISSUES—25 YOUR CHOICE..... \$20.00	BK7345 REPEATER ATLAS..... \$ 1.95
BK7307 BEHIND THE DIAL..... \$ 4.95	BK1044 RF DIGITAL TEST EQUIPMENT..... \$ 5.95
BN1001 BINDER—73—1..... \$ 6.50	BK7347 RTTY HANDBOOK..... \$ 5.95
BN1002 BINDER—73—2&UP..... \$ 6.00	BX1000 SHELF BOX—1..... \$ 2.00
BK7309 CHALLENGE OF 160..... \$ 4.95	BX1001 SHELF BOX—2..... \$ 1.50
CT7305 CODE TAPE—5 WPM..... \$ 4.95	BX1002 SHELF BOX—8 UP..... \$ 1.25
CT7306 CODE TAPE—6 WPM..... \$ 4.95	BK7351 SSB THE MISUNDERSTOOD MODE..... \$ 5.50
CT7310 CODE TAPE—10 WPM..... \$ 4.95	BK7354 SSTV HANDBOOK (HARDCOVER)..... \$ 7.00
CT7313 CODE TAPE—13 WPM..... \$ 4.95	BK7355 SSTV HANDBOOK (SOFTCOVER)..... \$ 5.00
CT7320 CODE TAPE—20 WPM..... \$ 4.95	CT7350 SSTV TAPE..... \$ 5.95
CT7325 CODE TAPE—25 WPM..... \$ 4.95	SG1081 STUDY GUIDE—ADVANCED CLASS..... \$ 5.95
CT7399 CODE TAPE—LEARN MORSE CODE..... \$ 4.95	SG1080 STUDY GUIDE—EXTRA CLASS..... \$ 5.95
CT7394 CODE TAPES (ANY FOUR ABOVE)..... \$15.95	SG7358 STUDY GUIDE—GENERAL CLASS..... \$ 5.95
BK7321 GUIDE TO HAM RADIO..... \$ 4.95	SG7357 STUDY GUIDE—NOVICE CLASS..... \$ 4.95
BK7325 HOW TO BUILD A MICROCOMPUTER..... \$ 9.95	LB7359 TEST EQUIP LIB V1—COMP TESTERS..... \$ 4.95
BK1028 IC OP AMP COOKBOOK..... \$12.95	LB7360 TEST EQUIP LIB V2—AUDIO TESTERS..... \$ 4.95
BK7380 INTRO TO RTTY..... \$ 2.00	LB7361 TEST EQUIP LIB V3—RADIO EQUIP..... \$ 4.95
CT7300 NOVICE THEORY TAPES..... \$15.95	LB7362 TEST EQUIP LIB V4—IC TEST EQUIP..... \$ 4.95
BK1100 PRACTICAL TEST INSTRUMENTS..... \$ 4.95	BK1069 VERTICAL BEAM & TRIANGLE ANTNS..... \$ 5.50
BK7302 PROPAGATION WIZARD'S HANDBOOK.. \$ 6.95	BK7368 VHF ANTENNA HANDBOOK..... \$ 4.95
QW0250 QSL CARDS—STYLE W—250..... \$ 8.95	BK7370 WEATHER SATELLITE HANDBOOK..... \$ 4.95

YAESU
The radio.



3+1+1=227

MODERN MATH??

NO

YAESU'S NEW

FT-227RA

(220 MHz Version - FT-127RA)

All this versatility plus . . .

3 simplex memories

1 programmable split (up to 4 MHz)

1 dial set frequency (\pm 600 KHz)

- Remote up/down scanning from the microphone
- 800 PLL synthesized channels in 5 KHz steps
- Built in programmable tone burst
- Hi/low power selection 10/1W
- Status lamps indicate "On Air" and "Channel Busy"
- Superior cross modulation, overload and image rejection characteristics
- Protection against high VSWR and reversed supply polarity



Covers the range.

Kenwood's TS-700SP...a time proven rig that now covers the new repeater subband (144.5 to 145.5 MHz).

TS-700SP features all of the fine attributes of the TS-700S: a digital frequency display, receiver preamp, VOX, semi-break-in, and CW sidetone. Of course, it's all mode, 144-148 MHz, VFO controlled...and Kenwood quality throughout. Get all the details and see the TS-700SP now at your nearest Authorized Kenwood Dealer!



KENWOOD

...pacesetter in amateur radio

TRIO-KENWOOD COMMUNICATIONS INC.
1111 WEST WALNUT / COMPTON, CA 90220