

# DU MONT

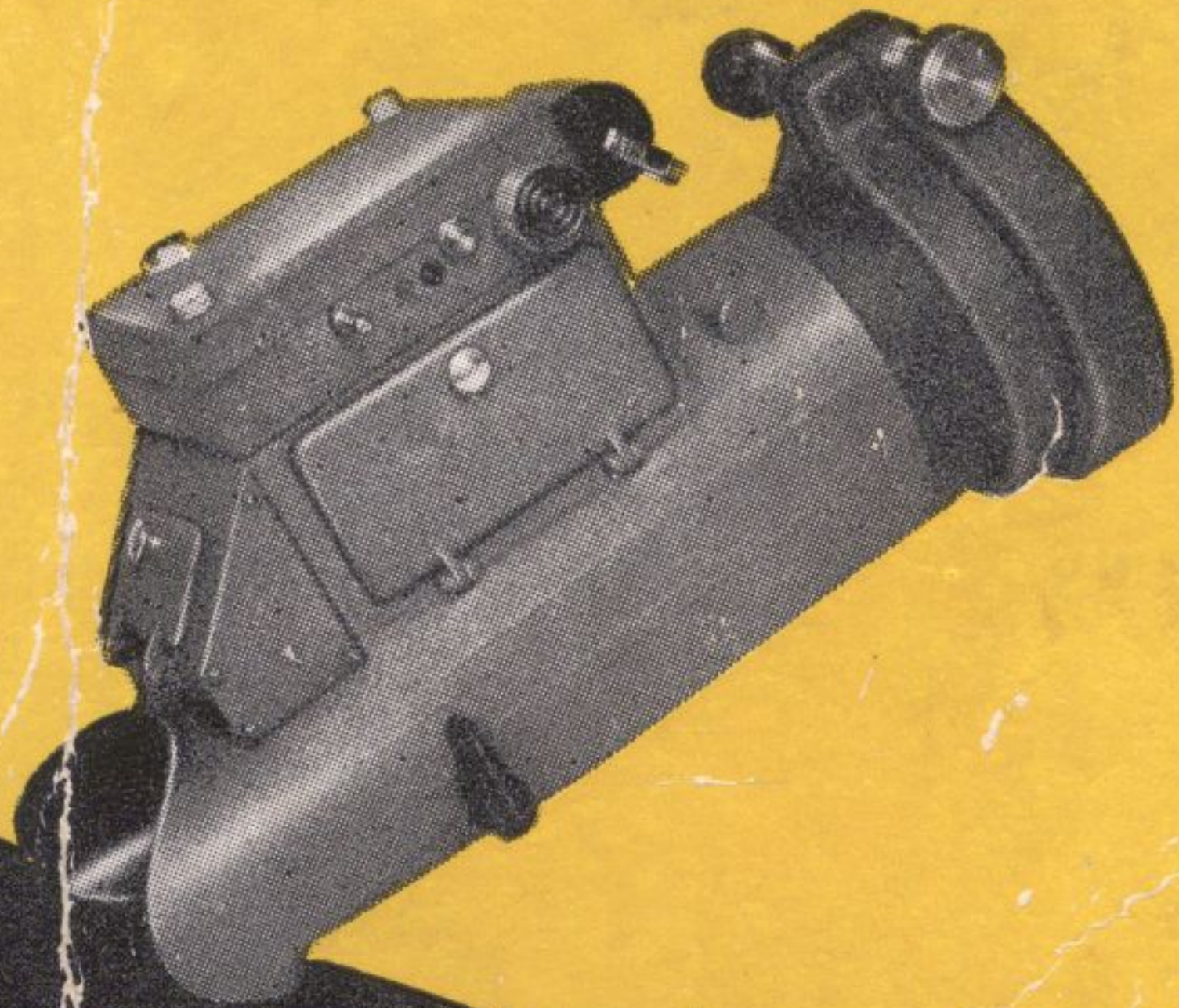

**cathode - ray  
EQUIPMENT**

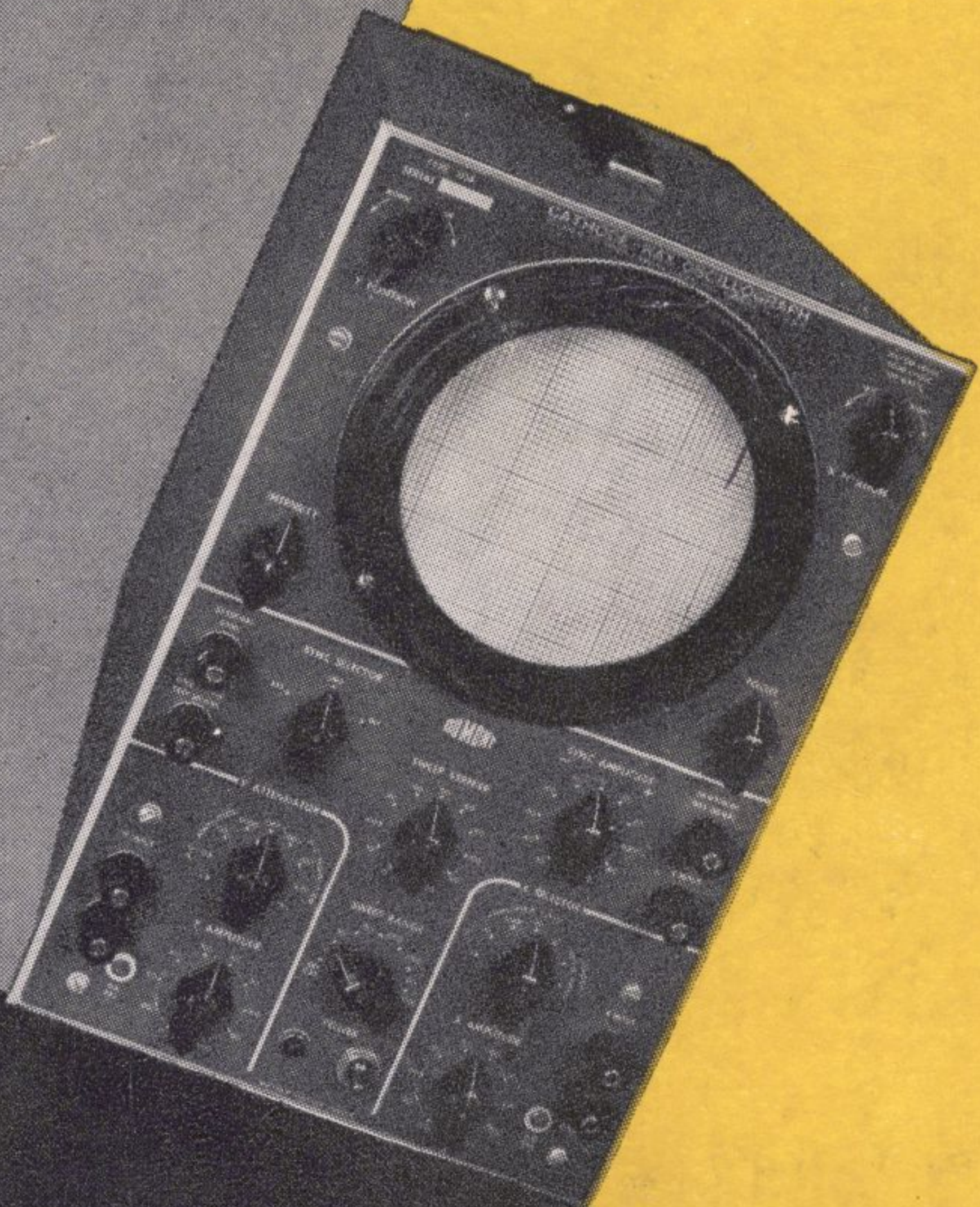

H. T. Neher

A DU MONT CATALOG  
FOR ENGINEERS  
INTERESTED IN  
CATHODE-RAY  
OSCILLOGRAPHY

---

*Eighth Edition*

H. T. Neher

A CATALOG  
OF  
EQUIPMENT  
FOR  
OSCILLOGRAPHY

*EIGHTH EDITION*

INSTRUMENT & CATHODE-RAY  
TUBE DIVISIONS

*ALLEN B. DU MONT LABORATORIES, INC.  
CLIFTON, NEW JERSEY, U. S. A.*

Copyright 1951  
INSTRUMENT & CATHODE-RAY TUBE DIVISIONS  
ALLEN B. DU MONT LABORATORIES, INC.  
CLIFTON, NEW JERSEY

---

*Eighth Edition*

First Printing

Printed in U.S.A.

March, 1951

H. T. Neher

## FOREWORD

This catalog is a description of the products of the Instrument and Cathode-ray Tube Divisions of Allen B. Du Mont Laboratories, Inc. In addition, we explain some fundamental principles of oscillography and some design problems which are encountered in the development of these products. We feel that any prospective user who understands these principles and who recognizes the goal which the designer tries to attain will be the better qualified to select the proper equipment to fulfill his specific needs.

The scope of activity of these Divisions embraces the development and manufacture of cathode-ray equipment which will meet the needs of the government and of private industry for oscillographic equipment. It is our desire to make such equipment available in commercial form at the earliest possible time, consistent with the state of the art. To this end, we feel it is the duty of an organization such as ours, which is devoted to engineering service, to work closely with the users and prospective users of cathode-ray instruments. Therefore, we hold ourselves available at all times for consultation on problems related to the field of cathode-ray oscillography.

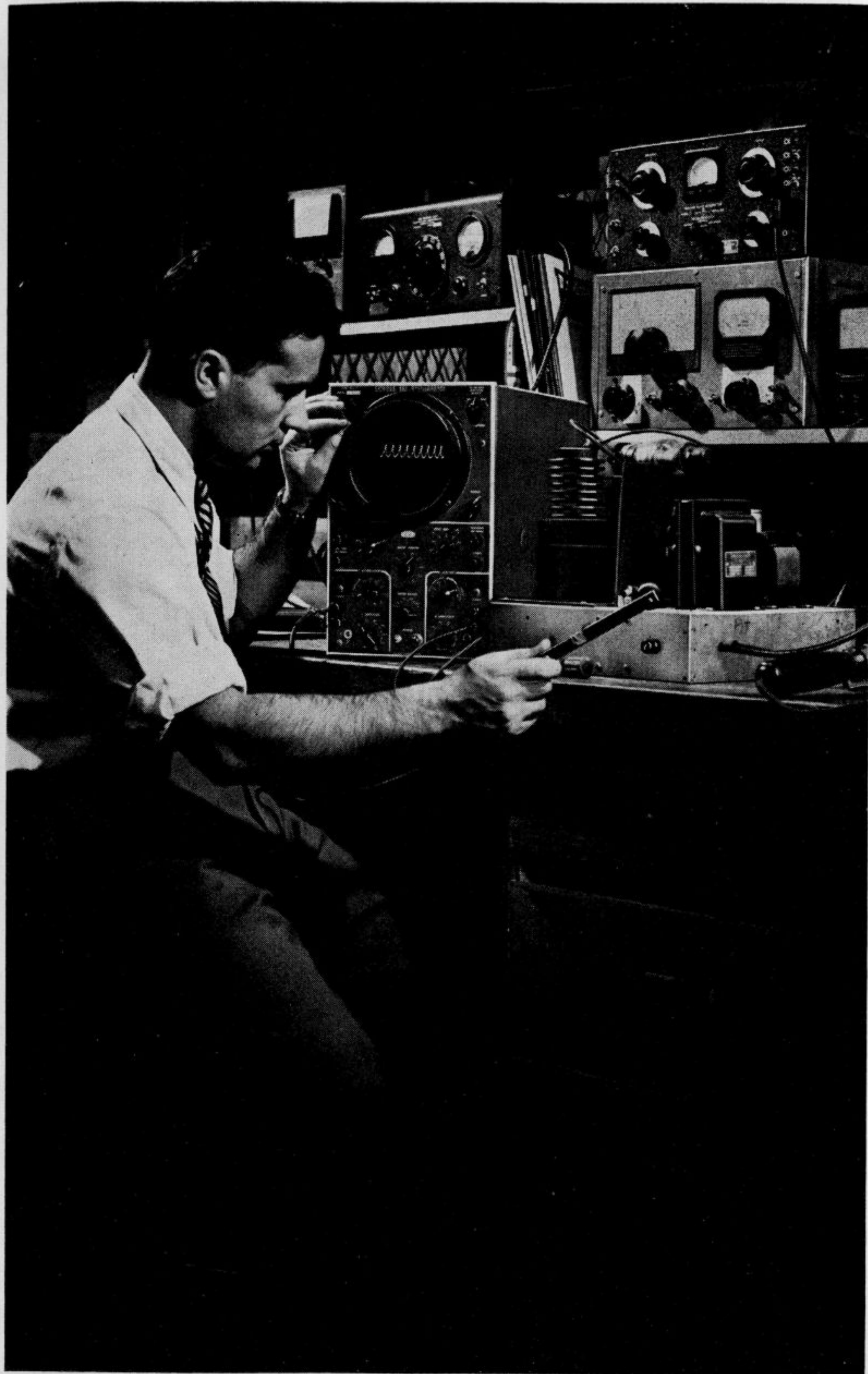

The Du Mont Type 304-H employed in the development of rectified r-f high-voltage power supplies

## TABLE OF CONTENTS

### DU MONT CATHODE-RAY OSCILLOGRAPHS

|  | PAGE |
|--|------|
| Type 250-AH Cathode-ray Oscillograph.....        | 1    |
| Type 256-D Cathode-ray Oscillograph.....         | 5    |
| Type 256-E Cathode-ray Oscillograph.....         | 5    |
| Type 274-A Cathode-ray Oscillograph.....         | 10   |
| Type 275-A Polar-coordinate Indicator.....       | 12   |
| Type 279 Dual-beam Cathode-ray Oscillograph..... | 16   |
| Type 281-A Cathode-ray Indicator.....            | 21   |
| Type 292 Cathode-ray Oscillograph.....           | 26   |
| Type 293 Cathode-ray Oscillograph.....           | 29   |
| Type 294-A Cathode-ray Oscillograph.....         | 35   |
| Type 303 Cathode-ray Oscillograph.....           | 39   |
| Type 304-H Cathode-ray Oscillograph.....         | 45   |
| Type 304-HR Cathode-ray Oscillograph.....        | 50   |

### DU MONT SPECIAL PROJECTS

|  |    |
|--|----|
| Special Four-channel Cathode-ray Oscillograph..... | 53 |
| Special Wide-band Cathode-ray Oscillograph.....    | 54 |

### DU MONT AUXILIARY INSTRUMENTS

|   |    |
|---|----|
| Type 185-A Electronic Switch.....         | 57 |
| Type 263-B High-voltage Power Supply..... | 59 |
| Type 308-A High-voltage Power Supply..... | 60 |
| Type 264-B Voltage Calibrator.....        | 61 |
| Type 286-A High-voltage Power Supply..... | 63 |

### DU MONT ACCESSORY EQUIPMENT

|                                       |    |
|---------------------------------------|----|
| Type 189 Movable Table.....           | 67 |
| Type 276-A Viewing Hood.....          | 67 |
| Type 2501 Bezel.....                  | 67 |
| Type 2502 Magnetic Shield.....        | 68 |
| Type 2503 Magnetic Shield.....        | 68 |
| Type 2521 Magnetic Shield.....        | 68 |
| Connectors for Cathode-ray Tubes..... | 68 |
| Type 2504 Step-down Transformer.....  | 69 |
| Type 2505 Step-down Transformer.....  | 69 |
| Type 2507 Test Probe.....             | 69 |
| Type 316 Test Probe.....              | 69 |
| Type 2518 Calibrated Scale.....       | 70 |
| Type 2519 Calibrated Scale.....       | 70 |
| Type 2520 Calibrated Scale.....       | 70 |
| Type 216 Calibrated Scales.....       | 70 |
| Type 2560 Color Filters.....          | 71 |
| Type 216 Color Filters.....           | 71 |
| Type 2561 Calibrated Scale.....       | 71 |

|   |    |
|---|----|
| Type 2542 Projection Lens.....                | 71 |
| Type 2546 High-voltage Chassis Connector..... | 72 |
| Type 2547 High-voltage Cable.....             | 72 |

**DU MONT PHOTO-RECORDING EQUIPMENT**

|   |    |
|---|----|
| Type 295 Oscillograph-record Camera.....    | 75 |
| Type 296 Oscillograph-record Camera.....    | 79 |
| Type 297 Oscillograph-record Camera.....    | 81 |
| Type 321 Oscillograph-record Camera.....    | 84 |
| Type 2512 Motor Driven Processing Unit..... | 86 |
| Type 2513 Stainless Steel Tank.....         | 86 |
| Type 2514 Portable Drying Rack.....         | 86 |
| Type 2580 Film Take-up Cassette.....        | 86 |
| Type 2581 Film Supply Magazine.....         | 87 |
| Type 2582 Film Take-up Magazine.....        | 87 |
| Polaroid-Land Film.....                     | 87 |

**GENERAL INFORMATION**

|  |     |
|--|-----|
| Cathode-ray Oscillograph.....  | 91  |
| History.....   | 91  |
| Du Mont Research and Development.....                                      | 92  |
| General Description of the Cathode-ray Oscillograph.....                   | 92  |
| Cathode-ray Tube.....  | 94  |
| Considerations Involved in Visual Observation of Cathode-ray Patterns..... | 97  |
| Operating Potentials, Spot Size, Intensity, Deflection Sensitivity.....    | 97  |
| Deflection-plate Capacitances.....   | 97  |
| Screens.....   | 97  |
| P1 Screen.....   | 97  |
| P2 Screen.....   | 97  |
| P5 and P11 Screens.....  | 98  |
| P7 Screen.....   | 98  |
| P15 Screen.....  | 99  |
| Grid-drive Characteristics.....  | 99  |
| Operating Notes.....   | 101 |

**OSCILLOGRAPH DESIGN CONSIDERATIONS**

|                                 |     |
|---------------------------------|-----|
| Power Transformer.....          | 102 |
| Low-voltage Power Supplies..... | 103 |
| High-voltage Power Supply.....  | 104 |
| Deflection Amplifiers.....      | 104 |
| Intensity Modulation.....       | 106 |
| Attenuator Circuits.....        | 107 |
| Positioning Circuits.....       | 108 |
| Time-base Generators.....       | 109 |
| Sweep-delay Circuits.....       | 115 |

**INTERPRETATION OF OSCILLOGRAPH SPECIFICATIONS**

|  |     |
|--|-----|
| Screen Size and Maximum Deflection.....            | 116 |
| Shape of Amplifier Frequency-Response Curves.....  | 116 |
| Phase Shift vs. Frequency Response.....            | 116 |
| Amplifier Band-width vs. Gain-control Setting..... | 117 |
| Usable Band-width.....                             | 118 |
| Balanced vs. Single-ended Deflection.....          | 118 |
| Resolving Power.....                               | 119 |
| Sensitivity vs. Input Impedance.....               | 119 |
| Sweep Linearity.....                               | 119 |
| Usable Duty Cycle on Triggered Sweeps.....         | 120 |
| Maximum Input Voltage.....                         | 120 |
| Connections to Deflection Plates.....              | 120 |
| Synchronizing-signal Polarity.....                 | 120 |
| Stability of Operation.....                        | 120 |
| Adequate Shielding.....                            | 120 |
| Accessibility for Servicing.....                   | 121 |
| Flexibility of Operation.....                      | 121 |
| Accessories and Auxiliary Equipment.....           | 121 |
| Manufacturers' "Know-How".....                     | 121 |
| Guarantee.....                                     | 121 |
| Repair and Servicing Facility.....                 | 121 |
| Du Mont Publication.....                           | 121 |

**CONSIDERATIONS INVOLVED IN OBSERVATION OF CATHODE-RAY PATTERNS**

|   |     |
|---|-----|
| Stationary Patterns of Periodic or Recurrent Phenomena..... | 122 |
| Low and Medium-Speed Transients.....                        | 122 |
| High-speed Single Transients.....                           | 123 |

**TECHNIQUES OF PHOTO-RECORDING**

|                                    |     |
|------------------------------------|-----|
| Conventional Film Emulsion.....    | 127 |
| Introduction.....                  | 127 |
| Single-frame Recording.....        | 127 |
| Stationary Patterns.....           | 128 |
| Continuously Varying Patterns..... | 128 |
| Single Transients.....             | 129 |
| Screen Considerations.....         | 130 |
| Recording Materials.....           | 130 |
| Film Speeds.....                   | 134 |
| Processing Techniques.....         | 134 |
| Sources of Fog.....                | 135 |
| Cathode-Glow.....                  | 136 |
| Stray Emission.....                | 136 |
| Continuous-motion Recording.....   | 138 |
| Calibration.....                   | 139 |

|   | PAGE |
|---|------|
| Polaroid-Land Process.....                    | 141  |
| Introduction .....                            | 141  |
| The Process.....                              | 141  |
| Recording Material .....                      | 142  |
| Recording of Stationary Patterns .....        | 142  |
| Transient Recording .....                     | 142  |
| Presensitizing the Film.....                  | 142  |
| Reproducing the Polaroid-Land Recording ..... | 142  |
| References .....                              | 143  |

**DU MONT CATHODE-RAY-TUBE SCREEN CHARACTERISTICS**

|                  |     |
|------------------|-----|
| P1 Screen .....  | 149 |
| P2 Screen .....  | 150 |
| P5 Screen .....  | 152 |
| P7 Screen .....  | 153 |
| P11 Screen ..... | 155 |

**DU MONT CATHODE-RAY TUBES**

|                                    |     |
|------------------------------------|-----|
| Type 3AP-A Cathode-ray Tubes.....  | 159 |
| Type 3GP-A Cathode-ray Tubes.....  | 161 |
| Type 3JP- Cathode-ray Tubes.....   | 163 |
| Type 3RP-A Cathode-ray Tubes ..... | 166 |
| Type 5BP-A Cathode-ray Tubes.....  | 169 |
| Type 5CP-A Cathode-ray Tubes.....  | 171 |
| Type 5JP-A Cathode-ray Tubes.....  | 174 |
| Type 5LP-A Cathode-ray Tubes.....  | 177 |
| Type 5RP-A Cathode-ray Tubes.....  | 180 |
| Type 5SP- Cathode-ray Tubes.....   | 184 |
| Type 5XP- Cathode-ray Tubes.....   | 188 |
| Type 5YP- Cathode-ray Tubes .....  | 192 |
| Type 2B4 Gas Triode.....           | 195 |
| Type 6Q5G Gas Triode.....          | 195 |

**LIST OF ILLUSTRATIONS**

**CATHODE-RAY OSCILLOGRAPHS**

|   | PAGE   |
|---|--------|
| Type 250-AH Cathode-ray Oscillograph .....  | 1      |
| Frequency-response characteristic of Type 250-AH .....  | 2      |
| Type 256-D Cathode-ray Oscillograph .....   | 5      |
| Oscillogram of 1-microsecond pulse taken from Type 256-D.....   | 7      |
| Block Diagram of Type 256-D .....   | 7      |
| Conversion chart: Microseconds to yards .....   | 8      |
| Type 274-A Cathode-ray Oscillograph .....   | 10     |
| Frequency-response characteristic of Type 274-A.....  | 11     |
| Type 275-A Polar-coordinate Indicator .....   | 12     |
| Radial deflections indicating the arrival and departure of shuttle at shuttle box .....               | 12     |
| The two-phase generator supplied with Type 275-A .....  | 13     |
| Typical oscillograms taken from ignition system of an automobile .....                                | 13     |
| Angle markers impressed on the circular trace.....  | 14     |
| Indication of the bounce of a relay arm.....  | 14     |
| Light-distribution pattern .....  | 15     |
| Type 279 Dual-beam Cathode-ray Oscillograph .....   | 16     |
| Type 5SP- and electron-gun structure .....  | 17     |
| Oscillograms taken from Type 279 .....  | 17, 18 |
| Frequency-response characteristic of Type 279 .....   | 19     |
| Type 281-A Cathode-ray Indicator.....   | 21     |
| Oscillograms taken from Type 281-A illustrating advantages of high accelerating potential..           | 22     |
| Type 281-A and Type 286-A High-voltage Power Supply fastened together in their cabinets               | 22     |
| Graphic comparison of deflection factor of Type 5RP-A and non-intensifier type.....                   | 23     |
| Top view of Type 281-A with cabinet removed .....   | 24     |
| Bottom view of Type 281-A.....  | 24     |
| Type 292 Cathode-ray Oscillograph.....  | 26     |
| Type 3RP-A Cathode-ray Tube.....  | 26     |
| Electron-gun and deflection-plate structure of the Type 3RP-A .....                                   | 27     |
| Type 293 Cathode-ray Oscillograph.....  | 29     |
| Detail view of front panel showing manual-trigger push-button.....                                    | 30     |
| Rear-panel connections to the Type 293.....   | 31     |
| Detail of panel showing voltage calibrator controls and meter.....                                    | 31     |
| Recording camera supplied with Type 293.....  | 32     |
| Illustration of relative size of Type 293.....  | 32     |
| Actual impulse-test records photographed from Type 293.....   | 33     |
| Type 294-A Cathode-ray Oscillograph.....  | 35     |
| Oscillogram: Positive trigger output of Type 294-A.....   | 37     |
| Type 294-A and Type 189 Movable Table.....  | 37     |
| Type 303 Cathode-ray Oscillograph.....  | 39     |
| Frequency-response characteristic of Type 303 .....   | 40     |
| Oscillogram: Multiple exposure showing capabilities of Type 303.....                                  | 41     |
| Oscillograms illustrating deflection-plate cut-off characteristic of Type 5YP- Cathode-ray Tube ..... | 41, 42 |
| Oscillogram: Output of Geiger-Mueller Tube.....   | 43     |

|  | PAGE |
|--|------|
| Oscillograms: Vertical sync and blanking pulses—unexpanded and expanded.....                         | 43   |
| Type 304-H Cathode-ray Oscillograph.....   | 45   |
| Vertical amplifier response of the Type 304-H.....   | 46   |
| Indication of an oscillating neon bulb.....  | 46   |
| Indication of variation in volume of contents of a retort, applied through d-c channel .....         | 47   |
| Indication of variation in volume of contents of a retort, applied through a-c channel .....         | 47   |
| Oscillogram of voltage field in the vicinity of a fluorescent lamp.....                              | 47   |
| Oscillogram of voltage field displayed with full expansion of sweep .....                            | 48   |
| Attempt to display high-frequency components of low-frequency signal by increasing sweep speed ..... | 48   |
| Random vibration displayed on recurrent sweep.....   | 49   |
| Random vibration displayed on driven sweep.....  | 49   |

### DU MONT SPECIAL PROJECTS

|   |    |
|---|----|
| Applying base to special 5-gun cathode-ray tube .....                 | 52 |
| Top view of special 4-channel oscillograph.....                       | 53 |
| Front-panel view of 4-channel oscillograph.....                       | 53 |
| Distributed amplifier as used in special wide-band oscillograph ..... | 54 |

### DU MONT AUXILIARY INSTRUMENTS

|   |        |
|---|--------|
| The Type 185-A Electronic Switch.....                                       | 57     |
| Typical oscillograms which are possible through use of the Type 185-A ..... | 57, 58 |
| The Type 263-B High-voltage Power Supply.....                               | 59     |
| R-F transformer of Type 263-B.....  | 60     |
| The Type 264-B Voltage Calibrator.....                                      | 61     |
| Schematic of Type 264-B circuit.....  | 61     |
| Photographs of Type 264-B in operation.....                                 | 62     |
| The Type 286-A High-voltage Power Supply.....                               | 63     |
| Inside view of the Type 286-A .....   | 63     |
| Voltage-regulation curves for the Type 286-A .....                          | 63     |

### DU MONT ACCESSORY EQUIPMENT

|   |    |
|---|----|
| Type 189 Movable Table.....                   | 67 |
| Type 276-A Viewing Hood.....                  | 67 |
| Type 2502 Magnetic Shield.....                | 68 |
| Type 2503 Magnetic Shield.....                | 68 |
| Type 2521 Magnetic Shield.....                | 68 |
| Type 316 Test Probe .....                     | 69 |
| Type 2542 Projection Lens.....                | 71 |
| Type 2546 High-voltage Chassis Connector..... | 72 |
| Type 2547 High-voltage Cable.....             | 72 |

### DU MONT PHOTO-RECORDING EQUIPMENT

|   |    |
|---|----|
| Type 304-H Cathode-ray Oscillographs in process of Manufacture.....         | 74 |
| Type 295 Oscillograph-record Camera .....                                   | 75 |
| Sketch of optical system of Type 295.....                                   | 76 |
| Spectral reflection characteristic of beam-splitter mirror of Type 295..... | 77 |
| Type 295, showing access ports open.....                                    | 79 |

|  | PAGE |
|--|------|
| Type 296 Oscillograph-record Camera.....       | 79   |
| Type 297 Oscillograph-record Camera.....       | 81   |
| Typical oscillograms taken with Type 297 ..... | 82   |
| Type 297 in recording position.....            | 82   |
| Type 321 Oscillograph-record Camera.....       | 84   |
| Type 2512 Motor-driven Processing Unit.....    | 86   |

### GENERAL INFORMATION

|   |     |
|---|-----|
| View of Instrument Service Shop.....  | 90  |
| Typical Oscillograms.....   | 91  |
| Block Diagram of typical cathode-ray oscillograph .....                                 | 93  |
| Cut-away view of electrostatic cathode-ray tube.....                                    | 94  |
| Cut-away view of magnetic cathode-ray tube.....   | 95  |
| Graph, grid voltage vs. screen current for 3 different tubes of the same type.....      | 99  |
| Grid-drive characteristics of typical electrostatic and magnetic cathode-ray tubes..... | 100 |
| Typical power supply for intensifier-type cathode-ray tubes.....                        | 101 |

### OSCILLOGRAPH DESIGN CONSIDERATIONS

|  |     |
|--|-----|
| Schematic of a cathode-ray oscillograph power transformer .....  | 102 |
| Schematic of a gas-tube regulated power supply.....  | 103 |
| Schematic of an electronically regulated power supply.....   | 103 |
| Circuit of an amplifier stage with capacitive input coupling .....   | 104 |
| Oscillogram showing square-wave signal with sawtooth distortion as introduced by an RC time-constant ..... | 104 |
| Circuit illustrating a method of compensating for sawtooth distortion .....                                | 105 |
| Circuit illustrating stray capacitance in an amplifier and a method for compensation .....                 | 106 |
| Frequency-response curves for three amplifiers with different degrees of high-frequency compensation ..... | 106 |
| Square-wave response of an over-compensated amplifier .....  | 106 |
| Circuit illustrating stray capacitances in a simple-potentiometer attenuator .....                         | 107 |
| Circuit of an attenuator with fixed attenuation ratios and adjustable capacitive elements .....            | 107 |
| Cathode-follower circuit used as a low-impedance gain-control .....  | 107 |
| A d-c positioning circuit for cathode-ray oscillographs .....  | 108 |
| An a-c positioning circuit for cathode-ray oscillographs .....   | 108 |
| Time-base family tree.....   | 108 |
| Sawtooth voltage waveform as produced by linear time-base generator .....                                  | 109 |
| Basic sawtooth generator using a gas-triode.....   | 109 |
| Graphic analysis of the synchronization of a gas-triode sawtooth generator.....                            | 110 |
| Gas-triode circuit for generating driven sweeps.....   | 111 |
| A multivibrator circuit used in high-vacuum sweep generators.....  | 112 |
| High-vacuum circuits for generating recurrent and driven sweeps .....                                      | 113 |
| A circuit for triggering precision-delayed sweeps.....   | 115 |

### INTERPRETATION OF OSCILLOGRAPH SPECIFICATIONS

|  |     |
|--|-----|
| Frequency-response curves for three oscillograph amplifiers with different degrees of compensation ..... | 116 |
| Oscillograms showing square-wave response of the amplifiers represented in preceding illustration .....  | 117 |



|   | PAGE |
|---|------|
| Oscillograms illustrating effect of high-impedance gain-control upon amplifier band-width..   | 117  |
| Oscillograms illustrating limitations in the usable band-width of an oscillograph resulting from insufficient sweep speed and insufficient pattern brightness ..... | 118  |
| Oscillograms comparing resolving power of two cathode-ray tubes having different spot-sizes and deflection sensitivities.....                                       | 118  |
| Oscillogram showing comparison between linear and non-linear sawtooth voltages .....  | 119  |
| Oscillograms showing sinewave plotted on linear and on non-linear time-bases .....  | 119  |
| Graph showing tube brightness required for visual observation of low or medium speed single transients with P1, P2 and P11 screens.....                             | 122  |
| Curves of persistence time vs. writing speed for single transients, comparing P2 and P7 screens .....   | 123  |
| Assembly of a delicate amplifier substage.....  | 126  |

### TECHNIQUES OF PHOTO-RECORDING

|  |     |
|--|-----|
| Oscillogram, Complex Modulated Carrier .....   | 127 |
| Oscillogram, High-voltage Impulse Test .....   | 127 |
| Oscillogram, Fluctuating Line Voltage .....  | 127 |
| Oscillogram, Improperly Exposed.....   | 128 |
| Three Oscillograms, Exposure Comparison.....   | 128 |
| Two Oscillograms: Use of a Brightening Gate to Record a Single Cycle.....                  | 129 |
| Oscillogram, Over-exposed to Record High Writing Speed.....                                | 129 |
| Two Oscillograms, Proper Intensity-control Setting for Beam Modulation.....                | 130 |
| Nomograph relating amplitude, frequency, and maximum writing speed.....                    | 131 |
| Nomograph for Determining Sinusoidal Writing Speeds .....                                  | 132 |
| Oscillogram, Typical Damped Oscillation.....   | 133 |
| Graph of Spectral Distribution Curves of the Type P11 Screen .....                         | 133 |
| Oscillogram, Long Persistence Blurring.....  | 133 |
| Graph, H and D Curve for Linograph Pan Film.....   | 134 |
| Graph, a Set of Curves Showing Failure of Reciprocity Law.....                             | 134 |
| Oscillogram, High-emulsion-speed Development .....   | 135 |
| Two Oscillograms, Chemical Reduction to Eliminate Halo and to Improve Contrast.....        | 136 |
| Oscillogram, Excessive Fogging due to Halo.....  | 136 |
| Two Oscillograms, Elimination of Cathode-glow.....   | 137 |
| Oscillogram, Electron Reflection.....  | 137 |
| Oscillogram, Fogging Due to Secondary Emission.....  | 137 |
| Two Oscillograms, Eliminating Brilliant Spot Caused by a Transient in the Grid-cathode.... | 138 |
| Oscillogram, Static Fog .....  | 138 |
| Oscillogram, Methods of Continuous-motion Recording.....                                   | 138 |
| Oscillogram, Nerve Reaction Patterns.....  | 139 |
| Oscillogram, Shock Transient.....  | 139 |
| Oscillogram, Expanded Shock Transient.....   | 139 |
| Oscillogram, Double-exposing a Calibrated Scale.....                                       | 140 |
| Oscillogram, A Matrix of Dots.....   | 140 |
| Oscillogram, Intensity-modulated Timing Markers Obtained by Brightening .....              | 140 |
| Oscillogram, Intensity-modulated Timing Markers Obtained by Blanking.....                  | 140 |
| A Diagram of Improvised Illuminated Data Card.....   | 141 |
| Steps in evolution of Type 5RP-A Cathode-ray Tube.....                                     | 148 |

# DU MONT

## CATHODE - RAY INSTRUMENTS

### DESCRIPTIONS *and* SPECIFICATIONS

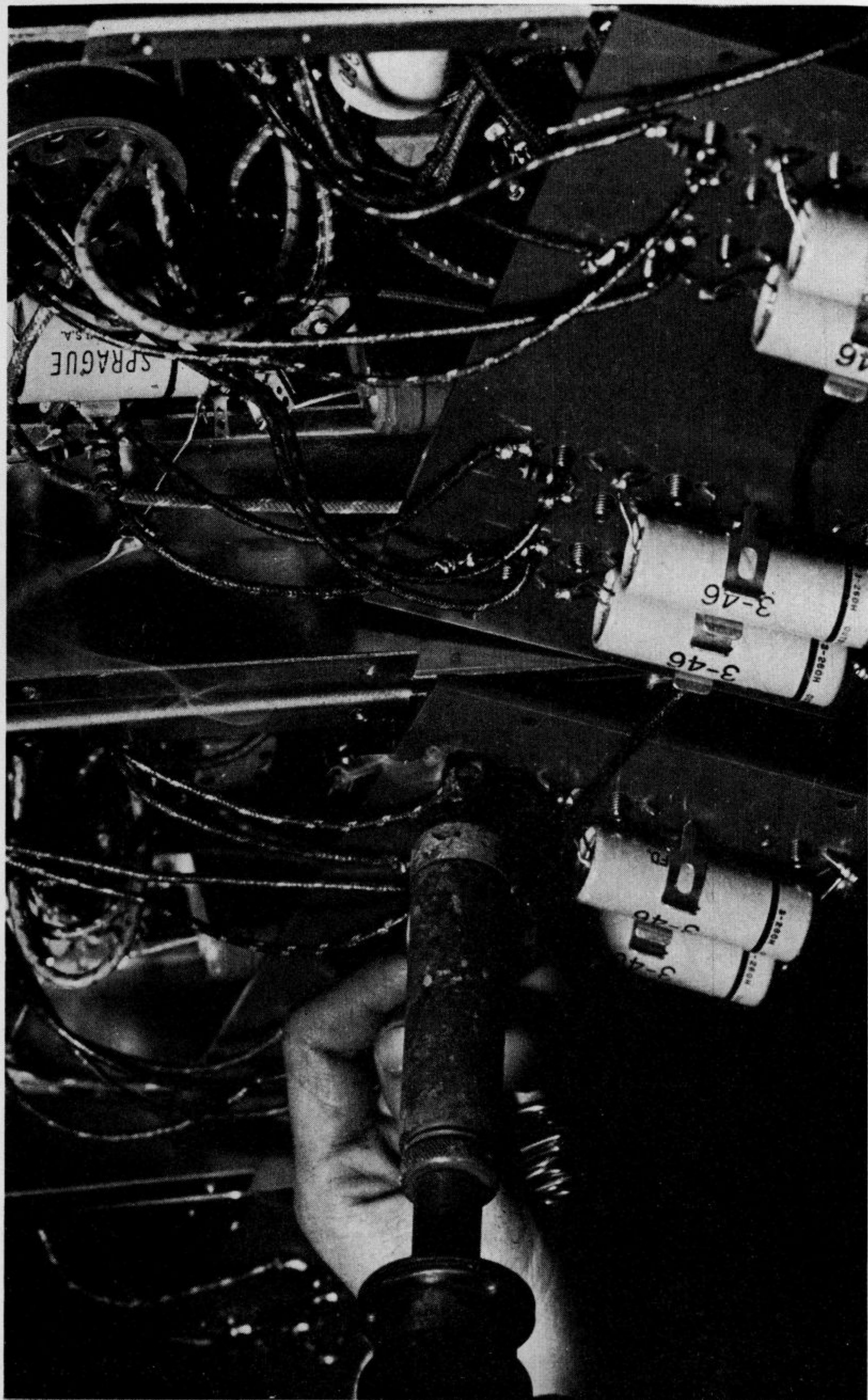

The Du Mont Type 304-H in manufacture

## TYPE 250-AH CATHODE-RAY OSCILLOGRAPH

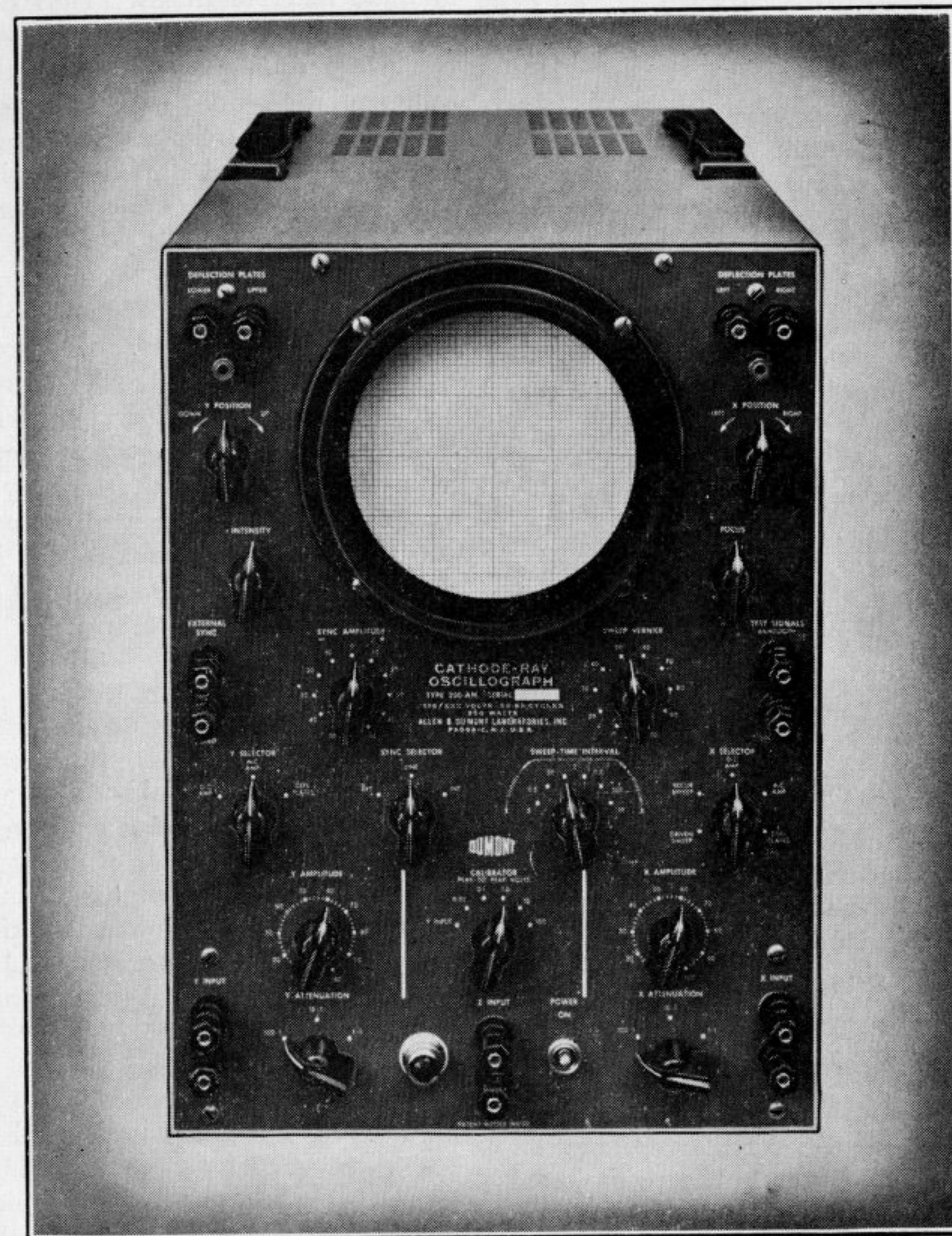

- Driven and recurrent sweeps variable in duration from 5 seconds to 10 microseconds
- Type 5RP-A Cathode-ray Tube, which may be operated at potentials as high as 15,000 volts
- Provision for amplification of both a-c and d-c signals
- Internal calibrator for signal-amplitude and deflection-sensitivity measurements
- Automatic beam-intensity control on all driven sweeps
- Connections at front panel directly to deflection plates
- Vertical amplifier response uniform within 10% to 200,000 cps
- Deflection factor of vertical a-c amplifier is 25 rms millivolts per inch with accelerating potential of 13,500 volts

## TYPE 250-AH CATHODE-RAY OSCILLOGRAPH

### FUNCTION

The Du Mont Type 250-AH Cathode-ray Oscilloscope is a high-quality, general-purpose laboratory instrument intended for the display and recording of recurrent, transient, or aperiodic phenomena.

The Type 250-AH is designed to operate in conjunction with the Du Mont Type 263-B High-voltage Power Supply, which provides an additional potential variable up to 12,000 volts for the intensifier of the Type 5RP-A Cathode-ray Tube. The high accelerating potential greatly increases the light output from the screen of the cathode-ray tube, enabling the observation and recording of transients of very high writing rates.

The Type 250-AH, equipped with d-c amplifiers and sweeps of durations as long as 5 seconds, is well suited for the study of low-frequency phenomena. The high accelerating potentials possible through the use of the Type 263-B High-Voltage Power Supply increase the efficiency of the long-persistence screens which are usually required for the observation of the low-frequency signals.

To facilitate the recording of non-repetitive phenomena, the electron beam of the Type 250-AH is automatically blanked on all driven sweeps, except during the forward portion of the trace, so that the shutter of a camera may be left open before and after a transient without danger of fogging the film.

The Du Mont Type 250-AH, operated in conjunction with the Type 263-B High-Voltage Power Supply, may also be used with the Du Mont Type 2542 Projection Lens for projection oscillography. With this lens, the pattern on the screen of the oscilloscope may be projected onto a standard projection screen, producing images up to 12 feet square, as an aid in lectures and demonstrations.

### DESCRIPTION

#### Cathode-ray Tube

The Type 5RP-A High-Voltage Cathode-ray Tube is employed in the Type 250-AH. Used in conjunction with the Du Mont Type 263-B High-Voltage Power Supply, the Type 5RP-A is operated at accelerating potentials up to 13,500 volts.

#### Vertical Deflection

Signals may be applied to the vertical deflection plates (1) through a capacitively-coupled amplifier, (2) a direct-coupled amplifier, or

(3) through a pair of terminals which are capacitively connected to the plates. Either balanced or unbalanced signals may be connected to these latter terminals. Thus signals which do not require amplification or which contain frequency components beyond the response limits of the amplifiers may be connected to these terminals. Sinusoidal response of the capacitively coupled amplifier is uniform within 10% from 5 to 200,000 cycles per second and within 40% to 500,000 cycles per second. Response of the direct-coupled amplifier is uniform within 10% from d-c (zero frequency) to 200,000 cycles per second.

A Du Mont Type 316 Test Probe may be connected to the amplifier in order to provide a low-capacitance input. It imposes minimum loading upon high-frequency signals and minimizes pick-up which might occur in connecting leads. Probe clips are insulated so that they may be safely connected to points of high potential.

#### Voltage Calibrator

A voltage calibrator is incorporated in the Type 250-AH. It is useful both for measuring the amplitude of an applied potential and for measuring the deflection factor of the oscilloscope at any particular setting of the signal attenuator controls. A switch permits connection of either the calibrator or an external signal to the vertical amplifier without disconnecting any leads.

#### Horizontal Deflection

External signals may be applied to the horizontal deflection plates through (1) a capacitively coupled amplifier, (2) a direct-coupled amplifier, or (3) a pair of terminals which are capacitively connected to the deflection plates. Either balanced or unbalanced potentials may be connected to these terminals. Sinusoidal frequency response characteristics of the capacitively coupled and the direct-coupled amplifiers are identical to those in the Vertical-deflection circuits.

The output of the linear time-base generator may be connected by means of a switch to provide horizontal deflection which is proportional to time.

#### Linear Time-Base

The high-vacuum linear time-base generator provides either recurrent or driven sweeps. Sweep duration is continuously variable from 5 seconds to 10 microseconds. Starting time of

## TYPE 250AH CATHODE-RAY OSCILLOGRAPH

the driven sweep is less than 1 microsecond. Direction of the sweep on the cathode-ray tube screen is from left to right.

### Synchronization of the Time-Base

The time-base generator may be synchronized on recurrent operation from (1) the vertical deflection signal, (2) a power-line frequency, or (3) an externally connected potential. Either polarity of signal may be used for synchronization.

The driven sweep may be initiated from either the vertical deflection signal, the power-line signal, or an externally connected potential. Either polarity of signal may be used for initiation. The driven sweeps may be initiated at rates up to the frequency which corresponds to the sweep duration.

### Automatic Beam Control

Intensity of the fluorescent spot is automatically reduced to zero when the sweep is changed to driven operation. Only during the actual duration of the sweep is the spot visible on the screen. If a camera is used to record the trace, the shutter may be opened before and after the occurrence of the sweep without exposing the film.

### Intensity Modulation

An external signal may be connected to modulate beam intensity. Timing marks may thus be impressed upon the trace, or certain portions of the trace may be brightened to facilitate observation of important detail.

### Positioning

The pattern may be moved to any portion of the cathode-ray tube screen by means of controls on the front panel. At least 4 inches of positioning are available vertically, and 10 inches horizontally.

### SPECIFICATIONS

**CATHODE-RAY TUBE** — Type 5RP-A Cathode-ray Tube with four free deflection plates. Accelerating potential, 3200 volts; up to 13,500 when used in conjunction with DuMont Type 263-B High-voltage Power Supply.

**VERTICAL DEFLECTION** (with 3200 volts accelerating potential)—**Deflection Factor:** through a-c amplifier at full gain, not more than 42 peak-to-peak (15 rms) millivolts per inch; through probe and amplifier, 420 peak-to-peak (150 rms) milli-

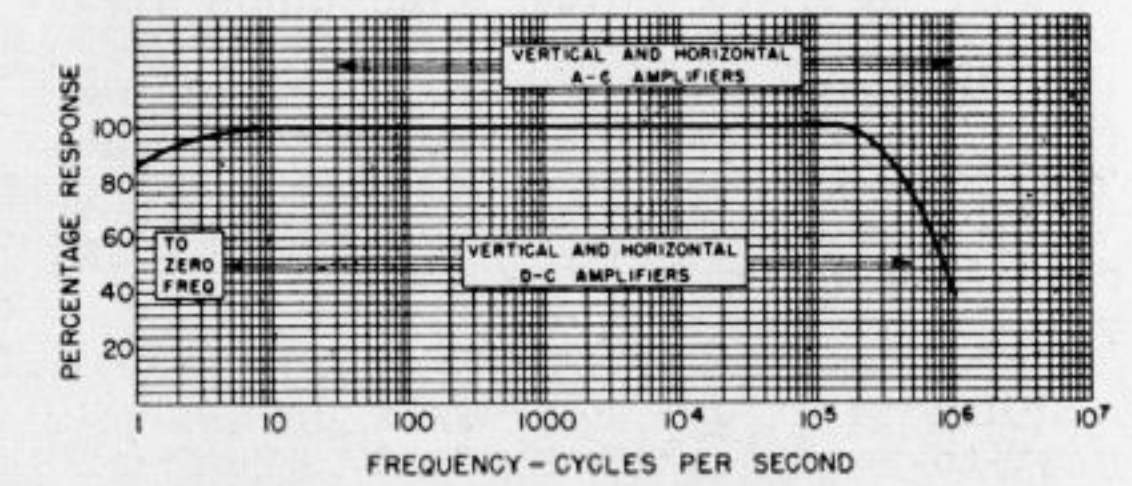

Figure 1. Frequency-response characteristic of the Type 250-AH

### Signal Outputs

A sinusoidal potential of 2.5 peak-to-peak volts at power-line frequency is available at a terminal on the front panel. It is useful as a test signal for trouble-shooting.

A sawtooth voltage of 1.5 volts, peak-to-peak from the time-base generator is available at another terminal. It may also be used as a test signal, or it may be used to provide a time-base for another oscilloscope.

### Recommended Accessories

In addition to the Du Mont Type 263-B High-voltage Power Supply, the Du Mont Type 2542 Projection Lens, and the Du Mont Type 316 Test Probe, mentioned above, the Du Mont Type 2560 Filters, and the Du Mont Type 276-A Viewing Hood are recommended as accessories that increase the utility and convenience of the Type 250-AH. Through the use of a filter, either the short- or long-persistence characteristic of the P2 screen may be viewed without the disturbing effects of the other. Also, for visual observation, a filter substantially increases contrast. (See page 71 for the use of the Type 2560 Color Filters.) Also a valuable aid in visual observation is the Du Mont Type 276-A Viewing Hood, which enables viewing under darkened-room conditions, regardless of the level of illumination in the room.

15  $\mu\mu\text{f}$ ; direct to plates, 4 megohms paralleled by 30  $\mu\mu\text{f}$  (balanced connection); 2 megohms paralleled by 40  $\mu\mu\text{f}$  (unbalanced connection). **Maximum Input Potential**—Total d-c + peak a-c, not to exceed 600 volts; direct to deflection plates, not to exceed 1000 volts.

**CALIBRATOR**—Furnishes square-wave amplitudes of 0.01, 0.1, 1, 10, or 100 volts peak-to-peak. Accuracy  $\pm 5\%$ . Connected to vertical amplifier by means of a switch.

**HORIZONTAL DEFLECTION** (with 3200 volts accelerating potential)—**Deflection Factor:** through a-c amplifier at full gain, not more than 1.1 peak-to-peak (0.4 rms) volts per inch; through d-c amplifier at full gain, not more than 1.1 volts per inch; direct, not more than 64 peak-to-peak (23 rms) volts per inch  $\pm 20\%$ . **Sinusoidal Frequency Response** of a-c amplifier within 10% from 5 to 200,000 cycles per second, and within 40% to 500,000 cycles. Response of d-c amplifier uniform within 10% from 0 to 200,000 cycles per second. **Undistorted Deflection:** through either amplifier, 5 inches. **Input Impedance:** to amplifier, 2 megohms paralleled by 40  $\mu\mu\text{f}$ ; direct to plate 4 megohms paralleled by 30  $\mu\mu\text{f}$  (balanced connection); 2 megohms paralleled by 40  $\mu\mu\text{f}$  (unbalanced connection). **Maximum Input Potential**—Total d-c + peak a-c, not to exceed 600 volts; direct to deflection plates, not to exceed 1000 volts.

**LINEAR TIME BASE**—Recurrent sweeps are continuously variable in duration from 5 seconds to 10 microseconds. Direction of sweep from left to right. Synchronization from vertical deflection signal of 0.1 inch peak-to-peak minimum am-

plitude at power-line frequency, or external signal of 0.1 peak-to-peak volt amplitude.

Driven sweeps with durations variable from 5 seconds to 10 microseconds. Initiation from vertical signal or external signal of 0.2 volts amplitude. Starting time of driven sweeps is less than 1  $\mu\text{sec}$ .

Either polarity of signals will synchronize or initiate the sweeps.

**INTENSITY MODULATION**—Input impedance to external signal 10,000 ohms paralleled by 50  $\mu\mu\text{f}$ . Amplitude of 3 volts peak provides visible modulation at medium or low intensity setting. Positive polarity decreases intensity of beam; negative polarity increases intensity.

**TUBE COMPLEMENT:** 6AL5; 5-12AU7; 4-6AG7; 7-6AU6; 2-6AQ5; OA3; 6X4; OA2; 5U4G; 2-2X2A.

**MAXIMUM PHOTOGRAPHIC WRITING RATES** (using Type 263-B High-voltage Power Supply): with Type 296, using f/2.8 lens, 10 inches/ $\mu\text{sec}$ ; with Types 321 and 295, using f/1.5 lens, 35 inches/ $\mu\text{sec}$ .

**POWER SOURCE**—The Type 250-AH may be operated from a 50-60 cycle power line at either 115 or 230 volts. Voltage changeover switch is accessible by removing the cabinet. Power consumption, 250 watts, fuse protection, 2 amperes.

**PHYSICAL CHARACTERISTICS**—Instrument is housed in a metal cabinet provided with carrying handles. **Overall Dimensions:** height, 15-1/8" (38.4 cm); width, 11" (27.9 cm); depth, 19" (48.3 cm). **Weight:** 68 lbs. (31 kg).

| Catalog No. | Type No. | Description  |
|-------------|----------|--|
| 1481-E      | 250-AH   | Cathode-ray Oscilloscope for 115-volt, 50-60 cycle operation, with Type 5RP2-A Cathode-ray Tube. |
| 1484-E      | 250-AH   | Same as above, with Type 5RP11-A Cathode-ray Tube.   |
| 1486-E      | 250-AH   | Cathode-ray Oscilloscope for 230-volt, 50-60 cycle operation, with Type 5RP2-A Cathode-ray Tube. |
| 1489-E      | 250-AH   | Same as above, with Type 5RP11-A Cathode-ray Tube.   |

## TYPE 256-D AND 256-E CATHODE-RAY OSCILLOGRAPHS



- Frequency response of vertical deflection amplifier uniform within 30% to 8 megacycles per second
- Undelayed or delayed, expanded sweeps
- Delay of sweeps read directly on calibrated dial with accuracy of 0.1 percent
- Trigger generator with variable repetition rate
- Crystal-controlled marker generator
- Trigger and timing-marker outputs
- Movable marker output

# TYPES 256-D AND 256-E CATHODE-RAY OSCILLOGRAPHS

## FUNCTION

The Du Mont Types 256-D and 256-E are wide-band precision cathode-ray oscillographs designed primarily for the study of pulses and allied high-frequency phenomena. The two instruments are similar, differing only in that the Type 256-D is calibrated in microseconds while the Type 256-E is calibrated in yards.

The Type 256-D is useful as a general-purpose test oscillograph in studies of pulse-generating circuits, or for such applications as line terminations and cable-fault location, or wherever precise measurement of time must be made. The Type 256-D is capable of measuring time intervals down to a fraction of one microsecond.

The Type 256-E is invaluable in the development of radar equipment, as well as an accessory unit for existing radar systems, where it may be used to increase accuracy of ranging, to provide accurate timing markers, or to act as a precision test instrument and calibrator.

## DESCRIPTION

### Cathode-ray Tube

The Type 5CP-A Cathode-ray tube is used in the Types 256-D and 256-E. The accelerating potential of 4000 volts is evenly divided between the second anode and the intensifier electrodes. The focus and auxiliary focus controls permit adjustment for a fine, clear trace at any point on the screen. The P1 phosphor, for visual observation, the P2 phosphor for observation of signals occurring at low repetition rates, and the P11 phosphor for photographic recording, are available as stock items.

### Sweeps

There are two types of sweeps provided in the Types 256-D and 256-E oscillographs: Undelayed and Delayed. The Undelayed sweeps of the Type 256-D have durations of 4, 10, 25, 100, and 1000 microseconds. These durations correspond to 800, 2000, 4000, 20,000, and 200,000 yards respectively in the Type 256-E. In both instruments a 4500-microsecond sweep is provided. Delayed

sweeps of 4, 10, or 25 microseconds\* may be selected. By means of the precision delay circuit, the start of the delayed sweeps may be retarded so that any 4-, 10-, or 25-microsecond portion of the 100-microsecond undelayed sweep, or any 10- or 25-microsecond portion of the 1000-microsecond undelayed sweep may be examined full scale on the screen.

The start of the delayed sweeps is accurate within  $\pm 0.1\%$  of the full scale of the delay range, and may be read directly on a calibrated dial. By means of the calibrated sweep-delay dial, therefore, the exact time relationship of any signal appearing on one of the undelayed sweeps with respect to the main trigger may be measured within an accuracy of  $\pm 0.1$  microsecond on the 100 microsecond scale of the Type 256-D, or within  $\pm 20$  yards on the 20,000 yard range sweep of the Type 256-E.

### Triggering Circuits

Sweeps of the Types 256-D and 256-E may be initiated by internally supplied trigger pulses having a continuously variable repetition rate of 80 to 2000 times per second for the 100-microsecond scale and 80 to 400 times per second for the 1000- to 4500-microsecond scales. External triggers of either polarity, having repetition rates from 0 to 2000 times per second for the 100-microsecond scale may also be employed to trigger the sweeps.

Input trigger signal of 15 volts, at either polarity, with a rise time of 100 volts per microsecond will initiate the sweep. Triggering signals with a rate of rise of as low as 10 volts per microsecond may be used to trigger the sweep, but accuracy of the dial reading will be impaired unless the instrument is recalibrated. The pulse employed to initiate the sweep is available at output terminals enabling initiation of external equipment in synchronism with the oscillograph. Also a trigger output of 100 volts, positive or negative, having a rise time of 0.3 microsecond, a duration of 1 microsecond and a repetition rate identical to that of the sweep trigger is also provided at output terminals on the front panel.

\* References to sweep lengths in microseconds apply to the Type 256-D. In every instance, sweep lengths of 4, 10, 25, 100, and 1000 microseconds in the Type 256-D correspond to sweeps representing 800, 2000, 4000, 20,000, and 200,000 yards, respectively, in the Type 256-E.

## TYPES 256-D AND 256-E CATHODE-RAY OSCILLOGRAPHS

### Markers

Timing markers are available only when the internal Trigger Generator is used. They appear on the screen of the cathode-ray tube as intensity-modulated marks, but they are also available at a terminal for use with associated equipment. Provision is made so that, when external markers are not required, intensity modulation signals may be applied to this same terminal.

It is possible to select either polarity for the markers, and also to select marker intervals of 10 or 50 microseconds. Markers are crystal-controlled, have an extremely fast rise-time, and are generated by a low-impedance source.

A Movable Marker of fixed duration shows the exact portion of the 100- or 1000-microsecond Undelayed Sweeps which will be expanded by the Delayed Sweeps. The movable marker is available at all times at an output terminal. It may also be used with associated equipment to indicate which portion of their signal is being displayed.

### Video Amplifier

The video amplifier of the Types 256-D and 256-E comprises a three-stage wide-band amplifier which provides excellent deflection sen-

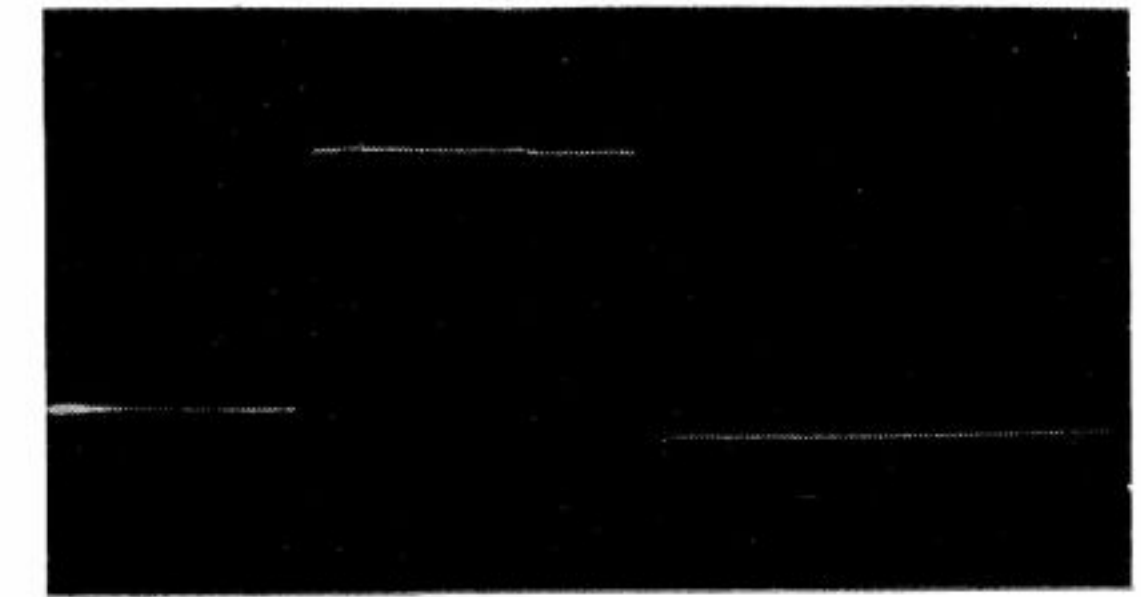

Figure 2. Oscilloscope taken from the Type 256-D showing a square pulse of 1 microsecond duration after it has passed through the vertical amplifier. Note the reproduction of the extremely fast rise and fall of the pulse

sitivity. It is preceded by a stepped, frequency-compensated attenuator which provides attenuation ratios of 1, 3, 100, 300, and 1000. Pulse response of this amplifier is such that an input pulse having a rise time of 0.01 microsecond or less is degraded to not more than 0.04 microsecond.

### Measurement of Signal Amplitudes

When a signal is connected directly to the deflection plates, the amplitude of that signal may be directly measured by connecting a voltmeter to the calibration jacks on the panel

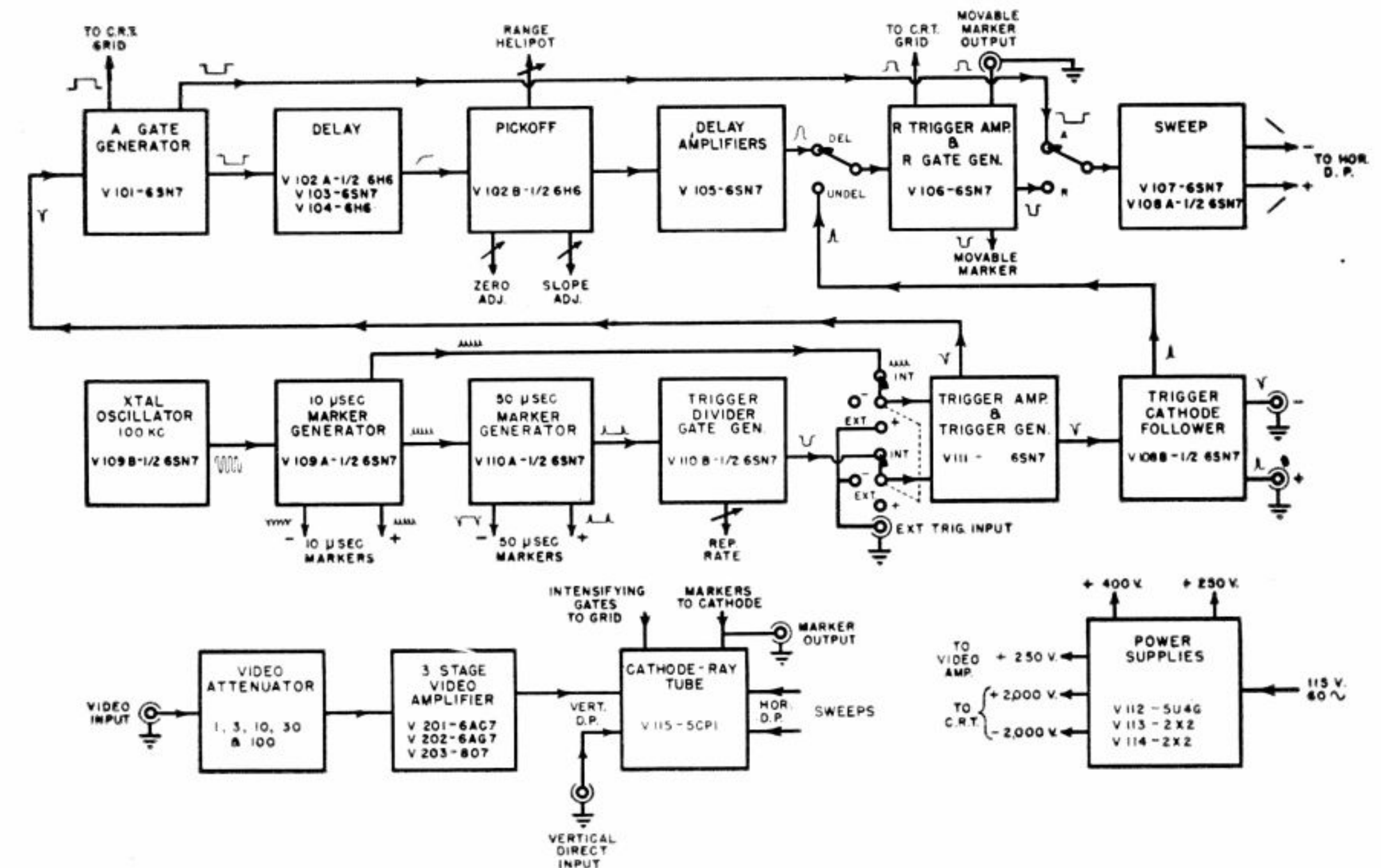

Figure 3. Block diagram of the Type 256-D Cathode-ray Oscillograph

of the Type 256-D Oscillograph and employing the vertical positioning control to move the trace vertically an amount equal to the amplitude of the signal being observed. The amplitude is read from the voltmeter.

will provide a substantial increase in pattern contrast when used with either a P1 or P2 screen (see Page 71). For photographic recording the Du Mont Type 296 or 297 Oscillograph-record Camera is recommended. If, as is frequently the case, high writing rates are to be photographed, the ultra-high speed Du Mont Type 295 Oscillograph-record Camera will provide more satisfactory results.

**Recommended Accessories**

It will be found that, for visual observation, the Du Mont Type 2560-A green filter

**SPECIFICATIONS**

**CATHODE-RAY TUBE**—Type 5CP-A tube operated with total accelerating potential of 4000 volts. Unbalanced vertical deflection.

**"A" SWEEPS**—"A" Sweep durations of 4500, 1000, 100, 25, 10, and 4 microseconds available. The 4500  $\mu$ s sweep used for observing entire duty cycle operation at repetition rates above 300 per second.

**"R" SWEEPS**—Sweep durations of 25, 10, or 4  $\mu$ s. Will expand any portion of 100  $\mu$ s "A" Sweep except first 4  $\mu$ s. 25 or 10  $\mu$ s sweeps will expand any portion of 1000  $\mu$ s "A" Sweep except first 5  $\mu$ s. Delay read directly on calibrated dial; accuracy,  $\pm 0.1\%$  of full scale.

**INTERNALLY TRIGGERED OPERATION**—Output triggers of 100 volts peak amplitude; positive or negative polarities. Trigger rise time, 0.3  $\mu$ s; duration, 1.0  $\mu$ s. Repetition rate variable 80-400 pulses per second on 1000 and 4500  $\mu$ s "A" Sweeps; 80-2000 per second on 100  $\mu$ s "A" Sweeps. Crystal-controlled timing-markers indicating intervals of 10  $\mu$ s or 50  $\mu$ s; either polarity available. First 50  $\mu$ s marker appears 40  $\mu$ s after the trigger; each subsequent one, 50  $\mu$ s later. Rise time of markers, 0.25  $\mu$ s; duration, 1.0  $\mu$ s. Marker accuracy,  $\pm 0.02\%$ .

**EXTERNALLY TRIGGERED OPERATION**—Input trigger of either polarity and 15 volts peak amplitude required. Rise time at least 100 volts/ $\mu$ s for accurate triggering. Trigger amplifier permits operation regardless of trigger waveform. Rise time as slow as 10 volts/ $\mu$ s will trigger sweep, but recalibration of instrument is necessary. Repetition rate of external trigger, 0-2000 pulses per second when 100  $\mu$ s "A" Sweep is used; 0-400 per second when 1000  $\mu$ s "A" sweep is used. Timing markers not available.

**INTENSITY MODULATION**—External signal may be connected to modulate intensity of cathode-ray beam if marker selector switch is set at position to provide for this.

**VERTICAL DEFLECTION**—Deflection Factor: direct to deflection plate, 79 d-c

volts/inch  $\pm 20\%$ ; through video amplifier at full gain, not more than 0.7 peak-to-peak (0.25 rms) volts/inch. Positive signal produces upward deflection on screen of cathode-ray tube. Maximum input potential, 600 volts (d-c) plus peak signal). Undistorted deflection, at least 1.2 inches. **Input impedance to amplifier**, 1 megohm paralleled by 20  $\mu$ f. **Sinusoidal frequency response** is down not more than 30% at 8 megacycles per second; no more than 50% at 11 megacycles per second; low-frequency response, flat down to 100 cps, and within  $\pm 1$  db to 20 cps. **Pulse response as follows:** The sum of rise and fall times of a 1  $\mu$ s pulse, with rise and fall times of 0.01  $\mu$ s, does not change vertical position of base does not exceed 0.08  $\mu$ s when pulse is passed through video amplifier. A 1000  $\mu$ s pulse line after the pulse by more than 10% of pulse height. Amplifier will not overload on signal less than 1 volt peak amplitude with attenuation ratio of 1:1.

**MAXIMUM PHOTOGRAPHIC WRITING RATES:** With Type 296 Camera, 1.2 in/ $\mu$ sec; with Types 295 and 321 Cameras (f/1.5 lens), 4.2 in/ $\mu$ sec.

**Tube Complement:** 9—6SN7; 6H6; 5U4G; 2—2X2; 6AC7; 6AG7; 6AL7; 807.

**Power Source**—Type 256-D is designed to operate from a 115-volt, 60 cycle power line. Higher power-line frequency may be used but accuracy of instrument may be decreased. Power consumption 220 watts; fuse protection, 2 amperes.

**Physical Characteristics**—Instrument housed in metal cabinet provided with carrying handles and removable front cover. Overall dimensions, 16-1/4" (28.8 cm.) height x 11-3/8" (41.4 cm.) width x 26" (66 cm.) depth; weight, 104 lbs. (47.1 kg.).

\* Reference to sweep lengths in microseconds apply to the Type 256-D. In every instance, sweep lengths of 4, 10, 25, 100, and 1000 microseconds in the Type 256-D correspond to sweeps representing 800, 2000, 4000, 20,000, and 200,000 yards, respectively, in the Type 256-E.

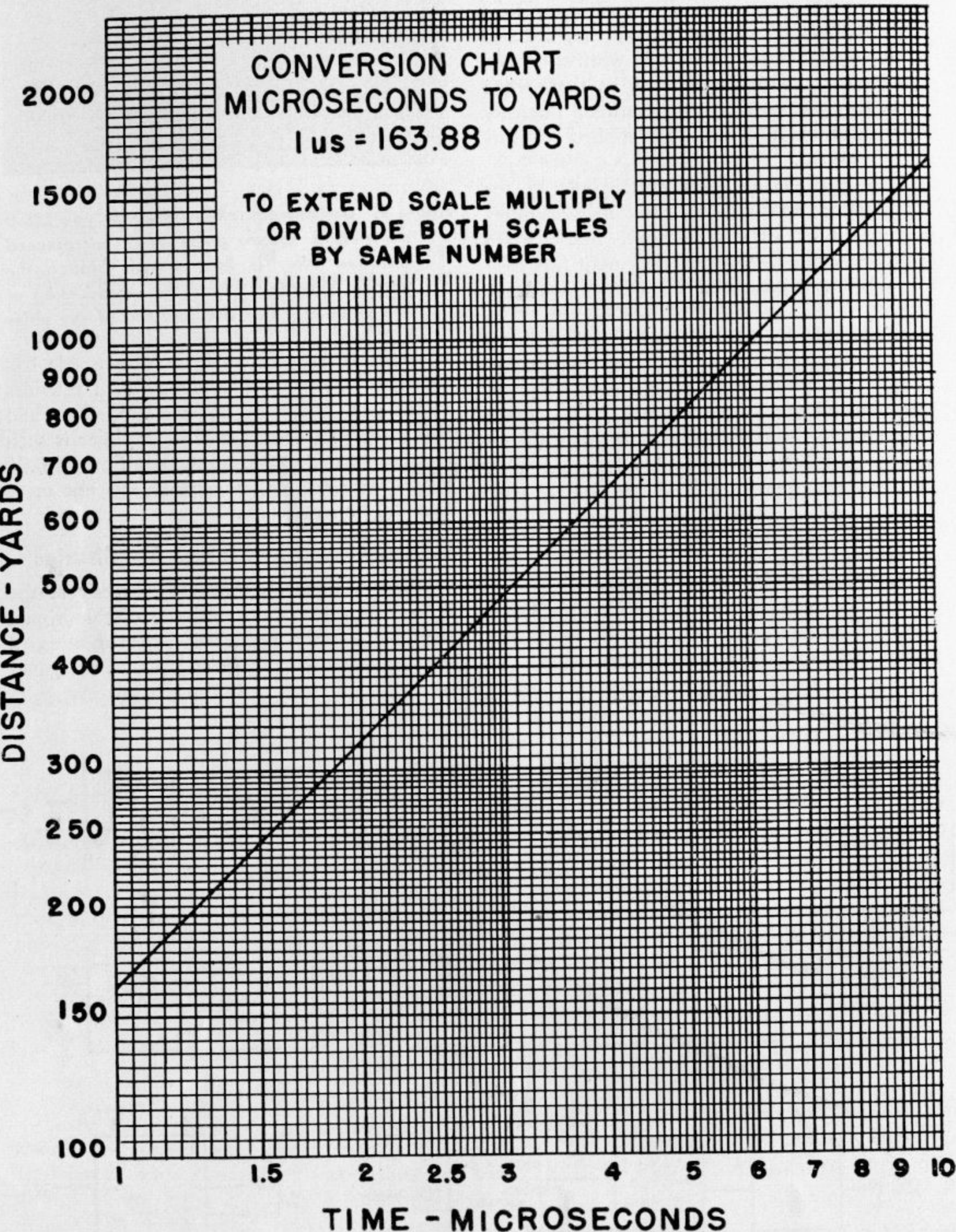

| Catalog No. | Type No. | Description   |
|-------------|----------|---|
| 1296-E      | 256-D    | Cathode-ray Oscillograph for 115 volts, 60 cycles; 5CP1-A Cathode-ray Tube. |
| 1297-E      | 256-D    | Same as above; 5CP2-A Cathode-ray Tube.                                     |
| 1300-E      | 256-D    | Same as above; 5CP11-A Cathode-ray Tube.                                    |
| 1562-E      | 256-E    | Cathode-ray Oscillograph for 115 volts, 60 cycles; 5CP1-A Cathode-ray Tube. |
| 1563-E      | 256-E    | Same as above; 5CP2-A Cathode-ray Tube.                                     |
| 1566-E      | 256-E    | Same as above; 5CP11-A Cathode-ray Tube.                                    |

# TYPE 274-A CATHODE-RAY OSCILLOGRAPH

- Light-weight, portable, general-purpose oscillograph
- Varied selection of deflection-plate connections
- Similar amplifiers for vertical and horizontal deflection
- Provision for intensity modulation
- Sinewave test signal output
- Recurrent sweeps from 8 cycles to 30,000 cycles per second

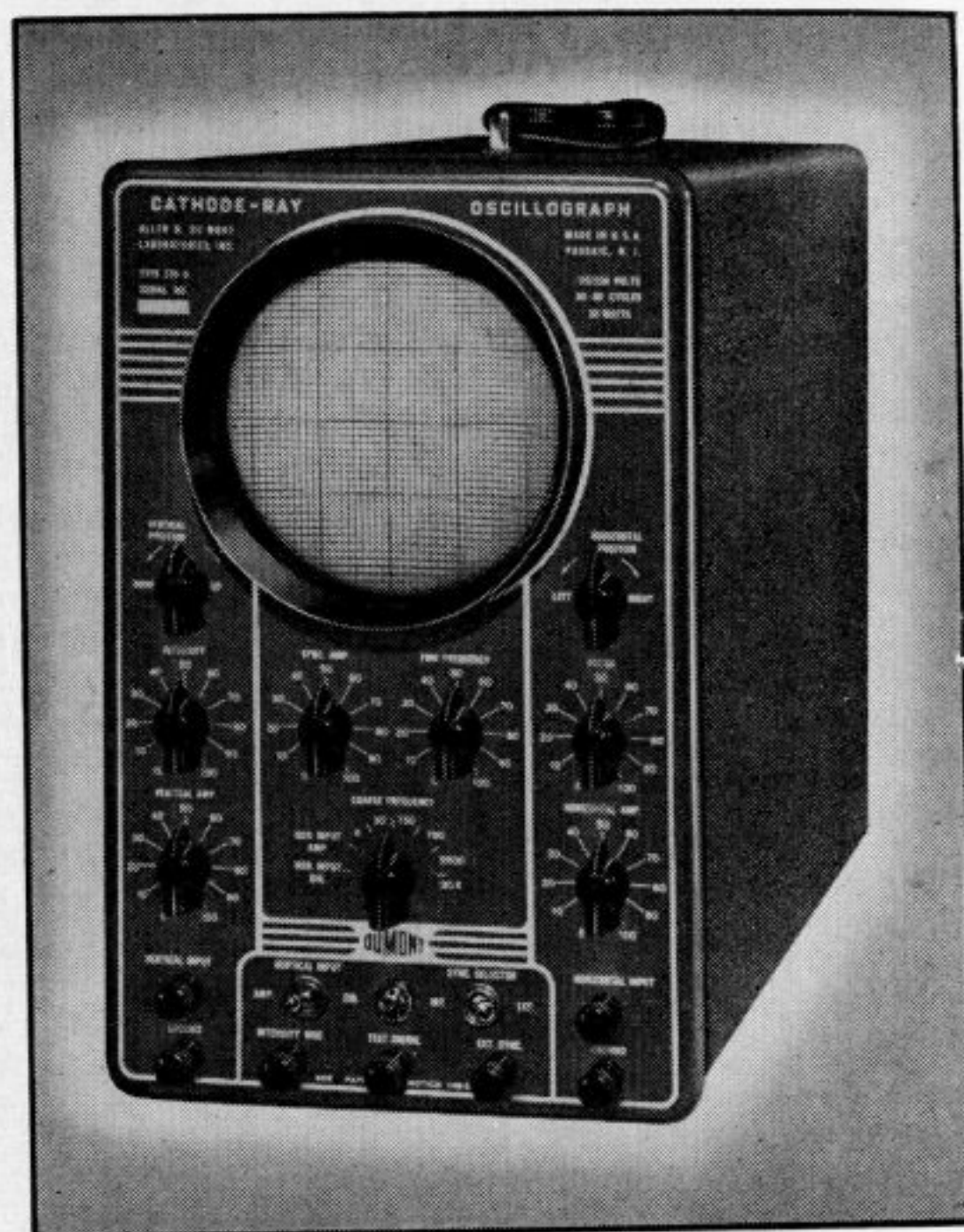

## FUNCTION

The Type 274-A is a general-purpose oscillograph for general electronic servicing or laboratory duties. Its light weight, easy portability and 5" screen make it an ideal instrument for unspecialized applications where above average performance is required. A high deflection sensitivity and at least full screen deflection without distortion have created a demand for the Type 274-A in the television industry where it has found a wide acceptance in the production-line testing of such units as television i-f strips. In addition to the usual horizontal and vertical deflection inputs, the instrument contains a Z-axis modulation input enabling the operator to impress timing markers on the trace from an external source.

## DESCRIPTION

### Cathode-ray Tube

A Type 5BP-A Cathode-ray Tube is used in the Type 274-A. Accelerating potential of 1200 volts is applied prior to deflection. A Mu-metal magnetic shield for the cathode-ray tube prevents spurious deflection or intensity modulation from stray magnetic fields.

### Vertical Deflection

Signals may be applied to vertical deflection plates (1) through the vertical amplifier, (2) through a panel terminal which may be capacitively connected to the deflection plate, or (3) through a terminal at the rear of the instrument which is directly connected to the deflection plate. Signals which do not require amplification or which contain frequency components beyond the response limits of the vertical amplifier may be either capacitively or directly connected to the deflection plates. Sinusoidal frequency-response characteristic of the vertical amplifier is uniform within 50% from 20 to 200,000 cycles per second.

### Horizontal Deflection

External signals may be applied to horizontal deflection plates (1) through the horizontal amplifier, (2) through a panel terminal which may be capacitively connected to the deflection plate, or (3) through a terminal at the rear of the instrument which is directly connected to the deflection plate. Signals which do not require amplification or which contain

## TYPE 274-A CATHODE-RAY OSCILLOGRAPH

frequency components beyond the response limits of the horizontal amplifier may be either capacitively or directly connected to the deflection plate.

### Linear Time Base

The time-base generator furnishes a recurrent sawtooth voltage variable in frequency from 8 to 30,000 cycles per second. Direction of the sweep produced on the cathode-ray tube is from left to right.

### Synchronization of the Time Base.

Frequency of the time-base generator may be synchronized from (1) the vertical deflection signal or (2) an external signal. The vertical deflection signal is obtained from the vertical amplifier; the external signal may be connected to a synchronizing terminal on the panel.

### Positioning

A pattern may be moved to any portion of the cathode-ray tube screen by means of controls on the panel. At least 5 inches of positioning are available both vertically and horizontally.

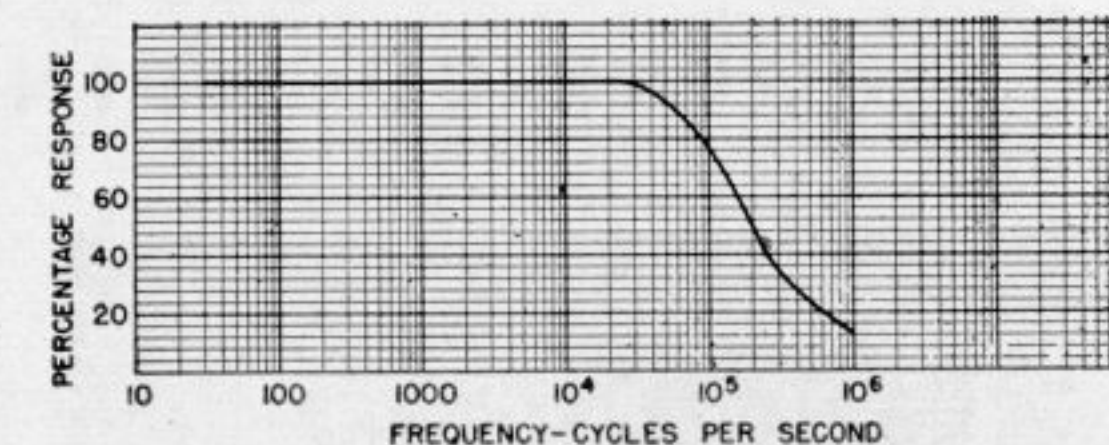

Figure 1. Frequency-response characteristic of the Type 274-A

### Test-Signal Output

A sinusoidal voltage of power-line frequency and 17 peak-to-peak volts amplitude is available at a terminal on the panel. It is useful as a test signal for trouble-shooting applications, or it may be connected to the synchronizing terminal to synchronize the time-base at power-line frequency.

### Intensity Modulation

An external signal may be connected to a terminal on the panel to provide modulation of beam intensity. An input signal of positive polarity will increase intensity; a negative polarity signal will decrease intensity.

## SPECIFICATIONS

**CATHODE-RAY TUBE**—Type 5BP-A cathode-ray tube. Accelerating potential, 1200 volts. Deflection plates are at ground potential.

**VERTICAL DEFLECTION—Deflection Factor:** amplifier at full gain, not more than 0.70 peak-to-peak (0.25 rms) volt/inch; directly to deflection plates, 45 peak-to-peak (16 rms) volts/inch  $\pm 20\%$ . **Sinusoidal frequency response:** amplifier at full gain, uniform within 50% from 20 to 200,000 cycles per second. **Input impedance:** to amplifier, 1 megohm paralleled by 40  $\mu\text{f}$ ; through capacitor to deflection plate, 4.7 megohms paralleled by 50  $\mu\text{f}$ . **Maximum Allowable Input Potential:** 400 rms volts, 600 d-c volts or 600 volts peak.

**HORIZONTAL DEFLECTION—Deflection Factor:** amplifier at full gain, not more than 0.7 peak-to-peak (0.25 rms) volt/inch; directly to deflection plates, 51 peak-to-peak (18 rms) volts/inch  $\pm 20\%$ . **Sinusoidal frequency response:** amplifier at full gain, uniform within 50% from 20 to 200,000 cycles per second. **Input impedance:** to amplifier, 1 megohm paralleled by 40  $\mu\text{f}$ ; through capacitor to deflection plates, 4.7 megohms paralleled by 50  $\mu\text{f}$ . **Maximum Allowable Input Potential:** 400 rms volts, 600 d-c volts or 600 volts peak.

| Catalog No. | Type No. | Description   |
|-------------|----------|---|
| 1420-A      | 274-A    | Cathode-ray Oscillograph with Type 5BP1-A Cathode-ray Tube; for operation with 115 volts, 50-60 cycles. |
| 1422-A      | 274-A    | Same as above, with Type 5BP11-A Cathode-ray Tube.  |
| 1423-A      | 274-A    | Cathode-ray Oscillograph with Type 5BP1-A Cathode-ray Tube for operation from 230 volts, 50-60 cycles.  |
| 1425-A      | 274-A    | Same as above, with Type 5BP11-A Cathode-ray Tube.  |

**LINEAR TIME BASE**—Recurrent sweeps variable in frequency from 8 to 30,000 cycles per second. Sweep direction, left-to-right. Synchronization from vertical deflection signal, or external signal.

**INTENSITY MODULATION**—Input impedance, 470,000 ohms paralleled by 45  $\mu\text{f}$ . 28 peak-to-peak volts input signal provides satisfactory modulation. Positive polarity increases intensity; negative polarity decreases intensity.

**POWER SOURCE**—Type 274-A is designed to operate from a 115- or 230-volt power line at 50-60 cycles. Power consumption, 50 watts; fuse protection, 1 ampere (115 volts) or 0.5 ampere (230 volts).

**MAXIMUM PHOTOGRAPHIC WRITING RATES**—With Type 296, using f/2.8 lens, 0.05 inches/ $\mu\text{sec}$ ; with Types 321 and 295, using f/1.9 lens, 0.14 inch/ $\mu\text{sec}$ .

**TUBE COMPLEMENT**—2—6AC7; 884; 2—80.

**PHYSICAL CHARACTERISTICS**—Instrument housed in metal cabinet provided with carrying handle. **Overall Dimensions:** height, 14" (35.6 cm); width, 8-5/8" (21.8 cm); depth, 19-3/8" (50.2 cm). **Weight:** 35 lbs. (15.9 kg).

## TYPE 275-A POLAR-COORDINATE INDICATOR

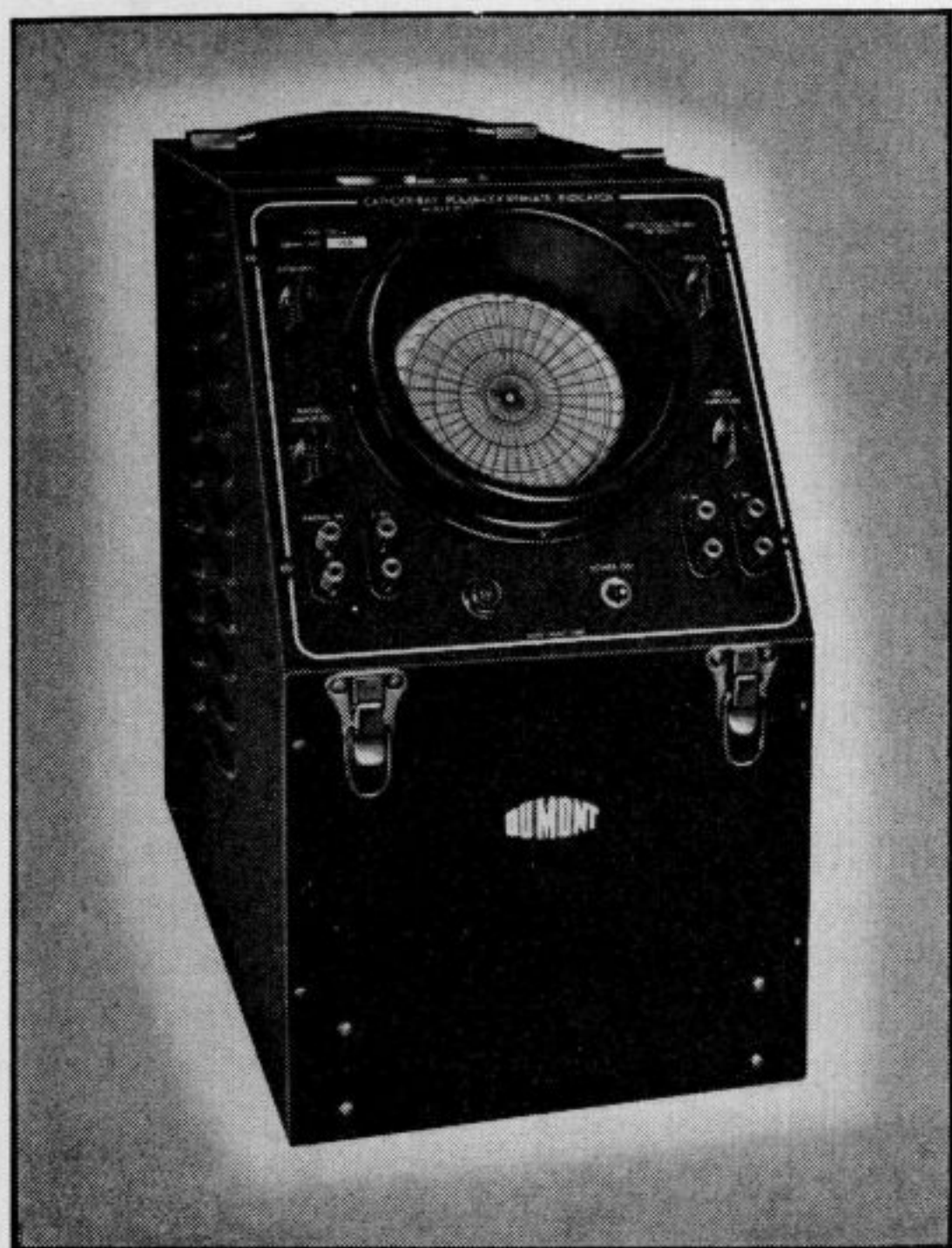

### FUNCTION

The Type 275-A Cathode-ray Indicator is designed specifically for use in the field of mechanical engineering, and plots the amplitude of an event in the cycle of a rotating or reciprocating machine against the angle at which it occurs. The revolving spot on the fluorescent screen (which appears as a circle due to visual persistence) is maintained in perfect synchronism with the rotation of the part under study, presenting a precise analog of that rotation. Since every point on this *analog circle* maintains a constant angular position relative to the rotating member, phenomena occurring in connection with this rotation may be impressed upon the analog circle where both the angle and nature of their occurrence are accurately indicated.

Since the indicating element, the electron beam, is for all practical purposes free from inertia effects, it can follow extremely rapid mechanical phenomena, reproducing them faithfully. And since every point on the analog circle holds a constant position relative to the rotating part, these phenomena are presented as stationary deflections on the analog circle. Thus such phenomena as vibration and resonance, angular acceleration and torsional stresses, peak transients, and so on, may be studied in careful detail by convenient analogy.

- A device eminently suited to the investigation of rotating and reciprocating machinery
- Plots the amplitude of an event against the angle at which it occurs
- Reproduces phenomena faithfully. Responds to the 500th harmonic of 3600 rpm

### DESCRIPTION

#### Cathode-ray Tube

The Type 5CP-A Cathode-ray Tube is used in the Type 275-A, displaying oscillograms on a screen five inches in diameter. This tube is available with various types of phosphors, each of which is designed for a specific

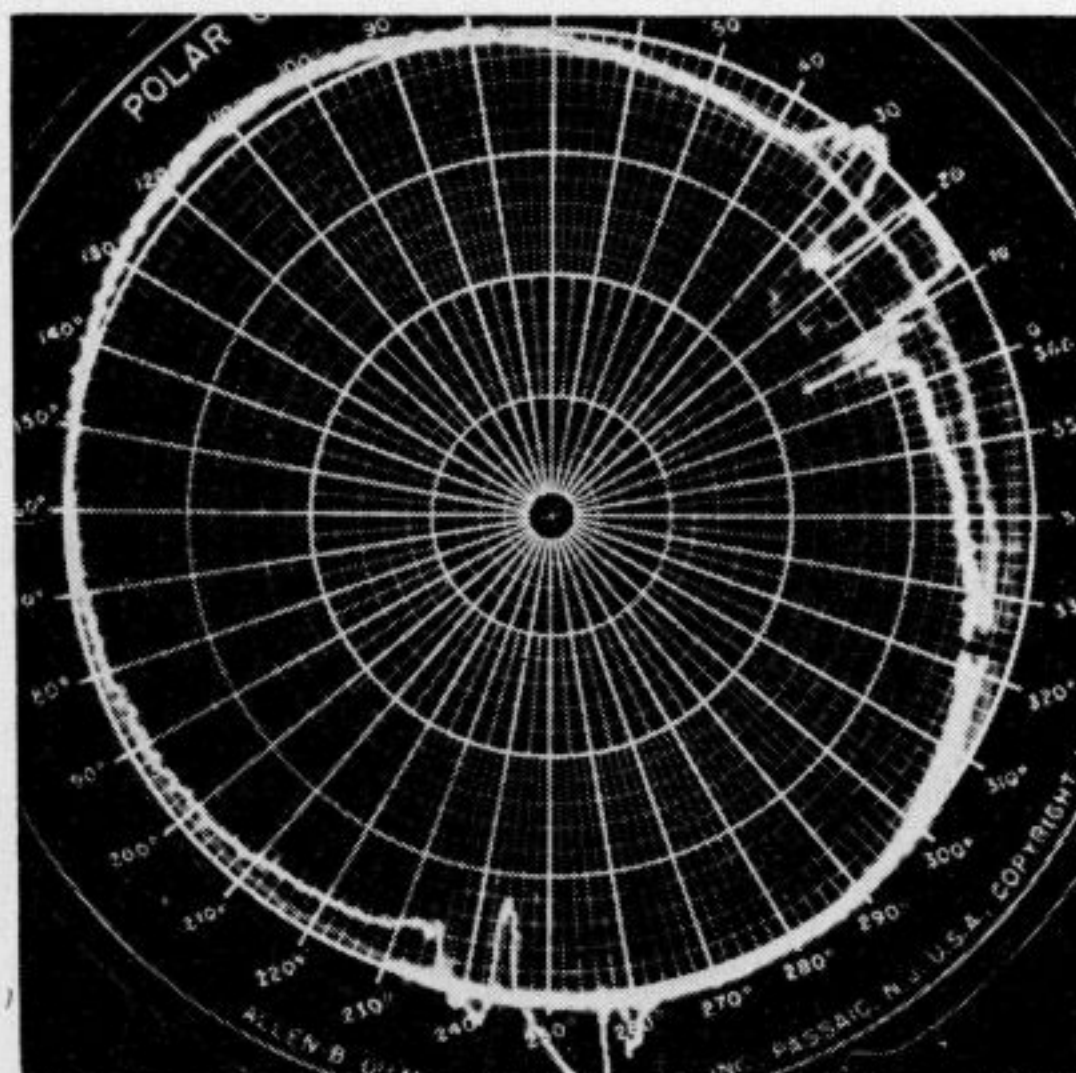

Figure 1. Radial deflections indicate the arrival and departure of a shuttle across a loom, to and from the shuttle box. The blank spot at 323° is a reference marker. Here a Du Mont Type 216-F Calibrated Scale has been double-exposed on the oscillogram negative to facilitate interpretation

## TYPE 275-A POLAR-COORDINATE INDICATOR

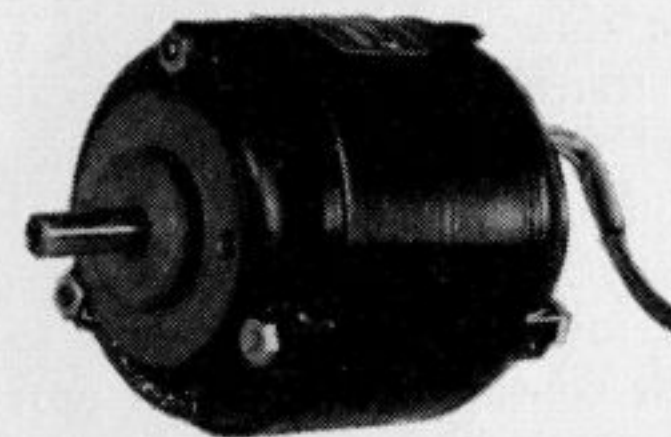

Figure 2. The small two-phase generator supplied with the Type 275-A to provide the analog circle which is automatically synchronized with the phenomenon under investigation

purpose. The Type 5CP1-A utilizes a green, medium-persistence screen which is suitable for all general-purpose work. The Type 5CP11-A provides a short persistence blue-luminescent trace of high actinic value which is primarily used for photographic recording. For visual observation of low-speed phenomena, the Type 5CP7-A is usually employed, since this phosphor provides long-persistence traces.

The cathode-ray tube operates at an overall accelerating potential of 3000 volts. This accelerating potential provides sufficient brilliance at all writing rates, under normal conditions of ambient light, to allow both visual observation and photographic recording of an oscillogram from the screen.

A shield is provided to protect the cathode-ray tube from the effects of external magnetic fields.

#### Analog Circle

A circular trace may be obtained on any cathode-ray oscillograph by applying a sine-wave to the vertical deflection plates and another sine-wave, 90° out of phase with the first, to the horizontal deflection plates. This principle is used in the design of the Type 275-A. The required sinusoidal voltages are obtained from a small two-phase sine-wave generator (supplied with instrument) which is driven by the rotating part under study. Thus the signal applied to each deflection plate is 180° out of phase with the voltage on an opposite deflection plate and 90° out of phase with the voltage applied to each of the deflection plates of the other pair.

The analog circle thus achieved is always in synchronism with the phenomenon being investigated, since the two-phase generator is driven from a shaft which is mechanically related to that phenomenon.

The generator has a punch mark on its shaft and another one on its case. When these marks are opposite each other, the spot on

the fluorescent screen is at the uppermost point of the analog circle. Connection from the generator to the Indicator is made through a terminal on the Indicator cabinet. In addition, there is provision for connection of other sinusoidal voltages through terminals on the panel. The diameter of the circular time-base is nearly constant over generator frequencies from 0.5 to 60 cycles per second, or rotational speeds from 30 to 3600 rpm. Diameter may be conveniently adjusted by means of a continuously variable control on the Indicator.

#### Radial Deflection

The phenomenon to be investigated by the Type 275-A must be converted to an electrical signal, if it does not already exist as such. There are many suitable transducers for such purposes, which are commercially available. The signal is connected to the "Radial Input" terminal to produce radial deflection of the analog circle.

The frequency response of the radial amplifier in the Type 275-A is uniform within 10% from 2 to 30,000 cycles per second. This frequency range corresponds, for the lower limit, to the fundamental motion of a shaft rotating at 120 rpm, and, for the higher limit to the 500th harmonic of the fundamental vibration of a shaft turning at 3600 rpm.

The input attenuator for the radial amplifier has 10:1 and 1:1 positions, and a position at which a 60-cycle test signal is applied to the

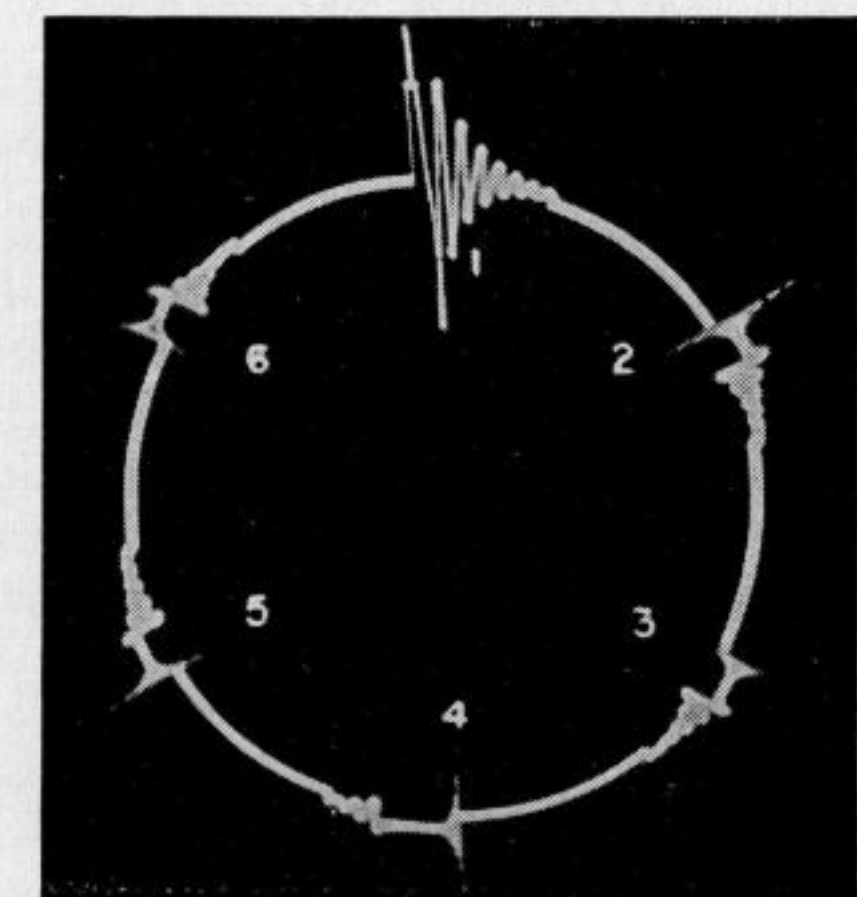

Figure 3. A typical oscillogram taken from the ignition system of an automobile. Each of the six oscillations on the analog circle is a plot of the voltage across the coil primary as the spark plugs fire. Interpretation of the oscillogram shows that plugs 2, 3, 5, and 6 are firing normally, while plug 1 is open and 4 is shorted



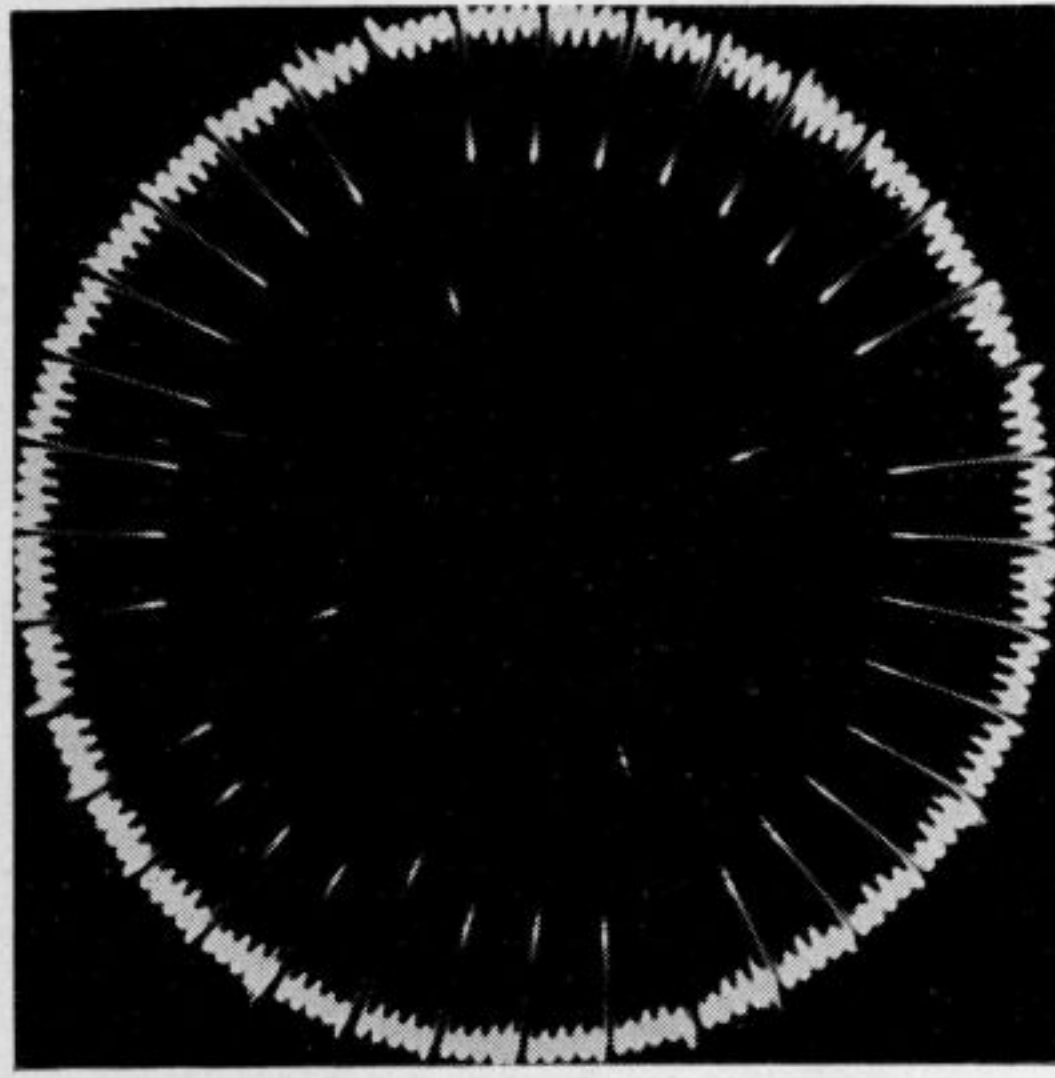

Figure 4. A test pattern showing the accuracy of the Type 275-A. Markers are at 2-degree intervals, with 10-degree markers accentuated, and 90-degree markers further accentuated

input of the radial amplifier. A continuously variable control permits adjustment of radial deflection amplitude.

### Intensity Modulation

The Type 275-A has provisions for applying an external signal to the grid of the cathode-ray tube. This channel is used either to apply timing marks, so that rotational speed of the device under investigation can be determined, or to apply a reference marker from which angular displacement can be measured.

### Applications

The Type 275-A Polar-Coordinate Indicator was developed for use in the mechanical industries for the study and analysis of phenomena occurring in connection with reciprocating and rotating machinery. Used with suitable transducers, it is capable of reproducing any such phenomena within the range of the instrument. There are many transducers, such as displacement pick-ups, vibration pick-ups, pressure pick-ups, strain and tension pick-ups, and photocells—to name but a few—which are commercially available. A potentiometer, too, may be used as a transducer to produce a proportional voltage from a rotary or reciprocating motion. In this instance, the potentiometer is connected across a d-c source, and is mechanically coupled in such a manner that its center arm moves in accordance with that motion. The proportional voltage appears between the center arm and one terminal on the potentiometer.

Extreme care must be taken in the selection of a transducer for any particular application, and the electrical and physical limitations of the transducer must be borne in mind if satisfactory results are to be obtained. Du Mont invites the opportunity to lend its services for consultation on such problems.

The Type 275-A has found a wide range of applications in many branches of mechanical engineering. For example, the Type 275-A is being used to time and analyze the weaving cycle of looms. The oscillogram in Figure 1 was made to determine the initial and terminal velocities and the average velocity of a shuttle across a loom, to and from the shuttle box. Acceleration was simultaneously obtained. The arrival and departure of the shuttle and the angular position at which these events took place during the weaving cycle of the loom are accurately indicated by the radial deflections. The dark spot in the analog circle at 323° is a reference marker.

The Type 275-A has been found extremely useful in the automotive field. A typical example is shown in Figure 3. This oscillogram was made from the ignition system of an automobile engine, with the voltage for the radial deflection obtained across the primary of the ignition coil. The continuation of oscillation at point 1 indicates that that particular spark plug was not firing. The long interval between the radial deflections at point 4 indicates that that spark plug is shorted.

The test pattern shown in Figure 4 demonstrates the accuracy of the Type 275-A. In this oscillogram two-degree markers were im-

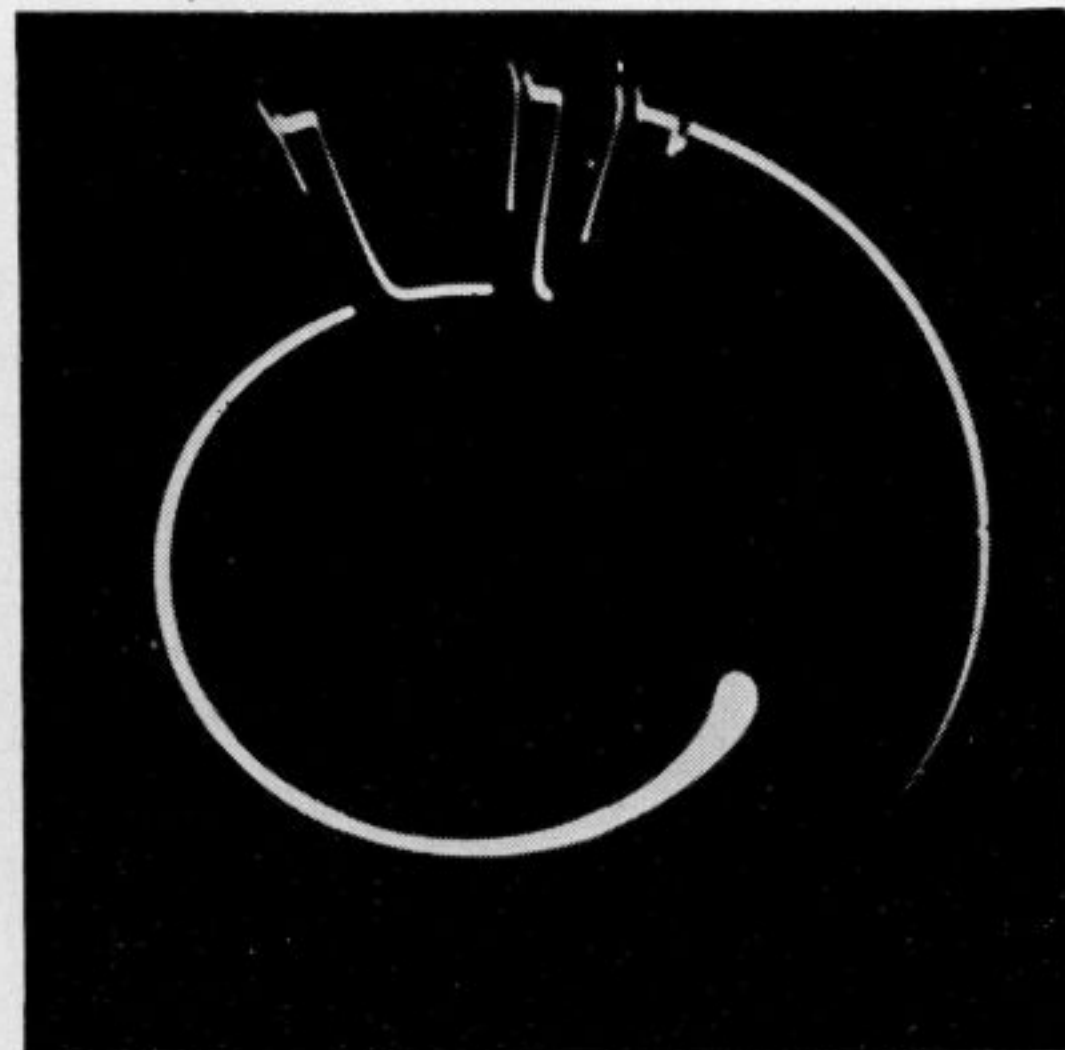

Figure 5. The bounce of the moving arm of a relay at the time of activation is clearly shown by the radial deflections

pressed on the analog circle by passing a beam of light through slits in the periphery of a spinning disc. Slits were two degrees apart, with those at 10° accentuated, and those at 90° further accentuated. The light passed through these slits was picked up by a photocell, and the resultant voltage was applied to the radial deflection amplifier.

Figure 5 is an oscillogram displaying the bouncing of the moving arm of a relay. The inner semi-circle represents the period before activation. Radial deflections indicate the bounce of the relay arm at the time of activation. The outer semi-circle indicates the rest period of the activated relay arm after bouncing had ceased.

The oscillogram in Figure 6 shows the light distribution pattern of two incandescent lamps with prefocused lenses, one perfect, the other imperfect. The flattening of the pattern on the left indicates the defective lens. This oscillogram was made by revolving the photocell pick-up around the two lamps under test. Similar procedures are applicable wherever a field distribution diagram is required.

The Type 275-A is also well suited for vibration studies. A vibration pick-up may be attached, say, to a bearing which supports a rotating shaft or pulley. The associated vibrations will be clearly displayed as stationary deflections on the analog circle, indicating both the nature of the vibrations, and the angle at which they occur.

### SPECIFICATIONS

**CATHODE-RAY TUBE**—Type 5CP-A electrostatic tube; overall accelerating potential, 3000 volts.

**ANALOG CIRCLE**—Derived from two-phase generator furnished with the equipment. Useful circle diameter, 1 to 4-1/2 inches. Positive polarity from generator deflects beam upward or to the right.

**RADIAL AMPLIFIER**—Less than 1.1 peak-to-peak (0.4 rms) volt produces deflection to center of circle. Positive input increases circle diameter. **Frequency Response:** uniform within 10% from 2 to 30,000 cycles per second. Input impedance: with 1:1 attenuation, 250,000 ohms; with 10:1 attenuation, 2.45 megohms. Input selection of external signal or 60-cycle test signal. **Maximum Allowable Input Potential:** a-c input, 600 volts d-c plus peak a-c; d-c input, 100 volts d-c or rms.

**INTENSITY MODULATION**—Input terminal capacitively connected to cathode-ray tube grid. **Input Impedance:** 2.2 megohms.

| Catalog No. | Type No. | Description  |
|-------------|----------|--|
| 1250-E      | 275-A    | Cathode-ray Polar-coordinate Indicator with Type 5CP1-A Cathode-ray Tube; 115 volts, 50-60 cycles. |
| 1254-E      | 275-A    | Same as above, with Type 5CP11-A Cathode-ray Tube.   |
| 1255-E      | 275-A    | Cathode-ray Polar-coordinate Indicator with Type 5CP1-A Cathode-ray Tube; 230 volts, 50-60 cycles. |
| 1259-E      | 275-A    | Same as above, with Type 5CP11-A Cathode-ray Tube.   |

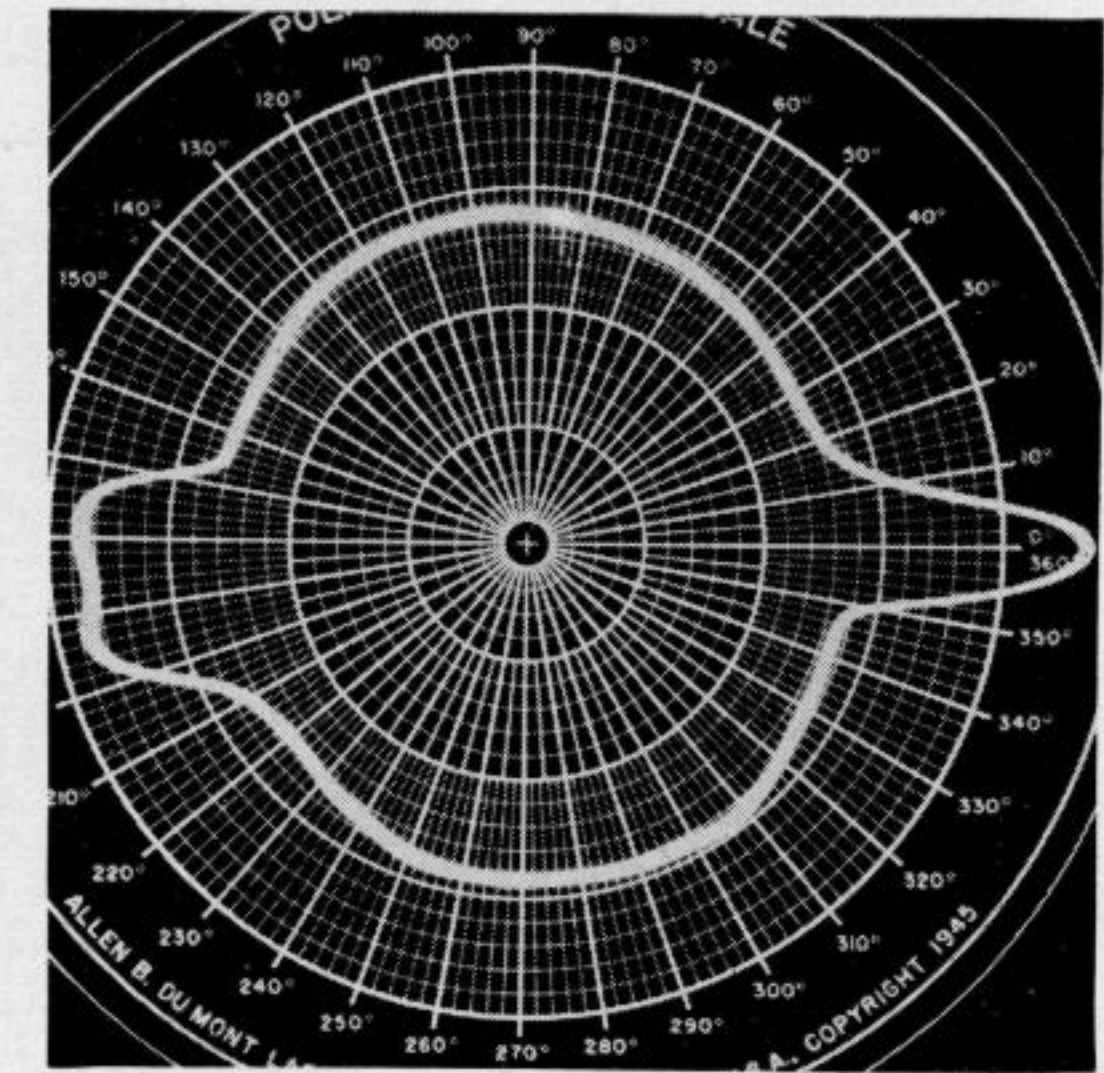

Figure 6. Light distribution pattern of two incandescent lamps with prefocused lenses. The flattened deflection at left indicates a defective lens on that lamp

Pressure pick-ups may also be employed with the Type 275-A. These may, for example, be attached to the cylinder of an internal combustion engine, to plot the pressure in the cylinder throughout the entire cycle.

### Accessories Supplied

A Type 216-F Calibrated Scale and a two-phase generator are supplied with the Type 275-A.

Positive input increases beam intensity; 45 volts peak signal drives cathode-ray tube from cut-off to zero bias.

**MAXIMUM PHOTOGRAPHIC WRITING RATES**—With Type 296, using f/2.8 lens, 0.4 inches/μsec; with Types 321 and 295, using f/1.5 lens, 2.8 inches/μsec.

**POWER SOURCE**—Type 275-A is designed to operate from either a 115- or 230-volt power line; change from one to the other by means of switch. Power-line frequency, 50-60 cycles; power consumption, 100 watts; fuse protection—1.5 amperes (115 volts), 0.75 amperes (230 volts).

**TUBE COMPLEMENT**—6SL7; 6SN7; 6SJ7; 2X2-A; 5Y3-GT; 6X5-GT; OC3.

**PHYSICAL CHARACTERISTICS**—Instrument housed in metal cabinet provided with carrying handle and removable panel cover. **Overall Dimensions:** height, 17" (43.2 cm); width, 10-1/2" (26.7 cm); depth, 19-1/2" (49.5 cm). **Weight:** 65 lbs. (29.4 kg).

# TYPE 279 DUAL-BEAM CATHODE-RAY OSCILLOGRAPH

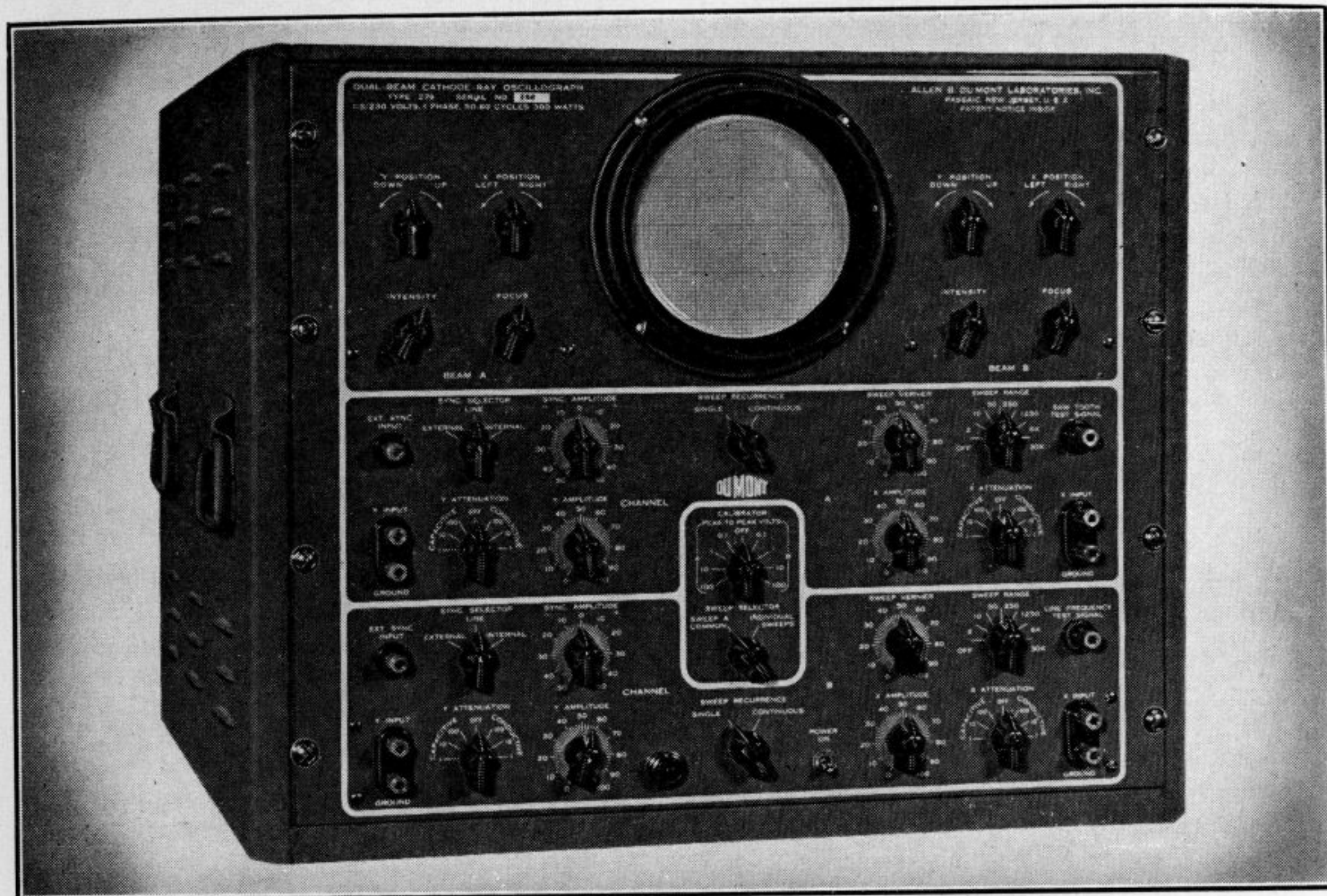

- Dual-beam cathode-ray tube
- Two oscillographs in one unit—either separate or common
- Built-in voltage calibrator
- Multiple combinations of input connections
- Intensity modulation channels
- Optional relay-rack mounting

## FUNCTION

The Du Mont Type 279 Dual-beam Cathode-ray Oscilloscope is a dual-channel instrument which employs the Du Mont Type 5SP-Dual-beam Cathode-ray Tube. This cathode-ray oscillograph enables two entirely independent oscillograms to be displayed simultaneously on a single screen.

Simultaneous oscillographic comparison of two phenomena has been the subject of research for many years. Prior to the development of the dual-beam tube, it had been accomplished (1) by utilizing an electronic switch, (2) by splitting the beam from a single electron gun and deflecting portions of the beam separately, or (3) by superimposing the patterns from two screens by optical means. The use of an electronic switch has a severe disadvantage. Since the phenomenon on each trace is viewed for only 50% of the entire sweep cycle, many important details may be obscured.

Both the first and second methods require that the two signals be observed on the same time-base, and the third method is quite cumbersome, and too elaborate for many applications. The Type 279 permits observation of the signals on separate time-bases or on a common time-base.

## DESCRIPTION

### Cathode-ray Tube

The Type 5SP-Cathode-ray Tube is the equivalent of two separate tubes. Its construction permits two completely independent traces to be viewed on a single fluorescent screen. Independent signals can also be used for intensity modulation of each beam. Overall acceleration of 4500 volts provides high light output from both beams.

Figure 1 shows the Type 5SP-Cathode-ray Tube and its electron gun structure. The two guns are physically separated, and electrostatically shielded to minimize interaction.

## TYPE 279 DUAL-BEAM CATHODE-RAY OSCILLOGRAPH

### Double Channels

Essentially the Du Mont Type 279 Dual-beam Cathode-ray Oscilloscope is two oscillographs in one cabinet. The beam controls for each channel are located on the front panel, on opposite sides of the cathode-ray tube. The remaining controls for each channel are independently grouped on two sections of the panel, and these sections are subdivided so that the vertical controls for each channel are located on the left side while the horizontal controls are on the right. Controls common to both channels are located in the center under the cathode-ray tube.

The two channels, each in reality an independent oscillograph, are referred to as Channel A and Channel B, with the corresponding beam-control circuits designated as Beam A and Beam B. Channels may be used with separate or common horizontal deflection. Either continuous sweeps or single sweeps are available in each channel. Z-axis modulation may be applied to both channels simultaneously or separately. A voltage calibrator is built into the instrument so that peak-to-peak calibration

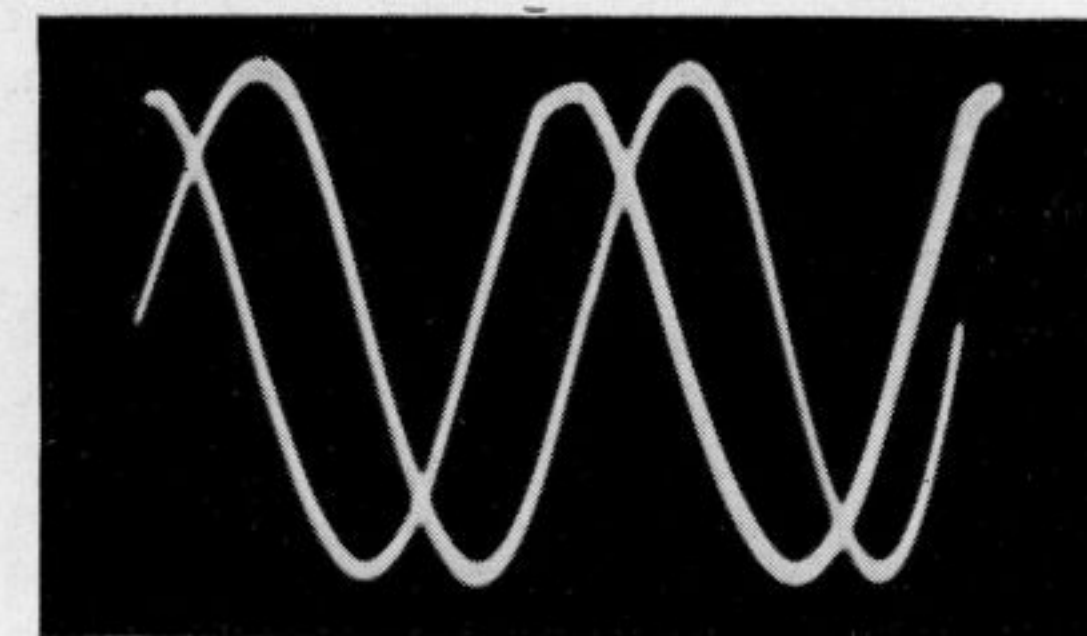

Figure 2. Oscillogram showing phase comparison between two sinewaves. They are plotted on a common sweep and superimposed to facilitate measurement

voltages may be applied to either of the two channels.

Some typical applications of this instrument are illustrated by the oscillograms of Figures 2, 3, 4, and 5. Figures 2 and 3 show the use of a common time-base for the observation of two signals simultaneously. Figure 2 shows the comparison of phase between two sinewaves of the same frequency. Figure 3 shows a square wave input as the upper trace and the output of a differentiator circuit, to which this square wave has been applied, as the lower trace.

Figure 4 illustrates the use of separate sweeps at different frequencies for observing parts of the same waveform. The complex wave obtained from the circuit of a fluorescent lamp (upper trace) is compared with an expanded portion of the same waveform (lower trace). The lower trace is plotted on a faster time-base. By properly phasing the synchronizing signal for the faster time-base, any portion of the upper signal may be observed in greater

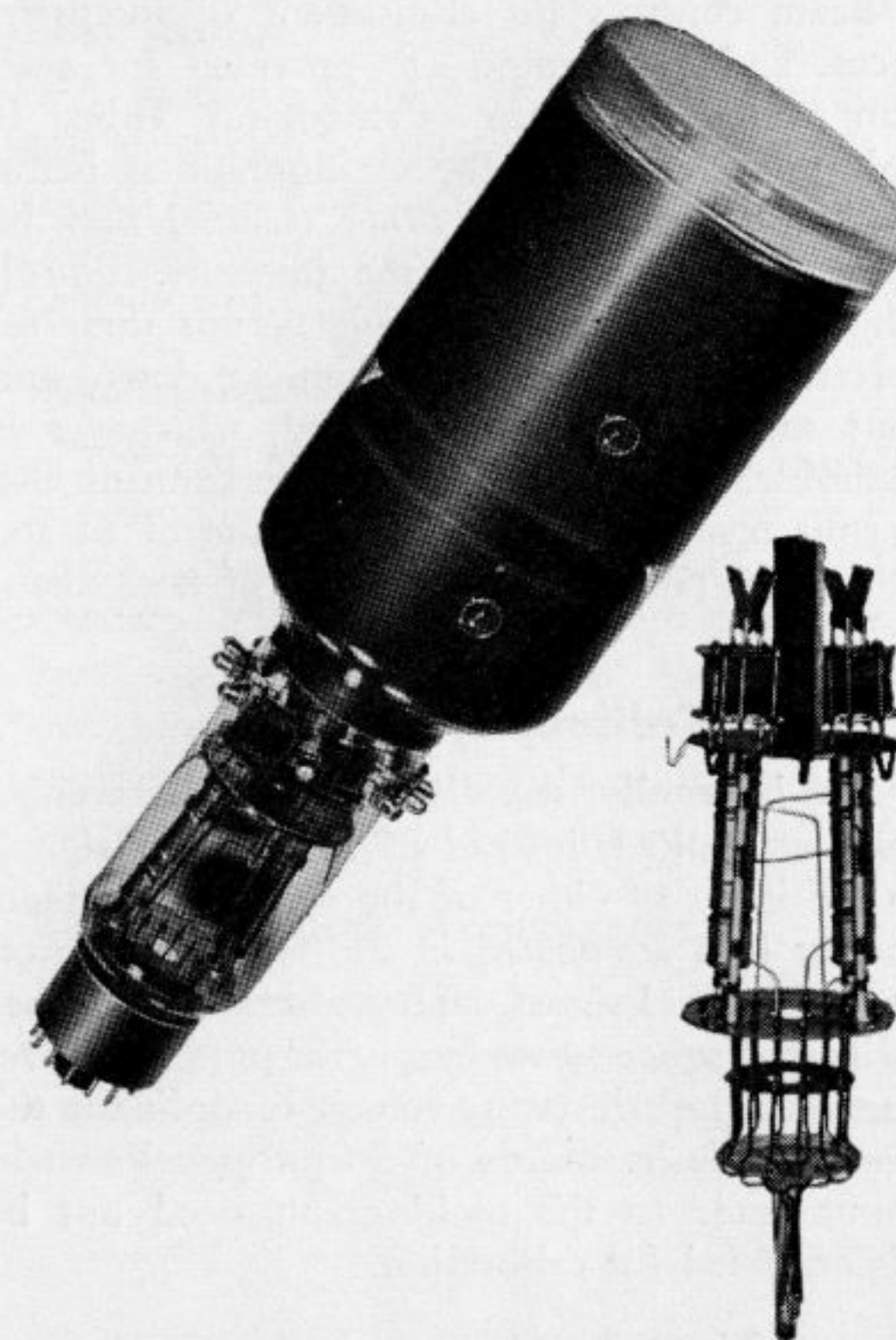

Figure 1. The Du Mont Type 5SP Dual-Beam Cathode-ray Tube showing the structure of its electron guns. The two guns are physically separate and are shielded to prevent interaction between the deflection plate associated with each.

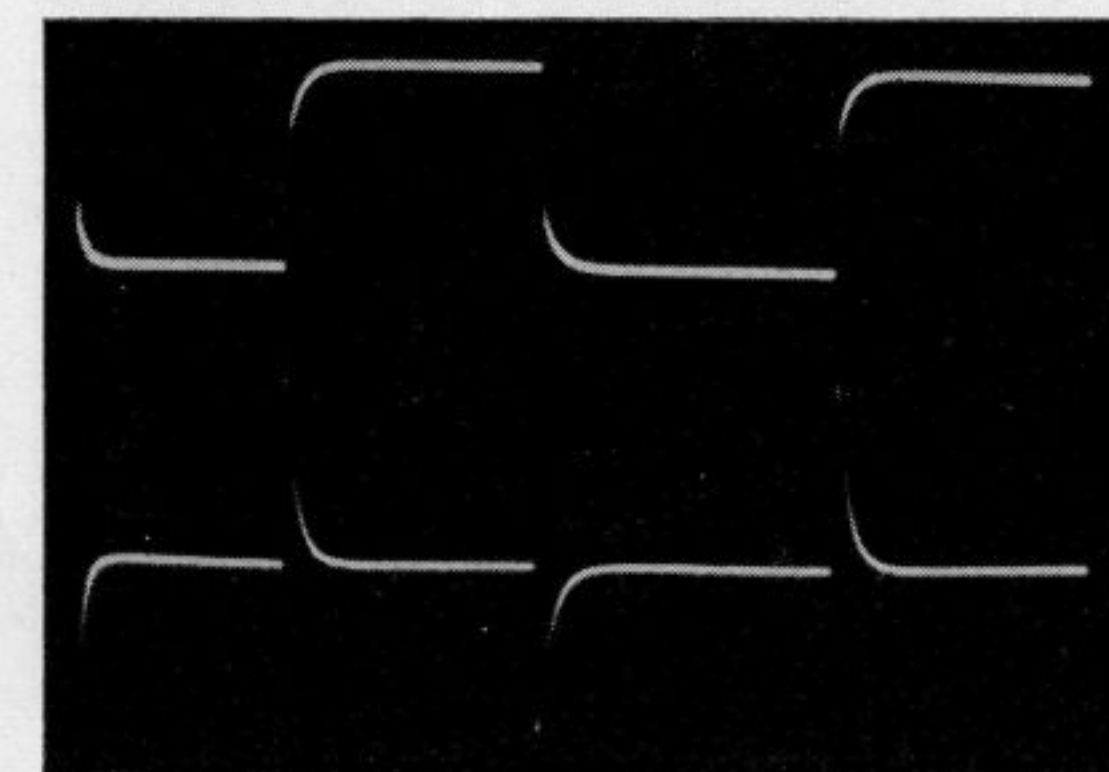

Figure 3. Oscillogram showing a square-wave signal (top) and the resultant waveform after differentiation by an RC network (bottom). Both signals are plotted on a common sweep

detail. Figure 5 illustrates the use of different frequencies for intensity modulating each beam. The two 60-cycle sinewaves shown are modulated with frequencies of 480 cps and 120 cps, upper and lower respectively.

### Amplifiers

Single-stage, direct-coupled amplifiers are employed for vertical and horizontal deflection in each channel. Signals applied to the input terminals of any of the four amplifiers may be coupled to the amplifier either capacitively or conductively through a combination of stepped and variable attenuators. The stepped attenuators have three positions for each type of coupling. An additional position of the attenuator switch automatically grounds the grid of the amplifier so that signals may be left connected to the amplifier input terminals without danger of interaction when other signals are connected directly to the deflection plates. Signals may be capacitively coupled to the deflection plates without going through the amplifier by connecting to terminals on the back of the instrument. The positioning controls on the panel retain their functions when signals are coupled to the deflection plates in this manner.

Response of the vertical amplifiers is flat to zero frequency (direct current) at the low end, and is down 30% at 200,000 cycles per second. The response of the horizontal amplifiers is flat to zero frequency at the low end, and it is down 30% at 110,000 cycles per second. Average frequency-response curves for the vertical and horizontal amplifiers are shown in Figure 6.

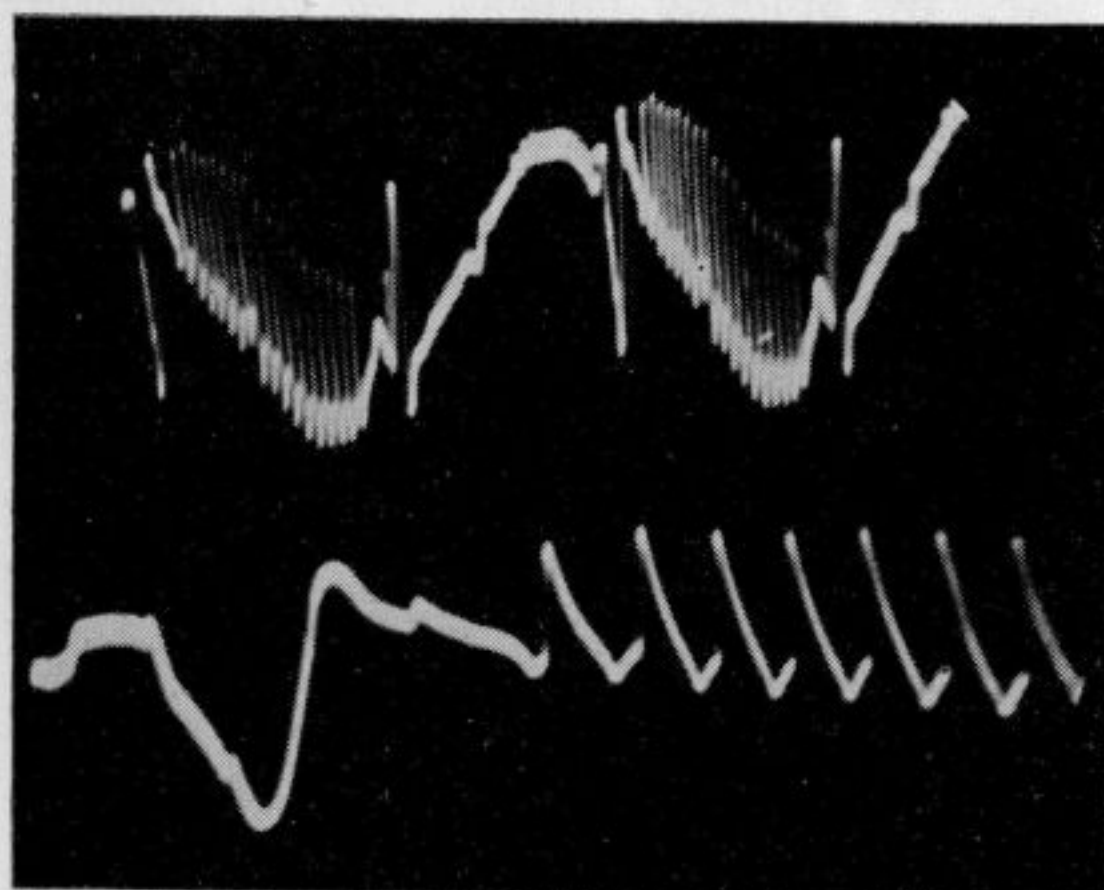

Figure 4. A complex wave-form taken from an ordinary fluorescent lamp (top) is compared with a greatly expanded portion of the same wave-form (bottom). Expansion is accomplished by plotting the lower trace on a much faster sweep

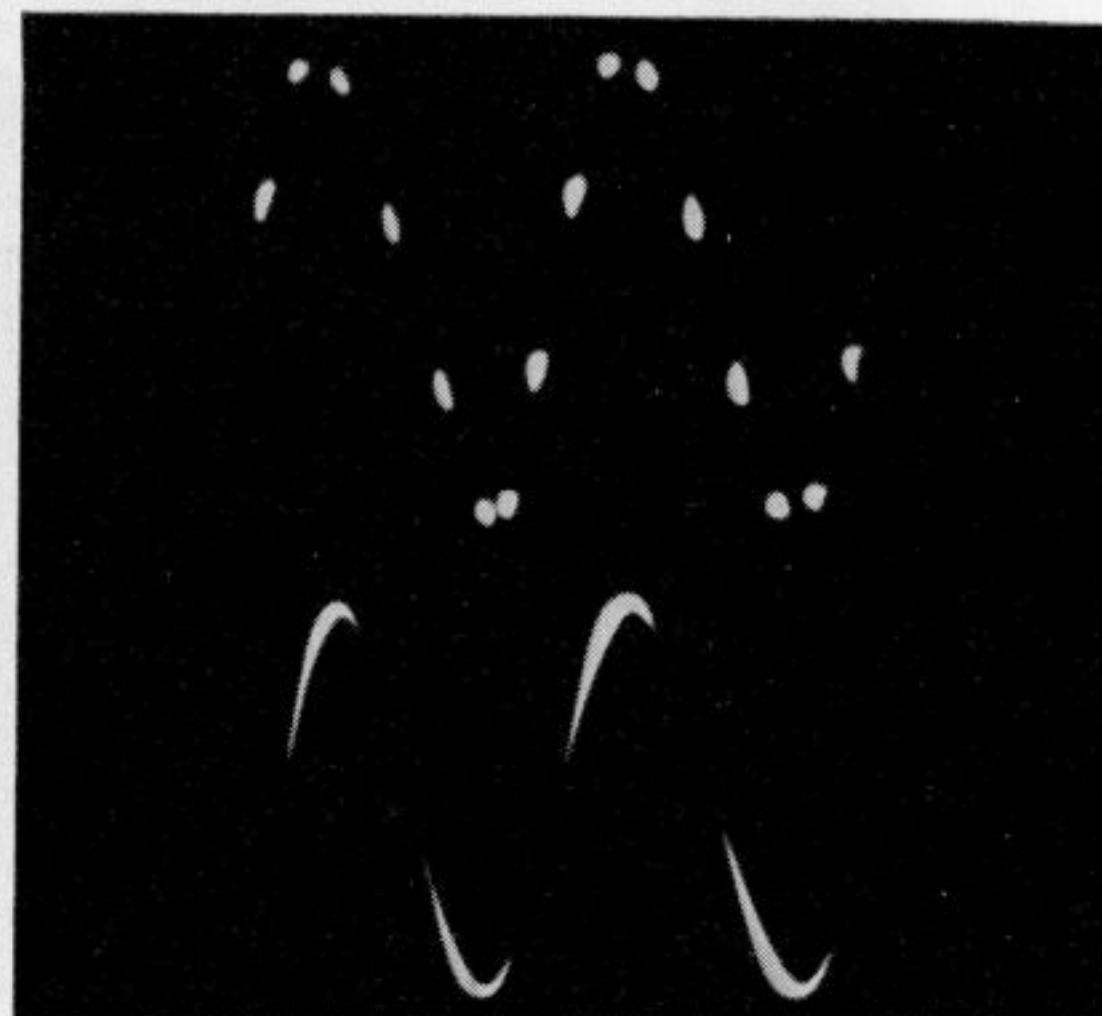

Figure 5. Oscilloscope showing intensity modulation by signals of different frequencies. At the top, a 60-cycle signal is intensity-modulated at 480 cycles per second. At the bottom, the same 60-cycle signal is modulated at 120 cycles per second

### Beam Controls

Beam controls for adjustment of intensity, focus, and positioning are provided for each gun of the Type 5SP-Cathode-ray Tube. If only one channel of the oscilloscope is being used, the beam of the other channel may be turned off by means of the intensity control. The vertical position controls permit their respective beams to be moved up or down, and thus superimposed or separated, whichever is desirable. The horizontal position controls also permit complete flexibility for control of the horizontal position of the traces of both channels.

### Voltage Calibrator

An internally supplied calibrating voltage may be applied, instead of an external signal, to the input of either of the vertical amplifiers so that it is attenuated in the same proportion as the external signal. The calibrator furnishes calibrated square-wave outputs at power-line frequency. The calibrating voltage is applied to the vertical axis by means of a front-panel switch. Input leads to the oscilloscope need not be disconnected for calibration.

### Linear Time-Base

A linear time-base generator is provided for each channel to produce continuous sweeps over the range from 2 to 30,000 cycles per second. Provision is also made for single sweeps variable in duration from 1/2 second to 33 microseconds. The time-base generators in each chan-

## TYPE 279 DUAL-BEAM CATHODE-RAY OSCILLOGRAPH

nel may be used independently, or the time-base of Channel A may be used as common to both channels to permit the simultaneous observation of two signals on a single time-base.

### Automatic Beam Control

An automatic beam-control circuit is incorporated in each channel to increase the brightness of the beam for the duration of any single sweep. The intensity is automatically reduced to zero when the time-base is switched from continuous-sweep to single-sweep operation, and is automatically returned to its original value upon initiation of the single sweep.

Automatic beam control is of particular value in photographing single transients. If a single-frame oscilloscope-record camera such as the Du Mont Type 295, 296, or 297 is used, the shutter can be opened prior to the occurrence of the transient, left open for the duration of the transient, and closed after the cycle is completed without fogging the film. The photographic technique required for making such recordings has thus been greatly simplified.

### Test Signals

A sinewave voltage of power-line frequency and a sawtooth voltage are available as test signals from terminals on the front panel. The sawtooth signal is obtained from the sweep generator of Channel A.

### Mechanical Features

The Du Mont Type 279 Dual-beam Cathode-ray Oscilloscope is mounted in its own metal cabinet. However, the front panel is of standard relay-rack design so that the instrument may readily be removed from its cabinet and installed in a relay rack as permanent equipment. Input terminals on both the front and rear of the instrument are easily accessible.

### Recommended Accessories

With a two-channel oscilloscope, it is virtually impossible for the operator to concentrate on both traces simultaneously. Thus, if no detail is to escape observation, it is impor-

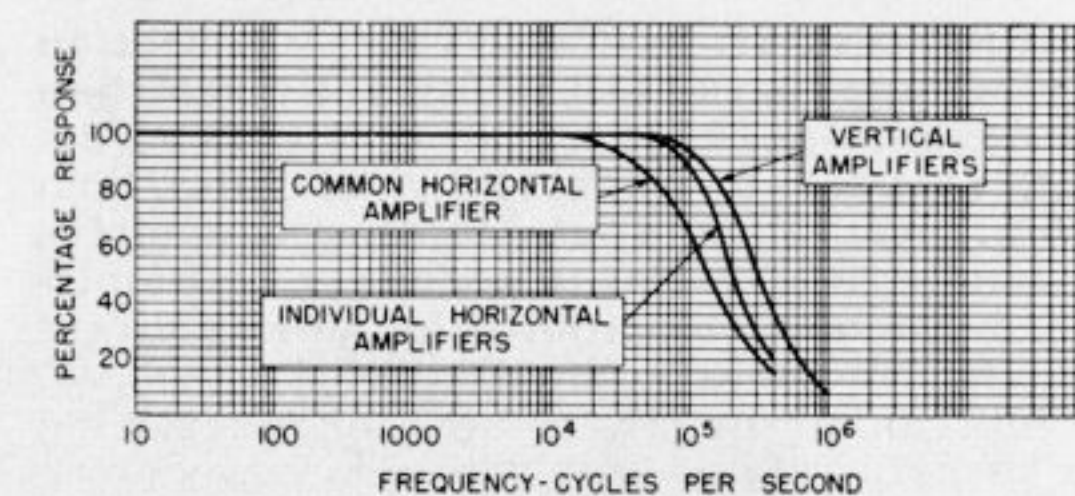

Figure 6. Frequency-response characteristic of the Type 279

tant that the patterns under study be photographed. The Du Mont Type 296 Oscilloscope-Record Camera is recommended for this application, providing no unusually high writing rates are involved. However, if writing rates are encountered which are beyond the capabilities of general-purpose recording equipment, the Du Mont Type 295 Ultra-High Speed Oscilloscope-Record Camera must be used. If a finished oscillogram is required in the shortest possible time, the Du Mont 297 Finished-Print Oscilloscope-Record Camera may be used.

For observation of two related phenomena over an extended period of time, the Du Mont Type 321 Continuous Motion Oscilloscope-Record Camera is recommended.

The Du Mont Type 316 Test Probe may be used for input connections to the Type 279. This Test Probe provides a low-capacity input and imposes minimum load upon sources of high-frequency signals. Moreover, it minimizes pick-up which might otherwise occur in connecting leads.

For visual observation, the Du Mont Type 2560-A (green) Filter provides additional contrast when used with a P1 screen. When a P2 screen is employed, the Type 2560-B (blue) or Type 2560-C (amber) Filter may be used to eliminate the long- or short-persistence characteristic, respectively.

For visual observation under conditions of excessively high ambient light, the Du Mont Type 276 Viewing Hood is recommended.

## SPECIFICATIONS

**CATHODE-RAY TUBE**—Type 5SP- dual-beam cathode-ray tube. Accelerating potential, 4500 volts overall.

**VERTICAL DEFLECTION**—Deflection Factor amplifiers (full gain), not more than 1.0 peak-to-peak (0.35 rms) volt/inch; direct 82 peak-to-peak (29 rms) volts/inch  $\pm 20\%$ . Amplifier input coupling, capacitive or conductive. **Input impedance:** to amplifiers, 2 megohms paralleled by 60

$\mu\mu\text{f}$ ; direct (balanced), 2 megohms paralleled by 20  $\mu\mu\text{f}$ ; direct (unbalanced), 1 megohm response of amplifiers (capacitive ohm paralleled by 20  $\mu\mu\text{f}$ . **Sinusoidal frequency** (input) within 10% from 10 to 100,000 cycles per second; (conductive input) flat to d-c (zero frequency) and within 10% to 100,000 cycles per second. Frequency response within 30% to 200,000 cycles per second, either capacitive or conductive input.

**HORIZONTAL DEFLECTION—Deflection Factor** amplifiers (full gain), not more than 1.0 peak-to-peak (0.35 rms) volt/inch; direct, 71 peak-to-peak (25 rms) volts/inch  $\pm 20\%$ . Amplifier input coupling, capacitive or conductive. **Input impedance:** to amplifier, 2 megohms paralleled by 60  $\mu\text{f}$ ; direct (balanced), 2 megohms paralleled by 20  $\mu\text{f}$ ; direct (unbalanced), 1 megohm paralleled by 20  $\mu\text{f}$ . **Sinusoidal frequency response** of amplifiers (capacitive input) within 10% from 10 to 50,000 cycles per second; (conductive input) flat to d-c and within 10% to 50,000 cycles per second. Sinusoidal frequency response within 30% to 110,000 cycles per second, either capacitive or conductive input. For common horizontal amplifier, sinusoidal frequency response is within 10% to 30,000 cycles per second, and within 30% to 60,000 cycles per second. Low-frequency square-wave response for a-c amplifier connection, 15% maximum saw at 10 cps.

**LINEAR TIME-BASE—**Provides recurrent sweeps variable in frequency from 2 to 30,000 cycles per second. Also provides single sweeps with durations variable from 1/2 second to 33  $\mu\text{sec}$ . Recurrent sweeps synchronize from external signal of either polarity and less than 0.3 volt peak amplitude, or from internal vertical-deflection signal of approx. 1/4" vertical deflection. Single sweeps initiated from external signal of either polarity and less than 5 volts peak amplitude, or from internal vertical-deflection. Repetition rate of initiating signal up to frequency corresponding to driven sweep duration.

Provision for sweep "A" to deflect both beams simultaneously.

**INTENSITY MODULATION—**Terminal for capacitive connection of external sig-

nals to cathodes of cathode-ray tube. Input impedance, 10,000 ohms paralleled by 40  $\mu\text{f}$ . Positive signal decreases intensity; amplitude of 7.5 volts peak provides satisfactory modulation.

**Return-trace** of recurrent sweeps blanked out. Beam blanked out on single sweeps except during sweep duration.

**CALIBRATOR—**Square-wave output at powerline frequency and 0.1, 1, 10, or 100 volts peak-to-peak amplitude. Accuracy,  $\pm 5\%$ . Calibrating voltage may be applied to either vertical amplifier without disconnecting input signal.

**TEST SIGNAL OUTPUTS—**Sinewave signal at power-line frequency and approx. 17 peak-to-peak (6 rms) volts amplitude. Sawtooth voltage is available from sweep "A".

**MAXIMUM PHOTOGRAPHIC WRITING RATES—**With f/2.8 lens, 1.6 in/ $\mu\text{sec}$ ; with f/1.5 lens, 5.6 in/ $\mu\text{sec}$ .

**POWER SOURCE—**Type 279 is designed to operate from either a 115- or 230-volt power-line. Changeover is made by switch. Power-line frequency, 50-60 cycles; power consumption, 300 watts; fuse protection, 3 amperes (115 volts) or 1.5 amperes (230 volts).

**TUBE COMPLIMENT—**6H6; 4-6J5; 8-6AG7; 4-6SN7; 2-6Q5G; 2-6SL7; 5U4G; 6B4G; 6SJ7; 2-OD3/VR150; 6X5GT; 3B24; 2X2A.

**PHYSICAL CHARACTERISTICS—**Instrument housed in metal cabinet provided with carrying handles. May be mounted without cabinet in standard 19" relay-rack. Overall dimensions, 17" (44.5 cm.) height x 21-3/4" (57.4 cm.) width x 22-1/4" (53.6 cm.) depth; weight with cabinet, 125 lbs. (56.5 kg.), without cabinet, 86 lbs. (39.0 kg.).

| Catalog No. | Type No. | Description  |
|-------------|----------|--|
| 1386-E      | 279      | Dual-beam Cathode-ray Oscilloscope for 115 volts, 50-60 cycles operation; with Type 5SP1 Cathode-ray Tube. |
| 1387-E      | 279      | Same as 1386-E with Type 5SP2 Cathode-ray Tube.  |
| 1390-E      | 279      | Same as 1386-E with Type 5SP11 Cathode-ray Tube.   |
| 1391-E      | 279      | Dual-beam Cathode-ray Oscilloscope for 230 volts, 50-60 cycle operation; with Type 5SP1 Cathode-ray Tube.  |
| 1392-E      | 279      | Same as 1391-E with Type 5SP2 Cathode-ray Tube.  |
| 1395-E      | 279      | Same as 1391-E with Type 5SP11 Cathode-ray Tube.   |

## TYPE 281-A CATHODE-RAY INDICATOR

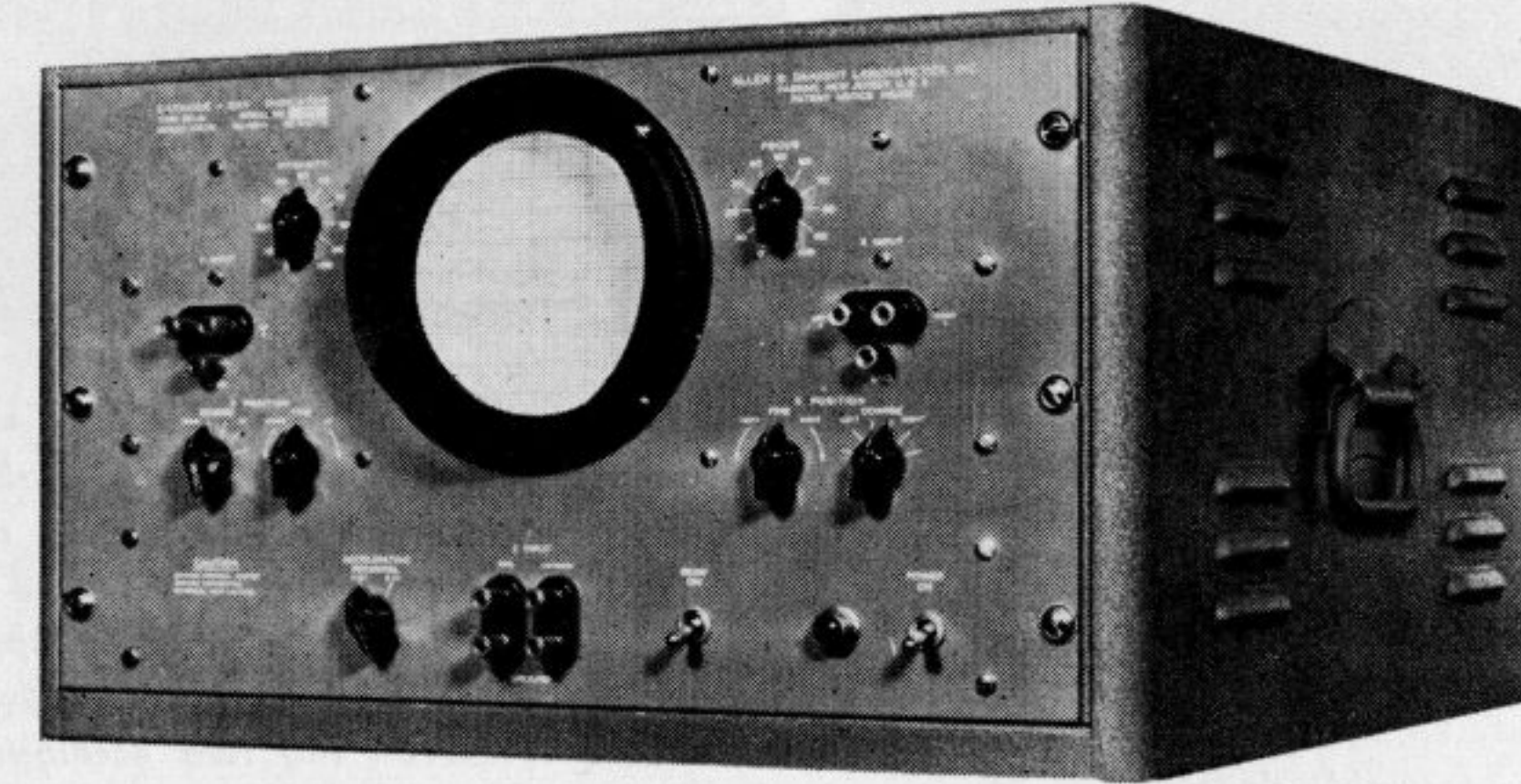

- Type 5RP-A Multi-band Cathode-ray Tube
- Electronically-regulated second anode and positioning voltages permit accurate quantitative measurements
- Provision for use of external high-voltage intensifier supply for cathode-ray tube as well as built in power supply
- Direct and capacitive connections to all deflection plates
- Provision for connection of external deflection amplifiers and time-base generator
- Intensity modulation channels
- May be used as projection oscillograph and for high-speed photographic recording

### FUNCTION

The Du Mont Type 281-A Cathode-ray Indicator is designed specifically to operate with the Type 5RP-A High-Voltage Cathode-ray Tube. It is a basic instrument containing the cathode-ray tube, power supplies to furnish potential for it, and controls to vary intensity, focus, and position of the trace on the screen.

This instrument fulfills three important requirements:

(1) It makes available an indicator capable of exploiting the full capabilities of the Du Mont Type 5RP-A cathode-ray tube, since it

may be used in conjunction with external high-voltage intensifier supplies, or as a self-contained unit.

(2) It makes available a basic instrument invaluable to those whose oscillographic needs are too specialized or too advanced to be satisfied by standard, commercially-available equipment. For example, it may be used for high-tension studies such as surge testing of power distribution transformers and cables, and studies of lightning and other discharges. Heretofore, commercially-available equipment almost invariably incorporated linear time-base generators, whereas a logarithmic time-base is sometimes more suitable for surge testing. The Type 281-A

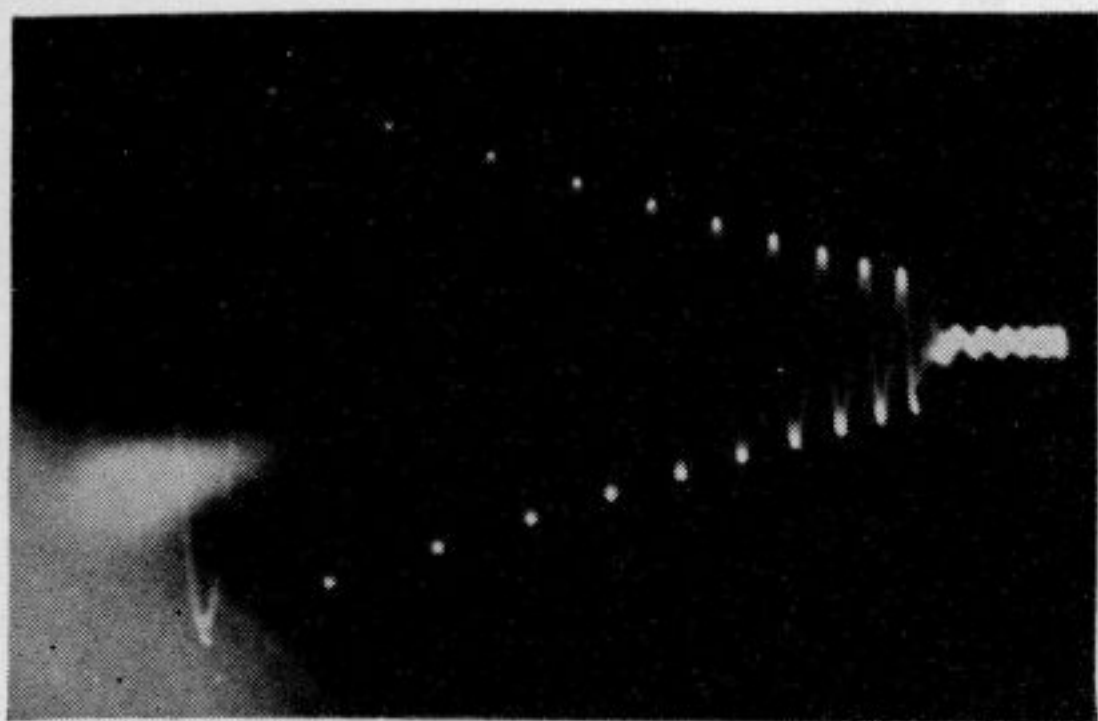

Figure 1. Unretouched oscillogram of a high-speed transient photographed from the Type 281-A, operated with an accelerating potential of 8000 volts. The spot-writing of the first cycle of the transient is 13 in/μsec.; in the 10th cycle 3.5 in/μsec. Note that only an extremely small portion of the pattern is recorded with usable density

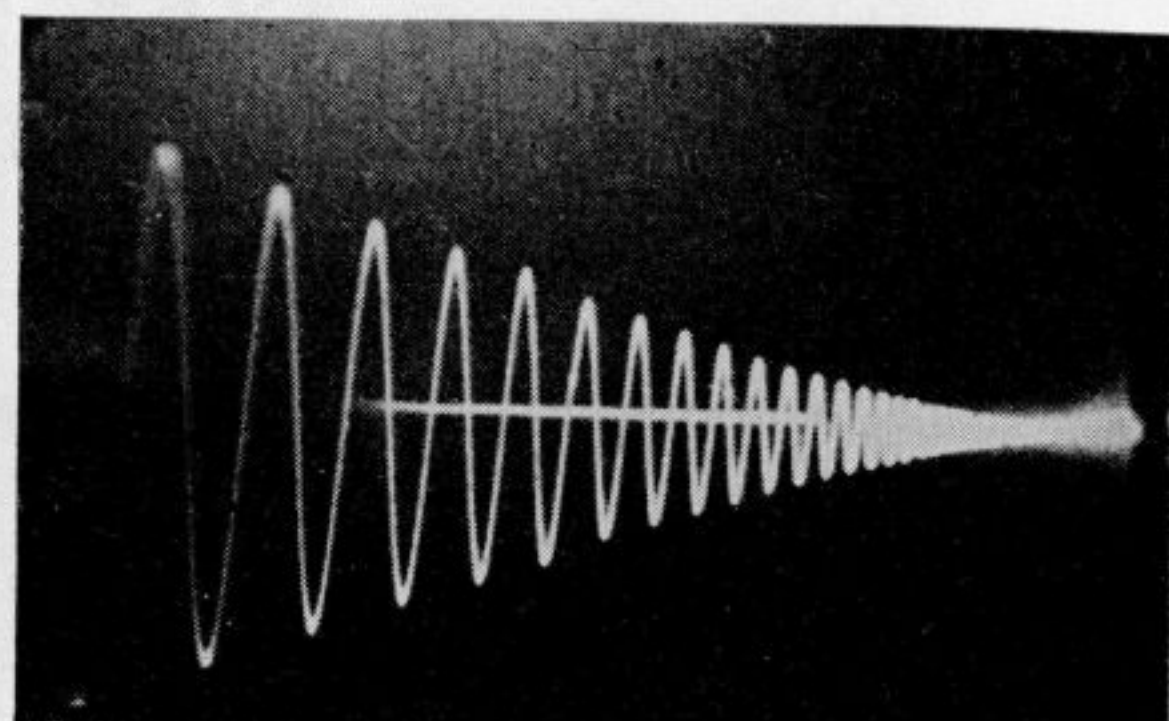

Figure 2. Unretouched oscillogram of the same transient as that of Figure 1 photographed from the Type 281-A operated at an accelerating potential of 29,000 volts (using Type 286-A High-voltage Power Supply). Note the difference in intensity between comparable cycles on the two oscillograms

makes possible the use of any type of time-base generator that the application may require.

(3) It makes available an indicator capable of displaying single transients containing writing speeds as high as 210 cm/μsec. (85 in./μsec.) when referred to standard conditions.<sup>1</sup>

Figures 1 and 2 offer a means of comparison between the photographic writing speeds obtainable with the Type 281-A Indicator operating at two different overall accelerating potentials, 8000 volts or 29,000 volts. (The Type 286-A High-voltage Power Supply is utilized to operate this instrument at an overall accelerating potential of 29,000 volts.) The maximum writing speed of the first cycle in each oscillogram is 32 cm/μsec. (13 in./μsec.), while the maximum writing speed of the tenth cycle is 8.7 cm/μsec. (3.5 in./μsec.). It should be noted that these are unretouched oscillograms. Some detail has been lost in the reproduction process. Furthermore, these photographs were made with a camera which employs an f/3.5 lens. A camera having an f/1.5 lens, such as the Du Mont Type 295 Oscillograph-record Camera, is capable of recording writing speeds 7 times as fast.

The average value of the maximum photographic writing speed obtainable with the Type

<sup>1</sup> The standard conditions to which photographic writing speeds are referred are given in the following definition: Maximum photographic writing speed is the maximum writing speed of the luminescent spot which will yield a negative density of 0.1 above fog, using a lens speed of f/1.0, a high-sensitivity photographic emulsion, an object: image ratio of 1:1, and with development in a high-contrast developer.

281-A Cathode-ray Indicator, using the Type 286-A High-voltage Power Supply as an auxiliary is 825 cm/μsec. or 330 in./μsec.<sup>2</sup>

Figure 3 illustrates the use of the Type 286-A High-voltage Power Supply with the Type 281-A Cathode-ray Indicator. They may be

<sup>2</sup> Average, rather than absolute maximum values are given to allow for normal manufacturing tolerances and variations in photographic technique. Higher values than those stated herein may be obtained under optimum conditions.



Figure 3. The Type 281-A Cathode-ray Indicator and the Type 286-A High-voltage Power supply, fastened together in their cabinets

either fastened one above the other, or mounted together in a standard 19-inch relay rack.

## DESCRIPTION

### Cathode-ray Tube

The Du Mont Type 5RP-A High-voltage Cathode-ray Tube is the result of a long research program aimed to overcome the oscillographic problems encountered when high values of accelerating voltage are used. The multi-band, post-deflection intensifier rings of the Type 5RP-A provide the following advantages over other cathode-ray tubes operating with comparable beam currents:

(1) Ordinary deflection amplifiers may be used with the Type 5RP-A because its deflection sensitivity with high accelerating potentials is reasonably similar to those found in low-voltage tubes.

(2) Insulation requirements for the cathode-ray tube heater transformer are similar to those for low-voltage tubes.

(3) Physical size and voltage rating of coupling capacitors to grid and cathode of the tube are reasonable.

(4) Small spot size allows great resolving power.

(5) Sufficient light output from the screen enables direct projection of patterns.

(6) Photographic recording at speeds equal to those obtained with continuously-evacuated, cold-cathode tubes, and with less auxiliary equipment and lower accelerating potentials.

A comparison of a non-intensifier type of cathode-ray tube with the 5RP-A is shown in Figure 4. Curves a and b indicate the moderate increase in the deflection factor of the Type 5RP-A cathode-ray tube, resulting from an increase in the potential applied to the stepped-intensifier rings. Curve c indicates the increase in the deflection factor of a similar non-intensifier-type cathode-ray tube resulting from an increase in the potential applied to the second anode.

### Vertical and Horizontal Deflection Circuits

Optimum flexibility is assured in the operation of the Type 281-A, since connections to each of the deflection plates are readily available. Capacitive coupling to the deflection plates is made through terminals on the front panel. Direct connection to deflection plates is made through terminals on a recessed panel in the top of the cabinet.

The capacitors which are used for capacitive coupling of the signal to the deflection plates have sufficient voltage rating to withstand input potentials as high as 3000 peak-to-peak volts. This value of input voltage would produce more than twice full-screen deflection even at 29,000 volts total accelerating potential.

Figure 5 is the top view of the Type 281-A Cathode-ray Indicator. Note the accessibility of the deflection plate terminals for direct connections, and the fact that short, direct leads may be used.

### Intensity-Modulation Circuits

A terminal connected to the control grid of the 5RP-A provides a high-impedance input for beam-blanking or timing signals, and a terminal connected to the cathode provides a low-impedance input for similar functions. Both connections are capacitively coupled and may be used simultaneously. For example, an intensifying pulse equal in duration to the time-base may be applied to the grid, while a circuit whose output is proportional to the rate-of-change of signal voltage may be connected to the cathode. These potentials will control the beam intensity as a function of the writing rate, and will prove especially valuable in photographic recording.

To protect the 5RP-A against screen burns when there is no signal applied to the deflection plates, a manually operated beam switch, located on the front panel, is used to control the grid bias. Since the grid is either 2000 or

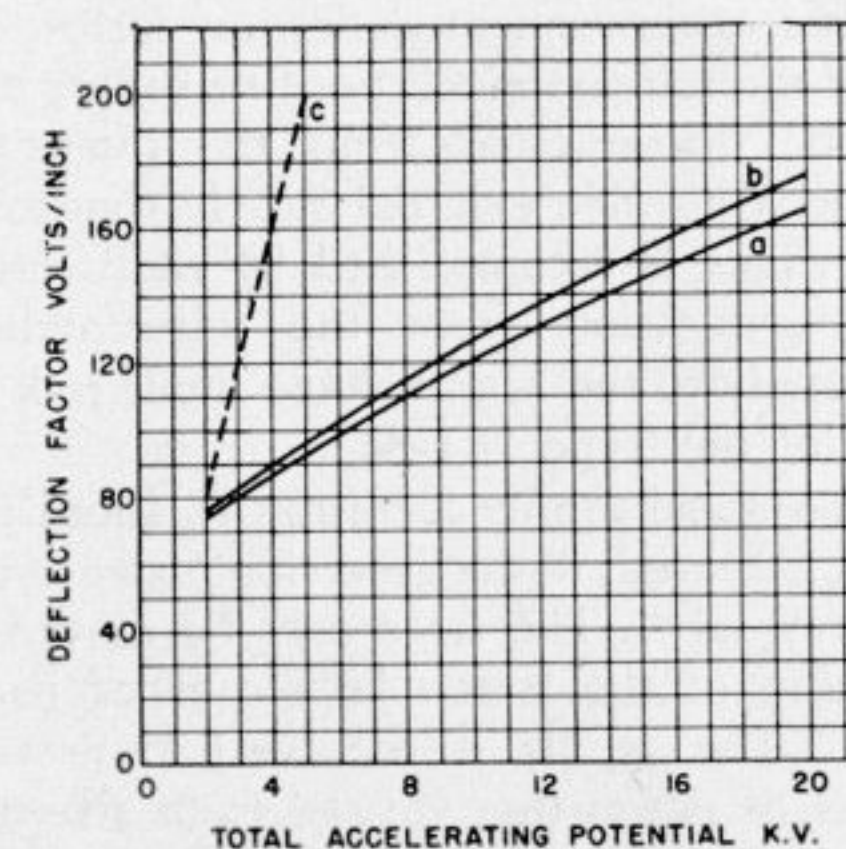

Figure 4. Deflection Factor as a function of total accelerating potential, comparing a non-intensifier type cathode-ray tube with the Type 5RP-A. (a) deflection plates nearer the electron gun in Type 5RP-A (vertical deflection in Type 281-A). (b) deflection plates nearer the screen in Type 5RP-A (horizontal deflection in Type 281-A). (c) non-intensifier cathode-ray tube with  $E_{b2}$  varied

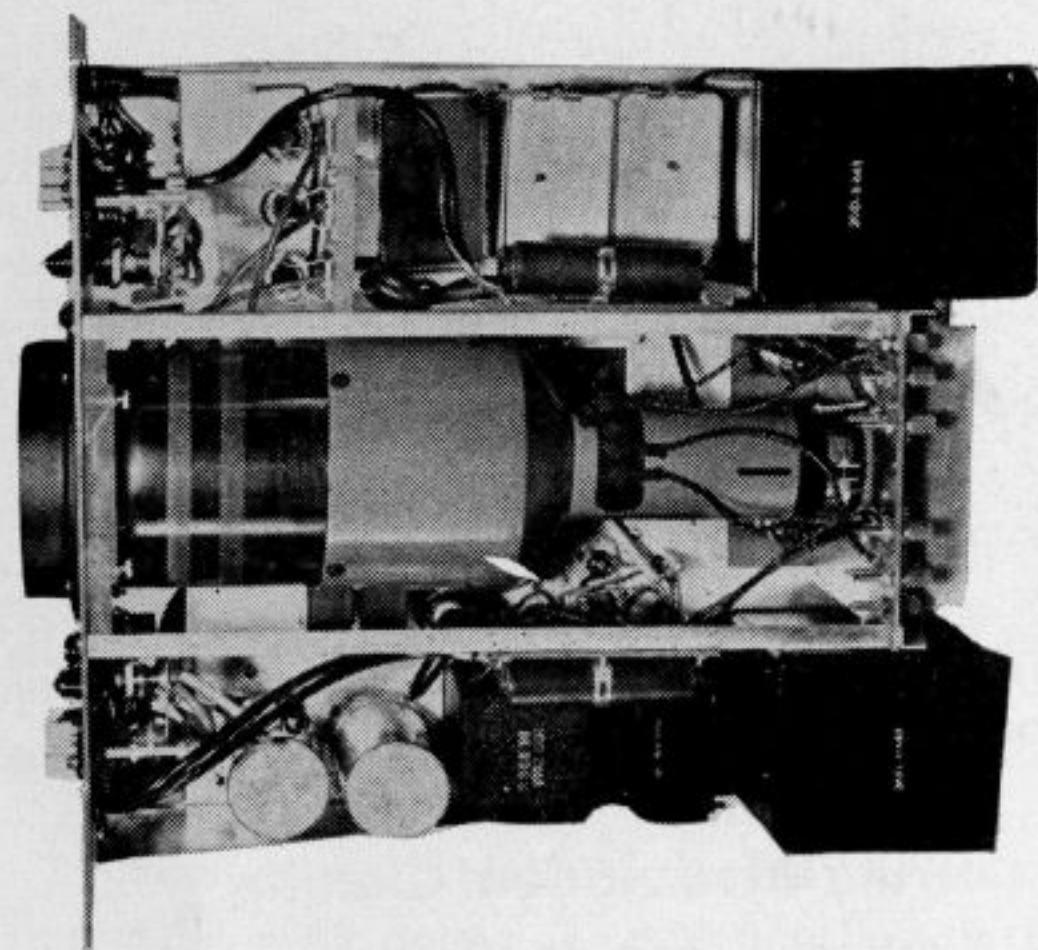

Figure 5. Top view of the Type 281-A Indicator with cabinet removed

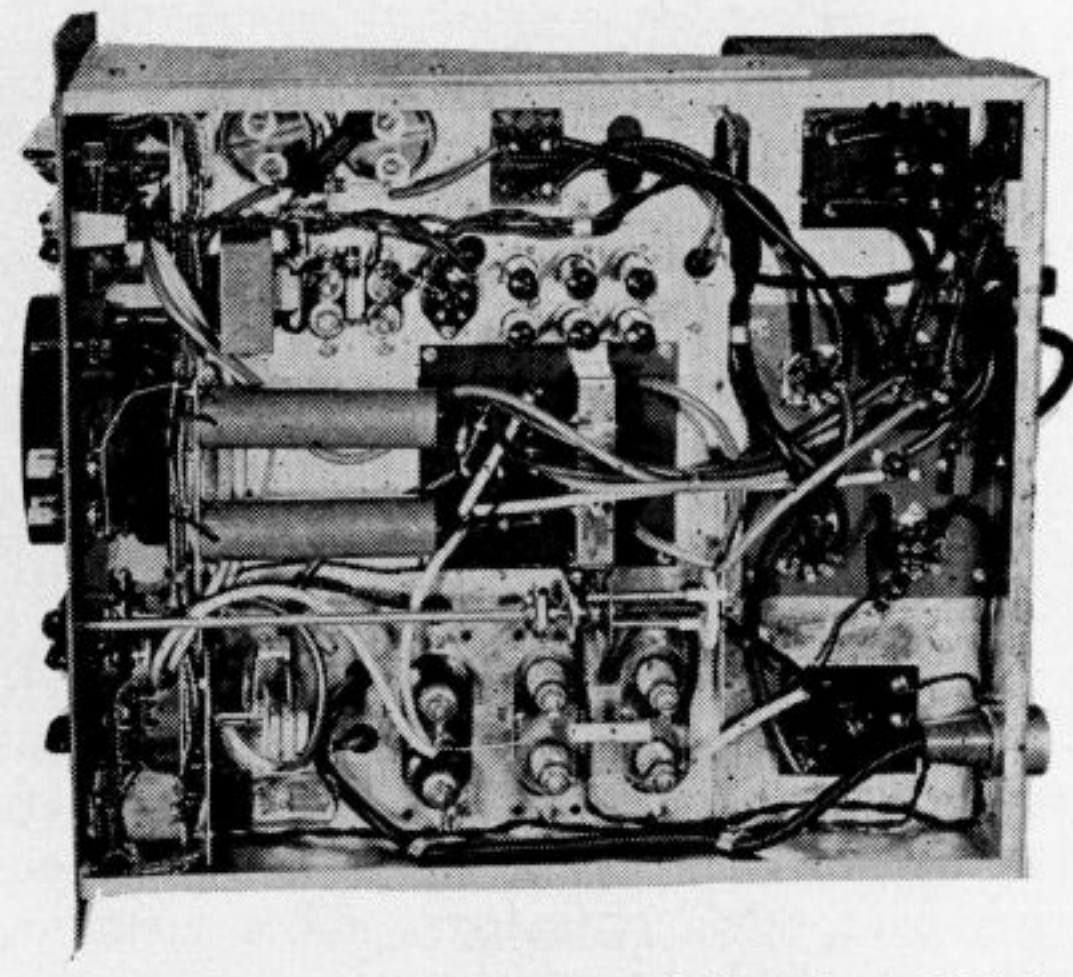

Figure 6. Bottom view of the Type 281-A Indicator with the cabinet removed

4000 volts negative with respect to ground (the chassis of the instrument), this beam switch operates a relay which, in turn, biases the grid below cut-off. No high-voltage connections are made to the switch on the panel.

#### Power Supplies

To further increase the flexibility of the Type 281-A Indicator, a switch is available on the front panel to permit the operation of the Type 5RP-A cathode-ray tube at either 4000 or 8000 volts overall accelerating potential. The pre-deflection accelerating voltage is electronically regulated so that it is not affected by power-line voltage changes or by beam current changes in the cathode-ray tube. Quantitative measurements may therefore be made without continuous calibration of deflection factor. In addition, the self-contained positive supply may readily be disconnected from the intensifier rings, and a positive external supply connected instead. This is accomplished by transferring a strap connection from the self-contained power supply to the high-voltage input jack on the rear of the Type 281-A.

A low-voltage supply furnishes balanced positioning potentials to the deflection plates of the cathode-ray tube. The trace may be moved to any portion of the screen by means of panel controls. The supply is regulated to prevent variations of power-line voltage from affecting the position of the spot.

#### SPECIFICATIONS

**CATHODE-RAY TUBE**—Type 5RP-A multiband tube with four free deflection plates. Deflection plate pairs average at ground potential. Accelerating potential 4000 or 8000 volts using internal power supplies; up to 29,000 volts using external positive intensifier supply.

#### Mechanical Construction

Flexibility is also enhanced by the manner in which the Type 281-A is constructed. Although the Type 281-A Cathode-ray Indicator is basically designed for relay-rack mounting, it is supplied with its own dust-proof cabinet so that it may be used as a portable instrument if required. The cathode-ray tube is mounted to provide adequate insulation for the high accelerating potentials used; a Du Mont Type 2519 Calibrated Scale is permanently attached in front of the screen. Provision is made for attaching auxiliary equipment such as the Type 2542 Projection Lens or the Du Mont Types 295, 296, 297, or 321 Oscillograph-record Cameras.

Figure 6 shows the wiring of circuits and placement of parts that have been carefully engineered to meet the problems presented by the high potentials. The high-voltage terminal for connection to the Type 286 High-voltage Power Supply, for operation of the cathode-ray tube at 29,000 volts total accelerating potential, is located at the rear of the instrument so that it does not interfere with any controls or connections on the panel.

#### Accessories Supplied

A Type 2519 Calibrated Scale is supplied with the Type 281-A.

**VERTICAL AND HORIZONTAL DEFLECTION CIRCUITS**—**Deflection Factor:** dependent upon accelerating potential (refer to Figure 4 in text). **Input Impedance:** (balanced), to terminals on front panel, 2 megohms paralleled by 30  $\mu\text{f}$ ; 1 megohm paralleled by 40  $\mu\text{f}$  (single-ended); direct

#### TYPE 281-A CATHODE-RAY INDICATOR

input impedance (balanced), 5  $\mu\text{f}$ ; (single-ended) 10  $\mu\text{f}$ . **Maximum Allowable Input Potential:** 1200 volts peak any deflection plate to  $A_2$  (same for capacitively coupled).

**INTENSITY MODULATION**—Terminals capacitively coupled to grid and to cathode of cathode-ray tube. Input impedance to grid, 0.5 megohm paralleled by 50  $\mu\text{f}$ ; to cathode, 4700 ohms paralleled by 60  $\mu\text{f}$ . Cut-off bias of 5RP-A tube with 2000 volts on second anode, -60 volts  $\pm 50\%$ ; with 4000 volts on second anode, -120 volts  $\pm 50\%$ .

**POWER SUPPLIES**—2000-volt negative supply regulated within  $\pm 1\%$  for variations in load from 0 to 1 milliamperes, and for power-line variations of  $\pm 10\%$ . 4000-volt negative supply regulated within  $\pm 1\%$  for loads of 0-2 milliamperes, and power-line variations of  $\pm 10\%$ .

Positioning voltages +450 and -450 volts, regulated so that  $\pm 10\%$  line voltage change does not move spot more than 0.1 inch in any direction, regardless of position on the screen.

**MAXIMUM PHOTOGRAPHIC WRITING RATES**—With Type 296, using f/2.8 lens, 40 inches/ $\mu\text{sec}$ ; with Types 321 and 295, using f/1.5 lens, 280 inches/ $\mu\text{sec}$ .

**POWER SOURCE**—Type 281-A is designed to operate from a power line at either 115 or 230 volts. Changeover is made by switch at rear of instrument. Power-line frequency, 50-60 cycles; power consumption, 100 watts; fuse protection, 1 ampere.

**TUBE COMPLEMENT**—2X2A; 6-OA2; 6NO-20; 2-1B3GT/8016; 3D21A; 2C53; 5651.

**PHYSICAL CHARACTERISTICS**—Instrument housed in metal cabinet provided with carrying handles. **Overall Dimensions:** height, 12-1/4" (31.1 cm); width, 20-3/4" (52.7 cm); depth, 20-1/2" (52 cm). **Relay-rack:** Provision for mounting without cabinet in standard 19" relay-rack. **Weight:** with cabinet, 120 lbs. (54.3 kg.); without cabinet, 90 lbs (40.8 kg.).

| Catalog No. | Type No. | Description   |
|-------------|----------|---|
| 1397-E      | 281-A    | Cathode-ray Indicator for 115 volts, 50-60 cycles; with Type 5RP2-A Cathode-ray Tube. |
| 1400-E      | 281-A    | Same as above with Type 5RP11-A Cathode-ray Tube.                                     |
| 1402-E      | 281-A    | Cathode-ray Indicator for 230 volts, 50-60 cycles; with Type 5RP2-A Cathode-ray Tube. |
| 1405-E      | 281-A    | Same as above, with Type 5RP11-A Cathode-ray Tube.                                    |

# TYPE 292 CATHODE-RAY OSCILLOGRAPH

- Small, portable, for general-purpose duty
- Type 3RP-A flat-face Cathode-ray Tube
- Balanced deflection for both vertical and horizontal axes
- Vertical deflection factor, 0.4 rms volt per inch
- Vertical frequency response uniform within 30% from 5 to 100,000 cps

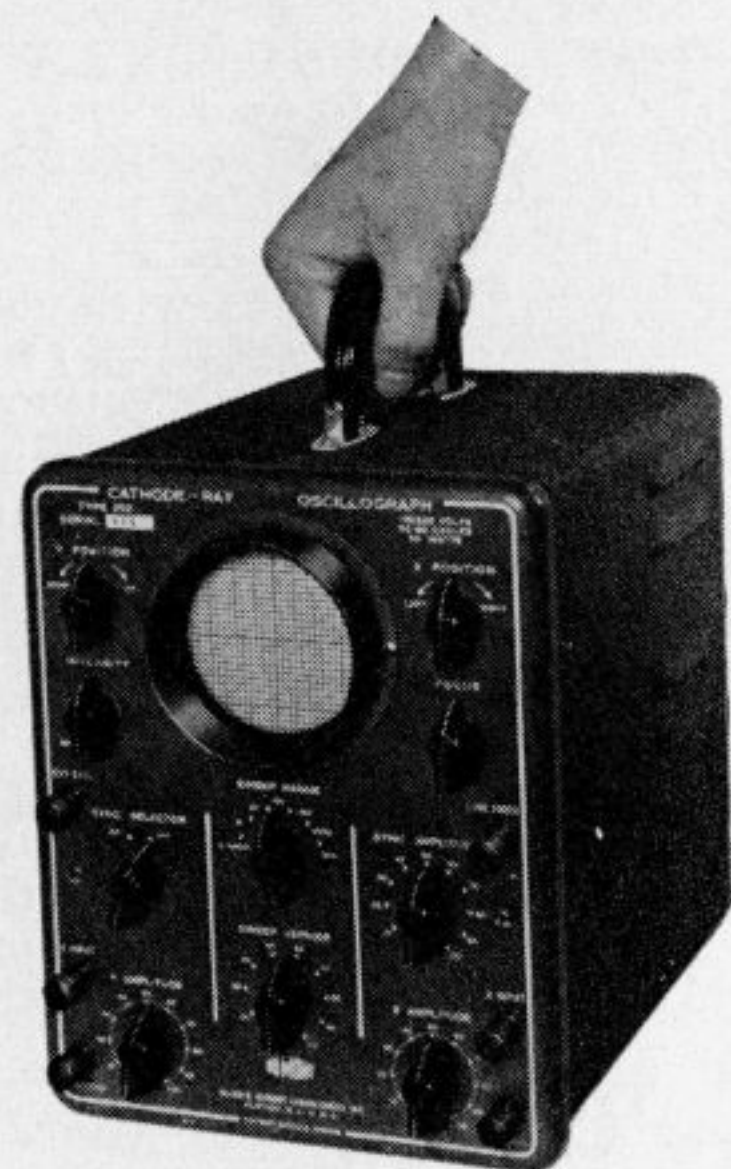

## FUNCTION

The new Du Mont Type 292 is a small, compact instrument for use wherever a highly portable, general-purpose oscillograph is required. The compact design of this instrument is made possible largely by the use of the new Du Mont Type 3RP-A Cathode-ray Tube which features unusually short overall length and a flat face. The flat face permits observation of wave forms with a minimum of error owing to parallax. The special electron-gun and deflection-plate construction of the Type 3RP-A overcome the problem of pin-cushion distortion usually associated with cathode-ray tubes

of short length and large deflection angle. Distortion of the trace is further minimized by the use of balanced signals for both the vertical and horizontal deflection.

Built with the same care and precision that characterize more expensive Du Mont instruments, this oscillograph has been designed with emphasis upon combining simplicity and utility with economy. An ideal balance of these has been achieved, none having been sacrificed at the expense of another. The resultant instrument is one which sets a new high in performance, portability, and economy.

## Cathode-ray Tube

The new Du Mont Type 3RP-A Cathode-ray Tube (see Figure 1) is employed in the Type

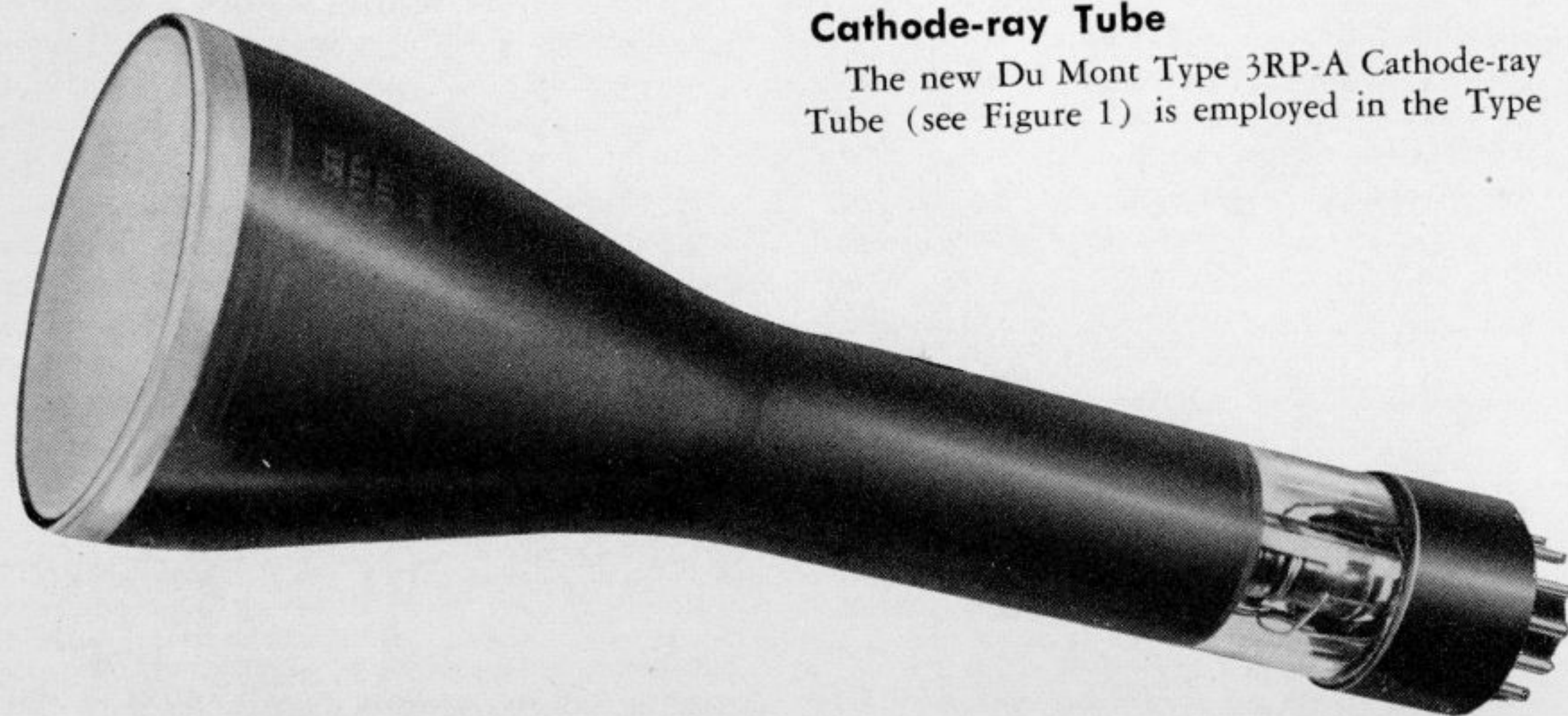

Figure 1. The Du Mont Type 3RP-A Cathode-ray Tube. Note the flat face

## TYPE 292 CATHODE-RAY OSCILLOGRAPH

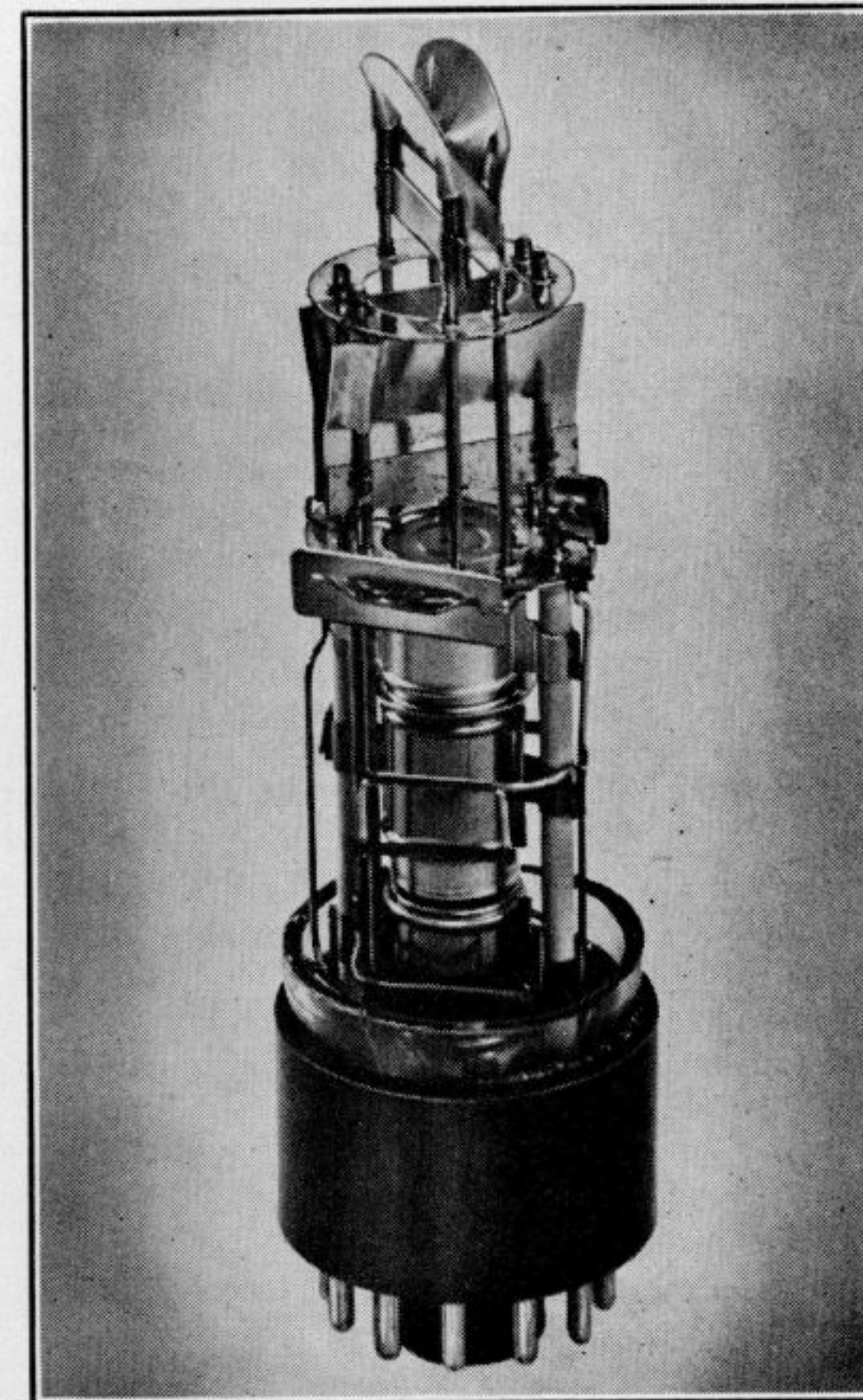

Figure 2. The electron-gun and deflection-plate assembly of the Type 3RP-A Cathode-ray Tube. Note the rounded vertical-deflection plates

292. The Type 3RP-A has a three-inch screen and high deflection sensitivity. It is capable of producing a fine brilliant spot even when operated at low accelerating potentials. As is apparent in Figure 2, the deflection plates of the Type 3RP-A are rounded to hold pin-cushion distortion to a minimum. The Type 3RP-A is supplied as standard with the medium-persistence, green P1 screen, which is generally considered the most efficient screen for visual observation.

## Vertical Deflection

Signals for vertical deflection may be applied either through the vertical-input terminals on the front panel to the vertical amplifier or they may be connected to the terminal board at the rear of the instrument for direct coupling to the deflection plates. The vertical-deflection amplifier provides a deflection factor of 0.40 rms volts per inch. Sinusoidal frequency-response of the amplifier is uniform within 30% from 5 to 100,000 cps. Signals

beyond the frequency response of the amplifier may be applied directly to the deflection plates through the terminal board at the rear of the instrument.

## Horizontal Deflection

The horizontal amplifier may be used to amplify either the output of the incorporated time-base generator or an external signal, by proper adjustment of the coarse-frequency-selector switch. Signals for horizontal deflection may be applied also to the terminal board at the rear of the instrument.

The deflection factor provided by the horizontal amplifier is 0.56 rms volts per inch. Otherwise the characteristics of the horizontal and vertical amplifiers are similar.

## Linear Time Base

The time-base generator of the Type 292 provides linear sweeps variable in frequency from 8 to 30,000 cps. The direction of the sweep on the cathode-ray tube is from left to right. The rapid right-to-left return trace of the sweep, or "fly-back," is automatically blanked. Thus is eliminated the confusion of pattern which might result, were the fly-back visible on the screen.

## Synchronization of Time Base

The frequency of the time-base generator may be synchronized from either an internal or an external signal. The internal synchronizing signal is obtained from the vertical amplifier. An external signal may be connected to a front-panel sync terminal.

## Positioning

The trace on the screen of the cathode-ray tube may be moved to any portion of the screen by means of vertical and horizontal positioning controls located on the front panel. Three inches of positioning range are available both horizontally and vertically.

## Test Signal

A sinusoidal test signal of power-line frequency and approximately 6.3 rms volts amplitude is provided at a front-panel terminal. This test signal is convenient for many troubleshooting applications, or as an external synchronizing signal to synchronize the time-base generator at power-line frequency.

(Specifications on Following Page)

**SPECIFICATIONS**

**CATHODE-RAY TUBE**—Type 3RP1-A Cathode-ray Tube with four free deflection plates. Accelerating potential: 1000 volts.

**VERTICAL DEFLECTION**—**Deflection factor:** with amplifier at full gain, 0.40 rms volt/in.; direct 20 rms volts/in.  $\pm 20\%$ . **Undistorted deflection** with amplifier: 3 inches. **Sinusoidal frequency response:** uniform within 30% from 5 to 100,000 cps. **Input impedance:** through amplifier, 1 megohm paralleled by 70  $\mu\mu\text{f}$ ; direct, 4.7 megohms paralleled by 25  $\mu\mu\text{f}$ .

**HORIZONTAL DEFLECTION**—**Deflection factor:** through amplifier at full gain 0.56 rms volt/in.; direct, 31 rms volts/in.  $\pm 20\%$ . **Undistorted deflection** with amplifier: 3 inches. **Sinusoidal frequency response** uniform within 30% from 5 to 100,000 cps. **Input impedance:** to amplifier 1 megohm, paralleled by 70  $\mu\mu\text{f}$ ; direct, 4.7 megohms paralleled by 25  $\mu\mu\text{f}$ .

**LINEAR TIME BASE**—Continuously variable from 8 to 30,000 cycles. Direction of sweep from left to right. Return trace blanking included. Synchronization from either the vertical deflection signal or from externally supplied signal of 0.5 peak-to-peak (0.2 rms) volt amplitude.

**POWER SOURCE**—The Type 292 is available for operation from either 115-volt or 230-volt, 50-60 cps power, whichever is specified. Power consumption 50 watts. Fuse protection 1 ampere (115 volts) or .053 ampere (230 volts).

**TUBE COMPLEMENT**—2-12AX7; 1-884; 2-80.

**PHYSICAL CHARACTERISTICS**—Instrument housed in metal cabinet provided with carrying handle. **Overall dimensions:** height, 10  $\frac{7}{8}$ " (28 cm); width, 8  $\frac{1}{8}$ " (21 cm); depth, 11" (28 cm). Weight 17  $\frac{1}{4}$  lbs. (7.4 kg).

| Catalog No. | Type No. | Description   |
|-------------|----------|---|
| 1500-A      | 292      | 115 volt, 50-60 cps, with Type 3RP1-A Cathode-ray Tube. |
| 1505-A      | 292      | 230 volt, 50-60 cps, with Type 3RP1-A Cathode-ray Tube. |

**TYPE 293  
CATHODE-RAY OSCILLOGRAPH**

- Specifically designed as an indicating and recording instrument for high-voltage impulse testing
- Packaged as single, mobile console
- No preparation of instrument or film required before operation
- Employs sealed-off, hot-cathode indicating tube
- Specially designed recording camera provides records containing all information required for standard performance tests
- Simplified operation

**FUNCTION**

The new Du Mont Type 293 offers a wholly new approach to the problem of high-voltage impulse-test recording. It employs a sealed-off, hot-cathode type of cathode-ray tube, and is packaged as a single, small, console that is readily movable. Since no elaborate preparation of the instrument or recording material is required, the Type 293 may be put into operation almost immediately.

The Type 293 is supplied as a complete recording and indicating instrument. It consists of the cathode-ray tube with its high-voltage power supplies, input attenuators, sweep circuits, a trigger generator for initiating external circuits, provision for calibration of both time and amplitude, and the power supplies required for the operation of these circuits. Also included is a specially designed camera, which conveniently records test waves.

To record the extremely high writing rates found in impulse-test waves, a special high-voltage cathode-ray tube has been developed for use in the Type 293. This tube, designated the Du Mont Type K1068P11, is similar to the standard Du Mont Type 5RP-A, except that the Type K1068P11 is equipped with a metallized fluorescent screen and an electrostatic shield between the deflection-plate pairs.

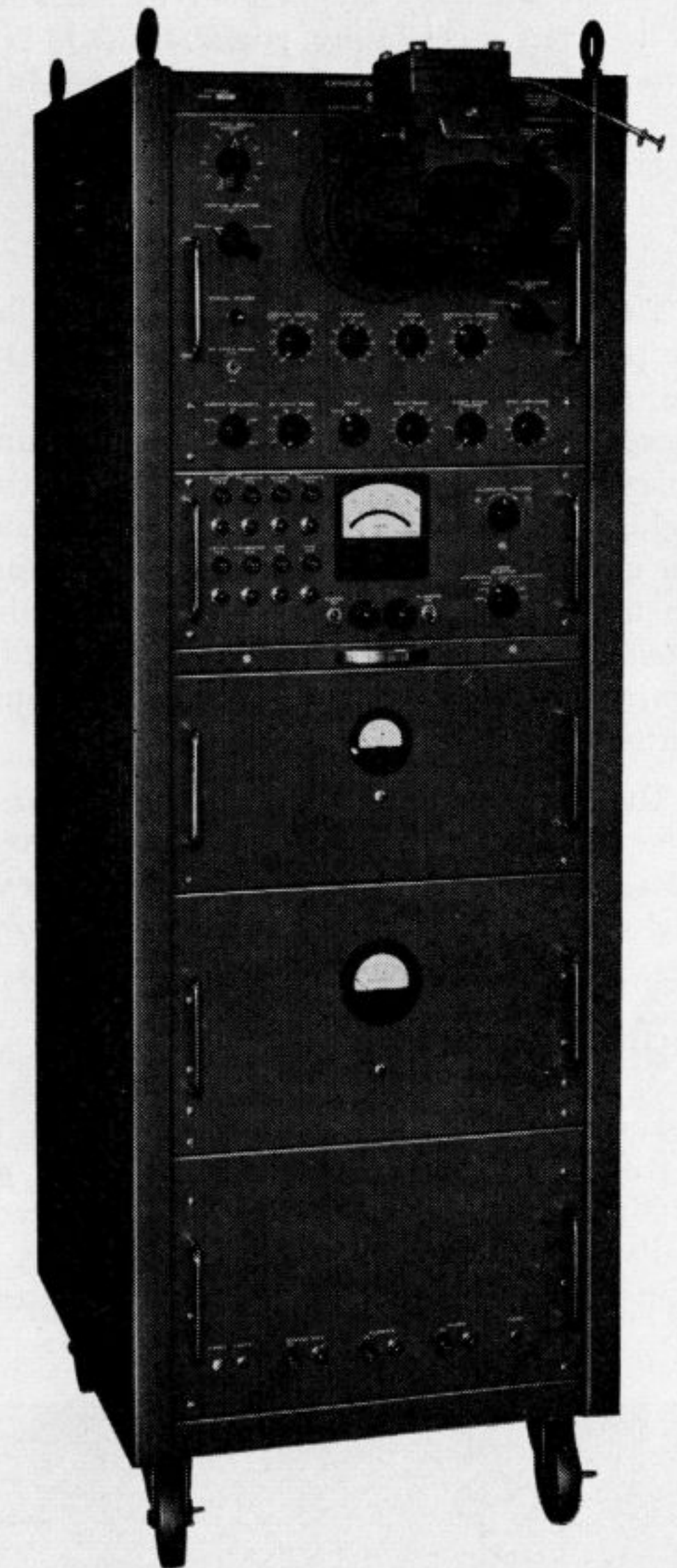

The aluminum layer, evaporated on the back of the fluorescent screen, provides a considerable increase in light output, owing largely to two factors: 1.) Since screen materials are, generally speaking, non-conductive, the number of primary electrons striking the screen frequently exceeds the number of secondary electrons returning to ground, causing the screen potential to become less positive than the accelerating potential. This condition becomes more pronounced as beam current is increased, and with the high beam currents required to record impulse-test waves, a differential of several thousand volts may exist between the screen potential and the applied accelerating potential. The conductive aluminum film assures a 1:1 ratio of primary electrons to secondary elec-



trons, so that the screen thus is maintained at the full accelerating potential. Thus the greatest possible energy is imparted to the screen for a given accelerating potential. 2.) Light output of the screen is further increased, since the metallized layer acts as an optical mirror that reflects forward much of the light which would otherwise be lost through the back of the screen.

The conductive layer serves also to eliminate the possibility of local charges building up on the screen, which charges may deflect the fluorescent spot sufficiently to render impossible the accurate measurements required in high-voltage impulse testing. Moreover, since the metallized coating is opaque, it minimizes the undesirable effects of cathode-glow which often cause serious fogging of the recording film, with a subsequent reduction of image contrast.

The electrostatic shield, inserted between the deflection-plate pairs minimizes the effects of cross coupling between the horizontal and vertical deflection signals.

### Signal Input

The signal from the equipment under test is fed to the signal-input terminal at the rear terminal panel through a standard, readily available, 75-ohm coaxial cable. It may be applied to the input attenuator either directly

or through a coaxial delay line which provides a signal delay of 0.25 microsecond. The delay line consists of a length of standard, 75-ohm coaxial cable that is terminated by the 75-ohm impedance of the input-signal attenuator. Standard 75-ohm coaxial cable is employed, since it is probably the most readily available of the low-impedance transmission cables.

The input attenuator has 10 steps in increments of 10%, and provides a multiplicity of deflection amplitudes from a given input signal, while maintaining a constant input impedance of 75-ohms for any attenuator setting. Frequency response is independent of attenuator setting, and each step of attenuation is accurate to  $\pm 1\%$ . After attenuation, the signal is applied directly to the vertical-deflection plates of the cathode-ray tube. External signals may be applied to the horizontal axis of the Type 293 in precisely the same manner as to the vertical axis, and the same attenuation ratios and signal delay are available. The horizontal input allows the plotting of such displays as current versus voltage.

Frequency response of both the vertical and horizontal channels, including the performance of the signal-delay lines, is essentially flat from d-c to 25 megacycles per second, and there is no distortion of a pulse having a rise time of 0.01 microsecond or greater. Thus, any high-frequency component of significance to the impulse test will be faithfully reproduced on the screen.

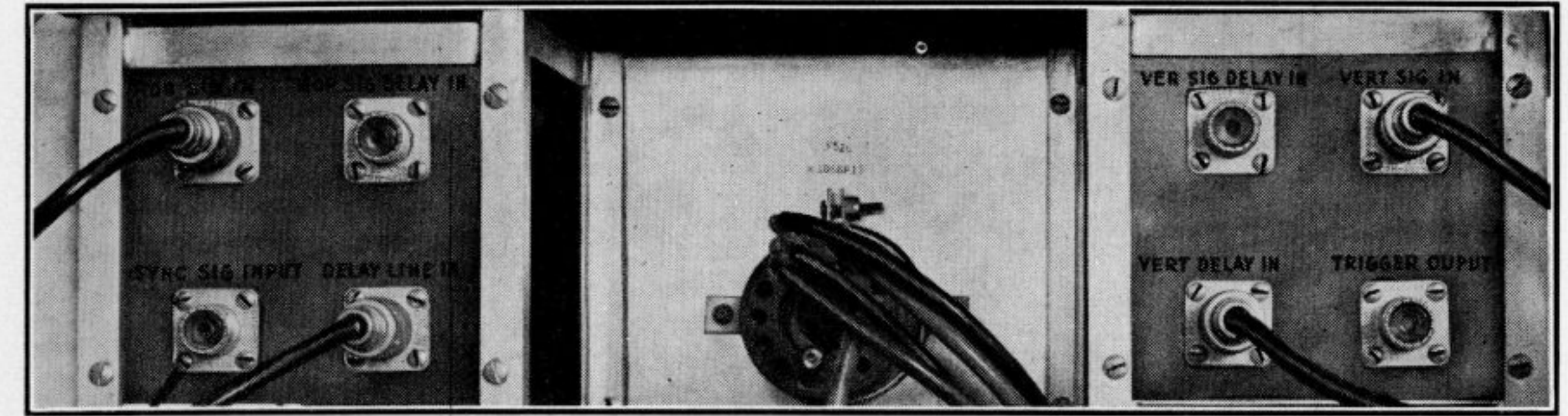

Figure 2. Rear terminal panels of the Type 293

### Sweeps

Conforming to standard impulse-test practices, exponential sweeps are employed in the Type 293. The wide range of sweep durations was carefully selected to provide a useful display of all standard test waves. In addition, high-speed sweeps have been incorporated in anticipation of certain proposed short-time impulse standards. Sweep-speed ranges different from those selected for the basic design of the Type 293, but within the practical range of the sweep circuit employed, may be provided in the equipment at the time an order is placed.

Operation of the sweep circuit of the Type 293 may be initiated by any of the following means:

1. *External signal:* The signal used to trigger the impulse generator may be used to initiate the sweep. This signal, taken from the external trigger generator by means of a stand-

ard 75-ohm coaxial cable, is applied to the external-sync connector, provided on the rear panel, to initiate the sweep.

*Manual:* A push-button control, conveniently located on the front panel, allows the operator the freedom of triggering the impulse generator and initiating the sweep from the recording position at his discretion. A trigger pulse, which is controlled by this push-button and has an amplitude of approximately 1200 volts, may be taken for initiating the impulse generator from a low-impedance source at the terminal panel at the rear of the instrument. A continuously variable delay of from 0.5 to 15 microseconds of the trigger pulse with respect to the sweep, or of the sweep with respect to trigger is provided. Thus it is possible to adjust the relative "positions" of the sweep and trigger to compensate for the delays commonly encountered in external circuits or cables, so that initiation



Figure 1. A portion of the control panel of the Type 293 showing, at extreme top-left, the manual trigger push-button.



Figure 3. A portion of the control panel of the Type 293 showing the voltage-calibrator controls and meter

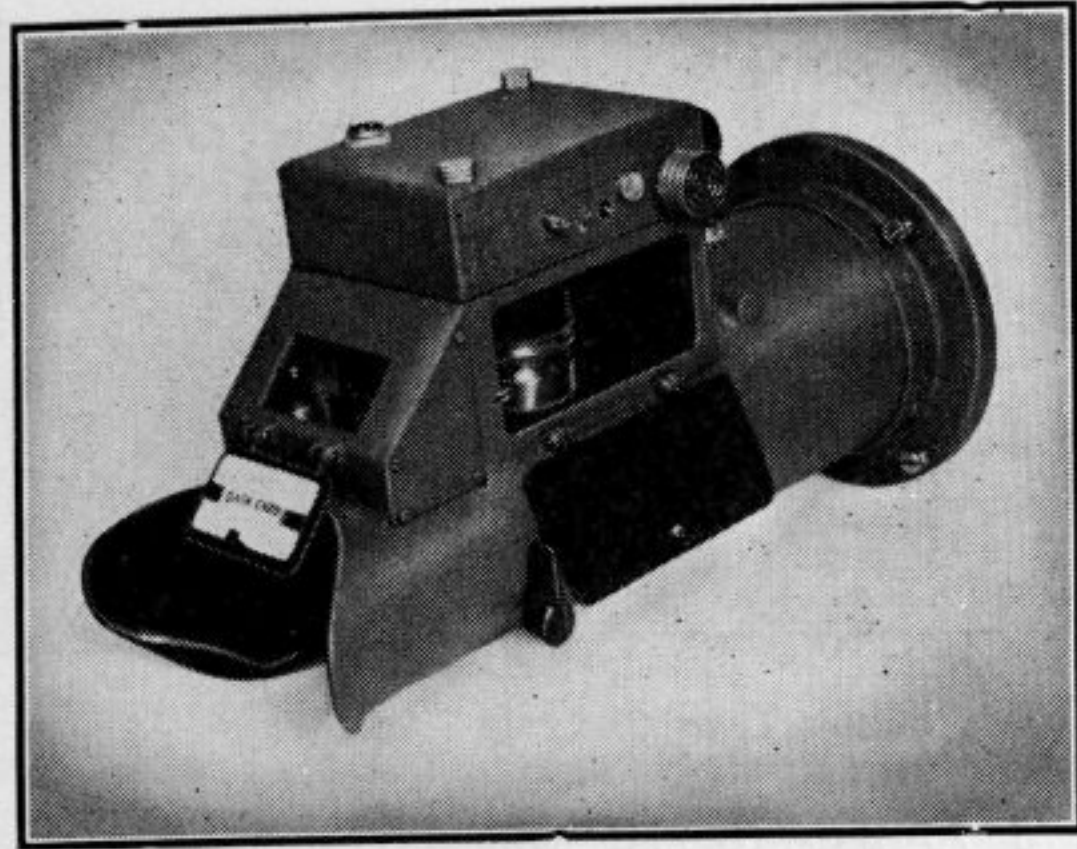

Figure 4. The specially designed 35-mm camera supplied as a component part of the Type 293. Note convenience of data-card plate over viewing port and the easy accessibility of the lens barrel through the port on the side of the camera housing. A camera providing an object-to-image ratio of one may be selected as an alternative

of the sweep simultaneously with, or immediately prior to the application of the test signal to the deflection plates, is always feasible.

The manual control is also used to trigger the sweep when voltage-calibration lines or timing markers are to be recorded.

**60-Cycle phasing:** The sweep may be initiated by using the manual push-button to fire a thyatron, which triggers the sweep generator. A 60-cycle voltage, taken from the power line is passed through a phase-shifting network and impressed on the grid of the thyatron. This enables the operator to fire the thyatron, triggering the sweep at any predetermined point through 360 degrees of the power-line cycle, so that the voltage impulse may be applied to the equipment under test at the positive peak, negative peak, or any other portion of the 60-cycle voltage. This technique will be useful for such operations as simultaneous impulse and excitation tests.

**Internal Signal:** Changing a patch-cord connection at the rear panel permits a sample of the input signal to be applied to the external-sync jack, so that the applied test signal initiates the sweep. Thus high-speed random impulses, such as lightning discharges, may be conveniently recorded.

It should be emphasized, that, regardless of the manner in which the sweep is initiated, the electron beam is "on" only during the actual sweep time. Thus the shutter of the recording camera may be left open for a considerable time before and after the exposure with no danger of fogging the film.

## Time and Voltage Calibration

Provision has been incorporated in the Type 293 to present on the recordings all information required for standard performance tests. Writing rates of all the sweeps of the Type 293 may be accurately calibrated and recorded by means of internally generated timing markers. These sinusoidal markers may be applied to the vertical axis by means of the Vertical Selector Switch. They may be photographed directly onto the recording, below the pattern, by a double exposure. The timing markers are generated by two crystal-controlled oscillators and are accurate to 0.1%.

The amplitude of test waves may be calibrated by a built-in voltage calibrator, which provides both a zero base-line and a d-c level continuously variable to 1000 volts. The d-c level is obtained from a special, regulated power supply, and, as in the case of time calibration, the base line and variable d-c level line may be applied by means of the Vertical Selector Switch, and are superimposed upon the pattern by multi-exposure. The voltage calibration line may also be applied to calibrate voltages on the X axis of the Type 293 by proper setting of the Horizontal



Figure 5. The Type 293 is packaged as a single, relatively small unit, and may easily be moved from one installation to another

## TYPE 293 CATHODE-RAY OSCILLOGRAPH

Selector Switch. Accuracy of voltage calibration is 1%.

A 35-mm recording camera, providing an image reduction ratio of 4.5, is supplied as a component part of the Type 293. Also available is a recording camera which provides an object-to-image ratio of approximately 1. Both cameras are capable of recording with excellent density the fastest writing rates of significance in impulse testing. Provision is incorporated for simultaneous viewing and recording of the impulse-test wave.

Shutter openings of "bulb" and "time" may be operated either manually or by means of an accessory solenoid. An interlock switch may be used to prevent associated electrical equipment from being triggered before the shutter is opened.

The Type 293 has been carefully designed with the constant co-operation of a number of well known impulse-test laboratories, to create a recording device, adaptable to all existing installations, which would meet the standards and requirements of present day techniques, as well as anticipate those of the future.

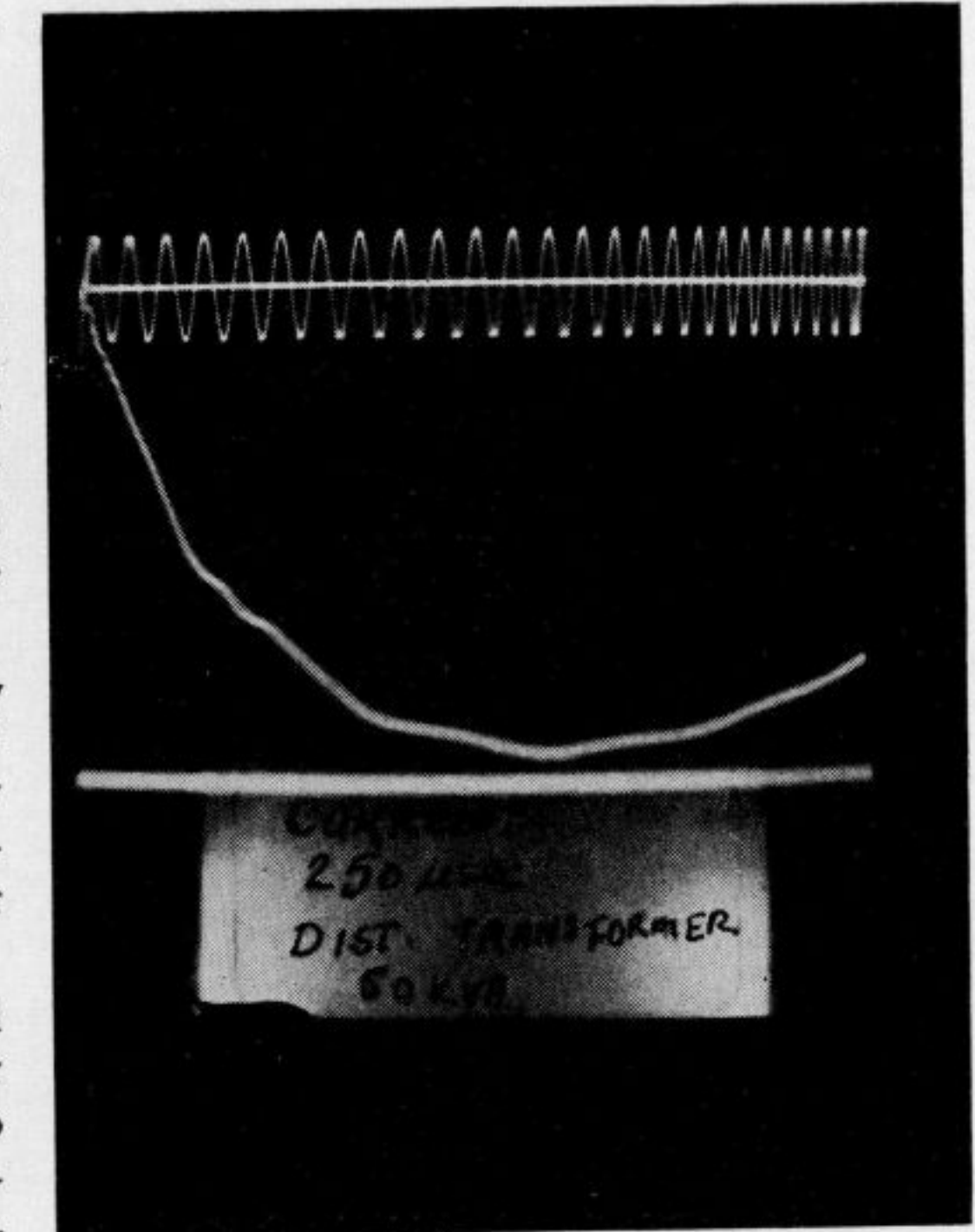
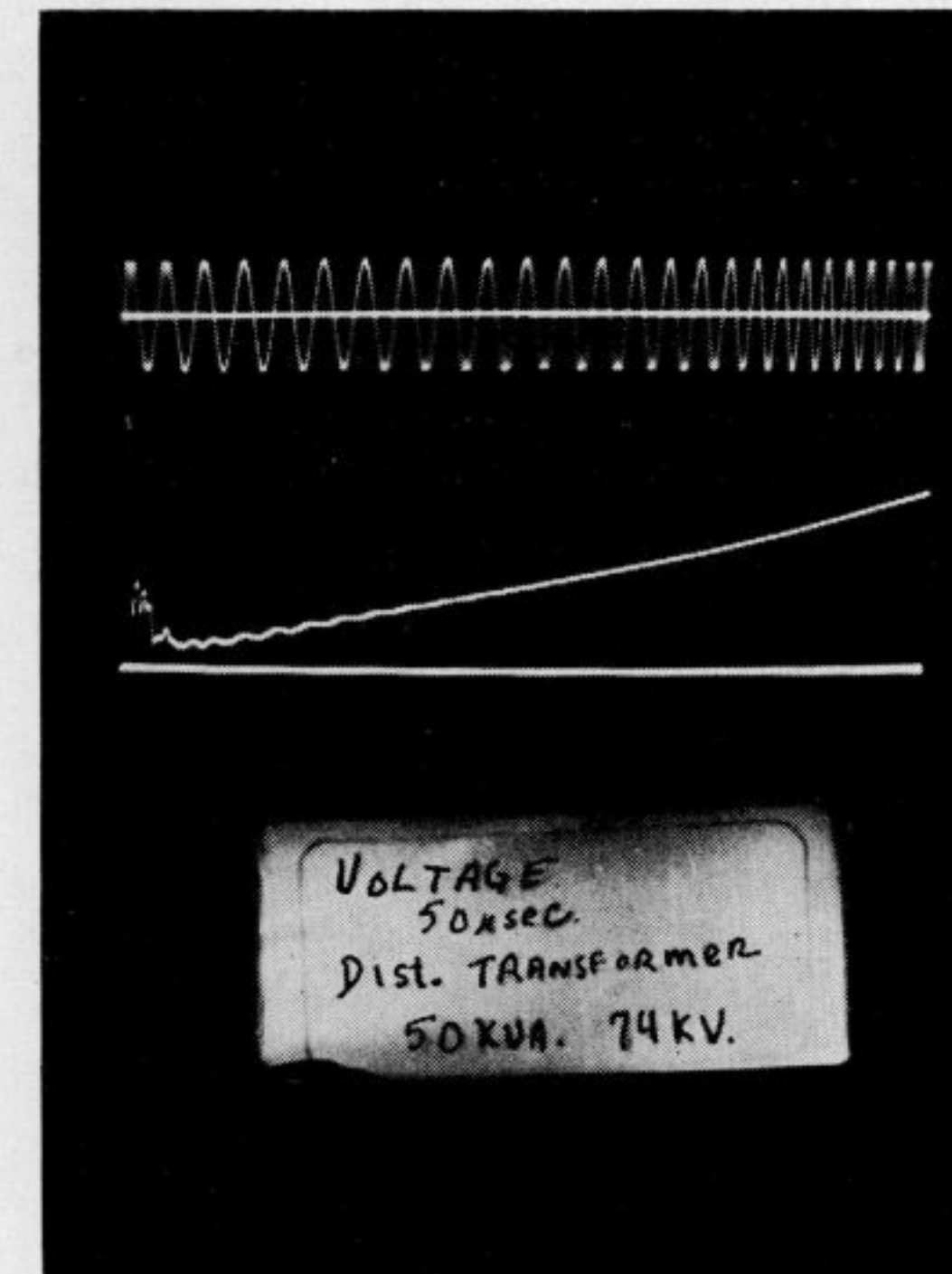
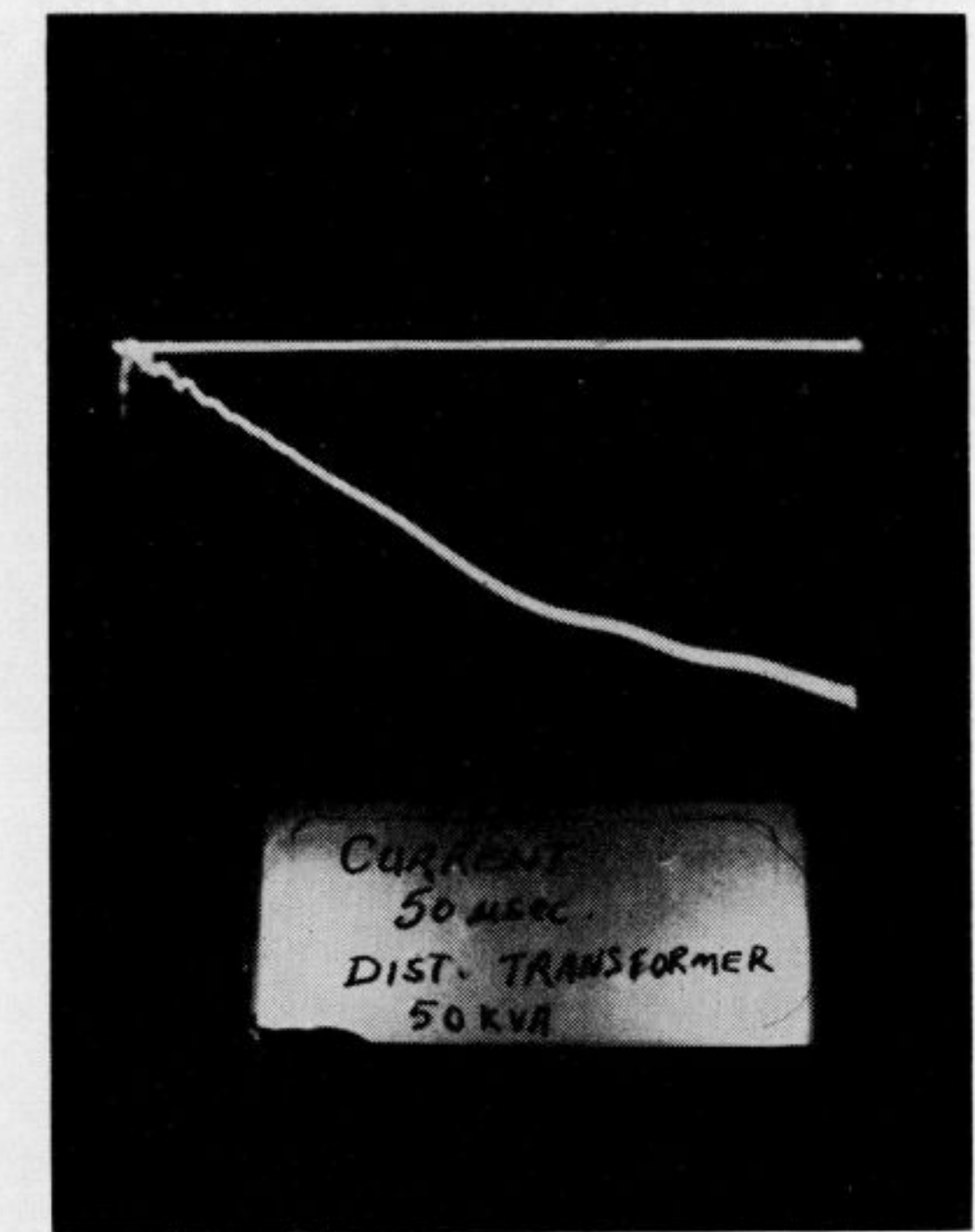

Figure 6. A current wave as recorded by the Du Mont Type 293 during an actual impulse test of a distribution transformer



A



B

Figure 7. Use of two Type 293's is strongly recommended. Aside from providing for stand-by operation in cases of emergency, use of two instruments enables simultaneous recordings of voltage (A) and current (B), as shown here, with a resultant saving of set-up time and expense. These recordings were made during the actual impulse-testing of a distribution transformer

(Specifications on following Page)

SPECIFICATIONS

**CATHODE-RAY TUBE**—Type K1068P-operated at overall accelerating potential of 26,000 volts.

**VERTICAL DEFLECTION—Signal Attenuation:** 10 steps of attenuation permit control of signal amplitude in increments of 10% of unattenuated value. Frequency response independent of attenuator setting. Accuracy for any step, 1%. **Deflection Factor:** approximately 250 peak-to-peak volts per inch with maximum acceleration and minimum attenuation. **Frequency Response:** essentially uniform from d-c to 25 megacycles per second. **Maximum Input Potential:** 2500 peak-to-peak volts. **Positioning:** ±1 inch from center of screen. **Signal Delay:** a signal delay of 0.25 μsec may be inserted at operator's option. **Input Impedance:** 75 ohms.

**HORIZONTAL DEFLECTION—Signal Attenuation:** 10 steps of attenuation permit control of signal amplitude in increments of 10% of unattenuated value. Frequency response independent of attenuator setting. Accuracy for any step, 1% maximum. **Deflection Factor:** approximately 250 peak-to-peak volts per inch with maximum acceleration and minimum attenuation. **Frequency Response:** essentially uniform from d-c to 25 megacycles per second. **Maximum Input Potential:** 2500 peak-to-peak volts. **Positioning:** ±1 inch from center of screen. **Signal Delay:** a signal delay of 0.25 μsec may be inserted at operator's option. **Input Impedance:** 75 ohms.

**SWEEPS**—Semi-logarithmic sweeps have durations of 0.5, 2.5, 10, 50, 250, and 1000 microseconds. Instruments may be ordered with other sweep speeds within the range from 0.5 μsec to 1000 μsec. **Sweep Initiation:** internally (by impulse test signal), externally (by tripping source), manual (by push-button). **Sweep Starting Time:** less than 0.2 μsec. **Output-Trigger Generator:** Output-trigger pulse of approximately 1200 volts amplitude is initiated by front-panel push-button. **Rate of Rise:** not less than 6000 volts per microsecond. **Maximum Repetition Rate:** once in 2 seconds. **Output Impedance:** 75 ohms. **Trigger Delay:** variable from 0.5 to 15 microseconds.

**VOLTAGE CALIBRATION**—Metered continuously variable d-c potential applied through selector to signal deflection plate. Calibrates range to 1000 volts with accuracy of ±1% of full scale.

**TIME CALIBRATION**—Sinusoidal wave train, each cycle of which indicates intervals of 0.5, 0.1, 1, 10, or 100 μsec. Time Calibration accurate to ±0.2%.

**RECORDING CAMERA**—Detachable Camera unit records single frame exposures. Either 4.5 reduction ratio, or full-scale negative.

**PHYSICAL CHARACTERISTICS**—Instrument enclosed in console-type cabinet equipped with rubber-tired casters. Side and rear panels removable. **Overall dimensions:** height, 64" (163 cm); width, 21" (53 cm); depth, 28" (71 cm) camera excluded. **Weight:** 475 lbs.

| Catalog No. | Type No. | Description   |
|-------------|----------|---|
| 1525-E      | 293      | Cathode-ray Oscilloscope for 115-volt, 50-60 cps operation, with Type K1068P2 Cathode-ray Tube. |
| 1526-E      | 293      | Same as above, with Type K1068P11 Cathode-ray Tube.   |
| 1527-E      | 293      | Cathode-ray Oscilloscope for 230-volt, 50-60 cps operation, with K1068P2 Cathode-ray Tube.      |
| 1528-E      | 293      | Same as above, with Type K1068P11 Cathode-ray Tube.   |

TYPE 294-A  
CATHODE-RAY OSCILLOGRAPH

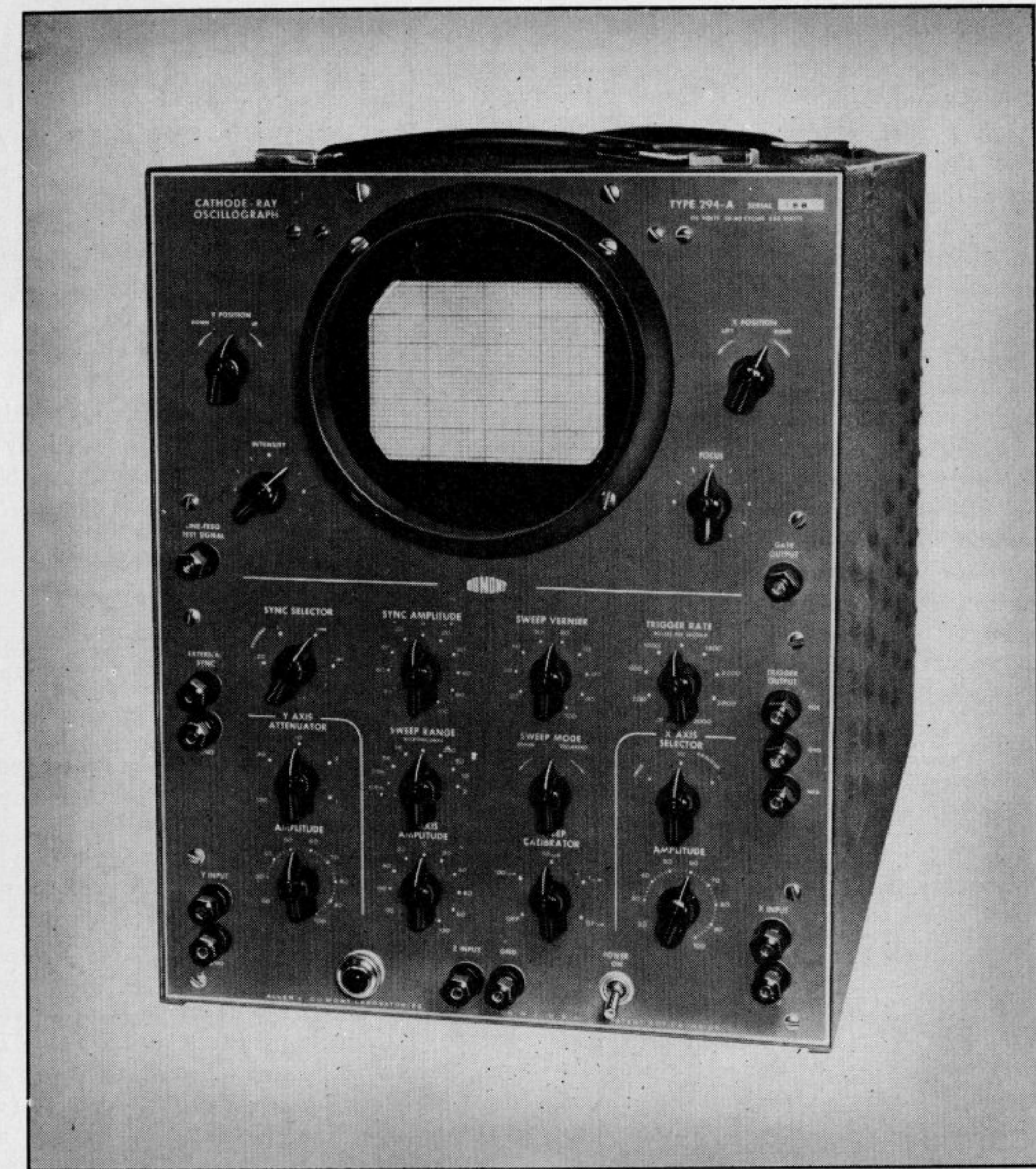

- Specifically designed for the investigation of pulses
- Pulse response of vertical amplifier 0.03 microsecond
- 1.75 inches of undistorted vertical deflection for unidirectional signals, with 12,000 volts accelerating potential
- Undistorted sweep length more than 3 inches with 12,000 volts accelerating potential
- Type 5XP- Cathode-ray Tube operated at accelerating potential of 7,000 or 12,000 volts
- Built-in signal-delay line
- Internally generated timing markers
- Trigger output of either polarity

# TYPE 294-A CATHODE-RAY OSCILLOGRAPH

## FUNCTION

The Du Mont Type 294-A Cathode-ray Oscillograph combines in one instrument the three features most important to the study of pulse waveforms: High sensitivity, high brightness, and extended bandwidth.

Although a chief emphasis in the design is placed on the faithful delineation of pulse waveforms, the Type 294-A contains many features which render the instrument valuable as a general-purpose oscillograph. The Y-axis amplifier is adjusted to provide optimum transient response without overshoot, even at some slight sacrifice in extension of sine-wave response at the high-frequency end. The amplifier will pass any pulse having a rise time of greater than 0.01 microsecond without degrading it to more than 0.03 microsecond. Reference to Figure 1 will show that this pulse is reproduced without overshoot.

Terminology customarily employed in describing amplifier performance would specify the Y amplifier of the Type 294-A as a 12-megacycle amplifier, since at 12 megacycles the amplifier response is 3 db below the mid-frequency value. This type of specification for an amplifier designed for optimum pulse response is neither very important nor very revealing, since an amplifier which will reproduce rates of rise of 0.03 microsecond or more without appreciable overshoot can very readily be used to amplify sinusoidal frequencies, not only of 12 megacycles, but of far more than 15 megacycles.

The excellent pulse response of the Type 294-A would have been achieved in vain, had care not been exercised to assure truly useful presentation of the input pulse. The output voltage of the vertical amplifier of the Type 294-A, thus, is sufficient to produce 1.5 inches of undistorted deflection with positive unidirectional signals, and 1.3 inches with negative unidirectional signals, on the Type 5XP-Cathode-ray Tube operated at 12,000 volts. With symmetrical signals, 2.75 inches of undistorted deflection is available. At this accelerating potential the useful vertical scan of the Type 5XP- is 1.75 inches; beyond this limit the beam is cut off by the vertical deflection plates. Thus the full usable deflection area of the cathode-ray tube is utilized, yet overloaded operation does not appear as an effect to confuse or mislead the operator.

Under some conditions, the full 12,000-volt accelerating potential may not be required, and an easily accessible switch permits reduction of this voltage to 7000 volts, with a corres-

ponding increase of 30% in deflection sensitivity, undistorted pulse amplitude, and usable vertical scan on the cathode-ray tube.

The selection of 12,000 volts as the accelerating potential was not an arbitrary one. It complements the response of the vertical amplifier and the sweep speeds necessary to delineate properly the steep slopes of short transients. The Type 294-A provides sufficient light output that even high-frequency components of a single transient, which are within the limits of response of the Y amplifier, may be readily recorded with the Du Mont Type 295 or 321 Oscillograph-record Cameras. (See pages 75 and 84, respectively).

The loss in deflection sensitivity at higher accelerating potentials is compensated by the considerable increase in deflection sensibility. See page 119 for a discussion of deflection sensibility.

## Linear Time Base

As a general rule, the power required to operate a sweep circuit increases very rapidly with increases in sweep speed. A sound compromise must therefore be established between necessary sweep speeds, desirable sweep speeds, and the size, weight, and cost of the complete instrument. Such a compromise has been achieved in the Type 294-A. Sweep speeds have been carefully selected to permit useful display of the high-frequency signals for which the instrument was designed, and a wide range of sweeps of lower speed have been provided. At the highest sweep speed, an undistorted sweep length of 2.7 inches permits an interval of 0.03 microsecond to occupy approximately two divisions horizontally on the calibrated scale (with 12,000 volts acceleration). Thus the most rapidly rising wave front passed by the amplifier may be readily observed and measured.

## Built-in Signal Delay

In the investigation of pulses whose initiation is under the operator's control, sweep starting time is of no great importance. However, when random pulses are to be observed, sweep-starting time becomes a major factor, and, in the extreme case, the signal may complete its entire cycle before the sweep is initiated. Care has been taken in the design of the Type 294-A to keep sweep starting time under 0.25 microsecond. To compensate for the finite existence of sweep starting time, a signal-delay line has been incorporated as an integral part of the vertical amplifier. This line provides sufficient delay to overcome com-

# TYPE 294-A CATHODE-RAY OSCILLOGRAPH

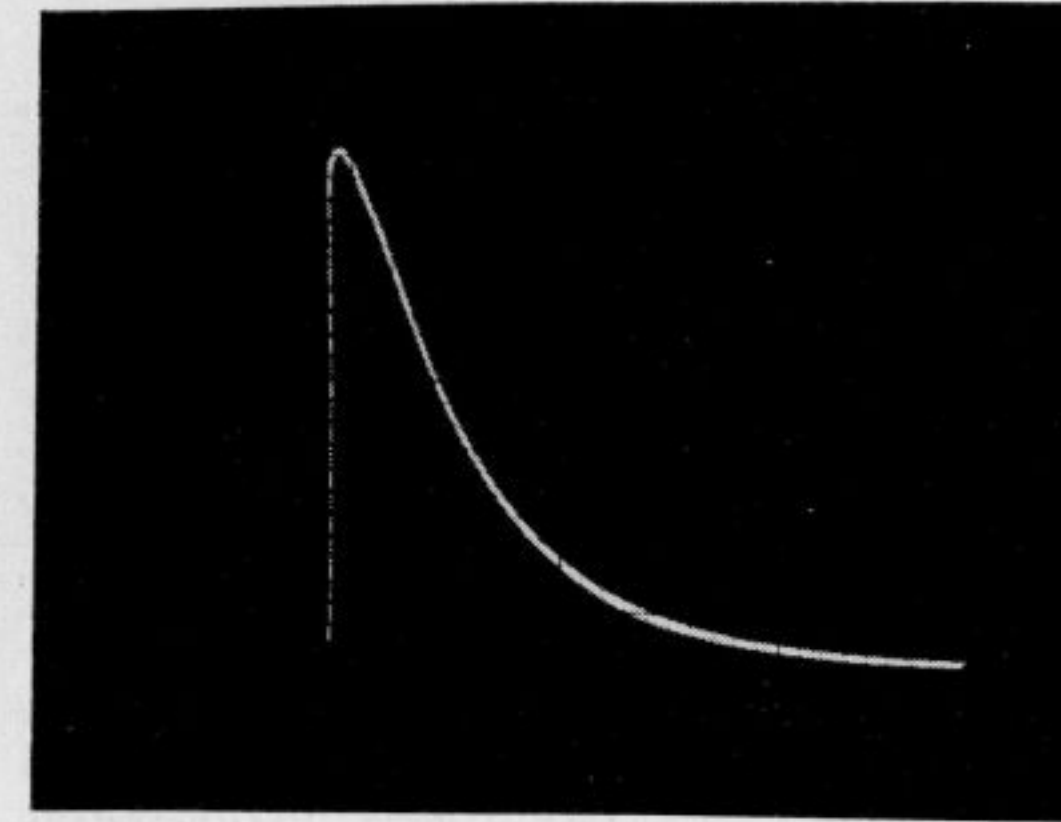

Figure 1. The positive trigger output of the Type 294-A

pletely the time required for the sweep to begin. It should be emphasized that all specifications quoted for the undistorted deflection, frequency response, and deflection sensitivity of the vertical amplifier account for the degradation of performance introduced by this delay line. Thus the only occasion when sweep-starting time becomes a consideration is when the input signal is applied directly to the deflection plates of the cathode-ray tube. However, owing to the extended bandwidth of the Y axis, such occasions will be in the minority.

## Trigger Output

Quite frequently, a device to be studied with the aid of an oscillograph requires an initiating pulse. This need has been anticipated, and the Type 294-A is equipped with a trigger generator which provides both positive and negative pulses at a minimum of 50 volts amplitude at a relatively low impedance (See Fig. 1). Rise time of this triggering pulse is no more than 0.3 microsecond.

## Time Calibration

Timing markers indicating intervals of 0.1, 1, 10, or 100 microseconds may be applied to the trace. Selection is accomplished by vertical deflections are displayed as markers and are accurate to 3%.

## Recommended Accessories

Frequently in the course of high-frequency investigations, it is essential that the displayed phenomenon be recorded. High-speed single transients, for example, are frequently displayed for too short a time to permit detailed study by visual observation. The Du Mont Type 295 Oscillograph-record Camera was specifically designed for such applications, and is capable of recording writing rates up to 35 inches per microsecond from the screen of the

Type 294-A. In instances where lower writing speeds are to be recorded, the Du Mont Type 296, a general purpose oscillograph-record camera, may be employed.

The Du Mont Type 189 Movable Table is a valuable accessory for the Type 294-A. With the indicator on top of the table, and the power supply on the shelf below, the Type 294-A may be conveniently transported as a single unit. (See Figure 2, below).

The high accelerating potential of the Type 294-A provides sufficient light output from the cathode-ray screen to permit projection of the oscillographic pattern. The Du Mont Type 2542 Projection Lens, specifically designed for projection oscillography, may be readily attached to the Type 294-A, making the instrument extremely useful in lectures, demonstration, etc.

Other accessories which contribute materially to convenience of visual observation are the Du Mont Type 2560 Color Filters. These may be used not only to filter out an undesired

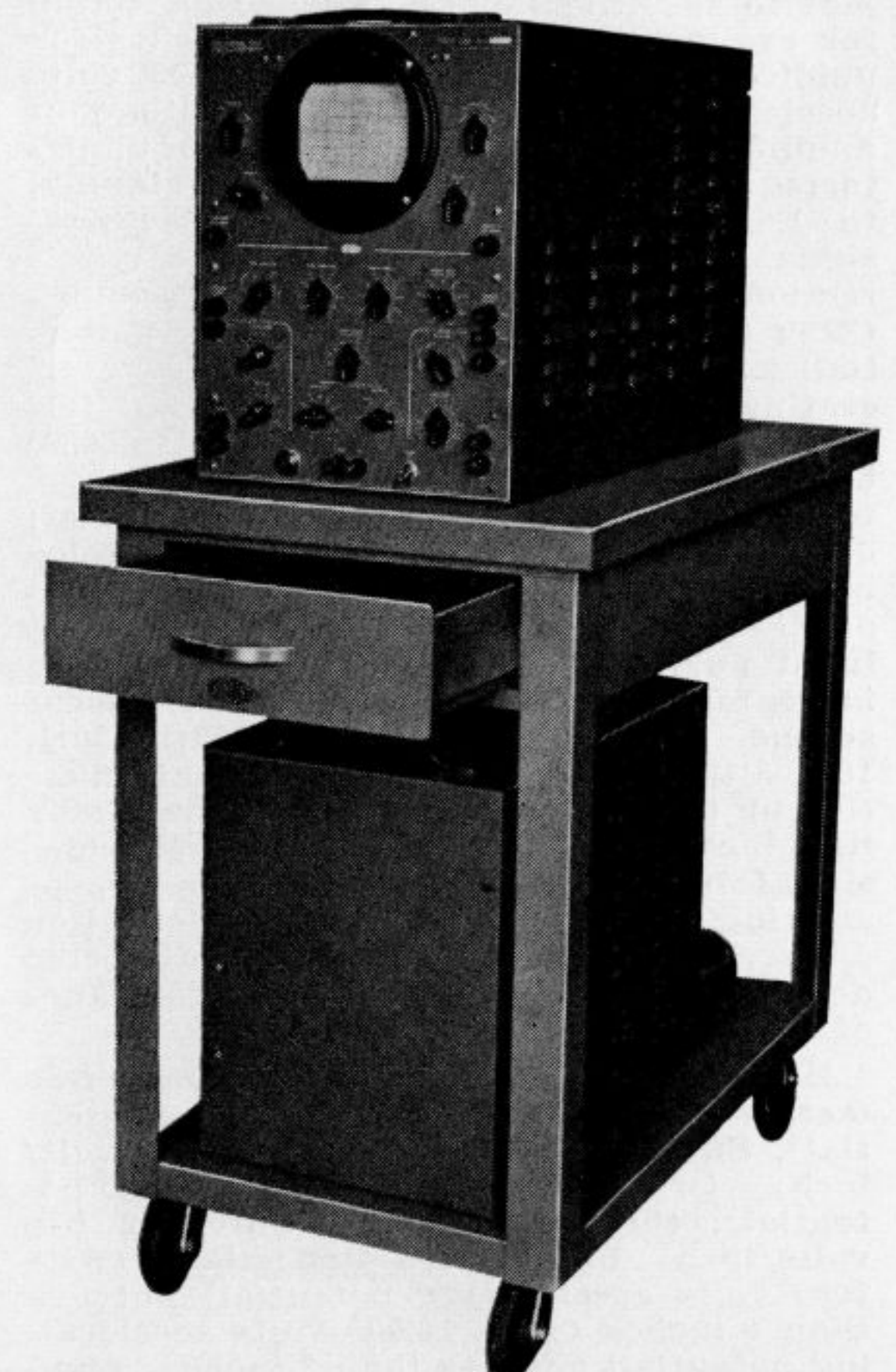

Figure 2. A particularly valuable accessory for the Type 294-A is the Type 189 Movable Table, which permits transporting both the indicator and power supply cabinets as a single unit

color component, but also, by employing a filter having a spectral transmission characteristic similar to the spectral distribution of the luminescence, pattern contrast may be substantially increased.

As is apparent from the accompanying specifications, every feature of the Type 294-A was carefully evaluated so that proper relationships exist between such characteristics as frequency

response of the amplifier, accelerating voltage on the cathode-ray tube, range of sweep speeds, and auxiliary provisions such as timing markers, trigger pulses, etc. While the Type 294-A was designed for the detailed study of pulses, its range of applications is by no means limited to this field. These same carefully balanced characteristics render the Type 294-A extremely useful for general purpose laboratory applications.

**SPECIFICATIONS**

**CATHODE-RAY TUBE**—Type 5XP-; accelerating potential, 7000 or 12,000 volts.

**VERTICAL DEFLECTION — Deflection Factor** (with 7000 volt accelerating potential); through amplifier, 0.42 peak-to-peak volt/inch; through amplifier with probe, 4.2 peak-to-peak volts/inch; direct, 36 peak-to-peak volts/in. Max.  $\pm 20\%$ ; (with 12,000 volts accelerating potential) through amplifier, 0.56 peak-to-peak volt/inch; through amplifier with probe, 5.6 peak-to-peak volts/inch; direct, 45 peak-to-peak volts/in. Max.  $\pm 20\%$ . **Undistorted deflection:** (with 7000 volts accelerating potential) output voltage of amplifier equivalent to 3.5 inches of undistorted deflection for symmetrical signals; to 2.5 inches for unidirectional signals; (with 12,000 volts accelerating potential) output voltage of amplifier equivalent to 2.75 inches of undistorted deflection for symmetrical signals; to 1.5 inches for positive unidirectional signals; to 1.3 inches for negative unidirectional signals; **Useful vertical scan on CRT:** (with 7000 volts accelerating potential) 2.25 inches; (with 12,000 volts accelerating potential) 1.75 inches. **Input impedance:** to amplifier, 2 megohms paralleled by  $30 \mu\text{f} \pm 10\%$  for all attenuator settings; to probe, 5 megohms paralleled by  $15 \mu\text{f}$ ; direct (balanced) 9.4 megohms paralleled by  $15 \mu\text{f}$ ; direct (unbalanced) 4.7 megohms paralleled by  $20 \mu\text{f}$ . **Square-wave response:** input pulse of 0.01 microsecond rise time is degraded to not more than 0.03 microsecond. **Input Attenuation:** 100:1, 30:1, 10:1, 3:1, and 1:1, plus continuous attenuation up to 4:1. **Signal Delay:** Signal-delay line incorporated in Y amplifier provides signal delay sufficient to overcome sweep-starting time. Specifications for deflection factor, frequency response and undistorted deflection take into account performance of delay line.

**HORIZONTAL DEFLECTION—Deflection factor:** (with 7000 volts accelerating potential), through amplifier only, 1.8 p-p volt/inch; (with 12,000 volts accelerating potential), through amplifier only, 2.2 p-p volts/inch; **Undistorted Deflection:** (with 7000 volts accelerating potential) not less than 4 inches (with 12,000 volts accelerating potential) not less than 3 inches. **Sinusoidal Frequency Response** is down not

more than 20% at 10 cycles per second and at 1 mc per second. **Input Impedance:** 1 megohm,  $40 \mu\text{f}$ . **Attenuation:** 10:1, 1:1, plus continuously variable amplitude control.

**LINEAR TIME BASE—Driven Sweeps** continuously variable in duration from 3  $\mu\text{sec}$  to 0.1 second. Starting time of driven sweep not more than 0.25  $\mu\text{sec}$ . from leading-edge rise time of 0.01  $\mu\text{sec}$ . Sweep initiated by signal producing 0.5" or more vertical deflection (12,000-volt acceleration) on Internal Sync, or  $\pm 0.5$  volt external signal. Duration of initiating signal not less than .1  $\mu\text{sec}$ . **Recurrent Sweeps** continuously variable in frequency from 10 cps to 150,000 cps. **Sync Sensitivity:** 0.1" or more of vertical deflection on internal sync, or  $\pm 0.1$  volt of external signal (12,000 volts acceleration). Departure of all sweeps from linearity, not more than 10%. Amplitude of all sweeps at least 3.5 inches with 7000 volts acceleration; 2.7 inches with 12,000 volts acceleration. Electron beam is blanked at all times except during actual sweep time.

**TIME CALIBRATION**—Timing markers indicating intervals of 0.1, 1, 10, or 100 microseconds are applied as vertical deflections. Accuracy, 3%.

**INTENSITY MODULATION** — Provision is included for modulating the intensity of the trace by means of external signals.

**TRIGGER GENERATOR**—Output pulse of 50 volts amplitude and of either polarity variable from 200 to 3600 pps. Leading-edge rise time does not exceed 0.3  $\mu\text{sec}$  from 10% to 90% of peak amplitude. Duration of pulse approximately 1  $\mu\text{sec}$  at 50% of peak amplitude. **Output Impedance:** positive trigger, not more than 330 ohms; negative trigger, not more than 1000 ohms.

**MAXIMUM PHOTOGRAPHIC WRITING RATES**—With Du Mont Type 296 Camera, 10 in/ $\mu\text{sec}$ ; with Du Mont Types 295 or 321 cameras, 35 in/ $\mu\text{sec}$ .

**POWER SOURCE**—Operates from 115-volt ( $\pm 10\%$ ) 50-60-cps power line. Power consumption, 600 watts.

**PHYSICAL CHARACTERISTICS** — Type 294-A is housed in two metal cabinets, each equipped with carrying handles. Overall Dimensions: Indicator unit, 15-3/4" height, 12-3/4" width, 34-1/2" depth; weight, 62 lbs. Power Supply, 15-3/4" height, 12-3/4" width, 19-3/4" depth; weight, 100 lbs.

**TYPE 303  
CATHODE-RAY OSCILLOGRAPH**

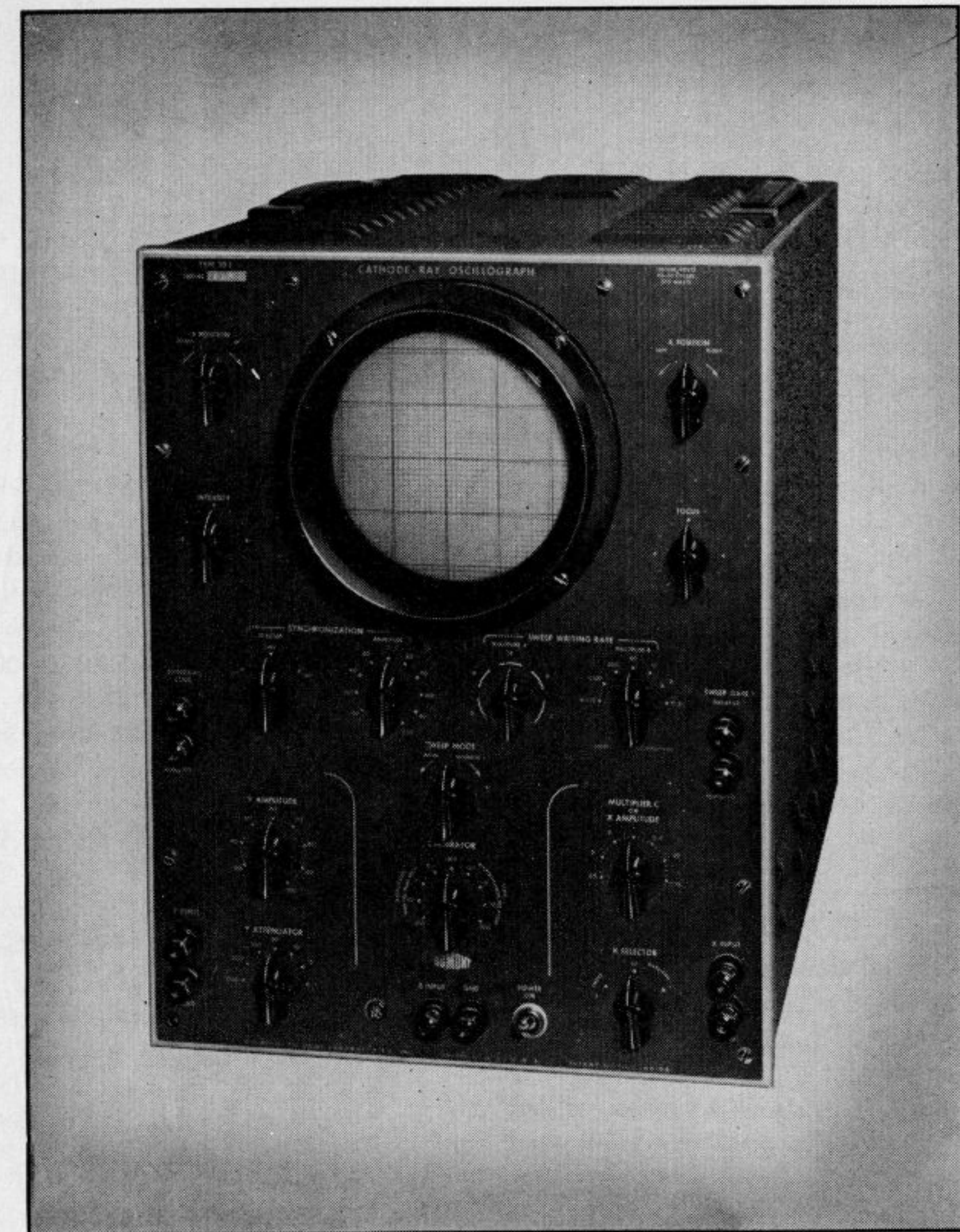

- 10-megacycle vertical amplifier
- 4 inches of undistorted vertical deflection
- Pulse response, 0.033 microsecond
- Expandable sweeps
- Deflection factor, 0.1 peak-to-peak volt per inch
- Maximum undistorted sweep writing speed, 6 inches per microsecond
- Calibration of both amplitude and time
- Type 5YP- high-sensitivity Cathode-ray Tube.

| Catalog No. | Type  | Description   |
|-------------|-------|---|
| 1541-E      | 294-A | Cathode-ray Oscilloscope for 115-volts, 50-60 cps, with Type 5XP2 Cathode-ray Tube. |
| 1544-E      | 294-A | Same as above, with Type 5XP11 Cathode-ray Tube.                                    |

# TYPE 303 CATHODE-RAY OSCILLOGRAPH

## FUNCTION

In the Type 303 Cathode-ray Oscillograph, Du Mont presents a quantitative instrument capable of a performance and versatility not before found in medium-priced equipment. With extended bandwidth, high sensitivity, and excellent pulse response, the Type 303 may be used not only for general laboratory oscillography but also for the display of pulses and similar high-frequency phenomena. Incorporation of circuits for the measurement of time and amplitude makes the Type 303 a truly quantitative cathode-ray oscillograph. In spite of its great versatility, the ingenious circuit design of the Type 303 permitted a reduction in the number of controls usually required for an oscillograph of this type, providing unusual simplicity of operation.

The Du Mont Type 303 represents a distinct advance in the art of cathode-ray oscillography. Each feature has been carefully selected and evaluated so that each complements the other, enabling fullest utilization of all. This, combined with the traditional Du Mont skill in producing the finest in oscillographic equipment, results in a precision quantitative oscillograph of enduring quality.

### Pulse Response, 0.033 Microsecond

The excellent pulse response of the Type 303 is indicated by the oscillogram of Figure 2. Illustrated here is a pulse of 0.25-microsecond duration, and having a rise time of 0.01 microsecond. The rise time of the pulse is reproduced on the screen of the Type 303 as not exceeding 0.033 microsecond. Note the absence of overshoot (see point C in Figure 2) in the presentation of this pulse. While the nominal bandwidth of the vertical amplifier is 10 megacycles, it should be noted that this amplifier is usable for sinusoids as high in frequency as 20 or 30 megacycles since the frequency response characteristic (see graph of Figure 1) falls slowly at the high-frequency end.

Figure 1. Frequency response characteristic of the vertical amplifier of the Type 303. As indicated by the gradual fall of the curve at the high-frequency end, the amplifier is usable for sinusoids of frequencies far higher than the nominal 10-megacycle bandwidth

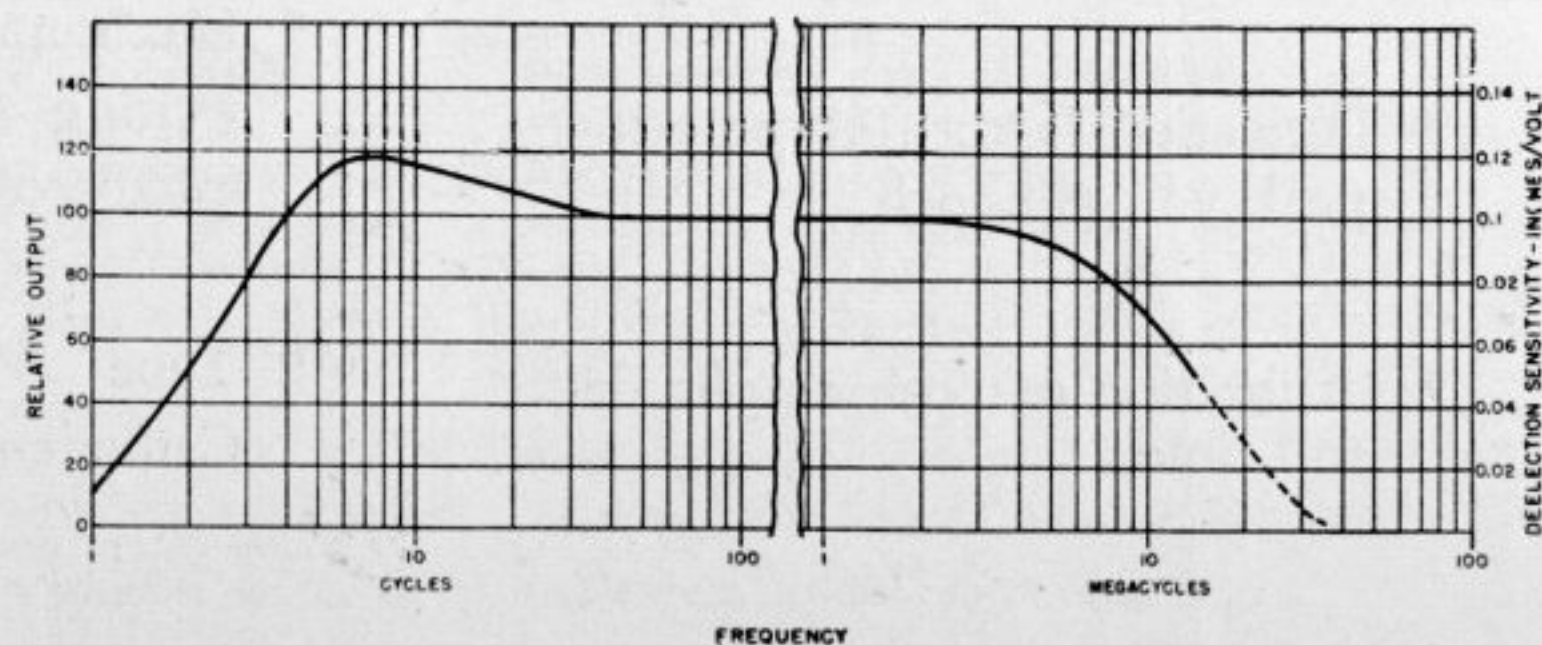

### Built-In Signal-Delay Line

In order to assure presentation of the entire leading edge of the input pulse, a signal-delay line is built into the vertical amplifier of the Type 303. The delay line provides sufficient delay of the signal to permit initiation of the sweep before the input signal is applied to the vertical channel. The function of the delay line is illustrated by interval A on the oscillogram of Figure 2. It should be noted that all specifications for deflection factor, undistorted deflection, and bandwidth of the vertical amplifier take into account the performance of this delay line.

### Voltage Calibration

The amplitude of a signal applied to the vertical axis may be readily measured by comparison with an internally supplied standard square-wave voltage (see D on Figure 2). Square waves having amplitudes of 0.1, 1, 10, or 100 volts may be applied by means of a front-panel selector switch. By means of this voltage calibrator, the scale of the Type 303 may be readily calibrated to read, say, 0.1 volt per 10 vertical divisions, simply by adjusting the vertical-gain control until the 0.1-volt square wave occupies that portion vertically on the scale. Then, so long as the settings of the vertical attenuator and gain control are not changed, the peak-to-peak amplitude of any signal subsequently applied to the vertical channel may be read directly from the calibrated scale. Standard voltages are accurate to  $\pm 5\%$ .

### Time Calibration

Time calibration is provided in the form of sinusoidal timing markers (see E on Figure 2) which may be substituted for the signal by means of a front-panel selector switch. These markers indicate intervals, of 0.1, 1, 10, and 100 microseconds and have an accuracy of  $\pm 3\%$ . Similar to the case of voltage calibration, the scale of the Type 303 may be cali-

## TYPE 303 CATHODE-RAY OSCILLOGRAPH

Figure 2. Multiple exposure illustrating the capabilities of the Type 303. Pulse having rise time of 0.01  $\mu\text{sec}$  is recorded together with voltage (D) and timing (E) calibrations. Pulse rise, (B) is reproduced as not exceeding 0.033  $\mu\text{sec}$ , with negligible overshoot

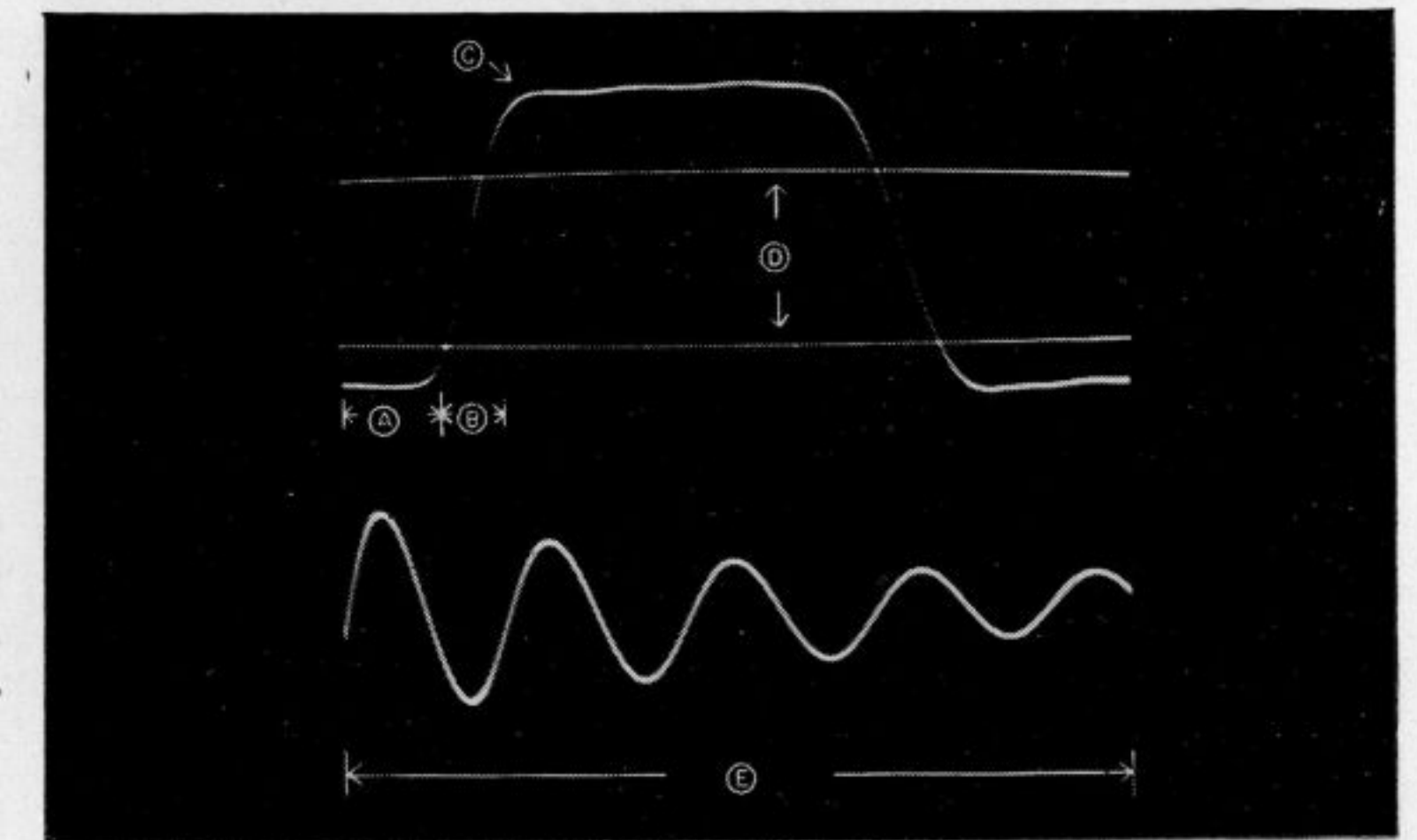

brated to read, say, 1 microsecond per 10 divisions by adjusting the horizontal-gain control until the distance between peaks of the 1-microsecond timing-wave train equals that horizontal portion of the scale. The relationship of an input signal to time may then be read directly from the scale, so long as the settings of the horizontal-gain control and the sweep writing rate controls are not changed.

### 4 Inches of Undistorted Deflection

A useful presentation of the input signal is assured with the Type 303, since the output of the vertical amplifier will produce an equivalent of 4 inches of undistorted vertical deflection with symmetrical signals, and 2 inches with unidirectional phenomena. Owing to the deflection cut-off characteristic of the Type 5YP- Cathode-ray Tube, which is employed in the Type 303, useful vertical scan is 3 inches. However, by using vertical positioning, any desired portion of the undistorted 4-inch deflection may be displayed, the unwanted portion being masked off. The oscillograms of figures 3, 4, and 5 illustrate this treated in oscillograms of Figure.

### Stabilized Sweeps

The range of sweep speeds of the Type 303 was carefully selected to complement the capabilities of the vertical amplifier. Sweeps of the instrument are continuously variable in duration from 0.1 second to 2 microseconds, and a maximum sweep-writing rate of 6 inches per microsecond is provided. A pulse rise time of 0.033 microsecond, displayed on a sweep of maximum writing rate, will occupy approximately 2 divisions horizontally on the calibrated scale. Thus even the most rapidly rising wave fronts passed by the amplifier may be readily observed and measured.

A sweep "lock out" circuit is incorporated in the Type 303, which renders the sweep generator insensitive to triggering pulses once the sweep cycle has begun. Thus multiple triggering is eliminated and display of aperiodic phenomena without confusion of pattern is assured. Sweep stability is further enhanced by the provision for "sweep clamping." By means of sweep clamping, the driven sweep is initiated from the same point on the screen, even when triggered by signals wholly random

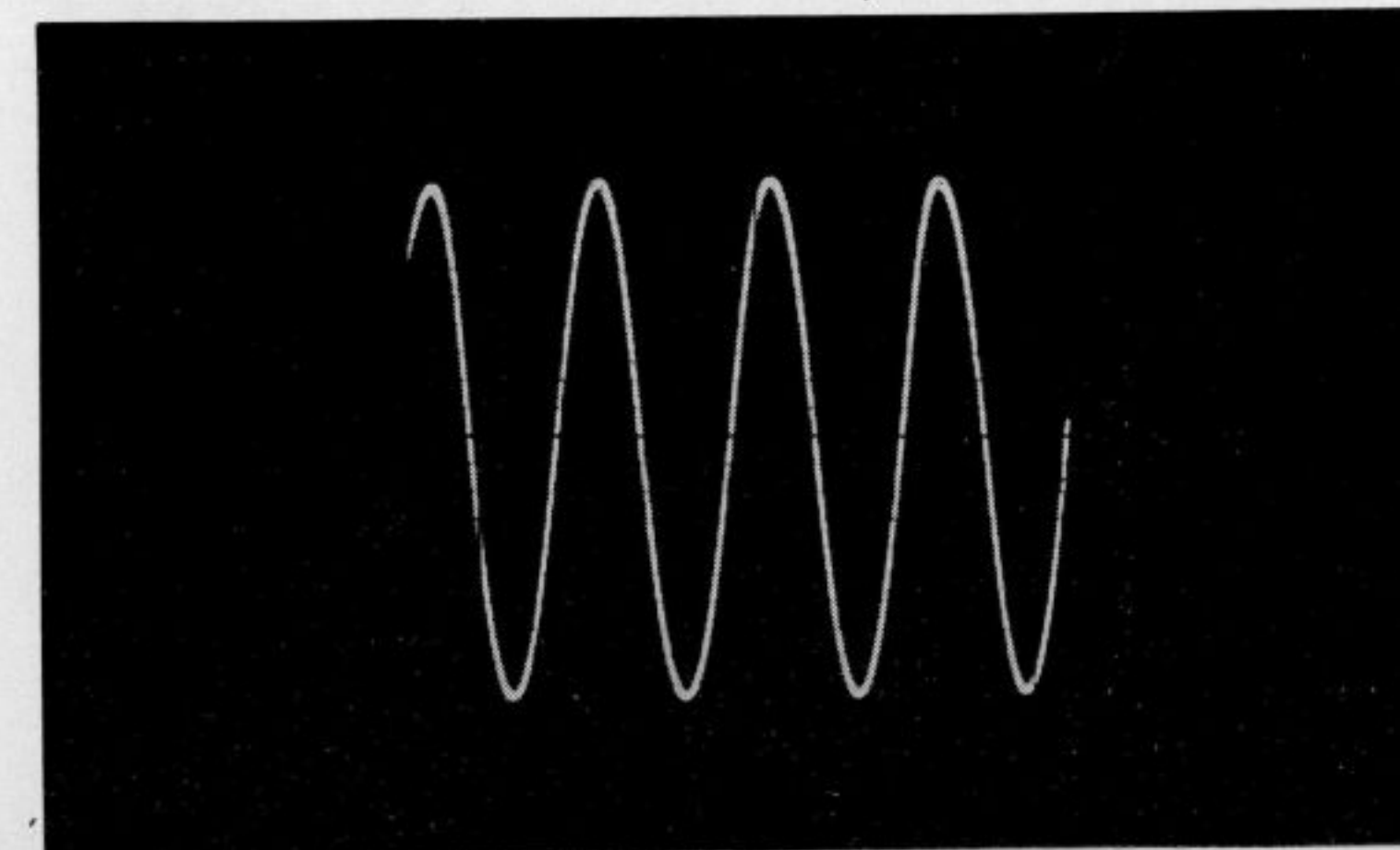

Figure 3. A sinusoidal wave train occupying the full useful vertical scan of the Type 5YP- Cathode-ray Tube. See Figures 4 and 5 for effects of this tube's deflection-cut-off characteristic

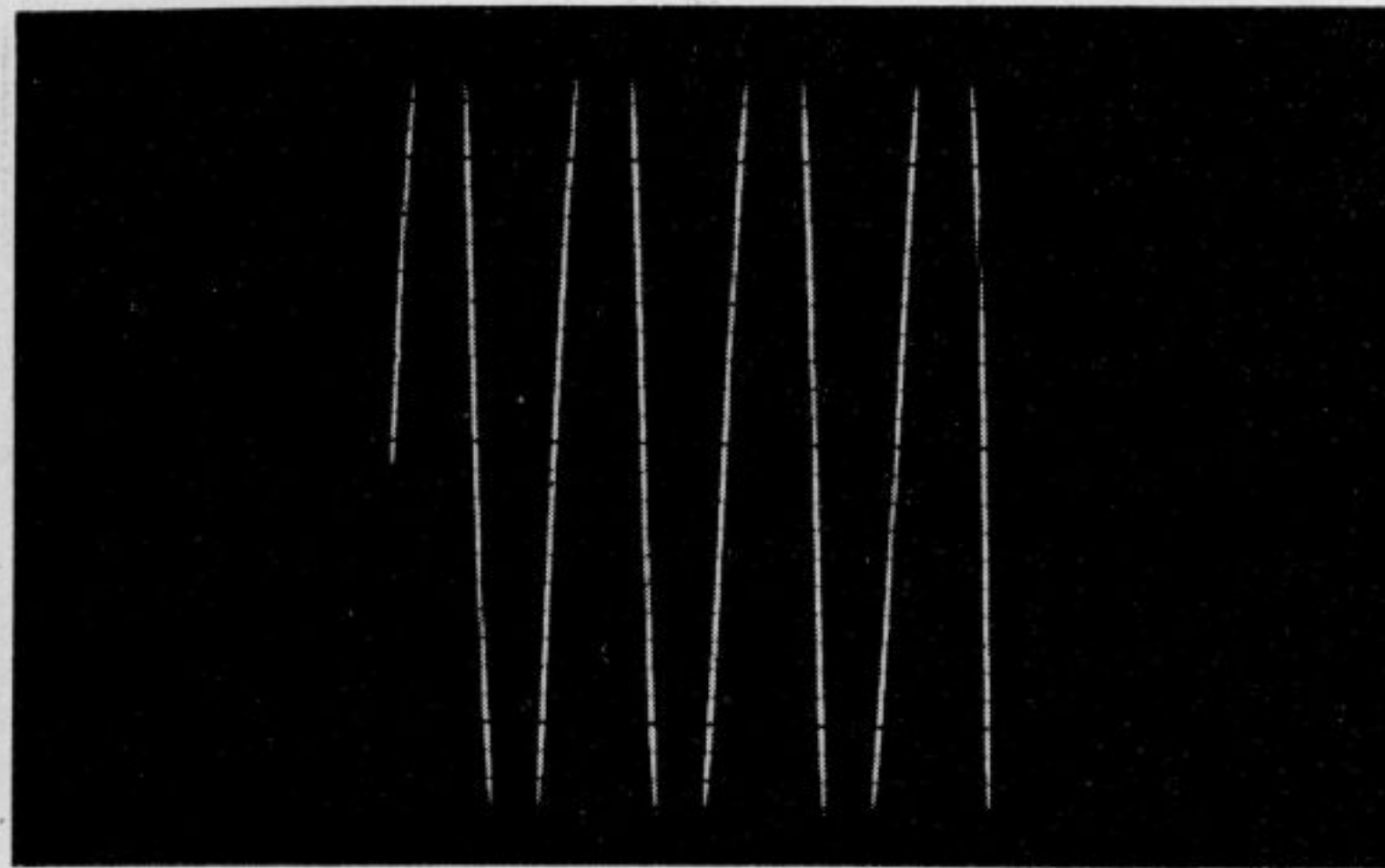

Figure 4. The same wave train as shown in Figure 3 is displayed here with increased vertical gain. Negative and positive peaks of the waves are obscured as a result of the deflection-cut-off characteristic of the Type 5YP-Cathode-ray Tube. (See Figure 5)

in nature. Thus a major cause of horizontal jitter is eliminated. Figure 6, a display of the output of a Geiger-Mueller tube, illustrates the unusual sweep stability of the Type 303.

**Sweep Expansion**

Sweeps of the Type 303 may be expanded up to six times full-screen diameter, so long as the maximum sweep-writing speed of six inches per microsecond is not exceeded, without distortion. Sweeps may be expanded beyond this limit, but some distortion may be introduced. The range of the horizontal positioning circuit is sufficiently great that any portion of the expanded, undistorted trace may be brought onto the screen. Sweep expansion is illustrated in the oscillograms of Figure 7.

**Type 5YP- High-Sensitivity Cathode-Ray Tube**

The Du Mont Type 5YP- Cathode-ray Tube, which is employed in the Type 303, embodies the latest development in cathode-ray tube design. The vertical-deflection plates of the Type 5YP- are longer, and are more closely spaced than is the practice in tubes of more

conventional design. The result is an increase in sensitivity of approximately 10 db over an equivalent conventional design. Deflection-plate connections of the Type 5YP- are brought out through the neck to reduce deflection plate capacitance. Either the P1, P2, or P11 screen is supplied as standard.

**Intensity Modulation**

Provision is incorporated in the Type 303 for modulating the intensity of the electron beam to impress markers which may be used to indicate time, angle, distance, etc., on the fluorescent trace. A positive signal of 15 peak volts will blank the beam from normal intensity settings.

**Additional Features**

The negative sweep gate is available at a front-panel binding post, and may be used for such applications as operating auxiliary equipment in synchronism with the Type 303. This negative sweep gate is approximately 75 peak volts will blank the beam from normal ohms.

The Type 5YP- Cathode-ray Tube is en-

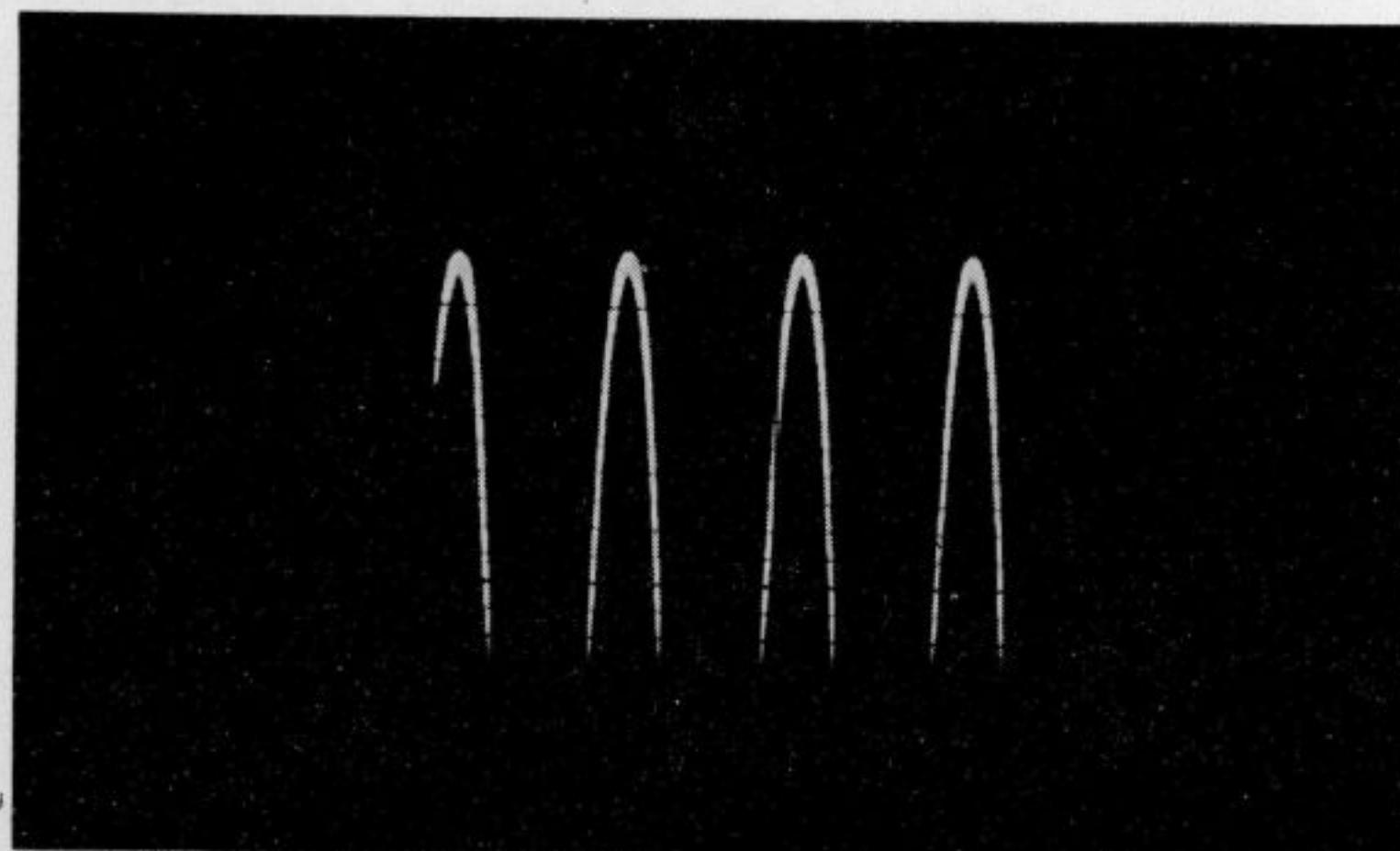

Figure 5. Full undistorted-deflection capabilities of the vertical amplifier may be exploited as peaks under study are positioned down to occupy entire usable vertical scan. Unwanted portions of pattern are now masked by the deflection-cut-off characteristic

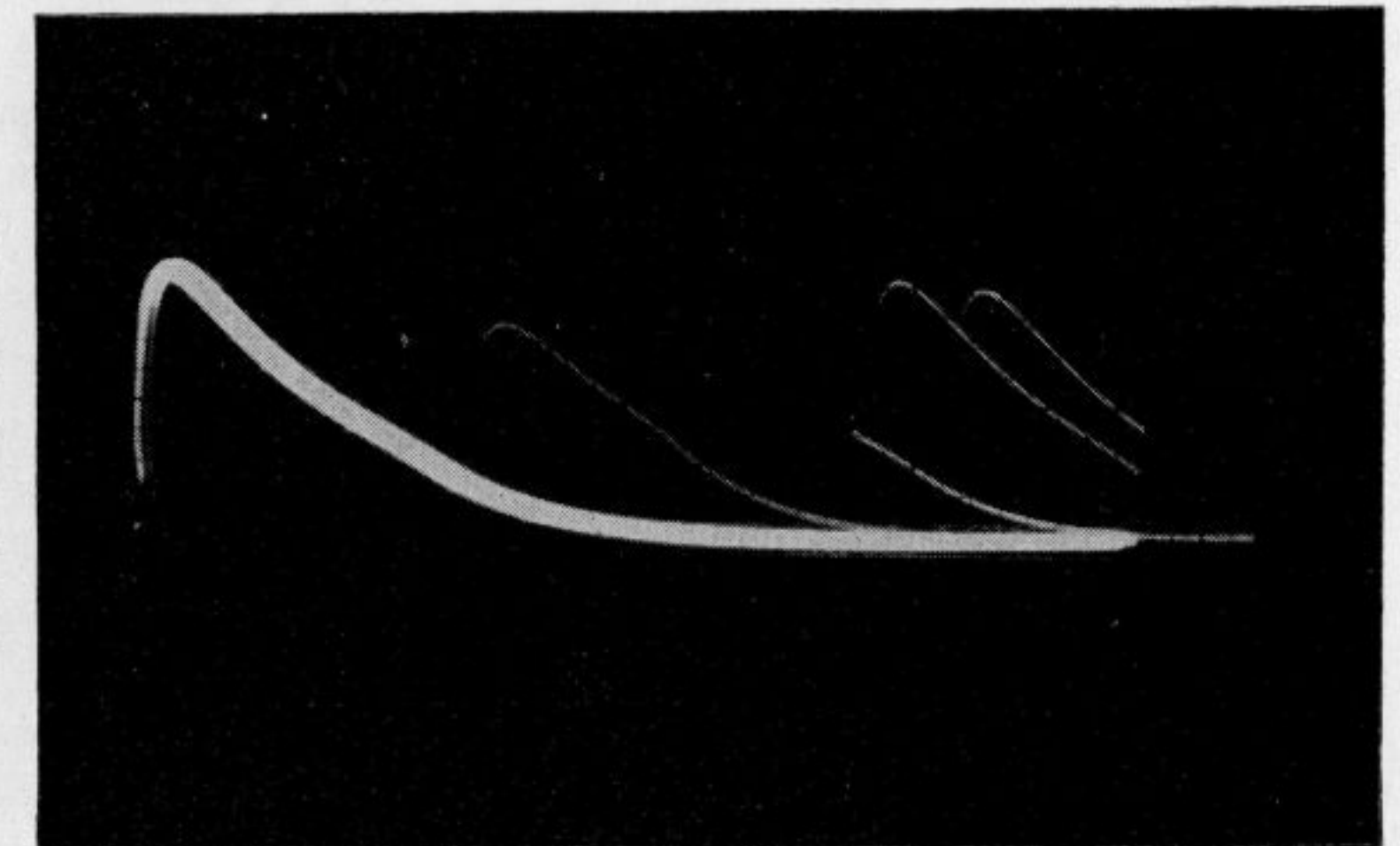

Figure 6. Unretouched recording of the output of a Geiger-Mueller tube, photographed from the screen of the Type 303. Even with the extremely random nature of these signals, a stable sweep is provided

closed in a Mu-metal shield to minimize spurious deflections from external magnetic fields.

A Du Mont Type 2520 Calibrated Scale is supplied with the Type 303, to facilitate making quantitative measurements. This scale is made from 1/8-inch plastic, and engraved with black calibrating lines at 1/10-inch intervals in both directions.

**Recommended Accessories**

If, at any time during oscillographic investigation it is desirable to record the pattern, the general-purpose Du Mont Type 296 Oscillograph-record Camera is recommended. If writing rates are encountered that are beyond the recording capabilities of general-purpose equip-

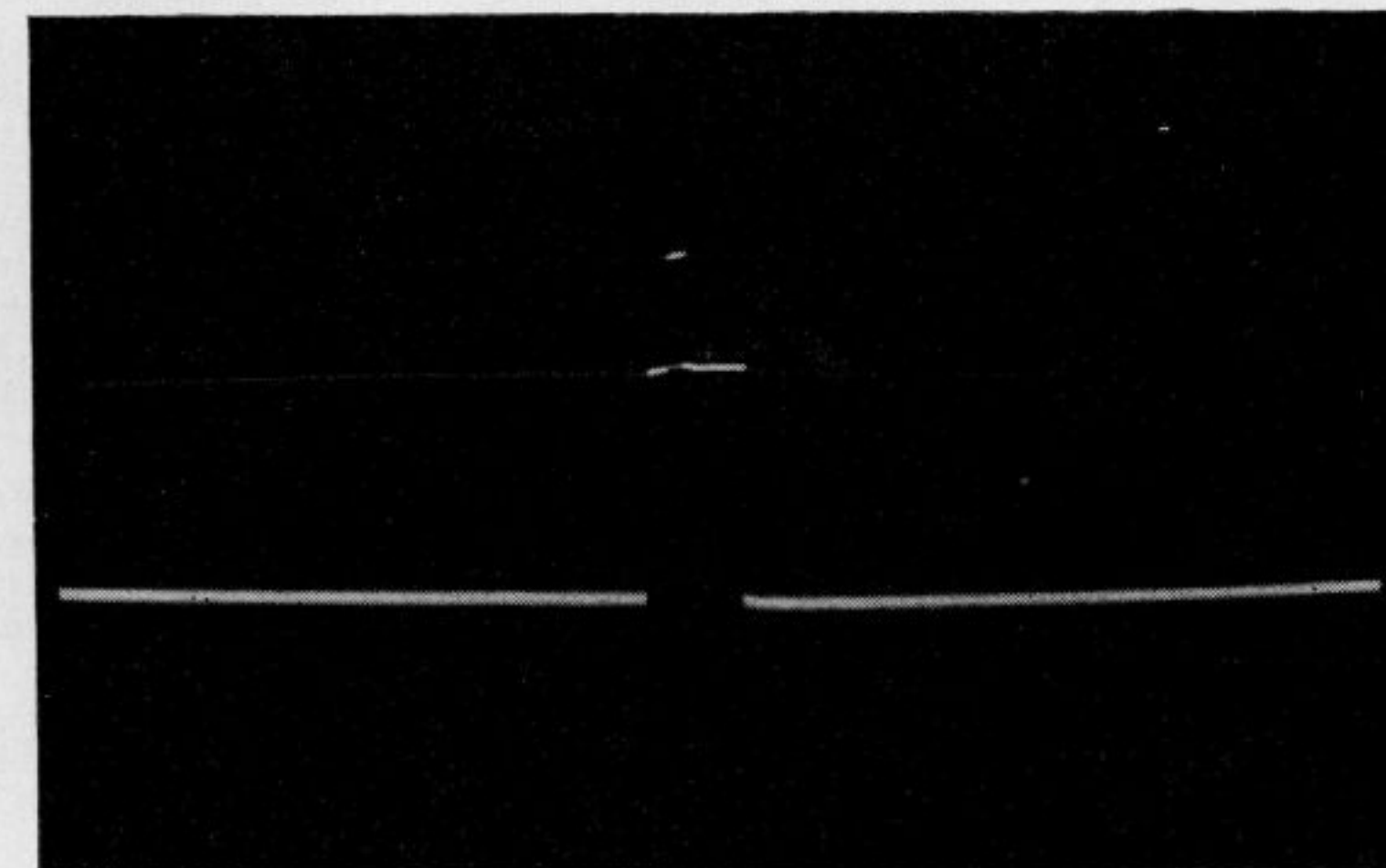
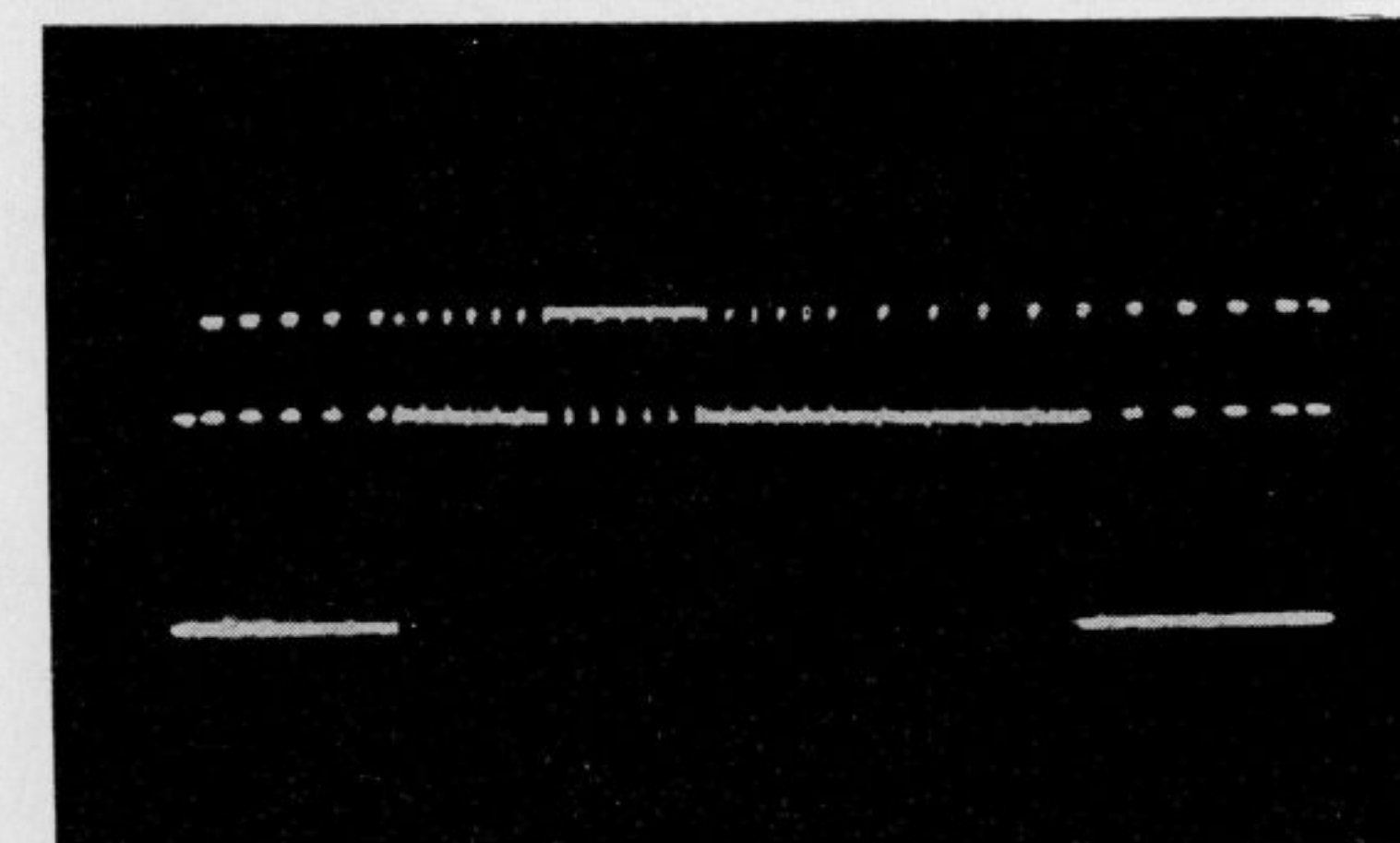

Figure 7. Sweeps of the Type 303 may be expanded without distortion so long as the maximum sweep speed of 6 times per  $\mu$ sec is not exceeded. (Sweeps may be expanded beyond this point, but some distortion may be introduced.)



Oscillograms at right, vertical sync and blanking pulses from a Du Mont Portable Sync Generator, illustrate this feature. Bottom oscillogram is a portion of top oscillogram, expanded to permit the study of detail

ment, the Du Mont Type 295 Oscillograph-record Camera is recommended. This camera, equipped with a high-speed lens, is capable of recording writing rates up to 3.5 inches per microsecond. Should finished recordings be required with the least possible delay, the Du Mont Type 297 Oscillograph-record Camera, which will provide finished oscillograms 60 seconds after exposure, is recommended.

The Du Mont Type 2560 Color Filters may be used with the Type 303, not only to elimi-

nate an undesired color component from the fluorescent pattern, but also to increase the contrast of pattern during visual observation.

The Type 316 Test Probe is also a useful adjunct to the Type 303. The Type 316 Test Probe provides a high-impedance input with low input capacitance. The use of the Type 316 thus minimizes loading of the signal source, and facilitates handling of high-frequency signals.

**SPECIFICATIONS**

**CATHODE-RAY TUBE**—The Type 5YP-Cathode-ray Tube; accelerating potential, Eb2 + 1600 volts with respect to cathode, intensifier + 3000 volts.

**VERTICAL DEFLECTION — Deflection Factor:** through amplifier at full gain, 0.1 peak-to-peak (0.030 rms) volt per inch; direct, 25 peak-to-peak (9 rms) volts per in. ±20%. **Sinusoidal Frequency Response:** for any setting of attenuator or gain controls, down not more than 30% from 10 cycles to 10 megacycles with no positive slope above 10 kilocycles. **Pulse Response:** 0.033 microsecond. **Undistorted Deflection:** 4 inches with symmetrical signals; 2 inches with unidirectional signals. Useful vertical scan, 3 inches. **Signal Delay:** A 0.25 microsecond delay of the vertical input signal allows the sweep to start before the amplified signal is applied to the vertical deflection plates. Thus the full input signal may be examined without losing its initial variation. **Input Impedance:** through amplifier, 2 megohms, 40 μμf; direct (balanced), 7.8 megohms, 10 μμf; direct (unbalanced), 3.9 megohms, 10 μμf. **Maximum Allowable Input Potential:** 600 volts d-c plus peak a-c.

**HORIZONTAL DEFLECTION—Deflection Factor:** through amplifier at full gain, 0.35 peak-to-peak (0.12 rms) volt per inch. **Sinusoidal Frequency Response:** uniform within 30% from 5 cycles to 500 kilocycles. **Undistorted Deflection:** 5 inches. **Input Impedance:** 2.2 megohms, 40 μμf. **Maximum Allowable Input Potential:** 1:1 attenuation, 50 volts d-c plus peak a-c; 10:1 attenuation, 500 volts d-c plus peak a-c.

**LINEAR TIME BASE—Driven and Recurrent Sweeps:** continuously variable in duration from 0.1 second to 2 microseconds. **Maximum Sweep-writing Rate:** 6 inches per microsecond; sweeps may be expanded up to 6 times full-screen diameter with no on-screen distortion. **Maximum Sweep-**

**starting Time:** 0.2 microsecond. **Synchronization:** from internal or external signals, or from internally supplied voltage of power-line frequency. Synchronization is possible from sinewaves signals of frequencies as high as 20 megacycles.

**VOLTAGE CALIBRATION**—Square waves of 0.1, 1, 10, or 100 volts amplitude may be substituted for the signal under study; accuracy, ±5%.

**TIME CALIBRATION**—Damped oscillation indicating intervals of 0.1, 1, 10, or 100 microseconds may be substituted for the signal under study; accuracy, ±3%.

**INTENSITY MODULATION**—Positive polarity decreases intensity; 15 peak volts will blank the beam at normal intensity settings.

**NEGATIVE SQUARE-WAVE OUTPUT**—A negative pulse of approximately 75 volts amplitude, at the selected frequency of the time base generator, is provided at a front-panel binding post; output impedance, less than 1000 ohms.

**MAXIMUM PHOTOGRAPHIC WRITING RATES**—With a Du Mont Type 296 Camera (f/2.8 lens), 1 inch per microsecond; with the Dumont Types 321 and 295 Cameras (f/1.5 lens), 3.5 inches per microsecond.

**TUBE COMPLEMENT**—8—6AH6, 1—12AU7, 1—12AT7, 2—6AU6, 2—6C4, 2—6AL5, 3—6J6, 2—5763, 2—2X2A, 2—5Y3, 1—5U4G, 1—5651, 2—6AQ5, 1—VR75.

**POWER SOURCE**—115 or 230 volts, 50-60 cycles; power consumption, 275 watts; fuse protection, (115 volts) 3 amps, (230 volts) 1-1/2 amps.

**PHYSICAL CHARACTERISTICS**—Instrument is housed in a metal cabinet, provided with two carrying handles. **Overall Dimensions:** width, 12-1/8" (30.8 cm); depth, 19-3/4" (50.2 cm); height, 16" (40.6 cm). **Weight:** 75 lbs (34 kg).

**TYPE 304-H  
CATHODE-RAY OSCILLOGRAPH**



*Handwritten notes:*  
2-10-57  
3-57  
281.1000  
84  
160  
140  
200

- Response of both X and Y amplifiers down less than 10% to 100,000 cps; down less than 50% to 300,000 cps
- Deflection factor through Y-axis amplifier, 0.01 rms volt per inch; through X-axis amplifier, 0.05 rms volt per inch
- High-gain a-c and d-c amplifiers for both X and Y axes
- Recurrent and driven sweeps variable from 2 to 30,000 cps
- Provision for extra-low-frequency sweeps
- Type 5CP-A Cathode-ray Tube operated at 3000 volts accelerating potential
- Stabilized synchronization
- Intensity modulation from external signals
- Expandable sweeps for study of high-frequency components of low-frequency signals

| Catalog No. | Type No. | Description  |
|-------------|----------|--|
| 1529-E      | 303      | Cathode-ray Oscillograph for 115 volts, 50-60 cps., with Type 5YP1 Cathode-ray Tube. |
| 1530-E      | 303      | Same as above, with Type 5YP2 Cathode-ray Tube.                                      |
| 1533-E      | 303      | Same as above, with Type 5YP11 Cathode-ray Tube.                                     |
| 1534-E      | 303      | Cathode-ray Oscillograph for 230 volts, 50-60 cps., with Type 5YP1 Cathode-ray Tube. |
| 1535-E      | 303      | Same as above, with Type 5YP2 Cathode-ray Tube.                                      |
| 1538-E      | 303      | Same as above, with Type 5YP11 Cathode-ray Tube.                                     |



## TYPE 304-H CATHODE-RAY OSCILLOGRAPH

## FUNCTION

The Du Mont Type 304-H, the successor to the Type 208-B, meets the demand for a modern, truly versatile oscillograph of low price and high-quality performance. The Type 304-H contains a number of features which enable the instrument to perform functions heretofore possible only with far more expensive equipment.

## High-gain d-c and a-c Amplifiers

D-C amplification, as well as the conventional a-c amplification, is provided for both the Y and X axes. Since it is possible to observe an a-c signal together with its d-c level, direct measurements may be made of such quantities as grid voltages and ionization potentials, (as illustrated in the oscillogram of Figure 2), as well as of static and dynamic strains, stresses, and pressures. In addition, d-c amplification permits the study of extremely low-frequency phenomena, which would normally be seriously distorted by the time constants usually employed in the coupling circuits of an ordinary a-c amplifier, as demonstrated by the oscillograms of Figures 3 and 4.

## Extra-low-speed Sweeps

In order that such low-frequency phenomena may be usefully displayed, provision is incorporated in the Type 304-H for sweeps of extremely long duration. While the internal sweep range extends down to 0.5 second, sweeps of 10-second duration, or longer, may be produced by attaching external capacitance between the sawtooth output terminal on the front panel and ground. A sweep duration of 0.5 second is secured for each microfarad of capacitance so attached, and the only limit to the sweep durations thus available is that of leakage in capacitors, and in the circuits of the oscillograph.

Three mutually opposing factors in the design of an oscillograph are price, gain and bandwidth. While maintaining the Type 304-H well within the boundaries of the low-price field, an excellent compromise between gain and bandwidth has been achieved, so that, while the bandwidth is more than adequate for general laboratory applications, extremely high gain has been preserved, and it is only under the most unusual conditions that pre-amplification is required.

The achievement of stability, generally recognized as one of the principal problems in

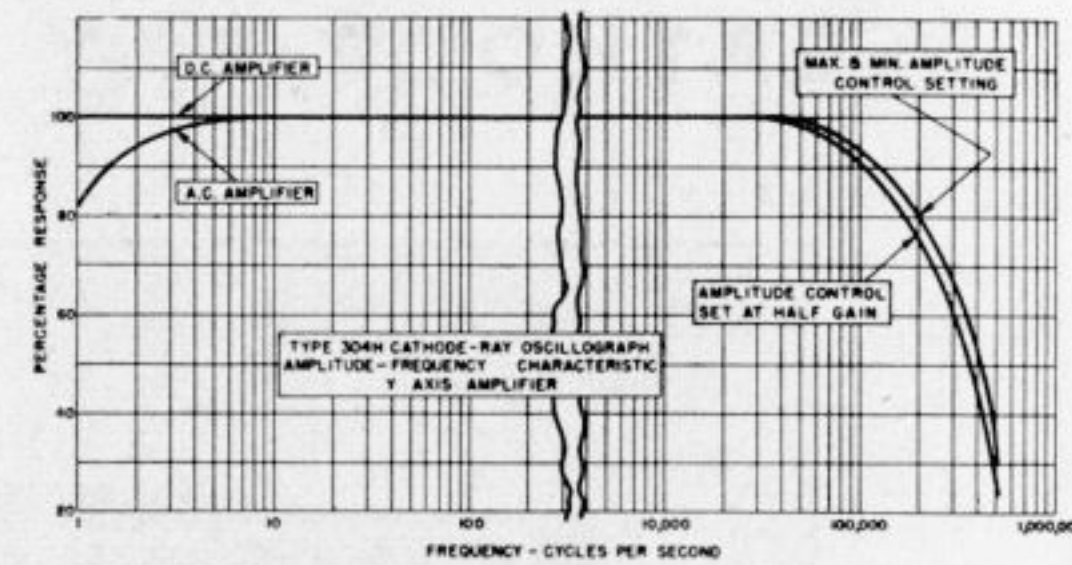

Figure 1. Vertical-amplifier response of the Type 304-H

the design of a high-gain, d-c amplifier, has been realized to a very high degree in the Type 304-H through the extensive use of negative feedback and by the employment of various self compensating elements in the circuit.

With a negative feedback factor,  $\beta$ , equal to  $-0.0005$  approximately, the gain of the Y-axis amplifier of the Type 304-H is reduced from a "normal" figure  $10^6$  to approximately 2000. This loss in voltage gain, obviously, is a measure of the contribution to stability that has been made in the design of this amplifier. Stability of the amplifiers has been further enhanced by excellent ventilation of the cabinet and by shock-mounting many components, to reduce microphonics well below the tolerable level.

Owing to its d-c response, the recovery time of the vertical amplifier is extremely short. Thus the loss of electrical zero of the amplifier is inconsequential, even with excessive variations of input-signal level.

By means of an ingenious bias-shift arrangement effected automatically by movement of the position control, the vertical deflection am-

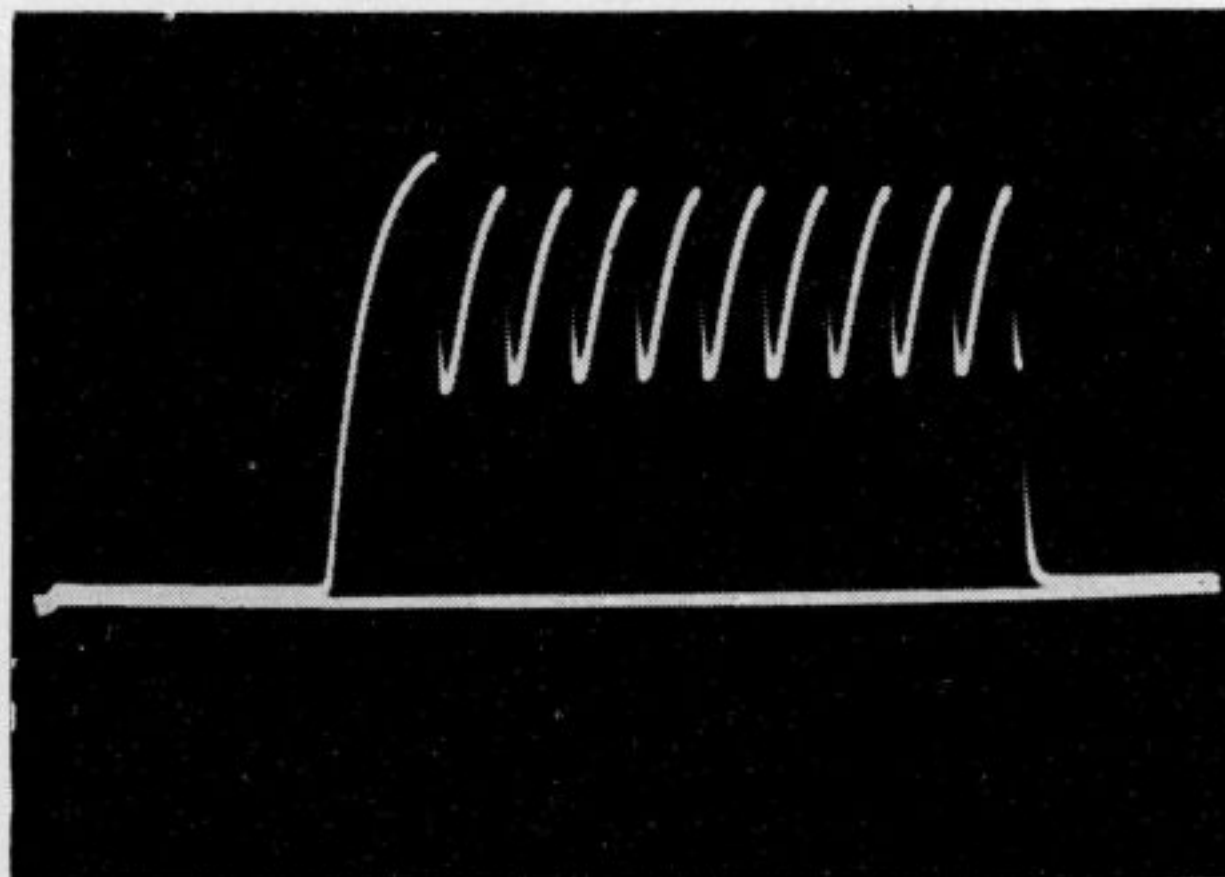

Figure 2. Indication of oscillating neon bulb, applied through d-c amplifier channel. Base line represents zero volts

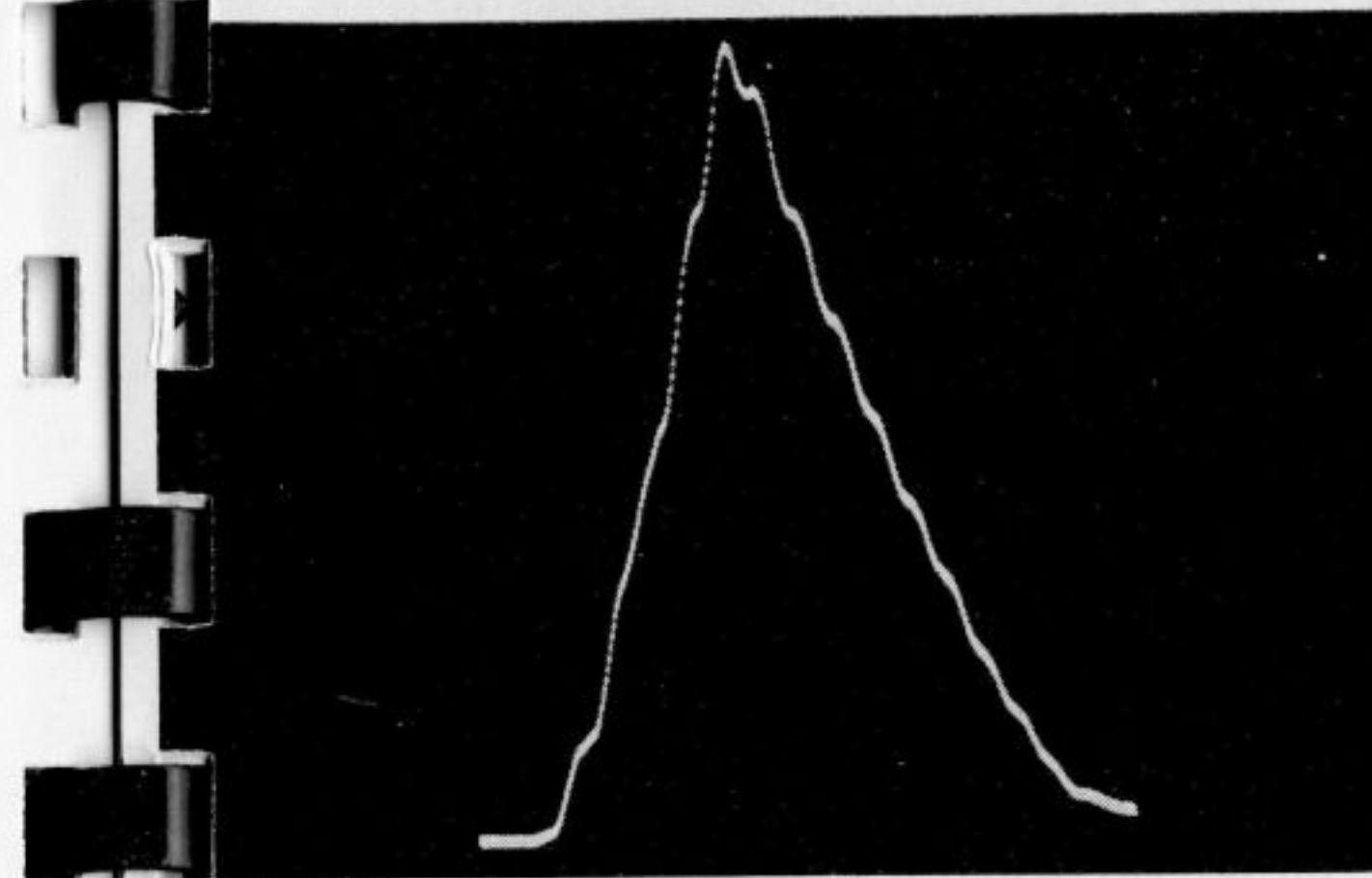

Figure 3. Indication of variation of volume of liquid in a retort. Signal, applied through d-c amplifier, was displayed on a 10-second sweep

plifier is caused to amplify the Y-axis signal as though it were capable of producing 20 inches of undistorted deflection. The effect is one of moving a mask of 5-inch diameter across a pattern 20 inches in amplitude. No distortion of the Y-axis signal is observable at any setting of the Y-position control.

This feature is particularly valuable in applications where there is a low-level signal superimposed upon a voltage of considerably greater amplitude, such as the observation of variations in power-line voltage.

By increasing the Y-gain control to produce maximum deflection, the low-level signal may be caused to produce a truly significant deflection. This may be centered on the screen and studied in detail, with no danger of distortion owing to overloading of the amplifier.

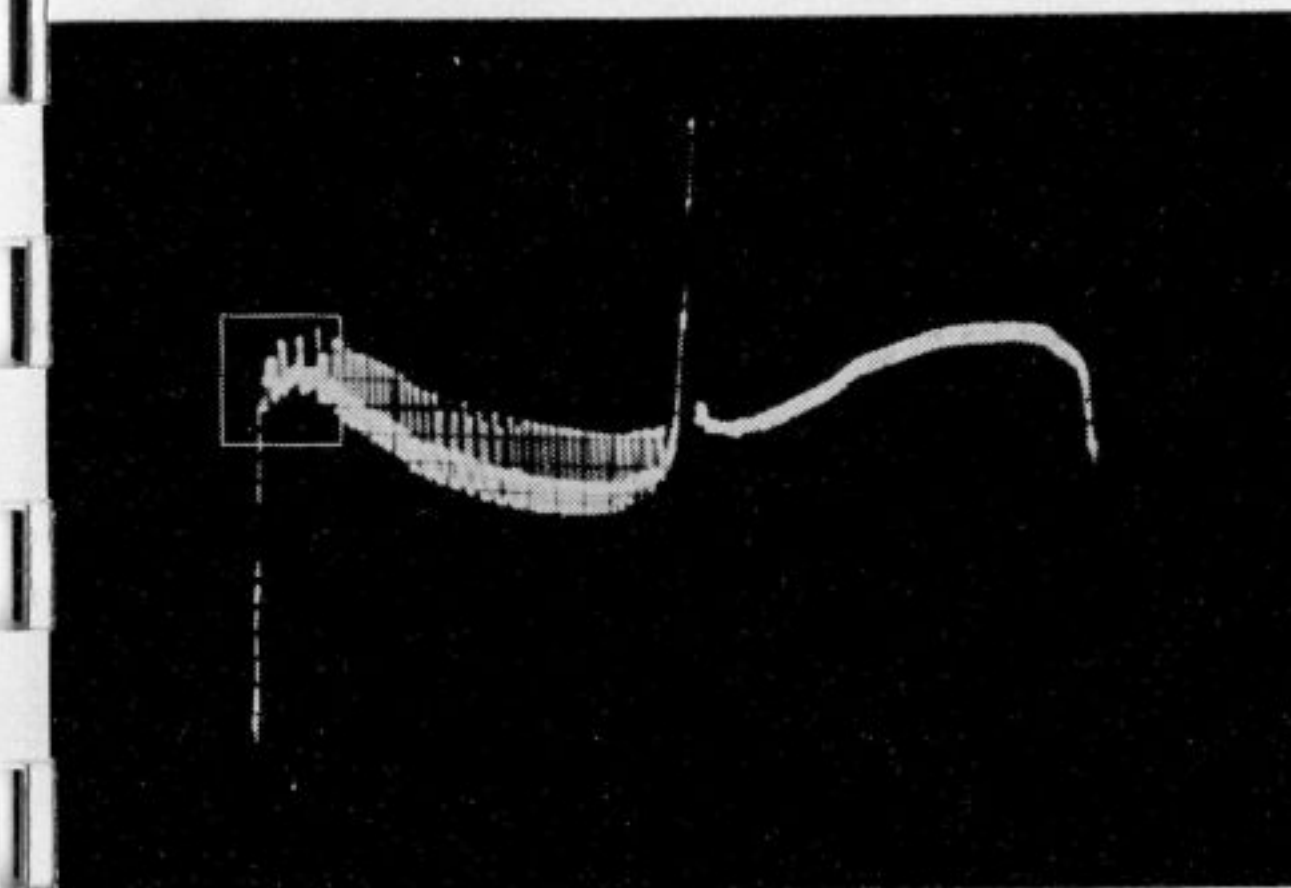

Figure 5. Voltage field in the vicinity of a fluorescent lamp, displayed with no expansion of sweep

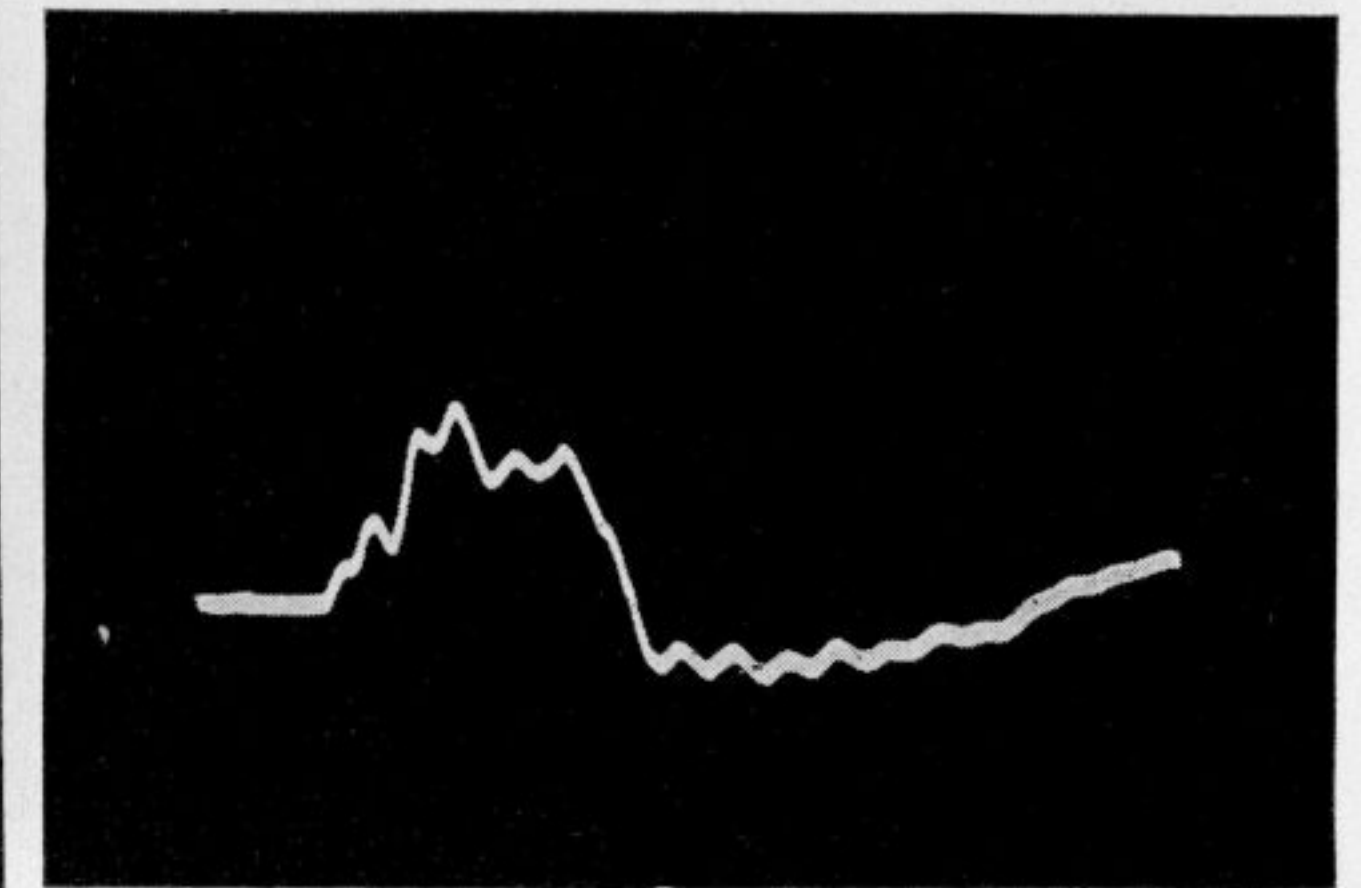

Figure 4. Indication similar to that of figure 3, passed through a-c amplifier. Note the distortion owing to the time constant of the a-c coupling

## Expandable Sweeps

High-frequency components of low-frequency signals may be observed or recorded in detail by means of the expandable sweeps of the Type 304-H. Sweeps of this instrument may be expanded up to 6 times full-screen diameter; the extremely broad range of the horizontal-positioning circuit permits any portion of the fully expanded sweep to be brought onto the screen and viewed without distortion. This feature is demonstrated in the oscillograms of Figures 6 and 7. Figure 5 shows the voltage field in the vicinity of a fluorescent lamp, displayed without expansion. The oscillogram of Figure 6 is a recording of the portion of Figure 5 outlined by the box, expanded to observe the high-frequency detail. If an attempt were made to observe these high-frequency components by increasing the sweep speed, the low-frequency elements of the signal would obscure the pattern, as shown in the oscillogram of Figure 7.

With the sweep fully expanded and adjusted to its highest writing speed, writing rates as high as 0.10 inch per microsecond may be obtained.

## Driven Sweeps

Many phenomena encountered in general laboratory work occur as transients, or as aperiodic rates. If an attempt were made to display these on recurrent sweeps, there would be no assurance that the start of the random signal would coincide with the beginning of the trace, and it would be only through chance that the entire signal was displayed. See Figure 8. For this reason, driven sweeps, initiated by the arrival of the phenomenon under study,

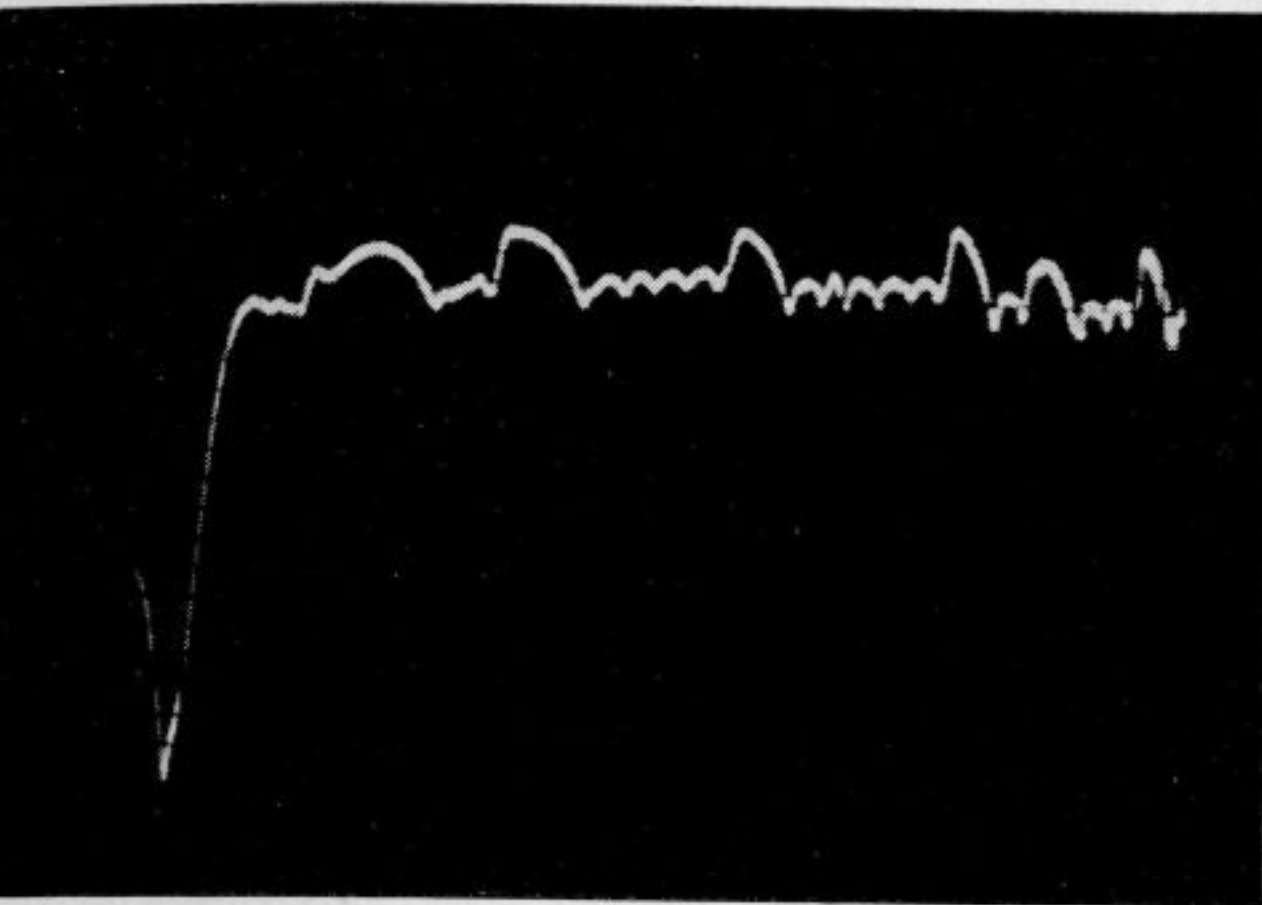

Figure 6. Portion of pattern outlined by box on Figure 5, expanded to full-screen diameter, to enable the study of the high-frequency components

are provided in the Type 304-H in addition to recurrent sweeps. See Figure 9. Input-signal amplitudes producing as little as 0.5 inch of vertical deflection will initiate the driven sweep when the sync-selector switch is set at the "Internal" position.

### High Accelerating Potential

In the study of low-speed phenomena, long-persistence screens must be employed if optimum results are to be obtained. The Type 5CP-A Cathode-ray Tube used in the Type 304-H is operated at an accelerating potential of 3000 volts, an unusually high accelerating potential for a general purpose oscillograph. This potential results in high efficiency of long-persistence screens so that fullest advantage may be taken of the low-speed driven and recurrent sweeps and the d-c amplifiers of the instrument.

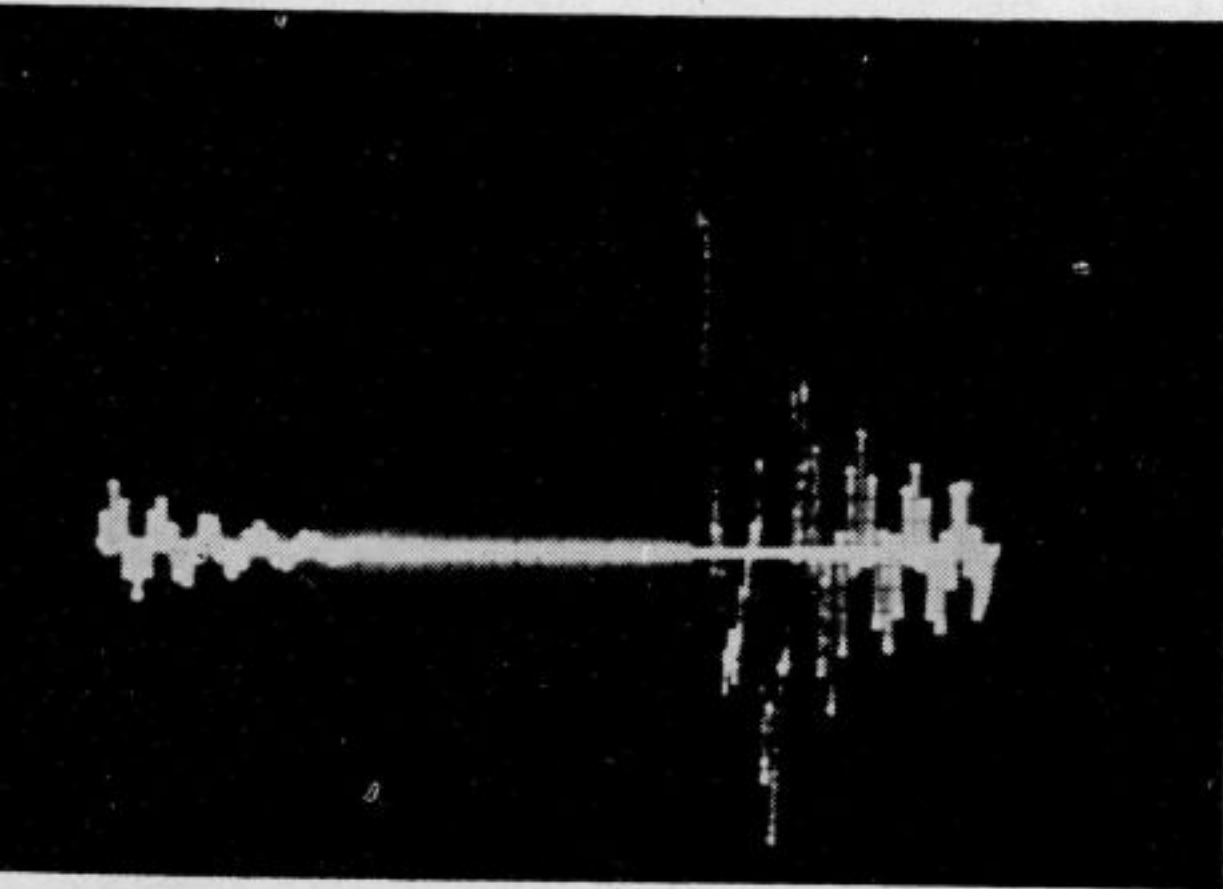

Figure 8. A random vibration displayed on a recurrent trace. Phenomenon begins toward end of trace, with much of the signal lost

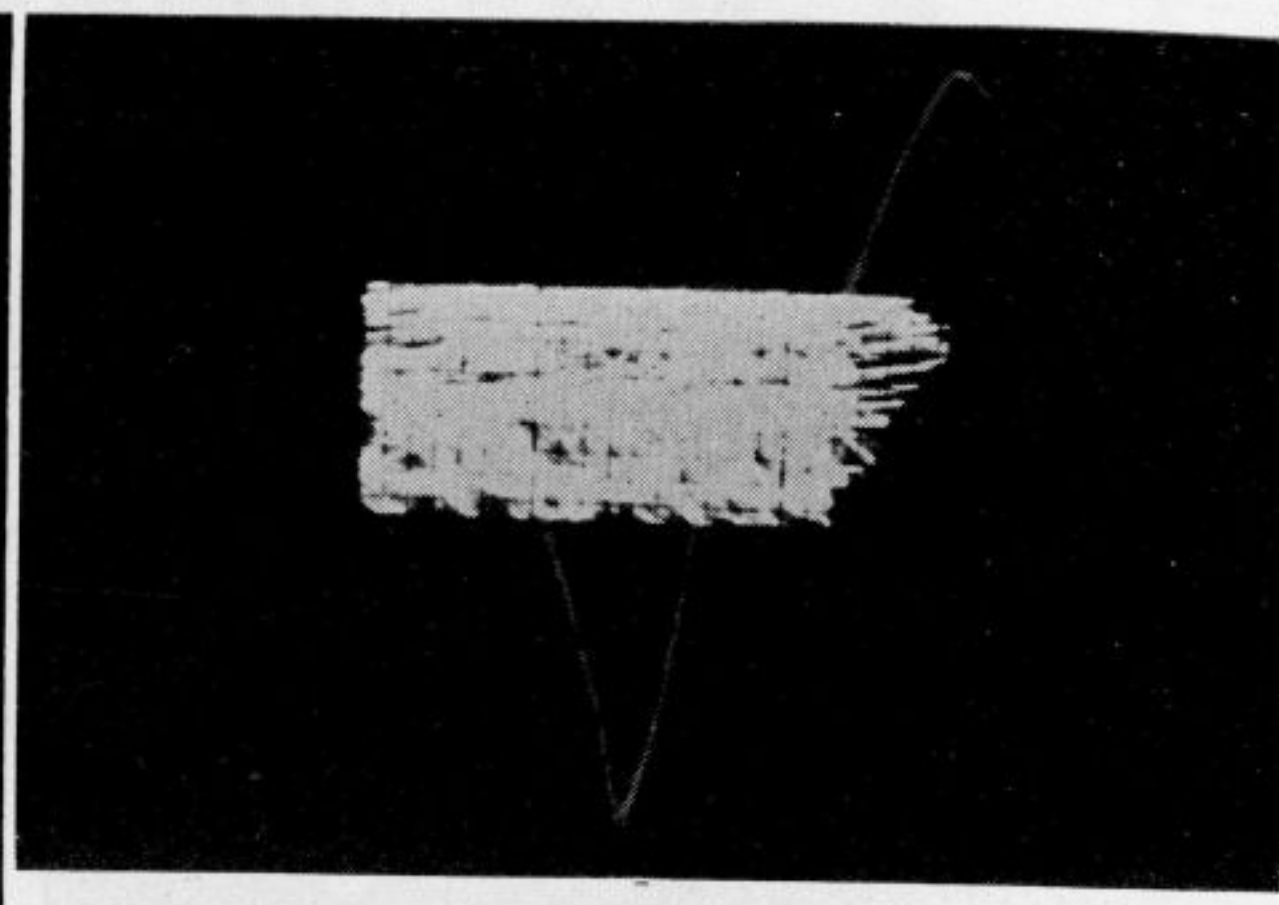

Figure 7. Increasing sweep frequency to gain same result as Fig. 6 fails because low-frequency components of signal obscure the pattern

The high light output resulting from the use of this accelerating potential makes the Type 304-H particularly well suited for use with oscillograph-record cameras such as the Du Mont Types 296, 297, or 321, and writing rates as high as 2.8 inches per microsecond may be readily recorded.

### Stabilized Synchronization

An unusual and convenient property of the Type 304-H is the stabilized synchronization. A sync-limiting circuit is incorporated on recurrent sweep, so that the possibility of distortion owing to the application of excessive synchronizing voltage is eliminated. Both synchronization and sweep length are unaffected by variations of sync signal level. Care has been taken in the design of the sync circuit so that, on internal sync, any signal of sufficient amplitude to produce a significant vertical deflection will synchronize the time base.

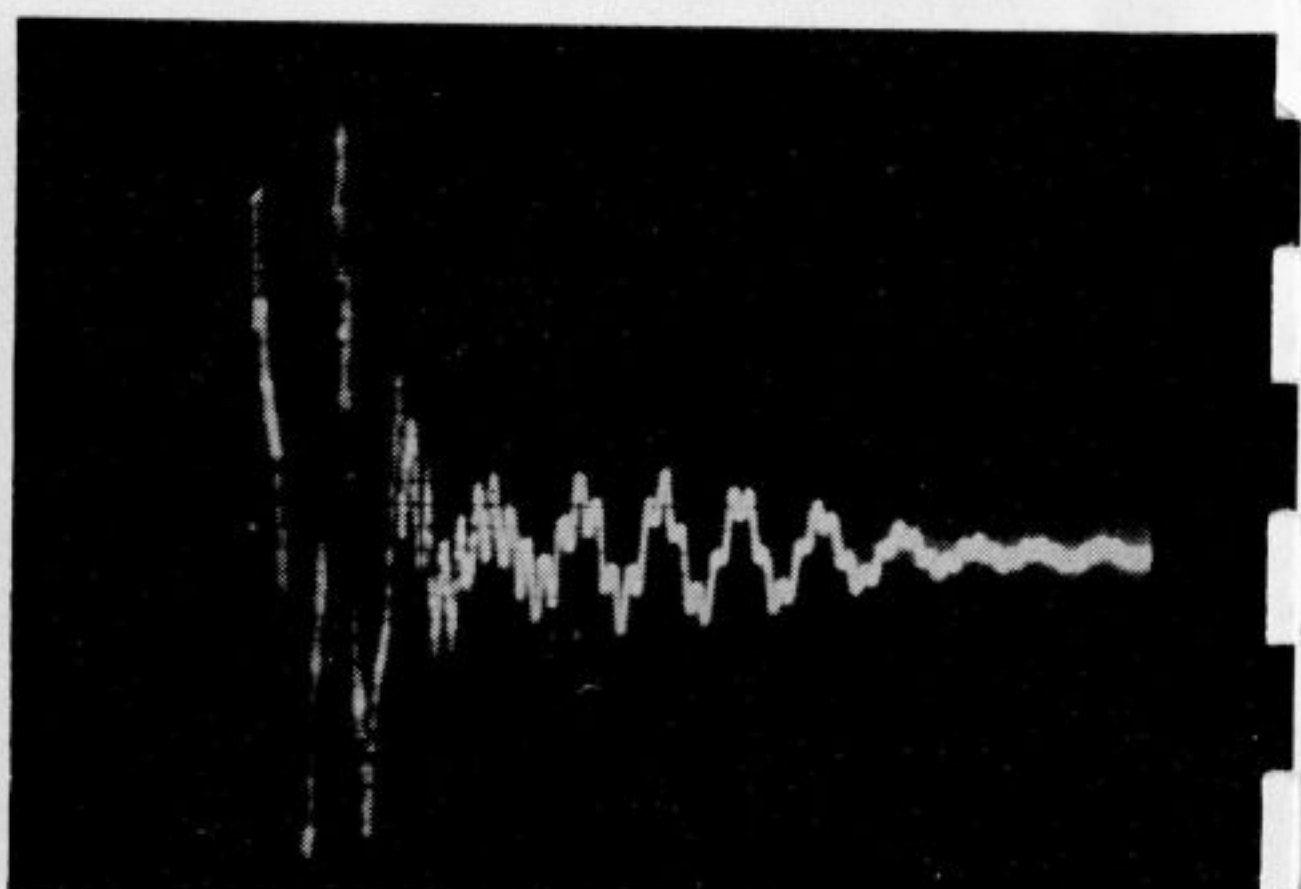

Figure 9. A random vibration displayed on a driven sweep. Note that entire signal is recorded on the trace

### Additional Features

A number of other features have been incorporated in the Type 304-H to enhance the instrument's utility. For example, provision is included for modulating the intensity of the fluorescent trace. By applying an intensity-modulation signal to the Z-axis input terminal on the front panel, markers indicating time, angle, distance, or other quantities may be impressed on the trace as variations in brightness.

Two test signals are provided through front-panel terminals; a sinusoidal voltage at power-line frequency, which is convenient for troubleshooting electronic circuits; and a sawtooth voltage at the frequency of the time-base generator. This sawtooth signal may be used to provide a time base for another oscillograph or to trigger a phenomenon so that it occurs in synchronization with the sweep of the oscillograph. For this purpose, the sawtooth voltage may first be differentiated, in which case, the phenomenon will be triggered during the return time of the trace; or the phenomenon may be arranged to trigger when the sweep voltage raises to a predetermined level, so that the start of the phenomenon is delayed a given time after beginning of the sweep.

A rigidly mounted, engraved, calibrated scale is provided to facilitate making quantitative measurements. Moreover, this scale offers considerable mechanical protection to the face of the cathode-ray tube.

The cathode-ray tube is enclosed in a shield fabricated from Mu-metal, which protects the tube from the effects of external magnetic fields, and the instrument is supplied with a Du Mont Type 2501 Bezel, for the attachment of such convenient accessories as the Du Mont Types 295, 296, 297 or 321 Oscillograph-record Cameras, the Type 276 Viewing Hood, etc.

### Applications

The Type 304-H is extremely well suited for a great number of applications, both in the laboratory and in the field. Bridge measurements, observation of waveforms in electronic circuits, time and amplitude measurements of electrical impulses, studies of light, sound and other physical phenomena, biological studies, and mechanical applications such as studies of vibration, motor-bearing noise, stress and strain, dynamic balance, and camera and synchronizer operation are but a few examples.

The extra-low-frequency sweeps and the d-c

amplifiers of the Type 304-H make the instrument well suited for such applications as studies of variations of pressure or volume plotted as a function of time.

The Type 304-H is useful as an aid in designing electrical equipment. It is important, in such work, that no component be over-rated; otherwise failure may result. Yet it is not desirable to underrate components, as this would add unnecessarily to the size, weight, and cost of the design. The direct-coupled amplifiers of this oscillograph make possible a quick check of the peak voltage across each component, which is especially useful when the voltage is made up of a complex a-c component super-imposed on a d-c voltage.

The high gain of the Y amplifier makes the instrument useful as a low-impedance ammeter for examining complex current waves quantitatively by inserting a series resistor and observing the voltage across the resistor. Since the instrument has 0.028 peak-to-peak volts per inch sensitivity, a 28-ohm resistor will result in a sensitivity of one milliampere per inch on the cathode-ray tube.

A biological application requiring many of the features of the Type 304-H is the observation of nerve potentials. The sawtooth test signal, differentiated, may be used to trigger, or may constitute, the stimulating pulse. And since the nerve is usually stimulated only once every few seconds, a triggered sweep, initiated by an external signal, must be used. Sweeps of 10 seconds or more must be employed if the time required for the nerve to transmit the stimulus is to be observed. Because of the low level of the signals, and the long time duration of the pulse, a high-gain d-c amplifier is required. While the gain of the Type 304-H may not be sufficient for some biological studies, the characteristics of this amplifier greatly simplify the problems of designing a satisfactory preamplifier for such applications.

Every feature of the Type 304-H was selected and designed with versatility as the goal. Each was engineered to complement the others, so that fullest advantage could be taken of all. It is this consistency of design, the result of many months of development, that enables the Type 304-H to enter fields heretofore restricted to far more costly instruments. The Du Mont Type 304-H is truly the most versatile general-purpose oscillograph presently available.

**SPECIFICATIONS**

**CATHODE-RAY TUBE**—Type 5CP-A Cathode-ray Tube operated at an overall accelerating potential of 3000 volts.

**VERTICAL DEFLECTION—Deflection Factor:** through amplifier at full gain, 0.028 peak-to-peak (0.01 rms) volt per inch; Direct, 50 peak-to-peak (18 rms) volts per inch  $\pm 20\%$ . **Sinusoidal frequency response** (For any setting of attenuator and gain controls.): with direct coupling, is down to more than 10% from 0 to 100,000 cps, and with capacitive coupling, response is down not more than 10% at 5 and 100,000 cps, and down not more than 50% at 300,000 cps. **Input Impedance:** to amplifier, 2 megohms, paralleled by 50  $\mu\mu\text{f}$ ; Direct, (unbalanced), 1.5 megohms paralleled by 20  $\mu\mu\text{f}$ ; (balanced) 3 megohms paralleled by 20  $\mu\mu\text{f}$ . **Maximum Allowable Input Potential:** a-c coupling, 1000 volts d-c plus peak a-c; d-c coupling, 1000 volts d-c plus peak a-c on all attenuation ranges except 1:1, where it is 100 volts d-c plus peak a-c.

**HORIZONTAL DEFLECTION—Deflection Factor:** through amplifier at full gain, 0.3 peak-to-peak (0.1 rms) volt per inch; Direct, 59 peak-to-peak (21 rms) volts per inch  $\pm 20\%$ . **Sinusoidal frequency response** (For any setting of attenuator and gain controls.): with direct coupling, is down not more than 10% from 0 to 100,000 cps; and down not more than 50% at 300,000 cps; with capacitive coupling, response is down not more than 10% at 5 and 100,000 cps, and down not more than 50% at 300,000 cps. **Input Impedance:** to amplifier 2 megohms paralleled by 50  $\mu\mu\text{f}$ ; Direct, (balanced); 3 megohms, paralleled by 20  $\mu\mu\text{f}$ ; (unbal-

anced) 1.5 megohm, paralleled by 20  $\mu\mu\text{f}$ . **LINEAR SWEEPS**—Recurrent and driven sweeps variable in frequency from 2 to 30,000 cps. Provision incorporated for sweeps of extra low-frequency by attaching external capacitance to convenient terminals. 0.5 second sweep is secured for each microfarad of external capacitance. Both driven and recurrent sweeps expandable up to 6 times full-screen diameter, with positioning available over entire range. Direction of Sweep is from left to right. Return trace is automatically blanked. Sweep may be synchronized by signal of either polarity.

**INTENSITY MODULATION**—Input impedance to external signals is 0.2 megohm, paralleled by 80  $\mu\mu\text{f}$ . A negative signal of 15 volts peak will blank beam at normal intensity settings.

**MAXIMUM PHOTOGRAPHIC WRITING RATES**—With Type 296, using f/2.8 lens, 0.8 inches/ $\mu\text{sec}$ ; with Types 321 and 295, using f/1.5 lens, 2.8 inches/ $\mu\text{sec}$ .

**TUBE COMPLEMENT**—8—12AU7; 2—6AQ5; 6Q5G; OB2; 2—6J6; 5Y3; 2—2X2A.

**POWER SOURCE**—115 or 230 volts (as specified on order), 50-60 cps. Power consumption, 100 watts; Fuse protection, 1½ amperes (115 volts), ¾ ampere (230 volts).

**PHYSICAL CHARACTERISTICS**—Instrument is housed in metal cabinet, provided with carrying handle. **Overall Dimensions:** height, 13-1/2" (33.6 cm); width, 8-5/8" (21.9 cm); depth, 19" (48.3 cm). **Weight:** 50 lbs. (22.6 kg).

| Catalog No. | Type No. | Description  |
|-------------|----------|--|
| 1490-A      | 304-H    | Cathode-ray Oscilloscope, for 115 volts, 50-60 cycles, with 5CP1-A Cathode-ray Tube. |
| 1493-A      | 304-H    | Same as above, with Type 5CP7-A Cathode-ray Tube.                                    |
| 1494-A      | 304-H    | Same as above, with Type 5CP11-A Cathode-ray Tube.                                   |
| 1495-A      | 304-H    | Cathode-ray Oscilloscope, for 230 volts, 50-60 cycles, with 5CP1-A Cathode-ray Tube. |
| 1498-A      | 304-H    | Same as above, with Type 5CP7-A Cathode-ray Tube.                                    |
| 1499-A      | 304-H    | Same as above, with Type 5CP11-A Cathode-ray Tube.                                   |

**TYPE 304-HR  
CATHODE-RAY OSCILLOGRAPH**

The Du Mont Type 304-HR differs from the Type 304-H only in that the Type 304-HR is intended for mounting in a standard 19-inch relay rack. Dimensions of the Type 304-HR are: Height, 8-3/4 inches; width, 19 inches;

depth, 19-1/2 inches. Electrically, the Type 304-HR is identical to the Type 304-H, and performance specifications for the Type 304-HR are the same as those published for the Type 304-H.

| Catalog No. | Type No. | Description   |
|-------------|----------|---|
| 1567-E      | 304-HR   | Cathode-ray Oscilloscope for 115 volts, 50-60 cycles, with 5CP1-A Cathode-ray Tube. |
| 1570-E      | 304-HR   | Same as above, with 5CP7-A Cathode-ray Tube.  |
| 1571-E      | 304-HR   | Same as above, with 5CP11-A Cathode-ray Tube.                                       |
| 1572-E      | 304-HR   | Cathode-ray Oscilloscope for 230 volts, 50-60 cycles, with 5CP1-A Cathode-ray Tube. |
| 1575-E      | 304-HR   | Same as above, with 5CP7-A Cathode-ray Tube.  |
| 1576-E      | 304-HR   | Same as above, with 5CP11-A Cathode-ray Tube.                                       |

DU MONT  
SPECIAL  
PROJECTS

*HIT NEHER* 

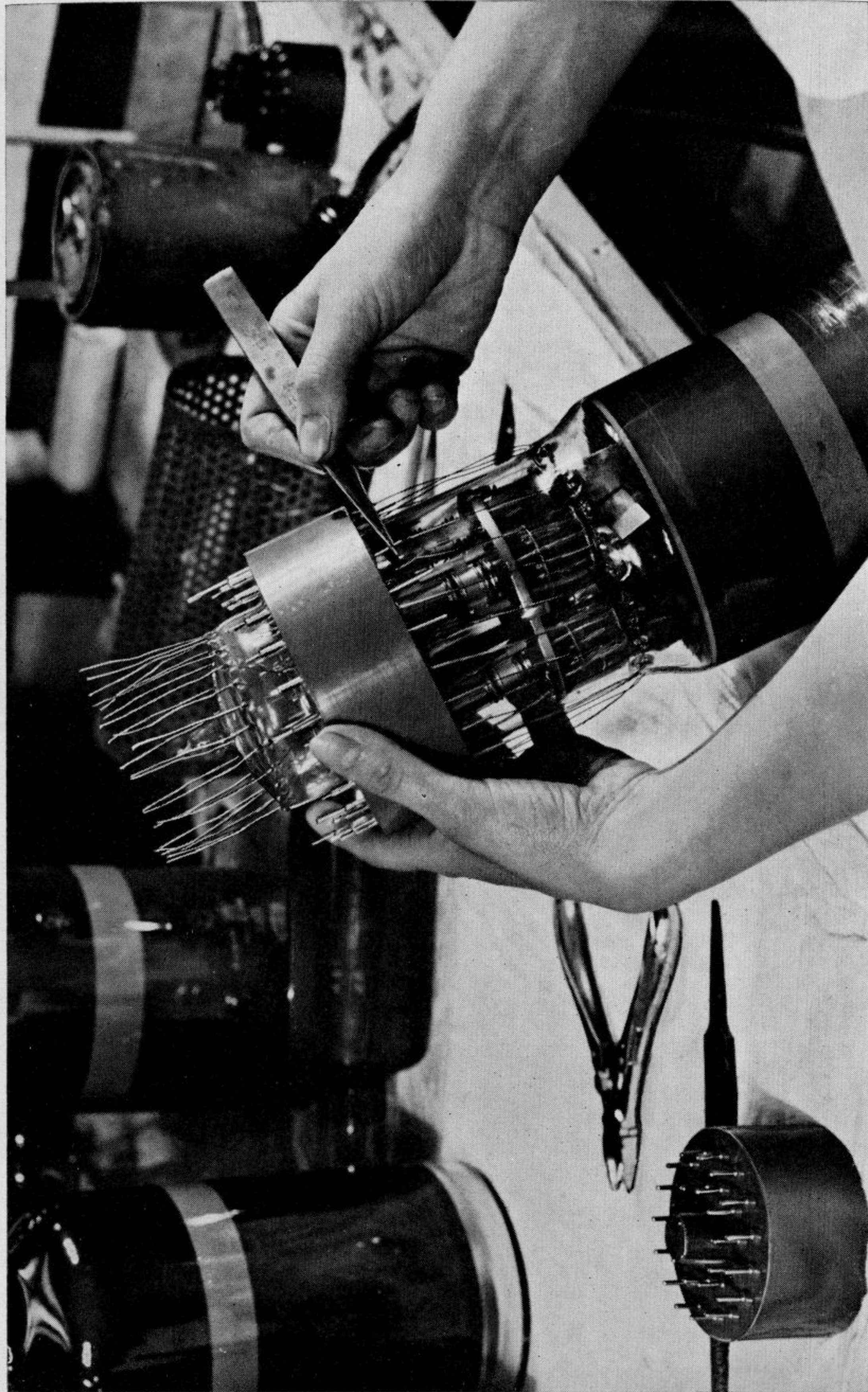

Applying the base to a 5-gun cathode-ray tube, one of the many special-purpose tubes produced by Allen B. Du Mont Laboratories, Inc.

## SPECIAL PROJECTS SECTION

The complete line of Du Mont cathode-ray equipment has been carefully designed to serve over as broad a range of applications as possible. However, occasionally there arises an application so highly specialized that no commercially available instrument can meet its requirements. In such instances, the Special Projects Section of the Instrument Engineering Department (Instrument Division) will modify existing equipment or design wholly new equipment.

### Special Four-Channel Cathode-ray Oscilloscope

Typical of the many instruments designed, developed, and manufactured by the Special Projects Section is a new four-channel cathode-ray oscilloscope which is capable of displaying four related or unrelated phenomena on a single screen.

The four vertical channels are equipped with identical, direct-coupled amplifiers having a bandwidth extending from dc to 200 kc. Each vertical amplifier has a sensitivity of better than 28 d-c millivolts for one inch of deflection.

A common sweep circuit provides driven or recurrent sweeps, variable in duration from 10 seconds to 10 microseconds, to the four chan-

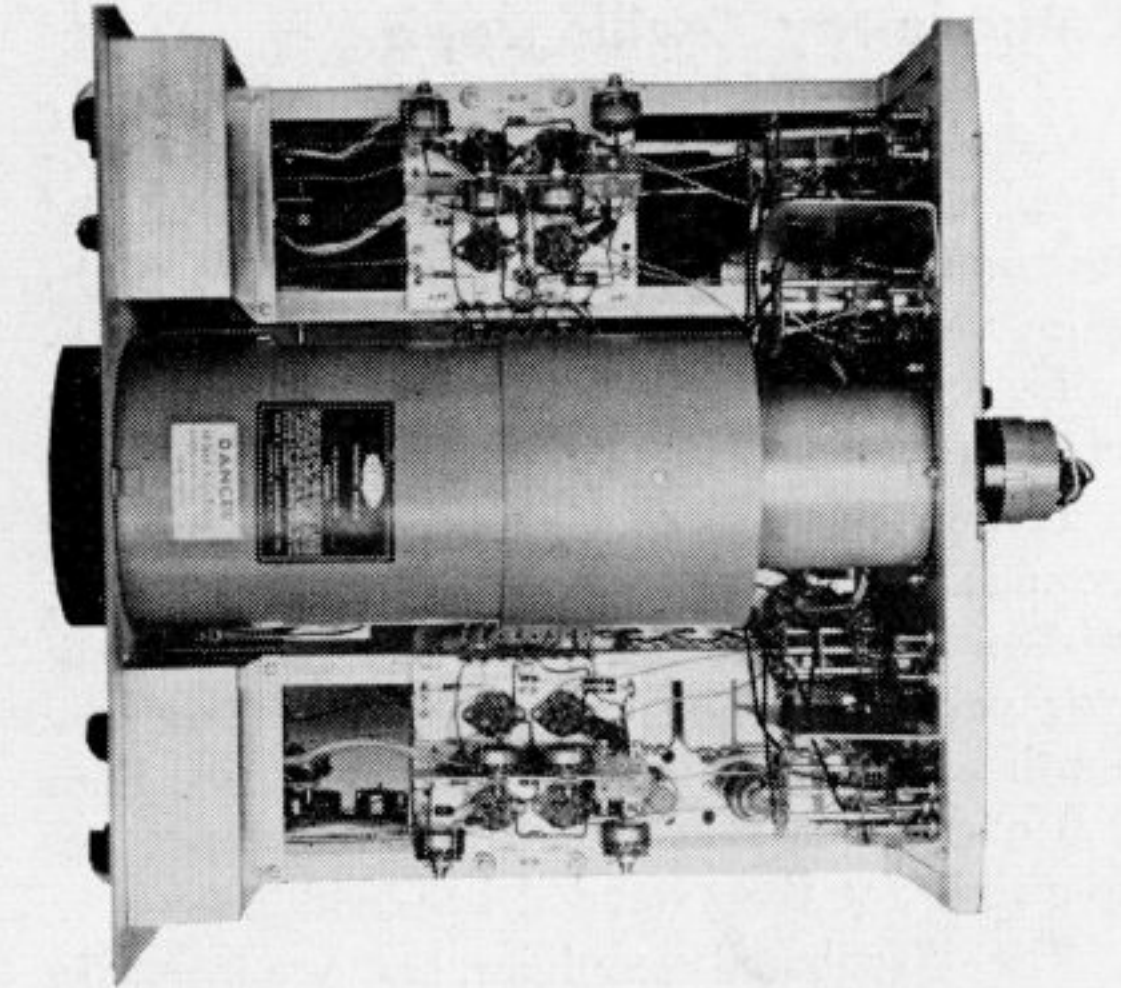

Figure 1. Top view of special four-channel oscilloscope, with cabinet removed

nels. Z-axis blanking circuits are incorporated into each channel. The instrument is also equipped with a voltage calibrator, whose output may be applied to any of the four vertical channels. A common power supply provides for all of the power requirements of the instrument. This special instrument is housed in a cabinet which is 17" high, by 20" wide, by 22 1/4" deep. A standard 19" rack panel is employed.

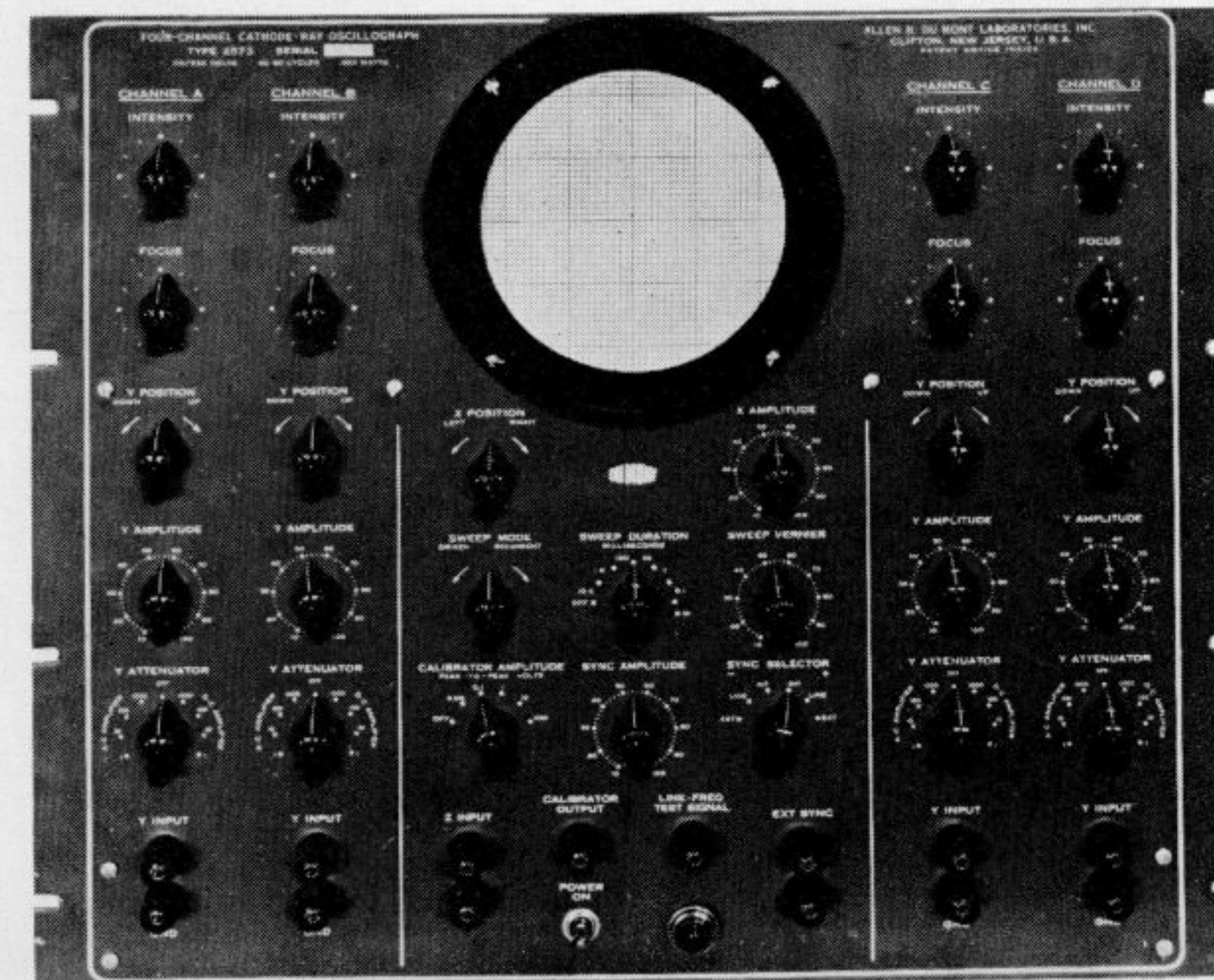

Figure 2. Front-panel view of the special four-channel cathode-ray oscilloscope. Note the convenient grouping of controls for all channels. This oscilloscope is typical of the instruments designed by the Special Projects Section

**Special Wide-band  
Cathode-ray Oscillograph**

Another example of the instruments produced by the Special Projects Section of the Instrument Engineering Department is a high-gain, wide-band oscillograph intended specifically for the detailed analysis of extremely high-frequency phenomena.

Frequency response of this special instrument extends from 1000 cps to over 150 megacycles, with a deflection factor of 0.1 peak-to-peak volt per inch. The overall rise time of the amplifier is 0.004 microsecond, with less than 2% overshoot. Distributed amplification is responsible for the extended bandwidth.

The distributed amplifier, as employed in this special oscillograph, comprises a combination of single-ended stages, a phase inverter, and a push-pull output stage, which applies balanced deflection signals to the Type 5XP-Cathode-ray Tube. The deflection amplifier employs a total of 58 vacuum tubes.

The amplifier delivers a balanced output voltage equivalent to one inch of undistorted deflection for unidirectional signals of either polarity or two inches of deflection for symmetrical signals. For this condition the Type 5XP-Cathode-ray Tube is operated with ac-

celerating potentials of 4 and 16 kv applied to the second and third anode respectively.

Over a length of 4-inches, driven-sweep durations are continuously variable from 0.01 second to 1 microsecond and in steps of approximately 3 to 1 from 1 microsecond to 0.01 microsecond. A continuously variable sweep delay, on any sweep range, of 0 to 100 microseconds is provided. This delay occurs with respect to a reference trigger generated within the instrument or to an external trigger. Accuracy of the delay is 1% of full scale.

With less than one microsecond delay, jitter does not exceed 0.0001 microsecond; with more than one microsecond delay, jitter does not exceed 0.005 microsecond.

\* \* \*

These instruments serve merely to illustrate the facilities of the Special Projects Section. The engineering staff of the Special Projects Section stands ready at all times to lend its skill and experience to the solution of highly specialized oscillographic problems. Inquiries concerning the Special Projects Section should be addressed to the Instrument Division, Allen B. Du Mont Laboratories, Inc., 1000 Main Avenue, Clifton, New Jersey.

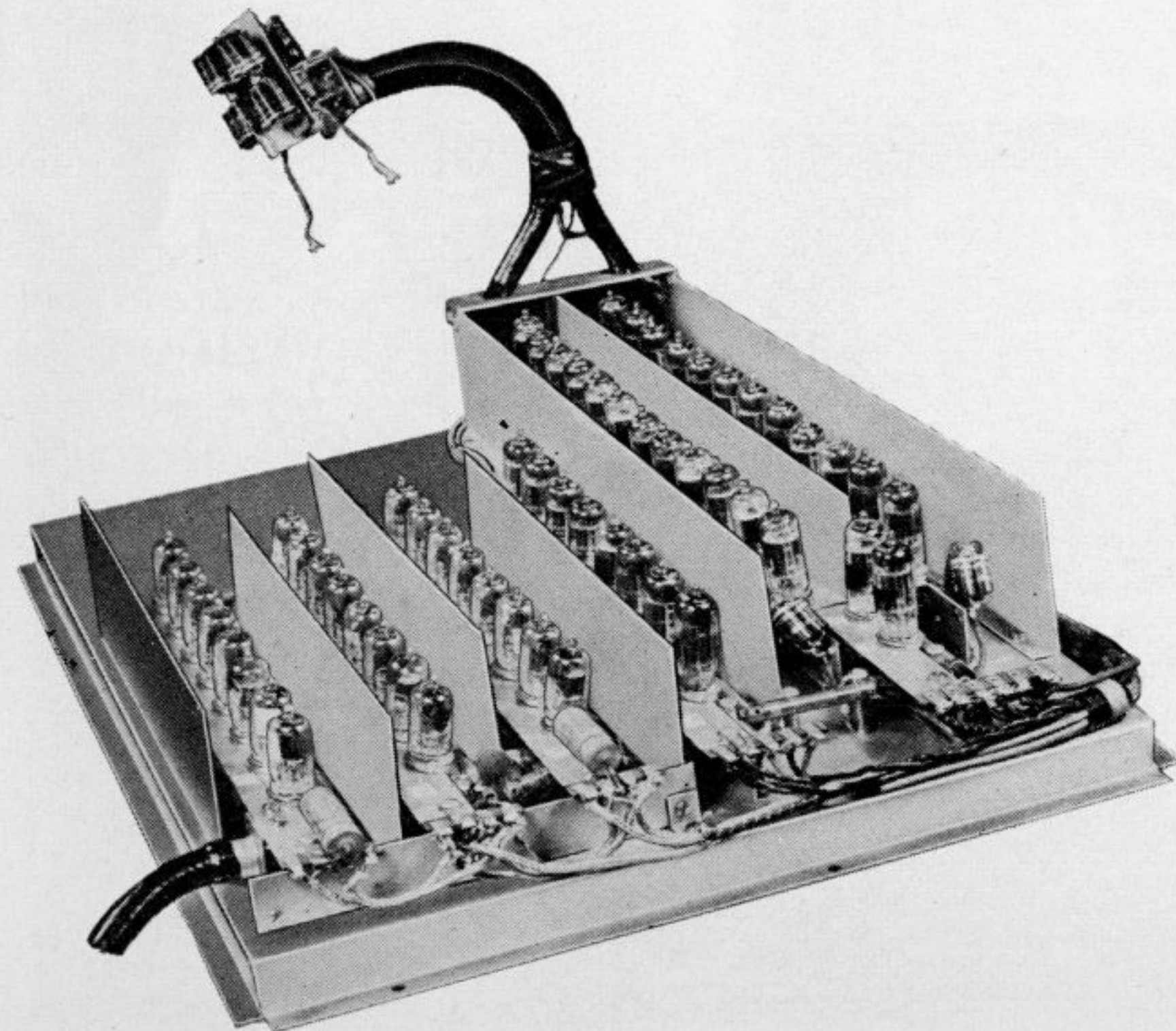

*Figure 3. A distributed amplifier of the type employed in the special wide-band cathode-ray oscillograph. Overall rise time of the amplifier is 0.004  $\mu$ sec with less than 2% overshoot. This amplifier provides a deflection factor of 0.1 p-p volt per inch with the Type 5XP-Cathode-ray Tube operated with 16,000-volt acceleration*

**DU MONT**  
AUXILIARY  
INSTRUMENTS

# TYPE 185-A ELECTRONIC SWITCH

## FUNCTION

The Type 185-A Electronic Switch is a portable instrument which makes possible simultaneous observation of two recurrent patterns on the screen of a single cathode-ray oscillograph. The relative positions may be varied so that the patterns are superimposed or else separated from each other by a desired amount. Direct comparison of amplitudes, waveforms, frequency, and phase relationships is thereby readily accomplished. Two Type 185-A's operated in tandem permit three patterns to be viewed simultaneously; three Type 185-A's may be connected so that four separate patterns can be seen. The latter arrangement is particularly useful for investigation of polyphase power systems and equipment.

There are direct-coupled amplifiers in the Type 185-A which are alternately operative and inoperative at a rate determined by the switching frequency. The instrument is therefore effective for "chopping" a d-c signal, making it suitable for transmission through the a-c amplifiers which are generally found in

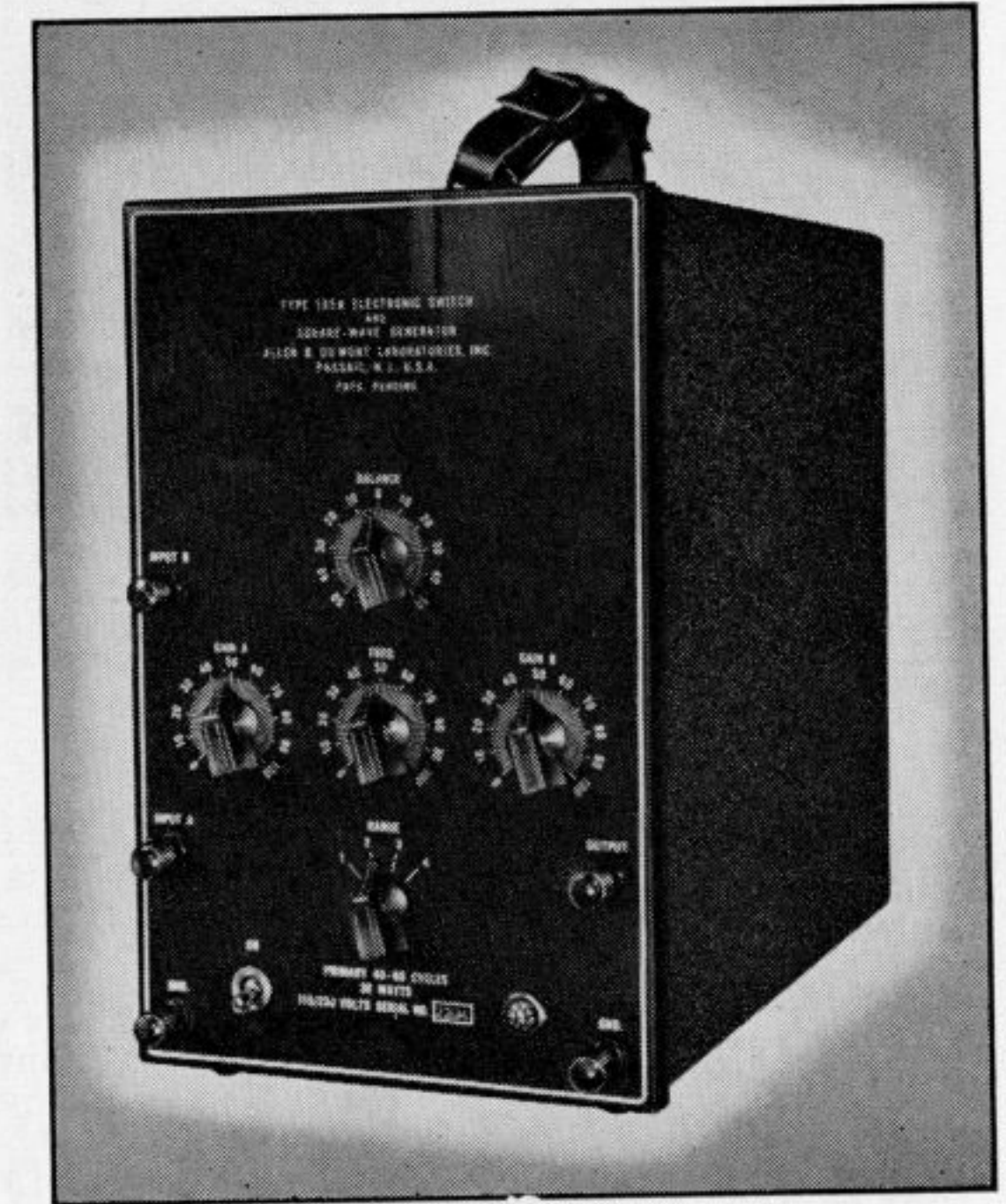

cathode-ray oscillographs. When the output of the Type 185-A is connected to an oscillograph, one channel may be used to establish a reference level while the other channel carries the d-c signal to be investigated. Qualitative as well as quantitative information concerning the d-c signal may be obtained in this manner.

## DESCRIPTION

The two signals to be investigated are connected to separate vacuum-tube amplifiers through the input terminals of the Type 185-A; a multivibrator circuit in the instrument generates a square-wave voltage which alternately blocks these amplifiers. The amplifier output circuits are connected so that the output of the Type 185-A is composed of first one signal and then the other; the rate of switching from one to the other is variable by means of front panel controls. This rate is sufficiently rapid that (1) the combined output may be connected to the amplifier of a cathode-ray oscillograph, and (2) the two signals appear simultaneously on the screen of the cathode-ray tube.

Frequency response characteristics of the signal amplifiers in the Type 185-A are adequate to allow satisfactory operation of instruments in tandem, thus providing additional channels for signal amplification.

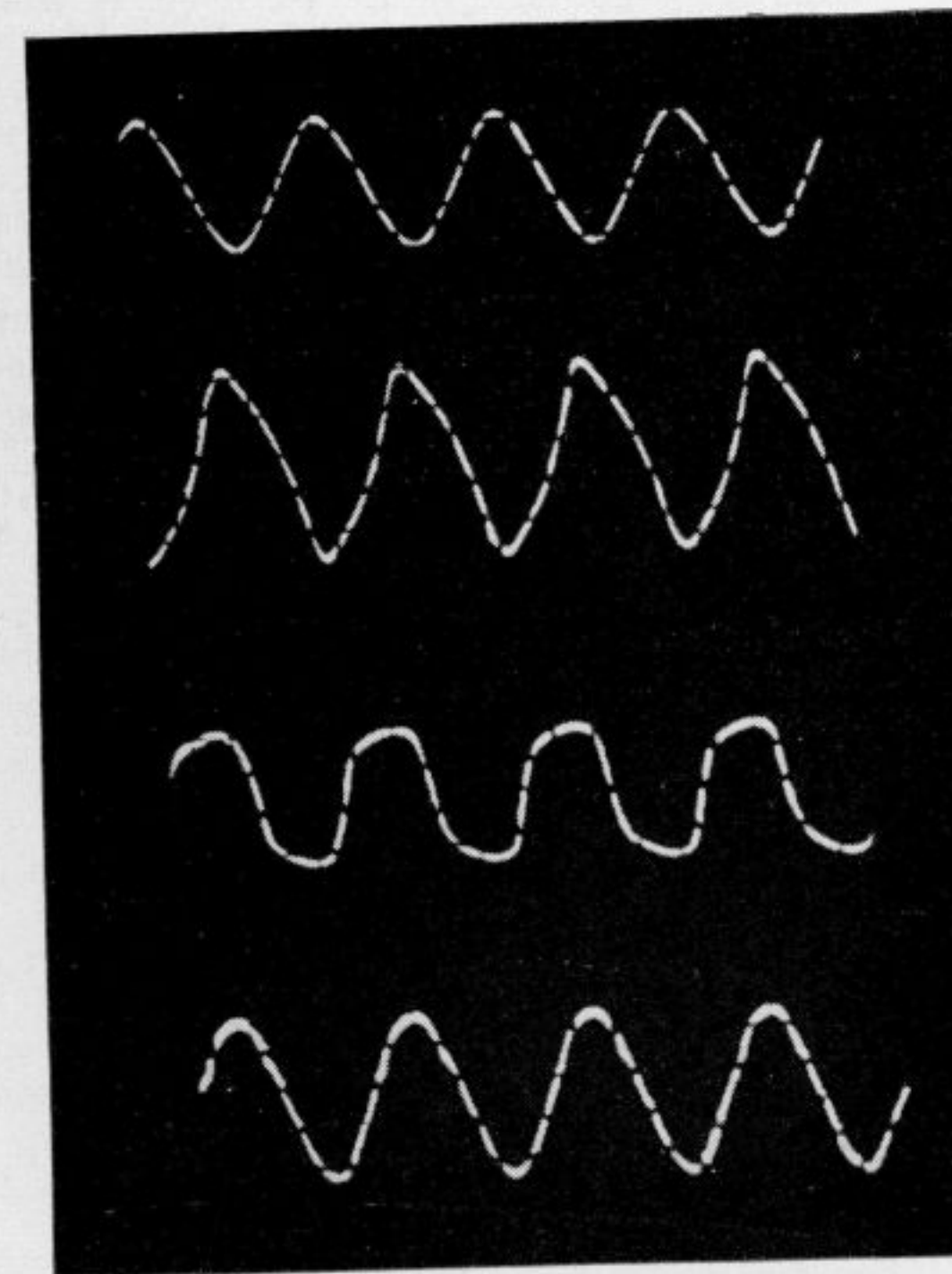

Figure 1. Four patterns, current and voltage input and output, of a voltage regulator, displayed simultaneously on a Du Mont Type 279 operating in conjunction with two Type 185-A electronic switches

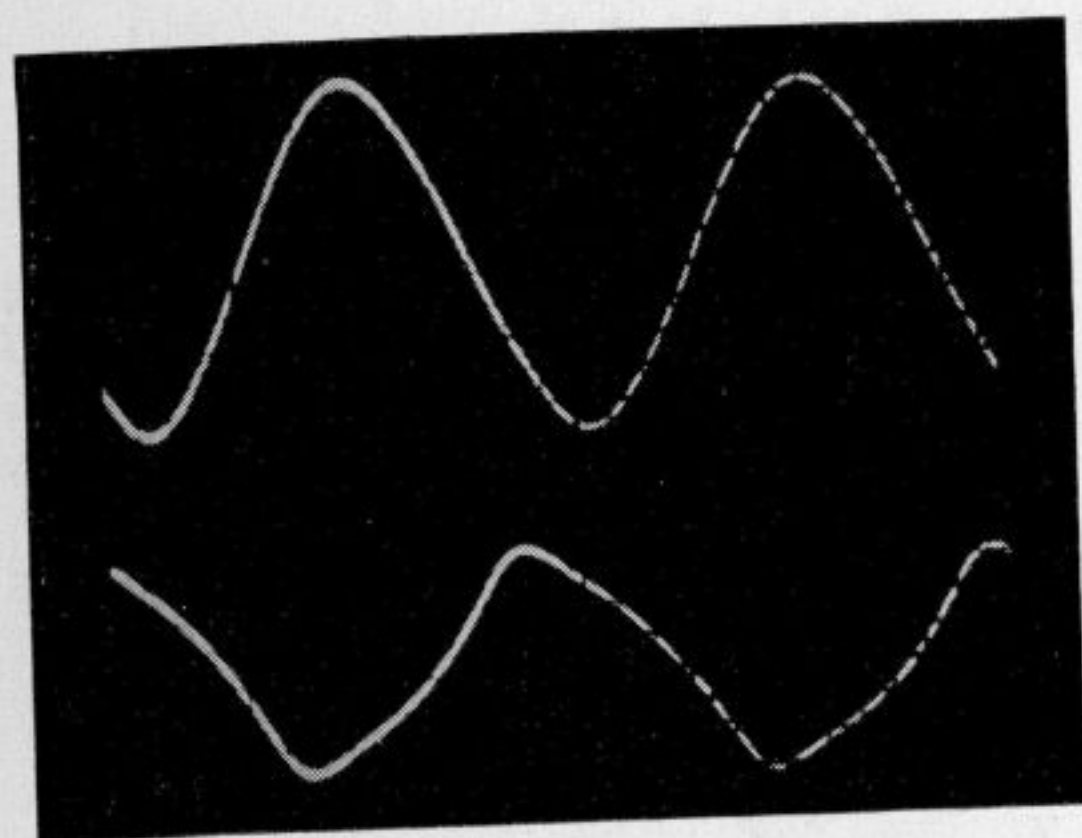

Figure 2. The two traces may be separated by adjusting the balance control to facilitate the detailed study of each

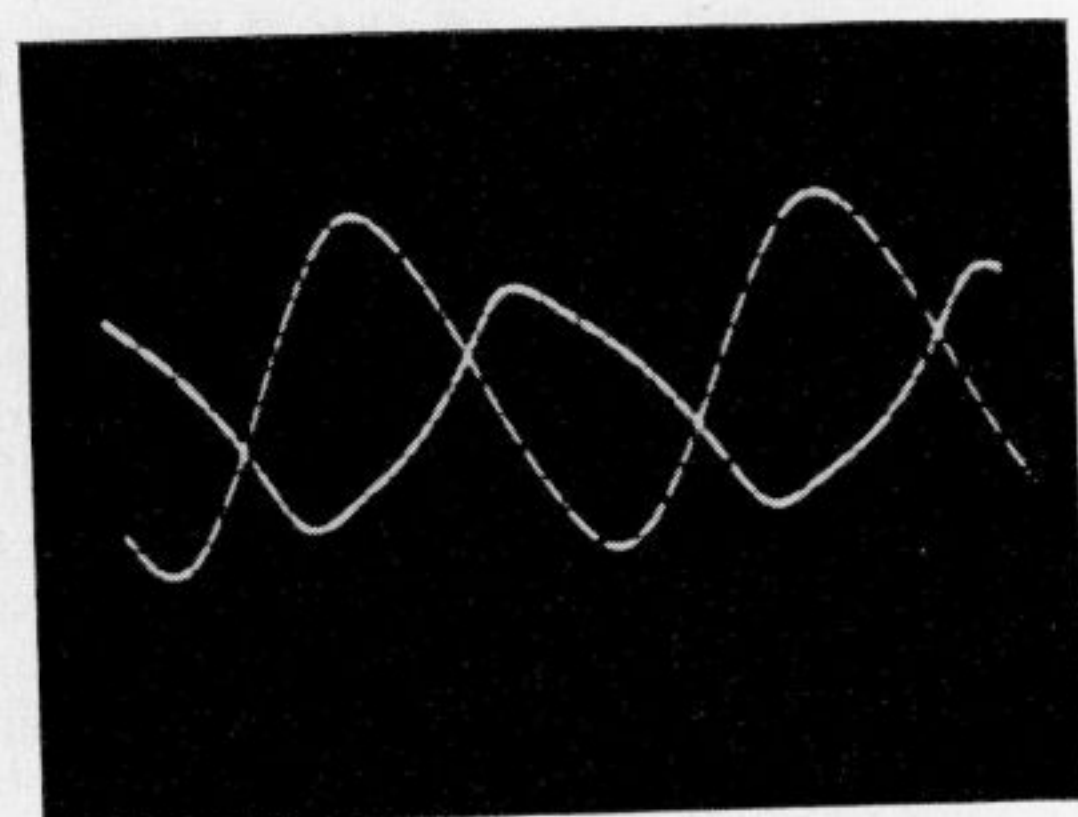

Figure 3. Direct comparison of the two signals is possible by superimposing them on the screen of the oscillograph

### SPECIFICATIONS

**SWITCHING RATE**—Continuously variable, 10 to 2000 times per second.

**SIGNAL AMPLIFIERS**—**Sinusoidal frequency response:** at full gain, uniform from d-c (zero frequency) to 5000 cycles per second; down not more than 25% at 25,000 cycles per second. **Maximum gain:** 10 times. Continuously variable attenuator with negligible phase distortion to 25,000 cycles per second. **Input impedance:** 100,000 ohms. Maximum input at greatest attenuation 425 peak-to-peak (150 rms) volts; with no attenuation, 7.1 peak-to-peak (2.5 rms) volts at balance, and 4.2 peak-to-peak (1.5 rms) volts at maximum unbalance. **Output impedance:** 50,000 ohms. Maximum signal output at balance, 75 volts peak-to-peak. Voltage gain between output terminals and deflection plates of cathode-ray tube should not exceed 5 times. **Maximum Allowable Input Potential:** 200 volts d-c plus peak a-c.

**SQUARE-WAVE GENERATOR**—Frequency continuously variable, 10 to 2000 cycles per second. Rise time of square-wave, 25 microseconds at 500 cycles. Maximum square-wave, output, 30 volts peak-to-peak.

**POWER SOURCE**—Type 185-A is available for operation from either 115- or 230-volt power, whichever is specified. May be changed from one to the other by changing connections to primary of power transformer. Power-line frequency, 40-60 cycles, power consumption, 30 watts; fuse protection, 1 ampere.

**TUBE COMPLEMENT**—2—6J5; 2—6V6; 2—6SJ7; 80.

**PHYSICAL CHARACTERISTICS**—Instrument housed in metal cabinet provided with carrying handle. **Overall Dimensions:** height, 11-3/4" (29.9 cm); width, 7-3/8" (18.7 cm); depth, 13" (33 cm). **Weight:** 17 lbs. (7.7 kg).

| Catalog No. | Type No. | Description                              |
|-------------|----------|--|
| 1072-A      | 185-A    | Electronic Switch; 115 v., 40-60 cycles. |
| 1073-A      | 185-A    | Same as above, for 230 volts.            |

## TYPE 263-B HIGH-VOLTAGE POWER SUPPLY

- Output variable from 6000 to 12,000 volts
- Direct-reading output meter
- No danger of serious injury from high-voltage shock
- No damage from accidental short circuits
- Shielded output circuit

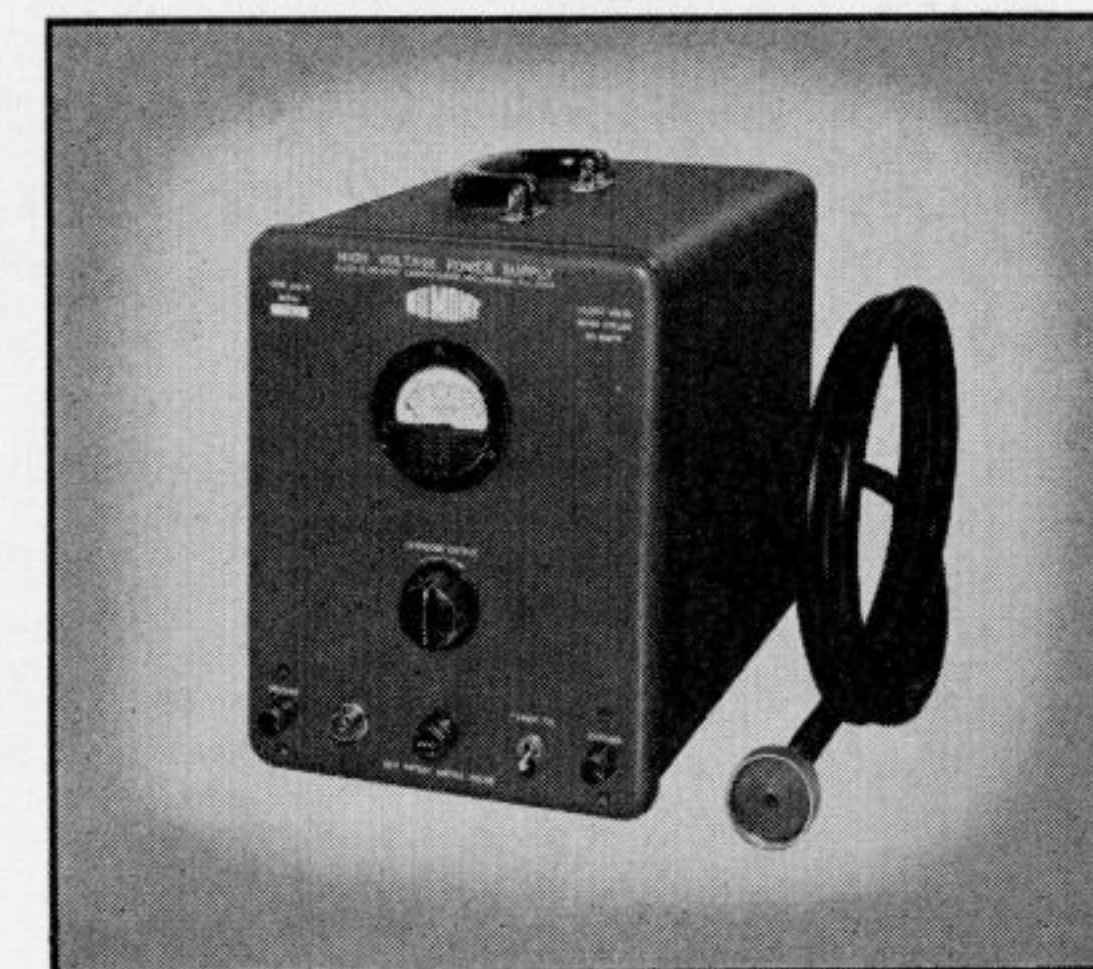

### FUNCTION

The Type 263-B is a rectified r-f-type, high-voltage power supply which is intended primarily as a source of additional intensifier potential for cathode-ray oscillographs, although it may be used almost anywhere to furnish high potentials at low currents. Connecting the output of Type 263-B to the intensifier electrode of the cathode-ray tube provides a greater overall accelerating potential than is normally furnished by the power supply in an oscillograph. This makes possible a considerable increase in light output from the fluorescent screen. This light output is a primary requirement where the oscillograph is to be employed in the investigation of high-speed transients or pulses having very low repetition rates, especially when photographic recordings are to be made or the fluorescent trace is to be projected.

In ordinary cathode-ray tubes, unfortunately, intensifier potential cannot be increased much above twice the second anode voltage without introducing serious distortions in deflection characteristics. For this reason Du Mont has developed the Types 5RP-A, and 5XP- series of cathode-ray tubes which are so designed that the intensifier may be operated at a potential as high as 10 times that of the accelerator.

Oscillographs such as the Type 250-AH, which utilize high-voltage cathode-ray tubes, may also employ the Type 263-B High-voltage Power Supply as an external source of intensifier potential.

A great advantage of an r-f-type high-volt-

age supply is its small size and lighter weight, as compared with other types of supplies of similar output. This reduction in weight and size is the result of the smaller and simpler filter circuits that are possible with high-frequency currents, as well as the lighter high-voltage transformer whose core is air, rather than iron. Another advantage of the r-f supply lies in the fact that (since very little power

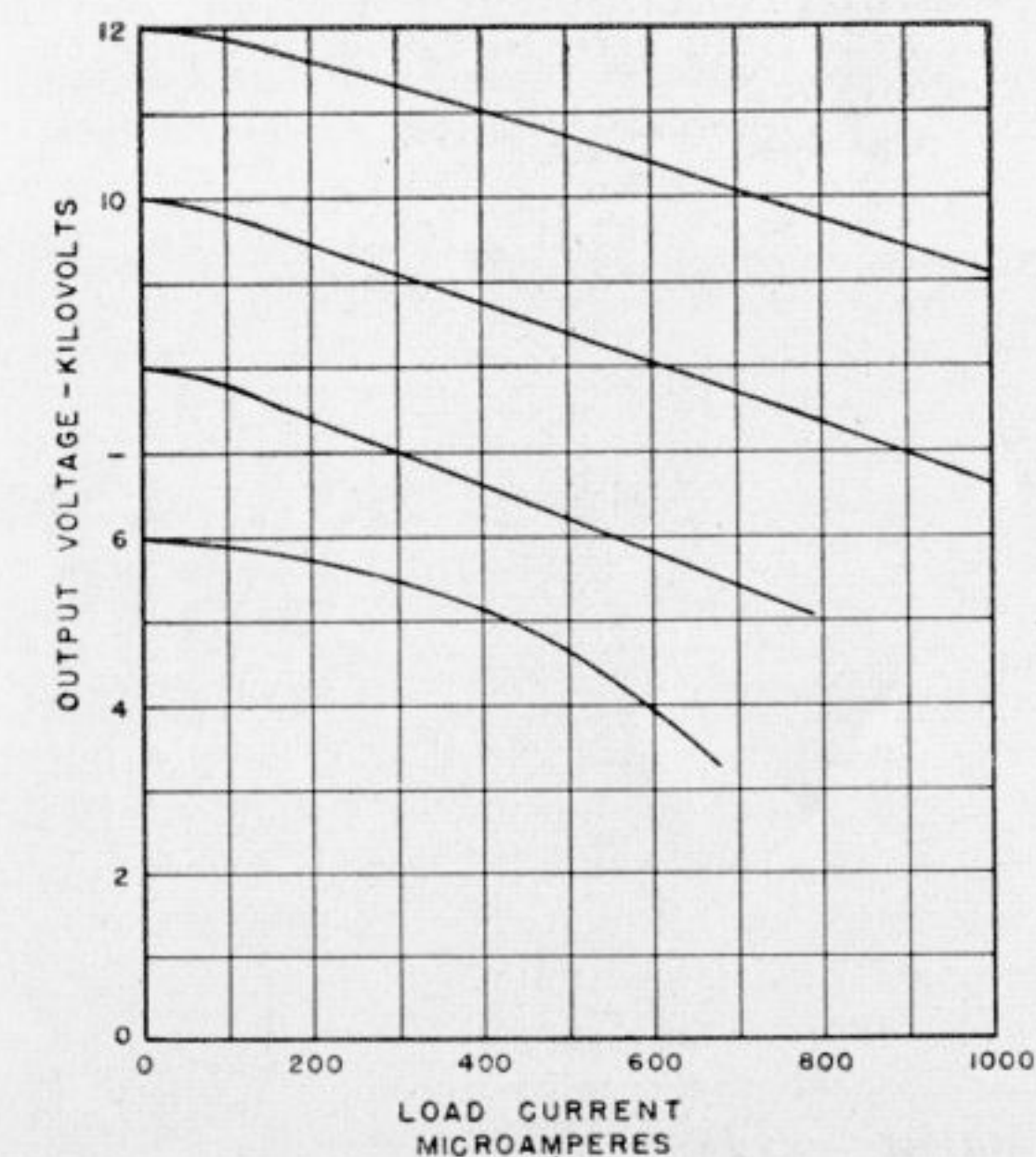

Figure 1. Output potential versus load current in The Type 263-B High-voltage Power Supply

is stored in the filter circuits and since touching a high-voltage point reduces the feedback to oscillator, immediately lowering the output) there is virtually no danger of injury from shock. Similarly, no damage will result if the output is accidentally shorted.

**DESCRIPTION**

The Type 263-B provides a positive d-c potential output which may be varied by means of a control on the front panel from 6000 to 12,000 volts; it will furnish currents up to 200 microamperes, or up to 1 milliampere at somewhat reduced total voltage values. The high voltage is obtained by rectification and filtering of the output from an r-f oscillator.

A direct-reading meter on the front panel indicates the output potential. A six-foot length of shielded cable and connector are provided for attachment to the output connector at the back of the Type 263-B.

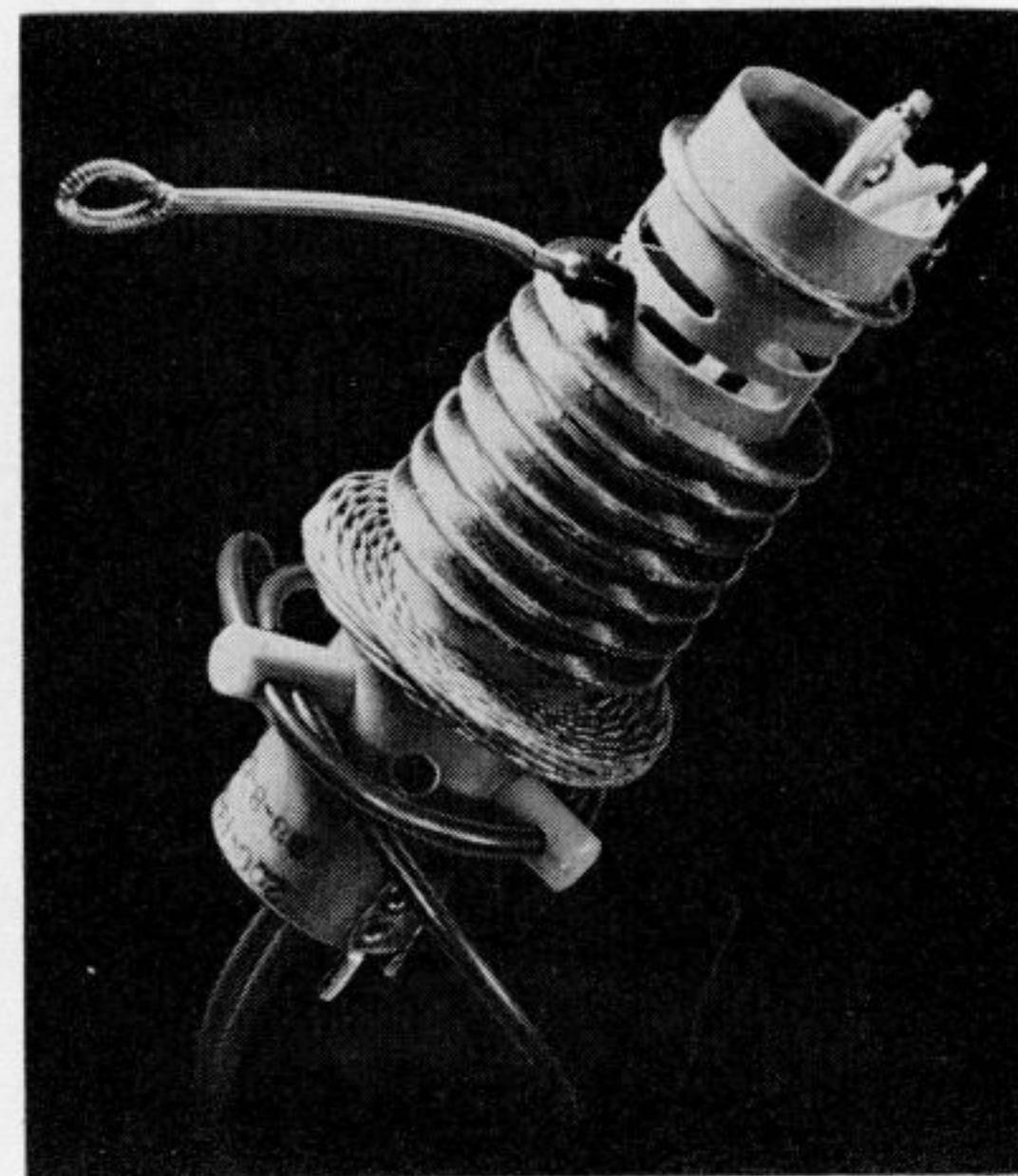

Figure 2. The r-f transformer of the Type 263-B High-Voltage Power Supply

**SPECIFICATIONS**

**VOLTAGE OUTPUT**—Potential is variable from 6000 to 12,000 volts, positive with respect to ground. Negative terminal is connected to chassis. Output may be shorted without causing damage.

**CURRENT OUTPUT**—Up to 200 microamperes are delivered at potentials from 6000 to 12,000 volts. Currents to 1 milliampere are available at somewhat lower total voltage values (see Figure 1 on page 59).

**REGULATION**—Output varies not more than 20% from zero to 200 microamperes external load.

**TUBE COMPLEMENT**—5U4G; 6L6; 1B3.

**POWER SOURCE**—Type 263-B is designed to operate from a 115-volt or 230-volt 50-60-cycle power line.

**POWER CONSUMPTION**—85 watts.

**PHYSICAL CHARACTERISTICS**—Instrument housed in metal cabinet provided with carrying handle. **Overall Dimensions:** height, 10-7/8" (27.4 cm); width, 8-1/8" (20.2 cm); depth, 14-3/4" (37.4 cm). **Weight:** 24 lbs. (10.8 kg).

| Catalog No. | Type No. | Description  |
|-------------|----------|--|
| 1208-E      | 263-B    | High-voltage Power Supply for 115 volts, 50-60 cycles. |
| 1209-E      | 263-B    | Same as above, for 230 volts, 50-60 cycles.            |

**TYPE 308-A HIGH-VOLTAGE POWER SUPPLY**

The Type 308-A is electrically similar to the Type 263-B High-voltage Power Supply but it is designed for mounting in a standard 19" relay-rack. The ventilated metal cover prevents radiation from interfering with the performance of adjacent units.

The high-voltage output is available at a connector on the rear of the chassis where it

is out of the way of all panel controls. A six-foot length of shielded output cable and connector are furnished with the instrument.

Overall dimensions of the Type 308-A are height, 10-1/2" (26.7 cm.); width, 19" (48.3 cm.); depth, 14-3/4" (20.2 cm.). Weight is 18 lbs. (8.1 kg.).

| Catalog No. | Type No. | Description   |
|-------------|----------|---|
| 1433-E      | 308-A    | High-voltage Power Supply for 115 volts, 50-60 cycle operation. |
| 1434-E      | 308-A    | Same as above, for 230 volts, 56-60 cycles.                     |

**TYPE 264-B VOLTAGE CALIBRATOR**



**FUNCTION**

The Type 264-B Voltage Calibrator is a simple, inexpensive instrument which can be used in conjunction with any cathode-ray oscillograph, and is small enough to fit on top of most. It provides a convenient method (1) for measuring the amplitude of a signal which is applied to the oscillograph, or (2) for determining deflection factor of the oscillograph at any given setting of amplifier gain controls.

**DESCRIPTION**

Output of the Calibrator is a square-wave signal the amplitude of which is variable from 0 to 100 volts peak-to-peak. Amplitude of the square-wave may be read directly from a calibrated dial and multiplier switch.

When the Type 264-B is used with a cathode-ray oscillograph, the signal to be investigated is connected to its input terminals, while

- Direct means for calibrating any cathode-ray oscillograph or measuring amplitude of any applied signal
- Not necessary to disconnect input to oscillograph while calibration is made
- Small size, simple operation

its output terminals are connected to the input of the oscillograph. The multiplier switch on the Calibrator selects either the signal or square-wave voltage for application to the oscillograph. No leads need be disconnected or re-connected during calibration.

To measure the amplitude of the signal, it is necessary only to (1) apply that signal to the oscillograph, (2) note the deflection which it produces on the screen, (3) apply Calibrator output to oscillograph without disturbing oscillograph controls, (4) adjust Calibrator square-wave amplitude to produce same deflection as signal, (5) read amplitude of square-wave from dial and multiplier on Calibrator panel. (6) This amplitude is the peak-to-peak signal amplitude.

To determine the deflection factor of an oscillograph, (1) set the oscillograph gain and attenuation controls at some position, (2) ap-

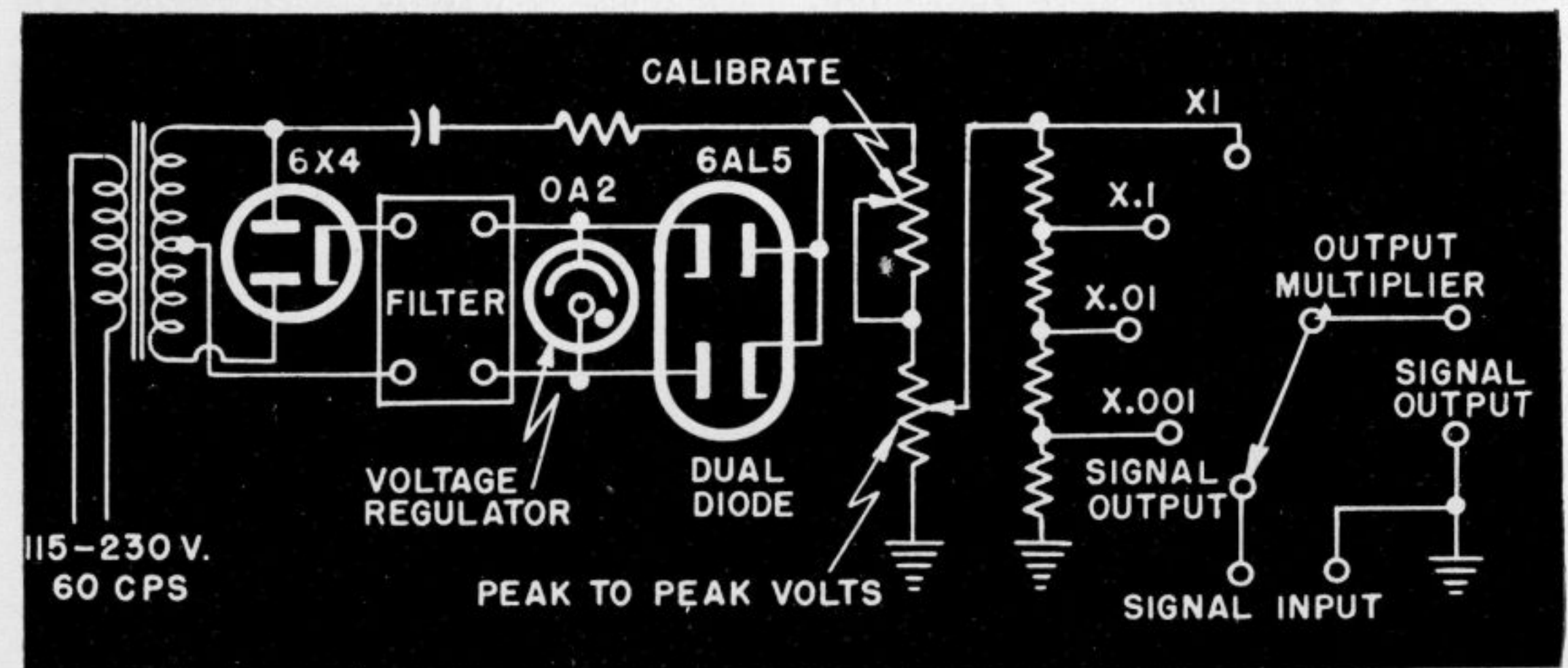

Figure 1. Simplified schematic circuit diagram for the Type 264-B voltage calibrator



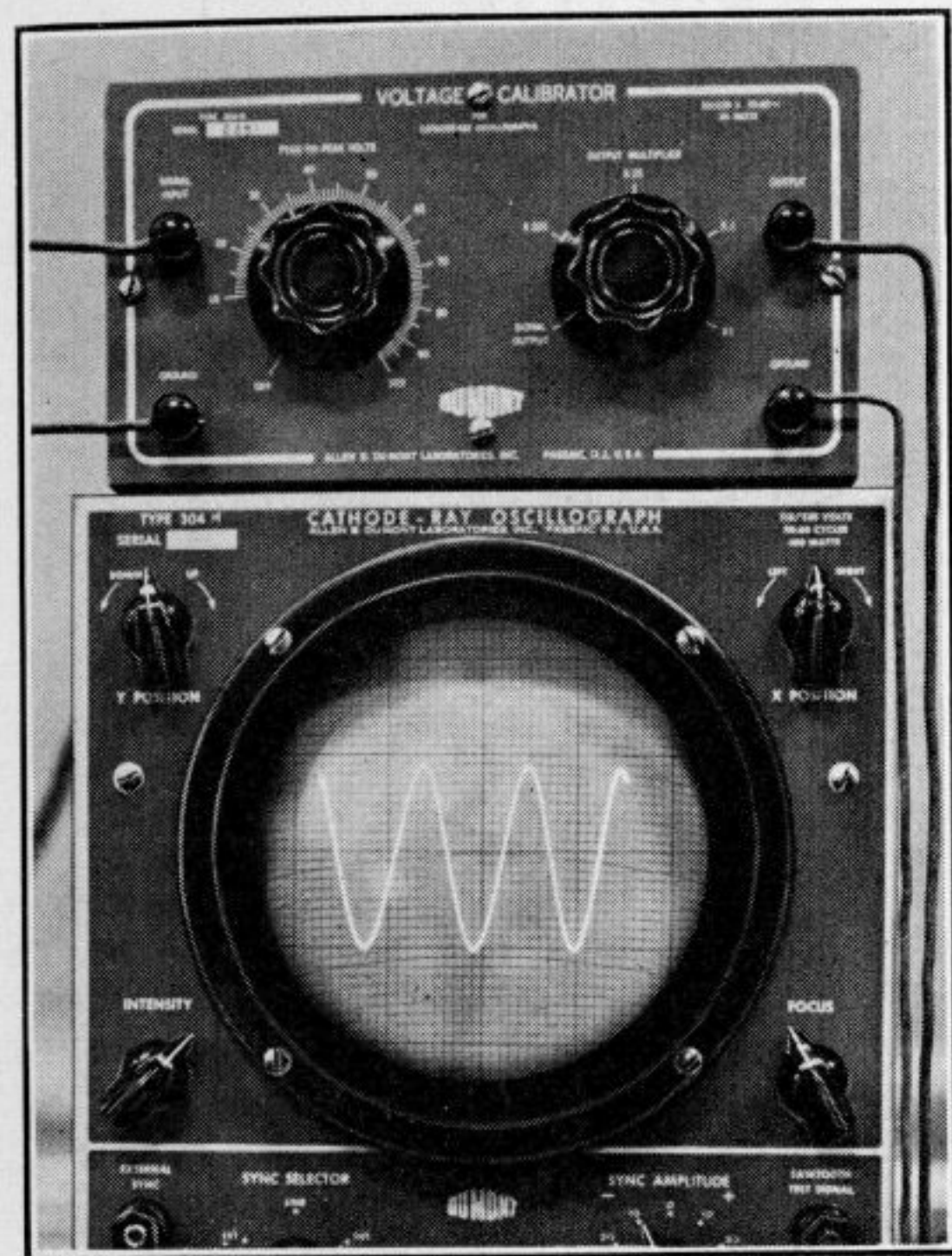

Figure 2. Signal voltage is passed through the Voltage Calibrator to the Vertical Input of the Cathode-ray Oscilloscope. The signal voltage appears on the screen

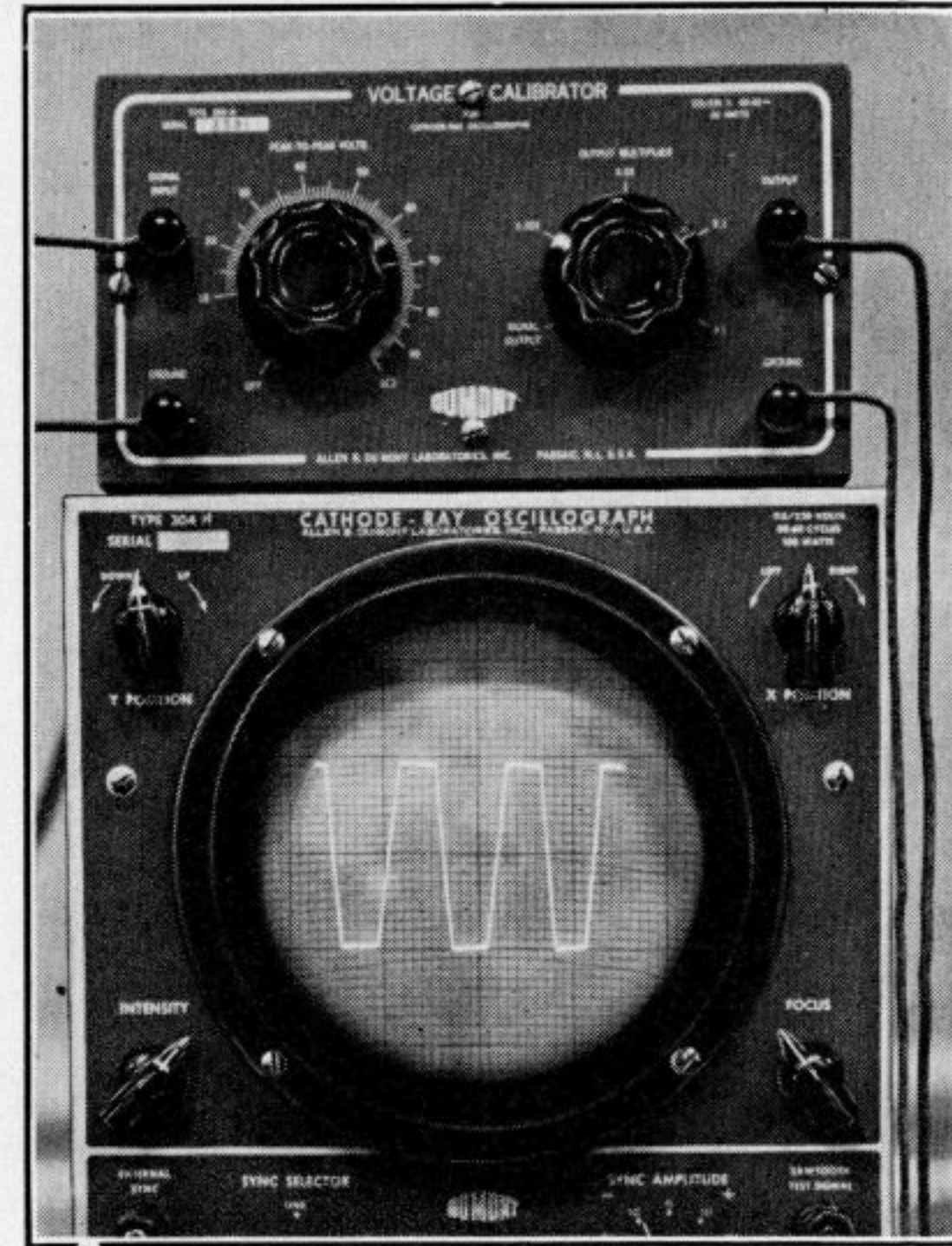

Figure 3. Same as Figure 2 except that the OUTPUT MULTIPLIER switch has been turned to the X.1 Position resulting in the calibration voltage appearing on the screen

ply the Calibrator output and note deflection which it produces. Deflection Factor is the quotient of the Calibrator square-wave amplitude

divided by the number of inches deflection produced, and is expressed in peak-to-peak volts per inch.

**SPECIFICATIONS**

**ELECTRICAL CHARACTERISTICS**—Output square-wave at power-line frequency, with full-scale readings of 0.1 volt, 1 volt, 10 volts, or 100 volts. Amplitudes are variable from zero on each scale. Accuracy of output dial reading  $\pm 5\%$  of full scale on each range (including power-line voltage variations of  $\pm 10\%$ ). Input impedance to signal, 20  $\mu\text{f}$ .

signed to operate from either 115- or 230-volt power line at 50-60 cycles. Power consumption, 20 watts; fuse protection, 1/2 ampere (115 volts), 1/4 ampere (230 volts).

**TUBE COMPLEMENT**—6X4; OA2; 6AL5.

**PHYSICAL CHARACTERISTICS**—Instrument enclosed in metal case. **Overall Dimensions:** height, 4-1/2" (11.4 cm); width, 8" (20.3 cm); depth, 5-3/4" (14.6 cm). **Weight:** 5 lbs. (2.3 kg).

**POWER SOURCE**—Type 264-B is de-

| Catalog No. | Type No. | Description                                     |
|-------------|----------|---|
| 1441-A      | 264-B    | Voltage Calibrator for 115 volts, 50-60 cycles. |
| 1442-A      | 264-B    | Same as above, for 230 volts, 50-60 cycles.     |

**TYPE 286-A  
HIGH-VOLTAGE POWER SUPPLY**

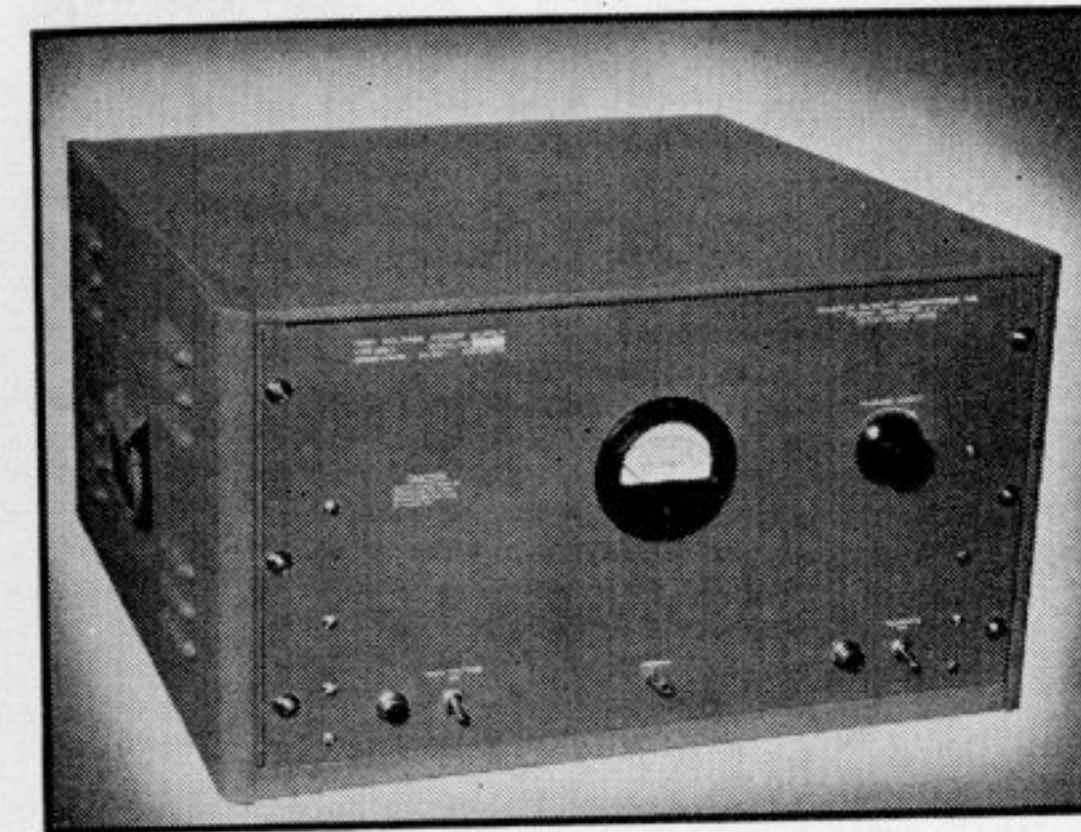

- Source of high voltage, variable from 18,000 to 25,000 volts
- Electronic regulation of output
- Safe, simple operation
- Portable instrument, or permanent mounting in standard relay-rack

**FUNCTION**

The Type 286-A High-voltage Power Supply is a rectified radio-frequency type of high-voltage power supply with regulated output. It is intended primarily as an intensifier supply for high-voltage cathode-ray tubes, but it may be used wherever a variable high-voltage source is called for, and the current required is not great.

the filtering circuits, and that contact with a point of high voltage reduces the feed-back voltage to the oscillator, immediately lowering the instrument's output. Similarly, no damage results if the output is shorted. Another advantage of the Type 286-A is its relatively light weight due to the simpler, smaller filtering circuits and the air-core high-voltage transformer.

The Type 286-A has several advantages over conventional types of power supplies. The danger of injury due to shock is vastly reduced by the facts that very little power is stored in

**DESCRIPTION**

All controls are located on the front panel. They include a primary-power switch, a high-voltage switch, and a control which varies the

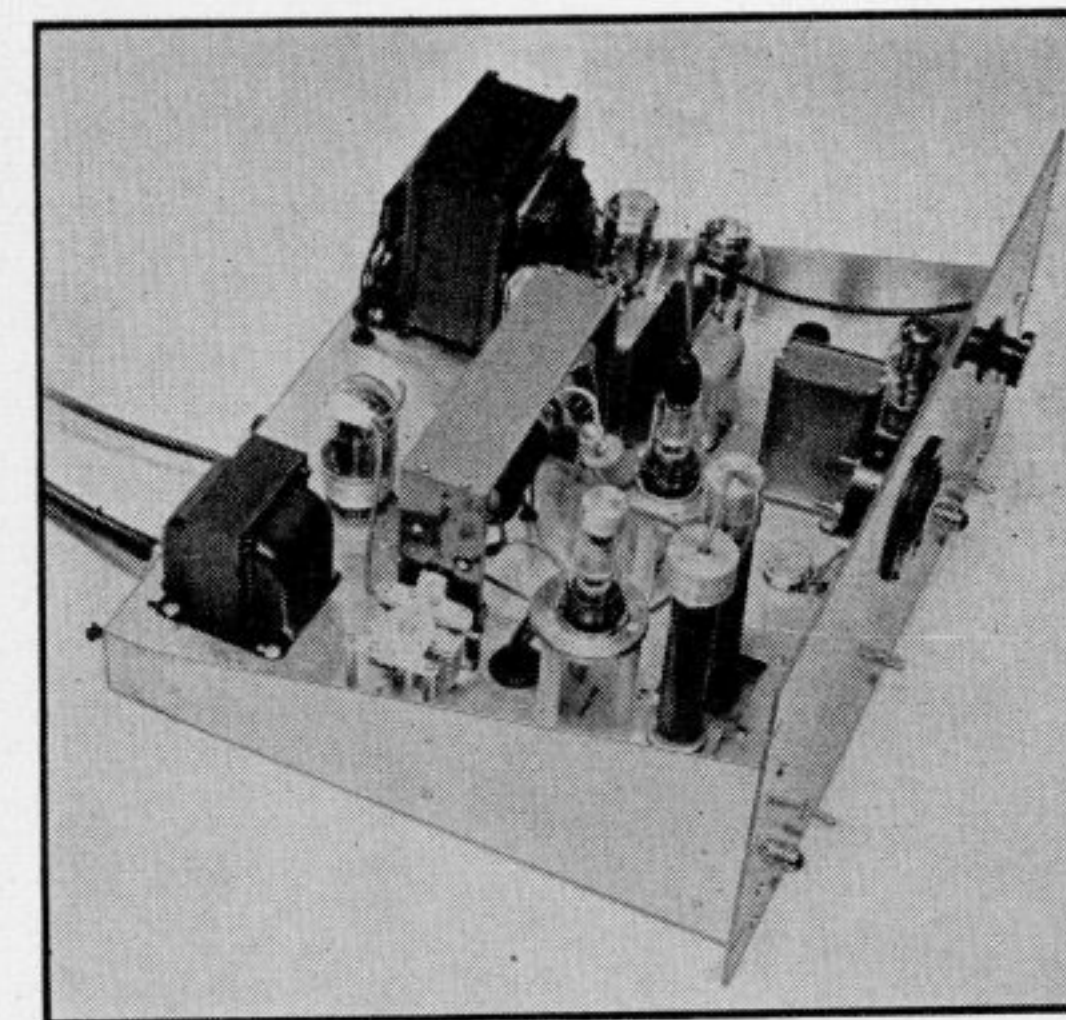

Figure 1. Top view of chassis. The simplicity of this high-voltage power supply and its comparatively light weight both result from the use of a rectified, high-voltage, radio-frequency signal to supply the output power

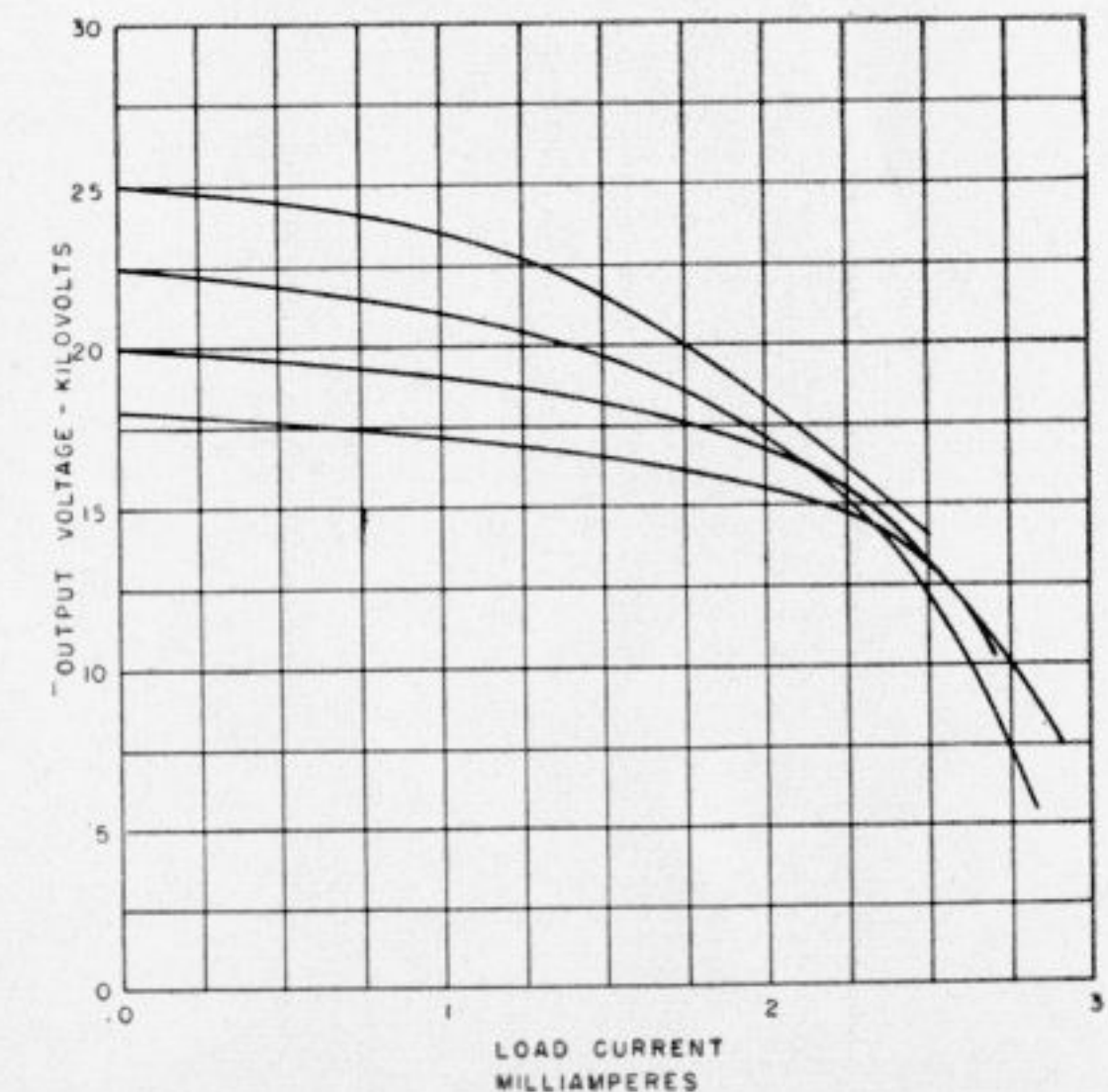

Figure 2. Output potential versus load current. The regulation of the Type 286-A Power Supply is provided to adapt the instrument particularly for use as a source of third-anode potential for high-voltage cathode-ray tubes

## DU MONT CATALOG

output potential between 18,000 and 25,000 volts. A direct-reading voltmeter indicates the output potential. Only the primary-power and plate-supply switches need be operated to turn the supply on or off.

The circuit consists of an r-f oscillator and associated power supply, a step-up transformer as part of the oscillator circuit, a voltage-doubling rectifier system, a high-voltage filter, and output-voltage regulator.

The arrangement of the components has been carefully designed to allow for the high potentials which are present.

Adequate shielding is provided to permit use

of this instrument in close proximity with sensitive amplifiers and cathode-ray tubes. The high-voltage output cable is located at the back of the Type 286-A where it is out of the way of the panel controls.

Although the Type 286-A is designed for relay-rack mounting, it is furnished with its own dust-proof cabinet, and can be used as a portable instrument. Provision is also made to fasten the cabinet conveniently to that of the Du Mont Type 281-A Cathode-ray Indicator to combine them into a single instrument. Refer to Figure 3, page 22.

### SPECIFICATIONS

**VOLTAGE OUTPUT**—High voltages are variable from 18,000 to 25,000 volts, positive with respect to ground (chassis of instrument).

**CURRENT OUTPUT**—Currents up to 500 microamperes are available at regulated voltages from 18,000 to 25,000 volts. Currents to 2.75 milliamperes are possible at somewhat reduced total voltage values. (See Figure 2, page 63.)

**REGULATION**—Output voltage changes less than 5% with a variation in external load from 0 to 500 microamperes, or with a 10% change in line voltage.

**POWER SOURCE**—The type 286-A is de-

signed to operate from either a 115-volt or 230-volt 50-60 cycle power line. Change-over is accomplished by a switch on the instrument. **Power Consumption**—200 watts.

**TUBE COMPLEMENT**—815; 2—1B3GT/8016; 5U4G; 6AS7G; OA3/VR75; 6SJ7.

**PHYSICAL CHARACTERISTICS**—Instrument housed in metal cabinet provided with carrying handles. **Overall Dimensions:** height, 12-1/4" (29.9 cm); width, 20-3/4" (52.6 cm); depth, 20-1/2" (52 cm). **Relay-rack:** Provision for mounting without cabinet in standard 19" relay-rack. **Weight:** with cabinet, 90 lbs. (40.7 kg.); without cabinet, 60 lbs. (27.2 kg.).

| Catalog No. | Type No. | Description  |
|-------------|----------|--|
| 1416-E      | 286-A    | High-voltage Power Supply for 115 volts, 50-60 cycles. |
| 1417-E      | 286-A    | High-voltage Power Supply for 230 volts, 50-60 cycles. |

# DU MONT

## ACCESSORY EQUIPMENT

## TYPE 189 MOVABLE TABLE

### DESCRIPTION

In a laboratory, it is often convenient to be able to move instruments and other equip-



ment from place to place as a unit without disturbing connections and without having to consume valuable work-bench space. The Type 189 Movable Table fulfills just such a need. It is constructed of welded, cold-rolled steel capable of supporting heavy weights, and is provided with large, rubber-tired, swivel casters which move easily and noiselessly along the floor.

The large table top at standard work-bench height provides an area of more than 600 square inches, ideal for accommodation of an oscillograph, signal generators, meters, and similar instruments. A lower shelf only a few inches from the floor is a handy space for carrying auxiliary units such as power supplies. The large, easily-working drawer underneath the top surface may be used to store and transport tools, test leads, notebooks, etc.

### SPECIFICATIONS

**Physical Characteristics**—Width, 2-1/4" (51.5 cm); depth, 32-1/4" (82 cm); height, 30-3/4" (78 cm); weight, 78 lbs (35.4 kg.).

| Catalog No. | Type No. | Description    |
|-------------|----------|----------------|
| 1156-E      | 189      | Movable Table. |

## TYPE 276-A VIEWING HOOD

This black rubber hood may be easily fitted to any equipment which uses a 5-inch cathode-ray tube. It improves pattern contrast on the tube screen by reducing ambient light level, and is shaped so that it can completely shield the eyes of an observer, producing darkened-room conditions under any circumstances.

In addition to its use wherever unfavorable ambient light conditions exist, the Type 276-A is also used for viewing on a cathode-ray tube screen fast writing speeds which would not be

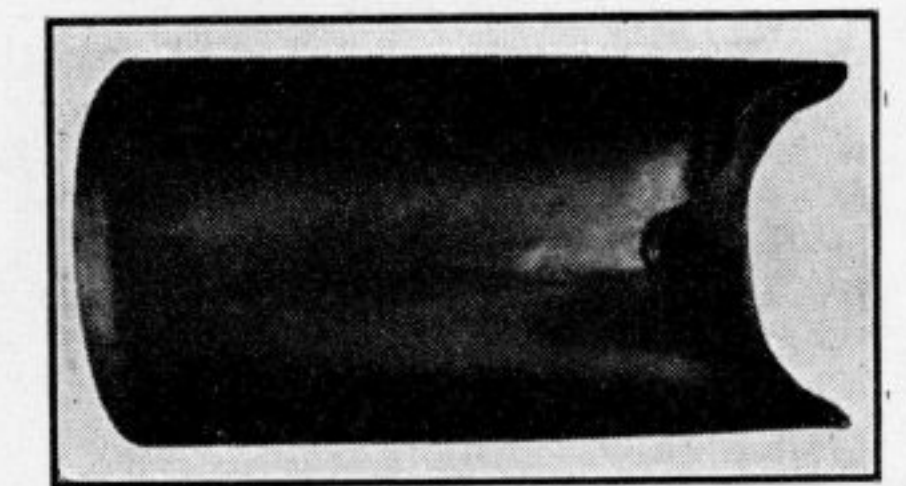

visible with less favorable contrast. Overall length of the hood is 10-1/2 inches.

| Catalog No. | Type No. | Description         |
|-------------|----------|---------------------|
| 1210-A      | 276-A    | 5-inch Viewing Hood |

## TYPE 2501 BEZEL

The Type 2501 Bezel is intended for mounting on a panel in front of any 5-inch cathode-ray tube. Its protruding flange is designed to accommodate the Du Mont Types 295, 296, 297, and 321 Oscillograph-record Cameras and the Type 2542 Projection Lens. Also, the Type 2501 Bezel will accommodate the Du

Mont Type 2560 Filters, as well as the Types 2518, 2519 and 2520 Calibrated Scales.

The Bezel is formed from sheet iron and has a durable, dull black finish. The maximum overall diameter is 6-5/8 inches; protrusion from the panel is 1-3/16 inches.

The Type 2501 is supplied as standard on most Du Mont Cathode-ray Oscillographs.

| Catalog No. | Type No. | Description |
|-------------|----------|-------------|
| 1215-E      | 2501     | Bezel.      |

## TYPE 2502 MAGNETIC SHIELD

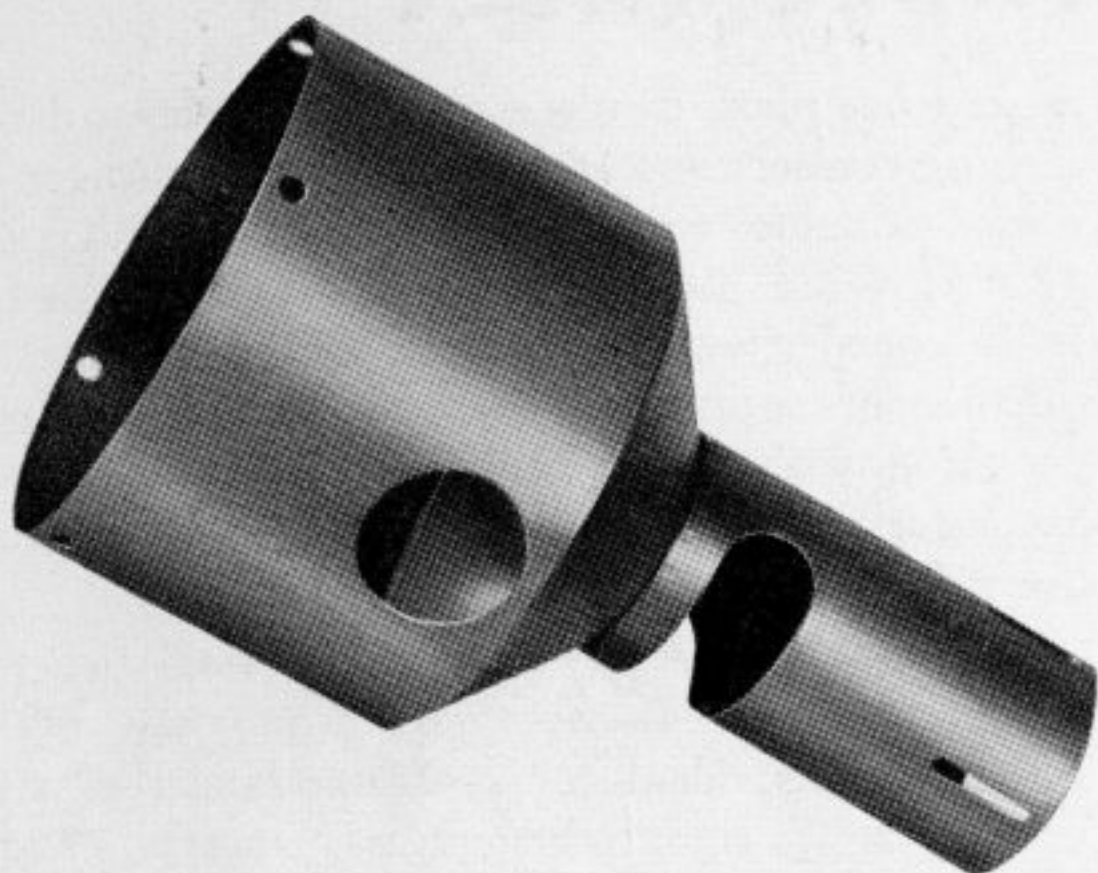

This shield is intended for use with the Types 5RP-A and 5XP- cathode-ray tubes, to prevent distortion and intensity modulation of the electron beam due to stray magnetic fields. The shield is fabricated from annealed mu-metal, an alloy with most excellent magnetic properties.

Holes are provided in the sides of the shield to permit easy access to the electrode terminals. The Type 2502 is supplied complete with a tube base clamp, ready to install. Maximum length of the Type 2502 shield is 10 inches; the maximum diameter is 5-5/8 inches.

| Catalog No. | Type No. | Description   |
|-------------|----------|---|
| 1382-E      | 2502     | Mu-metal Shield for Types 5RP-A and 5XP- Cathode-ray Tubes. |

## TYPE 2503 MAGNETIC SHIELD

The Type 2503 Magnetic Shield is similar to the Type 2502, except that it is designed for use with the Types 5SP- Cathode-ray Tube. Maximum length of the Type 2503 is 16-1/8"; maximum outside diameter is 5-11/16".

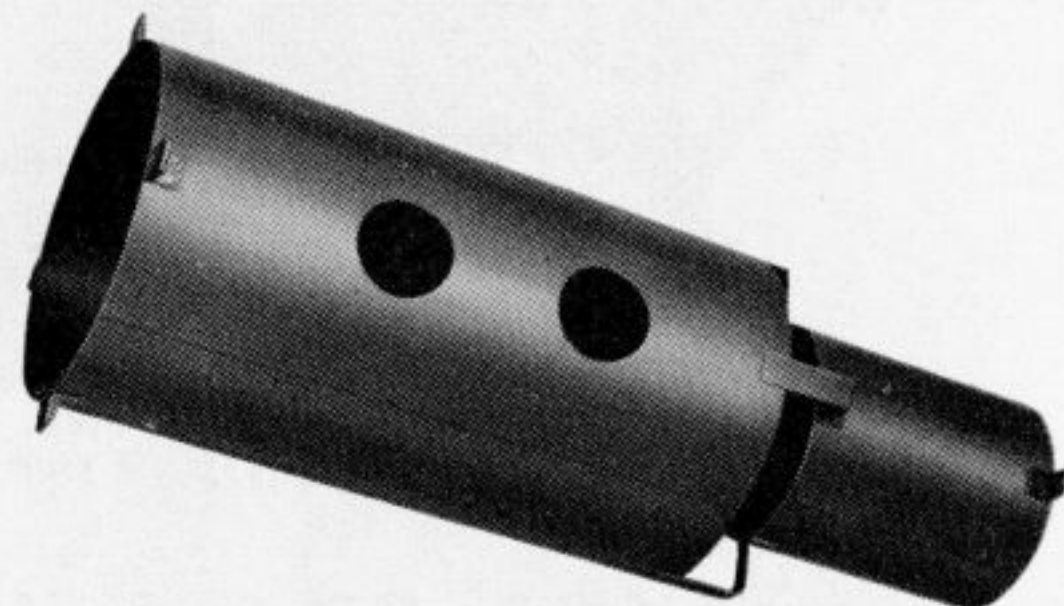

| Catalog No. | Type No. | Description                                     |
|-------------|----------|---|
| 1383-E      | 2503     | Mu-metal Shield for Type 5SP- Cathode-ray Tube. |

## TYPE 2521 MAGNETIC SHIELD

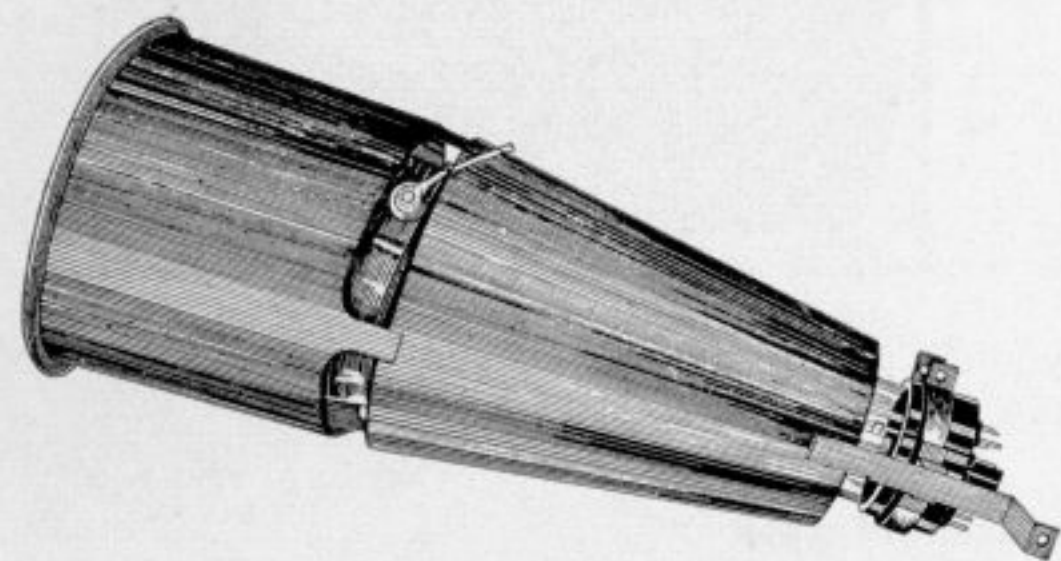

This shield serves a function similar to that of Type 2502 Magnetic Shield, except that it is designed for use with the Du Mont Type 5CP-A Cathode-ray Tube. Overall length, including the tube base clamp, is 17-1/4 inches. Maximum diameter is approx. 5-2/3 inches.

| Catalog No. | Type No. | Description                                      |
|-------------|----------|--|
| 1438-A      | 2521     | Mu-metal shield for Type 5CP-A Cathode-ray Tubes |

## CONNECTORS FOR CATHODE-RAY TUBES

For the convenience of those purchasing Du Mont Cathode-ray Tubes, sets of connectors are available to match the terminals on the glass bulb of those tubes whose connectors are not generally available through the usual

sources of supply. Sockets, which are generally available, are not included in these sets. Connectors are available for the Du Mont Types 5RP-A, 5SP-, 5XP-, and 5YP- Cathode-ray Tubes.

| Catalog No. | Description                              |
|-------------|--|
| 2365-E      | Set of connectors for Du Mont Type 5RP-A |
| 2366-E      | Same as above, for Du Mont Type 5SP-     |
| 2367-E      | Same as above, for Du Mont Type 5XP-     |
| 2368-E      | Same as above, for Du Mont Type 5YP-     |

## TYPE 2504 STEP-DOWN TRANSFORMER

This transformer is designed to operate from 50-60 cycle, single-phase, 230-volt power. It delivers 115 volts and has a maximum output rating of 250 volt-amperes. There is a power

cord and plug for making the 230-volt connection; 115-volt output is available from a standard receptacle on the case.

| Catalog No. | Type No. | Description                    |
|-------------|----------|--------------------------------|
| 1384-A      | 2504     | 250 va. Step-down Transformer. |

## TYPE 2505 STEP-DOWN TRANSFORMER

Similar to the Type 2504, except that it has a maximum output rating of 1000 volt-amperes

| Catalog No. | Type No. | Description                     |
|-------------|----------|---------------------------------|
| 1385-A      | 2505     | 1000 va. Step-down Transformer. |

## TYPES 2507 AND 316 TEST PROBES

In the oscillographic investigation of electronic circuits, it is extremely important that the oscillograph impose as little load upon the circuit as possible, since excessive loading alters the operating conditions of the circuit and renders oscillographic indications inconclusive. As a general rule of thumb, the input impedance of the oscillograph must exceed the impedance of the circuit under study by more than a factor of 10 if the effects of loading are to be avoided.

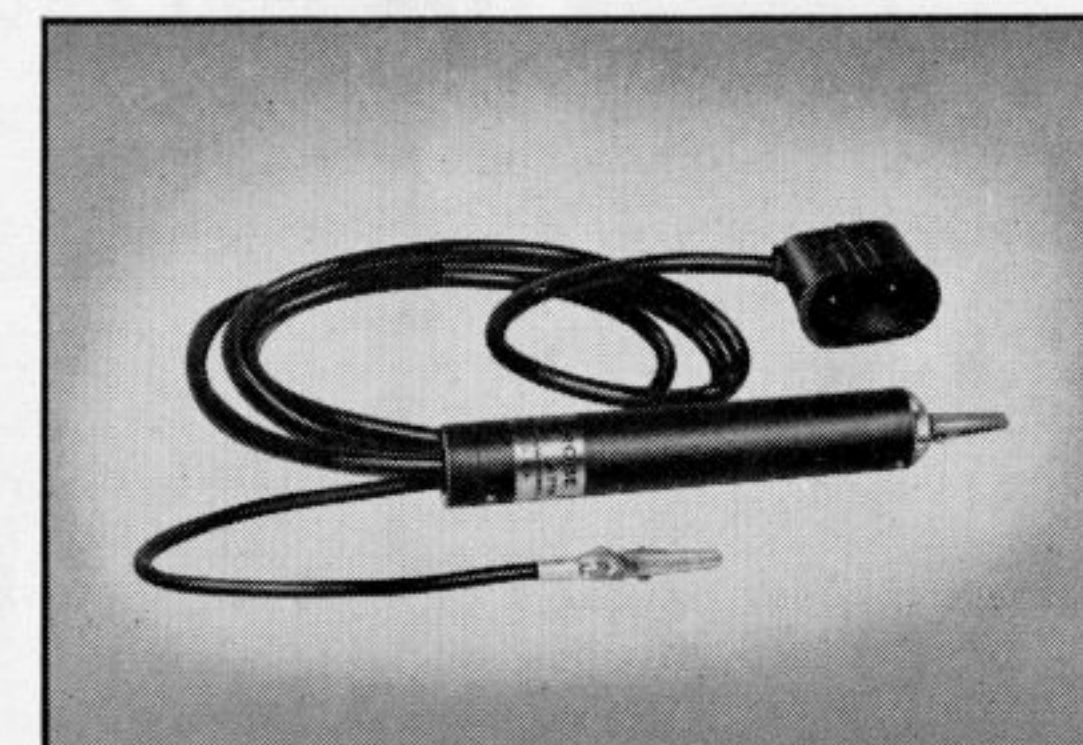

All Du Mont general-purpose oscillographs are designed to have high input impedance. However, in some instances a higher input impedance than that provided in the oscillograph may be required. In other cases, low input capacitance to the oscillograph is essential. Two high-impedance test probes, designated Du Mont Types 2507 and 316, are available,

which provide an input impedance sufficiently high, and input capacitance sufficiently low to satisfy the majority of such applications. The Type 2507 Test Probe is d-c coupled while the Type 316 is a-c coupled. In other respects, the probes are similar, and detailed characteristics of both are presented in the following table.

|                      | Type 2507   | Type 316  |
|----------------------|---|---|
| Frequency Range      | d-c to 20 mcps.   | 20 cps. to 20 mcps.   |
| Input Terminal       | Alligator clip  | Alligator clip  |
| Output Terminal      | General Radio Type 274ND  | General Radio Type 274ND  |
| Max. Input Potential | 500 volts (d-c & peak a-c)  | 1600 volts (d-c & peak a-c, with peak a-c not exceeding 500 volts)                |
| Input Impedance      | 4.7 megohms; 15 $\mu\mu\text{f}$  | 4.7 megohms; 15 $\mu\mu\text{f}$  |
| Attenuation          | 10:1 working into 2-megohm input impedance paralleled by a 20-50 $\mu\mu\text{f}$ | 10:1 working into 2-megohm input impedance paralleled by a 20-50 $\mu\mu\text{f}$ |
| Cable Length         | 60 inches   | 60 inches   |

| Catalog No. | Type No. | Description              |
|-------------|----------|--------------------------|
| 1443-A      | 2507     | Test probe, d-c coupled. |
| 1444-A      | 316      | Test probe, a-c coupled. |

## SCALES AND FILTERS

### TYPE 2518 CALIBRATED SCALE

This scale, fabricated from heavy (1/4-inch thick), clear acrylic plastic, may be mounted on any 5-inch oscillograph. The scale fits under the Du Mont Type 2501 Bezel, where it is held in place by the same screws that secure the bezel. Black calibrations are engraved 10 x 10 to the inch, with tenth lines accentuated horizontally, and fifth lines accentuated vertically.

Line widths are .005 and .015 inch. The scale is equipped with a rectangular mask, 3.2 inches by 4.2 inches, inside dimensions, which blocks off the unused portion of the screen to facilitate reading.

The Type 2518 Calibrated Scale is supplied as standard equipment with the Du Mont Type 294-A Cathode-ray Oscillograph.

| Catalog No. | Type No. | Description                                      |
|-------------|----------|--|
| 1435-A      | 2518     | Calibrated acrylic scale, with rectangular mask. |

### TYPE 2519 CALIBRATED SCALE

This scale is similar to the Type 2518, except that it has a circular mask, 4.5 inches inside diameter, rather than a rectangular mask.

| Catalog No. | Type No. | Description                                  |
|-------------|----------|--|
| 1436-A      | 2519     | Calibrated acrylic scale with circular mask. |

### TYPE 2520 CALIBRATED SCALE

The Type 2520 scale has black calibrations engraved 10 x 10 to the inch, with tenth lines accentuated, both vertically and horizontally. Line width is .010 and .005 inch. The scale

is made from clear acrylic plastic, 1/8-inch thick, and it is equipped with a circular mask whose inside diameter is 4.8 inches. It is mounted under the Du Mont Type 2501 Bezel, and may be used with any 5-inch oscillograph.

| Catalog No. | Type No. | Description                                  |
|-------------|----------|--|
| 1437-A      | 2520     | Calibrated acrylic scale with circular mask. |

### TYPE 216 CALIBRATED SCALES

The Type 216 Calibrated Scales, fabricated from clear plastic, provide convenient means for making both relative and quantitative measurements with a cathode-ray oscillograph. They are fastened in front of the cathode-ray tube screen by four plastic tabs which are equally spaced around their circumference, and which grip the sides of the tube. The scales may be quickly removed when not required.

The Type 216-A (3-inch) and the Type 216-C (5-inch) calibrated scales are made of clear, laminated Vinylite. Black calibrations are made 10 x 10 to the inch, with tenth lines accentuated both horizontally and vertically. The calibration lines are 0.01 and 0.02 inch in width and are protected from abrasion by a clear layer of plastic. These scales are not inflammable and will not warp.

The Type 216-D Scale (5 inch) is of clear Celluloid with a logarithmic decrement calibra-

tion along one ordinate. It is used principally in making measurements on oscillatory systems.

The Type 216-E Scale (5 inch), made of clear Celluloid, is logarithmically calibrated along one ordinate so that direct measurement of the Q of oscillatory systems may be made.

The Type 216-F Scale (5 inch) is calibrated from 0 to 360 degrees in polar co-ordinates. It is useful in measuring such quantities as radiation patterns from light sources or from antennae; it is also supplied with the Du Mont Type 275-A Polar-coordinate Indicator.

The Type 216 Calibrated Scales are intended for use primarily with instruments not equipped with a Du Mont Type 2501 Bezel. In instances where the oscillograph is equipped with the Type 2501 Bezel, either the Du Mont Type 2518, 1519, or 2520 Calibrated Scale is recommended.

| Catalog No. | Type No. | Description                       |
|-------------|----------|-----------------------------------|
| 1129-A      | 216-A    | Three-inch Calibrated Scale.      |
| 1128-A      | 216-C    | Five-inch Calibrated Scale.       |
| 1130-A      | 216-D    | Five-inch Decrement Scale.        |
| 1131-A      | 216-E    | Five-inch Q Scale.                |
| 1132-A      | 216-F    | Five-inch Polar-coordinate Scale. |

### TYPE 2560 COLOR FILTERS

The Type 2560 Filters are 5-inch discs of colored acrylic plastic designed to fit under the Type 2501 Bezel, either behind, or in front of a Du Mont Type 2518, 2519, or 2520 Calibrated Scale. The filter is attached by the same screws that secure the Bezel and Calibrated Scale. These filters are useful, for example, with the P2 and P7 cathode-ray tube screens, which have different color fluorescent and phosphorescent characteristics. There they provide for visual separation of initial screen excitation from the excitation which remains due to persistence characteristics of the screen.

These filters are also useful in many cases where ambient light renders visual observation of the pattern difficult. A filter of the same color as the trace eliminates all but a very small portion of the light reflected from the face of the cathode-ray tube, but readily passes the light from the trace. Thus the contrast between the trace and the face of the tube is greatly increased.

The following filters are available in this series: Green, 2560-A; Blue, 2560-B; Amber, 2560-C.

| Catalog No. | Type No. | Description             |
|-------------|----------|-------------------------|
| 1510-A      | 2560-A   | Five-inch Green Filter. |
| 1511-A      | 2560-B   | Five-inch Blue Filter.  |
| 1512-A      | 2560-C   | Five-inch Amber Filter. |

### TYPE 216 COLOR FILTERS

The Type 216 Color Filters serve a function similar to that of the Type 2560 Color Filters. The Type 216 Filters are designed to fit inside the Type 2501 Bezel, but are not fastened in place. The following are available in this series:

The Type 216-G, green; Type 216-H, blue; Type 216-J, amber.

The Type 216-K is a green, translucent

acrylic scale designed for use with 5-inch cathode-ray tubes. It is calibrated in polar co-ordinates and reads from 0 to 720 degrees in a clockwise direction. The zero degree line is normally at the top of the scale.

The Type 216 Filters are intended for use with instruments not equipped with the Du Mont Type 2501 Bezel.

| Catalog No. | Type No. | Description  |
|-------------|----------|--|
| 1133-A      | 216-G    | Five-inch Green Filter.  |
| 1134-A      | 216-H    | Five-inch Blue Filter.   |
| 1135-A      | 216-J    | Five-inch Amber Filter.  |
| 1136-A      | 216-K    | Calibrated, polar coordinate, green-translucent scale, 0-720° clockwise. |

### TYPE 2561 CALIBRATED SCALE

This three-inch calibrated scale is fabricated from laminated, non-inflammable plastic. Calibration lines indicate tenth-inches, with inch lines accentuated, both horizontally and vertically. The Type 2561 Scale is held in place by

means of two tabs which fit over the edge of the cathode-ray tube. Two other tabs, bent forward, facilitate removal of the Type 2561.

The Type 2561 is intended primarily for use with the Du Mont Type 3RP-A Cathode-ray Tube.

| Catalog No. | Type No. | Description                  |
|-------------|----------|------------------------------|
| 1523-A      | 2561     | Three-inch Calibrated Scale. |

### TYPE 2542 PROJECTION LENS

The Type 2542 Projection Lens throws a bright, sharp image of the pattern on the face of a cathode-ray tube onto a regular projection screen. Images up to 12 feet square in a semi-darkened room are possible, making the lens an invaluable aid to lecturing and demonstration. The Type 2542 is intended for use in conjunction with the Du Mont Types 5RP-A and 5XP- Cathode-ray Tubes, since these tubes alone, operating at accelerating potentials of from 12,000 to 29,000 volts, are capable of the light output required for satisfactory projection. The lens can be adapted to any Du Mont equip-

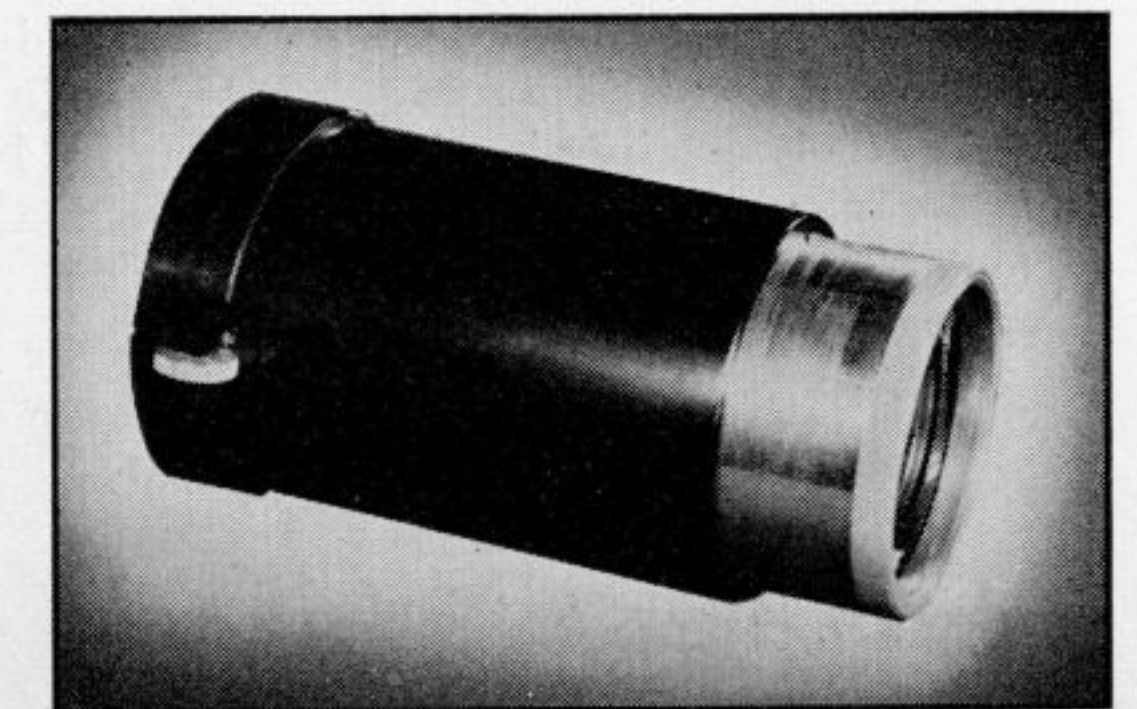

DU MONT CATALOG

ment employing a Type 5RP-A or Type 5XP-Cathode-ray Tube at the above accelerating potentials, and can be attached or removed in a matter of seconds.

Type 2542 is a two-element, symmetrical, objective lens with a relative aperture of  $f/3.3$  and focal length of 7.7 inches. It can project an area up to 3 inches by 3 inches from a cathode-ray tube screen to distances beyond 8 feet, producing a projected area approximately 12 feet square. Axial light transmission of the lens is about 85%.

The Projection Lens mounts in the Du Mont Type 2501 Bezel provided on the front of the instrument. A knurled knob expands a split ring inside the bezel, holding the Type

| Catalog No. | Type No. |
|-------------|----------|
| 1431-E      | 2542     |

2542 firmly in place, and it can be quickly and easily attached or removed without the use of tools. Stops on the lens barrel limit the distance to which the unit can be inserted in the bezel. Thus direct contact between the lens barrel and the face of the cathode-ray tube is rendered impossible, eliminating the danger of damaging the face of the tube.

The Type 2542 Projection Lens is focused simply by revolving the inner barrel. The pattern on the cathode-ray tube may be electrically focused by adjusting the controls of the oscillograph either while looking through the lens, or while observing the projected image of the fluorescent spot.

| Description     |
|-----------------|
| Projection Lens |

**TYPE 2546 HIGH-VOLTAGE CHASSIS CONNECTOR**

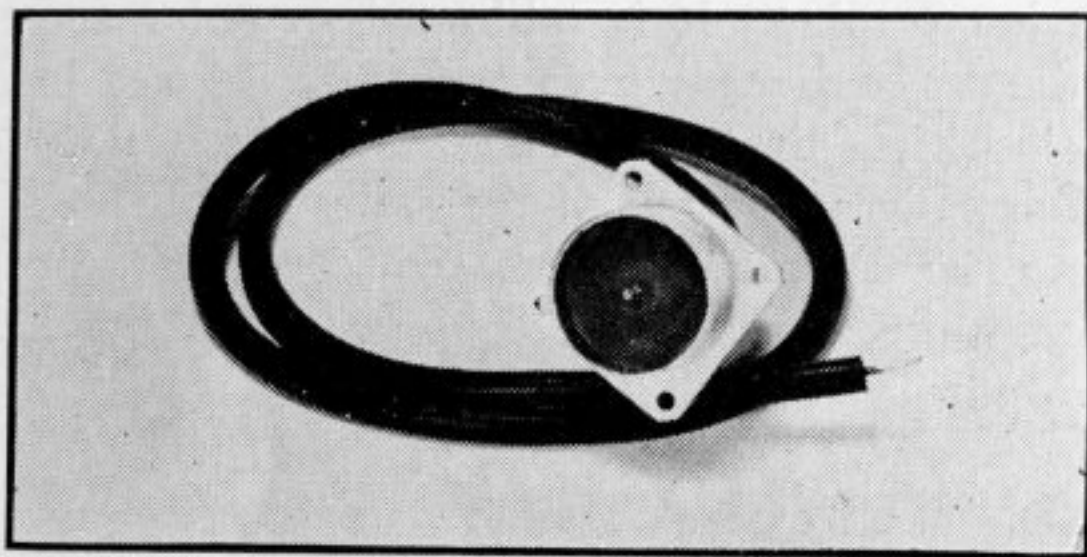

sisting of a receptacle approximately 1-1/2 inches O.D. and a mounting plate of 1-3/4 inch square which is provided with four No. 6 mounting holes.

(2) A male plug enclosed in molded synthetic rubber.

(3) A three-foot lead-in consisting of a stranded copper conductor encased in synthetic rubber.

The Type 2546 Chassis Cable Connector provides a means for connection of either the Du Mont Type 263-B and 286-A High-Voltage Power Supply to an instrument for operation at high voltage.

Intended for use with the Du Mont Type 2546 High-Voltage Cables, this male connector includes:

(1) A cast aluminum mounting shell con-

| Catalog No. | Type No. |
|-------------|----------|
| 1446-A      | 2546     |

**Description**

Chassis Connector for Type 2547 High-Voltage Cable.

**TYPE 2547 HIGH-VOLTAGE CABLE**

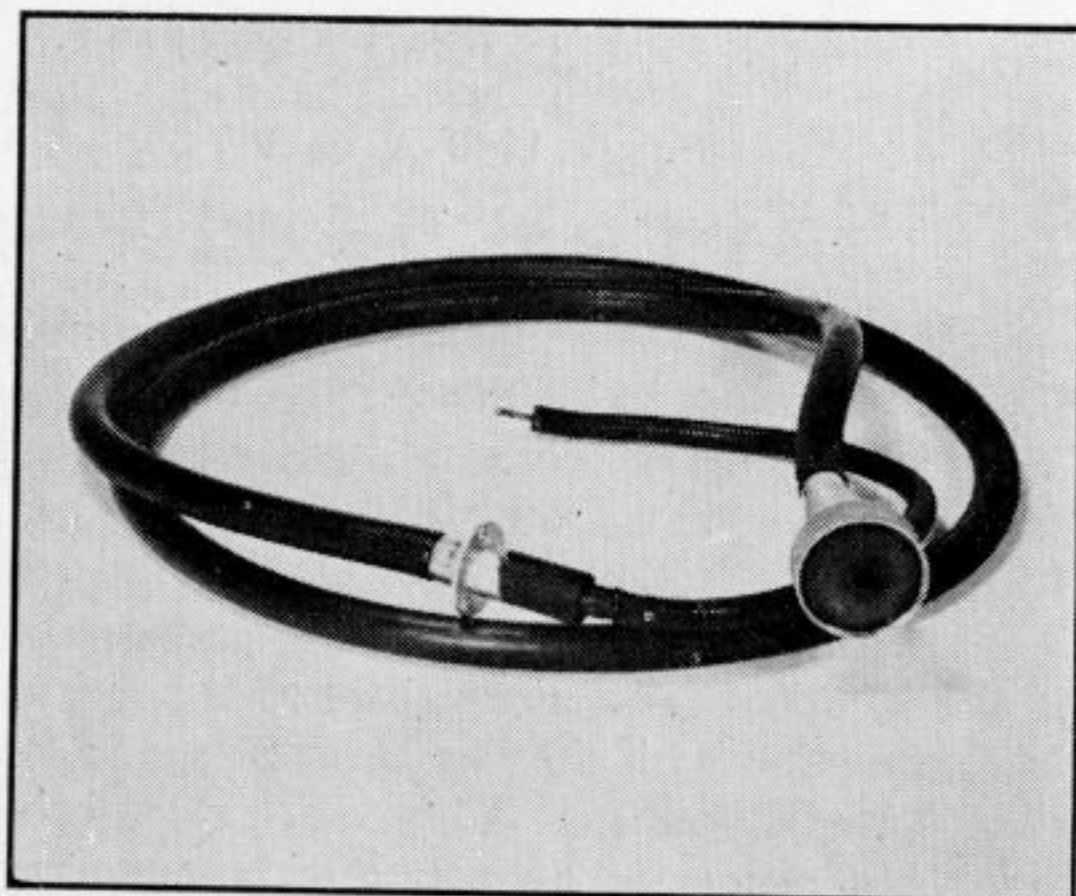

The Type 2547 High-Voltage Cable is designed for use with the Du Mont Types 263-B and 286-A High-Voltage Power Supplies. It is six feet in length, and consists of a stranded wire conductor and a braided copper shield enclosed in an insulating jacket of synthetic rubber. It is equipped with a size AN24 female connector which attaches to the Du Mont Type 2546 Chassis Connector.

The Type 2547 High-Voltage Cable is designed to carry up to 25 kilovolts dc, at low current values, with minimum corona loss.

| Catalog No. | Type No. |
|-------------|----------|
| 1445-A      | 2547     |

| Description               |
|---------------------------|
| 6-foot High-Voltage Cable |

**DU MONT**  
**PHOTO-RECORDING EQUIPMENT**



**OSCILLOGRAPH-RECORD CAMERAS**  
**PHOTOGRAPHIC ACCESSORY EQUIPMENT**

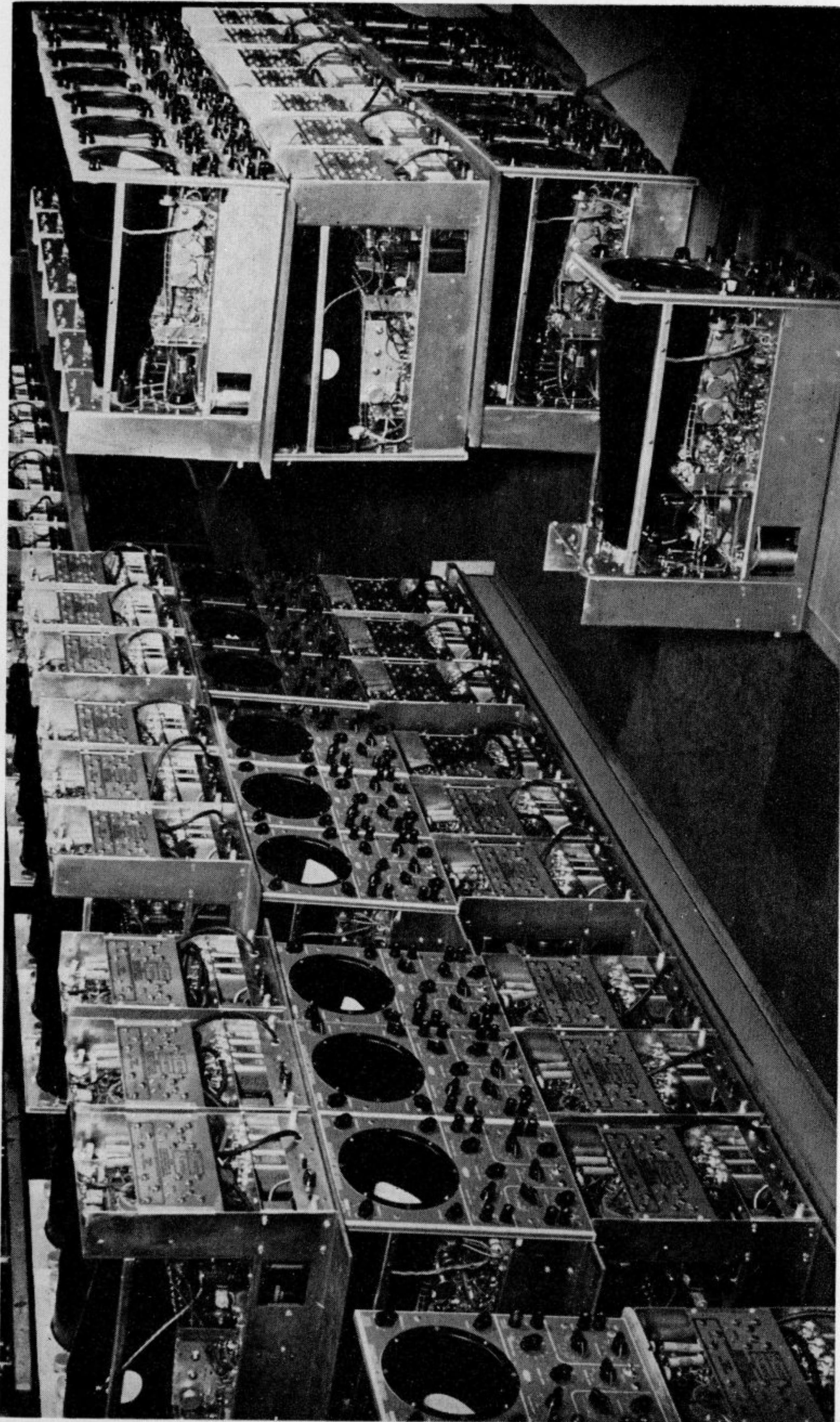

A group of Du Mont Type 304-H Cathode-ray Oscillographs in the process of manufacture

## TYPE 295 OSCILLOGRAPH-RECORD CAMERA

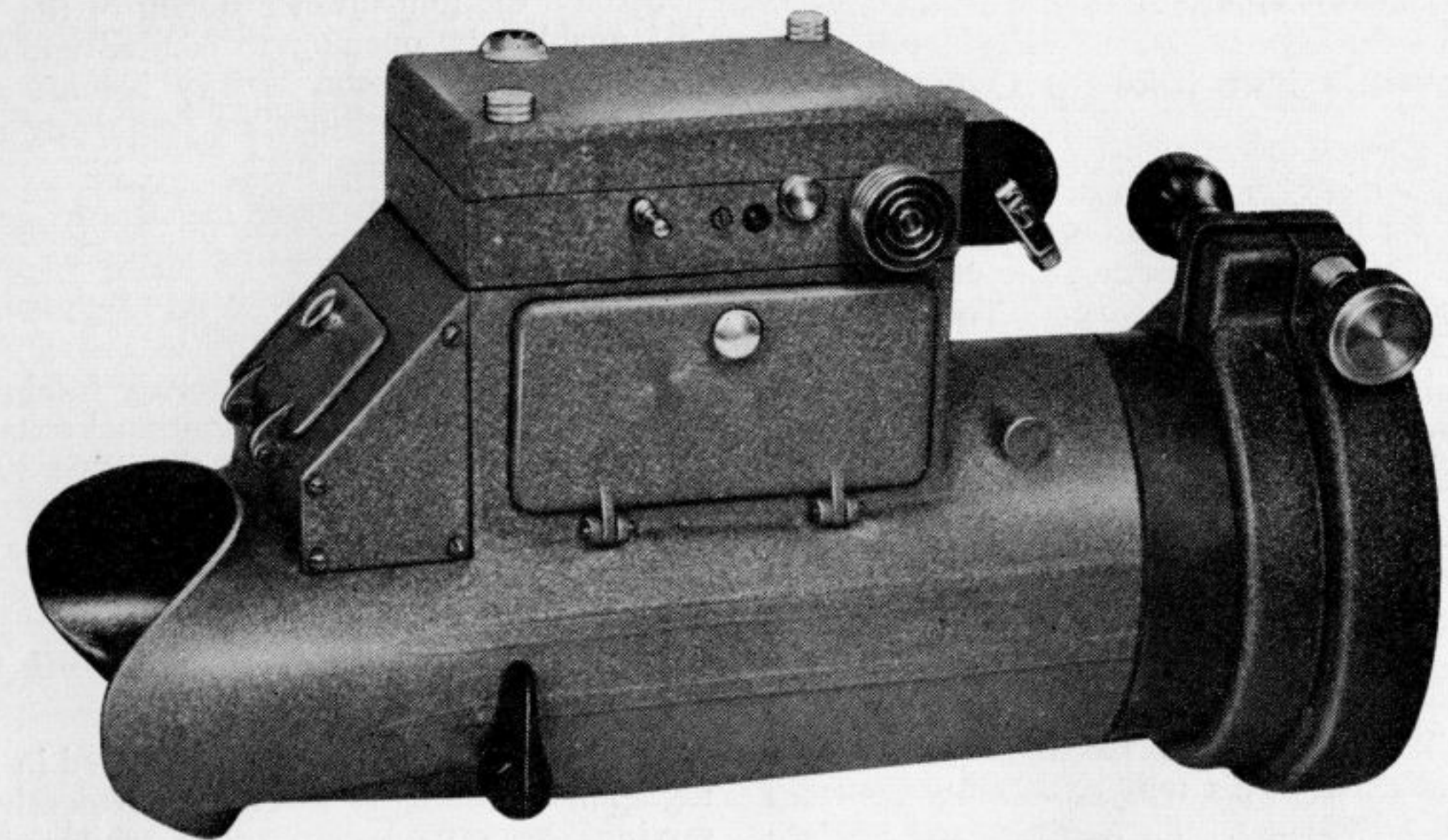

- Ultra-high-speed recording
- High-quality, coated f/1.5 lens enables recording of writing rates as high as 180 inches per microsecond
- Simultaneous binocular viewing and recording
- Built-in illuminated data card
- Sturdy, all-metal construction
- Provision for remote operation

### GENERAL DESCRIPTION

Frequently during the oscillographic investigation of signals containing high-frequency components, writing rates are encountered which are beyond the recording capabilities of general-purpose oscillograph-record cameras. This is particularly true in the case of high-frequency signals that occur as single transients or that have extremely low repetition rates, where there is little or no "build-up" of light resulting from successive traces.

To provide equipment for the recording of such high-speed phenomena, Du Mont has developed the new Type 295 Oscillograph-record Camera.

In addition to the high-quality, high-speed lens required to record the fast writing rates for which the Type 295 is intended, many features have been incorporated in the design of the camera, which contribute substantially to the efficiency and convenience of recording. An illuminated data card is built into the camera's housing. Provision is included for comfortable binocular viewing during recording. Great flexibility is provided in the type of recording materials that may be used with the Type 295,

and a specially designed take-up cassette enables the removal of short lengths of exposed film without disturbing the film remaining in the camera. The entire assembly of the Type 295 is of sturdy, all-metal construction, and will withstand years of active use.

### High-Quality, Coated F/1.5 Lens

The ideal optical system for a camera intended for such recording applications was conceived as one which would provide usable image densities for the most rapid writing rates encountered in cathode-ray oscillography, on commercially available emulsions, using standard processing solutions. This optical system should also be capable of recording without distortion the oscillographic pattern as it appears over the useful area of the fluorescent screen. Before a lens was selected for the Type 295, a number of lenses, supplied by manufacturers in the United States and abroad, were tested and evaluated. The objective finally chosen was an f/1.5, 50-mm Wollensak Raptar lens. With Eastman-Kodak Linagraph Pan film, this lens is capable of recording writing speeds as high as 180 inches per microsecond

when used with high-voltage oscillographs. (See Table on page 144.) The camera has also been designed to accommodate other lenses for various specific applications.

**Removable Film-take-up Cassette**

For greatest convenience, it should be possible to remove an individual frame or series of frames for immediate processing after exposure, without first either finishing the entire supply of film, or wasting most of it. The Du Mont Type 2580 Take-up Cassette is light-tight, and has a built-in cut-off knife and light trap to enable the removal of short lengths of 35-mm film without endangering the supply of unexposed film in the camera. Two Type 2580 Take-up Cassettes are provided with the Type 295. Thus, recording operations need not be interrupted when a section of film is removed for processing.

The Type 295 employs a friction drive for film advance, rather than the more conventional sprocket drive. This type of advance provides several advantages. First, such an advance mechanism simplifies the problem of obtaining film, since either perforated or unperforated

35-mm film or recording paper may be used. Sheet film, cut into 35-mm strips, may also be employed.

Second, the film-advance system of the Type 295 enables the operator to take advantage of new emulsions as soon as they become available, since new emulsions are frequently made available only on sheet stock.

Third, the friction drive mechanism greatly reduces the danger of tearing recording paper, which sometimes occurs with conventional film advance methods.

The Type 295 employs a square focal-plane opening, rather than the conventional rectangular one. This feature enables the Type 295 to yield 40 exposures on a standard 36-exposure length of film, providing a saving of more than 10% on consumption of film.

**Simultaneous Binocular Viewing and Recording**

One difficulty frequently encountered in photographic recording is that of conveniently observing the cathode-ray screen while photographing the pattern. The ideal oscillograph-record camera should provide binocular view-

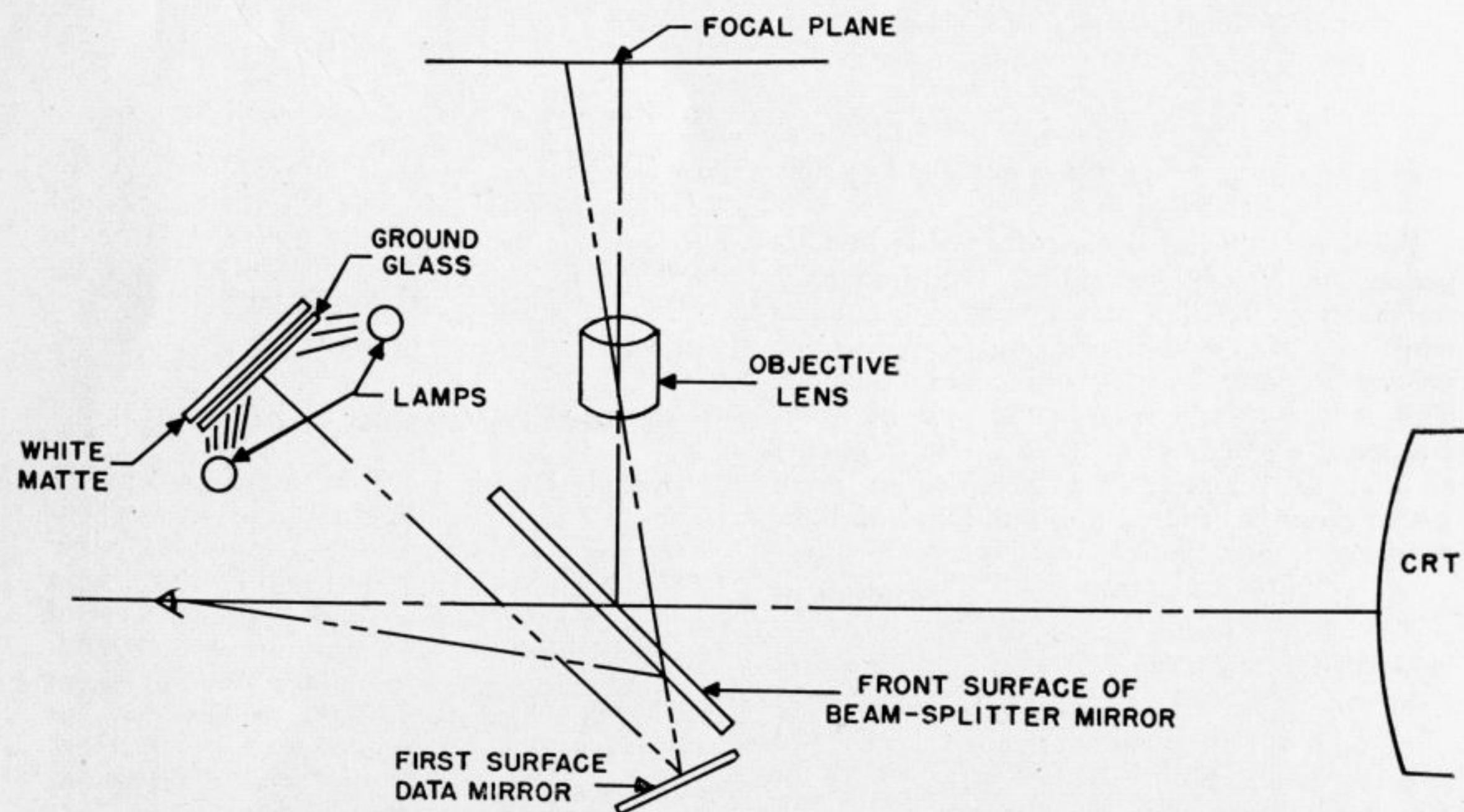

Figure 1. Diagrammatic sketch of the optical system of the Type 295. Use of mirrors permits more compact construction of camera by folding the light path to the focal plane. Same arrangement is used in the Du Mont Type 297 Oscillograph-record Camera

ing, with the eyes at a distance from the cathode-ray tube which enables the best vision, and with a direct view of the cathode-ray tube. This has been accomplished in the Type 295 by the use of a beam-splitter mirror which reflects the photographically useful light to the camera, while transmitting a sufficient amount of the remaining light from the cathode-ray tube to permit satisfactory visual observation of high-speed transients. The mirror also folds the light path to the camera. This permits compact construction of the entire assembly. The diagram of Figure 1 is a representation of the optical system of the camera. The beam-splitter chosen for this design is a dichroic, or interference-type, mirror. It is constructed by careful evaporation of quarter-wave-length layers upon a sheet of clear glass. When held at a 45-degree angle, the spectral reflectivity curve of the mirror closely resembles the spectral characteristic of a Type P11 screen (See Figure 2). The most important advantage of this type of mirror over the usual first-surface, partial-reflecting mirror is that it has practically no absorption. Photographic measurements of the dichroic beam-splitter show that it reflects 80% of all the photographically useful light from a P11 screen when using panchromatic film. With orthochromatic film the percentage of photographically useful light reflected is approximately 85%. For comparison, similar measurements were made with total-reflecting first-surface mirrors (not beam-splitters) showing that 85% of the photographically useful light is reflected. Thus, the dichroic mirror, which reflects the blue-violet portion of the light and transmits the red-yellow, is comparatively very efficient and is the most practical beam-splitting mirror presently available for this purpose.

It is apparent that the slight loss of the photographically useful light through employment of the dichroic mirror is completely inconsequential in comparison with the large number of variables, undeterminable within very substantially greater error, that affect the maximum photographic writing speed of an oscillograph-record camera.

**Built-in Data Card**

A great convenience in recording is a provision for the recording of pertinent data, simultaneously, if possible, on the same frame as the oscillogram. The diagram of Figure 1 shows how this is accomplished in the Type 295. The type of data-recording system employed in the Type 295 makes it possible to record either handwritten data, a digital counter, or any other object, such as the face of a watch, etc. The white matte surface, provided on the hinged door of the data card, on

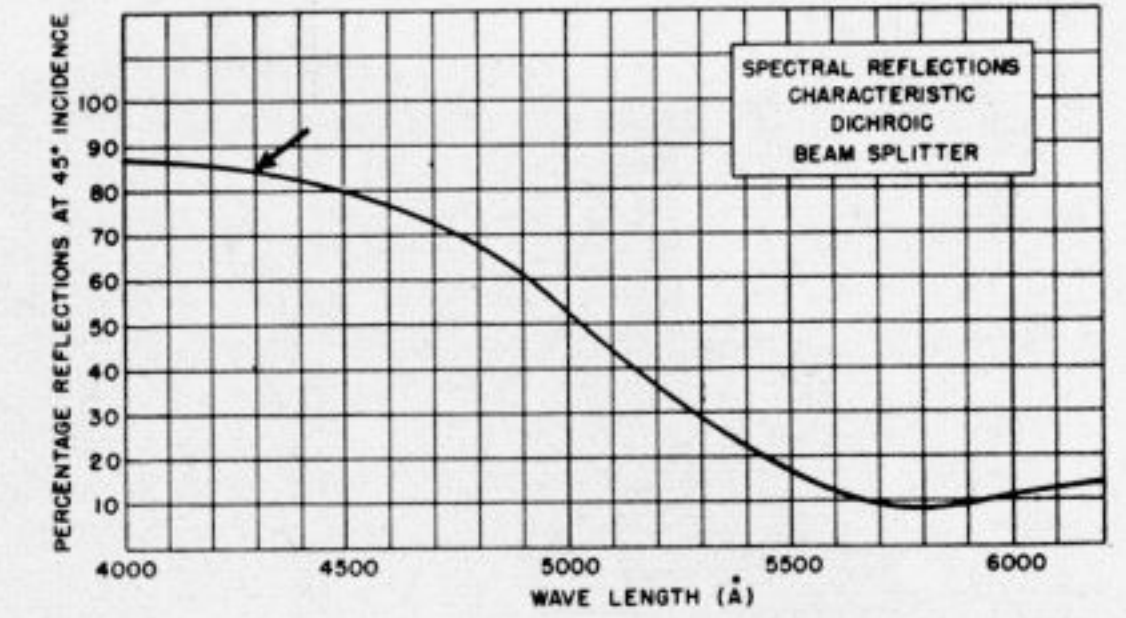

Figure 2. A graph of the spectral reflection characteristic of the beam-splitting mirror. Compare this graph to that of the spectral distribution of the light output of the P11 screen, Figure 12 on page 133. Arrow on graph above indicates maximum output of P11 screen

which the necessary data is written, is illuminated by two small lamps that draw power from a size C leak-proof flashlight battery built into the data-card compartment. A push-button switch on the side of the data-card assembly permits momentary exposure of the data card. This switch also insures that the light will not be left on accidentally, to drain the battery or expose the film. The diagram of the optical system of the Type 295 shows a small, first-surface mirror in the data-card system. Its purpose is to enable placement of the data-card surface at the most convenient point and to provide the same inversion of the data-card image as is obtained with the cathode-ray pattern. When a recording made with the Type 295 is observed or printed, the negative should be held with the emulsion in the opposite direction from that in which it normally would be held. Both the data-card image and oscillogram then print correctly.

**Synchronized Operation**

In using an oscillograph-record camera with high-voltage oscillographs, it is often desirable to provide some sort of automatic beam-control switch, which operates simultaneously with the shutter. The Type 295 is equipped with a switch and a connector to which a relay may be wired, either for brightening the cathode-ray trace only while the shutter is open, or for interlocking a piece of equipment, such as an impulse generator, to prevent its being triggered before the shutter is open.

**All-Metal Construction**

It should be noted that the entire assembly of the Type 295 is fabricated from metal. Aside from providing great mechanical strength, this all-metal construction permits the entire camera to be grounded to the oscillo-



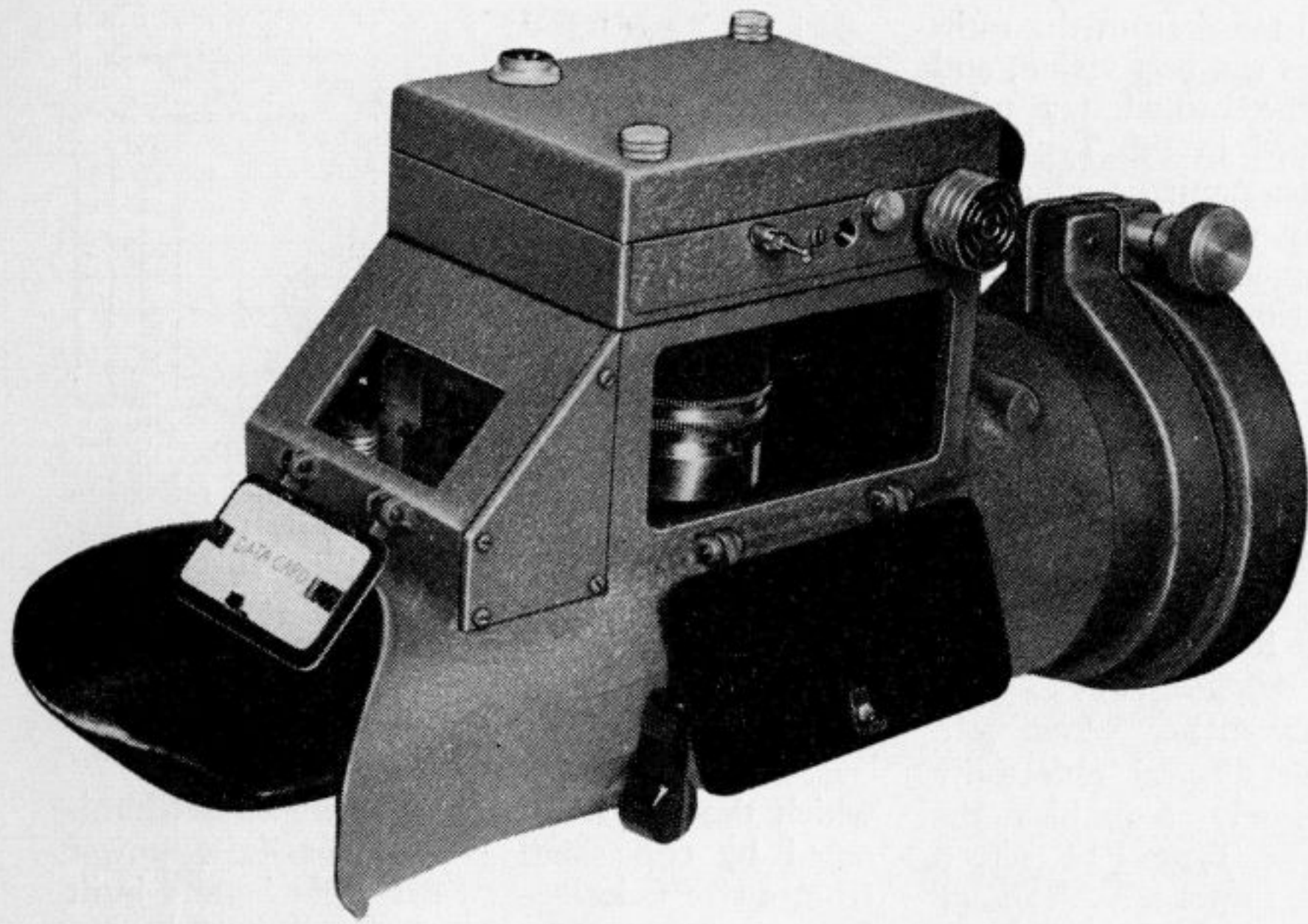

Figure 3. Type 295, with access port open, permitting adjustments of aperture setting. Data card, over viewing port, provides convenient means for recording pertinent information directly on oscillogram. Knob below access port controls mask to close port when not in use. Over access port are, from right to left, film-advance knob, frame-counter re-set knob, frame counter, and the shutter release

graph. Thus, danger of fogging the film as a result of static charge is minimized when the camera is employed with a high-voltage cathode-ray oscillograph.

**Mounting**

The Type 295 may be mounted on any standard, 5-inch oscillograph. The camera is fastened to a Du Mont Type 2501 Bezel\* by

\* All Du Mont Oscillograph-Record Cameras are designed for mounting on the Du Mont Type 2501 Bezel. If these cameras are to be used with oscillographs not equipped with this Bezel, the Type 2501 Bezel may be purchased separately.

means of a sturdy clamp ring. This clamp ring permits rapid, convenient mounting and dismounting of the camera without interfering in any way with the controls of the oscillograph. While attached, the camera is held firmly in place, and adjustments of the camera's controls may be made with no danger of dislodging the clamp ring. No additional support for the Type 295 is required.

**SPECIFICATIONS**

**Camera Back:** Specially designed camera with friction film-drive, frame counter, removable Du Mont Type 2580 take-up Cassette with cut-off knife and built-in light trap,<sup>2</sup> and provision for remote operation. All-metal construction with stainless steel film pressure plate.

**Lens:** f/1.5, 50-mm Wollensak Raptar mounted in barrel with iris diaphragm and "click" stops.

**Object-to-Image Ratio:** 4.5.

**Shutter:** Wollensak blade movement built into camera body, provides exposures of "Time" and "Bulb."

**Maximum Photographic Writing Rate:** Approximately 180 inches per microsecond with P11 screen and 29,000-volt accelerating potential.

**Mirror Housing:** Contains dichroic, beam-splitter mirror for binocular viewing; sturdy casting clamps easily to any oscillograph; comfortable eye shield.

**Film Supply:** Takes standard 35-mm Cassette, 40 exposures on standard 36-exposure roll. Frame counter, counts to 40 exposures. 35-mm perforated or unperforated film or recording paper may be employed.

**Film Drive:** Friction film drive to allow use of perforated or unperforated 35-mm film or paper; keyed shaft permits remote operation.

**Shutter-interlock Switch:** Permits interlocking electrical equipment with shutter or automatic control of cathode-ray tube beam.

**Data Card:** Built into mirror housing. Equipped with two miniature lamps, self-contained battery, and push-button switch for momentary exposures. Data may be inscribed in pencil on white, matte surface on hinged, data-card cover. Small front-surface mirror assures that data card is in focus. Data may be recorded simultaneously with oscillogram.

<sup>2</sup> Two Du Mont Type 2580 Take-up Cassettes are supplied with the Type 295.

| Catalog No. | Type No. | Description  |
|-------------|----------|--|
| 1550-E      | 295      | Oscillograph-record Camera with f/1.5 coated Wollensak 50-mm lens and two Du Mont Type 2850 Take-up Cassettes. |
| 1558-E      | 2580     | Film Take-up Cassette for Du Mont Type 295.  |

**TYPE 296  
OSCILLOGRAPH-RECORD CAMERA**

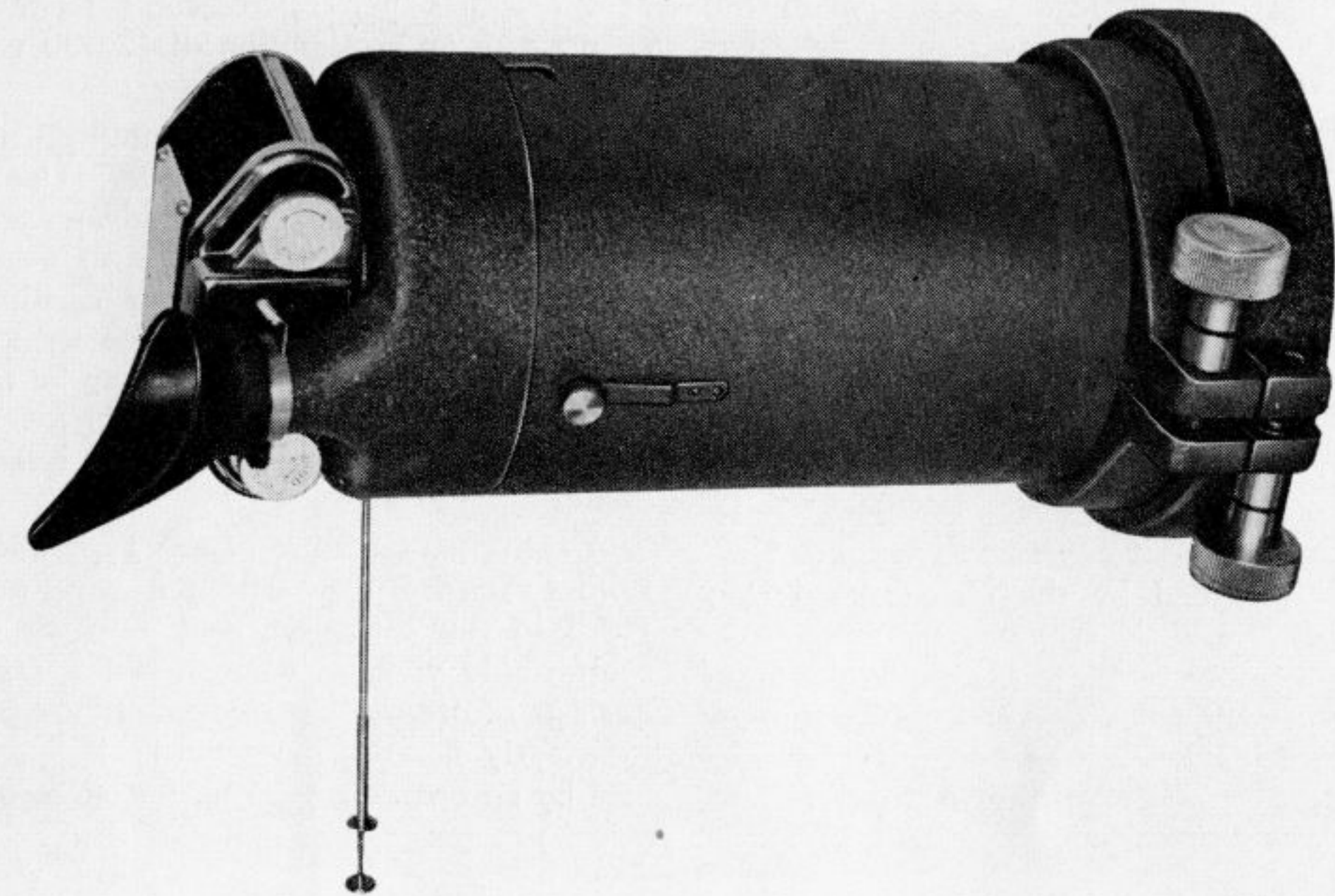

- Simplified operation
- High-quality, coated f/2.8 lens
- Records writing rates up to 20 inches per microsecond from P11 screen and 12,000 volts acceleration
- Economical single-frame recording
- Easily mounted or removed from any standard five-inch cathode-ray oscillograph
- All-metal construction

**GENERAL DESCRIPTION**

The Du Mont Type 296 Oscillograph-record Camera, directly replacing the Du Mont Type 271-A, is designed to serve economically over the entire range of general-purpose recording, including the photography of repetitive phenomena as well as of low- and medium-speed transients. The Type 296 is a basic camera consisting of the camera body with lens and shutter, the housing which adapts the camera to the extension barrel, the extension barrel, and the clamp ring by which the entire assembly is fastened to the Bezel\* of the oscillograph. The clamp ring permits rapid, convenient mounting and dismounting of the cam-

era. When attached, the Type 296 is held firmly in place and adjustments of the camera's controls may be made with no danger of dislodging the clamp ring. No additional support for the camera is required.

In designing the camera for general-purpose recording, dependability, simplicity of operation, and versatility were considered to be of prime importance. Dependability has been achieved in the Type 296 through careful design and construction throughout. For example, the clamp ring, extension barrel, and housing of the Type 296 are of cast aluminum. The camera back, a standard Bolsey Model B, modified to adapt it to this purpose, is a sturdy aluminum die casting. Thus the entire camera as-

\* All Du Mont Oscillograph-Record Cameras are designed for mounting on the Du Mont Type 2501 Bezel. If these cameras are to be used with oscillographs not equipped with this Bezel, the Type 2501 Bezel may be purchased separately.

sembly is rugged and durable. Aside from providing great mechanical strength, the all-metal construction of the Type 296 permits the entire assembly to be grounded. Eliminated thereby is the danger of fogging of the film owing to a static charge at the focal plane when the camera is used to record from cathode-ray tubes operated at high potentials. The shutter of the Type 296 is of extremely simple design and is of the self-winding type. It provides exposures of "Time" and "Bulb" in addition to a range of shutter speeds. This simple type of shutter is all that is required for oscillographic photography, and so it contributes materially to the simplicity and economy of the Type 296. Accurate synchronization of a mechanical shutter with an electrical phenomenon is quite difficult. In practice, therefore, records are nearly always made with the shutter in "Bulb" position, while timing, if any further timing is required, is provided by the phenomenon that is recorded.

The number of controls required to operate the Type 296 has been held to a minimum. No adjustments other than those for shutter speed and aperture setting are necessary.

Versatility of the Type 296 has been substantially increased over that of its predecessor, the Type 271-A, by use of an f/2.8 lens. The coated f/2.8 Wollensak Raptar lens enables the Type 296 to record writing rates in excess of 20 inches per microsecond from a P11 screen with an acceleration of 12,000 volts.

**Recording Material**

The Type 296 employs 35-mm film in standard 20- or 36-exposure Cassettes. Use of this recording medium has several advantages. First, 35-mm film is readily available in a large variety of emulsions suitable for oscillographic recording. Second, owing to the reduction of the image, faster writing rates may be recorded on the 35-mm film with a lens of given aperture than would be possible on a larger focal plane.

A convenient feature of the Type 296 is the rubber eye-piece fixed to the viewing port provided in the extension barrel, which permits comfortable viewing of the cathode-ray screen during recording. The rubber eye-piece is sufficiently flexible that it may be used with ease by an operator wearing eye glasses.

**SPECIFICATIONS**

**Optical System:** Wollensak f/2.8 Raptar coated lens. **Image-Reduction Ratio:** 5. **Shutter:** Wollensak Alphax shutter having speeds of Time, Bulb, 1/200, 1/100, 1/50, 1/25 and 1/10. **Recording Material:** 35-mm film, perforated, in standard Cassettes.

**Physical Dimensions:** Length, 11 3/8"; diameter, 4 3/4"; Weight, 4 1/2 lbs. Finished in blue-gray wrinkle. **Typical Writing Rate Capability:** 20 in./μsec with P11 screen with 12,000 volts acceleration.

| Catalog No. | Type No. | Description  |
|-------------|----------|--|
| 1427-E      | 296      | Oscillograph-record Camera with Wollensak, Raptar, 41.5-mm, coated, f/2.8 lens |

**TYPE 297  
OSCILLOGRAPH-RECORD CAMERA**

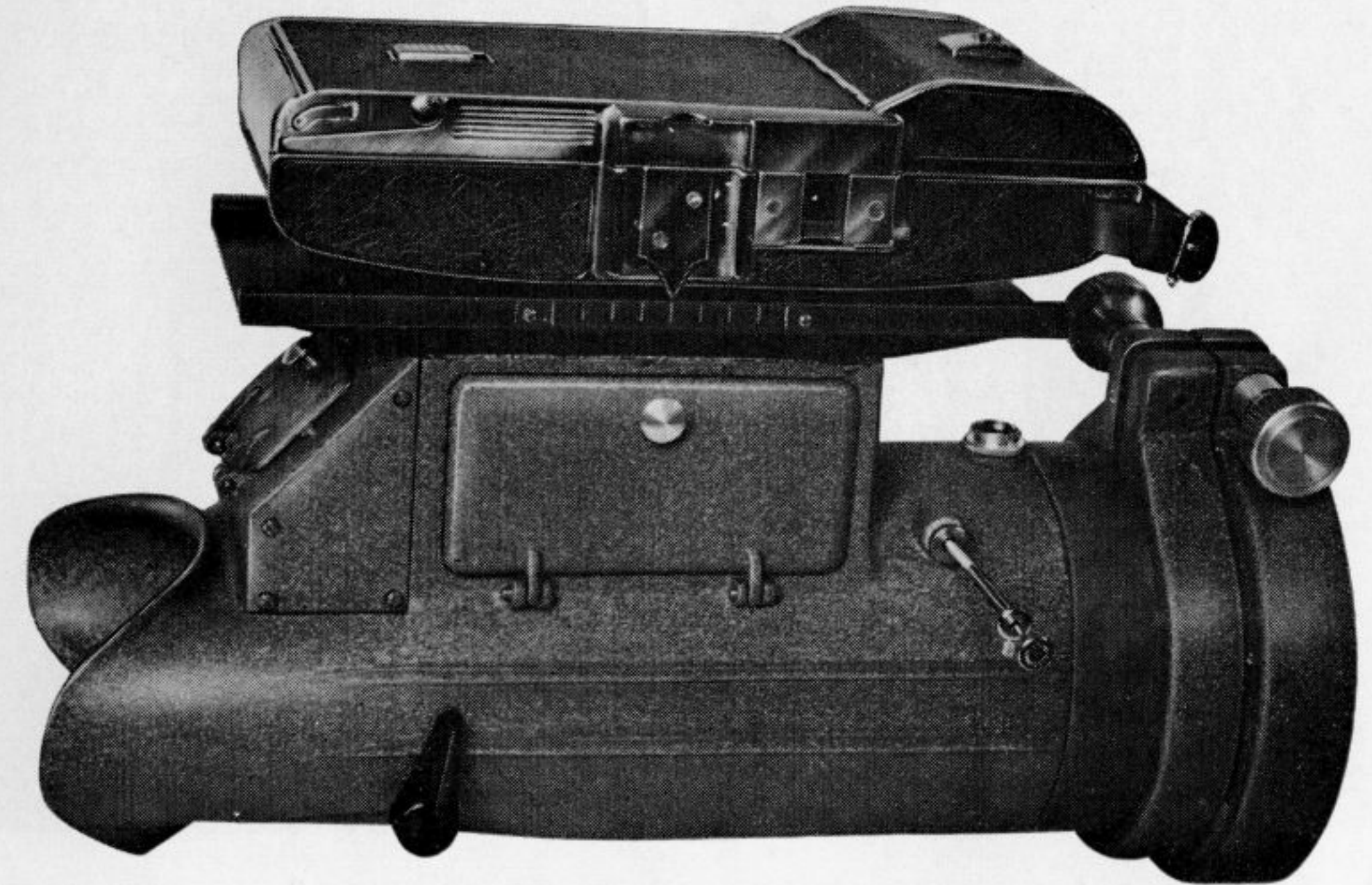

- Produces a finished oscillogram in 60 seconds after exposure
- Coated, f/2.8 or f/1.9 lens
- Mounts on any standard five-inch oscillograph
- Simultaneous binocular viewing and recording
- No additional supports required
- Built-in illuminated data card

**GENERAL DESCRIPTION**

Under certain circumstances, it is convenient or necessary to obtain a finished oscillogram with the least possible delay. This need might arise, for example, in circuit development work, where step-by-step, progressive recordings of the effects of circuit changes are to be recorded for immediate comparison, as well as for permanent documentation. The Du Mont Type 297 Oscillograph-record Camera has been designed to meet this need. Operating on the Polaroid-Land principle, the Type 297 produces a finished oscillogram 60 seconds after exposure.

The housing employed by the Type 297 is similar to that of the Type 295, and provides the same conveniences, such as binocular viewing and an illuminated data card. As may be seen from Figure 2, the camera back of the Type 297 is mounted on top of the mirror

housing out of the operator's way. A sliding adaptor attaches the camera back to the housing. This adaptor consists of two precision-machined castings, one of which slides inside the grooves of the other. This sliding action enables the operator to take a number of recordings on a single frame. The sliding mechanism is equipped with three detented stops which may be used to locate three equally spaced oscillograms, as shown in Figure 1b. A pointer and scale indicate a total of nine equally spaced positions for exposure, and a captive screw locks the mechanism in any position. Thus, when a comparison of a series of closely related oscillograms is to be made, the successive patterns may be placed one below the other, enabling the detection of minute changes occurring in the phenomenon, as in Figure 1a. The entire camera assembly may be carried by the strap on the camera if the slide mechanism is locked.

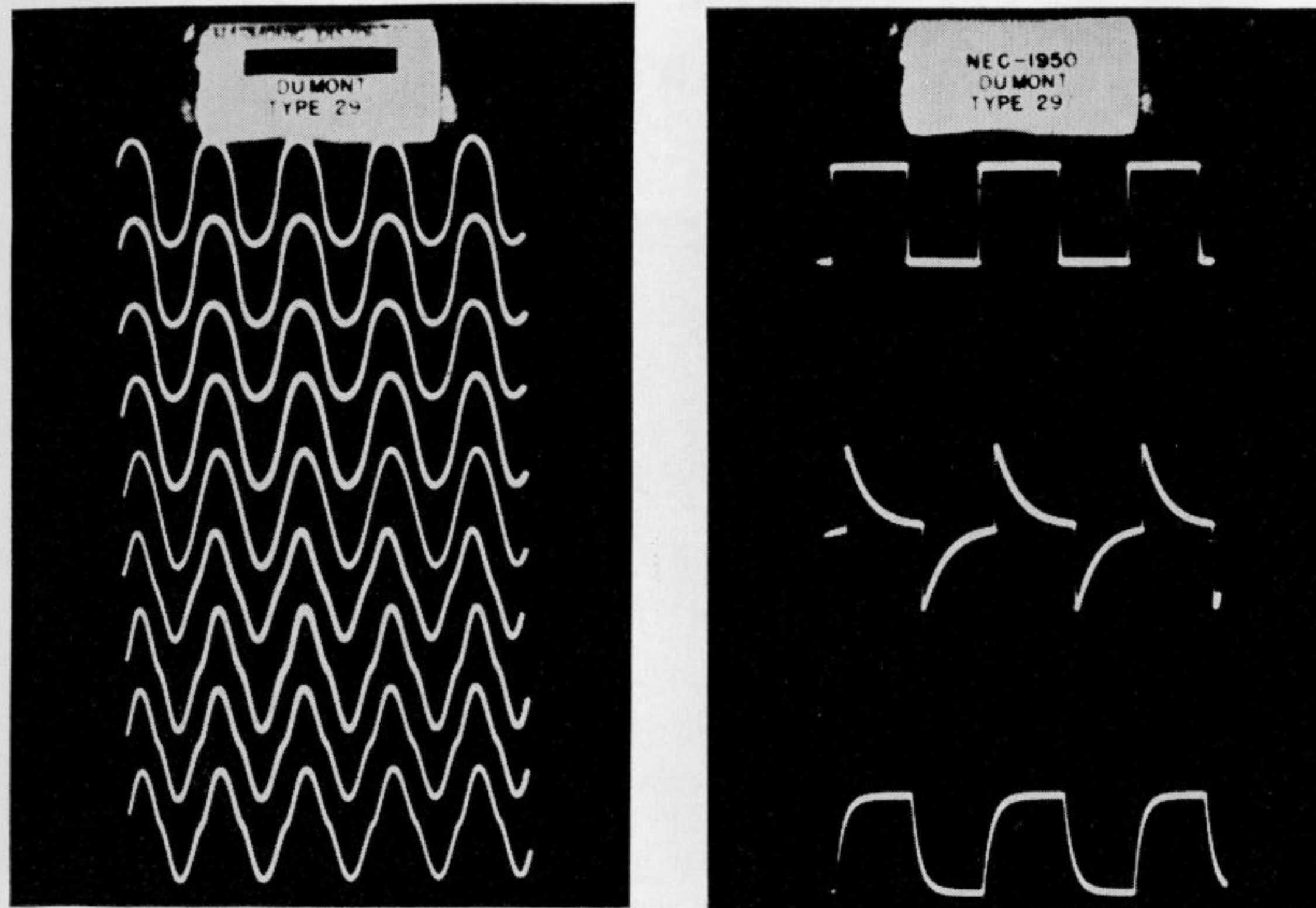

A

B

Figure 1. Two oscillograms taken with the Type 297. Oscillogram at left was made by multiple exposure, using slide and pointer to locate traces. Multiple-exposure oscillogram at right was made by using the three detented stops on slide

Another important advantage of the location of the camera back of the Type 297 is apparent from Figure 2. The camera back mounts in the most desirable position for pulling the end tab of the Polaroid-Land film from the back to initiate processing. A firm, steady pull is required to crush the container of jellied photo-

chemicals attached to the Polaroid-Land film and to spread this jelly evenly over the emulsion. The clamp ring holds the camera securely, so that during this operation there is no danger of dislodging the camera. No additional support, brace or clamp for the Type 297 is required. Moreover, as can be seen

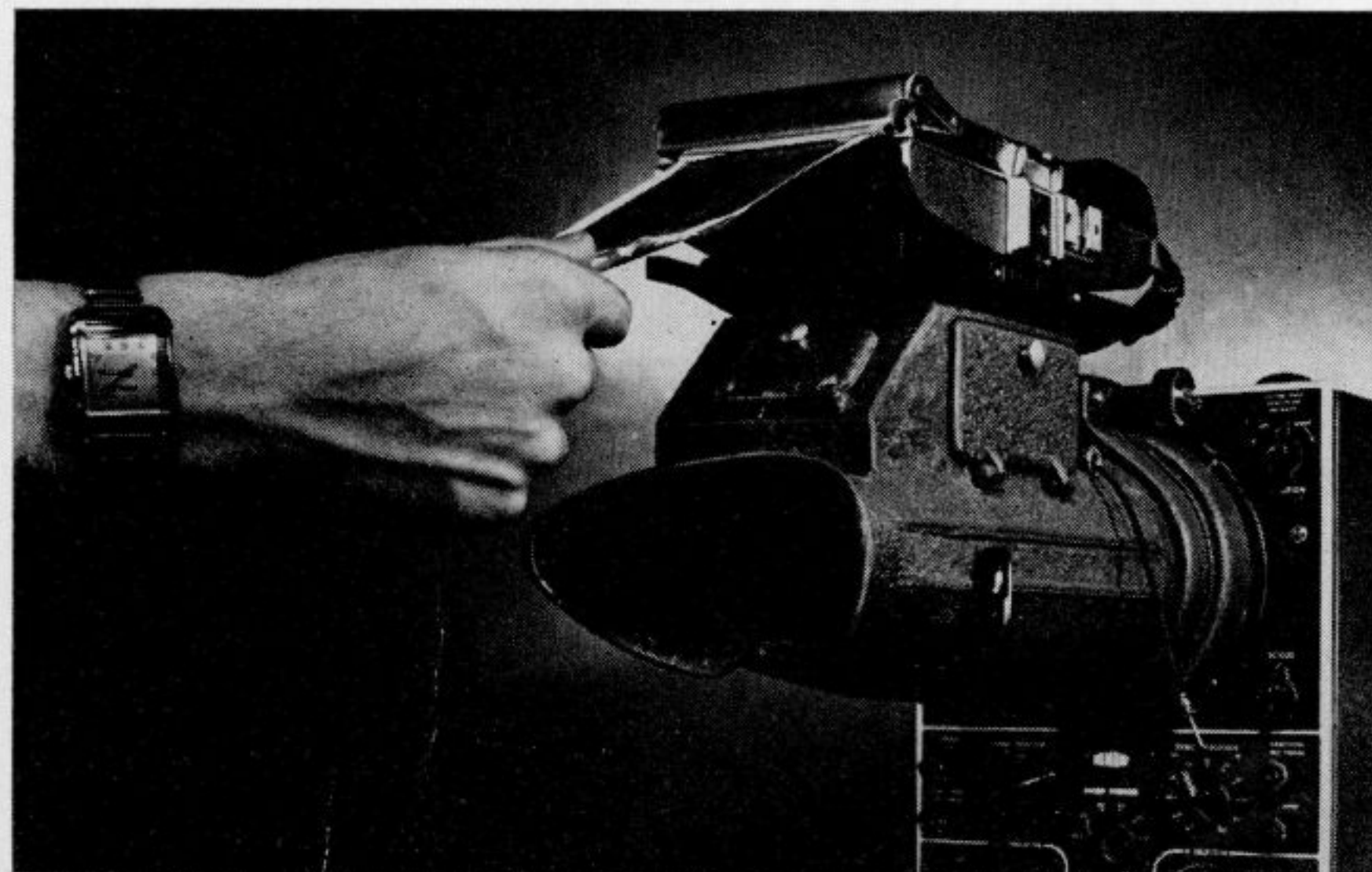

Figure 2. The camera back of the Type 297 is mounted in the most convenient position for pulling the film tab. The clamp ring holds the camera firmly to the oscillograph so that there is no danger of dislodging it during the film-advance operation. No additional brace or support of any kind is required

TYPE 297 OSCILLOGRAPH-RECORD CAMERA

from Figure 2, the camera does not interfere in any way with the operating controls of the oscillograph.

A Du Mont-Wollensak f/2.8 lens, coated to increase light transmission, is provided in the Type 297. This lens enables the recording of writing rates of up to 1 inch per microsecond from a P11 screen with 12,000 volts acceleration.

For applications where higher writing-rate capabilities are required, the Type 297 is available with an f/1.9 lens. The f/1.9 lens permits recording of writing rates up to 2 inches per microsecond under above mentioned conditions. Focus of the lens of the Type 297 is fixed. However, focus may be adjusted for special applications.

SPECIFICATIONS

**Camera Back:** Standard Polaroid-Land camera back.  
**Lens:** Special Du Mont-Wollensak f/2.8 or f/1.9 coated Lens; **Image-reduction Ratio:** 2.25  
**Shutter:** Wollensak Alphax, with speeds of "Time," "Bulb," 1/100, 1/50, 1/25.  
**Recording Material:** Polaroid-Land film, Type 41 (Black and white).

**Writing-rate Capability:** For Polaroid-Land Film, Type 41 (Black and white), 1 in/ $\mu$ sec for f/2.8 lens; 2 in/ $\mu$ sec for f/1.9 lens, with P11 screen and 12,000 volts.

**Physical Dimensions:** Length, 15 in.; width, 6 in.; height, 10 in.; weight, 12 lbs. Finished in blue-gray wrinkle.

| Catalog No. | Type No. | Description  |
|-------------|----------|--|
| 1552-E      | 297      | Oscillograph-record Camera with Wollensack, 75-mm, coated f/2.8 lens |
| 1553-E      | 297      | Oscillograph-record Camera with Wollensack, 75-mm, coated f/1.9 lens |
| 1561-E      | —        | 6 Rolls, Type 41 (Black and White) Polaroid-Land Film                |

# TYPE 321 OSCILLOGRAPH-RECORD CAMERA

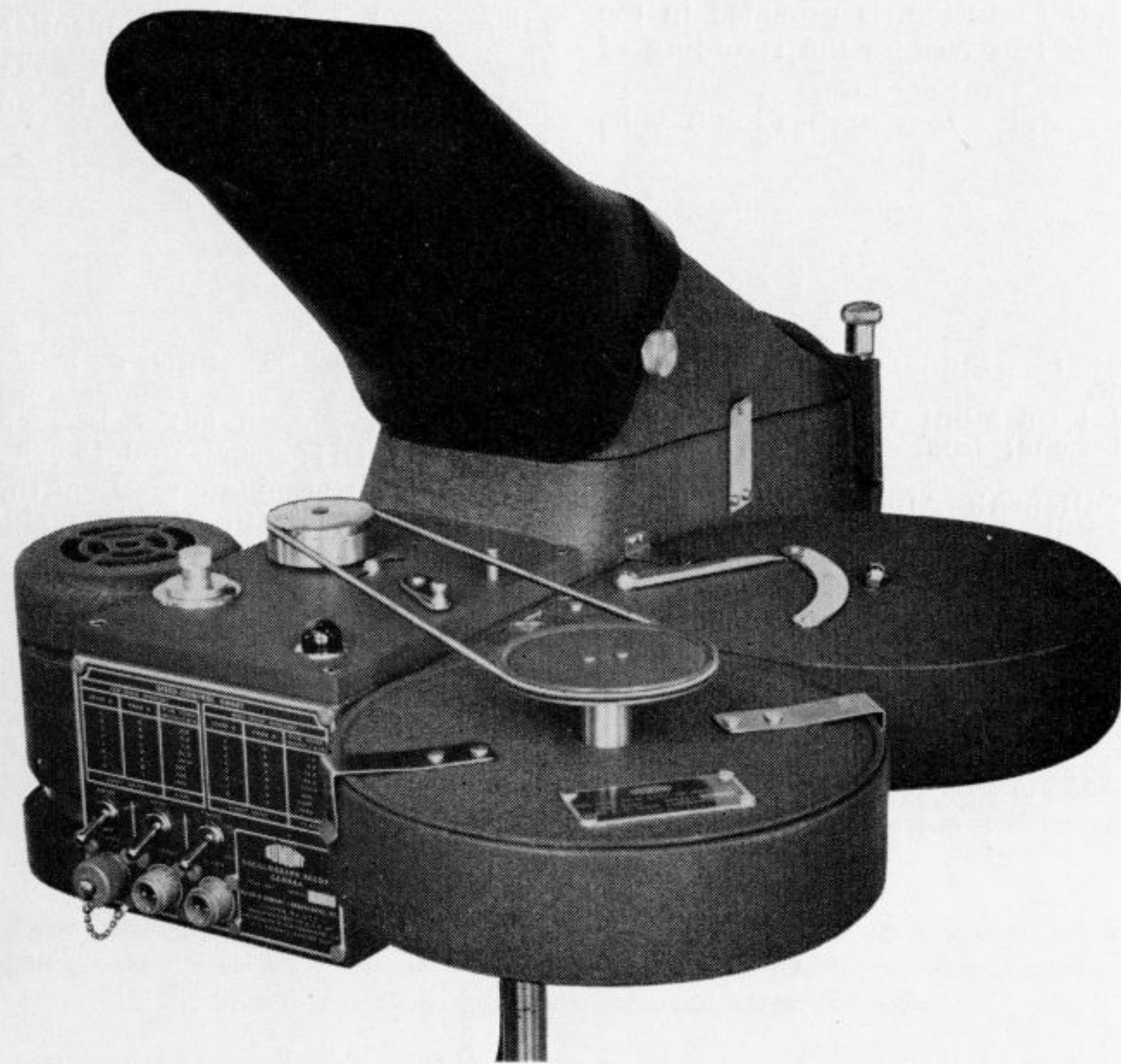

- Single-frame or continuous motion recording
- High-quality, coated f/1.5 lens
- Film speed variable from 1 to 10,800 inches per minute
- Built-in illuminated data card
- Simultaneous viewing and recording.
- Easily employed with any five-inch oscillograph

The Du Mont Type 321 Oscillograph-record Camera is designed to cover the entire range of oscillographic recording applications. Usable as either a single-frame or continuous-motion recorder, the Type 321 is capable of photographing virtually any oscillographic pattern encountered, even in the most highly specialized investigations. In spite of its great versatility, operation of the 321 is extremely simple, and a number of features have been incorporated which provide a convenience of recording not previously achieved.

The Type 321 may be used with any 5-inch oscillograph, and no elaborate mounting procedure is required.

### Optical System

The Type 321 employs high-quality coated f/1.5 lens, which enables recording of writing rates as high as 35-inches per microsecond from a P11 screen with 12,000 volts acceleration. Focus of the lens is normally fixed, the object distance being established by the extension barrel of the camera. However, for special applications, the focus may be quickly adjusted. Provision is incorporated for viewing the image on the focal plane, so that refocusing may be readily accomplished. Aperture settings of the Type 321 are variable from f/1.5 to f/22, and adjustment may be made through a port in the camera.

The shutter consists of a simple, sturdy, blade movement mounted behind the lens. The exposures of "time" and "bulb" are provided. This electrically operated shutter may be controlled either externally or internally, or automatically, by the motor control. A pilot light indicates when the shutter is open.

### Film Speeds

Film speeds are variable in 18 steps from 1 to 10,800 inches per minute. A friction film-drive is employed in the Type 321. Such a film-drive has several important advantages. First, this drive mechanism permits use of either perforated or unperforated 35-mm film or recording paper, greatly simplifying the problem of film procurement. Second, since there are no sprockets, film loading is extremely simple. To load the camera, it is necessary only to pull about 10 inches of film from the supply magazine, and push it into the supply slot of the camera body. The film is then automatically guided by the film gate, and quickly appears at the exit slot for attachment to the spool of the take-up magazine. Third, the friction drive mechanism greatly reduces the danger of tearing when recording paper is used.

The Type 321 is equipped with a solenoid film brake which is capable of bringing the film to a stop from full speed with a waste of less than one inch of film.

Film-supply and take-up magazines of the Type 321 may be easily attached or removed. These magazines are of sturdy, light-weight construction and may be easily carried to or from a dark room or handled in a changing bag. The supply magazine will take a standard 400-foot roll of 35-mm film or recording paper, or 100 foot spools of daylight-loading film or

paper. A length of exposed film may be removed from the camera in the light-tight take-up magazine at any time. A convenient film shear is built into the Type 321 for this purpose.

A neon glow lamp is provided in the Type 321 which may be used to record minor markers at the edge of the film. Light intensity from this glow lamp is sufficient to achieve adequate density of timing marks even at the highest recording speeds.

Since the shutter, film drive, and mechanism are electrically operated, remote operation of the camera may be easily accomplished. Manual film advance and manual operation of the shutter is also available.

An illuminated data card is built into the Type 321 for the recording of pertinent information on a frame or film strip. Also, convenient binocular viewing of the pattern is provided.

No modification of an oscillograph is required for use with the Type 321 Camera. The Type 321 is provided with a floor stand of adjustable height, which is equipped with casters so that the camera may be easily moved into the operating position. The camera is mounted in such a manner that it may be rotated through 90 degrees, enabling either horizontal or vertical recording, without altering deflection plate connections, or rotating the cathode-ray tube. Also, the Type 321 may be used with oscillographs having sloping front panels, as well as standard cabinet and rack-mounted models. Another advantage of this type of mounting is that, since there is no firm mechanical union between the oscillograph and camera, no motor vibration can be transferred to the oscillograph.

The entire camera, including controls, is packaged as a single unit.

### SPECIFICATIONS

**Optical System:** Wollensak f/1.5 coated Raptar lens. **Image Reduction Ratio,** 4.5  
**Shutter:** Permits exposures of Time and Bulb. Provision for operation by solenoid.  
**Writing-rate Capability:** 35 in./ $\mu$ sec with Type 5-RPA Cathode-ray Tube operated at 12,000 volts.

**Film Speed:** Variable in 18 steps from 1 to 10,800 inches/minute.  
**Recording Material:** Perforated or unperforated 35-mm film or, recording paper in lengths up to 400 ft.

| Catalog No. | Type No. | Description   |
|-------------|----------|---|
| 1554-E      | 321      | Oscillograph-record Camera with Wollensak Raptar, 50-mm, coated, f/1.5 lens for 115 volts, 60 cps only. |
| 1559-E      | 2581     | Supply Magazine for Type 321  |
| 1560-E      | 2582     | Take-up Magazine for Type 321   |

# PHOTOGRAPHIC ACCESSORY EQUIPMENT

## TYPE 2512 MOTOR DRIVEN PROCESSING UNIT

This Unit consists of two spools which will accommodate up to 100-feet of 35 mm film, a steel tank into which the spools fit, and a small, synchronous-inductor driving-motor. The spools and driving gear are attached to the tank cover-plate, but the spools are easily removed for loading and unloading of the film. Developer solution may be added to the tank or poured out through a solution spout without removing the cover-plate, which is held in place by spring-type clamps. The solution spout is light-baffled so that no light can enter the tank. The driving motor is placed on top of the cover plate. It turns the spools at a steady rate until the film is wound completely upon one of them, at which time it automatically reverses direction to rewind the film on the other reel. A time of approximately 1 minute is required

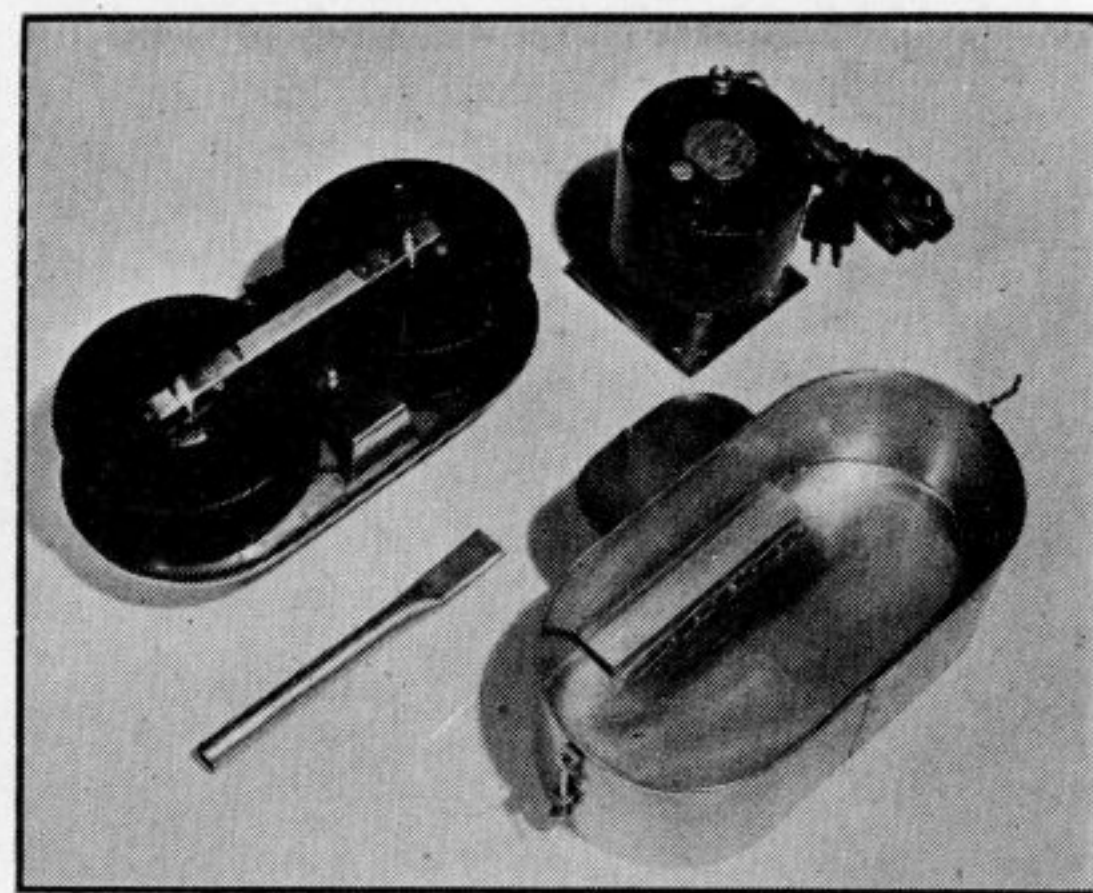

to wind 100-feet of film from one spool to the other. The spools can be cranked by hand if the motor drive is not used.

| Catalog No. | Type No. | Description  |
|-------------|----------|--|
| 1372-E      | 2512     | Motor-driven Processing Unit for 35 mm film; for operation from 115 volts, 50-60 cycles. |

## TYPE 2513 STAINLESS STEEL TANK

This Tank is for use with the Motor-driven Processing Unit, and is similar to the one supplied with the Unit except that it has no solution spout.

| Catalog No. | Type No. | Description   |
|-------------|----------|---|
| 1374-E      | 2513     | Extra Stainless-steel Tank, plain, without solution spout for use with Type 2512 Processing Unit. |

## TYPE 2514 PORTABLE DRYING RACK

This is an all-metal rack which will hold up to 200 feet of 35 mm film. A motor drive turns the Rack slowly, moving the film past a heating unit consisting of four infra-red lamps. A film squeegee is provided to remove excess moisture from the film as it is wound onto the rack. Clamps on the Rack hold the ends of

| Catalog No. | Type No. | Description   |
|-------------|----------|---|
| 1375-E      | 2514     | Portable Drying Rack, motor-driven; for operation from 115 volts, 50-60 cycles. |

## TYPE 2580 FILM TAKE-UP CASSETTE

The Type 2580 Film Take-up Cassette is designed for use with the Du Mont Type 295 Oscillograph-record Camera. Equipped with a light trap and a film-cut-off knife, the Type 2580 enables removal of strips of film in lengths from several inches to 5 feet without

| Catalog No. | Type No. | Description   |
|-------------|----------|---|
| 1558-E      | 2580     | Film Take-up Cassette for Type 295 Oscillograph-record Camera |

# PHOTOGRAPHIC ACCESSORIES

## TYPE 2581 FILM SUPPLY MAGAZINE

The Type 2581 is intended for use with the Du Mont Type 321 Oscillograph-record Camera. This supply magazine will accommodate

up to 400 feet of 35-mm feet of film or recording paper, and is designed so that attachment and removal may be readily accomplished.

| Catalog No. | Type No. | Description  |
|-------------|----------|--|
| 1559-E      | 2581     | Film Supply Magazine for Type 321 Oscillograph-record Camera |

## TYPE 2582 FILM TAKE-UP MAGAZINE

The Type 2582 Film Take-up Magazine, intended for use with the Du Mont Type 321 Continuous-motion Oscillograph-record Camera, enables removal of strips of 35-mm film or recording paper in length of up to 400 feet. Exposed film, cut off by means of the shear built into the Type 321, may thus be removed

for processing with no danger of fogging the remaining supply of film in the camera.

Use of an additional Take-up Magazine enables the operator to remove a length of exposed film for processing, and immediately continue recording, without having to wait for the original magazine to be returned from the dark room.

| Catalog No. | Type No. | Description   |
|-------------|----------|---|
| 1560-E      | 2582     | Film Take-up Magazine for Type 321 Oscillograph-record Camera |

## POLAROID-LAND FILM

Type 41 (black and white) recording material for the Du Mont Type 297 Oscillograph-record Camera is made available in cartons of six rolls, (each of which provides 8 frames).

For details on the nature of the Polaroid-Land recording material, as well as on recording techniques, see page 141.

| Catalog No. | Description  |
|-------------|--|
| 1561-E      | 6 rolls of Type 41 (Black and White) Polaroid-Land film. |

**GENERAL  
INFORMATION**

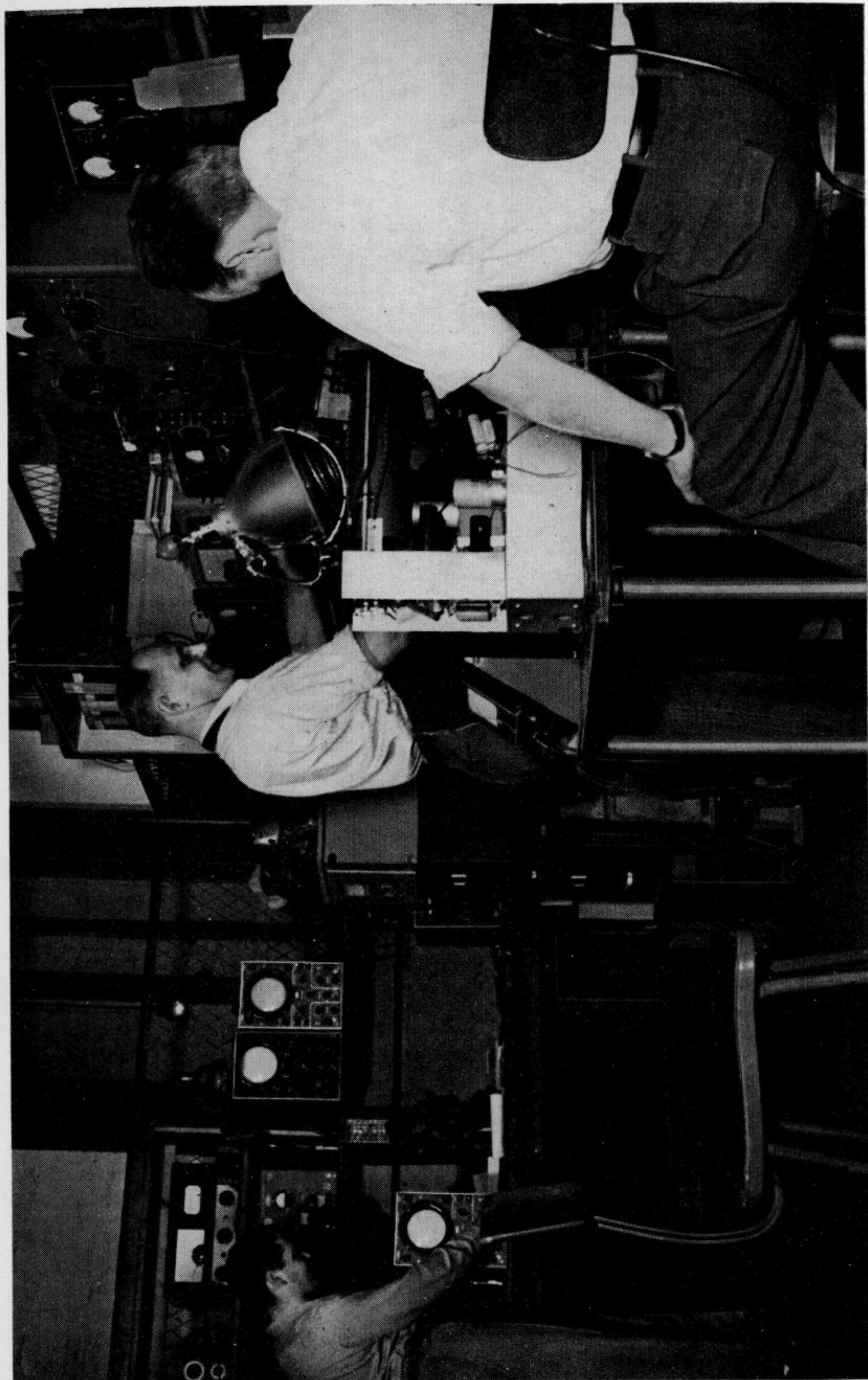

A view of the Instrument Service Depot at Clifton, New Jersey. The Instrument Division maintains well equipped Service Depots at strategic points throughout the country

## GENERAL INFORMATION

### The Cathode-ray Oscillograph

An oscillograph is, as the name implies, a device for graphing oscillations. And the cathode-ray oscillograph is an oscillograph whose indicating element is a "cathode-ray" or, more properly, an electron beam.

Owing to the inherent electrical charge of the electrons of this beam, the beam may be bent, or deflected, to trace a pattern on a fluorescent screen, plotting the instantaneous values of one electrical potential with respect to another. (For a full description of the function of the cathode-ray tube, see page 88.)

Although the cathode-ray oscillograph is basically an electrical instrument, the oscillations displayed on the screen need not be exclusively electrical. Mechanical vibrations, variations in heat or light intensity, changes in speed, pressure, weight, size, or shape—to cite only a few examples—may be presented as oscillographic patterns, providing that suitable means are available for converting such phenomena into proportional electrical signals. Such conversion is usually a relatively simple matter, and a great number of devices for such

a purpose (generally known as transducers) are commercially available. A few examples are: microphones, photocells, vibration and displacement pick-ups, and thermocouples, among many others.

The use of an electron beam as an indicating element has several important advantages over other indicating devices:

1. The electron beam has negligible inertia. Thus it can follow extremely high-speed phenomena, displaying rapidly changing quantities with a fidelity that cannot be approached by any other means.

2. It requires negligible power for indication, so that it imposes virtually no load upon the signal under investigation.

3. Excessive deflection voltage cannot injure the oscillograph. Thus it is not a delicate instrument.

In view of these facts, the cathode-ray oscillograph is unquestionably the most versatile indicating device available today.

### History

The first practical, commercial cathode-ray oscillograph was introduced in the United States in 1932 by the Allen B. Du Mont Labo-

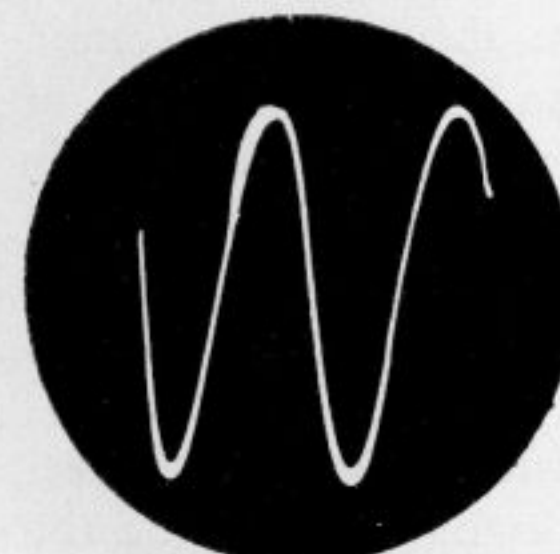

Sinewave produced by a tuning fork

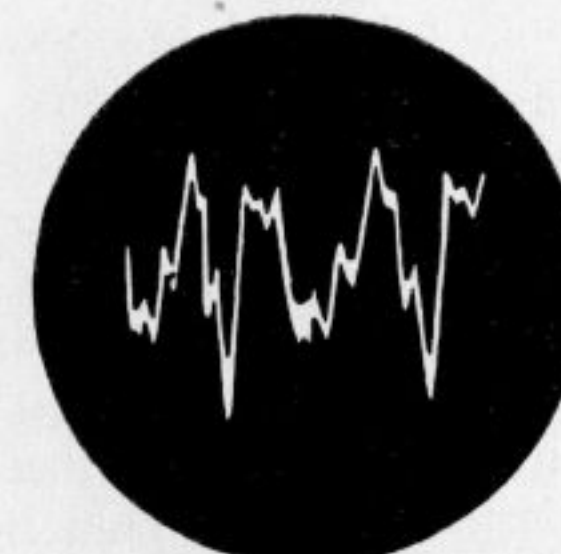

G-392 cycles per second as produced by a single reed of an accordion

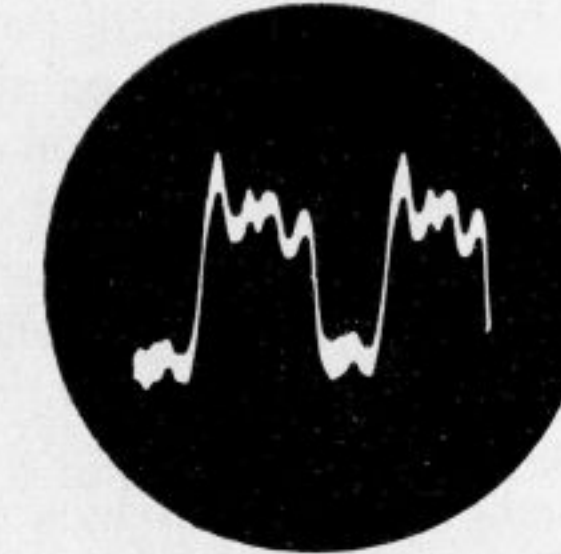

E-329.6 cycles per second as produced by the D string of a violin

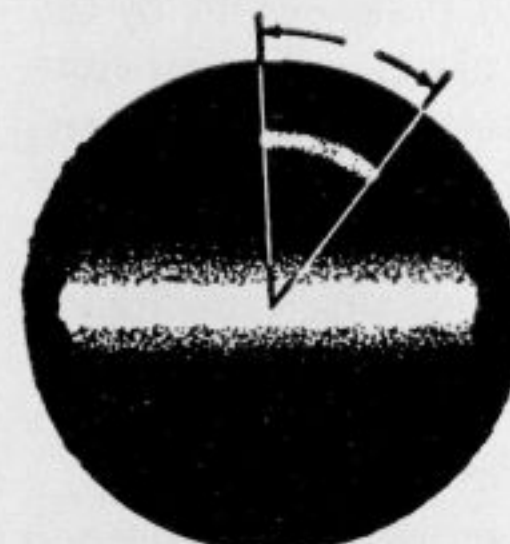

Operation of a two-way snap-switch accurately timed



Response of an amplifier to a square-wave signal

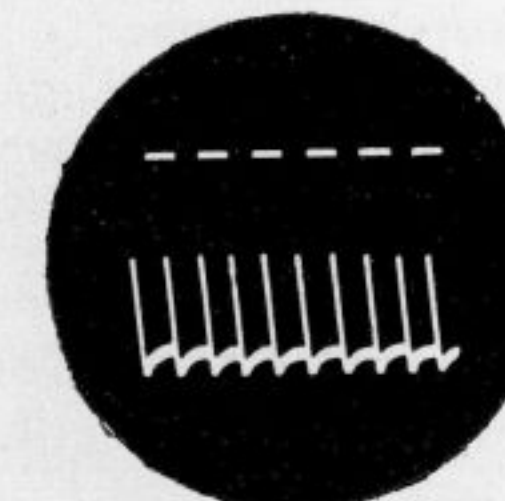

Wave-form produced by an instrument used for brain study and research

Figure 1. Typical oscillograms taken from a cathode-ray oscillograph

ratories. Limitations of early instruments were, of course, severe in relation to oscillographs produced today. However, improvements came rapidly, and by the time World War II began the cathode-ray oscillograph was established as an important laboratory instrument. The oscillograph opened the door for extensive circuit development, which, in turn, help create better oscillographs. This spiral, greatly accelerated by war-time demands, continues even now. Thus, in less than two decades, Du Mont has taken the cathode-ray oscillograph from the realm of the laboratory curiosity, and made it a vital tool of modern science and technology.

### Du Mont Research and Development

The intensive program of research and development continuously carried on at the Du Mont Laboratories is largely responsible for this company's position of leadership in the industry. New instruments are constantly being developed, making the Du Mont line of oscillographs and associated equipment the most complete one available. Similarly, new cathode-ray tubes are developed by Du Mont—a leading manufacturer of cathode-ray tubes as well as of oscillographic equipment—to fulfill the requirements created by advanced studies and design.

The design of any electronic equipment resolves from a series of compromises which represent the designer's opinion of an ideal instrument consistent with contemporary engineering and production techniques.

We feel, however, that the real test of an instrument is the opinion of those who use it. This day-to-day test of its advantages and its limitations will prove, better than any other method, just what characteristics are desirable, why the range of any given function of the equipment should be extended, and how important such modification is.

It is only by cooperation between the customer and our Engineering Department that satisfactory designs can be achieved. In an attempt to extend the applicability of our equipment to all kinds of engineering problems, we sincerely request suggestions from our customers.

### General Description of the Cathode-ray Oscillograph

The heart of the cathode-ray oscillograph is, of course, its indicating element, the cathode-ray tube. However, the cathode-ray tube by itself is not a complete instrument, since various potentials are required to operate it, and care-

fully designed auxillary circuits greatly extend its usefulness. Thus, the cathode-ray oscillograph may be said to consist of the indicating tube, plus the following circuits:

#### 1. The high-voltage power supply.

The high-voltage power supply provides the potentials required for operating the cathode-ray tube. These are: the accelerating potential, which drives the stream of electrons toward the fluorescent screen at high velocity; and the focusing voltage, which reduces the beam to its smallest possible cross section to obtain a fine, brilliant spot.

Power requirements for acceleration and focusing are small, although the potentials furnished by the high-voltage power supply usually run to several thousand volts. The combination of the cathode-ray tube and the high-voltage power supply is sufficient to form a basic cathode-ray indicator.

#### 2. Deflection amplifiers.

The basic indicator consisting simply of a cathode-ray tube and its associated high-voltage power supply is a relatively insensitive device, requiring potentials of the order of several hundred volts for significant deflection. However, since the majority of applications employs signals of far smaller amplitude, amplifiers are customarily included. While these deflection amplifiers permit the investigation of low-potential signals, they impose certain limitations upon the range of application of the instrument. Were the signal under study applied directly to the deflection plates of the cathode-ray tube, the only limitations would be those imposed by the physical characteristics of the tube itself. That is, the maximum amplitude that could be observed would be limited only by the full-screen deflection of the beam. The maximum frequency that could be displayed on the cathode-ray tube would be restricted only by the transit time—the time required for an electron to pass through the space between the deflection plates—and by the shunt capacitance between plates. Transit-time effects generally restrict usefulness to frequencies below 200 megacycles per second in commercial tubes operating at accelerating potentials of around 1500 volts. Shunt capacitance may load down a signal source at any frequency, depending upon the internal impedance of the source.

Should the signal under study be passed through a deflection amplifier, then the frequency-response characteristics of the amplifier limit the signal frequency which may be displayed, and any signal either below or above

the frequency-response limits of the amplifier will appear distorted on the screen of the cathode-ray tube.

The design of the deflection amplifier, therefore, is based upon a compromise of gain, bandwidth, and cost, with the ultimate decision resting largely upon the applications for which the particular instrument is intended. (Refer to the section on Design Considerations for more complete information on amplifier design.)

#### 3. Linear Time-Base Generator

The circuit which provides the time variable in the oscillograph is known as the linear time-base generator. The linear time-base generator develops a voltage wave which increases in amplitude at a rate directly proportional to time, and after reaching a certain peak voltage returns rapidly to the original minimum value. This "sawtooth" voltage is applied to the horizontal deflection plates of the cathode-ray tube, and causes the spot on the fluorescent screen to move (usually from left to right) in such a way that its velocity is directly proportional to time. When the spot reaches the extreme right end of its traverse, it moves rapidly back to the left and begins the cycle again. The frequency at which this function is performed may be varied by means of suitable controls.

The frequency of the sawtooth voltage may be synchronized, or "locked-in," with the frequency of the recurrent signal being applied to the vertical deflection plates. Since the spot then begins its left-to-right traverse at the same point in each cycle of the signal, the resultant pattern on the screen appears stationary to the observer, as long as the frequency of recurrence is equal to, or higher than, that required for persistence of human vision.

Sometimes it is necessary to observe a phenomenon which is not recurrent, but transient in nature. Such a phenomenon occurs either

once, or at a non-cyclic rate. If the sawtooth generator as described above were used, there would be no assurance that the beginning of the phenomenon would correspond with the start of the left-to-right traverse of the spot. The time base generator is therefore modified so that the left-to-right travel is initiated by the occurrence of the transient, and so that there is no motion of the beam at any other time. This type of operation of the time base generator is referred to as "driven" or "single" sweep. (More complete information on time-base generators is found in the section on Design Considerations.)

#### 4. Low-Voltage Power Supply

The low-voltage power supply furnishes power to the various vacuum tubes employed in the cathode-ray oscillograph. The requirements for this supply are more stringent than are those for the high-voltage power supply, in order to avoid cross coupling between various circuits. (Refer to section on Oscillograph Design Considerations.)

#### 5. Intensity Modulation Circuits

A signal applied to the grid or cathode of the cathode-ray tube will modulate the intensity of the spot on the screen in accordance with the polarity and amplitude of that signal. This principle is utilized to provide timing marks or reference points on the pattern. Such marks can be made by using an oscillator or pulse generator of known frequency or repetition rate.

Intensity modulation is also a useful means for intensifying the beam over portions of the pattern where the motion of the spot is extremely rapid. In these portions, the fluorescent screen might not otherwise be sufficiently excited to afford good visibility of indication.

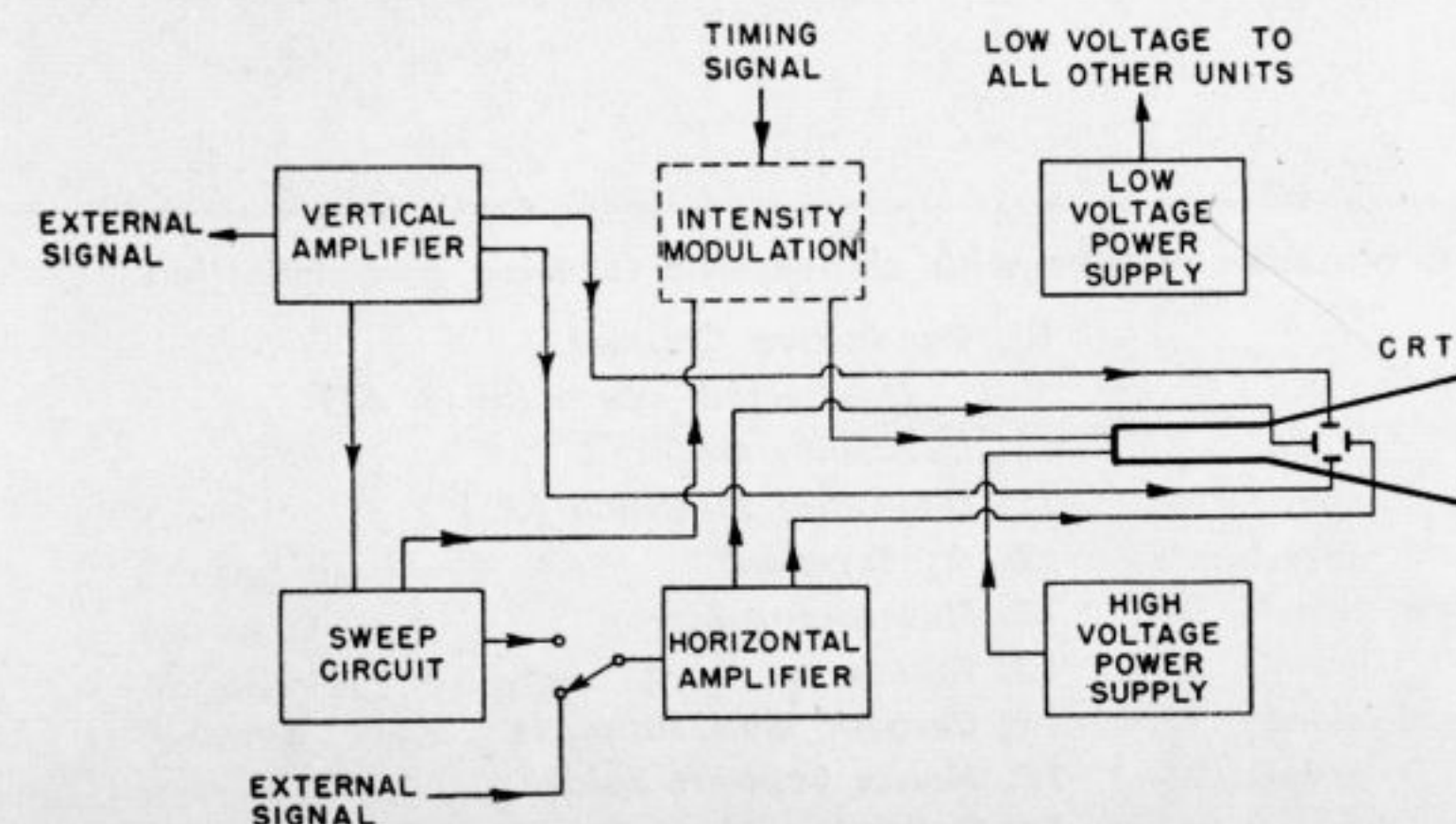

Figure 2. A simplified block diagram of a typical cathode-ray oscillograph, showing the relationship of the various elements to each other.



**Cathode-ray Tube**

The cathode-ray tube is a two dimensional indicating device capable of plotting one quantity as a function of another. Free from inertia effects, it has become a most important instrument by means of which electrical phenomena may be observed and measured. As used in the cathode-ray oscillograph, it is of immeasurable value to engineers and technicians since it makes possible instantaneous observation of the variations of one phenomenon with respect to another. In addition to oscillographic applications, the cathode-ray tube has become the medium for reproducing television pictures and the essential indicating device in radar, among many other applications.

The cathode-ray tube is not as new a device as might be supposed from its increased use in recent years. In fact, the first device in which an electron stream in a sealed tube was focused on a fluorescent screen to produce a movable fluorescent spot was built by Braun in 1897. The introduction of the hot cathode in 1905, the application of gas focusing (now generally abandoned), improvements in cathode design, the use of a negative grid, general improvement in the "electron gun", improvements in the fluorescent screen, and the development of suitable auxiliary circuits, gradually brought

the cathode-ray tube to its present form.

A cut-away drawing of a modern high-vacuum electrostatic focus and deflection cathode-ray tube is shown in Figure 3. The heater element (2), mounted in the cathode sleeve (3), heats the oxide coating on the end of the sleeve, causing electron emission. The electric field produced by the control electrode or grid (4) and by the pre-accelerating electrode (5)—internally connected to the accelerating electrode—acts to draw the electrons emitted from the cathode into a narrow beam having minimum cross-section in the vicinity of the grid.

From this point the electron beam diverges until it reaches the region of the focusing electrode (6) where the electric fields set up by the combined actions of the end of the pre-accelerating electrode, the focusing electrode, and the accelerating electrode cause the beam to converge so that when it reaches the fluorescent screen (14) it again has a minimum cross-section. This action is analogous to the action of optical lenses on light, and it may be said that the minimum cross-section of the beam in the vicinity of the grid is focused onto the screen by the electron lens formed by the fields the vicinity of the grid is focused on the between the focusing electrode and the pre-accelerating and accelerating electrodes.

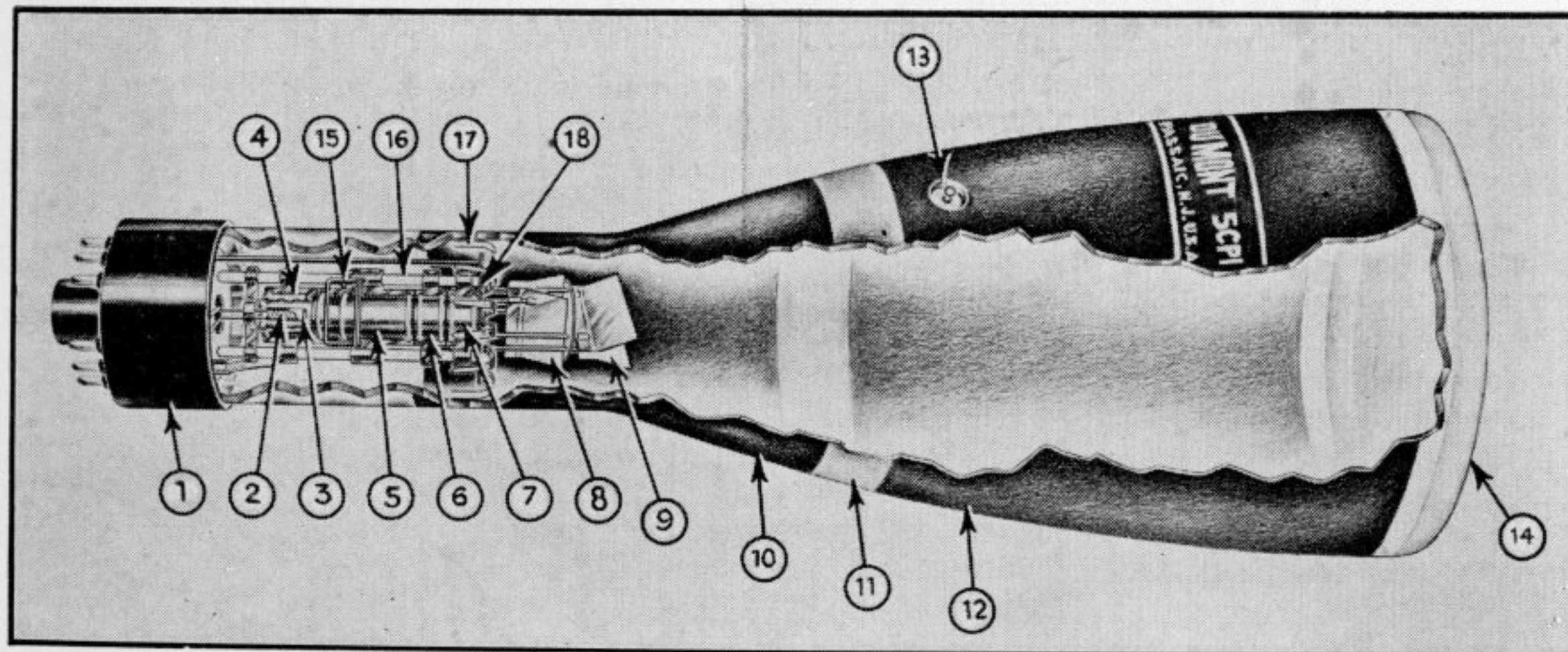

Figure 3. An example of a cathode-ray tube with electrostatic focusing and deflection

- |   |  |
|---|--|
| 1. Base   | 10. Conductive Coating<br>(connected internally to $A_2$ ) |
| 2. Heater   | 11. Intensifier Gap  |
| 3. Cathode  | 12. Intensifier Electrode ( $A_3$ )                        |
| 4. Control Grid ( $G$ )   | 13. $A_3$ Terminal   |
| 5. Pre-accelerating Electrode<br>(connected internally to $A_2$ ) | 14. Fluorescent Screen                                     |
| 6. Focusing Electrode ( $A_1$ )                                   | 15. Getter   |
| 7. Accelerating Electrode ( $A_2$ )                               | 16. Ceramic Gun Supports                                   |
| 8. Deflection Plate Pair ( $D_3D_4$ )                             | 17. Mount Support Spider                                   |
| 9. Deflection Plate Pair ( $D_1D_2$ )                             | 18. Deflection Plate Structure Support                     |

The control electrode is ordinarily operated at a negative potential with respect to the cathode, and the beam current (and therefore the brightness of the spot) is varied by varying this bias potential. This potential difference is of the order of 50 volts. The focusing electrode usually operates at a lower voltage than the accelerating electrode. By varying this focusing electrode voltage (which is usually about 200 volts per kilovolt of accelerating potential), the spot is properly focused on the screen. The entire beam-forming structure is known as the "electron gun."

After leaving the gun, the electron beam passes between the plates of the deflection-plate pair (8) and then between the plates of the pair (9). A potential difference applied between the plates of the pair (8) produces an electric field which deflects the electron beam in a direction perpendicular to the plane of those plates. Similarly, a potential applied between the plates of pair (9) results in deflection of the beam in a direction perpendicular to that produced by plate pair (8). Thus

it is possible to control the position of the spot on the screen by two potentials applied to the two sets of deflection plates.

The intensifier electrode (12), a Du Mont development, is operated at a higher voltage than the accelerating electrode. This intensifier electrode serves further to accelerate the electrons in the beam subsequent to deflection. The deflection sensitivity of the beam varies inversely with the potential applied to the accelerating electrode, which potential, measured from cathode, determines the velocity of electrons in the deflection-plate region. However, the brilliance of the fluorescent trace produced by the electron beam increases with increase in accelerating potential. A compromise must therefore be made between brilliance and deflection sensitivity. With the intensifier-type cathode-ray tube, the necessity for compromise is greatly reduced, since the beam may be deflected at a low accelerating electrode potential and then further accelerated after deflection by a higher potential applied to the intensifier electrode.

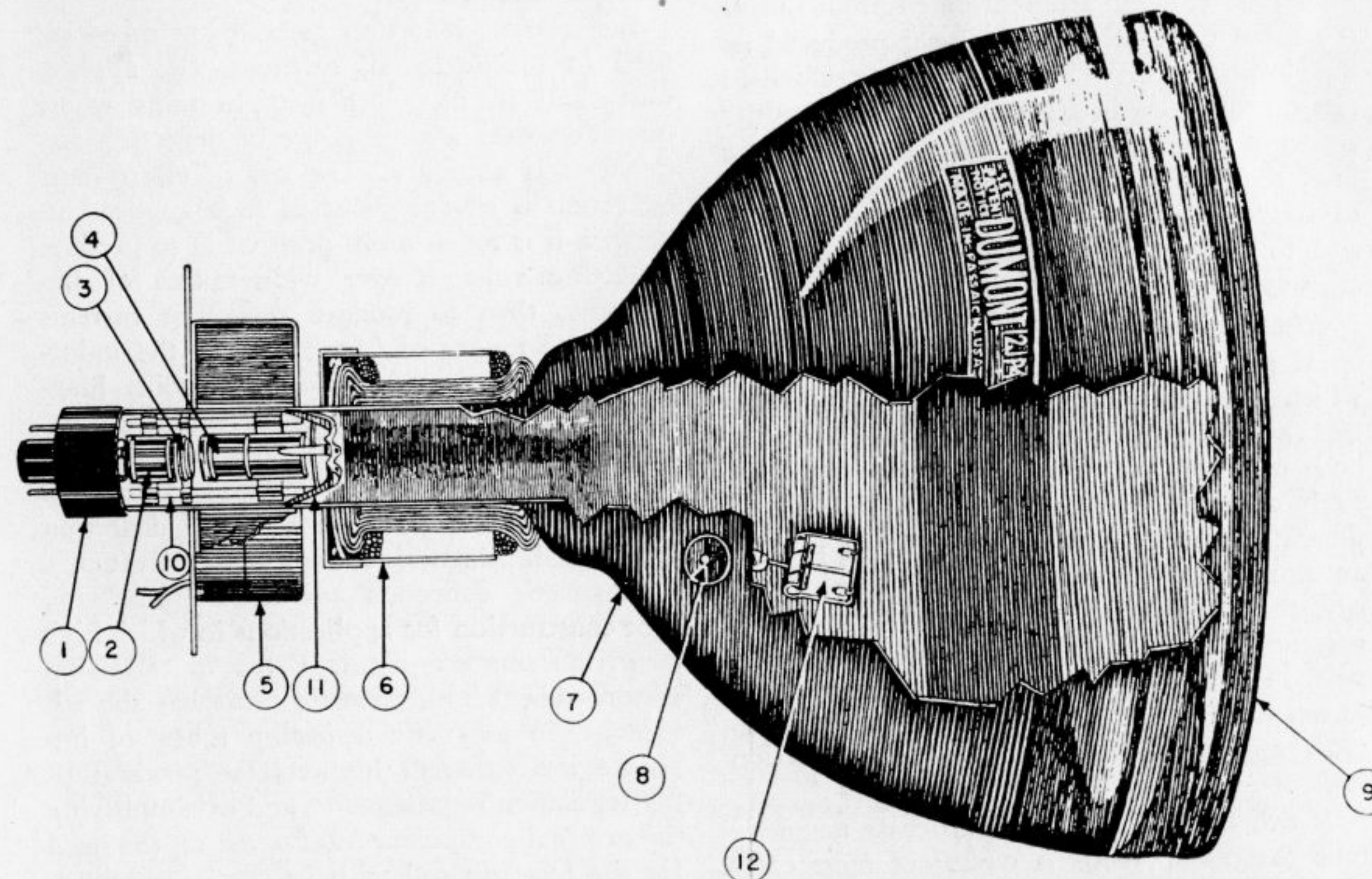

Figure 4. An example of a cathode-ray tube with magnetic focusing and deflection

- |                                   |                             |
|-----------------------------------|-----------------------------|
| 1. Base                           | 7. Anode Conductive Coating |
| 2. Control Electrode ( $G_1$ )    | 8. Anode Terminal           |
| 3. Screen Grid ( $G_2$ )          | 9. Fluorescent Screen       |
| 4. Accelerating Electrode ( $A$ ) | 10. Ceramic Gun Support     |
| 5. Focusing Coil                  | 11. Mount Support Spider    |
| 6. Deflection Yoke                | 12. Getter                  |

It will be noted that in the cathode-ray tube just described, focusing and deflection of the beam are both accomplished by electrostatic fields. It is also possible to use magnetic fields for either focusing or deflection or both.

An outline drawing of a typical magnetic focus and deflection cathode-ray tube is shown in Figure 4. As in the case of the electrostatic tube, a heater element mounted within a cathode sleeve heats the oxide coating on the end of this sleeve, causing electron emission. As in the case of the electrostatic tube, electrons emitted from the cathode are drawn into a narrow beam having a minimum cross-section in the vicinity of the control electrode (2). The beam diverges after leaving the cross-over and, continuing to diverge, passes through the screen grid (3) which is operated at a fixed positive potential (usually about 250 volts), and passes through the accelerating electrode (4) which accelerates the electrons to their final velocity. The beam continues to diverge (though it is made somewhat less divergent in passing through the electrostatic field between the screen grid and accelerating electrode) until it reaches the axial magnetic field produced by the focusing coil (5). This magnetic field acts on the beam in a manner analogous to the action of a lens on a light beam (insofar as the final result is concerned), to cause the beam to converge after leaving the magnetic field, and to arrive at the screen with a minimum cross-section.

After passing through the focusing coil, the beam passes through the deflection yoke (6), which contains two pairs of coils that produce two mutually perpendicular magnetic fields, both of which are perpendicular to the beam. Each of these fields deflects the beam in a direction perpendicular to its lines of flux by an amount which varies with the field intensity, the intensity in turn being varied by the current flowing through the corresponding coil pair. Thus, the position of the spot on the screen can be controlled by means of two currents applied to the two pairs of deflection coils.

It will be noted that the particular magnetic tube described, which is typical of most commercial magnetic types, differs from the electrostatic tube previously described, in that the role played by the pre-accelerating electrode in the electrostatic tube, insofar as the formation of the beam in the vicinity of the grid and crossover is concerned, is played by a screen grid (3) which is connected to a fixed positive potential. The use of such a separately con-

nected screen grid, the potential of which can be held constant regardless of the potential applied to the accelerating electrode, has the advantage of making it possible to operate the tube over a wide range of accelerating potentials, depending upon the requirements of the application, without greatly changing the grid control characteristic of the tube.

Other types of gun structures are possible. Many electrostatic focus tubes have only a grid, a long focusing electrode, and an accelerating electrode. In this case the focusing occurs as a result of the field between focusing electrode and accelerating electrode. Magnetic focus tubes have been made with only a control grid and accelerating electrode. In some magnetic tubes, the accelerating electrode has consisted merely of a conductive coating on the glass neck of the tube.

As previously mentioned, it is possible to use electrostatic focus and magnetic deflection. Magnetic focus is not used to any extent with electrostatic deflection, because it would be very inconvenient to center the beam between the deflection plates.

Electrostatic-deflection cathode-ray tubes are used in practically all oscillographic applications and in most other applications where operation over a wide range of deflection frequencies is necessary. The use of electrostatic deflection is advantageous in such applications because it is much more practicable to produce deflecting voltages over wide ranges of frequencies, than to produce deflecting currents over wide ranges of frequencies in the inductive circuits presented by deflecting coils. Magnetic deflection is advantageous where the deflection frequencies are fixed, and maximum intensity, minimum tube length, and minimum distortion of the spot as a result of deflection are desired. Magnetic focus has the advantage, in magnetic deflection tubes, of simplifying tube construction for applications in which high beam currents are required (as in television picture tubes). Electrostatic focus has the advantage, in magnetic deflection tubes, of imposing less stringent high-voltage power supply regulation requirements, and of simplifying the external equipment by eliminating the need for the focusing coil with its centering adjustments, etc. The power supply regulation does not need to be as good because, by obtaining the focusing electrode voltage from a bleeder across the accelerating voltage power supply, the focusing electrode voltage will vary in proportion to the accelerating voltage, and the tube will therefore not go out of focus if the accelerating voltage varies slightly.

## CONSIDERATIONS INVOLVED IN THE CHOICE AND USE OF CATHODE-RAY TUBES FOR OSCILLOGRAPHS AND FOR SPECIAL APPLICATIONS

In choosing a cathode-ray tube for any particular application, points which should be considered are type of screen to be used, operating potentials which can be supplied conveniently or economically, spot size and intensity required, deflection sensitivity required, and the importance of deflection-plate or grid capacitance.

### Operating Potentials, Spot Size, Intensity, Deflection Sensitivity

In most applications, high deflection sensitivity, high intensity, small spot-size, and minimum operating potentials are desirable. Since there are several conflicting factors involved, compromise is usually necessary. In general, intensity and spot size must be considered together. With a given tube, the spot size decreases and brilliance improves with increasing accelerating voltage, but the deflection sensitivity decreases. Furthermore, high accelerating voltages are in themselves undesirable from the standpoint of economy and simplicity in equipment. The particular application will, therefore, determine the tube to be used and the conditions of its operation. Where maximum intensity and minimum spot size are most im-

portant, high accelerating voltages are indicated. Where maximum deflection sensitivity is the most important requirement, lower accelerating potentials should be used. For applications where maximum deflection sensitivity and maximum brilliance are required, intensifier-type cathode-ray tubes should be used, since a high final accelerating potential can be used with a minimum of effect on the deflection sensitivity. The intensifier-type cathode-ray tube also simplifies the power supply problem for a given overall accelerating potential by reducing the maximum voltage for which the power supply must be insulated from ground.

### Deflection-plate Capacitances

For applications where high-frequency potentials are supplied to the deflection plates, minimum deflection-plate lead lengths and capacitances are essential. For such applications, special high-frequency cathode-ray tubes are made in which the leads are brought from the deflection plates directly to terminal caps on the neck of the cathode-ray tube opposite the plates. In this way the total effective capacitance between two plates of a deflection-plate pair can be lowered to two or three  $\mu\mu\text{f}$ .

## SCREENS

The screen is the part of the cathode-ray tube where the energy of the electron beam is transformed into useful light output. Particular attention must be given, therefore, to the proper choice of the screen material according to the desired application.

A brief description of various screen types and their applications is given in the following paragraphs, and the principle characteristics of each screen type are shown on individual characteristic sheets. It must be kept in mind, however, that the data given in the characteristic sheets are average data; characteristics may vary with individual tubes.

### P1 Screen

The Type P1 screen produces a green trace of medium persistence and is well suited for general-purpose, visual oscillographic work. It is quite efficient, and bright traces can be obtained with comparatively low accelerating voltages. The spectral distribution of the light produced is in the region of high sensitivity of

the human eye, resulting in good contrast even when the tube is illuminated by daylight or incandescent lighting. For photographic purposes, satisfactory results may be expected in the recording of recurrent phenomena and slow-speed transients where blurring is not a limitation. By increasing the accelerating voltage on the tube, both visual and photographic efficiency may be increased many times.

### P2 Screen

The P2 screen produces a bluish-green fluorescent trace with a long-persistence yellow phosphorescence. This phosphorescence is useful for visual observations of transient signals and very-low-frequency recurrent signals. With this type of screen a pattern can be observed for a period ranging from a fraction of a second to several minutes after it has been produced, depending upon the spot writing rate, accelerating potential, level of the ambient light, and the dark adaptation of the observer.

Since the fluorescent light output is many

times that of the phosphorescence, the P2 screen is also useful for observation and photography of the short-persistence fluorescent trace only. In applications where it is desired to attenuate the long-persistence phosphorescence, a blue filter (Du Mont Type 2560-B filter or equivalent) may be used.

Because of the dual-purpose feature of the Du Mont P2 screen, and because of its relatively high resistance to burning at high voltages and currents, this screen type is recommended for use in the Type 5RP-A and other high voltage oscillograph tubes.

For additional data on this screen type refer to sections "Visual Observation of Transients," and "Photographic Recording from Cathode-ray Tubes" on pages 122 and 130, respectively.

**P5 and P11 Screens**

Two general types of blue screen materials are available commercially for photographic work. These screens are the tungstate Type P5 and the sulphide, Type P11.

The general characteristics of the P5 and P11 screens may be compared as follows: Both screens are of the short persistence blue fluorescent type and of high photographic activity, the main difference being the considerably higher photographic and visual efficiency of the P11 screen, and the shorter persistence of the P5 screen. The use of the P11 Screen is advantageous for all still photographic applications, particularly of high-speed phenomena, and for continuously moving film recording up to the limit where persistence produces blurring of the picture (approximately 200 kc/sec). The use of the P5 screen is recommended only for high-speed, continuous-motion picture recording at speeds above

the limit at which blurring occurs with P11 screens. The P5 screen can be used above 200 kc/sec. without blurring. Detailed characteristics of the P5 and P11 screen are given on the accompanying characteristic sheets.

**P7 Screen**

The type P7 screen produces a blue fluorescent trace with a long persistent yellow phosphorescence. It is useful for visual observations of transient signals and very low frequency recurrent signals. With the P7 screen, as with the P2 screen, a pattern can be observed for a period ranging from a fraction of a second to several minutes after it has been produced, depending upon the writing rate of the spot, the accelerating potential, and the level of the ambient light. The P7 screen has greater persistence than the P2 screen for the lower writing rates, and has the further advantage that the large difference in color between the initial light and the persistent light makes it possible to filter out the initial bright "flash" by a yellow filter such as the Wratten #15.

The P7 screen may also be used for photographic recording, provided the proper precautions are taken. The yellow component of the light may be filtered out with a blue filter such as the Du Mont Type 2560-B, or a Corning #5030, or an even darker blue filter when continuous motion recording is desired. In some cases, as in repeated patterns, the yellow component may not interfere with photography, or may even aid it. For example, in photographing a single transient of high writing rate the light due to persistence may add some much needed exposure if a red sensitive or panchromatic film is used.

**Comparison of the Essential Characteristics of P5 and P11 Screens**

| Property   | P11            | P5               |
|--|----------------|------------------|
| * Relative photographic efficiency (Eb = 4000 V, Ib = 50 µa) .....                 | 5              | 1                |
| * Relative visual efficiency .....   | 3.3            | 1                |
| Persistence time for energy drop 50% .....   | 10 µsec.       | 5 µsec.          |
| Persistence time for energy drop 1/e .....   | 18.6 µsec.     | 7.2 µsec.        |
| Persistence time for energy drop 10% .....   | 116 µsec.      | 15.2 µsec.       |
| (Eb = 4000 V; Ib = 50 µa, 1 cm. spot) .....  |                |                  |
| Limit recording frequency for continuous-motion film camera (blurring limit) ..... | 200 kc./sec.   | >200 kc./sec.    |
| Spectral Range .....   | 3550-6100Å     | 3400-6100Å       |
| Maximum .....  | 4350Å          | 4300Å            |
| Film type recommended: .....   | Orthochromatic | Orthochromatic** |

\* These figures are based upon screen efficiency curves determined from measurements on a stationary 50-line raster. They are not necessarily the same as may be obtained under high-speed transient conditions, where the screen does not have time to build up to its maximum efficiency.

\*\*For photographing high-speed single transients use a high-speed panchromatic film such as E.K. Linagraph Pan or Super XX.

**P15 Screen**

The new P15 screen, an activated zinc oxide phosphor, is intended for applications such as in the scanning generator of a flying-spot scanner or in high-resolution recording of very-high-speed phenomena, where the shortest possible decay time is required. The P15 screen has a decay time of approximately 2 microseconds under normal operating conditions, and decay times of less than 1 microsecond are possible under special operating conditions. Color of the fluorescence of the P15 screen is light blue-green.

**Grid-drive Characteristics**

Due to unavoidable manufacturing tolerances, large variations occur in the grid-voltage versus screen-current<sup>1</sup> characteristics or the grid voltage versus light output characteristics of individual cathode-ray tubes of the same type. Average characteristics, plotted in the usual way as in Figure 5, are therefore of little help to equipment designers. A somewhat different method of approach has been found more satisfactory for cathode-ray tubes.

The designer of cathode-ray tube equipment is interested primarily in two characteristics insofar as the grid (control electrode) is concerned. First, he must know the cutoff bias limits in order that he may provide a sufficient range of negative d-c grid bias to cut the tube off (extinguish the beam and spot) in all cases. Secondly, he is interested in the variation of screen current or brightness as the grid is made more positive with respect to the cutoff voltage<sup>2</sup>. In general, the modulating signal is a-c and is superimposed on the d-c grid voltage, so that the absolute value of grid voltage for a given brightness is not so important as the voltage above cutoff; the designer must know how much modulation signal (above cutoff) he needs to provide in order to produce the required screen current or brightness. This voltage above cutoff has become known as *Grid Drive*, and the characteristic of Grid Drive versus screen current or light output has become known as the *Grid Drive Characteristic*.

If Grid Drive is plotted against screen current for a large number of tubes, it is found

1 Current in the electron beam reaching the fluorescent screen.

2 Note that this does not mean that the grid is made positive, but only less negative.

that most of the tubes give approximately straight lines, at least over the part of the curve which is of interest. In tubes in which only a small part of the total cathode current is utilized, which includes most electrostatic deflection tubes, this curve has a slope of approximately 2, indicating an exponential of the form  $I = KE_d^2$ , for the grid drive versus screen current characteristic. Furthermore, on such tubes, the grid drive characteristic curves do not vary appreciably with cutoff bias. It is therefore possible to represent the average grid drive characteristic of an electrostatic deflection tube by a straight-line curve on log paper such as shown in Figure 6. To provide for manufacturing variations, a minimum curve can be drawn below the average curve.

The equipment designers approach then resolves into the following: (1) provide sufficient negative d-c bias at the intensity control to cut off the tube having the maximum cutoff bias permitted by the tube specifications; and (2) if grid modulation is used, provide sufficient grid-modulation voltage (grid drive) to drive the tube to the desired screen current or brightness.

Of course, each tube type has a specified brightness, or beam-current rating, (specified for a given operating condition) and the

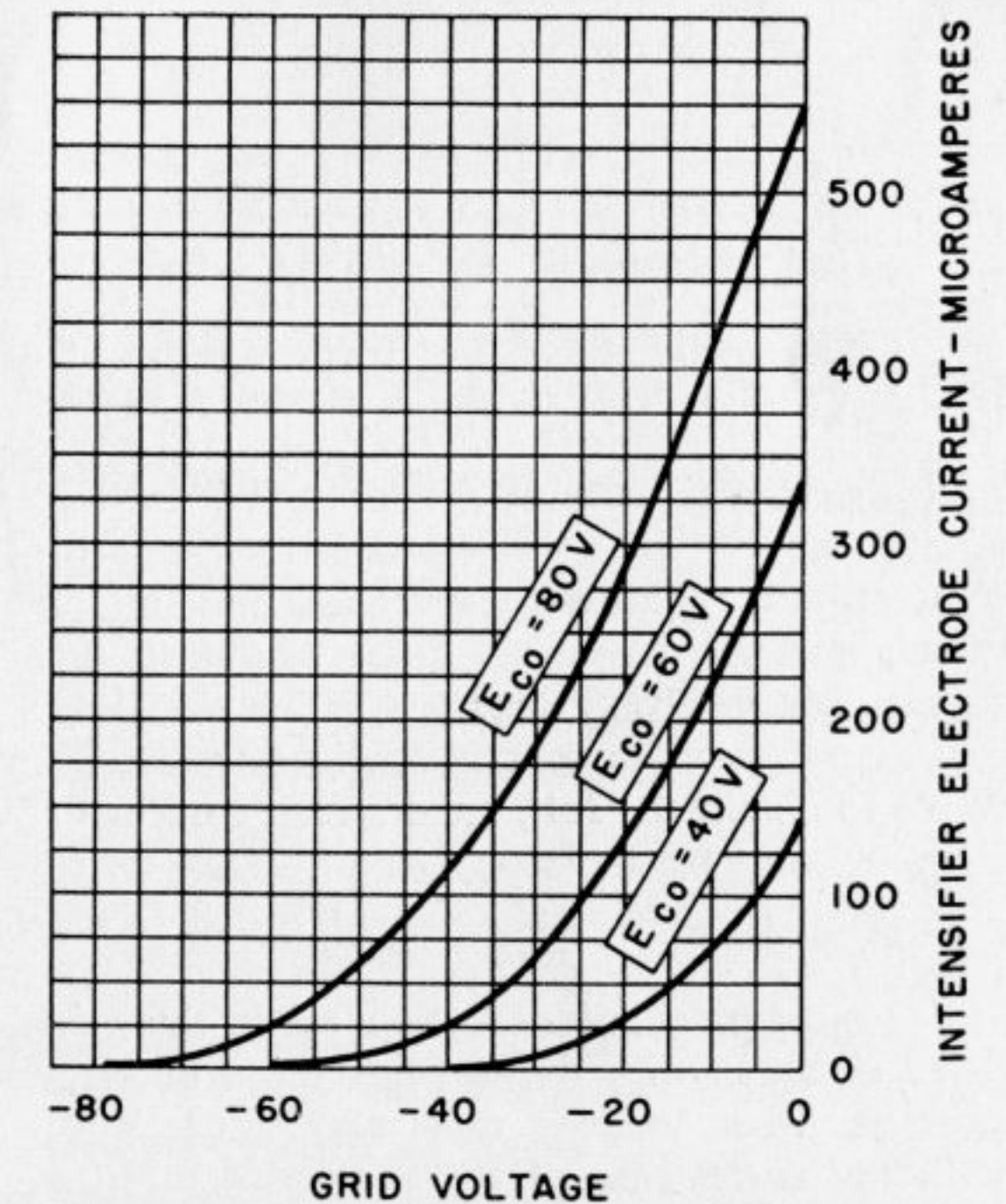

Figure 5. Typical grid-voltage vs. screen-current characteristics for three different tubes of the same tube type

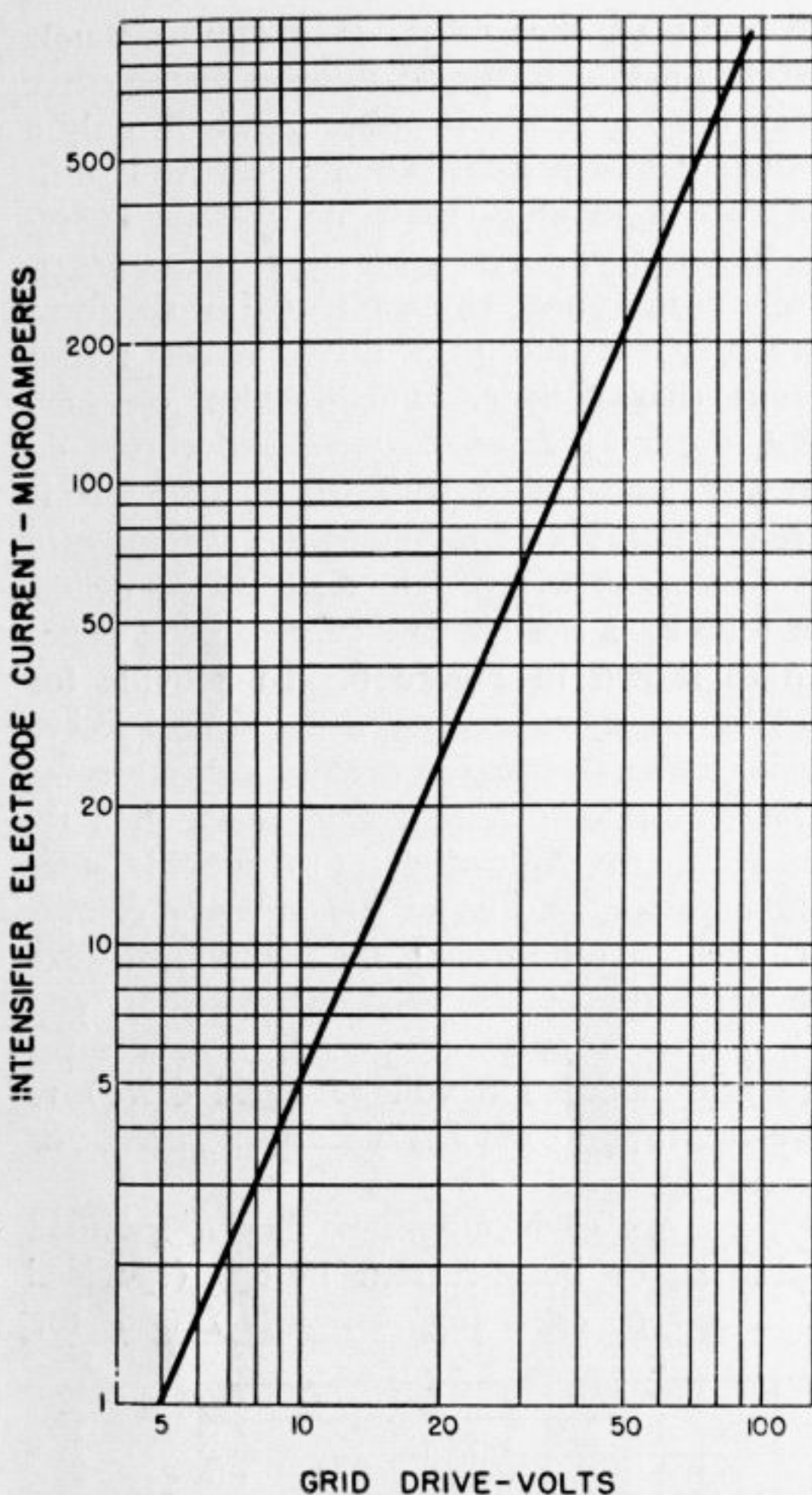

Figure 6. Average grid-drive characteristic for a typical electrostatic cathode-ray tube

equipment designer cannot depend upon the tube providing more than the specified value. The tube characteristic sheet also specifies the grid drive which must be provided in the equipment for the specified screen current or light output. Thus, the answer is given immediately for the designer who is operating the tube under the conditions for which the light output or screen current is specified, and who wants to obtain the full, rated screen current or light output. He must be careful, however, to take precautions against the grid being driven positive with respect to the cathode.

For most magnetic deflection tubes, the grid drive characteristics differ from those of electrostatic tubes in that they vary appreciably with the cutoff bias of the particular tube as shown in Figure 7. However, this fact in no way precludes the tube manufacturer from

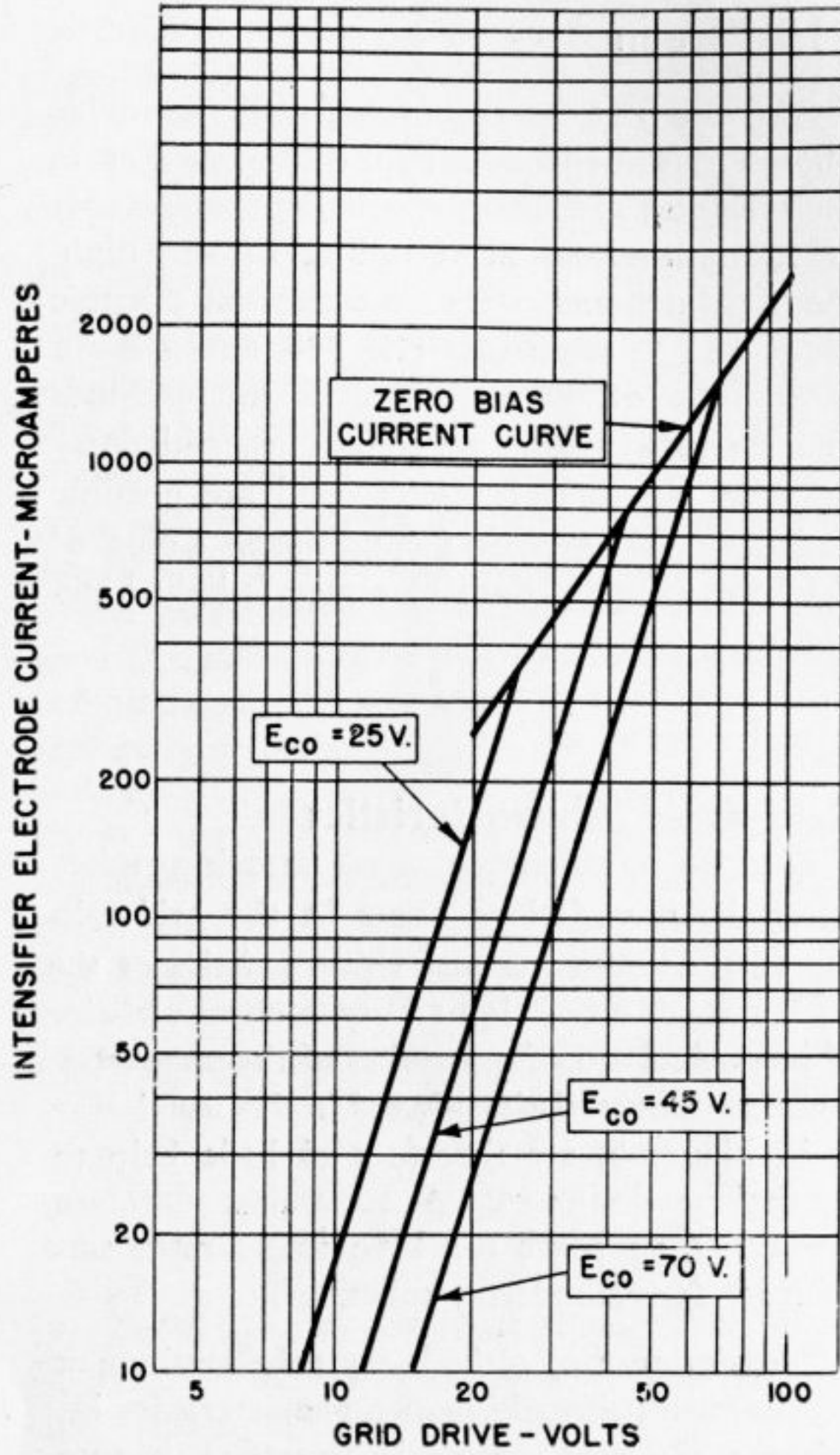

Figure 7. Average grid-drive characteristics for typical magnetic cathode-ray tubes

specifying a maximum grid drive for the rated screen current, and the equipment designer proceeds exactly as for the electrostatic tube.

In cases in which the tube is not operated at the conditions of accelerating voltage, etc., at which the maximum grid drive is specified, the following approximate relationships will guide the equipment designer in determining necessary grid drive:

Electrostatic Deflection Tubes<sup>3</sup>:

$$I = K_1 E_{b_2}^{-1/2} E_{d_2}$$

Magnetic Deflection Tubes<sup>3</sup>:

$$I = K_2 E_{c_2}^{-2/3} E_{d_3}$$

$$I = K_3 E_{c_0}^{-2/3} E_{d_3}$$

<sup>3</sup> The basic distinction is between tubes in which potential of the electrode next to the grid is proportional to  $E_{b_2}$  operating with small utilization of the total cathode current; as compared to tubes in which the potential of the electrode next to the grid is independent of  $E_{b_2}$  and in which most of the cathode current reaches the screen.

where  $K_1, K_2, K_3$  are constants<sup>4</sup> for a given gun design.<sup>4</sup>

**Operating Notes**

Cathode-ray tube power supplies must usually provide between 1000 and 5000 volts d-c at from one to three milliamperes. In oscillographic applications, usual practice is to operate the accelerating electrode (second anode) at ground potential, in order that the deflection plates may be substantially at ground potential and thus facilitate their coupling to deflecting-signal circuits and reduce the hazard in making connections directly to the deflection plates. When this method of operation is used, it is necessary to insulate the transformer winding supplying heater power to the cathode-ray tube for the full accelerating voltage, since the heater and cathode are operated at a negative potential with respect to ground equal to this voltage.

A voltage divider is ordinarily used to provide the required voltages for the control electrode (grid) and focusing electrode (first anode). The negative voltage is provided by a rheostat or potentiometer at the negative end of the voltage divider, and sufficient range should be provided to permit variation of grid bias from zero to a value at least equal to the maximum cut-off voltage for the tube at the accelerating voltage at which it is to be operated. The focusing voltage potentiometer should be capable of providing a range of voltage to the focusing electrode corresponding to the range over which the voltage required for focus is permitted to vary by the specification for the particular tube type involved.

In order to reduce defocusing of the spot to a minimum, positioning and signal voltages should be balanced whenever possible; that is, equal positive and negative voltages should be applied to the two plates of a deflection-plate pair.

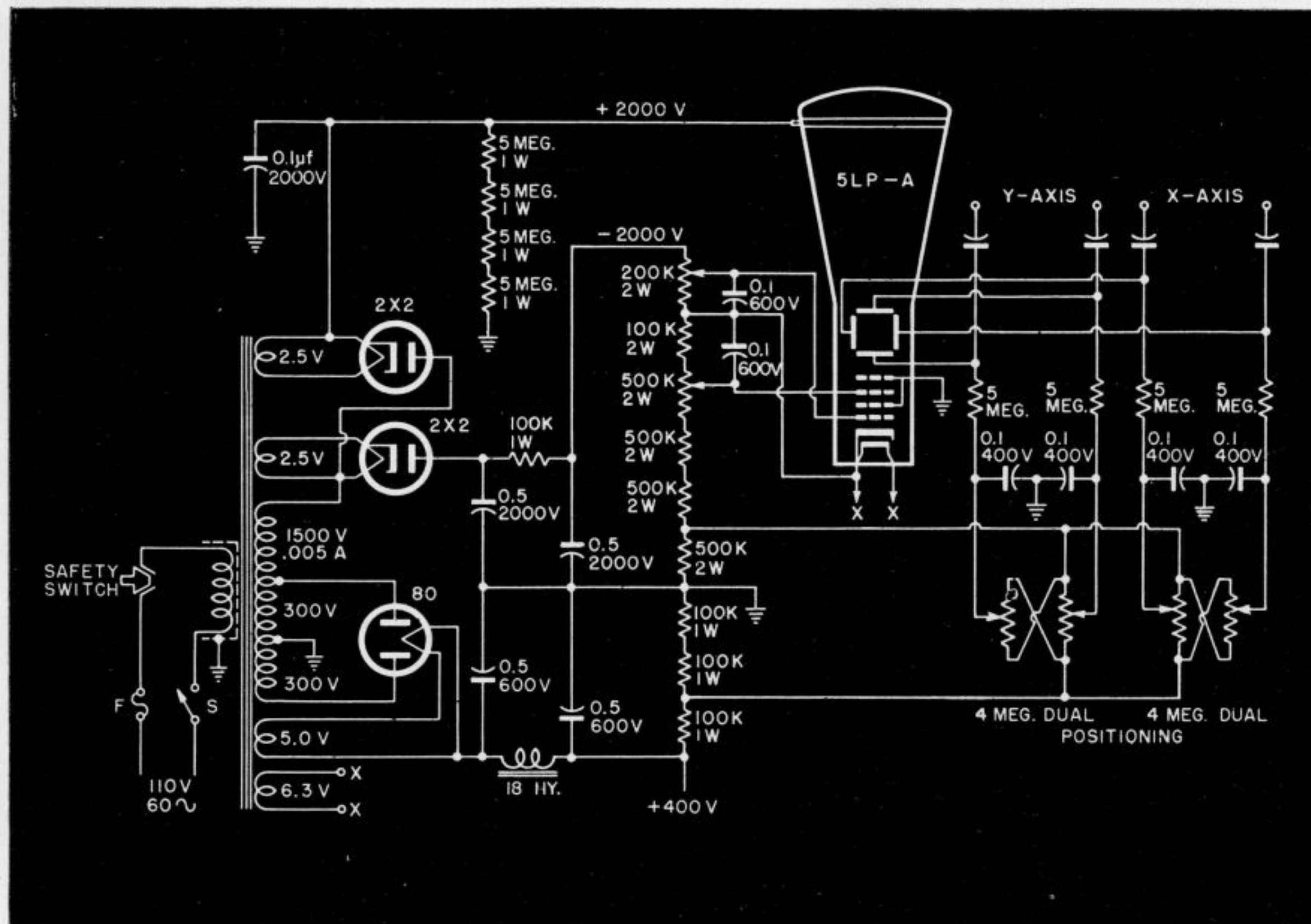

Figure 8. Typical power-supply circuit for intensifier-type cathode-ray tube, showing the bleeder system which furnishes proper potentials to all electrodes

<sup>4</sup> In the electrostatic case, the effect of accelerating electrode voltage on the grid drive characteristic is small; in the magnetic case the accelerating electrode voltage has no effect.

There is a tendency to institute the use of limiting apertures in magnetic guns, which will result in the accelerating voltage's having some effect on the grid-drive characteristics.

The intensifier should ordinarily be operated at a potential 30% to 100% of the accelerating electrode potential. When lower values of intensifier voltage are to be used, the intensifier can be connected to a 300- or 400-volt plate supply if such a supply is readily available. If a higher intensifier potential is desired, a separate rectifier, operating from the same high-voltage transformer winding as the accelerating voltage supply, with heater winding and a simple resistance-capacitance filter, are easily provided.

In a transformer designed for operating cathode-ray tube circuits, both the heater winding of the cathode-ray tube and the primary winding should be completely surrounded with grounded electrostatic shields. These shields are necessary

to prevent electrostatic coupling to the heater winding which might cause intensity modulation of the cathode-ray beam, and to prevent electrostatic coupling from the high voltage winding to the power-line. It is advisable to ground the chassis of cathode-ray equipment to prevent any possibility of the chassis attaining a high potential with respect to ground. The potentials at which cathode-ray tubes operate are dangerous, and precaution should be taken to prevent contact with them.

A typical power supply, with positioning circuits and deflection-plate input circuits, is shown in Figure 8. Such a supply will provide adequate voltages for operating intensifier-type cathode-ray tubes.

## OSCILLOGRAPH DESIGN CONSIDERATIONS

### Power Transformer

Since the cathode-ray tube is sensitive to both electric and magnetic fields, it is essential that the power transformer be designed to have a low external magnetic field. Sometimes a magnetic shield is provided for the transformer to cut down the external field to a negligible magnitude. The transformer should generally

be separated from the cathode-ray tube by as great a distance as possible, and should be so oriented that its field produces minimum deflection of the beam. In addition, since the transformer is usually the heaviest single component in an oscillograph, it should be located so that the instrument will balance well. Transformer location is therefore very important in oscillograph design, and may influence the design of other portions of the instrument.

Needless to say, it is well to keep the size and weight of the transformer at minimum values consistent with good design practices. However, sacrifice of ratings should never be made to obtain small size or light weight. Insulation of each winding must be adequate for much greater voltage than it will have to withstand during operation. The lamination stack should be designed for at least the minimum power-line frequency, and preferably for a lower frequency in order to keep the external magnetic field low. For the same reason a high turns-per-volt ratio and low flux density are desirable. It will be noted that transformers for cathode-ray oscillographs, because of the variety of rectifiers and amplifier circuits which they supply, are much more complex and have several more secondary windings than those transformers used in most other services, and consequently, are materially more expensive.

#### (a) Primary

The primary windings of the transformer should be shielded by a grounded electrostatic shield to prevent capacitive coupling from high-voltage windings in the secondary side, and to minimize power-line interference.

#### (b) Secondary

The exact voltages and currents required of

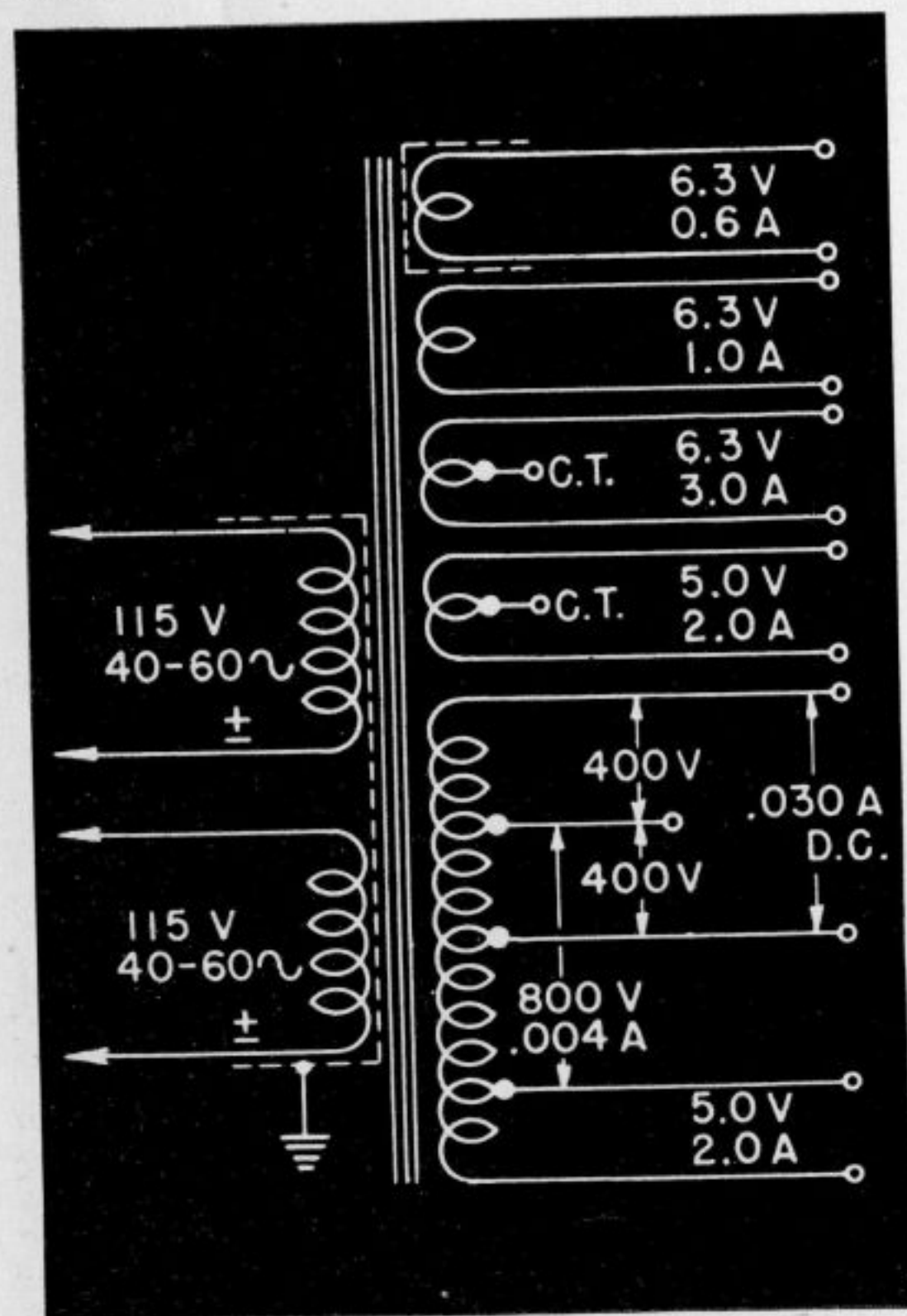

Figure 9. Circuit schematic of a typical power transformer for a cathode-ray oscillograph

the secondary windings will depend upon the circuits which they supply. The heater winding of the cathode-ray tube must be surrounded by a grounded electrostatic shield to prevent capacitive coupling from other windings. Such coupling would constitute an intensity-modulation signal which would cause modulation of the beam intensity at power-line frequency.

Center-tapped secondary windings are generally used to supply the rectifiers which furnish B+ power to amplifiers, time-base generator, etc. Ratings of about 400 rms volts each side of the center tap and 20 to 200 d-c milliamperes are common for these windings. They are a part of the low-voltage power supply mentioned in the section on General Description and more completely described in the following section.

It is common practice to extend one side of the center-tapped winding in order to supply the rectifier which furnishes high voltage for the cathode-ray-tube electrodes. Voltage and current ratings of 800 to 1500 rms volts and 3 to 5 d-c milliamperes are usual for this extended winding. It is a part of the high-voltage power supply mentioned under General Description and more completely described in one of the following sections.

Figure 9 is a schematic of a typical cathode-ray oscillograph transformer.

### Low-Voltage Power Supplies

Low-voltage power supplies are derived from the center-tapped winding referred to above. This winding feeds a full-wave rectifier; output from this is a pulsating d-c voltage. A capacitive-inductive filter is connected to the rectifier output to smooth the pulsating d-c into a nearly pure d-c potential. More than one supply potential can be derived from this same transformer winding; the supplies may be of either positive or negative polarity, and they may or may not be regulated. They furnish power to amplifiers, time-base generator, etc.

#### (a) Voltage and Current Requirements

Amplifier stages and similar circuits which deal with large signals and large outputs will in general require a d-c supply potential of from 350 to 500 volts, while those stages which furnish less output may be operated from lower potentials of 150 to 250 volts. The current which any supply must furnish is determined by adding the current requirements of all the circuits connected to it.

#### (b) Filtering and Regulation

The supplies which furnish power to the first stages of the amplifiers must be exceptionally well-filtered and regulated.

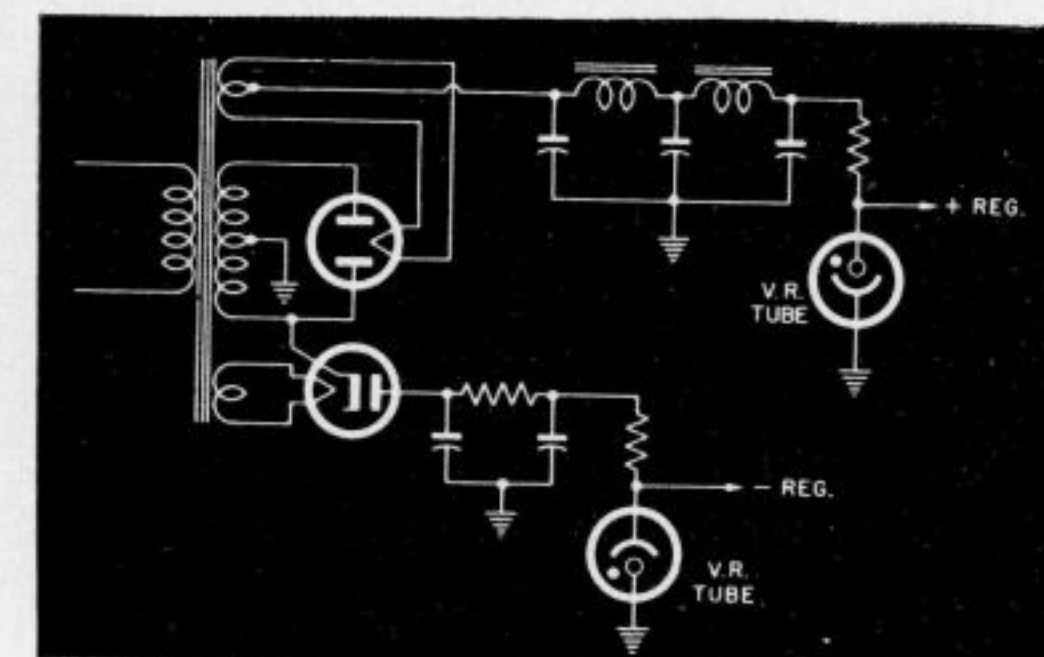

Figure 10. Schematic of a gas-tube regulated power supply

Spurious signals or power-line frequencies appearing in the power-supply potential would be amplified by subsequent stages and would therefore appear as deflections on the cathode-ray tube screen. A general design rule is that the amplitude of power-line or other a-c voltages appearing on the output of the power supply should not exceed 0.5% of the d-c supply voltage. Furthermore, since it is general practice to operate from a common supply several circuits performing different functions, coupling through the impedance of that supply must be reduced by reducing the impedance. This may be accomplished by the use of voltage-regulating devices.

Two general types of voltage-regulator devices are used: gas-tube, and electronic.

The characteristics of gas-tubes are such that, over a range of currents, the voltage between electrodes is constant. Some neon tubes and the VR series of cold-cathode discharge tubes are used in this application. VR tubes will maintain constant voltage with current ranging from 5 to 40 milliamperes. Figure 10 illustrates the use of VR tubes in regulating power supply potentials. Positive and negative polarity supplies are shown. Resistors must be used in series with the gas-tubes to adjust their current to the correct operating range.

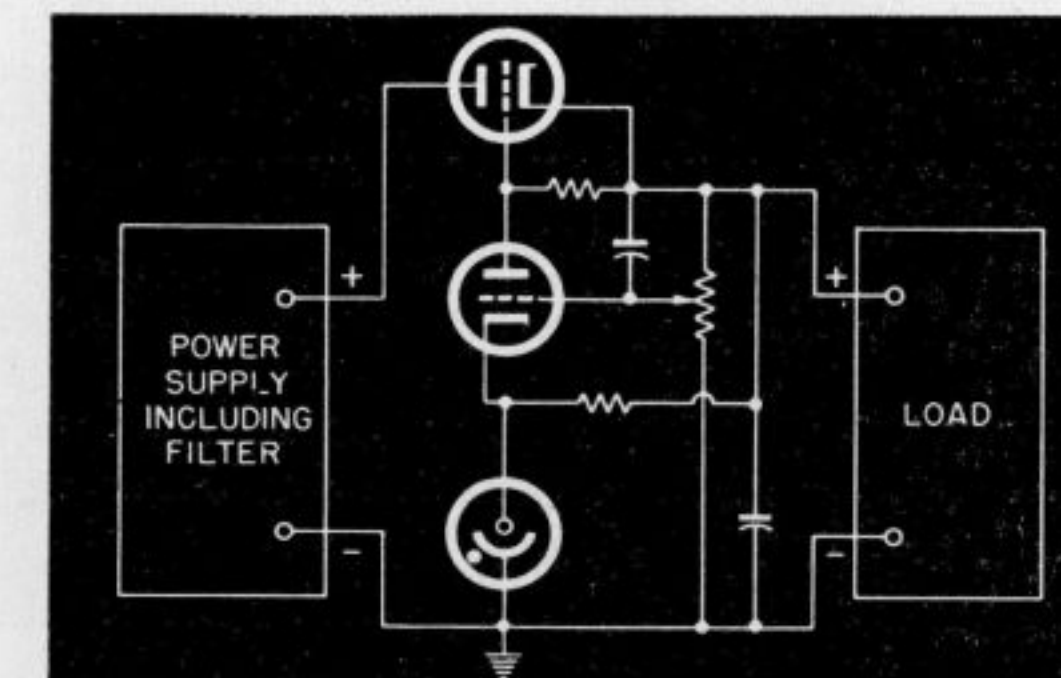

Figure 11. Schematic of an electronically regulated power supply

The electronic regulator circuit, such as the one illustrated Figure 11, generally employs a vacuum tube connected between the power supply and the load. The impedance of this tube is varied automatically if the voltage across the load tends to change; it is varied in such a way as to furnish a constant voltage to the load despite variation in power supply output or current requirements of the load.

**High-Voltage Power Supply**

The high-voltage power supply is often derived from the extended winding which was described with reference to the Power Transformer. This winding feeds a half-wave rectifier, which is ample because filtering requirements are not nearly so strict as for the low-voltage supplies. The rectifier output is usually filtered by a resistance-capacitance combination. Resistance can be used in this filter because the current furnished by the high-voltage supply is very small, and the resultant voltage drop across the resistor is small.

In many cathode-ray tubes the accelerating electrode is operated at ground potential and the cathode at some negative high-voltage which may range from 1000 volts up to 6000 volts or more. Other electrodes obtain their potentials from a bleeder connected to the high-voltage supply. Some cathode-ray tubes, however, are equipped with intensifier electrodes, and the total accelerating potential is divided, part of it being applied between the cathode and accelerating electrode and the remainder between accelerating electrode and intensifier. Ordinarily the potential between accelerator and intensifier should not exceed 50% of the total.

If the accelerator electrode is to be operated at ground potential, which is usually the case in order to permit operation of the deflection plates at ground potential, the cathode should be at negative potential and the intensifier at positive. Positive and negative high-voltage supplies are required in this case but both can be derived from the same transformer winding, and for a given accelerating potential,

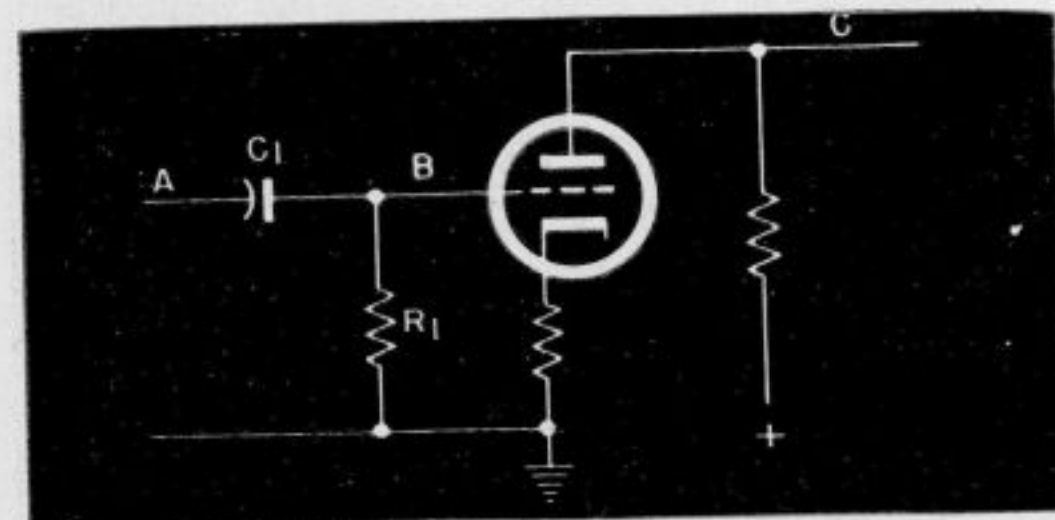

Figure 12. Circuit of a typical amplifier stage, with capacitive input coupling

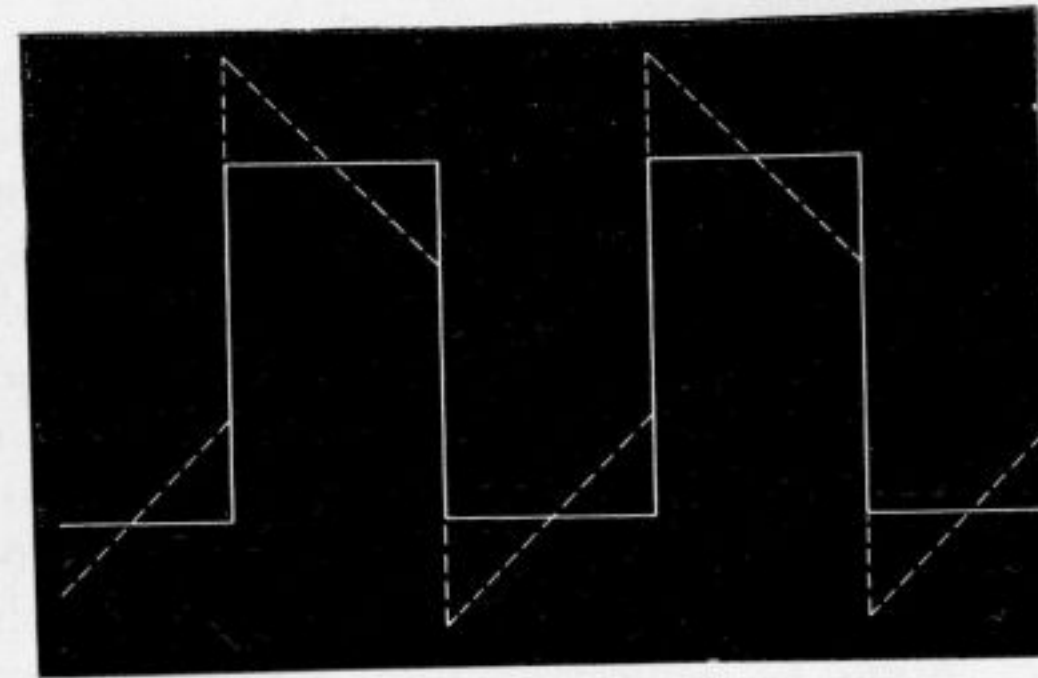

Figure 13. A square-wave signal (solid line) and sawtooth distortion (dotted line) which might result from an RC time-constant

each supply need have only half the voltage required of a single supply. This simplifies considerably the design of the transformer and also the high-voltage filters.

**Deflection Amplifiers**

The design of deflection amplifiers in a cathode-ray oscillograph is usually carried out to meet specifications with regard to: (1.) frequency-response or band-width; (2.) deflection factor; (3.) maximum output capabilities.

The frequency-response or band-width specification fixes the range of frequencies over which the gain of the amplifier must lie within certain limits. Under General Description we have already discussed the fact that, in general, amplifiers do not have constant gain characteristics from d-c (zero cycles per second) to the limit of usefulness of the cathode-ray tube (about 200 megacycles per second). Limitations exist both at low and high frequencies which restrict the constant-gain characteristic to a small fraction of this range, although compensating devices may be incorporated to extend the characteristic at both low and high frequencies. These devices will be discussed in a later section.

The term "deflection factor" is peculiar to oscillographic language. It has been customary to refer to the voltage or power gain of an amplifier as a measure of its performance. However, for oscillographic applications, these references have no significance since a given amplifier will produce entirely different results with different cathode-ray tubes. The results will also be different if the accelerating potential is changed on the same cathode-ray tube. Deflection factor is dependent upon amplifier gain, but it is a measure of the amplifier input signal required to produce a given amount of deflection on the screen of the cathode-ray tube. Its unit is volts per inch, and it is a true measure of the performance of an amplifier in conjunc-

tion with a given cathode-ray tube operated with a certain accelerating potential.

The considerations of band-width and deflection factor in amplifier design tend to pull in opposite directions. An amplifier that has a low deflection factor (high gain) will not usually have a wide band-width; an amplifier with wide band-width characteristics will have a high deflection factor (low gain). Of course, it is always possible to increase gain by adding stages of amplification, but there is usually a practical limit as well as a limit imposed by stability and noise requirements. Since the oscillograph provides a visual indication, stability must be excellent and noise level extremely low. The design of the deflection amplifiers is therefore usually a compromise between deflection factor and band-width.

*(a) Square-Wave Testing of Amplifiers*

The cathode-ray oscillograph is a test instrument; its amplifiers should therefore provide faithful reproduction of signals being investigated. In order to make a rapid determination of amplifier characteristics, a square-wave signal may be passed through it, and certain inferences made from the shape of the indication on the cathode-ray tube. The steep front of the square wave gives an indication of high-frequency or "transient" response of the amplifier; its flat top gives indication of the low-frequency characteristics. The terms "high-frequency" and "low-frequency" are of course relative to the fundamental frequency of the square wave signal. A general rule in regard to square-wave testing is that an amplifier which will reproduce a square-wave of fundamental frequency,  $f$ , will satisfactorily amplify sine-wave signals between the frequencies of  $1/10 f$  and  $10 f$ .

The application of three square-wave frequencies, one near the center of the amplifier's band pass, one near the upper end of the band, and one near the lower end, can indicate almost completely the frequency-response characteristics of the amplifier.

*(b) Low-Frequency Distortion and its Compensation*

The type of low-frequency distortion which may be introduced by an amplifier is illustrated by the following discussion. Suppose a low-frequency square-wave signal is applied to the amplifier in Figure 12 between point A and ground. If the time-constant in the input circuit (product of  $C1$  and  $R1$ ) is small with respect to the period of the square-wave, the waveform at point B, and therefore at point C (output of the amplifier), will be similar to that shown by the dotted line in Figure 13.

This is referred to as sawtooth distortion because of the shape which it takes. It is caused by the discharging of  $C1$  through  $R1$  during the flat-top portion of the square-wave.

This type of distortion could obviously be eliminated or reduced by making the values of  $C1$  and  $R1$  sufficiently large to produce a large time-constant. However, it has been found that the physical size of  $C1$  becomes impractical if such a solution is attempted. The value of  $R1$  is limited by the grid current characteristic of the amplifier tube. Another reason for keeping  $C1$  and  $R1$  as small as possible is that the time required for the circuit to recover from a large transient pulse will depend directly upon this time-constant.

One method of compensating for low-frequency distortion is illustrated in Figure 14A. Addition of  $R2$  and  $C2$  in the plate circuit of the amplifier produces a potential at point D of the form shown in Figure 14B. When this potential is added to that shown by the dotted line in Figure 13, the original square-wave results. The correct amount of compensation is quite critical. Over-compensation is apt to introduce sawtooth distortion which slopes flat tops of a square-wave in the other direction.

*(c) High-Frequency Distortion and its Compensation*

There are certain stray circuit capacitances and vacuum tube interelectrode capacitances which impose a load on an amplifier stage as

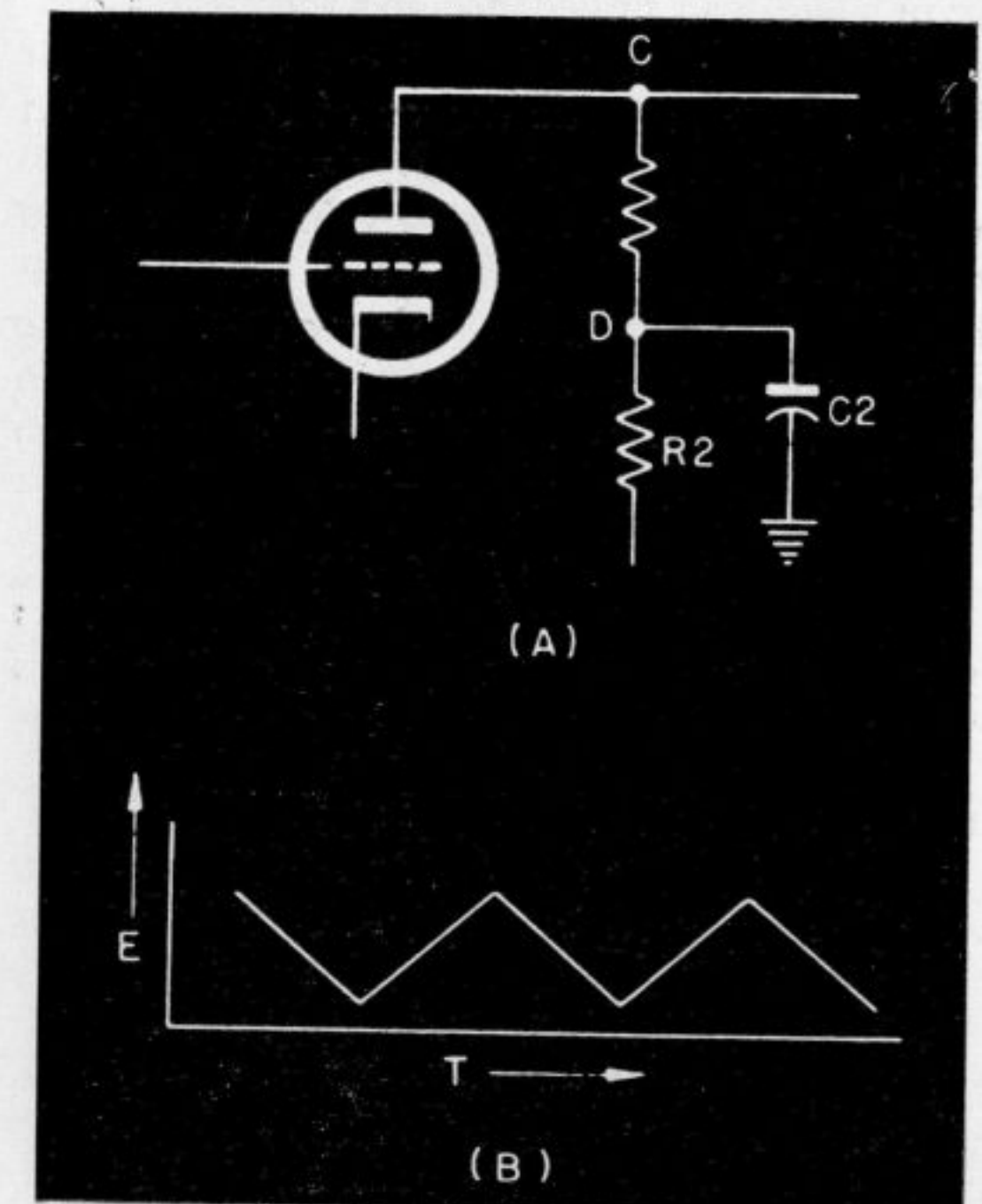

Figure 14. Circuit illustrating a method of compensating for low-frequency distortion in an amplifier stage

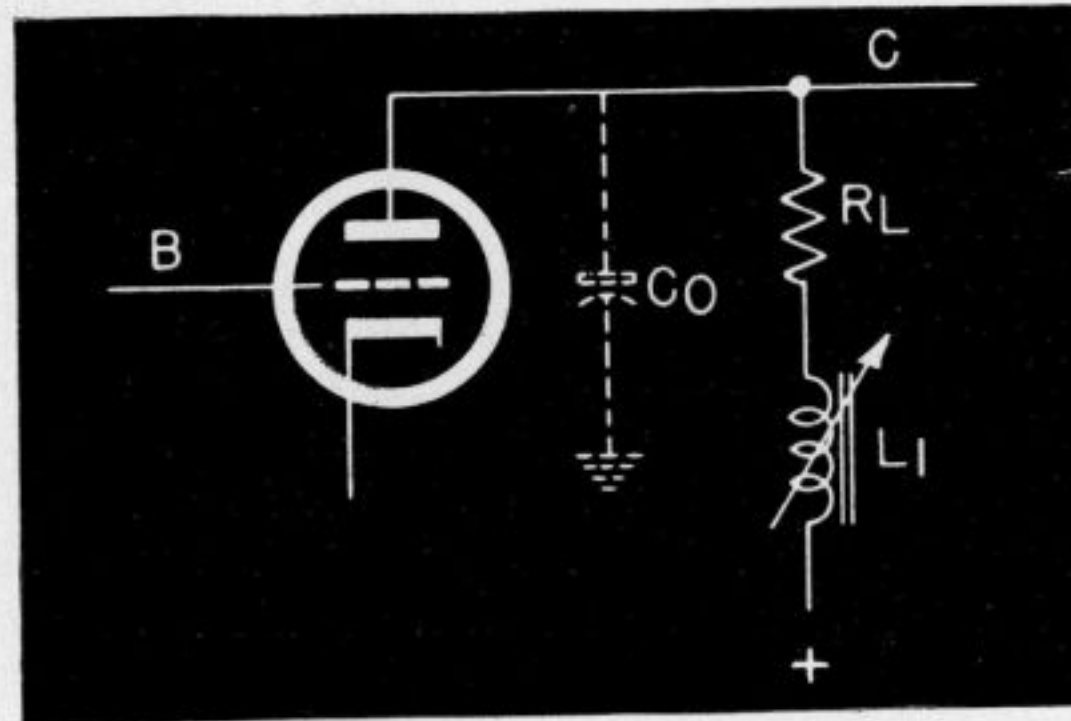

Figure 15. Circuit illustrating stray capacitance in an amplifier stage and a method of compensating for it

illustrated by  $C_0$  in Figure 15. This load, being in parallel with the plate load,  $R_L$ , has the effect of reducing the plate load impedance as the signal frequency is increased. The gain of the stage therefore falls off at high frequencies and the response curve might look like curve A in Figure 16. A square-wave passed through this amplifier would begin to exhibit a rounded front corner instead of a square one as the fundamental frequency was increased.

Addition of an element in the plate circuit, the impedance of which increases at higher frequencies, is one method of compensating for high-frequency distortion. In combination with the other elements, it tends to maintain a constant plate load impedance and therefore a constant gain characteristic. This is the function of  $L_1$  in Figure 15. The degree of compensation must be carefully designed. A value for  $L_1$  which is too large will cause a rising gain characteristic over a limited frequency range as shown by curve C in Figure 16. This would introduce distortion on a square-wave similar to that in Figure 17. Over-compensation is often less desirable than no compensation.

(d) Amplification of d-c Signals

The resistance-capacitance coupled amplifiers ordinarily used in cathode-ray oscillographs will not handle d-c signals because capacitors

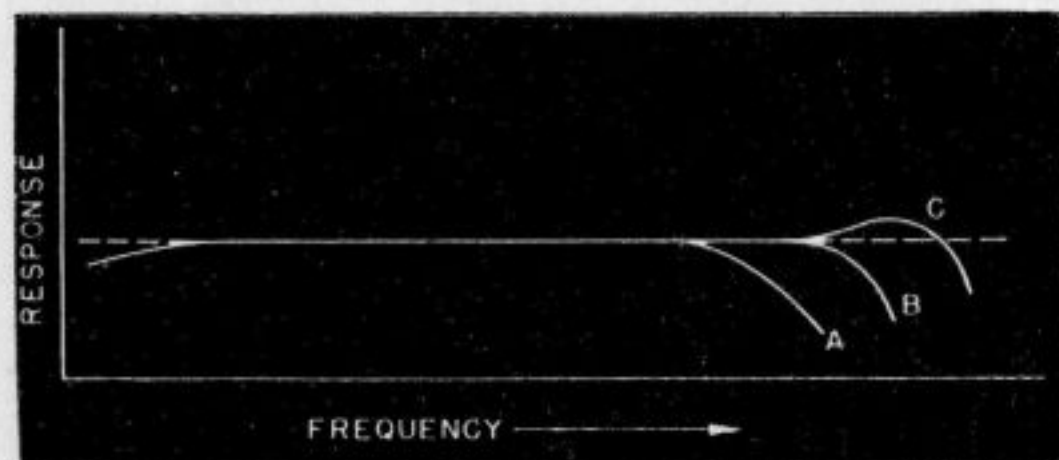

Figure 16. Frequency-response characteristics of three amplifiers with different degrees of high-frequency compensation

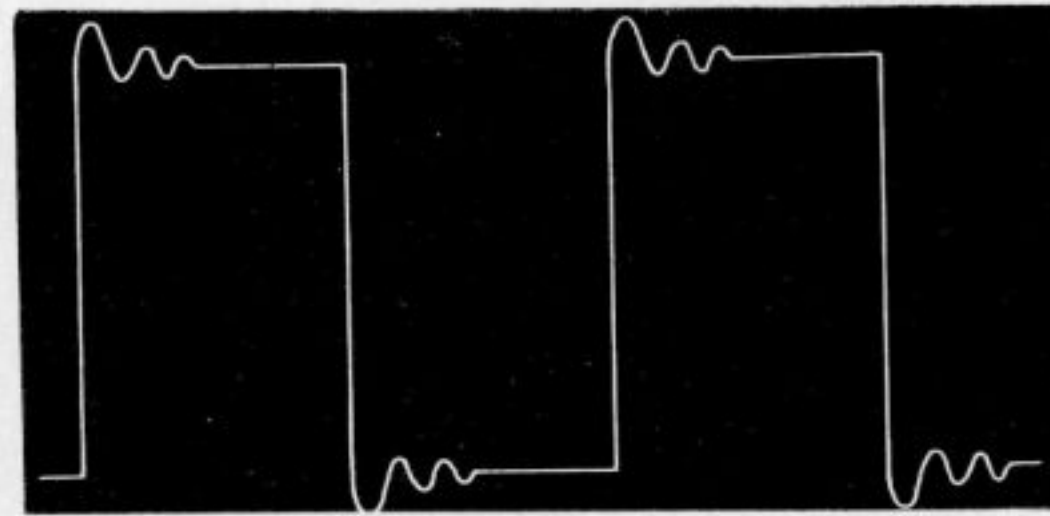

Figure 17. Response of an over-compensated amplifier to square-wave signal

will not transmit direct current. Any signals containing a-c and d-c components therefore produce deflection on the screen corresponding only to the a-c component.

Some oscillographs, such as the Du Mont Types 304-H and 250-AH, do contain direct-coupled amplifiers capable of amplifying d-c signals.

(e) Amplifier Noise

Noise is an important factor to be considered in amplifier design. It includes such things as spurious signals introduced by resistors, tube microphonics, and signals in the d-c power supplies. An oscillograph provides a visual indication; noise therefore is apparent since it distorts the signal being investigated. Extreme care must be exercised in regard to selection of gain-controls, vacuum tube types, and power supply filtering and regulation to minimize spurious "noise."

Intensity Modulation

Many cathode-ray oscillographs provide a means for connecting external signals to the grid or cathode of the cathode-ray tube in order to modulate the intensity of the beam. Some contain an amplifier for these signals so that modulation can be accomplished with smaller signal amplitudes.

The channel for connecting a signal to the grid or cathode of the cathode-ray tube is generally referred to as the Z axis of the oscillograph, and the amplifier, if one is incorporated, is known as the Z-axis amplifier.

Considerations for the design of the Z-axis amplifier are different from those for the deflection amplifiers. Whereas hundreds of volts on the deflection plates are required to deflect the beam over the entire screen of the cathode-ray tube, a signal of 5 to 100 volts at the grid or cathode will usually produce satisfactory beam-modulation. Since there is a much smaller voltage-output requirement in the case of the Z-axis amplifier, a low-gain amplifier will suffice. We have already discussed the fact that low gain means wide band-width, so that the problem of obtaining good frequency response

for this amplifier generally is not a difficult one. However, the problem of obtaining direct coupling and good low-frequency response may be difficult because both the grid and cathode of the cathode-ray tube are usually operated at negative high voltage. There is often included in the amplifier circuit a phase-selecting device which will allow either reduction or increase of the beam intensity with any given signal polarity.

(a) Uses of the Z Axis

One of the principal applications of the Z-axis channel is for impressing timing marks upon the pattern being observed. The signal used to create these markers is preferably in the form of sharp pulses of short duration which occur at a high rate with respect to the frequency of the signal being investigated. The sharp wave-form permits precise measurement of the time interval between pulses. The resultant pattern on the cathode-ray tube will have a number of bright or dark spots corresponding to the occurrence of the pulses and depending upon whether they increase or decrease the beam intensity.

Attenuator Circuits

Preceding the deflection amplifiers in the cathode-ray oscillograph, there must be provided means for attenuating (reducing amplitude of) the incoming signals. These attenuator circuits are designed to meet the following requirements: 1). High impedance to impose minimum loading upon the signal. 2). Sufficient attenuation that the amplitude of the signal will not overload the first amplifier stage.

The simplest method of obtaining such an attenuator would be to connect a high-resistance potentiometer across the input terminals to the amplifier. Such an attenuator, however, has distributed capacitances as shown in Figure 18, and the voltage attenuation will not be the same for all frequencies at any given interme-

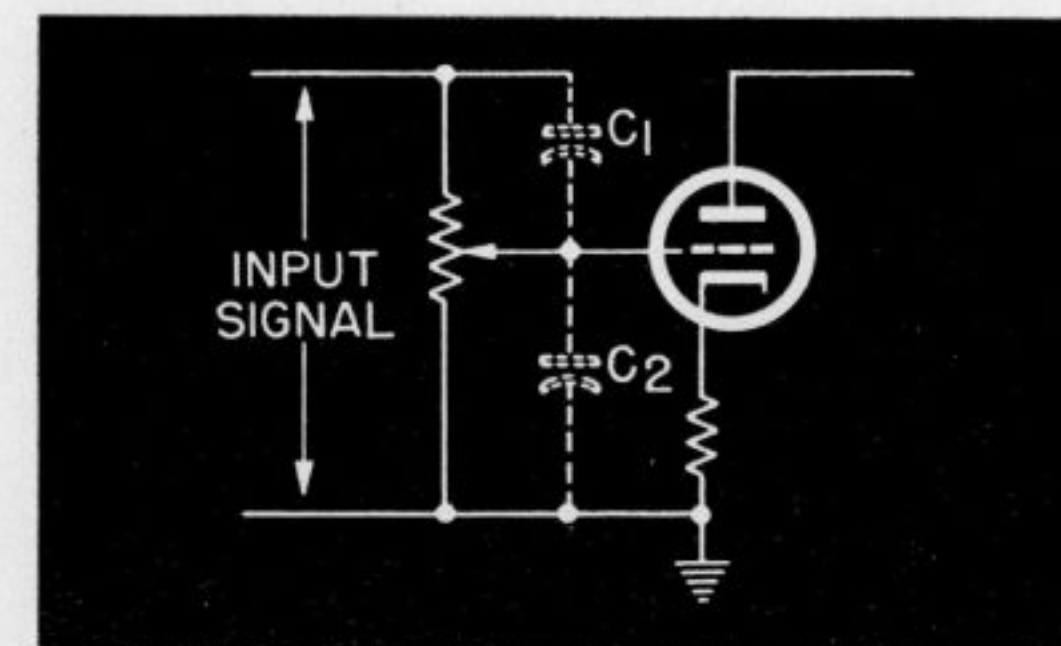

Figure 18. Circuit showing distributed capacitances in a simple potentiometer attenuator

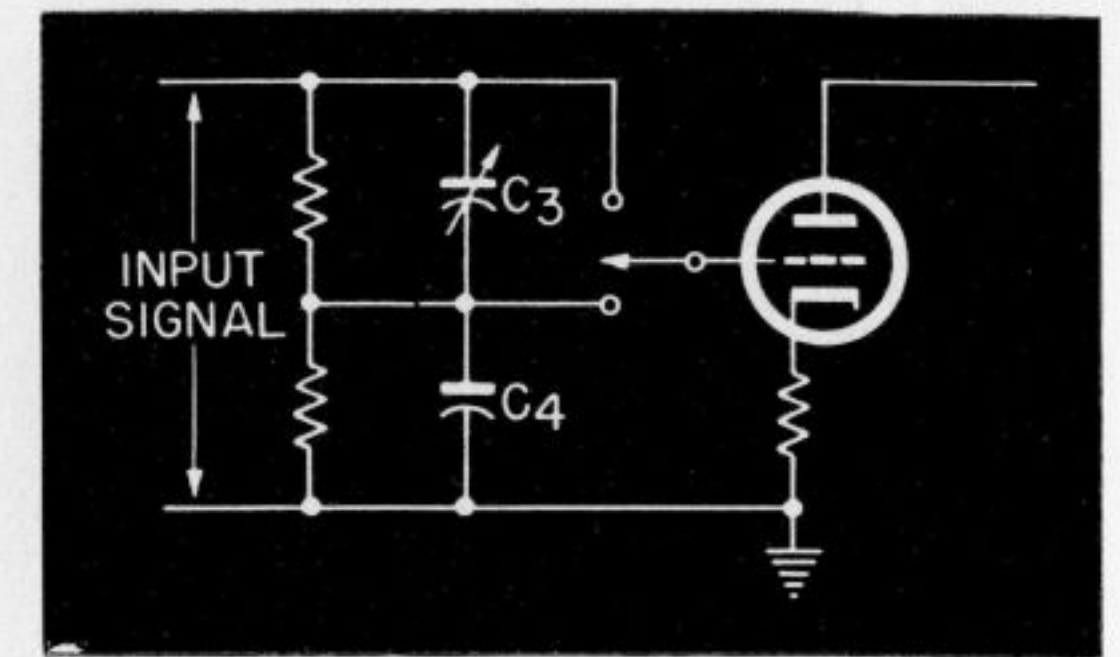

Figure 19. Circuit of an attenuator with fixed attenuation ratios and adjustable capacitive elements

diated position of the movable arm. A lower-resistance potentiometer would improve upon this characteristic but would load down the source of the input signal.

A solution to the problem lies in using an attenuator with fixed attenuation ratios and adjustable capacitive elements as shown in Figure 19. Proper adjustment of the capacitors will allow uniform attenuation over a wide frequency range. Experience with this circuit has shown, however, that a square-wave attenuated by it has rounded front corners unless the voltage-coefficients of the resistive elements are extremely low. Metallized types of resistors have been found to give best results. An additional low-impedance attenuator must be used, however, if continuous adjustment of attenuation between the fixed ratios is desired.

A cathode-follower circuit such as that shown in Figure 20, having a low-impedance output and suitable for use with a continuous potentiometer, may be used to provide this adjustment. It will handle a wide range of signal amplitudes and, with  $R_1$  and  $R_2$  being low resistances, has an output impedance so low that circuit capacitances will be ineffectual even at frequencies of several megacycles per second. This circuit, in conjunction with the compensated, fixed-ratio attenuator, permits a

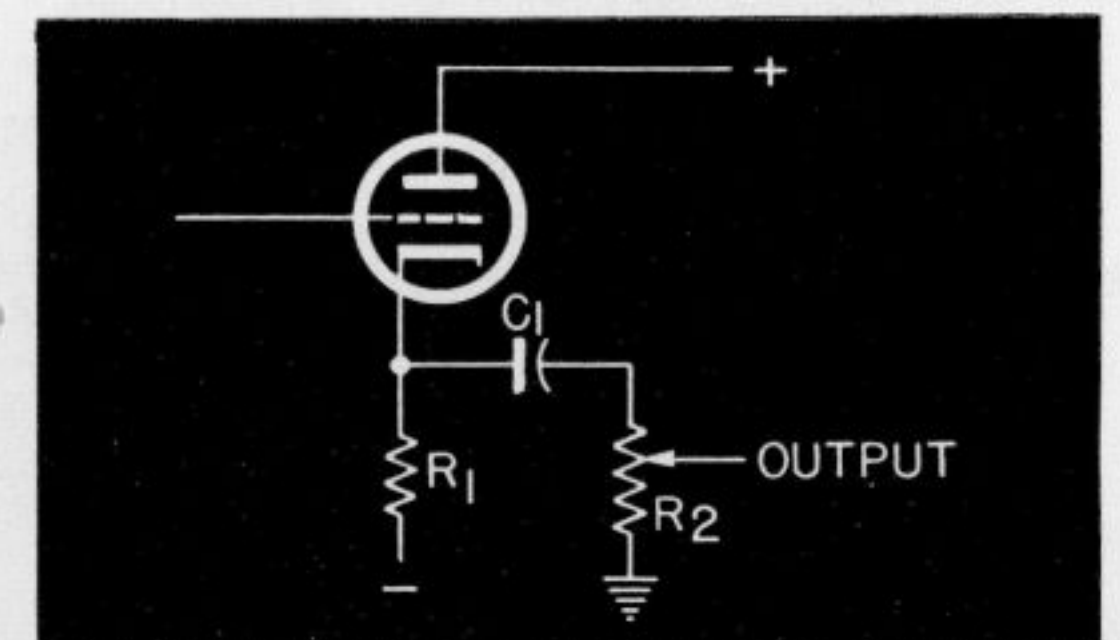

Figure 20. A cathode-follower circuit used as a low-impedance gain control

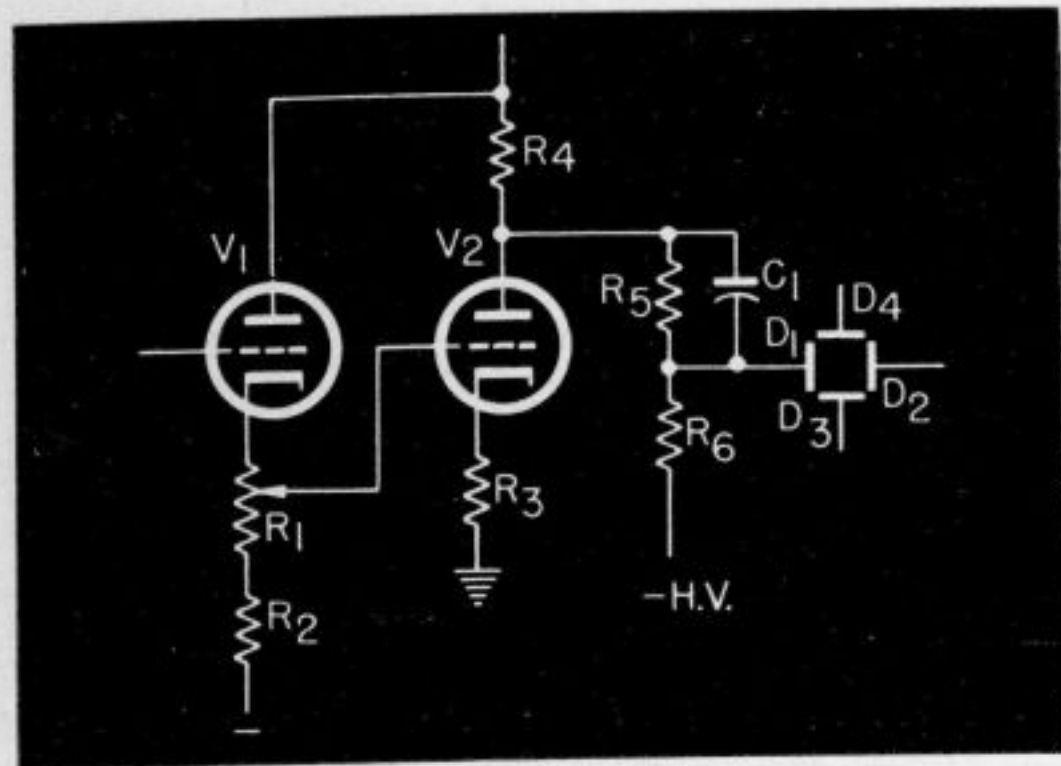

Figure 21. A circuit providing positioning of the spot on the cathode-ray tube screen

wide range of signal attenuation without frequency discrimination at any setting.

**Positioning Circuits**

*(a) D-C Positioning*

A cathode-follower circuit similar to the one illustrated in Figure 20 may be used in conjunction with direct-coupled amplifiers to provide positioning voltage to the deflection plates of the cathode-ray tube. (See Fig. 21).

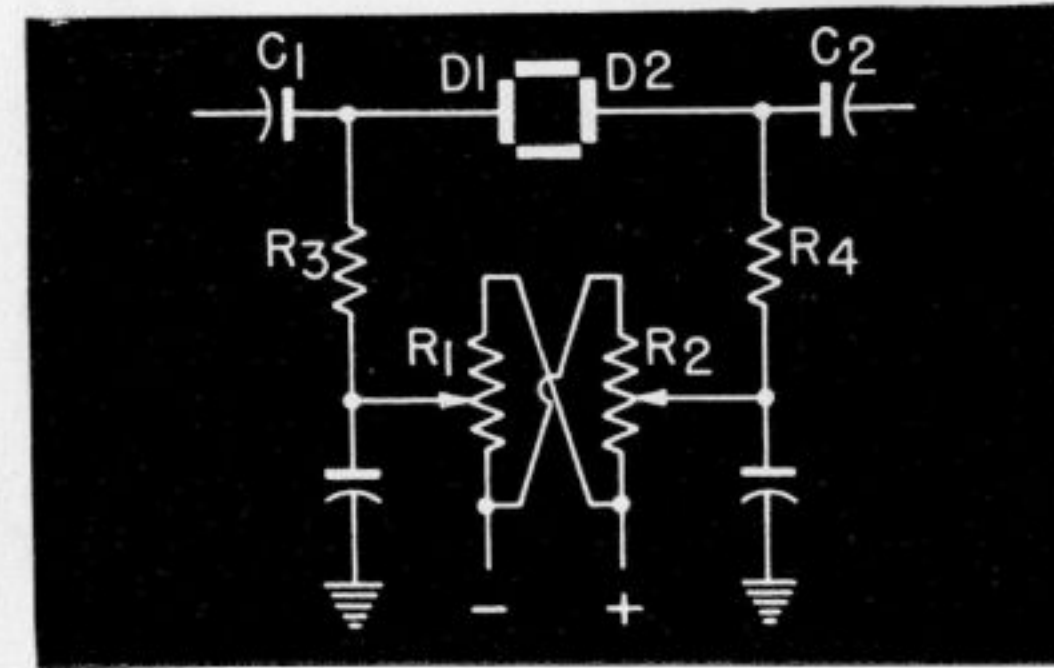

Figure 22. A circuit providing a-c positioning of the spot on the cathode-ray tube screen

The cathode of V1 operates at some positive potential with respect to ground, and R2 is connected to a negative supply. A d-c potential therefore exists across R1, and the bias of V2 may be varied by moving the arm of R1. This causes a change in the plate current of V2, and therefore a change in the d-c voltage at its plate, which is connected to the deflection plate of the cathode-ray tube through R5. Resistor, R4, is the plate load for the amplifier stage, V2. R5 and R6 provide d-c potential division to set point P at ground potential.

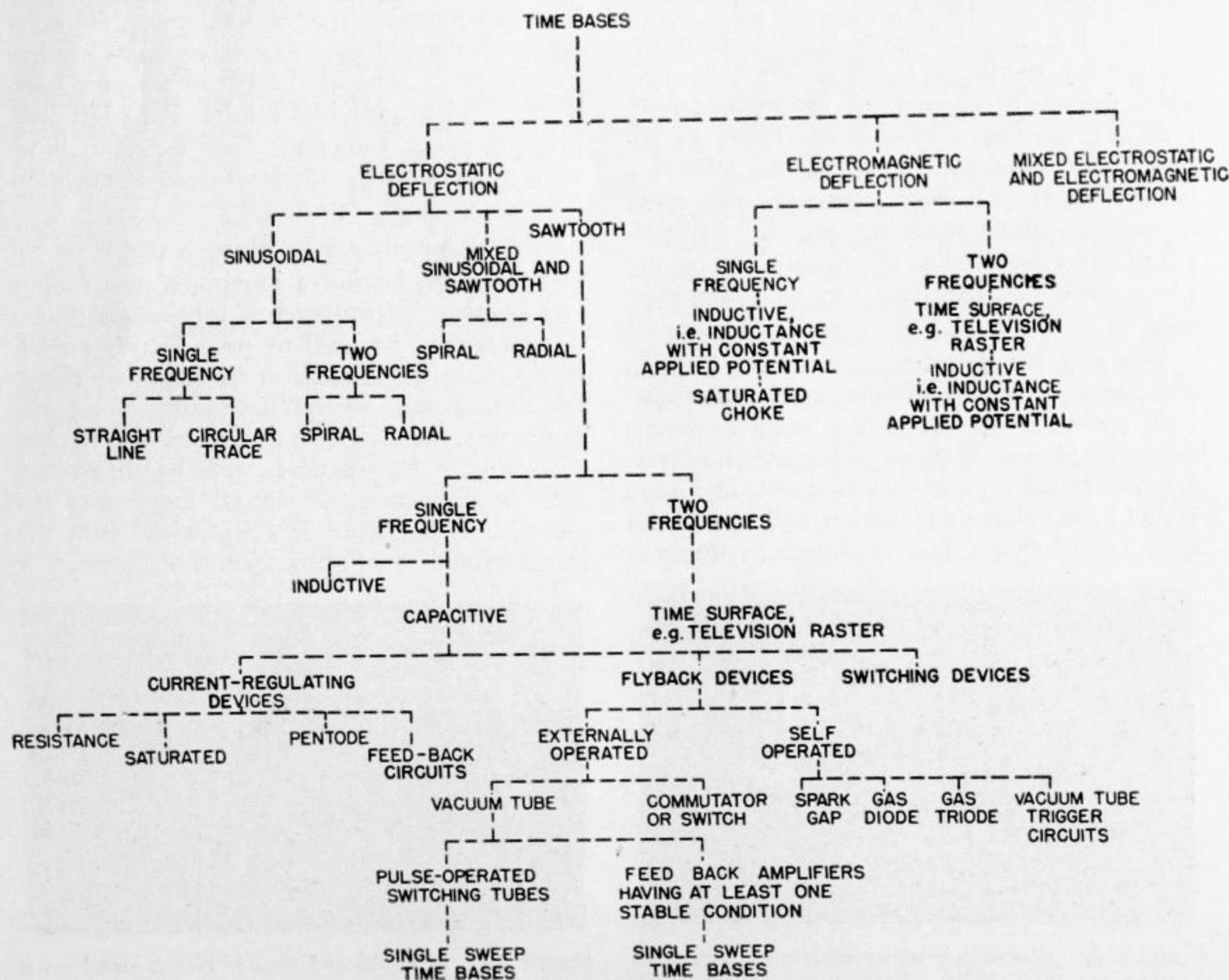

Figure 23. A time-base family tree

This is done since the deflection plates must be operated at nearly the same potential as the accelerator electrode, which is ordinarily connected to ground, particularly when external connections directly to the deflection plates are desired. C1 provides a path for the amplified signal from the plate of V2 to the deflection plate, D1. If it were not present, this signal would suffer some attenuation from the combination of R5 and R6.

*(b) A-C Positioning*

A circuit such as that shown in Figure 22 is used to provide positioning when there is no direct connection to the deflection plates. There is a lag in operation due to the time required for the capacitors C1 and C2 to establish a steady d-c potential at the plates, D1 and D2, after the potentiometers R1 and R2 are adjusted to some new value. Time-constants of C1 and R3, and C2 and R4 must be large in order to preserve the necessary low-frequency amplifier response. R3 and R4 are high resistances to maintain a direct-current path to the deflection plates.

**Time-Base Generators**

Most applications of the cathode-ray oscillograph require some investigated phenomenon to be plotted as a function of time. This is accomplished by applying to one pair of deflection plates a potential which is proportional to the phenomenon, and to the other pair of deflection plates, a potential proportional to some function of time. A circuit which generates this latter potential is referred to as a time-base generator or sweep generator. There are many varieties of time-bases, as illustrated by the family tree in Figure 23.

*(a) Linear Time-Base Generator*

The linear time base is probably the most universally adaptable. The potential applied to

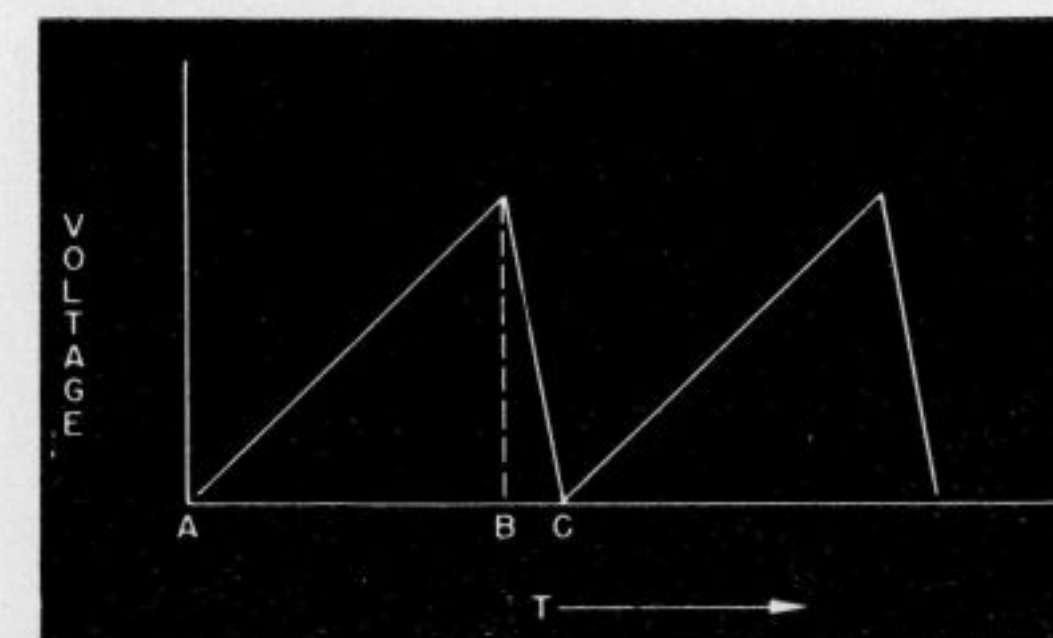

Figure 24. Wave-form produced by a linear time-base generator

the deflection plates is proportional to time and is of the form shown in Figure 24. The interval A to C comprises one cycle of the "sawtooth" wave. The linear portion A to B is referred to as "go time" or "sweep time" of the time base. The interval B to C is the "return time" or "fly-back time," during which the spot returns rapidly across the screen to begin the next cycle, from C on.

For the ideal linear time-base, the sawtooth increases in linear fashion during the sweep time, and has a return time of extremely short duration. Some factors to be considered in designing a linear time-base generator are:

1. Linearity of the sweep voltage.
2. Ratio of return time to sweep time
3. Possible frequency range of the sawtooth potential
4. Ease of synchronization (refer to following section)
5. Driven-sweep operation (see section on Driven Sweep)
6. Power supply potential required
7. Sawtooth output level and output impedance.
8. Number and types of vacuum tubes required
9. Number of variable circuit components necessary to provide operation over required range of frequencies.

Each of these factors must necessarily be considered in the light of the particular application for which the time-base is to be used.

*1. Synchronization*

In order to obtain a stationary oscillographic pattern the sawtooth voltage must have either the same period as the signal applied to the other pair of deflection plates, or some sub-multiple of that period. Adjustment of the time base to satisfy this condition is called synchronization. It is usually accomplished by injecting into the time-base generator, in such a manner that it controls the frequency of the sawtooth, voltage of the proper frequency to produce a stationary indication. The amplitude

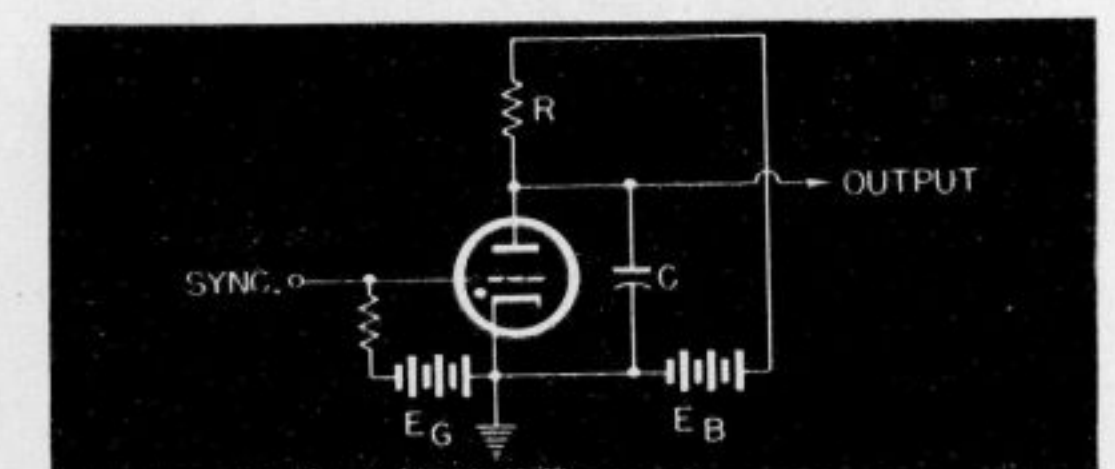

Figure 25. Basic circuit using a gas-triode for generating a saw-tooth voltage



of the voltage necessary for synchronization depends upon the particular circuit employed.

**2. Return-Trace Blanking**

The rapid motion of the fluorescent spot during the return time of the sweep will cause a faint trace to appear on the screen. It is usually of no value and only confuses interpretation of the pattern. To eliminate such confusion, the beam may be extinguished or blanked during the return time by applying a sufficiently negative voltage to the grid of the cathode-ray tube. The blanking voltage may be obtained by applying the sawtooth potential to a circuit which will produce a pulse corresponding to the rapid voltage-change during the return time. Once this pulse is generated, it is only necessary to apply it in correct polarity and amplitude to the cathode-ray tube.

**3. Driven or Single Sweep**

If a phenomenon of transient nature is to be investigated with a cathode-ray oscillograph, it is necessary to have a time-base which is initiated by that transient. The beginning of the sawtooth cycle will therefore coincide with the start of the phenomenon, and only a single sawtooth cycle will be generated for each time the time base is initiated. A description of one

method for obtaining driven sweeps appears in the section on Gas Triode Time-Base Generators.

**(b) Gas-Triode Time-Base Generators**

One of the simplest methods of generating a sawtooth voltage is by means of the circuit shown in Figure 25. The capacitor, C, charges through resistor, R, from the battery, E<sub>B</sub>. As it does so, it raises the plate potential of the gas-triode until a value is reached where the tube suddenly conducts current. This discharges the capacitor, and the cycle is repeated over and over. The discharge tube might also be a gas-diode, but the advantage of the triode lies in the fact that a synchronizing voltage may be applied to its grid, providing both sensitivity and isolation.

**1. Synchronization of Gas-Triode Time-Base**

Figure 26 illustrates the operation of this circuit as well as the method by which the synchronizing voltage locks the frequency of the sawtooth. The characteristic of the gas-triode is such that it will conduct current only with certain combinations of potentials on its plate and its grid. The static control characteristic of a typical gas-filled triode is shown at the left side of Figure 26. Once the tube does conduct, however, the grid has no control again

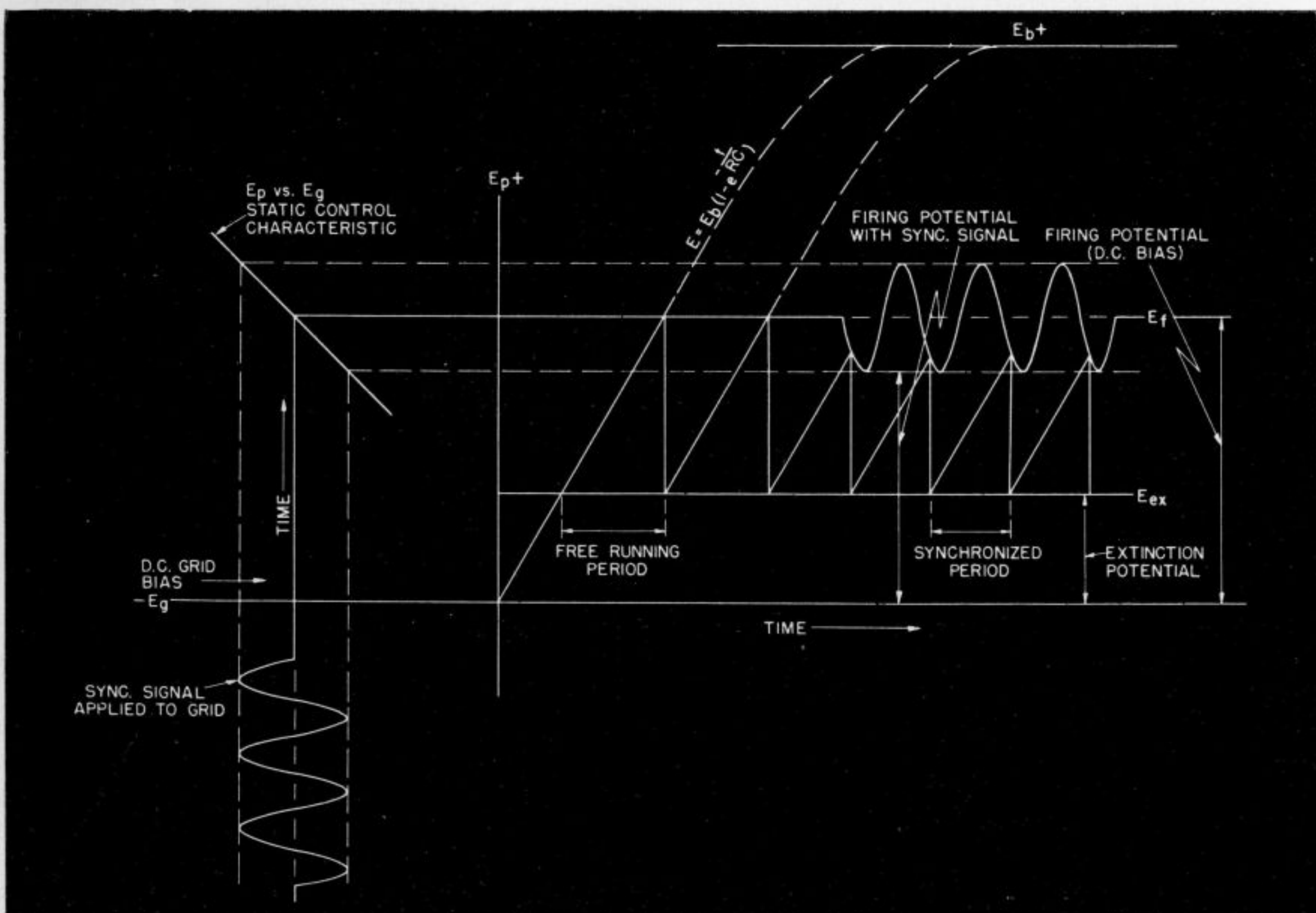

Figure 26. Graphic analysis of the operation and synchronization of the gas-triode sawtooth generator

until the tube has been extinguished or made to stop conducting. This can be accomplished only by reducing the plate potential to a sufficiently low value that the tube ceases to conduct.

If no synchronizing signal is used, the gas triode will conduct when its plate reaches E<sub>f</sub>. As it conducts, it shorts the capacitor, C, and its plate potential drops to the value E<sub>ex</sub>, which is the extinction potential for the tube. The tube then ceases to conduct and C begins to charge again. The rate at which the plate voltage rises depends on the values of C and R, and also on E<sub>B</sub>. The expression for the voltage, E, across C at time, t, is:

$$E = E_B \left( 1 - e^{-\frac{t}{RC}} \right)$$

The symbol, e, represents, of course, the natural logarithmic base. The "free-running" frequency of the sawtooth voltage will be approximately:

$$f = \frac{E_B}{RC} \left[ \frac{1}{E_f - E_{ex}} \right]$$

If a synchronizing voltage is applied to the grid of the gas-triode, its firing potential, E<sub>f</sub>, will vary in accordance with the signal. The tube will therefore conduct when the line representing its plate potential intersects the line which represents the conducting potential. If the "free-running" period of the time-base generator is slightly greater than the period of the synchronizing signal, the sawtooth frequency will be locked in with the synchronizing signal.

**2. The Practical Considerations**

In the practical form of this circuit, R is ordinarily a variable resistor and C is replaced by a number of capacitors, any one of which may be selected. This permits both coarse and fine adjustment of sawtooth frequency and a continuous variation over a wide frequency range.

It is also practical to allow selection of the synchronizing signal from one of several sources. Either an external signal, a powerline frequency voltage, or a signal obtained from the vertical amplifier may be used.

If the synchronizing voltage is obtained from this amplifier, it must be obtained at a point where its amplitude is sufficient to provide satisfactory synchronization. A control is ordinarily provided to allow adjustment of the amplitude synchronizing signal which reaches the grid of the gas-triode. Only that amount of synchronizing voltage should be applied to the tube which is necessary for stable synchronization. An excess may introduce non-linearity into the sweep.

The charging curve for the capacitor, C, is

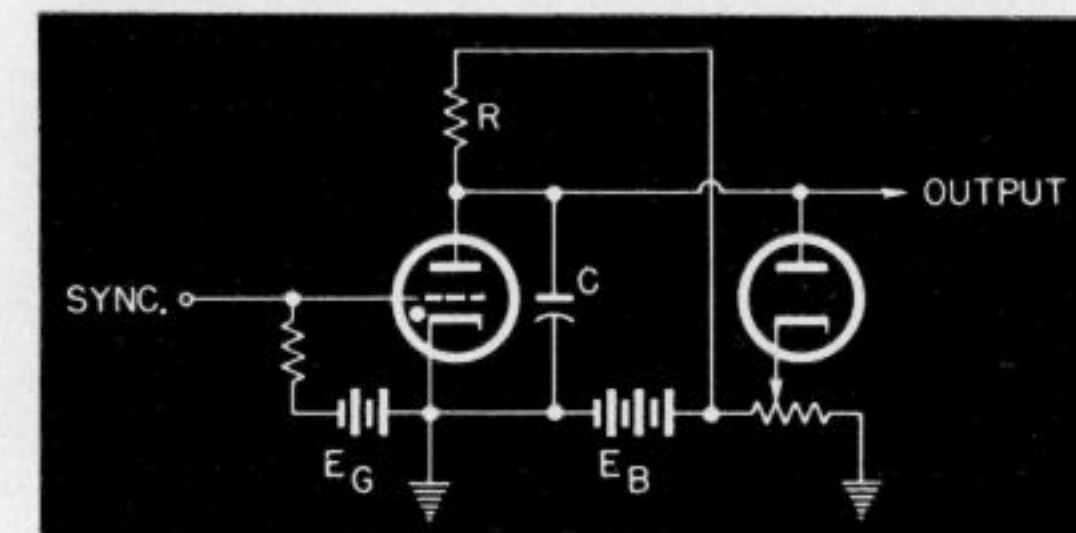

Figure 27. Basic-gas-triode circuit for generating driven or single sweeps

a portion of an exponential curve, as is seen in Figure 26 and by the mathematical expression previously given for the voltage across it. In practice, a sawtooth with linear rise is obtained by utilizing a small fraction of that charging curve; usually the amplitude of the sawtooth represents only 10 to 15% of the available power supply voltage, E<sub>B</sub>.

A time-base generator such as the one just described will furnish sawtooth voltage over a range of frequencies from about 0.5 to 50,000 cycles per second. At higher frequencies, the time required to discharge the capacitor (return time) becomes an appreciable fraction of the total cycle because of the de-ionization time of the gas-triode. Thus de-ionization time is a limiting factor in this type of time-base generator.

At low frequencies, leakage of the capacitor becomes a factor in determining the linearity of the sawtooth sweep time. The leakage prevents the capacitor from charging exponentially as it should, and the sweep will slow down during the last portion of its sweep period.

A form of feed-back circuit may be used to compensate for non-linearity in the sawtooth voltage. It utilizes some of the sawtooth voltage and feeds it back to a point in the charging circuit of the capacitor. If non-linearity exists, it tends to compensate for itself.

**3. Driven or Single Sweep Operation**

The gas-triode time-base lends itself to driven sweep operation without much revision of the circuit. Figure 27 illustrates a typical driven-sweep circuit in which the only addition is the diode vacuum tube and a suitable source of bias voltage. If the cathode of this diode is set at some potential below the conducting potential of the gas-triode, the diode will conduct when its plate also reaches that same potential. As long as the diode is conducting, the plate of the gas-triode is held at that potential and the triode will not conduct. If a synchronizing signal of positive polarity and sufficient amplitude is introduced on the grid of the gas-

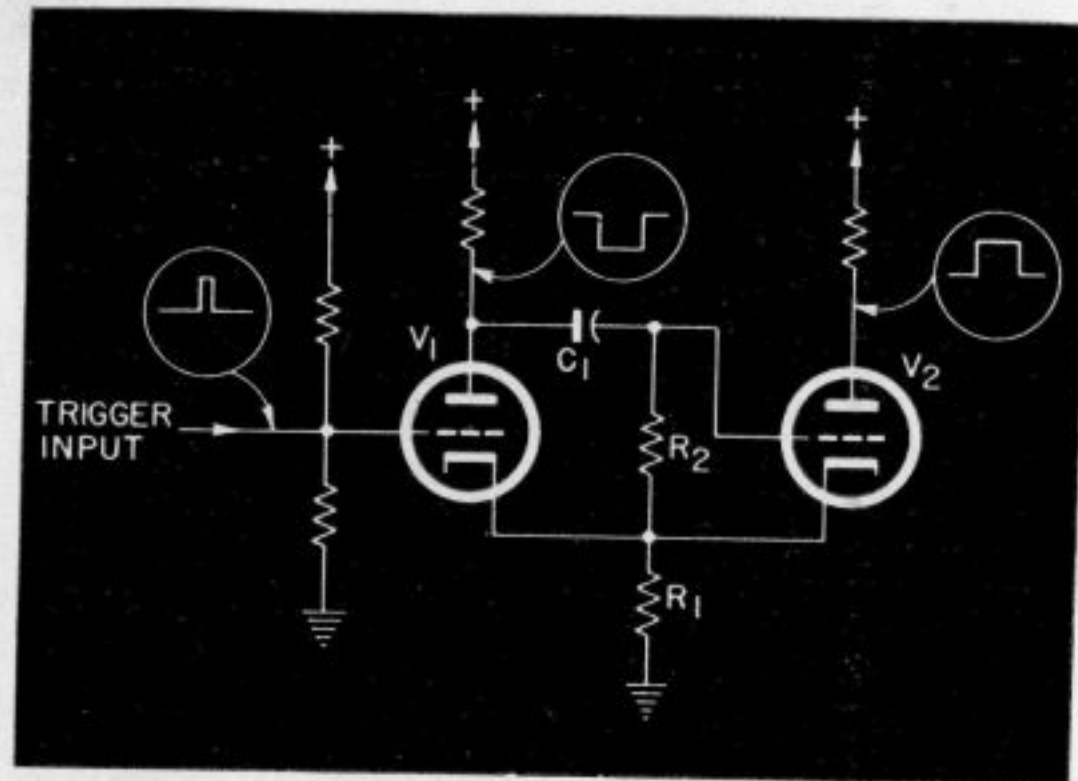

Figure 28. A basic multivibrator used in high-vacuum sweeps circuits

peculiar to this application. The fluorescent spot on the screen of the cathode-ray tube remains stationary except during the actual period of the sweep, and may therefore cause exposure and "fogging" of the film before and after the transient occurs. It is possible to use a camera shutter which opens only during the sweep period, but this is not practical for fast sweep speeds. The most effective method of preventing this fogging is to have the cathode-ray beam in the "on" condition during the sweep time and "off" at all other times. To accomplish this, a positive pulse may be applied to the biased-off grid of the cathode-ray tube during the sweep period. Such a pulse can be derived from the driven sweep circuit by one of several methods.

(c) High-Vacuum Time-Base Generators

As the name implies, these time-base generators do not make use of gas discharge tubes and they are therefore not subject to the limitations of de-ionization time. A number of different circuit configurations may be employed, but most of them make use of the "trigger" or "flip-flop" characteristic of triodes or pentodes connected as in the circuit of Figure 28. This "flip-flop" action is the result of a small potential change in one portion of the circuit producing a sudden large change in another.

Suppose in Figure 28 that V1 is cut off while V2, having no bias, is conducting. A positive voltage of sufficient amplitude to cause conduction applied to the grid of V1 will produce a negative signal at its plate. This negative signal will be transferred to the grid of V2 through capacitor, C1. V2 will be cut off

triode, its firing potential will be lowered to a value below that at which it is held by the diode, and the triode will conduct. The capacitor discharges until the triode ceases conduction, at which time it begins to charge again through the resistor, R. If the synchronizing signal has meanwhile been removed from the grid of the triode, the capacitor will charge only to the potential fixed by the setting of the diode. Thus a single sawtooth cycle is generated by initiation of the circuit with the synchronizing signal. Another sweep will not occur unless the circuit is again initiated.

By initiating the driven sweep with a signal occurring simultaneously with the transient to be studied, and by adjustment of the values of R and C, the driven sweep may be made to occupy the same period as the transient.

If photographic recording is to be made with driven sweep operation, there arises a problem

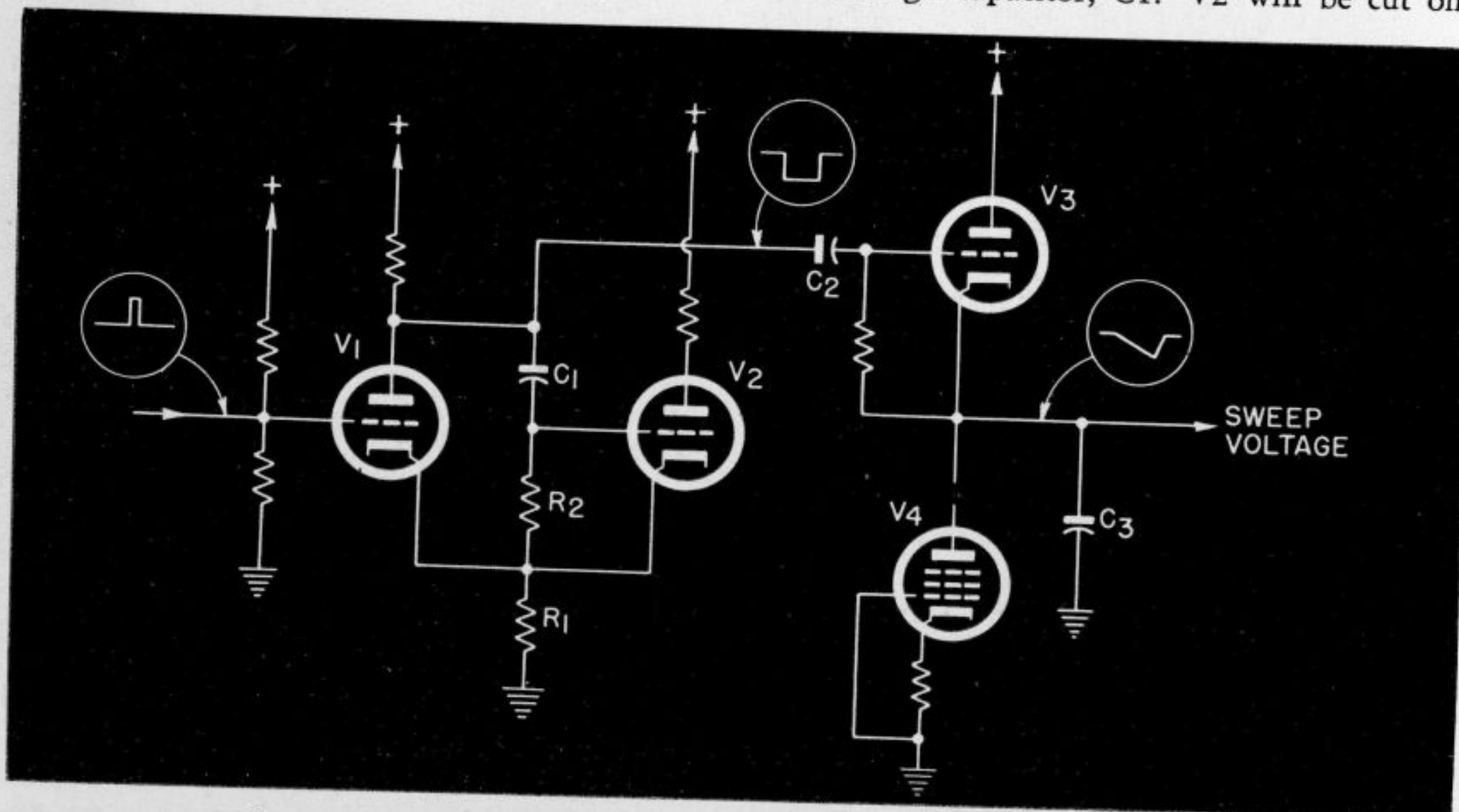

Figure 29. A high-vacuum circuit for generating driven sweeps

and its plate voltage will rise rapidly to power supply potential. The time-constant of R2 and C1 determines the length of time which V2 is cut off. When C1 no longer discharges through R2 at a sufficient rate to bias V2 to cut-off, V2 conducts and in so doing develops a potential across R1, biasing V1 to cut-off. Thus the circuit, when initiated by a signal, produces a rectangular pulse, the duration of which depends upon the values of C1 and R2.

1. High-Vacuum Circuit for Generating Driven-Sweep

It is only a step from the elementary circuit of Figure 28 to one which is suitable for driven-sweep operation. The circuit of Figure 29 shows this same trigger circuit with addition of a discharge tube, V3, and a constant-current pentode, V4. V3 and V4 are normally conducting, providing a current path from the power supply to ground and allowing C3 to charge. Introduction of the pulse of negative polarity from the trigger circuit to the grid of V3 cuts this tube off and allows C3 to discharge through V4, the constant-current tube. A linear, sawtooth voltage is generated, which begins immediately upon triggering. The return time occurs after the sweep. In the gas-triode circuit, the return time occurs before the driven sweep and some time is consumed before the sweep gets under way.

2. High-Vacuum Circuits for Generating Recurrent and Driven Sweeps

Figure 30 is a typical example of a circuit for generating recurrent sweeps. V2 and V1 are connected as an unbalanced multivibrator, and the circuit constants are so proportioned

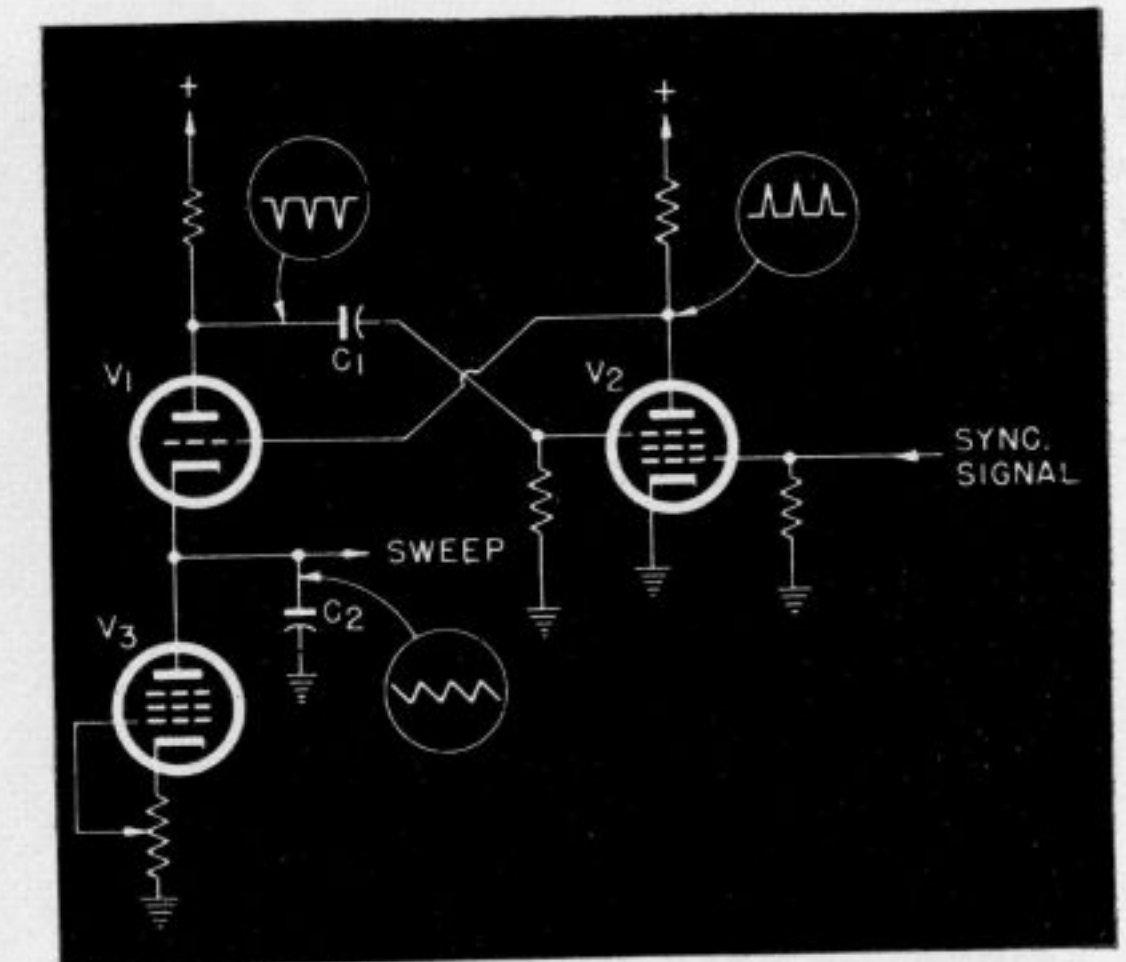

Figure 30. A high-vacuum circuit for generating both recurrent and driven sweeps

that a short positive pulse of large amplitude is delivered periodically to the grid of V1. This pulse lowers the impedance of V1 and allows C2 to charge rapidly from the power supply. During the time between pulses, C2 discharges through V3, a constant current pentode. The multivibrator frequency, and therefore the sweep frequency, is determined by the size of C2 and the impedance of V3. In practice, C2 is usually replaced by a number of capacitors, any one of which may be selected. The sweep frequency is thereby varied in steps by selection of the capacitor, and is variable between steps by adjusting the bias on V3. The sync signal is applied to the grid of V2.

Driven sweep operation is possible by application of a sufficiently positive bias to V2 to prevent continuous sweep. Then a nega-

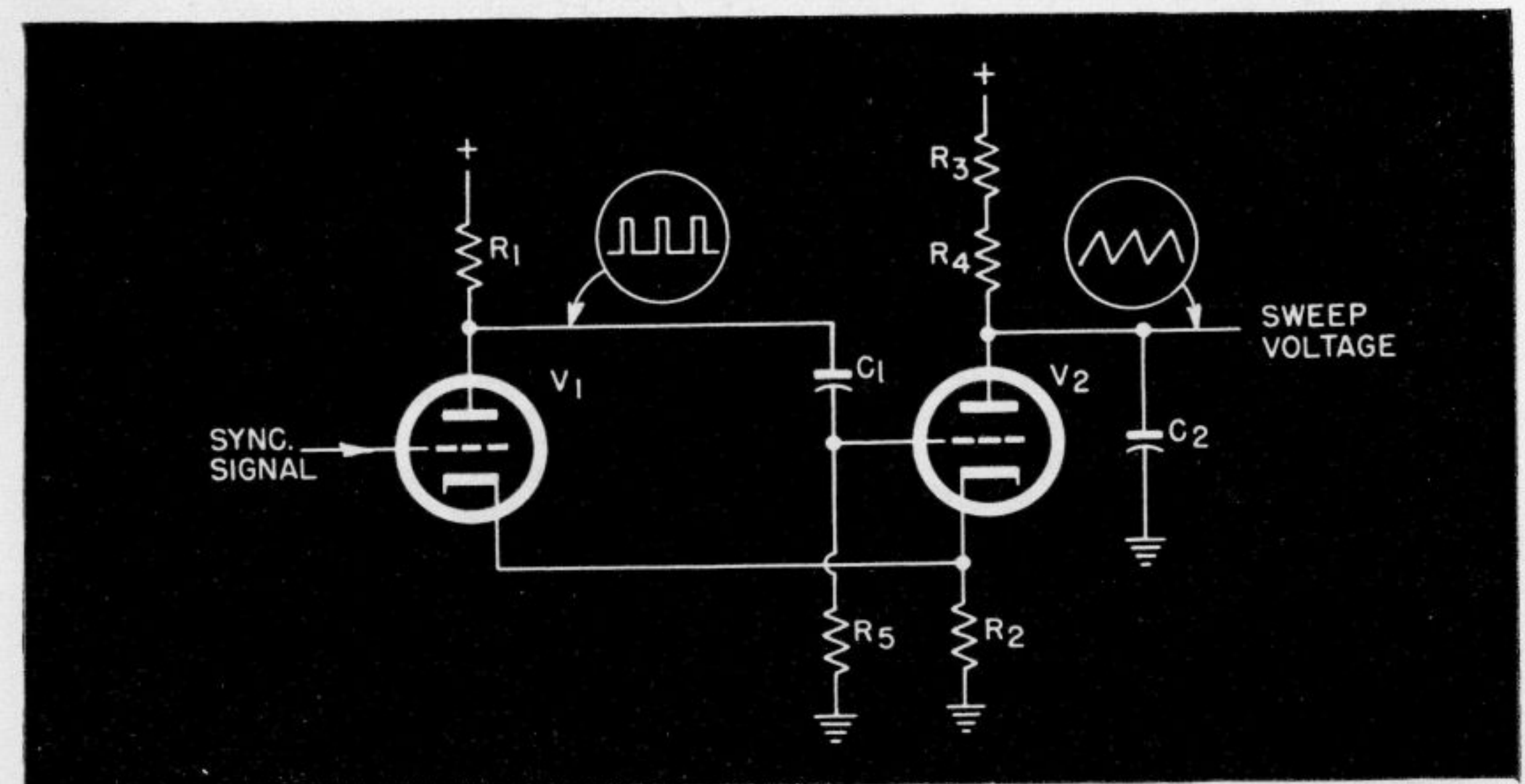

Figure 31. Another example of a high-vacuum circuit for generating recurrent and driven sweeps

rive potential on the grid of V2, sufficient to restore the circuit momentarily to its normal condition, will initiate the sweep for a single cycle. As in the case of the gas-triode driven sweep, the return time occurs before the sweep. However, both return time and sweep time may be made considerably shorter than is possible with the gas-triode circuit.

Figure 31 is still another example of a high-vacuum sweep generator which will furnish either recurrent or driven sweeps. On recurrent operation, V2 is not conducting at first. Then C2 charges through resistors R3 and R4 until the plate potential of V2 reaches a value sufficient to cause conduction. V2 and V1 are connected in a "flip-flop" circuit as described at the beginning of the section on High-Vacuum Time-Base Generators. As V2 begins to conduct, it raises the bias on V1 through the common cathode resistor, R2, and decreases the plate current of V1. The plate potential of V1 begins to increase, and the increase is transferred to the grid of V2 through C1. V2 therefore draws more plate current and cuts off the current in V1. This entire action takes place instantaneously, so that V2 flips from non-conduction to full-conduction almost at once. Of course when V2 does conduct, C2 discharges rapidly through it until it becomes non-conducting once more. Sawtooth voltage is obtained from C2. Synchronizing signal may be applied to the grid of V1.

For driven-sweep operation, the grid of V2 is biased negatively, and a diode is connected in parallel with C2. C2 begins to charge through R3 and R4, but the diode is set so that it conducts before V2 does. When the diode conducts, C2 cannot charge further so it stays at that potential until an initiating voltage of negative polarity is introduced on the grid of V1. A positive signal will be produced at the plate of V1, and this will be transferred to the grid of V2 through C1. If the signal is of sufficient amplitude, it will cause V2 to conduct, and C2 will discharge through it. C2 then charges up to the level where the diode conducts, and holds until the circuit is again initiated. A single sawtooth cycle is generated for each time the initiation occurs.

The practical revisions of this circuit are much the same as with the circuits previously described. Frequency of the sawtooth is variable by providing a selection of capacitors for C2 and by making R3 a variable resistor.

#### (d) Other Time-Bases

While the linear time base is used in most oscillographs, other time bases are often valuable for special applications.

#### 1. Sinusoidal Time-Base

Application of a sine-wave voltage to one pair of deflection plates of the cathode-ray tube provides a proportional deflection. Near the center of deflection where the sine-wave changes from one half-cycle to the next, the potential variation is nearly linear with respect to time. By expanding this center portion sufficiently, the time-base may be made practically linear. Then, by shifting the phase of the sinusoidal voltage through 180 electrical degrees, a phenomenon which occurs during any portion of the sine-wave period may be centered on the screen of the cathode-ray tube.

Still another type of time-base may be produced by applying two sine-wave voltages which are 90 degrees out of phase, one to each pair of deflection plates. If the amplitudes of these voltages are equal, a circular trace will be produced on the screen. The potential to be investigated may also be applied to one pair of deflection plates to produce rectilinear deflection, or it may be used to modulate simultaneously the two sinewave voltages to produce radial deflection. This potential might also be connected to the grid of the cathode-ray tube to produce intensity modulation of the beam.

#### 2. Spiral or Radial Time-Bases

A combination of sawtooth and sinusoidal voltages may be employed to generate a spiral or radial time-base. The circular time-base is produced as described above, and the sawtooth voltage is used to modulate the amplitude of the signals producing the circle. The radius of the circle varies in accordance with the sawtooth voltage, and the time-base will resemble in form the main spring of a watch.

The chief advantage of the circular and the spiral time-bases over the linear time-base is that, for a given size of cathode-ray tube, the length or duration of the time-base may be made much greater. The circular time-base is also useful in rotary motion studies where the quantity to be investigated can be plotted as a function of angular position.

#### (e) Marker Circuits

Many modifications and refinements may result from the circuits described in the preceding sections. One of the most useful is the circuit which provides time marks on the time-base. These marks may be in the form of intensity modulation of the cathode-ray tube beam, or short pulses applied to the deflection plates (not the same pair of deflection plates to which the time-base voltage is connected).

Such pulses are usually obtained from an extremely stable oscillator which is started as

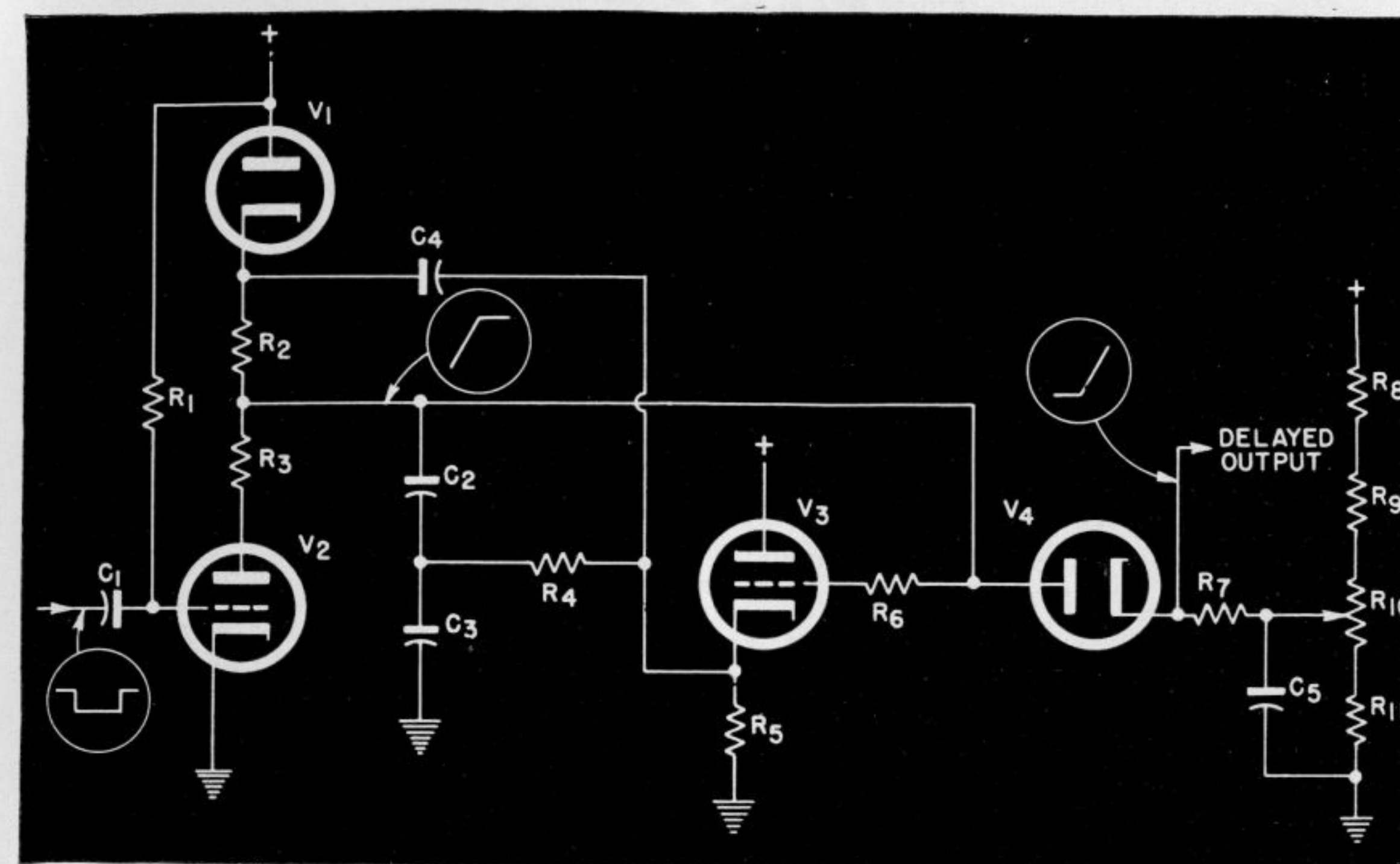

Figure 32. A delay circuit which is used to initiate or trigger a precision-delayed sweep generator

the time-base begins, and which stops oscillating before the succeeding cycle of the time-base begins. Shaping circuits are usually required to form sharp pulses from the oscillator output.

#### Sweep-Delay Circuits

It is possible to produce a pulse, the occurrence of which is delayed a known interval of time from a given pulse, in order to initiate or trigger a delayed-sweep circuit. This may be accomplished by means of a circuit such as is shown in Figure 32.

The grid of V2 is connected to a positive potential through R1, and therefore V2 is conducting until the negative initiating pulse is applied through C1. This pulse has sufficient amplitude to cut off V2; capacitors C2 and C3 charge up through V1 and R2. Their charge would collect exponentially, as has been previously discussed, except for the compensation provided by the feedback through V3, C4 and the integrating action of R4 and C3. The linear sawtooth output is applied to the plate of diode, V4.

Potential on the cathode of V4 is determined by the position of potentiometer, R10. This potentiometer is accurately wound so that the

resistance variation between one end and the movable arm is linear with respect to the position of that arm. V4 will not conduct until such time as the sawtooth potential on the plate reaches the potential of the cathode. Waveforms at plate and cathode of V4 are shown in the circuit.

The time delay is measured from the start of the negative initiating pulse to the point where the diode conducts. If the position of R10 is such that the cathode potential of V4 is low, then V4 will conduct relatively soon after the start of the initiating pulse. If the cathode potential is high, V4 will not conduct as soon after the pulse is applied.

In practice, a calibrated dial can be attached to the potentiometer, R10, and the delay in time read directly from it. The delayed output pulse from this circuit may be used to initiate a linear time-base generator, thus varying the start of the time-base with respect to the initiating pulse. Time intervals between investigated pulses may be measured by varying the delay to bring each pulse to the same point on the time-base, and subtracting the dial readings obtained thereby. Accuracy of measurements may be limited to the accuracy with which R10 is wound.

#### NOTICE

No liability is assumed with respect to the use of circuit and tube information contained in this manual.

# INTERPRETATION OF OSCILLOGRAPH SPECIFICATIONS

It is a well-known fact that in our language words frequently have ambiguous meanings. It is easy to see why, in the relatively new art of cathode-ray oscillography where exact definitions have not as yet been determined, specifications written by different people may have as many different interpretations in terms of actual oscillograph performance.

It is the policy of Du Mont to publish conservative specifications so that persons using our instruments are assured performance at least equal to that inferred from the specification. Elsewhere in the industry there has occurred the practice of publishing maximum specifications which indicate the best possible performance, and which may not be equaled by an instrument chosen at random.

In print, these maximum specifications might make an inferior instrument seem to compare favorably with another oscillograph, even though there could be no real comparison of performance. There are also many points to be considered which cannot be judged by reading written specifications alone.

The following outline will be helpful as a guide in appraising the true performance of any cathode-ray oscillograph.

## Screen Size and Maximum Deflection

Oscillographs are available which employ 7-inch and 9-inch cathode-ray tubes and in which the tube size alone has been pointed out as a distinct feature. Certainly, the larger screen is desirable, but only if everything else is equal. However, specifications should be examined to determine whether the amplifiers in the instrument are capable of producing sufficient undistorted deflection to utilize the entire area of the screen. If such deflection is not available, there is no advantage in the large screen. Furthermore the fluorescent spot-size in a 5-inch tube is smaller than in an equivalent larger tube, and better resolution is possible with the 5-inch tube for studying small details. Most Du Mont oscillographs are capable of producing more than full-screen undistorted deflection. Available undistorted deflection is clearly specified in all cases where it is less than full-screen.

Finally, a highly developed group of accessories that enhance the utility of the cathode-ray oscillograph is available only for use with tubes of 5-inch diameter.

## Shape of Amplifier Frequency-Response Curves

One method of evaluating amplifier per-

formance is in terms of its sinusoidal frequency-response characteristic, or its band-width characteristic. A specification may read: "Vertical amplifier response down 30% at 1 megacycle per second." This, however, does not tell a complete story. Another amplifier, while similarly specified, might perform quite differently, owing to the shape of its frequency-response curve.

The response curves of Figure 1 are drawn for three amplifiers, all of which have the same nominal band-width. Note, however, that curve A slopes gradually at the higher frequencies. It is typical of an amplifier without high-frequency compensation. Curve B is flat to a higher frequency, but then drops off more sharply, as is typical of an amplifier with correct compensation. Curve C rises slightly before falling off very sharply, typical of an improperly designed amplifier, over-compensated so that its response specification may read the same as the others.

The oscillograms in Figure 2 indicate the waveforms which might appear on the cathode-ray tube screen if a square pulse were applied to each of the three amplifiers. From them it is obvious that the performances of the amplifiers are not at all similar.

Specifications for Du Mont oscillographs shown in this catalog are accompanied by actual response curves. Note that all amplifiers are designed so that there are no positive slopes or rapid declines at the high-frequency end of the characteristics. Maximum performance in the amplification of complex as well as sinusoidal signals can be expected from these amplifiers.

## Phase Shift vs. Frequency Response

Many oscillograph specifications, particularly for those instruments which have wide-band amplifiers, give only the response of such amplifiers to a sinusoidal signal. However, the response of an amplifier to a complex signal

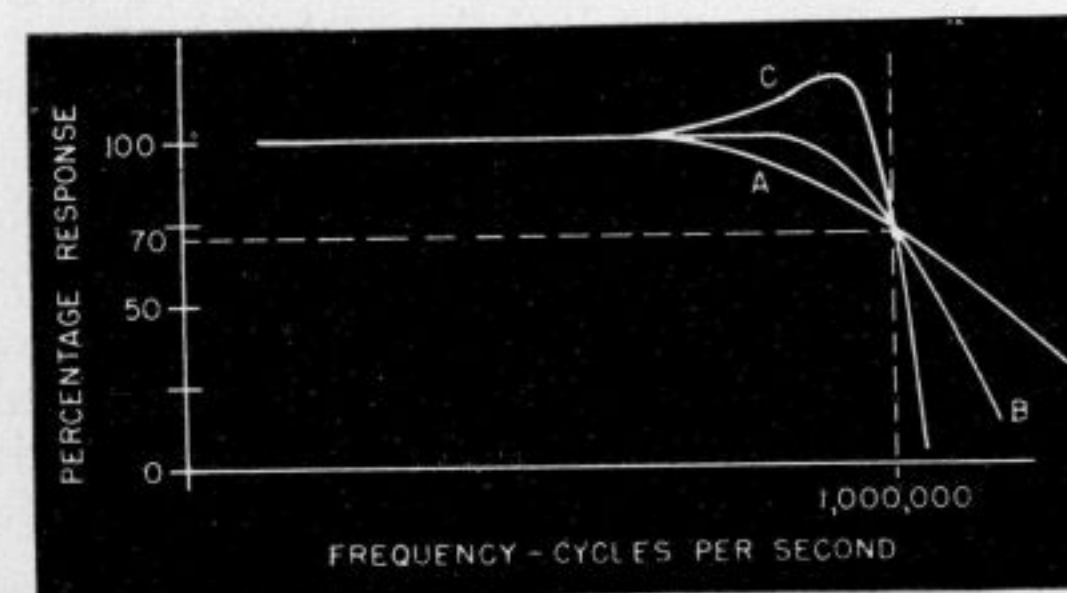
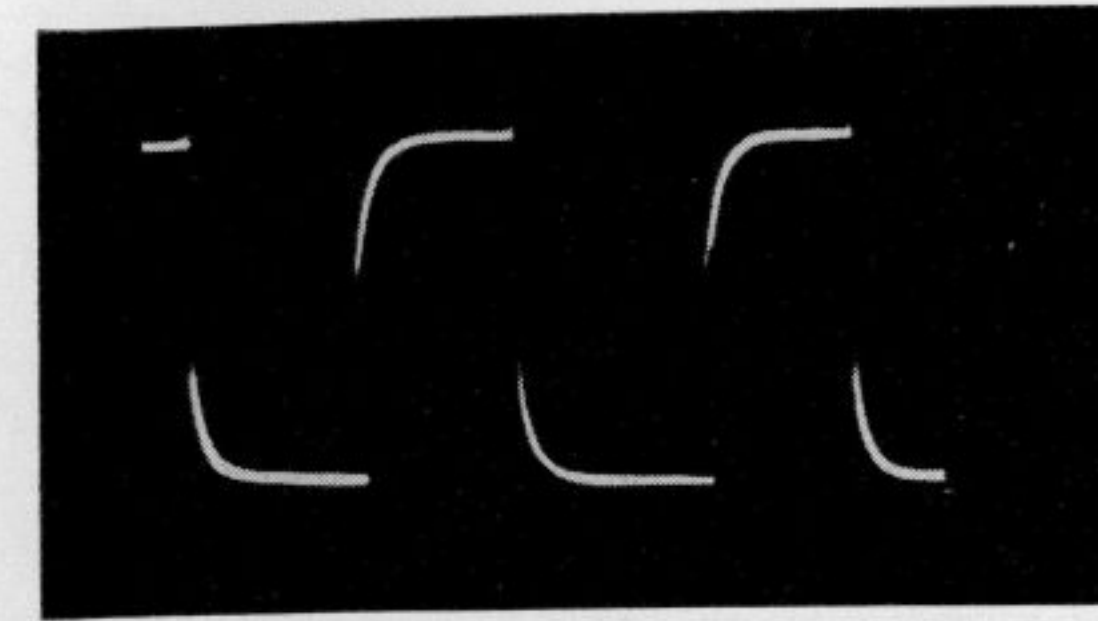
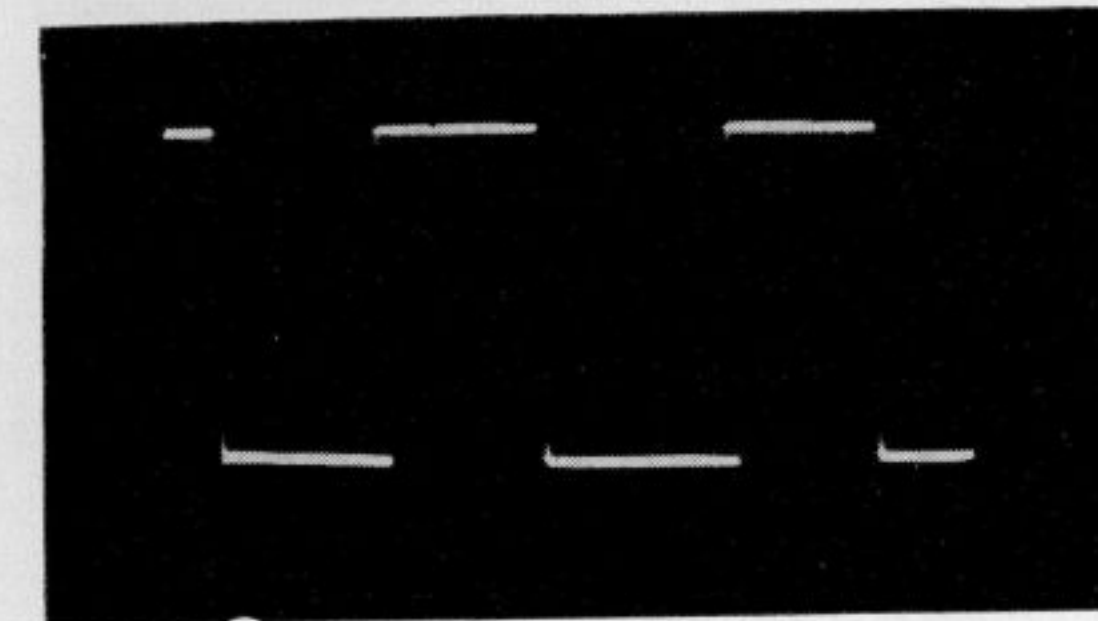

Figure 1. Frequency-response curves for 3 amplifiers with different degrees of compensation

## INTERPRETATION OF OSCILLOGRAPH SPECIFICATIONS



A



B

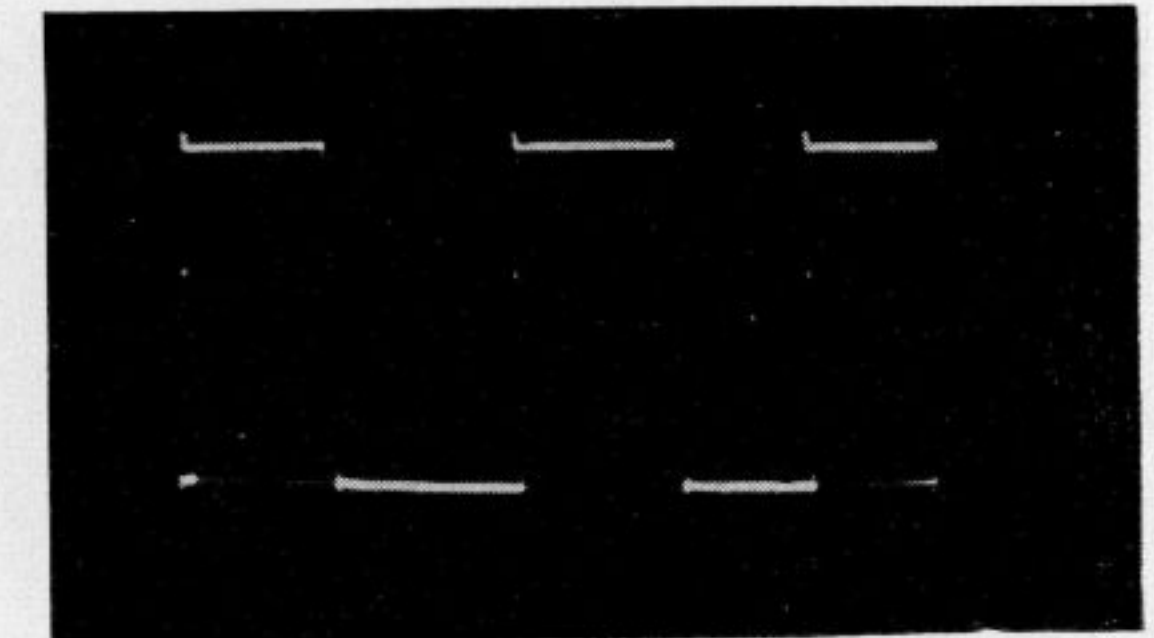

C

Figure 2. Oscillograms showing respectively the response of the three amplifiers represented by curves A, B, and C in Figure 1 to a square-wave signal with fundamental frequency of 100,000 cycles per second

formance. At all other positions, because of stray capacitances across the high-impedance, band-width may be seriously decreased.

The oscillograms of Figure 3 illustrate what may happen if a square-wave signal is applied to an amplifier which has a high-impedance gain control. The one at the left is obtained when the gain control is at maximum position, while the one at the right is obtained with the control at an intermediate position. It shows distortion produced by the narrower band-width characteristic. In these two illustrations, the amplitude of the input signal has been adjusted to give equal deflections, to facilitate comparison.

Specifications should be checked to see if amplifier frequency response is specified at some particular gain-control setting, or whether it applies to all gain-control positions. The better, more-expensive oscillographs should have low-impedance gain controls and, therefore, a band-width characteristic independent of amplifier gain.

All Du Mont oscillographs except the low-priced Types 274-A and 292 have specifications which state that frequency response of the amplifiers is the same for all positions of their gain control.

(one which contains a number of sinusoidal frequency components) depends as well upon the constancy of delay through the amplifier at all these frequencies, the delay usually being expressed in terms of phase-shift of a sinusoidal signal. If the component frequencies in the complex signal are not all delayed by the same amount (i. e.—phase shift proportional to the frequency), the complex waveform will be distorted in passing through the amplifier.

Du Mont oscillographs, such as the Types 256-D and 294-A, which are designed for the investigation of short pulses and other complex signals, have specifications for the response of their amplifiers to pulse waveforms.

## Amplifier Band-width vs. Gain-Control Setting

In an oscillograph having a high-impedance gain control, the specified amplifier band-width will hold only when that control is at maxi-

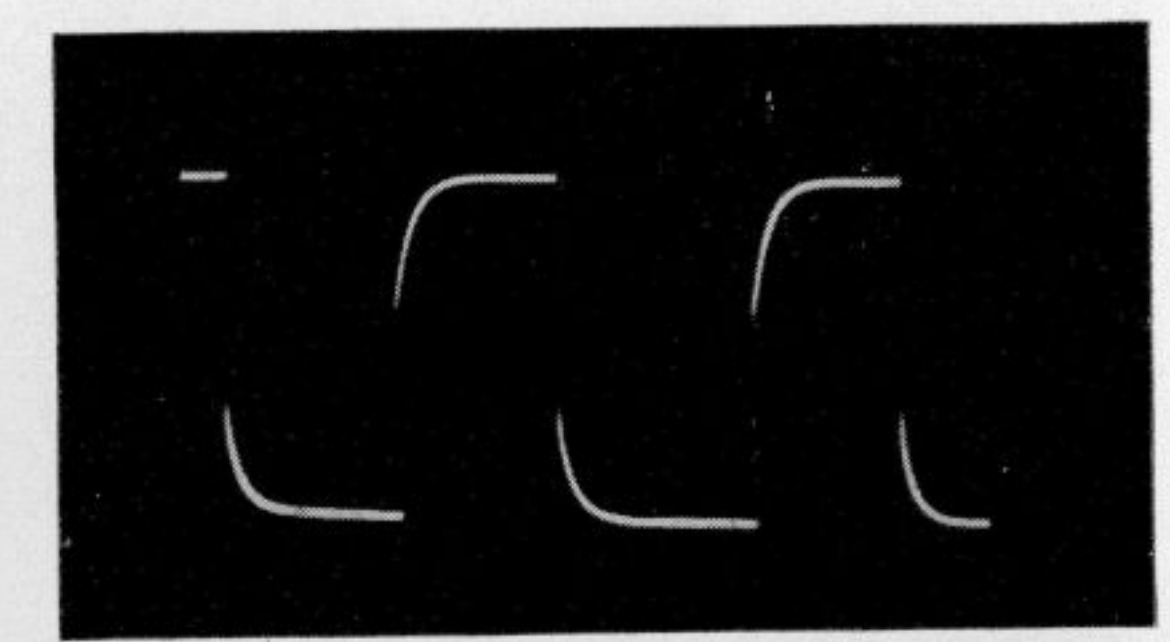
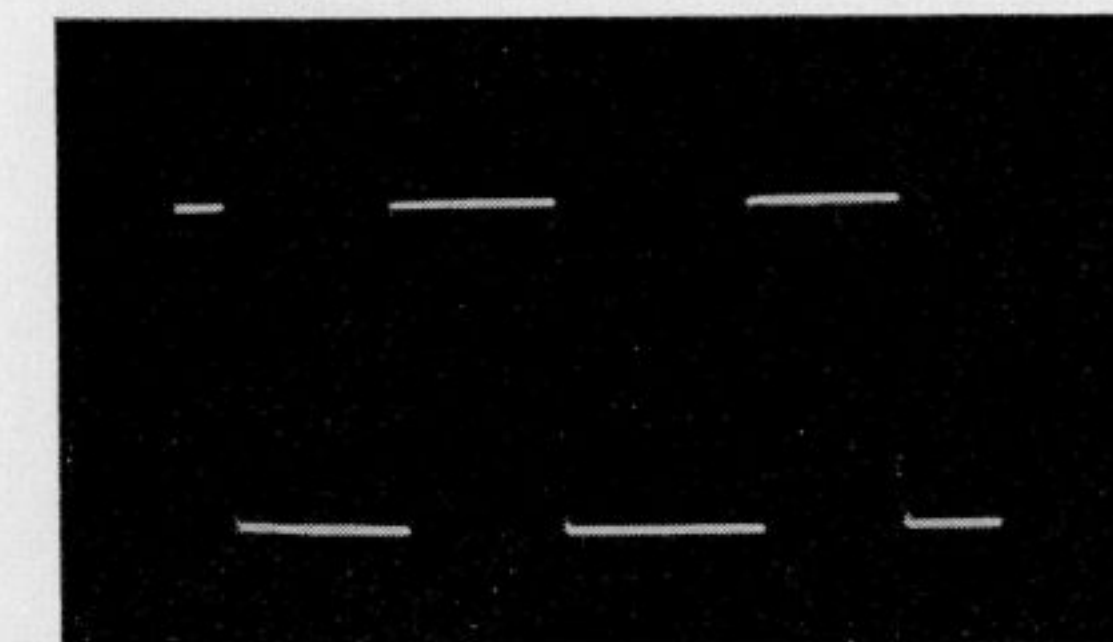

Figure 3. Oscillograms illustrating the effect of a high-impedance gain control upon amplifier band-width. They were made with maximum gain (left) and with reduced gain (right)

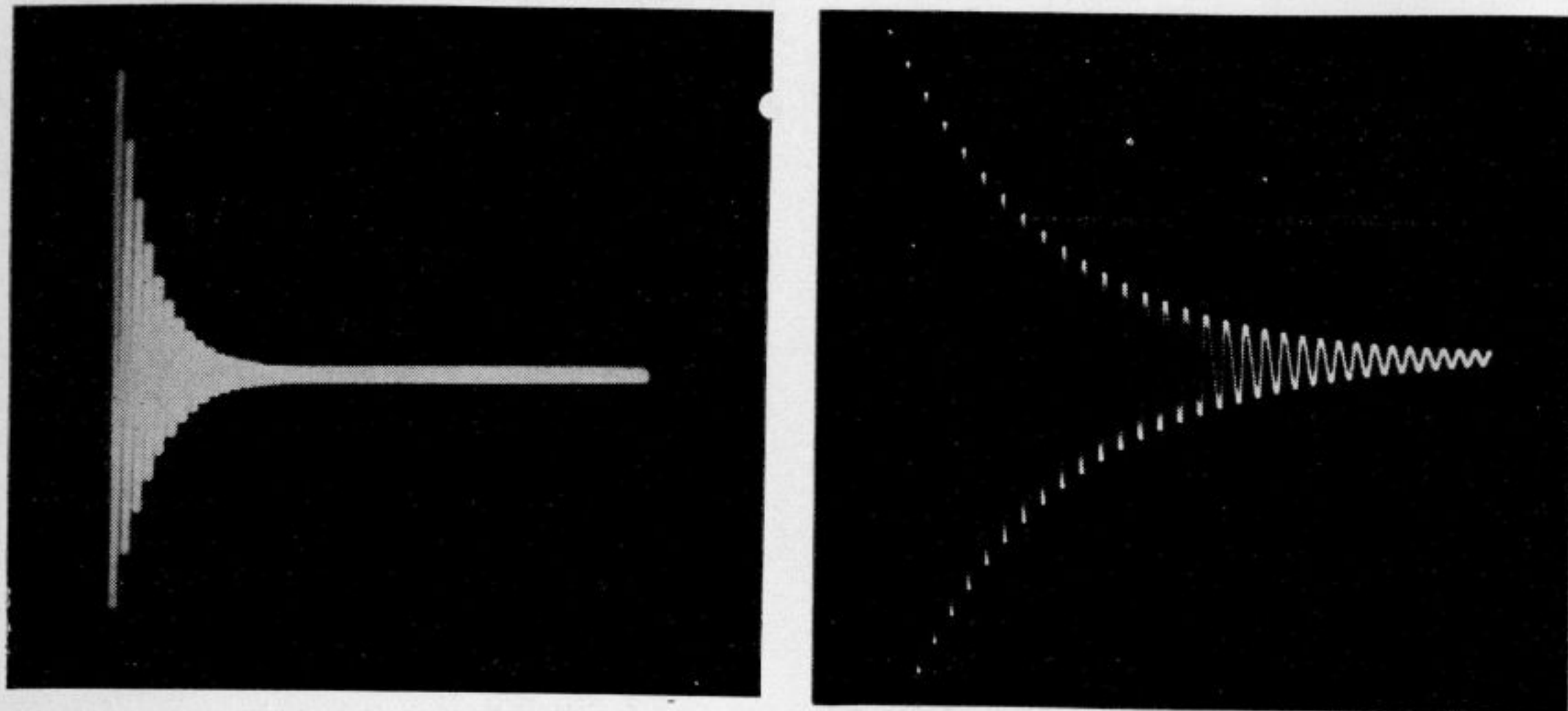

Figure 4. Oscillograms illustrating the limitations upon usable band-width of an oscillograph due to insufficient sweep speed (left) and insufficient pattern brightness (right)

**Usable Band-Width**

Amplifier band-width by itself does not determine the usable band-width of any cathode-ray oscillograph. Maximum available sweep speed and maximum brightness of the cathode-ray tube are also factors to be considered. In Figure 4, a damped sine wave oscillation is used as an illustration of this point. In the oscillogram on the left, brightness is satisfactory but sweep speed is not high enough to prevent crowding of the pattern at the frequency which is being plotted. The oscillogram on the right illustrates the effect when the sweep speed is high enough but brightness is insufficient because of improper selection of cathode-ray tube or accelerating potential. Only the peaks of the sine wave are visible during the first few cycles where the fluorescent spot is moving most rapidly. As the oscillation is damped, the spot moves more and more slowly until the complete cycles are finally visible.

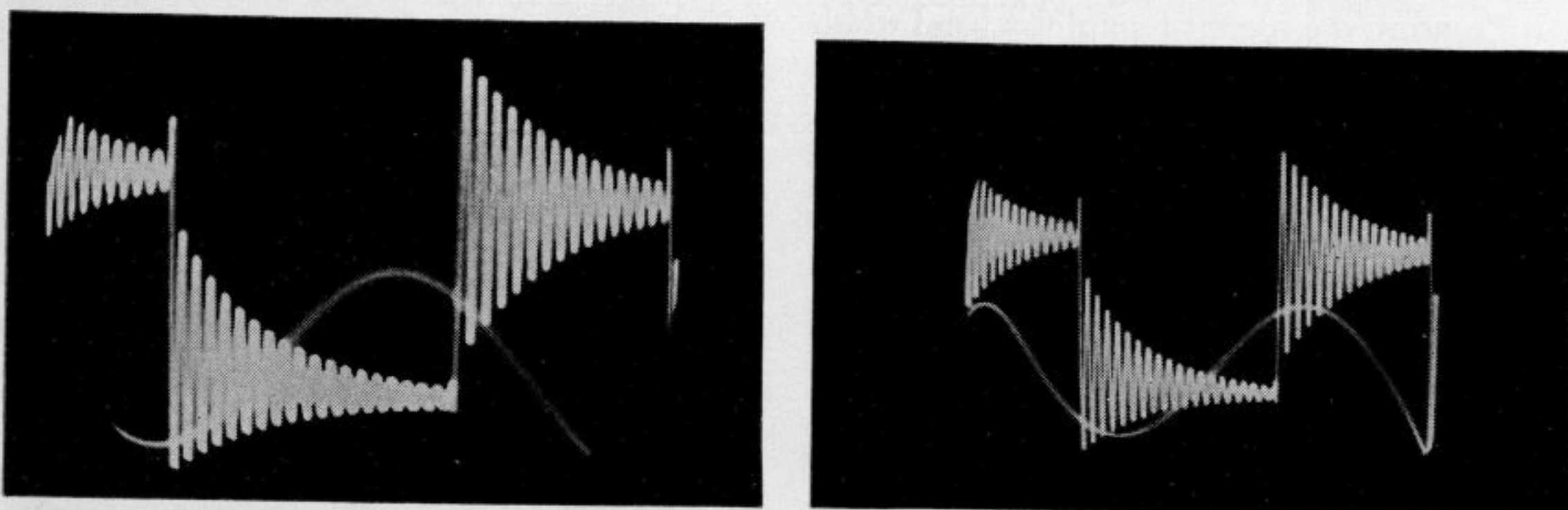

Figure 5. Oscillograms comparing the resolving power of a low-voltage cathode-ray tube with large spot-size (left) with that of a high-voltage tube (such as the Du Mont Type 5RP-A) which has a smaller spot-size (right)

We may conclude therefore that an oscillograph should have sufficiently fast sweeps and adequate accelerating potential in order to derive full benefit from the band-width provided by its amplifiers. Note that the Du Mont Type 294-A Cathode-ray Oscillograph has a maximum sweep speed of 0.2 microsecond per inch, and 12,000 volts acceleration in order to make full use of its 14 megacycle amplifier response.

**Balanced vs. Single-Ended Deflection**

In general, the use of single-ended or unbalanced deflection amplifiers is confined to the smaller, more inexpensive oscillographs. When a signal is applied to only one plate of a deflection-plate pair, it is ordinarily not possible to focus properly the resultant trace across the entire screen. The focus control on the oscillograph may be adjusted in order to focus some particular portion of the trace, but then some other portions will be de-focused. If unbalanced signals are applied to both pairs of de-

flection plates, there may be produced an astigmatic condition where either horizontal or vertical portions of the trace can be focused, but not both simultaneously.

In some oscillographs, such as the Du Mont Type 256-D, unbalanced vertical deflection is employed, but an auxiliary focus control as well as a conventional focus control provides excellent focusing over the entire screen.

**Resolving Power**

Comparisons between oscillograph performances cannot be made solely on the basis of deflection sensitivity (reciprocal of deflection factor). In order to make a fair evaluation, we should rather compare in terms of "deflection sensibility", which may be defined as the deflection voltage required to move the fluorescent spot a distance equal to its own diameter. It can be expressed by the formula:

$$\text{Deflection Sensibility} = \frac{\text{spot size}}{\text{deflection factor}}$$

and is a figure of merit for the resolving power of an oscillograph.

In Figure 5 the oscillogram on the left is typical of that obtained on a cathode-ray tube operated at low accelerating potential and having good sensitivity but large spot-size. Note the incompleteness of resolution even though the pattern itself is of large size. The oscillogram on the right is typical of one obtained when the same signal is applied to a cathode-ray tube operated at high accelerating potential. Every detail shows up clearly because this tube has much smaller spot-size and therefore better "deflection sensibility", even though deflection sensitivity is not nearly as great.

"Deflection sensibility" is particularly important in connection with the Type 5RP-A series of cathode-ray tubes. These are designed to operate with accelerating potentials from 7000 to 29,000 volts and they have slightly lower sensitivity than other tubes operated at

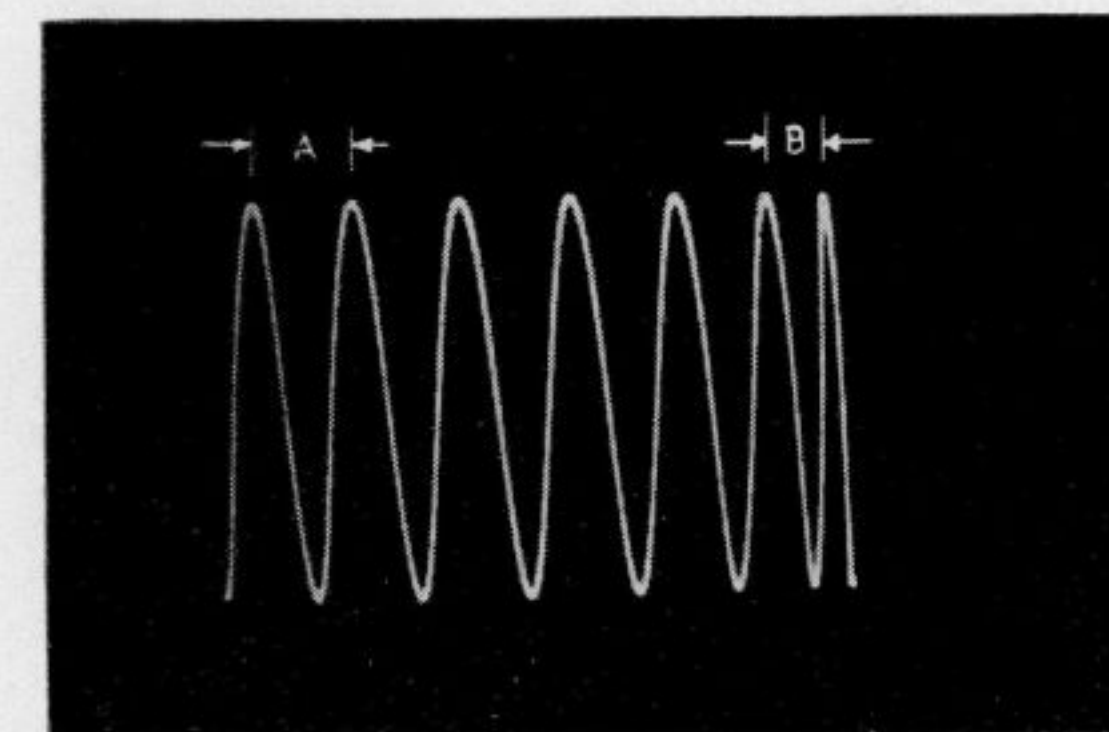

Figure 7. Oscillograms showing a sinusoidal voltage plotted on a time-base which is non-linear (left) and also on one which is linear (right)

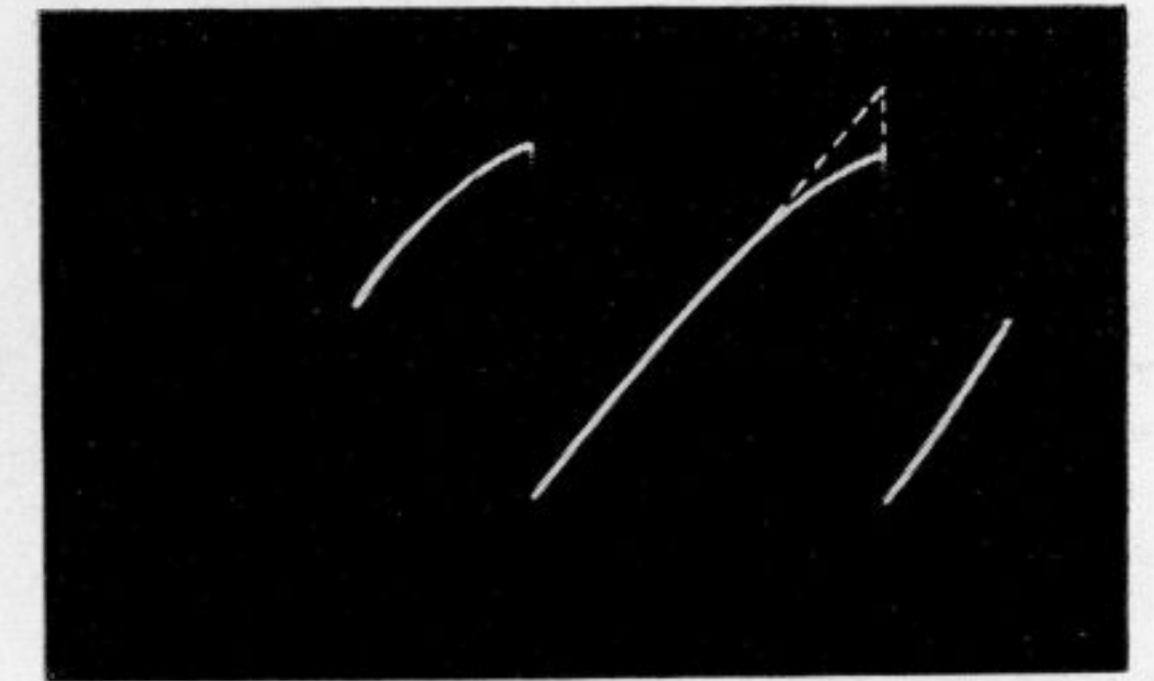

Figure 6. Oscillogram of a non-linear sawtooth voltage (solid line) showing comparison with a perfectly linear sawtooth (dotted line)

2000 to 3000 volts. However, they have much smaller spot-size and greater resolving power.

**Sensitivity vs. Input Impedance**

A probe is furnished with some oscillographs in order to provide a high-impedance, low-capacity, shielded input for the vertical amplifier. It is wise in these instances to check the specifications concerning input capacitance at the panel terminals. This capacitance may be so high that the panel-terminal input will impose too great a loading effect upon high-frequency signal sources and it will therefore be useless. If the use of the probe is absolutely required, then be sure that specified sensitivity (deflection factor) includes the probe, because the probe may introduce considerable signal attenuation.

**Sweep Linearity**

The time-base in most oscillographs is supposedly linear unless otherwise stated. However, not many oscillograph specifications include a statement concerning the linearity of their sweeps. Figure 6 is an oscillogram showing the waveform of the voltage generated by the linear time-base generator. The dotted line represents a sweep voltage which is perfectly linear; the solid line indicates the departure from linearity which occurs in many time-base

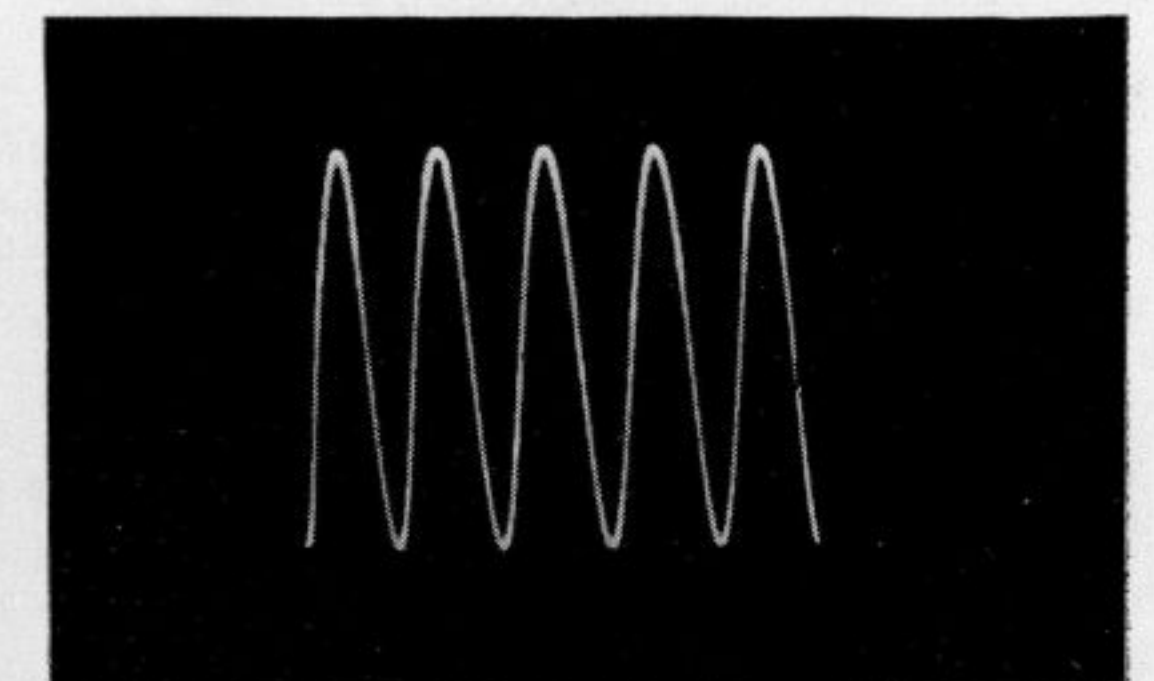

generators. In the oscillograms of Fig. 7, the one on the left represents the appearance of a sinewave signal as plotted on the non-linear time-base, while the one on the right shows the same sinewave plotted on the linear time-base. Linearity of the time-base may be measured as shown on the left-hand oscillogram. In measuring linearity of the sweep, not less than six increments should be used, and ten are usually considered most satisfactory. It should be remembered that results will vary somewhat with the number of increments used. Thus if a comparison of sweep linearity of two instruments is to be made, the same number of increments must be employed in both tests if results are to be significant. Spacing between sinewave peaks remains uniform if the sweep is linear.

### Usable Duty Cycle on Triggered Sweeps

For certain low-priced oscillographs, sweep speed are advertised which approach those available in the Du Mont Type 294-A (0.2 microsecond per inch). Note, however, that such high speeds are useless if the sweeps are to be triggered at low repetition rates, because accelerating potential on the cathode-ray tube is insufficient to make them visible on the screen. An oscillogram of a phenomenon having a repetition rate of only 30 cycles per second may be plotted on the 1 microsecond sweep of the Type 294-A. In order to produce a trace of comparable intensity on a competitive low-priced instrument, the repetition rate needed to be in the order of 600 cycles per second.

Since it is the energy furnished to the cathode-ray tube screen per unit of time per unit area which determines the brilliance of the trace, and since the energy is dependent upon accelerating potential, the Type 294-A which can operate with 12,000 volts on the tube is far superior to the instrument operating with, say, 3000 volts.

### Maximum Input Voltage

In a great many instances, the signal to be examined on an oscillograph has a d-c component as well as an a-c component. As an example, the potential at the plate of an amplifier tube is composed of the a-c, or signal, potential, plus an average, or d-c, potential. The input coupling circuits of an oscillograph should therefore be designed to withstand the sum of these components.

The voltage rating of input coupling capacitors is rather low in some oscillographs, whereas Du Mont oscillographs are generally designed

to handle either 600 or 1000 volts d-c plus peak a-c input.

### Connections to Deflection Plates

It may sometimes be necessary to investigate with an oscillograph signals which contain frequency components beyond the frequency-response limits of the deflection amplifiers. Such signals may be directly connected to the deflection plates of the cathode-ray tube, provided that terminals are available for this purpose.

It is extremely desirable that positioning controls on the oscillograph retain their usefulness even when connections are made to the deflection plates. Positioning of the trace on Du Mont oscillographs is either retained automatically or else may be retained by observing certain precautions outlined in the instruction book which is supplied with the instrument.

### Synchronizing-Signal Polarity

It is very convenient to be able to synchronize the sweep in an oscillograph from signals of either positive or negative polarity, since many times only one of them is readily available. Most Du Mont oscillographs have provision for such sync-phase selection.

### Stability of Operation

An oscillograph should be sufficiently stable in operation that it is not affected by line-voltage changes of ordinary magnitude. Instability may exhibit itself as shifting of trace position, change of beam intensity, non-operative amplifiers, etc., any one of which renders the instrument more or less useless.

Some oscillographs, for instance, derive amplifier bias from a negative high-voltage supply, the regulation of which is extremely poor with respect to line-voltage changes. Line surges are thereby actually amplified, and will appear on the screen of the cathode-ray tube.

Du Mont oscillographs are designed to deliver specified performance with power-line fluctuations up to 10% of the nominal line voltage.

### Adequate Shielding

The cathode-ray tube in an oscillograph should be shielded against magnetic disturbances to prevent undesirable deflection or modulation of the electron beam. All Du Mont oscillographs are housed in steel cabinets which serve to provide some shielding, and most of them are equipped with a mu-metal shield which surrounds the tube itself and effectively prevents any magnetic field from reaching the tube. The choice of mu-metal is made because it has the most excellent magnetic properties of any material known. Other materials provide inferior shielding.

### Accessibility for Servicing

While an oscillograph is primarily a test instrument which should not require much bench-space, it is nevertheless unwise practice to gain compactness at the expense of accessibility. Some small-size oscillographs are so compact that whole sections must be removed in order to reach a single component. This is particularly bad when the oscillograph is to be used under other than ideal laboratory conditions.

Du Mont oscillographs are as carefully designed mechanically as they are from an electronic standpoint. Size and weight are kept at minimum values consistent with good engineering practice, which certainly includes serviceability.

### Flexibility of Operation

The specifications of some oscillographs indicate that close tolerances on power-line voltage must be maintained. Overheating and reduced transformer life may result if line voltage should be consistently higher than nominal.

Du Mont oscillographs are designed to perform with power-line potential as much as 10% higher than nominal. Furthermore, most Du Mont instruments can be operated from either 115-volt or 230-volt lines, and they often will perform normally at power-line frequencies other than their rated 50-60 cps.

### Accessories and Auxiliary Equipment

The variety of accessories and auxiliary equipment which Du Mont provides does much to increase the value of our customers' oscillographic investment. Items such as the Type 264-B Voltage Calibrator, the Type 185-A Electronic Switch, the Types 295, 296, 297, and 321 Oscillograph-Record Cameras, the Type 2542 Projection Lens, the Types 2560 Color Filters, the Type 276-A Viewing Hood, among many others, are invaluable in extending the usefulness of an oscillograph. Complete information concerning their descriptions and applications is given in this catalog.

### Manufacturers' "Know-How"

Before one makes an investment such as oscillographic equipment represents, one should first satisfy himself that the manufacturer from whom he makes his purchases is qualified by experience to specify and recommend instruments to fit his particular problems.

Most manufacturers of oscillograph equipment fall into two general classes: those who have only recently entered this highly-specialized field, and those whose major activities concern other types of products. The former lack the experience and deep understanding of oscillography that can come only after years of activity

in the field. And the latter's interests in oscillographs as instruments are only a small fraction of their total and therefore they cannot afford to devote to them more than a fraction of their development, research, and sales service.

Du Mont has long been associated with the oscillographic industry, and the manufacture of oscillographs and cathode-ray tubes represents a major portion of its activities. We have gathered experience from many fields, and we know from experience what you need to do your job.

### Guarantee

When a manufacturer guarantees his product, he provides both protection and service to the customer. Protection, in that no one makes a guarantee unless he feels that his product can meet it; service, in that any fault occurring in the guarantee period will be the responsibility of the manufacturer.

Du Mont instruments carry a guarantee for one year; cathode-ray tubes, for six months or 1000 hours of operation.

### Repair and Servicing Facility

Du Mont's interest in satisfying its customers does not end at the time the sale is completed. Du Mont equipment is recognized as first quality merchandise, and it is backed by the above guarantee. Every precaution is taken in design and in production to insure long years of trouble-free operation. However, since there are exceptions to all rules, it is possible that a customer will at some time be confronted with a difficulty which he is not equipped to overcome. Du Mont maintains a qualified, capable Instrument Service Department to insure that proper service is always available. Authorization to return an instrument or tube for repair or replacement may be obtained by contacting this department. While it is in our hands, we will not only correct the fault which has occurred, but we will subject the instrument to a complete check-up before returning it.

### Du Mont Publication

Our quarterly publication, the Du Mont *Oscillographer*, contains articles prepared by various members of our Engineering staff which we believe will be of interest to engineers in all fields. Those who read the *Oscillographer* are kept abreast of latest oscillographic developments. Often the articles concern newly developed instruments and tubes, or they describe interesting application techniques which can be gainfully adopted by users of oscillographic equipment. Request that your name be added to our *Oscillographer* mailing list by writing to the editor at our home office.

# CONSIDERATIONS INVOLVED IN VISUAL OBSERVATION OF CATHODE-RAY TUBE PATTERNS

## Stationary Patterns of Periodic or Recurrent Phenomena

In general, no special techniques are involved in observing stationary patterns on an oscillograph screen. It should be kept in mind however, that the ambient light in the location of the oscillograph greatly affects the apparent brightness and contrast of the image. The actual brightness of a cathode-ray tube pattern varies approximately as the square of the accelerating potential and for most electrostatic tubes, approximately as the 1.5 power of the grid voltage. The different types of screens also have different visual efficiencies, as explained in the section on screens, and this section should be consulted when choosing a screen for a particular application.

Visual contrast may often be improved even in a brightly illuminated location if a filter of the same color as the image trace is placed in front of the screen. This serves to reduce the amount of surface illumination and so effectively darkens the background for the trace.

## Low and Medium-Speed Transients

Figure 1 shows tube brightness required for the visual observation of low or medium-speed single transients with P1, P2, and P11 screens at various writing speeds. These data are approximate for observation from a close distance in darkness, with dark adapted eyes, and for pulsed-grid operation. The brightness is measured on 2" x 2", 50-line raster by means of an illumination meter with a filter having a color transmission corresponding to the color response of the human eye. The signal is applied to the tube, which is first biased beyond cutoff, and the grid pulsed to the same level at which the brightness measurement was made.

The limit writing speed corresponds to a signal which, under these conditions, can just be recognized. In the case of sinusoidal transients, the limit writing speed corresponds to the writing speed of the spot at the x-axis crossover point. In making such measurements,

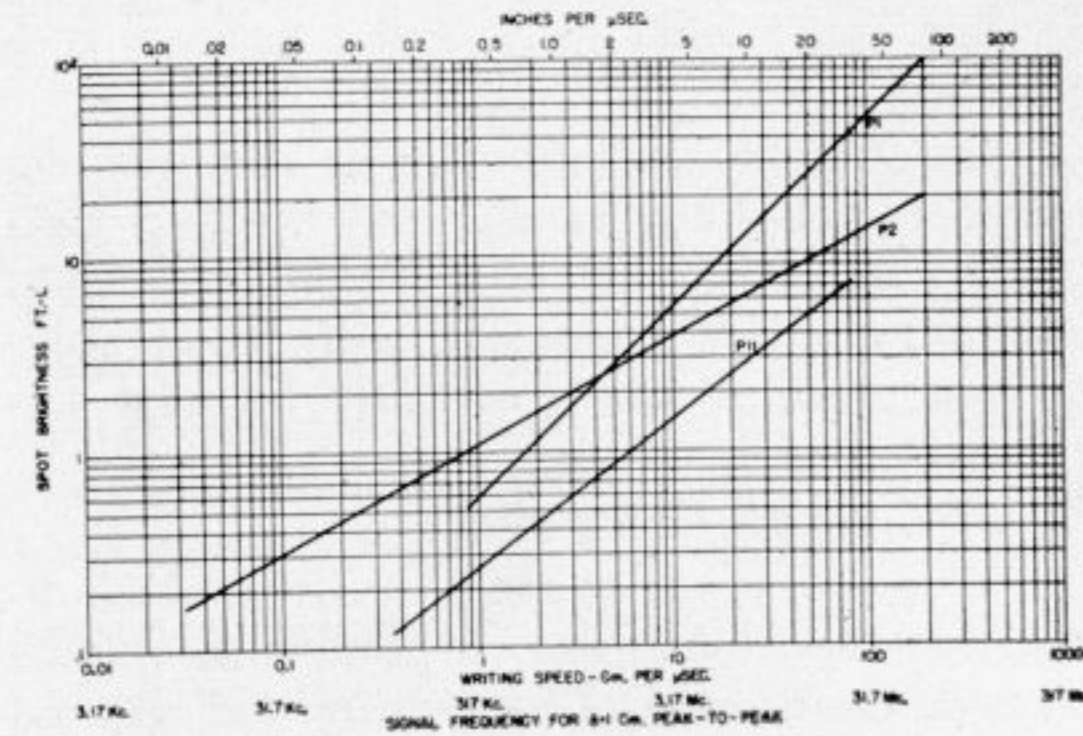

Figure 1. Graph showing limit writing speeds vs. spot brightness for visual observation of single transients on P1, P2, and P11 screens

the peaks of the sinewave are usually masked off to avoid the illusion of seeing the complete pattern when only the points of minimum writing speed are actually visible.

The following examples illustrate the use of this graph. A sinusoidal transient of 3 mc/sec and 3 cm peak-to-peak amplitude has to be observed. From the nomograph, Figure 9, on page 131, we find the corresponding writing speed at 28 cm/ $\mu$ sec. On our graph, Fig. 1, we locate P1 brightness of 15 Ft. L. which may be obtained on such cathode-ray oscillographs as the Types 294-A, and 250-AH. As a second case, let us take a single pulse which rises to a peak amplitude of 2 inches or 5 cm in 1 microsecond. This corresponds to a writing speed of 5 cm/ $\mu$ sec or 2 inches/ $\mu$ sec. On our graph we find 2.8 Ft. L. (P1), 2.6 Ft. L. (P2), or 0.9 Ft. L. (P11). These brightness levels can be obtained on all Du Mont oscillographs but only those types which have automatic beam control or permit grid-pulsing and have sufficient amplifier band-width would be used to study such transients.

Visual observation of single transients is facilitated by the use of long-persistence screens such as the P2 and P7.

The accompanying curves, and those in the P2 and P7 data sheets of this manual, are

typical persistence-time vs. writing-speed characteristics obtainable with Du Mont cathode-ray tubes under the conditions given. From these curves it is possible to predict the approximate persistence times available with a given oscillograph at various spot writing speeds. Thus, by knowing the accelerating voltages of the different oscillographs and the writing speed or frequency of the transient to be observed, one can refer to the curves and choose the proper oscillograph and tube screen for the purpose.

It is apparent from these curves that the P7 screen gives better results at low writing rates and that the P2 screen gives better results at high writing rates. It is also apparent that the useful persistence time increases with increasing accelerating voltage.

The curves shown below were obtained experimentally in total darkness.

It must be kept in mind that the useful persistence time depends to a large extent on the amount of ambient light which is present. In absolute darkness, an increase of persistence time by a factor of 10 to 20 may be expected,

while with higher ambient light levels, a shortening of persistence time occurs.

## High-Speed Single Transients

The curves of Figure 1 should *not* be extrapolated to very high writing speeds and brightness levels since they are based upon brightness data obtained under steady raster conditions and relatively low beam currents and accelerating potentials. Extremely high brightness levels may be obtained with the Type 5RP-A High-Voltage Tubes, but the visual efficiencies of the different phosphors do not remain relative as the accelerating potentials and writing speeds are increased. This is due partly to shifts in the color spectrum of the light output at high voltages, and to the different thermal effects upon the screen at higher spot writing speeds.

With very high-speed transient excitation of the screen, the light build-up may not be rapid enough to allow the phosphor to reach its maximum efficiency at the same instant that the beam current reaches its peak value.

The P2 screen will allow the observation of considerably higher speed transients than the P1 or P11 screen under these conditions.

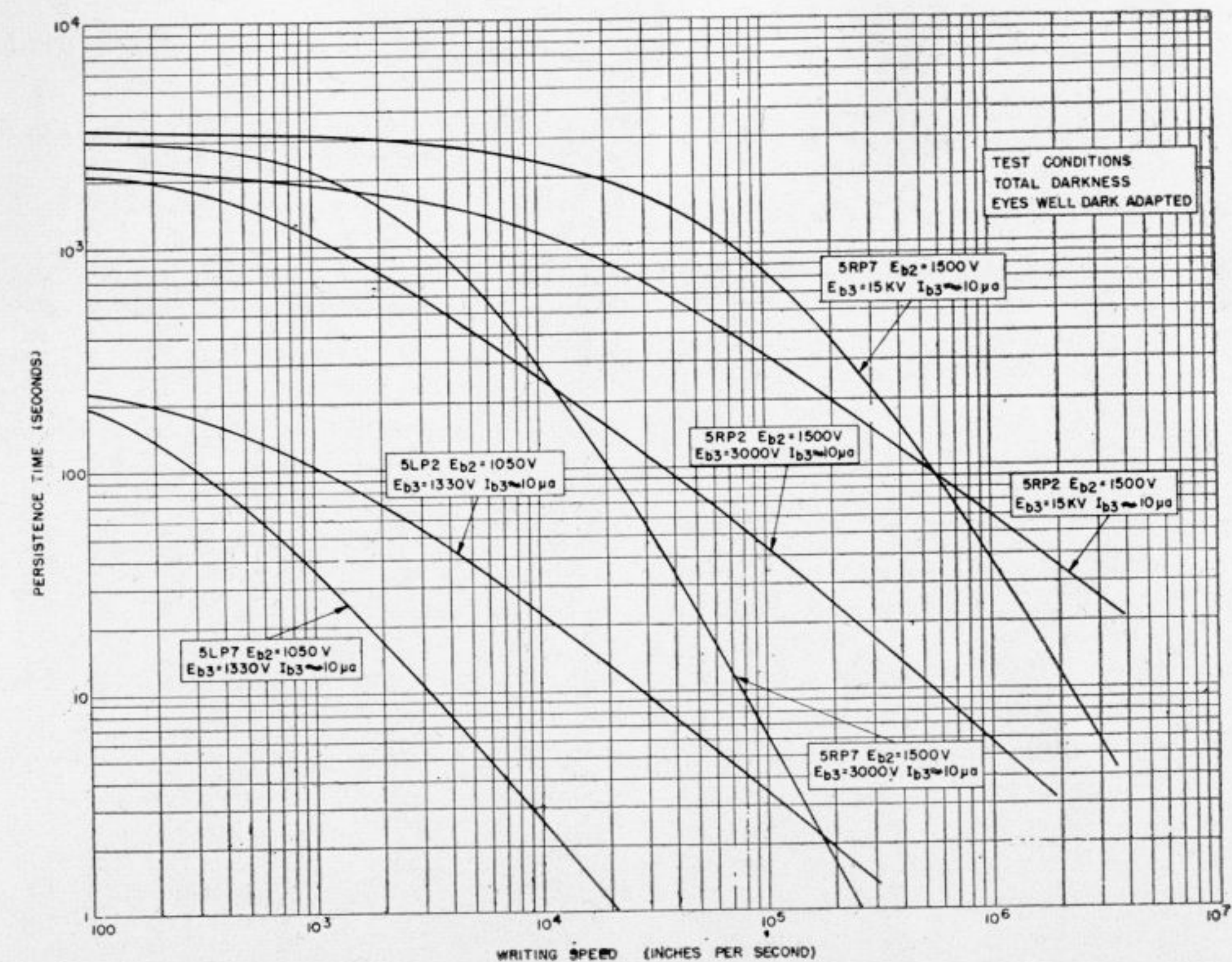
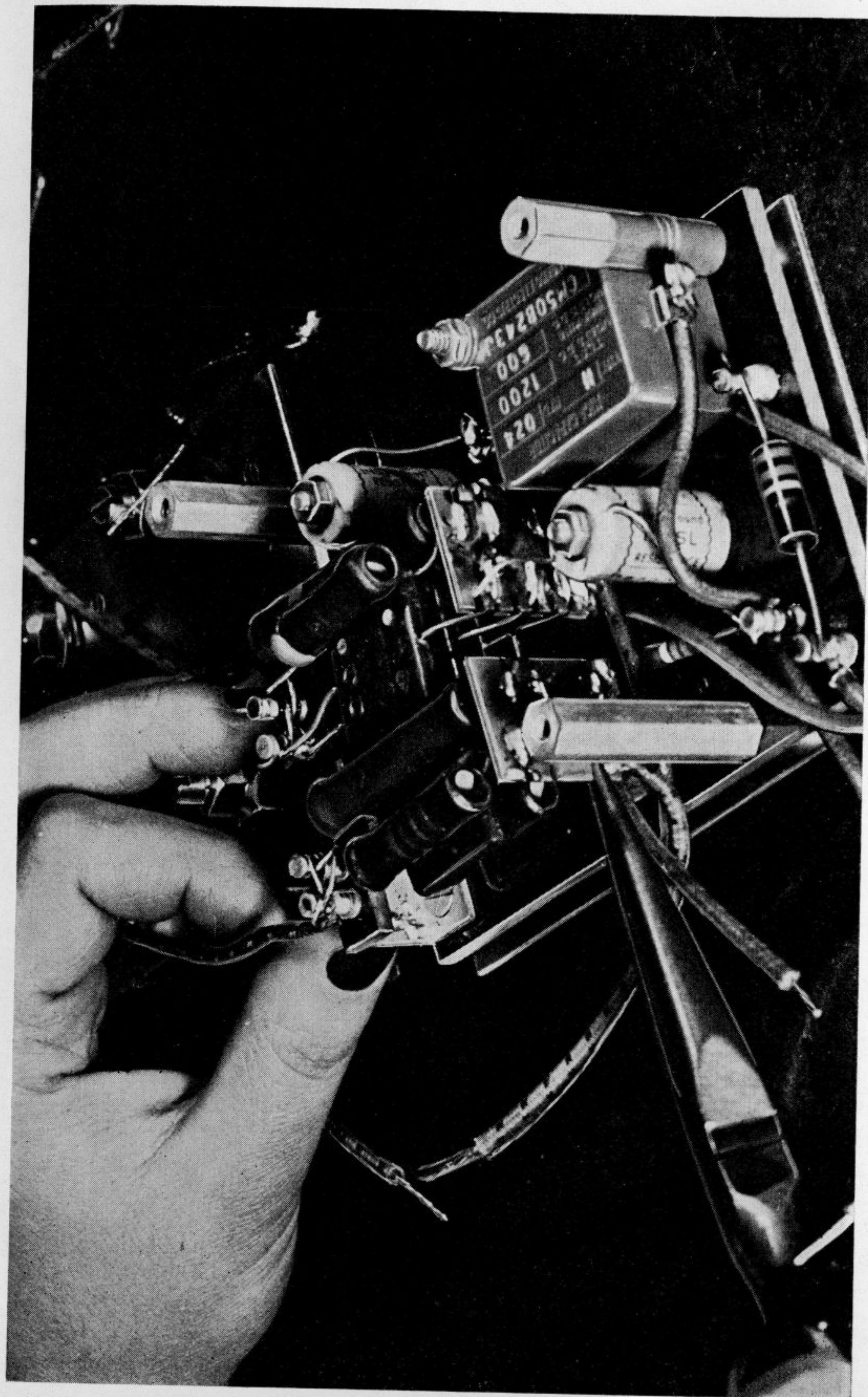

Figure 2. Typical curves of persistence time vs. writing speed for single transients, comparing P2 and P7 screens at different accelerating potentials

TECHNIQUES  
OF  
PHOTO-RECORDING

CONVENTIONAL FILM EMULSIONS  
POLAROID-LAND PROCESS





Many stages in the manufacture of a cathode-ray oscillograph do not lend themselves to mass production techniques. Thus meticulous operations, such as the assembly of this circuit, are done by highly skilled craftsmen to assure the utmost in quality

## TECHNIQUES OF PHOTO-RECORDING Conventional Film Emulsion

### Introduction

The process of recording phenomena from the cathode-ray screen may possibly be questioned by some as an unnecessary detail. Cannot a pattern be quickly sketched or directly studied from the screen of an oscillograph? A free-hand sketch of the pattern may prove satisfactory in many cases; but it is immediately apparent from Figure 1 that a thorough analysis of a complex waveform can be made only by studying a photographic recording. For single transients, or signals that occur at very low repetition rates, photographic recording becomes a necessity for even normal, off-hand observation, since in the short time the pattern is displayed, the eye is incapable of observing all of the pertinent data. A typical example of such a signal is the impulse-test wave of Figure 2. Photographing the phenomenon has another advantage in that it permits enlarging an oscillogram for observation of minute details, which might not be readily visible on an oscillograph. Figure 3 is an example of this photo-enlarging technique; here a sine wave is shown whose frequency is being modulated by another undesired frequency.

When great accuracy is required, the camera far surpasses a human observer since the camera employs a single, fixed point of observation. Thus error owing to effects of parallax is removed. Accuracy in the comparison of two separate phenomena may also be accomplished with the camera by means of double exposing the oscillograms in question on a single section of film.

The Cathode-ray oscillograph and camera combination may also serve as a monitoring system which, once placed into operation, can

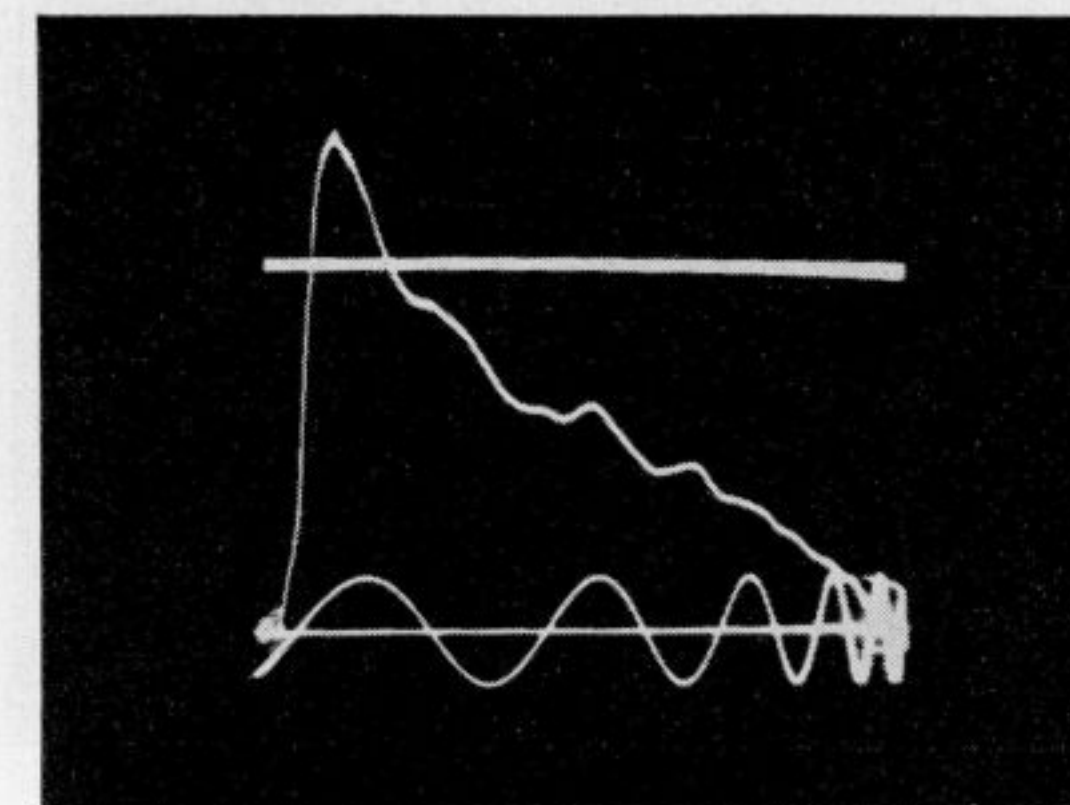

Figure 2. A photo-recording of a high-voltage impulse-test wave, displayed on a 50- $\mu$ sec. sweep. Photo-recording is required for detailed study of such rapid single transients

be maintained without personnel. This system will record instantaneously whatever phenomenon is displayed on the cathode-ray-tube screen.

But above all, the camera will supply a permanent, accurate, and unquestionable record of oscillographic work. These permanent records would be, for example, an invaluable aid to circuit development work, where to obtain particular improvements in waveshapes, continual reshuffling of circuit values occurs. Obviously, a progressive photographic record of resulting changes would provide an easy means for final evaluation. Furthermore, the degree to which photo-oscillographic equipment has been developed, ensures both efficient photography and an easy means for the rapid processing of the results.

### Single-Frame Recording

Photographic recording from the cathode-ray oscillograph is a relatively simple operation,

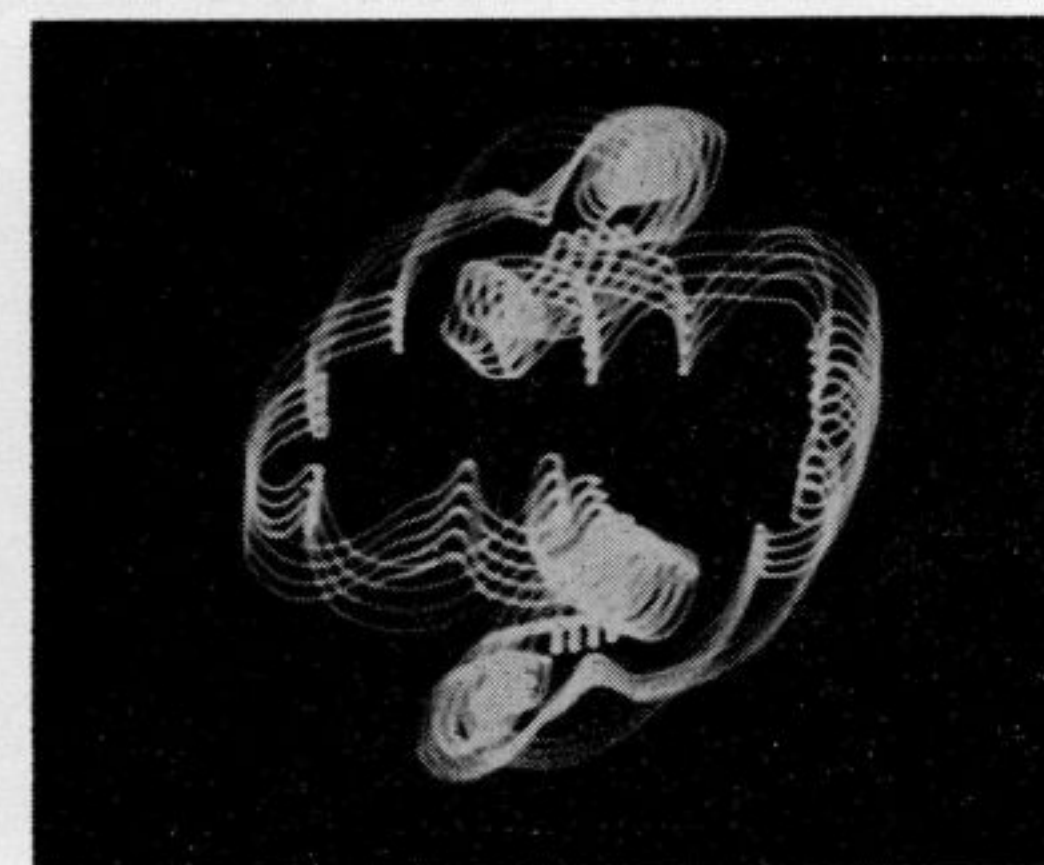

Figure 1. This complex wave form of a modulated carrier could not be studied by any means other than photo-recording

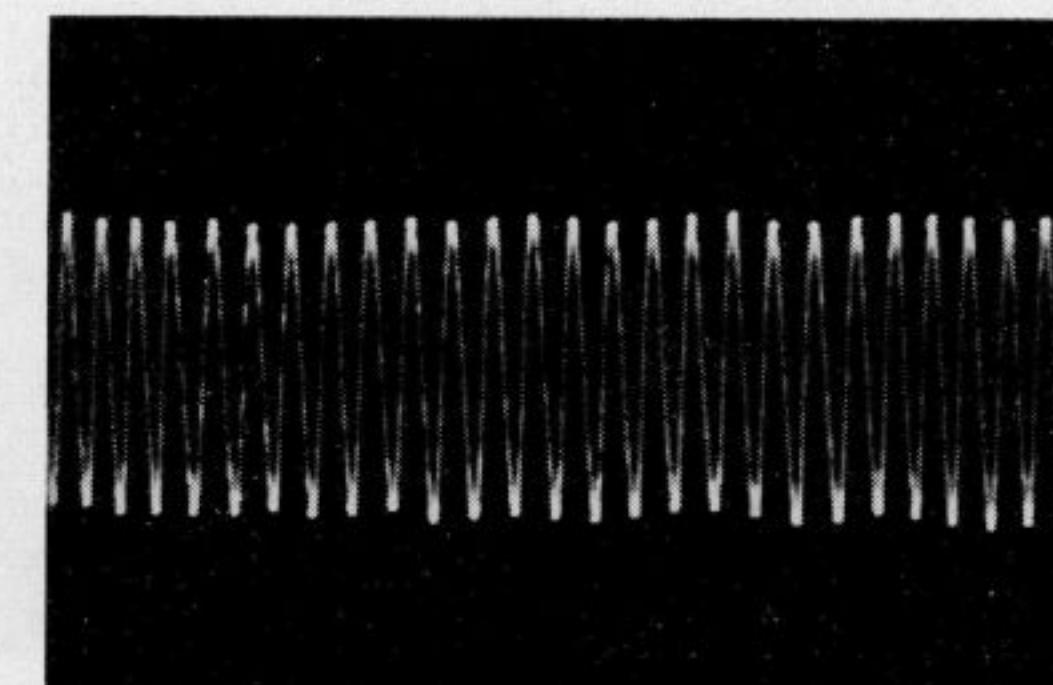

Figure 3. A continuous recording of fluctuating line voltage which shows variations which would not be detected by visual observation

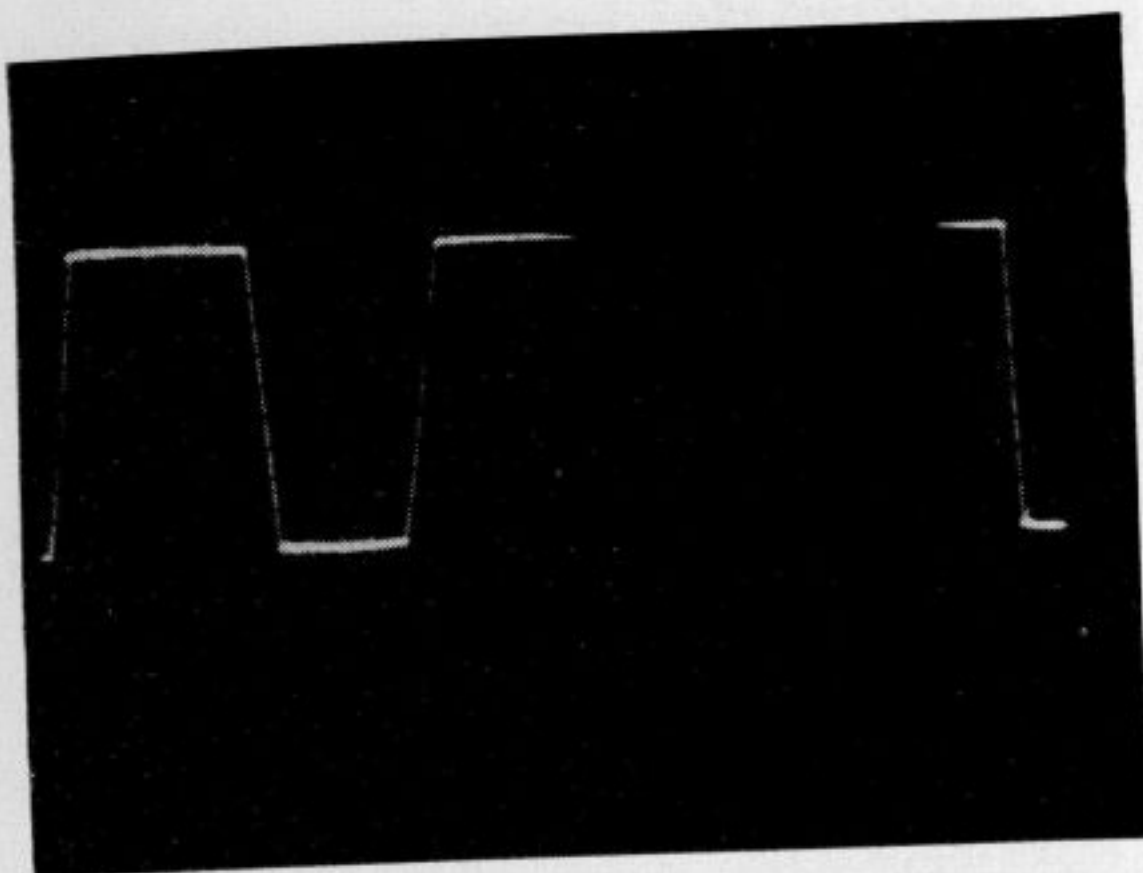

Figure 4. A portion of this oscillogram is missing because the exposure time was less than one sweep cycle

provided a few basic considerations are borne in mind. Neither extensive experience, nor elaborate equipment is required to achieve excellent results, although cameras specifically designed for oscillographic photography provide a convenience and versatility that are difficult to equal with conventional cameras.

### Stationary Patterns

The stationary pattern is the simplest to photograph, since the image recurs reproducibly from cycle to cycle without change. To record this type of pattern, the operator need only open the camera shutter long enough to photograph at least one complete sweep.

If the shutter does not remain open for this minimum time part of the pattern may be missing, as shown in the oscillogram of Figure 4. Beyond this minimum shutter time, neither the length of exposure nor the iris-diaphragm opening is particularly critical. Even with stationary patterns of high frequency the exposure is the same as with low-frequency phe-

nomena since, as the sweep speed for displaying higher frequencies is increased, the repetition rate of the recurrent sweep also increases. The net result is that the photographic emulsion receives the same total exposure. To illustrate the effects of varying exposure times upon a stationary pattern, Figure 5 shows three identical oscillograms taken with different exposures: A was given the minimum exposure; B, a slightly longer exposure; and C, a very long exposure. Note that the effect is merely that of increasing the apparent line width of the oscillogram. In all cases, however, these oscillograms are still useful.

Thus, the general rule may be stated: when an oscillograph is operating on continuous sweep, with a given setting of the intensity control, the exposure required with a particular camera will be constant regardless of the sweep- or signal-frequency, and will vary inversely with the area covered by the electron beam. For this reason, and for this case, it is sufficient for the oscillograph and camera manufacturers to publish a simple table of exposures for the various oscillographs with a given camera. (See table on Page 26). For the oscillographs not listed and for different cameras, the basic principles discussed later may be employed.

### Continuously Varying Patterns

When the pattern is varying continuously, the photographic technique becomes more critical. One method of accomplishing this type of photographic recording is to set the intensity control of the oscillograph at cut-off. A brightening gate or pulse is then applied to the grid of the cathode-ray tube to brighten the beam for one cycle of the phenomenon or sweep. Figure 6 shows two polar-coordinate oscillograms of the vibration in a rotating machine. Notice that in the oscillogram on

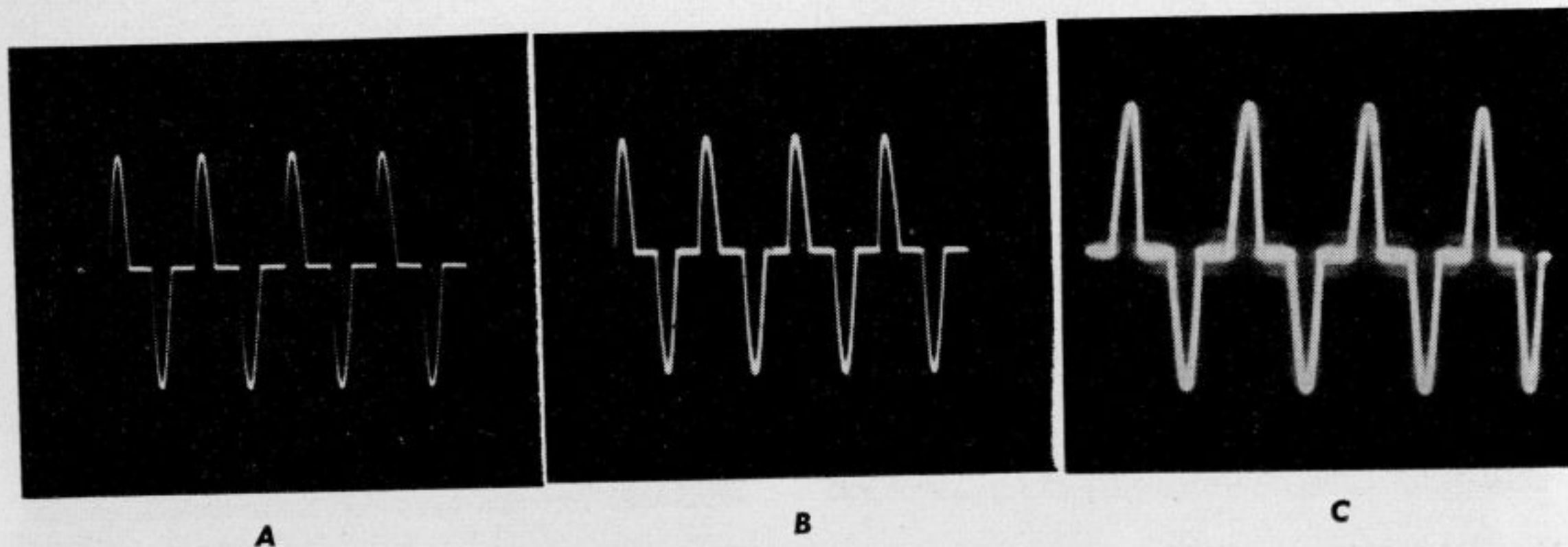

Figure 5. Three identical patterns given different exposure. (A) Too short; (B) correct exposure; (C) too long. Note, however, that all three oscillograms are usable.

the left the brightening gate was not long enough to record the complete cycle.

A table of exposures supplied by the manufacturer should by no means be accepted as a standard from which one must not deviate. In many applications the judgment of the operator is necessary. The table should be used as a guide for obtaining a rough idea of what the correct exposure would be under average conditions. In some cases it may be necessary to increase the exposure time given to obtain a certain desired effect. For example, in Figure 7 an oscillogram of a saw-tooth voltage is shown, in which the return-time is a short percentage of the total saw-time. In order to achieve sufficient density to record the return-time, the oscillogram was deliberately overexposed. The result is that the return-time has the proper density while the slow-writing part of the wave is greatly over-exposed. Frequently signals are encountered containing widely differing writing speeds, and it is necessary to choose an exposure which will show that part which is considered most important.

When recording patterns in which intensity modulation is present, as in Figure 8, the intensity modulation can be brought out more clearly by turning down the intensity control and increasing the exposure. If the intensity modulation happens to be an undesired one, the reverse procedure is indicated.

### Single Transients

To record single-transient phenomena, further basic considerations are necessary. Most of the problems encountered with stationary or recurrent phenomena are also encountered with transient phenomena, although the exposure is generally much more critical. The problem is

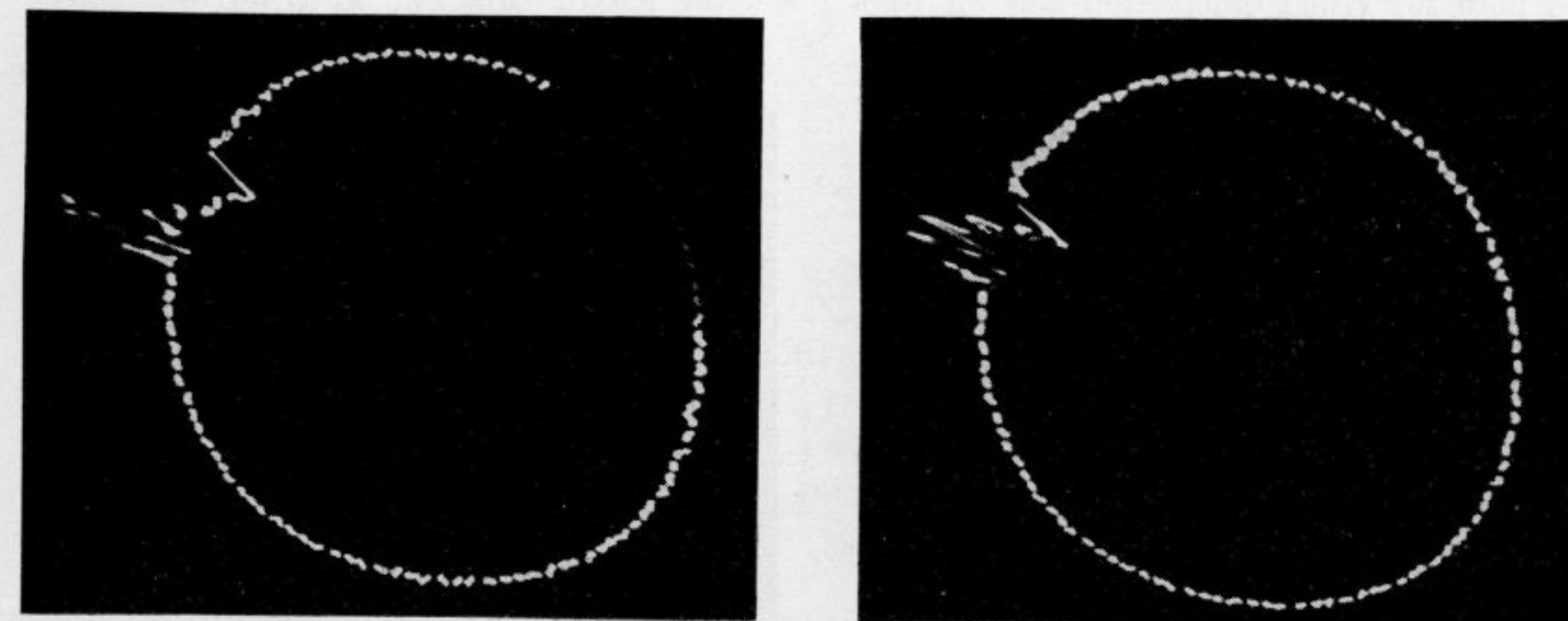

Figure 6. An illustration of the use of a brightening gate to record one cycle. In the oscillogram at the left the duration of the gate was insufficient

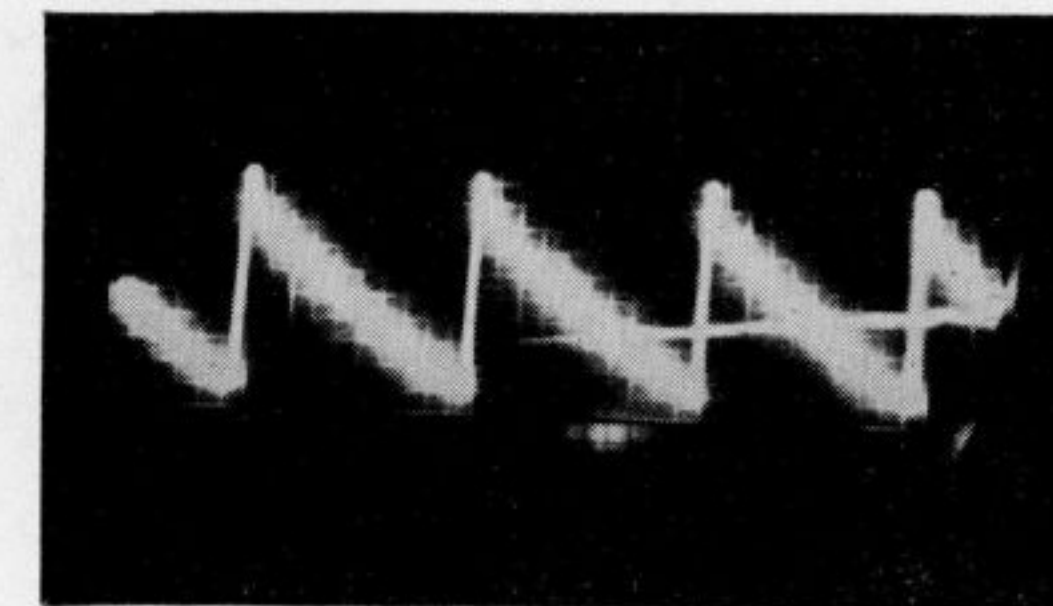

Figure 7. This oscillogram was deliberately overexposed to record the high-writing-speed portions of the trace

usually that of obtaining sufficient density for high-speed recordings. The first factor to determine is the approximate writing speed of the transient. For example, if the transient is a sinewave, the maximum writing speed, or rate of change, occurs at the X axis or cross-over point. In this particular case, if a large number of cycles are displayed on the cathode-ray-tube screen, the sweep speed or horizontal component of the writing speed is negligible, so that the writing speed is merely the vertical component of  $2\pi fA$ , where  $f$  is the frequency and  $A$  is one-half the peak-to-peak amplitude. A simple way of determining this writing speed is to use a nomograph, such as that shown in Figure 9.

By drawing a straight line from the known frequency point to the amplitude scale, the intersection on the writing-speed scale gives the maximum writing speed of the sinewave.

For various other types of waveforms the maximum writing speed in the transient may be approximated under the given conditions by photographing a single damped oscillation such as that shown on Figure 11. Notice that

in this damped oscillation the density decreases to that of the background fog at the higher peak-to-peak amplitudes, which corresponds to the faster writing speeds. By selecting and measuring on the oscillogram the cycle which displays the minimum usable density, the maximum photographic writing rate may be computed by using the foregoing formula. In measuring the amplitude of the selected peak, the object-to-image ratio of the camera must be taken into consideration, and the size of the peak restored to its true, on-screen amplitude before computation. The maximum writing rate has often been defined, for a given lens and photographic emulsion, as that writing speed which produces a density of 0.1 above film fog. This density is considered to be the minimum usable density for photographing oscillograms by standard methods.

**Screen Considerations**

Before making recordings, the characteristics of the cathode-ray oscillograph and the cathode-ray tube must also be considered. In general, the most satisfactory phosphor for photography is the RMA Type P11 screen. Because of its high actinic light output, it has the highest photographic efficiency of all the phosphors. A spectral-distribution curve of the light output of a P11 screen is shown in Figure 12. Note that the maximum emission occurs at 4300 Angstroms, which is roughly the point at which the more common photographic emulsions are most sensitive. Of course when the light output for a given phenomenon is sufficient, any phosphor will produce satisfactory recordings for either stationary or transient phenomena.

Frequently, the same oscillograph has to be used both for visual observation and for pho-

tographic recording. In this case, it is desirable to use a screen capable of efficient operation for both purposes. Two such screens are the RMA standard Types P2 and P7 screens. Since both are long-persistence screens, they ordinarily would not be satisfactory for photographing varying phenomena or for continuously moving-film recordings. The persistence of these screens would cause a blurring of the recording. This is apparent from the oscillogram of Figure 13. Here this train of sinewaves was recorded from a P7 screen. This severe blurring could have been eliminated by the use of a blue filter of the proper spectral transmission between the cathode-ray tube and the camera. Thus the yellow, or long-persistence component would have been filtered out, and only the blue, short-persistence component would have reached the camera.

In some cases the residual persistence of the P2 screen proves too long and therefore a very dark blue filter is required to remove completely any traces of persistence. This reduces the effective transmitted light to such an extent that a better alternative would be the use of the P7 screen in which the phosphorescence and fluorescence occur in rather widely separated positions of the spectrum. Using a photographic emulsion which is not sensitive to the persistent part of the radiated spectrum helps considerably.

**Recording Materials**

Many problems of oscillograph photography are simplified by the choice of the proper recording medium. The majority of oscillograph-record cameras employ 35-mm film. This almost universal choice stems largely from both economic and technical considerations. A lens with, say, a one-to-one image-reduction ratio, a focal length sufficient to cover the entire

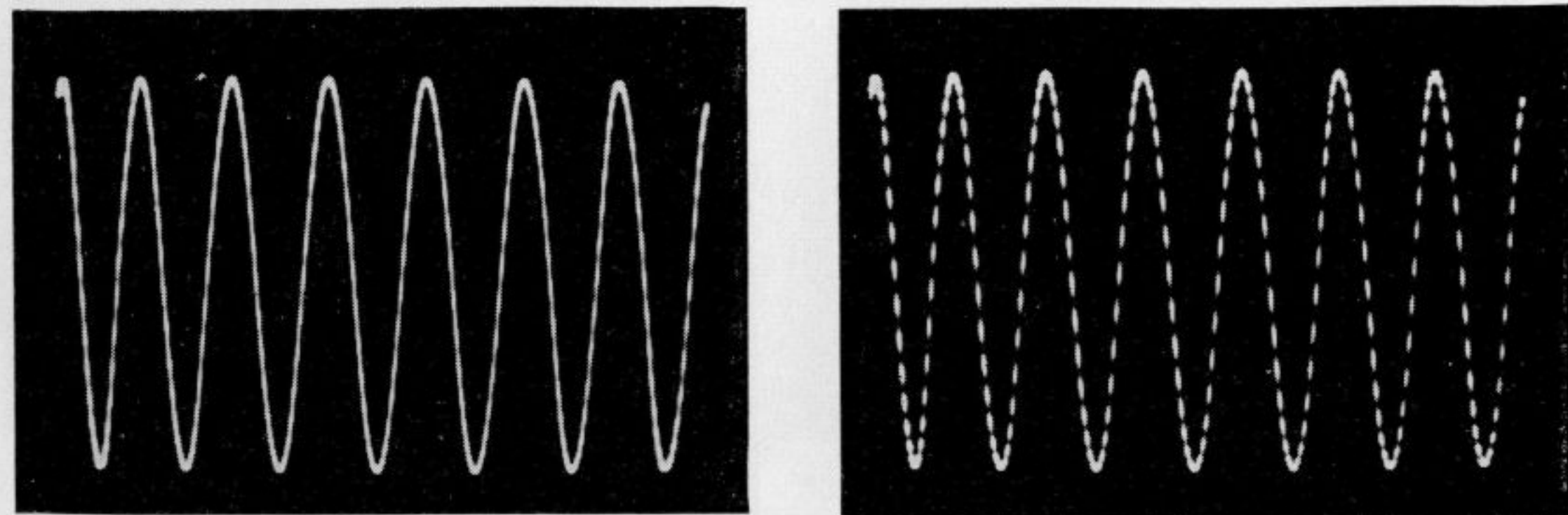
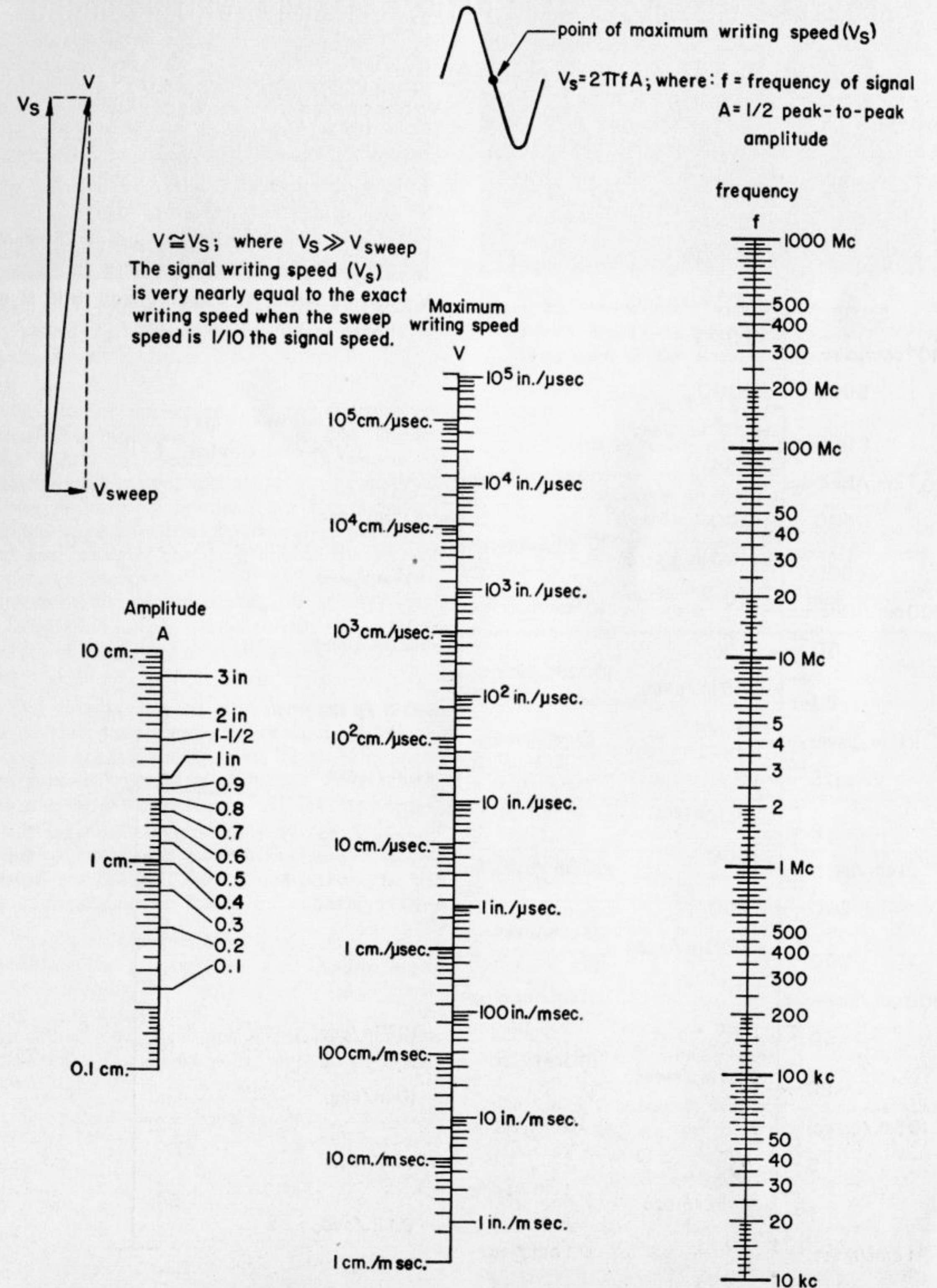

Figure 8. The effect of intensity-control setting on beam modulation. Modulation was brought out in oscillogram at right by decreasing intensity

TECHNIQUES OF PHOTO-RECORDING  
NOMOGRAPH RELATING AMPLITUDE, FREQUENCY, AND MAXIMUM WRITING SPEEDS FOR SINUSOIDAL TRACES



1 μsec. = 1 microsecond = 1/1,000,000 second.  
1 msec. = 1 millisecond = 1/1000 second.  
1 Mc = 1 megacycle per second = 1,000,000 cps.  
1 kc = 1 kilocycle per second = 1000 cps.

Frequency range may be extended below 10 kc or above 1000 Mc by applying a suitable factor.

Figure 9. Nomograph for determining sinusoidal writing speeds

NOMOGRAPH FOR DETERMINING WRITING SPEED IN TERMS OF LENS APERTURE  $f$ , OBJECT-IMAGE RATIO, & MAXIMUM WRITING SPEED

$$V = \frac{4 V_{\max}}{f^2 \left(1 + \frac{1}{M}\right)^2} \quad V' = \frac{V_{\max}}{f^2}$$

$f$  = lens aperture at infinity.  
 $M$  = optical object-to-image ratio.  
 $V_{\max}$  = maximum writing speed at  $f=1$  &  $M=1$   
 $V'$  = writing speed at any aperture  $f$ .  
 $V$  = writing speed at object: image ratio  $M$ , and aperture  $f$ .

$V' = V$  when  $M=1$   
 $V' = V_{\max}$  when  $f=1$

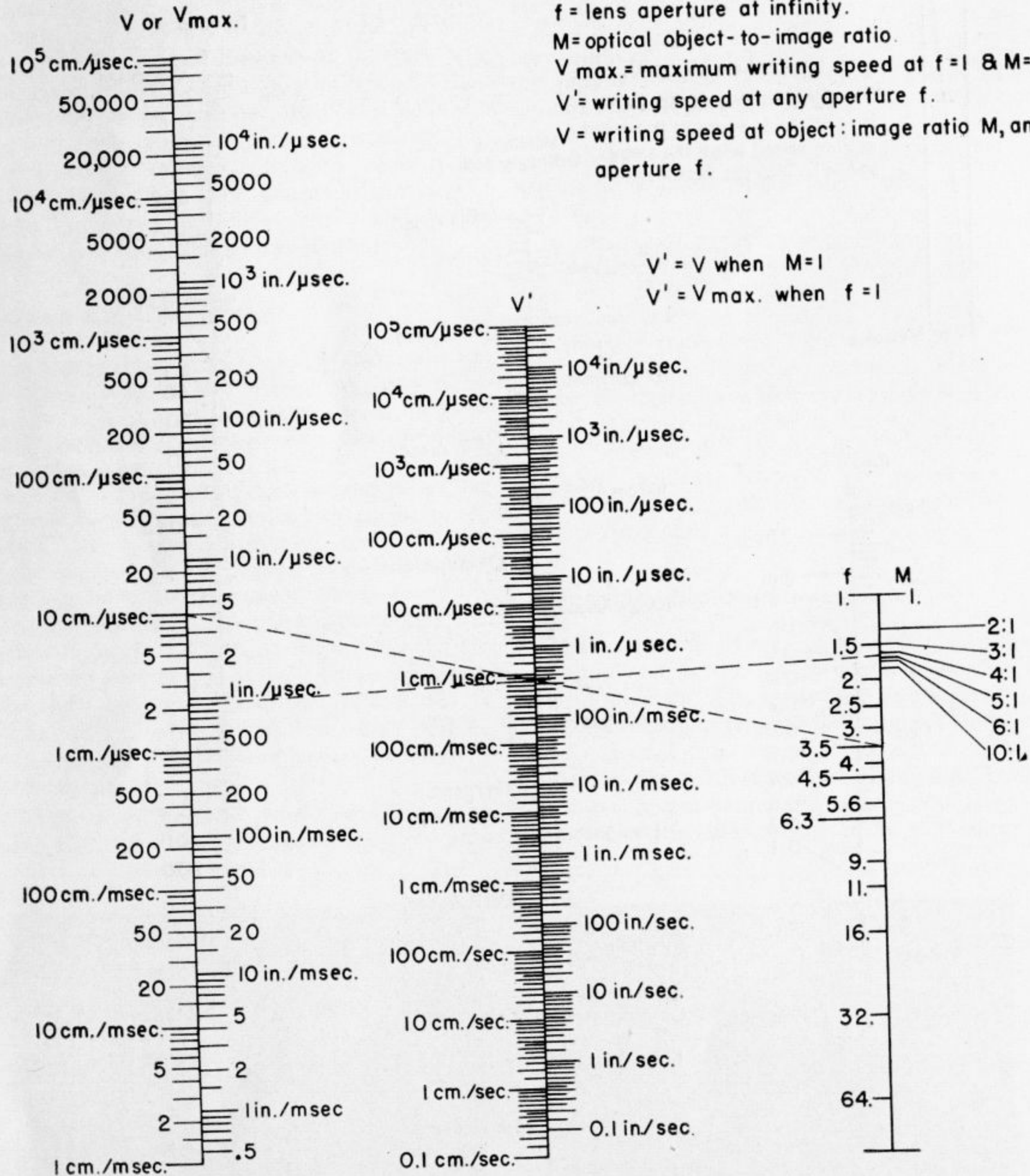

1 μsec. = 1 microsecond = 1/1,000,000 second

1 msec. = 1 millisecond = 1/1,000 second

Time scale changes below 1 in./μsec. & below 1 cm./μsec.

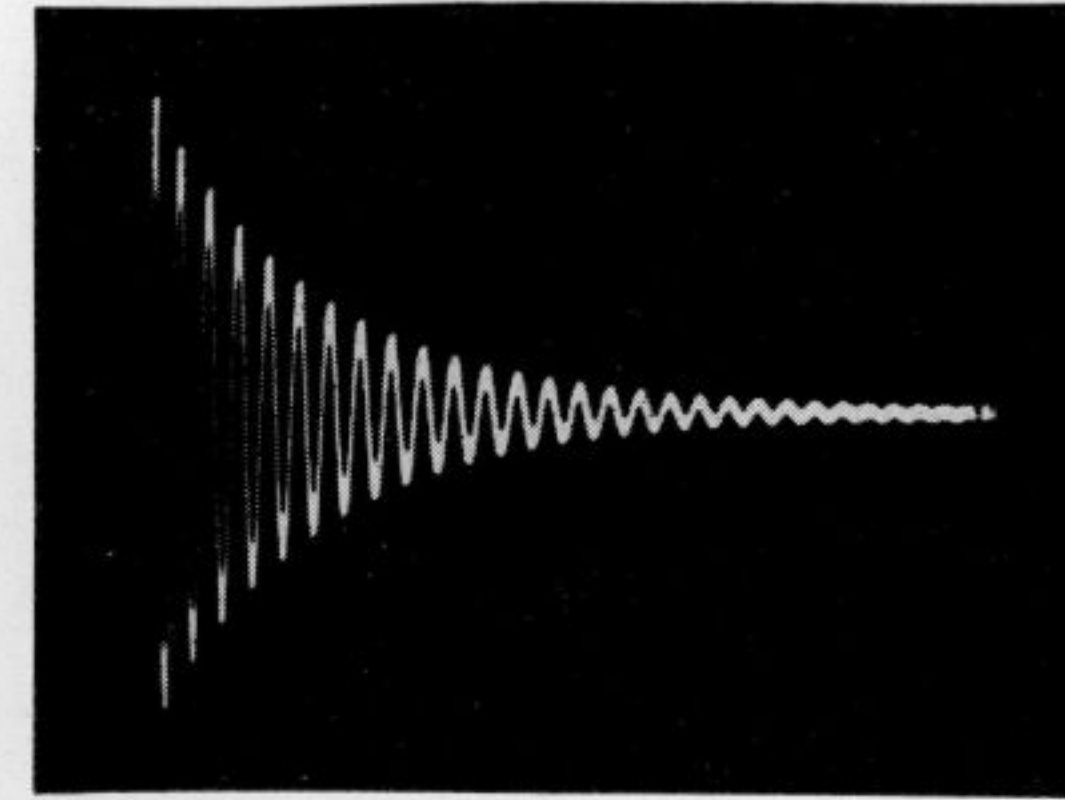

Figure 11. Typical single damped oscillation, useful for determining writing speeds of transients

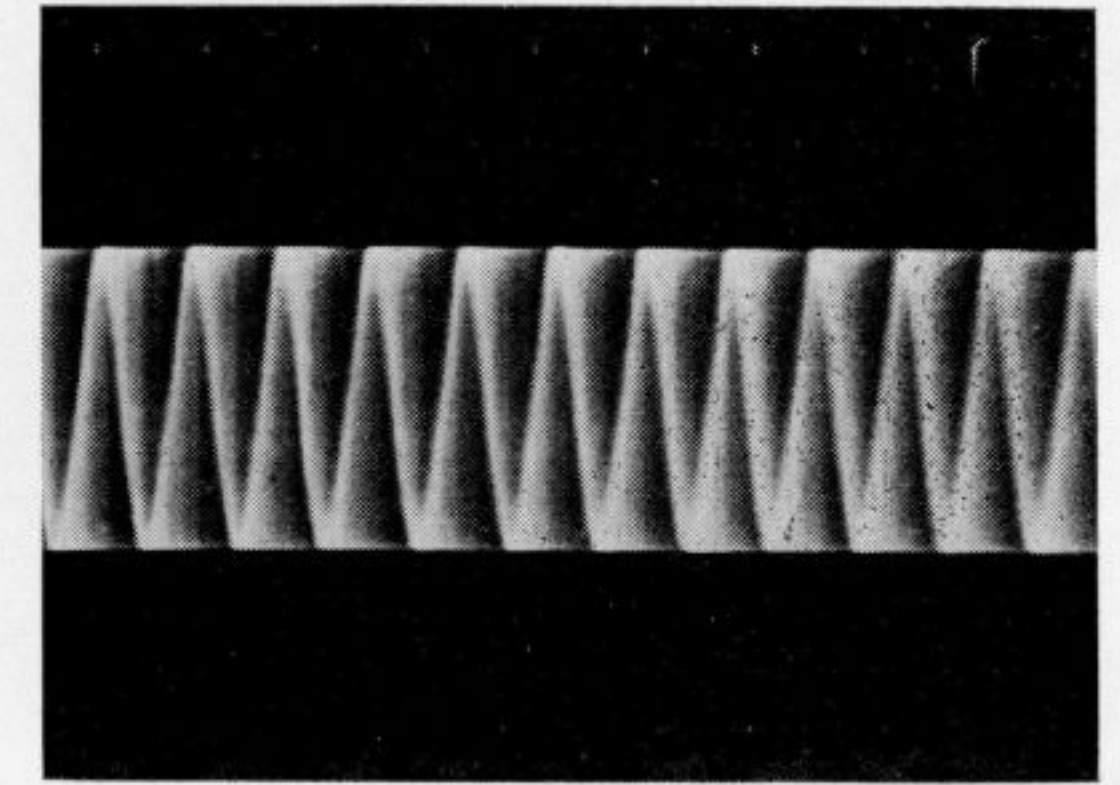

Figure 13. Sinewaves recorded from a P7 screen. Blurring is due to the long-persistence component of this screen material

TABLE I  
 Comparison of Emulsions

| Emulsion Type    | Relative Emulsion Speeds determined from maximum writing rates | Eastman Kodak 3 Relative Emulsion Speeds for short exposure to blue light |
|------------------|--|---|
| E.K. PAN.X FILM  | 1  | —   |
| E.K. 1115 PAPER  | 0.4  | 80  |
| E.K. 697 PAPER   | 0.73   | 125   |
| E.K. 1127 PAPER  | 0.47   | 200   |
| E.K. 1057 PAPER  | 0.47   | 100   |
| GRANT 663 PAPER  | 0.1  |   |
| GRANT 635 PAPER  | 0.33   |   |
| GRANT P235 PAPER | 0.3  |   |

usable area of the screen, and the aperture required for high-speed recording (no greater than  $f/2.8$ , and preferably  $f/1.5$ ) would be extremely expensive, and could not be justified by the majority of applications. On the other hand, a large selection of relatively inexpensive and fast lenses is readily available for 35-mm cameras. Moreover, 35-mm film is extremely economical to use and is available at most local photographic-supply stores. Also, the greatest variety of emulsions is available in the 35-mm size.

The image reduction ratio provided by lenses for 35-mm photography offers an increase by a factor of approximately 3, in image brightness, enabling the recording of higher writing rates for a given lens aperture. All factors considered, the highest writing rate per unit cost (this might be expressed in inches per microsecond per dollar) can be obtained by the use of 35-mm film.

The emulsions most commonly employed for oscillographic photography are: Panchromatic—or red-and-yellow sensitive, Orthochromatic—or blue-green sensitive, and the so-called color-blind—or blue and ultra-violet sensitive emulsions. Orthochromatic and blue-sensitive

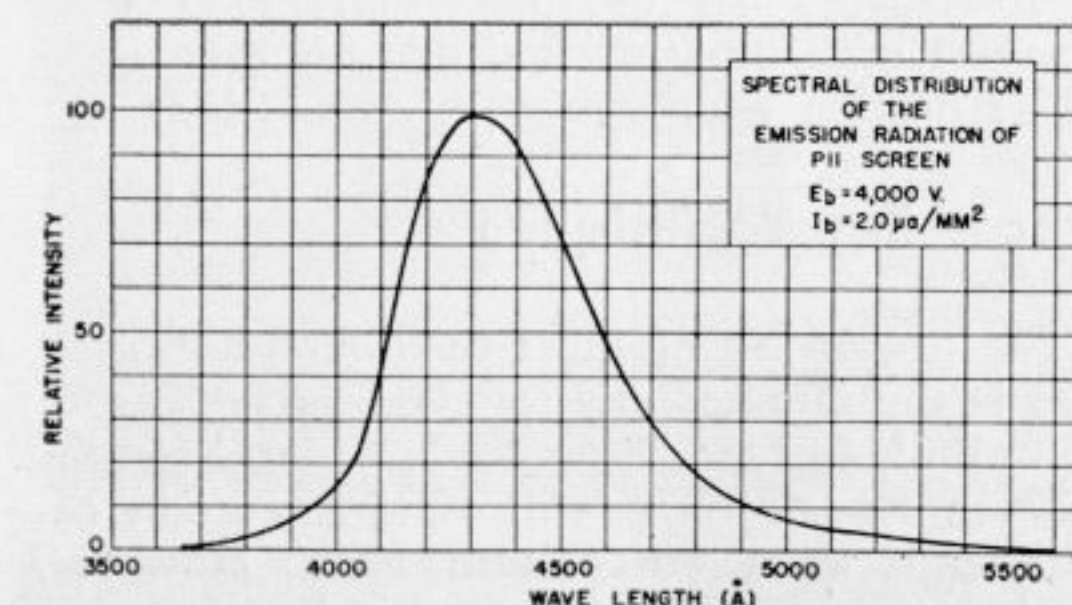

Figure 12. Spectral distribution curve of the Type P11 screen

films are advantageous when it is necessary to avoid response to the persistence, or yellow light. In addition, these films are easily handled in a darkroom under a deep-red safe-light, while panchromatic films must be handled in total darkness. However, panchromatic films have the advantage, when it is desirable to photograph the persistent, or yellow, component of the image. Panchromatic films in 35-mm size are also more readily available in local photo-supply shops.

The fastest recording emulsions for oscillograph photography have been found to be

Linagraph Pan and Linagraph Ortho, manufactured by Eastman Kodak Co. When processed properly, Linagraph Pan can provide maximum photographic writing rates higher than those of Super XX.

For many applications where a negative is not required, 35-mm recording paper can supply direct paper recordings. Paper has the advantages of lower cost, less processing time, and ease of reading. However, the fastest recording papers are slower than average films such as Panatomic X. Table I shows a comparison of most of the available photographic recording papers. The fastest paper-base emulsion was found to be Eastman-Kodak Type 697 which is only about 70% as fast as Panatomic X.

### Film Speeds

The terms "fast film" and "film speeds" may require clarification, especially in their relation to oscillograph photography. The relation between photographic density and exposure is often expressed as a D vs. log E curve, where D equals the reciprocal of the logarithm of transmission ( $D=1/\log T$ ), and the exposure E equals light intensity multiplied by time ( $E=It$ ). This D vs. log E curve is frequently known as the H and D curve (for Hurter and Driffield). The H and D curve for Linograph Pan film is shown in Figure 14\*. Notice that the curve has a "toe" and a fairly linear long slope. The slope at any particular portion of this curve is called the *gamma*, and this gamma determines the contrast of a given photograph. From this type of characteristic curve many methods for specifying an emulsion speed, or index, have been derived. One

\*These curves are obtainable for various emulsions from their respective manufacturers.

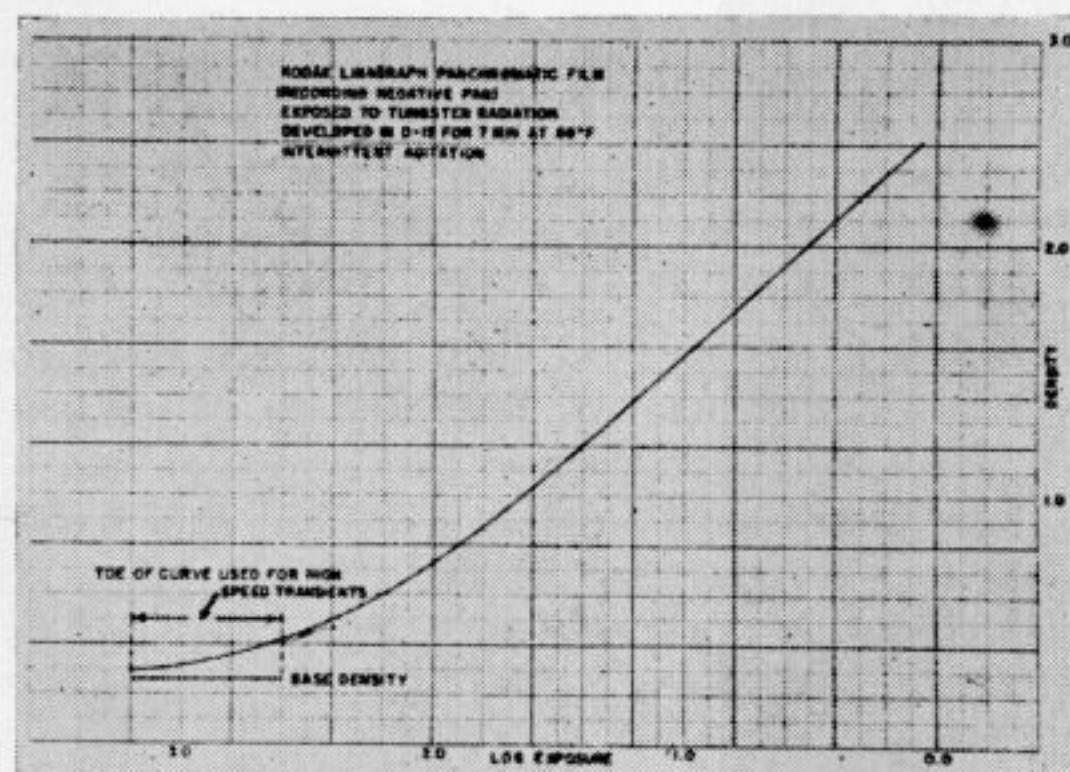

Figure 14. H and D curve for Linograph Pan recording film. Arrow at left indicates toe of curve used for high-speed transients

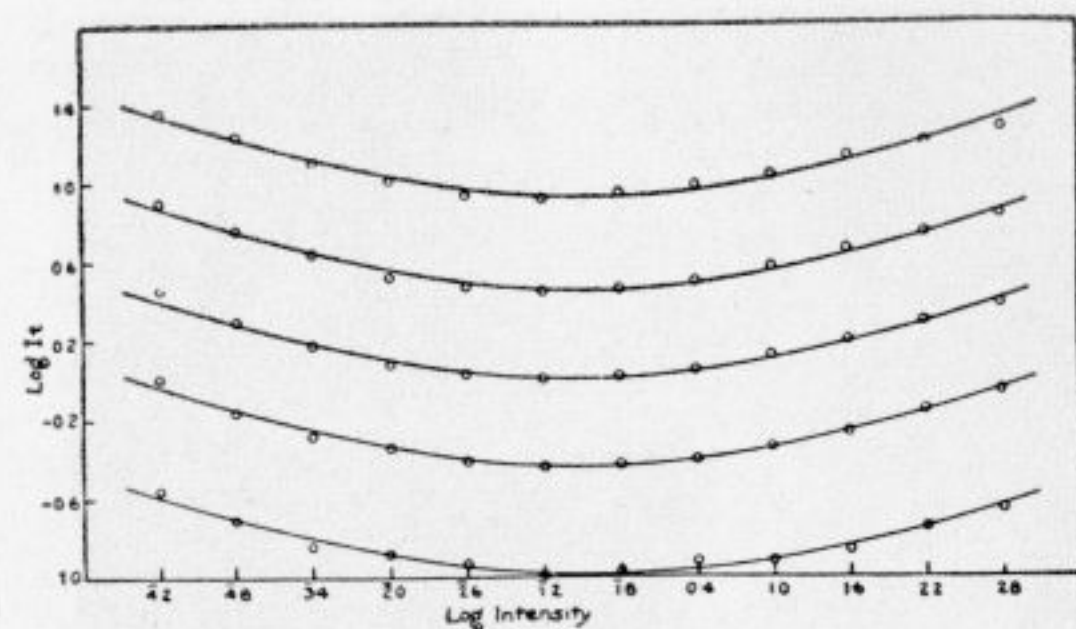

Figure 15. A set of curves of the failure of the reciprocity law

method, for example, extends the slope of the straight line portion and derives a speed index (Inertia index) from the intersection of this line and the log-exposure scale.

These ratings do not apply accurately to oscillograph photography, however, because of the extreme conditions under which exposures are often made. For example, in recording high-speed transients, the exposure often occurs in the "toe" of the curve, approaching the density of the film base. Then again when exposing for stationary patterns, densities above 2 are not uncommon.

One of the fundamental laws of photography, the so-called Bunsen and Roscoe Reciprocity Law (1876), states that for a given density, the exposure or light intensity, multiplied by time, is a constant. ( $It=K$ ) In other words, for a given density the exposure time may be decreased if the light intensity is increased proportionately. All deviations from this law are known as failures of the reciprocity law. With short exposure times this reciprocity law does fail. Figure 15 shows a set of curves illustrating this failure. It is evident that for a given density there is an optimum light intensity and exposure time. The importance of this effect is obvious when one realizes that the shortest exposure times are encountered in the photography of high-speed transients. For example, for a single transient, a writing speed of 400 inches per microsecond represents an exposure time of  $10^{-11}$  seconds for each individual portion of photographic emulsion.

### Processing Techniques

The processing of most oscillographic negatives is the same as any standard processing of 35-mm film. Employing such a developer as Eastman Kodak D-76 will yield fine-grain oscillograms, even on 35-mm film. However, development time is not as critical as for conventional 35-mm photographs because of the very limited density range required. Therefore

fine-grain development is very rarely necessary in oscillography, and in actual practice faster developers are used so that a minimum of time is wasted in producing oscillograms. For example, in processing 90 percent of the oscillographic recordings at Du Mont Laboratories, the film is developed in either D-72, diluted 1 to 1, at 68° F., for about 5 minutes, or in D-19, full strength, for 6 minutes. This fast development combined with fixing in fresh hypo of 5 to 10 minutes and washing for another 5 to 10 minutes provides a dry oscillogram recording in about 30 minutes.

For the processing of high-speed transient recordings, however, techniques not used in ordinary photography must be employed because of the unusual emulsion effects mentioned previously. The technique found most successful for processing high-speed oscillograms is to prolong the development time of the film in a high-emulsion-speed developer, such as Eastman Kodak D-19. This development is usually much longer than the specifications of the film manufacturer. The principle of prolonging the development time is based upon raising the operating point of the emulsion on the H and D curve so that a greater slope or "gamma" is obtained. Thus, in spite of the fact that the grain and the density of fog are raised, an optimum point of image density above fog is found. A development time of 9 minutes, at 70° F., in D-19, has been found to give optimum results in raising the maximum photographic writing rate for a given camera and oscillographic equipment. An example of high-emulsion-speed development is shown in Figure 16; here it was necessary to prolong the development time in order to obtain sufficient density of the rise time in this oscillogram. Although the fog and grain in this oscillogram are very high, the rise time of the pulse has been properly reproduced.

Various other methods for increasing the maximum photographic writing rates have

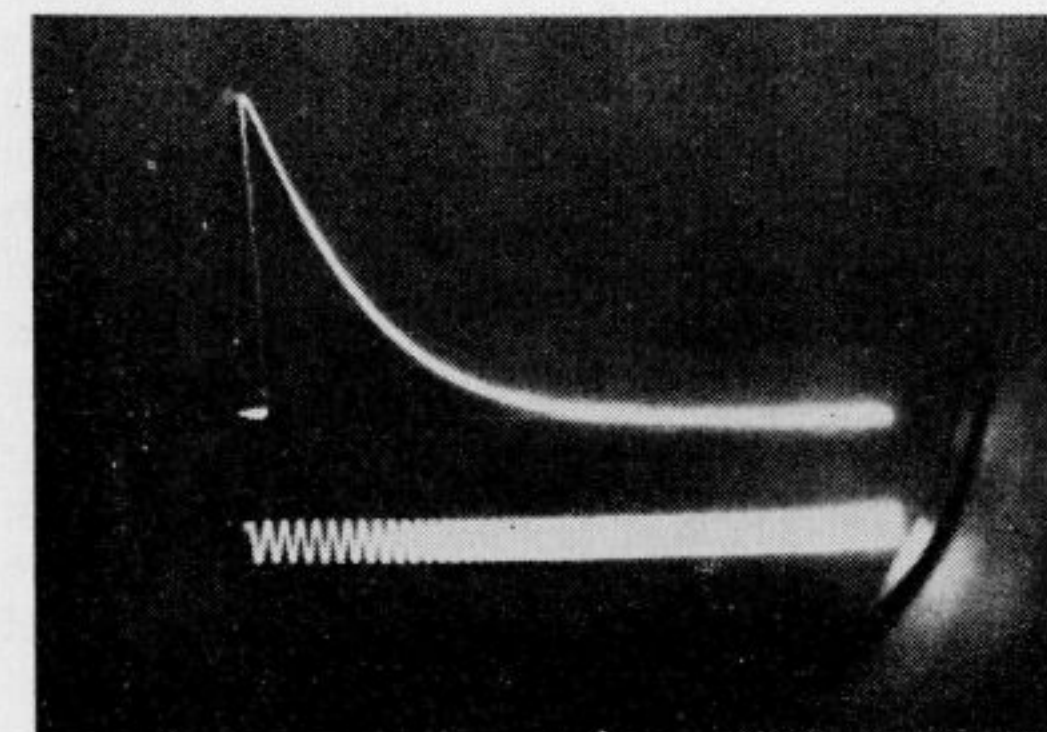

Figure 16. An example of high-emulsion-speed development. Developing time was prolonged to achieve sufficient density of the extremely rapid rise time

been attempted, such as: (1) hypersensitizing the film before exposure by bathing, exposure to vapor, or exposure to light; (2) "Latensification" by bathing between exposure and development; (3) chemical intensification after development. None of these techniques have been found to be as effective as a prolonged development, although intensification sometimes does produce an improvement.

Chemical reduction, on the other hand, is a process very often employed to improve the quality of recordings (see figure 17). In oscillograph photography it is always preferable to overexpose. Overexposed negatives can easily be reduced in a chemical solution such as Farmers Reducer\*, with a resulting increase in contrast because of the elimination of base fog. In fact, chemical reduction always seems to improve an oscillogram except when the image density is very low. Various reducer formulae have certain characteristics which can be utilized to improve negatives. For example, there are so-called subtractive reducers which subtract equally from all densities; there are proportional reducers which reduce all the densities in proportion; super-proportional reducers which have a higher reduction ratio for the higher densities than for the lower ones; and sub-proportional reducers where the reduction ratio is greater for the lower densities than for the higher ones.

Reduction of fog can also be accomplished by the use of fog-reducing agents, such as benzotriazol and 6-nitrobenzimidazol, which when added to developers in very small quantities enable further prolonging of development time without excessive fog. These anti-fog agents also serve to slow up a developer and, therefore, to increase the contrast when making prints or lantern slides.

For prints, glossy paper is always preferred, since the texture of other surfaces tends to obscure details of the pattern.

### Sources of Fog

In the course of preparing oscillograms of either high-speed transients or stationary patterns, problems of undesired illumination causing fog are often encountered. One source of fog is halation of either the film or the cathode-ray tube spot. The effect of halo is shown in Figure 18. This particular halo was caused by the film being overexposed. Note that on the upper oscillogram the halo effect has been eliminated by chemical reduction. This chemical reduction, by virtue of the properties discussed above, eliminated the lower density fog which was the result of halation.

\*Readily available from most local photographic-supply stores.

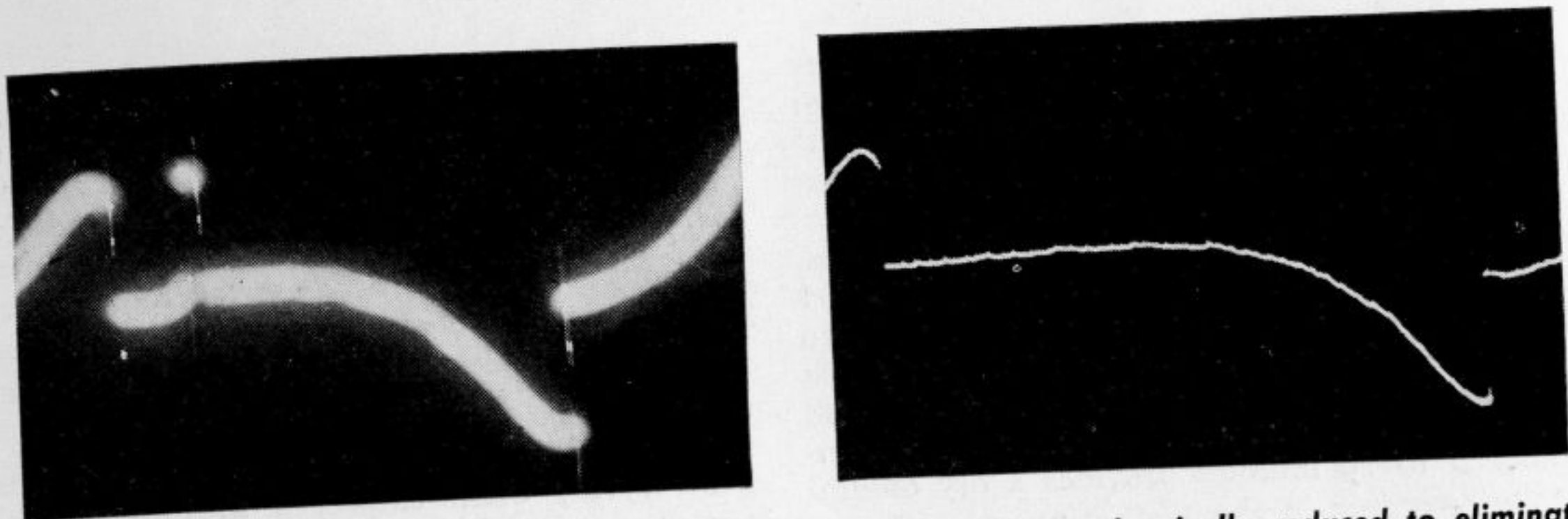

Figure 17. Two similar oscillograms; the oscillogram at right was chemically reduced to eliminate the halo and to improve the general contrast

Halo around the cathode-ray-tube spot is caused by total reflection beyond the critical angle at the glass-air surface. Improved methods of screen coating have resulted in less halo. Another method of reducing halo is to increase the thickness of the glass in the cathode-ray tube so that it is as great as the nominal radius of curvature. Since this is impractical, one of the experimental techniques has been to cement a thick, cup-shaped disc of clear plastic to the cathode-ray-tube face with a cement whose index of refraction was the same as that of the plastic. While this procedure is theoretically sound, the difficulty of processing makes its use impractical.

However, the most practical way of reducing halo normally, is to decrease the intensity-control setting of the oscillograph to the point where adequate density is still achieved. Chemical reduction, mentioned above, is also very useful in minimizing the effects of halo.

### Cathode-Glow

Another source of undesired illumination is "cathode-glow". This effect is caused by the integration on the film, of light coming directly from the cathode of the electron gun. This light penetrates the screen and if the shutter of

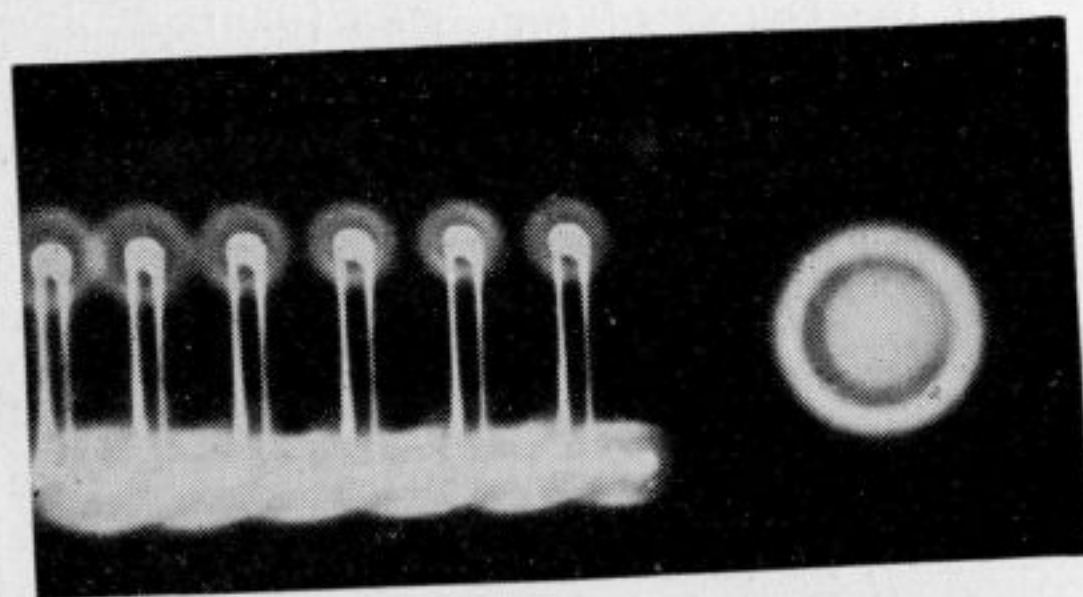
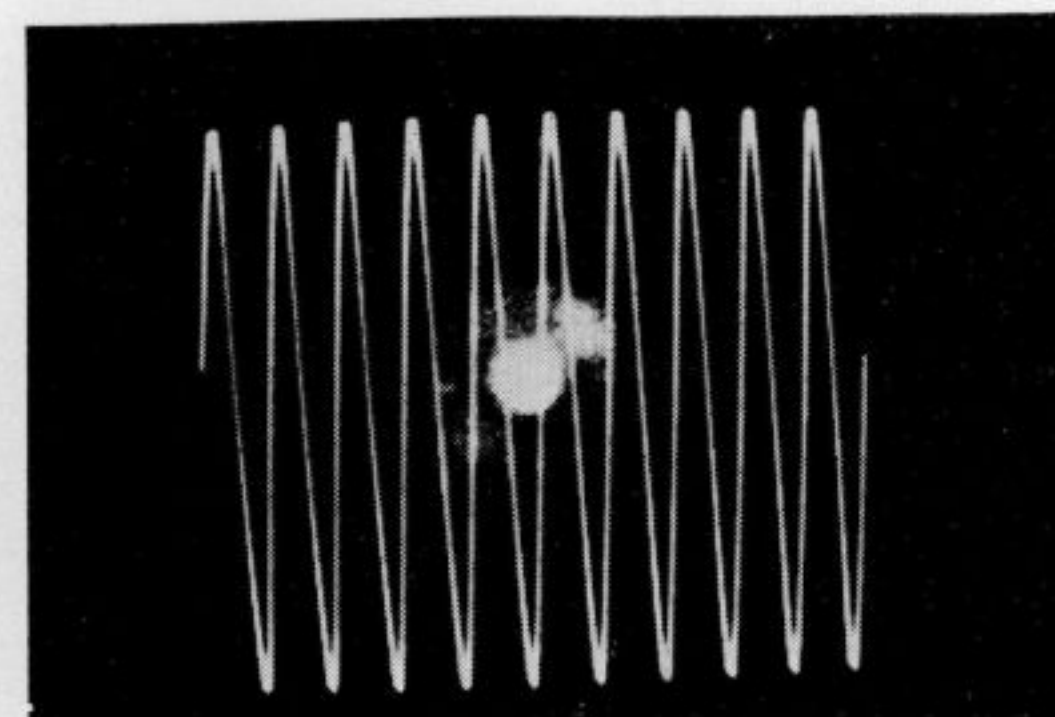

Figure 18. Illustration of excessive fogging owing to halo. Halo is caused by total reflection beyond the critical angle at the glass-air surface

the camera is open for an appreciable length of time, serious fogging results. This effect is most severe when panchromatic film is used, particularly when it is given high-emulsion-speed processing. In this case the shutter cannot be left open for more than two seconds. An example of this "cathode glow" is shown in Figure 19A. The fogging can be reduced or eliminated by either of several methods, or with a combination of them. One method is to keep the shutter open for only the minimum practical time necessary to record the pattern. Another means is to use a blue-sensitive film which is insensitive to the red light of the cathode. Still another method is to use a blue filter between the camera and cathode-ray tube. The cathode fogging in Figure 19B was eliminated by a blue filter used with orthochromatic film. Perhaps the best method, which completely removes all cathode fogging, is to employ a cathode-ray tube with a metallized coating on the inside surface of the phosphor. This coating is opaque to light, yet transparent to high-energy electrons. However, such a metallized coating is practical only in cathode-ray tubes operated at high accelerating potentials.

### Stray Emission

Another source of undesired illumination is stray emission. One form of stray emission is electron reflection from internal parts of the cathode-ray tube. For example, the oscillogram of Figure 20 shows fogging at the top, caused by reflection from one of the deflection plates. Electron reflection can usually be prevented by proper positioning of the spot with the positioning control of the cathode-ray oscillograph. Other forms of stray emission are due to the combination of a high-accelerating field and secondary emission which cause bombardment of the screen by stray electrons or ions. Emission of electrons from intensifier bands of high-voltage tubes cause similar disturbances. An example of this may be seen in Figure 21. Sometimes secondary emission can be reduced



A

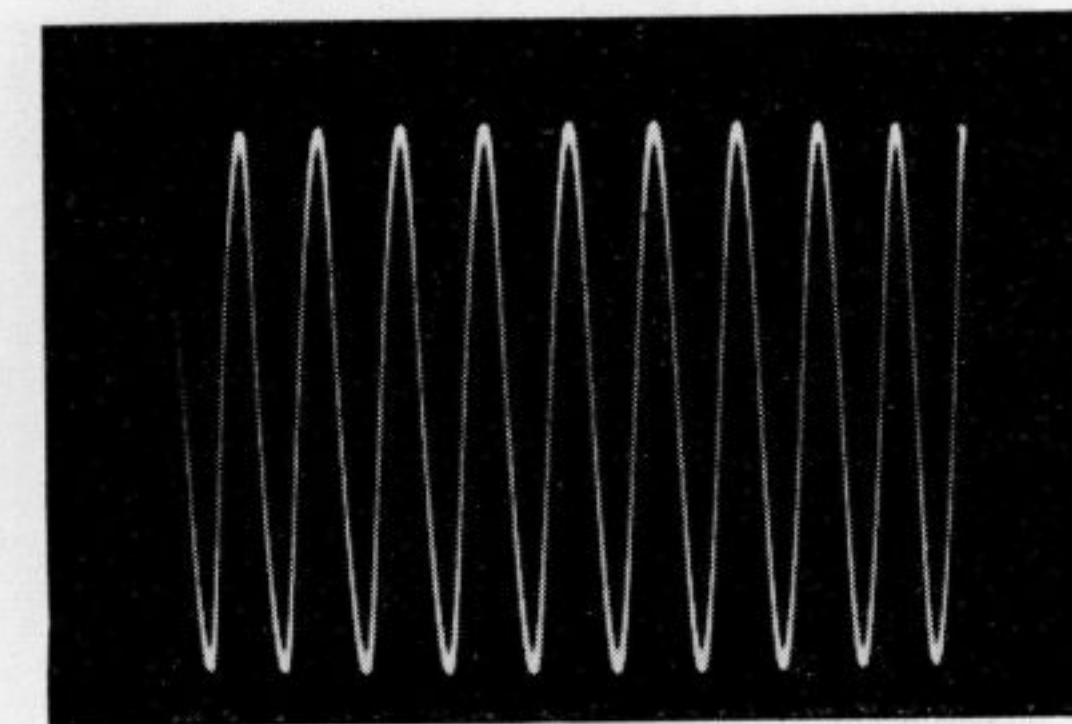

B

Figure 19. (A) An example of "cathode-glow". (B) Cathode-glow eliminated by the use of a blue filter. Recording on orthochromatic film also reduces this type of fog

by "ageing" the cathode-ray tube at full operating potentials. Stray emission caused by high field intensities may be minimized by changing the distribution of accelerating voltage between second anode and intensifier. Fortunately, since these secondary electrons usually have a lower velocity, metallized screens are relatively opaque to them.

Another source of stray light is sometimes encountered in the case of single-transient exposures, due to the fact that the blanking gate causes transient changes in the grid-cathode voltage of the cathode-ray tube. These changes cause an illuminated spot to appear at the pattern, as shown in Figure 22. Transients in the grid-cathode voltage sometimes are caused by surges in the line voltage. This type of fogging can be minimized by turning the cathode-ray tube at average brightness down to such a value that no transient occurring can produce a stationary spot.

Fogging can also be caused by external light. An oscillograph camera should include a light shield between the camera lens and the cathode-ray-tube screen. Sometimes fogging will occur due to light that enters through a view-

ing port in this light shield. Such viewing ports should be equipped with shutters, or with red or amber filters so that only light to which the film is insensitive can enter the light shield and reflect into the camera lens. Enough yellow light is emitted from the cathode-ray-tube phosphor so that the trace can be viewed through this filter. Fogging as a result of stray light from the incandescent filaments of tubes in the oscillograph can be eliminated by a blue filter placed at the face of the cathode-ray tube, and by use of orthochromatic film.

Because of the high voltage used in oscillographs designed for high-speed transients, unusual difficulties are sometimes encountered with static exposures on the film due to leakage of electrical charge. To avoid this, all metal parts, such as the pressure plate and film gate, should be grounded to a common point, with the oscillograph. An example of static fogging is shown in the oscillogram of Figure 23.

Under certain conditions, X-ray fogging may occur due to the high accelerating potentials used. The X-rays generated are generally so soft that they will not penetrate the cathode-ray tube or the camera. Any X-ray fogging usually

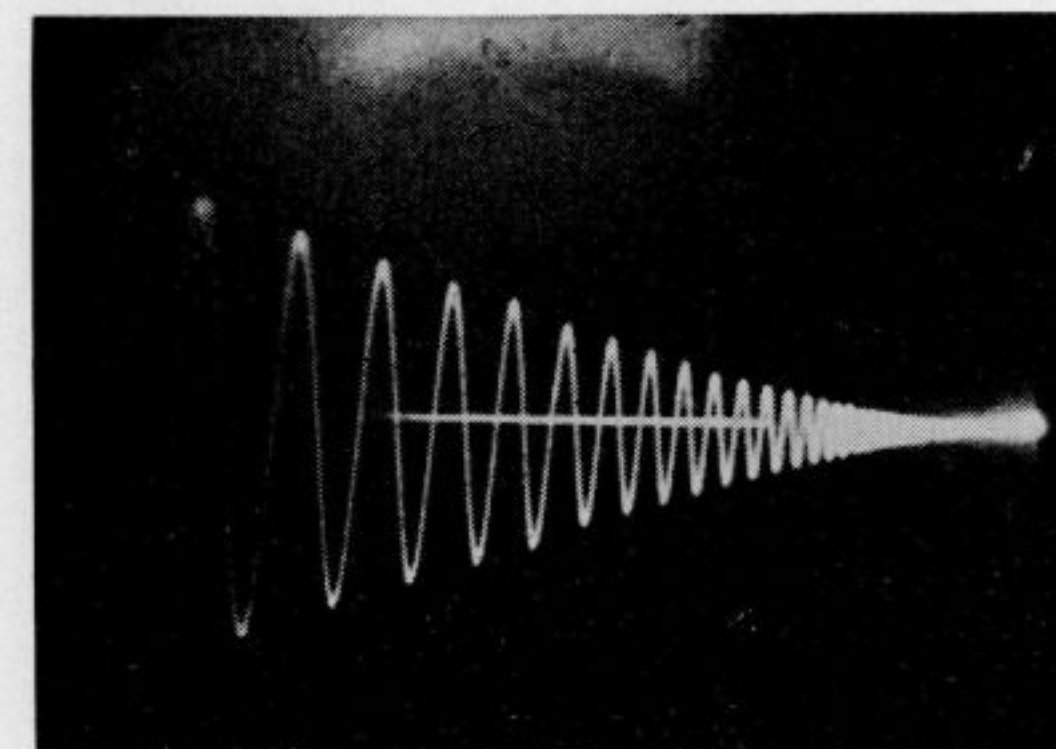

Figure 20. An illustration of fogging owing to electron reflection from one of the deflection plates

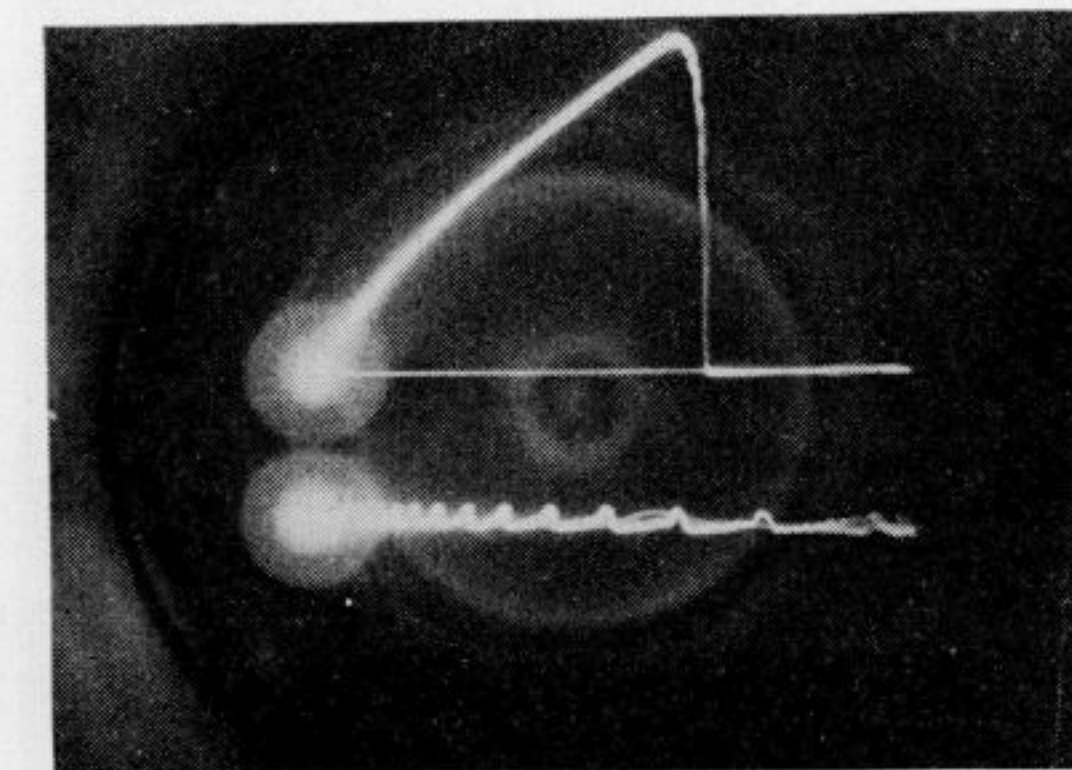

Figure 21. Fogging owing to secondary emission from the intensifier bands of the cathode-ray tube

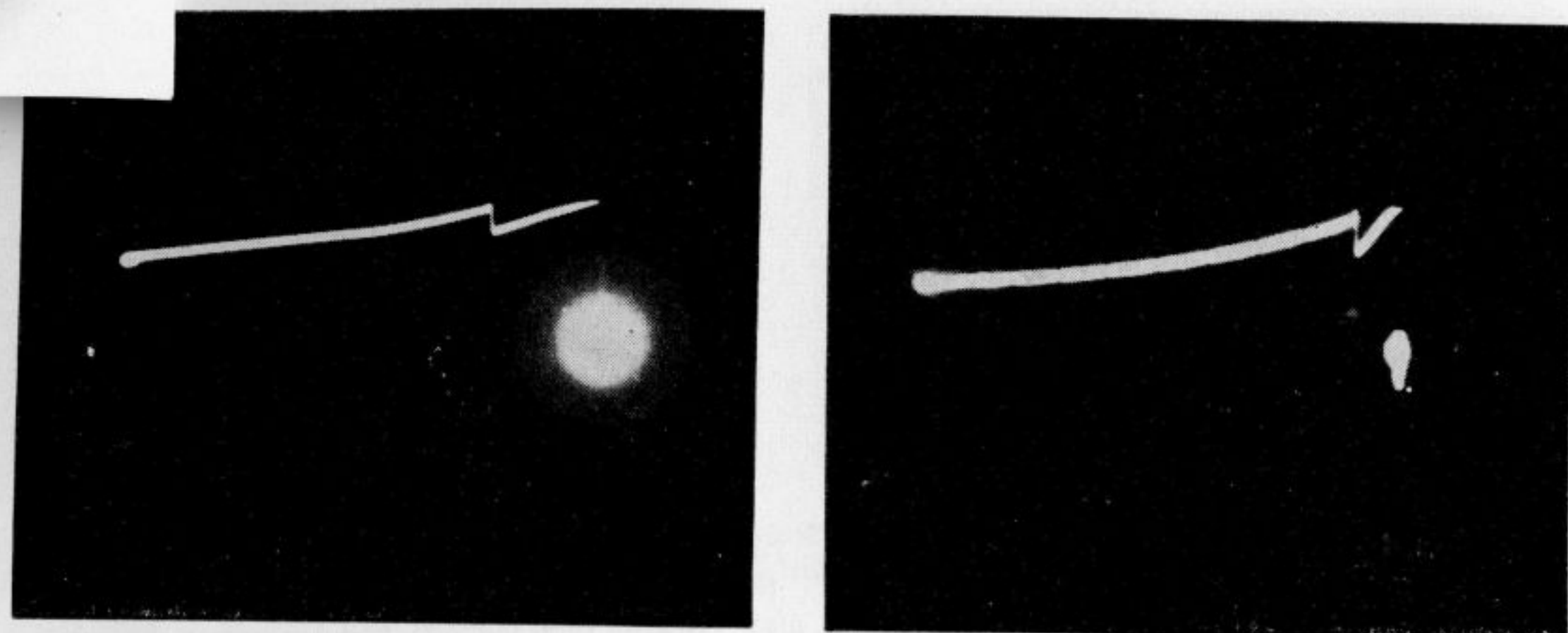

Figure 22. Brilliant spot in oscillogram at left is caused by a transient in the grid-cathode voltage of the cathode-ray tube. Spot was minimized in the oscillogram at right by reducing the intensity

originates outside the camera or cathode-ray tube from sources such as rectifier tubes or high-voltage test equipment. Simple shielding can nearly always eliminate this.

### Continuous-Motion Recording

Continuous-motion recording is, as the name implies, the technique of moving a film strip continuously across the focal plane (not as in the case of moving-picture photography, where the film undergoes a succession of rapid pull-down periods). The obvious method for using a continuously moving film recorder is to run the film in such a direction that it provides the time base.

However, for many applications, such as recording of high frequencies or of very narrow pulses, this becomes impractical because of the tremendous speeds required. Film speed in

a moving-film camera is not so great a limitation for high-frequency recording if the oscillograph sweep is operated to provide a time base perpendicular to the length of the film. This results in a recording where consecutive sweeps appear across the width of the film and are separated by a distance depending upon the repetition rate of the sweeps and the speed of the moving film. A comparison of the two methods for recording on moving film is shown in Figure 24. Note that when the oscillograph's sweep is used to provide the time base, the pulses can be expanded much further, more detail can be seen, and more efficient use is made of the total area of the film. The film speed necessary to achieve a desired separation between consecutive traces may be found from the expression:

$$S = \frac{HF}{M}$$

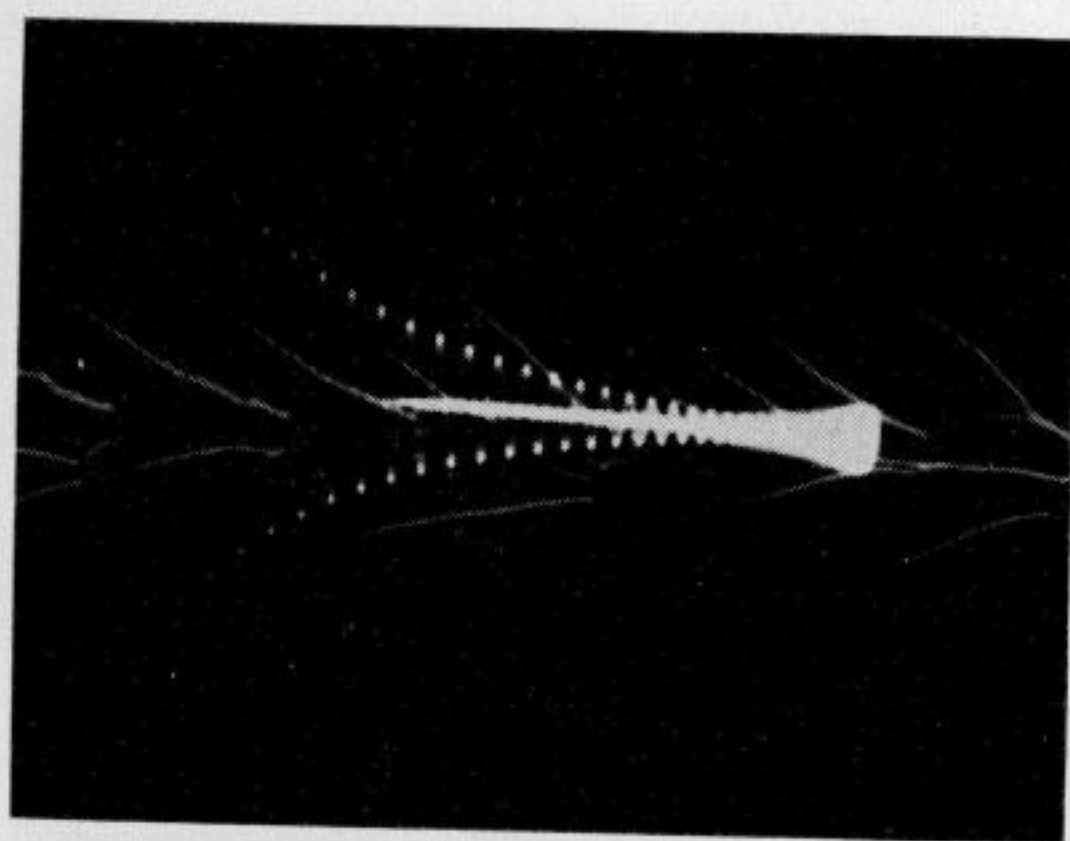

Figure 23. An example of static fog. Proper grounding of camera elements eliminates this type of fog

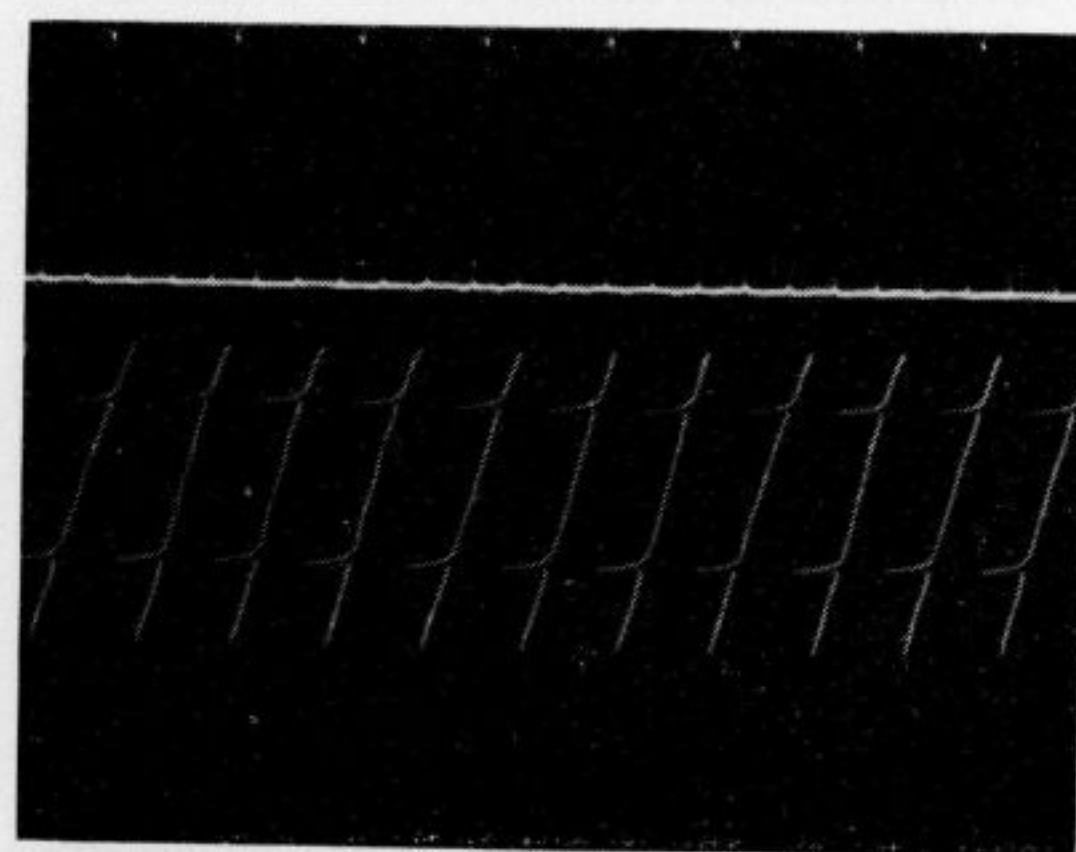

Figure 24. Two methods of continuous-motion recording. At top, film motion is the time base. Below, oscillograph sweep was used

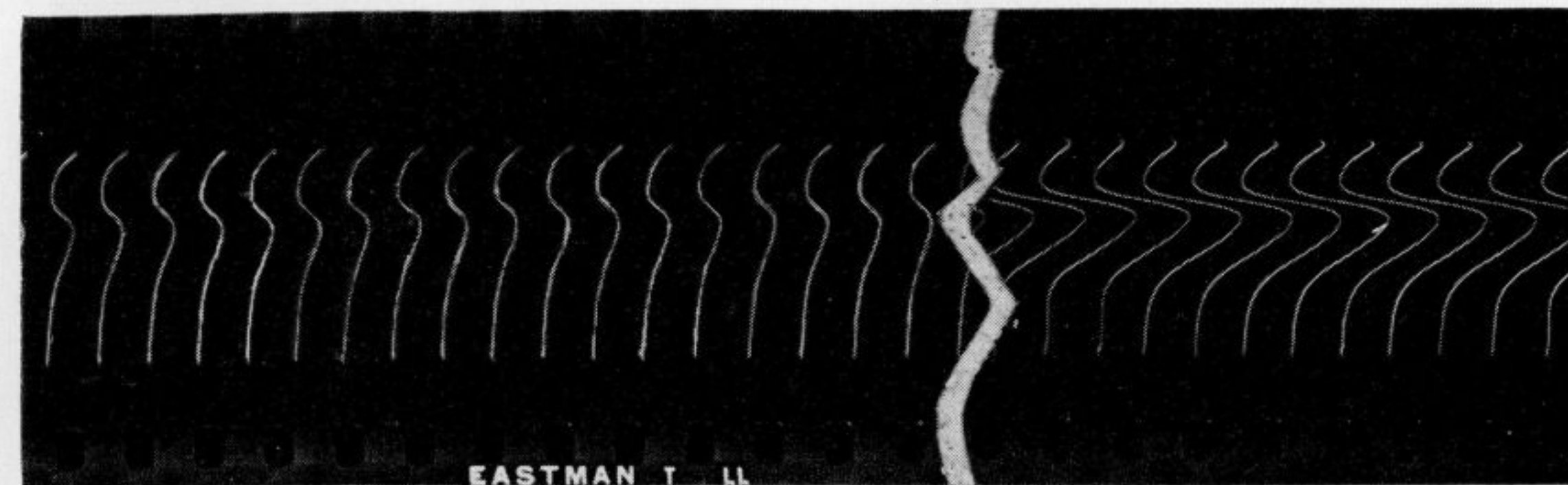

Figure 25. An oscillogram of nerve reaction potentials, showing interlacing of patterns

where S equals the film speed in inches per second, H equals the maximum height of the pulse or sine wave which is to be recorded from the cathode-ray-tube screen, M is equal to the optical-reduction ratio of the camera lens, and F is equal to the frequency of repetition of the sweep in cycles per second. This method of recording is often used in biological research, using cathode-ray oscillographs and recording cameras. As an example, Figure 25 shows a recording, made by this method, of the action potential of a frog's sciatic nerve. In this recording a very great number of pulses have been recorded on a given length of film by allowing the images of the pulses to interlace, as can be seen in the oscillogram.

When a phenomenon contains both high-frequency and low-frequency components, the problem of recording them becomes rather complicated. Such a pattern is shown in Figure 26, where the beginning of the transient is a high-frequency, shocked oscillation changing abruptly to a very-low-frequency oscillation. The most satisfactory method for recording this type of phenomenon is to trigger a single sweep of the oscillograph, which sweep is of proper speed and direction to expand the ini-

tial, high-frequency part of the transient. At the end of its sweep, the spot remains stationary without blanking out, while the motion of the film, which is relatively slow, provides the time base for displaying the low-frequency part of the phenomenon. The resulting oscillogram appears in Figure 27. This technique has many useful applications because it can be modified in several ways so the oscillograph sweep can be used to increase or decrease the effective speed of motion of the film. Probably the greatest advantage of this technique is that it results in more economy of film, by making it unnecessary to use great lengths of film to resolve properly the high-frequency, transient phenomenon. In order to interpret this type of recording, it is necessary to provide a time calibration on the film, so that the correct perspective is obtained when studying the oscillogram.

### Calibration

To evaluate oscillograms quantitatively, it is useful to have amplitude calibration, time calibration, and identification of the recording on the negative itself. Amplitude calibration can be recorded on the film directly, by double

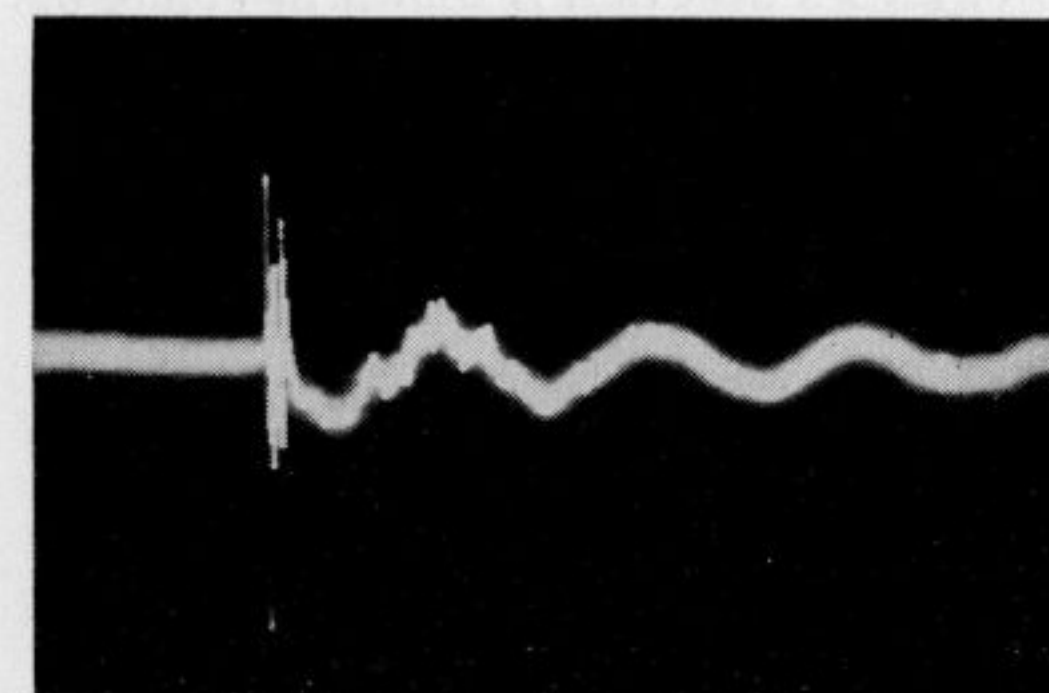

Figure 26. Shock transient and subsequent oscillations of a coil spring, displayed without use of the oscillograph sweep

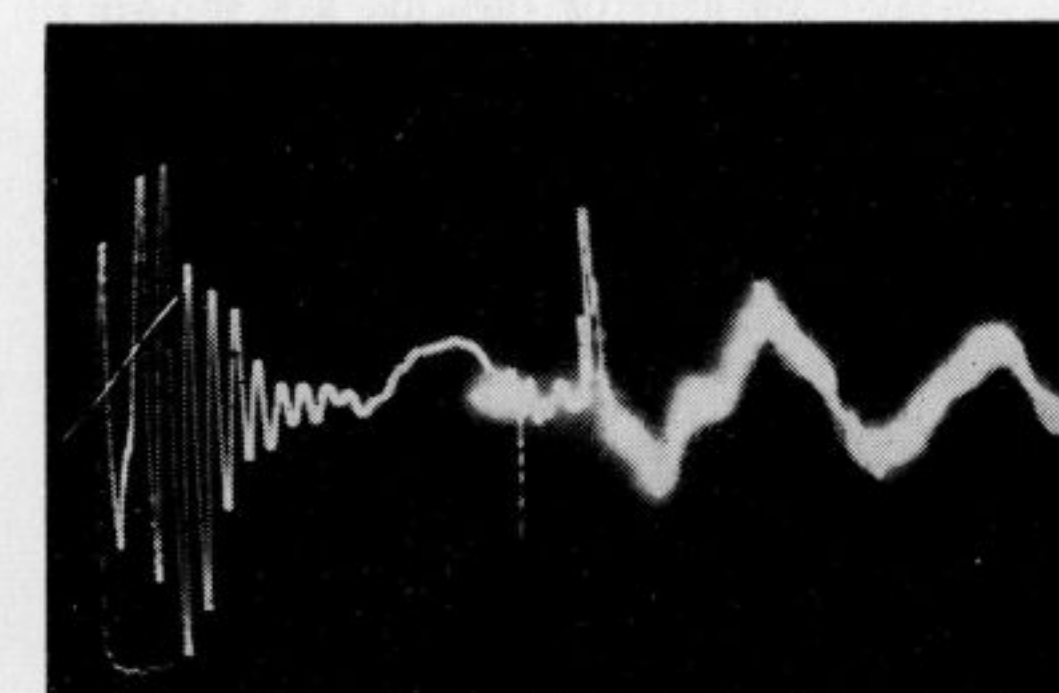

Figure 27. Same pattern as Fig. 25. Oscillograph sweep was used in addition to film motion to display initial portion

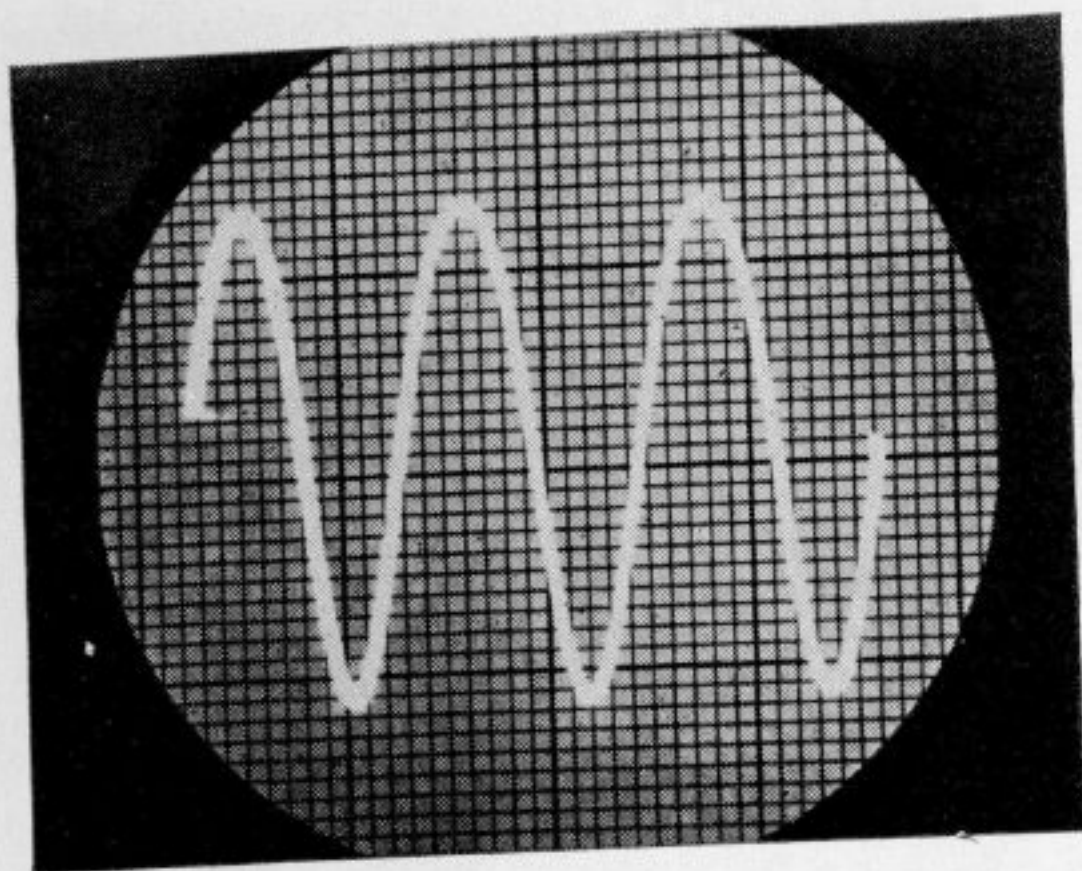

Figure 28. Quantitative analysis is facilitated by double-exposing calibrated scale onto oscillogram

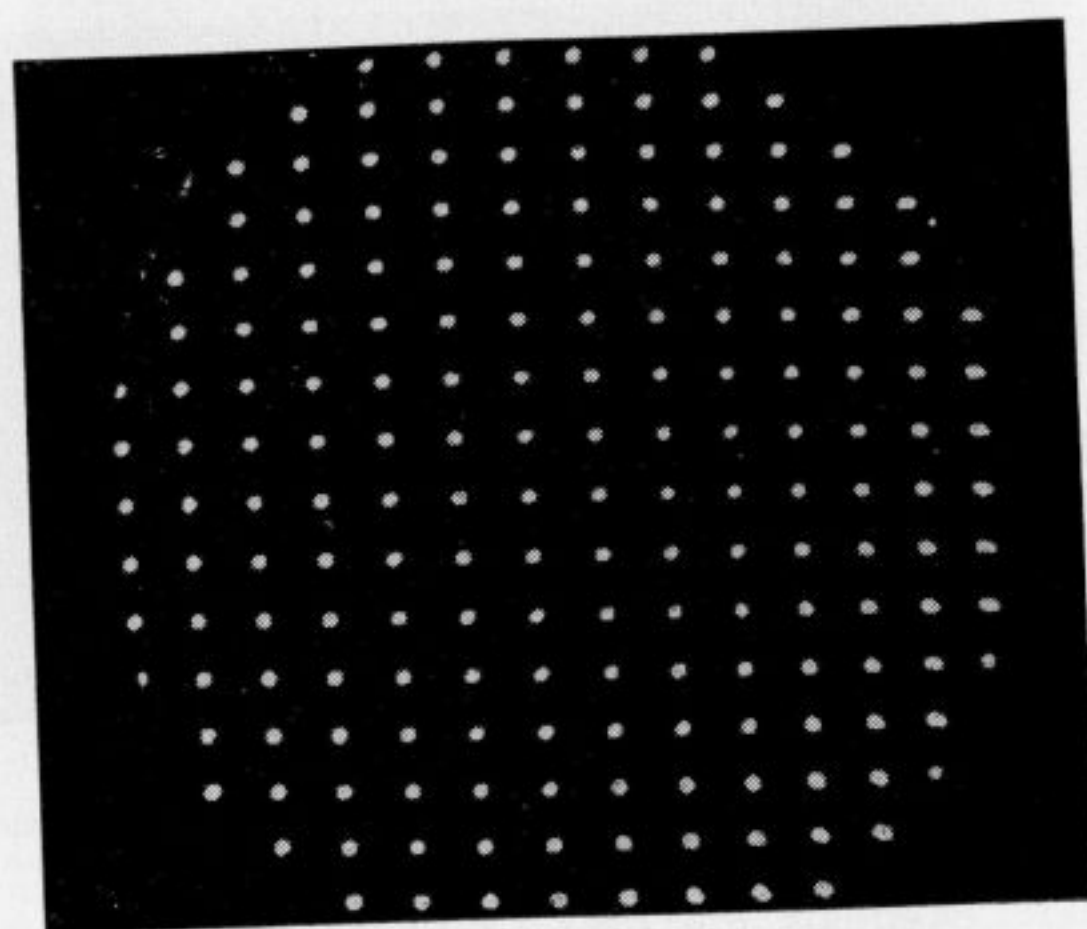

Figure 29. A matrix of dots which can be used for time calibration by superimposing on negative

exposing a known voltage from a voltage calibrator. Amplitude calibration can be made more useful by superimposing upon the oscillogram rectangular or polar coordinates, as shown in Figure 28. This can be accomplished by making a double exposure of a ruled transparent scale, illuminated from behind, or by the use of an edge-illuminated, clear plastic scale. Another method for amplitude-calibrating oscillograms is to produce a matrix, as in Figure 29, of dots on the cathode-ray-tube screen, with accurately known, vertical and horizontal, stepped voltages. A recording is then made of this matrix. The advantages of such a matrix are that non-linear deflections caused by cathode-ray tubes or associated amplifiers are indicated by this method. The matrix can be used for calibrating the oscillogram by placing the negative of the matrix over the negative of the oscillogram.

Time calibration is made either by bright or dark markers on the oscillograph's trace, by vertical pips, or by oscillations produced on a base line above or below the trace. Samples of intensity markers produced by modulating the cathode-ray-tube grid or cathode are shown in

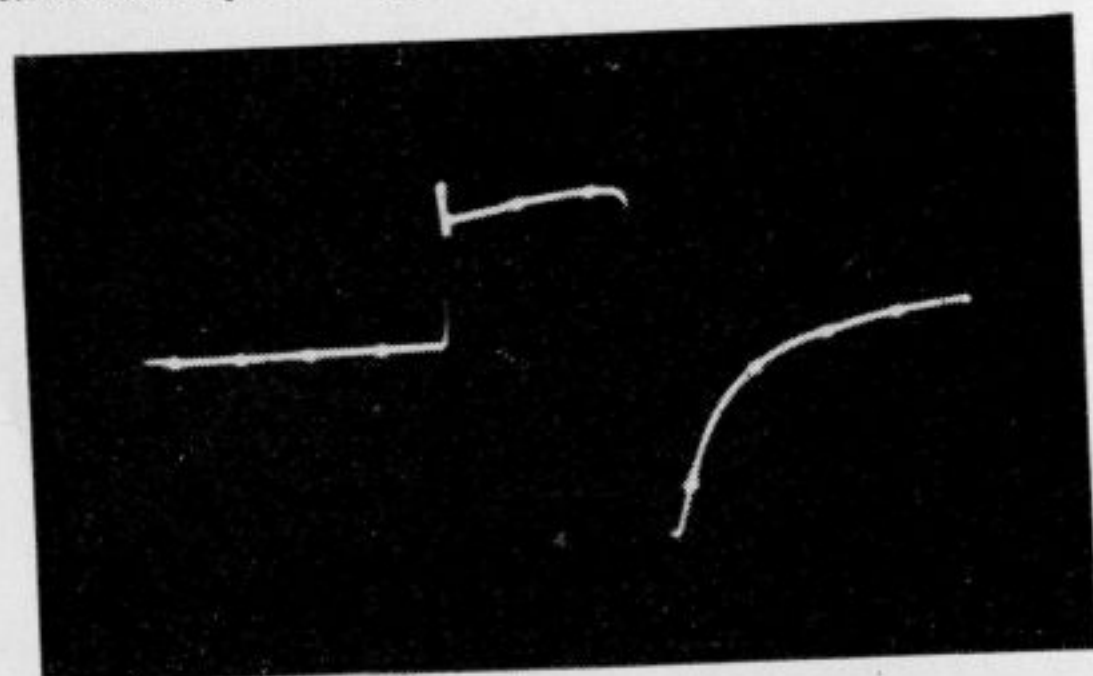

Figure 30. An example of intensity-modulated timing markers, which brighten the trace at known intervals

the oscillograms of Figures 30 and 31. Either bright or dark markers can be used, but dark markers sometimes obscure important information. Note that in one oscillogram overshoot of the pulse is not visible because a dark timing marker occurred at this point, while in the other oscillogram the timing marker brightened the beam at this point.

Identification of the data associated with an oscillogram should properly be recorded on the film to which it belongs, so that it is a permanent part of the negative. Recording of data by just writing on the film after it is processed can result in errors; and it is not permanent. Proper photographic identification is accomplished by writing data on an illuminated, ground-glass surface, and by double-exposing this upon an unused corner of the oscillogram or upon the following frame. Many commercially available oscillographs are provided with such "data cards" built in. For cameras not containing built-in data cards, a device for the purpose may be easily improvised. An example of such a data card is shown in Figure 32.

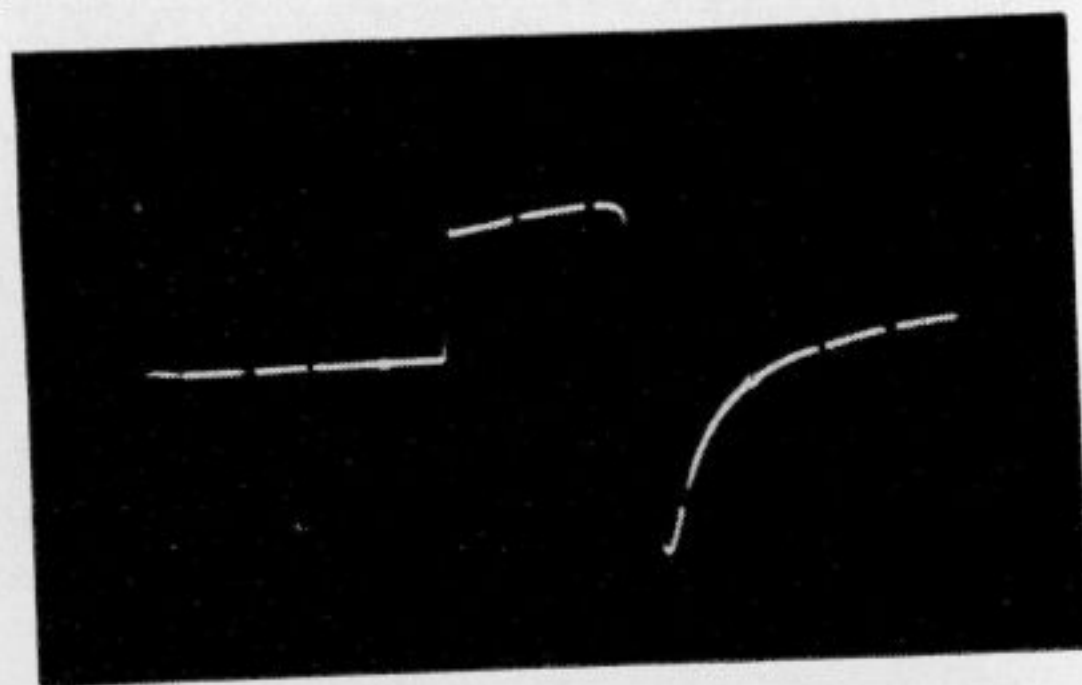

Figure 31. Intensity-modulated timing markers that blank the trace. Note that overshoot is obscured by one marker

TECHNIQUES OF PHOTO-RECORDING

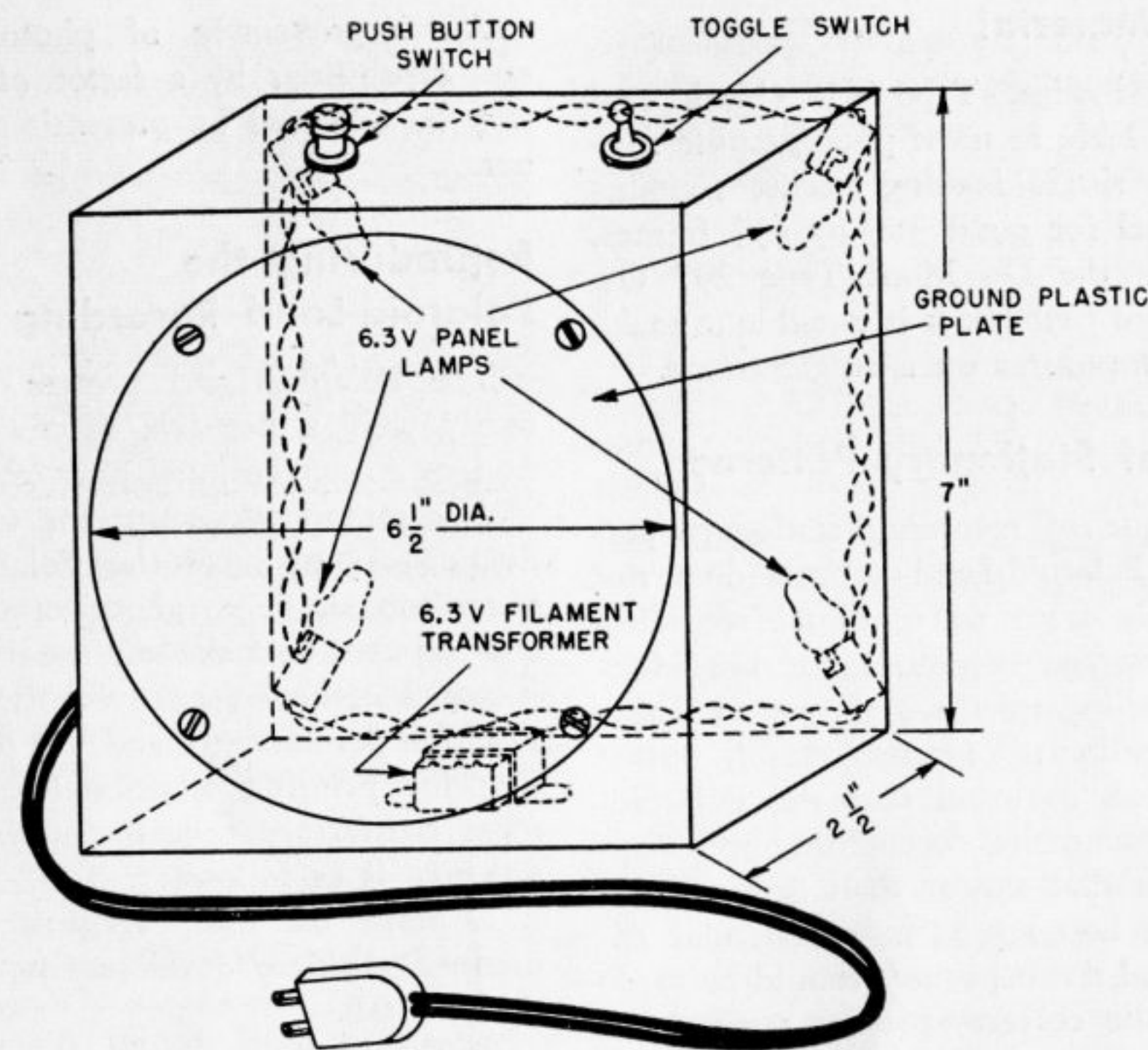

Figure 32. A diagrammatic sketch of an improvised illuminated data card

II. Polaroid-Land Process

Introduction

The Polaroid-Land photographic process, by means of which a finished, positive print is obtained in 60 seconds after exposure, is gaining importance rapidly in the field of oscillograph recording. The new Du Mont Type 297, operating on the Polaroid-Land principle, is now commercially available.

The Polaroid-Land process differs in several respects from conventional photographic processes, and an understanding of the basic photographic principles involved will aid in obtaining optimum results in oscillographic recording.

The Process

The Polaroid-Land photographic process is sometimes known as a soluble silver complex process. It involves the simultaneous development of both positive and negative images in adjacent layers of photographic material, the positive image being formed from the unexposed silver halide grains of the negative image. The adjacent layers, in the Polaroid-Land process, consist of a paper negative coated with the conventional silver halide emulsion, and a positive printing paper coated with crystals of

metallic sulfide. Attached to the printing paper, at the head of each frame, is a small air-tight "pod" which contains a chemical reagent and plasticizer. After exposure of the paper negative, the negative-emulsion surface and the positive-printing surface are pulled together and pressed firmly between steel rollers. Thus the pod is broken, and the jellied reagent is spread evenly in a thin film between the adjacent layers. The exposed grains of silver halide in the negative emulsion are thereby developed into metallic silver, while the unexposed silver halide grains are dissolved. These unexposed grains diffuse out of the negative emulsion into the immediately adjacent positive-printing surface. Sulfide crystals on the printing surface cause the silver solution to precipitate as a positive image on the printing surface. The entire process requires about 60 seconds at normal room temperatures.

Since any excess developer is trapped and resealed, it is not generally possible for the operator to come into contact with the reagent during the normal operation of the camera. However, if occasion to examine the reagent arises, caution should be observed, since the chemicals employed will stain clothing permanently.



## Recording Material

Polaroid-Land film, Type 41 (black and white), is available at most photographic supply stores. A single loading packet contains enough material for eight  $3\frac{1}{4}$  by  $4\frac{1}{4}$  frames. Moreover with the Du Mont Type 297 Oscillograph-record Camera, it is possible to make a number of exposures on a single frame.

## Recording of Stationary Patterns

The technique of recording stationary patterns by the Polaroid-Land process does not differ materially from conventional recording techniques. Average exposures for Du Mont cathode-ray oscillographs are shown in Table I. Exposure is by no means critical, but it should be borne in mind that the Polaroid-Land Film, Type 41 is, for oscillographic applications, somewhat slower than conventional emulsions. For best results in a particular application, several test exposures should be made to determine the correct aperture setting and exposure time.

## Transient Recording

Generally speaking, the Polaroid-Land process, with presently available materials, does not lend itself to the recording of high-speed single transients. For transients of medium and low speeds, the techniques do not differ from those for conventional recording materials, once the slower emulsion speed of the Polaroid-Land recording material is taken into consideration.

## Presensitizing the Film

It is possible to increase the photographic-writing-rate capabilities of the Type 41 Polaroid-Land film to a considerable degree by presensitizing the frame before the recording is made. The function of presensitizing is to raise the operating point of the film characteristic above the toe of the H and D curve, thereby increasing the contrast of the photographic image of the transient.

The recommended procedure for presensitizing Polaroid-Land Material, Type 41, is as follows:

1. Place the extension barrel opening of the Type 297 Oscillograph-record camera, loaded with the film to be presensitized, against a sheet of white opal glass, which is six inches in front of a 25-watt, frosted incandescent lamp.
2. Expose for  $1/25$  of a second at  $f/2.8$ .

An improvement of photographic-writing-rate capabilities by a factor of as much as 8 may be obtained by presentizing in this manner.

## Reproducing the Polaroid-Land Recording

The Polaroid-Land process does not ordinarily yield a negative suitable for reproduction, as do conventional photographic processes.

A common procedure for obtaining reproductions is to have the Polaroid-Land print photo-copied. The photo-copy negative then may be used to make any number of prints. It is possible, however, to fix the Polaroid-Land negative permanently and use this paper negative for printing additional recordings. The most satisfactory process for fixing the paper negative is as follows:

1. Make the first exposure in the normal manner. Initiate development by pulling out the film tab.
2. While the processing of the first print is underway, the next frame may be exposed. One minute after the first frame has been exposed, darken the room, or throw an opaque cloth over the top of the camera. Open the picture door, peel off the first print, and immediately close the picture door. The negative of the first print thereby remains in the camera, and will not fog so long as it is not exposed to light.
3. When the processing of the second print is to be initiated, pull out the tab (the negative of the first print) in a darkened room or under a cloth, and immediately after tearing this negative off, immerse it in a tray or jar of hypo. A concentrated hypo solution, such as Kodak Rapid Fixer Solution, is recommended. This paper negative should remain in the solution for about 2 minutes. (Meanwhile the next exposure may be made).
4. After fixing for 2 minutes, the paper negative may be washed and dried in the conventional manner.

The negative obtained may be subsequently printed by the Ozalid process, or it may be contact-printed on standard photographic paper. In the latter case, a soft or medium paper such as Azo #2 should be selected. Place the emulsion side of the paper negative in contact with the emulsion of the printing paper, and expose through the paper negative. Process the contact print in the conventional manner.

Clarity of the contact print may be improved by rubbing the back of the paper negative with

oil or melted wax to increase its transparency. Similarly, the Polaroid-Land print itself may be used to make contact-printed reproductions. Again oil or melted wax may be used to make the original print more transparent. The oiled

Polaroid-Land print may also be contact-printed upon conventional photographic film, yielding a transparent photographic negative, from which any number of reproductions may be made by conventional printing techniques.

Effort to develop the best in photographic equipment for oscillographic recordings, has removed most of the difficulties which were previously encountered in such work. Today, excellent recording of practically all oscillographic phenomena may be obtained, provided the proper attention to formulated techniques is observed. Moreover, while the recording of oscillograms is essentially a photographic operation, one should always bear in mind the nature and characteristics of oscillographic equipment.

## References

- H. P. Mansberg, "A New, Versatile Camera for the Cathode-ray Oscillograph," THE OSCILLOGRAPHER, Vol. 10, No. 4, Page 2, October-December, 1948.
- C. E. Kenneth Mees, "The Theory of the Photographic Process," MacMillan Co., Pages 236-260, 1942.
- Rudolph Feldt, "High Speed Photographic Recording and Projection Oscillography with the New Du Mont Type 5RP 5RP Multiband Tube," THE OSCILLOGRAPHER, Vol. 7, No. 4, Page 1, July-August, 1945.

C. Berkley, "Suppression of Halo Around the CRT Spot," UNPUBLISHED INTERNAL ENGINEERING REPORT NO. 24. Allen B. Du Mont Laboratories, April 5, 1943.

R. Feldt, "Long Persistence CR Tube Screens," Electronic Industries, Vol. V, Page 70, October 1946.

R. Feldt, "Luminescent Screens for Cathode-ray Oscillography," THE OSCILLOGRAPHER, Vol. 11, No. 2, Page 3, April-June 1949.

W. Nethercot, "Recording of High Speed Transient Phenomena," Electronic Engineering, Vol. 16, Page 369, February 1944.

P. S. Christaldi, "The Evaluation of Specifications for Cathode-ray Oscillographs." Technical Paper delivered at IRE National Convention, March 7-10, 1949.

H. P. Mansberg, "The New Du Mont Type 314-A, Oscillograph-record Camera," THE OSCILLOGRAPHER, Vol. 11, No. 3, Page 3, July-September 1949.

H. P. Mansberg, "An Illuminated Data Card for Use with the Du Mont Type 271-A Oscillograph-Record Camera," THE OSCILLOGRAPHER, Vol. 11, No. 4, October-December, 1949.

**TABLE 2**  
**AVERAGE EXPOSURE GUIDE FOR DU MONT**  
**CATHODE-RAY OSCILLOGRAPHS**

WITH STATIONARY PATTERN OF TEN SINEWAVE CYCLES ON SCREEN  
MEDIUM INTENSITY SETTINGS

E. K. Panatomic-X Film D-76 Developer—14 Minutes

For E. K. Type 1115 Paper—use twice the listed exposure  
For E. K. Super XX, Linagraph Ortho or Linagraph Pan and D-19 Developer, use ¼ of the listed exposure or two diaphragm stops higher.

| Du Mont Oscillograph, Type No. | Cathode-ray Tube | Accelerating Voltage | Diaphragm Setting | Exposure |                     |
|--------------------------------|------------------|----------------------|-------------------|----------|---------------------|
|                                |                  |                      |                   | Seconds  | Sweep Frequency cps |
| 208-B                          | 5LP11-A          | 1400                 | 5.6               | 1        | 15- 30,000          |
| 241                            | 5JP11-A          | 1500                 | 5.6               | 1        | 15- 30,000          |
| 247                            | 5CP11-A          | 3000                 | 8                 | ½        | 60- 30,000          |
| 247-A+263-B                    | 5RP11-A          | 11,500               | 16                | ½        | 60- 30,000          |
| 248                            | 5JP11-A          | 4000                 | 11                | ½        | 60-100,000          |
| 248-A+263-B                    | 5RP11-A          | 12,000               | 16                | ½        | 60-100,000          |
| 250-A                          | 5CP11-A          | 3200                 | 8                 | ½        | 1-150,000           |
| 250-AH+263-B                   | 5RP11-A          | 13,700               | 16                | ½        | 1-150,000           |
| 256-D or 256-E                 | 5CP11-A          | 4000                 | 11                | ½        | 80- 2300            |
| 274-A                          | 5BP11-A          | 1000                 | 4                 | 1        | 60- 30,000          |
| 275-A                          | 5CP11-A          | 3000                 | 8                 | 1        | 1-60                |
| 279                            | 5SP11            | 4500                 | 9                 | ½        | 15- 30,000          |
| 280-A                          | 5XP11            | 11,900               | 16                | ½        | 30                  |
| 288-A                          | 5XP11            | 19,000               | 16                | ½        | 30                  |
| 281-A                          | 5RP11-A          | 8000                 | 16                | ½        | 60                  |
| 281-A+263-B                    | 5RP11-A          | 14,000               | 16                | ¼        | 60                  |
| 281-A+286-A                    | 5RP11-A          | 29,000               | 16                | ¼        | 60                  |
| 294-A                          | 5XP11            | 12,000               | 16                | ½        | 10-150,000          |
| 303                            | 5YP11            | 3,000                | 8                 | ½        | 10-100,000          |
| 304                            | 5CP11-A          | 1780                 | 5.6               | 1        | 2- 30,000           |
| 304-H or 304-HR                | 5CP11-A          | 3000                 | 8                 | ½        | 2- 30,000           |

NOTE: for sweeps slower or faster than those given, decrease or increase (respectively) the exposure proportionately.

**TABLE 3**

**AVERAGE SINGLE TRANSIENT RECORDING SPEEDS OF**  
**DU MONT CATHODE-RAY OSCILLOGRAPHS**

For Eastman Kodak Linagraph Pan (5244) and D-19 Developer — 9 minutes.  
For Eastman Kodak Super XX-Developed in D-19 Maximum Photographic Writing  
Speeds will be slightly less than the given values.

| Oscillograph Type | Cathode-ray Tube | Maximum Accelerating Potential Volts |                 | Maximum Photographic Writing Speed With P11 Screen, In./µsec |       |
|-------------------|------------------|--------------------------------------|-----------------|--|-------|
|                   |                  | Eb <sub>2</sub>                      | Eb <sub>3</sub> | F/2.8  | F/1.5 |
| 208-B             | 5LP11-A          | 1120                                 | 1400            | 0.08   | 0.3   |
| 241               | 5JP11-A          | 1100                                 | 1500            | 0.08   | 0.3   |
| 247               | 5CP11-A          | 1550                                 | 3000            | 6.3  | 2.8   |
| 247-A+263-B       | 5RP11-A          | 1550                                 | 11,550          | 10   | 35    |
| 248               | 5JP11-A          | 2000                                 | 4000            | 1.2  | 4.2   |
| 248-A+263-B       | 5RP11-A          | 2000                                 | 14,000          | 20   | 70    |
| 250-A             | 5CP11-A          | 1700                                 | 3200            | 1  | 3.5   |
| 250-AH+263-B      | 5RP11-A          | 1700                                 | 13,700          | 10   | 35    |
| 256-D or 256-E    | 5CP11-A          | 2000                                 | 4000            | 1.2  | 4.2   |
| 274-A             | 5BP11-A          | 1000                                 | 1000            | 0.04   | 0.14  |
| 275-A             | 5CP11-A          | 1500                                 | 3000            | 0.8  | 2.8   |
| 279               | 5SP11            | 1700                                 | 4500            | 1.6  | 5.6   |
| 280-A             | 5XP11            | 1900                                 | 11,900          | 40   | 140   |
| 281-A             | 5RP11-A          | 4000                                 | 8000            | 40   | 140   |
| 281-A+263-B       | 5RP11-A          | 4000                                 | 16,000          | 60   | 200   |
| 281-A+286-A       | 5RP11-A          | 4000                                 | 29,000          | 80   | 280   |
| 288-A             | 5XP11            | 1900                                 | 19,000          | 50   | 175   |
| 294-A             | 5XP11            | 1700                                 | 12,000          | 10   | 35    |
| 303               | 5YP              | 1500                                 | 3,000           | 1  | 3.5   |
| 304               | 5CP11-A          | 1400                                 | 1780            | 0.09   | 0.4   |
| 304-H or 304-HR   | 5CP11-A          | 1400                                 | 3000            | 0.8  | 2.8   |

**TABLE 4**  
**AVERAGE EXPOSURE GUIDE FOR DU MONT**  
**CATHODE-RAY OSCILLOGRAPHS**  
**(Polaroid-Land Process)**

| Du Mont Oscillograph Type No. | Cathode-ray Tube | Accelerating Voltage | Diaphragm Setting | Exposure Time (Secs) |
|-------------------------------|------------------|----------------------|-------------------|----------------------|
| 208-B                         | 5LP11-A          | 1400                 | 5.6               | 1                    |
| 241                           | 5JP11-A          | 1500                 | 5.6               | 1                    |
| 247-A+263-B                   | 5RP11-A          | 11,500               | 11                | ½                    |
| 248                           | 5JP11-A          | 4000                 | 8                 | ½                    |
| 248-A+263-B                   | 5RP11-A          | 12,000               | 11                | ½                    |
| 250-A                         | 5CP11-A          | 3200                 | 11                | 1                    |
| 250-AH+263-B                  | 5RP11-A          | 13,700               | 16                | ½                    |
| 256-D or 256-E                | 5CP11-A          | 4000                 | 8                 | ½                    |
| 274-A                         | 5BP11-A          | 1000                 | 4                 | 1                    |
| 275-A                         | 5CP11-A          | 3000                 | 11                | 1                    |
| 279                           | 5SP11            | 4500                 | 8                 | ½                    |
| 280-A                         | 5XP11            | 11,900               | 11                | ½                    |
| 288-A                         | 5XP11            | 20,000               | 16                | ½                    |
| 281-A                         | 5RP11-A          | 8000                 | 16                | 1                    |
| 281-A+263-B                   | 5RP11-A          | 14,000               | 16                | ½                    |
| 281-A+286-A                   | 5RP11-A          | 29,000               | 22                | ½                    |
| 294-A                         | 5XP11            | 12,000               | 11                | ½                    |
| 303                           | 5YP11            | 3000                 | 8                 | 1                    |
| 304                           | 5CP11-A          | 1780                 | 8                 | 1                    |
| 304-H or 304-HR               | 5CP11-A          | 3000                 | 11                | 1                    |

\*Average exposures with stationary pattern of ten sine-wave cycles on screen and medium intensity settings.

Polaroid-Land Film Types 40 and 41; development time: 1 min.  
Type 297 Camera using **Blue-Reflecting Dichroic Mirror**  
Object—Image Ratio: 2.25/1.

NOTE: For approximate exposures for other phosphors, multiply the above exposures by the following factors:  
P<sub>1</sub>—4 times                      P<sub>2</sub>—5 times                      P<sub>7</sub>—2 times

DU MONT

CATHODE-RAY TUBES

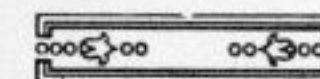

SCREEN CHARACTERISTICS

ALLEN B. DU MONT LABORATORIES, INC.  
PASSAIC, NEW JERSEY

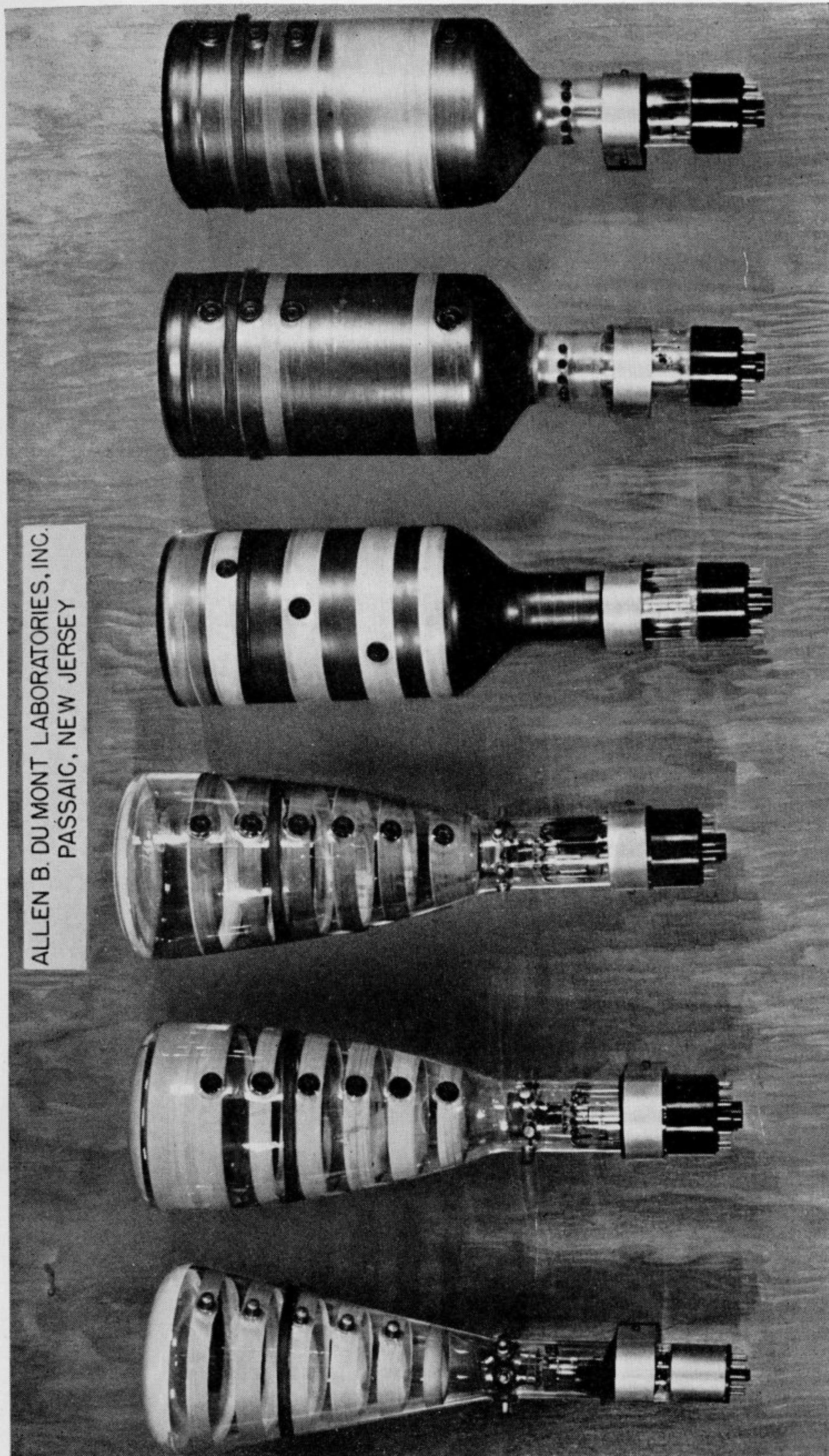

Steps in the evolution of the Type 5RP-A Cathode-ray Tube. From left to right: Early design had 5 intensifier rings on a standard 5JP blank. Satisfactory performance for  $E_{b3}/E_{b2} = 4$ . Next design included flush intensifier contacts on a standard 5CP blank.  $E_{b3}/E_{b2} = 5$ . Following model had stainless steel high-current gun with die-stamped parts.  $E_{b3}/E_{b2} = 5$ . Next design had improved field shape for high  $E_{b3}/E_{b2}$  ratios, better shielding of the deflection plates from  $E_{b3}$ , a flat face, and fewer intensifier rings.  $E_{b3}/E_{b2} = 8$ . Field shape was then further improved, and low capacity leads were furnished to deflection plates.  $E_{b3}/E_{b2} = 10$ . At extreme right, final design has a conductive coating in contact with screen material, and the focusing electrode is designed to draw negligible current. Satisfactory performance for  $E_{b3}/E_{b2} = 10$ .

## DU MONT P1 SCREEN CHARACTERISTICS

### General Description

Medium-persistence green screen of high visual efficiency, suited for general-purpose visual oscillographic and indicating applications.

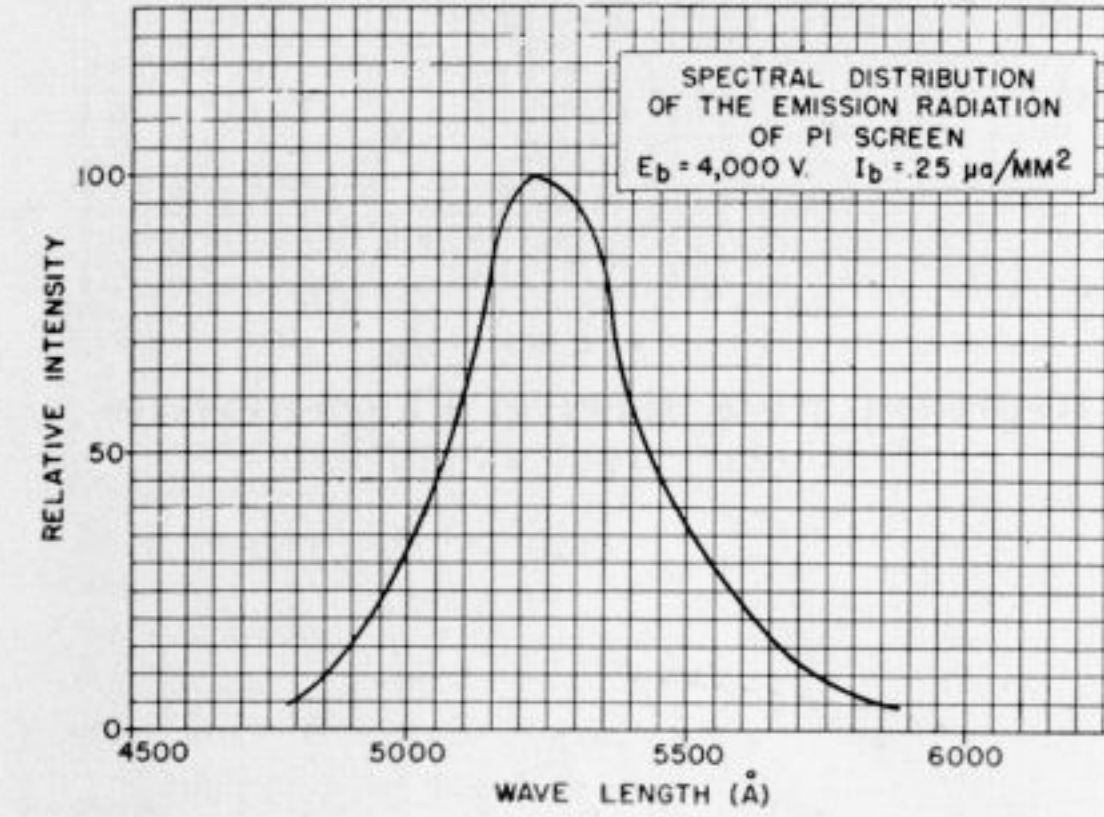

Representative Spectral Characteristic  
Stationary spot excitation.

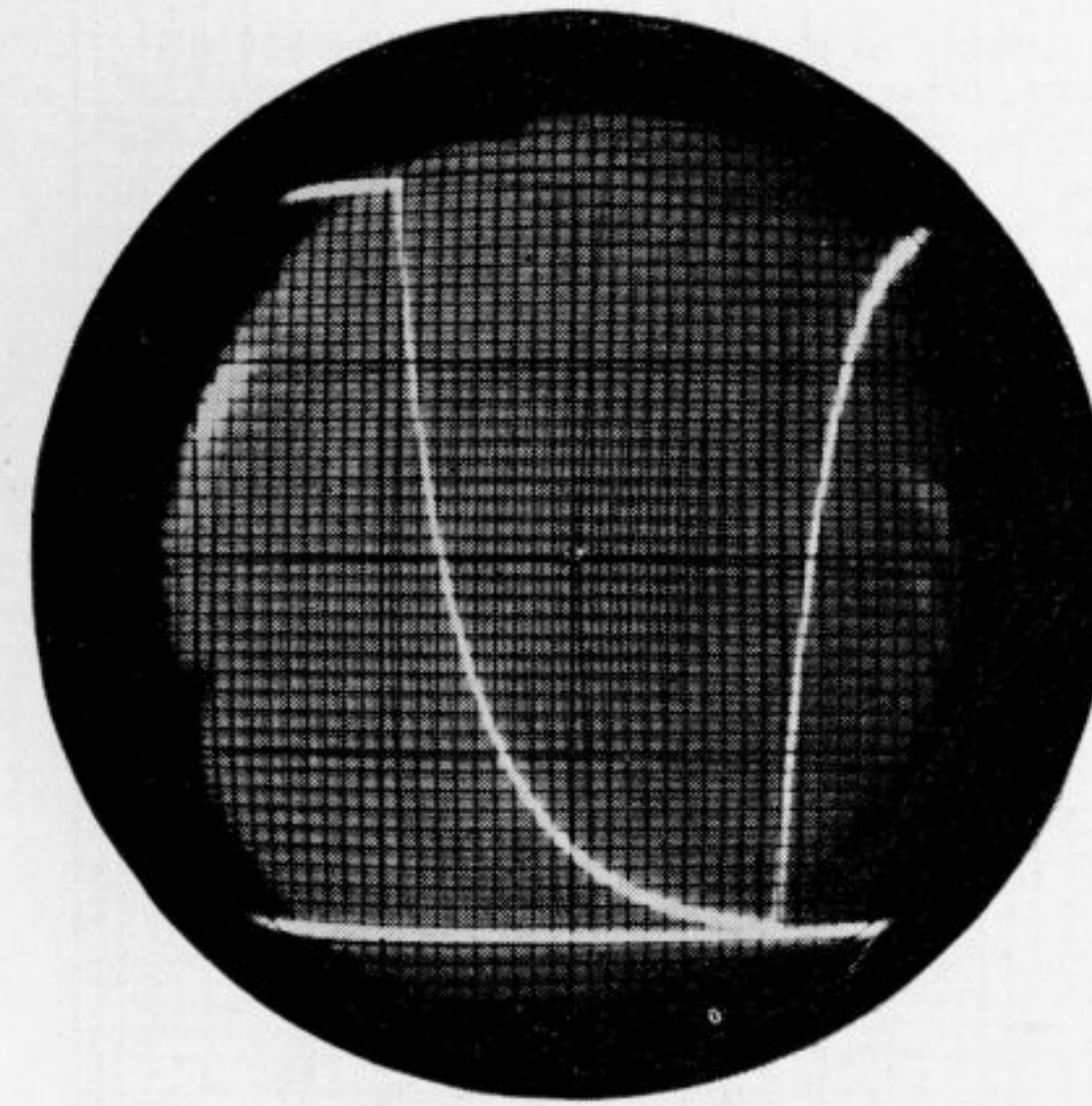

### Persistence

For 10% of the initial intensity, the persistence time for a current density of  $25 \mu\text{a}/\text{cm}^2$  at 4000 volts is approximately 30 milliseconds. The persistence time decreases slightly with increasing current density to about 25 milliseconds for  $600 \mu\text{a}/\text{cm}^2$ . There is little change in persistence time with voltage. Decay curve is for about  $25 \mu\text{a}/\text{cm}^2$  at 4000 volts; 1 division = 2.5 milliseconds. Data and curve are for repetitive stationary spot excitation.

AVERAGE VISUAL SCREEN EFFICIENCY  
P1 SCREEN

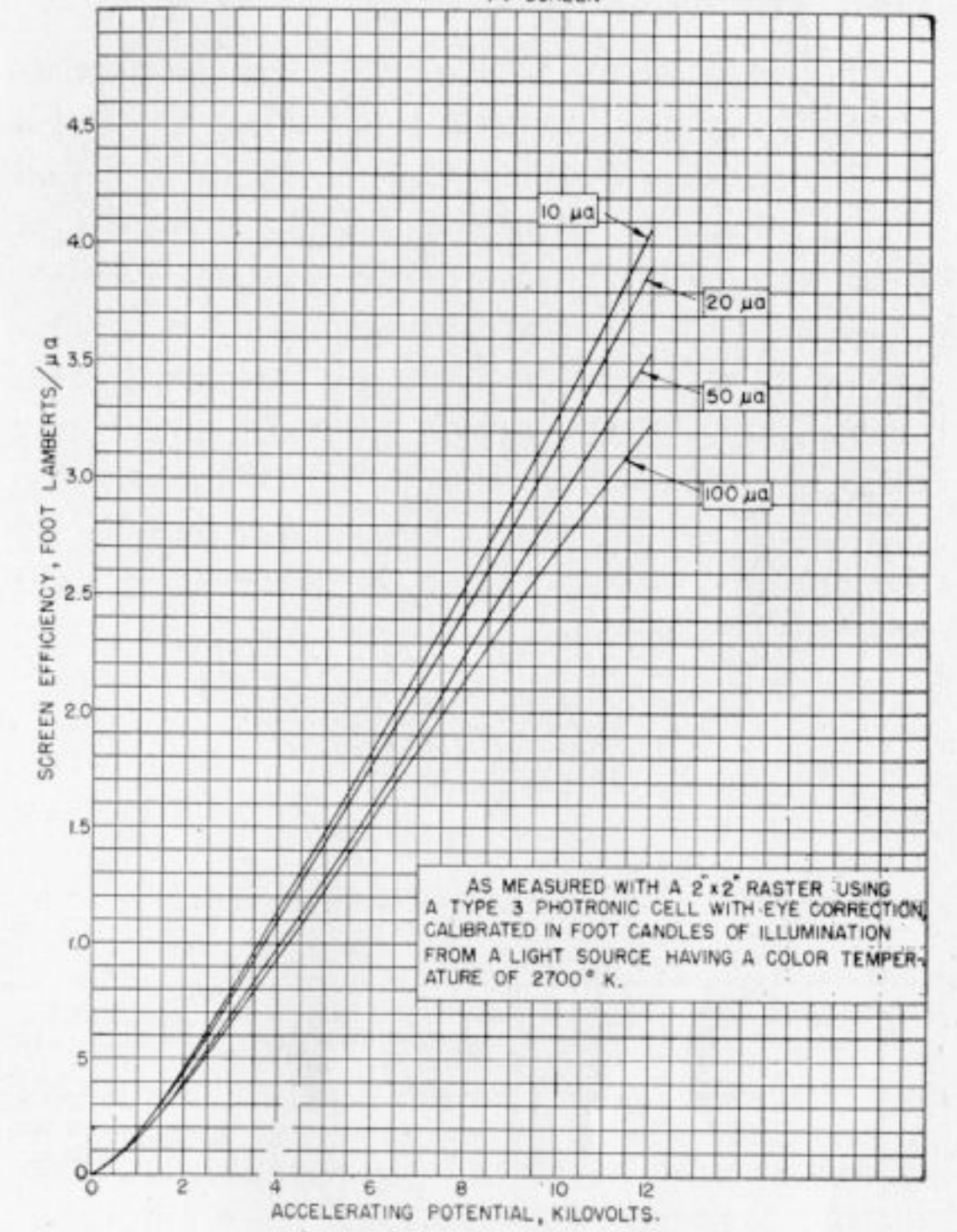

AVERAGE HIGH VOLTAGE VISUAL SCREEN EFFICIENCY  
P1 SCREEN

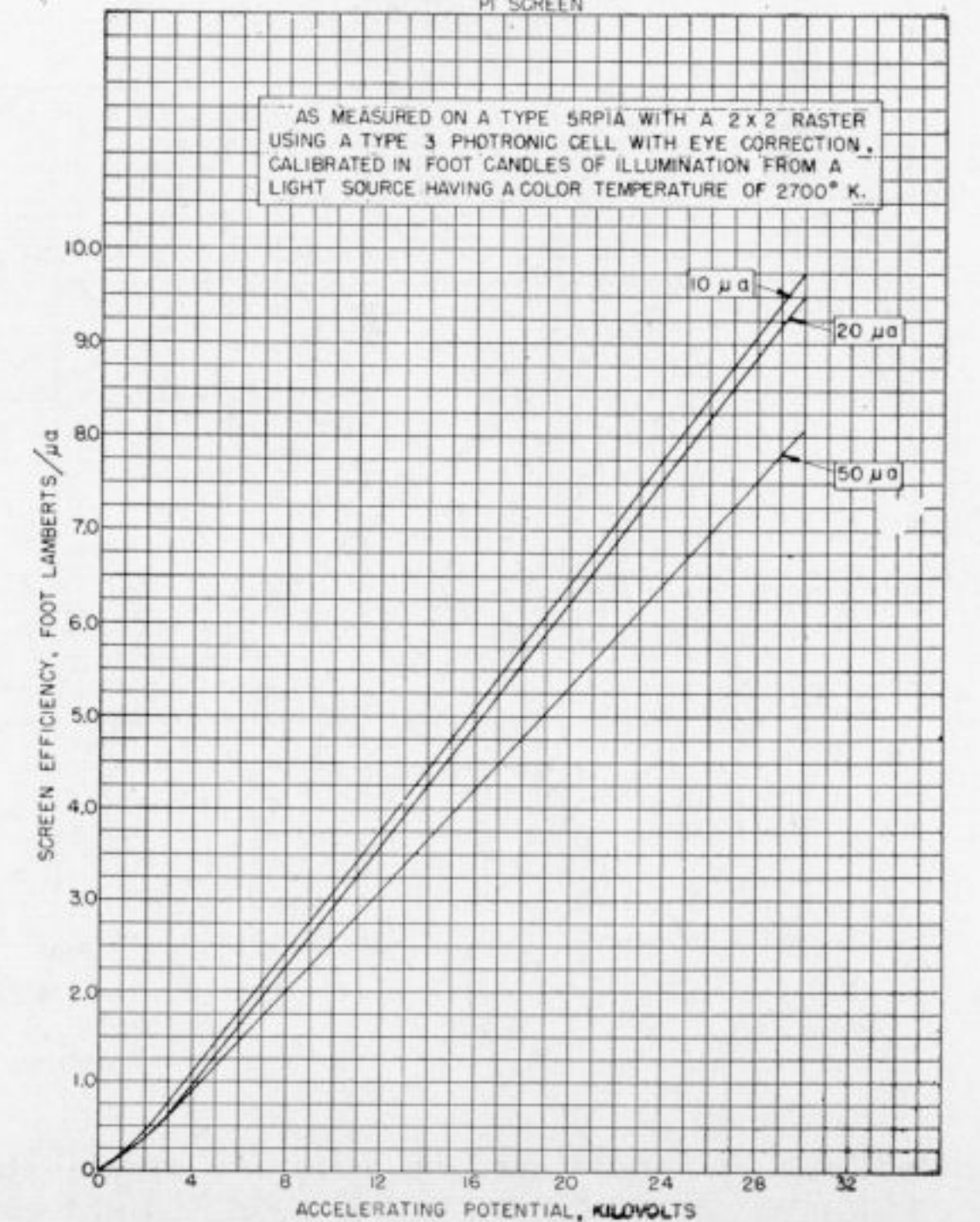

# DU MONT P2 SCREEN CHARACTERISTICS

## General Description

Long-persistence screen with a short persistence blue-green fluorescent characteristic, and a very long yellow-green phosphorescence, suited for applications requiring long persistence at high writing rates (short interval excitation).

Because the ratio of fluorescent to phosphorescent light is very high, the P2 screen may also be used for visual observation and photography in applications where it is desirable to have the characteristics of a short persistence screen. By the use of a suitable filter the fluorescent light only may be selected.

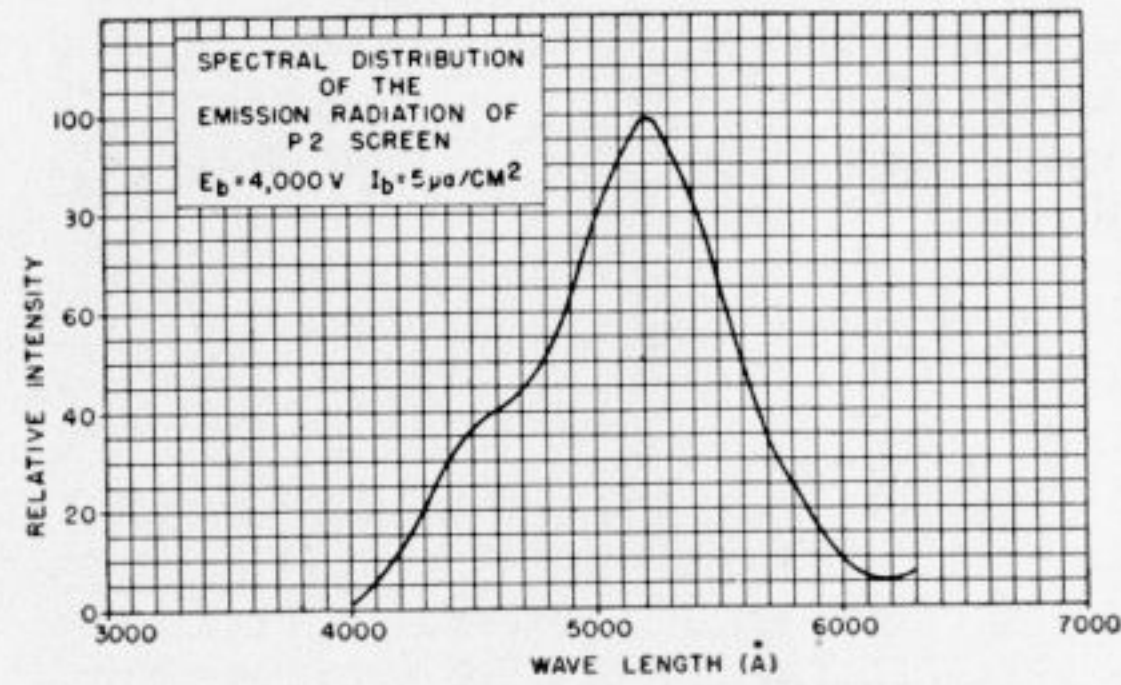

Representative Spectral Characteristic  
 Stationary spot excitation.

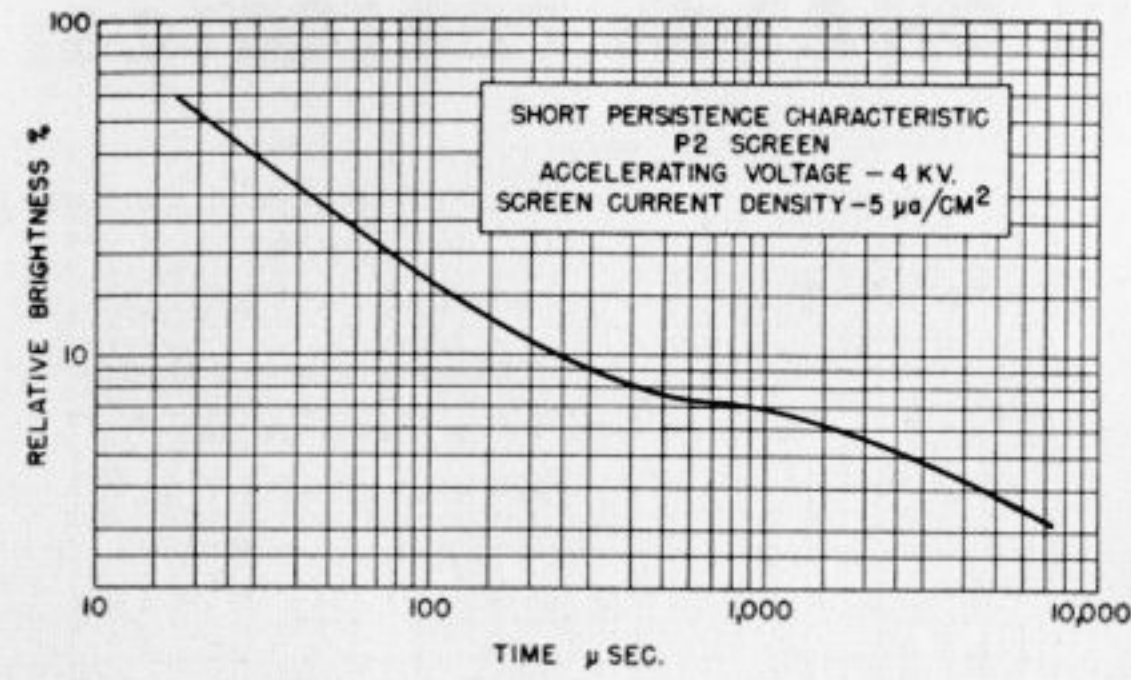

Persistence for early part of decay  
 Excitation by a single stationary spot impulse at a current density of 5  $\mu\text{a}/\text{cm}^2$  and 4000 volts.

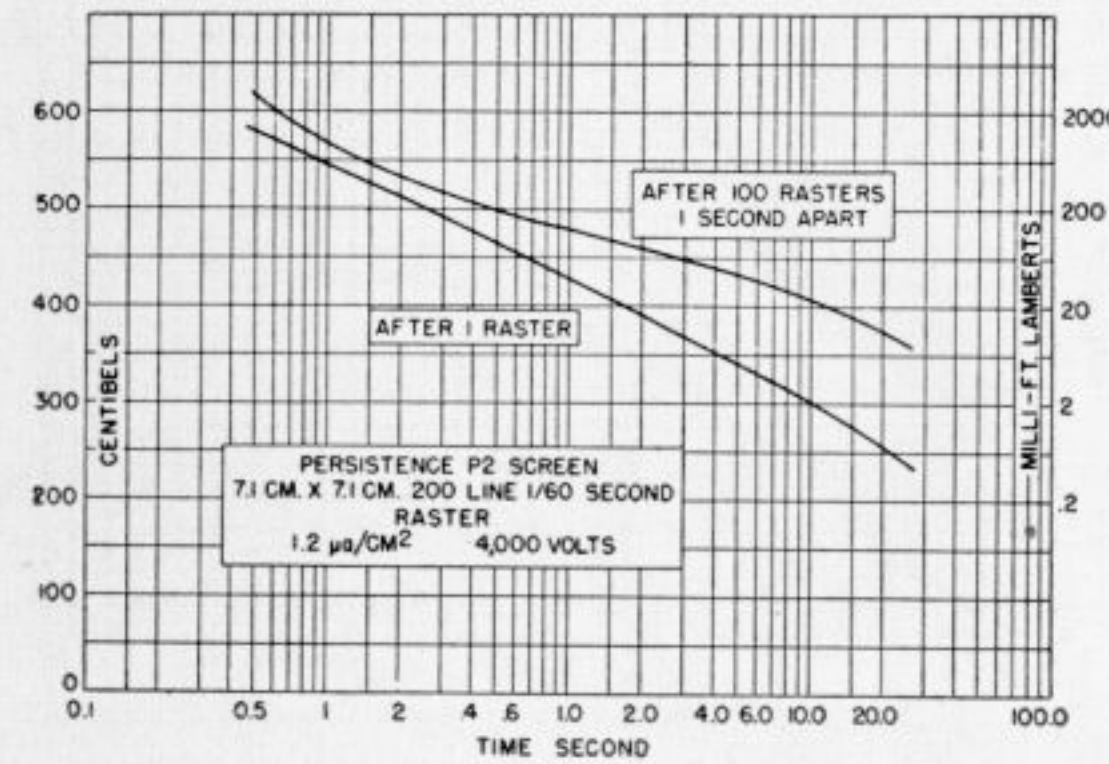

Persistence for latter part of decay  
 Excitation by a single 200 line raster in 1/60 second, and by a large number of 200 line rasters 1 second apart.

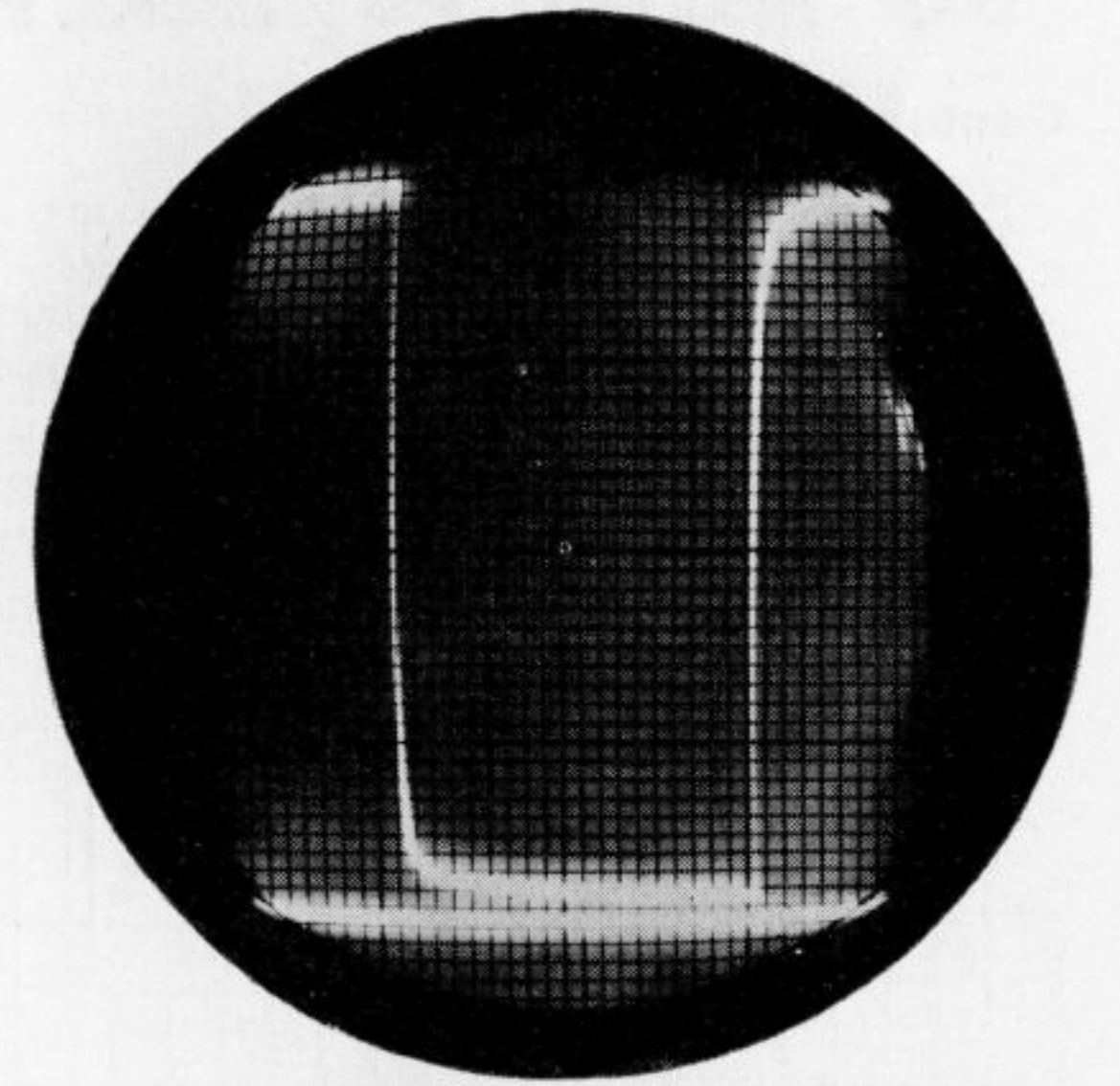

Persistence of early part of decay

For 10% of the initial intensity, the persistence time for current density of 25  $\mu\text{a}/\text{cm}^2$  at 4000 volts is approximately 95 microseconds. The persistence time decreases with increasing current density to about 35 microseconds for 600  $\mu\text{a}/\text{cm}^2$ . There is little change in persistence time with voltage at a current density of 25  $\mu\text{a}/\text{cm}^2$ . Decay curve is for about 25  $\mu\text{a}/\text{cm}^2$  at 4000 volts, 1 division = 2.5 milliseconds. The above data and curve are for repetitive stationary spot excitation.

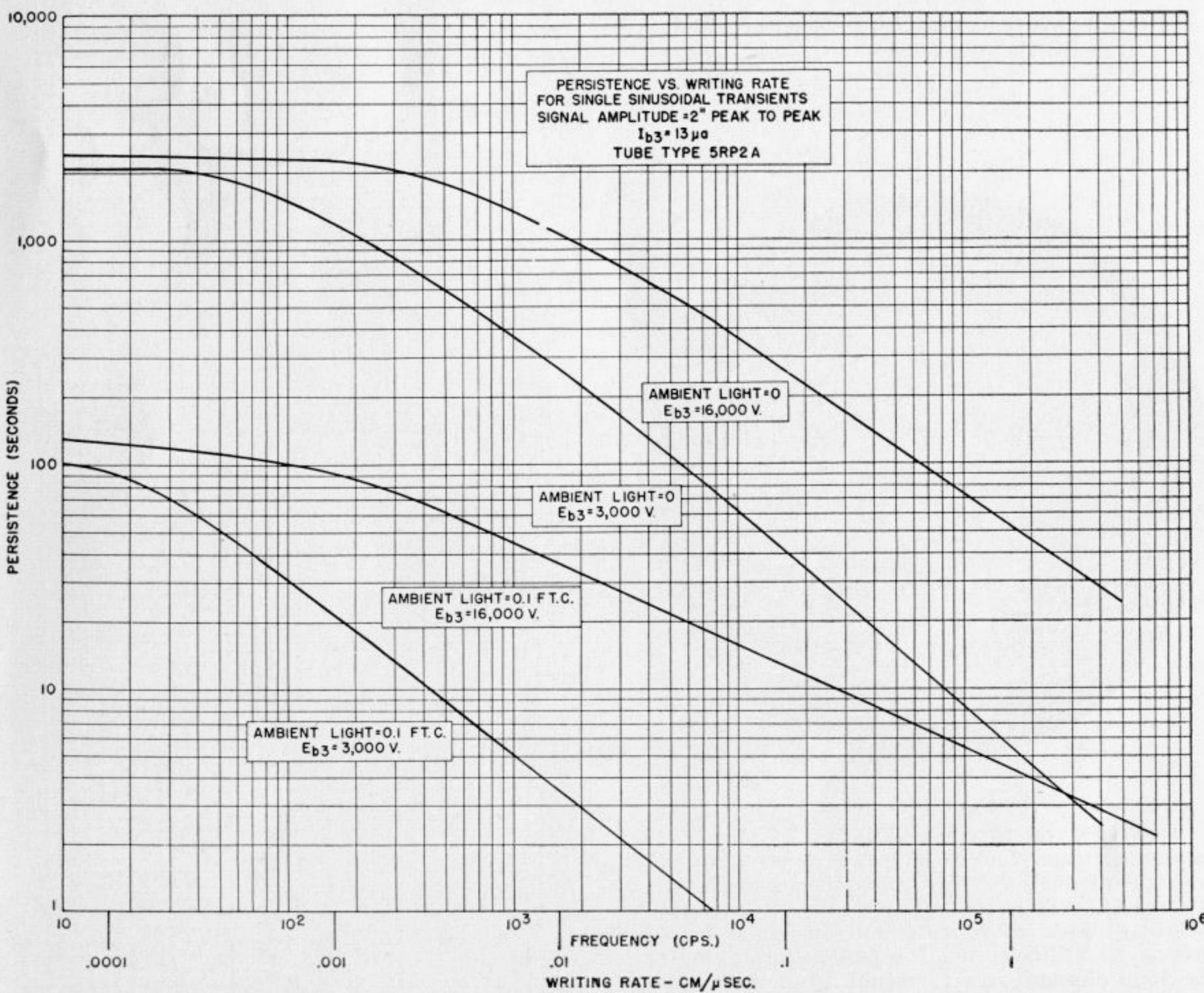

Persistence versus writing rate for single sinusoidal transients. (Eye adapted to ambient light condition.)

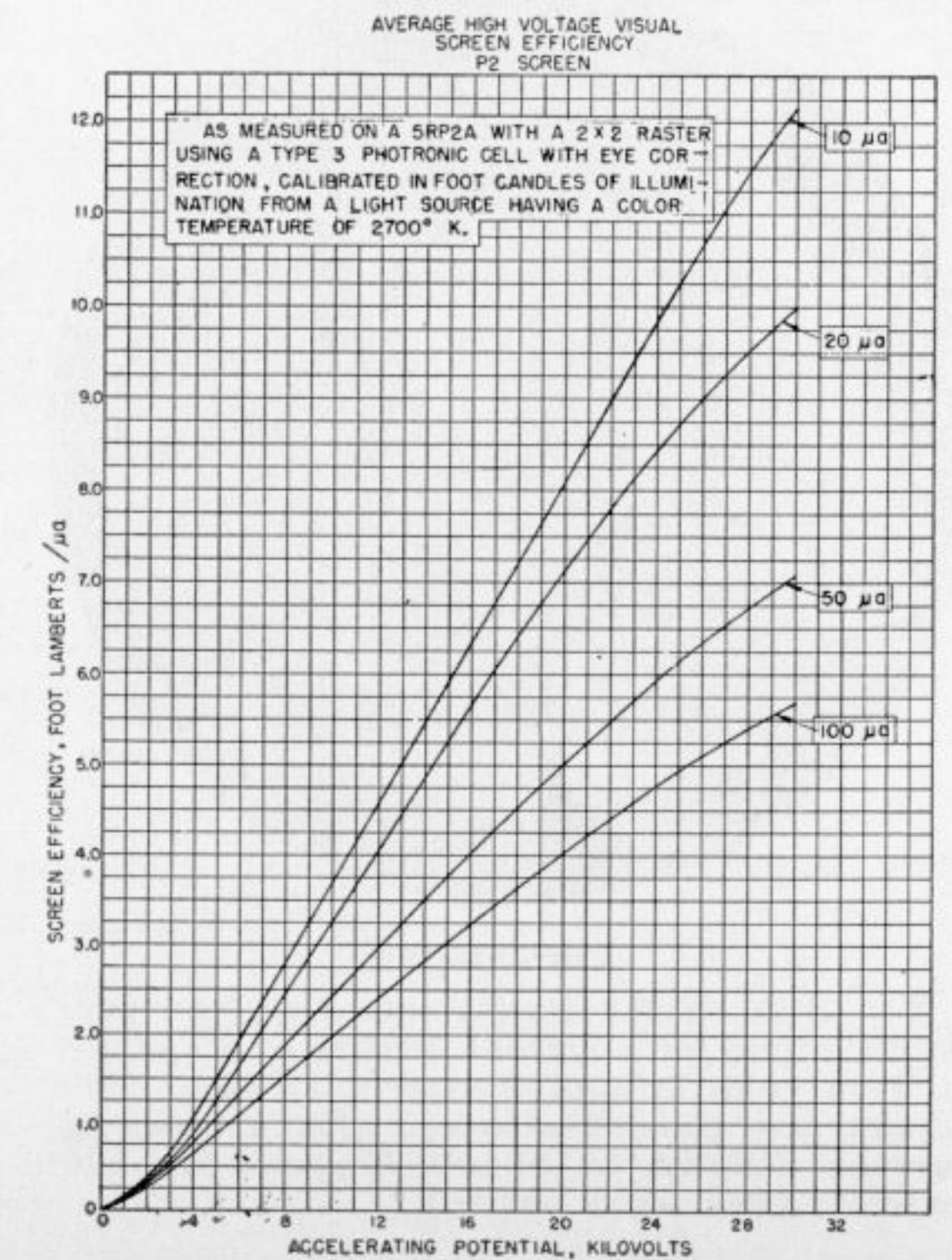
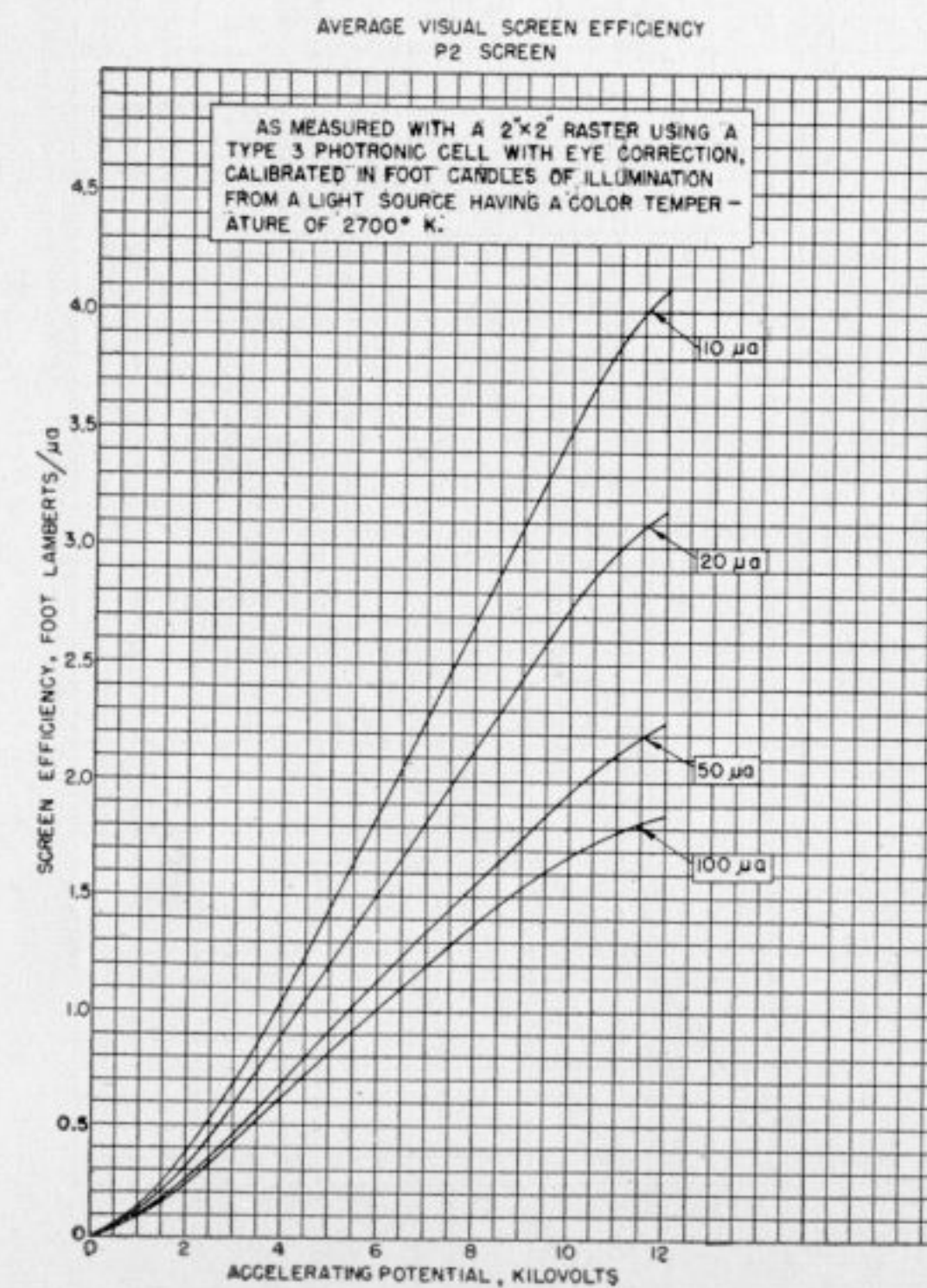

# DU MONT P5 SCREEN CHARACTERISTICS

## General Description

Extremely short-persistence blue screen material, suited for photographic recording applications where extremely short persistence is required.

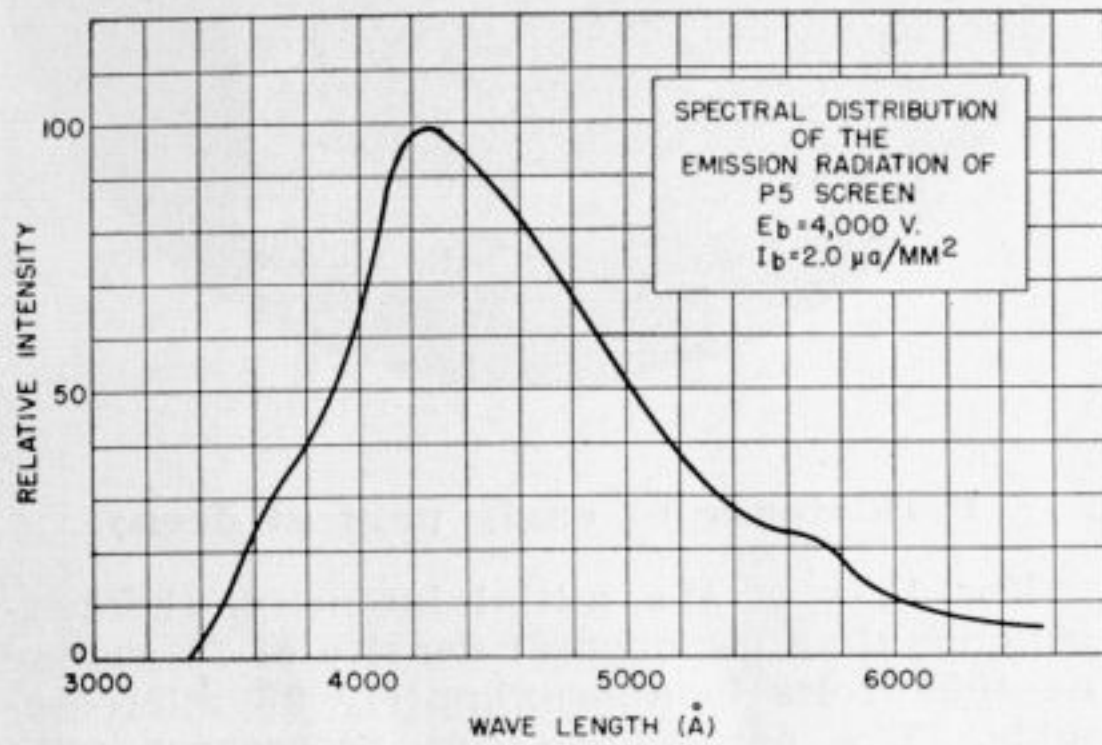

Representative Spectral Characteristic

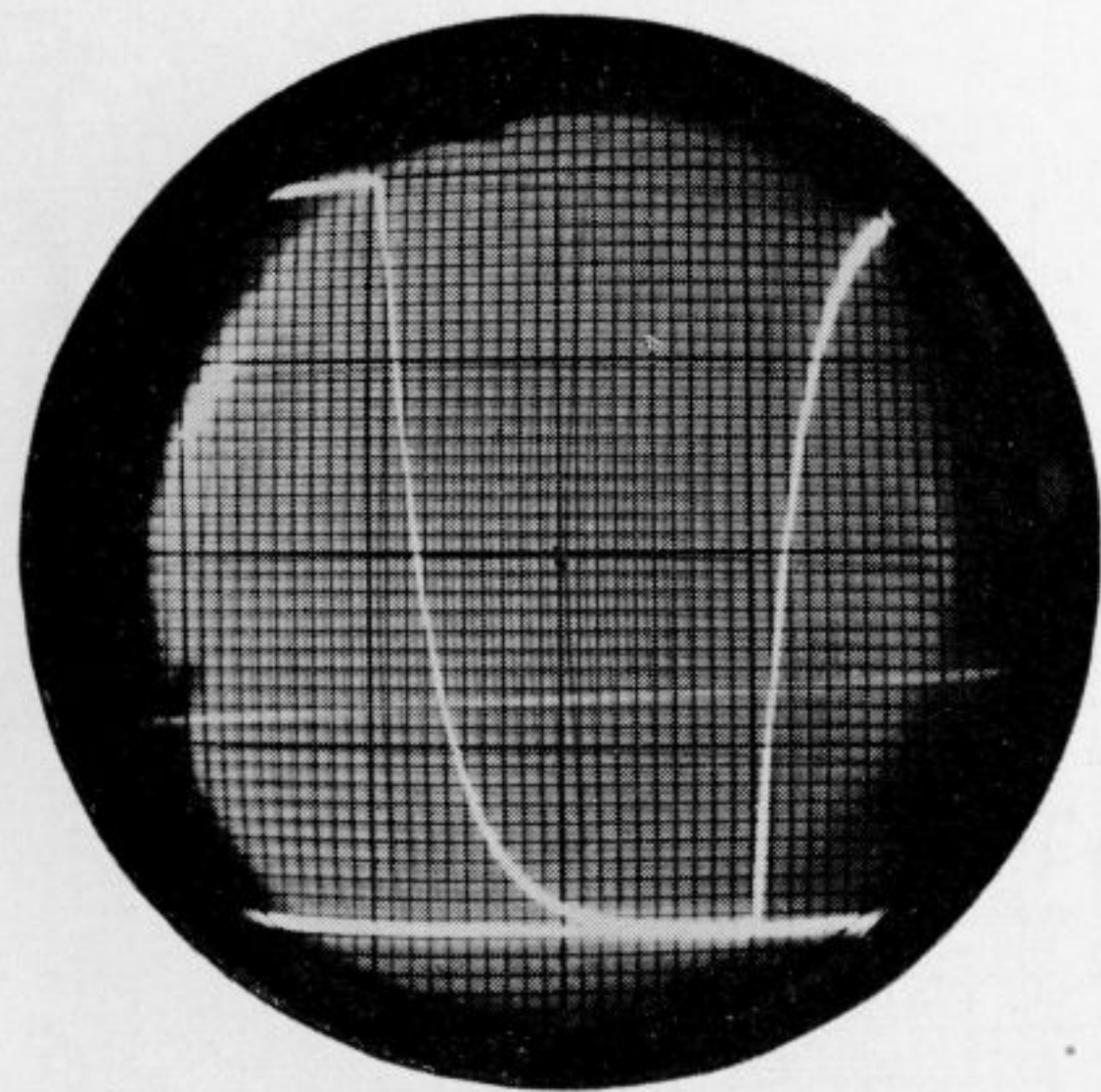

## Persistence

For 10% of the initial intensity, the persistence time for a current density of  $25 \mu\text{a}/\text{m}^2$  at 4000 volts is approximately 17  $\mu\text{sec}$ . The persistence time decreases with increasing current density to about 7  $\mu\text{sec}$ . for  $600 \mu\text{a}/\text{cm}^2$ . (See decay curve.)

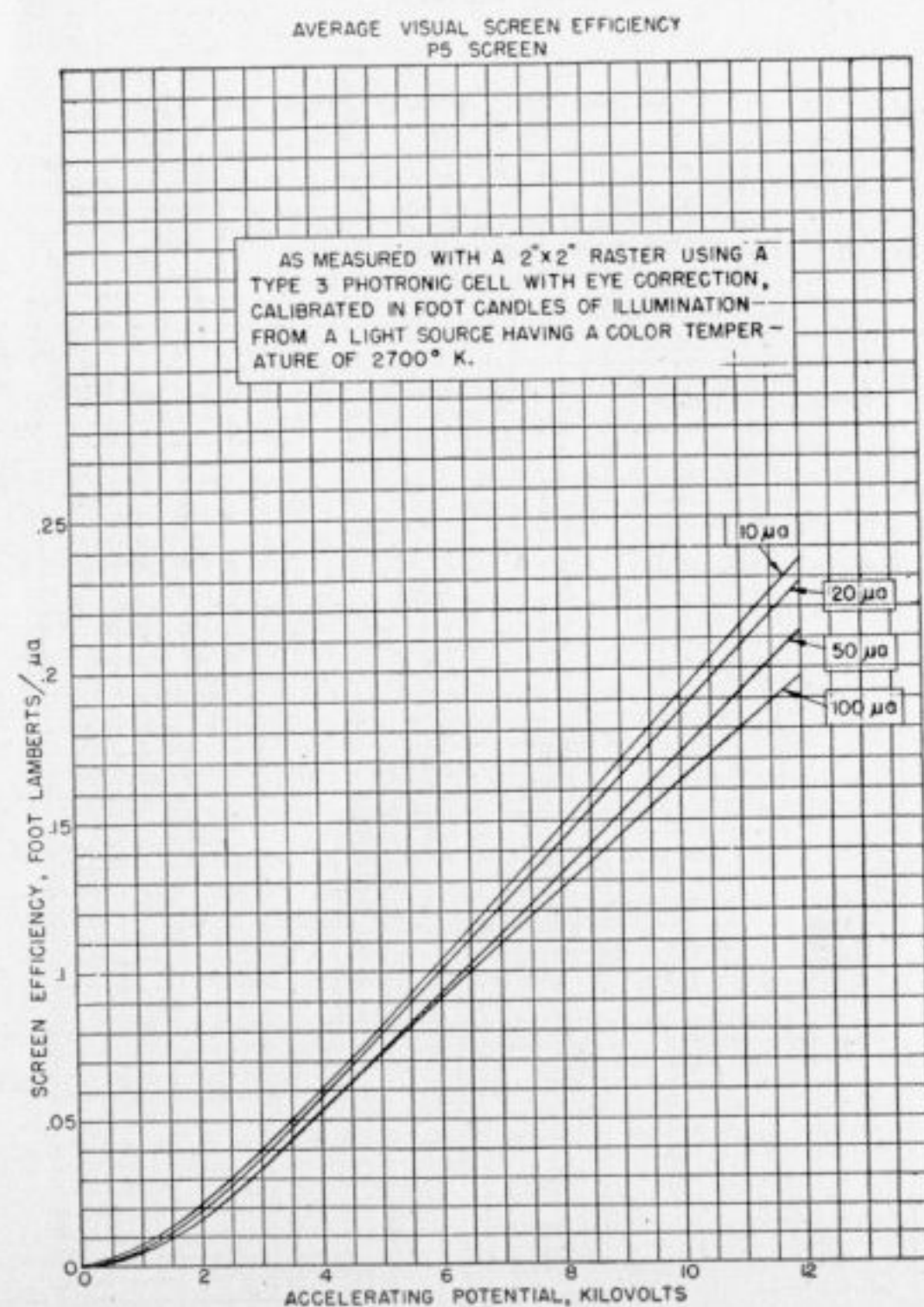
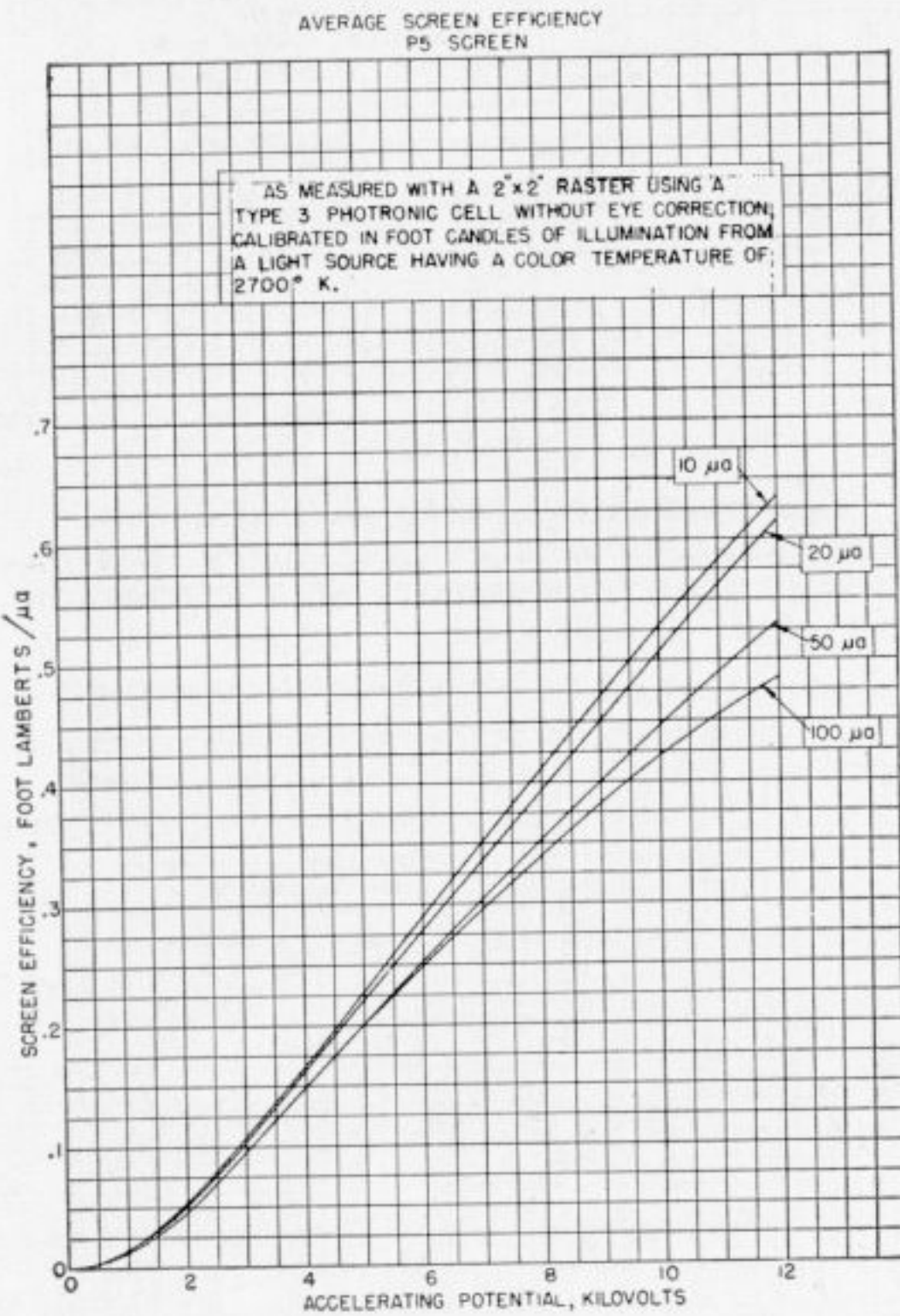

# DU MONT P7 SCREEN CHARACTERISTICS

## General Description

Long-persistence screen with blue fluorescence and yellow phosphorescence, suited for applications requiring long persistence at slow and intermediate writing rates, for applications where it is desirable to filter out the initial "flash", and for applications where high build-up of phosphorescent intensity as a result of repeated excitation is desired.

The P7 screen is also well suited for dual-purpose equipment where it is desirable to have available the characteristics of a long persistence screen and a short persistence screen in the same tube. By the use of suitable filters either the short persistent blue light, or the long persistent yellow light may be selected.

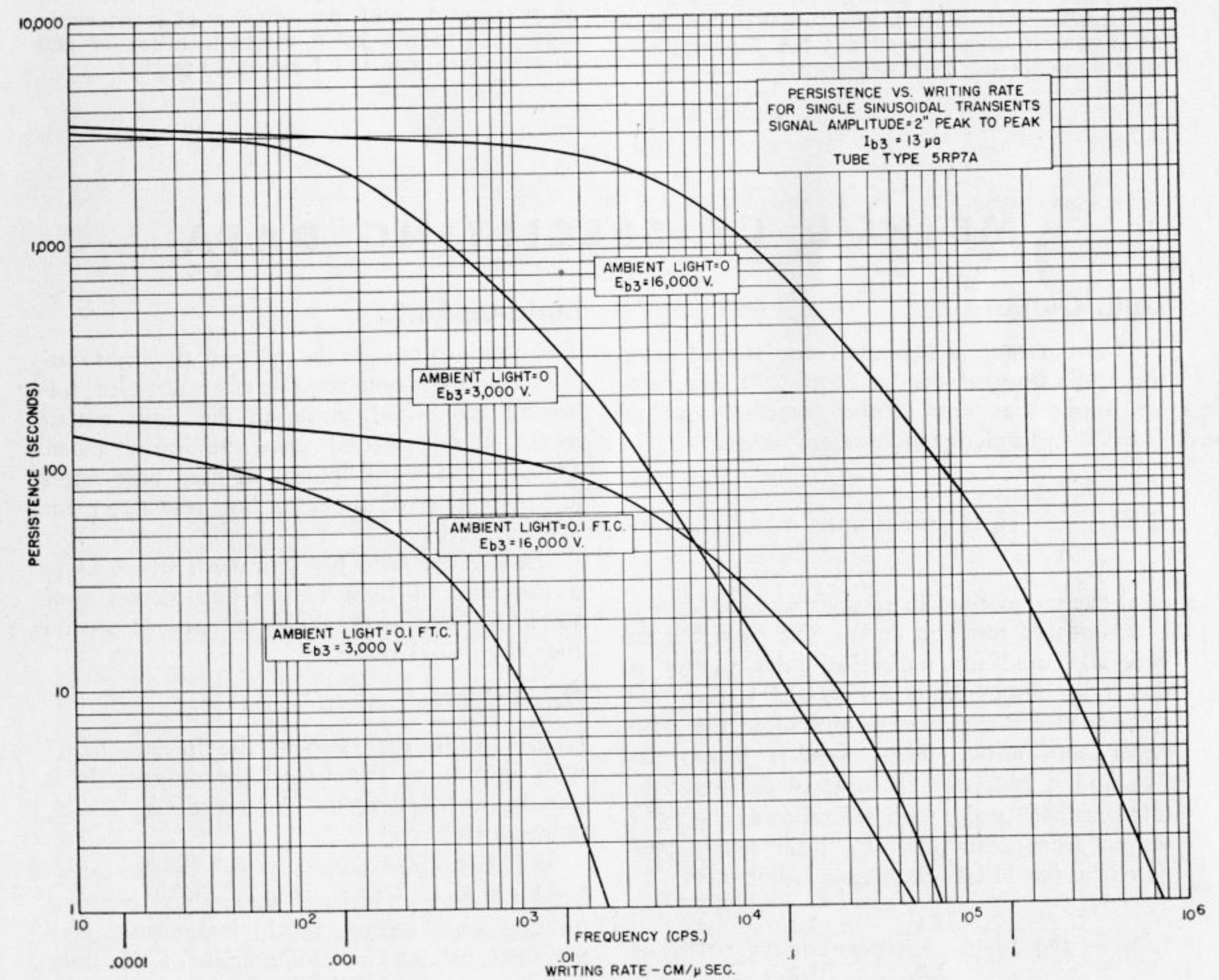

Persistence versus frequency for single sinusoidal transients. (No filter used; eye adapted to ambient light condition.)

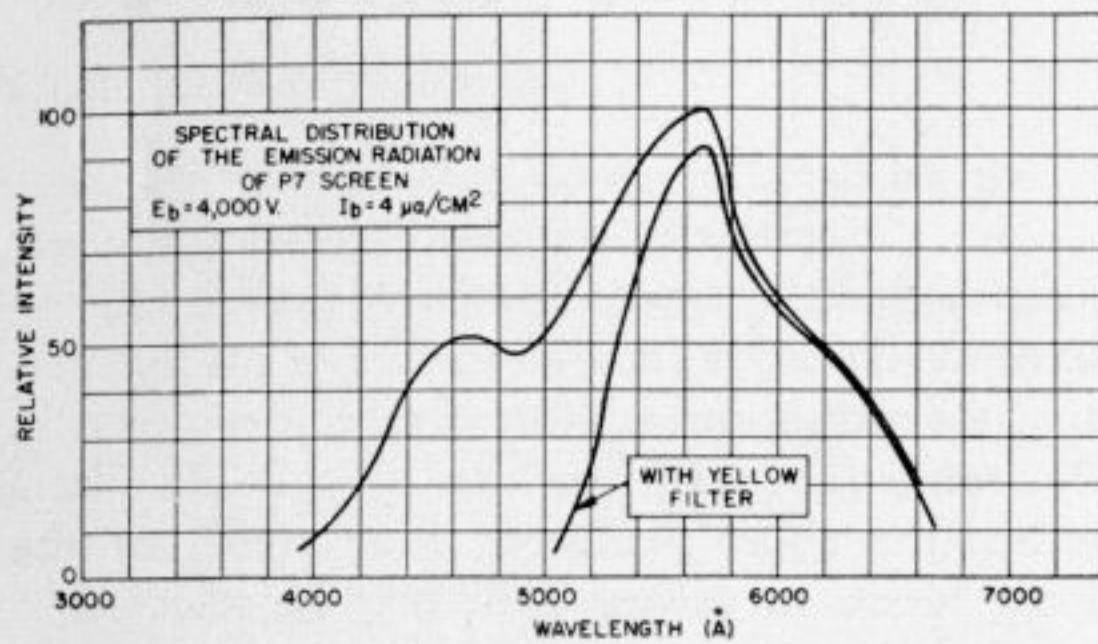

**Representative Spectral Characteristic**

Stationary spot excitation. The short wavelength peak is representative of the blue fluorescence. The long wavelength peak is representative of the yellow phosphorescence. The curve with filter is for the Wratten #15 filter which is recommended for filtering out the blue "flash" of the screen.

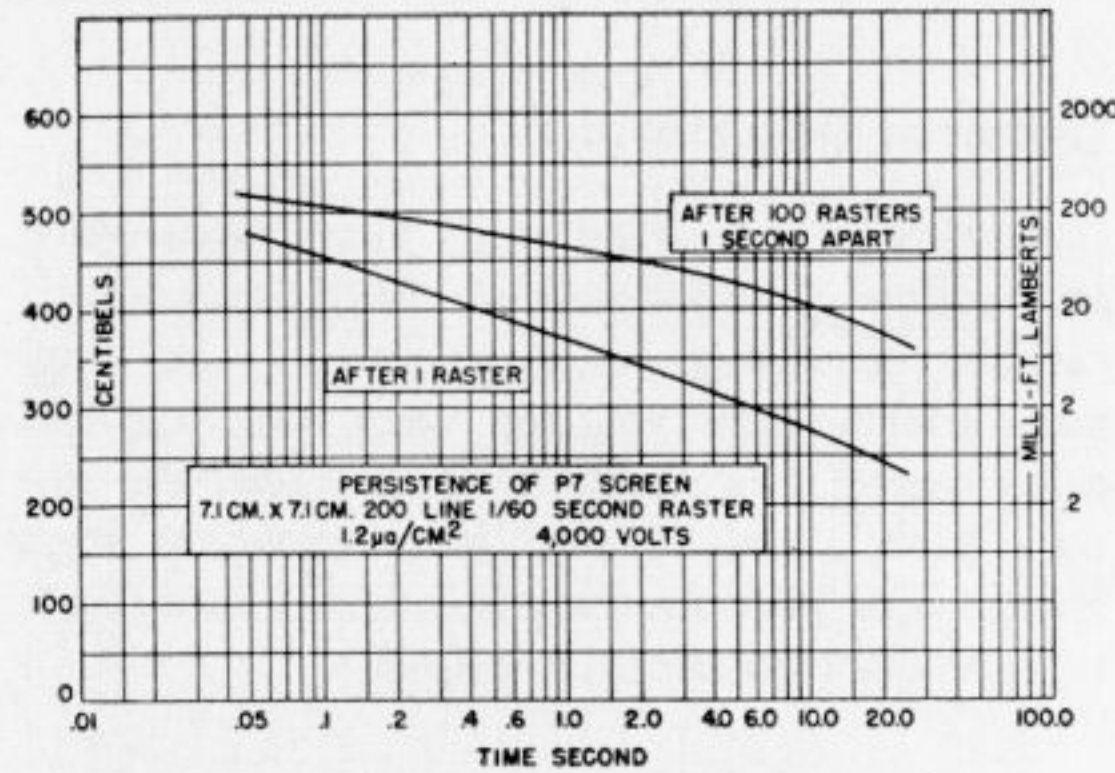

**Persistence Characteristic of P7 Screen**

Excitation by a single 200 line raster in 1/60 of a second, and persistence characteristic after excitation by a large number of 200 line rasters applied 1 second apart.

**METHOD OF SPECIFYING DATA**

**Light Output**

P7 light output is measured one second after the application of one or more 200 line rasters applied at one second intervals and at  $Q = 20$  millimicrocoulombs/cm<sup>2</sup> where

$$Q = \frac{I_b * t}{A}$$

( $I_b$  = microamps to screen,  $t$  =

total excitation time in seconds = 1/60 second,  $A$  = area of raster in cm<sup>2</sup>). The light output generally used for indicating tube quality is the light output from a standard screen area of 7.1 x 7.1 cm, one second after the fifth raster application. This value is known as  $Cb_5$ , and is expressed in units of the logarithmic centibel\* scale, with reference to the light output from a standard P7 light source prepared by the M.I.T. Radiation Laboratory.

\*  $Cb = 100 \log_{10} \frac{L1}{L2}$  where  $\frac{L1}{L2}$  = ratio of light output.

**Build-up Ratio**

The build-up ratio is the ratio of the light output measured one second after a pulse following the initial pulse, to the light output measured one second after the initial pulse. (Note: The word "pulse" as used here refers to application of the 200 line test raster for 1/60 second.)

Usually the ratio  $G_{5:1}$  is used, where  $G_{5:1}$  is the ratio of light output one second after the fifth pulse to the light output one second after the initial pulse.

**Flash Ratio**

Flash ratio is the ratio of the initial "flash" light output to the  $Cb_5$  light output. It is usually expressed as the difference  $Cb_1 - Cb_5$  in centibels.

The flash light output ( $Cb_1$ ) is the calculated  $Cb$  level which, if maintained constant for one tenth second, would integrate to give the same value as the integration of the light output one second following and including the initial excitation pulse.

**DU MONT P11 SCREEN CHARACTERISTICS**

**General Description**

A short-persistence blue screen material of very high photographic efficiency, suited for photography where the extremely short persistence of the P5 screen is not required.

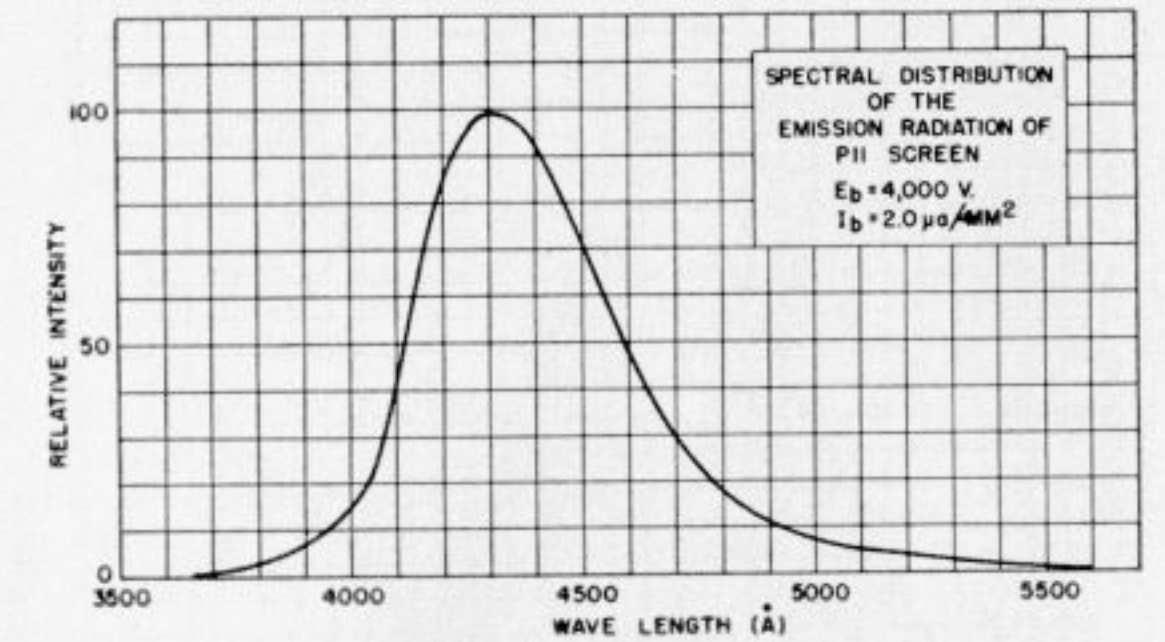

**Representative Spectral Characteristic**

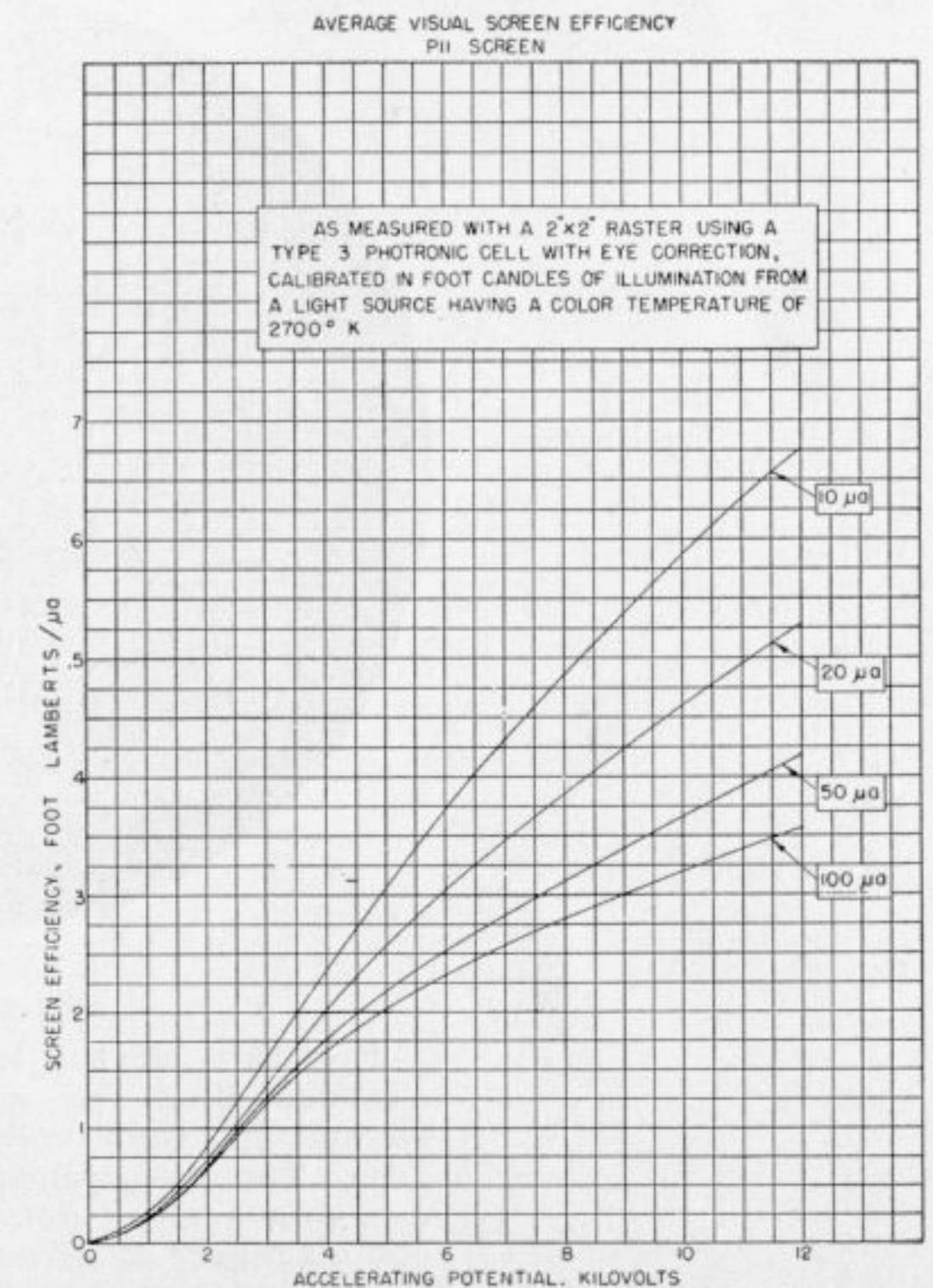
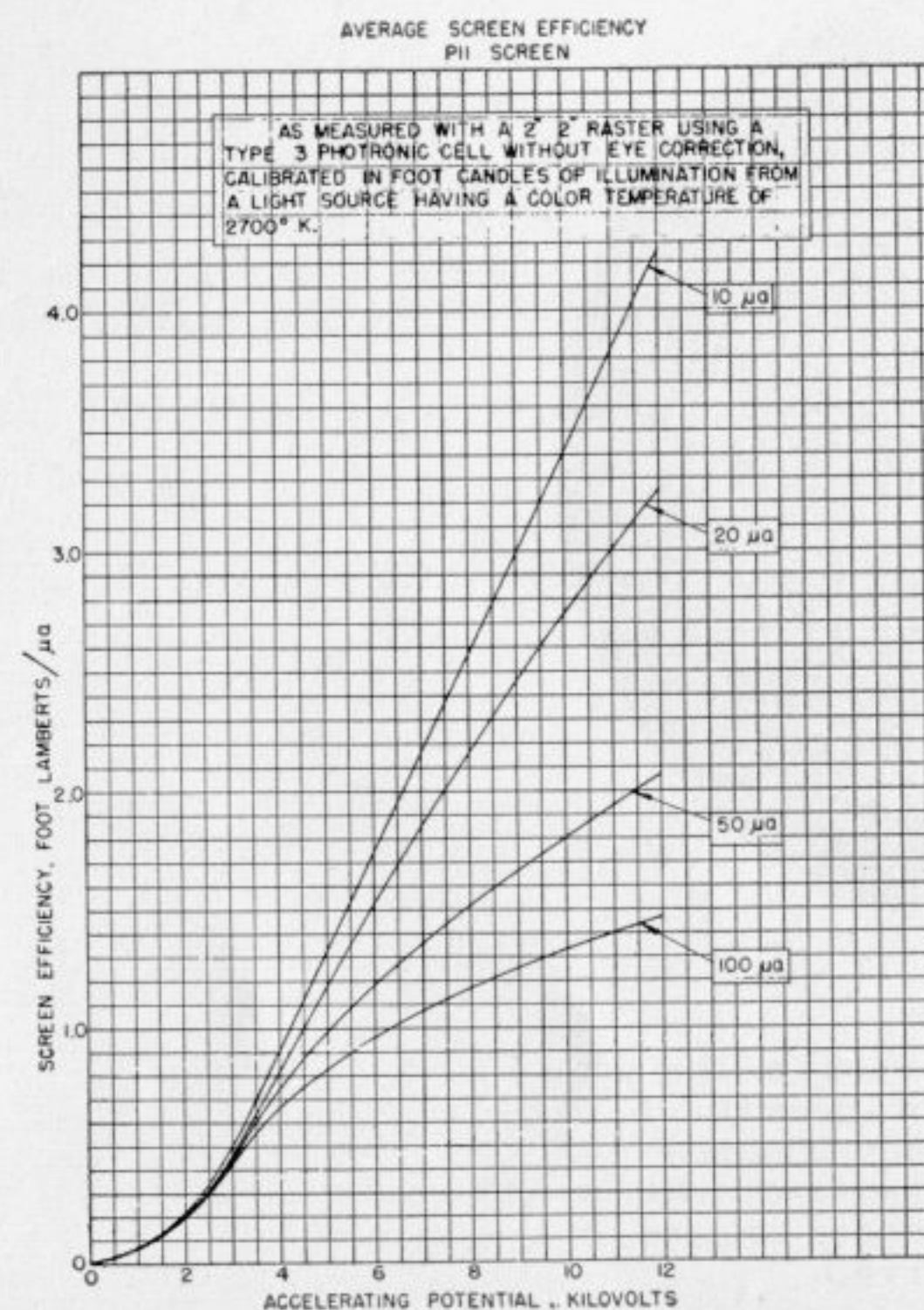

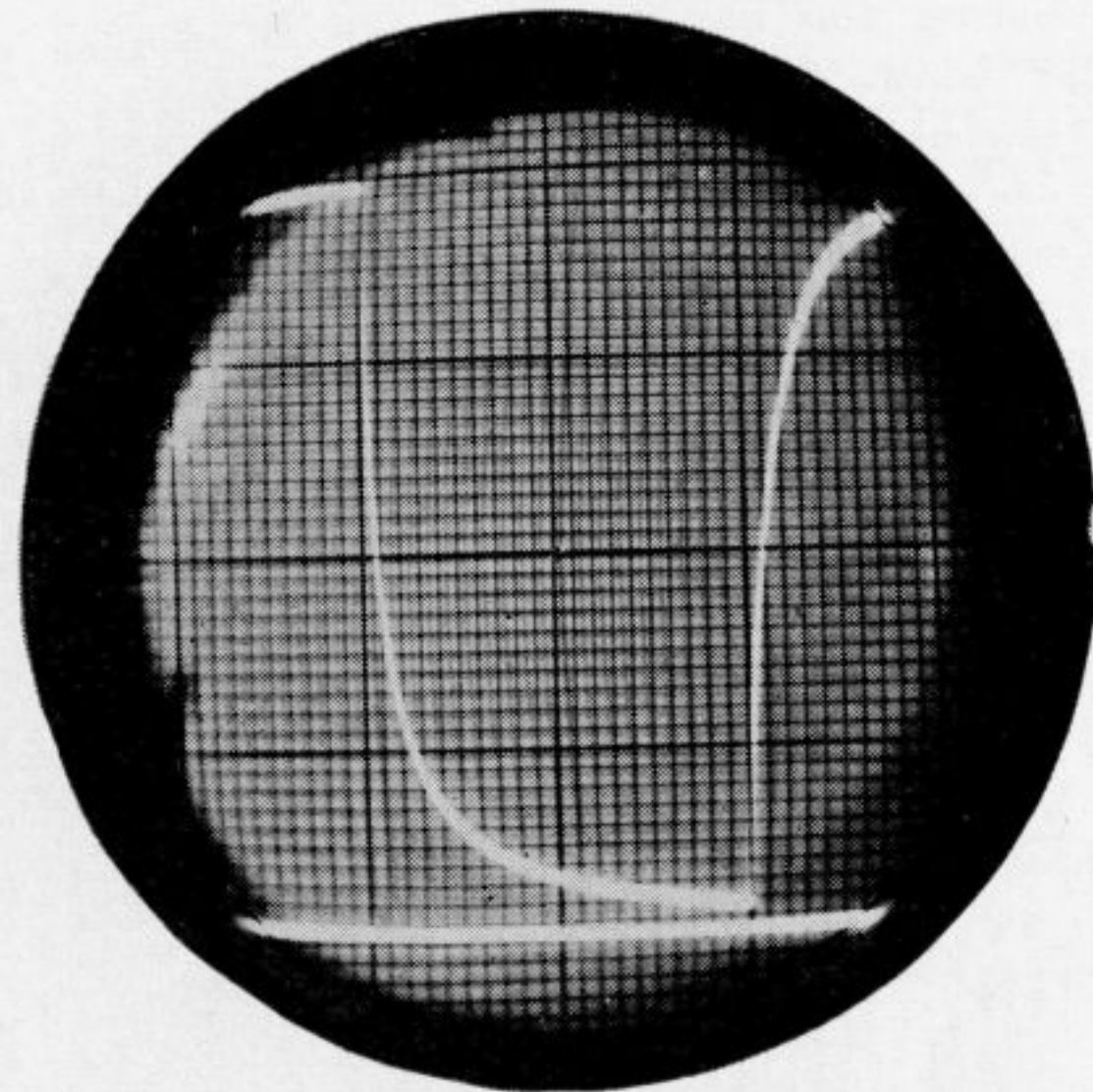
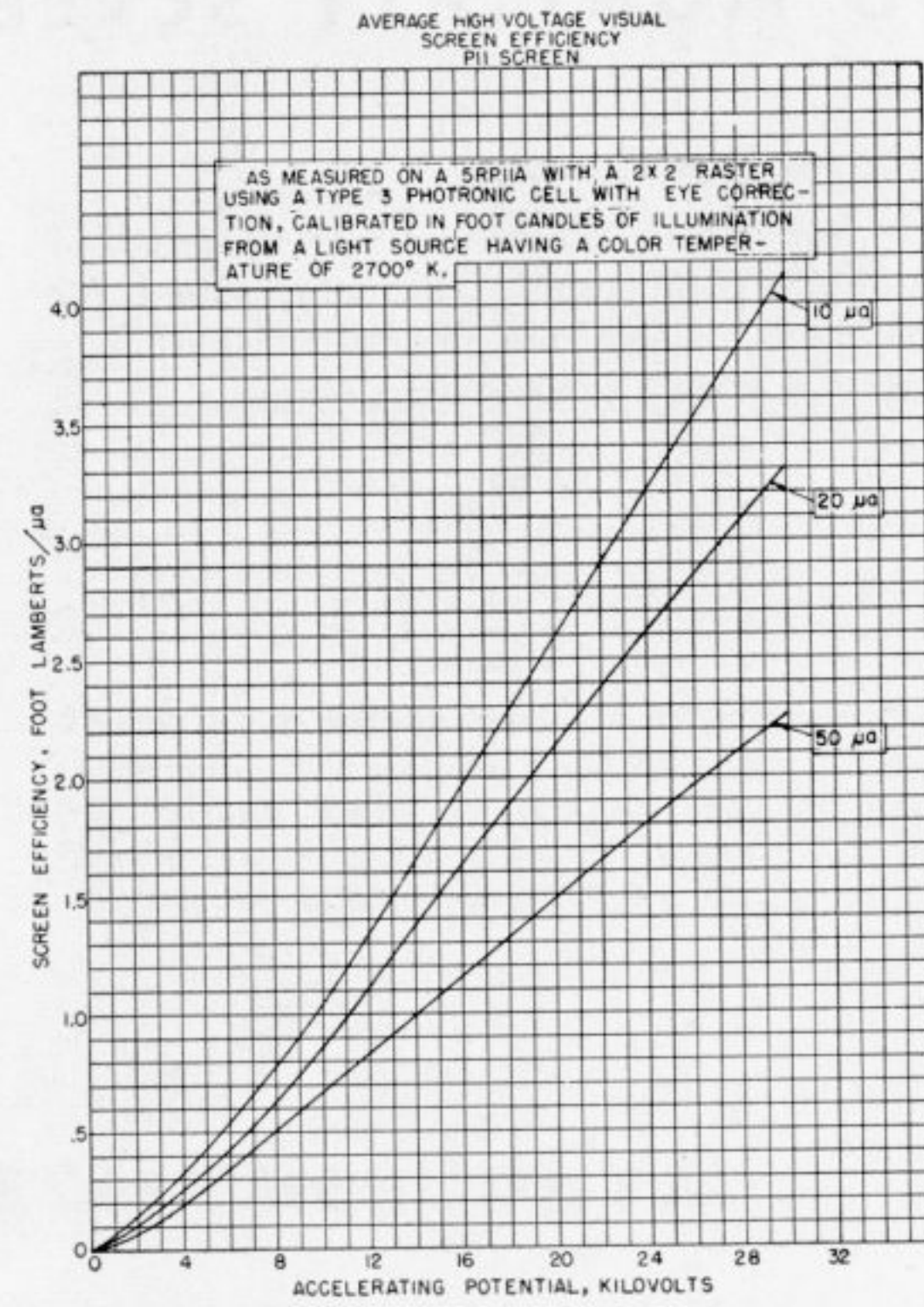
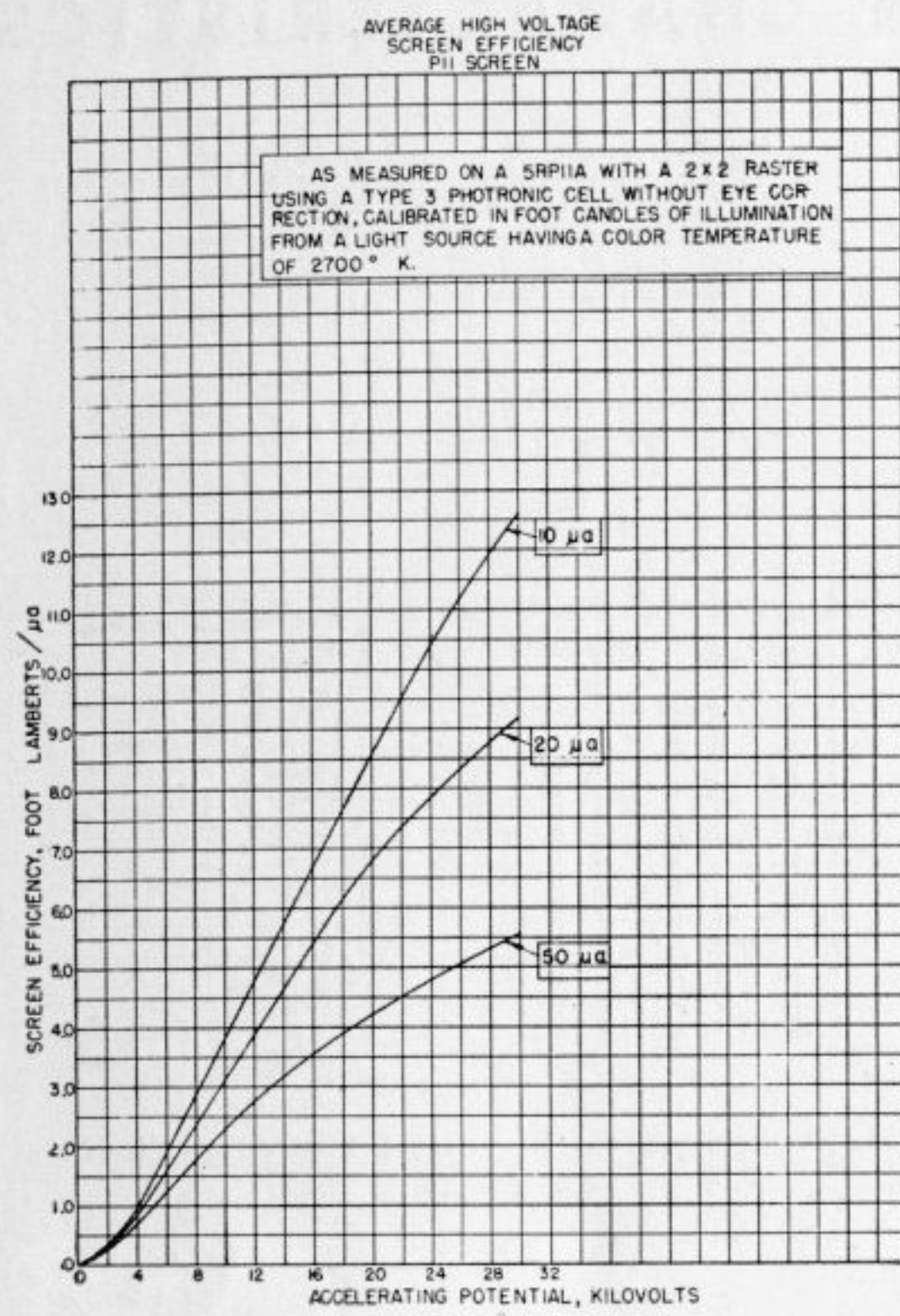

**Persistence**

For 10% of the initial intensity, the persistence time for a current density of 25  $\mu$ a/cm<sup>2</sup> at 4000 volts is approximately 100  $\mu$ sec. The persistence time decreases with increasing current density to about 20  $\mu$ sec for 600  $\mu$ a/cm<sup>2</sup>. (See decay curve.)

# DU MONT

## CATHODE-RAY TUBES

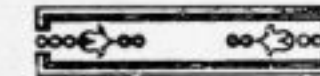

### TUBE CHARACTERISTICS



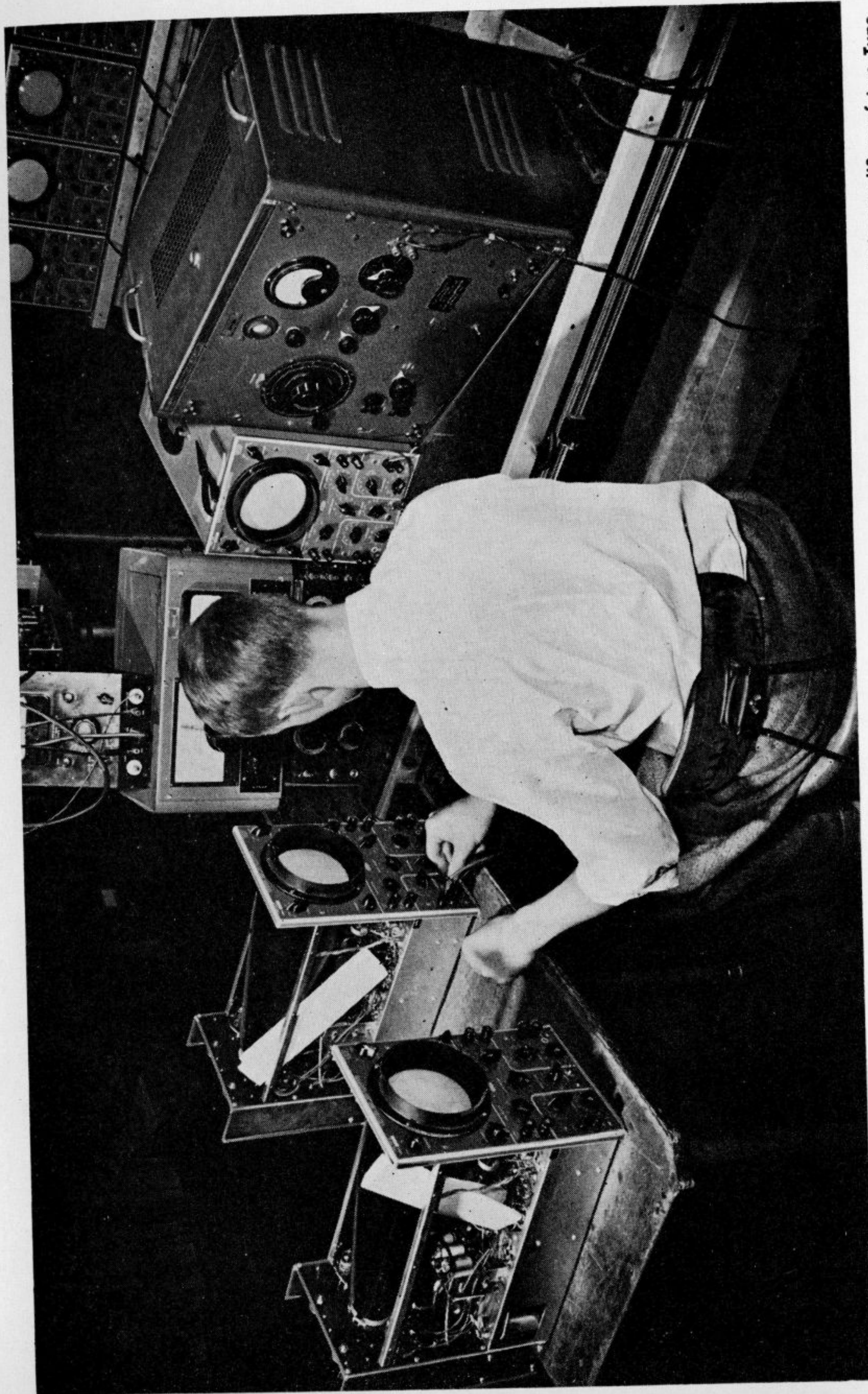

Every Du Mont instrument must undergo exhaustive testing before it is shipped to the customer. Here, the frequency response of the amplifiers of two Type 304-H Cathode-ray Oscillographs is being checked for conformance with published specifications

## 3AP-A CATHODE-RAY TUBES

The Type 3AP-A Cathode-ray Tubes are designed for oscillographic and other applications where simplicity of the equipment is of paramount importance. A small bright spot is obtained at low accelerating voltage and without balanced deflection. The gun is designed to draw negligible focusing electrode current.

The Type 3AP-A is recommended for replacement only.

### GENERAL CHARACTERISTICS

#### Electrical

|  |                   |
|--|-------------------|
| Heater Voltage.....                            | 2.5 ± 10% Volts   |
| Heater Current.....                            | 2.1 ± 10% Amperes |
| Focusing Method .....                          | Electrostatic     |
| Deflecting Method .....                        | Electrostatic     |
| Phosphor                                       | P1 P11            |
| Fluorescence .....                             | Green Blue        |
| Persistence .....                              | Medium Short      |
| Direct Interelectrode Capacitances,<br>Nominal |                   |
| Grid #1 to all other electrodes.....           | 9.0 μmf.          |
| D1 to all other electrodes .....               | 8.5 μmf.          |
| D3 to all other electrodes .....               | 6.5 μmf.          |

#### MECHANICAL

|  |                |
|--|----------------|
| Overall Length .....   | 11-1/2" ± 3/8" |
| Greatest Diameter of Bulb .....                                  | 3" ± 1/16"     |
| Minimum Useful Screen Diameter.....                              | 2-3/4"         |
| Base .....   | Medium 7 pin   |
| Basing .....   | 7CE            |
| Base Alignment:  |                |
| 3D4 trace aligns with Pin #6 and tube axis.....                  | ± 10 Degrees   |
| Positive voltage on D2 deflects beam approximately toward Pin #1 |                |
| Positive voltage on D4 deflects beam approximately toward Pin #6 |                |
| Angle between 3D4 and 1D2 traces.....                            | 90 ± 3 Degrees |

### MAXIMUM RATINGS—(Design Center Values)

|  |                    |
|--|--------------------|
| Anode No. 2 Voltage.....   | 1500 Max. Volts dc |
| Anode No. 1 Voltage.....   | 1000 Max. Volts dc |
| Grid No. 1 Voltage   |                    |
| Negative—Bias Value .....  | 125 Max. Volts dc  |
| Positive—Bias Value .....  | 0 Max. Volts dc    |
| Positive—Peak Value .....  | 2 Max. Volts       |
| Peak Voltage between Anode No. 2 and any Deflection Electrode..... | 550 Max. Volts     |

### TYPICAL OPERATING CONDITIONS

|  |                              |                    |
|--|------------------------------|--------------------|
| For Anode No. 2 Voltage of.....                      | 1000                         | 1500 Volts         |
| Anode No. 1 Voltage for focus.....                   | 200 to 344                   | 300 to 516 Volts   |
| Grid No. 1 Voltage <sup>1</sup> .....                | -16.5 to -49.5               | -25 to -75 Volts   |
| Deflection Factors:                                  |                              |                    |
| D1 and D2.....                                       | 61 to 91                     | 91 to 137 dc V/in. |
| D3 and D4.....                                       | 58 to 88                     | 87 to 131 dc V/in. |
| Anode No. 1 Voltage for focus.....                   | 20% to                       | 34.4% of Eb2 Volts |
| Grid No. 1 Voltage <sup>1</sup> .....                | 1.65% to                     | 4.95% of Eb2 Volts |
| Anode No. 1 Current for any operating condition..... | -50 to ± 10                  | Microamperes       |
| Spot Position (undeflected) <sup>2</sup> .....       | Within 15 Millimeters square |                    |



**MAXIMUM CIRCUIT VALUES**

Grid No. 1 Circuit Resistance .....1.5 Max. Megohms  
Resistance in any Deflecting Electrode Circuit<sup>3</sup>.....5 Max. Megohms

**NOTES**

1. Visual extinction of undeflected focused spot.
2. When tube is operated at (1) normal heater voltage (2)  $E_{b2}=1500$  volts; (3)  $E_{b1}$  adjusted for focus; (4)  $E_{c1}$  set at such a value as will avoid damage to the screen; (5) with each of the deflecting electrodes connected to Anode No. 2 and (6) with the tube shielded against external influences:

The spot will fall within a 15 mm. square, the center of which coincides with the geometric center of the tube face, and the sides of which are parallel to the traces produced by deflecting electrodes D1 and D2 and by deflecting electrodes D3 and D4 respectively.

3. It is recommended that the deflecting electrode circuit resistances be approximately equal.

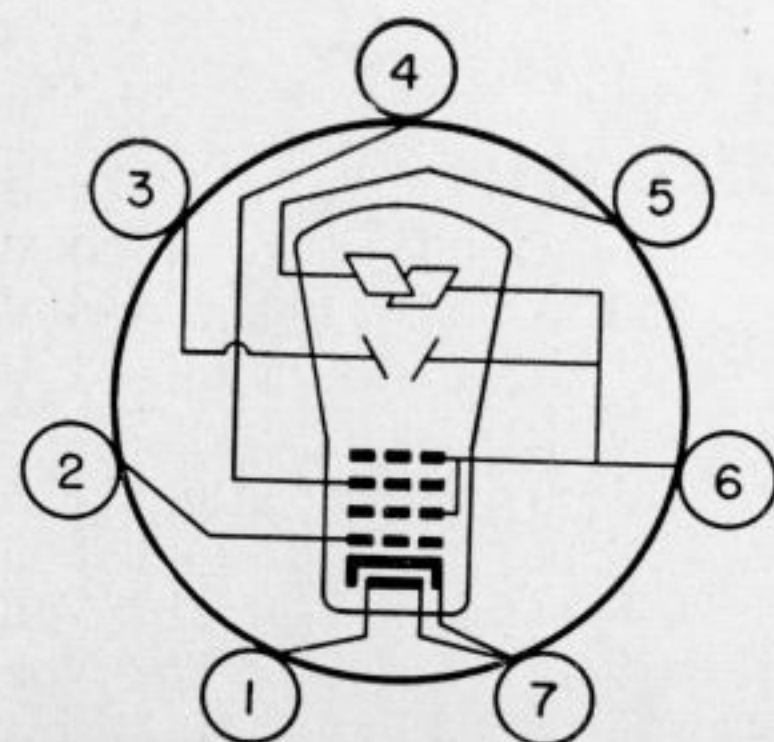
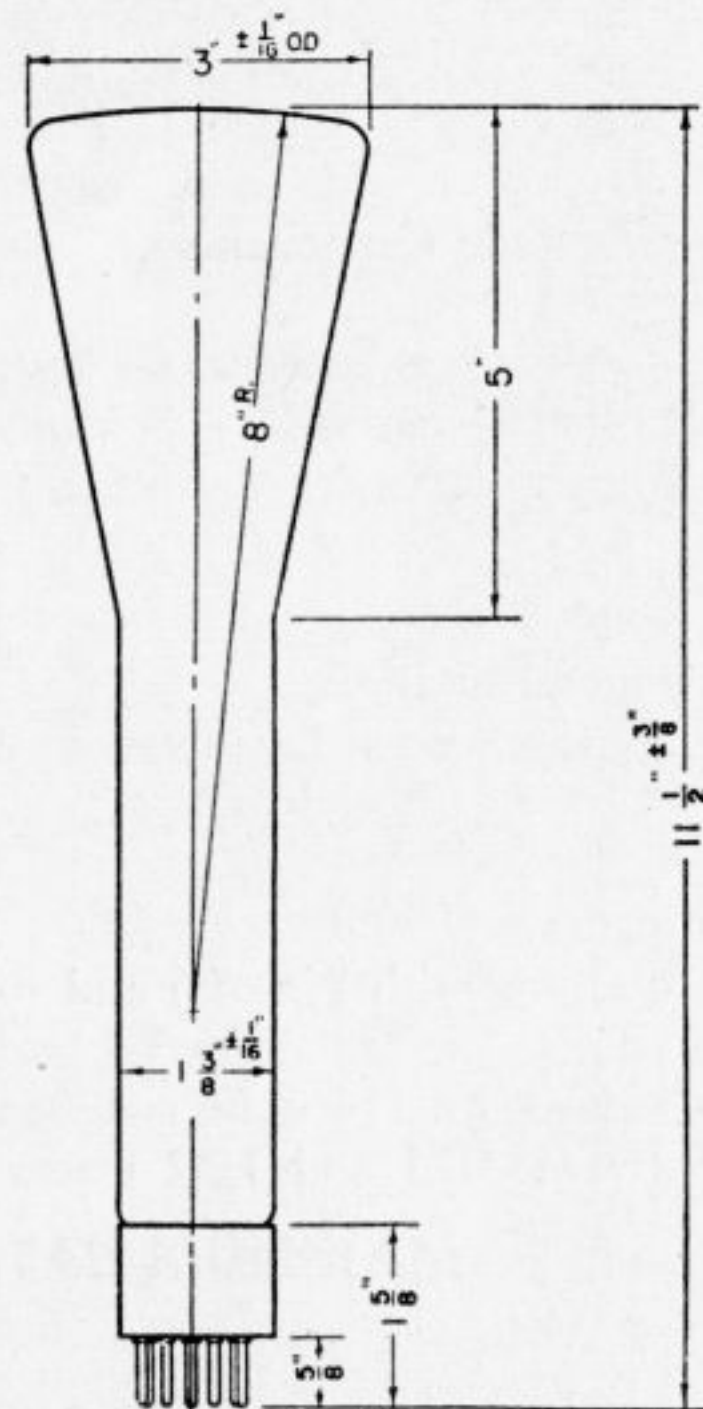
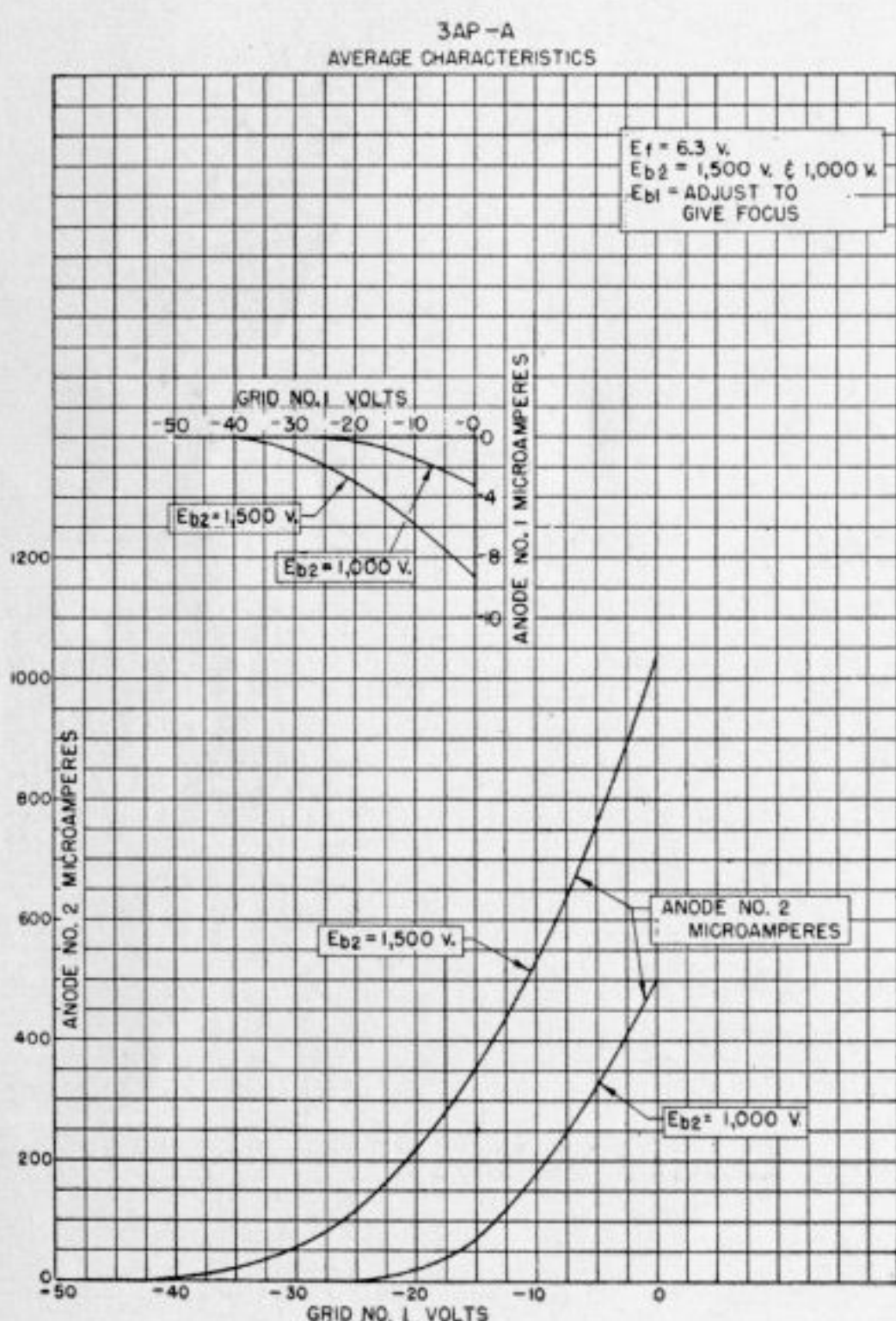

**Bottom View of Base**

| Pin No. | Element  |
|---------|--|
| 1       | Heater   |
| 2       | Control Electrode                                |
| 3       | Deflection Plate D3                              |
| 4       | Focusing Electrode                               |
| 5       | Deflection Plate D1                              |
| 6       | Accelerating Electrode, Deflection Plates D2, D4 |
| 7       | Heater and Cathode                               |

**3GP-A CATHODE-RAY TUBES**

The 3GP-A Cathode-ray Tubes are designed for oscillographic and other applications where small spot size, a brilliant trace, and a minimum of defocusing with deflection are required. The gun is designed to draw negligible focusing electrode current.

The 3GP-A is recommended for replacement only.



**GENERAL CHARACTERISTICS**

**Electrical**

|   |                  |
|---|------------------|
| Heater Voltage.....                         | 6.3 ± 10% Volts  |
| Heater Current .....                        | 0.6 ± 10% Ampere |
| Focusing Method .....                       | Electrostatic    |
| Deflecting Method .....                     | Electrostatic    |
| Phosphor                                    | P1 P11           |
| Fluorescence .....                          | Green Blue       |
| Persistence .....                           | Medium Short     |
| Direct Interelectrode Capacitances, Nominal |                  |
| Grid #1 to all other electrodes.....        | 7.0 μmf.         |
| D1 to D2.....                               | 1.7 μmf.         |
| D3 to D4.....                               | 1.5 μmf.         |
| D1 to all other electrodes except D2..      | 6.5 μmf.         |
| D2 to all other electrodes except D1..      | 6.4 μmf.         |
| D3 to all other electrodes except D4..      | 4.9 μmf.         |
| D4 to all other electrodes except D3..      | 4.7 μmf.         |

**Mechanical**

|   |                |
|---|----------------|
| Overall Length .....  | 11-1/2" ± 3/8" |
| Greatest Diameter of Bulb.....  | 3" ± 1/16"     |
| Minimum Useful Screen Diameter.....                                     | 2-3/4"         |
| Base .....  | Medium Magnal  |
| Basing .....  | 11N            |
| Base Alignment:   |                |
| 3D4 trace aligns with Pin #6 and tube axis.....                         | ± 10 Degrees   |
| Positive voltage on D1 deflects beam approximately toward Pin #3.       |                |
| Positive voltage on D3 deflects beam approximately toward locating key. |                |
| Angle between 3D4 and 1D2 traces.....                                   | 90 ± 3 Degrees |

**MAXIMUM RATINGS—(Design Center Values)**

|   |                    |
|---|--------------------|
| Anode No. 2 Voltage .....   | 1500 Max. Volts dc |
| Anode No. 1 Voltage.....  | 1000 Max. Volts dc |
| Grid No. 1 Voltage:   |                    |
| Negative Bias Value.....  | 125 Max. Volts dc  |
| Positive Bias Value .....   | 0 Max. Volts dc    |
| Positive Peak Value .....   | 2 Max. Volts       |
| Peak Voltage between Anode No. 2 and any Deflection Electrode ..... | 550 Max. Volts     |

**TYPICAL OPERATING CONDITIONS**

|                                       |                            |                    |
|---------------------------------------|----------------------------|--------------------|
| For Anode No. 2 Voltage of .....      | 1000                       | 1500 Volts         |
| Anode No. 1 Voltage for focus .....   | 163 to 291                 | 245 to 437 Volts   |
| Grid No. 1 Voltage <sup>1</sup> ..... | -16.5 to -49.5             | -25 to -75 Volts   |
| Deflection Factors:                   |                            |                    |
| D1 and D2 .....                       | 64 to 96                   | 96 to 144 d-cV/in. |
| D3 and D4 .....                       | 56 to 84                   | 84 to 126 d-cV/in. |
| Anode No. 1 Voltage for focus.....    | 16.3% to 29.1% of $E_{b2}$ | Volts              |

Grid No. 1 Voltage<sup>1</sup>..... 1.7% to 5% of Eb2 Volts  
 Anode No. 1 Current for any operating condition.....-50 to + 10 Microamperes  
 Spot Position (Undelected)<sup>2</sup>.....Within 15 Millimeters square

**MAXIMUM CIRCUIT VALUES**

Grid No. 1 Circuit Resistance.....1.5 Max. Megohms  
 Resistance in any Deflecting Electrode Circuit<sup>3</sup>.....5 Max. Megohms

**NOTES**

1. Visual extinction of undeflected focused spot.
2. When the tube is operated at (1) normal heater voltage; (2) Eb2=1500 volts; (3) Eb1 adjusted for focus; (4) Ec1 set at such a value as will avoid damage to the screen and with (5) each of the deflecting electrodes connected to Anode No. 2; and (6) with the tube shielded against external influences:  
 The spot will fall within a 15 mm. square, the center of which coincides with the geometric center of the tube face and the sides of which are parallel to the traces produced by deflecting electrodes D1 and D2 and by deflecting electrodes D3 and D4 respectively.
3. It is recommended that the deflecting electrode circuit resistances be approximately equal.

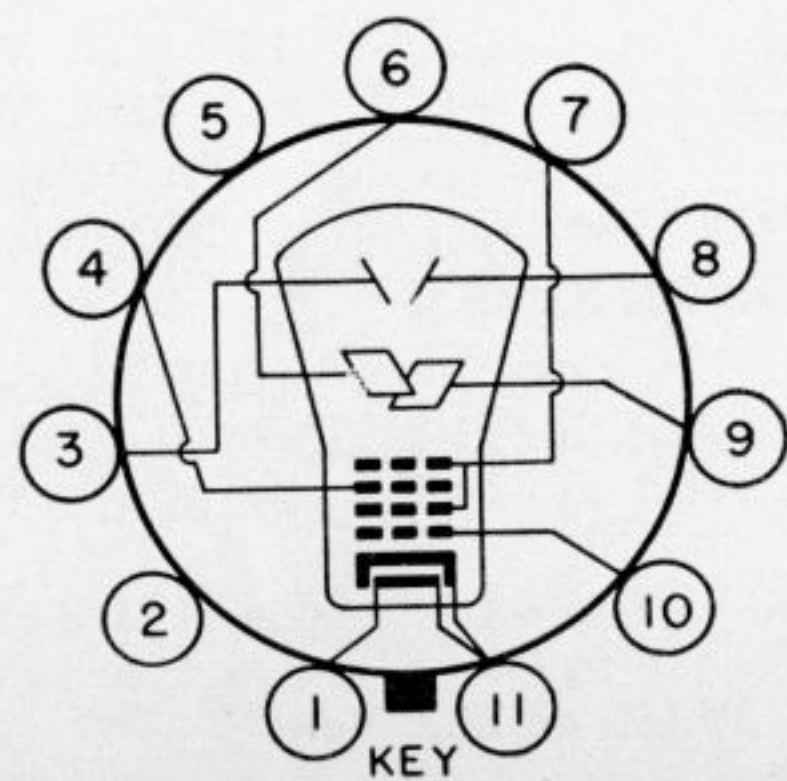
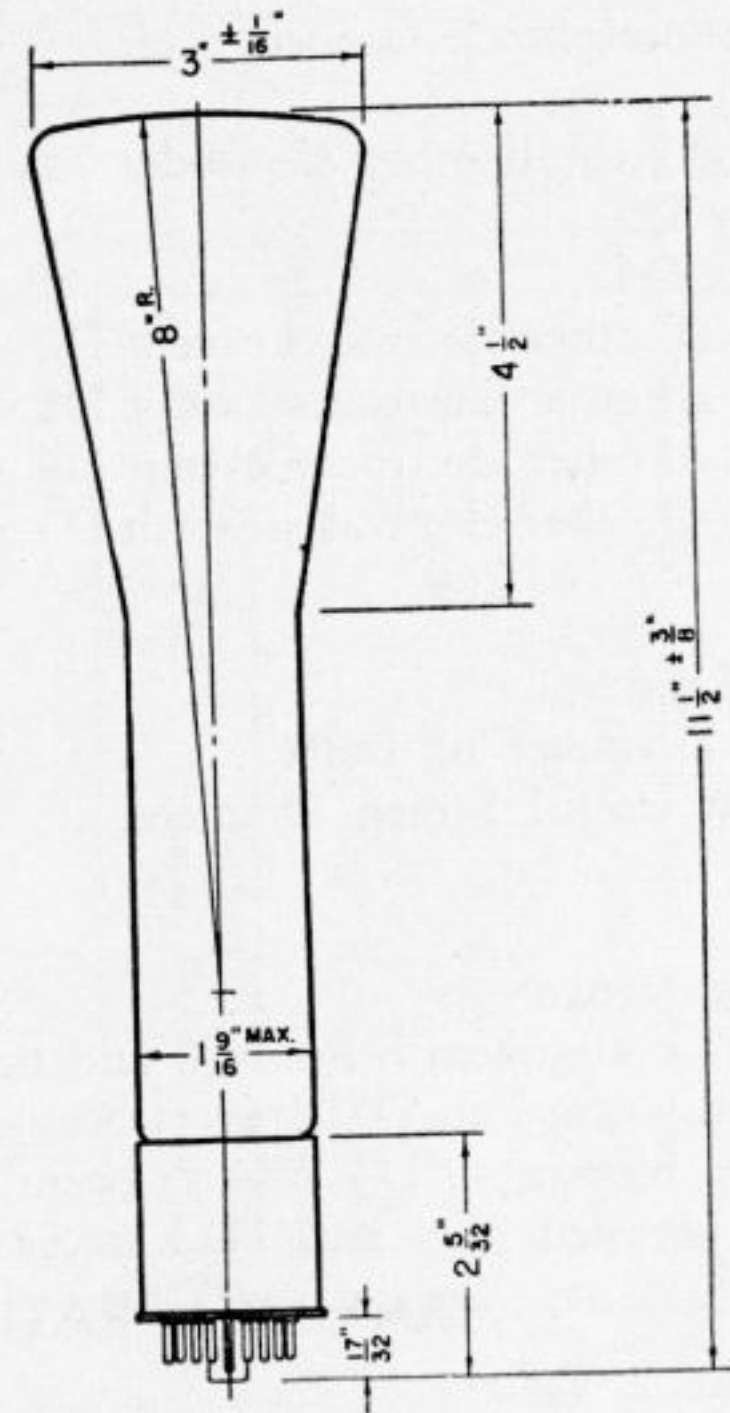
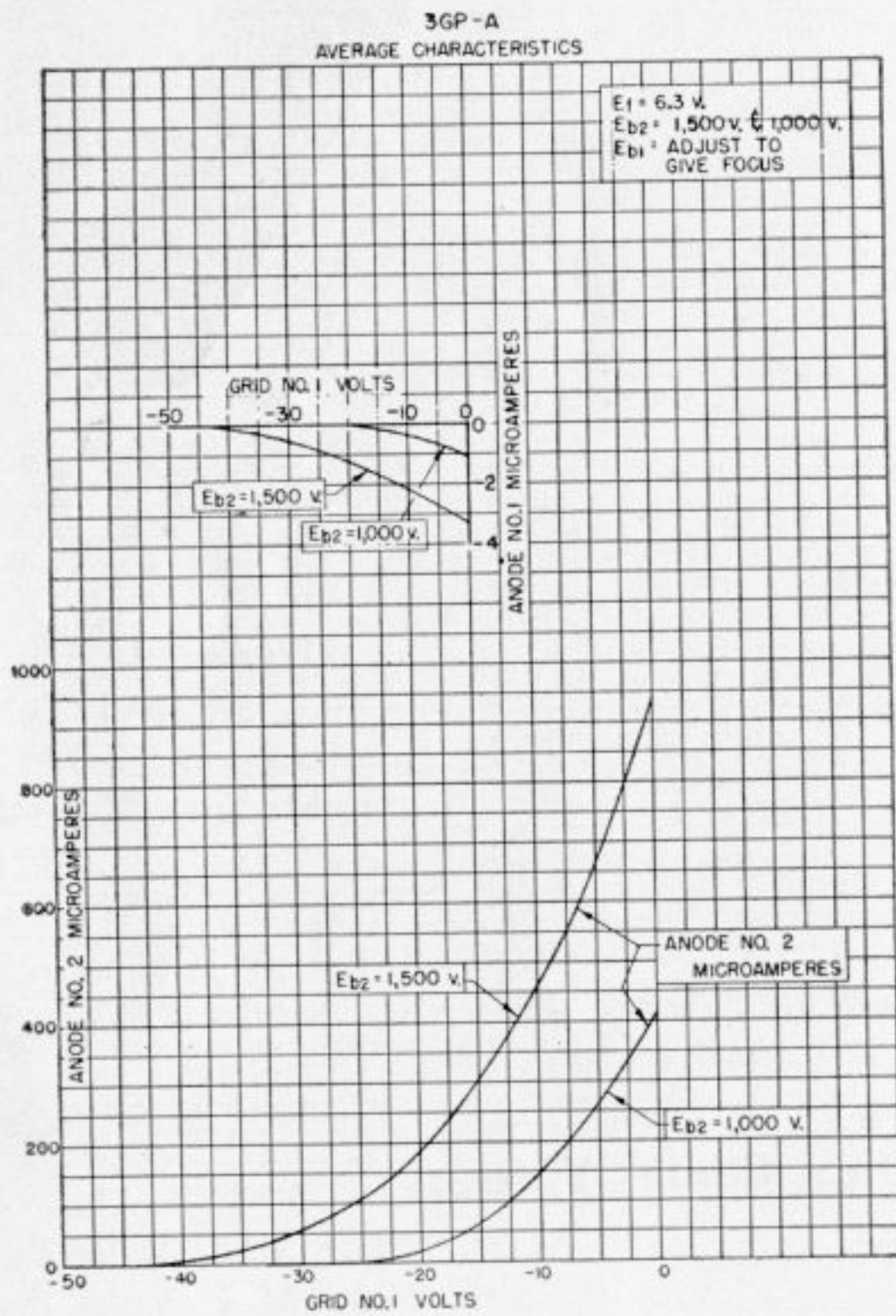

**Bottom View of Base**

| Pin No. | Element                |
|---------|------------------------|
| 1       | Heater                 |
| 2       | No Connection          |
| 3       | Deflection Plate D1    |
| 4       | Focusing Electrode     |
| 5       | Internal Connection    |
| 6       | Deflection Plate D4    |
| 7       | Accelerating Electrode |
| 8       | Deflection Plate D2    |
| 9       | Deflection Plate D3    |
| 10      | Control Electrode      |
| 11      | Heater and Cathode     |

**3JP- CATHODE-RAY TUBES**

The Type 3JP- Cathode-ray Tubes are designed for oscillographic applications requiring a small short tube with very high light output and good deflection sensitivity. The intensifier electrode and extremely high current gun provide high excitation of the screen. The gun is designed so that the focusing electrode current under operating conditions is negligible. The 2" diameter neck and diheptal base provide adequate insulation between electrode leads for high altitude installation.

The four types differ only in the characteristics of the fluorescent screens. Other screen types may be obtained on special order.

**GENERAL CHARACTERISTICS**

| Electrical                                  |                  |       |        |       |
|---|------------------|-------|--------|-------|
| Heater Voltage.....                         | 6.3 ± 10% Volts  |       |        |       |
| Heater Current .....                        | 0.6 ± 10% Ampere |       |        |       |
| Focusing Method .....                       | Electrostatic    |       |        |       |
| Deflecting Method .....                     | Electrostatic    |       |        |       |
| Phosphor                                    | P1               | P2    | P7     | P11   |
| Fluorescence....                            | Green            | Green | Blue   | Blue  |
| Phosphorescence                             | Green            |       | Yellow |       |
| Persistence .....                           | Medium           | Long  | Long   | Short |
| Direct Interelectrode Capacitances, Nominal |                  |       |        |       |
| Cathode to all other electrodes.....        | 4.6 μf.          |       |        |       |
| Grid #1 to all other electrodes.....        | 5.5 μf.          |       |        |       |
| D1 to D2.....                               | 2.6 μf.          |       |        |       |
| D3 to D4.....                               | 2.2 μf.          |       |        |       |
| D1 to all other electrodes except D2.....   | 5.3 μf.          |       |        |       |
| D2 to all other electrodes except D1.....   | 5.3 μf.          |       |        |       |
| D3 to all other electrodes except D4.....   | 4.5 μf.          |       |        |       |
| D4 to all other electrodes except D3.....   | 4.5 μf.          |       |        |       |

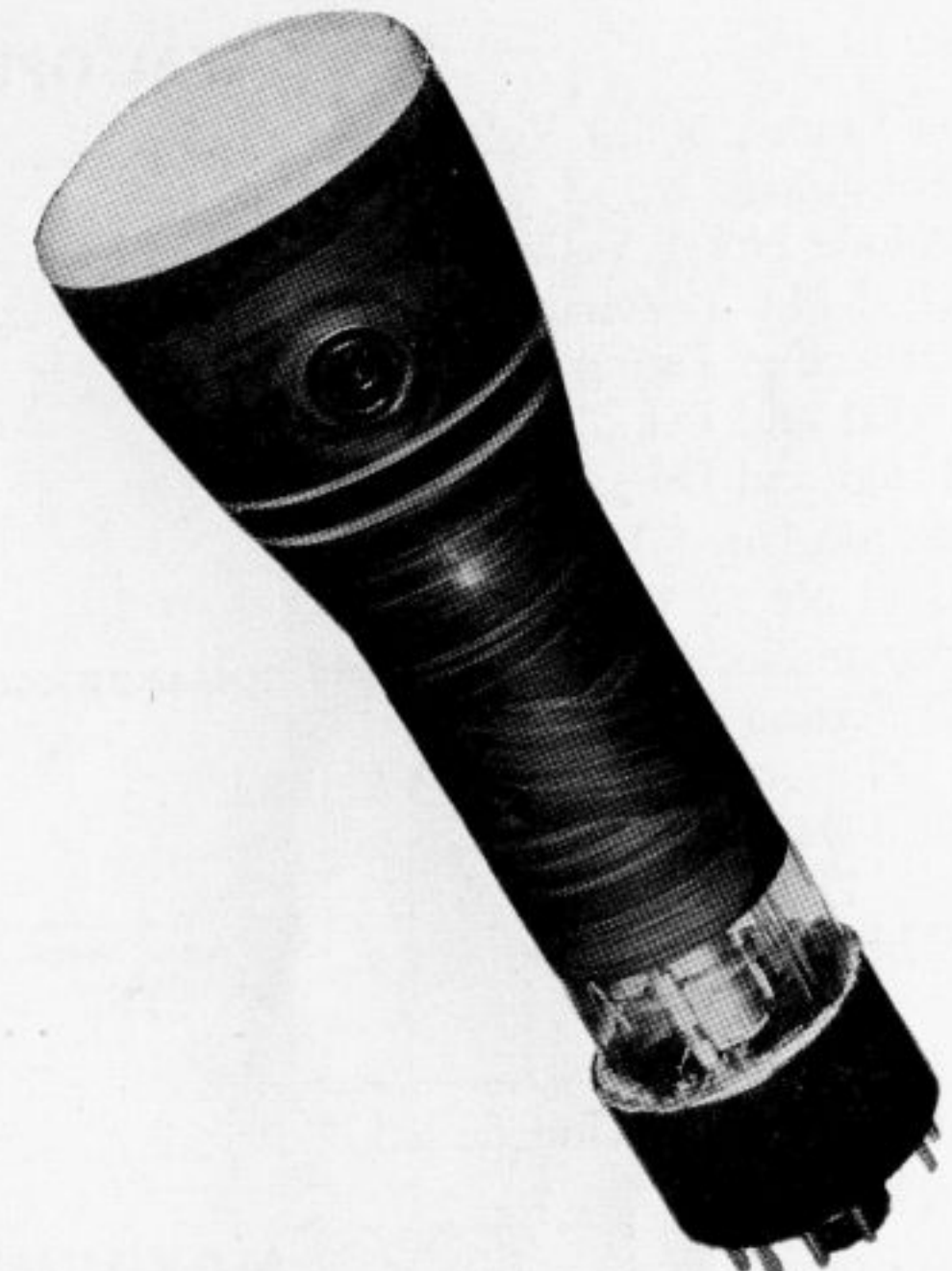

**Mechanical**

|   |                        |
|---|------------------------|
| Overall Length .....  | 10" ± 1/4"             |
| Greatest Diameter of Bulb.....                                    | 3" ± 1/16"             |
| Minimum Useful Screen Diameter.....                               | 2-3/4"                 |
| Base .....  | Medium 12-pin Diheptal |
| Basing .....  | 14J                    |
| Base Alignment:   |                        |
| 1D2 trace aligns with Pin #5 and tube axis.....                   | ± 10 Degrees           |
| Positive voltage on D1 deflects beam approximately toward Pin #5. |                        |
| Positive voltage on D3 deflects beam approximately toward Pin #2. |                        |
| Angle between 3D4 and 1D2 traces.....                             | 90 ± 3 Degrees         |
| Bulb Contact Alignment  |                        |
| Anode No. 3 contact aligns with 1D2 trace.....                    | ± 10 Degrees           |
| Anode No. 3 contact on same side as pin #5.                       |                        |

**MAXIMUM RATINGS—(Design Center Values)**

|   |                    |
|---|--------------------|
| Anode No. 3 Voltage (Accelerator High-Voltage Electrode)..... | 4000 Max. Volts ac |
| Anode No. 2 Voltage .....                                     | 2000 Max. Volts dc |
| Ratio Anode No. 3 Voltage to Anode No. 2 Voltage.....         | 2.3 Max.           |
| Anode No. 1 Voltage .....                                     | 1000 Max. Volts dc |
| Grid No. 1 Voltage:   |                    |

|  |                   |
|--|-------------------|
| Negative Bias Value.....   | 200 Max. Volts dc |
| Positive Bias Value .....  | 0 Max. Volts dc   |
| Positive Peak Value .....  | 2 Max. Volts      |
| Peak Heater Cathode Voltage <sup>1</sup>                           |                   |
| Heater negative with respect to cathode.....                       | 125 Max. Volts dc |
| Heater positive with respect to cathode .....                      | 125 Max. Volts dc |
| Peak Voltage between Anode No. 2 and any Deflection Electrode..... | 550 Max. Volts    |

**TYPICAL OPERATING CONDITIONS**

|   |                              |                                       |                     |
|---|------------------------------|---------------------------------------|---------------------|
| For anode No. 3 Voltage of.....                       | 1500                         | 3000                                  | 4000 Volts          |
| For Anode No. 2 Voltage of.....                       | 1500                         | 1500                                  | 2000 Volts          |
| Anode No. 1 Voltage for focus.....                    | 302 to 517                   | 302 to 517                            | 403 to 690 Volts    |
| Grid No. 1 Voltage <sup>2</sup> .....                 | -22.5 to -67.5               | -22.5 to -67.5                        | -30 to -90 Volts    |
| Deflection Factors:                                   |                              |                                       |                     |
| D1 and D2.....  | 102 to 138                   | 127 to 173                            | 170 to 230 d-cV/in. |
| D3 and D4.....  | 76 to 102                    | 94 to 128                             | 125 to 170 d-cV/in. |
| Anode No. 1 Voltage for focus.....                    | 20.1% to 34.5%               | of Eb2 Volts                          |                     |
| Grid No. 1 Voltage <sup>2</sup> .....                 | 1.5% to 4.5%                 | of Eb2 Volts                          |                     |
| Anode No. 1 Current for any operating condition ..... | -50 to + 10 Microamperes     |                                       |                     |
| Deflection Factors:                                   |                              |                                       |                     |
| No. 3rd Anode or Eb3 = Eb2                            |                              |                                       |                     |
| D1 and D2.....  | 68 to 92                     | Volts dc per Inch per Kilovolt of Eb2 |                     |
| D3 and D4.....  | 51 to 68                     | Volts dc per Inch per Kilovolt of Eb2 |                     |
| Eb3 = Twice Eb2                                       |                              |                                       |                     |
| D1 and D2.....  | 85 to 115                    | Volts dc per Inch per Kilovolt of Eb2 |                     |
| D3 and D4.....  | 63 to 85                     | Volts dc per Inch per Kilovolt of Eb2 |                     |
| Spot Position (Undelected) <sup>3</sup> .....         | Within 15 Millimeters square |                                       |                     |

**MAXIMUM CIRCUIT VALUES**

|   |                  |
|---|------------------|
| Grid No. 1 Circuit Resistance.....                                | 1.5 Max. Megohms |
| Resistance in any Deflecting Electrode Circuit <sup>4</sup> ..... | 5 Max. Megohms   |

**NOTES**

- Cathode should be returned to one side or to the mid-tap of the heater transformer winding.
- Visual extinction of undeflected focused spot.
- When the tube is operated at (1) normal heater voltage; (2) Eb3 = 3000 volts; (3) Eb2 = 1500 volts; (4) Eb1 adjusted for focus; (5) Ec1 set at such a value as will avoid damage to the screen and with (6) each of the deflecting electrodes connected to Anode No. 2; and (7) with the tube shielded against external influences:  
The spot will fall within a 15 mm. square, the center of which coincides with the geometric center of the tube face and the sides of which are parallel to the traces produced by deflecting electrodes D1 and D2 and by deflecting electrodes D3 and D4 respectively.
- It is recommended that the deflecting electrode circuit resistance be approximately equal.

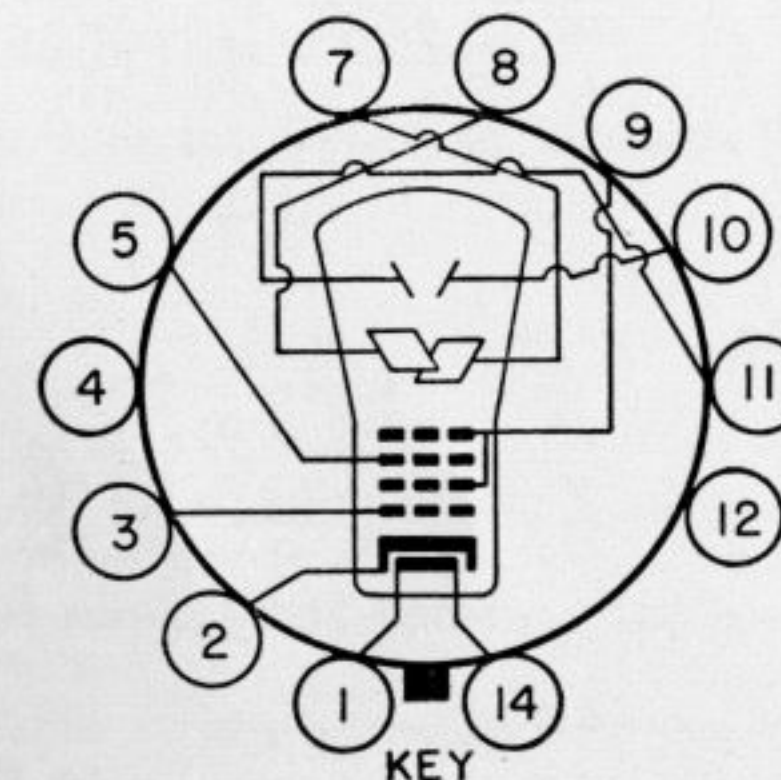
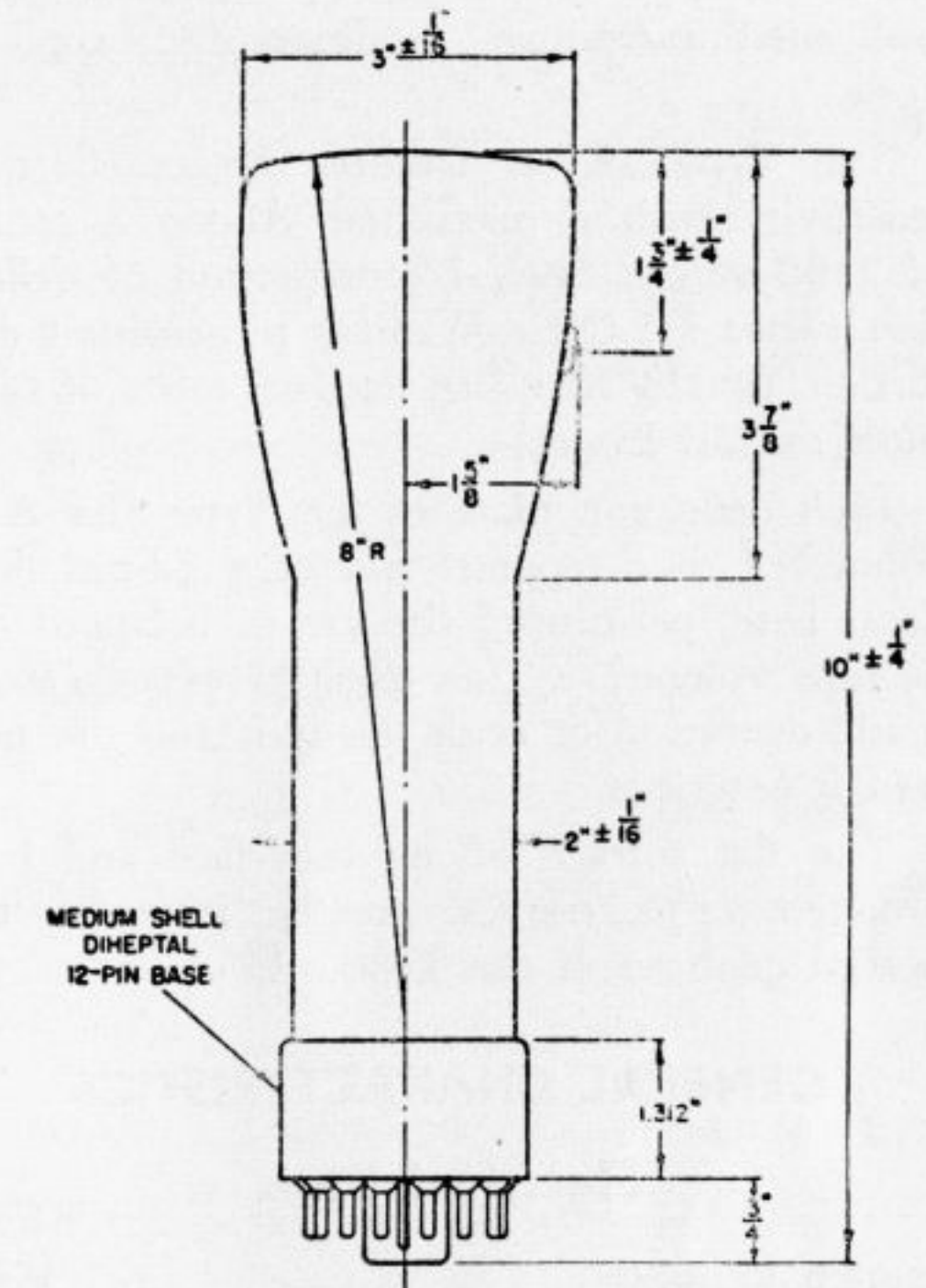
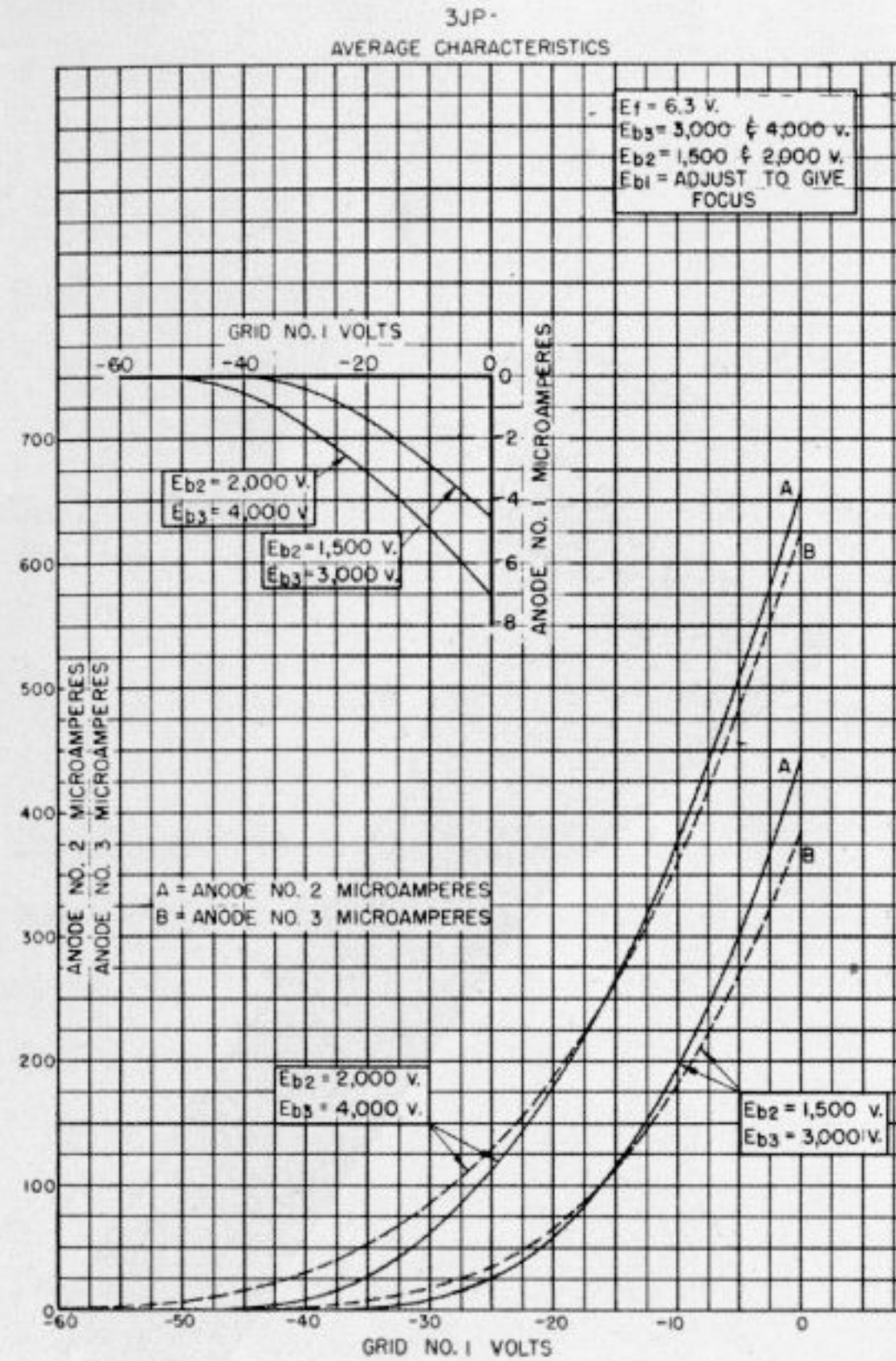

**Bottom View of Base**

| Pin No. | Element                |
|---------|------------------------|
| 1       | Heater                 |
| 2       | Cathode                |
| 3       | Control Electrode      |
| 4       | Internal Connection    |
| 5       | Focusing Electrode     |
| 7       | Deflection Plate D3    |
| 8       | Deflection Plate D4    |
| 9       | Accelerating Electrode |
| 10      | Deflection Plate D2    |
| 11      | Deflection Plate D1    |
| 12      | No Connection          |
| 14      | Heater                 |

# TYPE 3RP-A CATHODE-RAY TUBES

The Type 3RP-A is a short, flat-face, 3" cathode-ray tube. High brilliance and definition at relatively low Anode No. 2 voltages, and negligible focusing electrode current, make the Type 3RP-A ideally suited for low- and medium-voltage oscillographic applications.

The Type 3RP-A features high deflection sensitivity with a maximum Anode 2 rating of 2500 volts. Special construction of deflection plates D1-D2 minimizes pin-cushion distortion, usually found in flat-face tubes of such short overall length.

Each deflection plate of the Type 3RP-A is connected to a separate pin of a 12-pin duodecal base, permitting the use of balanced deflection voltages. This greatly reduces astigmatic distortion of both the spot and the pattern it describes.

The flat surface of its tube-face and new production techniques greatly improve the optical qualities of the Type 3RP-A.

## GENERAL CHARACTERISTICS

### Electrical Data

|   |                 |
|---|-----------------|
| Heater Voltage                              | 6.3 Volts       |
| Heater Current                              | 0.6 ±10% Ampere |
| Focusing Method                             | Electrostatic   |
| Deflecting Method                           | Electrostatic   |
| Phosphor                                    | P1              |
| Fluorescence                                | Green           |
| Persistence                                 | Medium          |
| Direct Interelectrode Capacitances, Approx. |                 |
| Grid No. 1 to all other electrodes          | 8 μf.           |
| D1 to D2                                    | 2 μf.           |
| D3 to D4                                    | 2 μf.           |
| D1 to all other electrodes                  | 11 μf.          |
| D2 to all other electrodes                  | 8 μf.           |
| D3 to all other electrodes                  | 7 μf.           |
| D4 to all other electrodes                  | 8 μf.           |

### Mechanical Data

|  |                             |
|--|-----------------------------|
| Overall Length   | 9 1/8 ± 1/4 Inches          |
| Greatest Diameter of Bulb  | 3 ± 1/16 Inches             |
| Minimum Useful Screen Diameter                                       | 2 3/4 Inches                |
| Base   | Small Shell 12-pin duodecal |
| Basing   | 12E                         |
| Base Alignment   |                             |
| 3D4 trace aligns with Pin No. 1 and tube axis                        | ±10 Degrees                 |
| Positive voltage on D1 deflects beam approximately toward Pin No. 4. |                             |
| Positive voltage on D3 deflects beam approximately toward Pin No. 1. |                             |
| Angle between 3D4 and 1D2 traces                                     | 90 ± 3 Degrees              |



## TYPE 3RP-A CATHODE-RAY TUBES

### MAXIMUM RATINGS—(Design Center Values)

|   |                      |
|---|----------------------|
| Anode No. 2 Voltage <sup>1,2</sup>                            | 2,500 Max. Volts D-C |
| Anode No. 1 Voltage   | 1,000 Max. Volts D-C |
| Grid No. 1 Voltage <sup>2</sup>                               |                      |
| Negative Bias Value   | 200 Max. Volts D-C   |
| Positive Bias Value   | 0 Max. Volts D-C     |
| Positive Peak Value   | 2 Max. Volts         |
| Peak Heater-Cathode Voltage <sup>3</sup>                      |                      |
| Heater Negative with respect to Cathode                       | 125 Max. Volts D-C   |
| Heater Positive with respect to Cathode                       | 125 Max. Volts D-C   |
| Peak Voltage between Anode No. 2 and any Deflection Electrode | 500 Max. Volts       |

### TYPICAL OPERATING CONDITIONS

|   |                              |                               |
|---|------------------------------|-------------------------------|
| For Anode No. 2 Voltage of                      | 1,000                        | 2,000 Volts                   |
| Anode No. 1 Voltage for focus                   | 165 to 310                   | 330 to 620 Volts              |
| Grid No. 1 Voltage <sup>4</sup>                 | -22.5 to -67.5               | -45 to -135 Volts             |
| Deflection Factors:                             |                              |                               |
| D1D2  | 73 to 99                     | 146 to 198 Volts D-C per Inch |
| D3D4  | 52 to 70                     | 104 to 140 Volts D-C per Inch |
| Anode No. 1 Voltage for focus                   | 16.5% to 31% of Eb2 Volts    |                               |
| Grid No. 1 Voltage <sup>4</sup>                 | 2.25% to 6.75% of Eb2 Volts  |                               |
| Anode No. 1 Current for any operating condition | -15 to +10 Microamperes      |                               |
| Spot Position (Undelected) <sup>5</sup>         | Within 15 Millimeters square |                               |

### MAXIMUM CIRCUIT VALUES

|   |                  |
|---|------------------|
| Grid No. 1 Circuit Resistance                               | 1.5 Max. Megohms |
| Resistance in any Deflecting Electrode Circuit <sup>6</sup> | 5 Max. Megohms   |

### NOTES

1. Anode No. 2 and Grid No. 2, which are connected together within the tube, are referred to herein as Anode No. 2.
2. The product of Anode No. 2 voltage and average Anode No. 2 current should be limited to 6 watts.
3. Cathode should be returned to one side or to the mid-tap of the heater transformer winding.
4. Visual extinction of undeflected focused spot.
5. With Eb2 = 1000 volts and Eb1 adjusted for focus.
6. It is recommended that the deflecting electrode circuit resistances be approximately equal.

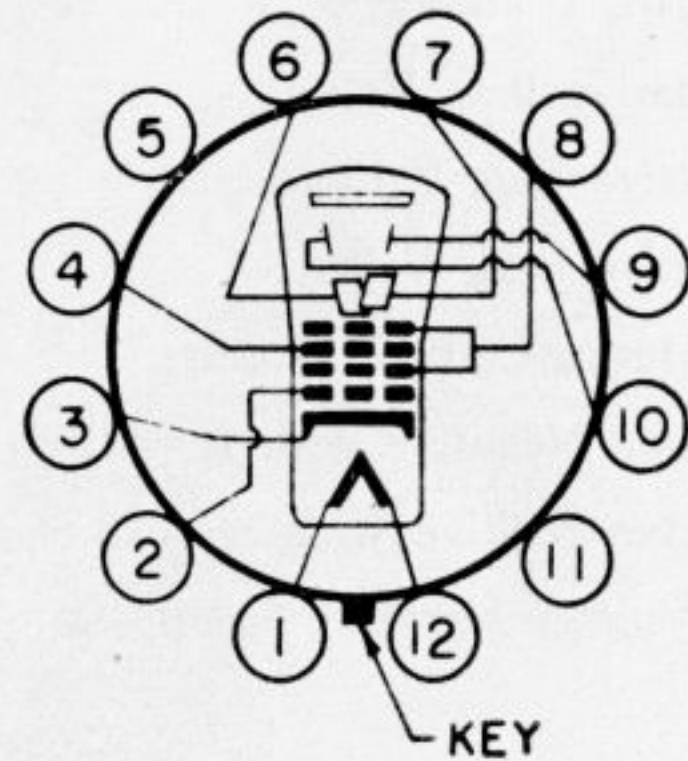
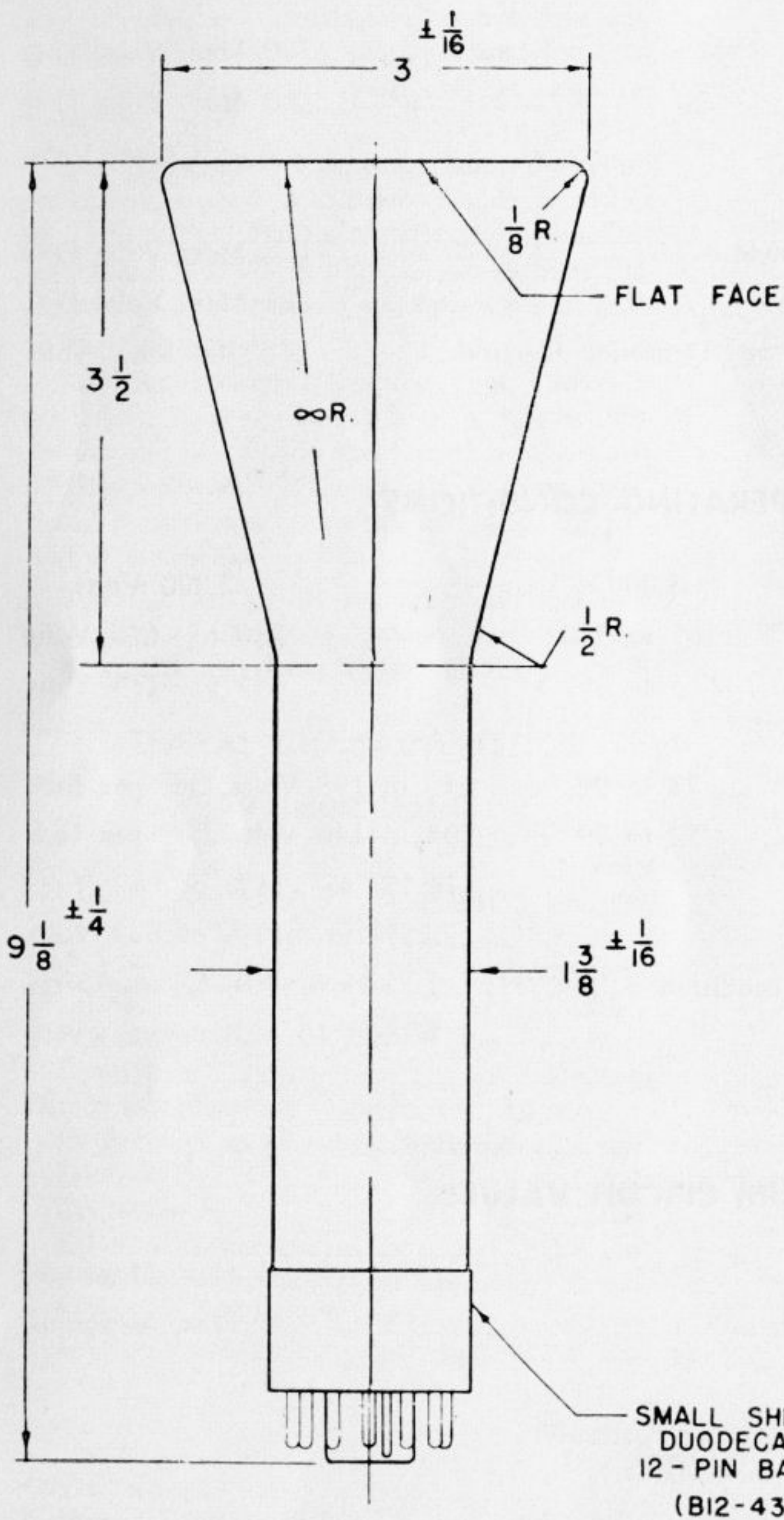

BOTTOM VIEW OF BASE

| PIN NO. | ELEMENT                             |
|---------|-------------------------------------|
| 1       | HEATER                              |
| 2       | GRID NO. 1                          |
| 3       | CATHODE                             |
| 4       | ANODE NO. 1                         |
| 5       | INTERNAL CONNECTION                 |
| 6       | DEFLECTING ELECTRODE D <sub>3</sub> |
| 7       | DEFLECTING ELECTRODE D <sub>4</sub> |
| 8       | ANODE NO. 2, GRID NO. 2             |
| 9       | DEFLECTING ELECTRODE D <sub>2</sub> |
| 10      | DEFLECTING ELECTRODE D <sub>1</sub> |
| 11      | INTERNAL CONNECTION                 |
| 12      | HEATER                              |

SMALL SHELL  
DUODECAL  
12-PIN BASE  
(B12-43)

## 5BP-A CATHODE-RAY TUBES

The Type 5BP-A Cathode-ray Tubes are designed for oscillographic applications where the use of an intensifier type tube is not essential. The gun is designed to draw negligible focusing electrode current.

The Type 5BP-A is recommended for replacement only.

### GENERAL CHARACTERISTICS

#### Electrical

|  |                  |
|--|------------------|
| Heater Voltage.....                            | 6.3 ± 10% Volts  |
| Heater Current .....                           | 0.6 ± 10% Ampere |
| Focusing Method .....                          | Electrostatic    |
| Deflecting Method .....                        | Electrostatic    |
| Phosphor                                       | P1 P11           |
| Fluorescence .....                             | Green Blue       |
| Persistence .....                              | Medium Short     |
| Direct Interelectrode Capacitances,<br>Nominal |                  |
| Grid #1 to all other electrodes.....           | 8.0 μmf.         |
| D1 to D2 .....                                 | 1.3 μmf.         |
| D3 to D4 .....                                 | 1.2 μmf.         |
| D1 to all other electrodes except D2 ..        | 8.0 μmf.         |
| D2 to all other electrodes except D1 ..        | 7.5 μmf.         |
| D3 to all other electrodes except D4 ..        | 10.0 μmf.        |
| D4 to all other electrodes except D3 ..        | 7.5 μmf.         |



#### Mechanical

|   |                        |
|---|------------------------|
| Overall Length .....  | 16-3/4" ± 3/8"         |
| Greatest Diameter of Bulb.....                                    | 5-1/4" + 1/16", -3/32" |
| Minimum Useful Screen Diameter.....                               | 4-1/2"                 |
| Base .....  | Medium Magnal          |
| Basing .....  | 11N                    |
| Base Alignment:   |                        |
| 3D4 trace aligns with Pin #1 and tube axis.....                   | ± 10 Degrees           |
| Positive voltage on D1 deflects beam approximately toward Pin #4. |                        |
| Positive voltage on D3 deflects beam approximately toward Pin #1. |                        |
| Angle between 3D4 and 1D2 traces.....                             | 90 ± 3 Degrees         |

#### MAXIMUM RATINGS—(Design Center Values)

|  |                    |
|--|--------------------|
| Anode No. 2 Voltage.....   | 2000 Max. Volts dc |
| Anode No. 1 Voltage.....   | 1000 Max. Volts dc |
| Grid No. 1 Voltage   |                    |
| Negative Bias Value.....   | 125 Max. Volts dc  |
| Positive Bias Value .....  | 0 Max. Volts dc    |
| Positive Peak Value .....  | 2 Max. Volts       |
| Peak Voltage between Anode No. 2 and any Deflection Electrode..... | 500 Max. Volts     |

#### TYPICAL OPERATING CONDITIONS

|                                       |            |                   |
|---------------------------------------|------------|-------------------|
| For Anode No. 2 Voltage of .....      | 1500       | 2000 Volts        |
| Anode No. 1 Voltage for focus .....   | 253 to 422 | 338 to 562 Volts  |
| Grid No. 1 Voltage <sup>1</sup> ..... | -15 to -45 | -20 to -60 Volts  |
| Deflection Factors:                   |            |                   |
| D1 and D2 .....                       | 52 to 74   | 70 to 98 d-cV/in. |
| D3 and D4 .....                       | 47 to 67   | 63 to 89 d-cV/in. |

- Anode No. 1 Voltage for focus.....16.9 to 28.1% of Eb2 Volts  
 Grid No. 1 Voltage<sup>1</sup>..... 1% to 3% of Eb2 Volts  
 Anode No. 1 Current for any operating condition....-50 to + 10 Microamperes  
 Deflection Factors:  
 D1 and D2.....35 to 49 Volts dc per Inch per Kilovolt of Eb2  
 D3 and D4.....31.5 to 44.5 Volts dc per Inch per Kilovolt of Eb2  
 Spot Position (Undelected)<sup>2</sup>.....Within 15 Millimeters square

**MAXIMUM CIRCUIT VALUES**

- Grid No. 1 Circuit Resistance.....1.5 Max. Megohms  
 Resistance in any Deflecting Electrode Circuit<sup>3</sup>.....5 Max. Megohms

**NOTES**

- Visual extinction of undeflected focused spot.
- When the tube is operated at (1) normal heater voltage; (2) Eb2 = 1500 volts; (3) Eb1 adjusted for focus; (4) Ec1 set at such a value as will avoid damage to the screen and with (5) each of the deflecting electrodes connected to Anode No. 2; and (6) with the tube shielded against external influences:  
 The spot will fall within a 15 mm. square, the center of which coincides with the geometric center of the tube face and the sides of which are parallel to the traces produced by deflecting electrodes D1 and D2 and by deflecting electrodes D3 and D4 respectively.
- It is recommended that all the deflecting electrode circuit resistances be approximately equal.

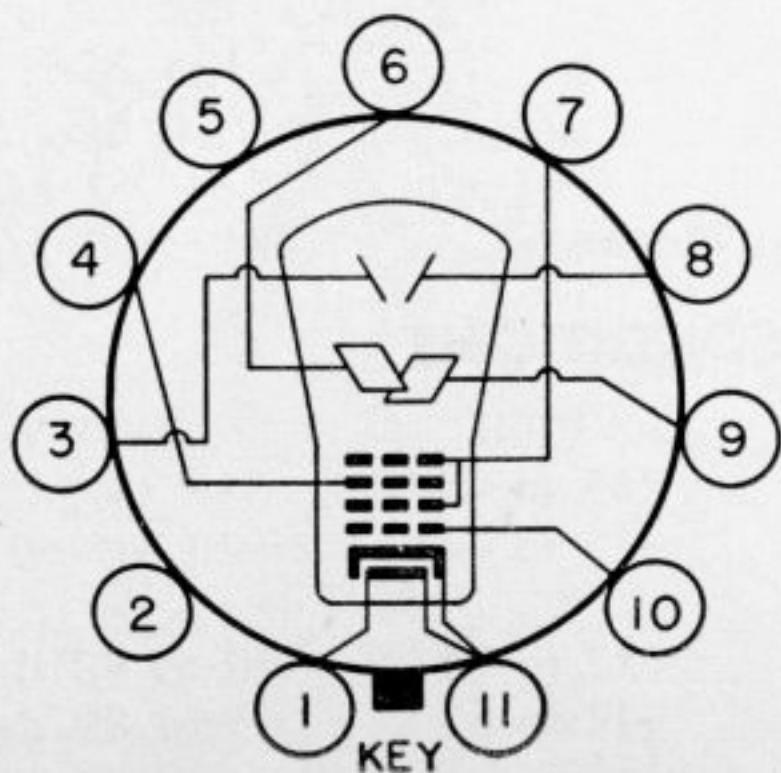
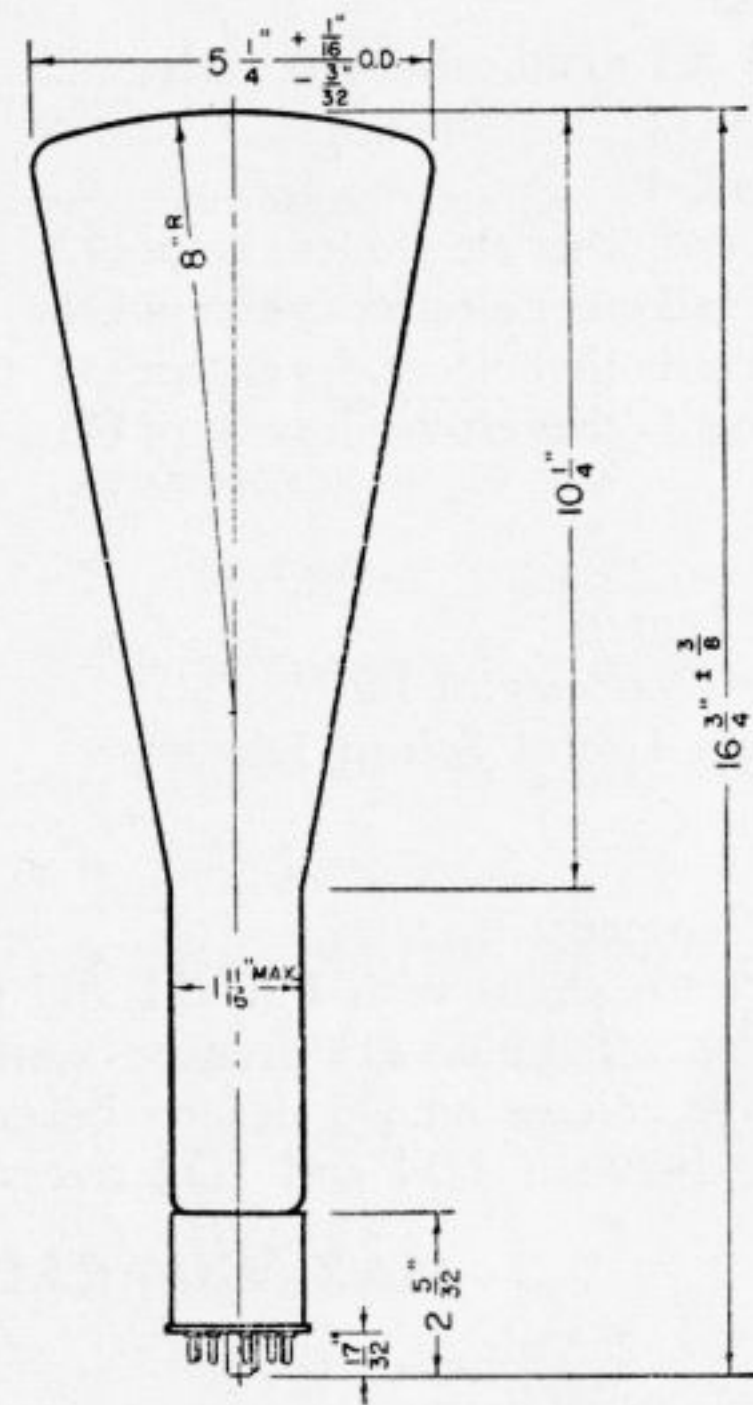
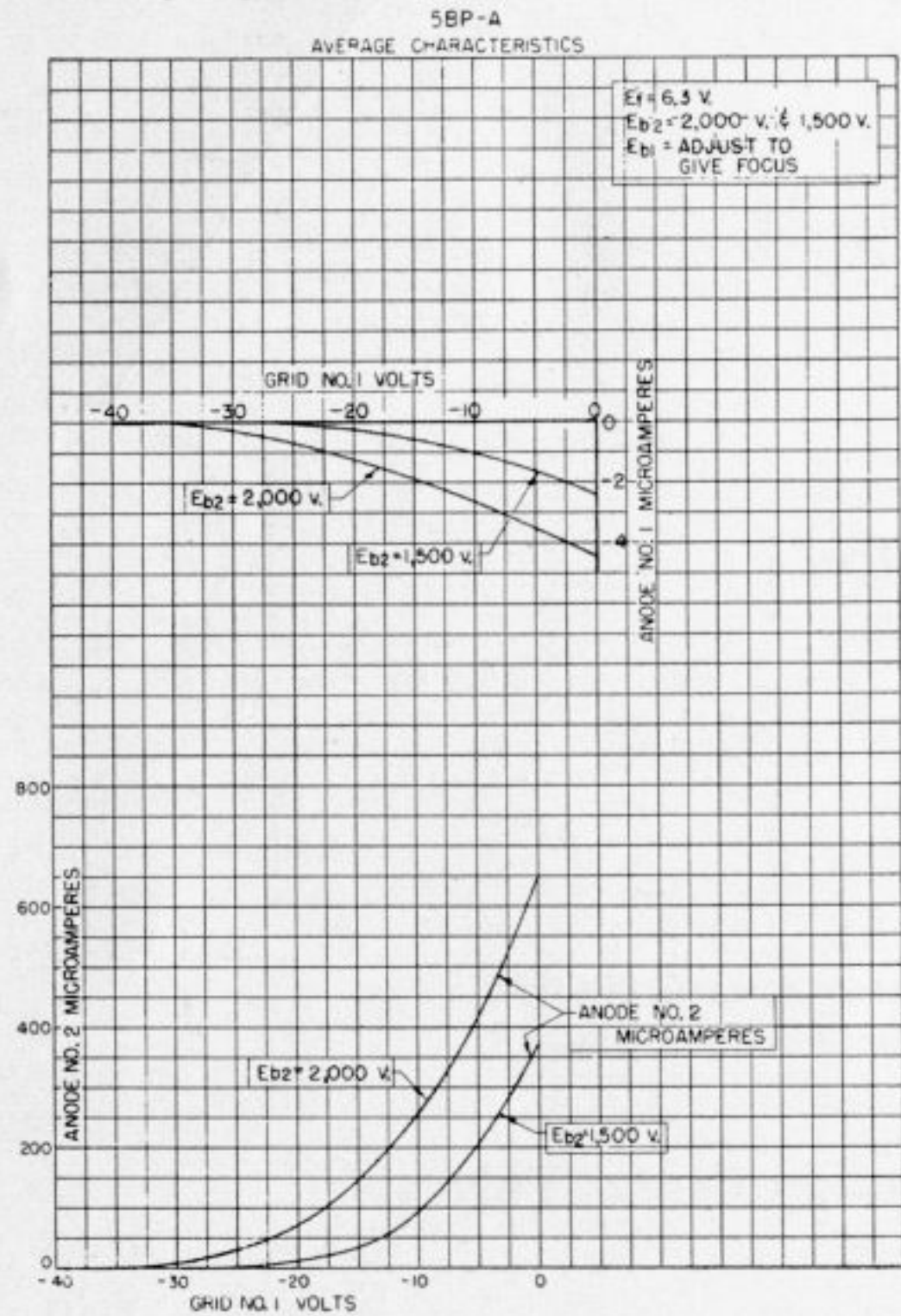

**Bottom View of Base**

| Pin No. | Element                |
|---------|------------------------|
| 1       | Heater                 |
| 2       | No Connection          |
| 3       | Deflection Plate D1    |
| 4       | Focusing Electrode     |
| 5       | Internal Connection    |
| 6       | Deflection Plate D4    |
| 7       | Accelerating Electrode |
| 8       | Deflection Plate D2    |
| 9       | Deflection Plate D3    |
| 10      | Control Electrode      |
| 11      | Heater and Cathode     |

**5CP-A CATHODE-RAY TUBES**

The Type 5CP-A Cathode-ray Tubes are designed for oscillographic applications. The intensifier principle is used to provide a maximum deflection sensitivity for a given final accelerating voltage. A glass envelope has been designed to provide great mechanical strength and the tube base design provides adequate insulation between electrode leads for high altitude installation. The gun is designed to draw negligible focusing electrode current.

The four types differ only in the characteristics of the fluorescent screens. Other screen types may be obtained on special order.

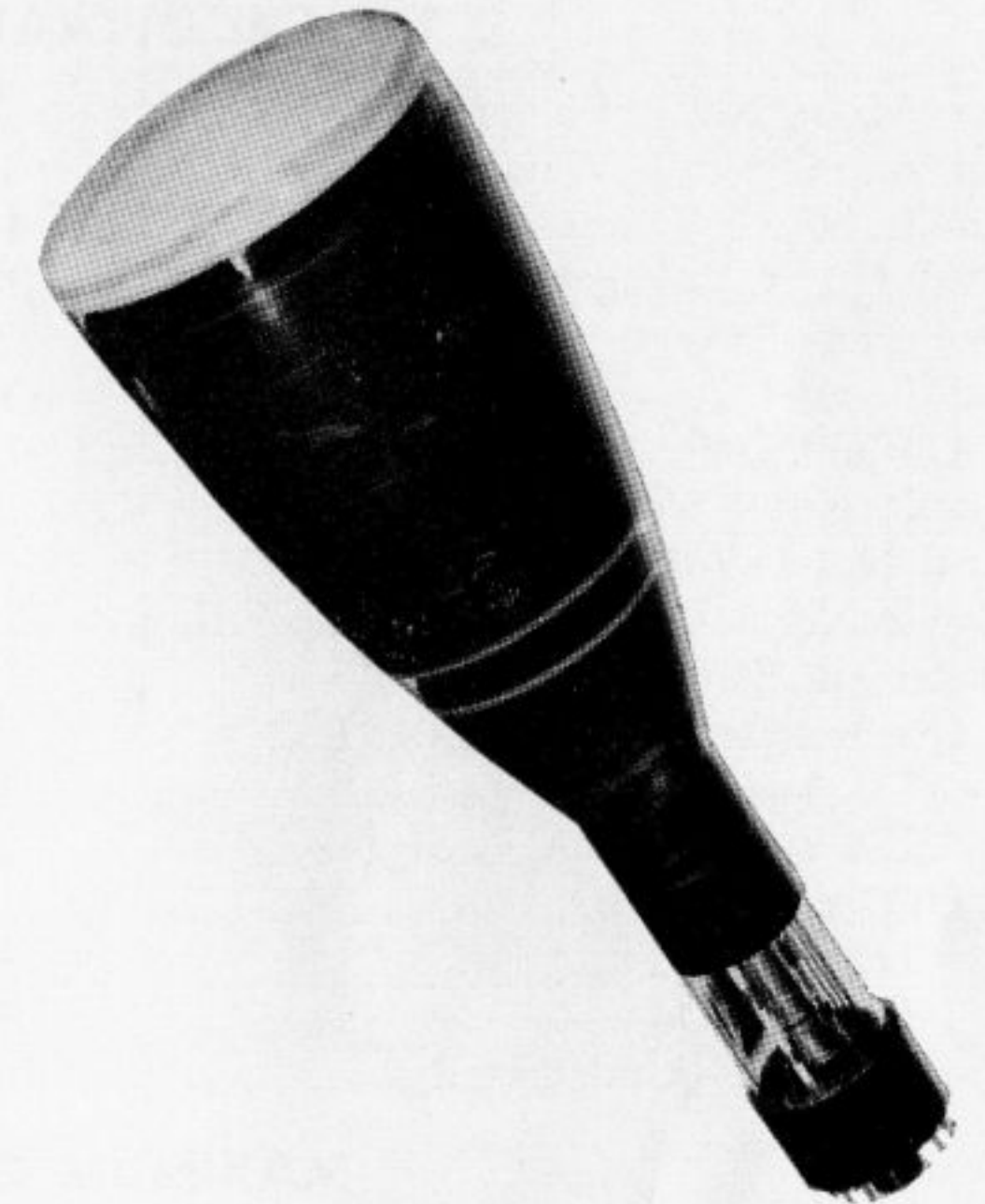

**GENERAL CHARACTERISTICS**

**Electrical**

- Heater Voltage.....6.3 ± 10% Volts  
 Heater Current.....0.6 ± 10% Ampere  
 Focusing Method..... Electrostatic  
 Deflecting Method..... Electrostatic  
 Phosphor P1 P2 P7 P11  
 Fluorescence... Green Green Blue Blue  
 Phosphorescence Green Yellow  
 Persistence..... Medium Long Long Short  
 Direct Interelectrode Capacitances, Nominal  
 Cathode to all other electrodes..... 9 μf.  
 Grid #1 to all other electrodes..... 8 μf.  
 D1 to D2..... 2 μf.  
 D3 to D4..... 2 μf.  
 D1 to all other electrodes except D2.. 7 μf.  
 D2 to all other electrodes except D1.. 7 μf.  
 D3 to all other electrodes except D4.. 5 μf.  
 D4 to all other electrodes except D3.. 6 μf.

**Mechanical**

- Overall Length .....16-3/4" ± 3/8"  
 Greatest Diameter of Bulb.....5-1/4" ± 3/32"  
 Minimum Useful Screen Diameter.....4-1/2"  
 Bulb Contact ..... Snap terminal ball contact  
 Base ..... Medium 12-pin diheptal  
 Basing ..... 14J  
 Base Alignment:

- 1D2 trace aligns with Pin #5 and tube axis..... ± 10 Degrees  
 Positive voltage on D1 deflects beam approximately toward Pin #5.  
 Positive voltage on D3 deflects beam approximately toward Pin #2.  
 Angle between 3D4 and 1D2 traces..... 90 ± 3 Degrees  
 Bulb contact alignment:  
 Anode #3 contact aligns with 1D2 trace ± 10 Degrees.  
 Anode #3 contact on same side as Pin #5.

**MAXIMUM RATINGS—(Design Center Values)**

- Anode No. 3 Voltage (accelerator High-Voltage Electrode).....4000 Max. Volts dc  
 Anode No. 2 Voltage .....2000 Max. Volts dc  
 Ratio Anode No. 3 Voltage to Anode No. 2 Voltage.....2.3 Max.  
 Anode No. 1 Voltage .....1000 Max. Volts dc  
 Grid No. 1 Voltage  
 Negative Bias Value.....200 Max. Volts dc

|  |                   |
|--|-------------------|
| Positive Bias Value.....   | 0 Max. Volts dc   |
| Positive Peak Value .....  | 2 Max. Volts      |
| Peak Heater-Cathode Voltage <sup>1</sup>                           |                   |
| Heater Negative with respect to Cathode.....                       | 125 Max. Volts dc |
| Heater Positive with respect to Cathode .....                      | 125 Max. Volts dc |
| Peak Voltage between Anode No. 2 and any Deflection Electrode..... | 550 Max. Volts    |

**TYPICAL OPERATING CONDITIONS**

|   |  |                |                    |
|---|--|----------------|--------------------|
| For Anode No. 3 Voltage of .....                      | 2000   | 3000           | 4000 Volts         |
| For Anode No. 2 Voltage of .....                      | 2000   | 1500           | 2000 Volts         |
| Anode No. 1 Voltage for focus .....                   | 374 to 690                                     | 302 to 518     | 374 to 690 Volts   |
| Grid No. 1 Voltage <sup>2</sup> .....                 | -30 to -90                                     | -22.5 to -67.5 | -30 to -90 Volts   |
| Deflection Factors:                                   |  |                |                    |
| D1 and D2 .....                                       | 62 to 84                                       | 59 to 80       | 78 to 106 d-cV/in. |
| D3 and D4 .....                                       | 54 to 74                                       | 50 to 68       | 66 to 90 d-cV/in.  |
| Anode No. 1 Voltage for focus.....                    | 18.7% to 34.5% of Eb2 Volts                    |                |                    |
| Grid No. 1 Voltage <sup>2</sup> .....                 | 1.5% to 4.5% of Eb2 Volts                      |                |                    |
| Anode No. 1 Current for any operating condition ..... | -50 to ± 10 Microamperes                       |                |                    |
| Deflection Factors:                                   |  |                |                    |
| No 3rd Anode or Eb3 = Eb2                             |  |                |                    |
| D1 and D2 .....                                       | 31 to 42 Volts dc per inch per Kilovolt of Eb2 |                |                    |
| D3 and D4 .....                                       | 27 to 37 Volts dc per inch per Kilovolt of Eb2 |                |                    |
| Eb3 = Twice Eb2                                       |  |                |                    |
| D1 and D2 .....                                       | 39 to 53 Volts dc per inch per Kilovolt of Eb2 |                |                    |
| D3 and D4 .....                                       | 33 to 45 Volts dc per inch per Kilovolt of Eb2 |                |                    |
| Spot Position (Undelected) <sup>3</sup> .....         | Within 25 Millimeters square                   |                |                    |

**MAXIMUM CIRCUIT VALUES**

|   |                  |
|---|------------------|
| Grid No. 1 Circuit Resistance .....                               | 1.5 Max. Megohms |
| Resistance in any Deflecting-Electrode Circuit <sup>4</sup> ..... | 5 Max. Megohms   |

**NOTES**

- Cathode should be returned to one side or to the mid-tap of the heater transformer winding.
- Visual extinction of undeflected focused spot.
- When the tube is operated at (1) normal heater voltage; (2) Eb3 = 3000 volts; (3) Eb2 = 1500 volts; (4) Eb1 adjusted for focus; (5) Ec1 set at such a value as will avoid damage to the screen; (6) with each of the deflecting electrodes connected to Anode No. 2; and (7) with the tube shielded against external influences:  
The spot will fall within a 25 mm. square, the center of which coincides with the geometric center of the tube face and the sides of which are parallel to the traces produced by deflecting electrodes D1 and D2 and by deflecting electrodes D3 and D4 respectively.
- It is recommended that the deflecting electrode circuit resistances be approximately equal.

**TYPE 5CP-A CATHODE-RAY TUBES**

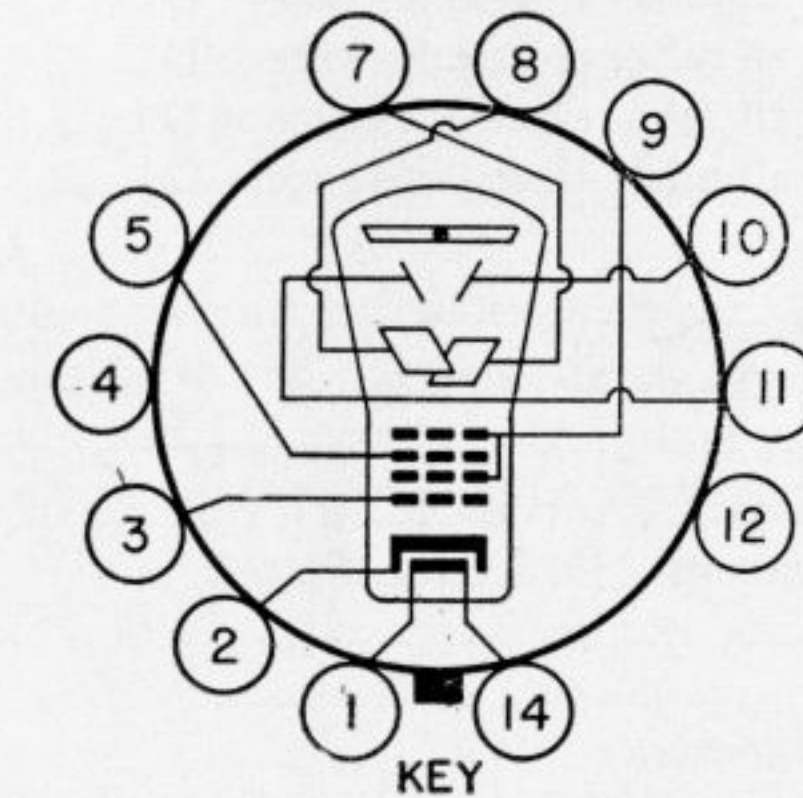
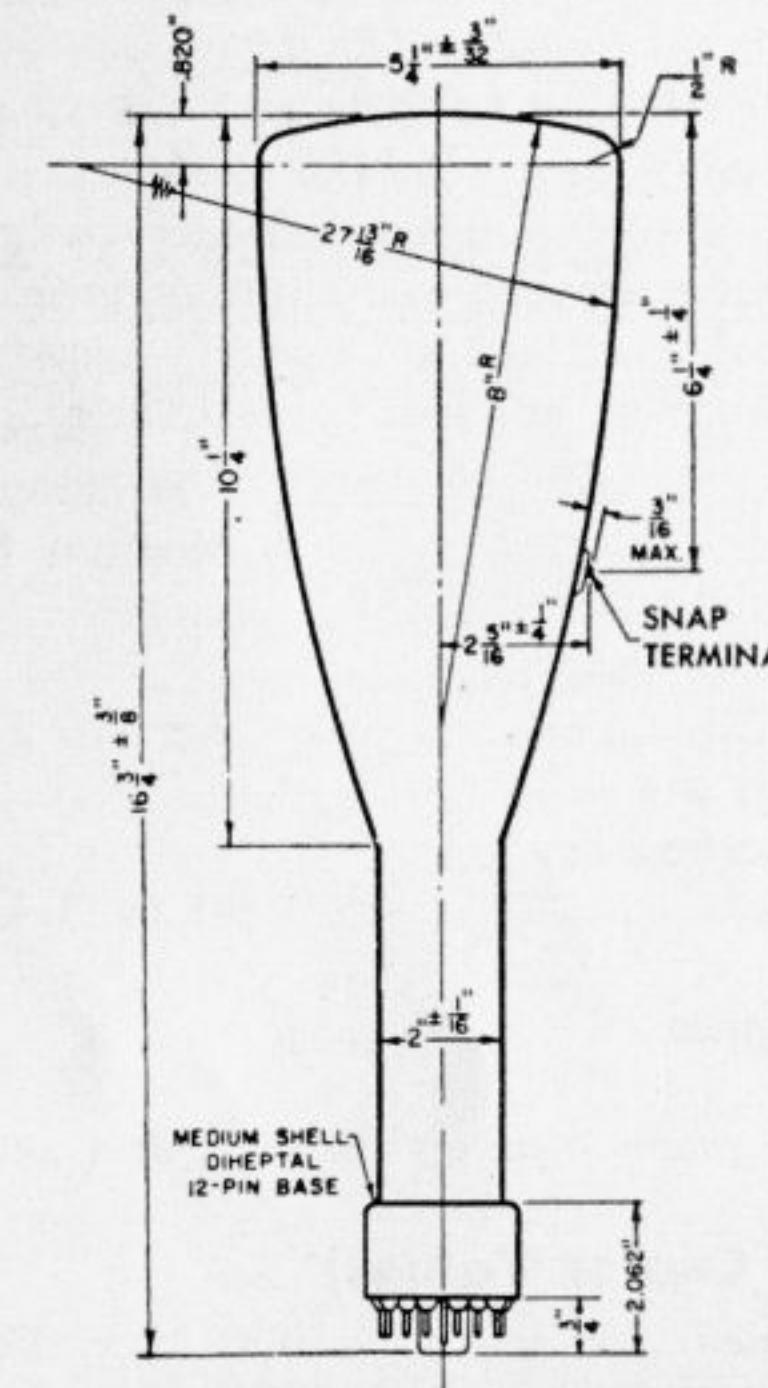
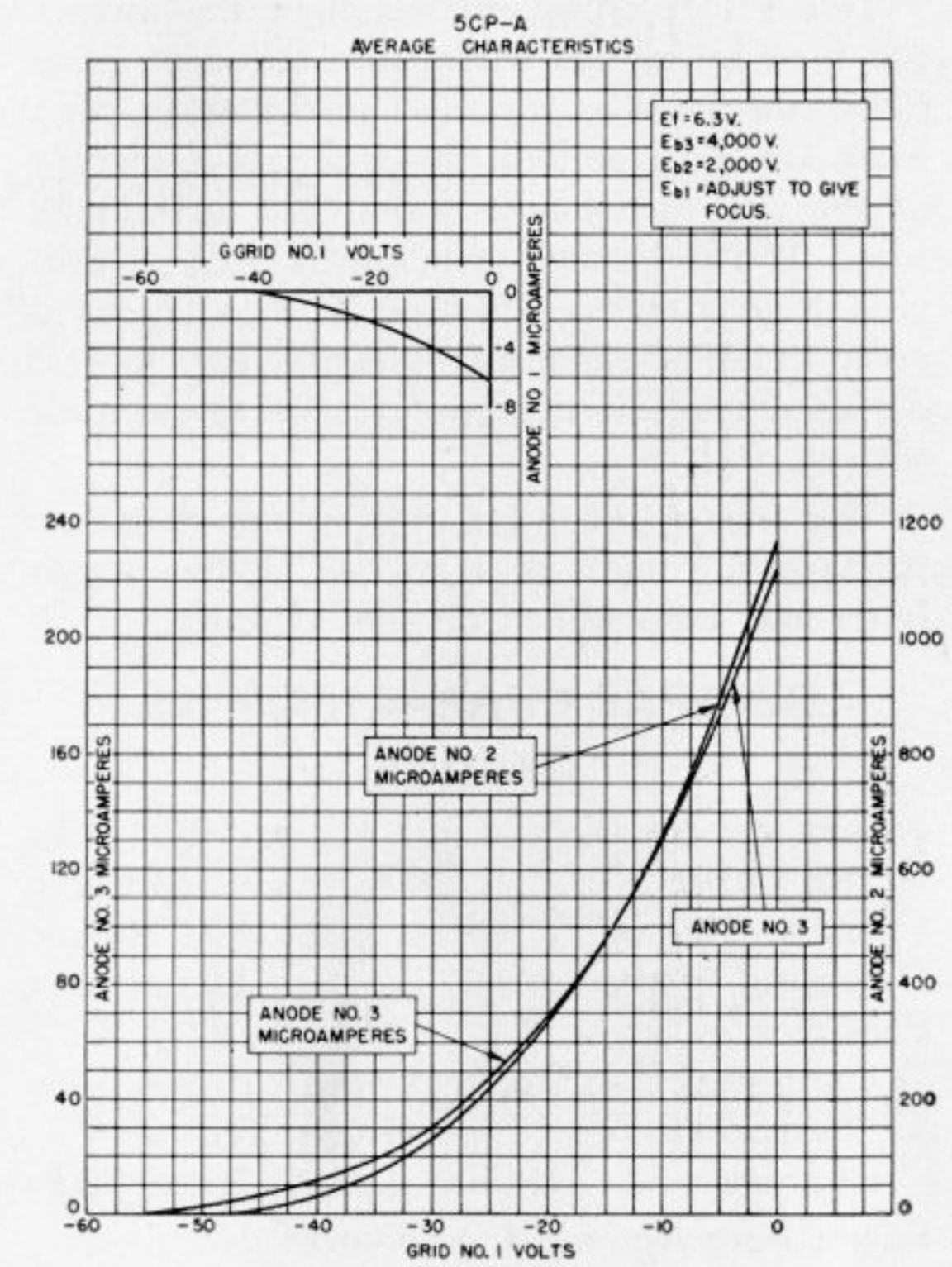
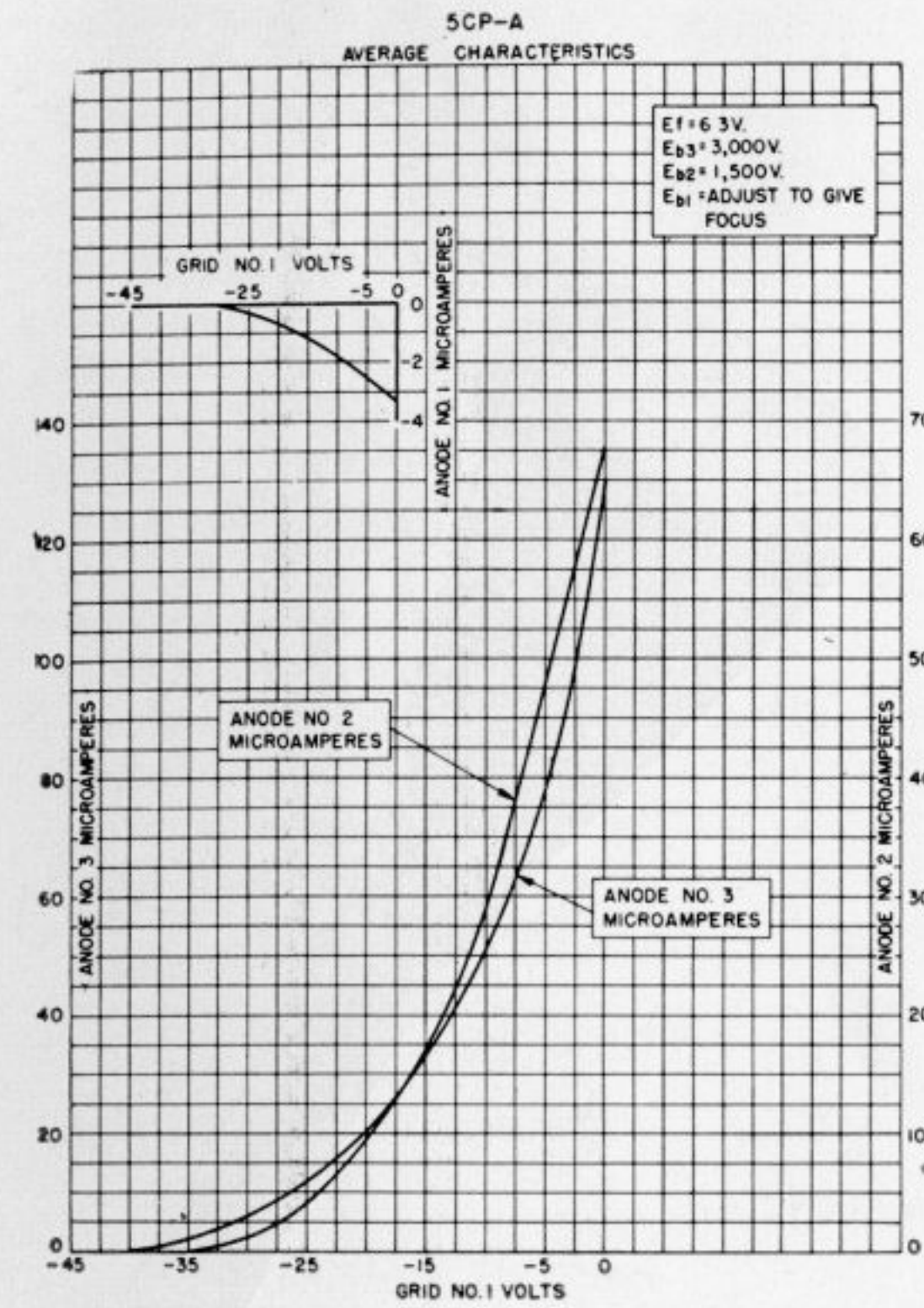

**Bottom View of Base**

| Pin No. | Element                |
|---------|------------------------|
| 1       | Heater                 |
| 2       | Cathode                |
| 3       | Control Electrode      |
| 4       | Internal Connection    |
| 5       | Focusing Electrode     |
| 7       | Deflection Plate D3    |
| 8       | Deflection Plate D4    |
| 9       | Accelerating Electrode |
| 10      | Deflection Plate D2    |
| 11      | Deflection Plate D1    |
| 12      | No Connection          |
| 14      | Heater                 |



## 5JP-A CATHODE-RAY TUBES

The 5JP-A types are designed for oscillographic applications where low deflection plate capacitances are essential. The deflection plate leads are short and direct terminating in caps on the wall of the tube rather than in the tube base. The intensifier principle is used to provide a maximum deflection sensitivity for a given final accelerating voltage. The gun is designed to draw negligible focusing electrode current.

The four types differ only in the characteristics of the fluorescent screens. Other screen types may be obtained on special order.

### GENERAL CHARACTERISTICS

#### Electrical

|   |                  |       |        |       |
|---|------------------|-------|--------|-------|
| Heater Voltage.....                         | 6.3 ± 10% Volts  |       |        |       |
| Heater Current .....                        | 0.6 ± 10% Ampere |       |        |       |
| Focusing Method .....                       | Electrostatic    |       |        |       |
| Deflecting Method .....                     | Electrostatic    |       |        |       |
| Phosphor                                    | P1               | P2    | P7     | P11   |
| Fluorescence....                            | Green            | Green | Blue   | Blue  |
| Phosphorescence                             | Green            |       | Yellow |       |
| Persistence .....                           | Medium           | Long  | Long   | Short |
| Direct Interelectrode Capacitances, Nominal |                  |       |        |       |
| Grid #1 to all other electrodes.....        | 8.2 μmf.         |       |        |       |
| D1 to D2 .....                              | 1.5 μmf.         |       |        |       |
| D3 to D4 .....                              | 1.4 μmf.         |       |        |       |
| D1 to all other electrodes except D2.....   | 2.5 μmf.         |       |        |       |
| D2 to all other electrodes except D1.....   | 2.9 μmf.         |       |        |       |
| D3 to all other electrodes except D4.....   | 2.6 μmf.         |       |        |       |
| D4 to all other electrodes except D3.....   | 2.7 μmf.         |       |        |       |

#### Mechanical

|   |                 |
|---|-----------------|
| Overall Length .....  | 16-3/4" ± 3/8"  |
| Greatest Diameter of Bulb .....   | 5.5/16" ± 1/16" |
| Minimum Useful Screen Diameter .....  | 4-1/2"          |
| Bulb Contact (Anode No. 3) .....  | Small Cap       |
| Bulb Contacts (Deflection Plate) .....  | Miniature Cap   |
| Base .....  | Medium Magnal   |
| Basing .....  | 11E             |
| Base Alignment:   |                 |
| 3D4 trace aligns with Pin #6 and tube axis.....   | ± 10 Degrees    |
| Positive voltage on D1 deflects beam approx. toward Pin #3.   |                 |
| Positive voltage on D3 deflects beam approx. toward locating key.   |                 |
| Angle between 3D4 and 1D2 traces.....   | 90 ± 3 Degrees  |
| Bulb contact alignment  |                 |
| Anode No. 3 Contact aligns with 3D4 trace ± 10 Degrees.   |                 |
| Anode No. 3 Contact on same side as locating key.   |                 |
| Deflection Plate Contacts are within 10 degrees of the plane through the tube axis and their respective traces. |                 |

#### MAXIMUM RATINGS—(Design Center Values)

|  |                    |
|--|--------------------|
| Anode No. 3 Voltage (accelerator High-Voltage Electrode) ..... | 4000 Max. Volts dc |
| Anode No. 2 Voltage .....                                      | 2000 Max. Volts dc |
| Ratio Anode No. 3 Voltage to Anode No. 2 Voltage .....         | 2.0 Max.           |
| Anode No. 1 Voltage .....                                      | 1000 Max. Volts dc |

## TYPE 5JP-A CATHODE-RAY TUBES

|   |                   |  |
|---|-------------------|--|
| Grid No. 1 Voltage  |                   |  |
| Negative Bias Value.....  | 125 Max. Volts dc |  |
| Positive Bias Value.....  | 0 Max. Volts dc   |  |
| Positive Peak Value.....  | 2 Max. Volts      |  |
| Peak Voltage between Anode No. 2 and any Deflecting Electrode ..... | 500 Max. Volts    |  |

### TYPICAL OPERATING CONDITIONS

|   |  |                    |
|---|--|--------------------|
| For Anode No. 3 Voltage of.....                       | 3000   | 4000 Volts         |
| For Anode No. 2 Voltage of.....                       | 1500   | 2000 Volts         |
| Anode No. 1 Voltage for focus .....                   | 250 to 472                                     | 333 to 630 Volts   |
| Grid No. 1 Voltage <sup>1</sup> .....                 | -34 to -79                                     | -45 to -105 Volts  |
| Deflection Factors:                                   |  |                    |
| D1 and D2 .....                                       | 58 to 86                                       | 77 to 115 d-cV/in. |
| D3 and D4 .....                                       | 58 to 86                                       | 77 to 115 d-cV/in. |
| Anode No. 1 Voltage for focus.....                    | 16.6% to 31.5% of Eb2 Volts                    |                    |
| Grid No. 1 Voltage <sup>1</sup> .....                 | 2.3% to 5.3% of Eb2 Volts                      |                    |
| Anode No. 1 Current for any operating condition ..... | -50 to + 10 Microamperes                       |                    |
| Deflection Factors:                                   |  |                    |
| No 3rd Anode or Eb3 = Eb2                             |  |                    |
| D1 and D2.....  | 34 to 50 Volts dc per inch per Kilovolt of Eb2 |                    |
| D3 and D4.....  | 34 to 50 Volts dc per inch per Kilovolt of Eb2 |                    |
| Eb3 = Twice Eb2                                       |  |                    |
| D1 and D2.....  | 38 to 58 Volts dc per inch per Kilovolt of Eb2 |                    |
| D3 and D4.....  | 38 to 58 Volts dc per inch per Kilovolt of Eb2 |                    |
| Spot Position (Undelected) <sup>2</sup> .....         | Within 15 Millimeters square                   |                    |

### MAXIMUM CIRCUIT VALUES

|   |                  |
|---|------------------|
| Grid No. 1 Circuit Resistance.....                                | 1.5 Max. Megohms |
| Resistance in any Deflecting Electrode Circuit <sup>3</sup> ..... | 5 Max. Megohms   |

### NOTES

- Visual extinction of undeflected focused spot.
- When the tube is operated at (1) normal heater voltage; (2) Eb3 = 3000 volts; (3) Eb2 = 1500 volts; (4) Eb1 adjusted for focus; (5) Ec1 set at such a value as will avoid damage to the screen; (6) with each of the deflecting electrodes connected to Anode No. 2; and (7) with the tube shielded against external influences:  
The spot will fall within a 15 mm. square, the center of which coincides with the geometric center of the tube face and the sides of which are parallel to the traces produced by deflecting electrodes D1 and D2 and by deflecting electrodes D3 and D4 respectively.
- It is recommended that the deflecting electrode circuit resistances be approximately equal.



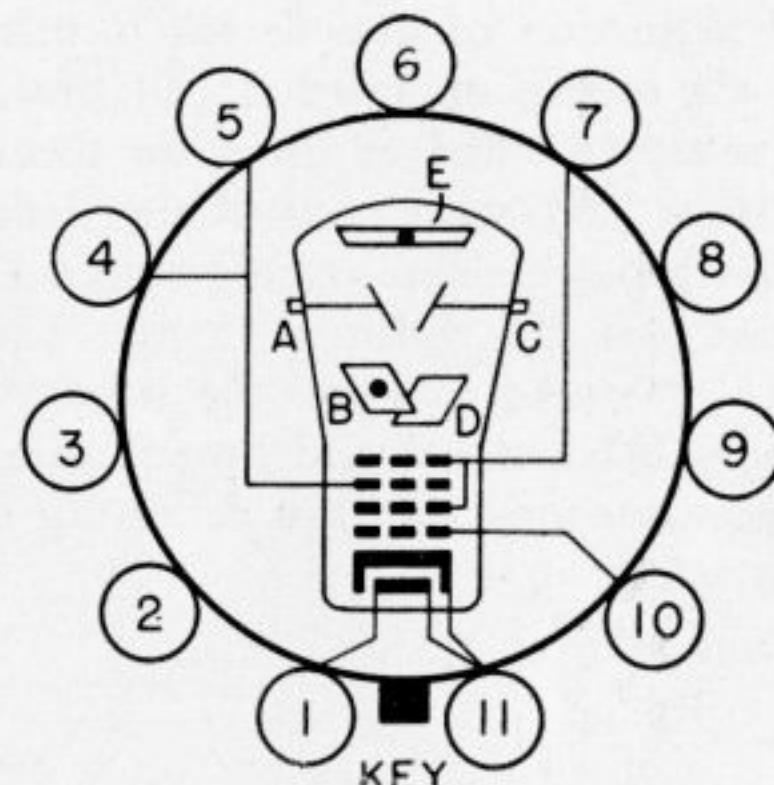
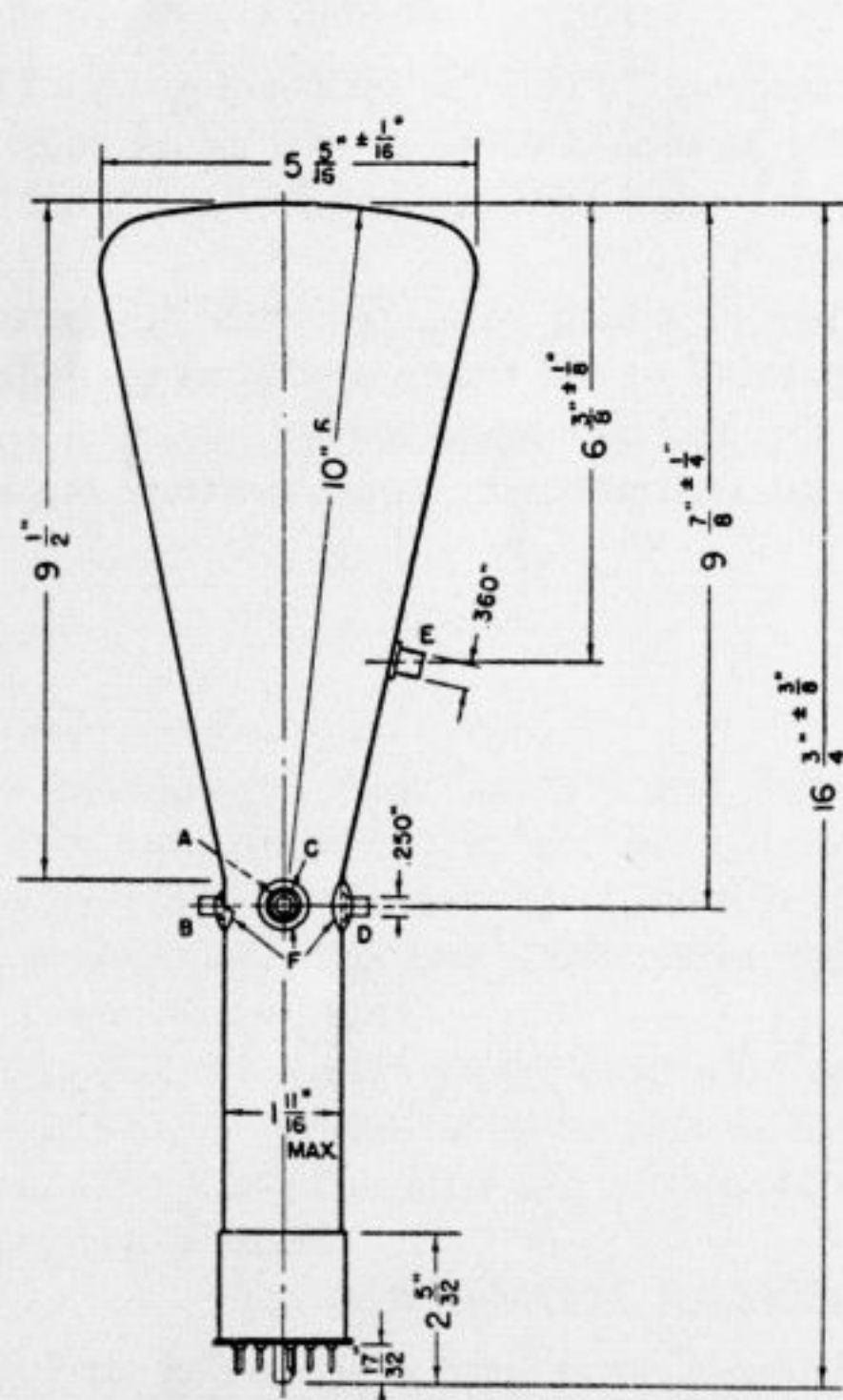
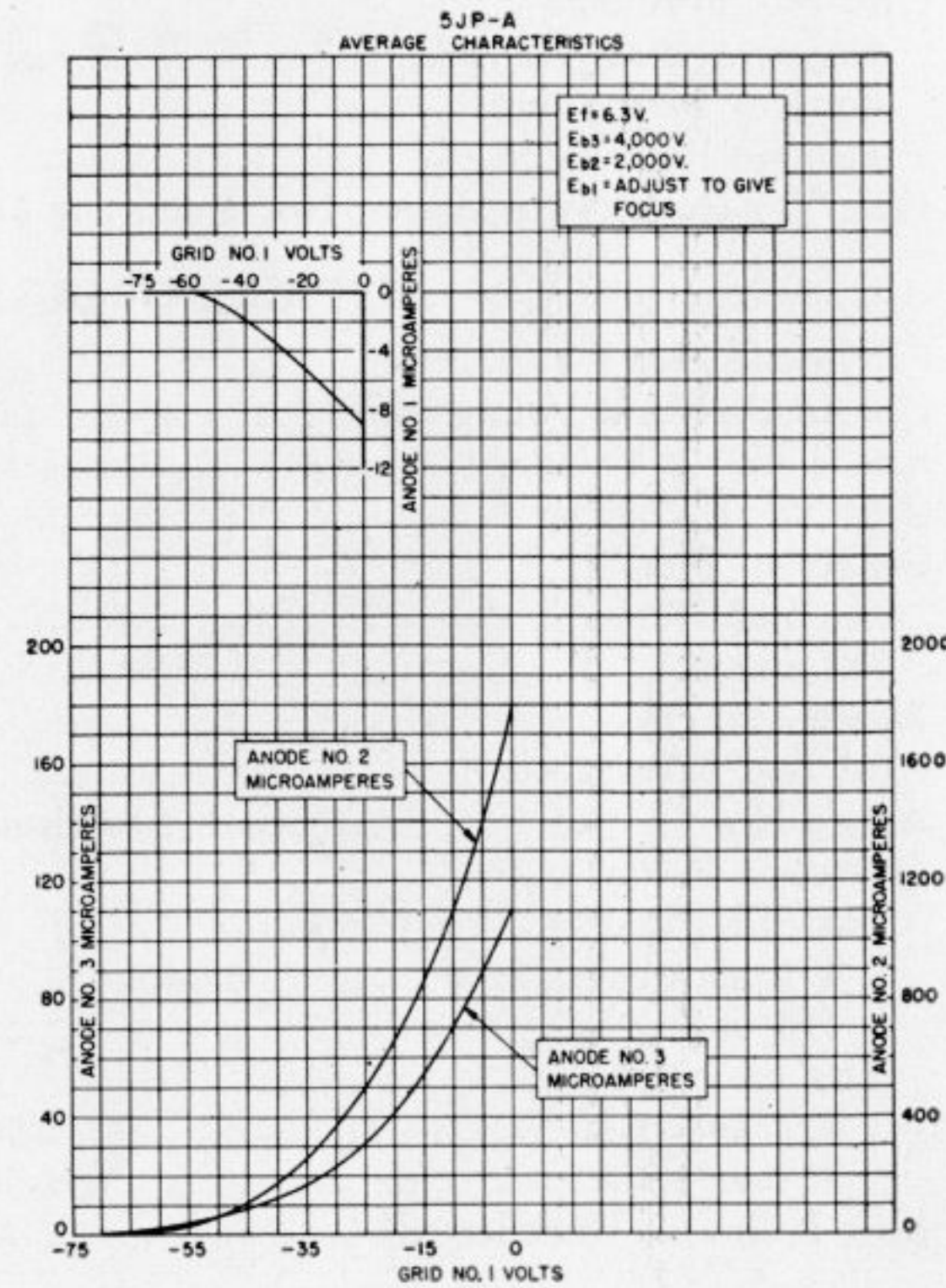
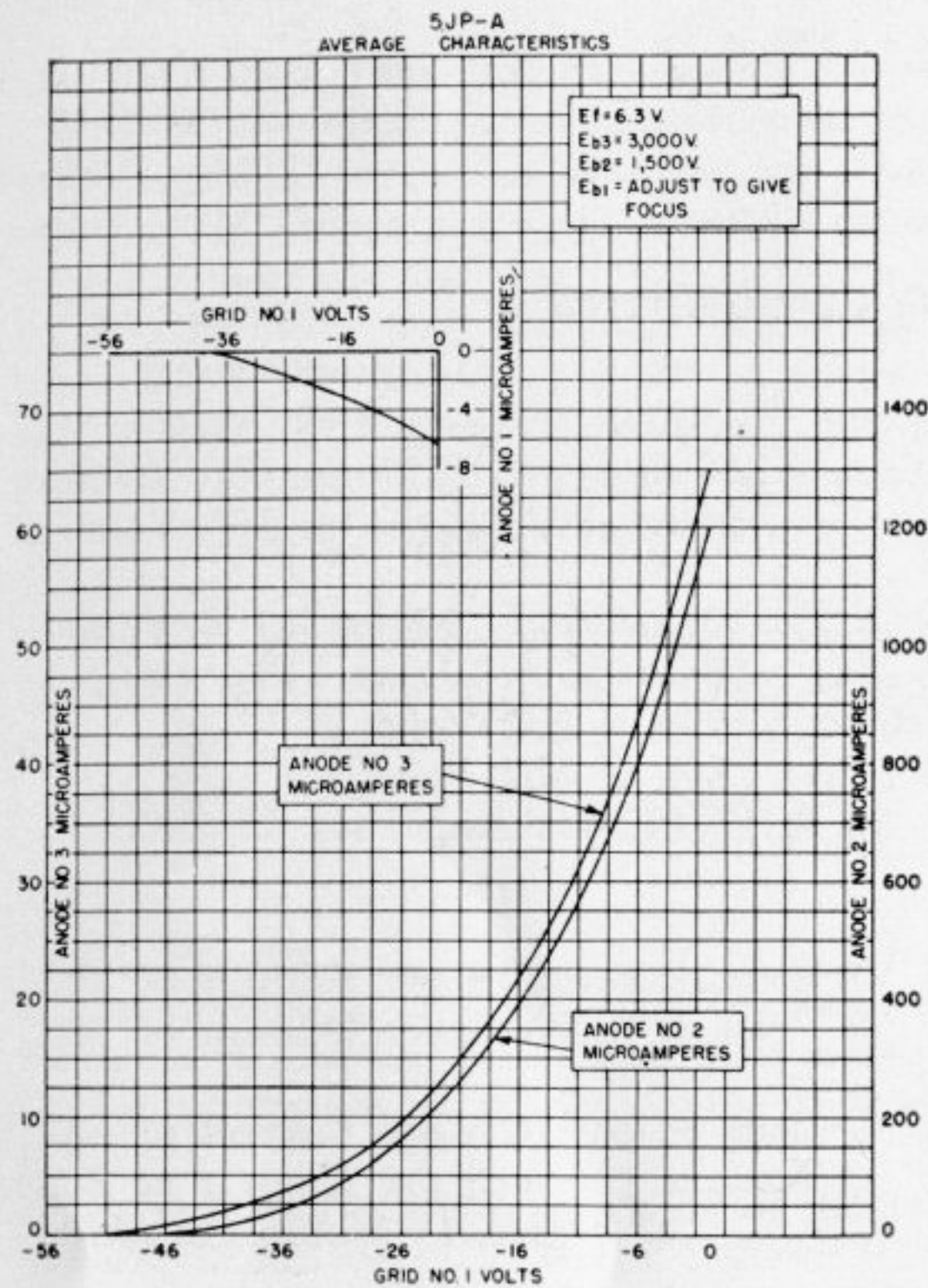

**Bottom View of Base**

| Pin No.    | Element                |
|------------|------------------------|
| 1          | Heater                 |
| 2          | No Connection          |
| 3          | No Connection          |
| 4          | Focusing Electrode     |
| 5          | Internal Connection    |
| 6          | No Connection          |
| 7          | Accelerating Electrode |
| 8          | No Connection          |
| 9          | No Connection          |
| 10         | Control Electrode      |
| 11         | Heater and Cathode     |
| Terminal A | Deflection Plate D1    |
| B          | Deflection Plate D4    |
| C          | Deflection Plate D2    |
| D          | Deflection Plate D3    |
| E          | Intensifier Electrode  |

## 5LP-A CATHODE-RAY TUBES

The Type 5LP-A cathode-ray tubes are designed for oscillographic applications. The intensifier principle is used to provide a maximum deflection sensitivity for a given final accelerating voltage. The gun is designed to draw negligible focusing electrode current.

The Type 5LP-A is recommended for replacement only.

### GENERAL CHARACTERISTICS

#### Electrical

|   |              |                        |
|---|--------------|------------------------|
| Heater Voltage                              | .....        | 6.3 ± 10% Volts        |
| Heater Current                              | .....        | 0.6 ± 10% Ampere       |
| Focusing Method                             | .....        | Electrostatic          |
| Deflecting Method                           | .....        | Electrostatic          |
| Phosphor                                    | P1 P2 P7 P11 |                        |
| Fluorescence                                | ....         | Green Green Blue Blue  |
| Phosphorescence                             |              | Green Yellow           |
| Persistence                                 | .....        | Medium Long Long Short |
| Direct Interelectrode Capacitances, Nominal |              |                        |
| Grid # 1 to all other electrodes            | .....        | 9.1 μμf.               |
| D1 to D2                                    | .....        | 2.0 μμf.               |
| D3 to D4                                    | .....        | 1.6 μμf.               |
| D1 to all other electrodes except D2        | .....        | 7.5 μμf.               |
| D2 to all other electrodes except D1        | .....        | 7.7 μμf.               |
| D3 to all other electrodes except D4        | .....        | 5.9 μμf.               |
| D4 to all other electrodes except D3        | .....        | 6.9 μμf.               |



#### Mechanical

|                                |       |                 |
|--------------------------------|-------|-----------------|
| Overall Length                 | ..... | 16-3/4" ± 3/8"  |
| Greatest Diameter of Bulb      | ..... | 5-5/16" ± 1/16" |
| Minimum Useful Screen Diameter | ..... | 4-1/2"          |
| Bulb Contact                   | ..... | Small Cap       |
| Base                           | ..... | Medium Magnal   |
| Basing                         | ..... | 11F             |

#### Base Alignment:

|   |       |                |
|---|-------|----------------|
| 3D4 trace aligns with Pin #6 and tube axis                              | ..... | ± 10 Degrees   |
| Positive voltage on D1 deflects beam approximately toward Pin #3.       |       |                |
| Positive voltage on D3 deflects beam approximately toward locating key. |       |                |
| Angle between 3D4 and 1D2 traces  | ..... | 90 ± 3 Degrees |

#### Bulb contact alignment:

|   |       |               |
|---|-------|---------------|
| Anode No. 3 Contact aligns with 3D4 trace         | ..... | ± 10 Degrees. |
| Anode No. 3 Contact on same side as locating key. |       |               |

### MAXIMUM RATINGS—(Design Center Values)

|   |       |                    |
|---|-------|--------------------|
| Anode No. 3 Voltage (accelerator High-Voltage Electrode)      | ..... | 4000 Max. Volts dc |
| Anode No. 2 Voltage   | ..... | 2000 Max. Volts dc |
| Ratio Anode No. 3 Voltage to Anode No. 2 Voltage              | ..... | 2 Max.             |
| Anode No. 1 Voltage   | ..... | 1000 Max. Volts dc |
| Grid No. 1 Voltage  |       |                    |
| Negative Bias Value   | ..... | 125 Max. Volts dc  |
| Positive Bias Value   | ..... | 0 Max. Volts dc    |
| Positive Peak Value   | ..... | 2 Max. Volts       |
| Peak Voltage between Anode No. 2 and any Deflection Electrode | ..... | 550 Max. Volts     |

**TYPICAL OPERATING CONDITIONS**

|   |  |                    |
|---|--|--------------------|
| For Anode No. 3 Voltage of .....                      | 3000   | 4000 Volts         |
| For Anode No. 2 Voltage of .....                      | 1500   | 2000 Volts         |
| Anode No. 1 Voltage for focus .....                   | 282 to 475                                       | 376 to 633 Volts   |
| Grid No. 1 Voltage <sup>1</sup> .....                 | -22.5 to -67.5                                   | -30 to -90 Volts   |
| Deflection Factors:                                   |  |                    |
| D1 and D2 .....                                       | 62 to 93   | 83 to 124 d-cV/in. |
| D3 and D4 .....                                       | 54 to 81   | 72 to 108 d-cV/in. |
| Anode No. 1 Voltage for focus .....                   | 18.8% to 31.6% of Eb2 Volts                      |                    |
| Grid No. 1 Voltage <sup>1</sup> .....                 | 1.5% to 4.5% of Eb2 Volts                        |                    |
| Anode No. 1 Current for any operating condition ..... | -50 to + 10 Microamperes                         |                    |
| Deflection Factors:                                   |  |                    |
| No 3rd Anode or Eb3 = Eb2                             |  |                    |
| D1 and D2 .....                                       | 33 to 51 Volts dc per Inch per Kilovolt of Eb2   |                    |
| D3 and D4 .....                                       | 31 to 45 Volts dc per Inch per Kilovolt of Eb2   |                    |
| Eb3 = Twice Eb2                                       |  |                    |
| D1 and D2 .....                                       | 41.5 to 62 Volts dc per Inch per Kilovolt of Eb2 |                    |
| D3 and D4 .....                                       | 36 to 54 Volts dc per Inch per Kilovolt of Eb2   |                    |
| Spot Position (Undelected) <sup>2</sup> .....         | Within 20 Millimeters square                     |                    |

**MAXIMUM CIRCUIT VALUES**

|   |                  |
|---|------------------|
| Grid No. 1 Circuit Resistance .....                               | 1.5 Max. Megohms |
| Resistance in any Deflecting Electrode Circuit <sup>3</sup> ..... | 5 Max. Megohms   |

**NOTES**

1. Visual extinction of undeflected focused spot.
2. When the tube is operated at (1) normal heater voltage; (2) Eb3 = 3000 volts; (3) Eb2 = 1500 volts; (4) Eb1 adjusted for focus; (5) Ec1 set at such a value as will avoid damage to the screen; (6) with each of the deflecting electrodes connected to Anode No. 2; and (7) with the tube shielded against external influences:  
The spot will fall within a 20 mm. square, the center of which coincides with the geometric center of the tube face and the sides of which are parallel to the traces produced by deflecting electrodes D1 and D2 and by deflecting electrodes D3 and D4 respectively.
3. It is recommended that the deflecting electrode circuit resistances be approximately equal.

**TYPE 5LP-A CATHODE-RAY TUBES**

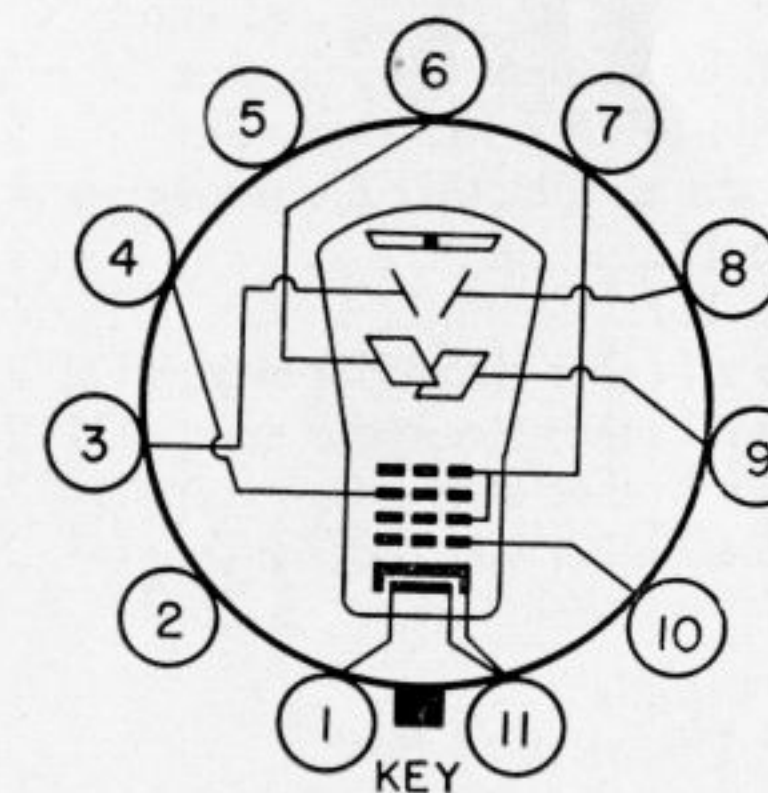
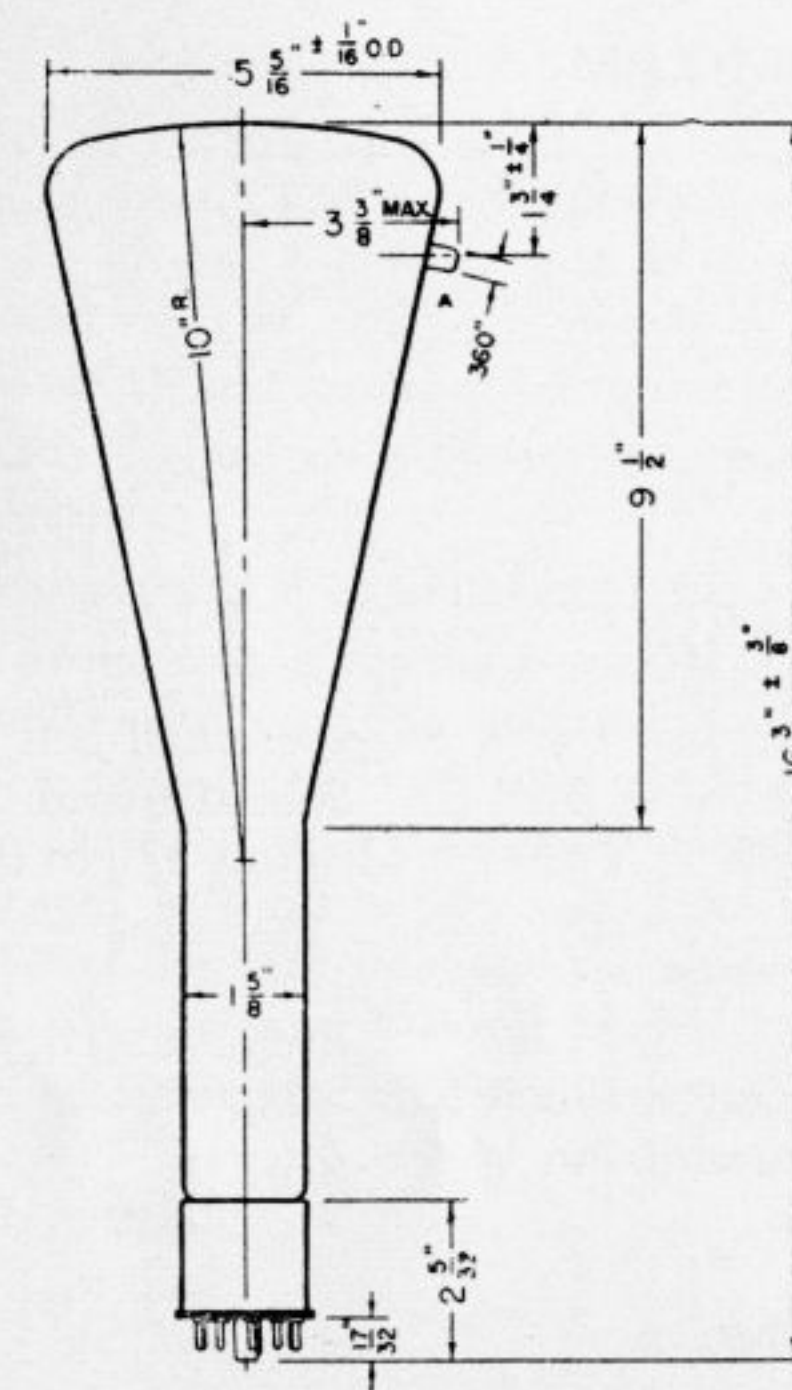
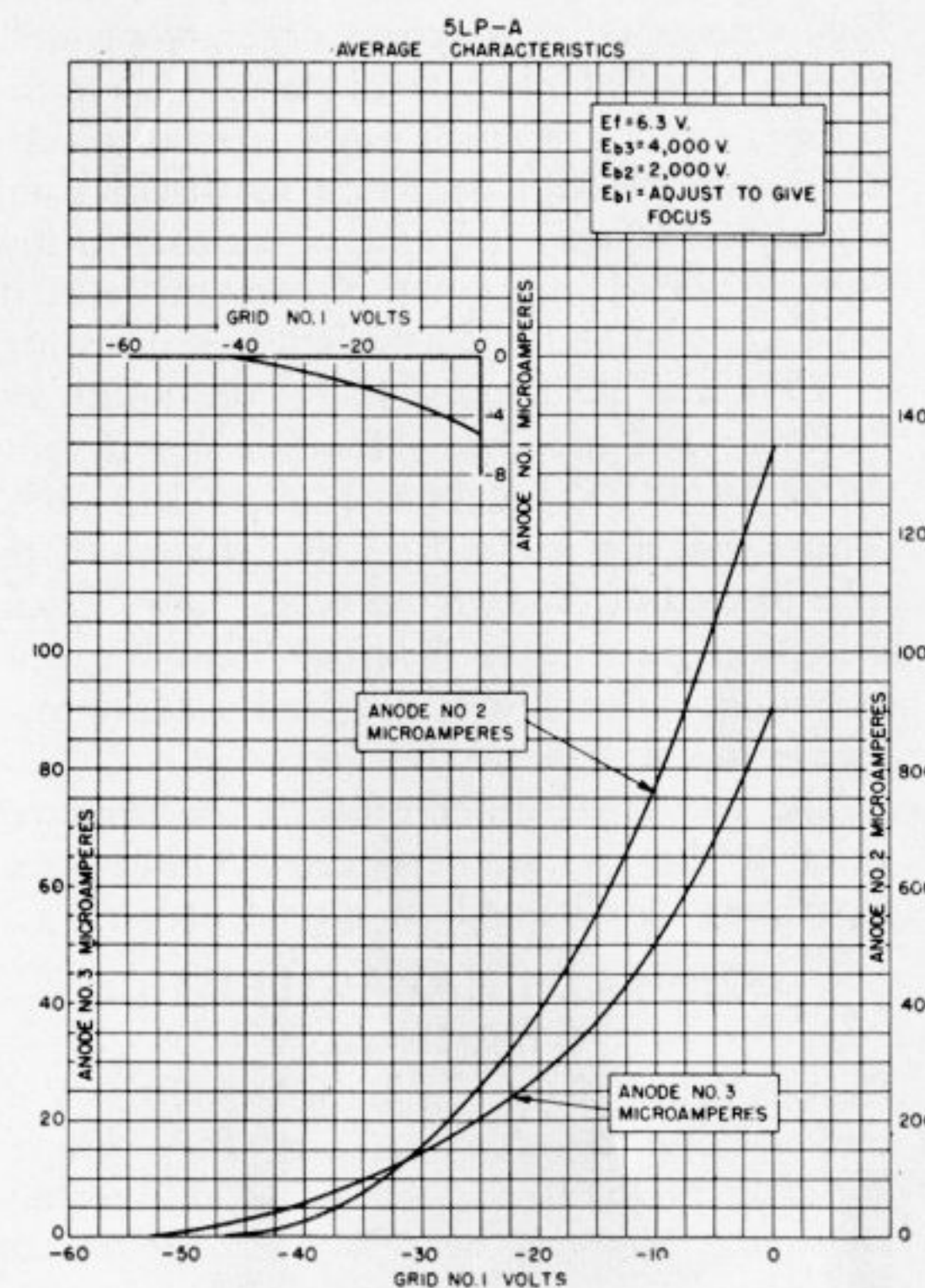
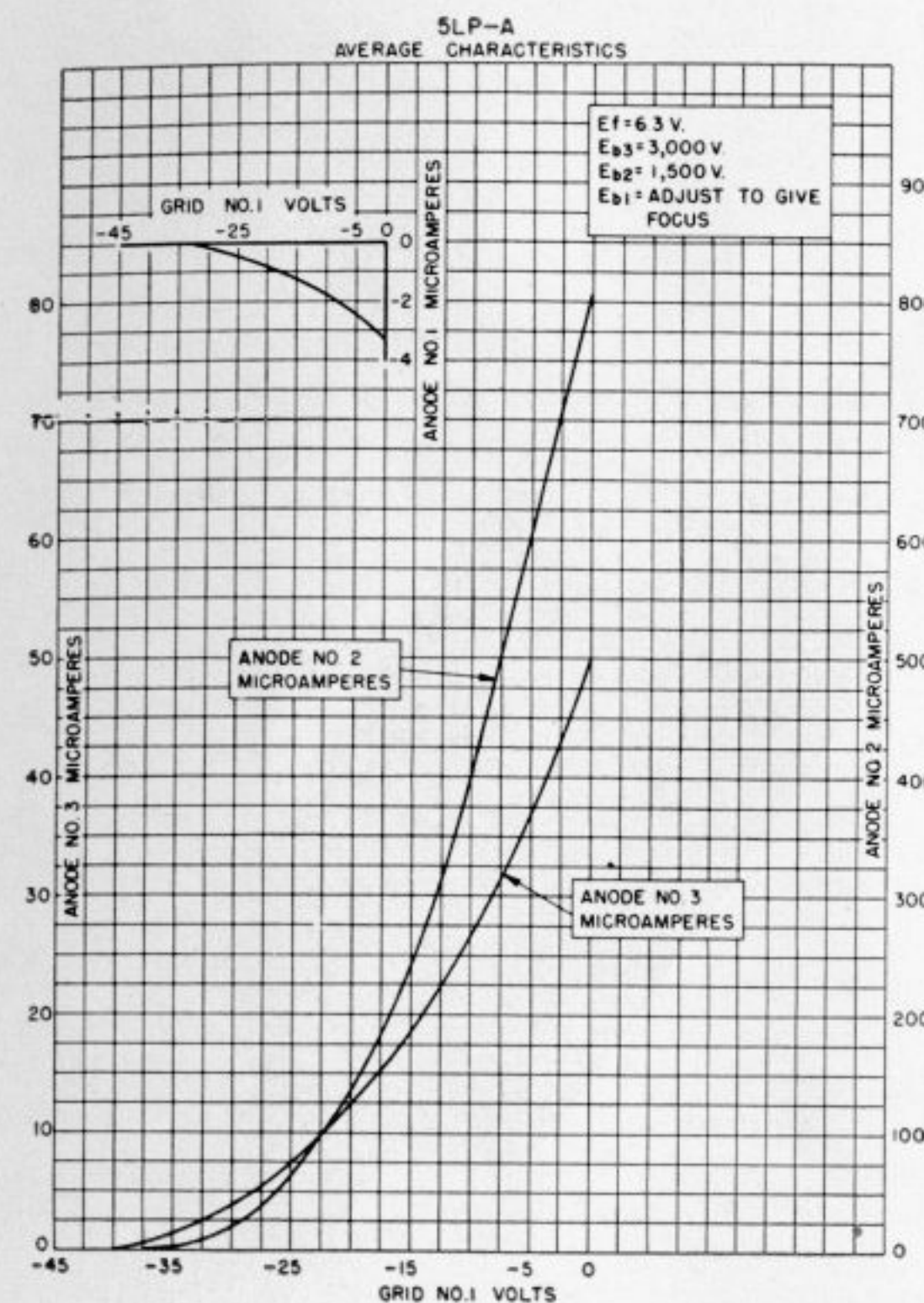

**Bottom View of Base**

| Pin No.    | Element                |
|------------|------------------------|
| 1          | Heater                 |
| 2          | No Connection          |
| 3          | Deflection Plate D1    |
| 4          | Focusing Electrode     |
| 5          | Internal Connection    |
| 6          | Deflection Plate D4    |
| 7          | Accelerating Electrode |
| 8          | Deflection Plate D2    |
| 9          | Deflection Plate D3    |
| 10         | Control Electrode      |
| 11         | Heater and Cathode     |
| Terminal A | Intensifier Electrode  |

# 5RP-A CATHODE-RAY TUBES

The Type 5RP-A Cathode-ray Tubes are high-voltage tubes which incorporate an intensifier subdivided into several steps. This feature permits the use of much higher overall accelerating voltages with deflection sensitivities only slightly less than heretofore obtainable in low-voltage cathode-ray tubes. Operation with intensifier to second anode voltage ratios as high as 10:1 are made possible by the multiband feature. The tube has a flat face and a cylindrical body. The deflection plate and anode connections are made through the neck of the tube instead of through the base. Low-capacity deflection plate leads facilitate high-frequency operation. The gun is designed to draw negligible focusing electrode current.

The two types differ only in the characteristics of the fluorescent screens. Other screen types may be obtained on special order.

## GENERAL CHARACTERISTICS

### Electrical

|   |               |        |
|---|---------------|--------|
| Heater Voltage.....                         | 6.3 ± 10%     | Volts  |
| Heater Current.....                         | 0.6 ± 10%     | Ampere |
| Focusing Method .....                       | Electrostatic |        |
| Deflecting Method .....                     | Electrostatic |        |
| Phosphor .....                              | P2            | P11    |
| Fluorescence .....                          | Green         | Blue   |
| Phosphorescence .....                       | Green         |        |
| Persistence .....                           | Long          | Short  |
| Direct Interelectrode Capacitances, Nominal |               |        |
| Cathode to all other electrodes .....       | 5.0 μmf.      |        |
| Grid #1 to all other electrodes .....       | 5.4 μmf.      |        |
| D1 to D2 .....                              | 1.8 μmf.      |        |
| D3 to D4 .....                              | 1.8 μmf.      |        |
| D1 to all other electrodes except D2 .....  | 2.3 μmf.      |        |
| D2 to all other electrodes except D1 .....  | 2.1 μmf.      |        |
| D3 to all other electrodes except D4 .....  | 2.4 μmf.      |        |
| D4 to all other electrodes except D3 .....  | 2.2 μmf.      |        |

### Mechanical

|   |                            |
|---|----------------------------|
| Overall Length .....  | 16-3/4" ± 3/8"             |
| Greatest Diameter of Bulb .....                                   | 5-1/4" ± 3/32"             |
| Minimum Useful Screen Diameter .....                              | 4-1/4"                     |
| Bulb Contacts .....   | Snap terminal ball contact |
| Neck Contacts .....   | Special lateral contacts   |
| Base .....  | Medium 12-pin diheptal     |
| Basing .....  | 14F                        |
| Base Alignment:   |                            |
| 1D2 trace aligns with Pin #5 and tube axis .....                  | ± 10 Degrees               |
| Positive voltage on D1 deflects beam approximately toward Pin #5. |                            |
| Positive voltage on D3 deflects beam approximately toward Pin #2. |                            |
| Angle between 3D4 and 1D2 traces .....                            | 90 ± 3 Degrees             |
| Bulb contact alignment:   |                            |
| Snap terminal contacts align with 1D2 trace ± 10 Degrees.         |                            |
| Contacts on same side as Pin #5                                   |                            |

### MAXIMUM RATINGS—(Design Center Values)

|  |                      |
|--|----------------------|
| Anode No. 3 Voltage (accelerator High-Voltage Electrode) ..... | 25,500 Max. Volts dc |
| Anode No. 2 Voltage .....                                      | 3500 Max. Volts dc   |

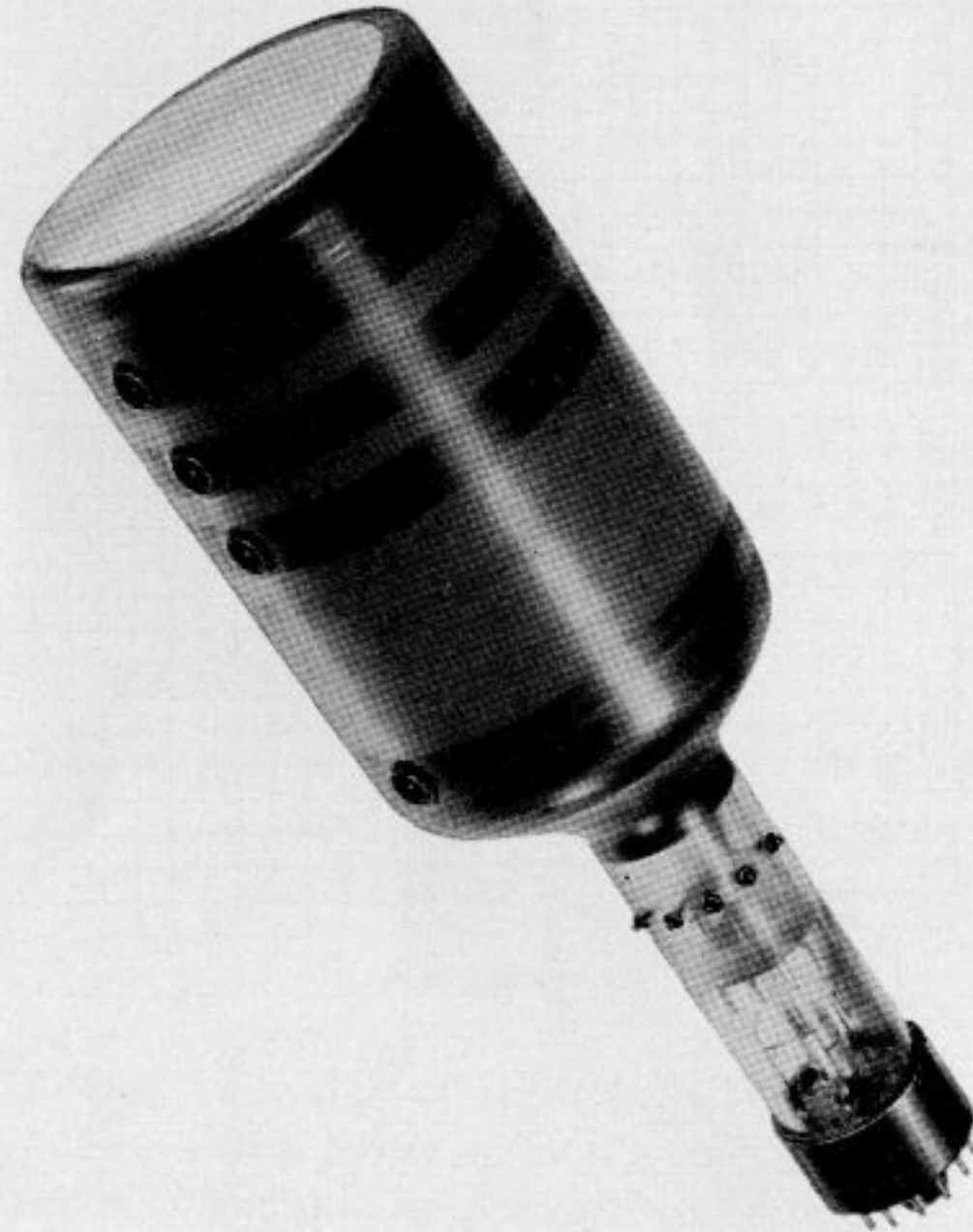

## TYPE 5RP-A CATHODE-RAY TUBES

|  |                    |
|--|--------------------|
| Ratio Anode No. 3 Voltage to Anode No. 2 Voltage.....              | 10 Max.            |
| Anode No. 1 Voltage .....  | 1550 Max. Volts dc |
| Grid No. 1 Voltage   |                    |
| Negative—Bias Value .....  | 200 Max. Volts dc  |
| Positive—Bias Value .....  | 0 Max. Volts dc    |
| Positive—Peak Value .....  | 2 Max. Volts       |
| Peak Heater Cathode Voltage <sup>1</sup>                           |                    |
| Heater Negative with respect to Cathode .....                      | 125 Max. Volts dc  |
| Heater Positive with respect to Cathode.....                       | 125 Max. Volts dc  |
| Peak Voltage between Anode No. 2 and any Deflection Electrode..... | 1200 Max. Volts    |

### TYPICAL OPERATING CONDITIONS

|   |                              |                                       |         |
|---|------------------------------|---------------------------------------|---------|
| For Anode No. 3 Voltage <sup>2</sup> of .....       | 10,000                       | 20,000                                | Volts   |
| For Anode No. 2 Voltage of .....                    | 2000                         | 2000                                  | Volts   |
| Anode No. 1 Voltage for focus .....                 | 362 to 695                   | 362 to 695                            | Volts   |
| Grid No. 1 Voltage <sup>3</sup> .....               | -30 to -90                   | -30 to -90                            | Volts   |
| Deflection Factors:                                 |                              |                                       |         |
| D1 and D2.....                                      | 102 to 154                   | 140 to 210                            | dcV/in. |
| D3 and D4.....                                      | 97 to 145                    | 131 to 197                            | dcV/in. |
| Anode No. 1 Voltage for focus .....                 | 18.1% to 34.8%               | of Eb2                                | Volts   |
| Grid No. 1 Voltage <sup>3</sup> .....               | 1.5% to 4.5%                 | of Eb2                                | Volts   |
| Anode No. 1 Current for any operating condition ... | -50 to ± 10                  | Microamperes                          |         |
| Deflection Factors:                                 |                              |                                       |         |
| No 3rd Anode or Eb3 = Eb2                           |                              |                                       |         |
| D1 and D2.....                                      | 30 to 45                     | Volts dc per inch per Kilovolt of Eb2 |         |
| D3 and D4.....                                      | 30 to 45                     | Volts dc per inch per Kilovolt of Eb2 |         |
| Eb3 = Twice Eb2                                     |                              |                                       |         |
| D1 and D2.....                                      | 36 to 54                     | Volts dc per inch per Kilovolt of Eb2 |         |
| D3 and D4.....                                      | 36 to 54                     | Volts dc per inch per Kilovolt of Eb2 |         |
| Spot Position (Undelected) <sup>4</sup> .....       | Within 20 Millimeters square |                                       |         |

### MAXIMUM CIRCUIT VALUES

|   |                  |
|---|------------------|
| Grid No. 1 Circuit Resistance .....                               | 1.5 Max. Megohms |
| Resistance in any Deflecting Electrode Circuit <sup>5</sup> ..... | 5 Max. Megohms   |

### NOTES

- Cathode should be returned to one side or to the mid-tap of the heater transformer winding.
- Equally divided over the three intensifier electrodes. See page 158 for suggested method of connection.
- Visual extinction of undeflected focused spot.
- When the tube is operated at (1) normal heater voltage; (2) Eb2 = 2000 volts; (3) Eb3 = 10,000 volts; (4) Eb1 adjusted for focus; (5) Ec1 set at such a value as will avoid damage to the screen; (6) with each of the deflecting electrodes connected to Anode No. 2; and (7) with the tube shielded against external influences:  
The spot will fall within a 20 mm. square, the center of which coincides with the geometric center of the tube face; and the sides of which are parallel to the traces produced by deflecting electrodes D1 and D2 and by deflecting electrodes D3 and D4 respectively.
- It is recommended that the deflecting electrode circuit resistances be approximately equal.

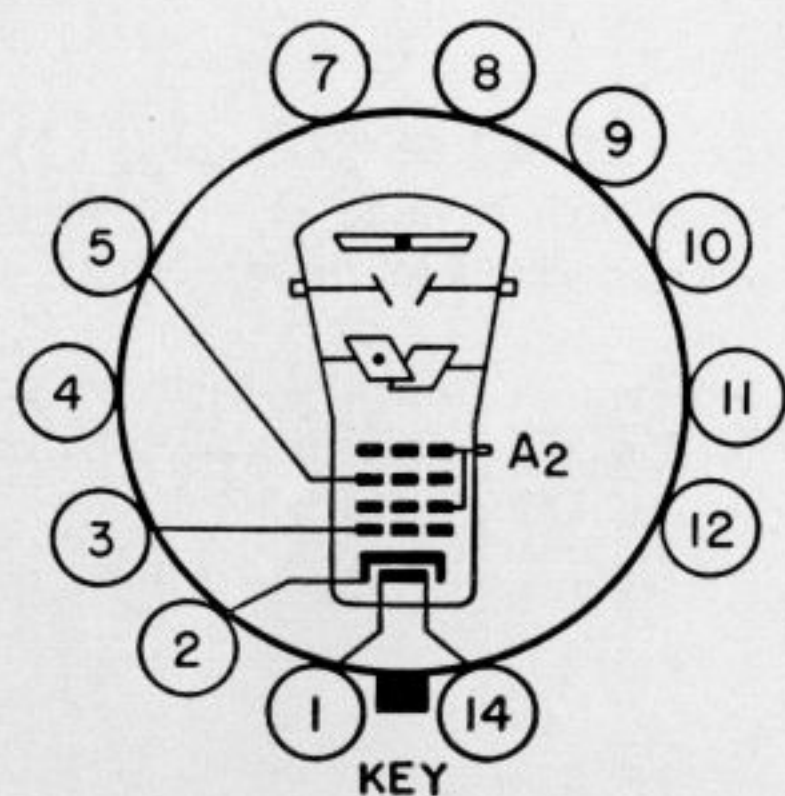
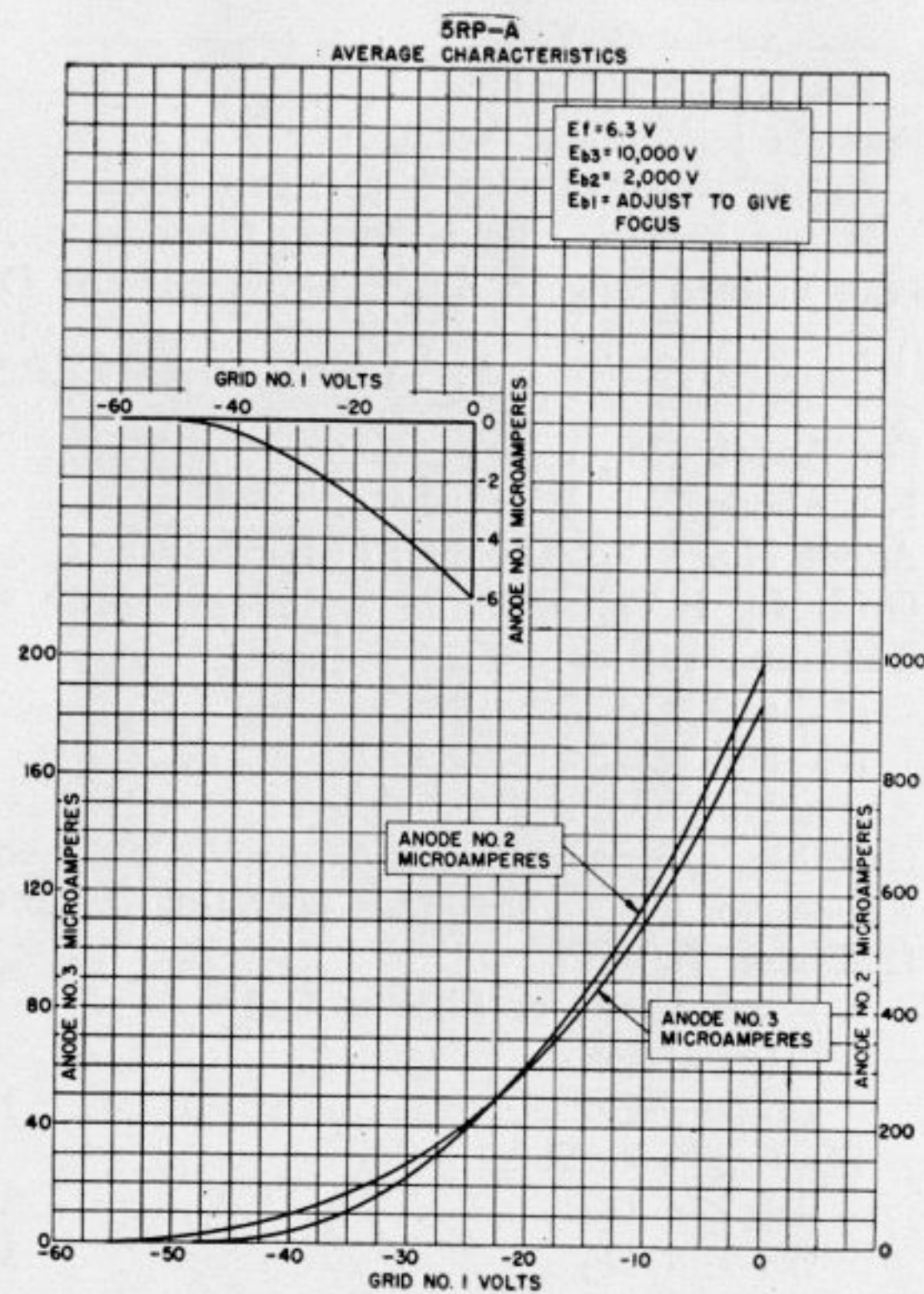
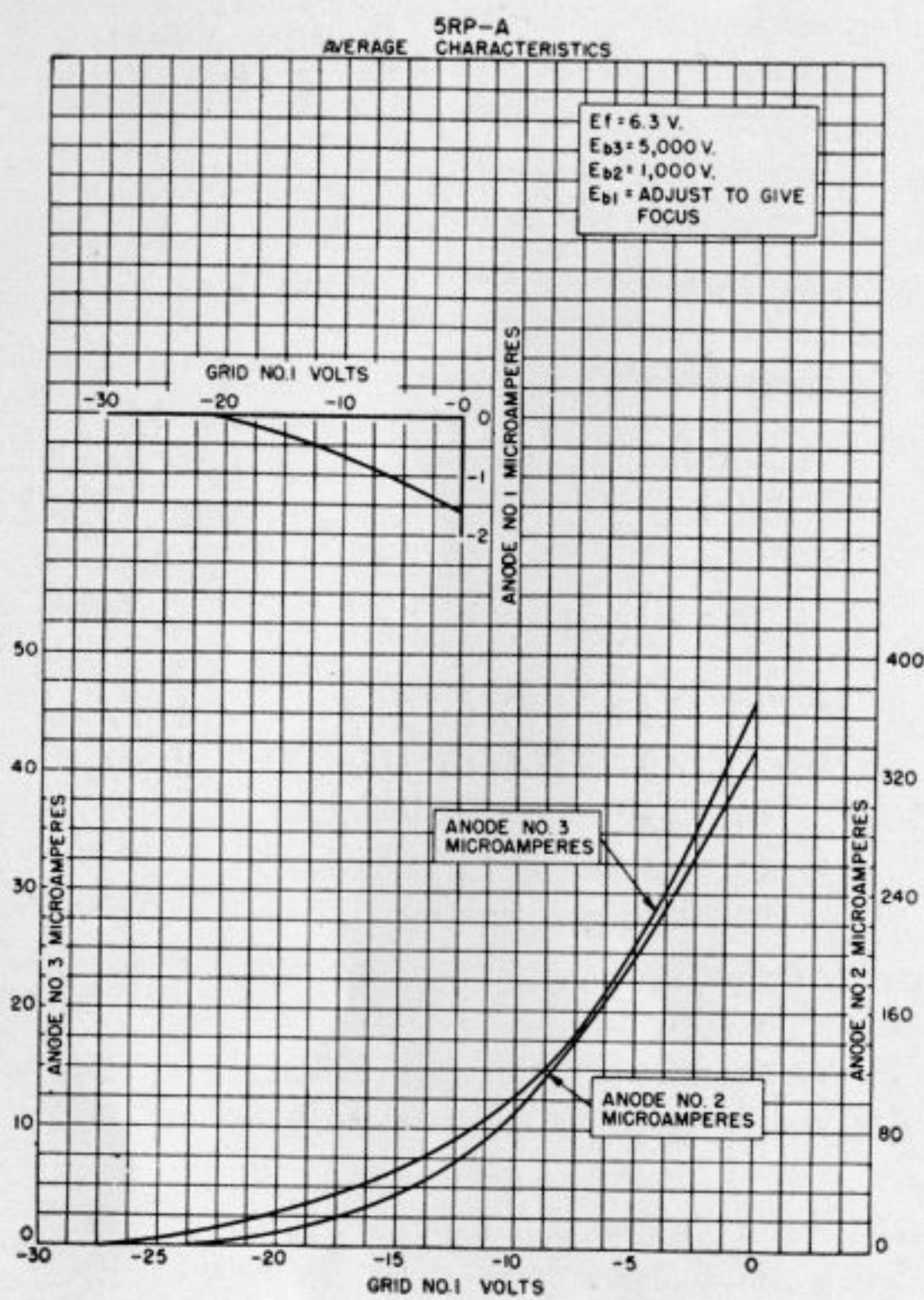

**Bottom View of Base**

| Pin No.    | Element                  |
|------------|--------------------------|
| 1          | Heater                   |
| 2          | Cathode                  |
| 3          | Control Electrode        |
| 4          | Internal Connection      |
| 5          | Focusing Electrode       |
| 7          | No Connection            |
| 8          | " "                      |
| 9          | " "                      |
| 10         | " "                      |
| 11         | " "                      |
| 12         | " "                      |
| 14         | Heater                   |
| Terminal A | Deflection Plate D4      |
| B          | Deflection Plate D3      |
| C          | Deflection Plate D1      |
| D          | Deflection Plate D2      |
| E          | 2nd Anode                |
| F          | Intensifier Electrode #1 |
| G          | Intensifier Electrode #2 |
| H          | Intensifier Electrode #3 |

TYPE 5RP-A CATHODE-RAY TUBES

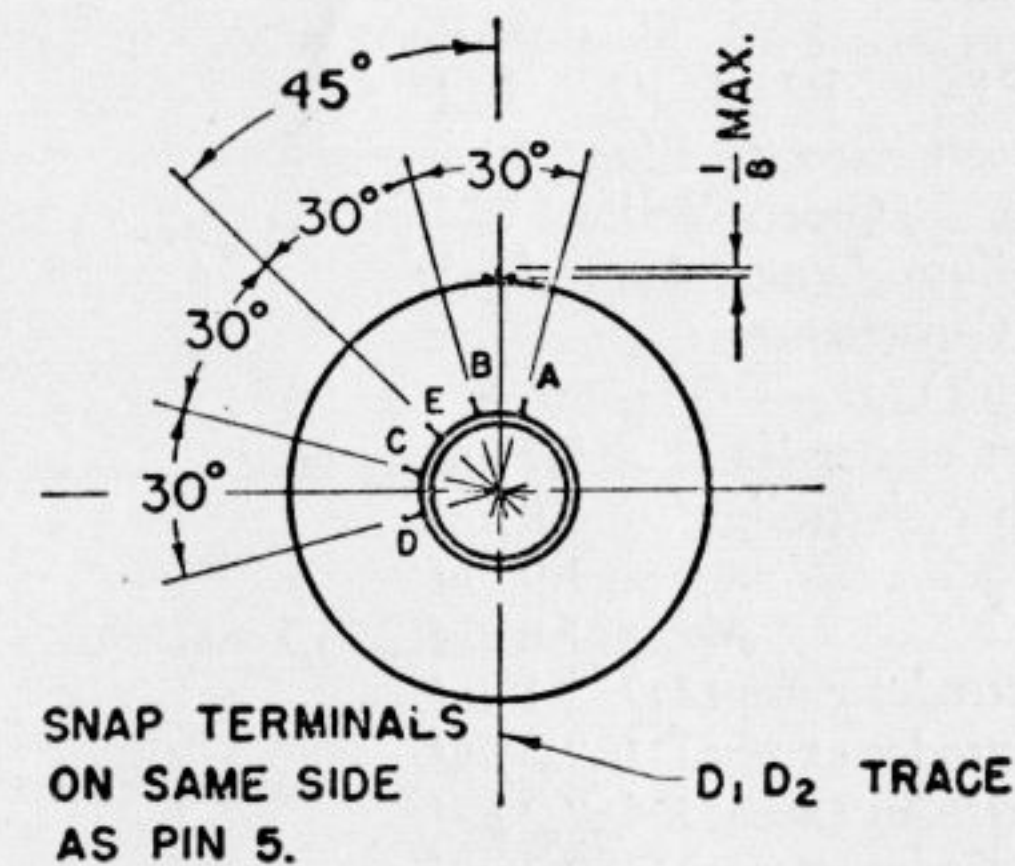
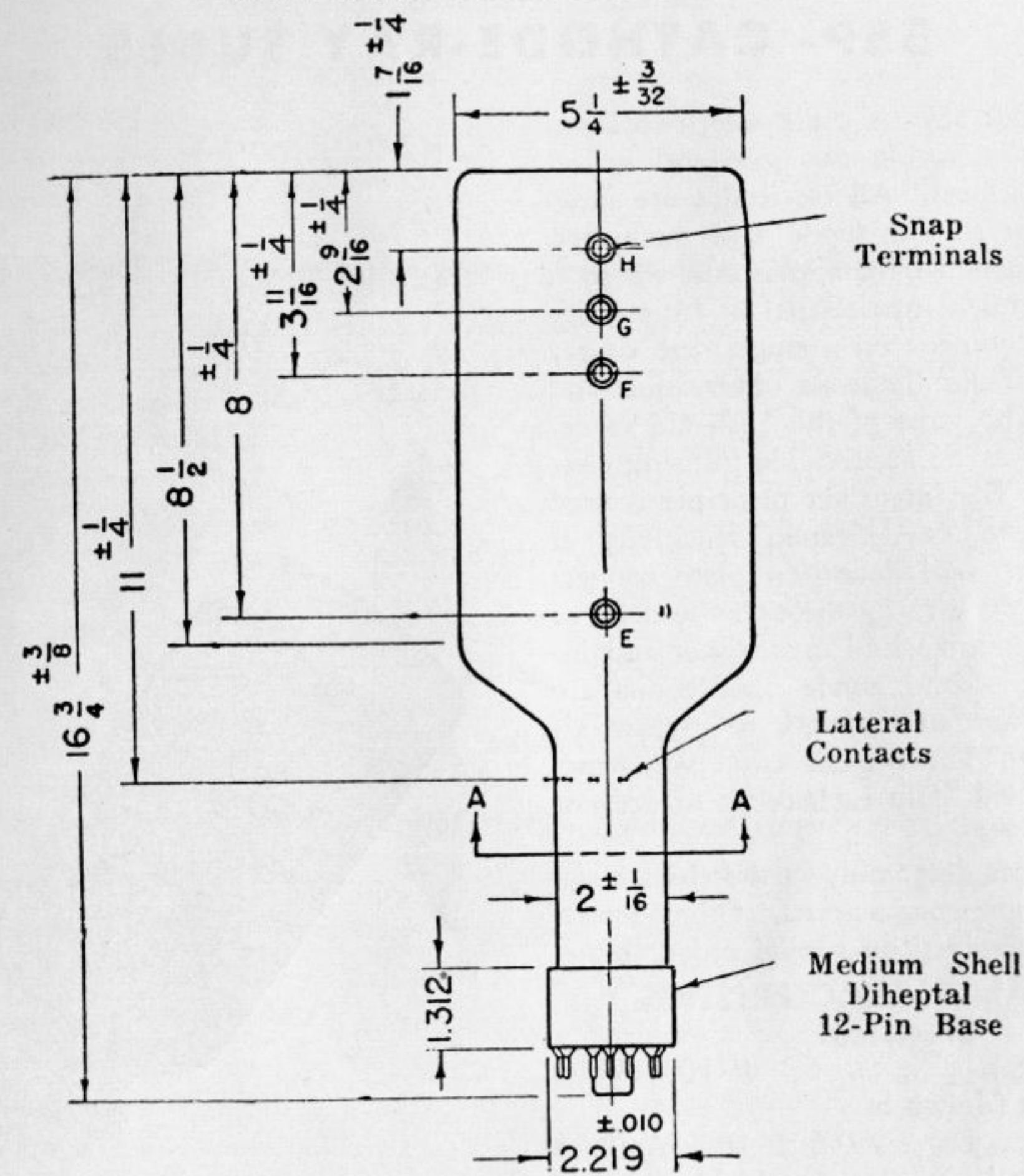

**SECTION A-A**  
**Suggested Method of Intensifier Connection**

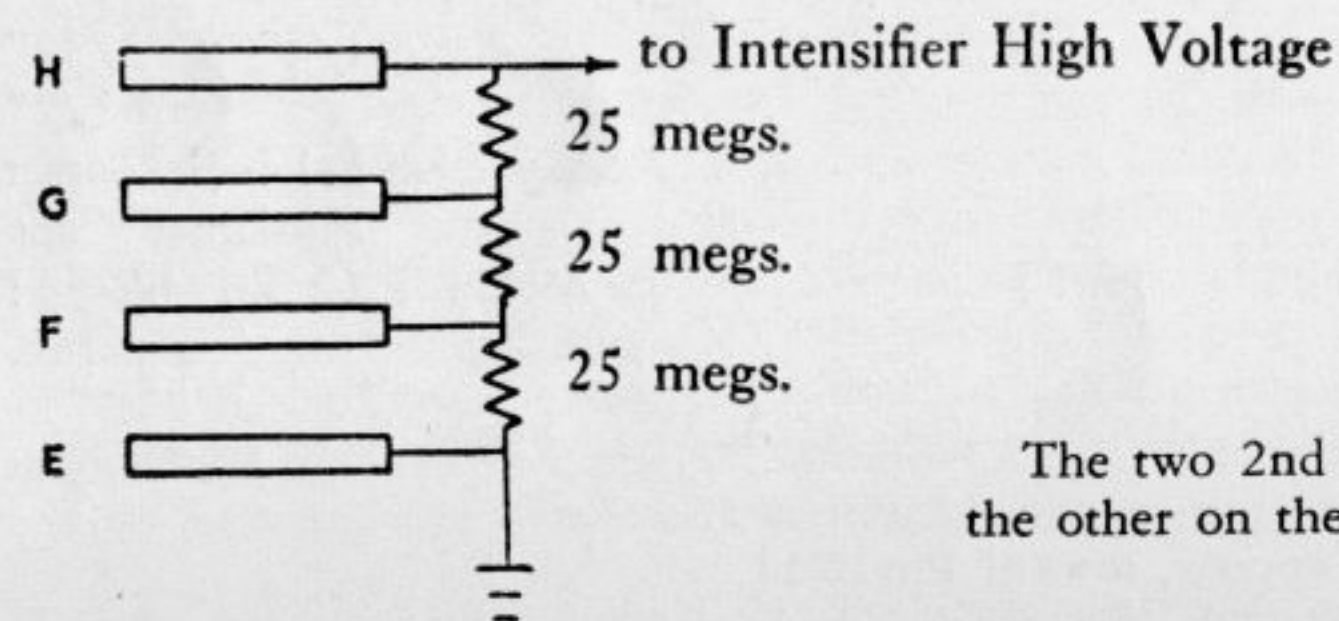

The two 2nd anode terminals (one on the tube head, the other on the tube neck) must be connected together.

# 5SP- CATHODE-RAY TUBES

The Du Mont 5SP- is a flat face, two beam cathode-ray tube having two gun and deflection plate structures. All electrodes are independent except second anode and intensifier. The 5SP- is intended for application where it is desired to present two related or entirely independent phenomena on a single cathode-ray tube screen for simultaneous observation and comparison. The guns of the 5SP- are so designed as to draw no appreciable focusing electrode current. The intensifier principle is used to obtain maximum deflection sensitivity at high brightness. All deflection plate connections are brought directly through the neck of the tube to minimize lead capacitance and inductance. The second anode connections are also brought through the neck to give maximum insulation. The two deflection plate structures are shielded from each other to prevent interaction.

The four types differ only in the characteristics of the fluorescent screens. Other screen types may be obtained on special order.

## GENERAL CHARACTERISTICS

### Electrical

|   |                  |       |        |       |
|---|------------------|-------|--------|-------|
| Heater Voltage.....   | 6.3 ± 10% Volts  |       |        |       |
| Heater Current (drawn by each unit) .....                   | 0.6 ± 10% Ampere |       |        |       |
| Focusing Method .....                                       | Electrostatic    |       |        |       |
| Deflecting Method .....                                     | Electrostatic    |       |        |       |
| Phosphor  | P1               | P2    | P7     | P11   |
| Fluorescence.....   | Green            | Green | Blue   | Blue  |
| Phosphorescence .....                                       | Green            |       | Yellow |       |
| Persistence .....   | Medium           | Long  | Long   | Short |
| Direct Interelectrode Capacitances, Nominal (for each unit) |                  |       |        |       |
| Cathode to all other electrodes.....                        | 3.7 μmf.         |       |        |       |
| Grid #1 to all other electrodes.....                        | 3.8 μmf.         |       |        |       |
| D1 to D2.....   | 1.9 μmf.         |       |        |       |
| D3 to D4.....   | 1.8 μmf.         |       |        |       |
| D1 to all other electrodes except D2.....                   | 2.1 μmf.         |       |        |       |
| D2 to all other electrodes except D1.....                   | 2.0 μmf.         |       |        |       |
| D3 to all other electrodes except D4.....                   | 2.2 μmf.         |       |        |       |
| D4 to all other electrodes except D3.....                   | 2.2 μmf.         |       |        |       |

### Mechanical

|  |                            |
|--|----------------------------|
| Overall Length .....   | 18-1/4" ± 3/8"             |
| Greatest Diameter of Bulb .....                              | 5-1/4" ± 3/32"             |
| Minimum Useful Screen Diameter .....                         | 4-1/2"                     |
| Bulb Contact .....   | Snap terminal ball contact |
| Neck Contacts .....  | Miniature Caps             |
| Base .....   | Medium 12-pin diheptal     |
| Basing .....   | 14K                        |
| Base Alignment (for each unit):                              |                            |
| 3D4 trace aligns with Pin #4 and tube axis.....              | ± 10 Degrees               |
| Positive voltage on D1 deflects beam approx. toward Pin #1.  |                            |
| Positive voltage on D3 deflects beam approx. toward Pin #11. |                            |

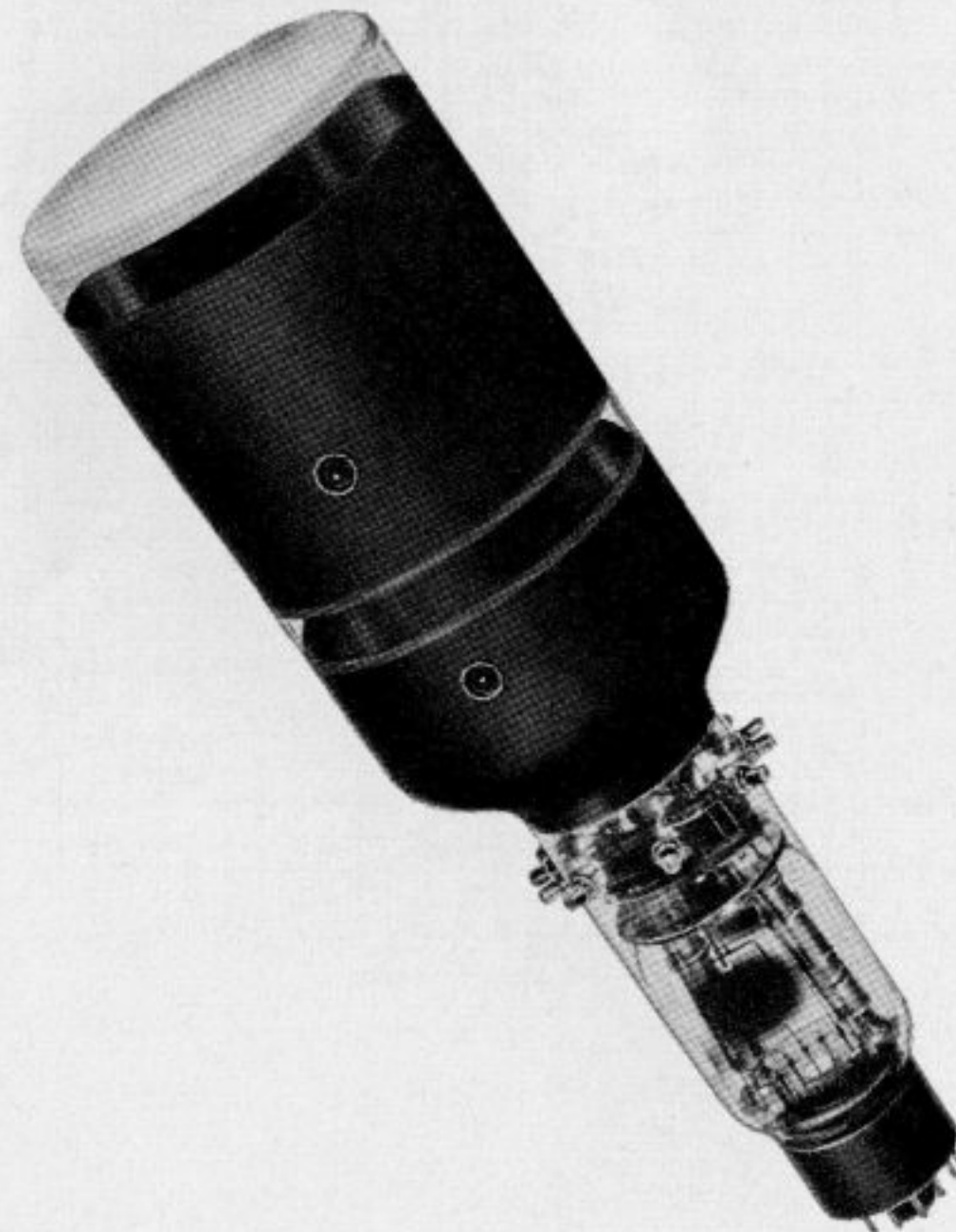

## TYPE 5SP- CATHODE-RAY TUBES

|   |                  |
|---|------------------|
| Angle between 3D4 and 1D2 traces.....             | 90 ± 1.5 Degrees |
| Bulb contact alignment                            |                  |
| Snap terminal contacts align with 3D4 trace ..... | ± 10 Degrees     |
| Contacts on same side as Pin #4.                  |                  |

### MAXIMUM RATINGS—Design Center Values (Values are for each unit)

|  |                    |
|--|--------------------|
| Anode No. 3 Voltage (accelerator High-Voltage Electrode).....      | 6000 Max. Volts dc |
| Anode No. 2 Voltage .....  | 2000 Max. Volts dc |
| Ratio Anode No. 3 Voltage to Anode No. 2 Voltage.....              | 3 Max.             |
| Anode No. 1 Voltage .....  | 1000 Max. Volts dc |
| Grid No. 1 Voltage   |                    |
| Negative Bias Value.....   | 200 Max. Volts dc  |
| Positive Bias Value .....  | 0 Max. Volts dc    |
| Positive Peak Value .....  | 2 Max. Volts       |
| Peak Heater-Cathode Voltage <sup>1</sup>                           |                    |
| Heater Negative with respect to Cathode .....                      | 125 Max. Volts dc  |
| Heater Positive with respect to Cathode .....                      | 125 Max. Volts dc  |
| Peak Voltage between Anode No. 2 and any Deflection Electrode..... | 550 Max. Volts     |

### TYPICAL OPERATING CONDITIONS—(Values are for each unit)

|  |  |            |         |
|--|--|------------|---------|
| For Anode No. 2 Voltage of.....  | 3000   | 4000       | Volts   |
| For Anode No. 2 Voltage of.....  | 1500   | 2000       | Volts   |
| Anode No. 1 Voltage for focus .....  | 272 to 521                                     | 363 to 695 | Volts   |
| Grid No. 1 Voltage <sup>2</sup> .....  | -22.5 to -67.5                                 | -30 to -90 | Volts   |
| Deflection Factors:  |  |            |         |
| D1 and D2.....   | 55 to 84                                       | 74 to 110  | dcV/in. |
| D3 and D4.....   | 47 to 71                                       | 63 to 95   | dcV/in. |
| Anode No. 1 Voltage for focus.....   | 18.1% to 34.8% of Eb2 Volts                    |            |         |
| Grid No. 1 Voltage <sup>2</sup> .....  | 1.5% to 4.5% of Eb2 Volts                      |            |         |
| Anode No. 1 Current for any operating condition.....                         | -50 to ± 10 Microamperes                       |            |         |
| Deflection Factors:  |  |            |         |
| Eb <sub>3</sub> = Eb <sub>2</sub> or Eb <sub>3</sub> tied to Eb <sub>2</sub> |  |            |         |
| D1 and D2 .....  | 29 to 44 Volts dc per inch per Kilovolt of Eb2 |            |         |
| D3 and D4 .....  | 25 to 39 Volts dc per inch per Kilovolt of Eb2 |            |         |
| Eb <sub>3</sub> = Twice Eb <sub>2</sub>                                      |  |            |         |
| D1 and D2 .....  | 37 to 55 Volts dc per inch per Kilovolt of Eb2 |            |         |
| D3 and D4 .....  | 31 to 47 Volts dc per inch per Kilovolt of Eb2 |            |         |
| Spot Position (Undelected) <sup>3</sup> .....                                | Within 25 Millimeters square                   |            |         |

### MAXIMUM CIRCUIT VALUES

|   |                  |
|---|------------------|
| Grid No. 1 Circuit Resistance.....                                | 1.5 Max. Megohms |
| Resistance in any Deflecting Electrode Circuit <sup>4</sup> ..... | 5 Max. Megohms   |

### NOTES

- Cathode should be returned to one side or to the mid-tap of the heater transformer winding.
- Visual extinction of undeflected focused spot.
- When both guns are operated at (1) normal heater voltage; (2) Eb<sub>3</sub> = 4000 volts; (3) Eb<sub>2</sub> = 2000 volts; (4) Eb<sub>1</sub> adjusted for focus; (5) Ec<sub>1</sub> set at such a value as will avoid damage to the screen; (6) with each of the deflecting electrons connected to Anode No. 2; and (7) with the tube shielded against external influences:  
The spots will fall within a 25 mm. square, the center of which coincides with the geometric center of the tube face and the sides of which are parallel to the traces produced by deflecting electrodes D1 and D2 and by deflecting electrodes D3 and D4 respectively.
- It is recommended that the deflecting electrode circuit resistances be approximately equal.

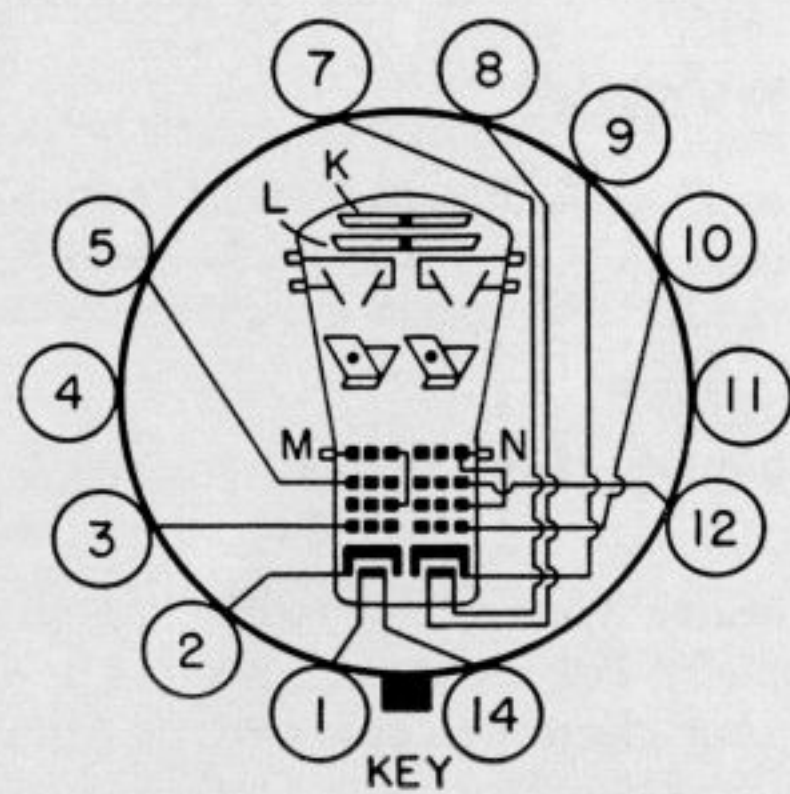
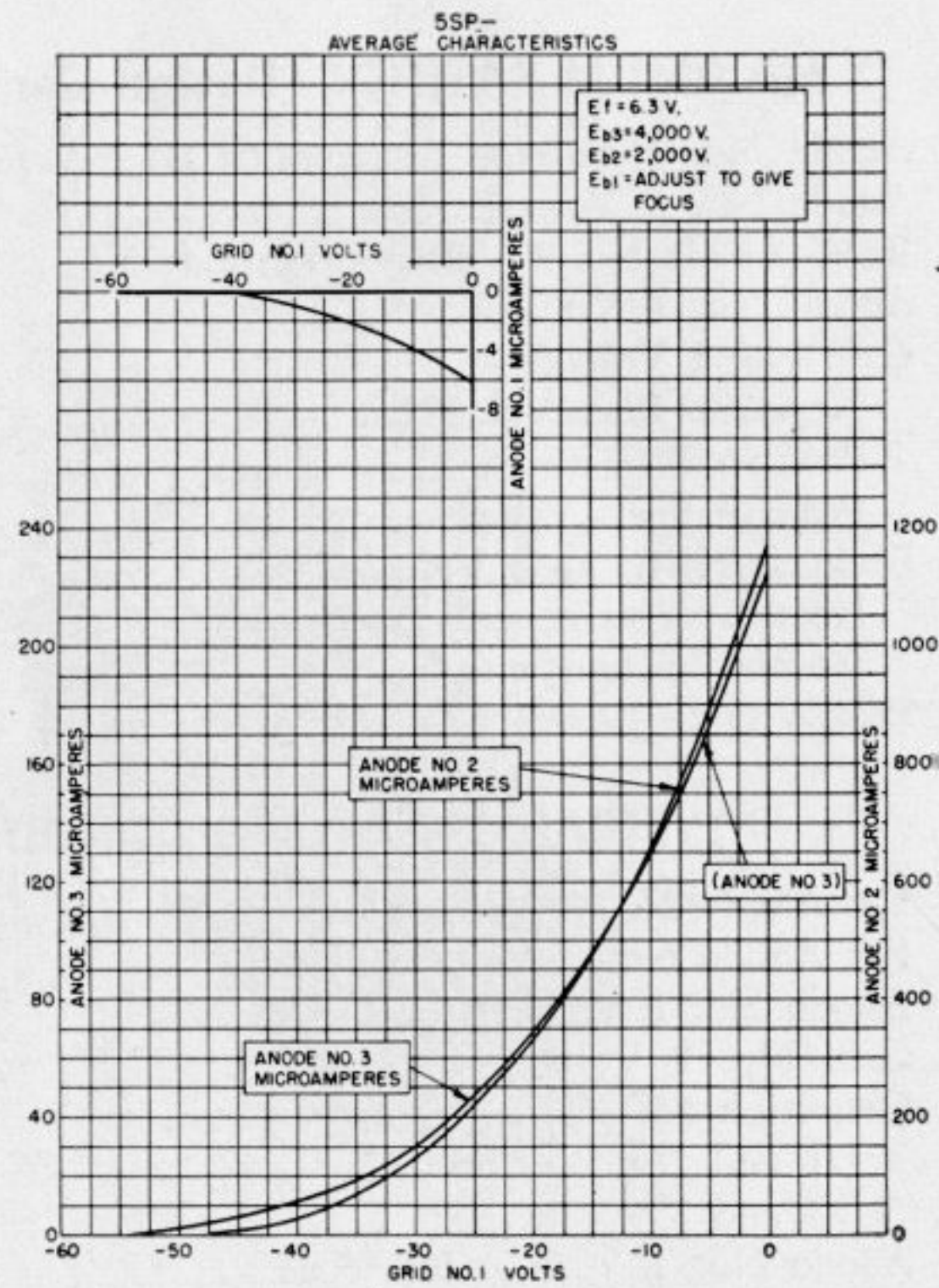
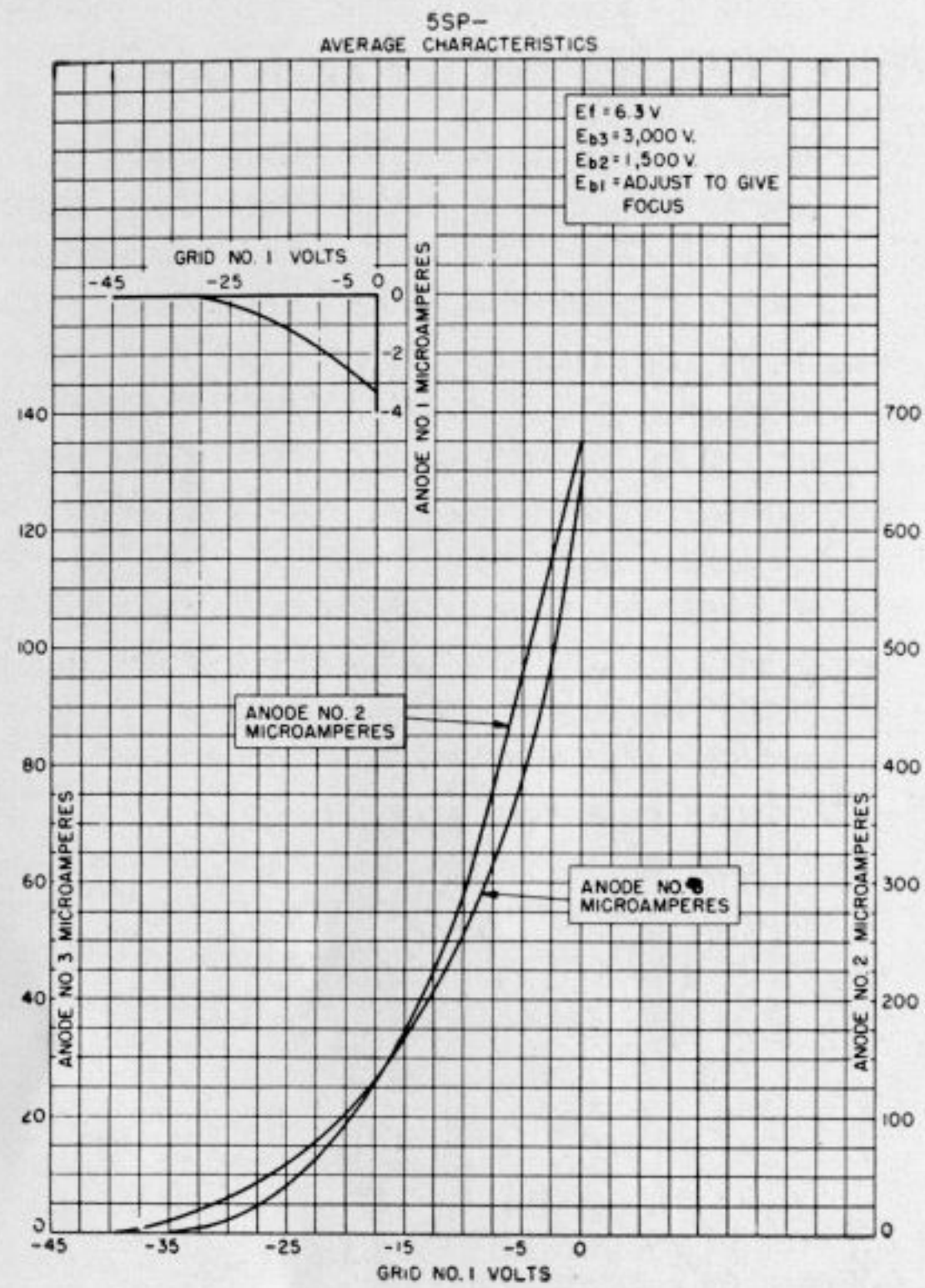

| Pin No.    | Element                |
|------------|------------------------|
| 1          | Unit A Heater          |
| 2          | Cathode                |
| 3          | Control Electrode      |
| 4          | Internal Connection    |
| 5          | Focusing Electrode     |
| 14         | Heater                 |
| Terminal A | Deflection Plate D2    |
| B          | Deflection Plate D1    |
| C          | Deflection Plate D3    |
| D          | Deflection Plate D4    |
| M          | Accelerating Electrode |
| 7          | Unit B Heater          |
| 8          | Heater                 |
| 9          | Cathode                |
| 10         | Control Electrode      |
| 11         | No Connection          |
| 12         | Focusing Electrode     |
| Terminal F | Deflection Plate D1    |
| G          | Deflection Plate D2    |
| H          | Deflection Plate D4    |
| J          | Deflection Plate D3    |
| N          | Accelerating Electrode |

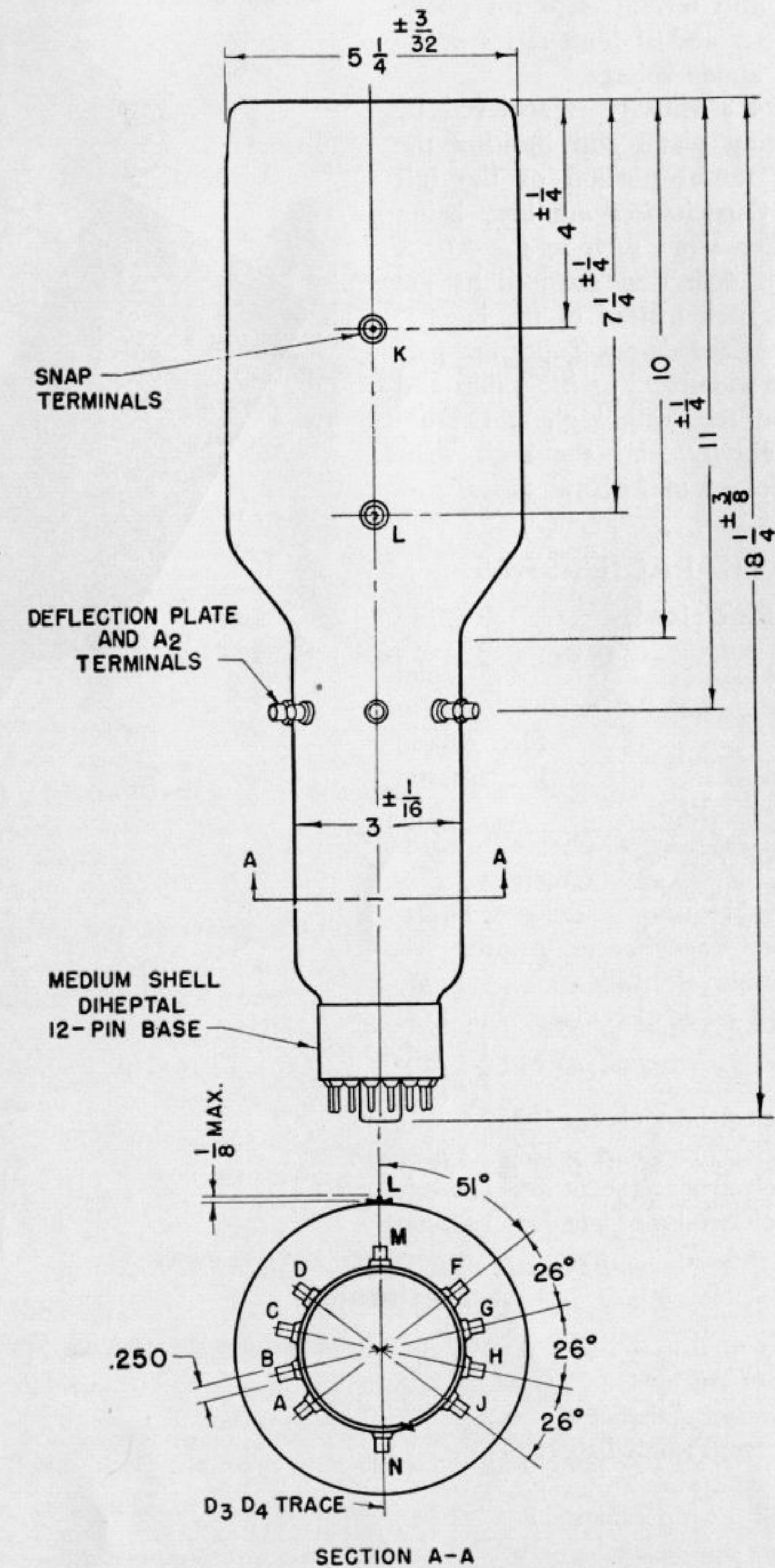

Note: Terminals M and N are connected internally; L and M-N must be connected together externally and to a common ground.

# 5XP- CATHODE-RAY TUBES

The Types 5XP-, electrostatic focus and deflection cathode-ray tubes, contain very high sensitivity D<sub>3</sub>D<sub>4</sub> deflection plates and an intensifier sub-divided into several steps for operation at high voltages and at high ratios of intensifier to second anode voltage.

The high D<sub>3</sub>D<sub>4</sub> sensitivity is achieved by using long deflecting plates and limiting the D<sub>3</sub>D<sub>4</sub> scan to a useful portion of the full screen diameter. Capacitances are low, being comparable to other types such as the 5JP-A and 5RP-A where deflection connections are made through the neck instead of the base.

The Type 5XP- Cathode-ray Tubes are particularly useful for wide-band oscillographs and for any application requiring high D<sub>3</sub>D<sub>4</sub> deflection plate sensitivity, and the high writing rate capabilities of multi-band tubes.

## GENERAL CHARACTERISTICS

### Electrical

|   |                 |       |       |
|---|-----------------|-------|-------|
| Heater Voltage                              | 6.3 Volts       |       |       |
| Heater Current                              | 0.6 ±10% Ampere |       |       |
| Focusing Method                             | Electrostatic   |       |       |
| Deflecting Method                           | Electrostatic   |       |       |
| Phosphor                                    | P1              | P2    | P11   |
| Fluorescence                                | Green           | Green | Blue  |
| Phosphorescence                             | Green           |       |       |
| Persistence                                 | Medium          | Long  | Short |
| Direct Interelectrode Capacitances, Approx. |                 |       |       |
| Cathode to all other electrodes             | 5.0 μmf.        |       |       |
| Grid No. 1 to all other electrodes          | 5.4 μmf.        |       |       |
| D1 to D2                                    | 1.7 μmf.        |       |       |
| D3 to D4                                    | 1.7 μmf.        |       |       |
| D1 to all other electrodes except D2        | 2.5 μmf.        |       |       |
| D2 to all other electrodes except D1        | 2.3 μmf.        |       |       |
| D3 to all other electrodes except D4        | 1.9 μmf.        |       |       |
| D4 to all other electrodes except D3        | 1.8 μmf.        |       |       |

### Mechanical

|  |                          |
|--|--------------------------|
| Overall Length   | 17-5/8 ± 3/8"            |
| Greatest Diameter of Bulb  | 5-1/4 ± 3/32"            |
| Minimum Useful Screen Diameter   | 4-1/4"                   |
| Bulb Contacts (recessed small ball cap)  | J1-22                    |
| Neck Contacts  | Special lateral contacts |
| Base (medium shell 12-pin diheptal)  | B7-51                    |
| Basing   | 14F                      |
| Base Alignment:  |                          |
| 1D2 trace aligns with Pin #5 and tube axis                                       | ± 10 Degrees             |
| Positive voltage on D1 deflects beam approximately toward Pin No. 5.             |                          |
| Positive voltage on D <sub>3</sub> deflects beam approximately toward Pin No. 2. |                          |
| Angle between 3D4 and 1D2 traces   | 90 ± 3 Degrees           |
| Bulb Contact Alignment:  |                          |
| J1-22 contacts, on same side as Pin No. 5, align with 1D2 trace                  | ± 10 Degrees             |

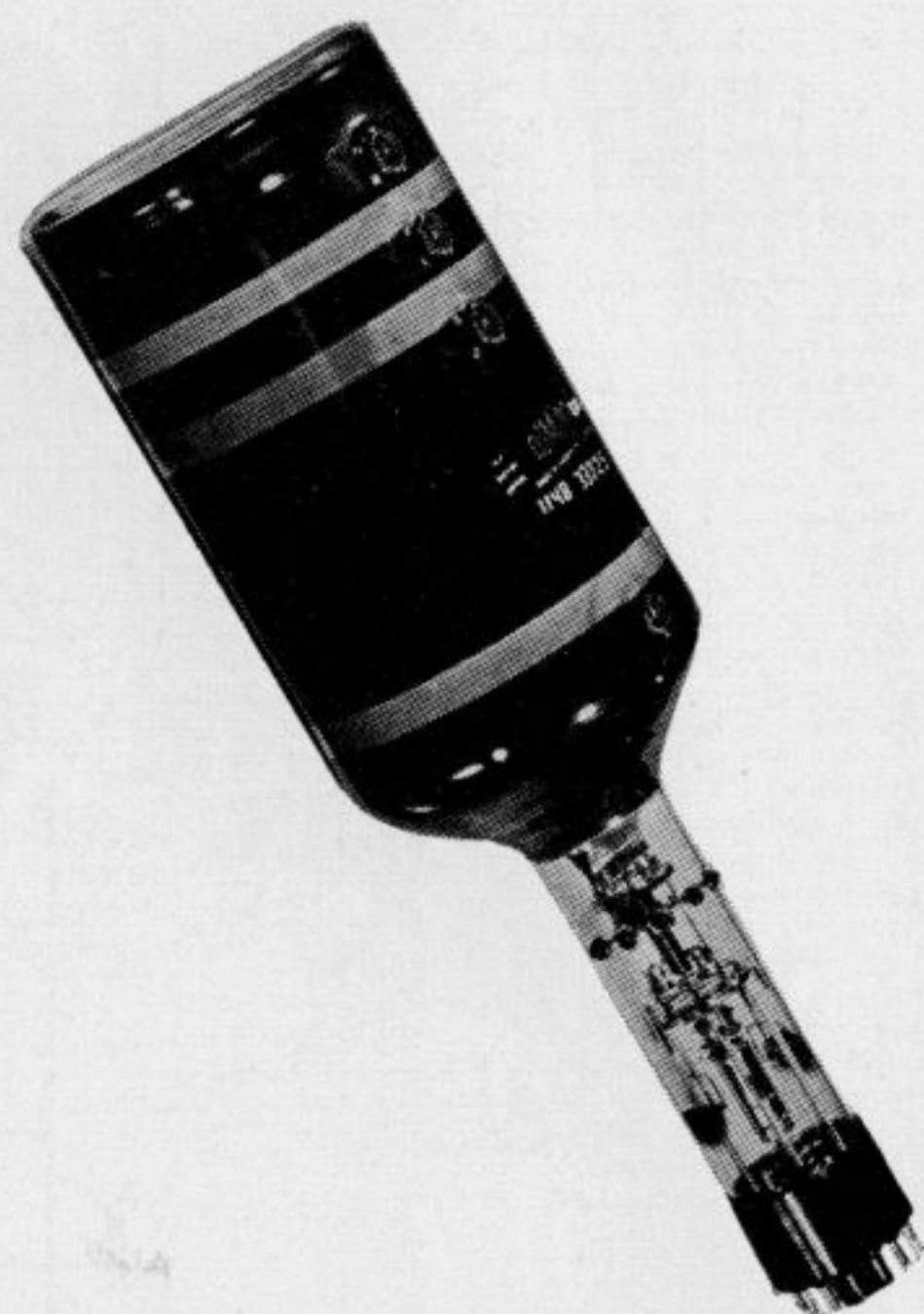

## TYPE 5XP- CATHODE-RAY TUBES

### MAXIMUM RATINGS—(Design Center Values)

|   |                      |
|---|----------------------|
| Anode No. 3 Voltage (Accelerator High-Voltage Electrode)      | 25,000 Max. Volts dc |
| Anode No. 2 Voltage   | 3500 Max. Volts dc   |
| Ratio Anode No. 3 Voltage to Anode No. 2 Voltage              | 10 Max.              |
| Anode No. 1 Voltage   | 1550 Max. Volts dc   |
| Grid No. 1 Voltage:   |                      |
| Negative Bias Value   | 200 Max. Volts dc    |
| Positive Bias Value   | 0 Max. Volts dc      |
| Positive Peak Value   | 2 Max. Volts         |
| Peak Heater Cathode Voltage <sup>1</sup>                      |                      |
| Heater Negative with respect to Cathode                       | 125 Max. Volts dc    |
| Heater Positive with respect to Cathode                       | 125 Max. Volts dc    |
| Peak Voltage between Anode No. 2 and any Deflection Electrode | 1200 Max. Volts      |

### TYPICAL OPERATING CONDITIONS

|   |   |   |            |                         |
|---|---|---|------------|-------------------------|
| For Anode No. 3 Voltage <sup>2</sup> of   | 2000                                    | 4000  | 10,000     | 20,000 Volts            |
| For Anode No. 2 Voltage of  | 1000                                    | 2000  | 2000       | 2000 Volts              |
| Anode No. 1 Voltage for focus   | 181 to 348                              | 362 to 695  | 362 to 695 | 362 to 695 Volts        |
| Grid No. 1 Voltage <sup>3</sup>   | -15 to -45                              | -30 to -90  | -30 to -90 | -30 to -90 Volts        |
| Deflection Factors:   |   |   |            |                         |
| D1 and D2   | 35 to 54                                | 72 to 108   | 102 to 154 | 140 to 210 Volts dc/In. |
| D3 and D4   | 12 to 18                                | 24 to 36  | 34 to 52   | 46 to 68 Volts dc/In.   |
| Useful Scan: <sup>4</sup>   |   |   |            |                         |
| D1 and D2   | 4.25                                    | 4.25  | 3.5        | Inches                  |
| D3 and D4   | 2.50                                    | 1.75  | 1.25       | Inches                  |
| Frequency for 10% reduction in D <sub>3</sub> D <sub>4</sub> deflection factor due to transit time <sup>5</sup> | 200                                     | 200   | 200        | mc.                     |
| Anode No. 1 Voltage for focus   | 18.1% to 34.8% of Eb <sub>2</sub> Volts |   |            |                         |
| Grid No. 1 Voltage <sup>3</sup>   | 1.5% to 4.5% of Eb <sub>2</sub> Volts   |   |            |                         |
| Anode No. 1 Current for any operating condition   | -50 to +10 Microampere                  |   |            |                         |
| Deflection Factors:   |   |   |            |                         |
| Eb <sub>3</sub> = Eb <sub>2</sub> or Eb <sub>3</sub> tied to Eb <sub>2</sub>                                    |   |   |            |                         |
| D1 and D2   | 30 to 45                                | Volts dc per inch per Kilovolt of Eb <sub>2</sub> |            |                         |
| D3 and D4   | 9.5 to 14.5                             | Volts dc per inch per Kilovolt of Eb <sub>2</sub> |            |                         |
| Eb <sub>3</sub> = Twice Eb <sub>2</sub>   |   |   |            |                         |
| D1 and D2   | 36 to 54                                | Volts dc per inch per Kilovolt of Eb <sub>2</sub> |            |                         |
| D3 and D4   | 12 to 18                                | Volts dc per inch per Kilovolt of Eb <sub>2</sub> |            |                         |
| Spot Position (Undelected) <sup>6</sup>   | Within 20 millimeter square             |   |            |                         |

### MAXIMUM CIRCUIT VALUES

|   |                  |
|---|------------------|
| Grid No. 1 Circuit Resistance                               | 1.5 Max. Megohms |
| Resistance in any Deflecting Electrode Circuit <sup>7</sup> | 5 Max. Megohms   |

### NOTES

- Cathode should be returned to one side or the mid-tap of the heater transformer winding.
- Anode No. 2 to final intensifier electrode voltage equally divided over the three intensifier electrodes.
- Visual extinction of undeflected focused spot.
- Reduction in useful scan when Eb<sub>3</sub> is greater than Eb<sub>2</sub> is determined by the ratio of Eb<sub>3</sub> to Eb<sub>2</sub> (note both voltages are with respect to cathode). Values shown are therefore applicable to any operating condition with Eb<sub>3</sub> to Eb<sub>2</sub> ratios of 2:1, 5:1, and 10:1.
- Computed.
- When the tube is operated at (1) normal heater voltage; (2) Eb<sub>2</sub> = 2000 volts; (3) Eb<sub>3</sub> = 10,000 volts; (4) Eb<sub>1</sub> adjusted for focus; (5) Ec<sub>1</sub> set at such a value as will avoid damage to the screen; (6) with each of the deflecting electrodes connected to Anode No. 2; and (7) with the tube shielded against external influences.
- The spot will fall within a 20 mm. square, the center of which coincides with the geometric center of the tube face and the sides of which are parallel to the traces produced by deflecting electrodes D1 and D2 and by deflecting electrodes D3 and D4 respectively.
- It is recommended that the deflecting electrode circuit resistances be approximately equal.



5XP1, 5XP2, 5XP11  
AVERAGE CHARACTERISTICS

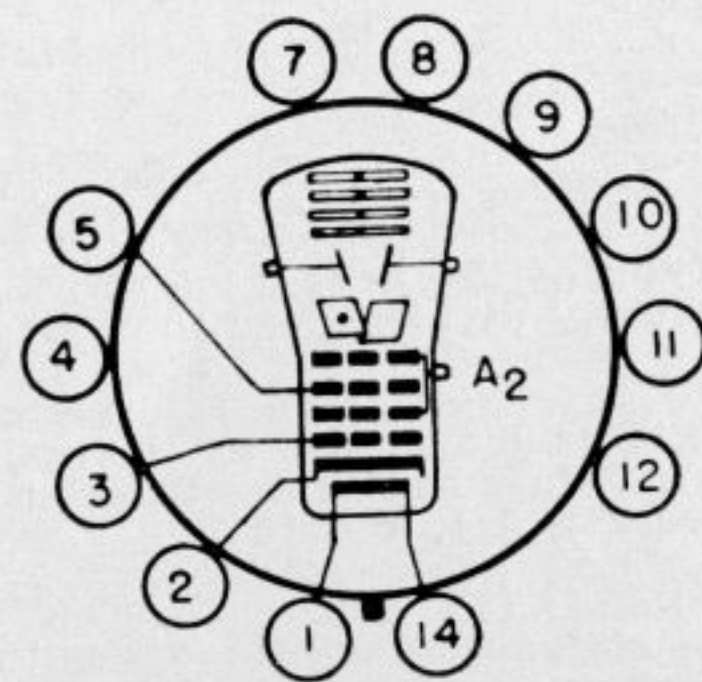
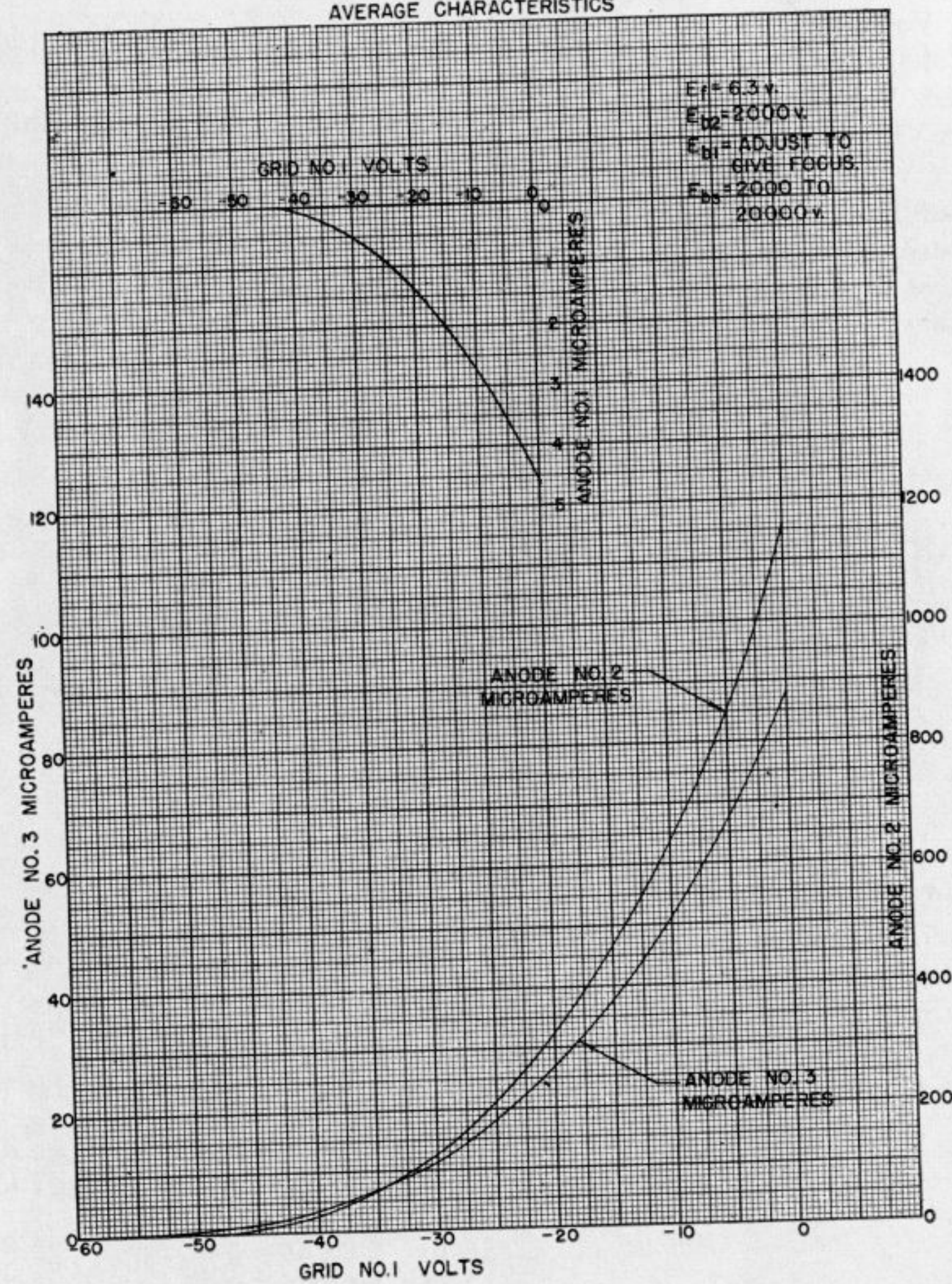

14F  
BOTTOM VIEW OF BASE

Bottom View of Base

| Pin No. | Element             |
|---------|---------------------|
| 1       | Heater              |
| 2       | Cathode             |
| 3       | Grid No. 1          |
| 4       | Internal Connection |
| 5       | Anode No. 1         |
| 7       | No Connection       |
| 8       | " "                 |
| 9       | " "                 |
| 10      | " "                 |
| 11      | " "                 |
| 12      | " "                 |
| 14      | Heater              |

TYPE 5XP- CATHODE-RAY TUBES

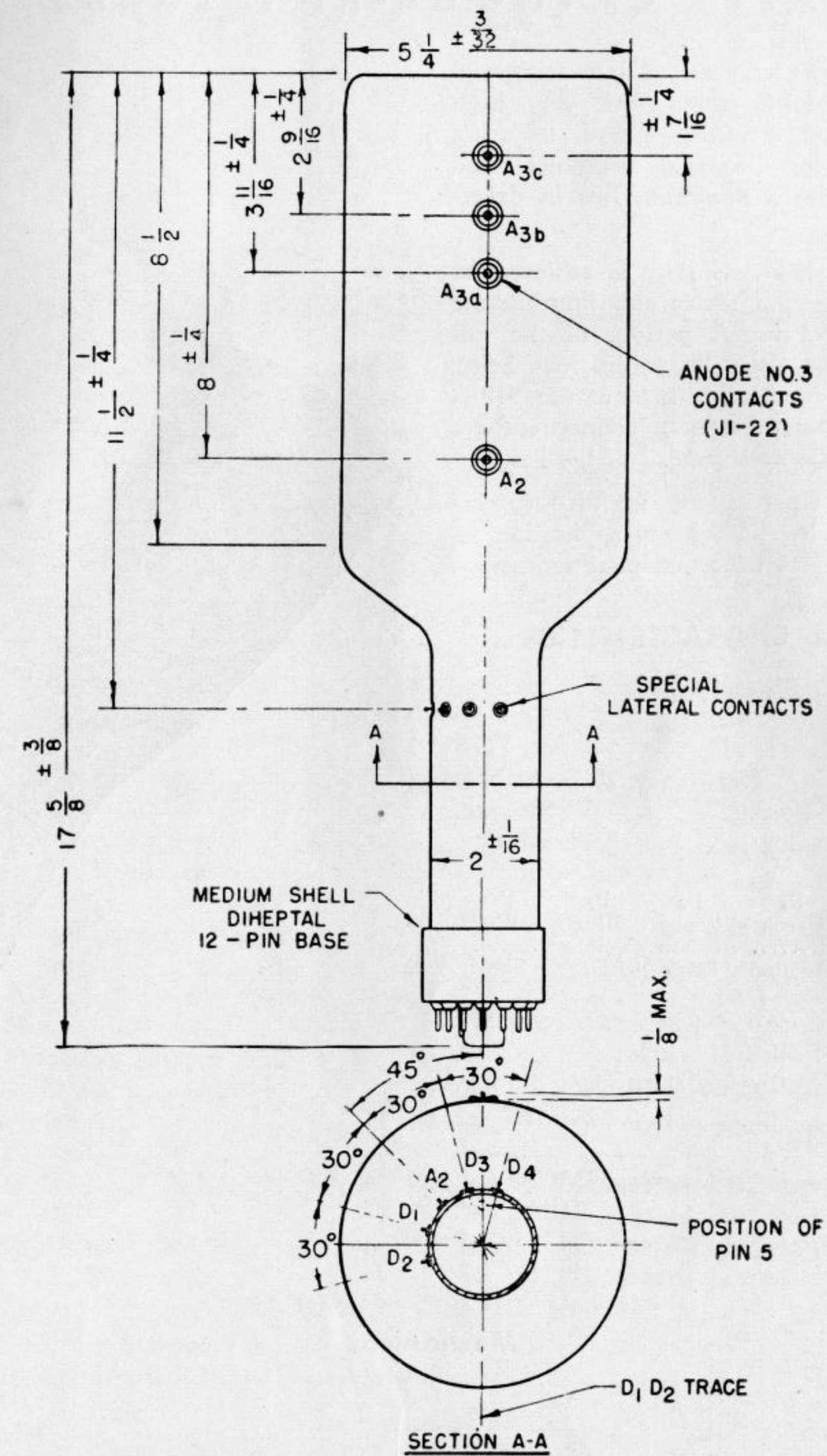

Suggested Method of Intensifier Connection

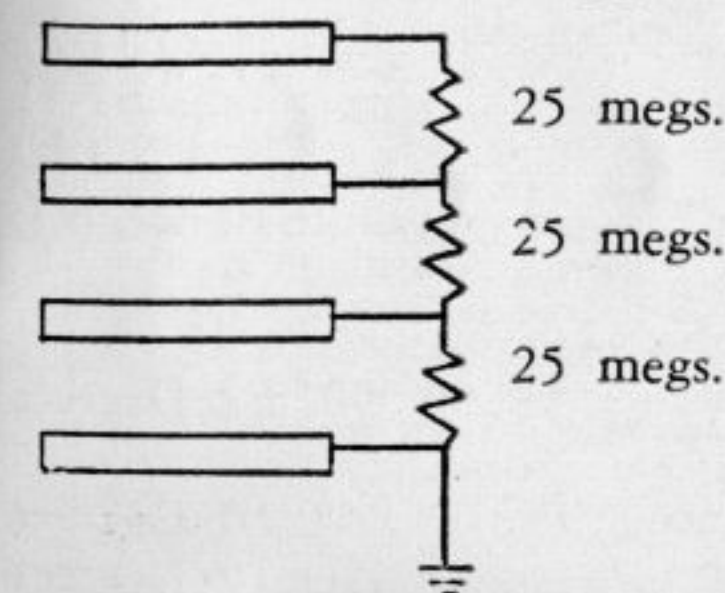

The two 2nd anode terminals (one on the tube head, the other on the tube neck) must be connected together.

# 5YP- CATHODE-RAY TUBES

The Type 5YP- is an electrostatic focus and deflection cathode-ray tube, with very high sensitivity D3D4 deflection plates, featuring an intensifier for increased brightness and writing rate, with a minimum loss in deflection sensitivity.

The high D3D4 sensitivity is achieved by using long deflection plates and limiting the D3D4 scan to a useful portion of the full screen diameter. Capacitances are low, being comparable to other types such as the 5JP-A and 5RP-A, where deflection connections are made through the neck instead of the base.

The 5YP- is particularly useful for wide band oscillographs and for any application requiring high D3D4 deflection plate sensitivity.

## GENERAL CHARACTERISTICS

### Electrical

|                   |                 |                |                |                 |
|-------------------|-----------------|----------------|----------------|-----------------|
| Heater Voltage    | 6.3 Volts       |                |                |                 |
| Heater Current    | 0.6 ±10% Ampere |                |                |                 |
| Focusing Method   | Electrostatic   |                |                |                 |
| Deflecting Method | Electrostatic   |                |                |                 |
| Phosphor          |                 |                |                |                 |
|                   | P <sub>1</sub>  | P <sub>2</sub> | P <sub>7</sub> | P <sub>11</sub> |
| Fluorescence      | Green           | Green          | Blue           | Blue            |
| Phosphor          | .....           | Green          | Yellow         | .....           |
| Persistence       | Medium          | Long           | Long           | Short           |

Direct Interelectrode Capacitances, Approx.

|                                      |         |
|--------------------------------------|---------|
| Cathode to all other electrodes      | 5.0 μf. |
| Grid No. 1 to all other electrodes   | 5.4 μf. |
| D1 to D2                             | 1.7 μf. |
| D3 to D4                             | 1.7 μf. |
| D1 to all other electrodes except D2 | 2.5 μf. |
| D2 to all other electrodes except D1 | 2.3 μf. |
| D3 to all other electrodes except D4 | 1.9 μf. |
| D4 to all other electrodes except D3 | 1.8 μf. |

### Mechanical

|  |               |
|--|---------------|
| Overall Length   | 17-5/8 ± 3/8" |
| Greatest Diameter of Bulb  | 5-1/4 ± 3/32" |
| Minimum Useful Screen Diameter                                       | 4-1/4"        |
| Bulb Contacts (Recessed Small Ball Cap)                              | J1-22         |
| Neck Contacts (Small Ball Caps)                                      | J1-25         |
| Base (Medium Shell Diheptal 12-Pin)                                  | B7-51         |
| Basing   | 14Q           |
| Base Alignment: D1D2 trace aligns with Pin No. 5 and tube axis       | ±10 Degrees   |
| Positive voltage on D1 deflects beam approximately toward Pin No. 5. |               |
| Positive voltage on D3 deflects beam approximately toward Pin No. 2. |               |
| Angle between D3D4 and D1D2 traces                                   | 90 ±2 Degrees |
| Bulb Contact Alignment:  |               |
| J1-22 contacts, on same side as Pin No. 5, align with D1D2 trace     | ±10 Degrees   |
| J1-22 contacts align with D1D2 trace                                 | ±10 Degrees   |



## MAXIMUM RATINGS—(Design Center Values)

|   |                    |
|---|--------------------|
| Anode No. 3 Voltage (Accelerator High-Voltage Electrode)      | 8000 Max. Volts dc |
| Anode No. 2 <sup>1,2</sup> Voltage                            | 3500 Max. Volts dc |
| Ratio Anode No. 3 Voltage to Anode No. 2 Voltage              | 2.3 Max.           |
| Anode No. 1 Voltage   | 1550 Max. Volts dc |
| Grid No. 1 Voltage:   |                    |
| Negative Bias Value   | 200 Max. Volts dc  |
| Positive Bias Value   | 0 Max. Volts dc    |
| Positive Peak Value   | 2 Max. Volts       |
| Peak Heater Cathode Voltage                                   |                    |
| Heater Negative with respect to Cathode                       | 150 Max. Volts dc  |
| Heater Positive with respect to Cathode                       | 150 Max. Volts dc  |
| Peak Voltage between Anode No. 2 and any Deflection Electrode | 1200 Max. Volts    |

## TYPICAL OPERATING CONDITIONS

|  |   |            |             |                             |
|--|---|------------|-------------|-----------------------------|
| For Anode No. 3 Voltage of   | 1500  | 4000       | 6000        | Volts                       |
| For Anode No. 2 Voltage of   | 1500  | 2000       | 3000        | Volts                       |
| Anode No. 1 Voltage for focus  | 271 to 521  | 362 to 695 | 541 to 1040 | Volts                       |
| Grid No. 1 Voltage <sup>3</sup>  | -22.5 to -67.5                                    | -30 to -90 | -45 to -135 | Volts                       |
| Deflection Factors:  |   |            |             |                             |
| D1 and D2  | 45 to 67.5  | 72 to 108  | 108 to 162  | Volts dc/Inch               |
| D3 and D4  | 14 to 22  | 24 to 36   | 36 to 54    | Volts dc/Inch               |
| Useful Scan: <sup>4</sup>  |   |            |             |                             |
| D1 and D2  | 4.25  | 4.25       | 4.25        | Inches                      |
| D3 and D4  | 3.00  | 2.50       | 2.50        | Inches                      |
| Centering of scanning area <sup>5</sup>  |   |            |             | 15 mm. sq.                  |
| Frequency for 10% reduction in D3D4 deflection factor due to transit time <sup>6</sup> | 175   | 200        | 250         | mc.                         |
| Anode No. 1 Voltage for focus  | 18.1% to 34.8% of Eb2                             |            |             | Volts                       |
| Grid No. 1 Voltage <sup>3</sup>  | 1.5% to 4.5% of Eb2                               |            |             | Volts                       |
| Anode No. 1 Current for any operating condition  | -50 to +10  |            |             | Microampere                 |
| Deflection Factors:  |   |            |             |                             |
| No 3rd Anode or Eb3 = Eb2  |   |            |             |                             |
| D1 and D2  | 30 to 45 Volts dc per inch per Kilovolt of Eb2    |            |             |                             |
| D3 and D4  | 9.5 to 14.5 Volts dc per inch per Kilovolt of Eb2 |            |             |                             |
| Eb3 = Twice Eb2  |   |            |             |                             |
| D1 and D2  | 36 to 54 Volts dc per inch per Kilovolt of Eb2    |            |             |                             |
| D3 and D4  | 12 to 18 Volts dc per inch per Kilovolt of Eb2    |            |             |                             |
| Spot Position (Undelected) <sup>7</sup>  |   |            |             | Within 15 millimeter square |

## MAXIMUM CIRCUIT VALUES

|   |                  |
|---|------------------|
| Grid No. 1 Circuit Resistance                               | 1.5 Max. Megohms |
| Resistance in any Deflecting Electrode Circuit <sup>8</sup> | 5 Max. Megohms   |

## NOTES

- Anode No. 2 and Grid No. 2, which are connected together within the tube, are referred to herein as Anode No. 2.
- The product of Anode No. 2 voltage and average Anode No. 2 current should be limited to 6 watts.
- Visual extinction of undeflected focused spot.
- Reduction in useful scan when Eb3 is greater than Eb2 is determined by the ratio of Eb3 to Eb2 (note both voltages are with respect to cathode). Values shown are therefore applicable to any operating condition with same Eb3 to Eb2 ratios.
- When the tube is operated at (1) normal heater voltage; (2) Eb2 and Eb3 set at the specified values; (3) Eb1 adjusted for focus; (4) E<sub>c1</sub> set at such a value as will avoid damage to the screen; (5) with the mean potential of each deflecting electrode equal to anode No. 2; and (6) the tube shielded against external influences; the geometric center of the scanning pattern will fall within the specified square whose edges are parallel to the traces produced by deflecting electrodes D1 and D2 and by deflecting electrodes D3 and D4 respectively.
- Computed.
- With Eb2 = 1500 volts, Eb3 = 3000 volts and Eb1 adjusted for focus.
- It is recommended that the deflecting electrode circuit resistances be approximately equal.

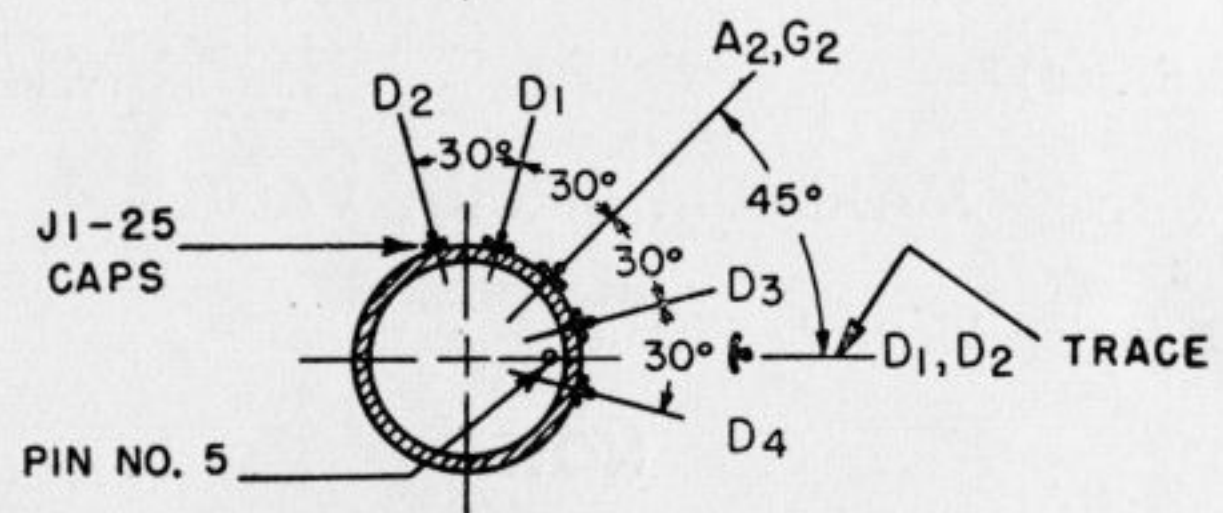
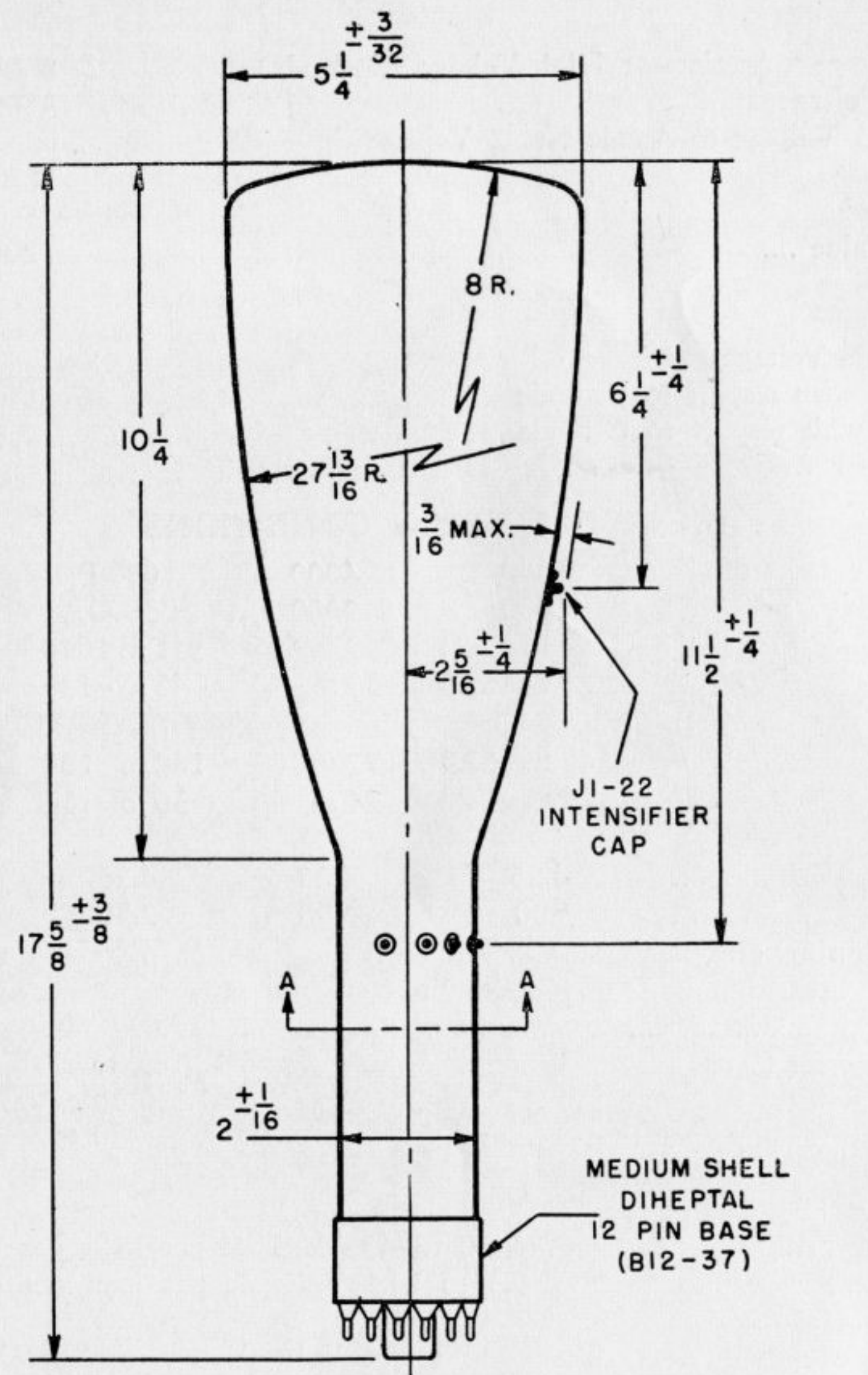

SECTION A-A

14 Q

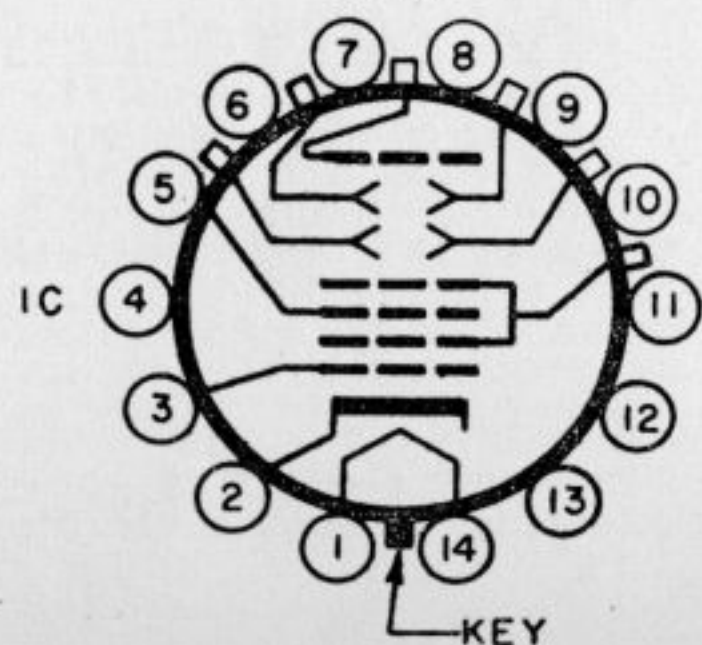

## DU MONT GAS TRIODES

Types 2B4 and 6Q5G

### Mechanical Dimensions, Basing, and Average Operating Characteristics

The Type 2B4 and Type 6Q5G Gas Triodes are intended for use in Du Mont Cathode-ray Oscillographs for sweep oscillator service. They are also designed for applications where a gas triode is required for control and counter circuits and where a wide frequency range is desired for sweep oscillators.

### CHARACTERISTICS

|   | 6Q5G        | 2B4                |
|---|-------------|--------------------|
| Heater .....  | 6Q5G        | 2B4                |
| Voltage (ac or dc) .....                            | 6.3         | 2.5 volts          |
| Current .....                                       | 0.6         | 1.4 ampere         |
| <b>Direct Interelectrode Capacitances (Nominal)</b> |             |                    |
| Grid to anode .....                                 |             | 2.8 $\mu\text{f.}$ |
| Grid to cathode .....                               |             | 1.7 $\mu\text{f.}$ |
| Anode to cathode .....                              |             | 2.0 $\mu\text{f.}$ |
| Tube Voltage Drop .....                             |             | 19 volts approx.   |
| Maximum Overall Length .....                        | 4 1/8"      | 4-3/16"            |
| Maximum Diameter .....                              | 1-9/16"     | 1-9/16"            |
| Bulb .....  | ST12        | ST12               |
| Base .....  | Small shell | Small              |
|   | Octal 8 pin | 5 pin              |
| Basing—RMA Basing Designation .....                 | 6Q          | 5A                 |

### SWEEP-CIRCUIT OSCILLATOR SERVICE

|                                     |                         |
|-------------------------------------|-------------------------|
| Anode Voltage (Instantaneous) ..... | 300 volts (max.)        |
| Peak Anode Current .....            | 300 milliamperes (max.) |
| Average Anode Current .....         | 1 milliampere (max.)    |
| Grid Resistance .....               | { 10,000 ohms (min.)    |
|                                     | { 100,000 ohms (max.)   |
| Frequency Range:                    |                         |
| 2B4 .....                           | 1-30,000 cps            |
| 6Q5G .....                          | 1-50,000 cps            |

Mechanical Dimensions, Basing, and Average Operating Characteristics

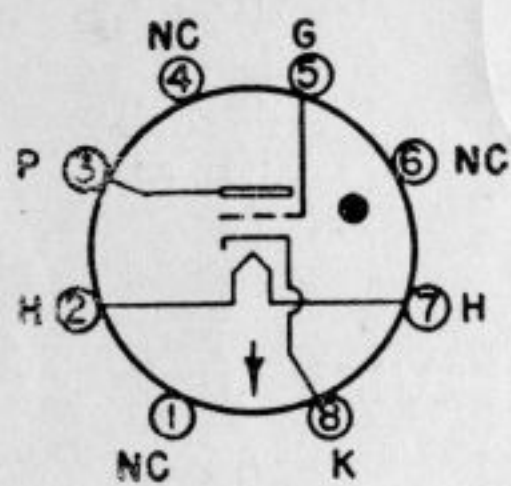
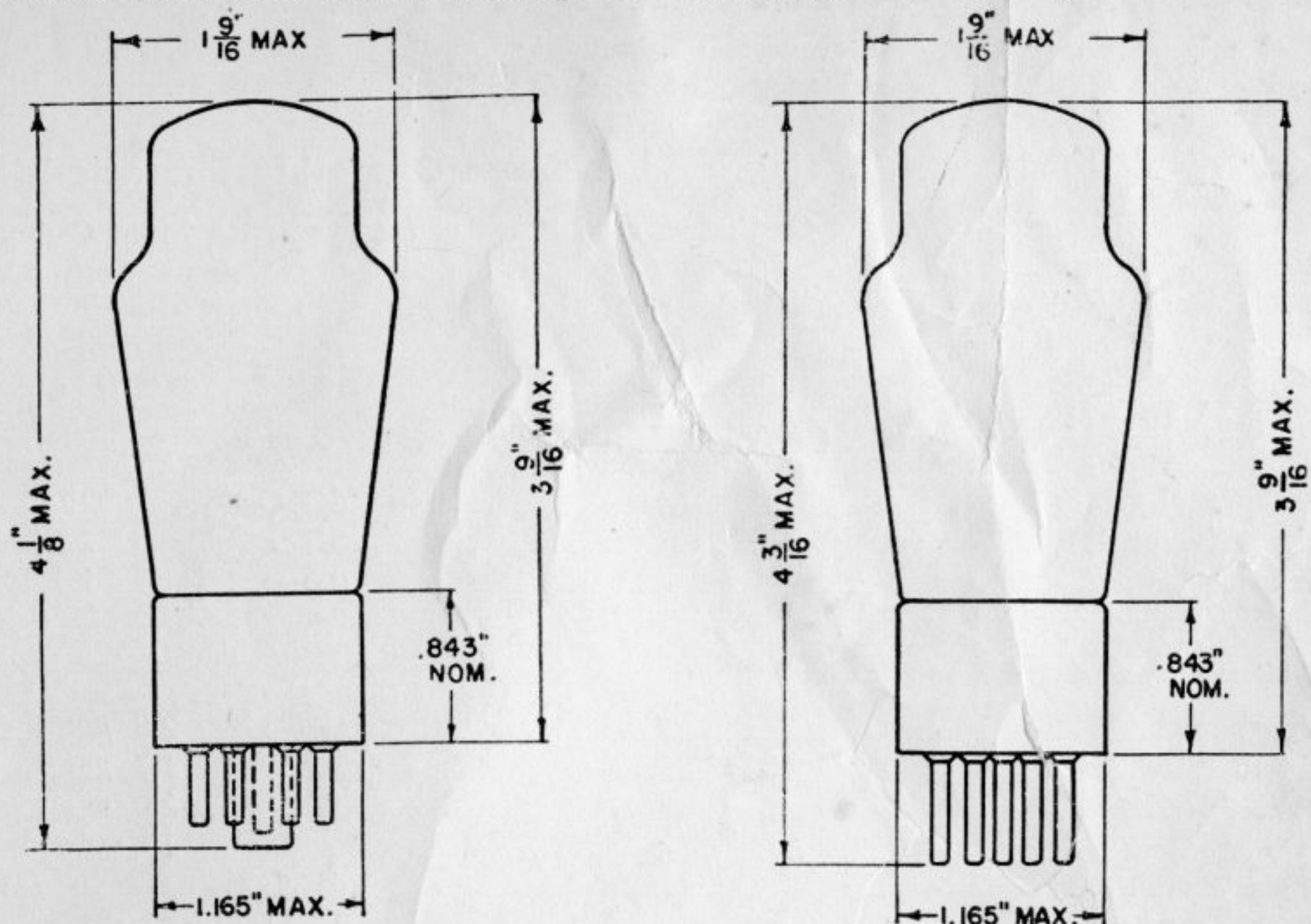

6-Q  
Type 6Q5G

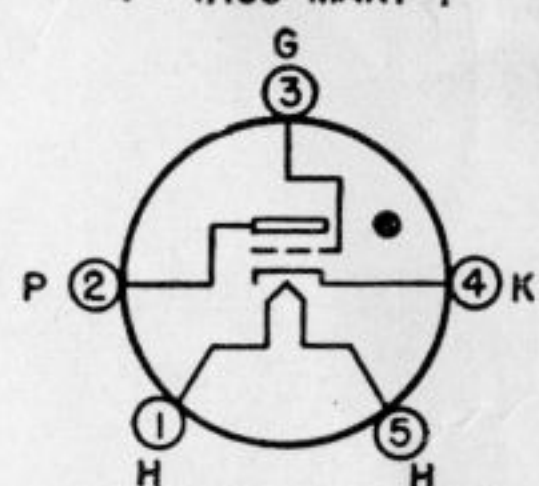

5-A  
Type 2B4

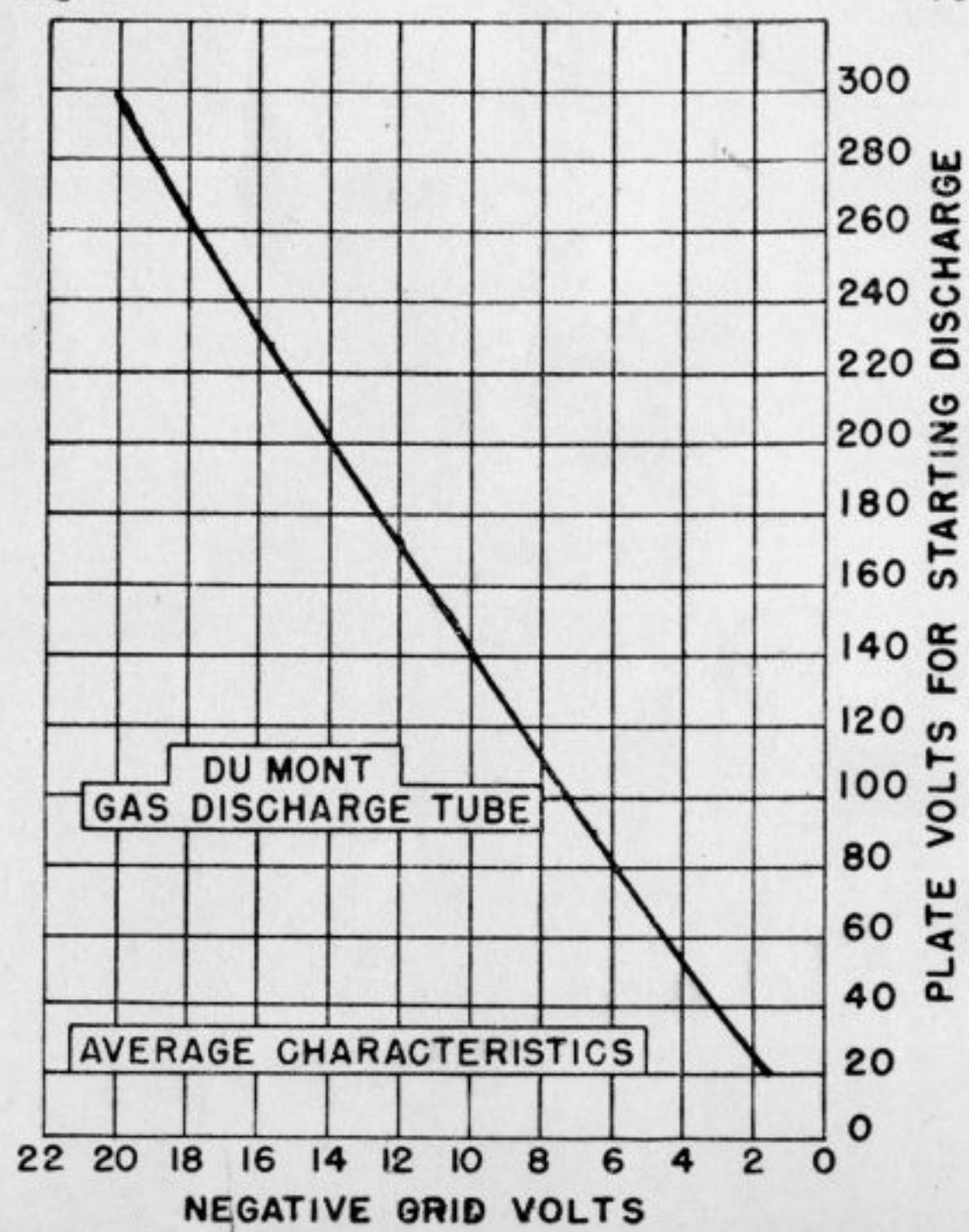

# DU MONT

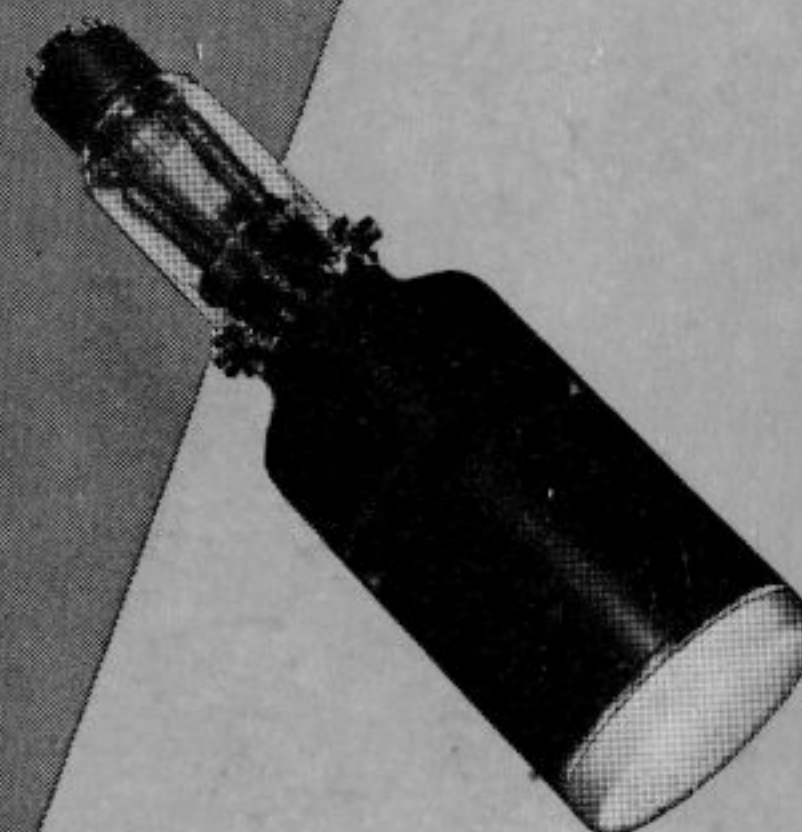

## cathode - ray EQUIPMENT

