

SERVICE - ANVISNING

NR. 15 - JUNI 1962

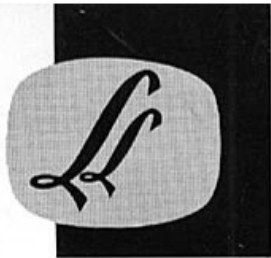

PICCOLONE 631 SIDE 79

Tekniske data:

TEKNISKE DATA:

BATTERISPÆNDING: 9 V

BATTERIBESTYKNING: 6 stk. 1,5 V batterier
dimensioner 60 × 33 mm

STROMFORBRUG: Ved neddrejet volume: ca. 20mA
Ved normal stuestyrke ca. 35-40mA

UDGANGSEFFEKT: 1,6W

HOJTTALER: Peerless E 570 TSN, spec.

VÆGT: 2 kg.

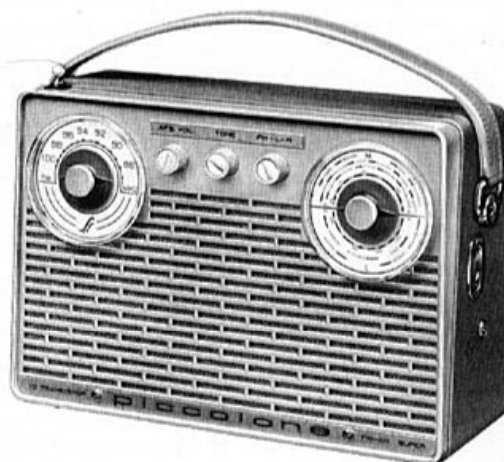

| DIMENSIONER | |
|-------------|--------|
| Højde | 167 mm |
| Bredde | 240 mm |
| Dybde | 96 mm |

| | AM-MODTAGER | FM-MODTAGER |
|--|--|--|
| TRANSISTORBESTYKNING | FUNKTION | |
| T 2228 AF 117 AF 116 AF 105 AF 105 AF 116 TF 65 OC 75 2 × AC 117 | SELVSVINGENDE BLANDINGSTRIN I MF-FORSTÆRKER II MF-FORSTÆRKER III MF-FORSTÆRKER LF-FORSTÆRKER DRIVER-TRIN UDGANGSTRIN (PUSH-PULL) | SELVSVINGENDE BLANDINGSTRIN I MF-FORSTÆRKER II MF-FORSTÆRKER III MF-FORSTÆRKER IV MF-FORSTÆRKER (begrænsertrin) LF-FORSTÆRKER DRIVER-TRIN UDGANGSTRIN (PUSH-PULL) |
| GERMANIUMDIODER 2 × OA 79 OA 160 OA 160 | AM-DETEKTOR AVC REGULERING | FORHOLDSDETEKTOR |
| MELLEMFREKVENNS | 449 KHz | 10,9 MHz |
| BØLGEOMRÅDER | LB: 2100-1300 ~ 146-255 KHz MB: 545-102 ~ 550-1650 KHz | 3,47-2,95 ~ 86,5-101,5 MHz |



Demontering af modtageren: 2 skruer på hver side af kabinettet løsnes og forpladen trækkes ud med chassiset.

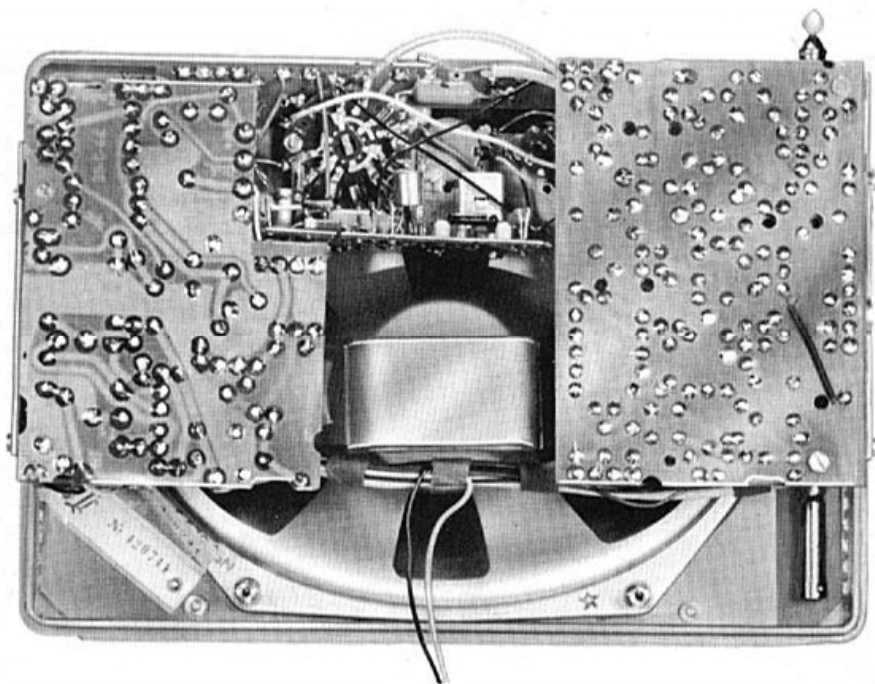

Ved evt. service kan de to printplader for LF-del og MF-del svinges op ved at løsne de med pil angivne skruer.

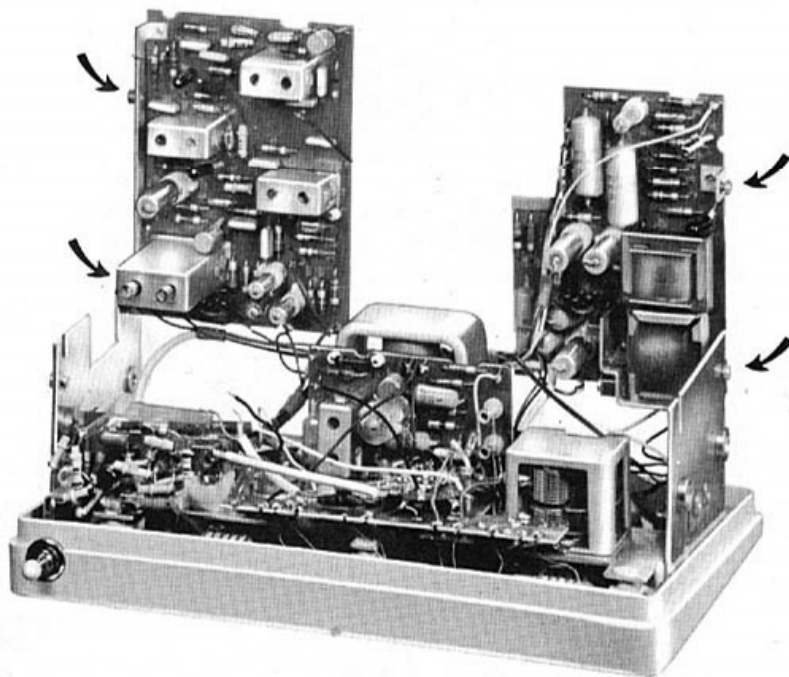

SERVICE - ANVISNING

NR. 16 - JUNI 1962



PICCOLONE 631 SIDE 83

STYKLISTE FOR PICCOLONE 631 AM / FM

| Diagr. nr. | Komponent | Værdi | Tolerance | Volt Watt | Bemærkninger |
|------------|---|-----------|--------------|-----------|---|
| 1 | Ker. Kondensator | 10pF | ±10% | 500V | C 304 GB/L 10 E PHILIPS |
| 2 | FM-Antennespole | | | | 100-F-171 LL |
| 3 | Ker. Kondensator | 100pF | ±10% | 500V | C 304 GB/A 100 E |
| 4 | Ker. Kondensator | 15pF | ±10% | 500V | C 304 GB/A 15 E PHILIPS |
| 5 | FM Drejekondensator | | | | PD 251 Gi PFM kd 66 82-F-579 P. DAU 82-F-579 P. DAU |
| 6 | Ker. Kondensator | 22pF | ±10% | 500V | C 304 GB/A 22 E PHILIPS |
| 7 | Ker. Kondensator | 47pF | ±10% | 500V | C 304 GB/A 47 E PHILIPS |
| 8 | Ker. Kondensator | 1,5nF | +50% +20% | 500V | 310 K F.E.C. |
| 9 | Modstand | 27kΩ | ±10% | 0,5W | SBT VITROHM |
| 10 | Modstand | 4,7kΩ | ±10% | 0,5W | SBT VITROHM |
| 11 | FM-MF-Sugekredsspole | 2μH | | | 100-F-172 LL T 2228 PILCO |
| 12 | Transistor | | | | C 304 GH/A 120 E |
| 13 | Ker. Kondensator | 120pF | ±10% | 500V | PHILIPS |
| 14 | | | | | |
| 15 | Ker. Kondensator | 10pF | ±10% | 500V | 9/0119 P FERROPERM |
| 16 | Modstand | 1,2kΩ | ±10% | 0,5W | SBT VITROHM |
| 17 | Ker. Kondensator | 56pF | ±10% | 500V | C 304 GB/A 56 E PHILIPS |
| 18 | | | | | |
| 19 | Modstand | 5,6kΩ | ±10% | 0,5W | SBT VITROHM |
| 20 | Ker. Kondensator | 33pF | ±10% | 500V | C 304 GB/A 33 E PHILIPS |
| 21 | Styroflex Kondensator | 200pF | ±10% | 125V | B 31010 D 200 K 125 |
| 22 | FM-Oscillatorspole | | | | SIEMENS |
| 23 | Samlet 1; FM-MF | | | | 100-F-170 LL |
| 24 | Ker. Kondensator | 56pF | ±10% | 500V | 99-C-38 LL |
| 25 | Samlet 4' FM-MF (AM-Detektor) | | | | C 304 GB/A 56 E PHILIPS |
| 26 | Modstand | 390Ω | ±10% | 0,5W | 99-C-27 LL |
| 27 | Transistor | | | | SBT VITROHM |
| 28 | Styroflex Kondensator | 500pF | ±10% | 125V | AF 105 A.E.G. |
| 29 | Ker. Kondensator | 18pF | ±10% | 500V | B 31010 D 500 K 125 |
| 30 | Modstand | 100Ω | ±10% | 0,5W | SIEMENS |
| 31 | Samlet 3' AM-MF + 3' FM-MF | | | | C 304 GB/A 18 E PHILIPS |
| 32 | Transistor | | | | SBT VITROHM |
| 33 | Modstand | 2,7kΩ | ±10% | 0,5W | 99-C-20 LL |
| 34 | | | | | AF 105 A.E.G. |
| 35 | Ker. Kondensator | 18pF | ±10% | 500V | SBT VITROHM |
| 36 | Modstand | 100Ω | ±10% | 0,5W | C 304 GB/A 18 E PHILIPS |
| 37 | Samlet 2' AM-MF + 2' FM-MF | | | | SBT VITROHM |
| 38 | | | | | 99-C-21 LL |
| 39 | Transistor | | | | AF 116 PHILIPS |
| 40 | Polyester Kondensator | 15nF | ±10% | 125V | C 296 AA/A 15 K PHILIPS |
| 41 | Drosselspole for AM-Tuner | 20μH | | | 100-F-157 LL |
| 42 | Modstand | 1kΩ | ±10% | 0,5W | SBT VITROHM |
| 43 | Polyester Kondensator | 47nF | ±20% | 30V | C 280 AA/P 47 K . PHILIPS |
| 44 | | | | | |
| 45 | Polyester Kondensator | 47nF | ±20% | 30V | C 280 AA/P 47 K . PHILIPS |
| 46 | Modstand | 3,3kΩ | ±10% | 0,5W | SBT VITROHM |
| 47 | Elektrolyt | 10μF | +50% +10% | 25V | C 425 CF/F 10 PHILIPS |
| 48 | | | | | |
| 49 | 1' AM-MF-Primærspole | 19,5-93μH | | | 100-F-165 LL |
| 50 | Styroflex Kondensator | 1nF | ±10% | 125V | 99-C-22 |
| 51 | Drosselspole for AM-Tuner | 20μH | | | B 31010 D 1000 K 125 |
| | | | | | SIEMENS |
| | | | | | 100-F-157 LL |

| Diagr. nr. | Komponent | Værdi | Tolerance | Volt Watt | Bemærkninger |
|------------|--|-------------|-----------|-----------|--|
| 52 | Trimmekondensator | 0,5-4,5pF | | | 9 Nr. 1021/P 100 |
| 53 | Modstand | 2,2MΩ | ±10% | 0,5W | FERROPERM |
| 54 | | | | | SBT VITROHM |
| 55 | Styroflex Kondensator | 1,5nF | ±10% | 125V | B 31010 E 1500 K |
| 56 | AM Drejekondensator | | | | SIEMENS |
| 57 | Styroflex Kondensator | 95pF | ±2,5% | 125V | PD 251 Gi PNN 69/02 kd 59 82-F-585 P. DAU |
| 58 | | | | | SIEMENS |
| 59 | LB-Ferritspole | 8-88 μH | | | 100-F-168 LL |
| | | 270μH-3,6mH | | | |
| | MB-Ferritspole | 0,9-1,5μH | | | 100-F-169 LL |
| | | 27-325μH | | | |
| 60 | Modstand | 8,2kΩ | ±10% | 0,5W | SBT VITROHM |
| 61 | Polyester Kondensator | 10nF | ±10% | 125V | C 296 AA/A 10 K PHILIPS |
| 62 | Modstand | 2,2kΩ | ±10% | 0,5W | SBT VITROHM |
| 63 | Modstand | 2,2kΩ | ±10% | 0,5W | SBT VITROHM |
| 64 | | | | | |
| 65 | Polyester Kondensator | 15nF | ±10% | 125V | C 296 AA/A 15 K PHILIPS |
| 66 | Modstand | 33Ω | ±10% | 0,5W | SBT VITROHM |
| 67 | Modstand | 0,18MΩ | ±10% | 0,5W | SBT VITROHM |
| 68 | | | | | |
| 69 | Ker. Kondensator | 168pF | ±1% | 500V | 9/0119,3 FERROPERM |
| 70 | Ker. Kondensator | 160pF | ±1% | 500V | 9/1019,3 FERROPERM |
| 71 | Trimmekondensator | 1-10 pF | | | 9 Nr. 1021/N 150 |
| 72 | Samlet MB-LB-Oscillatorspole | | | | FERROPERM |
| 73 | Transistor | | | | 99-F-23 LL |
| 74 | | | | | AF 117 PHILIPS |
| 75 | Polyester Kondensator | 0,1μF | ±10% | 125V | C 296 AA/A 100 K |
| 76 | Modstand | 470Ω | ±10% | 0,5W | PHILIPS |
| 77 | 1' AM-MF-Sekundærspole | 19,5-94μH | | | SBT VITROHM |
| 78 | | 0,4-0,8μH | | | 100-F-166 LL |
| 79 | Styroflex Kondensator | 1nF | ±10% | 125V | 99-C-22 |
| 80 | Diode | | | | B 31010 D 1000 K 125 |
| 81 | Polyester Kondensator | 47nF | ±20% | 30V | SIEMENS |
| 82 | Modstand | 2,7kΩ | ±10% | 0,5W | OA 160 A.E.G. |
| 83 | Styroflex Kondensator | 700pF | ±10% | 125V | C 280 AA/P 47 K . PHILIPS |
| 84 | | | | | SBT VITROHM |
| 85 | Polyester Kondensator | 47nF | ±20% | 30V | B 31010 D 700 K 125 |
| 86 | Styroflex Kondensator | 260pF | ±10% | 125V | SIEMENS |
| 87 | Modstand | 27kΩ | ±10% | 0,5W | C 280 AA/P 47 K . PHILIPS |
| 88 | | | | | SBT VITROHM |
| 89 | Modstand | 5,6kΩ | ±10% | 0,5W | SBT VITROHM |
| 90 | Polyester Kondensator | 47nF | ±20% | 30V | C 280 AA/P 47 K . PHILIPS |
| 91 | Styroflex Kondensator | 700pF | ±10% | 125V | B 31010 D 700 K 125 |
| | | | | | SIEMENS |

| Diagr. nr. | Komponent | Værdi | Tolerance | Volt Watt | Bemærkninger | Diagr. nr. | Komponent | Værdi | Tolerance | Volt Watt | Bemærkninger |
|------------|----------------------------|-------------------------------|--------------|-----------|----------------------------------|------------|---|--------|--------------|-----------|--|
| 92 | Polyester Kondensator..... | 47nF | ±20% | 30V | C 280 AA/P 47 K .PHILIPS | 149 | Elektrolyt..... | 10µF | +50% ±20% | 16V | C 426 AM/E 10...PHILIPS |
| 93 | Modstand..... | 1kΩ | ±10% | 0,5W | SBT.....VITROHM | 150 | Potentiometer..... | 25kΩ | | | P 457 Kv. 6 m/afbr. & udtag v/50% drejning. 82-F-617.....VITROHM |
| 94 | | | | | | 151 | Polyester Kondensator..... | 0,47µF | ±10% | 125V | C 296 AA/A 470 K.....PHILIPS |
| 95 | Styroflex Kondensator..... | 330pF | ±10% | 125V | B 31010 D 330 K 125.....SIEMENS | 152 | Modstand..... | 1,8kΩ | ±10% | 0,5W | SBT.....VITROHM |
| 96 | Modstand..... | 1,8kΩ | ±10% | 0,5W | SBT.....VITROHM | 153 | Modstand..... | 10kΩ | ±10% | 0,5W | SBT.....VITROHM |
| 97 | Modstand..... | 47kΩ | ±10% | 0,5W | SBT.....VITROHM | 154 | | | | | |
| 98 | | | | | | 155 | Elektrolyt..... | 10µF | +50% ±10% | 16V | C 426 AE/E 10...PHILIPS |
| 99 | Modstand..... | 6,8kΩ | ±10% | 0,5W | SBT.....VITROHM | 156 | Modstand..... | 10kΩ | ±10% | 0,5W | SBT.....VITROHM |
| 100 | Polyester Kondensator..... | 47nF | ±20% | 30V | C 280 AA/P 47 K .PHILIPS | 157 | Modstand..... | 100Ω | ±10% | 0,5W | SBT.....VITROHM |
| 101 | Styroflex Kondensator..... | 700pF | ±10% | 50V | B 31-100 A 700 K 50.....SIEMENS | 158 | | | | | |
| 102 | Modstand..... | 6,8kΩ | ±10% | 0,5W | SBT.....VITROHM | 159 | Elektrolyt..... | 64µF | +50% ±10% | 10V | C 426 CE/D 64...PHILIPS |
| 103 | Polyester Kondensator..... | 47nF | ±20% | 30V | C 280 AA/P 47 K .PHILIPS | 160 | Elektrolyt..... | 200µF | +50% ±10% | 16V | C 426 CE/E 200...PHILIPS |
| 104 | | | | | | 161 | Peakingspole for | | | | |
| 105 | Modstand..... | 2,2kΩ | ±10% | 0,5W | SBT.....VITROHM | 162 | AM-Tuner..... | 15µH | | | 100-F-153.....LL |
| 106 | Modstand..... | 0,68MΩ | ±10% | 0,5W | SBT.....VITROHM | 163 | Elektrolyt..... | 320µF | +50% ±10% | 10V | C 426 CE/D 320...PHILIPS |
| 107 | Modstand..... | 15kΩ | ±10% | 0,5W | SBT.....VITROHM | 164 | | | | | |
| 108 | | | | | | 165 | Modstand..... | 3,3kΩ | ±10% | 0,5W | SBT.....VITROHM |
| 109 | Polyester Kondensator..... | 10nF | ±10% | 125V | C 296 AA/A 10 K PHILIPS | 166 | Modstand..... | 2,2kΩ | ±10% | 0,5W | SBT.....VITROHM |
| 110 | Ker. Kondensator..... | 10nF | +50% ±20% | 35V | 9/0138,8...FERROPERM | 167 | Potentiometer..... | 10kΩ | | | P 454.....VITROHM 82-F-587 |
| 111 | Modstand..... | 3,3kΩ | ±10% | 0,5W | SBT.....VITROHM | 168 | | | | | |
| 112 | Modstand..... | 10kΩ | ±10% | 0,5W | SBT.....VITROHM | 169 | Modstand..... | 3,3kΩ | ±10% | 0,5W | SBT.....VITROHM |
| 113 | Styroflex Kondensator..... | 1,5nF | ±10% | 125V | B 31010 E 1500 K 125.....SIEMENS | 170 | Modstand..... | 68kΩ | ±10% | 0,5W | SBT.....VITROHM |
| 114 | | | | | | 171 | Modstand..... | 330Ω | ±10% | 0,5W | SBT.....VITROHM |
| 115 | Diode..... | | | | OA 160.....A.E.G | 172 | Elektrolyt..... | 200µF | +50% ±10% | 16V | C 426 CE/E 200...PHILIPS |
| 116 | Modstand..... | 2,2kΩ | ±10% | 0,5W | SBT.....VITROHM | 173 | Modstand..... | 330Ω | ±10% | 0,5W | SBT.....VITROHM |
| 117 | Styroflex Kondensator..... | 400pF | ±10% | 125V | B 31010 D 400 K 125.....SIEMENS | 174 | | | | | |
| 118 | | | | | | 175 | Polyester Kondensator..... | 0,47µF | ±10% | 125V | C 296 AA/A 470 K.....PHILIPS |
| 119 | Ker. Kondensator..... | 22pF | ±10% | 500V | C 304 GB/A 22 E .PHILIPS | 176 | Transistor..... | | | | OC 75.....PHILIPS |
| 120 | Transistor..... | | | | AF 116.....PHILIPS | 177 | Elektrolyt..... | 10µF | +50% ±10% | 16V | C 426 AE/E 10...PHILIPS |
| 121 | Polyester Kondensator..... | 47nF | ±20% | 30V | C 280 AA/P 47 K .PHILIPS | 178 | | | | | |
| 122 | Modstand..... | 12kΩ | ±10% | 0,5W | SBT.....VITROHM | 179 | Modstand..... | 1kΩ | ±10% | 0,5W | SBT.....VITROHM |
| 123 | Modstand..... | 4,7kΩ | ±10% | 0,5W | SBT.....VITROHM | 180 | Modstand..... | 10kΩ | ±10% | 0,5W | SBT.....VITROHM |
| 124 | | | | | | 181 | Styroflex Kondensator..... | 500pF | ±10% | 125V | B 31010 D 500 K 125.....SIEMENS |
| 125 | Samlet FM-Detektor.. | | | | 99-C-39.....LL | 182 | Modstand..... | 0,1MΩ | ±10% | 0,5W | SBT.....VITROHM |
| 126 | Styroflex Kondensator..... | 27pF | ±10% | 125V | B 31010 D 27 K 125.....SIEMENS | 183 | Polyester Kondensator..... | 0,1µF | ±10% | 125V | C 296 AA/A 100 K.....PHILIPS |
| 127 | Modstand..... | 470Ω | ±10% | 0,5W | SBT.....VITROHM | 184 | | | | | |
| 128 | | | | | | 185 | Modstand..... | 2,2kΩ | ±10% | 0,5W | SBT.....VITROHM |
| 129 | FM-Detektorpole.... | 4,3- 12µH 1,2- 2,6µH | | | 100-F-188.....LL | 186 | Polyester Kondensator..... | 0,1µF | ±10% | 125V | C 296 AA/A 100 KPHILIPS |
| 130 | Diode..... | | | | OA 79.....PHILIPS | 187 | Modstand..... | 68Ω | ±10% | 0,5W | SBT.....VITROHM |
| 131 | Styroflex Kondensator..... | 400pF | ±10% | 125V | B 31010 D 400 K 125.....SIEMENS | 188 | | | | | |
| 132 | Omskifter..... | | | | Type M 120.....M.E.C. 85-F-95 | 189 | Polyester Kondensator..... | 0,22µF | ±10% | 125V | C 296 AA/A 220 K PHILIPS |
| 133 | Trimmepotentiometer | 2kΩ | | | P 4.....VITROHM | 190 | Transistor..... | | | | AC 117.....A.E.G. RR 905.53. R. RUDHOLT |
| 134 | | | | | | 191 | Drivertransformator.. | | | | SBT.....VITROHM |
| 135 | Elektrolyt..... | 10µF | +50% ±10% | 25V | C 425 AL/F 10...PHILIPS | 192 | Modstand..... | 1,2kΩ | ±10% | 0,5W | SBT.....VITROHM |
| 136 | Modstand..... | 8,2kΩ | ±10% | 0,5W | SBT.....VITROHM | 193 | Trimmepotentiometer | 1kΩ | | | P 4.....VITROHM |
| 137 | Transistor..... | | | | TF 65 rød.....SIEMENS | 194 | | | | | |
| 138 | | | | | | 195 | Elektrolyt..... | 320µF | +50% ±10% | 10V | C 426 CE/D 320...PHILIPS |
| 139 | Modstand..... | 8,2kΩ | ±10% | 0,5W | SBT.....VITROHM | 196 | Modstand..... | 820Ω | ±10% | 0,5W | SBT.....VITROHM |
| 140 | Elektrolyt..... | 10µF | +50% ±10% | 25V | C 425 CF/F 10...PHILIPS | 197 | Polyester Kondensator | 47nF | ±20% | 30V | C 280 AA/P 47 K .PHILIPS |
| 141 | Modstand..... | 2,7kΩ | ±10% | 0,5W | SBT.....VITROHM | 198 | | | | | |
| 142 | Modstand..... | 1kΩ | ±10% | 0,5W | SBT.....VITROHM | 199 | Modstand..... | 2,2Ω | ±10% | 0,5W | BW.....VITROHM |
| 143 | Styroflex Kondensator..... | 400pF | ±10% | 125V | B 31010 D 400 K 125.....SIEMENS | 200 | Modstand..... | 33Ω | ±10% | 0,5W | SBT.....VITROHM |
| 144 | | | | | | 201 | Transistor..... | | | | AC 117.....A.E.G. |
| 145 | Diode..... | | | | OA 79.....PHILIPS | 202 | Modstand..... | 22Ω | ±10% | 0,5W | SBT.....VITROHM |
| 146 | Styroflex Kondensator..... | 33pF | ±10% | 125V | B 31010 D 33 K 125.....SIEMENS | 203 | Polyester Kondensator | 0,1µF | ±10% | 125V | C 296 AA/A 100 KPHILIPS |
| 147 | Modstand..... | 100Ω | ±10% | 0,5W | SBT.....VITROHM | 204 | | | | | |
| 148 | | | | | | 205 | Modstand..... | 150Ω | ±10% | 0,5W | SBT.....VITROHM |
| | | | | | | 206 | Udgangstransformator m. opspændingsvinkel | | | | RR 905.54 .R. RUDHOLT |
| | | | | | | 207 | Modstand..... | 560Ω | ±10% | 0,5W | SBT.....VITROHM |
| | | | | | | 208 | | | | | E 570 (nyt chassis)..... |
| | | | | | | 209 | Højttaler..... | | | |PEERLESS |



FØLSOMHEDSMÅLING OG TRIMMEFORSKRIFT.

| FREKVENNS | OMSK. STILLING | SKALA INDSTILLING | Tilslutning af HF-SIGNAL | tilsl. af OSC. GRAF | JUST. I NÆVNTE ORDEN | INDGANGSSPÆNDING | |
|---|----------------|-------------------|---------------------------------------|---------------------|----------------------|-------------------------|---------------------|
| AM-MF KREDSE, MODULATION: 30% AM | | | | | | FOR 50mW UDGANGS-EFFEKT | FOR 6db SIGNAL/STØJ |
| 449 KHz | MB | 1650 KHz | EMITTER PÅ 3.MF TRANSISTOR GEN. 0,1µF | PUNKT D | S 9 | 650µV | |
| " | " | " | " " 2.MF | " " | S 7 | 80µV | |
| " | " | " | " " 1.MF | " " | S 5 | 10µV | |
| " | " | " | BASEN PÅ T 2228 GENNEM 0,1µF | " " | S 12-S 13 | 2,5µV | |
| AM-FH KREDSE, MODULATION: 30% AM | | | | | | | |
| 600 KHz | MB | 500 KHz | AUTO ANT. STIK | | S 16-S 14 | 8µV | 6µV |
| 1500 " | " | 200 " | " " " | | C 1-C 2 | 8µV | 5µV |
| 160 " | LB | 1875 " | " " " | | S 15 | 8µV | 8µV |
| 245 " | LB | 1440 " | " " " | | | 5µV | 10µV |
| FM-MF KREDSE, MODULATION: FM ± 22,5 KHz | | | | | | FOR 26db SIGNAL/STØJ | |
| 10,9 MHz | FM | 94 MHz | EITTER PÅ 4. MF TRANSISTOR GEN. 0,1µF | PUNKT D | S 10-S 11 | 8mV | |
| " " | " | " " | " " 3.MF | " " | S 8 | 1mV | |
| " " | " | " " | " " 2.MF | " " | S 6 | 125µV | |
| " " | " | " " | " " 1.MF | " " | S 4 | 25µV | |
| " " | " | " " | ANTENNEINDGANG | " " | S 3 | | |
| FM-HF KREDSE, MODULATION: FM ± 22,5 MHz | | | | | | | |
| 94 MHz | FM | 94 MHz | ANTENNEINDGANG | PUNKT D | S 2-S 1 | | 3µV |

SPOLEPLACERING

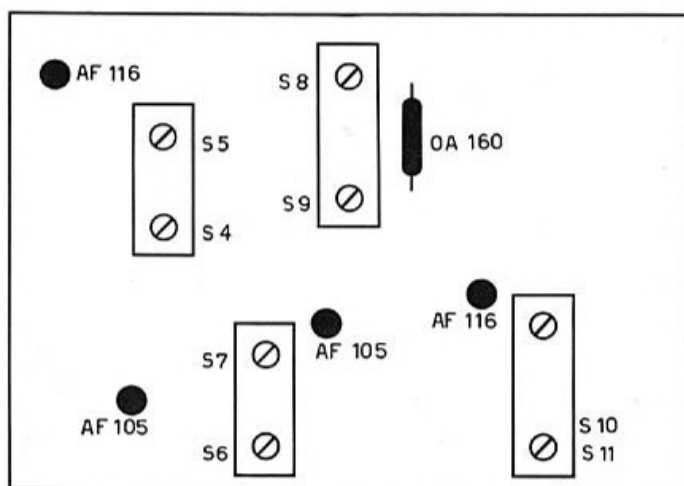

MF-DEL

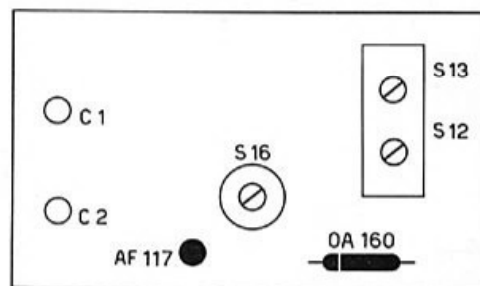

AM-DEL

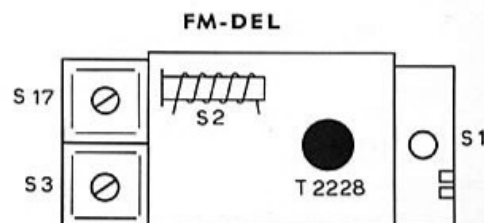

FM-DEL

- A - 147

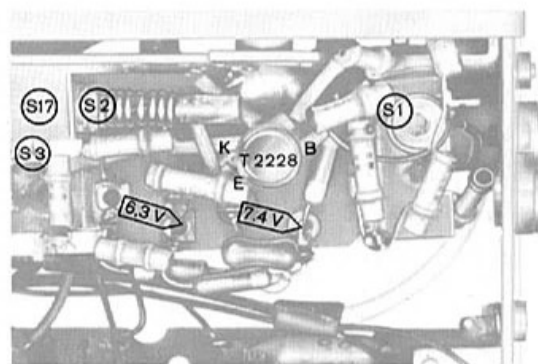
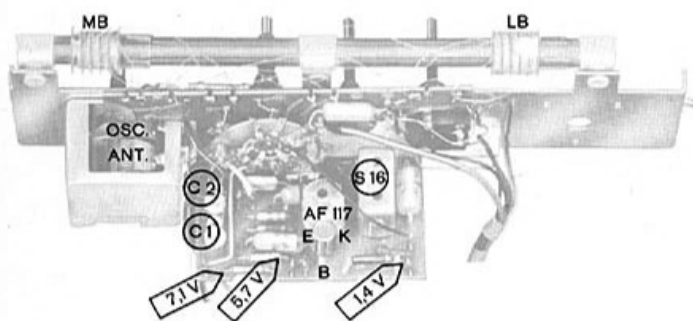
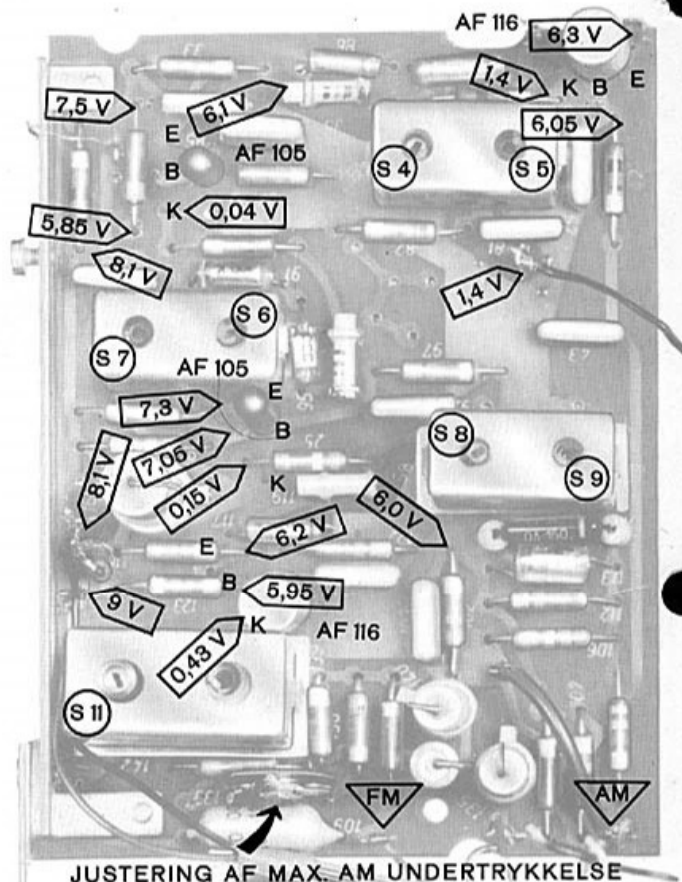
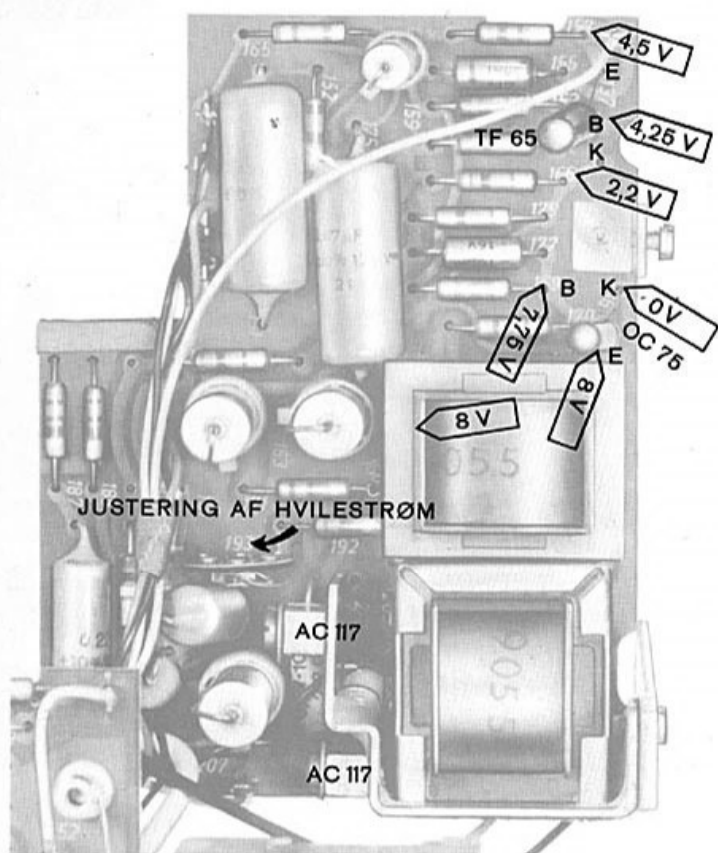

LF-del

Hvilestrøm i udgangstransistorene

Måling og indstilling af hvilestrømmen i udgangstransistorene skal foretages ved neddrejet volumenkontrol og umiddelbart efter, at modtageren er tændt.

Hvilestrømmen indstilles til $10\text{mA} \approx 22\text{mV}$ over modstanden $2,2\Omega$ fra emitter til plus.

FORSTÆRKNING I LF-FORSTÆRKEREN

Under måling af forstærkningen skal potentiometret være helt opdrejet og tonekontrollen i stilling lys. Målefrekvens 1000 Hz. Indgangsspænding tilsluttets potentiometerets top. For 50mWatts udgangseffekt: 3mV ind.

BÄNDOPTAGERTILSLUTNING

Grammofontilslutningen kan anvendes som båndoptager-tilslutning, ved at lægge en kortslutning over grammofonjackets to ledende kontakter mellem $10\mu\text{F}$ og Punkt D.

SERVICE - ANVISNING

NR. 15 - JUNI 1962

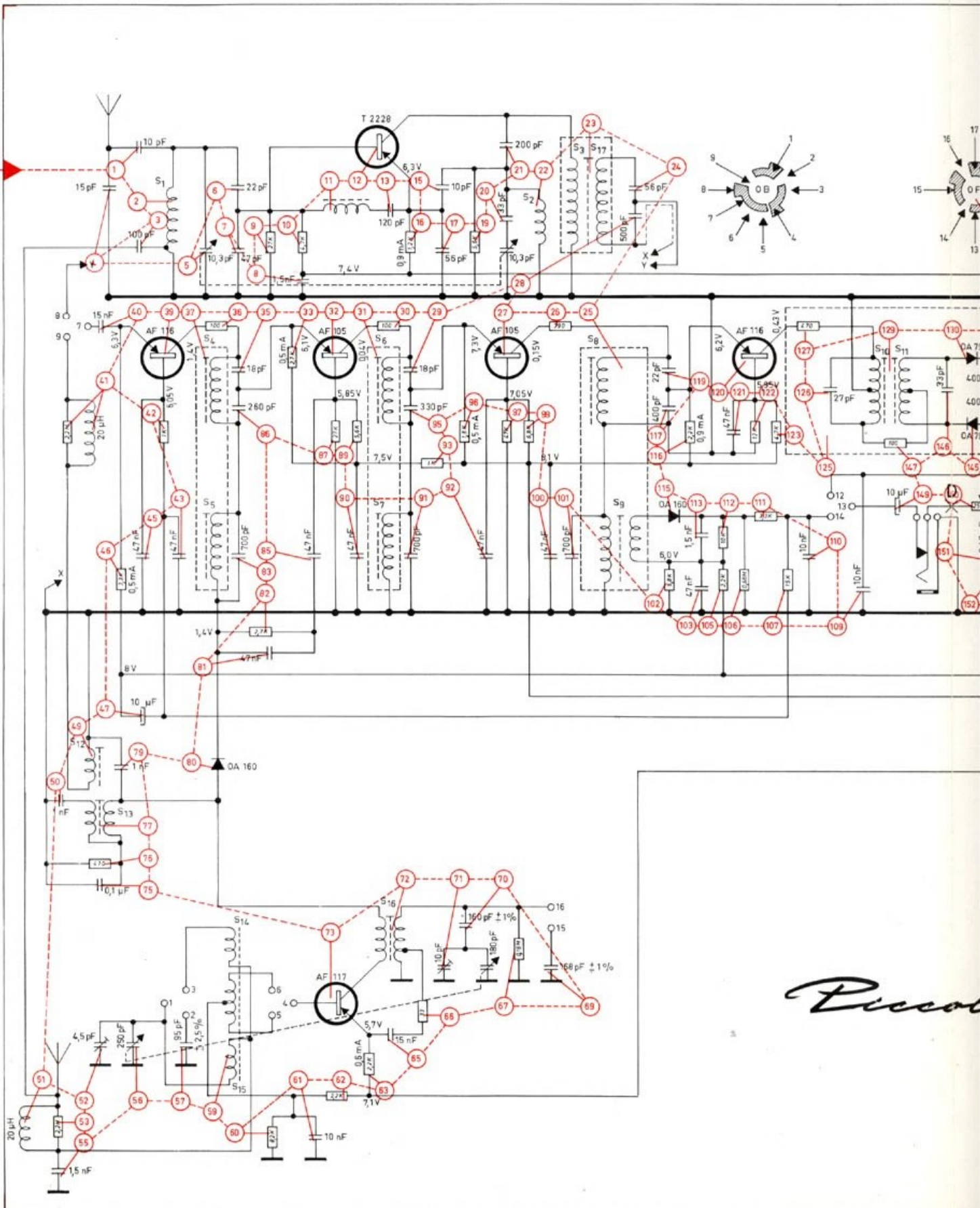

Piccolini

- A - 147

BØLGELÆNGDEOMSKIFTER VIST I VENSTRE YDERSTILLING (STILLING FM).
 ALLE IKKE MÆRKEDE MODSTANDE TYPE SBT (0.5 W).

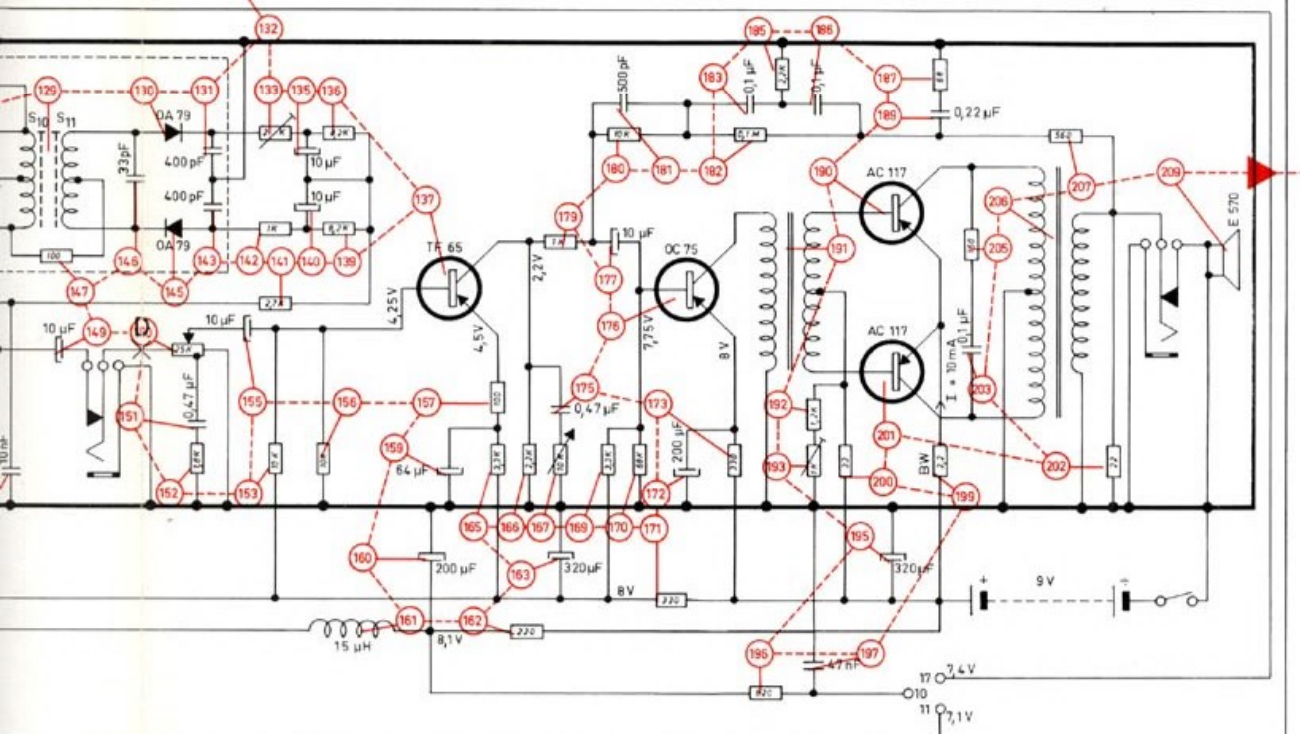
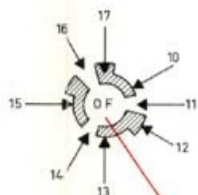

Piccolone 631 AM/FM



Angående strømforbruget på Piccolone 631

På grund af den kraftige basgengivelse i Piccolone 631 er der, ved max. udstyring, et væsentligt strømforbrug. Ved at reducere bassen er det muligt at nedsætte forbruget med ca. 40-50%.

Dette gøres ved følgende ændring:

pos. 180 ændres fra 10 K Ω til 27 K Ω

pos. 182 ændres fra 0,1 M Ω til 8,2 K Ω

Da det med denne ændring går noget ud over gengivelsen, anbefaler vi Dem kun at foretage ændringen hvor kunden spiller kraftigt.