

IMPORTANT: FOR COMPLETE APPRECIATION OF YOUR NC-300, READ THE BOOK FIRST!

tuned to tomorrow...

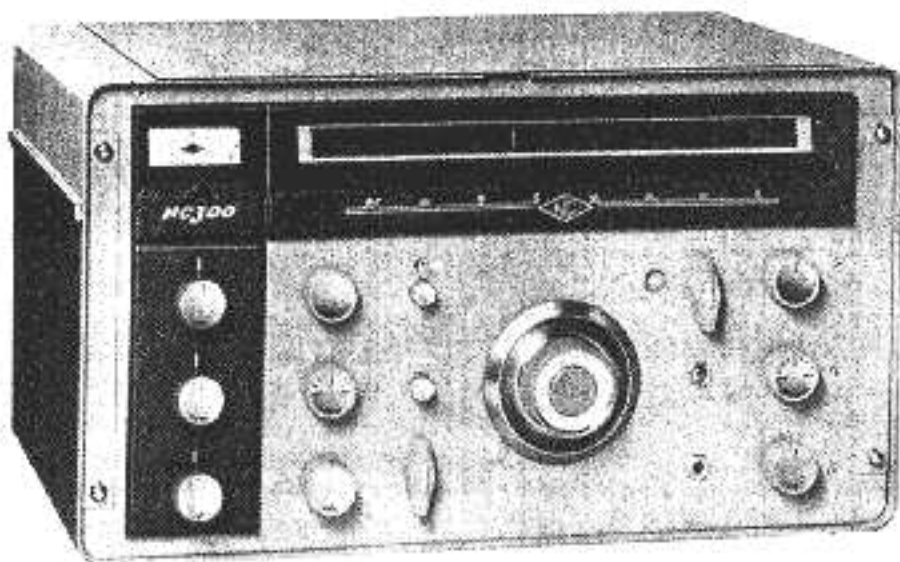

INSTRUCTION BOOK FOR
THE NATIONAL MODEL
NC-300 RADIO RECEIVER

SECTION 1. DESCRIPTION

1-1. GENERAL.

The National Model NC-300 is an amateur-band receiver incorporating all the design features necessary to provide optimum performance consistent with present day operating requirements. Elimination of general frequency coverage and all circuitry not pertinent to amateur operation has enabled National to produce a compact, efficient receiver with the built-in rugged dependability characteristic of National Company products. Contributing to the utility of the receiver are a newly-designed crystal filter, an S-Meter, variable IF selectivity, two-way RF gain control, a muting circuit and heterodyne detection for SSB and CW reception. These operational features are in addition to basic design improvements resulting in exceptional oscillator stability, high sensitivity and excellent selectivity.

The NC-300 features a double-conversion super-heterodyne circuit employing 10 tubes plus the rectifier, voltage regulator and current stabilizer. Through careful selection of IF frequencies, excellent selectivity and image rejection have been achieved. Frequency coverage includes the 160, 80, 40, 20, 15, 11 and 10 meter bands plus the "X" band. The "X" band functions as a tunable IF in the 30 to 35 megacycle range for use with suitable broad-band crystal converters. Individual scales provide direct reading calibration for 6, 2 and 1 1/4 meters. Each amateur band has an individual calibrated dial scale. Tuning is facilitated by the fact that only the calibrated dial scale that is in use is visible. Band-scanning is accomplished with ease as a result of the use of a heavily-weighted tuning knob coupled to a free-moving gear train. Careful attention to mechanical design has made this feature possible without intro-

ducing any trace of backlash.

The outward appearance of the receiver is completely modern and functional. Cabinet and panel construction permits the receiver to be removed from the cabinet and rack mounted without modification or the addition of any parts other than mounting hardware. Adequate ventilation is provided by the use of convection cooling through holes in the chassis and a perforated cabinet lid.

1-2. FREQUENCY COVERAGE

The NC-300 tunes all the amateur bands from 160 through 10 meters plus a 30-35 mc. band designated as the "X" band for use with external converters for the 6, 2 and 1 1/4 meter bands. Each dial scale is calibrated for only one band. Each scale has band limit marking plus underscoring to indicate the phone portion of the band. The dial drum rotates with the band switch so that only the dial scale associated with the band being tuned is visible. The following table gives the frequency of each band tuned by the NC-300.

BAND	FREQUENCY RANGE
160	1.8 - 2.0 mc.
80	3.5 - 4.0 mc.
40	7.0 - 7.3 mc.
20	14.0 - 14.4 mc.
15	21.0 - 21.5 mc.
11	26.5 - 27.5 mc.
10	28.0 - 29.7 mc.
6	49.5 - 54.5 mc. (with converter)
2	143.5 - 148.5 mc. (with converter)
1 1/4	220 - 225 mc. (with converter)

1-3. CONTROLS

The following controls appear on the front panel of the NC-300:

Tuning	Phasing
A.F. Gain	Antenna
R.F. Gain	Cal-Set
Tone	I.F. (1-2-3)
ANL	C.W.O.
Mode (ACC-AM-CW-SSB)	Xmt-Rec
Selectivity (Off-1-2-3)	Off-Cal
Band	

1-4. IF SELECTIVITY

The IF pass band may be set at 500 cycles, 3.5 kc or 8 kc at the operator's discretion. Figure 1 shows the IF selectivity characteristics. With the ever-increasing amount of activity on the amateur bands,

variable selectivity is a must on any modern communications receiver. For copying CW signals in the midst of heavy QRM, the 500 cycle bandwidth is invaluable. The 3.5-kc position is provided to improve the readability for phone operation when interference is heavy, and the widest range, 8 kc, makes it possible to copy net stations or roundtables with a minimum of retuning. The 8-kc bandwidth is also important when using the converters in the VHF ranges. The operator will find many varied combinations of crystal and IF selectivity adjustments that will best suit his particular receiving requirements.

1-5. CRYSTAL FILTER

Exhaustive tests have proved that the crystal filter is a necessary adjunct to communications receivers. Three degrees of crystal selectivity are provided. The Phasing control inserts the notch in the selectivity curve so necessary to interference-free reception. The filter used in the NC-300 has been specifically designed to work with the receiver IF circuitry. There is but one limitation. During CW operation, the crystal filter cannot be used with the IF switch at the sharp position (3).

1-6. TWO-WAY RF GAIN CONTROL

A special switch is made an integral part of the audio-frequency gain (AFG) control so that the switch may be operated at either extreme of control rotation. By means of this switch, the RF gain control may be removed from the RF amplifier stage permitting the stage to operate at maximum gain regardless of the setting of the RF gain control. Thus, when maximum front-end gain is desirable with reduced overall gain, the action of the control can be restricted to the IF stages only. In the presence of strong local signals, the control should be switched into the RF amplifier cathode circuit to prevent overloading by retarding the RF gain control as necessary.

1-7. MUTING CIRCUIT

A built-in muting circuit silences the NC-300, when desired, without resorting to the use of relays. Any point in the transmitter, which supplies approximately minus 22 volts with the transmitter on, may be connected to the muting terminals at the rear of the receiver. When the transmitter is energized, the audio amplifier in the receiver is cutoff to prevent feedback, key clicks etc.

1-8. SINGLE SIDEBAND DETECTION

To receive single sideband signals satisfactorily, the CW frequency oscillator (CWO) must supply stable output of sufficient amplitude to maintain adequate carrier re-insertion voltage. The single-sideband

detector used in the NC-300 utilizes the heterodyne detection principle.

1-9. CONVERTERS AND CABINET

The National types NC-300C1, NC-300C2 and NC-300C6 are broad-band, crystal-controlled converters to tune the 1 1/4, 2 and 6-meter Amateur bands respectively. The slide rule dial of the NC-300 incorporates three separate dial scales to provide direct-reading frequency calibration when the converters are used with the receiver. All operating voltages required by the converters are available at the accessory socket of the NC-300.

The National NC-300 Converter Cabinet is designed to provide a convenient and attractive means of mounting the converters. From one to three converters may be mounted in the cabinet which matches the receiver cabinet and is identical in size and appearance to the NC-300 speaker cabinet. A four-position switch is mounted on the front panel to permit operation of the receiver or any one of the three converters without changing connections to the receiver or antenna.

1-10. S-METER

The S-Meter gives the operator a true indication of

relative strength of incoming signals. The meter is calibrated in S units from 0 to 9 and in decibels from S-9 to 40 db over S-9. A potentiometer is provided on the chassis to zero-set the meter.

1-11. TUBE FUNCTIONS

The following table lists the types and functions of all tubes used in the NC-300:

<u>TUBE TYPE</u>	<u>FUNCTION</u>
6BZ6	R.F. Amplifier
6AH6	H.F. Oscillator
6BA7	First Mixer
6BE6	Second Converter
6BJ6	First I.F. Amplifier
6BJ6	Second I.F. Amplifier
6AL5	Detector and Noise Limiter
6BE6	C.W. Oscillator-Heterodyne Detector
12AT7	S-Meter Amplifier and A.F. Amplifier
6AQ5	Audio Output Amplifier
5Y3GT	High Voltage Rectifier
OB2	Voltage Regulator
4H4-C	Current Stabilizer

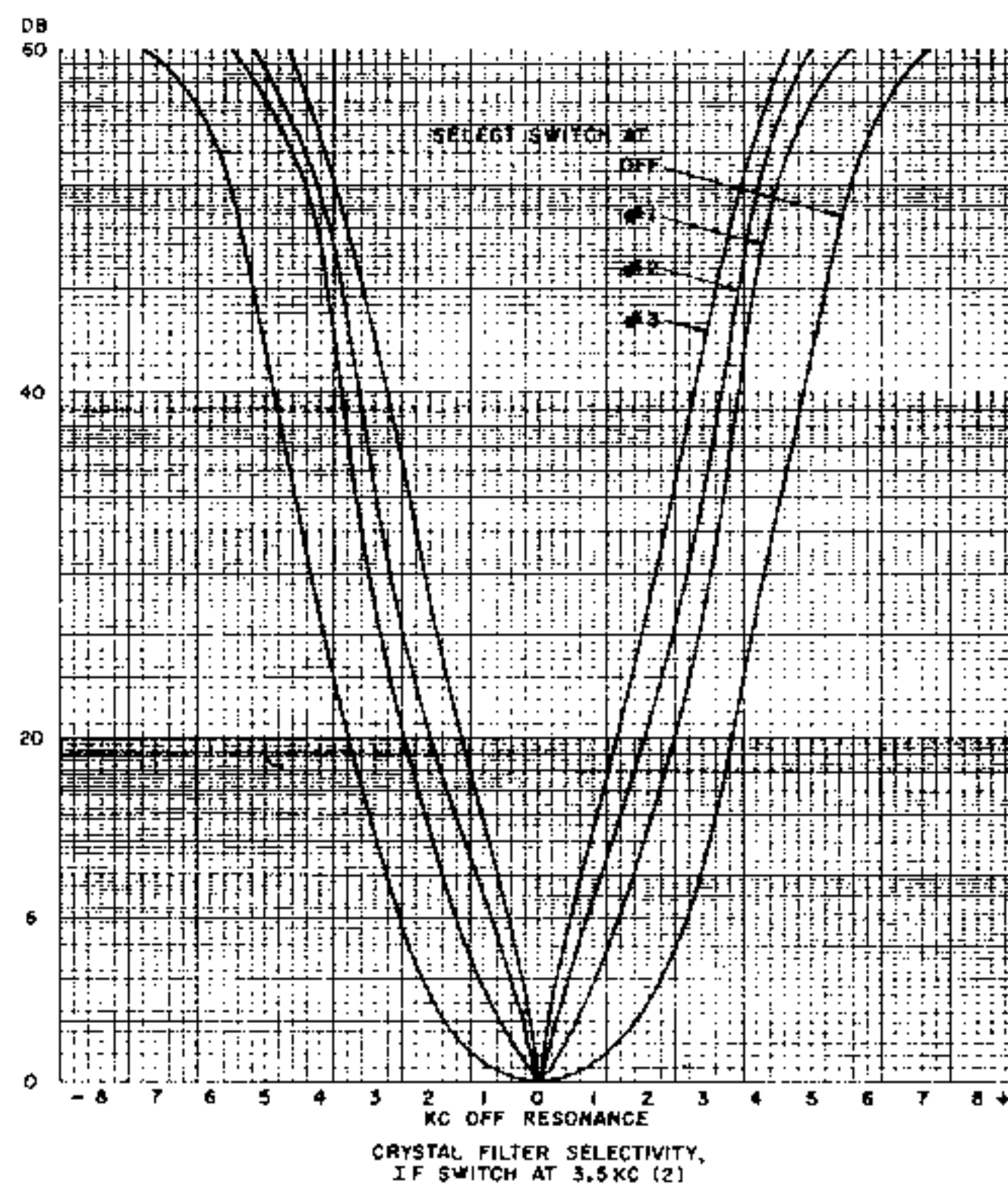
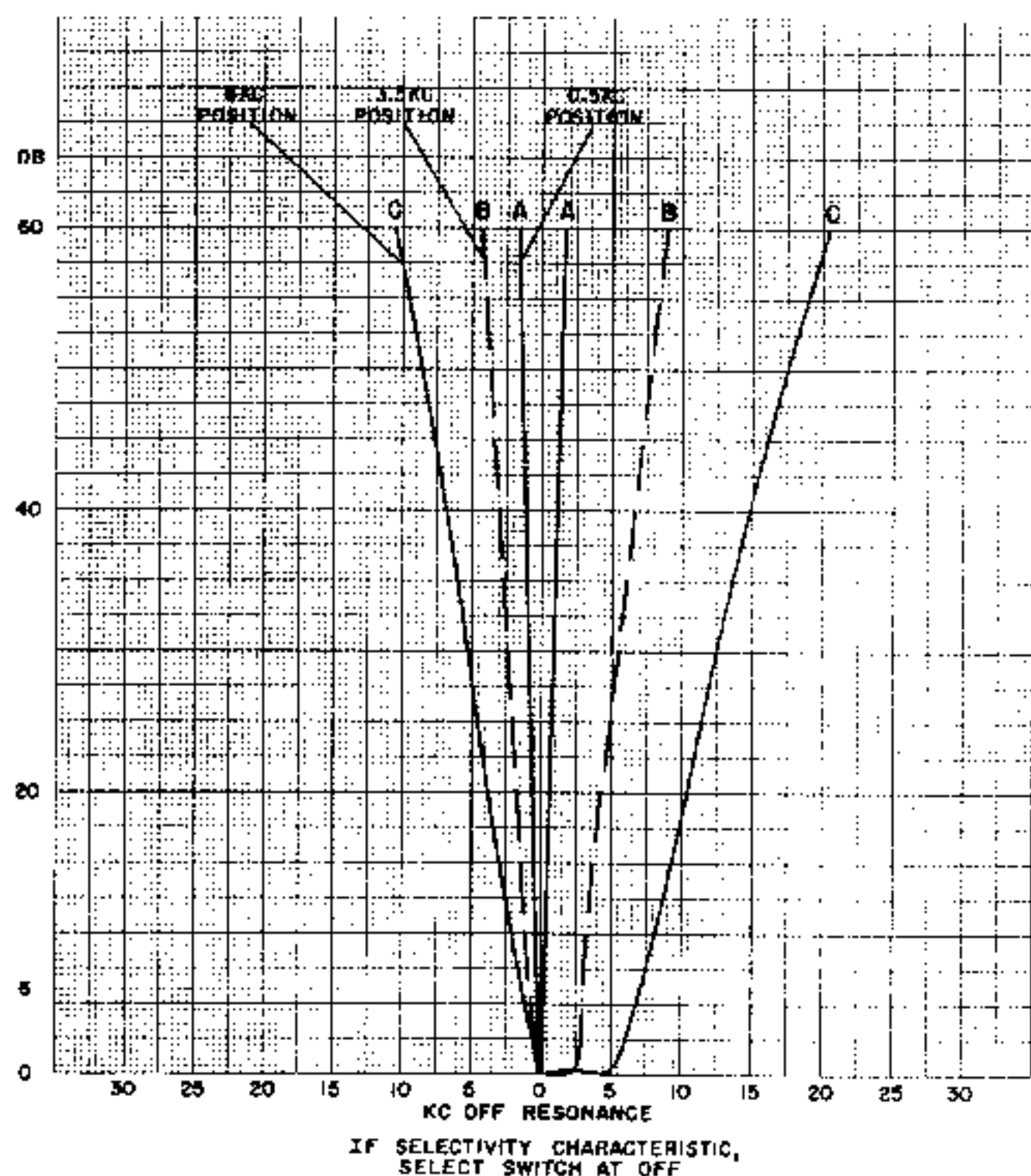

Figure 1. I.F. and Crystal Filter Selectivity Characteristics

1-12. POWER REQUIREMENTS

The NC-300 requires a 105-130 volt, 50/60 cycle AC source of supply. Power consumption is approximately 60 watts.

1-13. CALIBRATOR SOCKET

A socket is provided on the chassis to permit insertion of the National type XCU-300 crystal calibrator unit. The OFF-CAL switch on the front panel of the NC-300 provides the means for turning the

calibrator On or Off.

1-14. ACCESSORY SOCKET

The accessory socket provided at the left rear corner of the chassis is designed to accept suitable external accessories within the power limitations of 1.5 amperes at 6.3 volts A.C. and 25 milliamperes at 150 volts D.C. See the schematic diagram for pin connections etc. Refer to Section 3 for instructions on the use of external accessories.

SECTION 2. INSTALLATION

2-1. GENERAL

All installation procedures are described in this section. Figure 2 locates connection points on the receiver and depicts typical installations. Before proceeding with installation, raise the hinged cover of the receiver and make sure that all tubes are seated firmly in their sockets.

2-2. LOUDSPEAKER

A National type NC-300TS speaker or any permanent-magnet dynamic speaker with an 8-ohm voice coil may be connected to the speaker terminals. No polarity need be observed.

2-3. CHANGEOVER RELAY

A terminal marked Relay is mounted at the rear of the receiver. When the Xmt-Rec switch is set at Xmt, the two Relay terminals are shorted. Thus, they may be used to complete any external relay circuit whether it be AC or DC so long as the circuit requirements do not exceed 5 amps at 125 volts AC. A typical circuit might consist of a 110-volt AC antenna changeover relay in parallel with the transmitter plate supply relay with one side of the AC line broken by the NC-300 Relay connector strip. When connected in this manner the Xmt-Rec switch on the receiver front panel performs all the required change over operations for the entire station.

2-4. MUTING

A Stdby-Mute terminal strip is mounted at the rear of the receiver. These three terminals provide for two entirely different methods of receiver muting during transmitting periods. With no external connections made to the strip, the receiver will be muted whenever the Xmt-Rec switch is placed in the Xmt position. If muting is not desired, (for trans-

mitter monitoring etc.) a jumper wire may be connected between STBY and GND. The receiver now operates regardless of the Xmt-Rec switch position. For remote switching of the receiver, connect leads to Stdby and Gnd, leaving the switch in the Xmt position. If CW break-in operation is desired, the MUTE and GND terminals may be used to mute the receiver. To accomplish this it is necessary to find a point in the transmitter circuitry that will provide a source of negative 22 to 50 volts when the transmitter is on. (A 100,000 ohm resistor connected to the grid of a keyed stage which develops at least minus 22 volts with the key down will suffice). Since grid blocking is employed in the receiver, no current will be drawn from the transmitter. Connect the minus 22-volt lead to the terminal marked MUTE and the transmitter chassis to the terminal marked GND. Leave the Xmt-Rec switch in the Receive position. When the transmitter is turned on or keyed, the NC-300 will automatically mute. Since the muting circuit is well filtered, no key clicks should be heard.

2-5. ANTENNA

A two-terminal strip is provided for connection of antennas fed by unbalanced transmission line systems. Usually the most efficient antenna is the one which has been tuned and adjusted for optimum transmitting results. For the 40, 80 and 160 meter bands, a single wire antenna of between 15 and 40 feet is recommended. This should provide ample signal pickup and reduce the likelihood of interference from strong undesired signals outside the IF passband. Switching the antenna from the transmitter to the receiver is most easily accomplished by means of a relay actuated by the RELAY terminals of the NC-300.

Any of the popular dipoles, beams etc., which are fed with 50 to 70-ohm coaxial cable will be ideal. In installations where it is desired to use an already

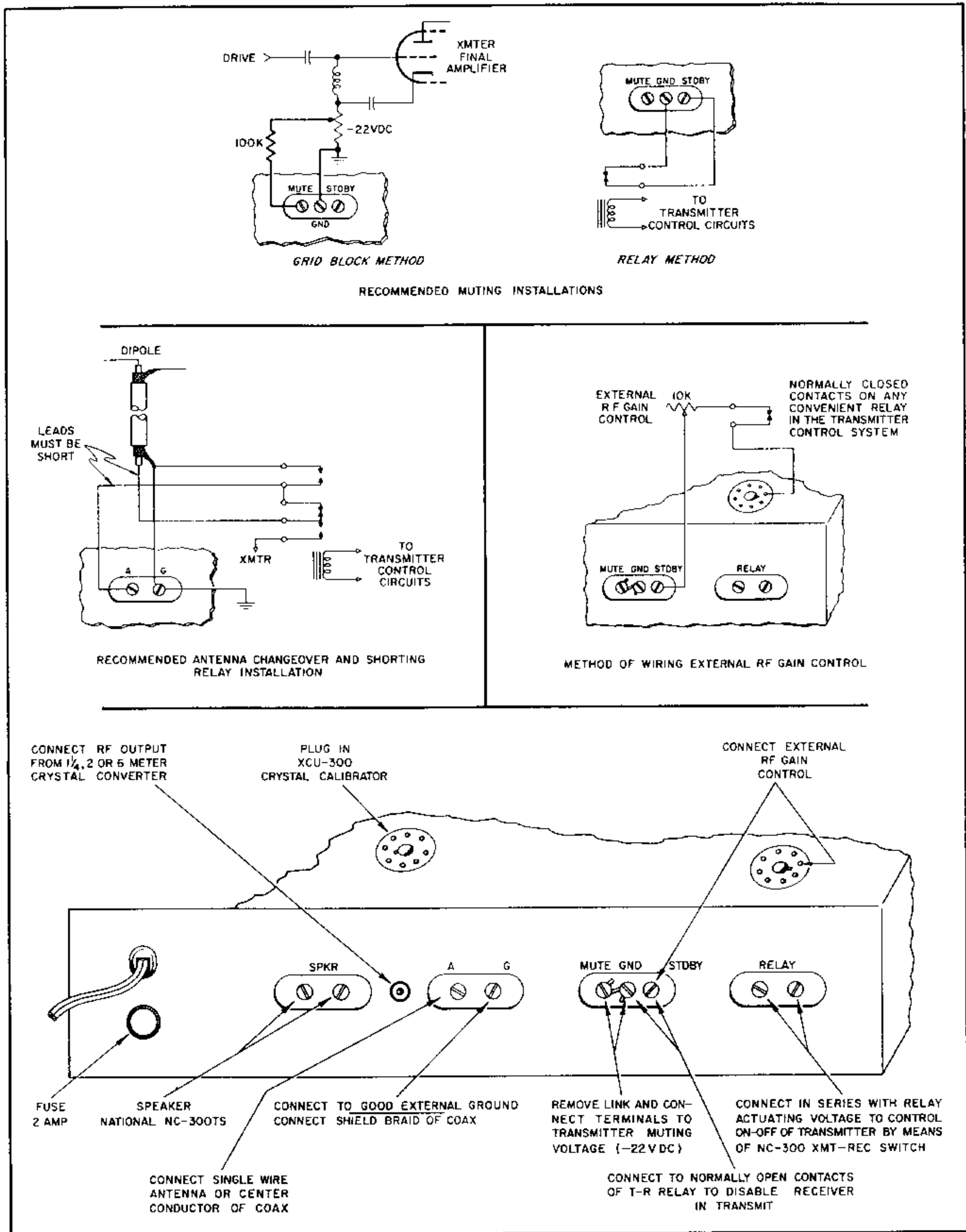

Figure 2. Typical Installation Plan

existing antenna with a 300-ohm balanced feedline, an antenna coupler such as a balun can be used to match this antenna to the 70-ohm unbalanced input of the NC-300. The balun may be either a quarter-wave section of coax or a pair of balun coils.

NOTE

If the receiver is used in close proximity to the transmitting equipment, some provision must be made to short the antenna terminals to ground during transmitting periods to prevent damage to the antenna coils. This is most easily accomplished by means of a relay connected to the antenna terminals and ground. The relay should be located within six inches of the antenna terminal strip to prevent excessive pick-up.

Connect the shield braid of the coax to terminal G and the inner conductor to the A terminal. A good electrical ground should be used. This may be a convenient cold water pipe scraped clean of paint and oxidation or a suitable ground-rod driven into the

earth as close as possible to the receiver location. The outstanding sensitivity and signal-to-noise characteristics of the NC-300 cannot be fully appreciated unless every effort is made to provide proper antenna and ground facilities.

2-6. CALIBRATOR SOCKET

The Calibrator socket at the rear of the receiver chassis is factory wired so that it is only necessary to plug in the National type XCU-300 Crystal Calibrator unit. The OFF-CAL switch on the front panel will then energize the calibrator when desired.

2-7. ACCESSORY SOCKET

This socket permits a variety of accessories to be used with the NC-300. Audio devices such as a crystal phono pickup may be connected to pins 5 and 6. Heater, B+, AVC and ground connections are available for external converters etc. The receiver IF output is connected to pin 4 for use with SSB devices and the RF Gain bus is brought to pin 1 for external control of RF Gain (see paragraph 3-3).

SECTION 3. OPERATION

The purpose of this section is to provide the operator with a clear and concise understanding of the operating techniques of the NC-300 to assist him in securing maximum satisfaction from the receiver. The design of the receiver circuitry provides every feature necessary for outstanding performance but a thorough knowledge of correct operation is required to utilize these features to full advantage. For complete appreciation of your NC-300 READ THESE INSTRUCTIONS CAREFULLY.

3-1. CONTROLS

Complete utilization of the operating instructions is not possible without a thorough understanding of all front-panel devices. See Figure 3 for the location of all controls. The control designations used correspond to the markings on the receiver.

ANL (Automatic Noise Limiter) - The ANL control is used only for phone reception. This control incorporates a switch which turns the limiter off when the control is rotated to its maximum counterclockwise position. Turning the control clockwise just enough to throw the switch places the limiter in operation.

Further rotation of the control increases the limiting action. Noise clipping is obtained at the expense of audio quality so a position should be chosen to provide maximum noise clipping consistent with satisfactory intelligibility. Noise conditions will vary with localities, so the limiting level is a matter of personal choice.

To provide noise limiting for CW reception, the IF amplifier of the NC-300 is designed to limit on pulse interference. The time constants incorporated in the grid circuits are very short to permit following fast pulses. To achieve limiting action the RFG control should be advanced until overload is approached. The AFG control should then be adjusted for best listening level. Then the RFG control can be used to adjust for best limiting action. Experience with the receiver will dictate the proper settings of the RF and AF gain controls to achieve the desired point of IF limiting.

CAL-SET (Dial Pointer Adjustment) - Used in conjunction with the XCU-300 Crystal Calibrator, this control provides calibration correction for each band. With the CW oscillator and the crystal calibrator switched on, and the receiver tuned to zero

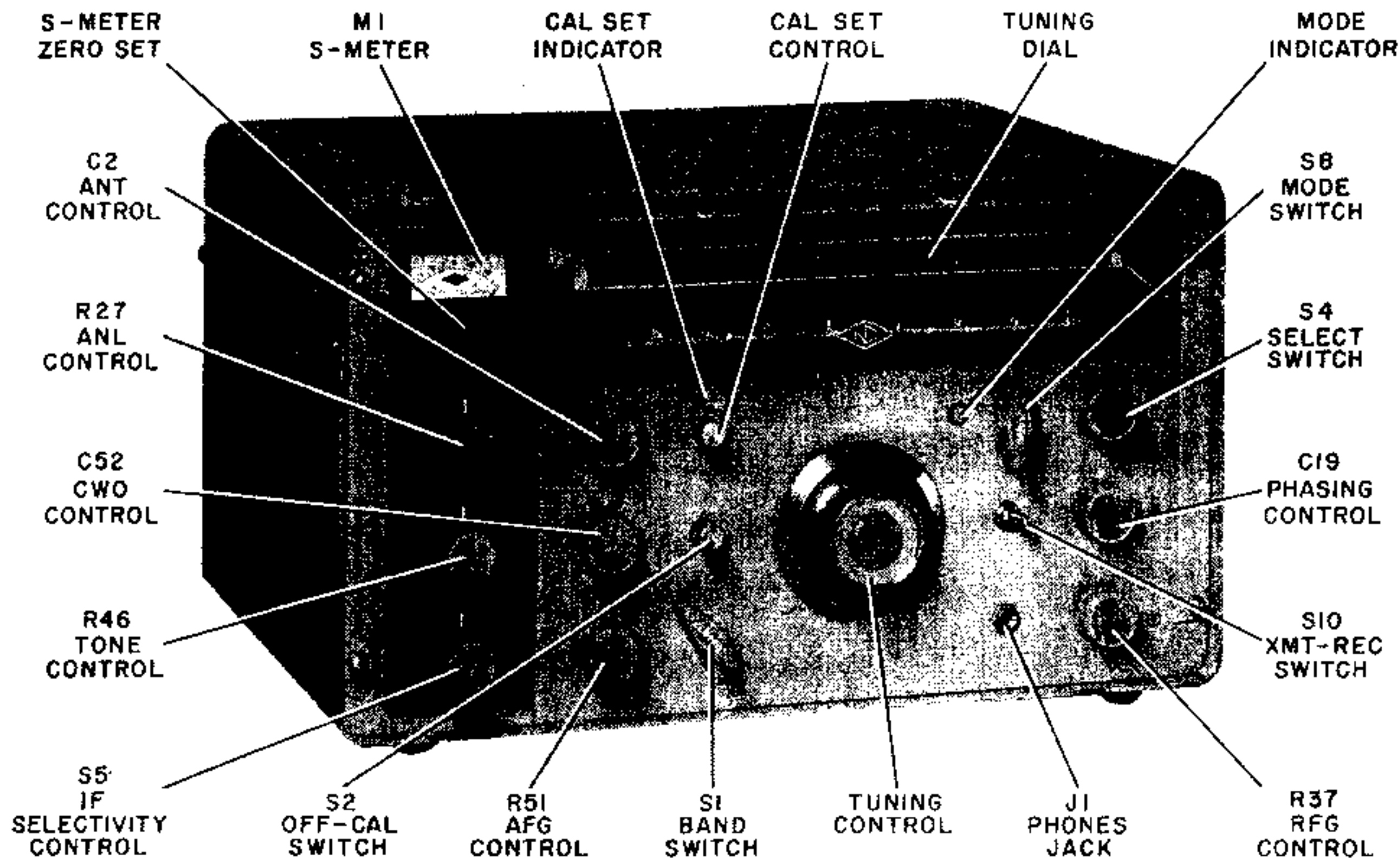

Figure 3. Front Panel Control Locations

beat at any 100-kc point of the band, any slight error in dial reading may be corrected by turning the CAL-SET control to position the pointer on signal. This is a mechanical adjustment of the dial pointer and in no way affects the receiver's oscillator frequency.

ANT (Antenna Trimmer) – This control is included to provide a means of matching the RF tuned circuits to varying antenna impedances. After the desired signal is selected, the antenna trimmer should be adjusted to produce maximum S-Meter reading.

MODE – The Mode switch selects the mode of operation i.e., ACC-AM-CW or SSB. The mode selected appears in the small round opening at the left of the switch knob. The AM position is used for all forms of amplitude-modulated transmissions. In the ACC position, the audio amplifier is connected to the accessory socket to permit use of the receiver as an amplifier for a phono-pick-up or similar audio device. In the CW position, the CW oscillator is energized and the AVC and S-Meter circuits are disabled. In the SSB position, the heterodyne detector is used for carrier reinsertion and the AVC and S-Meter circuits are active.

SELECT (Crystal Filter Selectivity) – Three degrees of crystal selectivity plus an Off position are provided by the SELECT knob. When used in conjunction with position 2 of the IF switch, the Select control affords the desired range of selectivity char-

acteristics. The crystal filter cannot be used in combination with the sharpest IF selectivity position.

TONE – The adjustment of the characteristics of the audio circuitry is permitted by the Tone control. Rotated in a clockwise direction it increases attenuation of the higher frequencies. At its extreme counterclockwise position it actuates a switch which effectively attenuates frequencies below the voice range. This feature is provided to equalize the roll-off characteristic introduced by the crystal filter. Figure 4 illustrates the audio characteristics of the receiver.

CWO (CW Oscillator Pitch) – This control varies the pitch of the generated audio tone to suit the operator when receiving CW signals. During single-sideband operation, the control is set at 1 to receive lower sideband signals on the 160, 80 and 40-meter bands, at 2 to receive the upper sideband on these bands. The converse settings are used for the 20, 15, 11 and 10-meter bands.

OFF-CAL (Calibrate Switch) – If the XCU-300 Crystal Calibrator is plugged into the receiver, the CAL switch is used to turn the calibrator Off and On. The calibrator provides a crystal controlled test signal every 100 kilocycles so that dial calibration may be checked and, if necessary, corrected by means of the CAL-SET control.

TUNING – The tuning knob provides a 40 to 1

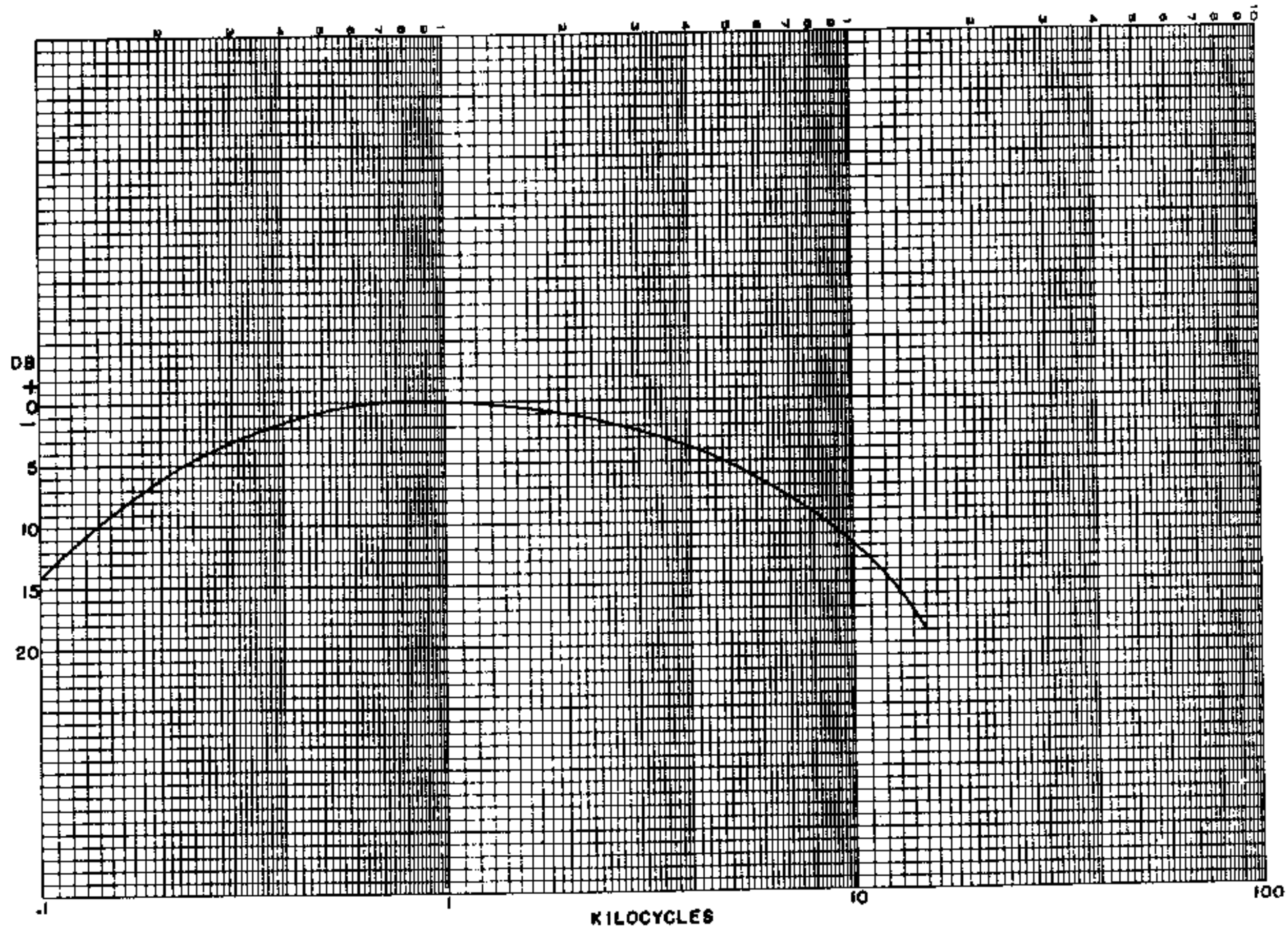

Figure 4. Audio Response

ratio for ease in selecting the desired signal as indicated on the slide-rule dial. Frequency increases with clockwise rotation of the knob.

XMT-REC - This is a two-position toggle switch which may be set at XMT to mute the receiver during standby and/or transmitting periods. In addition, it will turn the transmitter on and off if the relay terminals at the rear of the receiver have been connected to provide this function. Since the XMT-REC switch performs its muting function in the audio and IF stages, normal operating voltages are maintained on the oscillators and all other frequency-critical circuits to ensure that no frequency drift will occur during standby periods.

PHASING (Crystal Filter Phasing Control) - Maximum selectivity is obtained when the crystal filter circuits are balanced at the crystal frequency. The Phasing control is used to accomplish this balance. In addition, a characteristic of crystal filters is their ability to provide a pronounced null at any particular frequency. This feature is extremely useful in "tuning out" an unwanted signal very close to the desired signal. This control is operative only when the SELECT switch is at position 1, 2 or 3. When the SELECT switch is at off, it is important that the PHASING knob be set at mid-position in order to peak the preceding IF stage.

IF (IF Selectivity Switch) - In order to provide the wide range of selectivity characteristics neces-

sary to cope with the variety of amateur operating requirements, the IF switch permits the operator to select one of three different IF bandwidths. Position number 1 is 8 kc wide, position 2 is 3.5 kc and position 3 is 500 cps. In normal phone operation the 3.5 kc position would usually be used; position 3 affords the sharpest selectivity and is normally desirable for CW operation. Position 1 places the IF passband at its broadest.

AFG (Audio Frequency Gain Control) - Two functions are performed by this control. The first is the customary adjustment of audio output level to suit the listener. Turning the control clockwise increases the volume; turning it counterclockwise decreases the volume. The second function is the switching of the RF gain control out of the RF amplifier circuit for optimum performance during CW operation. Turning the AFG control fully clockwise so that the switch is actuated removes the RF gain control from the RF stage and allows the RF amplifier to run at full gain. This affords better reception of weak signals. It should be noted that regardless of the switch position, the gain of the second IF amplifier is always adjustable by means of the RFG control. The AFG control may then be returned to the desired position. To place the RFG control into the RF amplifier circuit, rotate the AFG control to its full counterclockwise position so that the switch is thrown, then the AFG control may be reset. This setting affords an improvement in reception when strong interfering

signals are encountered.

BAND CHANGE SWITCH – This control is used to select the desired frequency band to be tuned. Gear reduction is employed in the NC-300 to assure a smooth working control and positive locking switch positions. For this reason the BAND control makes more than one revolution in switching through all 10 bands. The band to which the receiver is set is identified by the scale visible on the slide rule dial since the dial and the BAND switch are mechanically coupled. Positive stops are provided at both ends of the BAND control travel.

PHONES JACK – Headphones of the high-impedance type may be plugged into the PHONES jack using a standard two-circuit phones plug. There is no DC voltage associated with the headphone circuit. The loudspeaker is automatically silenced when the phones plug is inserted.

RFG (RF Gain Control) – The sensitivity of the receiver is adjusted by means of this control. It may control the gain of the RF amplifier and second IF stages, or the second IF stages only, depending upon the position of the RF gain switch mounted on the AF gain control. This two-way feature may be used at the discretion of the operator, and generally, the gain control will be restricted to the IF amplifiers when maximum CW sensitivity is desired to provide better reception of weak signals. If very strong local signals tend to cause overloading, the RF gain control should be switched into the RF amplifier circuit to permit reducing the RF amplifier gain. The AC switch which turns the NC-300 ON and OFF is mounted on the RF gain control. When this control is rotated to its maximum counterclockwise position the AC power is shut off. Rotating the control slightly in the clockwise position will actuate the switch and turn the receiver on. Further rotation increases the receiver sensitivity until maximum is reached at the full clockwise position.

3-2. PHONE RECEPTION

The instructions in Steps 1 through 16 adjust the receiver for the normal reception of Phone signals.

1. Set the ANL control at OFF.
2. Set the MODE switch at AM.
3. Set the SELECT control at OFF.
4. Set the TONE control at OFF.
5. Set the OFF-CAL switch at OFF.
6. Set the XMT-REC switch at REC.
7. Set the IF control at position 2.
8. Turn the AFG control fully counterclockwise until the switch clicks, then advance it approximately to mid-position.
9. Set the BAND switch to the desired frequency range as indicated by the slide-rule dial scale.
10. By means of the CAL-SET knob, center the hairline in the diamond-shaped cutout directly above

the knob.

11. Turn the RFG control fully clockwise. Power is now applied to the receiver. Allow at least two minutes for the tubes to reach operating temperature before proceeding. Set the AFG control to provide the desired audio level.

12. Rotate the TUNING control until the desired signal is located. Adjust the TUNING control very carefully for maximum S-Meter reading.

13. Turn the ANT TRIM and PHASING controls to obtain maximum S-Meter reading. These controls may be set, in the absence of a signal, by adjusting them to obtain a peak in the background noise.

14. Set the AFG control to produce the desired listening level.

15. Turn the TONE control to a position giving the desired audio response.

16. To shut down the receiver, turn the RFG control fully counterclockwise.

The AFG control should be used in all cases to adjust the audio output level. The RFG control setting may require readjustment for true S-Meter readings. Refer to paragraph 3-5.

Various types of interference which may be encountered due to adverse receiving conditions can be minimized by adjusting the following controls in the manner described.

NOISE LIMITER – When an AM signal is accompanied by static peaks or noise pulses of high intensity and short duration, the best signal-to-noise ratio will be obtained by turning On the ANL control. In general, it will be found that turning this control just far enough to actuate the switch will effectively minimize interference caused by external noise pulses. In cases where the noise pulses are extremely pronounced, a higher degree of noise suppression will be realized by advancing the ANL control. Advancing the control fully clockwise will introduce some audio clipping. This is an inherent characteristic of all noise limiters and the operator must choose the setting which, under severe conditions, will produce best readability.

TONE CONTROL – The TONE control can be used to adjust the upper and lower cut-off frequencies of the audio amplifier.

IF SELECTIVITY – The NC-300 incorporates two separate means of adjusting its selectivity characteristics (IF and SELECT controls). This paragraph deals with the IF control. For normal phone reception, the IF switch will satisfy narrow bandwidth requirements in position 1 (8 kc) or position 2 (3.5 kc). The 500-cycle position (3) is too narrow and should not be used for phone signals.

CRYSTAL FILTER SELECTIVITY AND PHASING – The increased selectivity afforded by the crystal filter will frequently prove useful for phone reception. Position 1 of the SELECT control will probably

prove most useful. In this position, the PHASING control becomes operative. By careful adjustment of the PHASING control the unwanted signal can usually be reduced sufficiently to permit copying the desired signal. Experience in the use of the IF, SELECT and PHASING controls will ultimately indicate various combinations of settings that best suit the varying operating conditions encountered.

3-3. CW RECEPTION

The initial adjustment of the receiver controls for CW reception is the same as given in Section 3-2 with the following exceptions. Set the MODE switch at CW. Set the CWO control at its mid-scale position. Rotate the AFG control clockwise until the switch is actuated. Then rotate clockwise approximately to mid-position.

The audio level of the receiver should be adjusted by means of the RFG control. Strong CW signals cannot block the IF circuits but will result in an unnecessarily high background noise level. Always keep the RFG control below the point where this condition occurs.

If short-duration pulse interference (ignition etc.) is encountered, the noise reduction feature of the IF limiter circuits may be utilized to good advantage. Advance the RFG control and retard the AFG control until limiting occurs. This limiting takes place in the last IF stage and, because of the extremely fast time constants, the limiting action is similar to that encountered in FM receivers.

For CW reception, the IF control may also be used in its sharpest position (3). It is important to remember, however, that the IF passband in this position is only 500 cycles wide so that the receiver tuning and CWO tuning must be adjusted very slowly and carefully. The crystal filter must be off when this sharpest setting is used.

For the reception of CW signals the action of the crystal filter is similar to that for phone reception except that full use of the sharp selectivity position may be used without the loss of intelligibility experienced in phone reception. When maximum selectivity is used (SELECT switch at position 3), care must be used in tuning. When the receiver is slowly tuned across the carrier of the received signal, the beat note produced will be very sharply peaked in output at a particular audio pitch. This peak in response indicates the correct receiver dial setting. The setting of the CWO control must be such that the beat-note peak is well within the audible range so that the receiver peak response may be readily observed. After the receiver has been correctly tuned, the pitch of the beat-note peak may be adjusted by means of the CWO control to provide an audio tone which is pleasing to copy or coincides with

any response peaks in the speaker or headphones. Under these conditions the receiver will exhibit pronounced single-signal properties which may be demonstrated by tuning the receiver to the other side of zero-beat so that the pitch is the same as before and observe the marked reduction in output. This latter dial setting is not recommended for use other than to demonstrate the single-signal properties of the receiver. With the receiver tuned to crystal peak an interfering signal may be attenuated by proper setting of the PHASING control since this control has little effect on the desired signal.

As in phone operation, combinations of control settings may be selected to suit varying requirements except that it must be remembered that the crystal filter cannot be used with IF switch at position 3. It is possible, by means of judicious manipulation of these controls, to copy signals which would be completely unreadable on receivers which do not incorporate these features.

An important aid to CW operation of the amateur station has been included in the NC-300. It is frequently desirable for the operator to monitor his own transmitted signal while sending CW. To accomplish this, two gain controls adjusted for two different signal levels are necessary. The additional control may be mounted on the station control panel adjacent to the transmitter controls or at any other convenient location. Connect the control as shown on Figure 2.

Adjust the external control to receive the incoming signal at the desired level and adjust the RFG control of the NC-300 for comfortable monitoring level. When using an external RF gain control the XMT-REC switch must be left at the REC position at all times.

3-4. SINGLE-SIDEBAND OPERATION

Provision has been made in the NC-300 for the reception of single-sideband transmissions. The low IF frequency (80-kc) involved, and the oscillator circuit design provide an extremely stable oscillator with a high equivalent level of injection. Make the initial adjustments as in paragraph 3-3 of this section. While tuning, set the MODE switch at AM until the SSB signal is located then switch to SSB. Set the CWO control to receive the SSB signal. Position 1 is used for lower sideband reception on the 160, 80 and 40-meter bands, position 2 for upper sideband signals on these bands. The sidebands are reversed on the 20, 15, 11 and 10-meter bands. Optimum reception is obtained by careful adjustment of the CWO control about this previous setting. The selectivity controls may be set at the positions which provide the maximum readability under a particular set of receiving conditions. For single-sideband reception, the widest bandpass offers no particular

advantage, and interference elimination will probably be the criterion for choice of bandwidth settings. Normally, IF switch position 2 would be used. Reduction in background noise is best effected by adjustment of the RFG control.

3-5. MEASUREMENT OF SIGNAL STRENGTH

The strength of a received signal, as indicated by the S-Meter, will be correct only when the receiver is properly adjusted. Atmospheric noise levels will differ in different localities. An S-Meter does not have the ability to recognize the difference between this noise level and an actual signal. By adhering to the following instructions, this problem is overcome and accurate S-Meter readings will result.

1. Set the RFG control fully clockwise and the MODE switch at AM.
2. Set the SELECT switch at OFF.
3. Tune the receiver to a band setting where no signal is heard so that the S-Meter is reading background noise.
4. Set the RFG control so that the meter reads half-way between 0 and S-1.

SECTION 4. MAINTENANCE DATA

4-1. GENERAL

All circuits in the NC-300 receiver are carefully aligned before shipment using high-precision laboratory equipment to insure high accuracy. The quality of components used, together with careful design, makes any realignment unnecessary unless the receiver is tampered with, or certain part or tube replacements have been made. In no case should realignment be attempted unless conclusive tests indicate that such realignment is required. Even then it must be remembered that the NC-300 is a highly specialized instrument and should not be serviced or realigned by any individual who does not have a complete understanding of the functioning of the equipment and who has not had previous experience adjusting receivers of this type. In addition, because of the calibration accuracy and extreme bandwidth of the NC-300 it is mandatory that adequate test equipment be used.

Complete alignment of the receiver can be divided into three steps as follows:

- (a) IF Amplifier and CWO Alignment.
- (b) Second Conversion and Crystal Filter Alignment.
- (c) RF Amplifier.

All circuits must be tuned in the above order when complete alignment is required. All alignment adjustments and controls are shown on Figures 6 and 7.

5. Tune in the desired signal. The S-Meter will indicate the strength of the received signal in S-Units from 1 to 9 or in decibels above the S-9 level from zero to 40 db. These readings will remain accurate until the RFG control is moved or the receiver is switched to a different band.

The S-Meter circuit compensator requires adjustment only when it is impossible to obtain a zero reading with no antenna connected and the RFG control turned fully counterclockwise. See Section 4-5 for adjustment procedure.

Design of the S-Meter actuating circuit is such that a signal stronger than 60 db above S-9 cannot cause the meter pointer to come into violent contact with its stop pin thus preventing possible bending of the meter pointer.

Measurements of the signal strength of CW signals cannot be made with the MODE switch in the CW position.

With the AC switch on the RFG control set at OFF, or when the MODE switch is on CW, the S-Meter pointer will return to its mechanical zero located on the right hand or 60-db end of the meter.

4-2. IF AMPLIFIER AND CWO ALIGNMENT

The second intermediate frequency of the NC-300 must be aligned at exactly 80 kc. The signal generator used must be capable of being set at this frequency with precise accuracy. The IF transformers are tuned by means of adjustable Ferrite cores. These adjustments are located on Figure 7.

The IF alignment procedure is as follows:

- (1) Disregard the Band switch setting.
- (2) Connect the output lead of the signal generator to pin 7 of V3, the 6BE6 2nd converter tube and connect the ground lead to chassis. Use a generator output connection which may be attenuated.
- (3) Set the MODE switch at AM.
- (4) Set the IF switch at position 3.
- (5) Set the RFG control at its maximum clockwise position.
- (6) Set the XMT-REC switch at REC.
- (7) Turn the modulation of the signal generator off and set the frequency of the generator at EXACTLY 80 kc. Increase or decrease the generator output until the S-Meter of the receiver indicates S-5.
- (8) Adjust L13, L12, L10, L9, L7 and L5 in that sequence to produce maximum S-Meter reading. Each time a maximum is obtained for any one adjustment reduce the generator output to regain the S-5 reading. Failure to reduce the generator output may result in an overload condition and subsequent incorrect alignment. When the above procedure is followed, it is not necessary to disable the second oscillator

or AVC. Spurious signals from this source will only appear if the input from the generator is too high.

(9) To set the CW oscillator plug in headphones or connect a loudspeaker, set the MODE switch at CW and the CWO knob $3/4$ of a division (knob marking) clockwise from center.

(10) Adjust L16 for zero beat.

4-3. SECOND CONVERSION AND CRYSTAL FILTER ALIGNMENT

The first IF frequency of the NC-300 is 2215 kc ± 3 kc. The exact frequency is determined by the tolerance of the crystal in the crystal filter. For this reason the exact setting of the signal generator will be determined by the crystal peak frequency. The following alignment procedure must be used.

(1) Set the BAND switch at 80 meters.

(2) Move the output lead of the signal generator to connect to the stator of the first mixer tuning capacitor (center section of the main tuning capacitor). The ground lead may be connected to the capacitor frame.

(3) Set the IF control at position 1.

(4) Set the SELECT control at position 3.

(5) Set the PHASING control at its center.

(6) Tune the signal generator slowly from 2212 to 2218 kc observing the S-Meter closely. The crystal peak will be evidenced by a sharp upward swing of the S-Meter pointer. Carefully set the signal generator at the exact peak of the crystal frequency and leave it at that setting.

(7) Set the SELECT control at OFF and the IF control at position 2.

(8) Align the 2215 kc IF stage and crystal filter by first adjusting L6. This is the second conversion oscillator tuned circuit and must be tuned very slowly and carefully. The oscillator must operate 80 kc above the first intermediate frequency. If two peaks are noted, use the peak which occurs with the adjusting screw most nearly withdrawn. The peak will be evidenced by a pronounced increase in the S-Meter reading.

(9) Set the signal generator 2 kc either side of the crystal frequency noted in step (6). Set the SELECT switch at position 1 and adjust L4 for maximum output. To check this adjustment move the SELECT switch to 2 and then to 3, the bandpass should increase in sharpness at each position as noted by listening to background noise.

(10) Return the signal generator to the exact crystal frequency and set the SELECT switch at OFF. Adjust C16 for maximum output.

(11) Adjust T4 and L2A for maximum S-Meter deflection. Keep the output of the generator low enough to give maximum readings of approximately S-5.

(12) Set the signal generator exactly 160 kc higher

than the setting determined in step 6. Increase the generator output to obtain an S-Meter reading of S5. Tune L2B for minimum meter reading. Return the generator frequency and output to their previous settings. Tune L2A for maximum. Repeat adjustment of L2B and L2A as described above until true maximum and minimum are achieved.

(13) Disconnect the signal generator and keep SELECT control at off. Rotate the PHASING control to obtain maximum background noise. The control should now be at its exact center position or 180 degrees diametrically opposite. If this is not the condition, set the control on center and adjust T4 for maximum background noise.

(14) The following two checks may be performed to prove that the second conversion oscillator is in correct alignment.

(15) Set the MODE switch at CW, the SELECT switch at OFF, the PHASING control at center position, and the IF switch at position 3. Rotate the CWO knob about its center and listen to the background noise. Two peaks in noise with a null between will be heard. The null should occur with the CWO knob set $3/4$ of a knob division clockwise from center. If this is not the case, place the CWO knob at this setting and adjust L16 to obtain the null.

(16) Set the IF switch at position 2 and the SELECT switch at 3. The null should occur with the CWO knob at its center setting. Set the SELECT switch at OFF. The null should again appear at the CWO knob center setting. If this is not the case, set the CWO knob at center and adjust L6 to obtain the null.

4-4. RF AMPLIFIER

One of the outstanding features of the NC-300 is its accuracy of calibration. In order to maintain this precision, the signal source used for front-end alignment must have the accuracy of precision crystals. A secondary standard (crystal controlled) will suffice, or the XCU-300 Crystal Calibrator may be used. Either of these last-mentioned units may be used in conjunction with a standard signal generator to insure calibration accuracy.

Owing to the restricted frequency coverage of the receiver and the limits of the various alignment adjustments it is not necessary to move the signal generator from point to point. Connect the signal generator to the antenna terminals using a $1/2$ watt resistor of approximately 300 ohms between the hot lead and the antenna terminal. The generator may remain connected to this point for the remaining alignment adjustments. Leave the modulation of the generator shut off and proceed as follows:

(1) Set the CAL-SET control to position the hairline in the center of the diamond-shaped cutout.

(2) Set the BAND switch according to the Alignment

ALIGNMENT CHART

STEP	BAND	ADJUST SIGNAL SOURCE TO:	SET RECEIVER TO:	ADJUST TO RECEIVE TEST SIGNAL	ADJUST FOR MAXIMUM OUTPUT
1	160	2 mc	2 mc	C70	C68A Repeat steps 1, 3 and 4 if necessary
2	160	1.9 mc	1.9 mc		
3	160	1.8 mc	1.8 mc	T9	
4	160	2 mc	2 mc	C70	
1	80	4 mc	4 mc	C71	C68B Repeat steps 1, 3 and 4 if necessary
2	80	3.8 mc	3.8 mc		
3	80	3.5 mc	3.5 mc	T12	
4	80	4 mc	4 mc	C71	
1	40	7.3 mc	7.3 mc	C72	C68C Repeat steps 1, 3 and 4 if necessary
2	40	7.2 mc	7.2 mc		
3	40	7 mc	7 mc	T15	
4	40	7.3 mc	7.3 mc	C72	
1	20	14.4 mc	14.4 mc	C73	C68D Repeat steps 1, 3 and 4 if necessary
2	20	14.2 mc	14.2 mc		
3	20	14.0 mc	14.0 mc	T18	
4	20	14.4 mc	14.4 mc	C73	
1	15	21.5 mc	21.5 mc	C74	C69A Repeat steps 1, 3 and 4 if necessary
2	15	21.3 mc	21.3 mc		
3	15	21.0 mc	21.0 mc	T21	
4	15	21.5 mc	21.5 mc	C74	
1	11	27.5 mc	27.5 mc	C75	C69B Repeat steps 1, 3 and 4 if necessary
2	11	27.0 mc	27.0 mc		
3	11	26.5 mc	26.5 mc	T24	
4	11	27.5 mc	27.5 mc	C75	
1	10	29.7 mc	29.7 mc	C76	C69C Repeat steps 1, 3 and 4 if necessary
2	10	29.0 mc	29.0 mc		
3	10	28 mc	28 mc	T27	
4	10	29.7 mc	29.7 mc	C76	
1	X	7.5 35 mc	225 mc	C77	C69D Repeat steps 1, 3 and 4 if necessary
2	X	6.5 33 mc	223 mc		
3	X	15 30 mc	220 mc	T30	
4	X	17.5 35 mc	225 mc	C77	

Chart.

- (3) Set the MODE switch at AM.
- (4) Set the SELECT switch at OFF.
- (5) Set the IF control at position 3.
- (6) Set the RFG control fully clockwise.

The S-Meter of the receiver will be used as the indicating instrument for the ensuing procedures and, at all times, the output of the signal generator must be adjusted to produce an S-Meter reading of approximately 5 S-Units. When the XCU-300 is used, the RFG control can be used to regulate the signal strength.

Make all adjustments in the order set forth in the following Alignment Chart. The trimmer capacitors and inductance trimmers are located on Figures 6 and 7. The inductance adjustments are made by moving the small loop of wire inside the oscillator coil forms, using an insulated alignment tool or a small diameter bakelite rod. Because of the 2215-kc first IF frequency and the limited range of the trimmers, images will not be readable on the NC-300 so no special precautions need be taken in this regard.

4-5. S-METER ADJUSTMENT

The S-Meter balancing resistor R44 is used to obtain a zero meter reading in the absence of signal input to the receiver. To make this adjustment set the controls as follows: Set the RFG control just far enough in the clockwise direction to trip the AC switch. Set the MODE switch at AM. Set the AFG control fully counterclockwise so that the RF gain switch is actuated. Ground both A terminals of the Antenna terminal strip to the chassis. Adjust the S-Meter balancing resistor R44 to produce a zero reading on the S-Meter. This is a screwdriver adjustment located on top of the chassis.

4-6. MIXER IMAGE TRAP ADJUSTMENT

The mixer image trap should ordinarily not require

readjustment. If readjustment does become necessary due to replacement of L18 or C86, or inadvertent maladjustment of these components, proceed as follows:

- (1) Set the Band switch at the 20 meter band and the dial at 14.1 mcs.
- (2) Connect a signal generator as outlined in par. 4-4. Tune the generator to 9670 kc and adjust the output to produce an audible audio output.
- (3) Tune C86 for minimum output.

4-7. VOLTAGE DATA

The voltage measurements on Figure 5 will facilitate any servicing which might be required on the NC-300.

4-8. DIAL CORD STRINGING

In the event of breakage of the dial scale actuating cord or the dial pointer cord, the instructions shown on Figure 9 should be studied with care before attempting replacement. Failure to carry out these instructions correctly will result in incorrect indications of band setting and frequency. The dial scale in view at the front panel MUST correspond to the frequency range being tuned.

4-9. TUBE REPLACEMENT

Tubes which become weak or defective should be replaced. In the case of the 4H4C current regulator, a type 6V6 may be used as a temporary substitute. This substitution will sacrifice the current regulating qualities provided by the 4H4C but will keep the receiver operative. Type 4H4C regulators are not generally available at most supply houses. A replacement can be obtained from National Co. or any National Co. authorized service station. A type 4H4 will not provide the required regulating action.

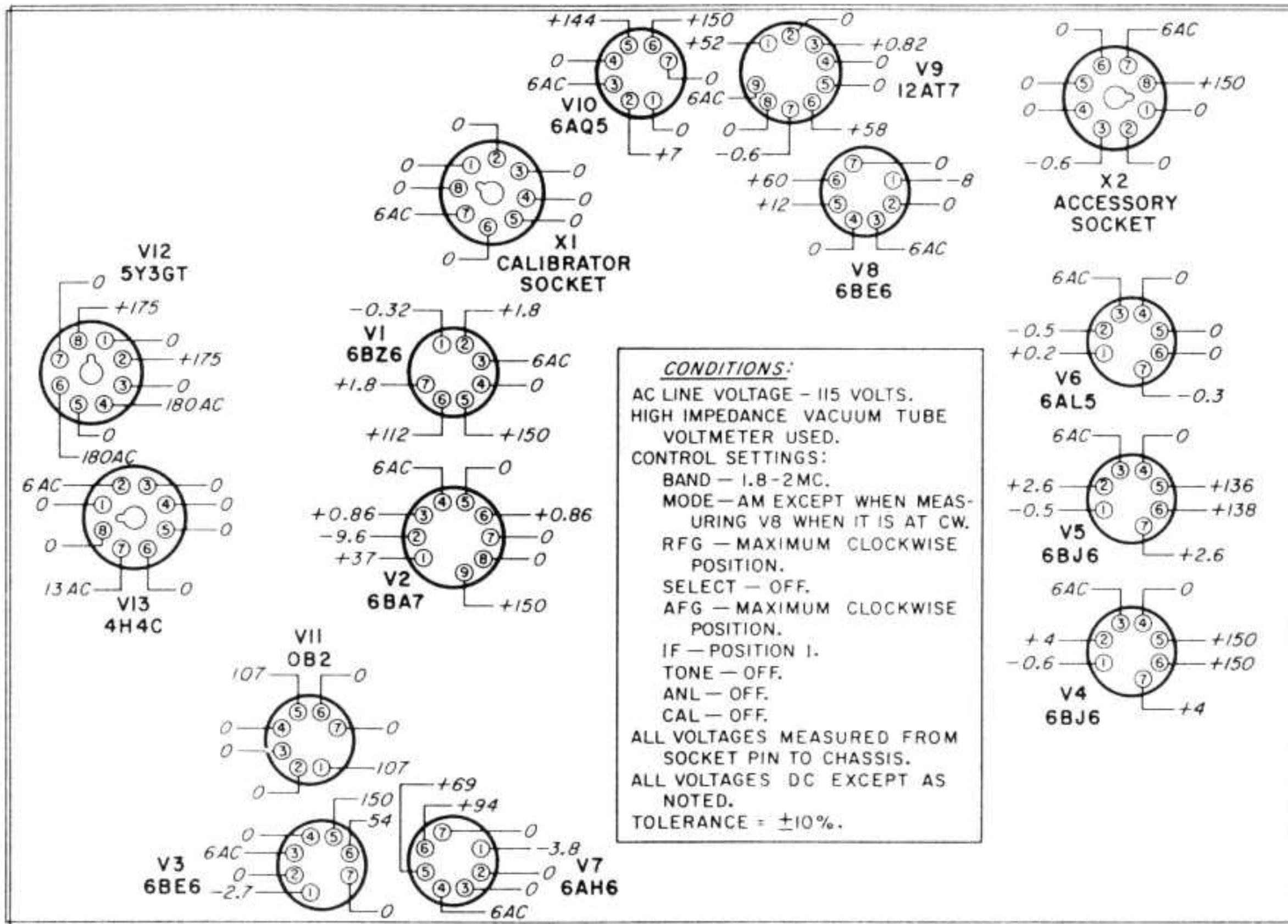

FRONT

Figure 5. Tube Socket Voltages

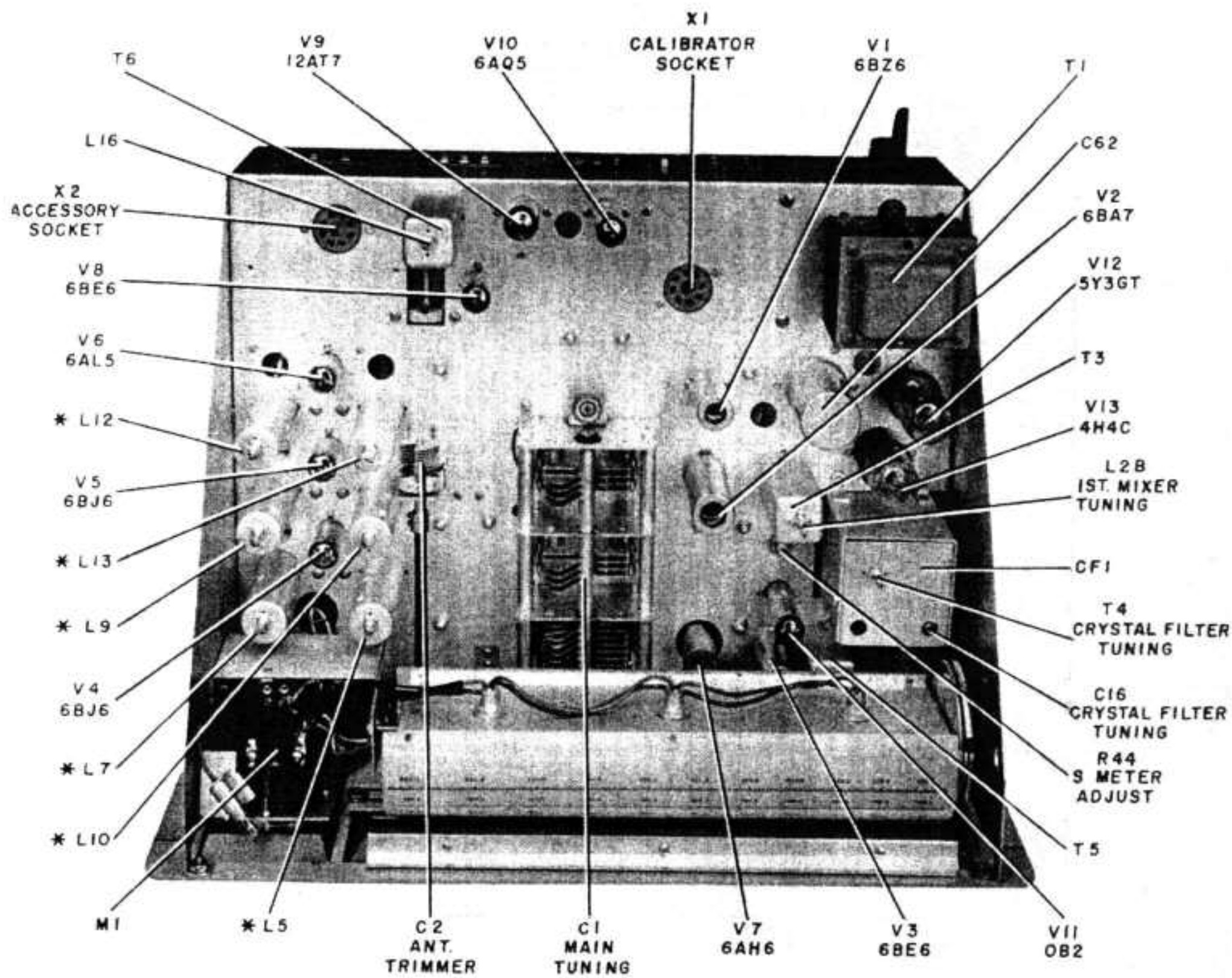

* DO NOT DISTURB THE SETTING OF THE SCREWS AT THE TOP OF THESE CANS.

Figure 6. Component Locations, Top View of Receiver

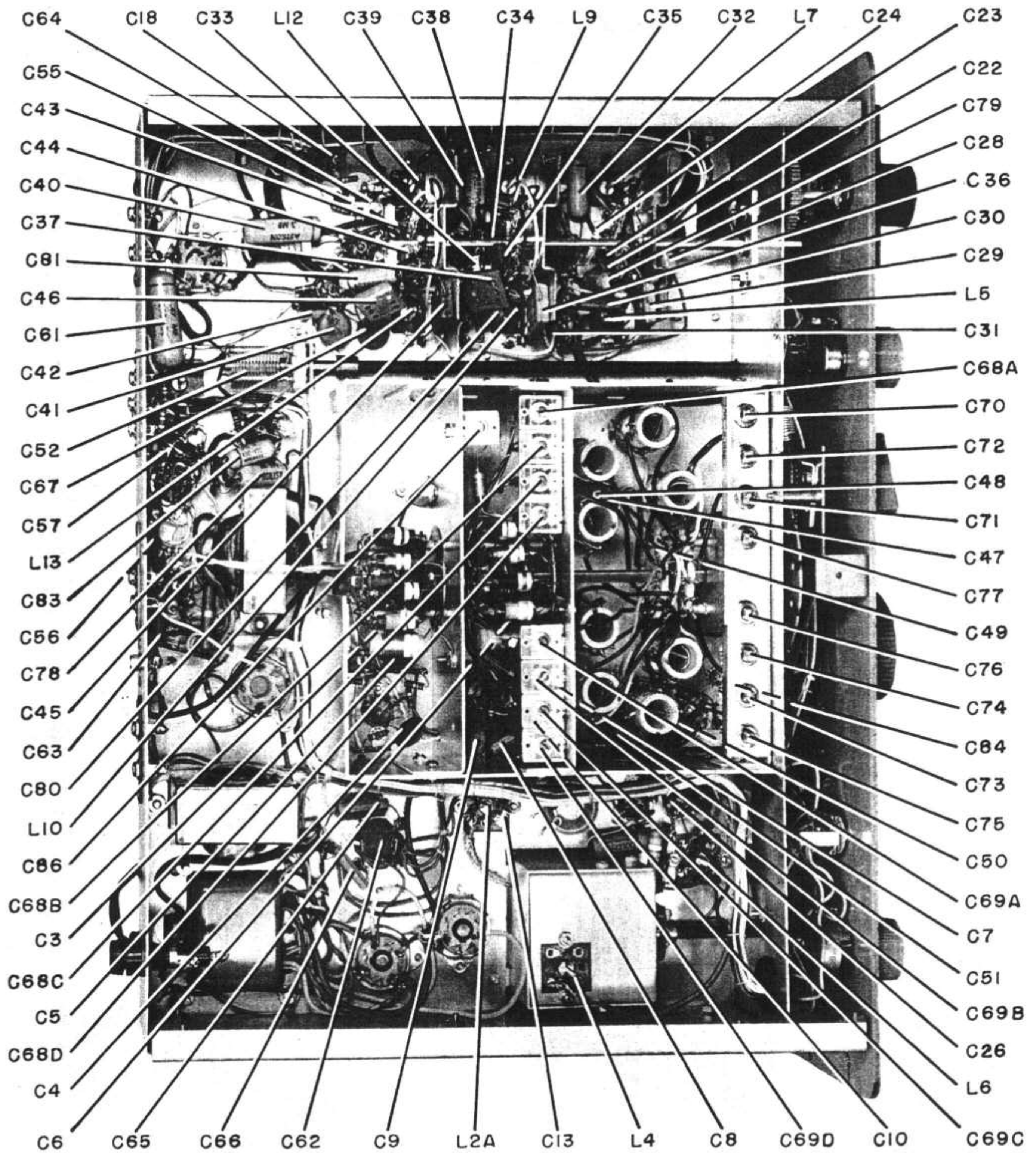

Figure 7. Capacitor and Alignment Adjustment Locations, Bottom View

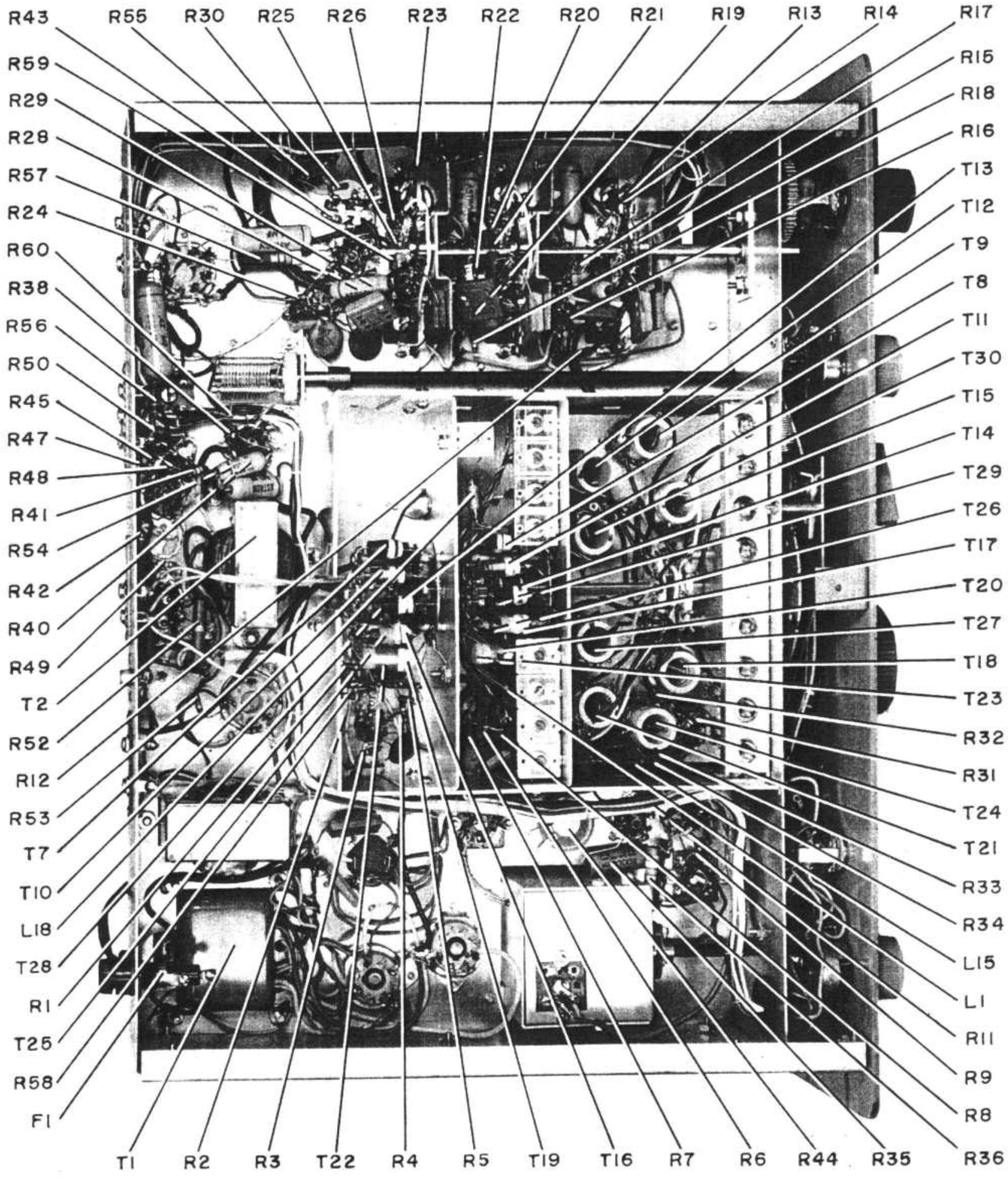

Figure 8. Resistor and Miscellaneous Component Locations, Bottom View

① SET BAND SWITCH AT 20 METER BAND. WITH CAL-SET HAIRLINE AT CENTER OF CUTOUT, TUNE IN KNOWN SIGNAL OF 14.2 Mc. MAKE SURE CAPACITOR REMAINS AT THIS SETTING DURING CORD STRINGING.

② REMOVE DIAL SCALE DRUM BY WITHDRAWING SCREW ON RIGHT SIDE OF RECEIVER AND RETAINING RING FROM LEFT END OF DRUM. NOTE POSITION OF SPRING WASHER AND DRUM DIAL CORD TO PERMIT EXACT REPLACEMENT. TO PREVENT DRUM CORD FROM SLIPPING OFF PULLEYS, MAINTAIN TENSION ON CORD.

⑧ REPLACE DRUM. SET POINTER AT EXACTLY 14.2 BY SLIDING DIAL CORD AROUND PULLEY.

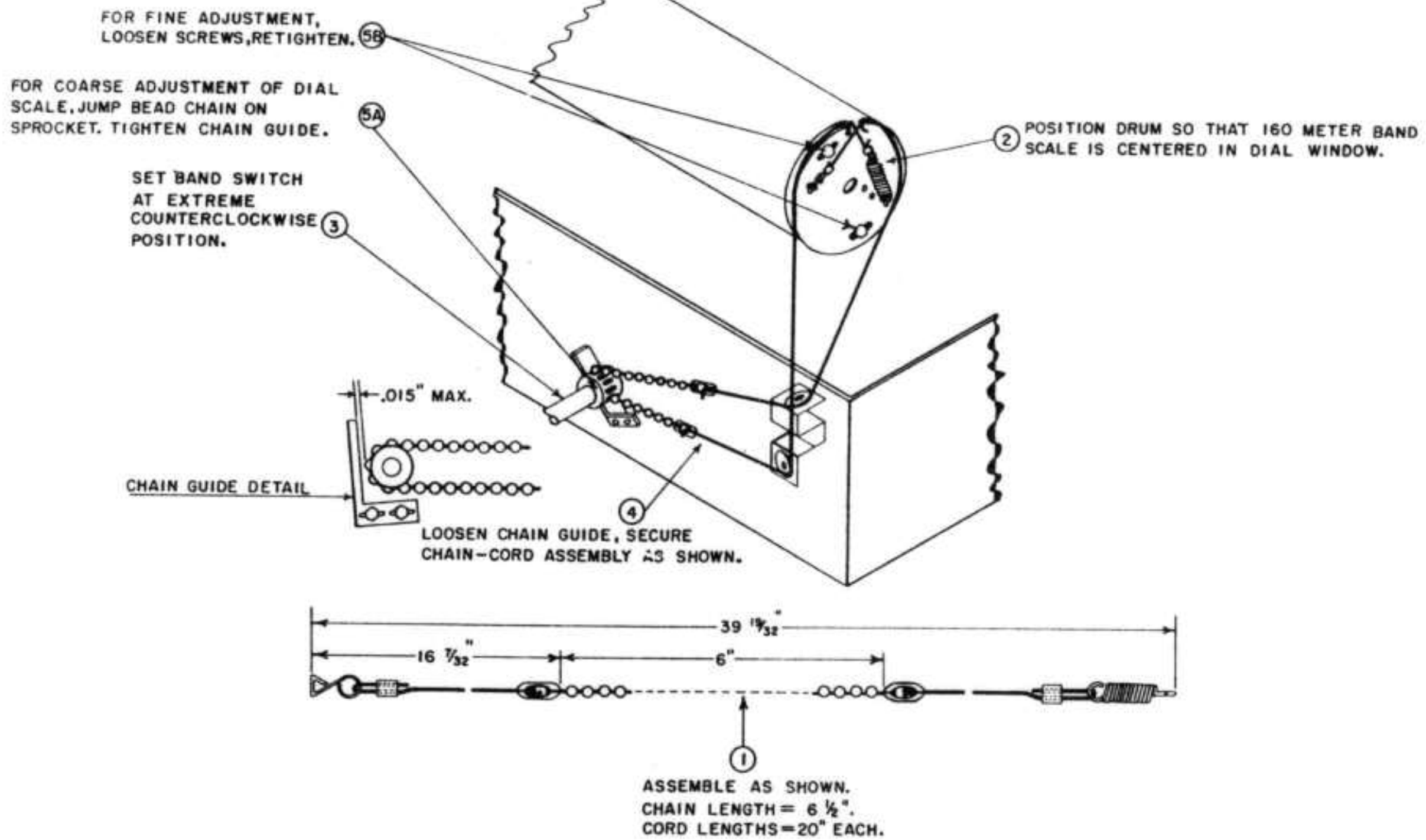
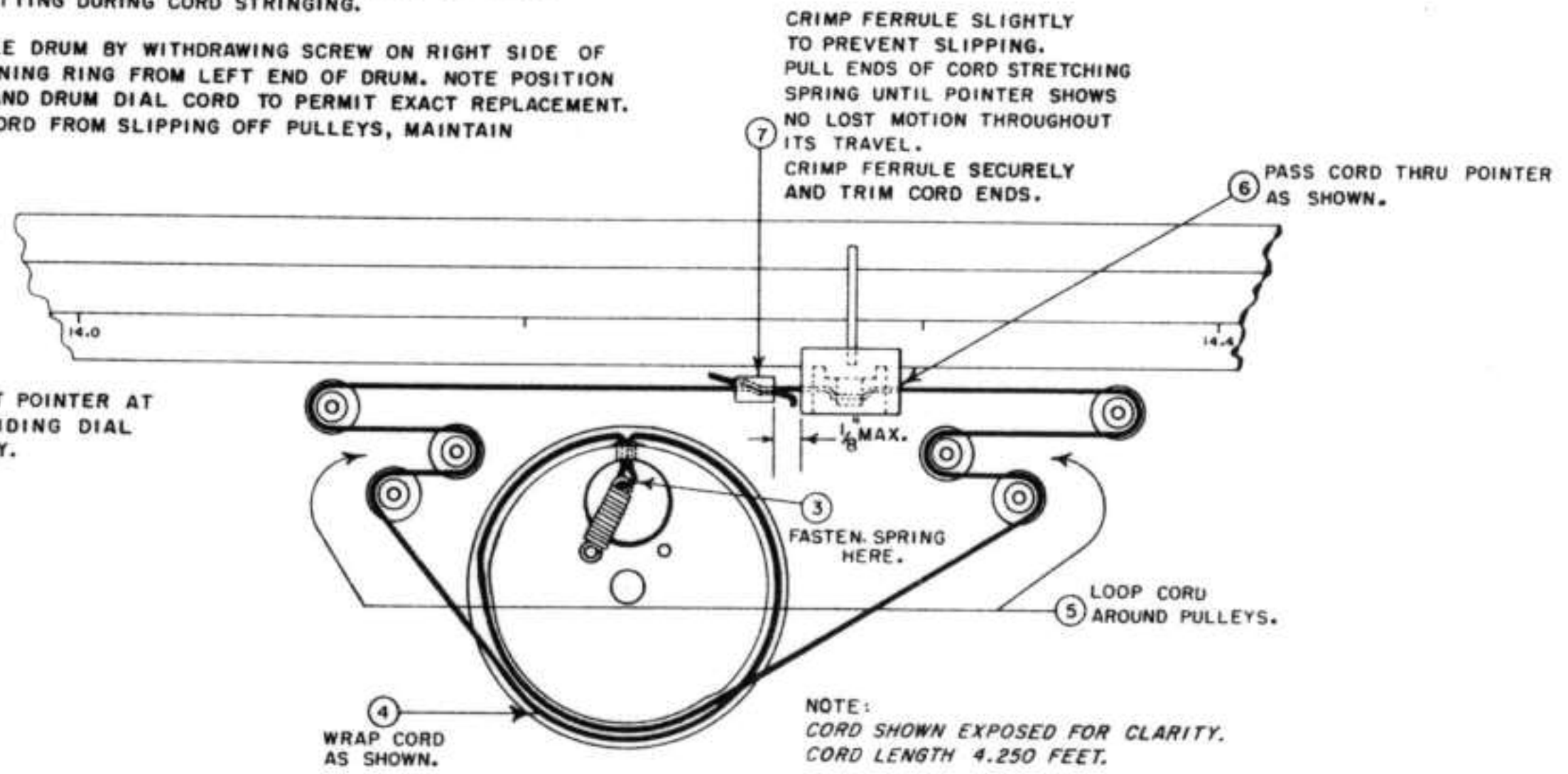

Figure 9. Cord Stringing Guide

PARTS LIST

Symbol	Description	Natco Type
CAPACITORS		
C1	Air Variable: 3 sections	C11779
C1A	7.4-40.3 mmf, part of C1	
C1B	7.4-40.3 mmf, part of C1	
C1C	14.4-80.7 mmf, part of C1	
C2	Air Variable: 3-50 mmf	A12502
C3	Ceramic: 100 mmf	D825C-304
C4	Ceramic: 0.01 mfd +100% -0%	K946-2
C5	Ceramic: 0.01 mfd +100%, -0%	K946-2
C6	Ceramic: 100 mmf	D825C-304
C7	Ceramic: 0.01 mfd +100%, -0%	K946-2
C8	Mica: 470 mmf	J665-56
C9	Ceramic: 0.01 mfd +100%, -0%	K946-2
C10	Ceramic: 0.01 mfd +100%, -0%	K946-2
C11	Ceramic: 39 mmf	D825D-455
C12	Ceramic: 62 mmf	D825D-472
C13	Ceramic: 1 mmf $\pm 20\%$	D825D-470
C14	Ceramic: 39 mmf	D825D-455
C15	Ceramic: 6.8 mmf $\pm 5\%$	D825D-475
C16	Mica Variable: 5-20 mmf; part of CF1	A12312
C17	Ceramic: 5 mmf $\pm 20\%$	D825D-401
C18	Ceramic: .01 mfd +100% -0%	K946-2
C19	Differential, Air: 25 mmf, part of CF1	B12510
C20	Ceramic: 3 mmf ± 0.25 mmf	D825D-499
C21	Ceramic: 39 mmf	D825D-455
C22	Mica: 120 mmf $\pm 5\%$	J665-34
C23	Mica: 150 mmf $\pm 5\%$	J665-37
C24	Ceramic: 5 mmf $\pm 20\%$	D825D-401
C25	Ceramic: 3 mmf ± 0.25 mmf	D825D-449
C26	Ceramic: 0.01 mfd +100%, -0%	K946-2
C27	Ceramic: 100 mmf $\pm 5\%$	D825C-342
C28	Paper: 0.047 mfd $\pm 20\%$	Q693-28
C29	Mica: 910 mmf $\pm 2\%$, 300 vdcw	J666-67
C30	Mica: 3,600 mmf $\pm 2\%$, 300 vdcw	J666-66
C31	Ceramic: 0.01 mfd +100%, -0%	K946-2
C32	Paper: 0.047 mfd $\pm 20\%$, 400 vdcw	Q693-28
C33	Ceramic: 5 mmf $\pm 20\%$	D825D-401
C34	Mica: 150 mmf $\pm 5\%$	J665-37
C35	Mica: 150 mmf $\pm 5\%$	J665-37
C36	Mica: 1,000 mmf $\pm 2\%$, 300 vdcw	J666-69
C37	Mica: 3,600 mmf $\pm 2\%$, 300 vdcw	J666-66
C38	Paper: 0.047 mfd $\pm 20\%$, 400 vdcw	Q693-28
C39	Paper: 0.047 mfd $\pm 20\%$ 400 vdcw	Q693-28
C40	Paper: 0.1 mfd, 400 vdcw	Q693-34

Symbol	Description	Natco Type
CAPACITORS (CONT'D)		
C41	Ceramic: 0.01 mfd +100%, -0%	K946-2
C42	Mica: 220 mmf +20%	J665-44
C43	Mica: 150 mmf $\pm 5\%$	J665-37
C44	Mica: 150 mmf $\pm 5\%$	J665-37
C45	Mica: 1,000 mmf +2%, 300 vdcw	J666-69
C46	Mica: 2,700 mmf $\pm 5\%$, 500 vdcw	J666-28
C47	Ceramic: 240 mmf $\pm 2\%$, 300 vdcw	A14157
C48	Ceramic: 12 mmf $\pm 5\%$	CC20UJ120J
C49	Ceramic: 15 mmf	D825D-467
C50	Mica: 470 mmf	J665-56
C51	Ceramic: 0.01 mfd +100%, -0%	K946-2
C52	Air Variable: 12-100 mmf	A12501
C53	Mica: 470 mmf	J665-56
C54	Ceramic: 100 mmf	D825C-304
C55	Ceramic: 5 mmf	D825D-401
C56	Paper: 0.01 mfd +20%, 400 vdcw	Q693-19
C57	Ceramic: 47 mmf	D825D-466
C58	Paper: 0.01 mfd +20%, 400 vdcw	Q693-19
C59	Paper: 0.001 mfd $\pm 20\%$, 400 vdcw	Q693-1
C60	Paper: 0.01 mfd $\pm 20\%$, 400 vdcw	Q693-19
C61	Paper: 0.47 mfd $\pm 20\%$, 150 vdcw	Q693-89
C62	Electrolytic: 40-40-20 mfd, 250 vdcw	A13183
C63	Mica: 0.001 mfd, 1,000 vdcw	J667-50
C64	Ceramic: 5 mmf	D825D-401
C65	Mica: 0.001 mfd, 1,000 vdcw	J667-50
C66	Mica: 0.001 mfd, 1,000 vdcw	J667-50
C67	Ceramic: 0.01 mfd +100%, -0%	K946-2
C68	Mica Variable: 4 sections, each 5-80 mmf	A12493
C68A	Part of C68	
C68B	Part of C68	
C68C	Part of C68	
C68D	Part of C68	
C69	Mica Variable: 4 sections, each 2.2-40 mmf	A12493
C69A	Part of C69	
C69B	Part of C69	
C69C	Part of C69	
C69D	Part of C69	
C70	Air Variable: 2.8-19.7 mmf	A12744
C71	Air Variable: 2.8-19.7 mmf	A12744
C72	Air Variable: 2.8-19.7 mmf	A12744

PARTS LIST (CONT'D)

Symbol	Description	Natco Type
CAPACITORS (CONT'D)		
C73	Air Variable: 2.8-19.7 mmf	A12744
C74	Air Variable: 2.8-19.7 mmf	A12744
C75	Air Variable: 2.8-19.7 mmf	A12744
C76	Air Variable: 2.8-19.7 mmf	A12744
C77	Air Variable: 2.8-19.7 mmf	A12744
C78	Paper: 0.047 mfd $\pm 20\%$, 400 vdcw	Q693-28
C79	Paper: 0.022 mfd, 400 vdcw	Q693-23
C80	Paper: 0.022 mfd, 400 vdcw	Q693-23
C81	Paper: 0.022 mfd, 400 vdcw	Q693-23
C82	Ceramic: 100 mmf $\pm 5\%$	D825D-342
C83	Paper: 0.001 mfd $\pm 20\%$, 400 vdcw	Q693-1
C84	Ceramic: 0.005 mfd $\pm 100\%$, -0%	K946-1
C85	Ceramic: 15 mmf	D825D-467
C86	Mica, Variable: 3.5-35 mmf	A12312
C87	Paper: .22 mf 400 vdcw	Q693-40

$\pm 10\%$ tolerance, 500 volts working on all capacitors unless otherwise noted.

* RESISTORS		
R1	Fixed: 1 megohm	J569-61
R2	Fixed: 33 ohms	J569-7
R3	Fixed: 330 ohms	J569-19
R4	Fixed: 100 ohms	J569-13
R5	Fixed: 47,000 ohms	J569-45
R6	Fixed: 220,000 ohms	J569-53
R7	Fixed: 470 ohms	J569-21
R8	Fixed: 68,000 ohms	J569-47
R9	Fixed: 100 ohms	J569-13
R10	Fixed: 100,000 ohms	J569-49
R11	Fixed: 22,000 ohms	J569-41
R12	Fixed: 2,200 ohms	J569-29
R13	Fixed: 220 ohms $\pm 5\%$	J569-108
R14	Fixed: 1,500 ohms $\pm 5\%$	J569-87
R15	Fixed: 12,000 ohms	J569-38
R16	Fixed: 1 megohm	J569-61
R17	Fixed: 330-1200 ohms $\pm 10\%$, 1/2 watt (value individually chosen to meet requirements of each receiver)	J569-
R18	Fixed: 1 megohm	J569-61
R19	Fixed: 1 megohm	J569-61
R20	Fixed: 1,000 ohms $\pm 5\%$	J569-139
R21	Fixed: 330 ohms $\pm 5\%$	J569-140
R22	Fixed: 560 ohms	J569-22
R23	Fixed: 2,200 ohms	J569-29
R24	Fixed: 1 megohm	J569-61
R25	Fixed: 1,200 ohms $\pm 5\%$	J569-79
R26	Fixed: 56 ohms $\pm 5\%$	J569-141
R27	Var: 100,000 ohms incl S6	A13597

* Resistors see Page 22

Symbol	Description	Natco Type
RESISTORS (CONT'D)		
R28	Fixed: 1 megohm	J569-61
R29	Fixed: 1 megohm	J569-61
R30	Fixed: 27,000 ohms	J569-42
R31	Fixed: 100,000 ohms	J569-49
R32	Fixed: 100 ohms	J569-13
R33	Fixed: 10,000 ohms	J569-37
R34	Fixed: 10,000 ohms	J569-37
R35	Fixed, Wire-Wound: 1,800 ohms $\pm 5\%$, 5 watts	E959-26
R36	Fixed: 39,000 ohms, 2 watts	J572-44
R37	Variable, Wire-Wound: 10,000 ohms	A13598
R38	Fixed: 68,000 ohms	J569-47
R39	Fixed: 100,000 ohms	J569-49
R40	Fixed: 68,000 ohms	J569-47
R41	Fixed: 1,500 ohms $\pm 5\%$	J569-87
R42	Fixed: 270,000 ohms	J569-54
R43	Fixed: 33,000 ohms	J569-43
R44	Variable, Wire-Wound: 1,000 ohms	A12166
R45	Fixed: 3,300 ohms	J569-31
R46	Variable: 500,000 ohms (with SPST switch S7)	A13596
R47	Fixed: 1 megohm	J569-61
R48	Fixed: 270,000 ohms	J569-54
R49	Fixed: 470,000 ohms	J569-57
R50	Fixed: 470,000 ohms	J569-57
R51	Variable: 1 megohm (with SPDT switch S3)	A11697
R52	Fixed: 220 ohms, 2 watts	J572-17
R53	Fixed: 100 ohms	J569-13
R54	Fixed: 10,000 ohms	J569-37
R55	Fixed: 470,000 ohms	J569-57
R56	Fixed: 10,000 ohms	J569-37
R57	Fixed: 4.3 ohms $\pm 5\%$, 1 watt	K098-48
R58	Fixed: 4.7 megohms	J569-69
R59	Fixed: 10,000 ohms	J569-37
R60	Fixed: 10 ohms	J569-1

Resistors 10% tolerance 1/2 watt except as noted.

MISCELLANEOUS		
CF1	Crystal Filter Assembly	C12721
E1	Knob: ANL	B11800
E2	Knob: Tone	B11801
E3	Knob: IF	B11802
E4	Knob: Zero	A11969
E5	Knob: CW0	B11804
E6	Knob: AFG	B11805
E7	Knob: Antenna Trimmer	B11803
E8	Knob: OFF-CAL	A11969
E9	Knob: Band Switch	A11917

PARTS LIST (CONT'D)

Symbol	Description	Natco Type
MISCELLANEOUS (CONT'D)		
E10	Knob: Main Tuning	B13599
E11	Knob: Mode	C11916
E12	Knob: Selectivity	B11808
E13	Knob: Phasing	B11807
E14	Knob: RFG	B11806
F1	Fuse: 2 amps, 250 v	F135-4
H1	Lamp, S Meter: type 47	A12285
I2	Lamp, Dial: type 47	A12285
I3	Lamp, Dial: type 47	A12285
I4	Lamp, Dial: type 47	A12285
J1	Phones Jack	A12241
J2	Converter Input Jack	A11998
L1	RF Choke: 41 microhenries	B14904
L2A	Inductor, Variable iron core; T3 primary; part of T3	
L2B	Inductor, variable iron core; T3 secondary; part of T3	
L3	Not used	
L4	Inductor, variable iron core, 2215 kc; part of CF1	B12588
L5	Inductor, variable iron core, 80 kc	B12415
L6	Inductor, variable iron core, 2295 kc; part of T5	
L7	Inductor, variable iron core, 80 kc	B12414
L8	Not used	
L9	Inductor, variable iron core, 80 kc	B12414
L10	Inductor, variable iron core, 80 kc	B12414
L11	Not used	
L12	Inductor, variable iron core, 80 kc	B12414
L13	Inductor, variable iron core, 80 kc	B12414
L14	Not used	
L15	RF Choke; 750 microhenries	SA:2868
L16	Inductor, variable iron core, 80 kc; part of T6	
L17	Not Used	
L18	Inductor	B16653
M1	S Meter: 0-1 ma, illuminated	C12323
O1	Dial Assembly	C12713
O2	Calibrated Dial	C11564
O3	Dial Mounting Drum	C11756
O4	Dial Pointer	A11814
O5	Dial Cord Assembly	A11966
O6	Dial Drum Cord Assembly	B13000
P1	A.C. Power Cord and Plug	A12612

Symbol	Description	Natco Type
MISCELLANEOUS (CONT'D)		
S1	Band Switch: 8 wafers, 13 poles, 8 positions	
S1A	Wafer: 2 poles, 8 positions	B12376
S1B	Wafer: 2 poles, 8 positions	B12373
S1C	Wafer: 1 pole, 8 positions	B12372
S1D	Wafer: 1 pole, 8 positions	B12372
S1E	Wafer: 1 pole, 8 positions	B12372
S1F	Wafer: 2 poles, 8 positions	B12373
S1G	Wafer: 2 poles, 8 positions	B12374
S1H	Wafer: 2 poles, 8 positions	B12375
S2	Calibrate Switch: 1 wafer, 1 pole, 2 positions	A12602
S3	R.F. Gain Switch: SPDT; mounted on R51	
S4	Selectivity Switch: 1 wafer, 2 poles, 4 positions	B12511
S5	L.F. Selectivity Switch: 3 wafers, 12 poles, 3 positions	
S5A	Wafer: 4 poles, 3 positions	B12577
S5B	Wafer: 4 poles, 3 positions	B12577
S5C	Wafer: 4 poles, 3 positions	B12577
S6	Limiter Switch: SPDT; mounted on R27	
S7	Tone Switch: SPST; mounted on R46	
S8	Mode Switch: 1 wafer	B12371
S9	A.C. Switch: SPST; mounted on R37	
S10	Xmit-Rec Switch: DPDT toggle	A13663
T1	Power Transformer: primary 115 volts 50/60 cycles	B13647
T2	Audio Output Transformer	A13615
T3	I.F. Transformer: 2215 kc	B12465
T4	Crystal Filter Transformer: part of CF1	B12562
T5	2nd Oscillator Transformer	B12649
T6	CWO Transformer	B12650
T7	Antenna Transformer: 160 meter band	B15294
T8	1st Mixer Transformer: 160 meter band	B15294
T9	1st Oscillator Transformer: 160 meter band	B14906
T10	Antenna Transformer: 80 meter band	B15295
T11	1st Mixer Transformer: 80 meter band	B15296
T12	1st Oscillator Transformer: 80 meter band	B14909
T13	Antenna Transformer: 40 meter band	B15297

PARTS LIST (CONT'D)

Symbol	Description	Natco Type
MISCELLANEOUS (CONT'D)		
T14	1st Mixer Transformer: 40 meter band	B15298
T15	1st Oscillator Transformer: 40 meter band	B14908
T16	Antenna Transformer: 20 meter band	B15300
T17	1st Mixer Transformer: 20 meter band	B15299
T18	1st Oscillator Transformer: 20 meter band	B14910
T19	Antenna Transformer: 15 meter band	B15302
T20	1st Mixer Transformer: 15 meter band	B15301
T21	1st Oscillator Transformer: 15 meter band	B14905
T22	Antenna Transformer: 11 meter band	B15304
T23	1st Mixer Transformer: 11 meter band	B15303
T24	1st Oscillator Transformer: 11 meter band	B14907
T25	Antenna Transformer: 10 meter band	B15305
T26	1st Mixer Transformer: 10 meter band	B15306
T27	1st Oscillator Transformer: 10 meter band	B14812
T28	Antenna Transformer: X band	B15307
T29	1st Mixer Transformer: X band	B15308
T30	1st Oscillator Transformer: X band	B14911
TB1	Antenna Terminal Board	
TB2	Speaker Terminal Board	A12617
TB3	Relay Terminal Board	A12616
TB4	Standby-Mute Terminal Board	A12615
V1	Tube: type 6BZ6	
V2	Tube: type 6BA7	
V3	Tube: type 6BE6	
V4	Tube: type 6BJ6	
V5	Tube: type 6BJ6	
V6	Tube: type 6AL5	
V7	Tube: type 6AH6	
V8	Tube: type 6BE6	
V9	Tube: type 12AT7	
V10	Tube: type 6AQ5	
V11	Tube: type OB2	

Symbol	Description	Natco Type
MISCELLANEOUS (CONT'D)		
VI2	Tube: type 5Y3	
V13	Tube: type 4H4-C	
X1	Crystal Calibrator Socket	A12831
X2	Accessory Socket	A12831
X3	S Meter Lamp Socket	A12284
X4	Dial Light Socket	A11721
X5	Dial Light Socket	A11721
X6	Dial Light Socket	A11721
X7	Fuseholder	A12613
Y1	Crystal Unit: 2215 kc; part of CF1	A12704
RESISTORS (CONT'D)		
R61	Fixed: 100,000 ohms $\pm 10\%$, 1/2 watt	J569-49
R62	Fixed, Wire-Wound: 330 ohms $\pm 10\%$, 10 watts	17436-1
R63	Fixed: 2.2 ohms $\pm 10\%$, 1 watt	K098-24

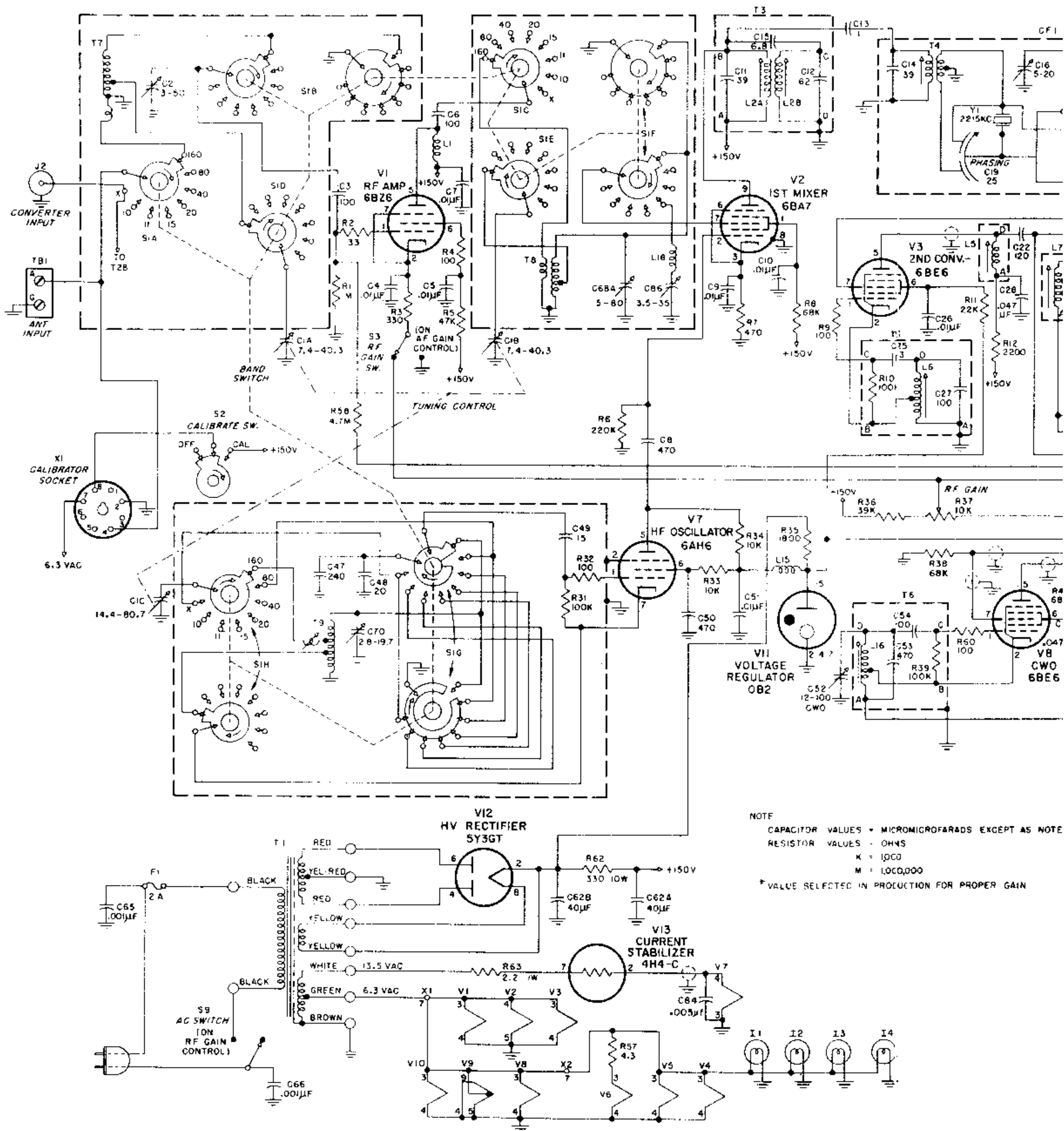

NOTE
 CAPACITOR VALUES - MICROMICROFARADS EXCEPT AS NOTE
 RESISTOR VALUES - OHMS
 K = 1000
 M = 1,000,000
 * VALUE SELECTED IN PRODUCTION FOR PROPER GAIN

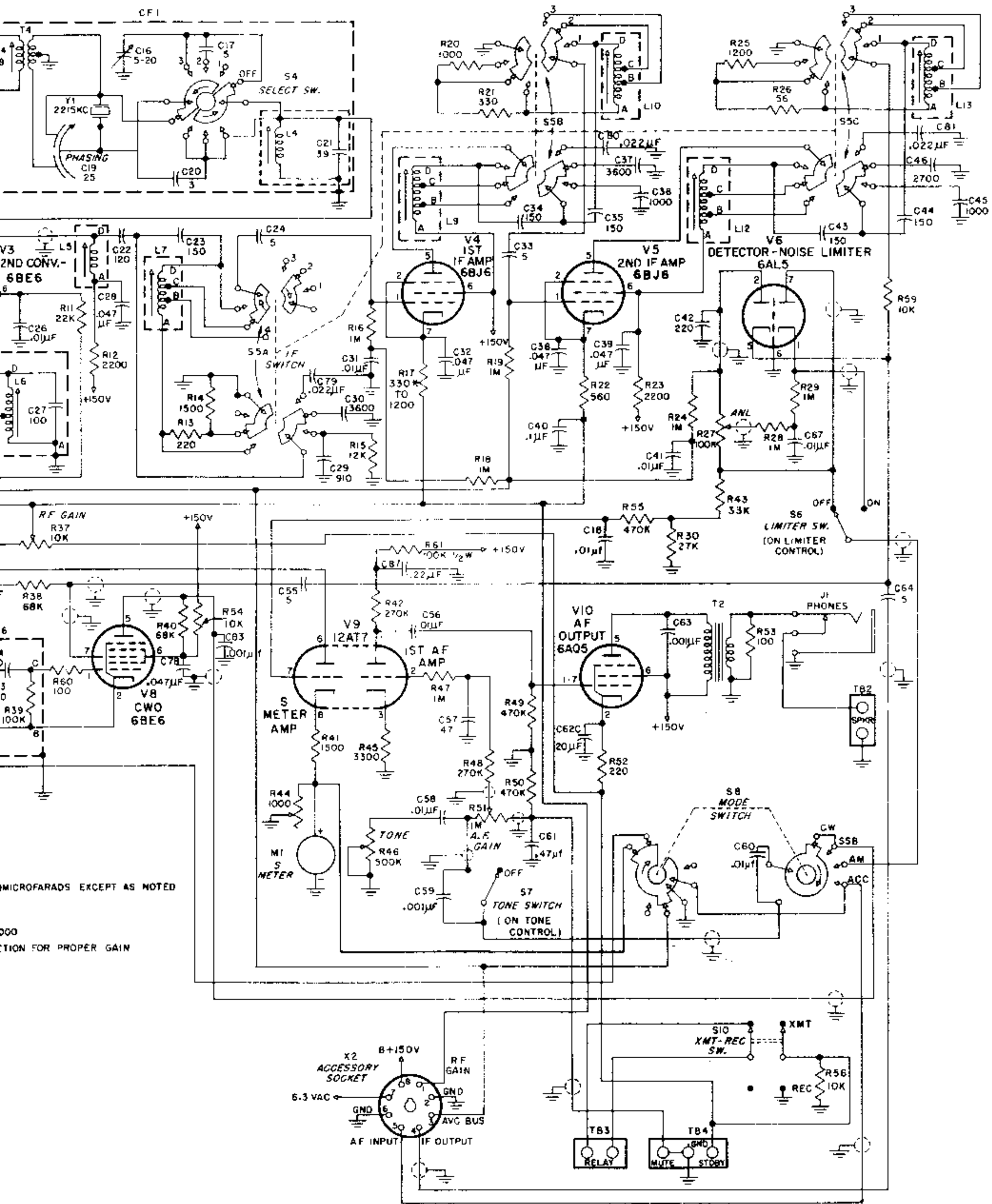

Figure 10. Schematic Diagram

**INSTRUCTIONS
FOR THE
NATIONAL XCU-300
CRYSTAL CALIBRATOR UNIT**

GENERAL

The type XCU-300 Crystal Calibrator Unit is designed expressly for use within NC-300 receivers. It utilizes an electron-coupled crystal oscillator circuit. The calibrator provides crystal-controlled marker frequencies of 100 kilocycles. When plugged into the Crystal Calibrator Socket, X1, the XCU output is coupled to the RF amplifier input circuit. Selection of the 100 kilocycle crystal-controlled signal is made possible by the front-panel mounted OFF-CAL switch on the receiver.

INSTALLATION

The XCU-300 Crystal Calibrator is installed in the NC-300 receiver by plugging the unit into the Crystal Calibrator Socket, X1, on top of the chassis.

OPERATION

The XCU-300 Crystal Calibrator provides a means of checking the accuracy of the frequency calibration of the receiver. The front-panel mounted Calibrate switch marked OFF-CAL connects B-plus to the Calibrator for instantaneous service. To check calibration accuracy tune in the desired marker signal with the MODE switch set at CW and zero beat the receiver with the harmonic marker. If the slide-rule dial does not read accurately correction should be made by adjusting the front-panel mounted CAL-SET control. Only a slight adjustment of the CAL-SET control should be necessary. If calibration is far off, the RF coils associated with the band being checked probably require realignment and reference should be made to Section 4.

PARTS LIST

Symbol	Description	Natco Type
C1	Ceramic, variable, 6-20 mmf	E311-2
C2	Ceramic, 10 mmf, 500 vdcw	H872-1
C3	Ceramic, 3 mmf, 500 vdcw	J695-4
C4	Ceramic, 220 mmf, 500 vdcw	K946-24
L1	5 mh, type R-100	SA:2608
P1	Octal	K783-1
R1	Fixed, 4.7 megohms, 1/2 W	J569-69
R2	Fixed, 470,000 ohms, 1 W	J571-57
V1	6AK6	
Y1	Quartz, 100 Kc	A16126

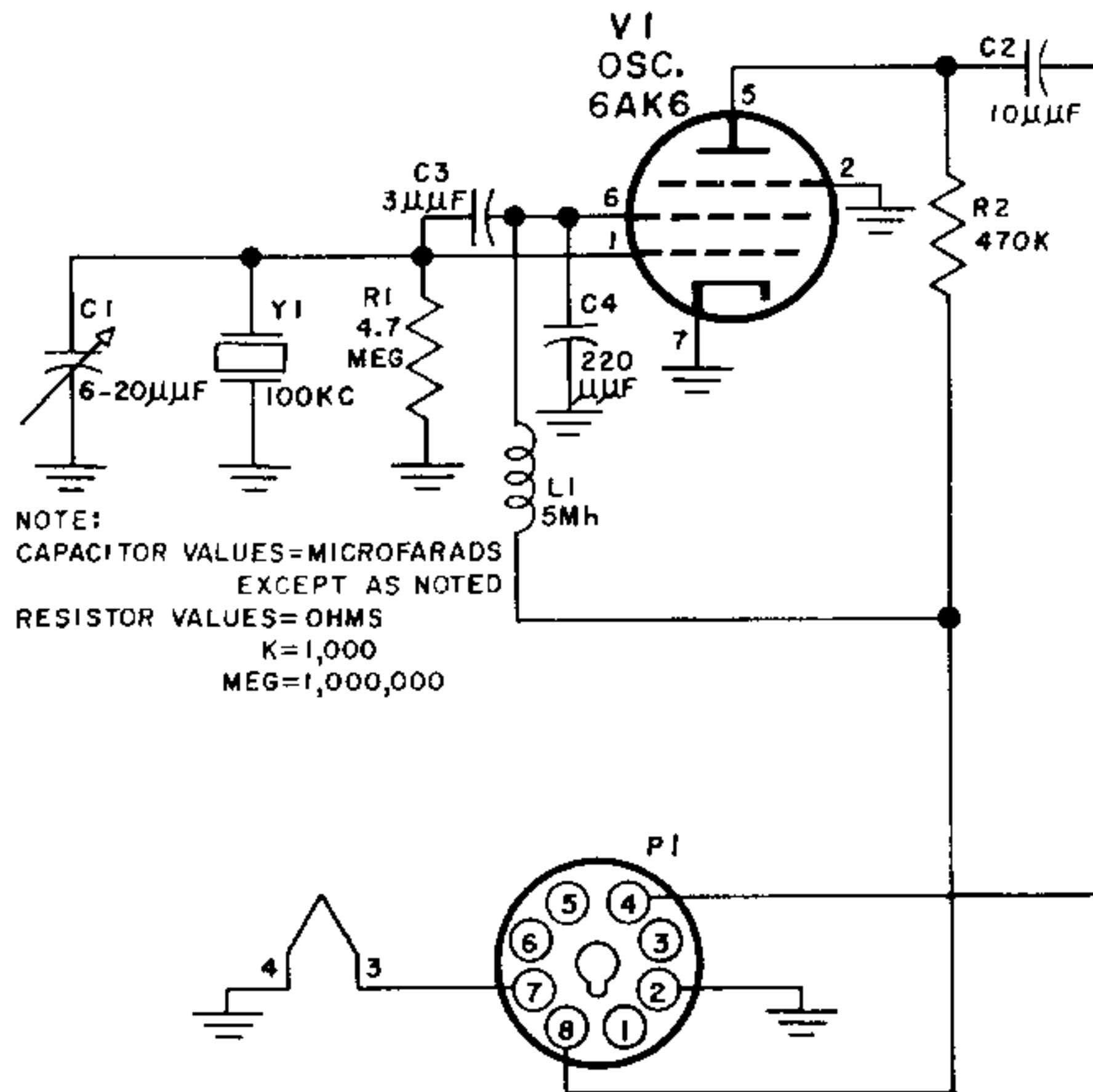

Figure 11. XCU-300, Schematic Diagram

R.F.

MIXER

OSCILLATOR

METERS

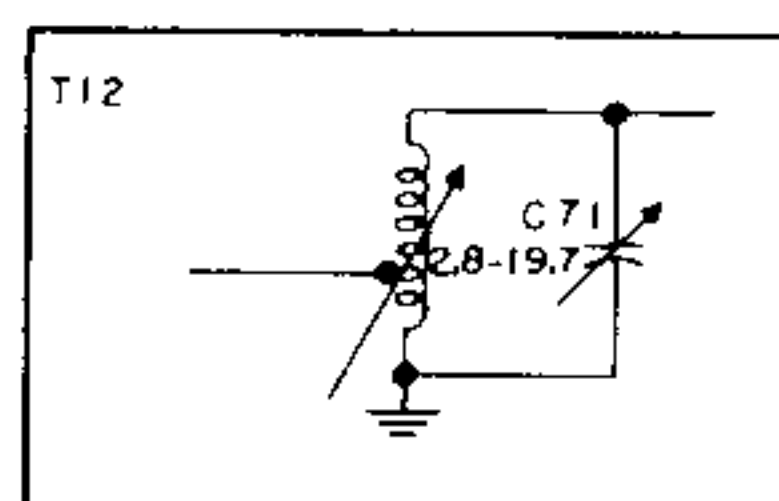
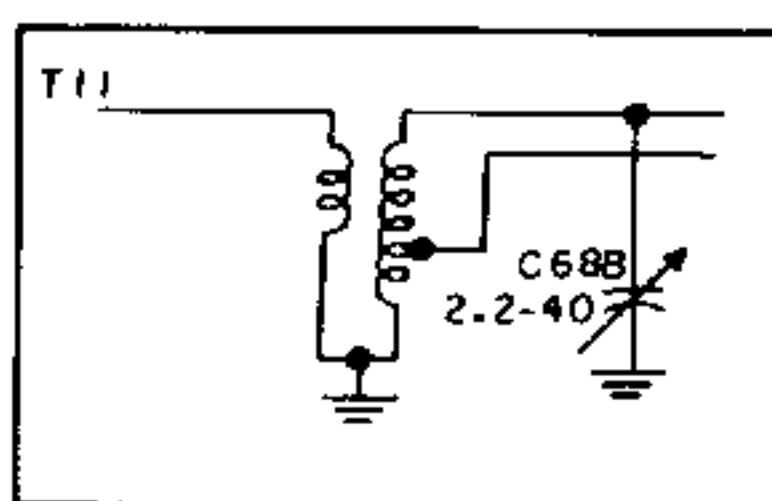
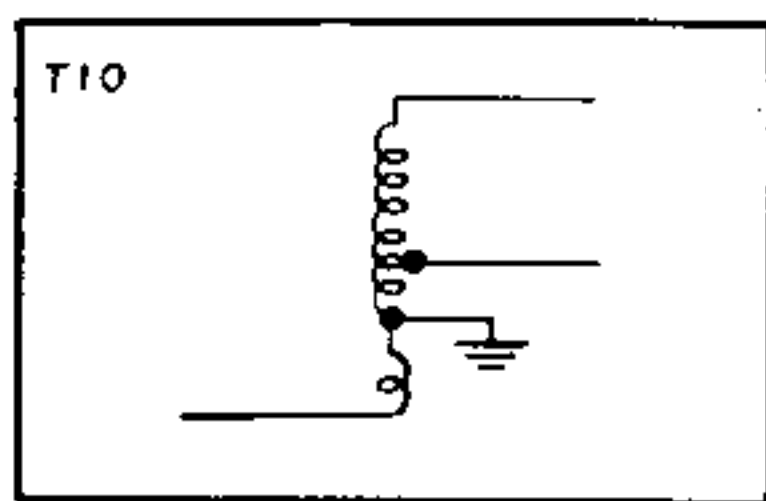

80

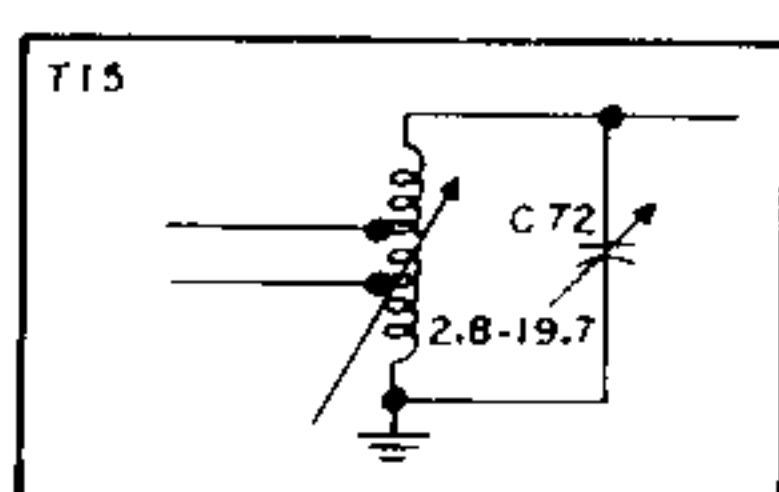
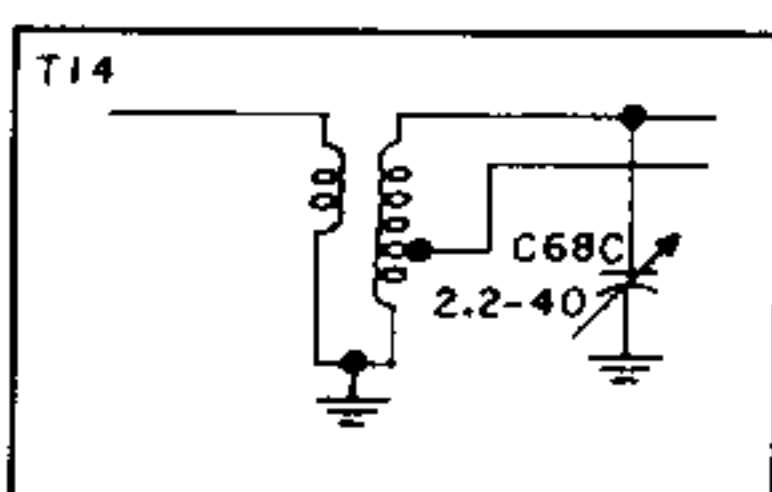
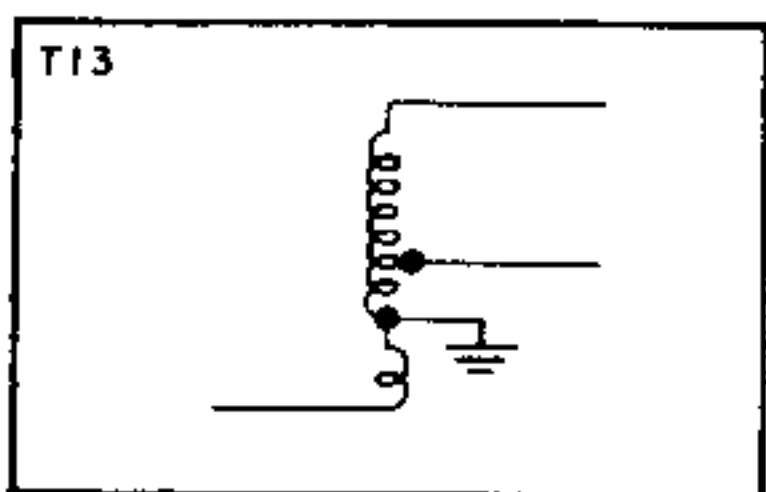

40

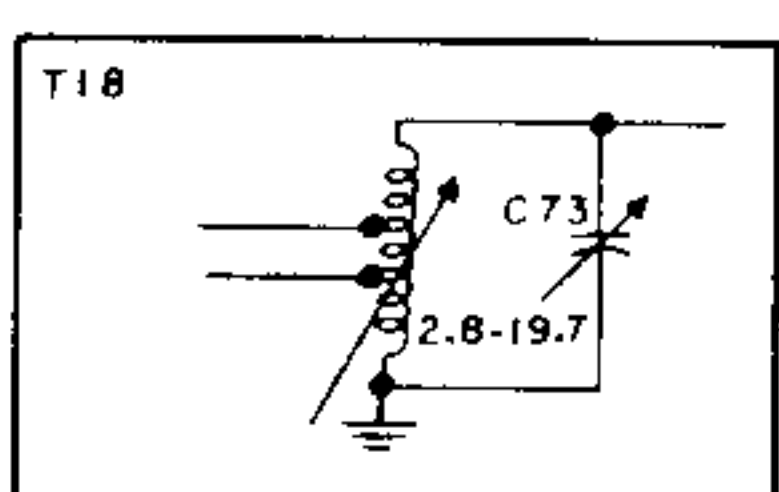
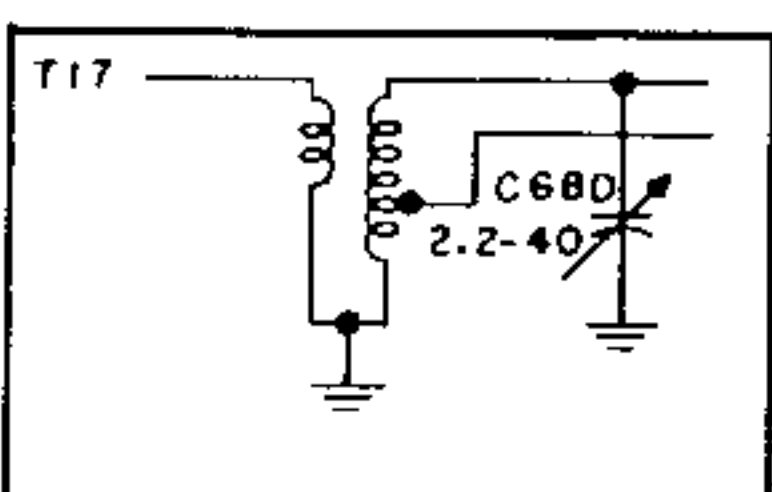
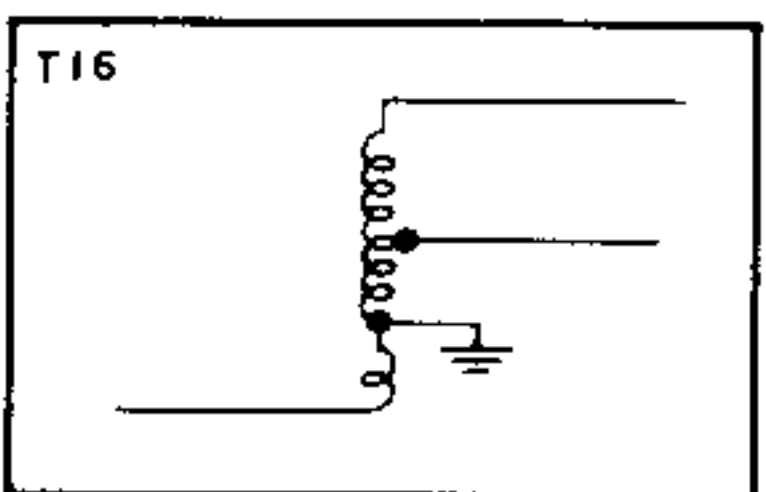

20

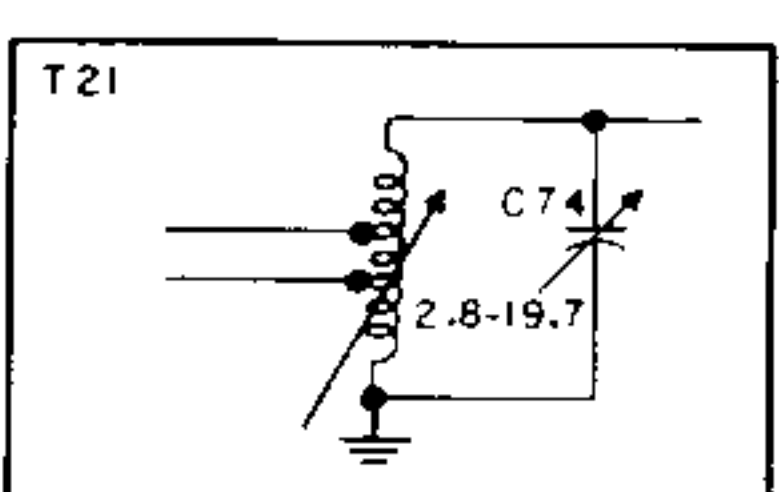
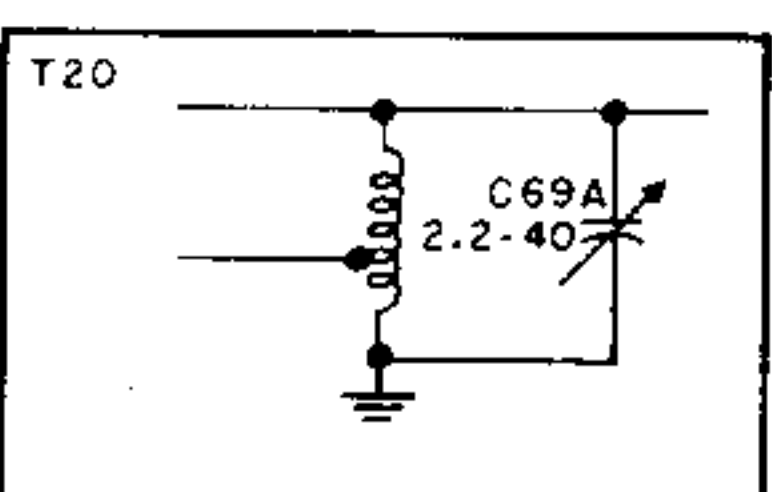
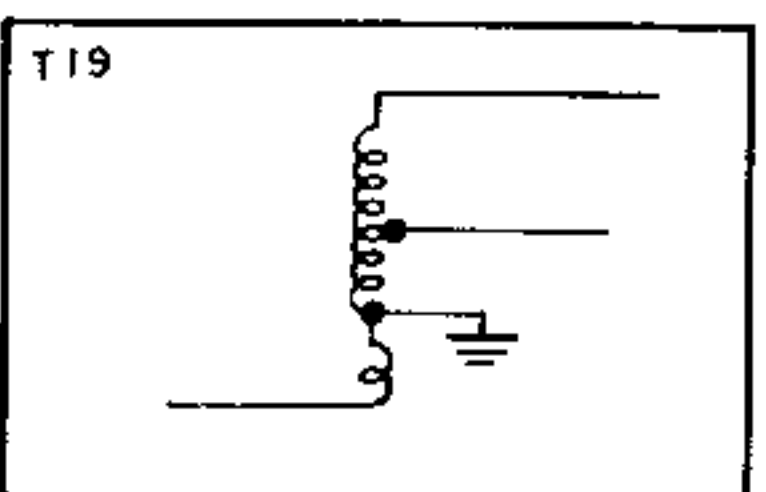

15

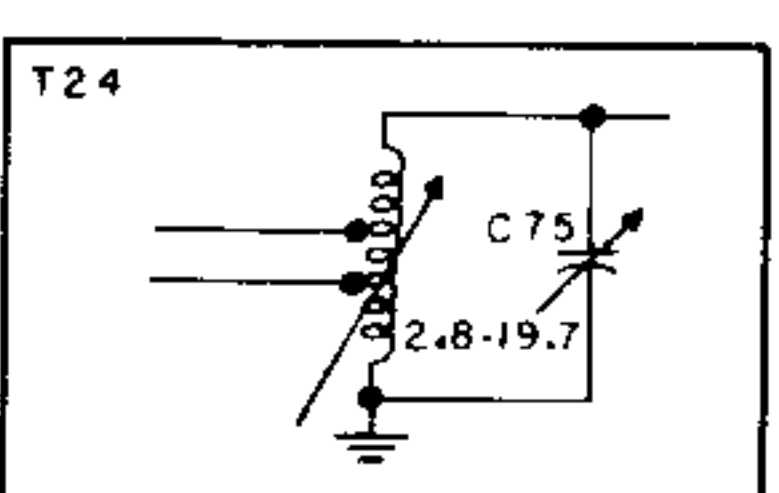
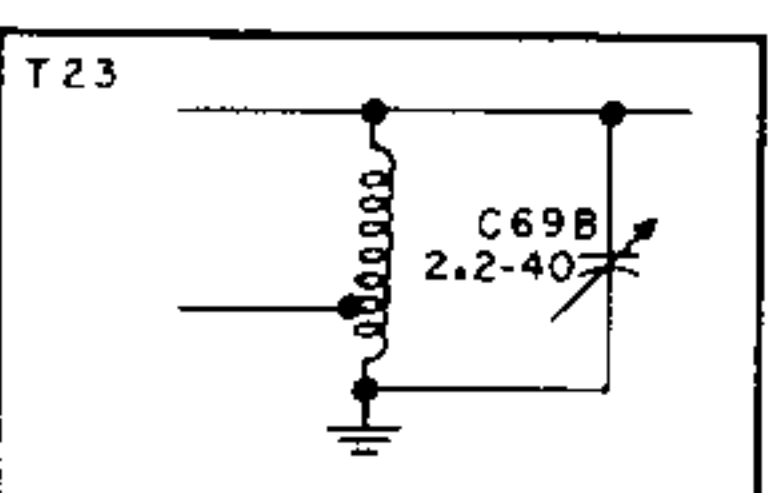
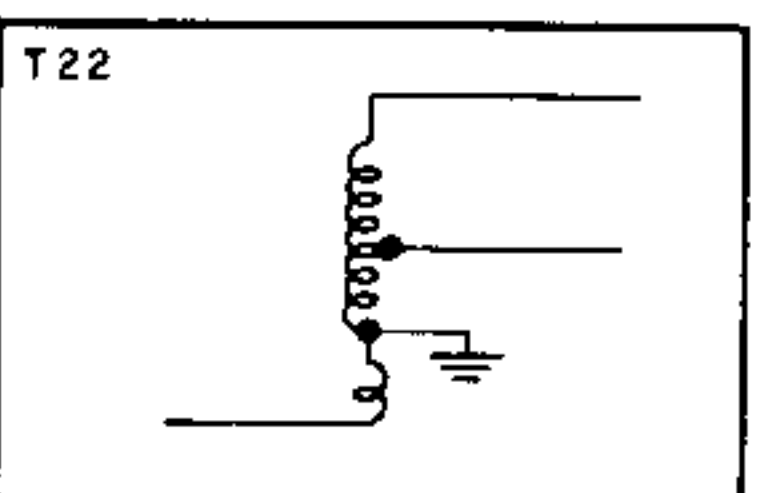

11

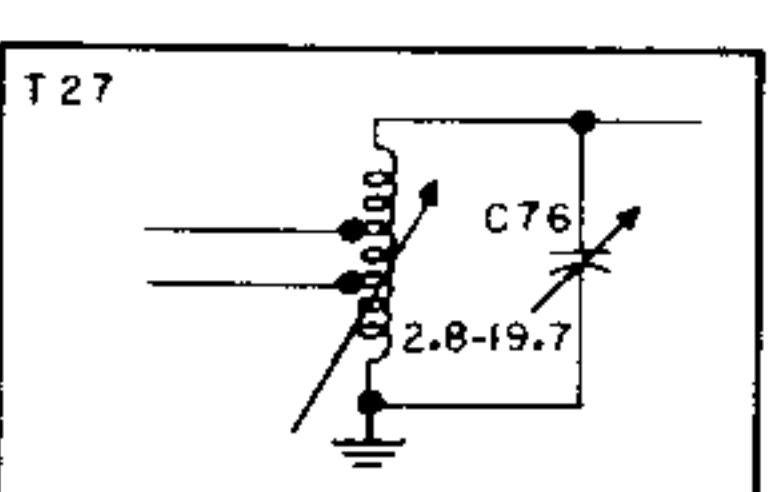
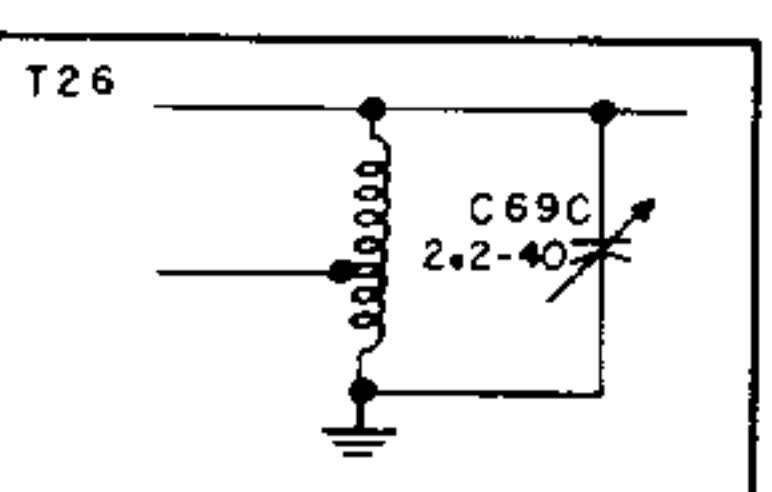
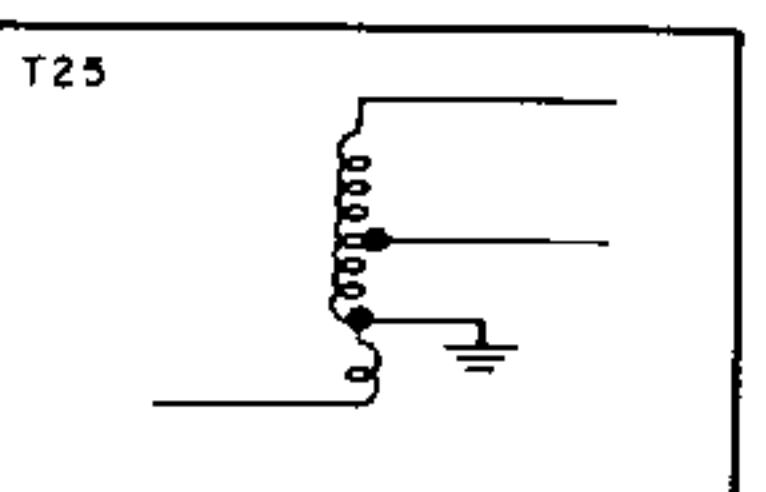

10

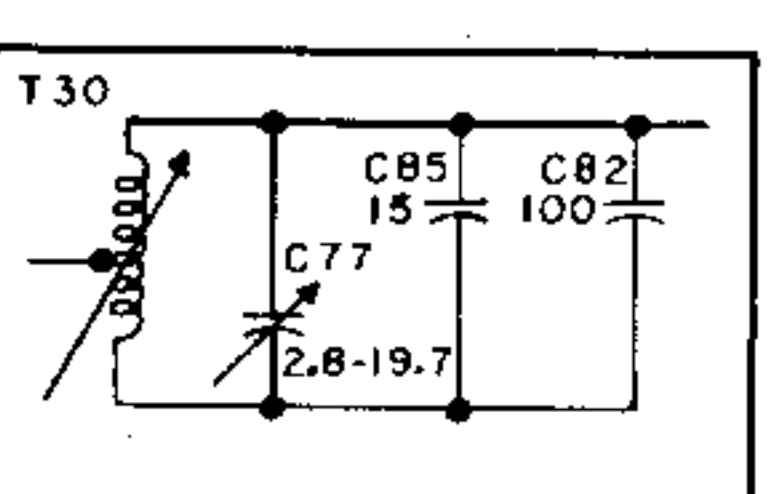
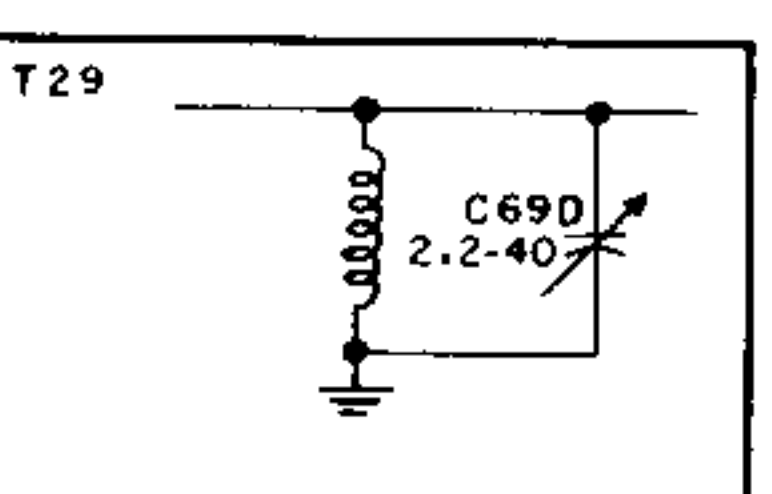
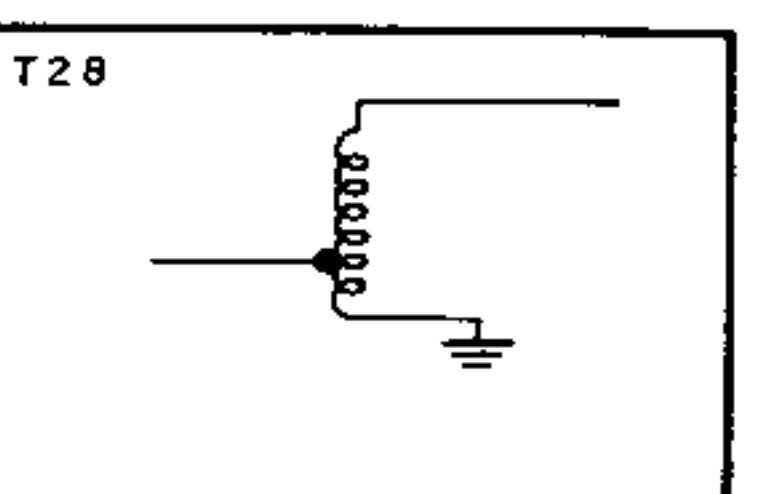

X



Service Bulletin FSN-30

To: Service Agencies,
Receiver Distributors,
Receiver Reps and
NG-300 Owners

November 15, 1955

Subject: NG-300 Changes

The attached bulletin should be self explanatory; however, a few words of additional explanation may forestall some confusion.

Paragraph 1 indicates errors in the NG-300 instruction book as it was first printed.

Paragraph 2 indicates changes made in the NG-300 after the instruction books had been printed but before production had started.

Paragraph 3 indicates changes that were made after production had started. All receivers shipped after October 25, 1955 have had these changes made at the factory.

Respectfully,

R. J. Murray
Robert Murray
Service Manager

1. Errors in the NC-300 Instruction Book

a. Connections shown in Figure 2, Page 5.

Connections shown connecting remote RF gain control should be such that remote control connects to STDBY and PIN 1 of accessory socket. Drawing is incorrect in that it shows control connected to Pin 8 of the accessory socket. This is B plus.

b. Page 8 under "AFC" states that the RF gain control is normally set to full on for phons operation, page 9 under Phone Reception indicates that the RF gain control must be run full on to obtain proper AVC action. This is contradictory with page 11 under Measurement of Signal Strength where reduction of the RF gain is advised to bring the reading on the S meter to S-1. Page 11 is correct since the amount of reduction made to have the meter read S-1 is small enough to have no effect on the AVC action.

c. Page 14 indicates pin voltages. V-11 the OB2 should have pins 1 and 5 with 107 volts and pins 2,3,4,6 and 7 zero volts.

On page 23 the schematic indicates grounding of condenser C-15 in T-3. This is incorrect. The condenser connects from terminal B to terminal C. Terminal D is grounded. There is no connection made to the shield can inside the transformer as indicated on the diagram.

On the schematic diagram the crystal filter switch S-4 shows C-17 on Position 1. Position 1 and 2 are reversed on this side of the switch. C-17 should be on position 2 and 1 should be open.

2. Changes made after books were printed but prior to production.

a. Coil - T-28 has tapped winding instead of separate primary. (30-35 mc range for converters).

b. Resistor R-45, 2200 ohms changed to 3300 ohms. ^{OK}

c. A new condenser and coil were added to the mixer partition to form an image trap on the 14 mc band to raise the image ratio from 60 db to 80 db. This trap is adjusted by tuning the receiver to 14.1 mc, feeding in a signal at 9670 kc sufficient to produce output and adjusting the variable condenser for minimum output.

d. New resistor 4.3 ohms added in series with the heater of V-6 6AL5 detector/noise limiter. (to reduce hum).

e. Location of R-3 changed from lug on S-3 to cinch lug near V-1.

3. Changes made during production (applies to all sets shipped after October 25, 1922)

4. Resistor R-1 removed from AVC feed and connected from junction of C-3 and R-2 to ground. Additional resistor added, 4.7 megohms 1/2 watt 10% connected from AVC feed (where R-1 was) to junction of C-3 and R-2. This change puts divided AVC voltage on the RF tube and improves the signal-to-noise ratio on AM and SSB signals. This has no effect on CW. Strong local signals could cause overload which could be taken care of by reducing the gain with the panel RF gain control.
5. Resistor R-30 has been changed to 27,000 ohms 1/2 watt 10% to decrease the S meter sensitivity. This change was necessitated by change 4a which reduced the AVC action on the RF stage.
6. Yellow lead connecting between switch 85G and Pin 5 of V-6 has been replaced with a 10,000 ohm resistor. This gives clearer beat note on CW. The coil L-13 should be retuned after this change is made by tuning in a steady signal with the receiver in the AM position, in the #3 RF selectivity position, for maximum S meter reading and adjusting the slug in the bottom of L-13 for maximum.
7. Condenser C-16 changed to 2700 mmfd mica, 5% to obtain another 3.5 kc bandwidth position. Effect not noticeable therefore not recommended in field.

SERVICE NOTES

tuned to tomorrow

National

NATIONAL COMPANY, INC., 61 SHERMAN ST., MALDEN 48, MASS. • PHONE MA 2-7950 • CABLE "NATCO" BOSTON

Service Bulletin FSN-32

To: All Distributors, Service
Agencies and Representatives

From: Robert J. Murray

November 18, 1955

SUBJECT: Replacement 4H4C Ballast Tubes Used in the HRO-60 and NC-300

It has been called to our attention that some difficulty is being experienced in the field obtaining replacement 4H4C ballast tubes as used in the NC-300 and the HRO-60.

We wish to advise that these current regulator tubes are carried by our Service Department and are net to you at \$1.80. Suggested retail price \$2.75.

In the event that a replacement 4H4C tube is not immediately available, your customer can use his receiver temporarily by merely plugging a 6V6 type tube in the 4H4C socket until the proper replacement is received.

RJM/s

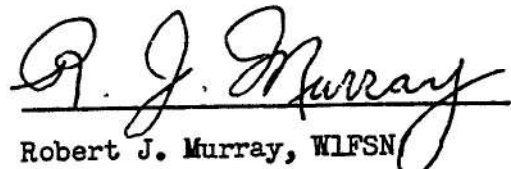
Robert J. Murray, WLFSN
Service Manager

SERVICE NOTES

tuned to tomorrow

National

NATIONAL COMPANY, INC., 37 WASHINGTON ST., MELROSE, MASS. • TEL. ME 4-4800 • CABLE "NATCO" BOSTON

Bulletin Number FSN-33

To: All Service Agencies

January 26, 1956

Through a clerical error in transmittal of information from our Engineering Test Section to our Production Test Section, certain NC-300 receivers were allowed to pass through test with:

1. Unsatisfactory attenuation of spurious responses 40 kc. ($\frac{1}{2}$ the 80 kc. I.F.) removed from a strong signal's frequency.
2. Crystal filter improperly aligned for satisfactory bandwidth in the three crystal positions.

This bulletin will be separated into two parts:

1. Dealing with the spurious responses.
2. Dealing with the alignment of the crystal filter.

Regards,

R. J. Murray
R. J. Murray
Service Manager

RJM:s
attachments

PART I.

When measuring the magnitude of the spurious response, it is necessary that the antenna trimmer and the phasing capacitor be set to the true signal frequency and not to the spurious frequency.

A considerable improvement in the response of the NC-300 receiver to this spurious frequency can be effected by the following modifications:

A shielded lead should be constructed as shown below:

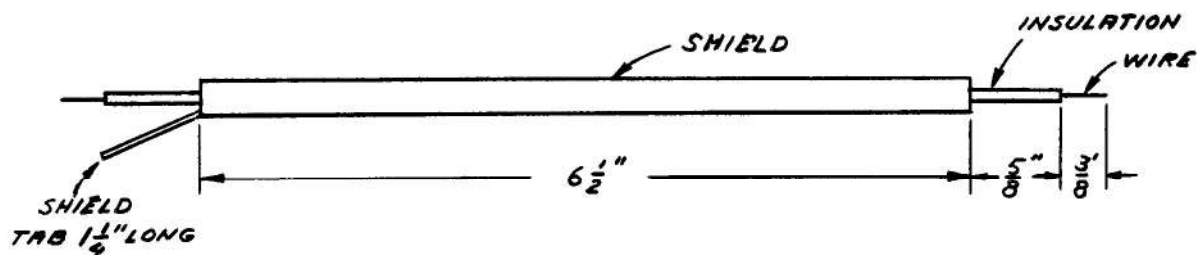

- A. Replace shielded lead from L4 to grid of second converter, V3 with above lead, placing it under phasing control shaft as shown in the pictorial diagram below.

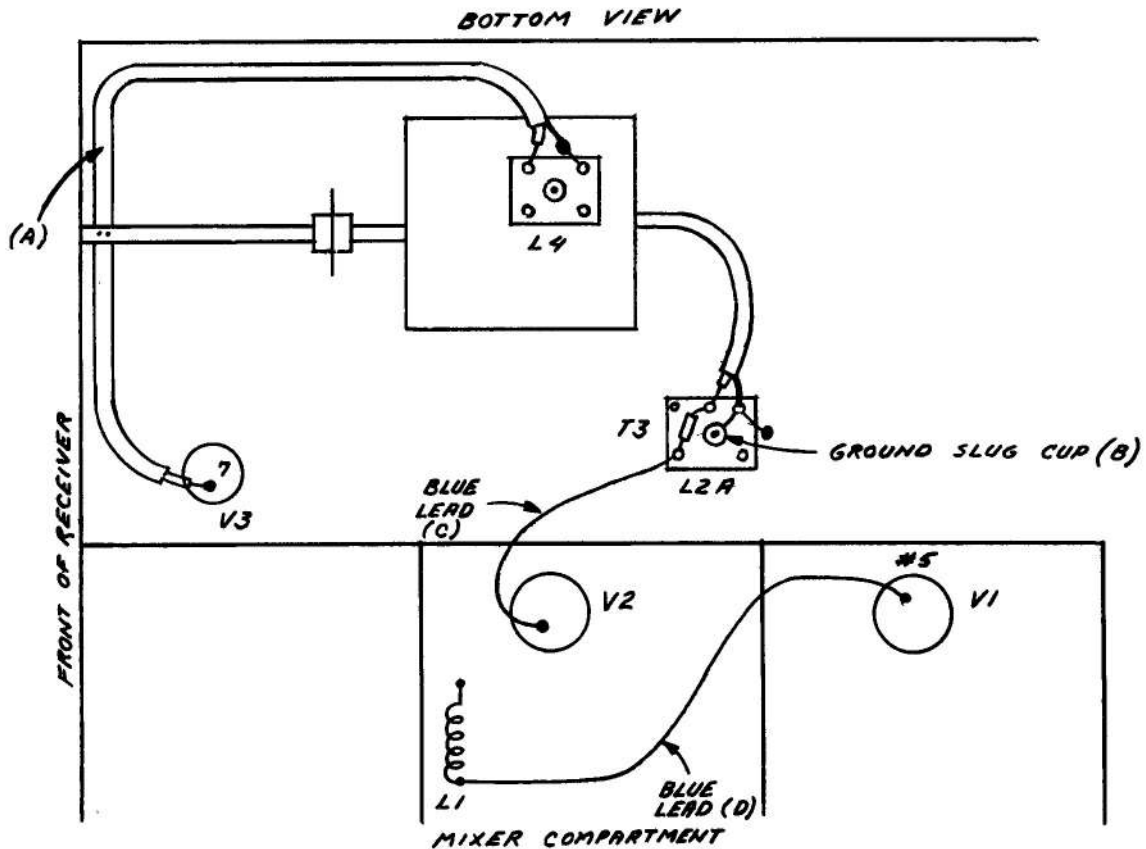

PART I. (Continued)

- B. Ground the slug cup of T3, as shown, with a short piece of bus wire.
- C. Push blue lead from T3 to first mixer, V2 (6BA7), against the chassis for its entire length.
- D. Push blue lead from the plate of the R. F. amplifier, tube V1, to choke L1 down against the chassis for its entire length.
- E. Repeak eight trimmer capacitors (all in a row) in the mixer compartment for maximum background noise in the middle of each range.
- F. Recheck alignment of L2A and L4. With receiver on AM and Phasing Control peaked, select at off and I.F. at #2. Trim the slug of L2A for maximum background noise.

(The adjustment of L4 will have to be made when adjusting crystal filter for optimum performance.)

PART II.

This procedure provides for the proper alignment of the crystal filter as used in the NC-300.

- A. Mode switch at AM, I. F., on #1 position (broad); select control on #1 position (broad); turn up R. F. gain until background noise is heard.
- B. Antenna trimmer at maximum noise position; phasing at center.
- C. Adjust slug of L4 until background noise assumes the maximum amount of high-pitched hiss characteristic, indicating maximum broadness due to the passing of the higher pitched sideband frequencies. Turning the slug out from this position will result in a not-so-rapid loss of gain, but the hiss will disappear. The slug should be set at the point of maximum hiss.
- D. Turning select control from one to two to three should indicate increasing selectivity by progressive reduction in high pitched background noise.

PART II. (Continued)

- E. With Phasing Control set at center, turn select control to "off", and I. F. control to position #2 (medium).
- F. Adjust capacitor C16 on top of crystal filter for maximum noise.
- G. To check, turn mode switch to CW and rock CWO control to find center of I. F. pass band.
- H. Turn select control to position #3 (sharp), and again find center of pass band by rocking CWO; this should be very close to that of G. above. If it is not, a slight adjustment of the second conversion oscillator will be necessary until this condition does occur.

Regards,

R. J. Murray
R. J. Murray
Service Manager

RJM:s

SERVICE NOTES

tuned to tomorrow

National

NATIONAL COMPANY, INC., 37 WASHINGTON ST., MELROSE, MASS. • TEL. ME 4-4800 • CABLE "NATCO" BOSTON

Bulletin Number FSN-34

January 26, 1956

TO: Service Agencies
Receiver Representatives

SUBJECT: NC-300 C6 Changes

The following changes are recommended in the 6-meter converter to reduce cross-modulation:

Change cathode resistor in 6AK5 2nd R.F. amplifier stage from 470 ohms $\frac{1}{2}$ watt to 2200 ohms $\frac{1}{2}$ watt

A 100,000 ohm $\frac{1}{2}$ watt resistor should be connected between Pin #6 and Pin #2 - 7 of the same 6AK5 2nd R.F. stage

Revised circuit below:

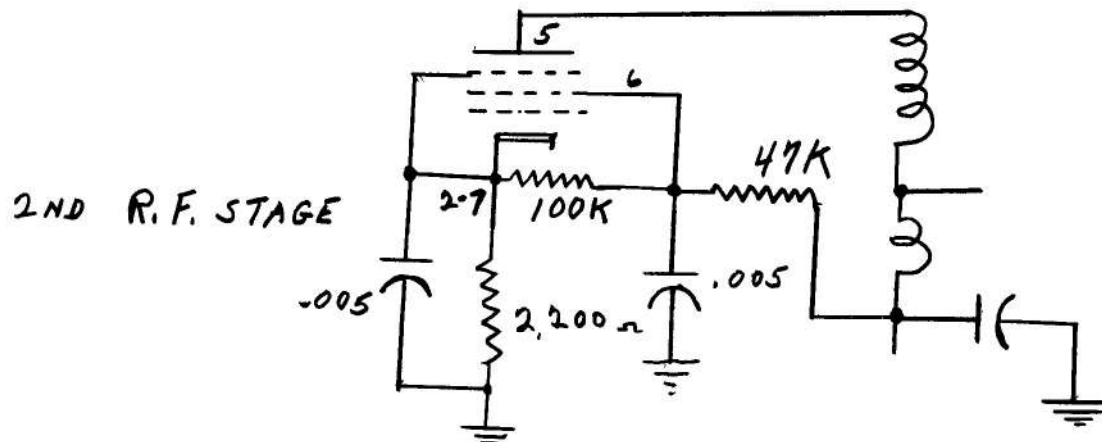

Regards,

Robert J. Murray
R. J. Murray, W1FSN
Service Manager

vlh/1-14-57

SERVICE NOTES

tuned to tomorrow



National

NATIONAL COMPANY, INC., 61 SHERMAN ST., MALDEN 48, MASS. • PHONE MA 2-7950 • CABLE "NATCO" BOSTON

Bulletin Number FSN-35

To: Service Agencies
and
Receiver Reps

February 17, 1956

Subject: "S" Meter - NC-300

Some users of the NC-300 have complained about the fact that the "S" meter on the NC-300 seemed too sensitive. This may be adjusted in two ways to satisfy the individual user.

1. To decrease sensitivity of the "S" meter by a fixed amount, decrease the value of R-30 (68K 1/2 watt).
2. To decrease or increase the sensitivity of the "S" meter by a variable amount, replace R-43 (33K 1/2 watt) and R-30 (68K 1/2 watt) with 100 K potentiometer, connect arm of potentiometer to R-55 (47-OK 1/2 watt).

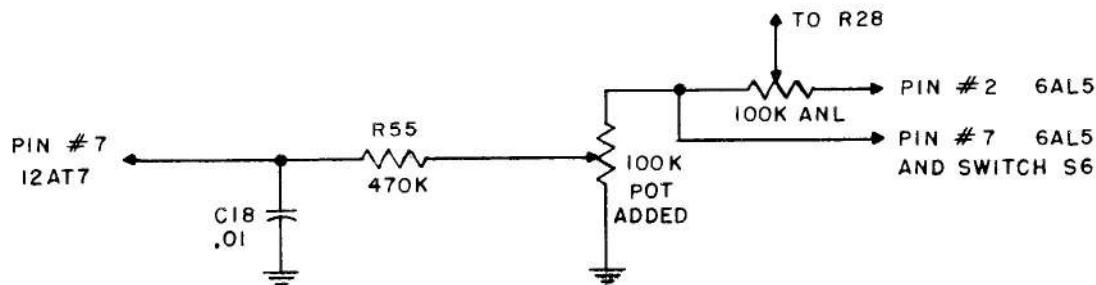

Regards,

R. J. Murray
R. J. Murray
Service Manager

RJM/mp

SERVICE NOTES

tuned to tomorrow

National

NATIONAL COMPANY, INC., 37 WASHINGTON ST., MELROSE, MASS. • TEL. ME 4-4800 • CABLE "NATCO" BOSTON

Bulletin Number FSN-36

March 28, 1956

To: All Service Agencies
Receiver Representatives
Receiver Distributors

Subject: Additional Notes on Reduction of Spurious Responses
and B.C.I. in NC-300 Receivers

1. One shielded cable should be substituted for the blue lead connecting the plate of the first mixer (V2 Pin No. 9) to T3 (B). Drawing of cable below. The vinyl tubing is used to prevent grounds to other sections of the circuitry. Shield tab can be connected to the slug cup of L2-A which should already be grounded in accordance with FSN-33. It may be necessary to repeak L2-A after installation of this shielded lead.

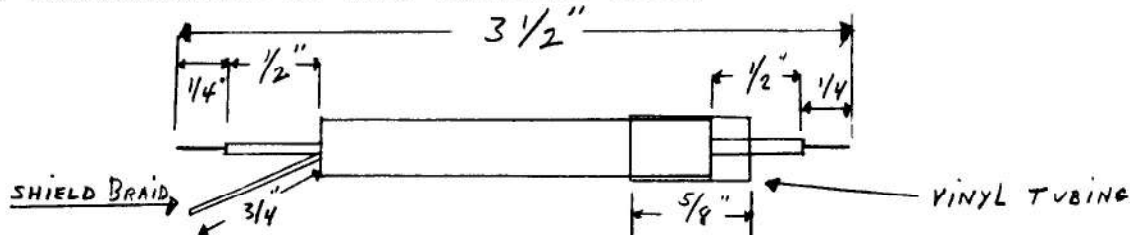

2. Receivers with the prefix 460 preceding the serial number will have new first mixer signal input coils. These coils differ from the original coils in that the 160 meter coil has one turn on the primary, and the 80 meter coil has three turns on the primary.

3. In individual instances where the operator is using unbalanced feed (coaxial cable), the input circuit can be revised by reducing the number of turns on the primary of the antenna input coils. The number of turns remaining on the various primary coils after revision is as follows:

160 meters	4 turns
80 meters	3 turns
all others	2 turns

Extreme caution is required when revising these coils as the fine wire involved is easily broken.

Regards,

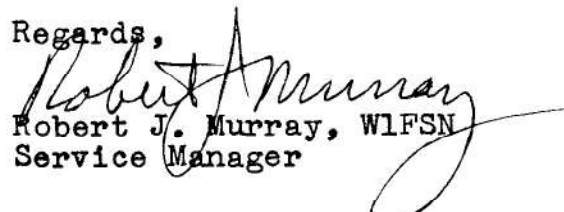
Robert J. Murray, W1FSN
Service Manager

vlh/9-13-56

SERVICE NOTES

tuned to tomorrow

National

NATIONAL COMPANY, INC., 37 WASHINGTON ST., MELROSE, MASS. • TEL. ME 4-4800 • CABLE "NATCO" BOSTON

Bulletin Number FSN-37

April 16, 1956

TO: Service Agencies
Receiver Representatives
Receiver Distributors

Subject: Final Notes on NC-300

The information contained in this bulletin is intended to supplement previously furnished information and should, when properly applied, result in the finest performing amateur receiver on the market today.

1. Service Bulletin FSN-31 should indicate that the 2.2 ohm resistor referred to is a 1-watt wire-wound type.
2. Service Bulletin FSN-33 and FSN-36 should indicate that the shielded cable to be used is a good grade of polyethylene type insulated coax such as RG 58 U or equivalent. We are using Turbo 2101 Microphone cable which is somewhat smaller in diameter but has excellent characteristics.
3. C13 which is normally a 1 uufd capacitor (our part number D825-D 470) should be changed to a $\frac{1}{2}$ uufd capacitor (our part number CCC 20UKOR5C). It is permissible to use two 1 uufd capacitors in series, provided the leads are kept short.

73,

Robert J. Murray, W1FSN
Service Manager

RJM:s
mp
vlh/1-14-57

SERVICE NOTES

tuned to tomorrow

National

NATIONAL COMPANY, INC., 37 WASHINGTON ST., MELROSE, MASS. • TEL. ME 4-4800 • CABLE "NATCO" BOSTON

Bulletin Number FSN-38

To: Service Agencies
Receiver Reps
Receiver Distributors

July 25, 1956

Subject: TV Picture Information Interference on Hi-Fi Frequency Bands of NC-300

In certain metropolitan areas, I.T.V. is experienced on the 21 mc, 28 mc and X bands of the NC-300. This can be minimized by proper selection of antenna and the use of a low pass filter shown in the diagram below. This filter should be inserted in series with the antenna and located as close as practicable to the antenna terminals on the back of the chassis. A good earth ground helps considerably.

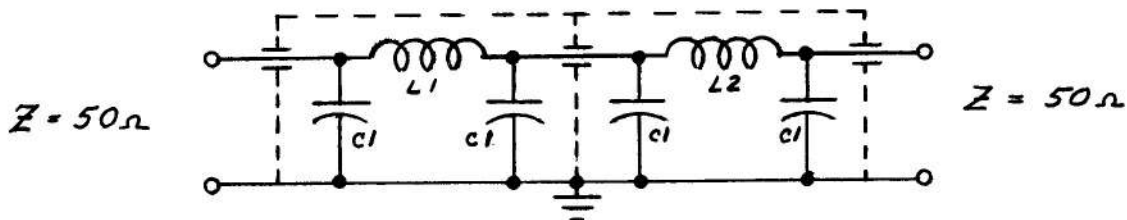

L_1 = .4 uh 10 Turns #20 on 3/8" form spaced 1/2"
 L_2 = .4 uh
C1 = 80 uuf Ceramic

Regards,

R. J. Murray
R. J. Murray
Service Manager

RJM/mp

SERVICE NOTES

tuned to tomorrow

National

NATIONAL COMPANY, INC., 37 WASHINGTON ST., MELROSE, MASS. • TEL. ME 4-4800 • CABLE "NATCO" BOSTON

Bulletin Number FSN-39

July 30, 1956

To: All Service Agencies
Receiver Representatives
Receiver Distributors

Subject: Reception of WWV on NC-300

WWV at 10 mcs. may be received on the NC-300 by connecting a 330 uuf silver mica capacitor from the stator of the high-frequency oscillator section of the main tuning capacitor to chassis ground. Set the front panel antenna trimmer to minimum capacity and look for WWV on the 7 mc. band. Just where it comes in will be determined by the capacitance tolerance of the capacitor.

I suggest that the capacitor be equipped with pee-wee clips so that it can be quickly connected and disconnected.

73,

NATIONAL COMPANY, INC.

Robert J. Murray, W1FSN
Service Manager

RJM/vlh
10-25-56

SERVICE NOTES

tuned to tomorrow



National

NATIONAL COMPANY, INC., 37 WASHINGTON ST., MELROSE, MASS. • TEL. ME 4-4800 • CABLE "NATCO" BOSTON

Bulletin Number FSN-41

November 23, 1956

To: All Service Agencies
Receiver Representatives

Subject: 4H4C Ballast HRO-60 NC-300

In instances where the 4H4C current regulator tube repeatedly fails, our Engineering Department recommends that the customer discard the 4H4C altogether and replace it with a 6V6GT previously recommended as a temporary substitute.

The additional drift caused by this substitution will not exceed 250 to 300 cycles at 29 megacycles, which is negligible.

Regards,

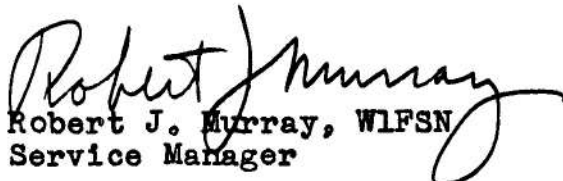
Robert J. Murray, WLFSN
Service Manager

RJM/vlh

SERVICE NOTES

tuned to tomorrow

National

NATIONAL COMPANY, INC., 37 WASHINGTON ST., MELROSE, MASS. • TEL. ME 4-4800 • CABLE "NATCO" BOSTON

Bulletin Number FSN-48

August 4, 1958

TO: ALL Service Agencies
Receiver Representatives

SUBJECT: Calibration and Crystal Filter NC-300

This time of year with relatively high heat and humidity usually brings sporadic reports of calibration errors and ineffective crystal filter action in the NC-300. This is due to the second conversion oscillator coil having drifted off its correct frequency of 2295 kc.

In most instances all that is necessary is that L6 in T5 be trimmed to the correct frequency by means of the slug in it. There are other rare cases where the second conversion oscillator will not maintain its frequency for more than a period of a month or so. These reports usually originate in areas of high humidity such as Florida and Louisiana and other localized areas.

In these instances we recommend crystal control of the second conversion oscillator as per the attached schematic. It should be remembered that there are now two crystals in the circuit which must be properly coordinated if the receiver is to work at maximum efficiency. Normal production tolerances in the grinding of the crystals may allow a situation to exist where the difference in frequency of the crystal in the crystal filter (2215 kc) and the crystal in the second conversion oscillator (2295 kc) is not exactly 80 kc (second IF).

If this is so the second IF strip must be adjusted accordingly either slightly higher or slightly lower to compensate.

73,

NATIONAL COMPANY, INC.



Robert J. Murray, W1FSN
Service Manager.

RJM:rh

August 4, 1958

- NOTE -

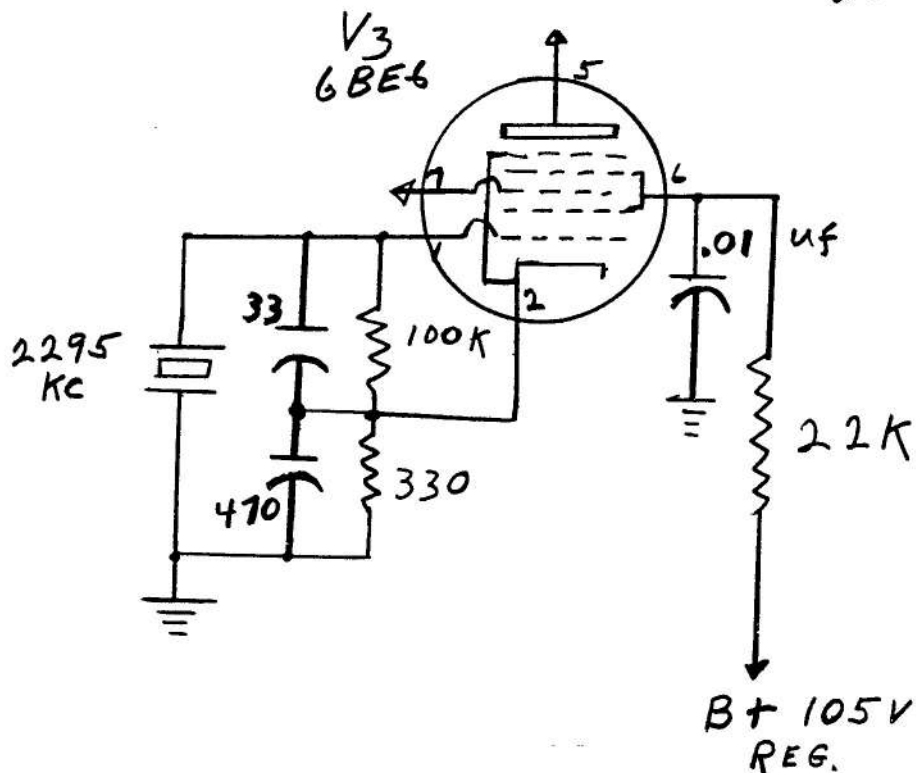
1. RESISTORS 1/2 WATT
2. CAPACITANCE IN μF UNLESS OTHERWISE SPECIFIED



R.J.M.
8-4-58

Robert J. Murray, W1FSN

60 Main Street
Saugus, Mass.

The summer months of the year occasionally bring reports of calibration errors and ineffective crystal filter action in the NC-300, particularly in areas of high humidity. This is due to the second conversion oscillator drifting off its normal frequency of 2295 kc. This situation is evidenced by calibration errors on the dial in one direction on the high frequency ranges and in the opposite direction on the low frequency ranges and also by erratic operation of the crystal filter.

It is a simple matter to crystal control the second converter oscillator which effectively eliminates these problems.

The crystal and its associated components may be mounted in the shield can which formerly housed L6 the second conversion oscillator coil.

It should be remembered that there are now two crystals in the circuit which must be properly coordinated if the receiver is to work at maximum efficiency. Normal production tolerances in the grinding of the crystals may allow a situation to exist where the difference in frequency of the crystal in the filter (2215 kc) and the crystal in the second conversion oscillator (2295, kc) is not exactly 80 kc (second IF). If this is so the second IF strip must be adjusted accordingly, either slightly higher or slightly lower in frequency to compensate.

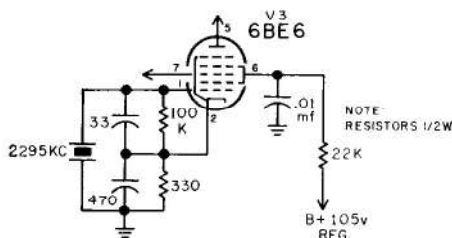

Fig. 1—Crystal controlled second converter.

Improved Audio

An audio change that will improve the phone quality is shown in fig. 2. It consists of a 1 megohm resistor connected between the plate of the output tube and the plate of the preceding audio stage. This has a tendency to drop the audio level which can be restored by bypassing the cathode of V9, R45 with a 20 mf. 50 volt capacitor to chassis ground.

Dial Vernier

On the front panel of the NC-300 there is a plug button to the lower left of the main tuning dial. This originally was designed for removal of the bandswitch shaft without the necessity of dismantling the entire receiver. A vernier for the main tuning dial may be mounted in this spot if it so desired by enlarging the hole to 1/2" and inserting a National SB bushing. A neoprene or rubber washer cemented to the under surface of an HR or similar knob with a 1/4" shaft going into the SB bushing will do it beautifully a la Atwater Kent Model 40 shades of 1928. Stick a cotter pin through the shaft so that it won't keep pulling out. ■

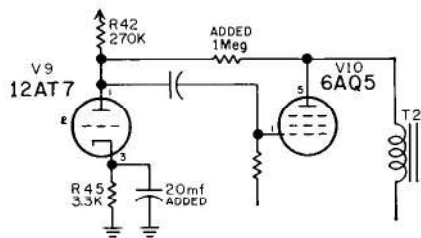

Fig. 2—Two new components improves audio.