

MANUAL

Oscilloscope

HM 203

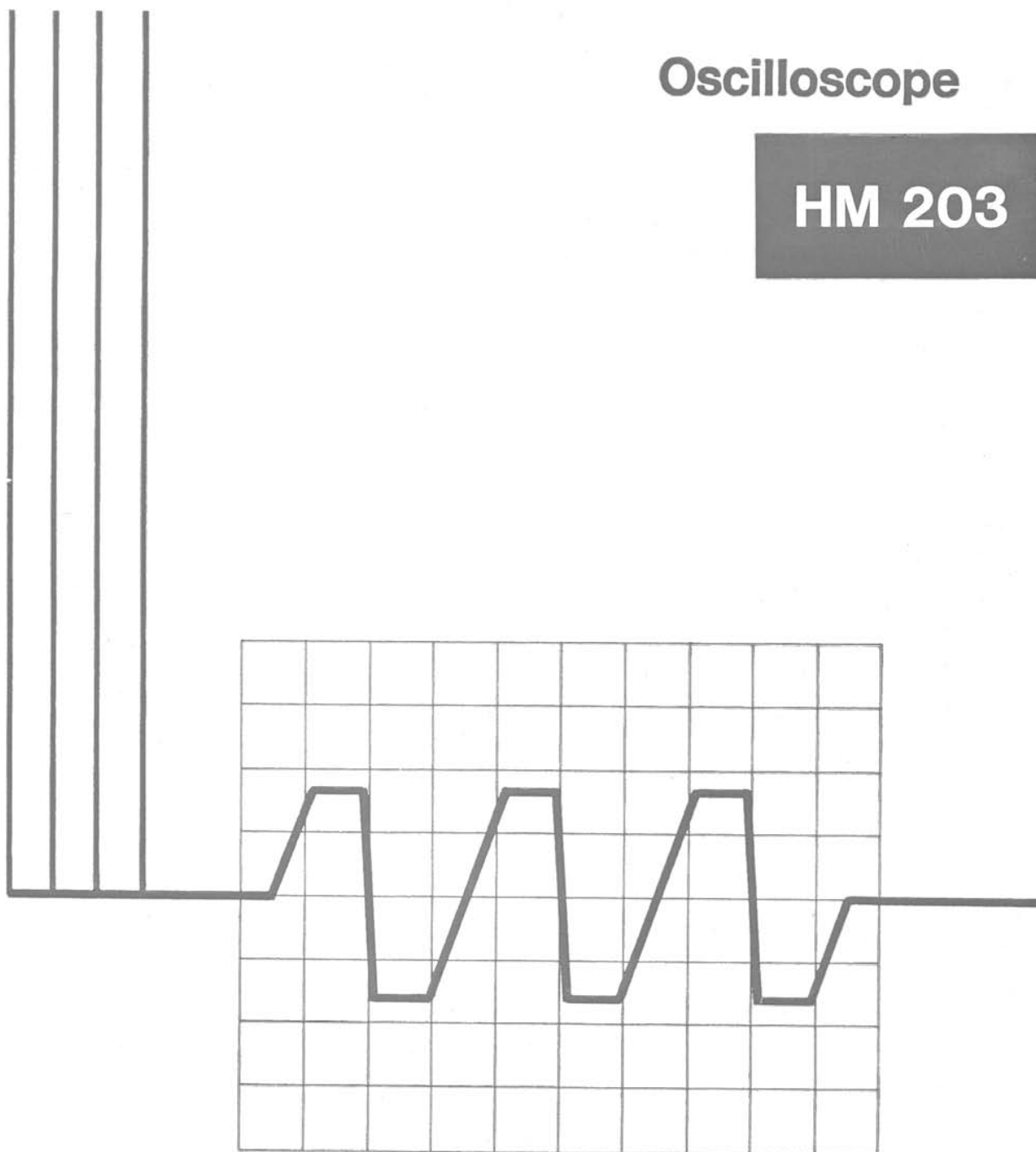

HAMEG MESSTECHNIK

Specification

Vertical Deflection (Y)

Bandwidth of both channels

DC to 20MHz (-3dB), DC to 28MHz (-6dB).

Risetime: ≈ 17.5 ns. Overshoot: max. 1%.

Deflection coefficients: 12 calibr. steps, 5mV/cm to 20V/cm in 1-2-5 sequence, with variable control uncal. 1:2.5 to **2mV/cm**.

Accuracy in calibrated position: $\pm 3\%$.

Input impedance: 1 M Ω || 28 pF.

Input coupling: DC-AC-GND.

Input voltage: max. 500V (DC + peak AC).

Operating modes

Channel I, Channel II, Channel I and II alternate or chopped (chop freq. ≈ 1 MHz), sum or difference Ch. II \pm Ch. I (with Invert button for Channel I).

Timebase

Time coefficients: 18 calibrated steps, 0.5 μ s/cm to 0.2s/cm in 1-2-5 sequence, with variable control uncal. 1:2.5 to 0.2 μ s/cm, with 5x magnification uncal. to 40ns/cm. Accuracy in calibrated position: $\pm 3\%$.

Trigger System

Modes: Auto or Normal (with level adj.).

Slope: positive or negative.

Sources: Ch. I, Ch. II, line, external.

Coupling: DC-AC-HF-LF (TV frame).

Threshold: internal 5mm, external 0.6V.

Bandwidth: DC up to 40MHz.

Horizontal Deflection (X)

Bandwidth: DC to 2.5MHz (-3dB).

Input: via Channel II (see Y deflection spec.).

X-Y phase shift: $< 3^\circ$ up to 300kHz.

Component Tester

Test voltage: max. 8.5Vrms (open circuit).

Test current: max. 24mA rms (shorted).

Test frequency: 50-60Hz (line frequency).

Test connection: 2 banana jacks 4mm dia.

One test lead is grounded (Safety Earth).

General Information

Cathode-ray tube: D14-362 P43/93 (med.), P7/93 optional (long decay characteristic), rectangular screen, internal graticule **8x10cm**. Accelerating potential: 2000V.

Trace rotation: adjustable on front panel.

Calibrator: square-wave generator ≈ 1 kHz for probe compensation. Output 0.2V $\pm 1\%$.

Regulated DC power supplies: all operating voltages including the high voltage.

Protective system: Safety Class I (IEC 348).

Line voltages: 110, 125, 220, 240V AC.

Permissible line fluctuation: $\pm 10\%$.

Line frequency range: 50 to 60Hz.

Power consumption: 36 Watts (approx.).

Weight: 7kg (approx.). Color: techno-brown.

Cabinet (mm): **W** 285, **H** 145, **D** 380.

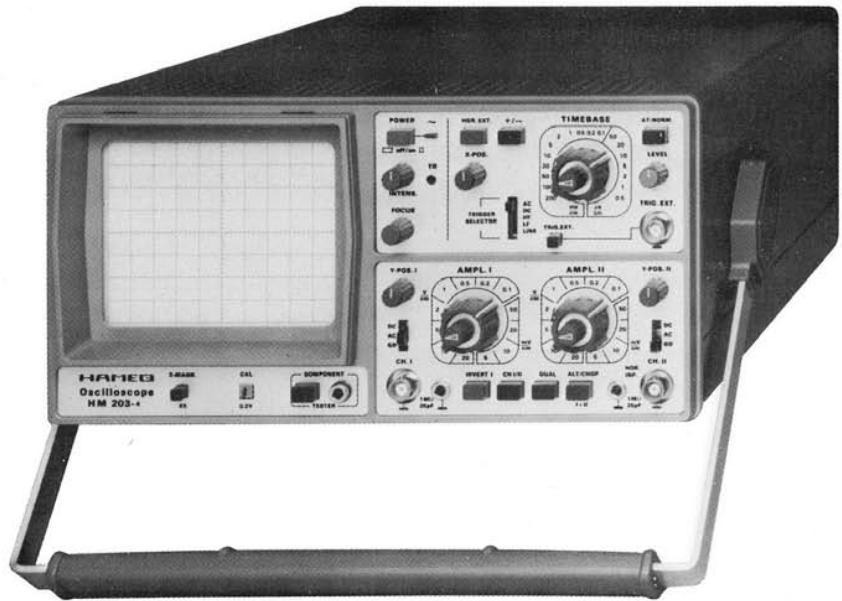

■ **Y:** DC-20MHz, max. 2mV/cm ■ **X:** 40ns/cm to 0.2s/cm

■ **Triggering:** DC to 40MHz ■ **Component Tester**

The already well-known good **price/performance ratio** of the **HM203-4** was again improved. Both vertical amplifiers now have **variable controls** and an input sensitivity of **max. 2mV/cm** at full bandwidth. New is also that the sum and difference of two signals can be displayed. The trigger facilities were also extended. Besides Line- and TV-triggering, **HF-** and **DC-triggering** are now possible, as well. At 5mm display height the HM203 will trigger up to **at least 40MHz**. The CRT's internal graticule permits **parallax-free viewing** from different angles. Particularly for maintenance purposes, the HM203-4 also has a built-in **Component Tester** for quick **tests of semiconductors** and other components, single or in-circuit.

The HM203 has been designed for **general purpose applications in industry and service**. The multitude of operating modes, concise layout of the front panels, and ease of operation recommend it also for the **training of engineers and technicians**.

Accessories optional

Attenuator probes 1X, 10X, 100X; demodulating probe; various test cables; 50 Ω BNC feed-through termination; BNC-banana adapter; 4-Channel Amplifier; viewing hood.

Subject to change.

General

The **high performance** and competitive price of the HM203-4 has been achieved by the optimum use of both discrete semiconductor and **integrated circuit** technology. Quality and long term reliability are assured, as only **high quality components** are selected for the instrument. The well-arranged subassemblies combined with a **stable construction** ensure easy servicing. The subdivision of the complete circuitry into two large printed circuit boards enables each component to be easily reached, without dismantling any other parts.

A square-wave generator for probe compensation and a trace rotation device are incorporated.

Each instrument is supplied with a **comprehensive manual** including operating and servicing instructions, circuit diagrams, and PCB layouts. It also contains **test instructions** for checking the most important functions by relatively simple means.

Modes of Operation

The HM203 can be used for **single or dual trace** operation. Two time-related signals differing in waveform and amplitude can be displayed either consecutively (**alternate mode**) or by the multiple switching of the channels within one sweep period (**chop mode**). The sum or the difference of two signals are displayed by **algebraic addition** (Channel I can be inverted). When **X-Y operation** is selected, the X input is via Channel II. Input impedance and sensitivity ranges are then the same for both X and Y deflection.

Vertical Deflection

The HM203 has two preamplifiers with **diode-protected FET inputs**. These are electronically switched either individually, alternately or together to the Y final amplifier. The switching circuit operates with bistable-controlled diode gates. Control for the alternate mode is effected by the unblanking pulse from the sweep generator and for the chopped mode by a 1 MHz signal. The chop generator and the bistable multivibrator are

both combined in a single integrated circuit. The preamplifier input stages utilize **monolithic integrated circuits to minimize drift**. Exact measurement of the displayed waveform is achieved by the 12-step frequency compensated input attenuator calibrated in V/cm. In order to obtain reliable triggering at higher frequencies, the bandwidths of the preamplifiers are approximately **40MHz**. The total bandwidth of the Y amplifier is dependent on the output stage. The value stated refers to -3dB (70% of 80mm).

Timebase and Triggering

The timebase of the HM203 operates with a **new type of trigger technique** developed by HAMEG. Here, the entire trigger preparation is through a **monolithic integrated voltage comparator** whose TTL output is connected directly to the control logic of the sweep generator. The fast operation of this circuit means that **very small signal amplitudes up to a frequency of 40MHz can be reliably triggered**. Using AC, DC, HF- or LF-filter coupling, automatic or normal triggering from positive- or negative-going trigger edges can be selected from Channel I, Channel II, Line or external sources. With the trigger switch in the **Auto** position, a baseline is always displayed even in the absence of a signal. The HM203 allows the triggering of **TV signals** (line or frame frequency). A **voltage-proof opto-coupler** controls the unblanking of the CRT.

Component Tester

By simply **pressing a single pushbutton**, the HM203 can be **switched into test mode** without actually affecting the oscilloscope measuring set-up. The test result is displayed on the screen in the way of a typical current-voltage characteristic. Display height and width are constant. Test voltage and current are such that standard semiconductors and other components cannot be damaged. **Components can be tested individually or "in-circuit"**. Easy and time-saving troubleshooting is possible in complex circuitry by simple comparison with an equivalent functioning circuit. Simply release the Component Tester pushbutton to resume normal oscilloscope measurements.

Examples of test displays

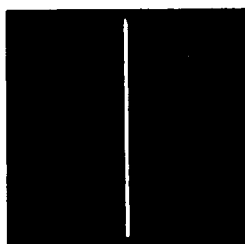

Short-circuit

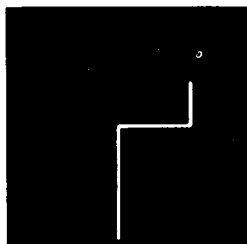

Z-diode below 8 volts



Transistor base-collector

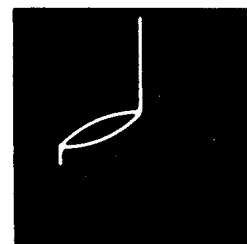

Transistor base-emitter
paralleled to 1µF + 680Ω

HZ30 100MHz Oscilloscope Probe 10:1

Bandwidth DC-100MHz, Risetime 3.5ns. Maximum input voltage 600V (DC+peak AC). Input impedance 10M Ω . Input capacitance approx. 13pF, compensation range 10-60pF. Cable length 1.5m. Supplied with sprung hook, trimmer tool, spare tip, IC tip, and insulating tip.

HZ35 Oscilloscope Probe 1:1

Bandwidth DC-10MHz. Maximum input voltage 600V (DC+peak AC). Input resistance equal to that of oscilloscope. Input capacitance 47pF + input capacitance of oscilloscope. Cable length 1.5m. Supplied with sprung hook, insulating tip, IC tip, and BNC adapter.

HZ36 Switchable Probe 10:1/1:1

This probe combines the specifications of the HZ30 and the HZ35 in their respective attenuation ranges. In the reference position the probe tip is grounded via a 9M Ω resistor, the oscilloscope input is connected directly to ground. Cable length 1.5m. Supplied with sprung hook, trimmer tool, spare tip, insulating tip, IC tip, and BNC adapter.

HZ37 High Voltage Probe 100:1

Bandwidth DC-50MHz, Risetime 7ns. Maximum input voltage 1500V (DC+peak AC). Input resistance 100M Ω . Input capacitance approx. 4pF. Compensation range 12-48pF. Cable length 1.5m. Supplied with sprung hook, trimmer tool, insulating tip, IC tip, and BNC adapter.

HZ38 High Frequency Probe 10:1

Bandwidth DC-200MHz. Risetime 1.7ns. Maximum input voltage 500V (DC+peak AC). Input resistance 10M Ω . Input capacitance approx. 13pF. Compensation range 12-48pF. Cable length 1.5m. Supplied with sprung hook, trimmer tool, spare tip, IC tip, insulating tip.

HZ39 Demodulator Probe

Bandwidth approx. 35kHz-250MHz RF input voltage range 0.25Vrms to 40Vrms. Maximum input voltage 200V (DC+peak AC). Output polarity is positive. Cable length 1.5m. Supplied with sprung hook, IC tip, insulating tip, and BNC adapter.

HZ32 Test Cable BNC-4mm

Coaxial test cable with BNC male plug at one end and shielded banana-plug at the other. Cable length 1.15m. Cable capacitance 126pF. Characteristic impedance 50 Ω . Maximum input voltage 500V (DC+peak AC).

HZ34 Test Cable BNC-BNC

Coaxial test cable with BNC male plugs at each end. Cable length 1.2m. Cable capacitance 126pF. Characteristic impedance 50 Ω . Maximum input voltage 500V (DC+peak AC).

HZ20 Adapter 4mm to BNC

Two 4mm binding posts 19mm between centers to standard BNC male plug. Maximum input voltage 500V (DC+peak AC). Dimensions 42x35x18mm.

HZ22 50 Ω Through-Termination

Should be used to terminate signal generators or coax-cables with 50 Ω characteristic impedance or when measuring high frequency sine wave signals to avoid standing waves. Maximum load 2W. Maximum voltage 10Vrms. Dimensions 14x20x62mm.

HZ42 Carrying Case

Suitable for Oscilloscopes HM203-1, 203-3.

HZ43 Carrying Case

Suitable for Oscilloscopes HM312, 412, 512, 705.

HZ44 Carrying Case

Suitable for Oscilloscopes HM307 and for HZ62, 64.

HZ45 Carrying Case

Suitable for Oscilloscope HM103.

HZ46 Carrying Case

Suitable for Oscilloscope HM203-4, HM204.

HZ47 Viewing Hood

Suitable for Oscilloscopes HM203, 204, 705, 808.

HZ65 Component Tester

Works with any oscilloscope featuring X-Y operation. An indispensable aid when repairing electronic equipment as it displays the current-voltage characteristics of any component on the screen. Components can also be tested "in-circuit", with clear go / no go indication within seconds. For low power transistors two sockets are provided with switchable connections, facilitating tests of each junction. Test currents of approx. 3.7mA rms, 37mA rms, and 320mA rms can be selected with slide switch. Supplied with pair of test leads, two coax-cables for scope, power cord. Safety Class II.

OPERATING INSTRUCTIONS

General Information

The new HM203-4 is as easy to use as all HAMEG instruments. Technologically it represents the latest state of engineering in this price range. This is particularly illustrated by the increased use of monolithic integrated circuits. The logical arrangement of the controls and connectors on the front panel ensures that the user will quickly become familiar with the operation of the instrument. However, even experienced operators are advised to read the following instructions thoroughly, as they include important information relating to the use of the HM203-4.

The front panel is subdivided into three sections according to the various functions. The **X-MAGN. X5** pushbutton, the calibrator output (**CAL. 0.2V**), and the **COMPONENT TESTER** pushbutton and its measuring socket are located on the left directly below the screen of the cathode-ray tube (CRT).

The X-Section, located on the upper right, contains the red **POWER** pushbutton and indicating lamp, the **INTENS.**, **FOCUS**, and **TR** (trace rotation) controls. To the right of them, all controls and switches for **TIMEBASE** and triggering and the **TRIG. EXT.** input connector are arranged.

The lower Y-Section contains the controls for the vertical deflection system. On the right and left in this section are located: vertical input connector, **DC-AC-GD** input coupling slide switch, **Y-POS.** control, **AMPL.** attenuator switch with variable control, and ground jack. All these controls and connectors exist in duplicate for each of the Channels I and II. Four pushbuttons for selecting the operating mode are arranged below the attenuator switches: **INVERT I**, **CHI/II — TRIG.I/II**, **DUAL**, and **ALT/CHOP — I+II**.

The instrument is so designed that even incorrect operation will not cause serious damage. The pushbuttons control only minor functions, and it is recommended that before commencement of operation all pushbuttons are in the "out" position. After this the pushbuttons can be operated depending upon the mode of operation required. For a better understanding of these Operating Instructions the front panel picture at the end of these instructions can be unfolded for reference alongside the text.

The HM203 accepts all signals from DC (direct voltage) up to a frequency of at least 20MHz (-3dB). For sine-wave voltages the upper frequency limit will be 30-35MHz. However, in this higher frequency range the vertical display height on the screen is limited to approx. 4-5cm. In addition, problems of time resolution also arise. For example, with 25MHz and the fastest adjustable sweep rate (40ns/cm), one cycle will be

displayed every 1 cm. The tolerance on indicated values amounts to $\pm 3\%$ in both deflection directions. All values to be measured can therefore be determined relatively accurately. However, from approximately 6MHz upwards the measuring error will increase as a result of loss of gain. At 12MHz this reduction is about 10%. Thus, approximately 11% should be added to the measured voltage at this frequency. As the bandwidth of the amplifiers differ (normally between 20 and 25MHz), the measured values in the upper limit range cannot be defined exactly. Additionally, as already mentioned, for frequencies above 20MHz the dynamic range of the display height steadily decreases. The vertical amplifier is designed so that the transmission performance is not affected by its own overshoot.

Warranty

Before being shipped each instrument must pass a 10 hour quality control test. Almost every early failure can be detected by means of intermittent operation during this test. Nevertheless, a component may fail but only after a longer period of operation. Therefore, ***all HAMEG instruments are under warranty for a period of one year***, provided that the instrument has not undergone any modifications. HAMEG will repair or replace products which prove to be defective during the warranty period. No other warranty is expressed or implied. HAMEG is not liable for consequential damages. It is recommended that the instrument be repackaged in the original manner for maximum protection. We regret that transportation damage due to poor packaging is not covered by this warranty.

In case of any complaint, attach a tag to the instrument with a description of the fault observed. Please supply name and department, address and telephone number to ensure rapid service.

Safety

This instrument is designed and tested according to international safety standards (e.g. ***IEC 348: Safety requirements for electronic measuring apparatus***). The instrument has left the factory in perfect safety condition. To preserve this state and to ensure operation without danger, the user must observe all advises and warning remarks in these Operating, Test, and Service Instructions. ***The case, chassis, and all measuring terminals are connected to the Safety Earth conductor.*** The specification of the instrument corresponds to ***Safety Class I*** (three-conductor AC power cable). The grounded accessible metal parts (case, sockets, jacks) and the power line circuit of the HM203 are tested against one

another with 1500V 50Hz. Under certain conditions, 50Hz or 60Hz hum voltages can occur in the measuring circuit due to interconnection with other mains/line powered instruments or devices. This can be avoided by using a protective isolating transformer between the mains/line outlet and power plug of the HM203. Without an isolating transformer, the instrument's power cable must be plugged into an approved three-contact electrical outlet, which meets International Electrotechnical Commission (IEC) safety standards.

Warning!

Any interruption of the protective conductor inside or outside the instrument or disconnection of the protective earth terminal is likely to make the instrument dangerous. Intentional interruption is prohibited.

If a protective isolating transformer is used for the display of signals with high zero potential, it should be noted that these voltages are also connected to the oscilloscope's case and other accessible metal parts. Voltages up to 42V are not dangerous. Higher voltages, however, involve a shock hazard. In this case, special safety measures must be taken and must be supervised by qualified personnel.

As with most electron tubes, the cathode-ray tube develops X-rays. With the HM203 **the dose equivalent rate falls far below the maximum permissible value of 36pA/kg.**

Operating Conditions

Admissible ambient temperature range during operation: +10°C ... +40°C. Admissible ambient temperature range for storage or transportation: -40°C ... +70°C. If condensed water exists in the instrument it should not be turned on before acclimatization is achieved. In some cases (an extremely cold oscilloscope) about two hours should be allowed before putting the instrument into operation. The instrument should be placed in a clean and dry room. In other words, the instrument may not be put into operation in explosive, corrosive, dusty, or moist environments. The instrument may be operated in any position, however, the convection cooling must not be impaired. Therefore, when the instrument is in continuous operation it should be used in the horizontal position preferably on its tilt stand.

The instrument must be disconnected and secured against unintentional operation if there is any presumption that safe operation is not possible. This supposition is qualified

- if the instrument has visible damage,
- if the instrument has loose parts,

- if the instrument does not function,
- after a long storage under unfavourable circumstances (e.g. out of doors or in moist environments),
- after excessive transportation stress (e.g. in poor packaging).

Use of the Tilt Handle

The handle of the oscilloscope can be fixed in three positions, one for use as a carrying handle and two positions as a tilt stand. With the tilt handle the instrument can be inclined 10° or 20° to the horizontal.

Handling is as follows:

- Place the HM203 on its rear feet. The front drop-in pins in the hinges will fall back into the front groove of the notched discs (fixed on cabinet).
- Pull the handle only about 5mm out of its locking position and turn it towards the lower edge of the front panel.
- Lock the handle into the required position by pushing it back towards the hinges.
- Place the instrument in its work area.

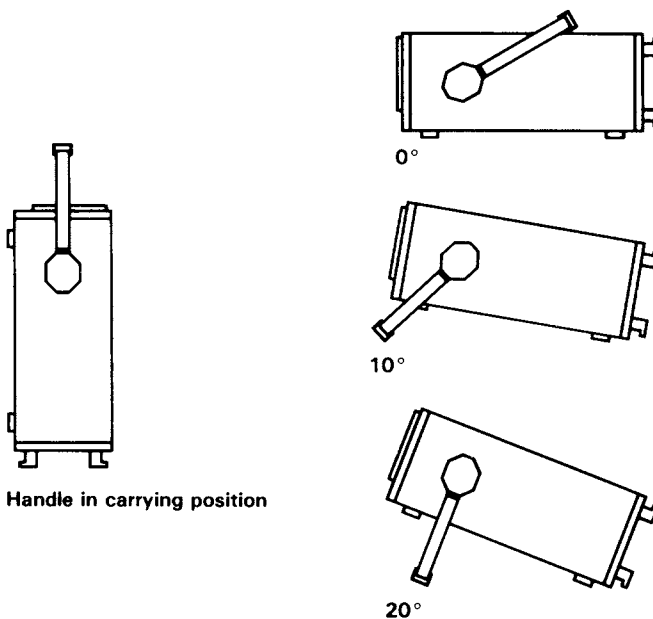

First Time Operation

Check that the instrument is set to the correct mains/line voltage.

On delivery, the instrument is set to AC 240V ±10% (50-60Hz) mains/line voltage. The power plug-in unit at the rear contains the three-pin power connector. For this a three wire power cord with triple-contact connector and three-pole power plug is required. The unit also con-

tains the power fuse, which is interchangeable for the different mains/line voltages. The fuse holder with its square top plate can be pulled out, and **changing of the mains/line voltage** is possible by turning this plate 90 degrees for each of the four voltages marked on the plate (see triangle on the rear panel below the fuse holder). The fuse holder should then be plugged in again in the desired position, which should be the **closest value of the measured mains/line voltage in your area**. The set value is always readable on the **lower** edge of the fuse holder. The power fuse must correspond to the voltage selected and when necessary should be replaced. The type and rated current are given on the rear panel and in the Service Instructions.

Before applying power to the oscilloscope, it is recommended that the following simple procedures are performed:

- Check that all pushbuttons are in the **out** position, i.e. released.
- Rotate the three variable controls with arrows, i.e. **TIMEBASE** variable control, **CH.I** and **CH.II** attenuator variable controls, fully counterclockwise in their calibrated detent.
- Set the control knobs with marker lines to their mid-range position (marker lines pointing vertically).
- The slide switch in the X-Section should be set to its uppermost **AC** position.
- Both input coupling slide switches for **CH.I** and **CH.II** in the Y-Section should be set to the **GD** position.

Switch on the oscilloscope by depressing the red **POWER** pushbutton. An LED will illuminate to indicate the working order. The trace, displaying one baseline, should be visible after a short warm-up period of 10 seconds. Adjust **Y-POS.I** and **X-POS.** controls to center the baseline. Adjust **INTENS.** (intensity) and **FOCUS** controls for medium brightness and optimum sharpness of the trace. The oscilloscope is now ready for use.

If only a spot appears (**CAUTION!** CRT phosphor can be damaged.), reduce the intensity immediately and check that the **HOR. EXT.** pushbutton is in the released (out) position. If the trace is not visible, check the correct positions of all knobs, buttons, and switches (particularly **AT/NORM.** button in out position).

To obtain the maximum life from the cathode-ray tube, the minimum intensity setting necessary for the measurement in hand and the ambient light conditions should be used. **Particular care is required when a single spot is displayed**, as a very high intensity setting may cause damage to the fluorescent screen of the CRT. Switching the oscilloscope off and on at short intervals stresses the cathode of the CRT and should therefore be avoided.

In spite of Mumetal-shielding of the CRT, effects of the earth's magnetic field on the horizontal trace position cannot be completely avoided. This is dependent upon the orientation of the oscilloscope on the place of work. A centred trace may not align exactly with the horizontal center line of the graticule. A few degrees of misalignment can be corrected by a potentiometer accessible through an opening on the front panel marked TR.

DC Balance Adjustment

The vertical preamplifiers for **CH.I** and **CH.II** contain input source followers with matched dual FETs. After long periods of use the FET characteristics may change which can alter the DC balance of the vertical amplifier.

A quick check can be made on each channel by rotating the variable control knob on the attenuator switch to and fro, clockwise and back to the calibrated detent **C**. If the trace moves from the vertical position (up or down) by more than 1 mm, the DC balance will require readjustment. This check should be made after a 20 minute warm-up period.

Adjustment procedure

The following instructions should be performed to obtain the correct DC balance adjustment of both channels.

- Remove all input cables and adjust oscilloscope controls to display the baseline.
- Center the baseline using **Y-POS.** and **X-POS.** controls.
- Set attenuator switches to **5mV/cm** and input coupling switches to **GD**.
- Release all pushbuttons in the Y-Section.
- Place the oscilloscope so that it rests firmly on its back (upright position) and locate DC balance adjustment potentiometer access holes — marked **CH.I DC-BALANCE CH.II** — which are found underneath the instrument.
- Insert a screwdriver (blade approx. 3 mm, length min. 20mm) in **CH.I** hole. Behind the hole, a plastic funnel with slotted bottom is located.
- Rotate **AMPL.I** variable control to and fro and adjust balance pot so that the baseline no longer moves up or down. When the trace remains steady, correction of **CH.I** is completed.
- Depress **CH.I/II** button. Repeat adjustment procedure for **CH.II**.

Probe Adjustment

To achieve the undistorted display of signals when using an X10 or X100 attenuator probe, the probe must be

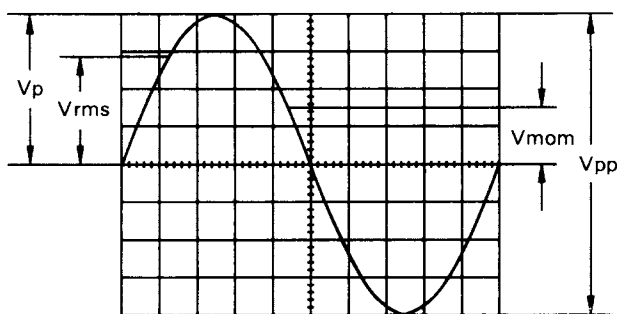

Voltage values of a sine curve

Vrms = effective value; Vp = simple peak or crest value;
Vpp = peak-to-peak value; Vmom = momentary value.

The minimum signal voltage required at the vertical amplifier input for a display of 1cm is approximately **2mVpp**. This is achieved with the **AMPL.** attenuator control set at **5mV/cm** and its **variable control in the fully clockwise position**. However, smaller signals than this may also be displayed. The **deflection coefficients** on the input attenuators are indicated in **mV/cm** or **V/cm** (peak-to-peak value).

For exact amplitude measurements, the variable control on the attenuator switch must be set to its calibrated detent C.

The magnitude of the applied voltage is ascertained by multiplying the selected deflection coefficient by the vertical display height in cm.

If an attenuator probe X10 is used, a further multiplication by a factor of 10 is required to ascertain the correct voltage value.

With direct connection to the vertical input, signals up to 160Vpp may be displayed.

With the designations

H = display height in cm,

U = signal voltage in Vpp at the vertical input,

D = deflection coefficient in V/cm at attenuator switch,
the required quantity can be calculated from the two given quantities:

$$U = D \cdot H$$

$$H = \frac{U}{D}$$

$$D = \frac{U}{H}$$

However, these three values are not freely selectable. They have to be within the following limits (trigger threshold, accuracy of reading):

H between 0.5 and 8cm, if possible 3.2 to 8cm,

U between 2.5mVpp and 160Vpp,

D between 5mV/cm and 20V/cm in 1-2-5 sequence.

Examples:

Set deflection coefficient **D = 50mV/cm** $\hat{=}$ 0.05V/cm,

observed display height **H = 4.6cm,**
required voltage U = 0.05 · 4.6 = 0.23Vpp.

Input voltage **U = 5Vpp,**
set deflection coefficient **D = 1V/cm,**
required display height H = 5:1 = 5cm.

Signal voltage $U = 220V_{rms} \cdot 2 \cdot \sqrt{2} = 622V_{pp}$
(voltage > 160Vpp, with probe X10: **U = 62.2Vpp**),
desired display height **H = min. 3.2cm, max. 8cm,**
max. deflection coefficient $D = 62.2:3.2 = 19.4V/cm,$
min. deflection coefficient $D = 62.2:8 = 7.8V/cm,$
adjusted deflection coefficient D = 10V/cm.

If the applied signal is superimposed on a DC (direct voltage) level, the total value (DC + peak value of the alternating voltage) of the signal across the Y-input must not exceed ±500V. This same limit applies to normal attenuator probes X10, the attenuation ratio of which allows signal voltages up to approximately 1,000Vpp to be evaluated. Voltages of up to approximately 3,000Vpp may be measured by using the HZ37 high voltage probe which has an attenuation ratio of 100:1. It should be noted that its Vrms value is derated at higher frequencies (see page M7: Connection of Test Signal). If a normal X10 probe is used to measure high voltages, there is the risk that the compensation trimmer bridging the attenuator series resistor will break down causing damage to the input of the oscilloscope. However, if for example only the residual ripple of a high voltage is to be displayed on the oscilloscope, a normal X10 probe is sufficient. In this case, an appropriate high voltage capacitor (approx. 22-68nF) must be connected in series with the input tip of the probe.

It is very important that the oscilloscope input coupling is set to **DC**, if an attenuator probe is used for voltages higher than 500V (see page M7: Connection of Test Signal).

With input coupling switched to **GD** and with the **Y-POS.** control, a horizontal graticule line can be adjusted as a **reference axis for ground potential**. It can be placed underneath, on, or above the horizontal center line, as the case may be to measure positive and/or negative deviations from ground potential. Some switchable probes have a built-in reference switch position for the same application.

Time Measurements

As a rule, all signals to be displayed are periodically repeating processes and can also be designated as periods. The number of periods per second is the recurrence frequency or repetition rate. One or more signal

periods or even part of a period may be shown as a function of the adjustment of the **TIMEBASE** switch. The time coefficients on the **TIMEBASE** switch are indicated in **ms/cm** and **μs/cm**. Accordingly, the dial is subdivided into two sectors.

The duration of a signal period or a portion of the waveform is ascertained by multiplying the relevant time (horizontal distance in cm) by the time coefficient selected on the TIMEBASE switch.

The time variable control (small knob on the TIMEBASE switch) must be in its calibrated detent (C) for accurate measurement (arrow horizontal and pointing to the left).

With the designations

L = displayed wave **length in cm** of one period,

T = **time in seconds** for one period,

F = recurrence **frequency in Hz** of the signal,

Tc = **time coefficient in s/cm** on timebase switch

and the relation $F = 1/T$, the following equations can be stated:

$$T = L \cdot Tc \qquad L = \frac{T}{Tc} \qquad Tc = \frac{T}{L}$$

$$F = \frac{1}{L \cdot Tc} \qquad L = \frac{1}{F \cdot Tc} \qquad Tc = \frac{1}{L \cdot F}$$

However, these four values are not freely selectable. They have to be within the following limits:

L between 0.2 and 10cm, if possible 4 to 10cm,

T between 0.05μs and 2s,

F between 0.5Hz and 20MHz,

Tc between 0.5μs/cm and 200ms/cm in 1-2-5 sequence (with **X-MAGN. X5** button in out position).

With depressed X-MAGN. X5 pushbutton the Tc value must be divided by 5.

Examples:

Displayed wavelength **L** = 7 cm,

set time coefficient **Tc** = 0.5μs/cm,

required period T = $7 \cdot 0.5 \cdot 10^{-6} = 3.5 \mu s$

required rec. freq. F = $1 : (3.5 \cdot 10^{-6}) = 286 \text{ kHz}$.

Signal period **T** = 0.5 s,

set time coefficient **Tc** = 0.2s/cm,

required wavelength L = $0.5 : 0.2 = 2.5 \text{ cm}$.

Displayed ripple wavelength **L** = 1 cm,

set time coefficient **Tc** = 10ms/cm,

required ripple freq. F = $1 : (1 \cdot 10 \cdot 10^{-3}) = 100 \text{ Hz}$.

TV-line frequency **F** = 15 625Hz,

set time coefficient **Tc** = 10μs/cm,

required wavelength L = $1 : (15 \ 625 \cdot 10^{-5}) = 6.4 \text{ cm}$.

Sine wavelength **L** = min. 4cm, max. 10cm,

Frequency **F** = 1 kHz,

max. time coefficient **Tc** = $1 : (4 \cdot 10^3) = 0.25 \text{ ms/cm}$,

min. time coefficient **Tc** = $1 : (10 \cdot 10^3) = 0.1 \text{ ms/cm}$,

set time coefficient Tc = **0.2ms/cm**,

required wavelength L = $1 : (10^3 \cdot 0.2 \cdot 10^{-3}) = 5 \text{ cm}$.

Displayed wavelength **L** = 0.8 cm,

set time coefficient **Tc** = 0.5μs/cm,

pressed X-MAGN. X5 button: Tc = 0.1μs/cm,

required rec. freq. F = $1 : (0.8 \cdot 0.1 \cdot 10^{-6}) = 12.5 \text{ MHz}$,

required period T = $1 : (12.5 \cdot 10^6) = 80 \text{ ns}$.

If the time is relatively short as compared with the complete signal period, an expanded time scale should always be applied (**X-MAGN. X5** button depressed). In this case, the ascertained time values have to be divided by **5**.

When investigating pulse or square waveforms, the critical feature is the **risetime of the voltage step**. To ensure that transients, ramp-offs, and bandwidth limits do not unduly influence the measuring accuracy, the risetime is generally measured between **10%** and **90%** of the vertical pulse height. For peak-to-peak signal amplitudes of **5cm** height, which are symmetrically adjusted to the horizontal center line, the internal graticule of the CRT has two horizontal dotted lines ± 2.5 cm from the center line. Adjust the Y attenuator switch with its variable control together with the **Y-POS.** control so that the pulse height is precisely aligned with these 0 and 100% lines. The 10% and 90% points of the signal will now coincide with the two lines, which have a distance of ± 2 cm from the horizontal center line and an additional subdivision of 0.2cm. **The risetime is given by the product of the horizontal distance in cm between these two coincidence points and the time coefficient setting.** If magnification is used, this product must be divided by 5. The **fall time** of a pulse can also be measured by using this method.

The following figure shows correct positioning of the oscilloscope trace for accurate risetime measurement.

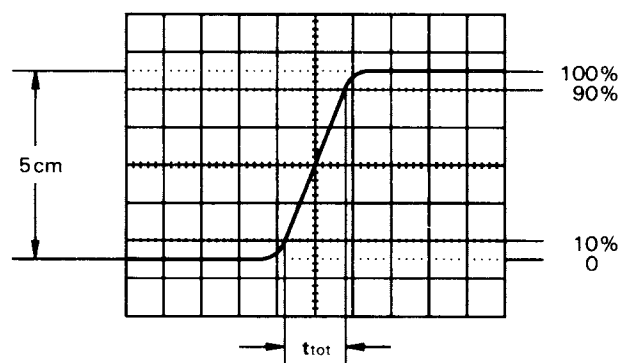

With a time coefficient of $0.5\mu\text{s}/\text{cm}$ and depressed **X-MAGN. X5** pushbutton, the example shown in the above figure results in a measured total risetime of

$$t_{\text{tot}} = 1.6\text{cm} \cdot 0.5\mu\text{s}/\text{cm} : 5 = 160\text{ns}$$

When very fast risetimes are being measured, the risetime of the oscilloscope amplifier has to be deducted from the measured time value. The risetime of the signal can be calculated using the following formula.

$$t_r = \sqrt{t_{\text{tot}}^2 - t_{\text{osc}}^2}$$

In this t_{tot} is the total measured risetime, and t_{osc} is the risetime of the oscilloscope amplifier (approx. 17.5ns with HM203). If t_{tot} is greater than 100ns, then t_{tot} can be taken as the risetime of the pulse, and calculation is unnecessary (error smaller than 1%).

Connection of Test Signal

The signal to be displayed should be fed to the vertical input of the oscilloscope by means of a shielded test cable, e.g. the HZ32 or HZ34, or by a X10 or X100 attenuator probe. The use of these shielded cables with high impedance circuits is only recommended for relatively low frequencies (up to approx. 50kHz). For higher frequencies, and when the signal source is of low impedance, a cable of matched characteristic impedance (usually 50Ω) is recommended. **In addition, and especially when investigating square or pulse waveforms, a resistor equivalent to the characteristic impedance of the cable must also be connected to the cable directly at the input of the oscilloscope.** When using a 50Ω cable, such as the HZ34, a 50Ω through-termination type HZ22 is available from HAMEG. When investigating square or pulse waveforms with fast risetimes, transient phenomena on both the edge and top of the signal may become visible if the correct termination is not used. It must be remembered that the 50Ω through-termination will only dissipate a maximum of 2 watts. This power consumption is reached with 10Vrms or with 28Vpp sine signal. If a X10 attenuator probe (e.g. HZ30) is used, no termination is necessary. In this case, the connecting cable is matched directly to the high impedance input of the oscilloscope. When using attenuator probes, even high internal impedance sources are only slightly loaded (by approximately $10\text{M}\Omega \parallel 12\text{pF}$). Therefore, when the voltage loss due to the attenuation of the probe can be compensated by a higher sensitivity setting on the HM203, the probe should always be used. Also it should be remembered that the series impedance of the probe provides a certain amount of protection for the input of the oscilloscope amplifier. It should be noted that all

attenuator probes must be compensated in conjunction with the oscilloscope (see: Probe Adjustment, page M4).

If a X10 or X100 attenuator probe is used, the DC input coupling must always be set. With AC coupling, the attenuation is frequency-dependent, the pulses displayed can exhibit ramp-off, DC-voltage contents are suppressed — but loads the respective input coupling capacitor of the oscilloscope. The electric strength of which is maximum 500V (DC + peak AC). For the suppression of unwanted DC voltages, a **capacitor** of adequate capacitance and electric strength **may be connected before the input tip of the probe** (e.g. for ripple measurements).

With the HZ37 X100 probe, the permissible AC input voltage is frequency-dependent limited:

below 20kHz (TV line frequency!) up to

$$\text{max. } 1.500\text{Vp} \triangleq 3.000\text{Vpp} \triangleq 1.061\text{Vrms};$$

above 20kHz (with f in MHz) up to

$$\text{max. } \frac{212}{\sqrt{f}}\text{Vp} \triangleq \frac{424}{\sqrt{f}}\text{Vpp} \triangleq \frac{150}{\sqrt{f}}\text{Vrms}.$$

It is important to remember that when low voltage signals are being investigated the position of the ground point on the test circuit can be critical. This ground point should always be located as close as possible to the measuring point. If this is not done, serious signal deformation may result from any spurious currents through the ground leads or test chassis parts. This comment also applies to the ground leads on attenuator probes which ideally should be as short and as thick as possible. For the connection of a probe to a BNC socket, a BNC-adaptor should be used. It forms often a part of the probe accessory. Grounding and matching problems are then eliminated.

The location and quantitative measurement of a magnetic leakage (e.g. from power transformer) into a circuit is possible using a pick-up coil. If the coil has many windings, it should be shielded against static fields (non-magnetic shield without short-circuited turn). Also the interconnection between coil and oscilloscope vertical input should be made by a shielded cable with BNC male connector at one end. A resistor of approx. 100Ω should be connected in series between cable core and connector core. This resistor attenuates radio-frequency excitation. The shieldings prevent any undesired capacitive couplings. During measurement, use line triggering (**TRIGGER SELECTOR** switch to **LINE**).

Hum or interference voltage appearing in the measuring circuit (especially with a small deflection coefficient) is possibly caused by multiple grounding, because through it equalizing currents can flow in the shieldings of the measuring cables (voltage drop between the non-fused

earthed conductors of other line powered devices, which are connected to the oscilloscope or test object, e.g. signal generators with anti-interference capacitors).

Sometimes the trace will disappear after an input signal has been applied. The attenuator switch must then be turned back to the left, until the vertical signal height is only 3-8cm. With a signal amplitude greater than 160Vpp, an attenuator probe must be inserted before the oscilloscope's vertical input. If, after applying the signal, the trace is nearly blanked, the period of the signal is probably substantially longer than the set value on the **TIMEBASE** switch. It should be turned to the left on an adequately greater time coefficient.

Caution: When connecting unknown signals to the oscilloscope input, always use automatic triggering and set the **DC-AC** input coupling switch to **AC**. The attenuator switch should initially be set to **20V/cm**.

Operating Modes of the Y Amplifier

The required operating modes are selected on four pushbuttons located in the Y-Section. For **Mono** operation, all pushbuttons should be in the out position, the instrument is then operating on **Channel I** only. For **Mono** operation with **Channel II**, the **CHI/II** pushbutton has to be pressed. Automatically, the internal trigger voltage is derived from Channel II. When the **DUAL** button is depressed, the HM203 is in **Dual** channel operation. In this mode, the channels are displayed consecutively (alternate mode). This mode is not suitable for the display of very low frequency signals (< 1 kHz), as the trace will appear to flicker or jump. Under these conditions, the **ALT/CHOP** button should be depressed additionally selecting chopped mode. In this position, both channels then share the trace during each sweep period. For the display of high frequency signals, the type of channel switching selected is less important.

To select the **Add mode**, only the **ALT/CHOP (I + II)** button should be depressed. The signals on both channels are then added together. If in this mode Channel I is **inverted** (pushbutton **INVERT I** depressed), then the **difference** between the two channels is displayed. For both of these operating modes, the vertical position of the trace depends on the setting of the **Y-POS.** controls of both channels.

For **X-Y operation**, the pushbutton in the X-Section marked **HOR. EXT.** must be depressed. The X signal is then derived from the **Channel II (HOR. INP.)**. **The calibration of the X signal during X-Y operation is determined by the setting of the Channel II input attenuator and variable control.** This means that the

sensitivity ranges and input impedances are identical for both the X and Y axes. However, the **Y-POS. II** control is disconnected in this mode. Its function is taken over by the **X-POS.** control. It is important to note that the **X-MAGN. X5** pushbutton switch, normally used for expanding the sweep, should not be operated in the X-Y mode. It should also be noted that the bandwidth of the X amplifier is approximately 2.5MHz (-3dB), and therefore an increase in phase difference between both axes is noticeable from 50kHz upwards.

Triggering and Timebase

In order to obtain a satisfactory stable display, the timebase must be triggered synchronously with the test signal. The trigger signal can be derived from the test signal itself, when internal triggering is selected, or from a frequency related signal applied to the external trigger input.

If the **AT/NORM.** pushbutton in the X-Section is in the out position **AT (Automatic Triggering)**, the sweep generator will be triggered automatically. In the **AT** position and with proper trigger control settings, the sweep can be started by virtually all uncomplicated signals with repetition rates above about 30Hz and within the frequency range selected by the trigger coupling switch, provided that the displayed signal height is at least **5mm** (trigger threshold for internal triggering). In the absence of an adequate trigger signal or when the trigger controls are misadjusted, the sweep free-runs and produces a baseline (time axis) as a reference trace. **Automatic Triggering takes place without operating the LEVEL control.** This trigger mode operates in principle also with external triggering via the **TRIG. EXT.** connector. However, the (synchronous) trigger voltage required for it should be approximately in the 0.6-10Vpp range.

With **Normal Triggering (AT/NORM.** button depressed) and **LEVEL** adjustment, the sweep can be started by signals within the frequency range selected by the trigger coupling switch. In the absence of an adequate trigger signal or when the trigger controls (particularly the **LEVEL** control) are misadjusted, no trace is visible, i.e. the screen is blanked completely. When using the internal Normal Triggering mode, it is possible to trigger at any amplitude point of a signal edge, even with very complex signal shapes, by adjusting the **LEVEL** control. Its adjusting range is directly dependent on the display height, which should be at least **5mm**. If it is smaller than 1 cm, the **LEVEL** adjustment needs to be operated with a sensitive touch. In the external Normal Triggering mode, the same is valid relating to a small external trigger voltage amplitude.

Triggering can be selected on either the rising or falling edge of the trigger signal depending on whether the **+ / —** slope pushbutton is in the out or in position. In the out position, triggering from the positive-going edge is selected. The correct slope setting is important in obtaining a display when only a portion of a cycle is being displayed.

With **internal triggering** in the **Mono channel mode** on the Y amplifier, the trigger signal is derived from the respective channel in use. In the **Dual channel mode**, the internal trigger signal may be selected from either **Channel I** or **Channel II** using the **CH I/II — TRIG. I/II** button; in the out position, the trigger signal is derived from Channel I. However, it is always preferable to trigger from the less complicated signal.

For **external triggering**, the small **TRIG. EXT.** pushbutton in the X-Section must be depressed. The sync. signal (**0.6-10 Vpp**) must then be fed to the **TRIG. EXT.** input connector.

Coupling mode and frequency range of the trigger signal are selected with the **TRIGGER SELECTOR** slide switch in the X-Section for internal and external triggering. The HM203-4 has 4 coupling modes: **AC, DC, HF, LF**.

The **AC** coupling mode is mainly used. **DC** trigger coupling is recommended only, when very low frequency signals are being investigated and triggering an appointed level value is necessary, or when pulses, which change strongly their duty cycle during observation time, have to be displayed. If **DC** coupling is selected, it is advisable to use the **Normal Triggering** mode (**AT/NORM.** button depressed), as there is the possibility that, in the **AT** mode, triggering may not be achieved on signals without zero-axis crossing point (DC offset). However, automatic peak-to-peak value triggering is not impossible with **DC** trigger coupling, but it needs a precise adjustment of the DC input balance (see page M3).

In the **HF** coupling mode, a **high-pass filter** is switched into the trigger amplifier. This filter cuts off the DC content and frequency range under 1 kHz of the trigger signal.

In the **LF** coupling mode, a **low-pass filter** is switched into the trigger amplifier. This filter cuts off any amplifier noise and the frequency range above 1 kHz of the trigger signal.

Frequency ranges of the trigger coupling:

- AC and DC to 1 MHz,**
- HF above 1 MHz,**
- LF below 1 kHz.**

If the **video signal** of a television set is to be displayed at **frame frequency**, triggering is generally difficult due to the presence of the higher line frequency synchronization pulses contained in the signal. The line pulses can be attenuated by switching the **TRIGGER SELECTOR** switch in the X-Section to **LF**. With **Normal Triggering** and correct setting of the **+ / —** slope button, it will now be found that the trigger **LEVEL** control can be adjusted to trigger from either the leading or trailing edge of the frame pulse. This setting is also advantageous for triggering from other signals that have a recurrence frequency of 800 Hz or less, as high frequency harmonics or noise in the signal are suppressed by the presence of the low-pass filter. However, **TV triggering at line frequency** needs **AC** or **HF** (or **DC** if necessary) setting of the **TRIGGER SELECTOR** switch in the X-Section. In both cases, always **Normal Triggering** with **LEVEL** adjustment should be used.

As already mentioned, simple signals may be triggered automatically in the automatic trigger mode (**AT/NORM.** button in out position). The repetition rate may also vary in such cases. However, if the pulse duty factor on square-wave or pulse signals changes drastically or deforms to a needle pulse, the **Normal Triggering** mode with **LEVEL** adjustment may well become necessary. With composite signals, the trigger facility is dependent on the occurrence of certain periodically recurring levels. The **LEVEL** adjustment of these signals will require some care.

If it is found that a trigger point cannot be located on extremely complex signals even after repeated and careful adjustment of the **LEVEL** control in the **Normal Triggering** mode, a stable display may be obtained using the **TIMEBASE** variable control.

For the purpose of **line triggering** (**TRIGGER SELECTOR** slide switch in the X-Section to **LINE**), a (divided) secondary voltage of the power transformer is used as a trigger signal (50-60 Hz). This trigger mode is independent of the signal amplitude or display height and allows a display below the (internal) trigger threshold. Line triggering is recommended for all signals which are time-related (multiple or submultiple) to the mains/line frequency or when it is desirable to provide a stable display of a line-frequency component in complex waveforms. Therefore it is especially suited for the measurement of small ripple voltages from power supply rectifiers or of magnetic or static leakage fields in a circuit.

In some countries, the standard power plug has symmetrically arranged plugs (interchanging of **Line** and **Neutral** is possible). In such cases, the **+ / —** slope pushbutton may indicate the wrong polarity compared with the display (triggering with falling edge instead of rising edge). For correction, the power plug of the instrument has to be turned.

The time coefficient settings on the **TIMEBASE** switch are calibrated when the variable control (small knob on the **TIMEBASE** switch) is set in the **C** position. When this control is set fully clockwise, the sweep speed is increased by a factor of at least 2.5. This factor is not precisely calibrated. When the x5 expansion of the sweep (**X-MAGN. X5** button pressed) is also operated in conjunction with the variable control, a maximum sweep speed of approximately 40ns/cm is obtained (**TIMEBASE** switch to **0.5 μ s/cm**). The choice of the optimum time coefficient depends on the repetition rate of the signal being measured. The number of cycles displayed will increase with the time coefficient (by turning the **TIMEBASE** switch counterclockwise).

Component Tester

General

The HM203-4 has a built-in electronic Component Tester (abbreviated **CT**), which is used for an instant display of a test pattern to indicate whether or not components are in working condition. The **CT** can be used for quick checks of semiconductors (e.g. diodes and transistors), resistors, capacitors, and inductors. Certain tests can also be made to integrated circuits. All these components can be tested in and out of circuit.

The test principle is of fascinating simplicity. The power transformer of the HM203 delivers a sine voltage, which feeds the series connection of the test object and a built-in fixed resistor. The sine voltage across the test object is used for the horizontal deflection, and the voltage drop across the resistor (i. e. current through test object) is used for the vertical deflection of the oscilloscope. So the test pattern shows a current-voltage characteristic of the test object.

Since this circuitry operates with mains/line frequency (50 or 60Hz) and a voltage of 8.5V max. (open circuit), the indicating range of the **CT** is limited. The impedance of the component under test is distinguishable in a range from 20 Ω to 4.7k Ω . Below and above these values the test pattern shows only short-circuit or open-circuit. For the interpretation of the displayed test pattern these limits should always be borne in mind. However, the most important electronic components can normally be tested without any restriction.

Setting and Component Connection

The **CT** is switched on by depressing the **COMPONENT TESTER** pushbutton in the front panel section below the CRT screen. Then both vertical preamplifiers and the timebase generator are switched off. Nevertheless, signal voltages at the three BNC connectors on front panel are allowed. It is not necessary to remove their

cable connectors. However, this is valid only for the test of single components (see below: In-Circuit Tests). In the **CT** mode, the only controls which can be operated are **INTENS.**, **FOCUS**, and **X-POS**. The **X-MAGN. X5** pushbutton should be released (out position). All other controls and settings have no influence on the test operation.

For the connection of the component, two simple test leads with 4mm \varnothing banana plugs, provided with test prod, alligator clip or sprung hook at one end, are required. The test leads are connected to the insulated **CT** socket and an oscilloscope ground socket on front panel. So the component has a bipolar connection.

To return the oscilloscope to normal operation, release the **COMPONENT TESTER** pushbutton.

Test Procedure

Caution! Do not test any component in live circuitry — remove all grounds, power and signals connected to the component under test. Set up Component Tester as stated above. Connect test leads across component to be tested. Observe oscilloscope display.

Test Pattern Displays

Page M13 shows the typical test pattern displayed by the various components under test.

- **Open circuit is indicated by a straight horizontal line.**
- **Short circuit is shown by a straight vertical line.**

Testing Resistors

If the test object has a linear ohmic resistance, both deflecting voltages are in the same phase. The test pattern expected from a resistor is therefore a sloping straight line. The angle of slope is determined by the resistance of the resistor under test. With high values of resistance, the slope will tend towards the horizontal axis, and with low values, the slope will move towards the vertical axis.

The values of resistance from 20 Ω to 4.7k Ω can be approximately evaluated. The determination of actual values will come with experience, or by direct comparison with a component of a known value.

Testing Capacitors and Inductors

Capacitors and inductors cause a phase difference between current and voltage, therefore between the X and Y deflections too, giving an ellipse-shaped display. The position and opening width of the ellipse will vary according to the impedance value (at 50 or 60Hz) of the component under test.

An ellipse in lying position indicates a high impedance

or a relatively small capacitance or a relatively high inductance resp.

An ellipse in upright position indicates a small impedance or a relatively high capacitance or a relatively small inductance resp.

A sloping position of the ellipse means that the component has a considerable ohmic loss resistance in addition to its reactance.

The values of capacitance of normal or electrolytic capacitors from $0.1\mu F$ to $1000\mu F$ can be displayed and approximate values obtained. More precise measurement can be obtained in a smaller range by comparing the capacitor under test with a capacitor of known value. Inductive components (coils, transformers) can also be tested. The determination of the value of inductance needs some experience, because inductors have usually a higher ohmic series loss resistance. However, the impedance value (at 50 or 60Hz) of an inductor in the range from 20Ω to $4.7k\Omega$ can easily be obtained or compared.

Testing Semiconductors

Most semiconductor devices, such as diodes, Z-diodes, transistors, FETs can be tested. The test pattern displays vary according to the component type as shown in the figures below.

The main characteristic displayed during semiconductor testing is the voltage dependent knee caused by the junction changing from the conducting state to the non-conducting state. It should be noted that both the forward and the reverse characteristic are displayed simultaneously. It refers always to a two-terminal test, therefore testing e.g. of a transistor amplification is not possible, but testing of the single junction areas is easily and quickly possible. Since the **CT** test voltage applied is only very low (max. $8.5V_{rms}$), all sections of most semiconductors can be tested without damage. However, a check of the breakdown or reverse voltage on semiconductors for high operating voltage is not possible. More important in practical operation is the simple pass/reject information for components with disconnection or short-circuit, which from experience is needed frequently.

Testing Diodes

Normal diodes show at least their knee in the forward characteristic. This is not valid for some high voltage diode types, because they contain a series connection of several diodes. Possibly only a small portion of the knee is visible. Z-diodes have to show always their forward knee and, up to approx. 10V, their Z-breakdown, which forms a second knee in the opposite direction. A

Z-breakdown voltage of more than 12V can not be displayed.



Type: Normal Diode High Voltage Diode Z-Diode 12V
 Terminals: Cathode-Anode Cathode-Anode Cathode-Anode
 Connections: (CT-GD) (CT-GD) (CT-GD)

If the printing of the type designation or the polarity symbol of a diode is unrecognizable, the type, or usability of another type, or the cathode terminal can be identified easily making a comparison with a known diode.

Testing Transistors

Three different tests can be made to transistors: base-emitter, base-collector and emitter-collector. The resulting test patterns are shown below, too.

According to the (basic) equivalent circuit of a transistor with a Z-diode between base and emitter and a normal diode with reverse polarity between base and collector in series connection, there are 3 different test patterns:

N-P-N Transistor:



Terminals: b-e b-c e-c
 Connections: (CT-GD) (CT-GD) (CT-GD)

P-N-P Transistor:



Terminals: b-e b-c e-c
 Connections: (CT-GD) (CT-GD) (CT-GD)

For a transistor mainly the figures b-e and b-c are important. The figure e-c can vary; but a short circuit (a vertical line only) is not permitted.

These transistor test patterns are valid in most cases, but there are exceptions to the rule (e.g. Darlington, FETs). With the **CT** the distinction between a P-N-P to a N-P-N transistor is possible, also as the determination of the correct terminal sequence. In case of doubt, the comparison with a known type is helpful. It should be noted that the same socket connection (**CT** or ground resp.) for the same terminal is then absolutely necessary. A connection inversion effects a rotation of the test pattern by 180 degrees round about the center point of the scope graticule.

Pay attention to the usual caution with single MOS-components relating to static charge or frictional electricity!

In-Circuit Tests

Caution! During in-circuit tests make sure the circuit is dead. No power from mains/line or battery and no signal inputs are permitted. Remove all ground connections inclusive Safety Earth (pull out power plug from outlet). Remove all measuring cables inclusive probes between oscilloscope and circuit under test. Otherwise the connection of both CT test leads is not optional.

In-circuit tests are possible in many cases. However, they are not so well-defined. Caused by shunt connection of real or complex impedances — especially if they are of relatively low impedance at 50 or 60Hz — to the component under test, often great differences result compared with single components. In case of doubt, one component terminal may be unsoldered. This terminal should then be connected to the insulated **CT** socket avoiding hum distortion of the test pattern.

Another way is a test pattern comparison to an operating circuit with the same circuit diagram (likewise without power and any external connections). Using the test prods, identical test points in each circuit can be checked, and a defect can be determined quickly and easily. Possibly the device itself under test contains a reference circuit (e. g. a second stereo channel, push-pull amplifier, symmetrical bridge circuit), which is not defective.

The test patterns on page M13 show some typical displays for in-circuit tests.

Maintenance

Within the context of maintenance, it is recommended that the most important characteristics and criteria of the HM203 be periodically checked. The following Test Instructions indicate only those tests, which can be performed without the use of expensive ancillary instruments.

Accessories

Each HAMEG oscilloscope is supplied with an Instruction Manual only. However, a wide range of accessories, which include test cables and probes, are available and should be ordered according to the particular application.

Single Components

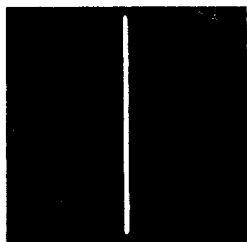

Short circuit

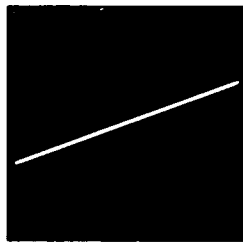

Resistor 510Ω



Mains transformer prim.

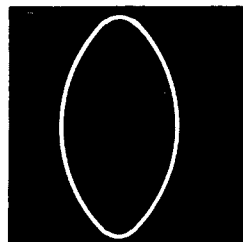

Capacitor 33μF

Single Transistors



Junction B-C

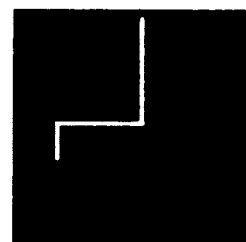

Junction B-E

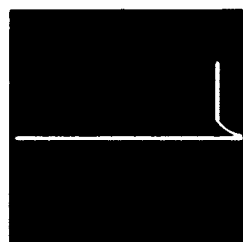

Junction E-C

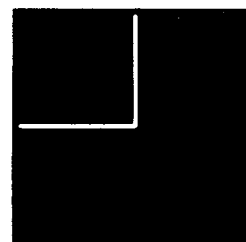

FET

Single Diodes

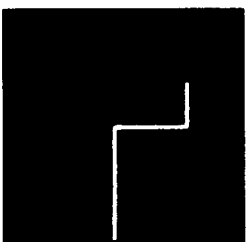

Z-diode under 8V



Z-diode beyond 12V

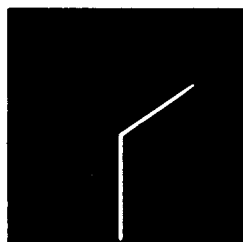

Diode paralleled by 680Ω

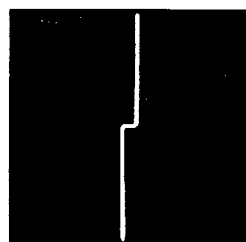

2 Diodes antiparallel

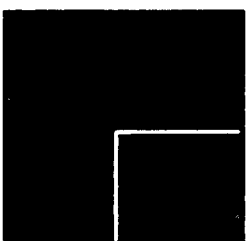

Silicon diode



Germanium diode



Diode in series with 51Ω

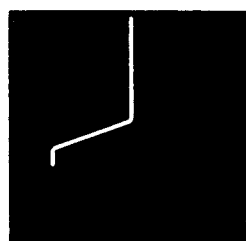

B-E paralleled by 680Ω

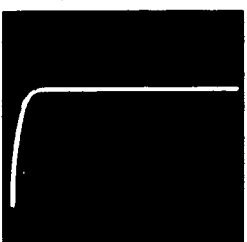

Rectifier

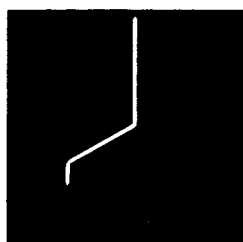

Thyristor G + A together



B-E with 1μF + 680Ω

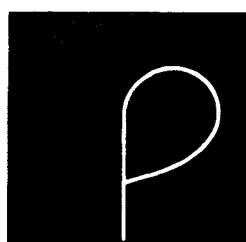

Si-diode with 10μF

In-circuit Semiconductors

FRONT VIEW

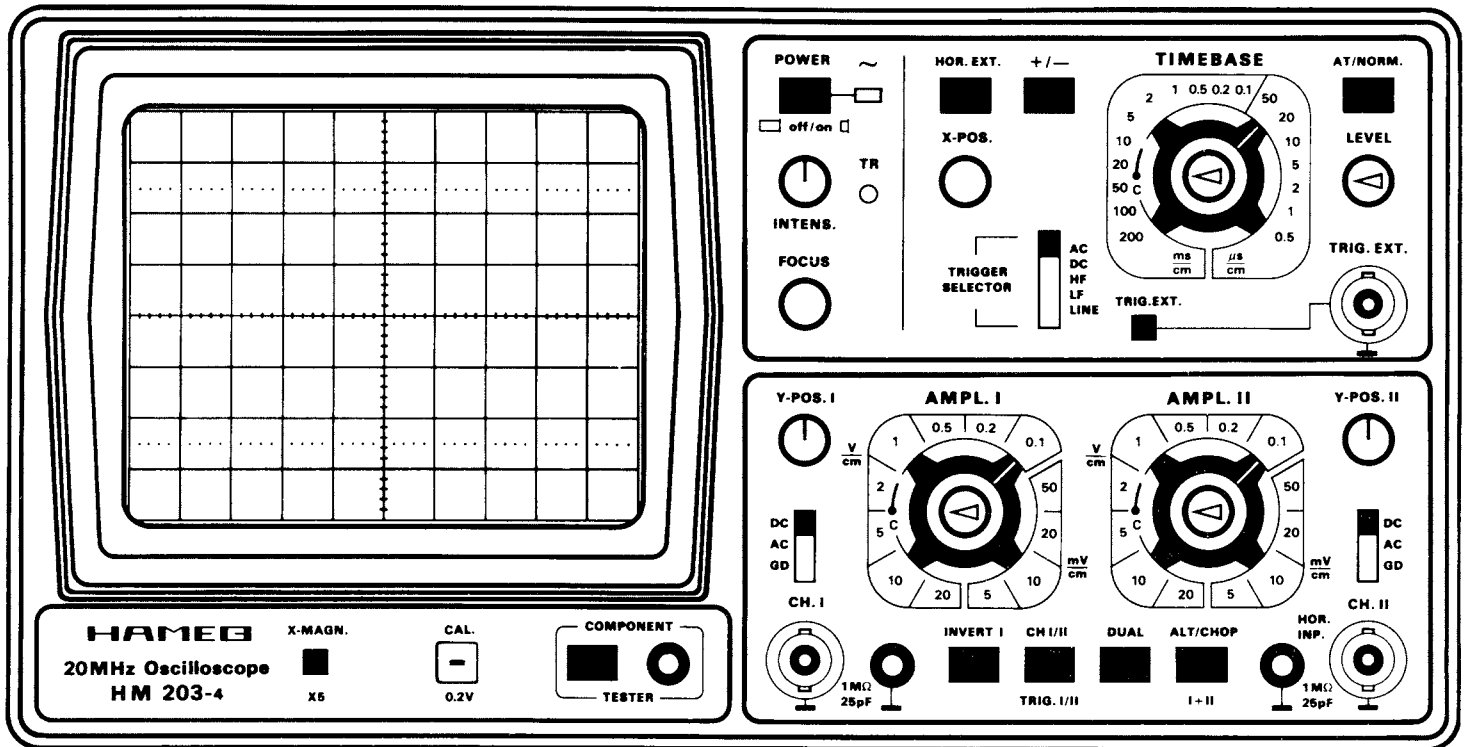

SHORT INSTRUCTION FOR HM 203-4

First Time Operation

Connect the instrument to power outlet. Switch on **POWER** pushbutton. No other button is pressed. LED indicates operating condition. **Case, chassis, and all measuring connectors are connected to the Safety Earth conductor (Safety Class I).**

TRIGGER SELECTOR switch to **AC, AT/NORM.** button in out position (Automatic Triggering).

Adjust **INTENS.** control for average brightness.

Center trace on screen using **X-POS.** and **Y-POS.** controls. Then focus trace using **FOCUS** control.

Operating Modes of the Vertical System

Channel I: All pushbuttons in out position.

Channel II: **CHI/II** button pressed.

Channel I and Channel II: **DUAL** button pressed.

Alternate channel switching: **ALT/CHOP** button in out position.

Chopped channel switching: **ALT/CHOP** button pressed. Signals < 1 kHz with **CHOP.**

Channel I + II (sum): **I + II (ALT/CHOP)** button pressed only.

Channel -I + II (difference): **I + II (ALT/CHOP) and INVERT I** buttons pressed.

Trigger Modes

Automatic Triggering: **AT/NORM.** button in out position. Trace always visible.

Normal Triggering: **AT/NORM.** button pressed. Trace visible when triggered.

Triggering from positive-going signal edge: **+ / -** slope button in out position.

Triggering from negative-going signal edge: **+ / -** slope button pressed.

This facility is important when only a portion of a cycle is being displayed.

Internal triggering from Channel I: **TRIG. I/II (CHI/II)** button in out position.

Internal triggering from Channel II: **TRIG. I/II (CHI/II)** button pressed.

These both internal trigger modes are valid also for dual channel operation.

External triggering from **TRIG. EXT.** connector: small **TRIG. EXT.** button pressed.

External trigger signal: **0.6-10Vpp**, time-related to vertical input signal.

Line triggering: **TRIGGER SELECTOR** switch in **LINE** position.

Trigger coupling selected with **TRIGGER SELECTOR** switch **AC-DC-HF-LF.**

DC coupling needs Normal Triggering.

Trig. freq. range: **AC** and **DC** to 1 MHz, **HF** above 1 MHz, **LF** below 1 kHz.

Video signal mixtures with line freq.: **TRIGGER SELECTOR** to **AC** or **DC.** Use Normal Triggering.

Video signal mixtures with frame freq.: **TRIGGER SELECTOR** to **LF.** Use Normal Triggering.

Measuring

Connect test signal to **CH. I** and/or **CH. II** vertical input connector.

Compensate attenuator probe using **CAL. 0.2V** square-wave signal.

Select **AC** or **DC** input coupling. **GD:** Y amplifier is disconnected from input and grounded.

Adjust required display height of signal with **AMPL.** attenuator switch and variable control.

Select sweep speed with **TIMEBASE** switch and variable control.

Adjust trigger point with **LEVEL** control (only for Normal Triggering).

Calibrated amplitude measurement with **AMPL.** attenuator variable control to **C.**

Calibrated time measurement with **TIMEBASE** variable control to **C.**

Horizontal x5 expansion: **X-MAGN. X5** button pressed.

External horizontal deflection (**X-Y operation**) with **HOR. EXT.** button pressed (X input via **CH. II**).

Component Tester

Press **COMPONENT TESTER** button. Connect both component terminals to **CT** and ground jacks.

In-circuit test: Test circuit must be disconnected to power, signals and ground (earth).

Pull out power plug, remove all connections to scope (cable, probe), then start testing.

TEST INSTRUCTIONS

General

These Test Instructions are intended as an aid for checking the most important characteristics of the HM203 at regular intervals without the need for expensive test equipment. Resulting corrections and readjustments inside the instrument, detected by the following tests, are described in the Service Instructions or on the Adjusting Plan. They should only be undertaken by qualified personnel.

As with the First Time Operation instructions, care should be taken that all knobs with arrows are set to the calibrated positions. None of the pushbuttons should be depressed. **TRIGGER SELECTOR** switch to **AC**, **TIMEBASE** switch in **50 μ s/cm** and **AMPL.** switches in **5mV/cm** position. It is recommended to switch on the instrument for about 15 minutes prior to the commencement of any check.

Cathode-Ray Tube: Brightness and Focus, Linearity, Raster Distortions

Normally, the CRT of the HM203 has very good brightness. Any reduction of this brightness can only be judged visually. However, decreased brightness may be the result of reduced high voltage. This is easily recognized by the greatly increased sensitivity of the vertical amplifier. The control range for maximum and minimum brightness (intensity) must be such that the beam just disappears before reaching the left hand stop of the **INTENS.** control (particularly when the **HOR. EXT.** button is depressed), while with the control at the right hand stop the focus and the line width are just acceptable.

With maximum intensity the timebase fly-back must on no account be visible. It should be noted that with wide variations in brightness, refocusing is always necessary. Moreover, with maximum brightness, no "pumping" of the display must occur. If pumping does occur, it is normally due to a fault in the regulation circuitry for the high voltage supply. The presetting pots for the high voltage circuit, minimum and maximum intensity, are only accessible inside the instrument (see Adjusting Plan and Service Instructions).

A certain out-of-focus condition in the edge zone of the screen must be accepted. It is limited by standards of the CRT manufacturer. The same is valid for tolerances of the orthogonality, the undeflected spot position, the non-linearity and the raster distortion in the marginal zone of the screen in accordance with international standards (see CRT data book). These limit values are strictly supervised by HAMEG. The selection of a cathode-ray tube without any tolerances is practically impossible.

Astigmatism Check

Check whether the horizontal and vertical sharpness of the display are equal. This is best seen by displaying a square-wave signal with the repetition rate of approximately 1 MHz. Focus the horizontal tops of the square-wave signal at normal intensity, then check the sharpness of the vertical edges. If it is possible to improve this vertical sharpness by turning the **FOCUS** control, then an adjustment of the astigmatism control is necessary. An alternative method is to check the shape of the spot with both vertical inputs switched to the **GD** position (and the **HOR. EXT.** pushbutton depressed); the **FOCUS** control is then repeatedly varied around the optimum focusing point. The shape of the spot (not its size), whether round or oval or rectangular, must stay the same to the right and left of the optimum focusing point. A potentiometer of 50k Ω (see Adjusting Plan) is provided inside the instrument for the correction of astigmatism (see Service Instructions). A certain loss of marginal sharpness of the CRT is unavoidable; this is due to the manufacturing process of the CRT.

Symmetry and Drift of the Vertical Amplifier

Both of these characteristics are substantially determined by the input stages of the amplifiers. **The checking and correction of the DC balance for the amplifiers should be carried out as already described in the Operating Instructions.**

The symmetry of Channel I and the vertical final amplifier can be checked by inverting Channel I (depress **INVERT I** pushbutton). The vertical position of the trace should not change by more than 5mm. However, a change of 1 cm is just permissible. Larger deviations indicate that changes have occurred in the amplifier.

A further check of the vertical amplifier symmetry is possible by checking the control range of the **Y-POS.** controls. A sine-wave signal of 10-100kHz is applied to the amplifier input. When the **Y-POS.** control is then turned fully in both directions from stop to stop with a display height of approximately **8cm**, the upper and lower portions of the trace that are visible should be approximately of the same height. Differences of up to 1 cm are permissible (input coupling should be set to **AC**).

Checking the drift is relatively simple. **Ten minutes after switching on the instrument**, set the baseline exactly on the horizontal center line of the graticule. The beam position must not change by more than **5mm** during the following hour. Larger deviations generally result from different characteristics of the dual FETs in both channel inputs to the Y amplifier. To some extent, fluctuations in

drift are caused by offset current on the gate. The drift is too high, if the vertical trace position drifts by more than **0.5mm** on turning the appropriate attenuator switch through all 12 steps. Sometimes such effects occur after long periods of operation.

Calibration of the Vertical Amplifier

A square-wave voltage of **200mVpp** $\pm 1\%$ is present at the output eyelet marked with a square-wave. If a direct connection is made between this eyelet and the input of the vertical amplifier, the displayed signal in the **50mV/cm** position (variable control to **C**) should be **4cm** high (**DC** input coupling). Maximum deviations of 1.2mm (3%) are permissible. If a **X10 probe** is connected between the output eyelet and Y input, the same display height should result in the **5mV/cm** position. With higher tolerances it should first be investigated whether the cause lies, within the amplifier or in the amplitude of the square-wave signal. On occasions it is possible that the probe is faulty or incorrectly compensated. If necessary, the measuring amplifier can be calibrated with an accurately known DC voltage (**DC** input coupling). The trace position should then vary in accordance with the deflection coefficient set. With variable control at the attenuator switch fully clockwise, the input sensitivity is increased at least by the factor 2.5 in each position. In the **100mV/cm** position, the displayed calibrator signal height should vary from 2 cm to at least 5 cm.

Transmission Performance of the Vertical Amplifier

The transient response and the delay distortion correction can only be checked with the aid of a square-wave generator with a fast risetime (**max. 5ns**). The signal coaxial cable (e. g. HZ34) must be terminated at the vertical input of the oscilloscope with a resistor equal to the characteristic impedance of the cable (e. g. with HZ22). Checks should be made at 50Hz, 500Hz, 5kHz, 50kHz, 500kHz and 1MHz, the deflection coefficient should be set at **5mV/cm** with **DC** input coupling (Y variable control in **C** position). In so doing, the square pulses must have a flat top without ramp-off, spikes and glitches; no overshoot is permitted, especially at 1MHz and a display height of **4-5cm**. At the same time, the leading top corner of the pulse must not be rounded. In general, no great changes occur after the instrument has left the factory, and it is left to the operator's discretion whether this test is undertaken or not.

Of course, the quality of the transmission performance is not only dependent on the vertical amplifier. **The input attenuators**, located in the front of the amplifier, **are**

frequency-compensated in each position. Even small capacitive changes can reduce the transmission performance. Faults of this kind are as a rule most easily detected with a square-wave signal with a low repetition rate (e. g. 1kHz). If a suitable generator with max. output of 40Vpp is available, it is advisable to check at regular intervals the deflection coefficients on all positions of the input attenuators and readjust them as necessary. A compensated **2:1 series attenuator** is also necessary, and this must be matched to the input impedance of the oscilloscope. This attenuator can be made up locally. It is important that this attenuator is shielded. For local manufacture, the electrical components required are a $1M\Omega \pm 1\%$ resistor and, in parallel with it, a trimmer 3-15pF in parallel with approx. 20pF. One side of this parallel circuit is connected directly to the input connector of the vertical amplifier and the other side is connected to the generator, if possible via a low-capacitance coaxial cable. The series attenuator must be matched to the input impedance of the oscilloscope in the **5mV/cm** position (variable control to **C**, **DC** input coupling; square tops exactly horizontal; no ramp-off is permitted). This is achieved by adjusting the trimmer located in the 2:1 attenuator. **The shape of the square-wave should then be the same in each input attenuator position.**

Operating Modes:

Mono/Dual, Alt./Chop., I+II, X-Y Operation

On depressing the **DUAL** pushbutton, two traces must appear immediately. On actuation of the **Y-POS.** controls, the trace positions should have no effect on each other. Nevertheless, this cannot be entirely avoided, even in fully serviceable instruments. When one trace is shifted vertically across the entire screen, the position of the other trace must not vary by more than 0.5mm.

A criterion in chopped operation is trace widening and shadowing around and within the two traces in the upper or lower region of the screen. Set **TIMEBASE** switch to **1 μ s/cm**, depress the **DUAL** and **ALT/CHOP** pushbuttons, set input coupling of both channels to **GD** and advance the **INTENS.** control fully clockwise. Adjust **FOCUS** for a sharp display. With the **Y-POS.** controls shift one of the traces to a +2cm, the other to a -2cm vertical position from the horizontal center line of the graticule. Do not try to synchronize the chop frequency (1MHz) by means of the **TIMEBASE** variable control! Then alternately release and depress the **ALT/CHOP** pushbutton. Check for a negligible trace widening and periodic shadowing in the chopped mode.

It is important to note that in the **I+II** add mode (only **ALT/CHOP** depressed) or the **-I+II** difference mode (**INVERT I** button depressed in addition) the vertical posi-

tion of the trace can be adjusted by using **both** the Channel I and Channel II **Y-POS.** controls.

In X-Y Operation (**HOR. EXT.** pushbutton depressed), the sensitivity in both deflection directions will be the same. When the signal from the built-in square-wave generator is applied to the input of Channel II, then, as with Channel I in the vertical direction, there must be a horizontal deflection of **4cm** when the deflection coefficient is set to **50mV/cm** position (variable control set to its **C** position, **X-MAGN. X5** button in out position). The check of the mono channel display with the **CHI/II** button is unnecessary; it is contained indirectly in the tests above stated.

Triggering Checks

The internal trigger threshold is important as it determines the display height from which a signal will be stably displayed. It should be approx. 3-5mm (frequency-dependent) for the HM203. An increased trigger sensitivity creates the risk of response to the noise level in the trigger circuit, especially when the sensitivity of the vertical input is increased by turning the variable control fully clockwise. This can produce double-triggering with two out-of-phase traces. Alteration of the trigger threshold is only possible internally. Checks can be made with any **sine-wave voltage** between 50Hz and 1 MHz. The **AT/NORM.** button should be in out position (Automatic Triggering). Following this it should be ascertained whether the same trigger sensitivity is also present with Normal Triggering (**AT/NORM.** button depressed). In this trigger mode, a **LEVEL** adjustment is necessary. The checks should show the same trigger threshold with the same frequency. On depressing the **+/-** slope button, the start of the sweep changes from the positive-going to the negative-going edge of the trigger signal. As described in the Operating Instructions, the trigger frequency range is dependent on the trigger coupling selected. For higher frequencies, the **HF** coupling mode must be selected. In this mode, triggering up to at least 40MHz (sine-wave) is possible. Internally the HM203 should trigger perfectly at a display height of approx. 5mm, when the appropriate trigger coupling mode is set.

For external triggering (**TRIG. EXT.** button depressed), the **TRIG. EXT.** input connector requires a signal voltage of at least 0.6Vpp, which is in synchronism with the Y input signal. The voltage value is dependent on the frequency and the trigger coupling mode (**AC-DC-HF-LF**).

Checking of the internal TV triggering is possible with a video signal of any given polarity. In the **LF** position only, reliable triggering on **frame** frequency is possible. However, triggering on **line** (horizontal-scanning) fre-

quency requires **AC** (possibly **DC**) trigger coupling. If no video signal is available, the function of the **LF** position (low-pass filter) can be checked using mains/line frequency or the built-in calibrator signal. With a mains/line frequency signal (50-60Hz), switching from **AC** to **LF** trigger coupling should have no effect. In contrast, the minimum signal voltage required for reliable triggering should be at least double, when the 1kHz calibration signal is applied.

The display should not shift horizontally during a change of the trigger coupling from **AC** to **DC** with a sine-wave signal without DC offset. The basic requirement for this is a correct **DC Balance Adjustment** on the input of the vertical amplifier (see Operating Instructions, page M3).

If both vertical inputs are **AC** coupled to the same signal and both traces are brought to coincide exactly on the screen, when working in the **alternate dual channel mode**, then no change in display should be noticeable, when the **CHI/II** button is depressed or released.

Checking of the line/mains frequency triggering (50-60Hz) is possible, when the input signal is time-related (multiple or submultiple) to the power line frequency (**TRIGGER SELECTOR** switch to **LINE**). In this trigger mode, there is no trigger threshold. Even very small input signals are triggered stably (e.g. ripple-voltage). For the check, use an input of approx. 1V from a (separate) power transformer. The displayed signal height can then be varied by turning the respective input attenuator switch and its variable control.

Timebase

Before checking the timebase it should be ascertained that the **trace length is precisely 10cm**. If not, it can be corrected with the potentiometer for sweep amplitude (see Adjusting Plan). This adjustment should be made with the **TIMEBASE** switch in a mid-position (i.e. **50µs/cm**). Prior to the commencement of any check set the time variable control to **C**. The **X-MAGN. X5** button should be in out position. This condition should be maintained until the variation ranges of these controls are checked.

Check that the **sweep runs from the left to the right side of the screen** (**TIMEBASE** switch to **200ms/cm**; **X-POS.** control in mid-range). This check is only necessary after changing the cathode-ray tube.

If a precise marker signal is not available for checking the **Timebase** time coefficients, then an accurate sine-wave generator may be used. Its frequency tolerance should not be greater than $\pm 1\%$. The timebase accuracy of the

HM203 is given as $\pm 3\%$, but as a rule it is considerably better than this. For the simultaneous checking of timebase linearity and accuracy at least 10 oscillations, i.e. **1 cycle every cm**, should always be displayed. For precise determination, set the peak of the first marker or cycle peak exactly behind the first vertical graticule line using the **X-POS.** control. Deviation tendencies can be noted after some of the marker or cycle peaks.

The **20** and **10ms/cm** ranges of the **TIMEBASE** switch can be checked very precisely with line frequency (**50Hz** only). On the **20ms/cm** range a cycle will be displayed every cm, while on the **10ms/cm** range it will be every 2cm.

If a precise Time Mark Generator is used for checking, Normal Triggering (**AT/NORM.** button depressed) and **LEVEL** control adjustment is recommended.

The following table shows which frequencies are required for the particular ranges.

200ms/cm — 2Hz	0.2ms/cm — 5kHz
100ms/cm — 10Hz	0.1ms/cm — 10kHz
50ms/cm — 20Hz	50 μ s/cm — 20kHz
20ms/cm — 50Hz	20 μ s/cm — 50kHz
10ms/cm — 100Hz	10 μ s/cm — 100kHz
5ms/cm — 200Hz	5 μ s/cm — 200kHz
2ms/cm — 500Hz	2 μ s/cm — 500kHz
1ms/cm — 1kHz	1 μ s/cm — 1MHz
0.5ms/cm — 2kHz	0.5 μ s/cm — 2MHz

The **time variable control** range can also be checked. The sweep speed becomes faster by turning this variable control clockwise to its right stop. One cycle at least every **2.5cm** should be displayed (with **X-MAGN. X5** button in out position; measurement in the **50 μ s/cm** range).

When the **X-MAGN. X5** button is depressed, a marker or cycle peak will be displayed every 5cm $\pm 5\%$ (with variable control in **C** position; measurement in the **50 μ s/cm** range).

Component Tester

After pressing the **CT** button, a horizontal straight line has to appear immediately when the **CT** socket is open. The length of this trace should be approx. **8cm (50Hz)** or **7.4cm (60Hz)** respectively. With connection of the **CT** socket to one of the ground jacks in the Y-Section, a vertical straight line with approx. **6cm** height should be displayed. The above stated measurements have some tolerances. They are dependent among other things on the mains/line voltage and frequency.

Trace Alignment

The CRT has an admissible angular deviation $\pm 5^\circ$ between the X deflection plane D1-D2 and the horizontal center line of the internal graticule. This deviation, due to tube production tolerances (and only important after changing the CRT), and also the influence of the earth's magnetic field, which is dependent on the instrument's North orientation, are corrected by means of the **TR** potentiometer. In general, the trace rotation range is asymmetric. It should be checked, whether the baseline can be adjusted somewhat sloping **to both sides** round about the horizontal center line of the graticule. With the HM203 in its closed case, an angle of rotation $\pm 0.57^\circ$ (1mm difference in elevation per 10cm graticule length) is sufficient for the compensation of the earth's magnetic field.

Power Voltage Fluctuations

If a variable mains/line transformer is available, the characteristics of the HM203 on power voltage fluctuations of $\pm 10\%$, referred to the voltage indicated by a triangle (**▲**) below the fuse holder (rear panel), should be checked. Under these conditions no variations should be detected on the display in either the vertical or horizontal axis.

SERVICE INSTRUCTIONS

General

The following instructions are intended as an aid for the electronic technician, who is carrying out readjustments on the HM203-4, if the nominal values do not meet the specifications. These instructions primarily refer to those faults, which were found after using the Test Instructions. However, this work should only be carried out by properly qualified personnel. For any further technical information call or write to HAMEG. Addresses are provided at the back of the manual. It is recommended to use only the original packing material, should the instrument be shipped to HAMEG for service or repair (see also Warranty, page M1).

Mains/Line Voltage Change

The instrument has an appliance inlet at the rear. This device contains the power fuse, which is interchangeable for the different mains/line voltages. The fuse holder with its square top plate can be pulled out by means of a small screwdriver (after disconnection of the power cord from the plug-in unit), and **changing of the power voltage** is possible by turning this plate 90 degrees for each of the four power voltages marked on the plate (see triangle **below** the fuse holder). The fuse holder should then be plugged in again in the desired position, which should be **the closest value of the measured mains/line voltage in your area**.

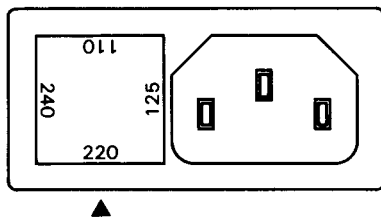

Required power fuse-link:
5x20mm, time lag (slow-blow), **250V ~, C**,
to IEC 127/III; DIN 41662.

Mains/line voltage	Rated current
110V ~ ±10%	T 0.63A
125V ~ ±10%	T 0.63A
220V ~ ±10%	T 0.315A
240V ~ ±10%	T 0.315A

The power fuse has to match the set mains/line voltage and must be changed if necessary. It should be checked that only fuses of the specified type and current are used in this case. Patched fuses or short circuit of the fuse holder must not be used as an alternative.

Instrument Case Removal

The rear cover can be taken off after two cross recessed pan head screws (M4x30mm) with two washers on it have been removed and after unplugging of the power cord's triple-contact connector. While the instrument case is firmly held, the entire chassis with its front panel can be withdrawn forward. When the chassis is inserted into the case later on, it should be noticed that the case has to fit under the flange of the front panel. The same applies for the rear of the case, on which the rear cover is put.

Caution

During opening or closing of the case, the instrument must be disconnected from all power sources for maintenance work or a change of parts or components. If a measurement, trouble-shooting, or an adjustment on the opened instrument is unavoidable, this work must be done by a specialist, who is familiar with the risk involved.

When the instrument is set into operation after the case has been removed, attention must be paid to the accelerating voltage for the CRT — 2000V — and to the operating voltages for both final amplifier stages — together 260V. Potentials of these voltages are on the CRT socket, on the upper and the lower horizontal PCBs, and on the lateral PCB directly beside the CRT neck. Such potentials are moreover on the checkpoint strip on the upper PCB. They are highly dangerous and therefore precautions must be taken. It is noticed furthermore that shorts occurring on different points of the CRT high voltage and unblanking circuitry will definitely damage some semiconductors and the optocoupler. For the same reason it is very risky to connect capacitors to these points while the instrument is on.

Capacitors in the instrument may still be charged, even when the instrument is disconnected from all voltage sources. Normally, the capacitors are discharged 6 seconds after switching off. However, with a defective instrument, an interruption of the load is not impossible. Therefore, after switching off, it is recommended to connect one by one all terminals of the check strip on the upper PCB across 1kΩ to ground (chassis) for a period of 1 second.

Handling of the CRT needs utmost caution. The glass bulb must not be allowed — under any circumstances — to come into contact with hardened tools, nor should it undergo local superheating (e.g. by soldering iron) or local undercooling (e.g. by cryogenic-spray). We recommend the wearing of safety goggles (implosion danger).

Operating Voltages

Besides the two AC voltages for the CRT heating (6.3V) and Component Tester and line triggering (12V) there are seven electronically regulated DC operating voltages generated (+24V, +5V, -12V, +141V, +260V, -1900V, and 22V for the unblanking circuit). These different operating voltages are fixed voltages, except the +141V (vertical final stage) and the high voltage, which can be adjusted. The variation of the fixed voltages greater than $\pm 5\%$ from the nominal value indicates a fault. Both adjustable voltages have to be set precisely for +141V and -1900V respectively by the adjustments of two potentiometers $2.5\text{k}\Omega$. These voltages are measured on the Checkpoint strip with reference to ground (see Adjusting Plan). Measurements of the high voltage may only be accomplished by the use of a sufficient highly resistive voltmeter ($> 10\text{M}\Omega$). You must make absolutely sure that the electric strength of the voltmeter is sufficiently high. The 22V for the unblanking circuit can be measured as the difference between two high voltages with reference to ground. It is recommended to check the ripple and also the interaction from other possible sources. Excessive values might be very often the reason for incomprehensible faults. The maximum ratings are specified on the circuit diagrams. For the measurement of the high voltage ripple, a probe capable of withstanding 2000V (e.g. X100 probe HZ37) is needed. But also a normal probe X10 is sufficient with a capacitor (10 ... 22nF 2000V) connected in series to the probe tip.

Maximum and Minimum Brightness

Two variable resistors of $500\text{k}\Omega$ each, located on the upper X-PCB, are used for these adjustment procedures (see Adjusting Plan). They may only be touched by a properly insulating screwdriver (Caution! High voltage!). The adjustments may possibly have to be repeated, because the functions of both variable resistors are dependent on each other. Correct adjustment is achieved, when the trace can be blanked while **HOR. EXT.** pushbutton is depressed and, in addition, when the requirements described in the Test Instructions are met.

Astigmatism Correction

The ratio of vertical and horizontal sharpness can be adjusted by the variable resistor of $50\text{k}\Omega$, located on the lower Y-PCB (see Adjusting Plan). As a precaution however, the voltage for the vertical deflecting plates (approx. +85V) should firstly be checked, because this voltage will affect the astigmatism correction. While the adjustment is being carried out (with pressed **HOR. EXT.** button and medium brightness), the **FOCUS** control knob

has to be repeatedly turned to and fro until the shape of the luminous spot, whether round or oval or rectangular, stays the same to the right and left of the optimum focusing. The interaction of focus adjustment and astigmatism correction should be noted. After this adjustment, a square-wave signal should be displayed and verified once more in accordance with the Test Instructions. The final adjustment has always to be the **FOCUS** control.

Trigger Threshold

The internal trigger threshold should be in the range 3 to 5mm display height. It is strongly dependent on the 710CN comparator IC. If there are compelling reasons to replace this comparator, it may be that triggering becomes too sensitive or too insensitive caused by IC gain tolerances (see Test Instructions: "Triggering Checks", page T3). In most cases, these tolerances can be eliminated by adjusting the "Trig. threshold" pot (see Adjusting Plan). In extreme cases, the series resistor to this pot should be changed. Generally, halving or doubling of its resistance value should normally be sufficient. A too small trigger threshold cause double-triggering or premature trigger action due to interference pulses or random noise. A too high trigger threshold prevents the representation of very small display heights.

Trouble-Shooting the Instrument

For this job, at least an isolating variable mains/line transformer (protection class II), a signal generator, an adequate precise multimeter, and, if possible, an oscilloscope are needed. This last item is required for complex faults, which can be traced by the display of signal or ripple voltages. As noted before, the regulated high voltage and the supply voltage for the final stages (approx. 260V) are highly dangerous. Therefore it is recommended to use **totally insulated extended probe tips**, when trouble-shooting the instrument. Accidental contact with dangerous voltage potentials is then unlikely. Of course, these instructions cannot thoroughly cover all kinds of faults. Some common-sense will certainly be required, when a complex fault has to be investigated.

If trouble is suspected, visually inspect the instrument thoroughly after removal of the case. Look for loose or badly contacted or discolored components (caused by overheating). Check to see that all circuit board connections are making good contact and are not shorting to an adjacent circuit. Especially inspect the connections between the PCBs, to the power transformer, to front chassis parts, to CRT socket, to trace rotation coil (inside of the CRT's shielding), to the 3 BNC connectors at the rear chassis, and to the control potentiometers and

switches on top of and beneath both main-PCBs. Furthermore, the soldering connections of the 9 transistors and Fixed Three-Terminal Regulators resp. on the rear chassis. This visual inspection can lead to success much more quickly than a systematic fault location using measuring instruments. Prior to any extensive troubleshooting, also check the external power source.

If the instrument fails completely, the first and most important step — **after checking the mains/line voltage and power fuse** — will be to measure the deflecting plate voltages of the CRT. In almost any case, the faulty section can be located. The sections represent:

1. Vertical deflection.
2. Horizontal deflection.
3. CRT circuit.
4. Power supply.

While the measurement takes place, the position controls of both deflection devices must be in mid-position. When the deflection devices are operating properly, the separate voltages of each plate pair are almost equal then (Y = +85V and X = +140V). If the separate voltages of a plate pair are very different, the associated circuit must be faulty. An absent trace in spite of correct plate voltages means a fault in the CRT circuit. Missing deflecting plate voltages is probably caused by a defect in the power supply.

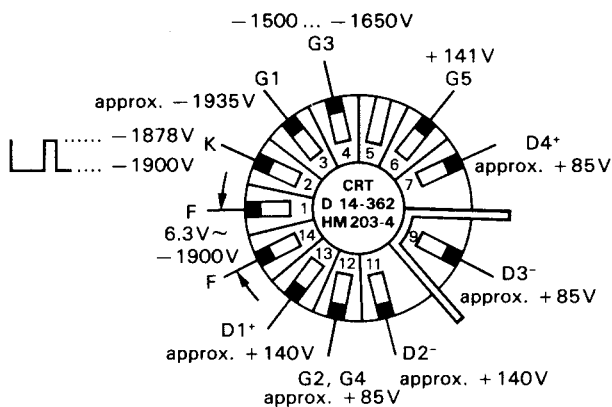

Voltages at the CRT socket

Replacement of Components and Parts

For the replacement of parts and components use only parts of the same or equivalent type. Resistors without specific data in the diagrams have a power dissipation of 0.25 Watt and a tolerance of 2%. Resistors in the high voltage circuit must have sufficient electric strength. Capacitors without a voltage value must be rated for an operating voltage of 63V. The capacitance tolerance should not exceed 20%. Many semiconductors are selected, especially the gate-diodes 1N4154, and all amplifier transistors, which are contained in push-pull cir-

cuits (including the FETs). If a selected semiconductor is defective, all gate-diodes or both push-pull transistors of a stage should be replaced by selected components, because otherwise there are possibly deviations of the specified data or functions. The HAMEG Service Department can give you advice for troubleshooting and replaceable parts. Replacement parts can be ordered by letter or telephone from the nearest HAMEG Service Office. Please supply the following information: Instrument type and serial number, description of the part (including function and location in the instrument), quantity desired.

Replacement of the Power Transformer

Should it be necessary to replace the mains/line transformer, the correct terminal sequence (color identification) for primary and secondary windings must be followed (see diagram "Power Supply" and the figure below). In addition, the relevant Safety Regulations must be observed. Here, we refer only to those requirements relative to parts conductively connected to the supply mains:

- The construction of the instrument shall be such as to prevent any short-circuiting or bridging of the insulation, clearances or creepage distances between those parts connected to the supply mains and any accessible conductive parts due to accidental loosening or freeing of the wiring, screws, etc.
- The rigidity of the mains wiring connections, which may be subject to mechanical stresses, shall not be dependent upon the soldering alone. To meet this requirement, the bare ends of the wires must be pushed through the holes in the respective soldering tab, bent over with a pair of pliers, and subsequently fixed by soldering.
- The minimum cross section of the protective earth connection between the instrument's power inlet and the connecting soldering tab on the rear chassis must be 0.81mm² in North America and 0.75mm² in Western Europe. The connecting soldering tab on the rear chassis has to be secured mechanically against loosening (e.g. with lock washer).

After replacing the power transformer, all remaining bits of wire, solder and other foreign matter must be removed from the PCBs, the vicinity of the power transformer and from within the insulating connecting box by shaking, brushing and blowing. Finally, the top plate of the insulating connecting box has to be replaced. Before connecting the instrument to the power supply, replace the possibly defective fuse, press the **POWER** button and make sure that there is an adequate insulation state between chassis (= safety earth conductor) on the one hand, and the live/line pin as well as the neutral pin, on the other. Only after proper insulation has been established may further function tests with open chassis follow, but with appropriate precautionary measures.

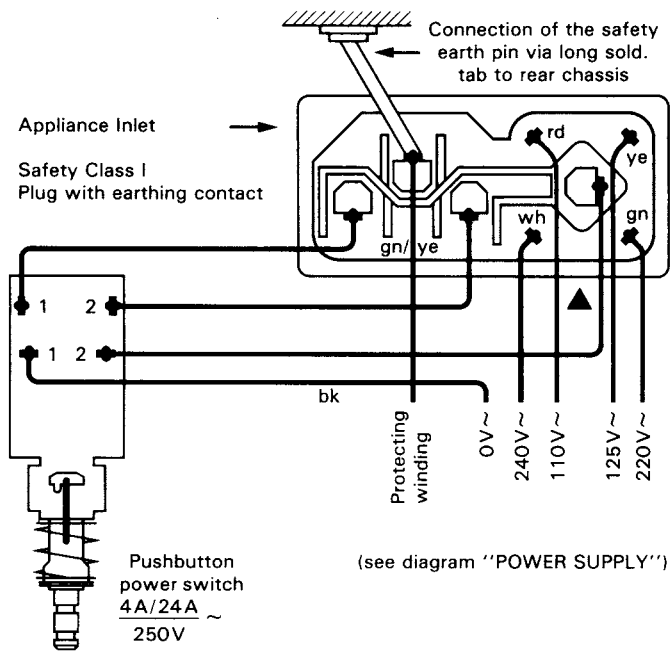

Rear View of Power Switch and Appliance Inlet with Voltage Selector and Fuse

Adjustments

As advised in the Operating, Test and Service Instructions, small corrections and adjustments are easily carried out with the aid of the Circuit Diagrams and **Adjusting Plan**. However, a complete recalibration of the scope should not be attempted by an inexperienced operator, but only someone with sufficient expertise. Several precision measuring instruments with cables and adapters are required, and only then should the pots and trimmers be readjusted, provided that the result of each adjustment can be exactly determined. Thus for each operating mode and switch position, a signal with the appropriate sine or square waveform, frequency, amplitude, risetime and duty cycle is required.

HAMEG

West Germany **G.m.b.H.**
Kelsterbacher Str. 15-19 — 6 FRANKFURT/M. 71
Tel. (0611) 676017-19 — Telex 0413866

HAMEG

France **S.A.R.L.**
5-9, avenue de la République — 94800 VILLEJUIF
Tél. (1) 678.09.98 — Télex 270705

HAMEG

España **IBERICA S.A.**
Villarroel 172-174 — BARCELONA-36
Tel. 230.15.97

HAMEG

United Kingdom **LTD**
74-78 Collingdon Street — LUTON, LU1 1RX
Tel. (0582) 413.174 — Telex 825.484

HAMEG

U.S.A. **INC.**
88-90 Harbor Road — PORT WASHINGTON
N. Y. 11050
Tel. 516.883.3837 — TWX 510.223.0889