

MODEL 417A
VHF DETECTOR
Serial 884 and Above



HEWLETT-PACKARD COMPANY
275 Page Mill Road • Palo Alto, California, U.S.A.

INSTRUCTION AND OPERATING MANUAL
FOR

MODEL 417A
VHF DETECTOR
Serial 884 and Above

Copyright 1954 by Hewlett-Packard Company

The information contained in this booklet is intended for the operation and maintenance of Hewlett-Packard equipment and is not to be used otherwise or reproduced without the written consent of the Hewlett-Packard Company.

HEWLETT-PACKARD COMPANY
395 PAGE MILL ROAD, PALO ALTO, CALIFORNIA, U.S.A.

#417A001

General Description

The Model 417A VHF Detector is a super-regenerative receiver covering all frequencies between 10 and 500 mc in 5 bands and with a sensitivity of 5 microvolts over the entire frequency range. It has a single frequency control calibrated directly in megacycles.

Although it was designed as a detector for the Hewlett-Packard Model 803A Bridge, it may also be used for approximate frequency measurements.

Parts Substitutions

Difficulties in procuring some of the parts used in this instrument may cause the electrical or physical values to deviate from those shown in this instruction manual. These substitutions have been made so as not to impair the performance of this instrument. Whenever replacement of any of these parts is necessary, either the substitute value or the original value may be used.

TABLE OF CONTENTS

MODEL 417A

VHF DETECTOR

Page No.

Specifications	1
Operating Instructions	
Controls and Terminals	2
Operation	2
Circuit Description	3
Maintenance	
Cabinet Removal	3
Tube Replacement.	3
Detector Tube Replacement.	3
Disassembly	4
Assembly.	4
Table of Replaceable Parts	5

INSTRUCTIONS

MODEL 417A

VHF DETECTOR

Specifications

Frequency Range --

10 to 500 Mc.

Ranges --

10 - 20 Mc
20 - 40 Mc
40 - 90 Mc
90 - 205 Mc
205 - 500 Mc

Sensitivity --

Approximately 5 microvolts from 10 to 500 Mc

Power Supply Rating --

Voltage - 115 volts
Frequency - 50/60 cycles/sec.
Wattage - 30 watts

Overall Dimensions --

9-1/4" wide x 12-1/4" high x 9-1/8" deep

Weight --

18-1/2 pounds

Operating Instructions

Inspection --

This instrument has been thoroughly tested and inspected before being shipped and is ready for use when received.

After the instrument is unpacked, the instrument should be carefully inspected for damage received in transit. If any shipping damage is found, follow the procedure outlined in the "Claim for Damage in Shipment" page at the back of this instruction book.

Controls and Terminals --

QUENCH - This variable resistor controls the sensitivity of the detector circuit.

VOLUME - This variable resistor controls the amount of audio voltage admitted to the amplifier and therefore the loudness of the sound produced by the speaker or the phones.

TUNING - This knob drives the frequency dial and tuning capacitor by means of a friction drive on the edge of the tuning dial. A direct reading scale, calibrated in megacycles, for each range is engraved on the dial. The scale in use is indicated by the position of the RANGE knob.

10 - 20 Etc. - This knob rotates the coil turret so that coils covering the desired range may be inserted in the detector tuning system.

PHONES - Whenever it is desirable to operate the instrument with headphones instead of the built-in speaker, the phones are plugged into the jack in the lower left corner of the panel. The loudspeaker is automatically disconnected whenever the phones are plugged in.

INPUT - The type BNC jack, located in the lower left corner of the control panel, is the input terminal for the primary of the detector tuning system.

.4 AMP - The fuseholder, located in the lower right corner of the control panel, contains a .4 ampere cartridge fuse. The fuse may be replaced by unscrewing the fuseholder cap and inserting a new fuse. Replacement fuses for this instrument must be as specified in the Replaceable Parts List.

ON - This toggle switch, which is located in the lower right corner of the control panel, controls the power supplied to the instrument from the power line. When the switch is in the ON position, the dial lamp will be lighted.

Power Cable - The power cable consists of three conductors. Two of these conductors carry power to the instrument while the third conductor (green wire) is connected to the instrument chassis. The third wire projects from the cable near the plug end of the cable and may be connected to a ground when it is desirable to have a grounded chassis.

Operation --

The procedure for operating the Model 417A is as follows:

1. Connect the power cable to a 115 volt power line and turn the power switch to ON. The instrument will be ready to operate in less than a minute.
2. Connect the DETECTOR jack of the Hewlett-Packard Model 803A VHF Bridge to the INPUT jack of the Model 417A.

3. Set the range knob (10-20, etc.) to the desired frequency range and the frequency dial (TUNING) to approximately the desired frequency.

4. Turn the QUENCH control knob in a clockwise direction until noise is heard. The point of maximum sensitivity is just beyond this point. The VOLUME control should be turned completely clockwise.

5. Peak the TUNING control and adjust the QUENCH and VOLUME controls for the desired sensitivity and loudness.

Any spurious signal of test frequency which is picked up by the receiver in any manner other than through the probe on the slotted line in the Model 803A VHF Bridge will tend to make the balance indeterminate and the results inaccurate. The Model 417A is well shielded to prevent stray pick-up and therefore the cable to the input of the detector should be shielded.

When seeking the null point on the VHF Bridge, it is preferable to reduce the sensitivity of the detector by means of the QUENCH control rather than by the VOLUME control. If the detector is too sensitive, the null point may be difficult to locate.

Circuit Description

The Model 417A VHF Detector consists of super-regenerative detector, a multivibrator, an amplifier, and a power supply.

This super-regenerative circuit uses a pencil triode tube (V1) as the detector. The interruptor frequency of about 30 Kc is generated by the multivibrator tube (V2A, V2B) and fed into the grid of tube V1. Tube V3B acts as a rectifier to provide a source of negative direct current voltage for biasing the detector tube. The amount of bias voltage on the grid of tube V1 and therefore the sensitivity of the detector is determined by the setting of the "Quench" control (R15).

The amplifier and power supply are conventional.

Maintenance

Cabinet Removal --

Remove the eight screws around the edge of the control panel and pull the cover away from the panel.

Tube Replacement --

All tubes except the detector tube (V1) may be replaced with tubes having RMA standard characteristics.

Detector Tube Replacement --

The procedure for replacing the detector tube is as follows:

Disassembly -

1. Pry off the 2" diameter plug button (Fig. 2A) on top of the detector assembly. Remove the tube socket (Fig. 1).
2. Unscrew the three screws (Fig. 1, #1) from the oscillator tube socket and lift out tube socket and 5876 tube.

Assembly -

1. Insert 5876 tube in plate contact (Fig. 2B) filament lead end of tube up.
2. Slip oscillator tube socket over 5876 tube with the spring and insulator side down.
3. Replace the three screws (Fig. 1, #1) which fasten the oscillator tube socket to the chassis. Fasten filament lead ground lug under one screw.
4. Slide bakelite tube socket over filament leads and replace plug button. This completes the assembly.

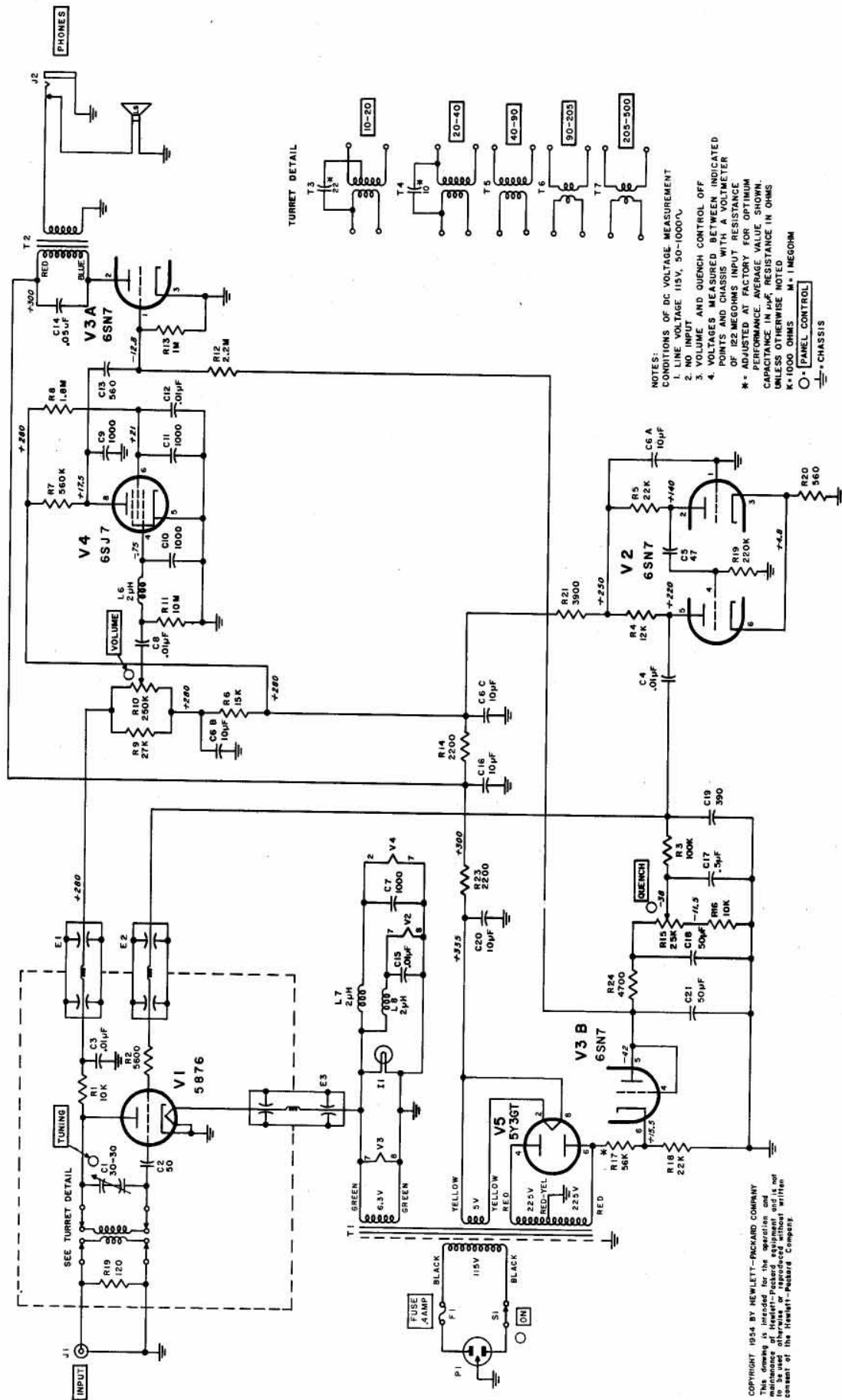

TURRET DETAIL

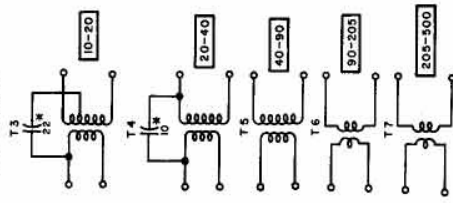

- NOTES:
 1. CONDITIONS OF DC VOLTAGE MEASUREMENT
 2. LINE VOLTAGE 115V, 50-1000V
 3. VOLUME AND QUENCH CONTROL OFF
 4. POINTS AND CHASSIS WITH A VOLTMETER OF 122 MEGOHMS INPUT RESISTANCE PERFORMANCE. AVERAGE VALUE SHOWN, UNLESS OTHERWISE NOTED
 K = 1000 OHMS M = 1 MEGOHM
 ○ = PANEL CONTROL
 ⊞ = CHASSIS

SCHEMATIC DIAGRAM OF MODEL 417A
 SERIAL 884 & ABOVE

COPYRIGHT 1954 BY HEWLETT-PACKARD COMPANY
 All rights reserved. Reproduction in whole or in part without the written consent of the Hewlett-Packard Company is prohibited.

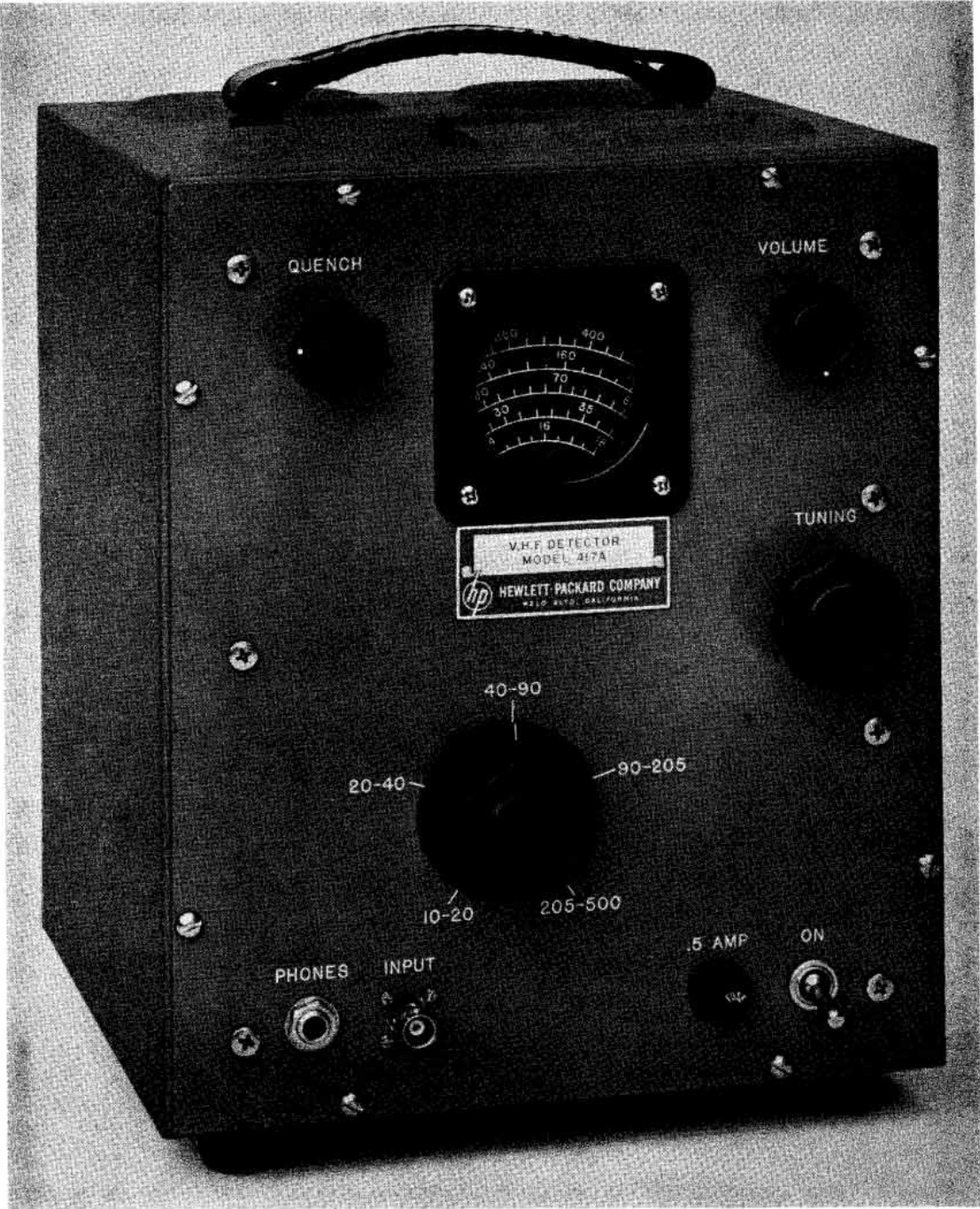

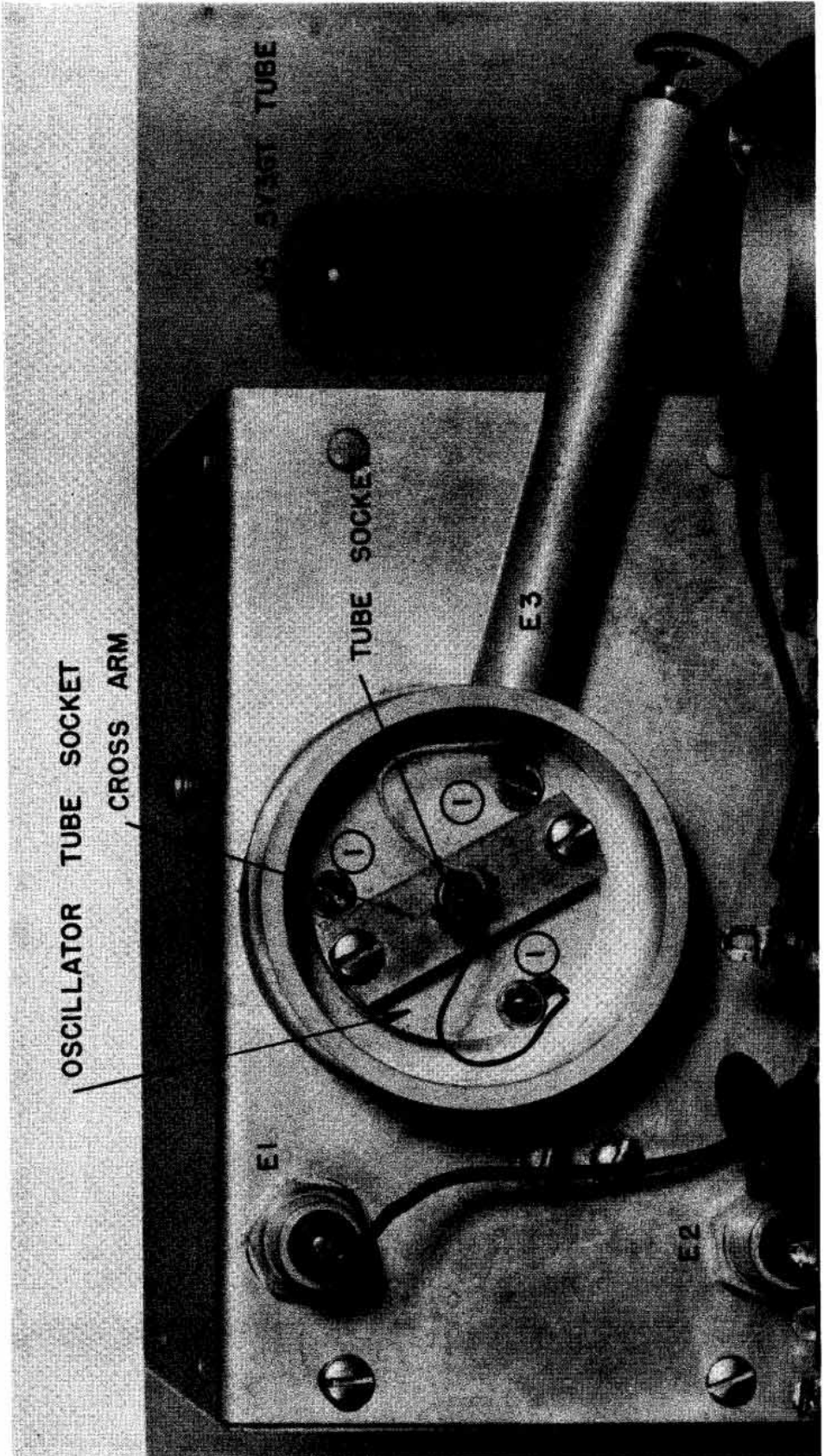

Model 417A
Detector Tube Socket Assembly
With Plug Button Removed
Fig. 1

PLUG BUTTON

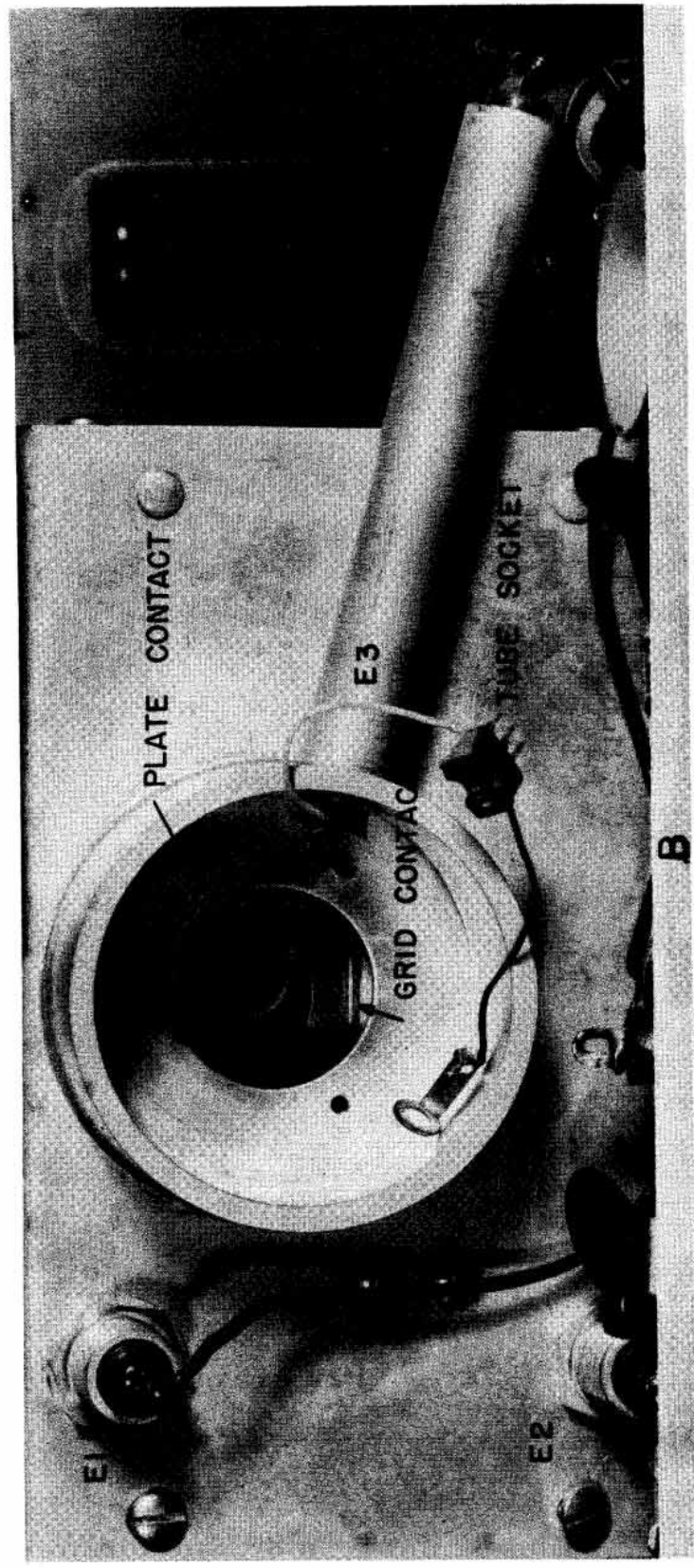
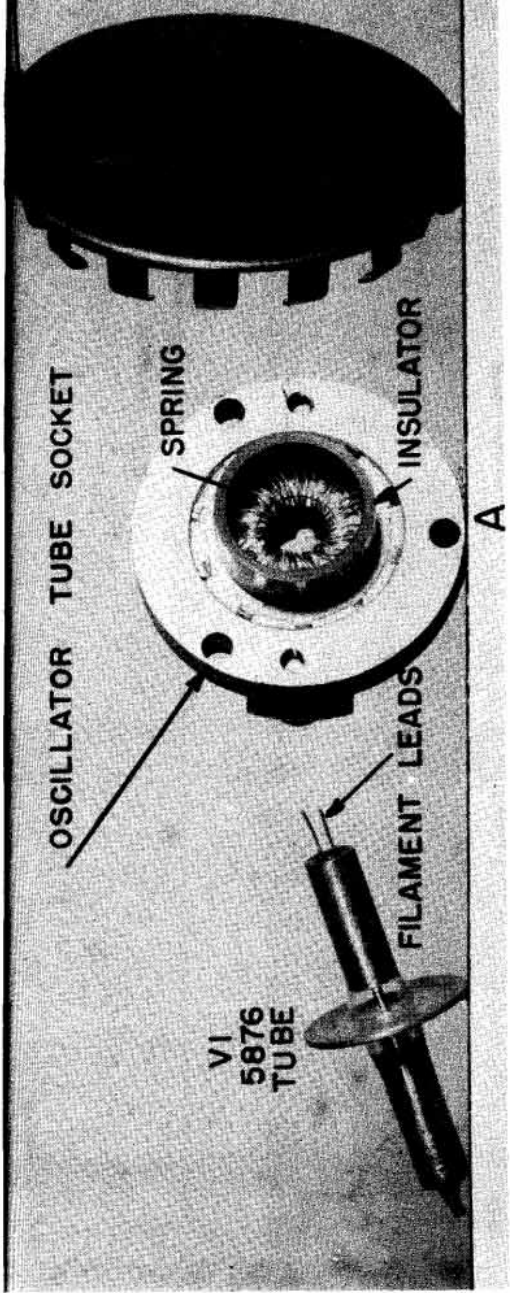

Model 417A
 Detector Tube Socket
 With Tube Removed
 Fig. 2

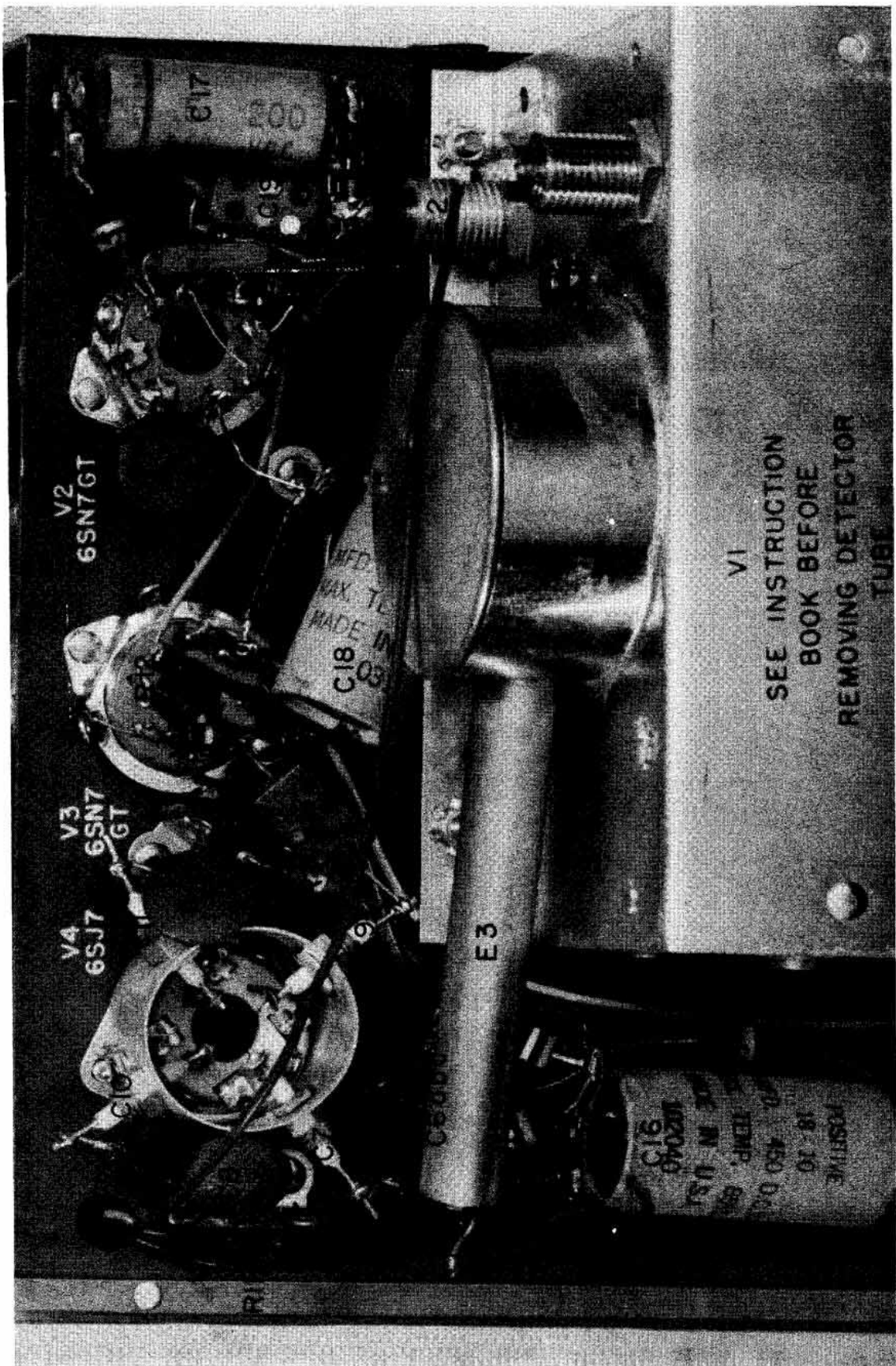

Model 417A Rear View
(Cabinet Removed)

Fig. 3

TABLE OF REPLACEABLE PARTS

Circuit Ref.	Description	-hp- Stock No.	Mfr. * & Mfrs. Designation
C1	Capacitor: variable, air, 30 - 30 μ f	12-25	Hammarlund VU-30
C2	Capacitor: Part of Detector Assembly		
C3	Capacitor: fixed, ceramic, .01 μ f, 600 vdcw	15-43	K Type BPD-10
C4	Capacitor: fixed, ceramic, .01 μ f, 600 vdcw	15-43	K Type BPD-10
C5	Capacitor: fixed, mica, 47 μ f, \pm 10%, 500 vdcw	14-67	V Type OXM
C6 abc	Capacitor: fixed, electrolytic, 10, 10, 10 μ f, 450 vdcw	18-31	X FPT-389
C7	Capacitor: fixed, ceramic, 1000 μ f, 500 vdcw	15-21	K Type CP-123
C8	Capacitor: fixed, ceramic, .01 μ f, 600 vdcw	15-43	K Type BPD-10
C9	Capacitor: fixed, ceramic, 1000 μ f, 500 vdcw	15-21	K Type CP-123
C10	Capacitor: fixed, ceramic, 1000 μ f, 500 vdcw	15-21	K Type CP-123
C11	Capacitor: fixed, ceramic, 1000 μ f, 500 vdcw	15-21	K Type CP-123
C12	Capacitor: fixed, ceramic, .01 μ f, 600 vdcw	15-43	K Type BPD-10
C13	Capacitor: fixed, mica, 560 μ f, \pm 10%, 500 vdcw	14-63	V Type OXM
C14	Capacitor: fixed, paper, .05 μ f, 600 vdcw	16-15	A Type P688
C15	Capacitor: fixed, ceramic, .01 μ f min., 500 vdcw	15-43	A HI-Q Div.
C16	Capacitor: fixed, electrolytic, 10 μ f, 450 vdcw	18-10	X WB-72
C17	Capacitor: fixed, paper, .5 μ f, 200 vdcw	16-37	CC 68P-25
C18	Capacitor: fixed, electrolytic, 50 μ f, 50 vdcw	18-50	X TC-39

*See "List of Manufacturers Code Letters For Replaceable Parts Table."

TABLE OF REPLACEABLE PARTS

Circuit Ref.	Description	-hp- Stock No.	Mfr. * & Mfrs. Designation
C19	Capacitor: fixed, mica, 390 μ f, $\pm 10\%$, 500 vdcw	14-65	V Type OXM
C20	Capacitor: fixed, electrolytic, 10 μ f, 450 vdcw	18-10	X WB72
C21	Capacitor: fixed, electrolytic, 50 μ f, 50 vdcw	18-50	X TC - 39
R1	Resistor: fixed, wirewound, 10,000 ohms, $\pm 10\%$, 10 W	26-10	S Type 1-3/4E
R2	Resistor: fixed, composition, 5600 ohms, $\pm 10\%$, 1/2 W	23-5600	B EB 5621
R3	Resistor: fixed, composition, 100,000 ohms, $\pm 10\%$, 1/2 W	23-100K	B EB 1041
R4	Resistor: fixed, composition, 12,000 ohms, $\pm 10\%$, 1 W	24-12K	B GB 1231
R5	Resistor: fixed, composition, 22,000 ohms, $\pm 10\%$, 1 W	24-22K	B GB 2231
R6	Resistor: fixed, composition, 15,000 ohms, $\pm 10\%$, 1 W	24-15K	B GB 1531
R7	Resistor: fixed, composition, 560,000 ohms, $\pm 10\%$, 1/2 W	23-560K	B EB 5641
R8	Resistor: fixed, composition, 1.8 megohms, $\pm 10\%$, 1/2 W	23-1.8M	B EB 1851
R9	Resistor: fixed, composition, 27,000 ohms, $\pm 10\%$, 1/2 W	23-27K	B EB 2731
R10	Resistor: variable, composition, 250,000 ohms, semi log	210-38	HP
R11	Resistor: fixed, composition, 10 megohms, $\pm 10\%$, 1/2 W	23-10M	B EB 1061
R12	Resistor: fixed, composition, 2.2 megohms, $\pm 10\%$, 1/2 W	23-2.2M	B EB 2251
R13	Resistor: fixed, composition, 1 megohm, $\pm 10\%$, 1/2 W	23-1M	B EB 1051
R14	Resistor: fixed, composition, 2200 ohms, $\pm 10\%$, 2 W	25-2200	B HB 2221
R15	Resistor: variable, composition, 25,000 ohms, linear taper	210-54	B JU 2531

*See "List of Manufacturers Code Letters For Replaceable Parts Table."

TABLE OF REPLACEABLE PARTS

Circuit Ref.	Description	-hp- Stock No.	Mfr. * & Mfrs. Designation
R16	Resistor: fixed, composition, 10,000 ohms, ±10%, 1/2 W	23-10K	B EB 1031
R17	Resistor: fixed, composition, 56,000 ohms, ±10%, 2 W Electrical value adjusted at factory	25-56K	B HB 5631
R18	Resistor: fixed, composition, 22,000 ohms, ±10%, 1 W	24-22K	B GB 2231
R19	Resistor: fixed, composition, 220,000 ohms, ±10%, 1/2 W	23-220K	B EB 2241
R20	Resistor: fixed, composition, 560 ohms, ±10%, 1/2 W	23-560	B EB 5611
R21	Resistor: fixed, composition, 3900 ohms, ±10%, 1 W	24-3900	B EB 3921
R22	Resistor: fixed, composition, 120 ohms, ±10%, 1/2 W	23-120	B EB 1211
R23	Resistor: fixed, composition, 2200 ohms, ±10%, 2 W	25-2200	B HB 2221
R24	Resistor: fixed, composition, 4700 ohms, ±10%, 1 W	24-4700	B GB 4721
F1	Fuse: .4 Amp. (opens in 5 sec. min. to 60 sec. max. at 200% overload)	211-56	T, 313,400
	Fuseholder:	312-8	T, 342001
E1, E2 E3	Filter C: Filter D:	417A-27C 417A-27D	HP HP
	Telephone Jack:	38-25	X, #706
I1	Lamp:	211-47	O, #47
	Knob: 1-1/8" diam.	37-9	HP
	Knob: 1-5/8" diam.	37-12	HP
	Knob: 2" diam.	608A-74	HP
L1 - L5	Coil Assembly:	417A-60	HP
L6, L7, L8	RF Choke:	48-1	K
S1	Switch: Toggle, SPST	310-11	D, 20994-HW
T1	Transformer: Power	910-22	HP
T2	Transformer: Output	912-21	Thordarson TS-24S49

*See "List of Manufacturers Code Letters For Replaceable Parts Table."

TABLE OF REPLACEABLE PARTS

Circuit Ref.	Description	-hp- Stock No.	Mfr. * & Mfrs. Designation
	Speaker:	912-19	Oxford Elec. Co. 2 AM-S
	Dial Window:	417A-99	HP
	Power Cable:	812-56	HP
V1	Tube: 5876	212-5876	Y
V2	Tube: 6SN7	212-6SN7	ZZ
V3	Tube: 6SN7	212-6SN7	ZZ
V4	Tube: 6SJ7	212-6SJ7	ZZ
V5	Tube: 5Y3GT	212-5Y3GT	ZZ
	Tube Socket; for 5876 tube	120-26	H, 54A11953
	Plug Button:	51-20	United Carr Fastener Co. 48175
	Oscillator Tube Socket:	608A-100D	HP
	Cross Arm:	M-26B	HP

*See "List of Manufacturers Code Letters For Replaceable Parts Table."

LIST OF MANUFACTURERS CODE LETTERS
FOR REPLACEABLE PARTS TABLE

<u>Code Letter</u>	<u>Manufacturer</u>
A	Aerovox Corp.
B	Allen-Bradley Co.
C	Amperite Co.
D	Arrow, Hart and Hegeman
E	Bussman Manufacturing Co.
F	Carborundum Co.
G	Centralab
H	Cinch Manufacturing Co.
HP	Hewlett-Packard
I	Clarostat Manufacturing Co.
J	Cornell Dubilier Electric Co.
K	Hi-Q Division of Aerovox Corp.
L	Erie Resistor Corp.
M	Federal Telephone and Radio Corp.
N	General Electric Co.
O	General Electric Supply Corp.
P	Girard-Hopkins
R	International Resistance Co.
S	Lectrohm, Inc.
T	Littelfuse, Inc.
V	Micamold Radio Corp.
X	P. R. Mallory Co., Inc.
Z	Sangamo Electric Co.
AA	Sarkes Tarzian
CC	Sprague Electric Co.
DD	Stackpole Carbon Co.
EE	Sylvania Electric Products, Inc.
FF	Western Electric Co.
HH	Amphenol
II	Dial Light Co. of America
KK	Switchcraft, Inc.
LL	Gremer Mfg. Co.
MM	Carad Corp.
ZZ	Any tube having RETMA standard characteristics

90BY013

CLAIM FOR DAMAGE IN SHIPMENT

The instrument should be tested as soon as it is received. If it fails to operate properly, or is damaged in any way, a claim should be filed with the carrier. A full report of the damage should be obtained by the claim agent, and this report should be forwarded to us. We will then advise you of the disposition to be made of the equipment and arrange for repair or replacement. Include model number, type number and serial number when referring to this instrument for any reason.

WARRANTY

Hewlett-Packard Company warrants each instrument manufactured by them to be free from defects in material and workmanship. Our liability under this warranty is limited to servicing or adjusting any instrument returned to the factory for that purpose and to replace any defective parts thereof (except tubes, fuses and batteries). This warranty is effective for one year after delivery to the original purchaser when the instrument is returned, transportation charges prepaid by the original purchaser, and which upon our examination is disclosed to our satisfaction to be defective. If the fault has been caused by misuse or abnormal conditions of operation, repairs will be billed at cost. In this case, an estimate will be submitted before the work is started.

If any fault develops, the following steps should be taken:

1. Notify us, giving full details of the difficulty, and include the model number, type number and serial number. On receipt of this information, we will give you service instruction or shipping data.
2. On receipt of shipping instruction, forward the instrument prepaid, and repairs will be made at the factory. If requested, an estimate of the charges will be made before the work begins provided the instrument is not covered by the warranty.

SHIPPING

All shipments of Hewlett-Packard instruments should be made via Railway Express. The instruments should be packed in a wooden box and surrounded by two to three inches of excelsior or similar shock-absorbing material.

DO NOT HESITATE TO CALL ON US

HEWLETT-PACKARD COMPANY

Laboratory Instruments for *Speed and Accuracy*

395 PAGE MILL ROAD



PALO ALTO, CALIFORNIA

90BY013