

SERVICE MANUAL

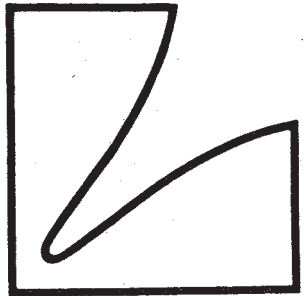

DUO-BETA CIRCUIT STEREO
INTEGRATED AMPLIFIER

L-205

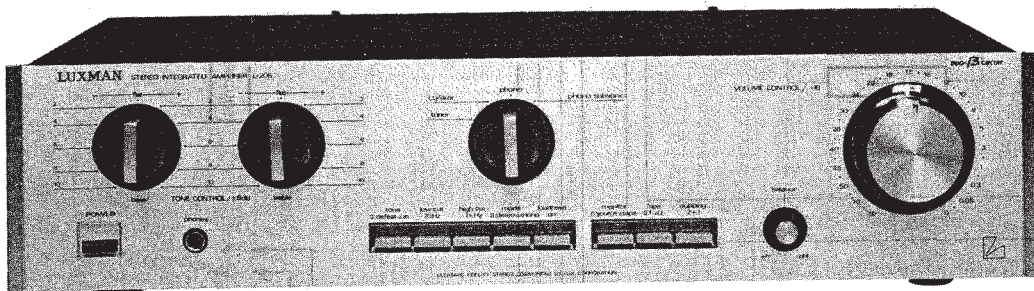

Contents

Block Diagram	1
Adjustment Procedures	2
Packing Material Parts List	2
Exploded View	3
Exploded View Parts List	4,5
Pre Main Amp PCB	6
Tone Control PCB	7
Function SW PCB	7
VR Control PCB	7
AV Input Terminal PCB	7
Destination's Parts List	7
Pre Main Amp PCB Parts List	8,9
Tone Control PCB Parts List	9
Function SW PCB Parts List	9
VR Control PCB Parts List	9
AV Input Terminal PCB Parts List	9
IC Handling Guide	10
Schematic Diagram	11
Specifications	12

L-205

Block Diagram

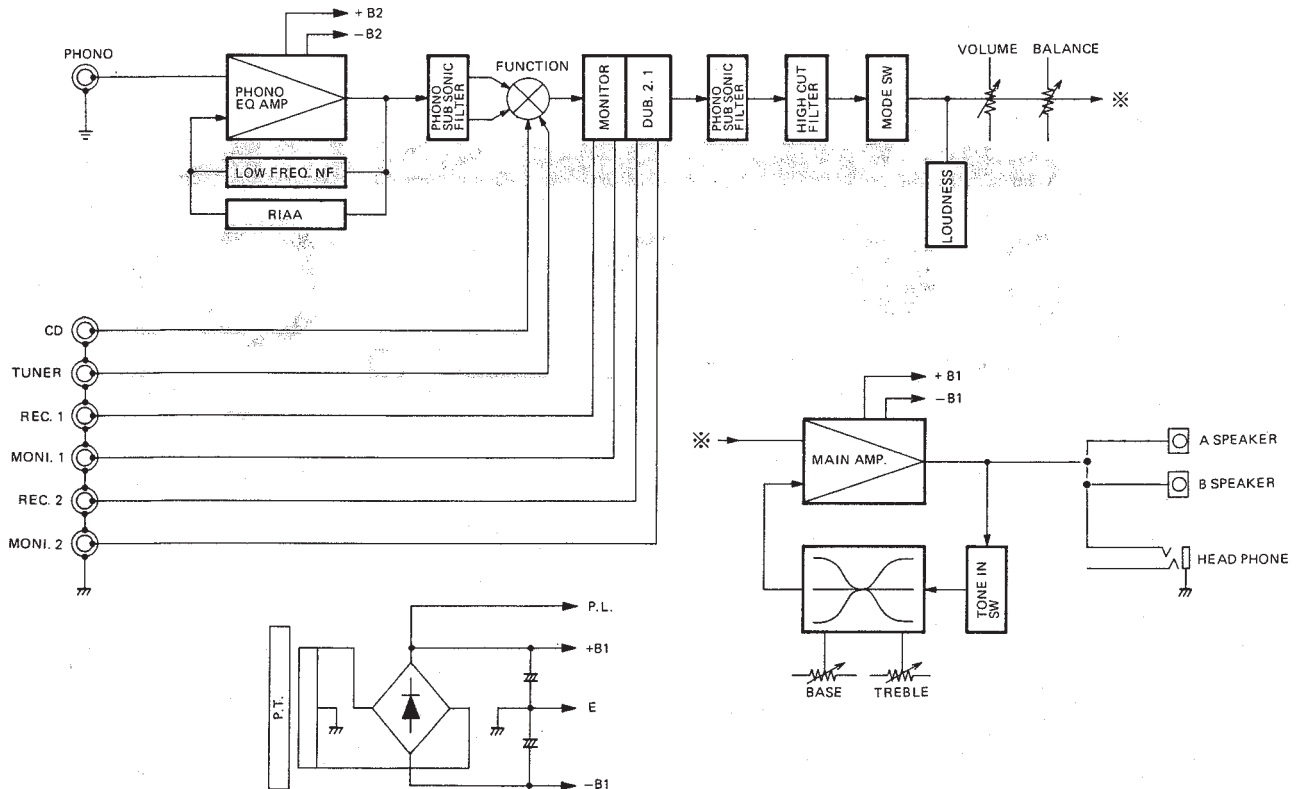

Adjustment Procedures

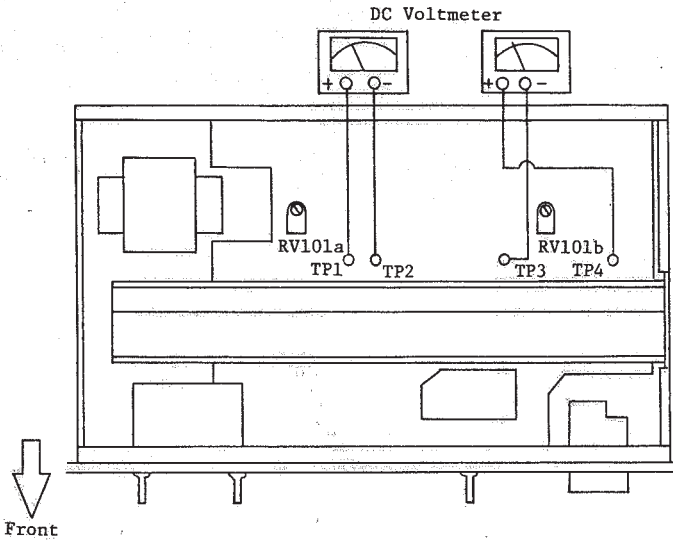

Bias (Idle) Current Adjustment

1. Connect a DC Voltmeter in between TP1 and TP2 on L-ch and or TP4 and TP3 on R-ch, Making TP1 and TP4 positive respectively.
2. Adjust the RV101a and RV101b to obtain $15\text{mV} \pm 5\text{mV}$ reading on the meter.

Packing Material Parts List

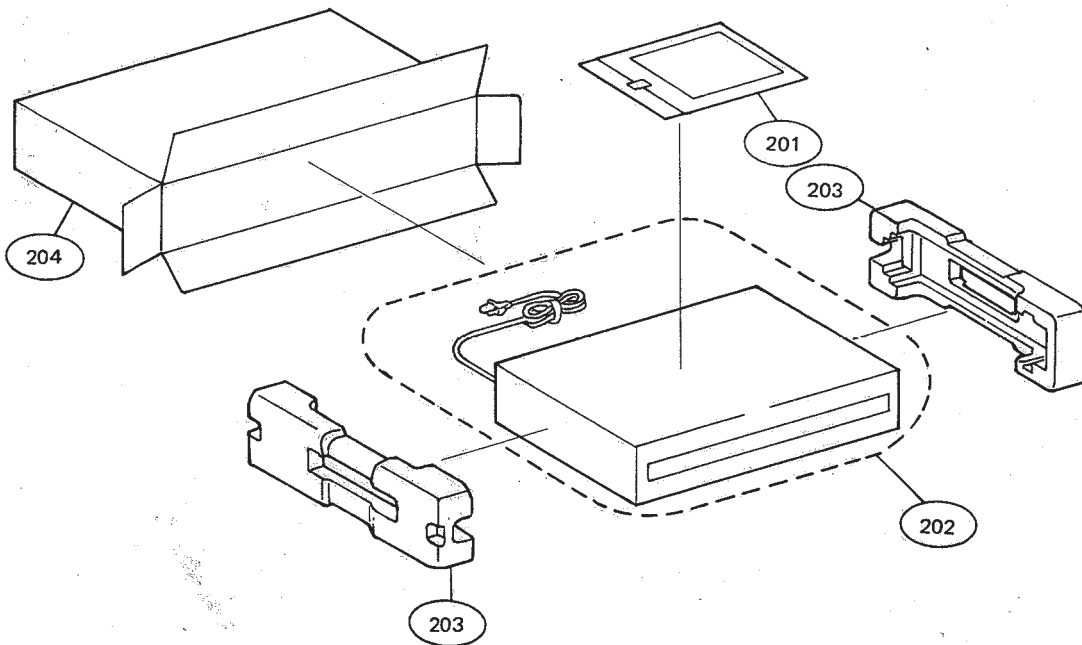

Packing Material Parts List

Index	Symbol No.	Stock No.	Description	Remarks
	201	68P65432F35	Owner's Manual	
	202	56B63425F11	S, Poly 620x480	
	203	56C56637F01	Packing Tray	
	204	56S60482F36	Carton, Packing	

Exploded View

L-205

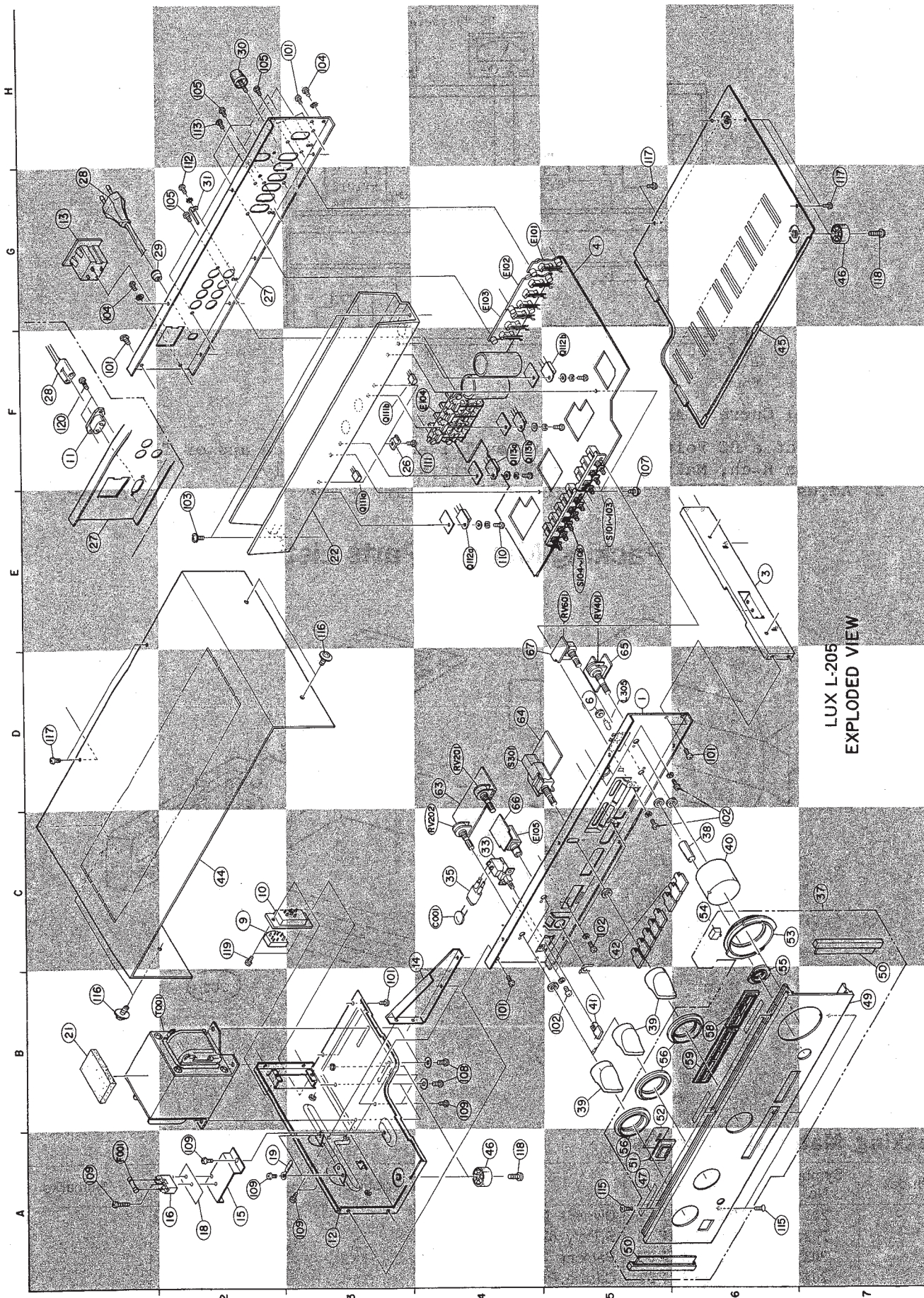

LUX L-205
EXPLODED VIEW

Exploded View Parts List

Note : ※The parts whose parts numbers are not entered will not be supplied.

Index	Symbol No.	Stock No.	Description	Remarks
D5	1	※	Chassis Front	
E6	3	※	Bracket, R	
G5	4	※	Ass'y Pre M/A PCB	
D5	6	43A62016F02	Bushing, UZ1077-2	
C2	9	09T51830F01	Plug, Switch P-2120	AK, AG
C2	10	09T51831F01	Socket, Switch M-1615	AK, AG
F1	11	09T67078F01	Inlet, 2P	AK, AG
A3	12	※	Bracket, Trans	
G1	13	09T57066F01	AC, Outlet S2-724B-04	UP
C4	14	※	Bracket, Trans	
A2	15	※	Bracket, Fuse	
A2	16	09T51074F01	Fuse Holder	
		09T51828F01	Fuse Holder X-N1157	UP
A2	18	※	Spacer, Fuse	
A2	19	29C41045P01	Lug, Wrap Around	
	20	※	Cushion, Rubber	
B1	21	※	Spacer, 60x34	
E3	22	07C60750F01	Heat Sink	
F3	26	※	Support, Tr	
E1, G2	27	15D56636F19	Cover, Rear	SK, SD
		15D56636F25	Cover, Rear	AK, AG
		15D56636F27	Cover, Rear	UP
F1, G1	28	28T43182P02	Plug, AC Cord	SK, SD
		30T67077F01	Cord Set	AK
		30T67359F01	Cord Set	AG
		28T55335P02	Plug, AC Cord	UP
G2	29	43B41625J02	Support, Cord	SK, UP
H2	30	29T66964F01	Terminal, GND	
G2	31	※	Lug, Wrap Around	
C4	33	40T45561F02	Switch Power (SDLIP)	
C4	35	※	Bush, Cap	
C7	37	01V66800F47	Ass'y Panel Front	
C6	38	36A66510F01	Knob, Rotary VR A	
		36A66510F02	Knob, Rotary VR A	UP
B5	39	36B66511F01	Knob, Rotary VR B	
		36B66511F03	Knob, Rotary VR B	UP
C6	40	36B66512F01	Knob, Rotary VR C	
		36B66512F03	Knob, Rotary VR C	UP
B5	41	36A56639F02	Knob, Push 1171	
C5	42	36A66836F02	Knob, Push	
C2	44	15C56629F02	Cover, Top	
F6	45	※	Cover, Bottom	
A4, G7	46	75A52969F01	Pad, Trann-leg	
A5	47	※	Insulator, 50x5	
B7	49	64D66508F01	Panel, Front	
A5, B7	50	07B56624F03	Frame, Panel Side	
A5	51	61A56641F01	Crystal, Indicator	
B5	52	43A56628F01	Spacer, Power	
C6	53	07B56643F01	Frame, Knob 1140	
C6	54	61A61746F01	Lens 1020-WG1020	
C6	55	07A56645F01	Frame, Knob 1156	
A5, B5	56	07A56648F01	Frame, Knob	
B6	58	07B56646F01	Frame, Knob 1154	
B6	59	07C56647F01	Frame, Knob 1155	
D4	63	※	Ass'y, Tone Control PCB	
D4	64	※	Ass'y, Function SW PCB	

L-205

Index	Symbol No.	Stock No.	Description	Remarks
D5	65	※	Ass'y,VR Control PCB	
D4	66	※	Ass'y,HD Phone PCB	
D4	67	※	Ass'y,Balance Control PCB	
B3,B4	101	03S44205G02	Screw,T-Tite M3x6	
B5,C5	102	03C40014G04	Screw,MCH M3x6	
E2	103	03C42723U02	Screw,CUP M3x8	
G1,H3	104	03S40036U18	Screw,T-Tite M3x8 T.L.	
G2,H2	105	03S40012G41	Screw,Tapping M3x8	
E5	107	03S40018G02	Screw,Tapping M3x8	
B4	108	03S40036U01	Screw,T-Tite M4x8	
A1,A2	109	03S44205G02	Screw,T-Tite M3x6	
E4	110	03C40121T15	Screw,MCH M3x12	
F4	111	03S40012G28	Screw,Tapping M3x8	
H2	112	03S40036U18	Screw,T-Tite M3x8 T.L.	
A5,A6	115	03S40012G55	Screw,Tapping M3x8	
B1,E3	116	03S40036U01	Screw,T-Tite M4x8	
D1,G7	117	03S44205G02	Screw,T-Tite M3x6	
A4,G7	118	03S44205G25	Screw,T-Tite M4x10	
C2	119	03S44205G03	Screw,T-Tite M3x8	AK,AG
F1	120	03S40012G98	Screw,Tapping M3x8 Flat	AK,AG
D4	RV201	18T56663F01	Volume 50KCx2	
C4	RV202	18T56663F01	Volume 50KCx2	
E5	RV401	18T68333F01	Volume 10KBx2	
E5	RV601	18T56666F01	Volume 250KW	
G4	E101	09T57203F01	Plate,Phono 2P	
G4	E102	09T57203F02	Plate,Phono 6P	
G4	E103	09T57203F02	Plate,Phono 6P	
F4	E104	09T51101F01	Terminal,SP	
C4	E105	09T55174F01	Jack Mic	
E5	S101-103	40T56653F01	Switch,Push SUN 33	
E5	S104-110	40T56652F01	Switch,Push SUN 53	
D4	S301	40T56664F01	Switch,Rotary SRZ	
B2	T1	25T60748F01	Trans Power	SK,SD
		25T67304F01	Trans Power	AK,AG
		25T67305F01	Trans Power	UP
A1	F1	65T42077U16	Fuse Semko T-1A	
		65T52486F09	Fuse MF61NM 3-125	UP
D5	L305	65T66752F01	Lamp,Pilot	
E3,F3	Q111a,b	48T47682F02	Transistor 2SC1845 FA	
E4,F5	Q112a,b	48T57130F03	Transistor 2SC3180 O,R	
F4	Q113a,b	48T57129F03	Transistor 2SA1263 O,R	
C4	C1	08T57437F09	Capacitor (Ac) 0.01uF	

PCB

Pre Main Amp PCB

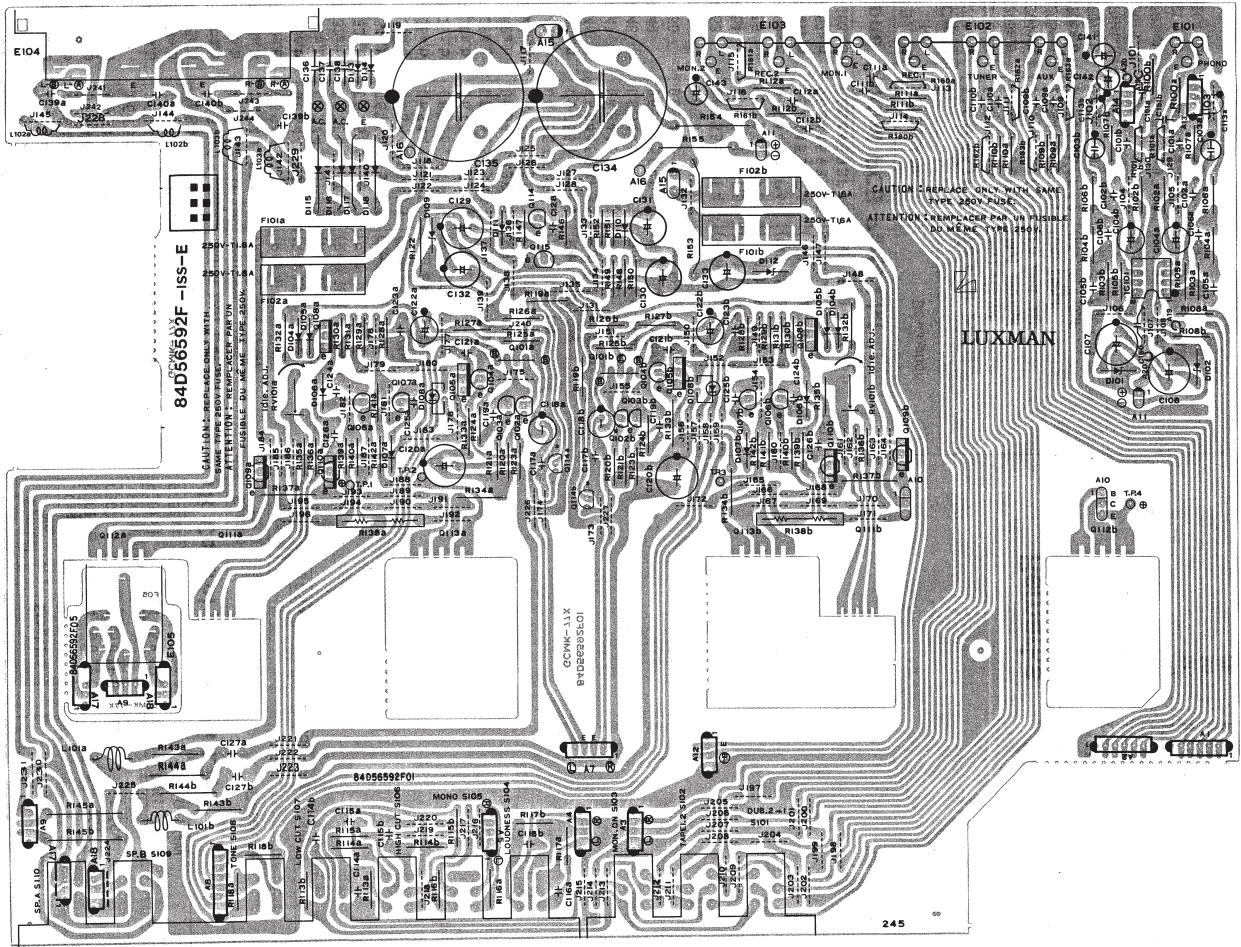

Tone Control PCB

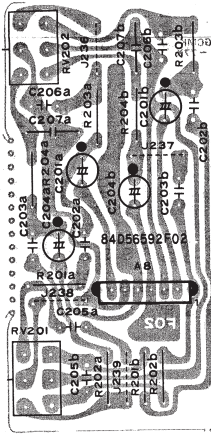

Function SW PCB

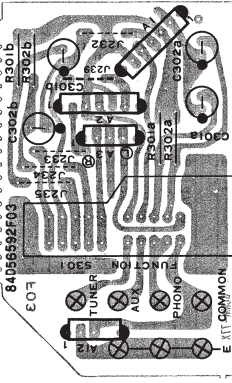

VR Control PCB

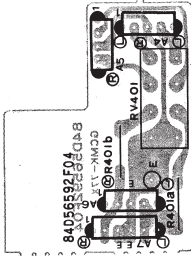

AV Input Terminal PCB

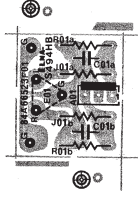

Destination's Parts List

Symbol No.	Description	SK 220V Europe	SD 220V W. Germany	AK 220V Other's	AG 240V Australia England	UP 120V Canada
9	Plug, SW P-2120	None Use	None Use	09T51830F01	09T51830F01	None Use
10	Socket, SW M-1615	None Use	None Use	09T51831F01	09T51831F01	None Use
11	Inlet, 2P	None Use	None Use	09T67078F01	09T67078F01	None Use
13	Outlet, AC	None Use	None Use	09T51074F01	09T51074F01	09T51828F01
16	Holder, Fuse	09T51074F01	09T51074F01	15D56636F19	15D56636F25	15D56636F27
27	Cover, Rear	15D56636F19	15D56636F19	30T67359F01	30T67359F01	28T55335P02
28	AC Cord	28T43182P02	28T43182P02	None Use	None Use	438A1625J02
29	Support, Cord	438A1625J02	438A1625J02	36A66510F01	36A66510F01	36A66510F02
38	Knob, Rotary A	36A66510F01	36A66510F01	36B66511F01	36B66511F01	36B66511F03
39	Knob, Rotary B	36B66511F01	36B66511F01	36B66512F01	36B66512F01	36B66512F03
40	Knob, Rotary C	36B66512F01	36B66512F01	03S44205G03	03S44205G03	None Use
119	Screw	None Use	None Use	03S44205G03	03S44205G03	None Use
120	Screw	None Use	None Use	03S44205G03	03S44205G03	None Use
T001	Trans, Power	25T60748F01	25T60748F01	25T67304F01	25T67304F01	25T67305F01
F001	Fuse	65T42077U16	65T42077U16	65T42077U16	65T42077U16	65T52486F09
F101a, b	Fuse	65T42077U25	65T42077U25	65T42077U25	65T42077U25	65T52486F07
F102a, b	Fuse	65T42077U25	65T42077U25	65T42077U25	65T42077U25	65T52086F07
L102a, b	Choke Coil	None Use	24T67516F01	None Use	None Use	None Use
L103a, b	Choke Coil	None Use	08T42081U01	08T42081U01	08T42081U01	08T42081U01
C101a, b	Capacitor	None Use	08S40805F11	None Use	None Use	None Use
C102a, b	Capacitor	None Use	08T42081U01	None Use	None Use	None Use
C110a, b	Capacitor	None Use	08T42081U01	None Use	None Use	None Use
C111a, b	Capacitor	None Use	08T42081U01	None Use	None Use	None Use
C112a, b	Capacitor	None Use	08S44505F61	None Use	None Use	None Use
C136	Capacitor	None Use	08S44505F61	None Use	None Use	None Use
C137	Capacitor	None Use	08S44505F61	None Use	None Use	None Use
C138	Capacitor	None Use	08S40656F13	None Use	None Use	None Use
C139a, b	Capacitor	None Use	08S40656F13	None Use	None Use	None Use
C140a, b	Capacitor	None Use	08S44593P53	None Use	None Use	None Use
R101a, b	Resistor	None Use	06S44593P45	None Use	None Use	None Use
R160a, b	Resistor	None Use	06S44503P45	None Use	None Use	None Use
R161a, b	Resistor	None Use	06S44503P45	None Use	None Use	None Use
R162a, b	Resistor	None Use	06S44593P45	None Use	None Use	None Use
R163a, b	Resistor	None Use	06S44593P45	None Use	None Use	None Use

Pre Main Amp PCB Parts List

Symbol No.	Stock No.	Description
(Fuse)		
F101a,b	65T42077J25	Semko T1.4A
F102a,b	65T57086F07	51NM 2.0 250 (UP)
F103a,b	65T42077J25	Semko T1.4A
F104a,b	65T57086F07	51NM 2.0 250 (UP)
(Variable Resistor)		
RV101a,b	18C42061J28	470-B
(Coil)		
L101a,b	24T67516F01	Choke 1.1uH
L102a,b	24T67516F01	Choke 1.1uH (SD)
L103a,b	24T67516F01	Choke 1.1uH (SD)
(IC)		
IC101	51T52153F01	NJM2043D-D
(Transistor & FET)		
Q101a,b	48T53430F01	2SA979-G
Q102a,b	48S43525F05	2SC1815-Y,GR
Q103a,b	48S43525F05	2SC1815-Y,GR
Q104a,b	48S43525F05	2SC1815-Y,GR
Q105a,b	48T60752F01	2SC22705 O.Y
Q106a,b	48S43525F02	2SC1815-Y
Q107a,b	48T51118F01	2SA1015-Y
Q108a,b	48T60751F01	2SA1145 O.Y
Q109a,b	48T51120F02	2SC2235-O.Y
Q110a,b	48T51119F02	2SA965-O.Y
Q111	48T47682F02	2SC1845 FA
Q112a,b	48T52152F01	2SC390A-GR
Q115	48S43525F05	2SC1815-Y,GR
(Diode & Zener & LED)		
D1	48T51117F01	1S1553
D2	48T51117F01	1S1553
D3	48T51117F01	1S1553
D4	48T51117F01	1S1553
D101	48T52741F54	HZ18 -3L -AX
D102	48T52741F54	HZ18 -3L -AX
D104a,b	48T51117F01	1S1553
D105a,b	48T51117F01	1S1553
D106a,b	48T51117F01	1S1553
D107a,b	48T51117F01	1S1553
D108a,b	48T40955T01	TLR124 RED
D109	48T52741F62	HZ24 -2L -AX
D110	48T51117F01	1S1553
D111	48T44992F01	DS135D
D112a,b	48T52739F87	HZ20 -3
D113	48T44992F01	DS135D
D114	48T44992F01	DS135D
D115	48T51115F02	S3V20(4004)
D116	48T51115F02	S3V20(4004)
D117	48T51115F02	S3V20(4004)
D118	48T51115F02	S3V20(4004)
(Capacitor)		
C101a,b	08T42081U01	(Pp) 100pF
C102a,b	08T42081U13	(Pp) 330pF (SD)
C103a,b	08S40805F11	(Ce) 2200pF (SD)
C104a,b	23T44501P08	(EI) 22uF 16V
C105a,b	08S40805F22	(My) 56000pF

Symbol No.	Stock No.	Description
C106a,b	08S40150T97	(Rd) 22KΩ 1/4W
C107	23S411198U42	(E) 220uF 25V
C108	23S411198U42	(E) 220uF 25V (SD)
C109a,b	08T42081U01	(Pp) 100pF (SD)
C110a,b	08T42081U01	(Pp) 100pF (SD)
C111a,b	08T42081U01	(Pp) 100pF (SD)
C112a,b	08T42081U01	(Pp) 100pF (SD)
C114a,b	23T440656F22	(My) 0.056uF
C115a,b	08S40656F10	(My) 5600pF
C116a,b	08S40656F21	(My) 47000pF
C117a,b	08T42081U01	(Pp) 100pF
C118a,b	23T44501P08	(E) 3.3uF 25V
C119a,b	08S40656F06	(My) 2700pF
C120a,b	23S411198U37	(E) 100uF 50V
C121a,b	08C42195G15	(St) 33pF 125V
C122a,b	23S40657F08	(E) 100uF 10V
C123a,b	21S40655F06	(Ce) 5pF
C124a,b	08S40656F05	(My) 2200pF
C125a,b	08S40656F05	(My) 2200pF
C126a,b	08S40656F01	(My) 1000pF
C127a,b	08S40656F21	(My) 47000pF
C128	08S40656F01	(My) 1000pF
C129	23S411198U37	(E) 100uF 50V
C130	23S40657F26	(E) 47uF 35V
C131	23S40657F24	(E) 22uF 35V
C132	23S40657F20	(E) 47uF 25V
C133a,b	23S40657F26	(E) 47uF 35V
C134	23T60749F01	(E) 4700uF 35V
C135	23T60749F01	(E) 4700uF 35V
C136	08S44505P61	(Ce) 10000pF (SD)
C137	08S44505P61	(Ce) 10000pF (SD)
C138	08S44505P61	(Ce) 10000pF (SD)
C139a,b	08S40656F13	(My) 10000pF (SD)
C140a,b	08S40656F13	(My) 10000pF (SD)
C141	23S40657F10	(E) 10uF 16V
C142	23S40657F10	(E) 10uF 16V
C143	23S40657F10	(E) 10uF 16V
(Resistor)		
R1	06S40150T97	(Rd) 22KΩ 1/4W
R2	06S40150T97	(Rd) 22KΩ 1/4W
R3	06S40150T97	(Rd) 22KΩ 1/4W
R4	06S40150T97	(Rd) 22KΩ 1/4W
R101a,b	06S44593P53	(Rd) 330Ω 1/4W
R102a,b	06S44594P08	(Rd) 56KΩ 1/4W
R103a,b	06S44594P08	(Rd) 56KΩ 1/4W
R104a,b	06S44593P81	(Rd) 4.7KΩ 1/4W
R105a,b	06S44594P38	(Rd) 1MΩ 1/4W
R106a,b	06S44593P29	(Rd) 33Ω 1/4W
R107a,b	06S44593P37	(Rd) 68Ω 1/4W
R108a,b	06S44593P57	(Rd) 470Ω 1/4W
R109a,b	06S44594P38	(Rd) 1MΩ 1/4W
R110a,b	06S44594P38	(Rd) 1MΩ 1/4W
R111a,b	06S44594P38	(Rd) 1MΩ 1/4W
R112a,b	06S44594P38	(Rd) 1MΩ 1/4W
R113a,b	06S44594P38	(Rd) 1MΩ 1/4W
R114a,b	06S44594P38	(Rd) 1MΩ 1/4W
R115a,b	06S44593P75	(Rd) 2.7KΩ 1/4W
R116a,b	06S44593P75	(Rd) 2.7KΩ 1/4W

Function SW PCB Parts List

Symbol No.	Stock No.	Description
(Capacitor)		
C301a,b	23T44501P06	(EI) 2.2uF 35V
C302a,b	23T44501P03	(EI) 0.33uF 50V
(Resistor)		
R301a,b	06S44594P30	(Rd) 470KΩ 1/4W
R302a,b	06S44594P30	(Rd) 470KΩ 1/4W

VR Control PCB Parts List

Symbol No.	Stock No.	Description
(Resistor)		
R401a,b	06S44593P57	(Rd) 470Ω 1/4W

Tone Control PCB Parts List

Symbol No.	Stock No.	Description
(Capacitor)		
C201a,b	23S40657F16	(E) 4.7uF 25V
C202a,b	08S40656F11	(My) 6800pF
C203a,b	08S40656F20	(My) 39000pF
C204a,b	23S40657F11	(EI) 22uF 16V
C205a,b	21S40655F31	(Ce) 560pF
C206a,b	08S40657F22	(My) 0.056uF
C207a,b	08S44503P30	(My) 0.27uF 50V
(Resistor)		
R201a,b	06S44593P71	(Rd) 1.8KΩ 1/4W
R202a,b	06S44593P53	(Rd) 330Ω 1/4W
R203a,b	06S44593P87	(Rd) 8.2KΩ 1/4W
R204a,b	06S44593P69	(Rd) 1.5KΩ 1/4W

Remarks

- Resistor : RfCarbon
 RcFrame Proof
 CeCeramic
 MyMylar
 StStyrol
 MiMica
 PpPolypropylene
- Capacitor : EIElectrolytic
 CeCeramic
 MyMylar
 StStyrol
 MiMica
 PpPolypropylene

IC Handling Guide

NJM204-3D-D
ICL01
(Stock No. 51T52153F01)

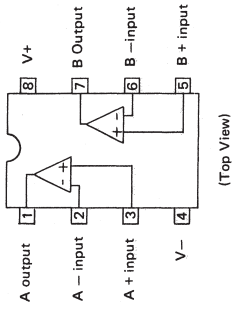

TR, 2SA979C
Q101a, b
(Stock No. 48T53430F01)

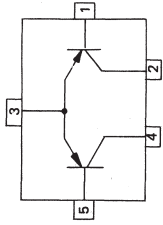

Schematic Diagram

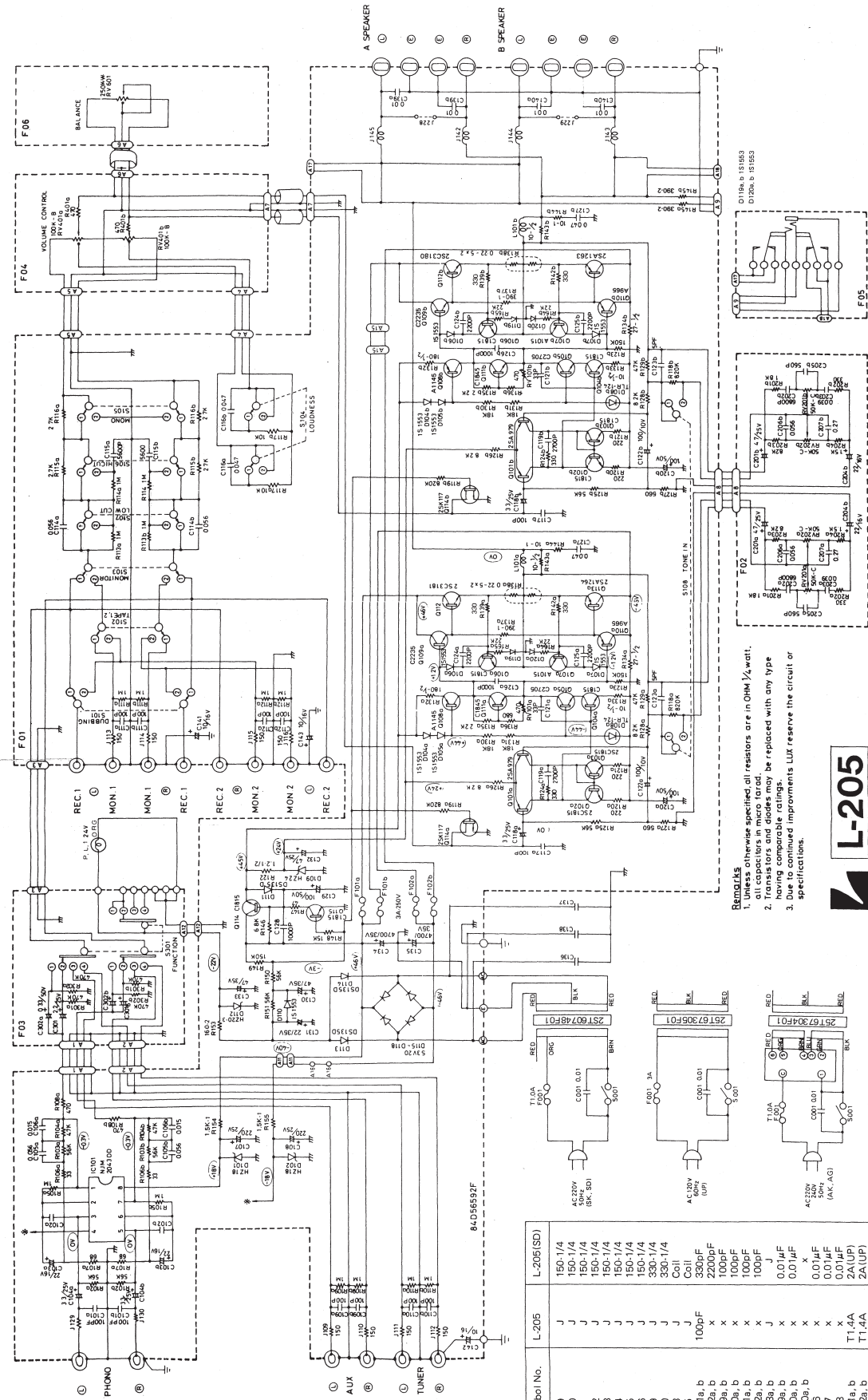

- REMARKS**
1. Unless otherwise specified, all resistors are in OHM $\frac{1}{4}$ watt, all capacitors in micro farad.
 2. Transistors and diodes may be replaced with any type.
 3. Due to combined improvements LUX reserve the circuit or specifications.



Symbol No.	L-205	L-205(SD)
J109	150-1/4	150-1/4
J110	150-1/4	150-1/4
J111	150-1/4	150-1/4
J112	150-1/4	150-1/4
J113	150-1/4	150-1/4
J114	150-1/4	150-1/4
J115	150-1/4	150-1/4
J116	150-1/4	150-1/4
J117	150-1/4	150-1/4
J118	150-1/4	150-1/4
J119	330-1/4	330-1/4
J120	Coil	Coil
J121	330pF	330pF
C101a, b	2200pF	2200pF
C102a, b	100pF	100pF
C108a, b	100pF	100pF
C110a, b	100pF	100pF
C111a, b	100pF	100pF
C112a, b	100pF	100pF
C113a, b	0.01μF	0.01μF
C138a, b	0.01μF	0.01μF
F140a, b	0.01μF	0.01μF
C137	2A(UP)	2A(UP)
C138	2A(UP)	2A(UP)
F102a, b	T1.4A	T1.4A

Specifications

Power Output:		
8 ohms, 1KHz		40Wx2
Distortion:		0.02%
Input Sensitivity/Impedance:		
Phono MM		1.8mV/50K ohms
Tuner, Monitor		160mV/40K ohms
CD/Aux		160mV/40K ohms
S/N ratio:		
Phono MM (IHF-A weighted, 5mV, Input short)		90dB
Tuner, Monitor (IHF-A weighted)		107dB
CD/Aux		107dB
Residual Noise:		0.5mV
Filter:		
Low cut		70Hz(-6dB/oct)
Phono Subsonic		15Hz(-6dB/oct)
Phono MM Overload:		130mV
Frequency Response:		
Phono MM		20Hz~20KHz (± 0.5 dB)
Tuner, Monitor		10Hz~100KHz (+0, -1.5dB)
CD/Aux		10Hz~100KHz (+0, -1.5dB)
Tone Control:		
Treble		± 8 dB at 10KHz
Bass		± 8 dB at 100Hz
Loudness (Volume: -3dB)		+8dB at 100Hz
Dimensions:		453(W)x317(D)x111(H) mm (17.8"x12.5"x4.4")
Weight:		
Net		5.4 Kgs
Gross		6.6 Kgs
Power Consumption:		120V 2A (CSA rated)

Specifications and appearance design subject to change without notice.