

Digital storage oscilloscope PM3311(U)

Operating Manual/Bedienungsanleitung/Notice d'Emploi

9499 440 23001

821022



PHILIPS

CONTENTS	Page
1. GENERAL INFORMATION	1- 1
1.1. Introduction	1- 1
1.2. Characteristics	1- 2
1.3. Accessories	1- 8
1.4. Accessory information	1- 9
1.5. Principle of operation	1-22
2. INSTALLATION INSTRUCTIONS	1-24
2.1. Important safety instructions	1-24
2.2. Removing and fitting the front cover	1-24
2.3. Position of the instrument	1-24
2.4. Mains voltage setting and fuse	1-25
2.5. Earthing	1-26
3. OPERATING INSTRUCTIONS	1-27
3.1. General information	1-27
3.2. Switching-on and power-up routine	1-27
3.3. Explanation of controls and sockets	1-28
3.4. Detailed operating information	1-44
4. BRIEF CHECKING PROCEDURE	1-52
4.1. General information	1-52
4.2. Preliminary settings of the controls	1-52
4.3. Checking procedure	1-52
5. PREVENTIVE MAINTENANCE	1-55
5.1. General information	1-55
5.2. Cleaning the Nextel suède coating	1-55
5.3. Removing the bezel and contrast plate	1-55
5.4. Recalibration	1-55

1. GENERAL INFORMATION

1.1. INTRODUCTION

The PM 3311 Digital Storage Oscilloscope is a portable, two-channel 60 MHz measuring instrument featuring micro-processor controlled electronic circuits.

A compact ergonomic design facilitates the extensive measuring capabilities of the instrument.

The versatile circuit arrangement combined with the software of the micro-processor gives a wide range of facilities, including:

- Brilliant display.
- Pre-trigger view.
- Storage of two channels with four different "event" signals per channel.
- IEC-bus optional (with the aid of PM 3325).
- Plotter output.
- Trigger delay.
- Battery powered memory back-up.

Furthermore, a large 8 cm x 10 cm screen with illuminated graticule lines provides for easier viewing, a 10 kV accelerating potential giving a high-intensity trace with a well-defined spot.

The oscilloscope is provided with numerous integrated circuits, which ensure stable operation and reduce the number of adjusting points.

The supply voltage can be set to one of two ranges: 100 ... 120 V \pm 10 % or 220 ... 240 V \pm 10 %.

As a result of the features listed above, the oscilloscope is suitable for a wide range of applications, for example the measurement and observation of:

- Rise-time (gives brilliant display intensity).
- Fast signals with a very low repetition rate.
- Very low frequency signals (up to 1 hour per division).



Fig. 1.1. 60MHz Digital storage oscilloscope PM 3311

1. GENERAL INFORMATION

1.1. INTRODUCTION

The PM 3311 Digital Storage Oscilloscope is a portable, two-channel 60 MHz measuring instrument featuring micro-processor controlled electronic circuits.

A compact ergonomic design facilitates the extensive measuring capabilities of the instrument.

The versatile circuit arrangement combined with the software of the micro-processor gives a wide range of facilities, including:

- Brilliant display.
- Pre-trigger view.
- Storage of two channels with four different "event" signals per channel.
- IEC-bus optional (with the aid of PM 3325).
- Plotter output.
- Trigger delay.
- Battery powered memory back-up.

Furthermore, a large 8 cm x 10 cm screen with illuminated graticule lines provides for easier viewing, a 10 kV accelerating potential giving a high-intensity trace with a well-defined spot.

The oscilloscope is provided with numerous integrated circuits, which ensure stable operation and reduce the number of adjusting points.

The supply voltage can be set to one of two ranges: 100 ... 120 V \pm 10 % or 220 ... 240 V \pm 10 %.

As a result of the features listed above, the oscilloscope is suitable for a wide range of applications, for example the measurement and observation of:

- Rise-time (gives brilliant display intensity).
- Fast signals with a very low repetition rate.
- Very low frequency signals (up to 1 hour per division).



Fig. 1.1. 60MHz Digital storage oscilloscope PM 3311

1.2. CHARACTERISTICS

This instrument has been designed and tested in accordance with IEC Publication 348 for Class 1 instruments and UL 1244 and has been supplied in a safe condition. The present Instruction Manual contains information and warnings that shall be followed by the purchaser to ensure safe operation and to retain the instrument in a safe condition.

- This specification is valid after the instrument has warmed up for 30 minutes (reference temperature 23 °C).
- Properties expressed in numerical values with tolerance stated, are guaranteed by the manufacturer. Numerical values without tolerances are typical and represent the characteristics of an average instrument.
- Inaccuracies (absolute or in %) relate to the indicated reference value.

<i>Designation</i>	<i>Specification</i>	<i>Additional information</i>
1.2.1. C.R.T.		
Cathode ray tube	D14 - 292 GH/39	
Accelerating voltage	10 kV	
Screen size	8 x 10 cm	Metal backed
Phosphor type	P31 (GH)	
Graticule	Internal	With centimeter divisions and 2 mm subdivisions along the central vertical axis shorter 2 mm divisions along the second, fourth, sixth and eight horizontal axis.
Graticule illumination	Clearly visible under normal light conditions and continuously variable	
Trace rotation	Front panel screwdriver adjustment	
Focus	Adjusted automatically	
1.2.2. Input vertical		
Frequency range	d.c. 0 ... 60 MHz a.c. 10 Hz ... 60 MHz	
Rise-time	< 6 ns	
Pulse aberrations	± 3 %	Measured in Y-expand with a test pulse of 8 div; rise-time 1 ns; frequency 1 MHz (except first 0.2 cm measured from mid pulse)
Vertical deflection		
Defl. coeff.	10 mV/div ... 50 V/div	12 Calibrated positions in 1-2-5 sequence
Error limit	± 3 %	± 5 % in Y - expand
Continuous control range	1 : > 2.5	
Input impedance	1 MΩ // 25 pF	
Coupling	a.c. - 0 - d.c.	
 Max. safe input voltage	400V	d.c. + a.c. peak
Input selection	A only B only Add A and B	Channel B can be inverted

C.M.R.R.	100 : 1	At 2 MHz max. common mode signal 8 div.
Dynamic range	2x voltage range	
DC offset	± 4x voltage range	
Max. sample rate	125MHz	
Visible signal delay	> 10 ns	See also "delay"

1.2.3. Time-base

Time coefficients		
Repetitive only	5 ns ... 0.1µs/div	
Direct	0.2 µs ... 0.2 s/div	
Roll	0.5 s ... 60 min/div	
Coefficient error	< 2 %	4% combined with delay in "REPETITIVE ONLY"
Resolution	25 samples/div	

1.2.4. Triggering

Source	A B EXT EXT : 10 Line	
Sensitivity		
Internal	0.3 div 0.15 div	at 60 MHz at 40 MHz
External	0.3 V 0.15 V	at 60 MHz at 40 MHz
Ext : 10	3 V 1.5 V	at 60 MHz at 40 MHz
Slope	+/-	
Modes	Auto d.c. a.c. TV-frame (1/1 picture)	20 Hz ... 60 MHz dc ... 60 MHz 10 Hz ... 60 MHz Acc. to CCIR (625 lines)
Level		
Auto	Proportional to peak-to-peak value of trigger signal	
a.c./d.c.	± 3 div	
Delay		
Range	-9 ... +9999 div 0 ... 100 div	0.2 s ... 0.5 µs/div 0.2 µs ... 5 ns/div
Accuracy	±2 mm or 0.01 % ±2 div + visible delay	0.2 s ... 0.5 µs/div 0.2 µs ... 5 ns/div
Input impedance	1 MΩ // 25 pF	
 Max. safe input voltage	400V	dc + ac peak

1.2.5. **Memory**



Number of memories	4	1 accumulator memory and 3 store memories
Resolution horizontal	1 : 250	In single trace mode
Resolution vertical	1 : 250	

1.2.6. **Operation modes**

Single	Refreshment of accumulator mem. takes place, when trigger level is reached and time set with trigger delay has been passed. Signal is stored according to position of trigger delay. During waiting time accumulator, is displayed and LED "NOT TRIG'D" lights up.	0.2 μ s ... 0.2 s/div
Recurrent	Signal in accumulator memory is displayed on the screen. After the time set with the trigger delay the memory is overwritten by new information.	5 ns ... 0.2 s/div
Roll	Signal is built-up point by point at the right-hand side of the screen and moves to the left. When accumulator is completely filled, information is placed in register 3, next in 2, then in 1 and next in accumulator. After this, roll-mode stops, indicated by flashing "RUN" light.	0.5 s ... 60 min/div
Multiple	4 times single with "SAVE" in memories	0.2 μ s ... 0.2 s/div

1.2.7. **Display modes**

Memory	Covers 2 div. screen height	
Channel display combinations		
Accumulator	Depends on input selection	
Register	Information as stored in accumulator can be selected for storage in each of the three register memories and is displayed if display button is depressed.	Total information held in STORE 1, 2 or 3 can be inverted.
Vertical position range	± 8 div	
Vertical expand	5 x	Memory covers 10 cm screen height. Indicated via LED in display section.
Horizontal expand	1 : > 2.5	Continuous
X-Y selection	Deflection in X-direction can be derived from time base or from memory contents derived from A-input	

	Memory modes	Clear	Accumulator memory is cleared
		Save (3x)	Contents of accumulator memory are stored in selected register
		Write	Input signal can be written in accumulator memory
		Lock	Memory system is closed
	Dot join	Pushbutton	Changes normal display mode (dot-join) into display of only dots.
1.2.8.	Plot output		
	Horizontal	1 V / full scale	
	Vertical	1 V / full scale	
	 Pen lift	TTL comp. "0" = unblanked (pen down) "1" = blanked (pen up)	open collector output max. load 0,5V at 500 mA cont.
	Max. permissible voltage	20V PEAK	
	Plot time	approx. 100 s.	
	Plot sequence	B plot after A plot	
1.2.9.	Interfaces		
	IEC-Bus	Optional by means of a plug-in p.c. board	
	IEC-Bus	Settings and output controllable from bus-line controller	
	Local/Remote	With IEC connector.	
1.2.10.	X-Y Display		
	Y f(t)	From time-base	
	Y f(x)	From YA input	Dot join is not in operation
	Bandwidth	See YA	
	Accuracy	< 5 %	Tube included
	Phase difference	Distance between signal derived from A and signal derived from B is 1/25 div.	
	Position	0 of stored A signal will be at centre of screen	
1.2.11.	Calibration output		
	Frequency	2.5 kHz	
	Voltage	3 V	
	Current	6 mA	
1.2.12.	Power supply		
	 Line voltage	100 ... 120 V \pm 10 % 220 ... 240 V \pm 10 %	
	Line frequency	50 ... 400 Hz \pm 10 %	
	Power consumption	< 70 W	

Battery		
Function	For memory back-up only	
Type	2 pen light batteries of 1.5 V	For instance 2 x 1.5 Philips R6P
Insulation	The insulation of the power supply fulfils the safety requirements of IEC 348 cl. I for metal-encased instruments	

1.2.13. Environmental characteristics

Note: The characteristics are valid only if the instrument is checked in accordance with the official checking procedure. Details on these procedures and failure criteria are supplied on request by the PHILIPS-organisation in your country, or by N.V. PHILIPS' GLOEILAMPENFABRIEKEN, TEST AND MEASURING DEPARTMENT, EINDHOVEN, THE NETHERLANDS.

Ambient temperature	+ 5 °C ... +40 °C -10 °C ... +40 °C -55 °C ... +75 °C	Rated range of use Operating temperature range Storage temperature in accordance with MIL 28800 and a maximum at 24 hours on high and low temperature
Altitude		
Operating	5000 m (15000 ft)	} In accordance with IEC 68-2-13 test M
Non-operating	15000 m (50000 ft)	
Humidity	Acc. IEC 68 Db	Instrument withstands 95 % RH over a temperature cycle of 25 °C to 40 °C (non-operating)
Shock	30 m/s ²	Operating; half sine-wave shock of 11 ms duration; 3 shocks per direction for a total of 18 shocks.
Vibration	3 m/s ²	Operating; vibrations in three directions with a maximum of 20 min. per direction; 10 minutes with a frequency of 5 - 25 Hz and amplitude of 1.016 mm p-p; 10 min with a frequency of 25 - 55 Hz and an amplitude of 0.5 mm p-p. An extra 10 minutes of the resonant of frequency with the highest rise in amplitude. Unit mounted on vibration table without shock absorbing material.
Dimensions	Length 460 mm Width 316 mm Height 154 mm	Handle and controls excluded Handle excluded Feet excluded See also Fig. 1.2.
Weight	Approx. 12 kg	

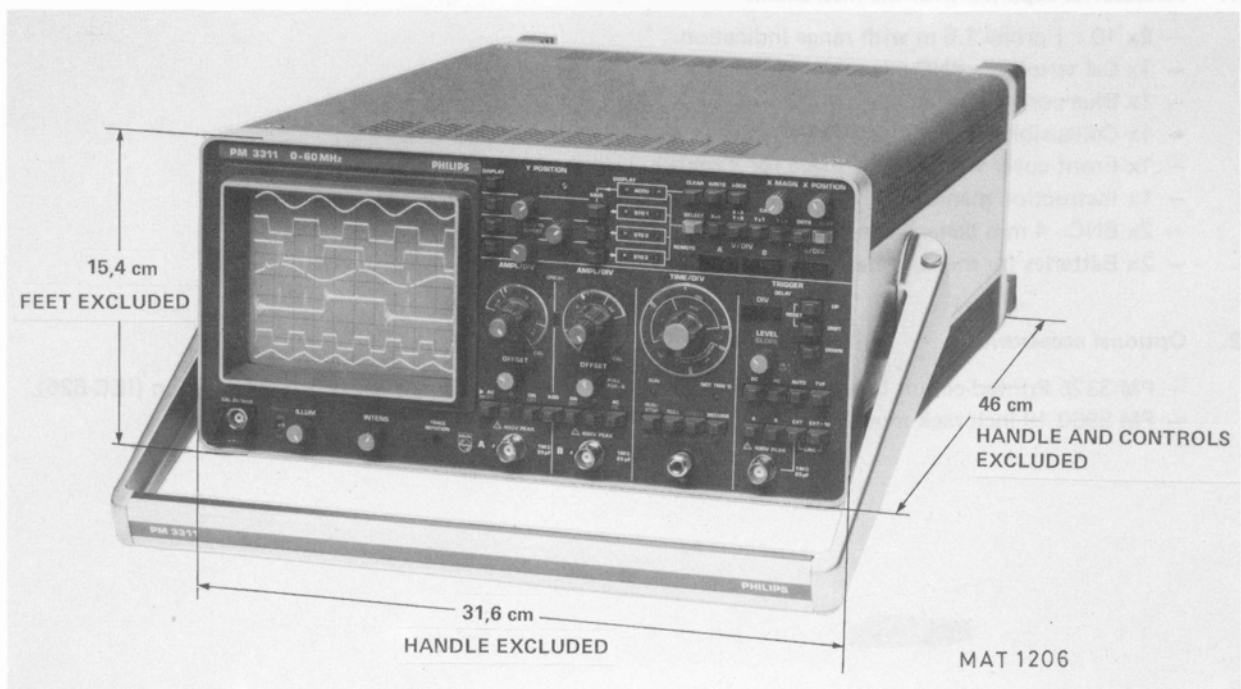

Fig. 1.2. Dimensions

1.3. ACCESSORIES

1.3.1. Accessories supplied with the instrument

- 2x 10 : 1 probe 1.5 m with range indication.
- 1x Cal terminal - BNC adaptor.
- 1x Blue contrast filter.
- 1x Collapsible viewing hood PM 9366.
- 1x Front cover with storage space for 3 probes.
- 1x Instruction manual.
- 2x BNC - 4 mm banana adaptor PM 9051.
- 2x Batteries for memory back-up (Not mounted, installation only by a qualified person).

1.3.2. Optional accessories

- PM 3325 Printed-circuit board with connector and mounting materials for IEC bus operation (IEC-625).
- PM 8960 19-inch rack mount.

1.4. ACCESSORY INFORMATION

1.4.1. 10 : 1 probe (1.5 m) with range indication

The probe delivered with the oscilloscope PM 3311 is comparable to the standard probe PM 8927S. This is a 10x attenuator probe, designed for oscilloscopes up to 80 MHz, having a BNC input jack and 14 ... 40 pF input capacitance paralleled by 1 M Ω . At delivery the h.f. step response has been adjusted to the input capacitance of the PM 3311.

The probe is provided with a special BNC jack in order to obtain range indication. This means that the attenuator scale of the oscilloscope is adapted to the probe attenuation automatically.

Characteristics

Electrical

Attenuation	10x \pm 2 % (Oscilloscope input 1 M Ω)
Input resistance d.c.	10 M Ω \pm 2 % (Oscilloscope input 1 M Ω)
a.c.	See curve Fig. 1.3.
Input capacitance d.c. and l.f.	11 pF \pm 1 pF (Oscilloscope input 1 M Ω \pm 5 % paralleled by 13 pF \pm 3 pF)
Input reactance h.f.	See curve Fig. 1.3.
Useful bandwidth	See curve Fig. 1.4a
Max. input voltage	500 V d.c. + a.c. peak, derating with frequency. See Fig. 1.4. Oscilloscope input 1 M Ω and voltage applied between probe tip and earthed part of probe body. Test voltage 1500 V _{d.c.} during 1 s. at a temperature between 15 and 25 °C, a rel. hum. of 80 % at maximum and at sea level.
Check-zero button probe shell	Same function as 0 position of input coupling switch on oscilloscope.
Compensation range	14 ... 40 pF

Environmental

Probe operates within specifications over the following ranges:

Temperature	-25 °C to +70 °C
Altitude	Up to 5000 meters (15000 feet)
Other environmental data	Same as for any PHILIPS oscilloscope the probe is used with

Mechanical

Dimensions	Probe body 103 mm x 11 mm dia (max.) Cable length 1500 mm or 2500 mm Correction box 55 x 30 x 15 mm incl. BNC
Mass	Incl standard accessories 140 g

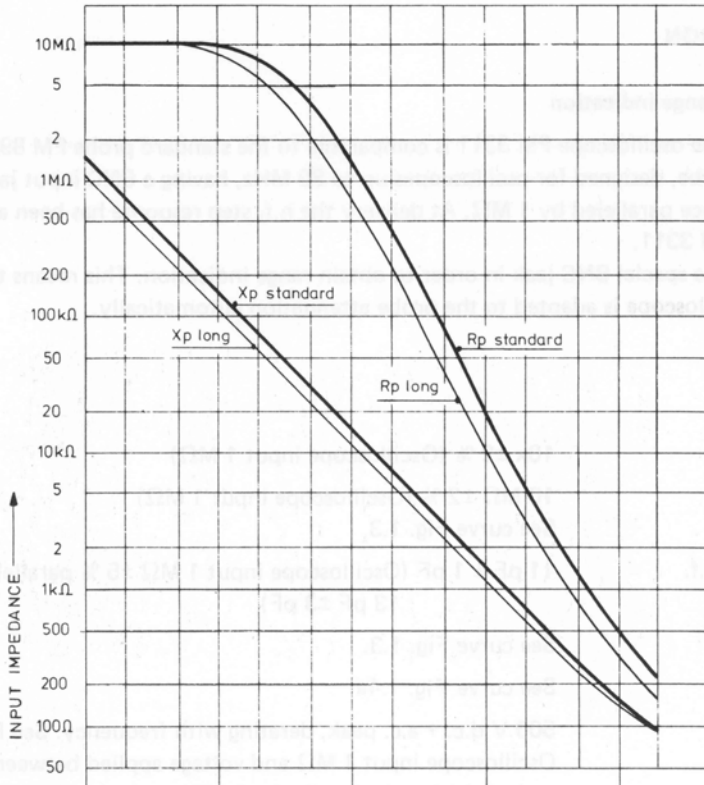

Fig. 1.3.

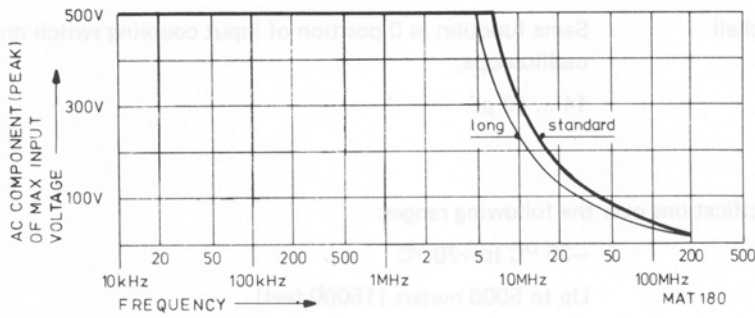

Fig. 1.4.

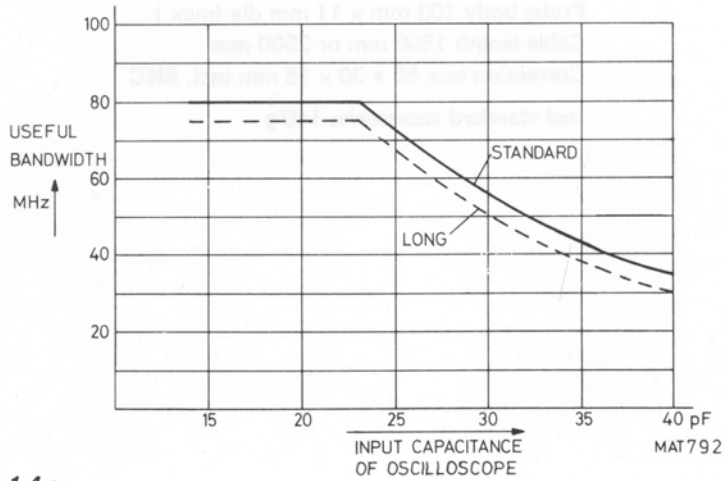

Fig. 1.4.a.

Adjustments

Matching the probe to your oscilloscope

The measuring probe has been adjusted and checked by the manufacturer. However, to match the probe to your oscilloscope, the following manipulation is necessary.

Connect the measuring pin to the CAL socket of the oscilloscope.

A trimmer C2 (Fig. 1.11.) can be adjusted through a hole in the compensation box to obtain optimum square-wave response. See Fig. 1.5., 1.6. and 1.7.

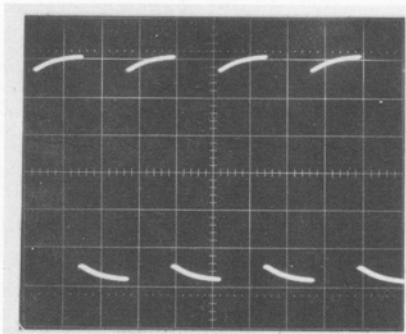

*Fig. 1.5. Over-compensation
(adjustment C2)*

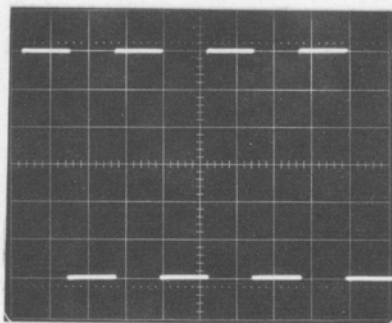

*Fig. 1.6. Correct compensation
(adjustment C2)*

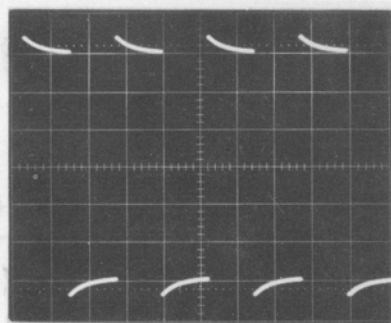

*Fig. 1.7. Under-compensation
(adjustment C2)*

1.4.1.1. CAL TERMINAL—BNC adaptor

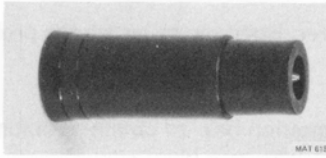

Fig. 1.8.

1.4.1.2. BLUE CONTRAST FILTER

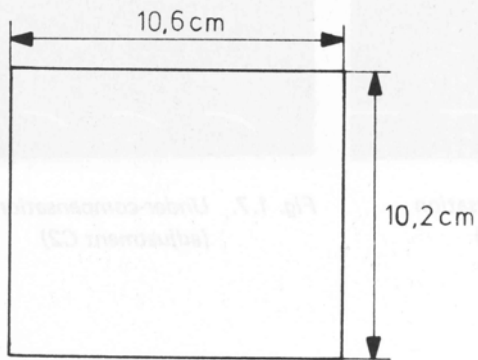

Fig. 1.9

1.4.1.3. PM9366 COLLAPSIBLE VIEWING HOOD



Fig. 1.10.

1.4.1.4. FRONT COVER

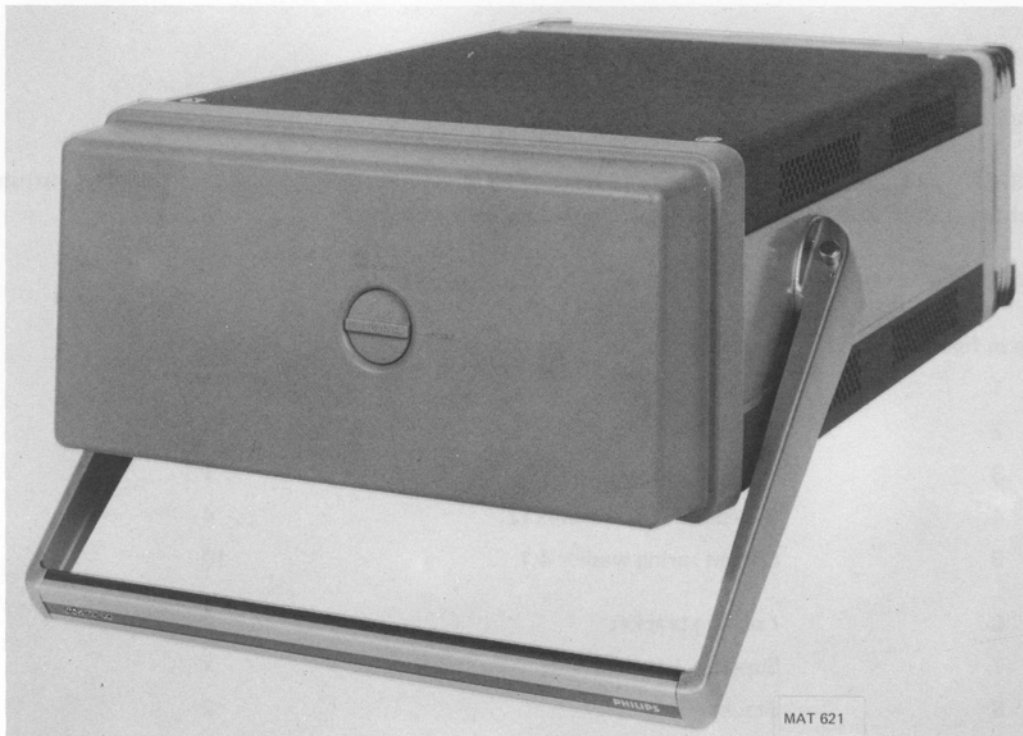

Fig. 1.11

1.4.1.5. BNC- 4mm BANANA ADAPTOR PM9051



Fig. 1.12.

1.4.2. Accessory information for optional items

1.4.2.1. Assembling instructions for rack-mount adaptor kit PM8960

Introduction

PM 8960 is an adaptor kit to enable the PM 3311 to be mounted in a 19" rack or cabinet. The instrument mounted with this kit can be slid out and inverted for easy inspection.

Contents of an adaptor kit PM 8960

Item in figure	Description	Number in kit
1	Handle	2
2	Front panel	1
3	Support, right-hand side	1
4	Cheese-head screw M4x12	4
5	Curved spring washer 4.1	10
6	Locking bracket	2
7	Support, left-hand side	1
8	Bracket	2
9	Telescopic rail	2
10	Countersunk screw M4x10	6
11	Hexagonal nut M4	6
12	Bracket	2
13	Cheese-head screw M5x10	8
14	Curved spring washer 5.1	8
15	Washer 5.3x10	8
16	Cupped washer 5.3x12	4
17	Countersunk M5x12	4

Mounting the telescopic rails

- Screw brackets, item 8, to the telescopic rails, item 9, by means of countersunk-head screws, item 10, curved spring washers, item 5, and hexagonal nuts, item 11. The fixing holes are accessible through an opening in the centre guide of the telescopic rails.
- Screw brackets item 12 to the rear end of the telescopic rails using equal numbers of items 5; 10 and 11.
- Screw the assembly between the mounting supports of the 19" cabinet or rack by means of cheese-head screws, item 13, washers, item 14, and curved spring washers, item 15.

Carrying handle

For removal:

- Remove the upper and lower instrument cover plates.
- Remove the plastic strip which is snapped on to the grip by slight leverage under one edge.
- Remove the four screws which secure the grip to the brackets.
- Depress the pushbuttons in the brackets and turn the carrying handle horizontally above the upper side of the oscilloscope.
- Keep the pushbutton of the right-hand bracket depressed and pull the bracket from its bearing.
- Remove the grip from the remaining bracket.
- Depress the pushbutton of the left-hand bracket and turn the latter horizontally below the base of the instrument.
- Keep the pushbutton depressed and pull the bracket from its bearing.

Fitting handles and supports to the front panel

Screw the supports, items 3 and 7, via the holes in front panel, item 2, to the handles with the aid of cheese-head screws, item 4, and curved spring washer, item 5.

Fitting the front panel to the oscilloscope

Pull the supports (items 3 and 7) slightly outwards and slip the front panel over the oscilloscope facia. Ensure that the narrower parts of the key holes in the supports point to the top of the oscilloscope. If they point downwards, turn the front panel-support combination 180° and fit it again round the oscilloscope. Slip the key holes in the supports over the handle bearings of the oscilloscope. Lock the supports to the oscilloscope by inserting locking brackets item 6 into the slots in the handle bearings.

Fitting the oscilloscope to the telescopic rails

Pull the telescopic rails all the way out. Slip the key holes in the supports (item 3 and 7) over the mushroom nuts in the front part of the rails and see that the oscilloscope slides down until the narrower part of the key holes rest on the mushroom nuts.

Slide the whole into the rack or the cabinet and secure the panel by means of countersunk-head screws, item 17, and cupped washers, item 16.

Turning the oscilloscope over for easy inspection

Pull the oscilloscope all the way out of the rack or cabinet.

Disengage the front key holes from their mushroom nuts and turn the oscilloscope over until its front rests against the rack or cabinet. For fitting the oscilloscope again in its normal position, proceed in reverse order.

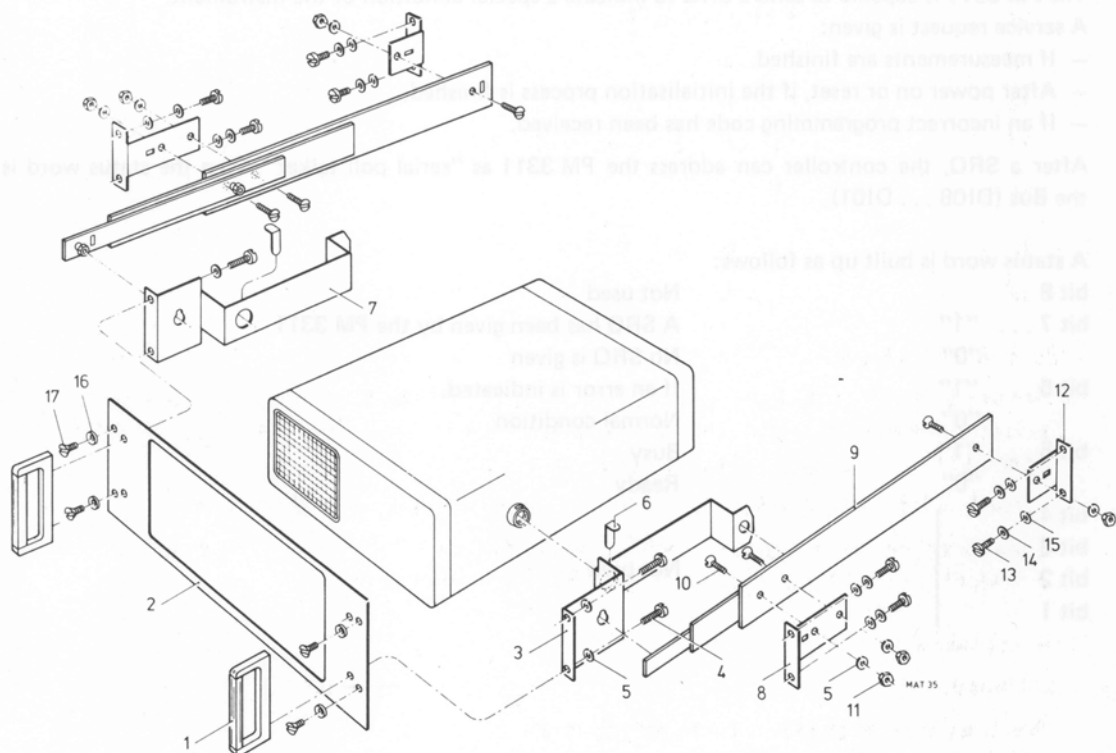

Fig. 1.13.

1.4.2.2. IEC bus interface PM 3325

General

The PM 3325 is a General Purpose Bus Interface according the IEC - TC 66 document, including a self-test facility.

Address selection is done by 5 switches (5 least significant bits of the ASCII characters).

A card function identification is also implemented.

Interface function repertoire for PM 3311

<i>Interface function</i>	<i>Symbol.</i>	<i>Identification</i>	<i>Remark</i>
Source handshake	SH	SH1	
Acceptor handshake	AH	AH1	
Talkerfunction	T	T6	
Listener function	L	L4	
Service request	SR	SR1	The PM 3311 is capable of sending a Service request. No local lock out.
Remote local	RL	RL2	
Device clear	DC	DC1	
Parallel poll	PP	PP0	No capability
Device trigger	DT	DT1	
Controller function	C	C0	No capability

Service Request (SRQ)

The PM 3311 is capable to send a SRQ to indicate a special condition of the instrument.

A service request is given:

- If measurements are finished.
- After power on or reset, if the initialisation process is finished.
- If an incorrect programming code has been received.

After a SRQ, the controller can address the PM 3311 as "serial poll talker", than the status word is set on the Bus (DI08 . . . DI01).

A status word is built up as follows:

bit 8	Not used
bit 7 . . . "1"	A SRQ has been given by the PM 3311
"0"	No SRQ is given
bit 6 . . . "1"	If an error is indicated.
"0"	Normal condition
bit 5 . . . "1"	Busy
"0"	Ready
bit 4	} Not used
bit 3	
bit 2	
bit 1	

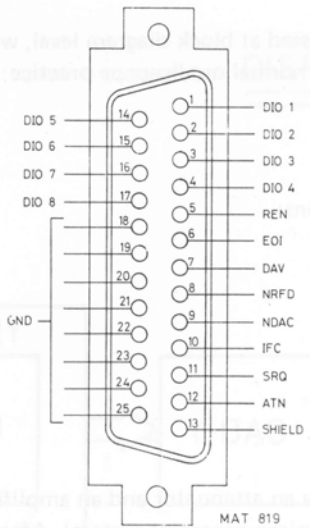

Input – Output

Input/output system

Bit parallel – Character serial

Input/output code

ISO 7 bit code ISO 646 (similar to ASCII)

Input/output levels:

L = -0.5 V . . . +0.8V

H = +2V . . . +5.5V

Logic levels for the 8 DIO lines

L = 1

H = 0

Connector contact assignment.

Connector Philips type

F161 male

Mounting

For mounting instructions see information delivered with the PM 3325.

Function of signals

Mnemonic	Signal name	Direction	Description
DIO 1	Data in/out 1	E ↔ O	Data input/output
DIO 2	Data in/out 2	E ↔ O	Data input/output
DIO 3	Data in/out 3	E ↔ O	Data input/output
DIO 4	Data in/out 4	E ↔ O	Data input/output
REN	Remote enable	E → O	Remote enable
EOI	End or identify	E ↔ O	End or identify
DAV	Data valid	E ↔ O	Condition of information
NRFD	Not ready for data	E ↔ O	Device is busy
NDAC	Not data accepted	E ↔ O	Condition of data acceptance
IFC	Interface clear	E → O	Resetting of the interface
SRQ	Service request	E ← O	Oscilloscope asks for service
ATN	Attention	E → O	Attention
SHIELD		E - O	
DIO 5	Data in/out 5	E ↔ O	Data input/output
DIO 6	Data in/out 6	E ↔ O	Data input/output
DIO 7	Data in/out 7	E ↔ O	Data input/output
DIO 8	Data in/out 8	E ↔ O	Data input/output
GND	Ground	E - O	Common
GND	Ground	E - O	Common
GND	Ground	E - O	Common
GND	Ground	E - O	Common
GND	Ground	E - O	Common
GND	Ground	E - O	Common
GND	Ground	E - O	Common
GND	Ground	E - O	Common
GND	Ground	E - O	Common

E = External Controller

O = Digital storage oscilloscope

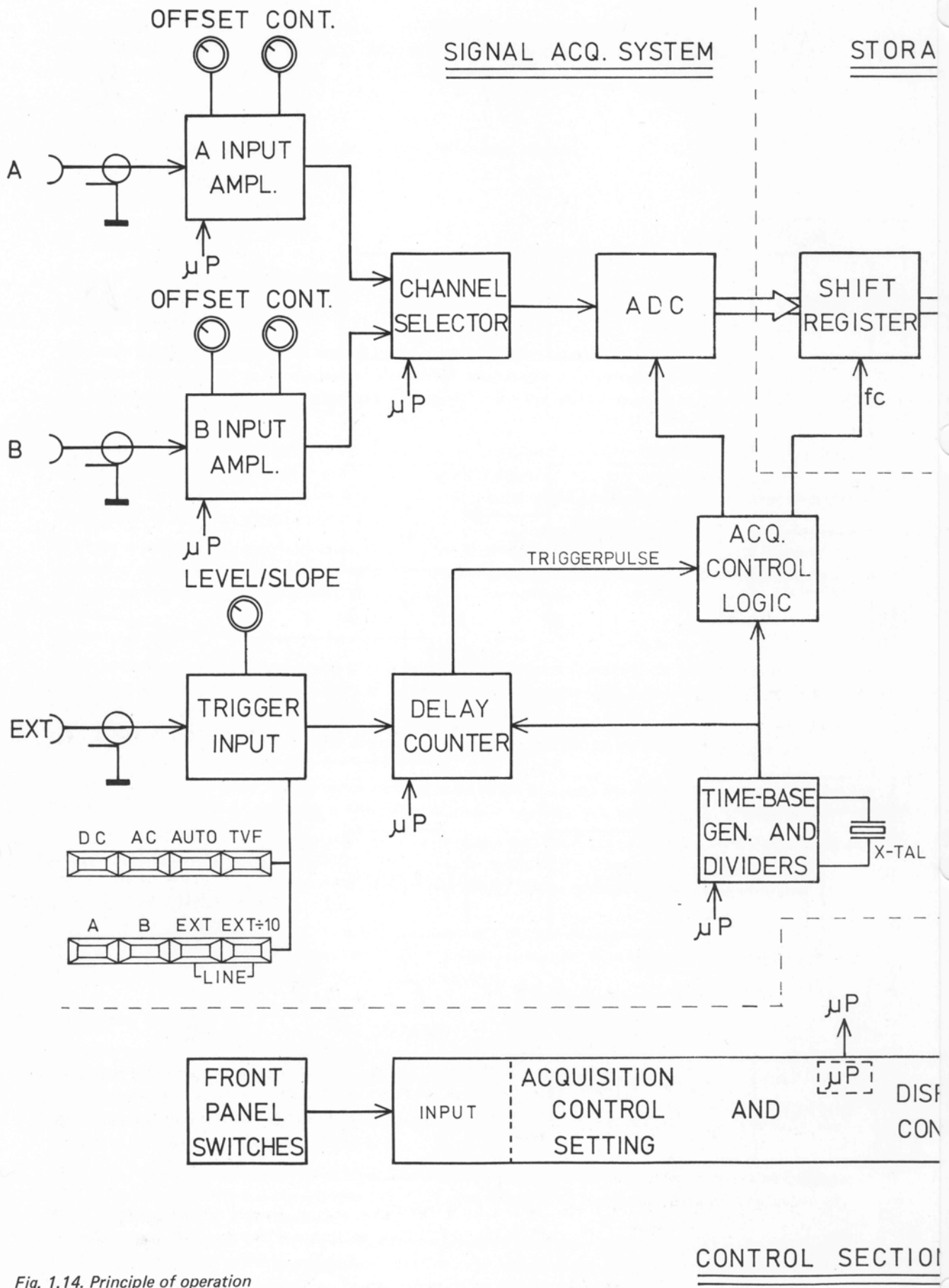
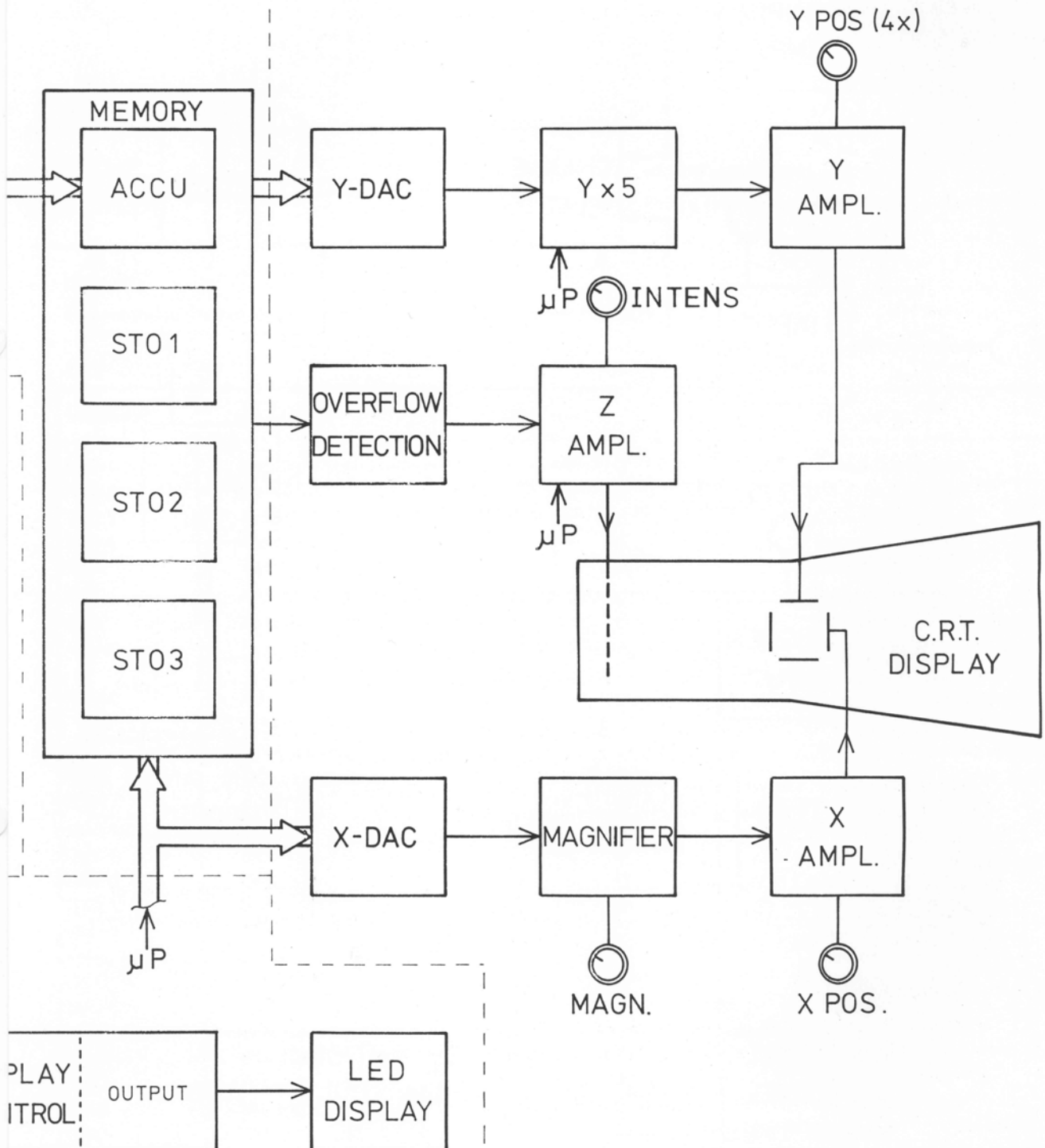

Fig. 1.14. Principle of operation

CONTROL SECTION

GE SECTION

DISPLAY SECTION



1.5. PRINCIPLES OF OPERATION (See Fig. 1.14.)

In this section, the principles of operation of the PM 3311 are discussed at block diagram level, with special emphasis being applied to those parts of the circuit that differ from normal oscilloscope practice; i.e. the digital storage and control facilities.

1.5.1. General

The PM 3311 digital storage oscilloscope comprises four basic sections:

- a signal acquisition system
- a storage section
- a display section
- a control section.

These sections are now considered in some detail.

1.5.2. The signal acquisition system

The input signal to be displayed is applied to the channel selector via an attenuator and an amplifier. The front-panel control settings are scanned by the control section (the micro-processor system). After decoding, this information is applied to the attenuator, the amplifier and the channel selector to determine their correct characteristics.

The output of the channel selector is fed to the Analogue-to-Digital Converter (ADC) to convert it from an analogue signal into digital form. A conversion is started if the ADC receives a control pulse from the Acquisition Control Logic (ACL). On receipt of a control pulse, one instantaneous analogue value of the input signal is converted into a digital word by the ADC.

A trigger signal derived either from channel A, channel B, an external input, or from the mains frequency, is applied to the trigger delay counter. After a particular time, determined by the presetting of the delay counter, a trigger pulse is generated and applied to the acquisition control logic.

1.5.3. The storage section

After an analogue-to-digital conversion is completed, the Acquisition Control Logic (ACL) generates a clock pulse for the shift register. At every clock pulse one digital word of the ADC output is stored in the shift register and all existing stored information will shift one position.

The capacity of the shift register is 256 digital words, and therefore 256 converted instantaneous analogue values.

As soon as the trigger delay counter sends a trigger pulse to the ACL, and the ACL has supplied more than 256 pulses to the shift register, the latter is filled with information and the ACL stops generating clock pulses.

The contents of the shift register are now ready to be copied into the Random Access Memory referred to as ACCU. The transfer of information from the shift register to the ACCU is arranged via a "handshake" procedure in order to obtain a flicker-free display on the CRT. When the copying is completed, the shift register is "ready" and the action restarts.

The stored information in the ACCU can be copied into one of the other memories (STO 1, STO 2, STO 3). Each of these RAMs is able to contain 256 bytes of digital information. With both channels ON, the memory capability is equally divided into 128 bytes for each channel.

1.5.4. The display section

The information in the RAMs may now be displayed. The contents of each RAM are 256 words, each consisting of 8 bits. Each 8-bit word is capable of indicating 256 different amplitudes (i.e. $2^8 = 256$): Y parameters.

Each address of the memory corresponds to a specified vertical line of the display along the X-axis; i.e. the display of 10 divisions is divided into 256 lines.

With each 8-bit value per address being an instantaneous value in the Y direction, a display area of 2 vertical and 10 horizontal divisions is divided into 256×256 dots. When Y x 5 is selected, this area is expanded to 256×256 dots over 10×10 divisions.

An address counter sends 256 different addresses sequentially (starting with address 0 and ending with address 255) to the RAMs and to the Digital-to-Analogue Converter (DAC) of the X-system. To provide the discrete steps for the horizontal time-base display, the output of the X-DAC is a linear staircase voltage, which is applied to the X amplifier via the magnifier. The resulting output of the X amplifier is routed to the horizontal deflection plates of the CRT.

Similarly, the 8-bit instantaneous values for each address (i.e. the Y information) are converted into analogue signals by means of the Y-DAC. Via the Y x 5 magnifier, the converted signal is applied to the Y amplifier and then to the vertical deflection plates of the CRT.

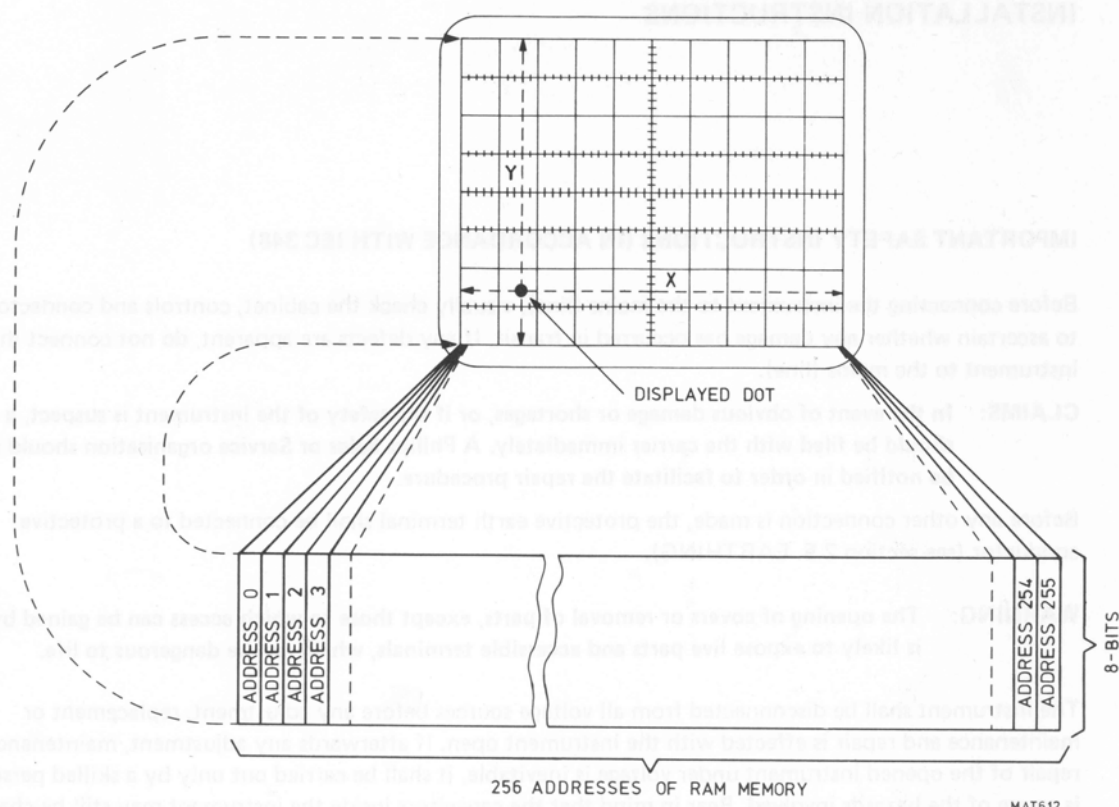

Fig. 1.15.

1.5.5. The control section

The control section consists of a micro-processor, memories, latches, input and output ports and relevant logic circuits.

The following functions are under its control:

– Front panel switches

At a defined time interval the control section scans all switches (except the trigger source and trigger mode switches) on the front panel. The settings are decoded and the corresponding functions are set.

To simplify operation, incorrect settings will be translated into meaningful settings (e.g. both channels OFF would be translated into channel A ON).

– Recalculation

In the expand mode, the setting of AMPL/DIV are recalculated and displayed.

– Display control

The control of the complete display is handled by the control section. The display section comprises the CRT, the pilot lamps, the alpha-numeric LEDs and associated circuits for the display elements.

The CRT display is built-up dot by dot. In order to obtain a line display, the control section generates the control signals for the dot-joining system.

– Handshake procedure

The input system (including the shift register) and the display system have different operating cycles. To obtain a flicker-free display, both systems are coupled via a handshake procedure, organised by the control section.

In addition to these standard oscilloscope functions, the control section also supervises the plot output and the handling of the IEC-bus option.

2. INSTALLATION INSTRUCTIONS

2.1. IMPORTANT SAFETY INSTRUCTIONS (IN ACCORDANCE WITH IEC 348)

Before connecting the instrument to the mains (line), visually check the cabinet, controls and connectors etc. to ascertain whether any damage has occurred in transit. If any defects are apparent, **do not** connect the instrument to the mains (line).

CLAIMS: In the event of obvious damage or shortages, or if the safety of the instrument is suspect, a claim should be filed with the carrier immediately. A Philips Sales or Service organisation should also be notified in order to facilitate the repair procedure.

Before any other connection is made, the protective earth terminal shall be connected to a protective conductor (see section 2.5. EARTHING).

WARNING: The opening of covers or removal of parts, except those to which access can be gained by hand, is likely to expose live parts and accessible terminals, which can be dangerous to life.

The instrument shall be disconnected from all voltage sources before any adjustment, replacement or maintenance and repair is effected with the instrument open. If afterwards any adjustment, maintenance or repair of the opened instrument under voltage is inevitable, it shall be carried out only by a skilled person who is aware of the hazards involved. Bear in mind that the capacitors inside the instrument may still be charged even if the instrument has been separated from all voltage sources.

2.2. REMOVING AND FITTING THE FRONT COVER

Removing:

- Push and rotate the knob in the centre of the cover a quarter-turn anti-clockwise to the UNLOCKED position.
- Remove the cover.

Fitting:

- Push and rotate the knob to the UNLOCKED position.
- Fit the cover over the front of the oscilloscope.
- Press and rotate the knob a quarter-turn clockwise to the LOCKED position.

Space is available in the front cover to accommodate accessories such as probes, collapsible viewing hood, etc. To open the front cover, press both tongues of the locking device and lift the inner plate.

2.3. POSITION OF THE INSTRUMENT

The instrument may be used in any desired position. With the handle folded down the instrument may be used in sloping position. The electrical characteristics in accordance with para. 1.2. are guaranteed for any position of the instrument. (Ensure that the ventilation holes in the top and bottom covers are free). Do not position the instrument on any surface which produces or radiates heat, or in direct sunlight.

The carrying handle can be rotated if the push-buttons on its bearings are depressed.

2.4. MAINS VOLTAGE SETTING AND FUSE

Before inserting the mains plug into the mains socket, make sure that the instrument is set to the local mains voltage.

This can be done by the MAINS ADAPTOR SWITCH on the rear panel.

⚠ The two-position switching enables the instrument to operate at any mains voltage between 100 V and 120 V $\pm 10\%$ (115 V visible in MAINS ADAPTOR SWITCH window) and between 220 V and 240 V $\pm 10\%$ (230 V visible in window). If the mains plug has to be adapted, it must be executed by a qualified person only.

The fuse-holder mounted on the rear panel carries a 2 A delayed-action fuse (4822 253 30025).

Make sure that only fuses with the required rated current and of the specified type are used for replacement. The use of mended fuses and the short-circuiting of fuse holders must be avoided. The instrument must be disconnected from all voltage sources when a fuse is to be replaced or when the instrument is to be adapted to a different mains voltage. The fuses shall be replaced only by a qualified person who is aware of the danger involved.

Note: The same 2 A delayed-action fuse is applicable for all settings of the mains adaptor switch.



Fig. 2.1. Rear view of oscilloscope showing mains adaptor switch and fuse.

When not in use, the mains lead can be stored around the feet on the rear panel.

2.5. EARTHING

Before switching on, the instrument shall be connected to a protective earth conductor in one of the following ways:

- via the protective earth terminal;
- via the three-core mains cable. The mains plug shall only be inserted into a socket outlet provided with a protective earth contact. The protective action shall not be negated by the use of an extension cord without protective conductor.

WARNING: Any interruption of the protective conductor inside or outside the instrument, or disconnection of the protective earth terminal, is likely to make the instrument dangerous. Intentional interruption is prohibited.

When an instrument is brought from a cold into a warm environment, condensation may cause a hazardous condition. Therefore, make sure that the earthing requirements are strictly adhered to.

3. OPERATING INSTRUCTIONS

3.1. GENERAL INFORMATION

This section outlines the procedures and precautions necessary for operation. It identifies and briefly describes the functions of the front and rear panel controls and indicators, and explains the practical aspects of operation to enable an operator to evaluate quickly the instrument's main functions.

3.2. SWITCHING-ON AND POWER-UP ROUTINE

3.2.1. Switching-on

After the oscilloscope has been connected to the mains (line) voltage in accordance with sections 2.4. and 2.5., it can be switched on with the **POWER** switch.

The **POWER** switch is incorporated in the graticule **ILLUM** control on the front panel, below the screen bezel. The associated **POWER ON/OFF** indicator lamp is adjacent to the **ILLUM** control/**POWER** switch.

When switching on the oscilloscope, it is immediately ready for use. With normal installation, according to Section 2, and after a warming-up time of 30 minutes, the characteristics according to Section 1.2. are valid.

WARNING: The oscilloscope must never be switched on whilst any circuit board is removed. (Except for **IEC** and **SPARE** circuit board).

Never remove a circuit board until the oscilloscope has been switched-off for at least one minute.

3.2.2. Power-up routine

When switching-on the instrument, note that the in-built micro-processor initiates an automatic test of a number of internal circuits including:

- Start test.
- PROM test.
- LED display test.
- RAM test.

The tests start automatically after switching-on. At the end of the test cycle all pilot lamps, scale lamps and alpha-numerical display will light for about three seconds, and then the oscilloscope switches to normal operation.

If during the test a circuit is found to be faulty, the test stops. This will be visible by:

1. The instrument does not operate normally.
2. A number (but not all) pilot lamps and scale lamps will light.

If this occurs it is recommended to switch-off the instrument and switch-on again after a few seconds.

If after switching-on the same fault condition appears, contact your Philips service department.

If one or more of the pilot lamps and scale lamps do not light and the instrument reverts to the operative mode after the tests, that particular lamp might be defect.

If during operation the system blocks, which may be caused by extreme high static voltages, a switch-off and switch-on action will automatically reset the micro-processor controlled system and the oscilloscope will become operative again.

3.3. EXPLANATION OF CONTROLS AND SOCKETS

The controls and sockets are listed according to their sections and a brief description of each is given.

3.3.1. CRT section

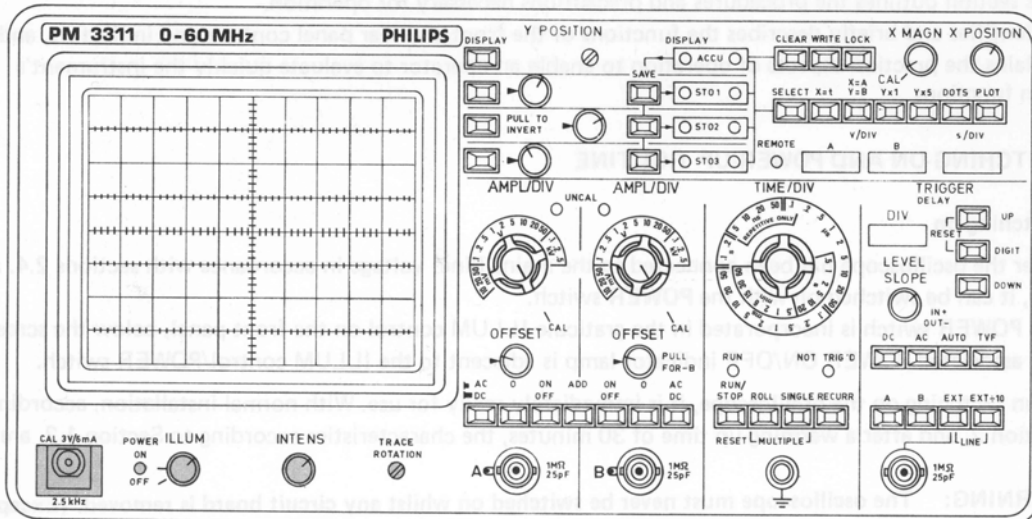
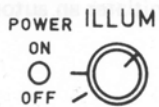

Fig. 3.1.



Continuously variable control of the graticule illumination, incorporating the POWER ON/OFF switch. Pilot lamp indicates when the power is switched on.



Continuously variable control of the trace intensity.
Note: The PM 3311 is equipped with an automatic focus control. Therefore, external focus adjusting is superfluous.



Preset control for aligning the trace with the horizontal graticule lines (screwdriver control).

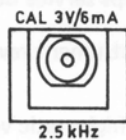

Output providing a 3 V_{p-p}, 2.5 kHz square-wave voltage, to calibrate vertical deflection AMPL control, or for frequency compensation of voltage divider probes.
Current loop with 6 mA_{p-p} for calibration of current probes.

3.3.2. Vertical section

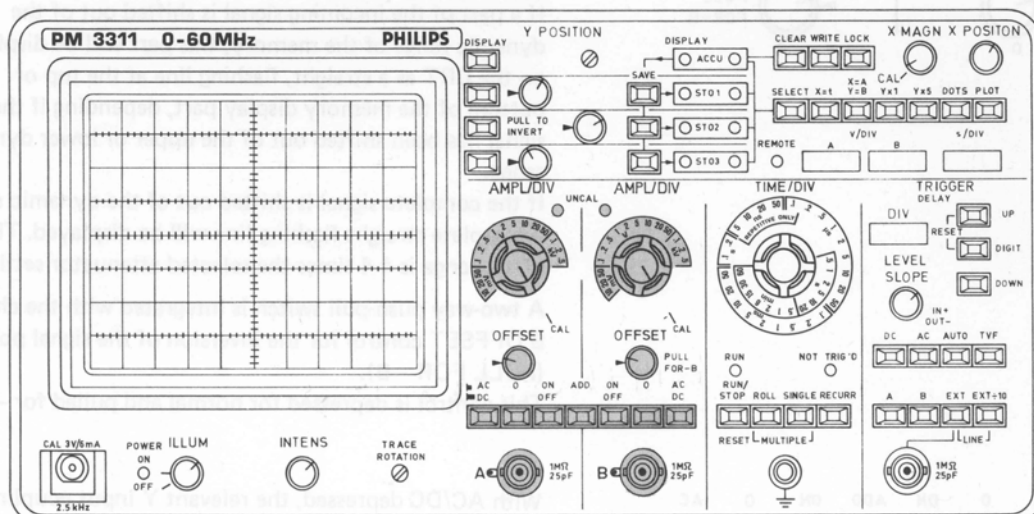
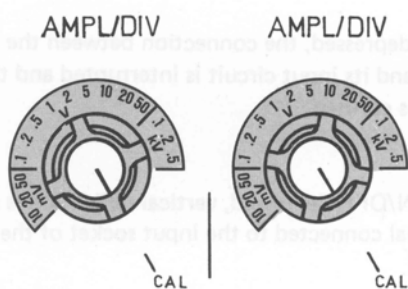

Fig. 3.2.



12-way step control of the vertical deflection coefficients, operating in a 1-2-5 sequence.

Using a 10:1 probe with range indication*, ranging is automatically effected from 0.1 V/div up to 0.5 kV/div. With a 1:1 probe, ranging is possible from 10 mV/div up to 50 V/div.

Two indicator lamps are located under the AMPL/DIV outer knob scale. Normally the one on the left is ON, but when a 10:1 probe with probe indicator is used, the one on the right is ON.

* Probes with range indication are delivered with the instrument.

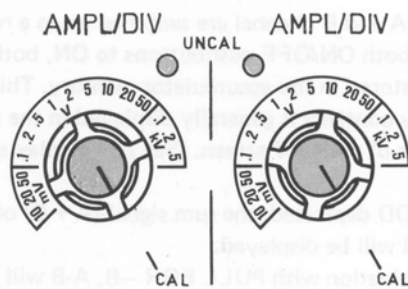

Continuously variable control of the vertical deflection coefficients.

In the CAL position the selected deflection coefficient is calibrated.

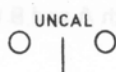

Pilot lamp indicating that the relevant AMPL/DIV switch off the CAL position. This situation is indicated by an asterisk (*) in the alpha-numeric display.

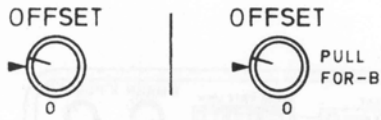

Continuous control for shifting the signal within the dynamic range of the memory (2 divisions on the screen). If a part of the incoming signal is shifted out of the dynamic range of the memory, this part will be displayed on the CRT as a straight, flashing line at the top or bottom of the memory display part, depending if the signal has been shifted out of the upper or lower dynamic range.

If the complete signal is shifted out of the dynamic range a complete straight flashing line will be displayed. The offset range is ± 4 times the selected attenuator setting.

A two-way push-pull switch is integrated with the channel B OFFSET control for the inversion of the signal polarity (PULL FOR -B).

This control is depressed for normal and pulled for -B.

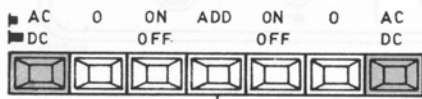

With AC/DC depressed, the relevant Y input coupling is achieved via a blocking capacitor (AC).

With AC/DC released the input coupling is direct (DC).

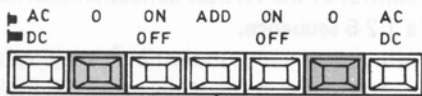

With 0 depressed, the connection between the Y input socket and its input circuit is interrupted and the input circuit is earthed.

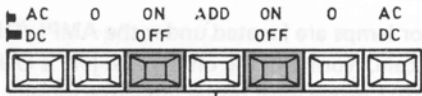

With ON/OFF depressed, vertical deflection is achieved by the signal connected to the input socket of the relevant Y channel.

With ON/OFF released, the relevant Y channel trace will not be displayed.

To simplify operation, with both ON/OFF switches released, channel A will be displayed (i.e. the circuit makes allowance for human error!).

If both A and B channel are switched on as a result of setting both ON/OFF pushbuttons to ON, both signals will be stored in the accumulator memory. This ACCU memory contents is generally displayed in the upper two divisions of the CRT screen. (See also display section).

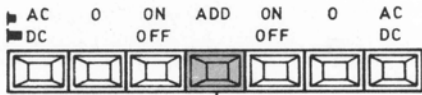

With ADD depressed, the sum signal (A + B) of channels A and B will be displayed.

In combination with PULL FOR -B, A-B will be displayed. The ADD mode can be selected independent of the ON/OFF switch settings.

For example, if channel A has been switched to OFF and channel B to ON, both A and B OFFSET controls are operative.

Note: With all pushbuttons released, channel A is automatically selected.



BNC input socket, including a range indicator input.

3.3.3. Horizontal section

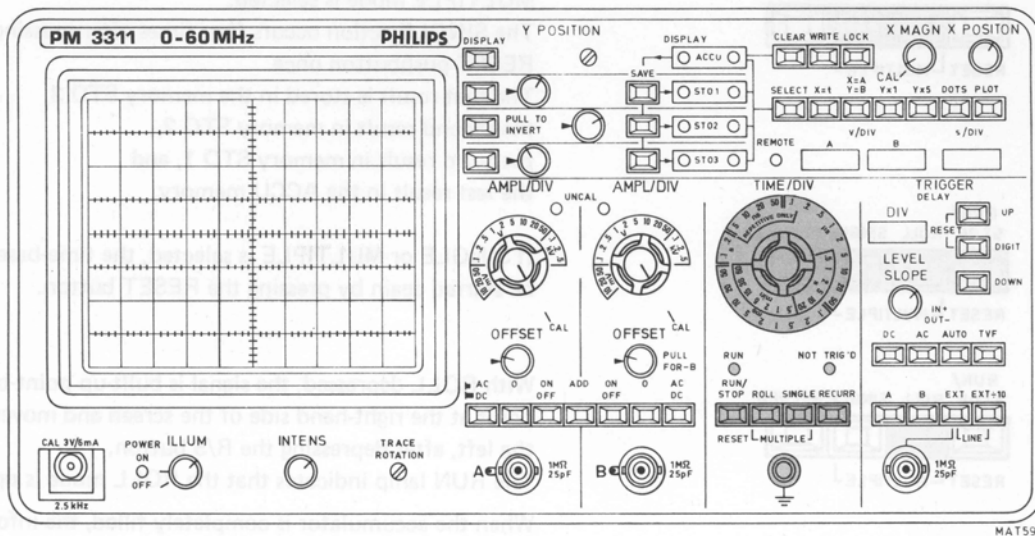
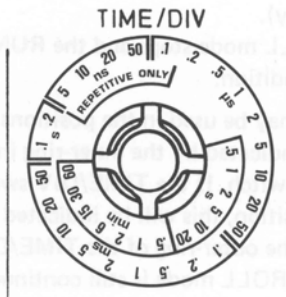

Fig. 3.3.



Time coefficient step control of the time-base:
24-way rotary switch (without stop).

The selected position is indicated by one of the indicator lamps located under the scale of this knob. In the positions marked with REPETITIVE ONLY, signals of a repetitive character may be measured only.

The inner scale ring is for ROLL mode only, and is automatically indicated by selecting ROLL mode. The correct display of the input signal on the CRT screen can be found by turning the TIME/DIV switch from fast to slow (starting at position 0.5 ns/DIV) until the first triggered display is obtained.



Pilot lamp indicating that the ROLL mode is operative and running.

This lamp blinks to indicate that the ROLL mode action is completed. (See also description "ROLL" function).



Pilot lamp indicating that there is no trigger signal present. No light means:

- A). In ROLL/RECURR mode: Time-base is triggered.
- B). In SINGLE/MULTIPLE mode: Indicates that signal(s) is (are) captured.

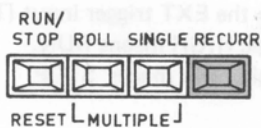

With RECURR depressed, the ACCU memory only is constantly overwritten by new information. This action occurs at particular time intervals depending on the position of the TIME/DIV and the trigger delay setting.

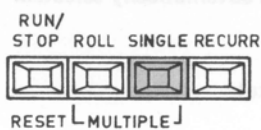

With SINGLE depressed, refreshment of the ACCU memory contents takes place only once, when the trigger level is reached and the time set with the trigger delay has elapsed.

This refreshment takes place only after pressing the RESET pushbutton. The signal is started according to the position of the trigger delay. During the waiting time, the accumulator contents are displayed and lamp NOT TRIG'D is ON.

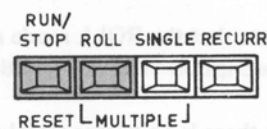
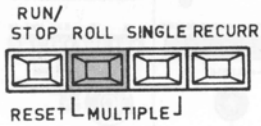
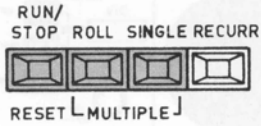
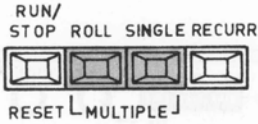

With both ROLL and SINGLE pushbuttons depressed, the MULTIPLE mode is selected.

The SINGLE action occurs four times after pressing the RESET pushbutton once.

The first result is stored in the memory STO 3, the second result in memory STO 2, the third result in memory STO 1, and the last result in the ACCU memory.

If SINGLE or MULTIPLE is selected, the time-base can be started again by pressing the RESET button.

With ROLL depressed, the signal is built-up point-by-point at the right-hand side of the screen and moves to the left, after depressing the R/S button.

The RUN lamp indicates that the ROLL mode is operative.

When the accumulator is completely filled, the information is saved in memory STO 3, the next information in memory STO 2, the next in memory STO 1 and the last information in the ACCU memory (the RUN lamp will be ON continuously).

After this, the ROLL mode stops and the RUN lamp blinks to indicate this condition.

The ROLL mode may be used in the positions 0.5 sec/div up to 60 min/div indicated by the inner-ring indicator lamp of the TIME/DIV switch. If the TIME/DIV switch is set to an out-of-range position, this will be indicated by a flashing indicator lamp in the outer-ring of the TIME/DIV switch. In these positions, ROLL mode is still continued but in 0.5 s/div.

The total information will only be visible on the CRT screen after depressing the four display push-buttons for the ACCU, STO 1, STO 2 and STO 3.

By pushing the CLEAR button, the contents of the ACCU memory will be cleared and the ROLL mode action can be restarted by pushing the RUN/STOP switch. (See also display section).

During the ROLL mode action (i.e. while the RUN lamp is continuously ON) the action can be stopped and/or started by pressing the RUN/STOP pushbutton.

With the ROLL mode stopped by pressing RUN/STOP, the start/stop function of this pushbutton can be taken over by a signal applied to the EXT trigger input (TTL level):
 +5 V (> +2,4 V) logic HIGH means RUN.
 0 V (< 0,8 V) logic LOW means STOP.

Note: To simplify operation, with all pushbuttons released, RECURR is automatically selected.



Measuring earth socket.

3.3.4. Triggering

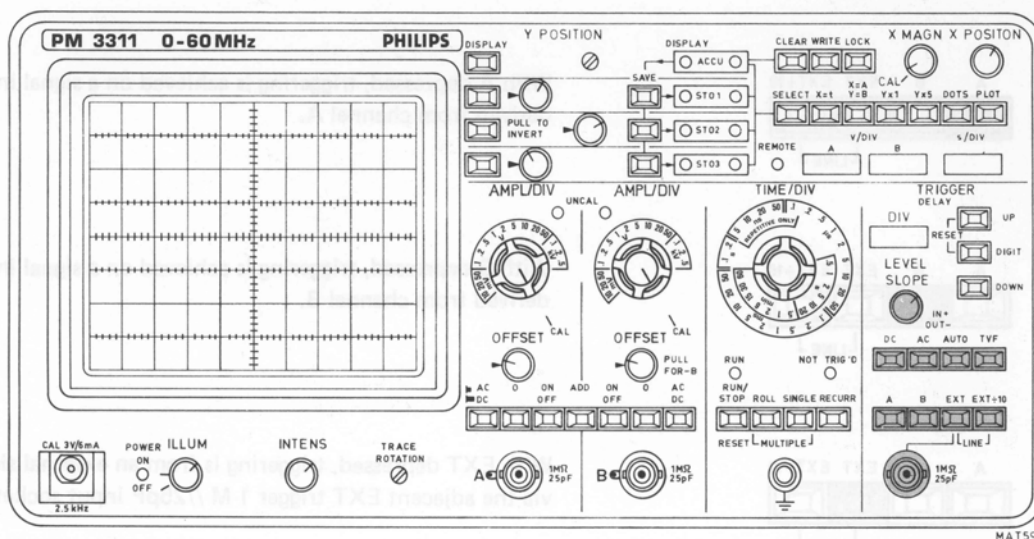
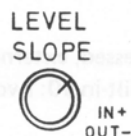

Fig. 3.4.



Continuously variable control for selecting the level of the trigger point on the input signal.

This control incorporates a push-pull switch that enables choice of triggering on either the positive or the negative-going edge of the triggering signal (IN +, OUT -).

Trigger Mode Selection



With DC depressed, the time-base generator is triggered by a trigger signal including DC. (Trigger bandwidth DC ... 60 MHz).

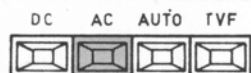

With AC depressed, the time-base generator is triggered by a signal of which the DC component is blocked. (Trigger bandwidth 10 Hz ... 60 MHz).



With AUTO selected, the time-base is free-running in the absence of trigger signals. (The DC component is blocked in this mode and the trigger bandwidth is 20 Hz ... 60 MHz).



By selecting TVF, television frame signal synchronisation is obtained (For CCIR system 625 lines). *

Note: To simplify operation, with all pushbuttons released the AUTO mode is selected.

* Check the correct setting of the trigger slope (in accordance to the T.V. system under test).

Trigger source selection

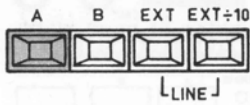

With A depressed, triggering is achieved on a signal internally derived from channel A.

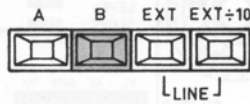

With B depressed, triggering is achieved on a signal internally derived from channel B.

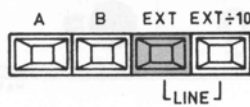

With EXT depressed, triggering is from an external signal via the adjacent EXT trigger 1 M //25pF input socket.

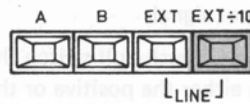

With EXT ÷ 10 depressed, external triggering is obtained as above but via a built-in 10:1 voltage divider.

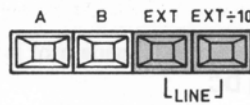

With both the EXT and the EXT ÷ 10 buttons depressed, triggering is achieved by a signal internally derived from the line (mains) voltage.

Note: To simplify operation, with all pushbuttons released, A is automatically selected.



BNC input socket for external triggering or external RUN/STOP signal for ROLL mode.

3.3.5. Trigger delay

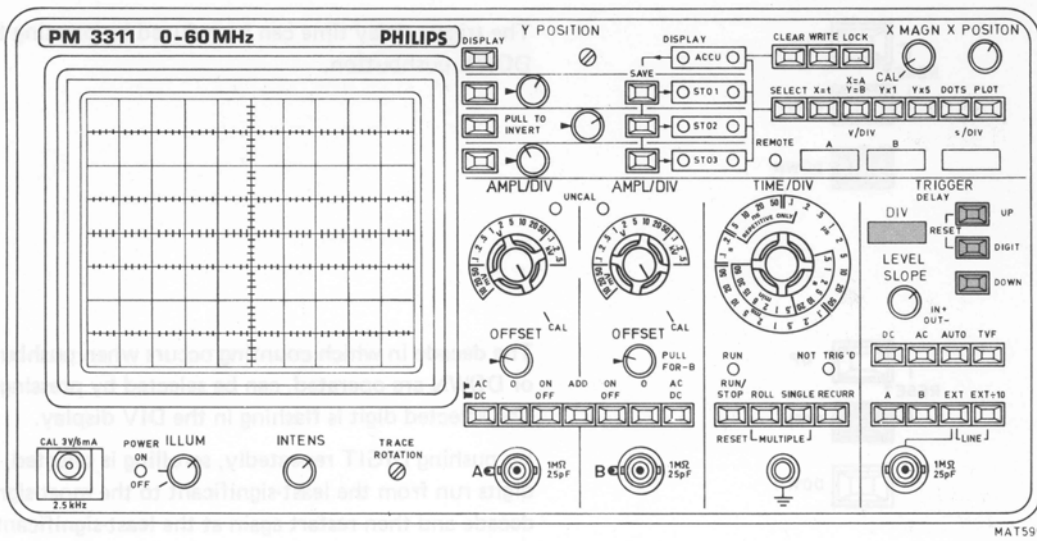
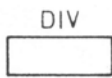

Fig. 3.5.



A four-decade display indicating the selected time in divisions between the trigger pulse and the beginning of the displayed signal on the CRT.

This trigger delay time can be varied between -9 and $+9999$ divisions in the 0.2 s to $0.2\ \mu\text{s}/\text{div}$ positions of the TIME/DIV switch.

In positions $0.1\ \mu\text{s}$ to $5\ \text{ns}/\text{div}$ of the TIME/DIV switch (for repetitive signals only) the delay time range is $0 \dots 100$ divisions.

When switching on the instrument, the display is automatically reset to zero, except with memory back-up, where the previous value will be displayed.

In the ROLL mode the next "OFF" will be displayed.

With both the pushbuttons UP and DIGIT depressed, the trigger delay time is reset to zero. This will be indicated in the DIV display.

The trigger delay time can be increased by pressing the UP pushbutton.

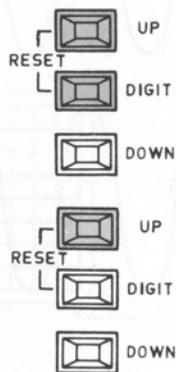

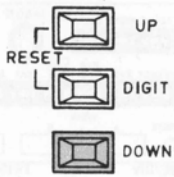

The trigger delay time can be reduced by pressing the DOWN pushbutton.

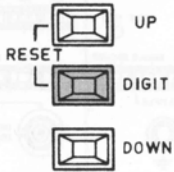

The decade in which counting occurs when pushbuttons UP or DOWN are operated, can be selected by pressing DIGIT. The selected digit is flashing in the DIV display.

By pushing DIGIT repeatedly, scrolling is selected; i.e. the digits run from the least-significant to the most-significant decade and then restart again at the least-significant decade.

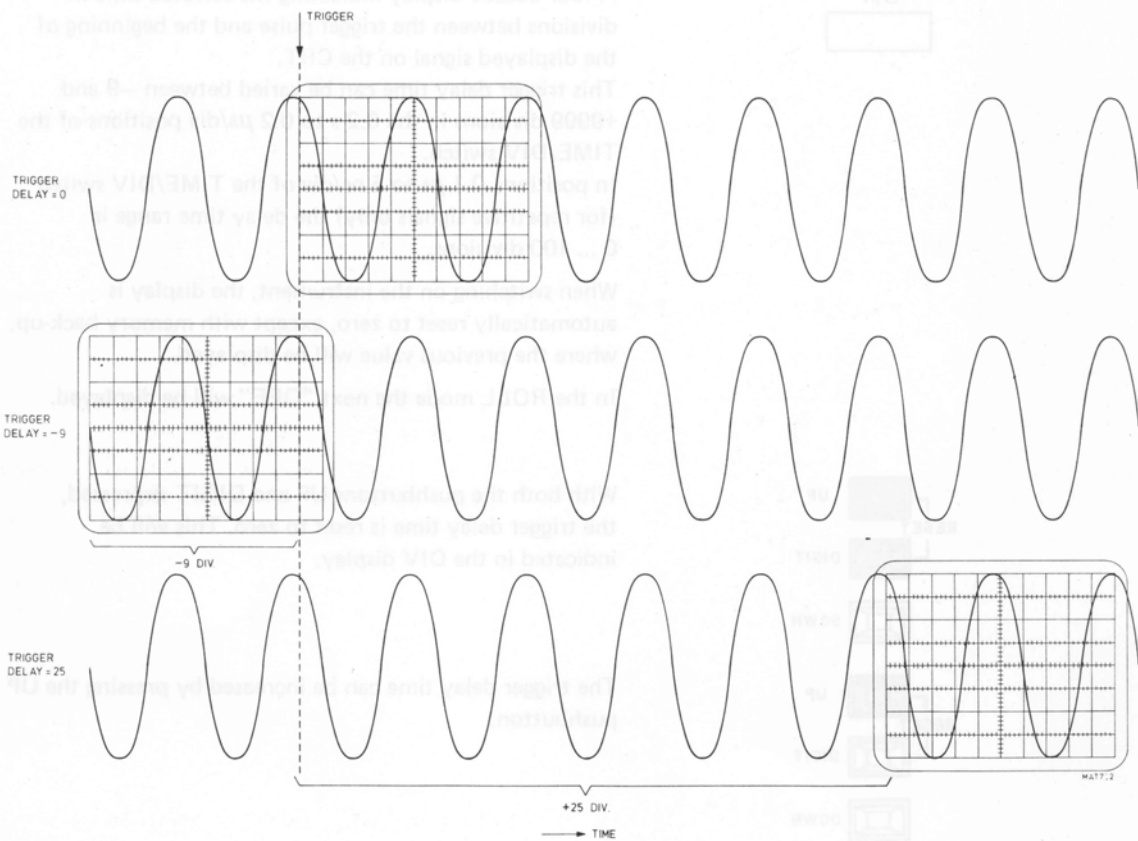

Fig. 3.6.

3.3.6. Display section

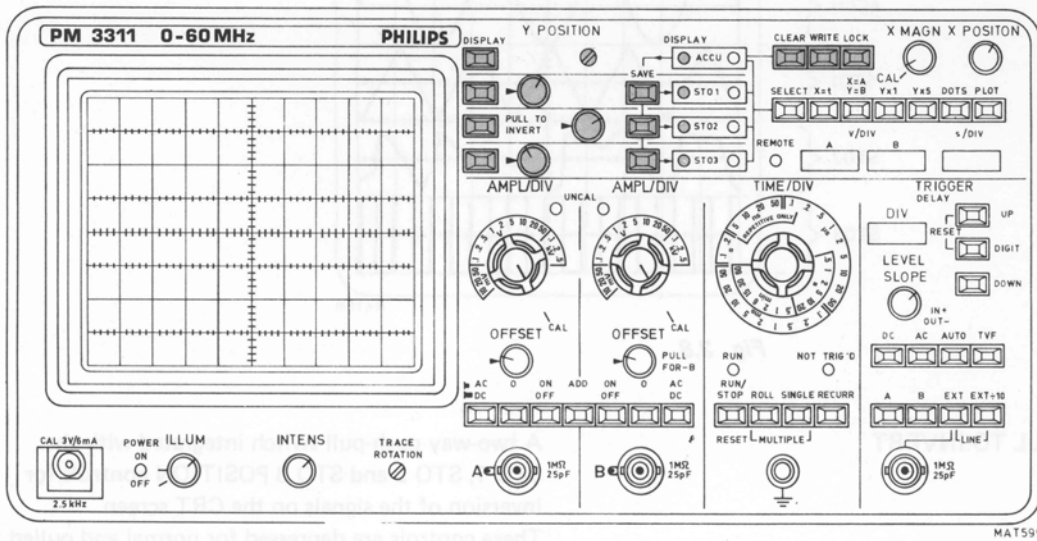
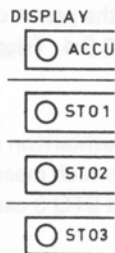

Fig. 3.7.



Depending on the settings of the four DISPLAY pushbuttons, the contents of one or more of the four memories ACCU, STO 1, STO 2, and STO 3 can be selected for display on the CRT screen.

With no DISPLAY pushbutton depressed, the ACCU LED indicates that the accu memory is selected. This can be influenced by pressing the SELECT pushbutton. In the case when all the DISPLAY pushbuttons are released, the memory that was last switched off is selected.



These pilot lamps indicate which memories are selected for display on the CRT screen by choice of DISPLAY pushbuttons or by the SELECT pushbutton when all DISPLAY buttons are released.

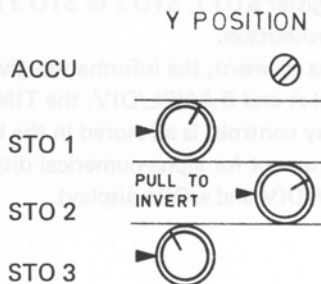

Continuously variable controls giving vertical shift of the display.

In the position marked the channels are equally spaced over the whole screen area. Each channel occupies two divisions of the screen (see figure). The ACCU positions control is screwdriver operated.

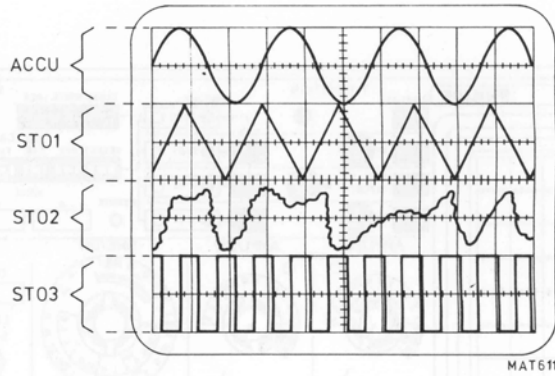

Fig. 3.8.

PULL TO INVERT

A two-way push-pull switch integrated with the STO 1, STO 2 and STO 3 POSITION controls for inversion of the signals on the CRT screen. These controls are depressed for normal and pulled for invert (PULL TO INVERT).



On pressing the CLEAR pushbutton the contents of the ACCU memory are cleared. The other three memories can only be cleared by transferring the cleared memory contents of the ACCU into these memories. (Refer also to the function of the SAVE pushbuttons).

The ROLL mode action can be restarted by pushing the CLEAR pushbutton and then the RUN/STOP button.



With the WRITE pushbutton depressed, the input signal will be written into the ACCU memory after a trigger pulse and after passing the preset delay time. (See also Section 3.3.4. Triggering).



With the LOCK pushbutton depressed, the whole memory system is locked, which means that the contents of ACCU, STO 1, STO 2 and STO 3 cannot be changed in this mode.

Note: For simplicity of operation, with all pushbuttons released, WRITE mode is automatically selected.

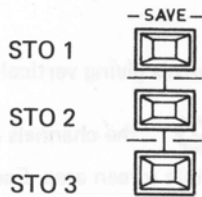

The contents of the ACCU memory are saved in the selected register STO 1, STO 2 or STO 3 by depressing the relevant pushbutton.

At the same moment, the information giving the settings of the channel A and B AMPL/DIV, the TIME/DIV and the trigger delay controls, is all stored in the internal memory of the instrument for alpha-numerical display purposes. (See also V/DIV and s/DIV display).

3.3.7. AMPL/DIV and TIME/DIV switch settings

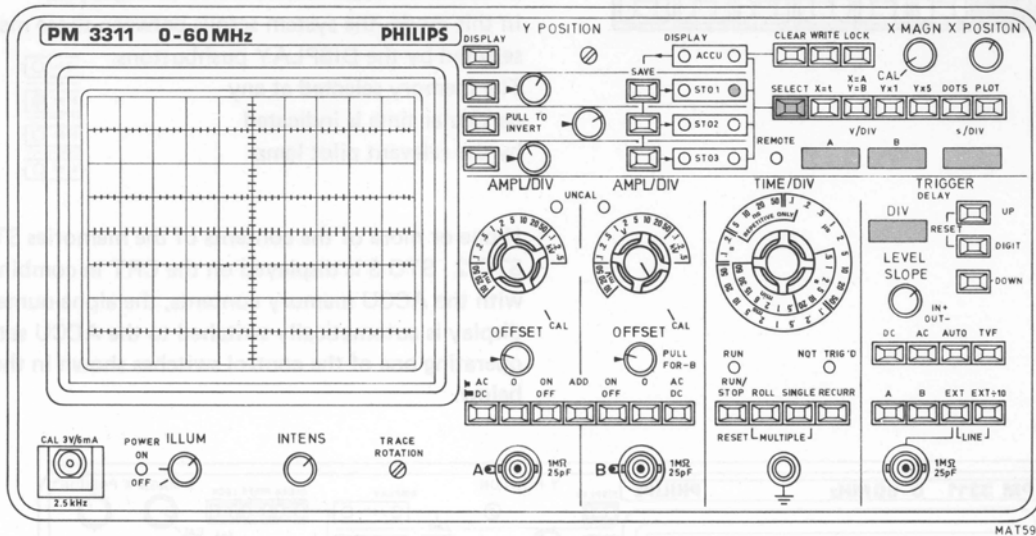
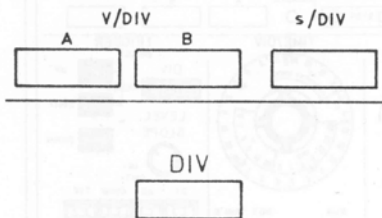
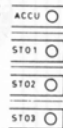

Fig. 3.9.



The displays indicate the settings of the AMPL/DIV and TIME/DIV switches and trigger delay settings appropriate to the register indicated by one of the pilot lamps:



To display the switch settings corresponding to one of the four memories, operate the SELECT button. Memories not displayed will be skipped.

The display shows a mantissa (decimal part) and a ten's exponent.

This exponent can be:

- Blank (0) to indicate Volts or seconds
- -3 for mV or ms
- -6 for μ s
- -9 for ns

A * in the display indicates that the relevant AMPL/DIV continuous control was not in the CAL position during the storage of signals into one of the memories, so the display shows a more sensitive range than in calibrated position.

Other display possibilities are:

- ADD: ADD mode was operating.
- SUB: SUB mode was operating (ADD with channel B inverted).
- OFF: the relevant channel was not operating.
- NOP: the relevant setting is not of interest; (e.g. after switch-on when no battery back-up is in use).

Note: In the ADD and SUB mode it is recommended to set both A and B AMPL/DIV switches in the same position in order to interpret the stored signal correctly.

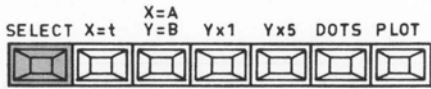

The SELECT pushbutton enables selection of the memory of which the scale factors are to be displayed. In this mode, the system scrolls between those memories selected by the DISPLAY pushbuttons. The memory selected at any particular time is indicated by the relevant pilot lamp.



If one or more of the contents of the memories STO 1 - STO 2 - STO 3 is displayed on the CRT in combination with the ACCU memory contents, the alpha-numeric display is automatically switched to the ACCU settings by operating one of the control switches shown in the figure below.

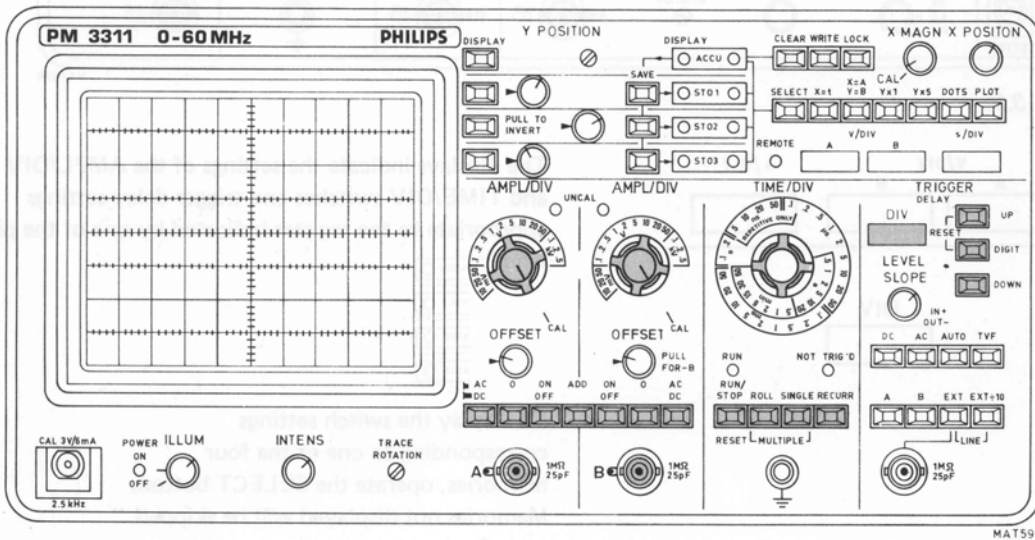
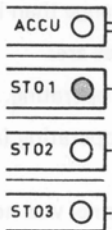

Fig. 3.10

With no DISPLAY pushbuttons depressed, use of the SELECT pushbutton results in scrolling of:

- the screen trace
- the pilot lamps
- the scale-factor displays.

The SELECT pushbutton is also functional in the PLOT mode. (See Section 3.3.8. Display modes).



These pilot lamps indicate the particular memory to which the scale factors and trigger delay settings in the V/DIV, s/DIV and DIV displays relate.

Only one of the pilot lamps in ON at a time.

3.3.8. Display modes

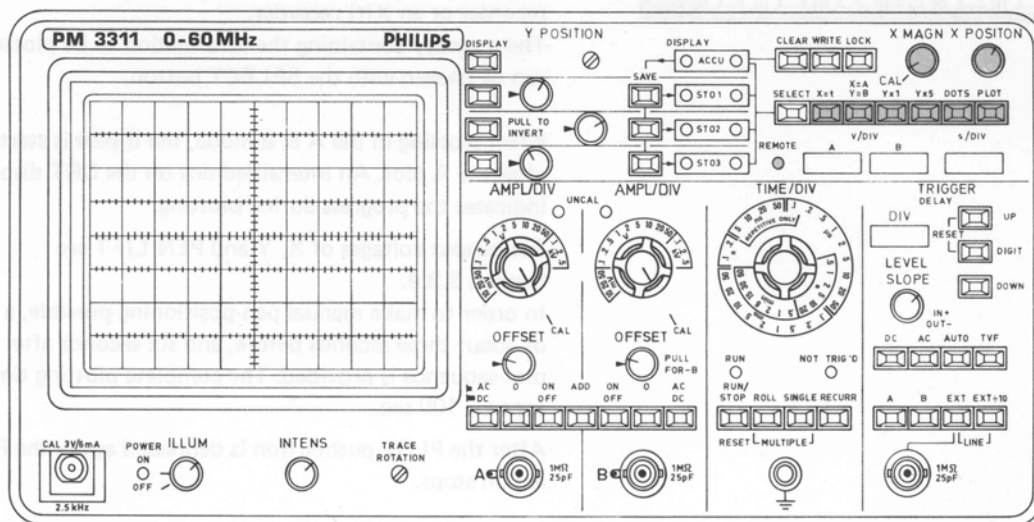
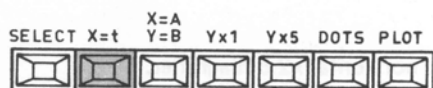
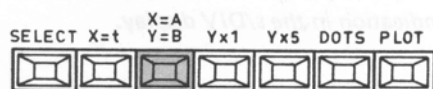

Fig. 3.11.



X = t display derived from the original setting of the time-base. (Information from memory).



X/Y display from the A and B inputs.

The A and B signals are used for horizontal and vertical deflection respectively.

A picture of 10 x 2 divisions is displayed.

When the Y x 5 mode is selected, a picture of 10 x 10 divisions can be obtained, of which 10 x 8 divisions can be displayed on the CRT screen.

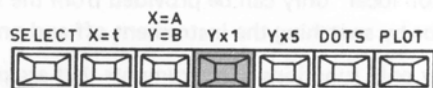

Vertical deflection coefficient x1.

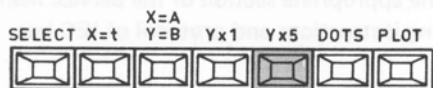

Vertical deflection coefficient x5.

In this mode, the scale factor in the V/DIV display is also modified (divided by a factor of 5). The displayed memories are also displayed now over 10 vertical divisions. The zero lines, if correctly adjusted, are located at the same base-line.

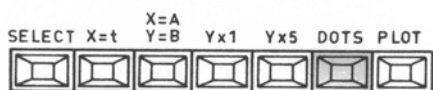

With this pushbutton depressed, normal display (dot-join) is changed into a display of discrete dots.

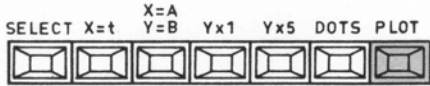

With the PLOT pushbutton depressed, output signals are available on the rear panel for plotting on an X/Y recorder or an X(t) recorder.

The memory containing the information to be plotted, can be chosen with the SELECT button.

When plotting in the A & B mode, the B plot is started after the A plot. An intensified dot on the CRT display indicates the progress during plotting.

For output voltages of X, Y and PEN LIFT see Section 3.3.9.

In order to make manual pen-positioning possible, a delay of about three seconds before, and six seconds after the plot sequence is provided. The complete plotting time is approx. 100 sec.

After the PLOT pushbutton is depressed again, the PLOT action stops.

Note: For simplicity of operation, with all pushbuttons released, X = t and Y x 1 are automatically selected.

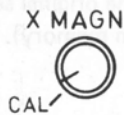

Continuous horizontal x2.5 magnifier.

Note: There is no expand in the CAL position, and no indication in the s/DIV display.



Continuous control for horizontal shift of the trace on the screen.



Pilot lamp indicating that the IEC-bus overrules all the front-panel control settings.

Resetting to "local" only can be provided from the IEC-bus controller or by switching the instrument off and on.

This facility only functions in instruments that are provided with the IEC-bus option PM 3325. Settings and outputs can then be controlled by other instruments external to the oscilloscope.

(Refer to the appropriate section of the Service Manual for mounting instructions and protocol of IEC-bus operation).

3.3.9. Rear panel

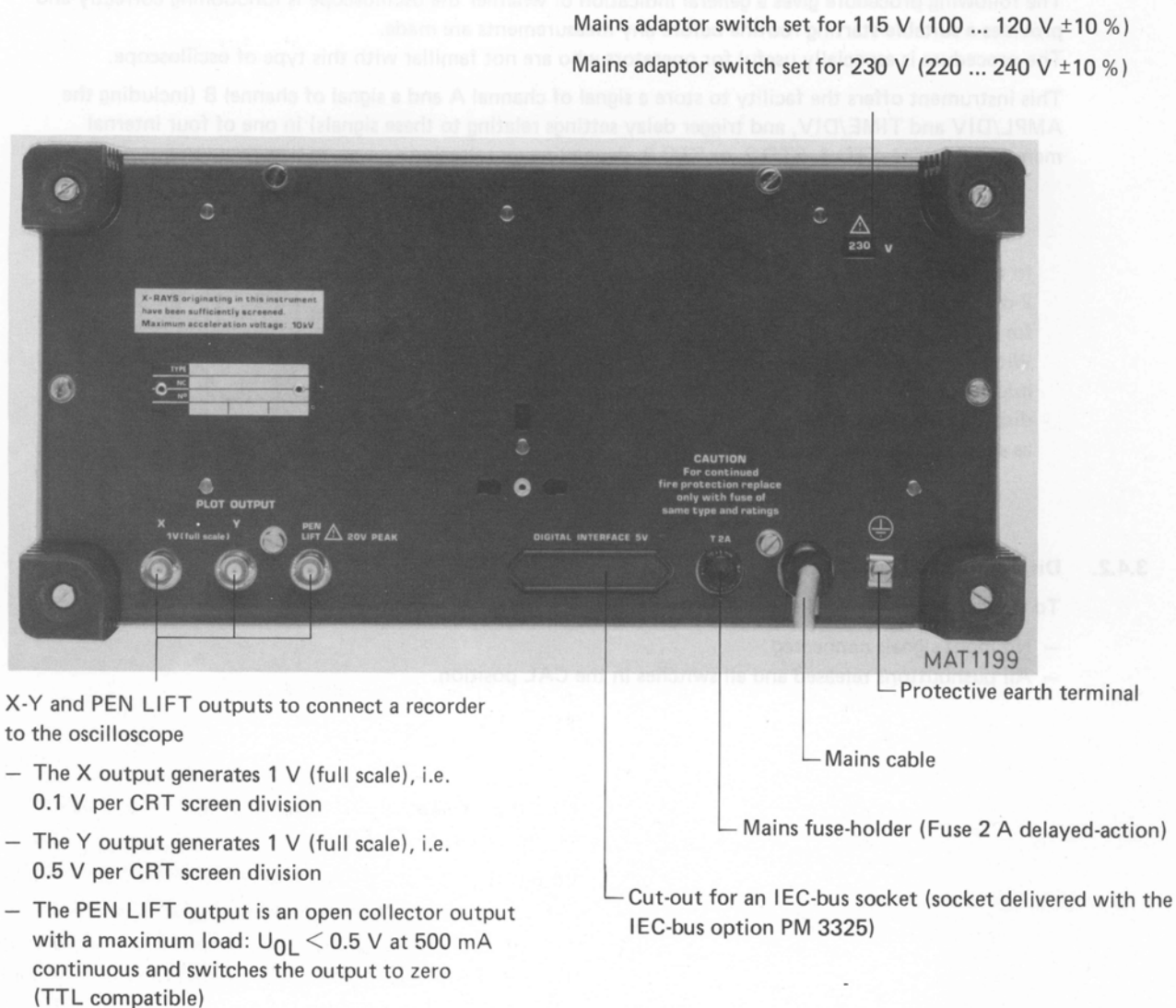

Fig. 3.12.

3.4. DETAILED OPERATING INFORMATION

3.4.1. General

Before switching on, ensure that the oscilloscope has been correctly installed in accordance with the instructions given in Section 2, and that the various precautions outlined have been observed.

The following procedure gives a general indication of whether the oscilloscope is functioning correctly and provides a suitable starting routine before any measurements are made.

The procedure is especially useful for operators who are not familiar with this type of oscilloscope.

This instrument offers the facility to store a signal of channel A and a signal of channel B (including the AMPL/DIV and TIME/DIV, and trigger delay settings relating to these signals) in one of four internal memories: ACCU, STO 1, STO 2, or STO 3, depending on selection.

In the normal mode (Y x 1), 2 divisions are available for each memory as shown. With the POSITION controls at mid-range position, the display format is typically as shown in the diagram.

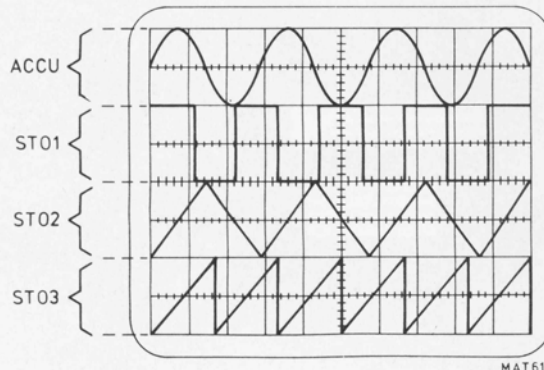

Fig. 3.13.

3.4.2. Displaying ACCU contents

To display the contents of the ACCU the following settings are necessary:

- No input signals connected.
- All pushbuttons released and all switches in the CAL position.

The following functions will now be operative

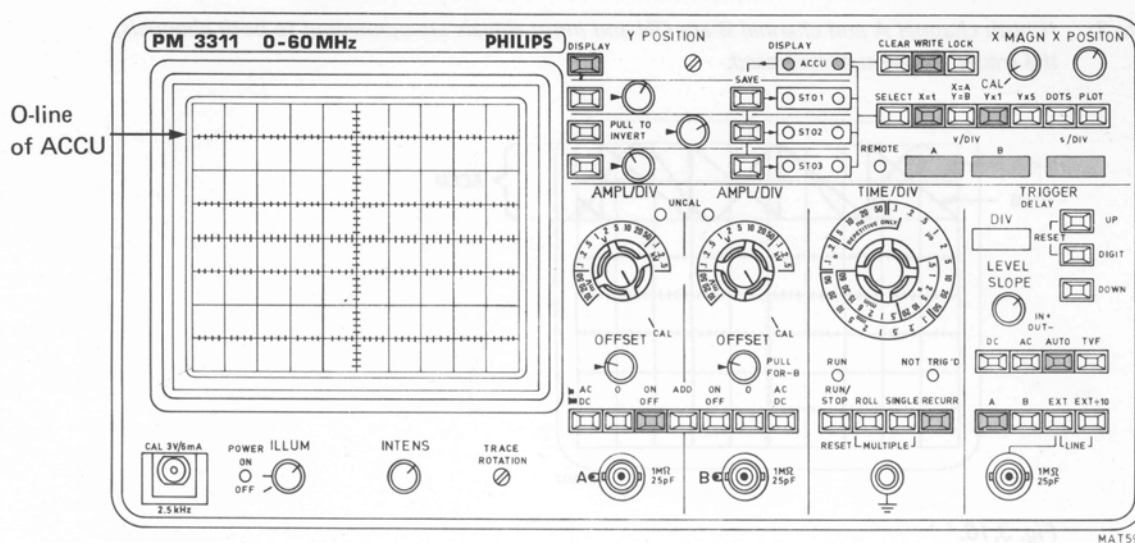

Fig. 3.14.

– Set POWER switch to ON. Check that pilot lamp is ON and that the power-up test starts. (See Section 3.2.2.).

A trace will now appear within the upper two divisions of the screen.

- Set the INTENS control for a suitable trace intensity.
- Adjust the OFFSET control of the A channel so that the displayed baseline coincides with the 0-line of the ACCU display part.

The oscilloscope is now ready to accept an input signal, but before continuing it is advisable to depress the pushbuttons as indicated in figure (view of controls).

Connect a sine wave signal to input A and set the TIME/DIV switch to a suitable position.

The correct display of the input signal on the c.r.t. screen can be found by turning the TIME/DIV switch from fast to slow (starting at position 5 ns/div.) until the first triggered display is obtained.

Note 1: The AMPL/DIV switch of the A channel should be adjusted so that the input signal covers not more than two divisions of the screen.

To indicate an overflow or incorrect OFFSET adjustment, the signal blinks until a correct setting is made.

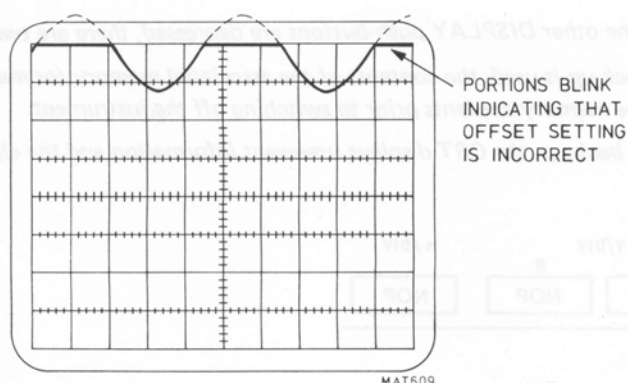

Fig. 3.15.

Note 2: To obtain full screen display depress *Y x 5* pushbutton.
The zero line is then automatically located on the centre-line of the screen.

Note 3: If both channel A and channel B are ON and input signals are connected to both channels, the traces will be superimposed.

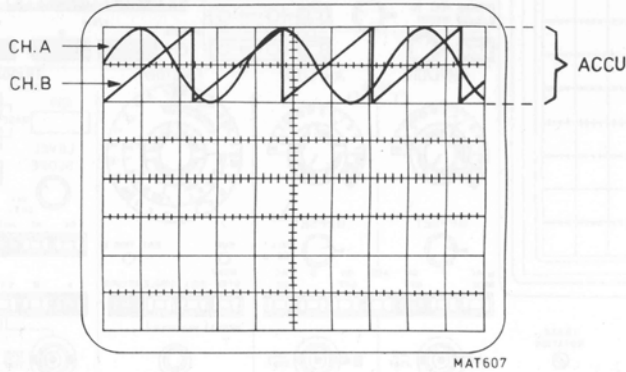

Fig. 3.16.

In this event, it is possible to adjust the AMPL/DIV switch and the OFFSET controls of channels A and B so that in the normal mode (*Y x 1*) each trace occupies one division.

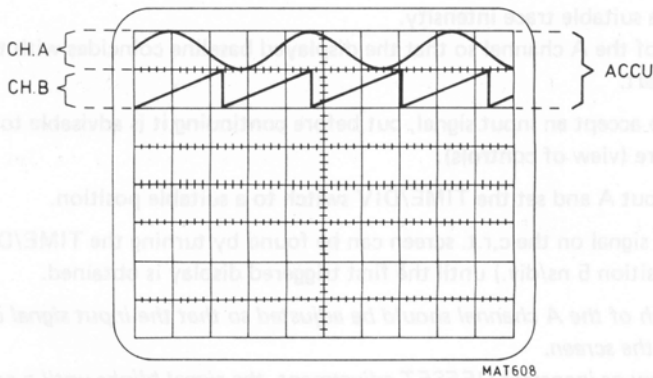
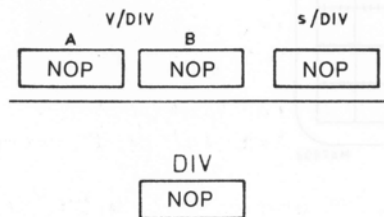

Fig. 3.17.

Note 4: If one or more of the other *DISPLAY* push-buttons are depressed, there are two possible situations:

1. When battery back-up is used, the contents of the associated memory (or memories) are displayed; i.e. the memory contents prior to switching off the instrument.
2. Without battery back-up, the CRT displays irrelevant information and the alpha-numeric display will indicate:



3.4.3. Storing ACCU contents

The procedure for storing the ACCU contents in one of the memories STO 1, STO 2 or STO 3 is now described.

The memories STO 1, STO 2 and STO 3 are only able to store the contents of the ACCU.

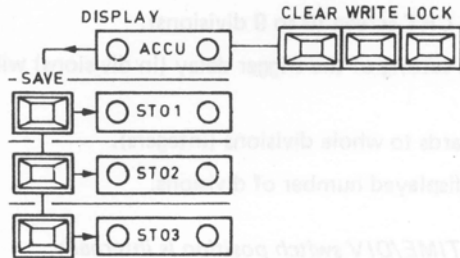

- Depress the SAVE button of the memory chosen for storing the ACCU information.
 - Verify that the information is written into the memory by pressing the DISPLAY button of that memory.
- The contents will now be displayed on the CRT screen.

A memory can be cleared (in WRITE mode only) by clearing the ACCU with the CLEAR pushbutton and then storing the cleared ACCU contents in that memory by pressing the relevant SAVE button. In other words, clearing a memory by storing blank ACCU contents.

3.4.4. Using the SELECT pushbutton

The functions of the SELECT pushbutton are:

- a. To select the memory holding the settings V/DIV, s/DIV and DIV (delay) that have to be indicated.
- b. To select the memory holding the contents to be plotted.
- c. If no DISPLAY pushbutton is depressed, SELECT initiates scrolling of the displayed memories, the pilot lamps and the settings V/DIV, s/DIV and DIV (delay).

Note:

- If only one DISPLAY button is depressed, pushing SELECT has no visible effect.
- If two or more DISPLAY buttons are depressed, pushing SELECT causes the system to scroll the pilot lamps and the information in the V/DIV, s/DIV and DIV (delay) indicator.

With pushbutton LOCK it is possible to keep all the memory contents unchanged.

3.4.5. Trigger delay

a. Positive delay

The trigger delay enables the time (in divisions) between triggering and the start of the CRT display (left-hand side) to be chosen.

EXAMPLE: Suppose the 6th line in a TV pattern is desired (TV line = 64 μ s).

Required trigger delay is therefore $5 \times 64 \mu\text{s} = 320 \mu\text{s}$.

i.e. after 5th line has passed.

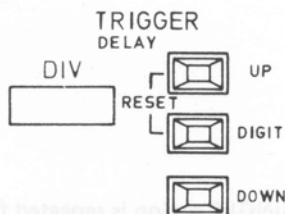

- Select TVF.
- Set TIME/DIV switch to position 10 μ s/DIV.
- Depress UP until the least-significant digit displays 2.
- Depress DIGIT once.
- Depress UP until the second digit displays 32.

A delay of $32 \times 10 \mu\text{s}$ between frame pulse and the left-hand side of the CRT display is now obtained. This results in displaying the information of the 6th line.

b. Negative delay

While the oscilloscope continuously stores information in the shift register it offers the capability of pre-triggering.

In effect, this means that a portion of the signal preceding the trigger point can be shown on the CRT display.

The trigger point can be chosen on any division of the CRT screen (0 to 9 divisions).

If the TIME/DIV switch is set to another position, the setting of the trigger delay (in divisions) will be automatically changed (recalculated) and displayed.

The result of this recalculation is to round off downwards to whole divisions (integers).

The starting point of recalculation is the momentary displayed number of divisions.

Note 1: The preset TRIGGER DELAY at a certain TIME/DIV switch position is internally stored and will always be the same preset delay, independent of the round off faults of operating the TIME/DIV switch.

TIME/DIV	first example		second example	
	DIV	DIV	DIV	DIV
Set position → 5 μs	0095	0095	0095	0095
10 μs	1 ↓ 0047	12 ↑ 0000	1 ↓ 0047	10 ↑ 0040
20 μs	2 ↓ 0023	11 ↑ 0000	2 ↓ 0023	9 ↑ 0020
50 μs	3 ↓ 0009	10 ↑ 0000	3 ↓ 0009	8 ↑ 0008
. 1 ms	4 ↓ 0004	9 ↑ 0000	4 ↓ 0004	7 ↑ 0004
. 2 ms	5 ↓ 0002	8 ↑ 0000	5 ↓ 0004	6 ↑ 0004
. 5 ms	6 ↓ 0000	7 ↑ 0000	5 ↓ 0002	6 ↑ 0002
	range down	range up	range down	range up

Note 2: If by operation of the TIME/DIV switch a TRIGGER DELAY of "0" is reached, all lower positions will show a TRIGGER DELAY of "0".

The trigger delay is switched OFF in the ROLL mode, the indicator (DIV) then shows OFF

3.4.6. Single and multiple modes

When pushbutton SINGLE is depressed, the ACCU is refreshed once after a trigger pulse and delay, as also the accu display.

If the instrument is waiting for a trigger pulse, the pilot lamp NOT TRIG'D will light.

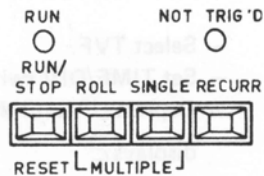

When both the ROLL and SINGLE pushbuttons are depressed, the SINGLE action is repeated four times. This is called the MULTIPLE mode. The result of the first action is stored in the memory STO 3, the second result is stored in STO 2, the third in STO 1 and the fourth in the ACCU.

When either the SINGLE or the MULTIPLE action is completed, the same mode can be chosen again by pressing the RESET button.

3.4.7. ROLL mode

The ROLL mode is typically used for very low frequency signals and is effective with TIME/DIV settings from 0.5 s ... 60 min. The signal is built-up point-by-point from the right-hand side of the CRT screen and "writes" towards the left. If ten divisions of the screen are built-up in the ACCU memory, then the SAVE action is started automatically, the contents of the ACCU being saved in memory STO 3.

Roll-mode action can be started by selecting ROLL and pushing pushbutton RUN/STOP once.

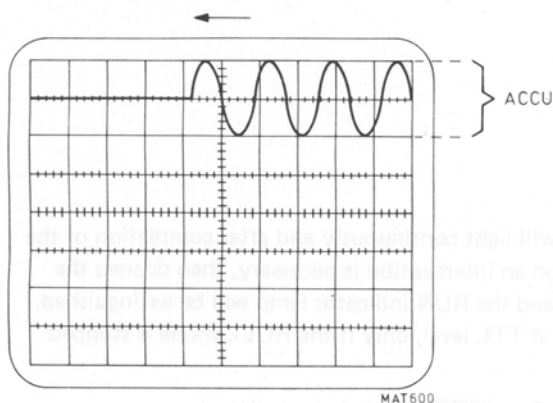

Fig. 3.18. Build-up of first information in the ACCU

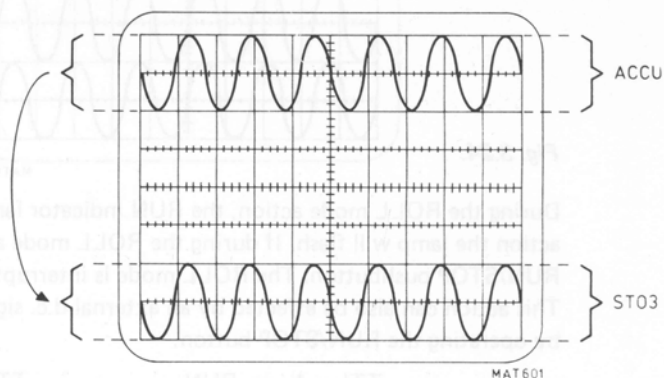

Fig. 3.19. First SAVE action

New information is now built-up in the ACCU memory point-by-point and after completion (ten divisions) the new information will be stored in memory STO 2.

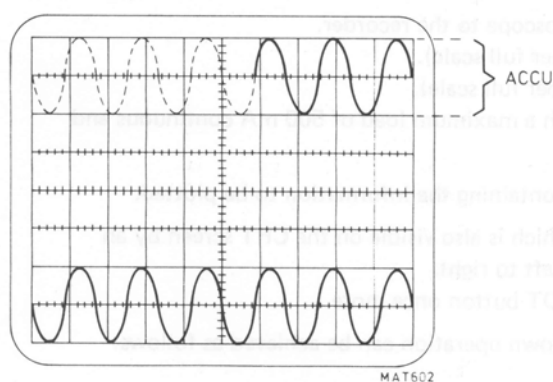

Fig. 3.20. Build up of second trace information in ACCU

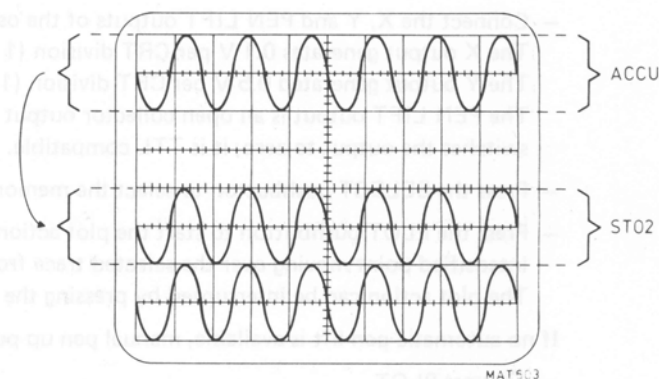

Fig. 3.21. Second SAVE action

The third information trace built-up in the ACCU is stored in STO 1 as shown below.

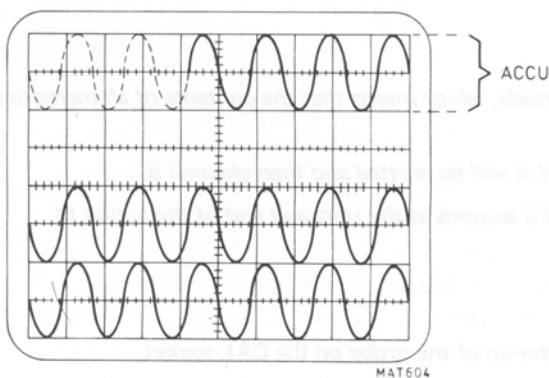

Fig. 3.22. Build-up of third trace information in the ACCU

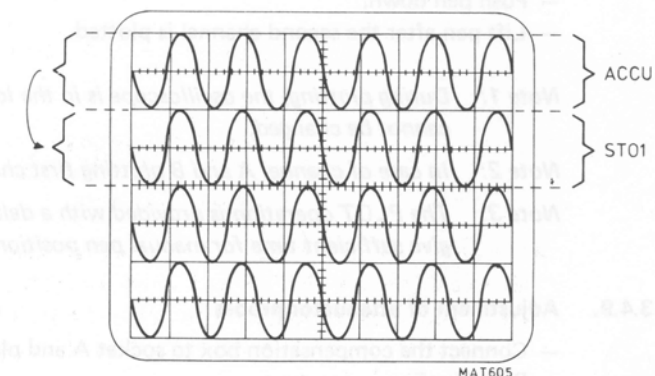

Fig. 3.23. Third SAVE action

The last information is stored in the ACCU itself as shown below.

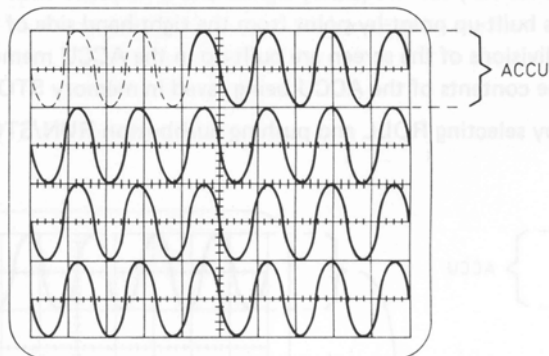

Fig. 3.24.

MAT606

During the ROLL mode action, the RUN indicator lamp will light continuously and after completion of the action the lamp will flash. If during the ROLL mode action an interruption is necessary, then depress the RUN/STOP pushbutton. The ROLL mode is interrupted and the RUN indicator lamp will be extinguished. This action can also be effected by an external d.c. signal at TTL level, only if the ROLL-mode is stopped by operating the RUN/STOP button.

TTL = 1 → RUN

TTL = 0 → STOP

By again depressing the RUN/STOP button the ROLL mode action is continued.

When the ROLL mode action is completed (flashing RUN light), the action can be restarted by pushing the CLEAR button followed by the RUN/STOP button.

3.4.8. Plotting

- Connect the X, Y and PEN LIFT outputs of the oscilloscope to the recorder.
 - The X output generates 0.1 V per CRT division (1 V per full scale).
 - The Y output generated 0.5 V per CRT division (1 V per full scale).
 - The PEN LIFT output is an open collector output with a maximum load of 500 mA continuous and switches the output to zero; it is TTL compatible.
- Press the SELECT pushbutton to select the memory containing the information to be plotted.
- Press the PLOT pushbutton to start the plot action, which is also visible on the CRT screen by an intensified point moving over the selected trace from left to right.
 - The plot action can be interrupted by pressing the PLOT button once more.

If no automatic pen lift is available, manual pen up-pen down operation can be achieved as follows:

- Depress PLOT.
- Wait 2 seconds.
- Push pen down (after 1 second the plot action will start).
- Lift pen after the signal is plotted.
- In dual channel operation the pen will move after 6 seconds to the starting point of the second channel.
- Push pen down.
- Lift pen after the second channel is plotted.

Note 1: During plotting, the oscilloscope is in the lock-mode, which means that the contents of all memories cannot be changed.

Note 2: In case of channel A and B plotting first channel A will be plotted and then channel B.

Note 3: The PLOT operation is provided with a delay of 3 seconds at the start and end of the action to give sufficient time for manual pen positioning.

3.4.9. Adjustment of attenuator probes

- Connect the compensation box to socket A and place the tip of the probe on the CAL socket.
- Push Y × 5.
- Select an appropriate setting of the AMPL/DIV switch of channel A.
- Insert a small screwdriver through the hole in the compensation box and adjust the trimmer to obtain a correct display as shown in Fig. 3.25.

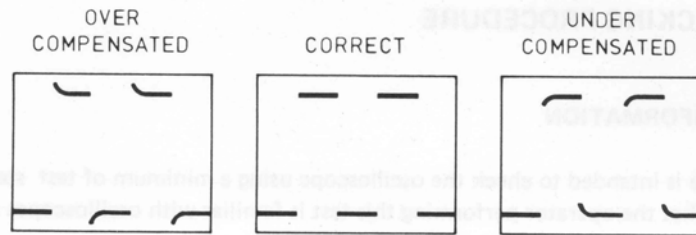

Fig. 3.25.

MAT 635

3.4.10. Differential mode

The A-B mode can be selected by depressing ADD and pulling the channel B OFFSET control. In measurements where signal lines carry substantial common-mode signals (e.g. hum), the differential mode will cancel out these signals and leave the remainder of interest (A-B). The capability of the oscilloscope to suppress common-mode signals is given by the CMR factor (see Fig. 3.26).

To obtain the degree of common-mode rejection as specified, channel A and B gains must first be equalised. This can be done by connecting both channels to the CAL output connector, and adjusting one of the continuous controls with the AMPL/DIV switch for minimum deflection on the screen.

When passive 10:1 probes are used, a similar equalisation process is recommended by adjusting their compensating controls for minimum deflection.

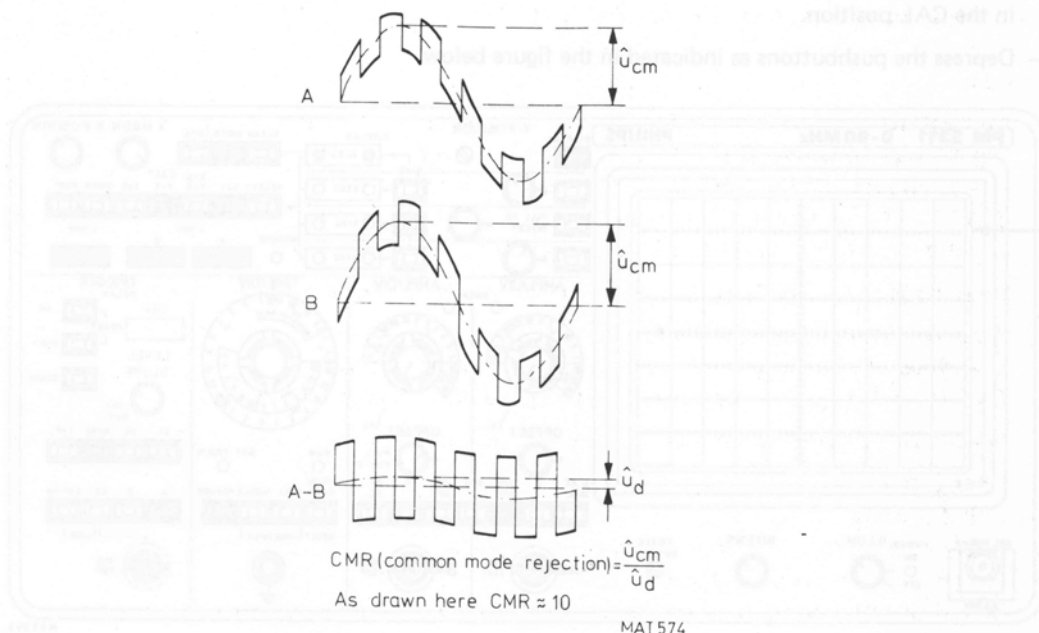

MAT 574

Fig. 3.26.

3.4.11. X = A and Y = B

In this mode the signal is built up point by point. This means that the dot join circuit is switched off automatically.

Procedure:

- Connect input signals to both channel A and channel B input sockets.
- Set the AMPL/DIV switches to an appropriate position.
- Depress X = A.
Y = B.

Horizontal deflection is now determined by the channel A input and vertical deflection by the channel B input.

4. BRIEF CHECKING PROCEDURE

4.1. GENERAL INFORMATION

This procedure is intended to check the oscilloscope using a minimum of test steps and actions. It is assumed that the operator performing this test is familiar with oscilloscopes and their characteristics.

WARNING: Before switching on, ensure that the oscilloscope has been installed in accordance with the instructions outlined in Section 2.

If this test is started a few minutes after switching on, bear in mind that test steps may be out of specification, due to insufficient warming-up time. To avoid this situation, allow the specified warming-up time.

The test should be performed at an environmental temperature of 20 - 30 °C.

All the checks in this procedure can be made without removing the instrument's top and bottom covers.

For a complete check of every facet of the instrument's calibration, refer to the section Checking and Adjusting Procedure and omit the adjustment steps.

4.2. PRELIMINARY SETTINGS OF THE CONTROLS

- Start this check procedure with **NO** input signals connected, **ALL** pushbuttons released and **ALL** switches in the CAL position.
- Depress the pushbuttons as indicated in the figure below.

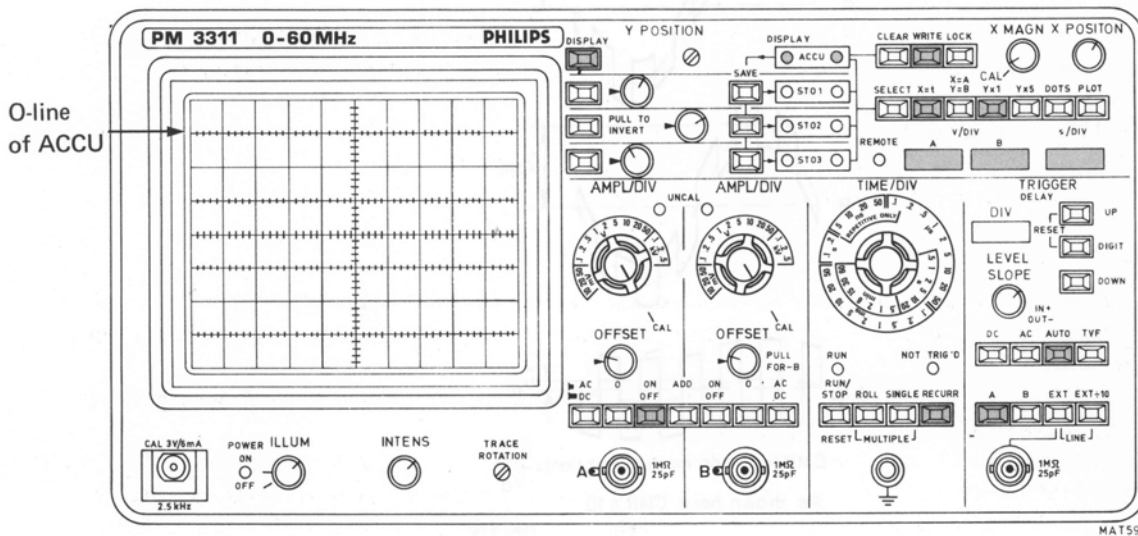

Fig. 3.27.

Unless otherwise stated the controls always occupy the same position as in the previous check.

4.3. CHECKING PROCEDURE

CRT section

- Set POWER switch to ON. Check that the pilot lamp lights and that the power-up test starts according to Section 3.3.2.
- After warm-up the CRT display will show the base-line of the ACCU memory contents.
- Check the screen illumination by turning the ILLUM control.
- Set the INTENS control for a suitable intensity of the display.
- A horizontal line should appear in the centre of the upper two divisions of the CRT display as long as the CLEAR button is depressed.

Vertical section

- Set the AMPL/DIV switch to position 5 V/div.
- Set the TIME/DIV switch to position 0.2 ms/div.
- Check that the displayed line runs exactly in parallel with the horizontal graticule lines.
(Correction is possible by adjusting screw-driver control TRACE ROTATION at the front panel).
- Turn the OFFSET control clockwise and check that the trace is flashing at the top end of the screen. The trace will blink at the bottom line of the ACCU display part by turning OFFSET anti-clockwise.
- Adjust the OFFSET control so that the base-line is shifted to the centre of the upper two divisions.
- Connect the output signal of the CAL terminal to the A or B input socket. Check that horizontally each period covers two divisions and vertically the amplitude is 0.6 divisions.
- Depress the AC/DC input coupling switch to AC and check that the signal is symmetrical around the centre-line of the upper two divisions.
- Release the switch to DC.
- Depress the O switch. A base-line should appear on the centre line of the upper two divisions.
- Release the O switch.
- Check that the range of the continuous AMPL/DIV control is 2.5 times attenuation or more.
- If the continuous AMPL/DIV control is out of its CAL position the UNCAL pilot lamp should light and an asterisk * should appear in the V/DIV display.
Set the continuous control in its CAL position.
- Check that the range of the continuous AMPL/DIV control is 2.5 times attenuation or more (≈ 2 divisions). 5 V/div.
- The previous check can now be made for the other channel.
- Push the channel B ON-OFF switch to ON.
- Set both channel A and B input coupling switches to AC.
- Connect the CAL signal to both channel A and B inputs.
Adjust the OFFSET controls to overlap the traces.
- Push ADD and check that the displayed signal is doubled with respect to the amplitude.
- Operate the PULL FOR -B switch and check that a minimum signal amplitude is displayed.
- Set both input coupling switches to DC. Release ADD.
- Release the channel B ON OFF switch to OFF.
- Push the channel B OFFSET control for normal operation.
- Disconnect the B input signal.

Display section

- Depress all four DISPLAY pushbuttons and check that the DISPLAY lamps will light.
- Depress pushbutton CLEAR and check that the ACCU display part (i.e. the ACCU memory contents) is cleared.
- Check that the memories STO 1, STO 2 and STO 3 can also be cleared by simultaneously depressing the CLEAR and relevant SAVE pushbutton.
- Check that there are four traces on the screen e.g. the input signal and the three base-lines of STO 1, STO 2 and STO 3 and check that the three base-lines can be shifted in the vertical direction by turning the Y-POSITION controls.
Adjust the Y-POSITION controls so that the traces are located on their base-lines.
- Check that the ACCU memory contents can be stored in the memories STO 1, STO 2 or STO 3 by depressing the relevant SAVE pushbuttons.
- Check that the STO 1, STO 2 and STO 3 traces can be inverted by pulling the Y-POSITION controls.
- Push the Y-POSITIONS controls.
- Depress LOCK and check that the memory contents are not influenced until WRITE is depressed.

Display modes

- Turn the X MAGN control fully clockwise.
- Check that by operating the X-POSITION control the magnified display can be completely shifted.
- Depress DOTS and check that separate dots are displayed on the screen.
- Switch X MAGN to CAL; release DOTS and set X-POSITION for correct display.

Set TIME/DIV to	Push SAVE for	ACCU	Push SELECT for	Read s/DIV
1 ms/div	STO 1		STO 1	1 - 3
.5 ms/div	STO 2		STO 2	.5 - 3
.2 ms/div	STO 3		STO 3	.2 - 3
.1 ms/div		ACCU	ACCU	.1 - 3

- Release the STO 1, STO 2 and STO 3 DISPLAY buttons.
- Depress the input coupling switch to AC.
- Check that by pushing Y x 5 full screen display can be obtained and that the zero line is located at the centre of the screen.
- Push Y x 1.
- Depress PLOT and check that an intensified dot appears at the left-hand side of the screen. This dot will follow the trace after a few seconds. Eventually check the recorder outputs at the rear (1 V full-scale).
- Wait until the PLOT action is finished.

Horizontal section

- Depress SINGLE.
Each time the RESET button is depressed the ACCU memory contents are refreshed and so the display.
- Check that during the SINGLE action the NOT TRIG'D pilot lamp is on.
- Depress the STO 1, STO 2 and STO 3 DISPLAY buttons.
- Depress MULTIPLE (both ROLL and SINGLE) and check that the SINGLE action is repeated four times (in the four memories ACCU, STO 1, STO 2 and STO 3).
- Depress ROLL and apply a 1 Hz signal to the input socket and set AMPL/DIV to an appropriate position.
- Set TIME/DIV to .5 s/DIV.
- Depress RUN and check that the signal is stored as described in Section 3.4.7.
- Check that the RUN lamp lights permanently when rolling and blinks if the RUN action is finished.
- Disconnect the input signal and depress RECURR.
- Check if all positions of the TIME/DIV switch are displayed correctly in the s/DIV display and set the TIME/DIV switch in .2 ms/div.
- Connect the CAL output to the input socket.

Trigger delay

- Check that by pressing UP once the trace shifts one division to the left.
Check that by pressing DOWN once the trace is shifted to its original position.
- Press DIGIT. Check that the next digit in the DIV display blinks and can be changed by pressing UP or DOWN.
Pressing DOWN will never result in a reading less than -9.
- Check that the DIV display indicates 0 by pressing RESET (UP and DIV together).

5. PREVENTIVE MAINTENANCE

5.1. GENERAL INFORMATION

This instrument generally requires no maintenance, as the instrument contains no components that are subject to wear.

However, to ensure reliable and troublefree operation, the instrument should not be exposed to moisture, heat, corrosive elements or excessive dust.

5.2. CLEANING THE NEXTEL SUEDE COATING

WARNING: The nextel suède coating is ethanol-resistant, but is susceptible to methylated spirit, which will attack the surface (due to one of the de-naturing substances).

The bright appearance of the cabinet, lacquered with Nextel suède coating will deteriorate after some time as the surface becomes soiled. Cleaning with a cloth soaked in water, ethanol or a common household cleansing agent does not always restore this lustre and leaves dirt in the holes and the pores.

The 3M Company have developed a new cleansing pad (White Cleansing Pad, Catalogue No. 8440) which when moistened in water, ethanol or a common household cleansing agent will also penetrate holes and pores.

This method is similar to that of abrasive cleaning pads but lacks their abrasive action. Abrasive cleaning pads should not be used, otherwise surface scratches will result.

5.3. REMOVING THE BEZEL AND THE CONTRAST PLATE TO CLEAN THE CONTRAST FILTER

- Grip the bottom corners of the bezel and gently pull it from the front panel (Fig. 3.28.).
- The contrast filter can now be removed by gently pressing it out of the bezel.
- To prevent scratching the filter when cleaning, ensure that a soft cloth is used, free from dust and abrasive material.

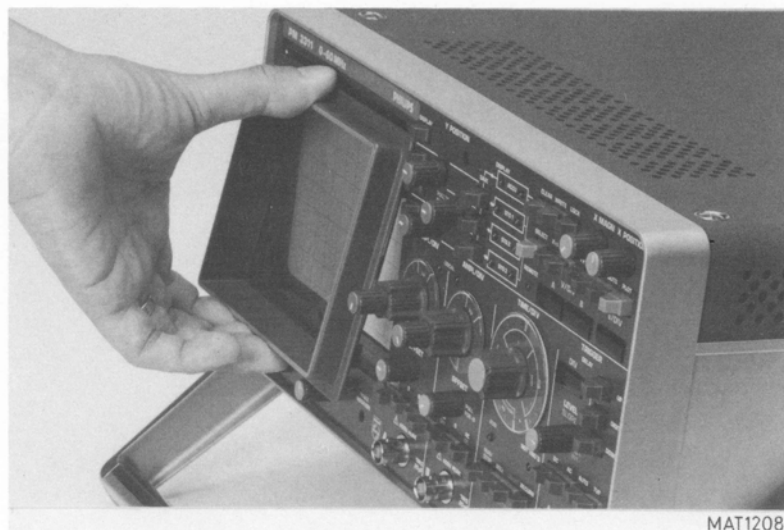

Fig. 3.28. Removing the bezel and the contrast plate.

5.4. RECALIBRATION

From experience it is expected that the oscilloscope operates within its specification for a period of at least 1000 hours or for six months if used infrequently.

In addition, replacement of components may necessitate recalibration of the affected circuits. The checking & adjusting procedure can also be helpful in localising certain troubles in the instrument.

In some cases, minor troubles may be revealed and/or corrected by recalibration. Complete checking & adjusting instructions are given in the Checking & Adjusting Section. (If only a partial calibration is performed, refer to the interaction chart).



PHILIPS

SERVICE

Scientific & Analytical Equipment
Test & Measuring Instruments
Industrial Automation
Advanced Automation Systems
Welding

Scientific &
Industrial
Equipment
Division

821123

TEST AND MEASURING INSTRUMENTS

OSC141

OSCILLOSCOPE PM3311

Already published: —

- Subject: 1. Service information of the probes.
2. Installation of batteries for memory back-up.
3. Installation and address selection of the IEC bus option PM3325.

WARNING: The opening of covers or removal of parts, except those to which access can be gained by hand, is likely to expose live parts, and also accessible terminals may be live.
The instrument shall be disconnected from all voltage sources before any adjustment, replacement or maintenance and repair during which the instrument will be opened.
The following procedures shall only be carried out by a qualified person who is aware of the danger involved.

1. PROBE INFORMATION

1.1. ADJUSTING THE H.F. STEP RESPONSE

The h.f. step response correction network has been adjusted by the manufacturer to match the oscilloscope input. For optimum pulse response, for separate delivered probes, the probe can be adjusted to match your particular oscilloscope. Later readjustment is only necessary if the probe is to be used with a different type of oscilloscope, or after replacement of an electrical component.

For the adjustment, proceed as follows:

Connect the probe to a fast pulse generator (rise-time not exceeding 1 ns) which is terminated by its characteristic impedance. Dismantle the compensation box. Set the generator to 100 kHz. Adjust R2 and R3 alternatively to obtain a display as shown in Fig. 1.

It is important that the leading edge is as steep, and the top is as flat, as possible. Incorrect settings of R2 and R3 give rise to pulse distortions as shown in Fig. 2. and 3.

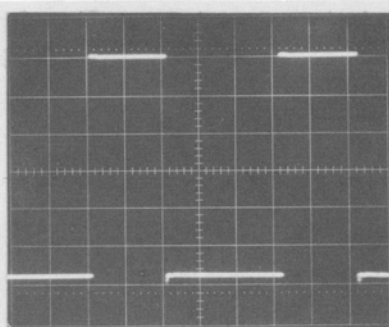

Fig. 1. Preset potentiometers correctly adjusted

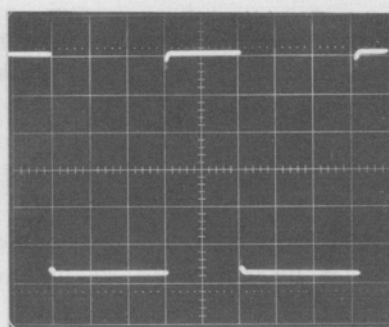

Fig. 2. Rounding due to incorrectly adjusted potentiometers

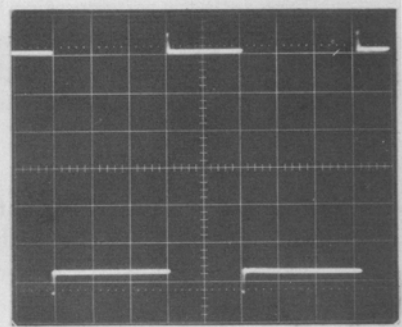

Fig. 3. Overshoot due to incorrectly adjusted potentiometers.

MAT 615

9499 448 22311

PRINTED IN THE NETHERLANDS

1.2. DISMANTLING

Dismantling the probe (see Fig. 4.)

The front part 11 of the probe can be screwed from the rear part 13. Item 11 can then be slid from 12 and 13.

The RC combination 12 is soldered to 13. For replacement of 12 refer to the next section.

Dismantling the compensation box (see Fig. 4.)

Unscrew the ribbed collar of the compensation box to the cable. The case 14 can then be slide sideways off the compensation box. The electrical components on the printed-wiring board are then accessible.

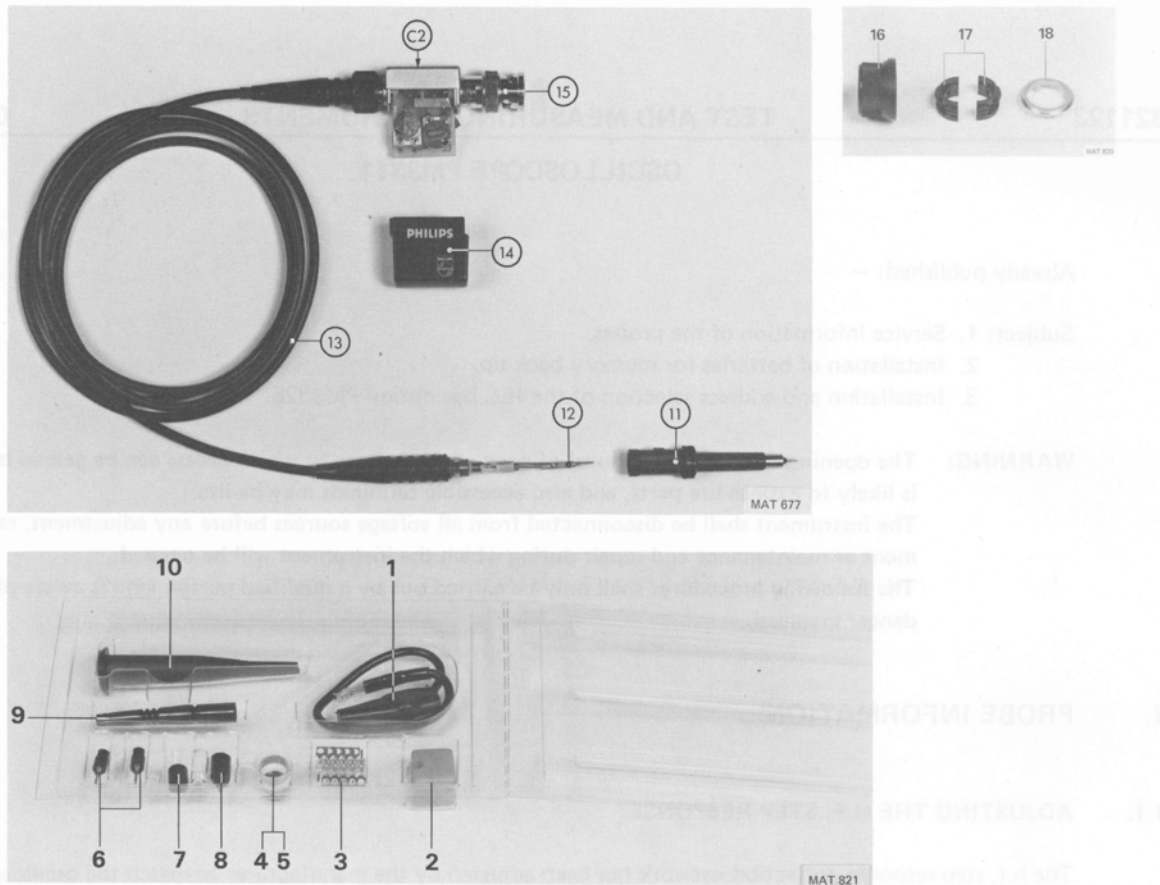

Fig. 4. Dismantling + accessories

1.3. REPLACING PARTS

Assembling the probe

A new RC network is slid over the cable nipple, after which the cable core is soldered on to the resistor wire. When the measuring probe is assembled, the RC network must be at dead centre in the probe tip.

Replacing the cable assembly

Dismantle the compensation box.

Unsolder the connection between the inner conductor and the printed-wiring board. Keep the frame of the compensation box steady and loosen the cable nipple with a 5 mm spanner on the hexagonal part. Replace the cable and fit it, working in the reverse order.

Replacing the BNC

Dismantle the compensation box.

Unsolder the connection to the printed-wiring board. Hold the frame of the compensation box firmly and loosen the BNC with a 3/8 inch spanner. Replace the BNC and fit it, working in the reverse order.

Replacing the probe tip

The damaged tip can be pulled out by means of a pair of pliers. A new tip must be firmly pushed in.

1.4. PARTS LIST

Mechanical parts (see Fig. 4. and 5.).

Items 1 to 10 are standard accessories supplied with the probe.

Item	Order number	Qty	Description
1	5322 321 20223	1	Earth cable
2	5322 256 94136	1	Probe holder
3	5322 255 44026	10	Soldering terminals which may be incorporated in circuits as routine test points
4	5322 532 64223	2	Marking ring red
5	5322 532 64224	2	Marking ring white
	5322 532 64225	2	Marking ring blue (not shown)
6	5322 268 14017	2	Probe tip
7	5322 462 44319	1	Insulating cap to cover metal part of probe during measurements in densely wired circuits
8	5322 462 44318	2	Cap facilitating measurements on dual-in-line integrated circuits
9	5322 264 24018	1	Wrap pin adaptor
10	5322 264 24019	1	Spring-loaded test clip
11	5322 264 24021	1	Probe shell with check-zero button
12	5322 216 54152	1	RC network
13	5322 320 14063	1	Cable assembly
14	5322 447 64016	1	Cap
15	5322 268 44019	1	BNC connector
16	5322 532 64277	1	Holder
17	5322 532 64278	2	Ring
18	5322 532 14696	1	Contact ring
—	5322 492 64765	1	Contact spring
R	5322 116 55552	1	Resistor 2K32

Electrical parts

Item	Order number	Description
C1	—	Part of RC network (not supplied separately)
C2	5322 125 54003	Trimmer 60 pF, 300 V
R1	—	Part of RC network (not supplied separately)
R2	5322 101 14047	Potmeter 470 Ω , 20 %, 0.5 W
R3	5322 100 10112	Potmeter 1 k Ω , 20 %, 0.5 W

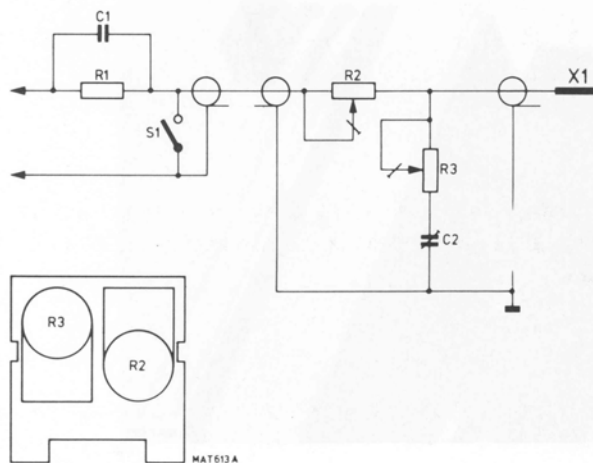

Fig. 5. Printed-wiring board showing adjusting elements, circuit diagram

2. BATTERIES FOR MEMORY BACK-UP

The instrument is equipped with a back-up facility to enable the memory contents and also the switch settings to be saved when the POWER switch is OFF.

When battery back-up is used, the information that was stored in the random access memories (RAMs) before the instrument was switched off is displayed again when the instrument is switched on after a period of time. Automatic display is given of the contents of the memory in which the last information was stored and also the associated switch settings.

Faulty or low battery functioning is not indicated by the oscilloscope. In that event, the instrument will function as if no memory back-up is present.

For technical reasons batteries are not included. If memory back-up is required install the batteries as described below.

Replacing the batteries

The instrument is protected by four covers: a front panel protection cover, a rear plate and an upper and lower cabinet plate.

The batteries are accessible after the upper instrument cover is removed.

To remove instrument covers, proceed as follows:

- The upper cabinet plate can be removed after slackening the four quick-release fasteners at the corners of the plate. To prevent the fasteners coming apart, do not slacken more than two turns.

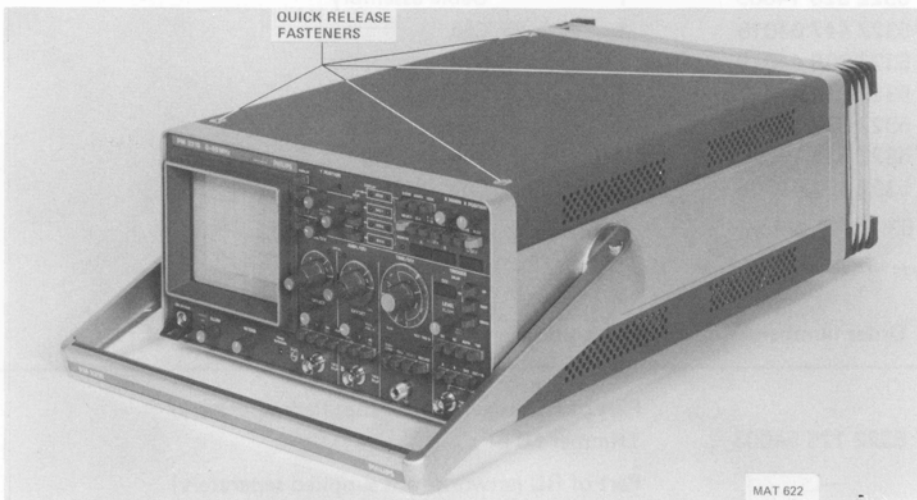

Fig. 6. Removing the instrument cover

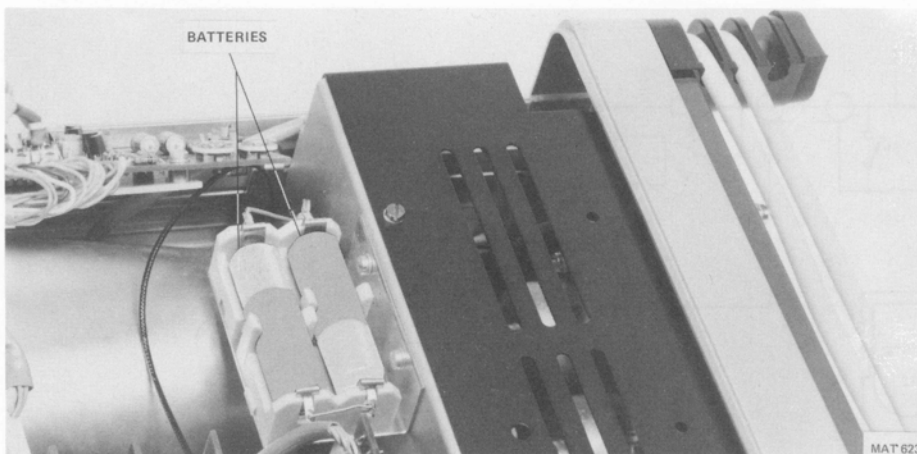

Fig. 7. Location of internal batteries

Recommended battery types: 2x 1.5 V Philips R6P.

3. INSTALLATION INSTRUCTIONS OF PM3325

WARNING: The opening of covers or removal of parts, except those to which access can be gained by hand, is likely to expose live parts, and also accessible terminals may be live.
The instrument shall be disconnected from all voltage sources before any adjustment, replacement or maintenance and repair during which the instrument will be opened.
If afterwards any adjustment, maintenance or repair of the opened instrument under voltage is inevitable, it shall be carried out only by a qualified person who is aware of the hazard involved.
Bear in mind that capacitors inside the instrument may still be charged even if the instrument has been separated from all voltage sources.

- Disconnect the oscilloscope from the mains supply
- Switch the POWER ON-OFF switch to OFF

3.1. REMOVING THE COVERS

Both upper and lower cabinet plates can be removed after slackening the four quick-release fasteners at the corner of each plate.

To prevent the fasteners coming apart, do not slacken more than two turns.

3.2. REMOVING THE BLACK PANEL COVERING THE POWER SUPPLY AT THE LOWER SIDE OF THE PANEL

Remove the two screws that secure the black panel at the lower side of the instrument.

3.3. MOUNTING THE CABLE AND THE PLUG IN UNIT A 14

Remove the plastic insert which is mounted in the opening in the rear panel which is reserved for the I.E.C. interface connector X 13.

Place the I.E.C. interface connector X 13 in this opening in the rear panel and fix the connector with the metal bracket and the two special screws and washers as shown in the following figure.

Adapting microprocessor unit A4.

The PROM circuit containing the I.E.C. software can be placed in the empty socket D 407 on microprocessor unit A4.

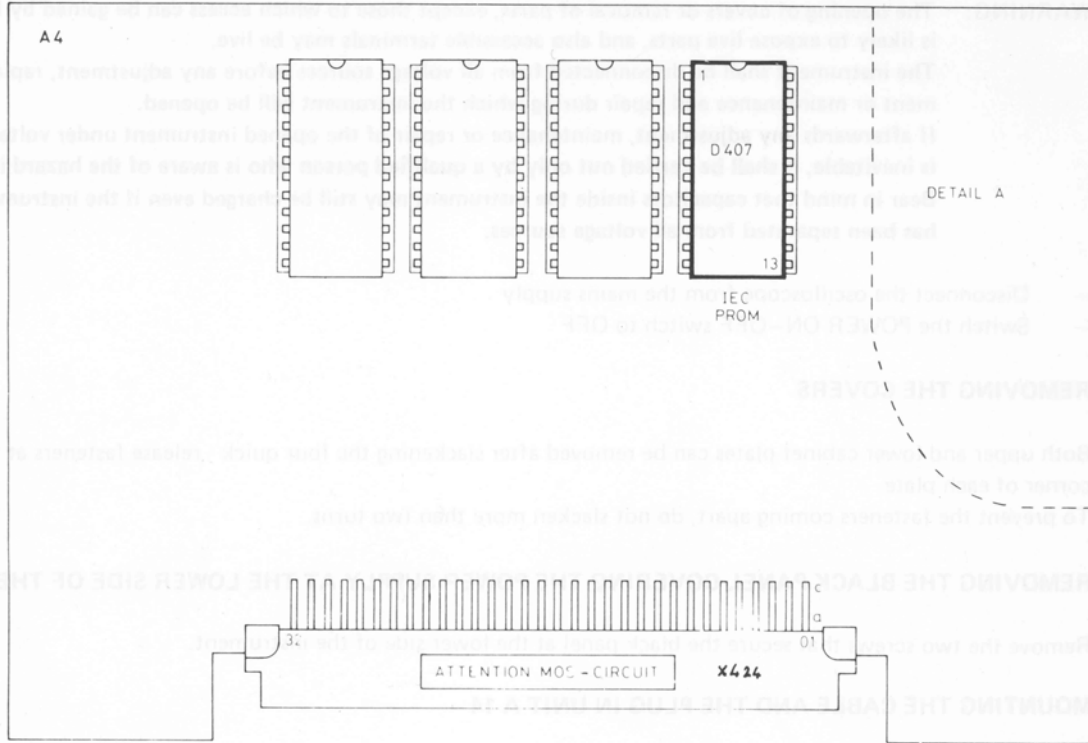

MAT 894

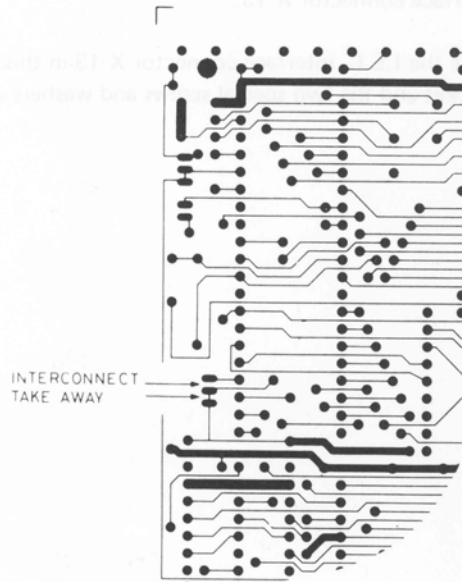

MAT 895

"Detail A" conductor side

Furthermore a connection must be interrupted and a connection must be made. To make the new connection, a soldering iron is needed.

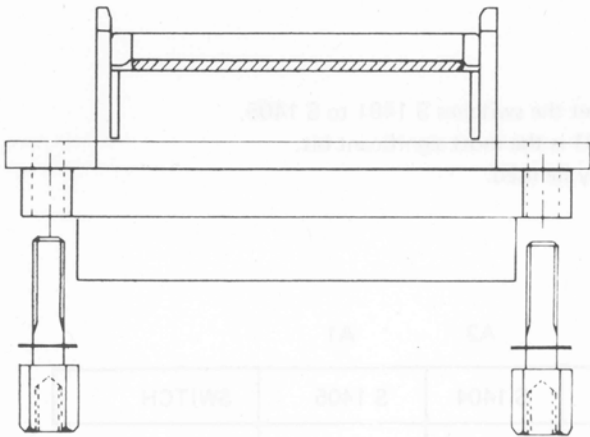

MAT 891

The cable can now be placed in the instrument as shown in the following figure.

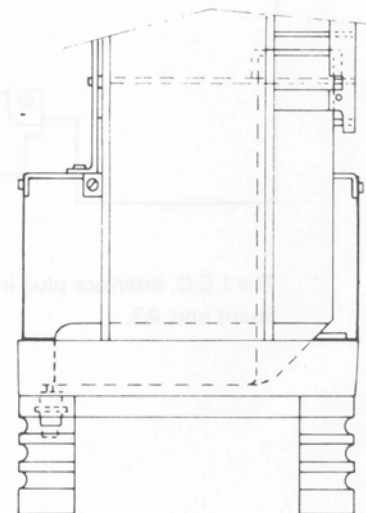
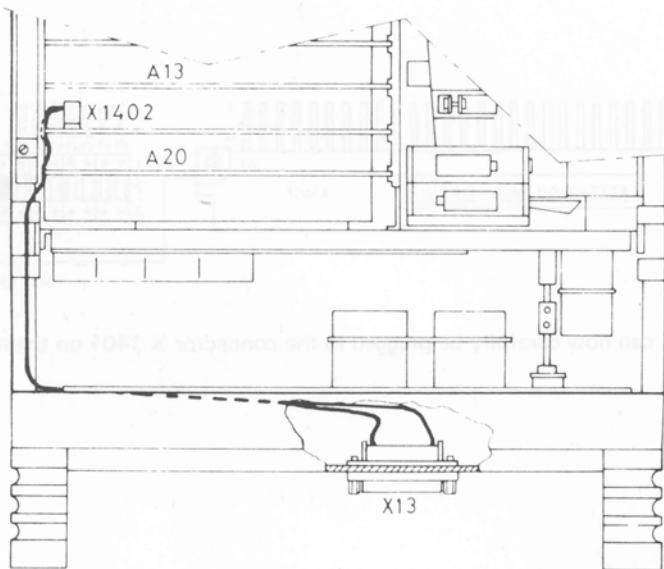
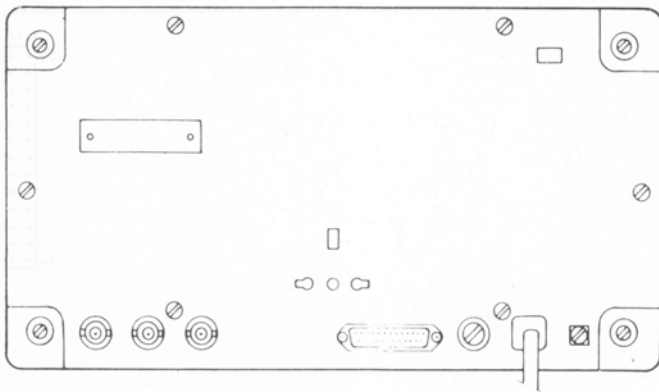

MAT 892

Connect the cable plug X 1402 to the contact pins X 1402 on the plug in unit A 14, such that the marked pin 1 of the cable plug is connected with pin 1 on the plug in unit. (Pin is marked with ▲).

Set switch LON to position 0
 Set switch TON to position 0

Select the proper oscilloscope address and set the switches S 1401 to S 1405.
 S 1405 is the least significant bit, and S 1401 is the most significant bit.
 Only the addresses 1 up to 30 (decimal) may be used.

Example

	A5	A4	A3	A2	A1	
	S 1401	S1402	S 1403	S 1404	S 1405	SWITCH
01	0	0	1	0	1	Listen address 5 Talk address 5
10	0	0	1	0	1	

Controlled by the system controller.

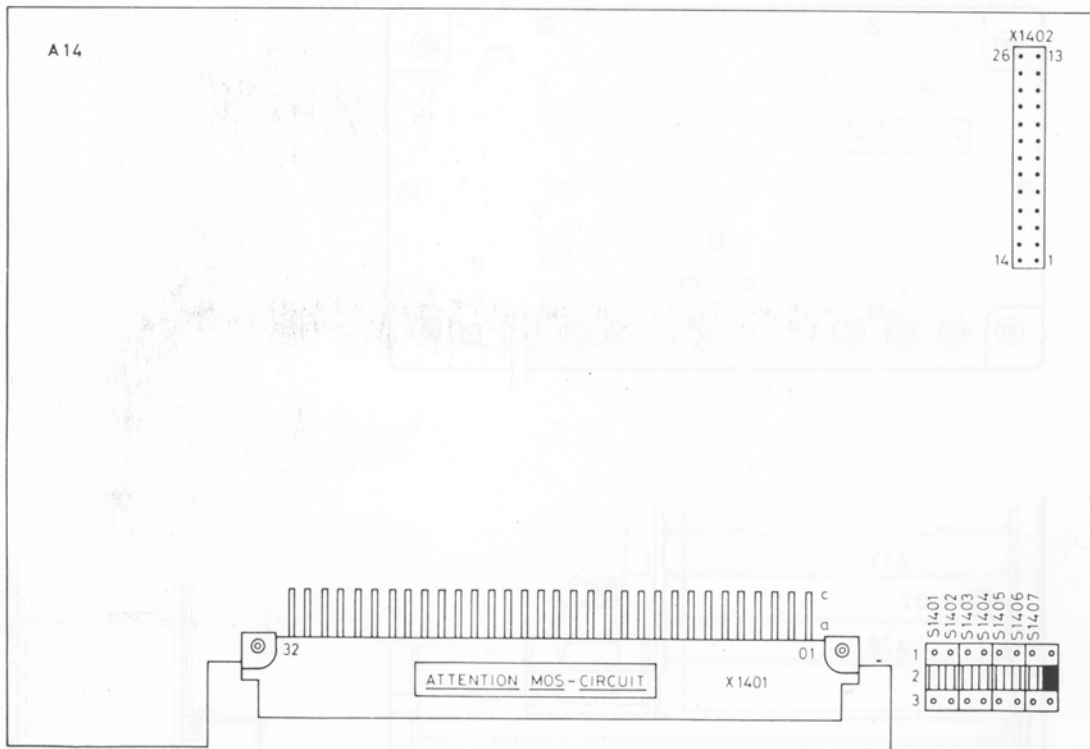

MAT 893

The I.E.C. interface plug-in unit A 14 can now carefully be plugged in the connector X 1401 on the mother-board unit A3.