



Service Manual

ATS-909

CONTENTS

Specification	2-5
Disassembly Instructions	6
Block Diagram	7-8
Alignment Instruments	9-25
(1) Alignment For Clock Time Accuracy	9
(2) Alignment For Indication Level Of Battery	10
(3) Alignment For Tuning Voltage Of FM Band	11
(4) Alignment For 452 kHz/ 448 kHz Oscillator	12
(5) Alignment For FM IF Detection	13
(6) Alignment For FM Station Detection	14
(7) Alignment For FM Sensitivity	15
(8) Alignment For FM Signal Level Indication	16
(9) Alignment For FM MPX	17
(10) Alignment For FM 2nd Local Oscillator	18
(11) Alignment For AM Sensitivity	19
(12) Alignment For 450 kHz Trap	20
(13) Alignment For Time Base Of Frequency	21
(14) Alignment For USB/LSB Fine Tuning	22
(15) Alignment For AM AGC	23
(16) Alignment For AM Signal Level Indication	24
Troubleshooting Flow Chart	26-30
Wiring Diagram	31
Main PCB Top View	32
Main PCB Bottom View	33
Control PCB Top View	34
Control PCB Bottom View	35
LCD Configuration	36-37
Mechanical Parts list	38
Exploded View	39
Electrical Parts List	40-44
IC Circuit Block Diagram	45-52
IC's & Transistor Voltage List	53-58
Semiconductor Lead Identifications	59
Schematic Diagram	60-61

SPECIFICATION

FM

TEST ITEM	CONDITION	NOMINAL	LIMIT	UNIT	
Tuning Range	Min.	87.5	± 0.15	MHz	
	Max.	108.0	± 0.15		
Intermediate Frequency		10.70	± 0.15	MHz	
Maximum Sensitivity	90 MHz		16	dB μ	
	98 MHz		16		
	106 MHz		16		
Usable Sensitivity	90 MHz	16	22	dB μ	
	98 MHz	16	22		
	106 MHz	16	22		
Image Rejection	106 MHz	36	30	dB	
I.F. Rejection	90 MHz	60	50		
3dB Limiting (1 mV)	98 MHz	18	24	dB μ	
Minimum Output		0.6	3	mV	
Tuning Indication Sens. (2nd. dot)		18	24	dB μ	
Auto. Scan. Stop. Sens.			24		
Stereo Indicator Sens.			24		
Stereo Separation (1 kHz)		25	20	dB	
Spurious Rejection			50	dB	
S/N Ratio		50	44	dB	
Alter. Channel Select.			25	dB	
Am. Suppression (66 dB μ)			30	dB	
** Output Power		350	300	mW	
T.H.D. (75 kHz dev.)		2	4	%	
Overload Capacity			106	dB μ	
Calibration				± 100	kHz
* Lowest Battery Voltage		3.9	4.2	V	
Audio Fidelity -3dB (W/Pre-emphasis)			150 8K	Hz	
Tone Action 10kHz/1kHz Volume At Center Position		+7.5	+3	dB	
		-22	-16		
Supply Voltage : DC 6 V		R.O. : 50 mW	Load : 8 ohm	Modulation : 1 kHz/22.5 kHz Dev.	

MW

TEST ITEM	CONDITION	NOMINAL	LIMIT	UNIT
Tuning Range	Min.	520	± 1	kHz
	Max.	1710	± 1	
Intermediate Frequency	1st. IF	55845	± 1	kHz
	2nd. IF	450		
Maximum Sensitivity	500 kHz		58	dB μ /m
	1000 kHz		56	
	1400 kHz		56	
Usable Sensitivity	600 kHz	58	64	dB μ /m
	1000 kHz	56	62	
	1400 kHz	56	62	
Image Rejection	1400 kHz	36	30	dB
I.F. Rejection (450 kHz)	1000 kHz		50	
Selectivity (± 10 kHz)	1000 kHz		40	dB
Bandwidth (wide) 6dB		7	4-8	kHz
Bandwidth (narrow) 6dB		4.5	2.5-6	kHz
T.H.D. (5 mV)		2	4	%
*Lowest Battery Voltage		3.9	4.2	V
Tuning Indication Sensitivity (2nd. dot)		56	60	dB μ /m
Auto. Scan. Stop. Sens.		56	62	dB μ /m
S/N Ratio (5 mV)			32	dB
Tone Action (3 kHz)		10	6	dB
Audio Fidelity (-6dB)			150	Hz
			2100	Hz
**Output Power		350	300	mW
Overload Capacity			100	dB μ /m
A.G.C.F.O.M			50	dB
Calibration			± 1	kHz
			± 1	
			± 1	
A.C.A. (± 10 kHz)			28	dB
Whistle Modulation (5mV/M)			15	%
Supply Voltage : DC 6 V		R.O. : 50 mW	Load : 8 ohm	Modulation : 1000 Hz/30% M Od.

LW

TEST ITEM	CONDITION	NOMINAL	LIMIT	UNIT	
Tuning Range	Min.	153	± 1	kHz	
	Max.	519	± 1		
Intermediate Frequency	1st. IF	55845	± 1	kHz	
	2nd. IF	450			
Maximum Sensitivity	180 kHz		68	dB μ/m	
	225 kHz		66		
	279 kHz		64		
Usable Sensitivity	180 kHz	68	74	dB μ/m	
	225 kHz	66	72		
	279 kHz	64	70		
Image Rejection	279 kHz	30	24	dB	
I.F. Rejection (450 kHz)	225 kHz		50		
Selectivity (±10 kHz)	225 kHz		40	dB	
Bandwidth (wide) 6dB				kHz	
Bandwidth (narrow) 6dB				kHz	
T.H.D. (5 mW)		2	4	%	
*Lowest Battery Voltage		3.9	4.2	V	
Tuning Indication Sensitivity (2nd. dot)			70	dB μ/m	
Auto. Scan. Stop. Sens.			72	dB μ/m	
S/N Ratio (5 mV)			24	dB	
Tone Action (3 kHz)				dB	
Frequency Response (-6 dB)				150	Hz
				2.1	kHz
**Output Power			350	300	mW
Overload Capacity				106	dB μ/m
A.G.C.F.O.M					dB
Calibration		180 kHz		± 1	kHz
	225 kHz		± 1		
	279 kHz		± 1		
Supply Voltage : DC 6 V		R.O. : 50 mW	Load : 8 ohm	Modulation : 1000 Hz/30% Mod.	

SW

TEST ITEM	CONDITION	NOMINAL	LIMIT	UNIT
Tuning Range	Min.	1711	$\pm 1K$	kHz
	Max.	29999	$\pm 1K$	
Intermediate Frequency	1st. IF	55845	± 1	kHz
	2nd. IF	450		
Maximum Sensitivity	3900 kHz		22	dB μ /m
	15100 kHz		18	
	25600 kHz		18	
Usable Sensitivity	3900 kHz	22	28	dB μ /m
	15100 kHz	18	24	
	25600 kHz	18	24	
Image Rejection	15100 kHz	42	36	dB
I.F. Rejection (450 kHz)	15100 kHz	76	60	
Selectivity (± 10 kHz)	15100 kHz		50	dB
Bandwidth (wide) 6dB		6	4-8	kHz
Bandwidth (narrow) 6dB		4.5	3-7	kHz
T.H.D. (60 dB μ)		2	4	%
*Lowest Battery Voltage		3.9	4.2	V
Tuning Indication Sensitivity (2nd. dot)			24	dB μ /m
Auto. Scan. Stop. Sens.			26	dB μ /m
S/N Ratio (60 dB μ)			40	dB
RF Gain Control		25	± 6	dB
Audio Fidelity (-6dB)			150	Hz
			2200	Hz
**Output Power				mW
Overload Capacity			300	
A.G.C.F.O.M (86 dB μ)			86	80
Calibration	3900 kHz		60	dB
	15100 kHz		± 1	kHz
	25600 kHz		± 1	
A.C.A. (± 10 kHz)	15100 kHz		± 1	
SSB/CW Sens. (S/N=10 dB)	15100 kHz	-3	28	dB
Supply Voltage : DC 6 V	R.O. : 50 mW	Load : 8 ohm	+3	dB μ /m
Modulation : 1000 Hz/30% Mod.				

DISASSEMBLY INSTRUCTIONS

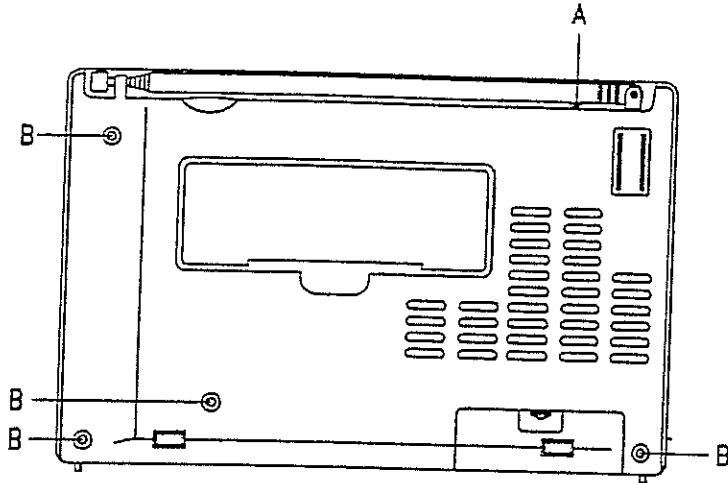

TO REMOVE BACK COVER

- a. Unscrew 1 screw A.
and 4 PTP screws B.
- b. Separate Front and Back cabinet.

TO REMOVE MAIN PCB

- a. Release Main PCB from hooks C
to remove it.

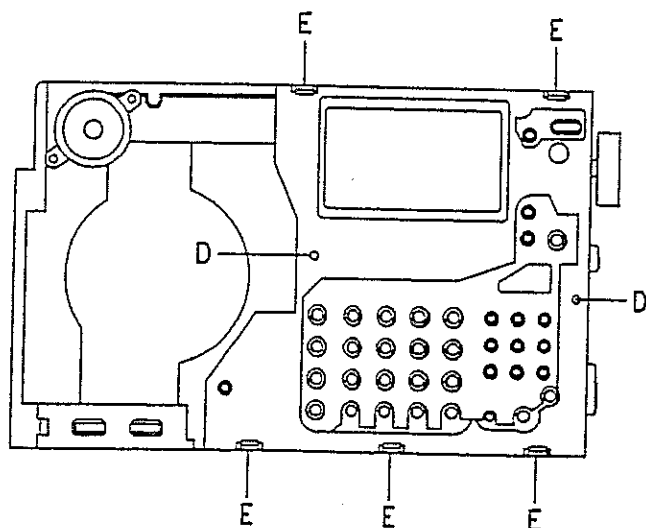
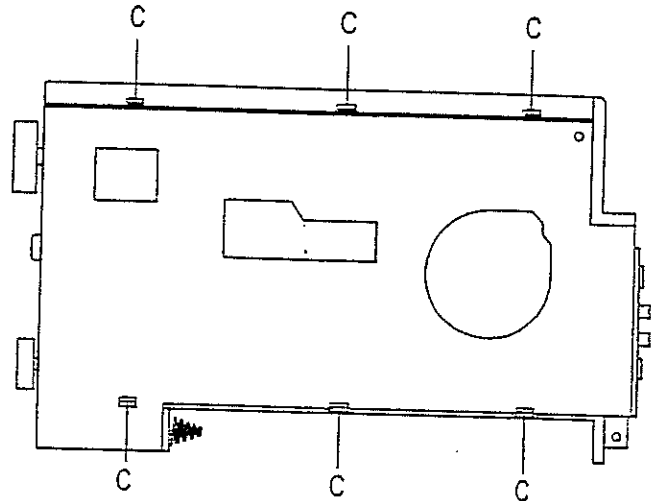

TO REMOVE CONTROL PCB

- a. Unscrew 2 screws D.
- b. Release Control PCB from hooks E
to remove it.

ALIGNMENT INSTRUCTIONS

(1) ALIGNMENT FOR CLOCK TIME ACCURACY

a. Required Instrument
Quartz Clock Analyzer

b. Alignment Procedure

Setting		Procedure
RECEIVING FREQUENCY	RADIO OFF	(1) Turn the radio to OFF and Set keylock function to ON position.
ADJUSTMENT	TC302	(2) Bar sensor of quartz clock analyzer close to X302 and adjust TC302 to reach the range of zero error ($\pm 7.6\text{ppm}$ or ± 20 sec/month)

c. Instrument Connection

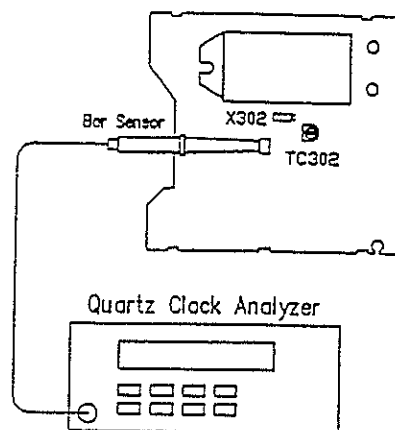
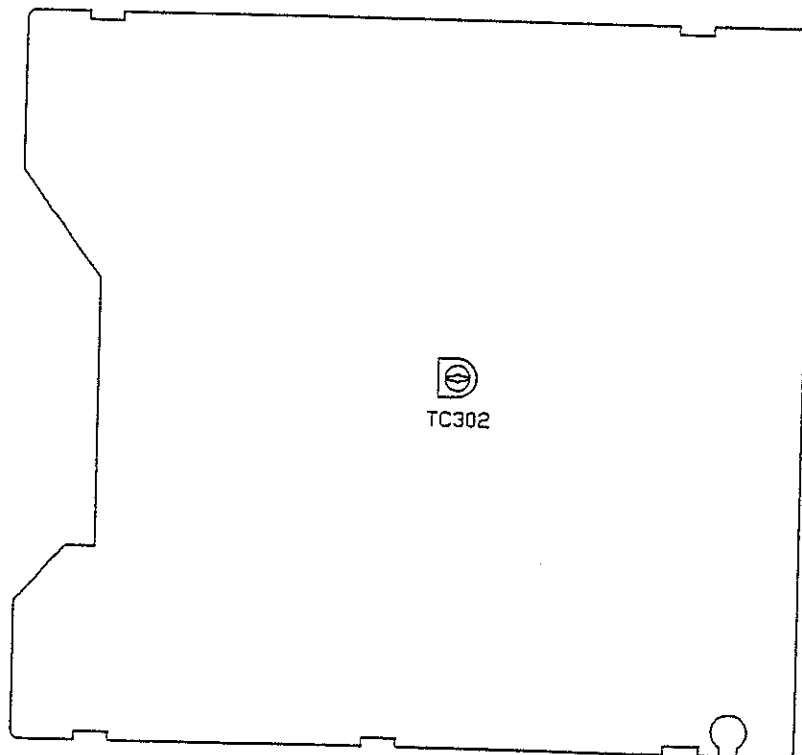

(2) ALIGNMENT FOR INDICATION LEVEL OF BATTERY

a. Required Instrument

Digital Voltage Meter (DVM)

DC Power Supply With Voltage Meter

b. Alignment Procedure

Setting		Procedure
RECEIVING FREQUENCY	153 kHz	(1) Take off the batteries and connect 5.02VDC of DC power supply to TP28 and GND. (2) Checking battery level should be appear 4 scales at all 7 scales zebra when radio power from ON to OFF. (3) When can't meet specification that adjust VR301 and recheck STEP(2) until the scale is corrected.
BAND	LW	
AM MODE	AM	
ADJUSTMENT	VR301	

c. Instrument Connection

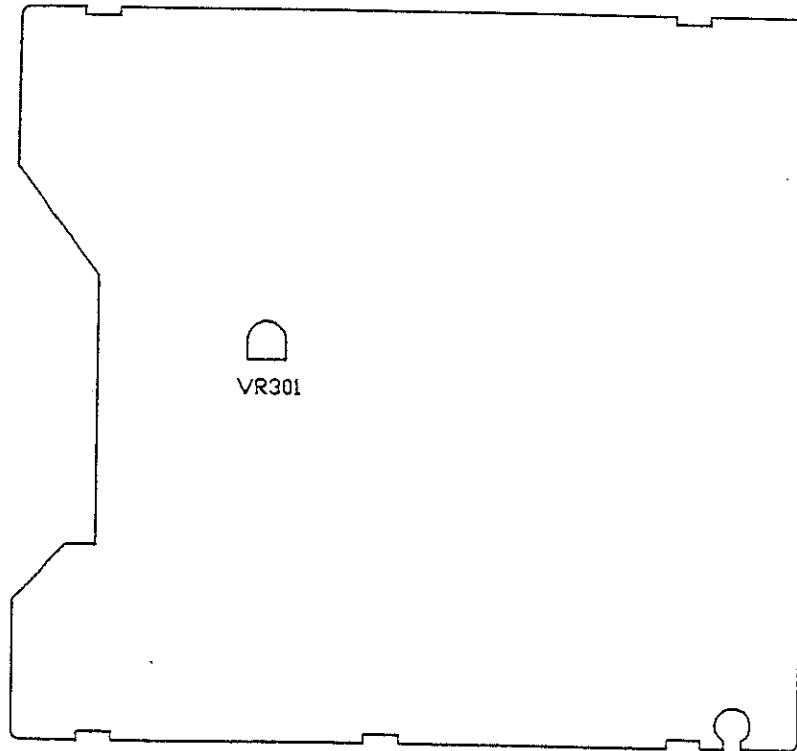

Power Supply

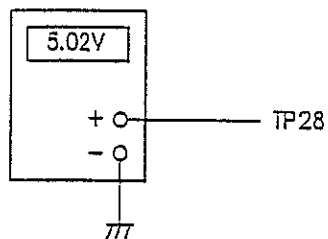

(3) ALIGNMENT FOR TUNING VOLTAGE OF FM BAND

a. Required Instrument
Digital Voltage Meter (DVM)

b. Alignment Procedure

Setting		Procedure
RECEIVING FREQUENCY	108 MHz	(1) Turn the radio to ON and Set receiving frequency to 108 MHz. (2) Connect a DVM to TP1 and GND. (3) Adjust T11 to read correct value 10.2V - 10.8V from DVM.
BAND	FM	
TONE	NORM	
ADJUSTMENT	T11	

c. Instrument Connection

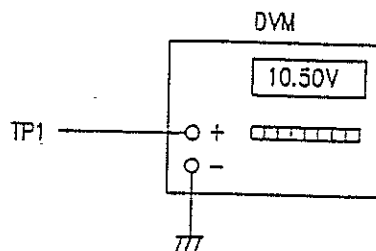
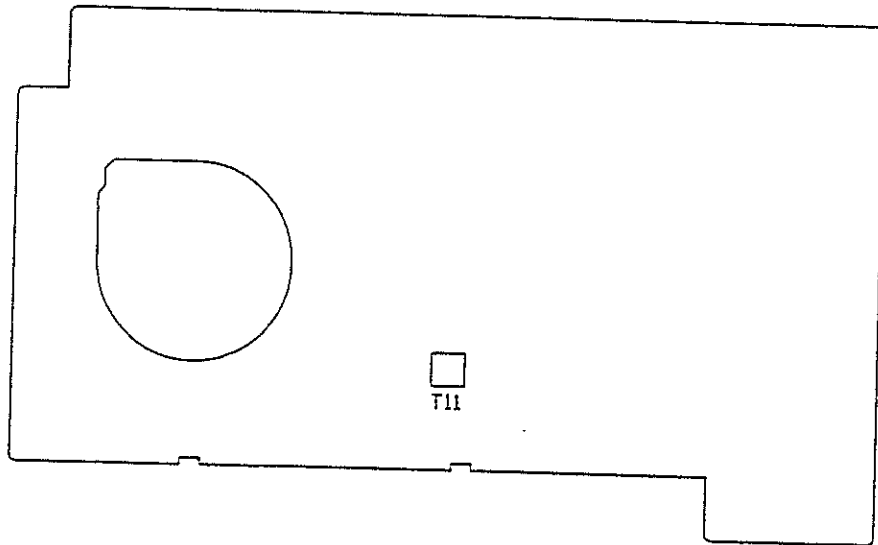

(4) ALIGNMENT FOR 452KHZ / 448 KHZ OSCILLATOR

a. Required Instrument
Frequency Counter

b. Alignment Procedure

Setting		Procedure
RECEIVING FREQUENCY	15.1 MHz	(1) Connect a frequency counter to TP2. (2) Turn the radio to ON and set AM mode to "USB". (3) Adjust VC5 to have a reading specification frequency $452 \text{ kHz} \pm 30 \text{ Hz}$. (4) Set AM mode to "LSB" condition. (5) Adjust VC4 to have a reading specification frequency $448 \text{ kHz} \pm 30 \text{ Hz}$.
BAND	SW	
AM MODE	USB/LSB	
TONE	NORM	
RF GAIN	MAX.	
ADJUSTMENT	VC5 VC4	

c. Instrument Connection

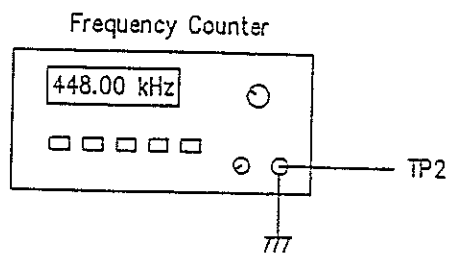
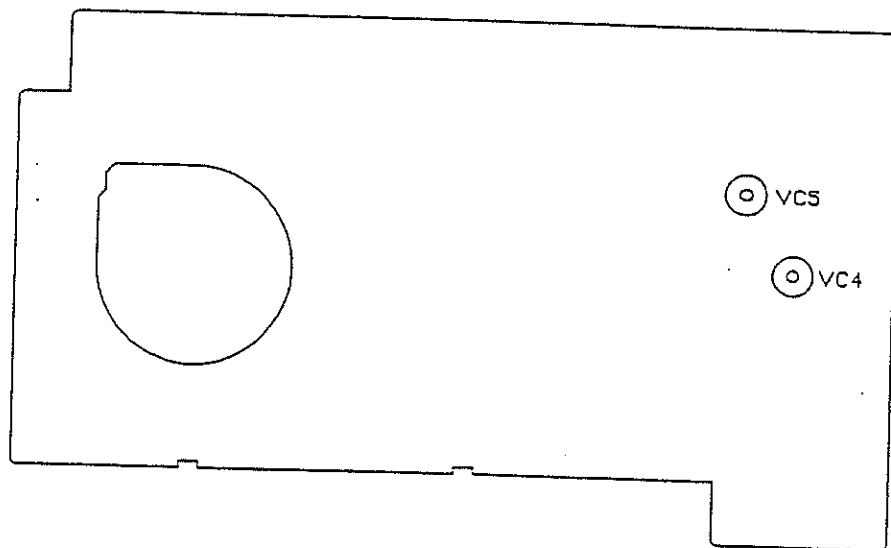

(5) ALIGNMENT FOR FM IF DETECTION

a. Required Instrument
FM IF Sweep Generator With Scope

b. Alignment Procedure

Setting		Procedure
RECEIVING FREQUENCY	98 MHz	(1) Turn the radio to ON. (2) Connect the input of the FM IF Sweep Generator in series with a 1.2K ohm resistor to test point TP5. (3) Connect the IF output of the FM IF Sweep Generator in series with a 2.2K ohm resistor to test point TP7. (4) Adjust T3 and T9 to have a maximum output and the best symmetrical S curve with respect to the center marker frequency of 10.7MHz.
BAND	FM	
STEREO/MONO	STEREO	
ADJUSTMENT	T3 T9	

c. Instrument Connection

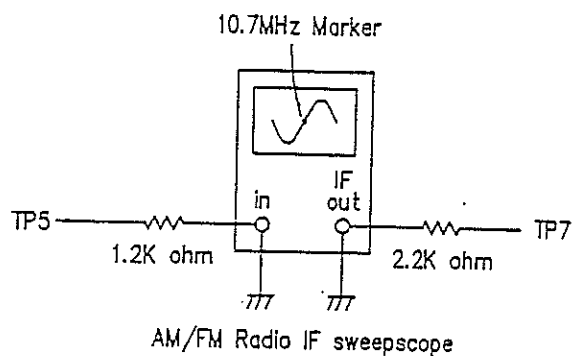
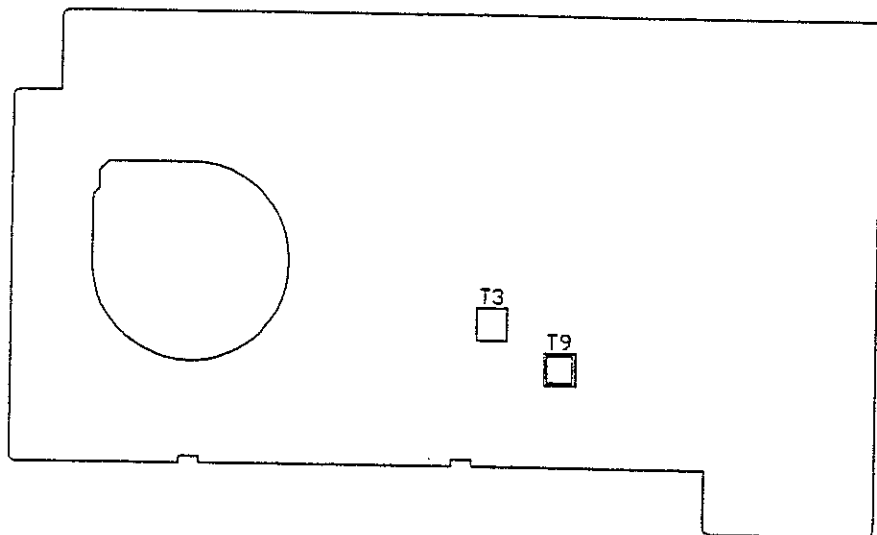

(6) ALIGNMENT FOR FM STATION DETECTION

- a. Required Instrument
 Digital Voltage Meter (DVM)
 FM RF Signal Generator (RFSG)

b. Alignment Procedure

Setting		Procedure
RECEIVING FREQUENCY	98 MHz	(1) Set RFSG frequency to 10.7MHz and output level to 60 emi/dB μ without modulation. (2) Connect the RFSG output to TP7. (3) Connect a DVM to TP8 and TP9. (4) Adjust SVR1 to get DC voltage value within $\pm 0.3V$ between TP8 and TP9.
BAND	FM	
STEREO/MONO	STEREO	
ADJUSTMENT	SVR1	

c. Instrument Connection

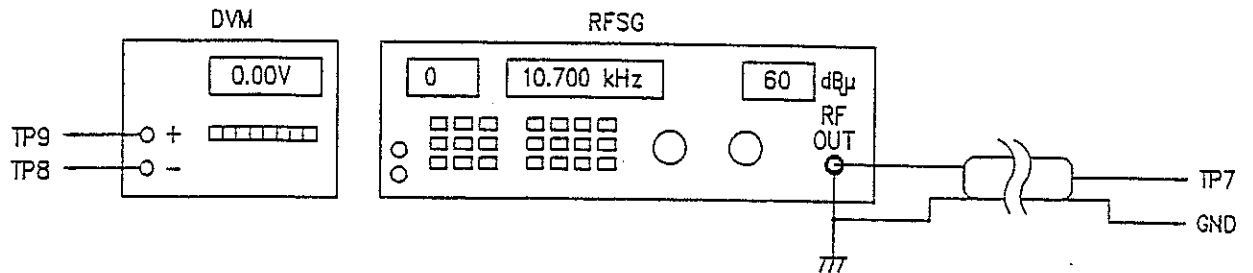
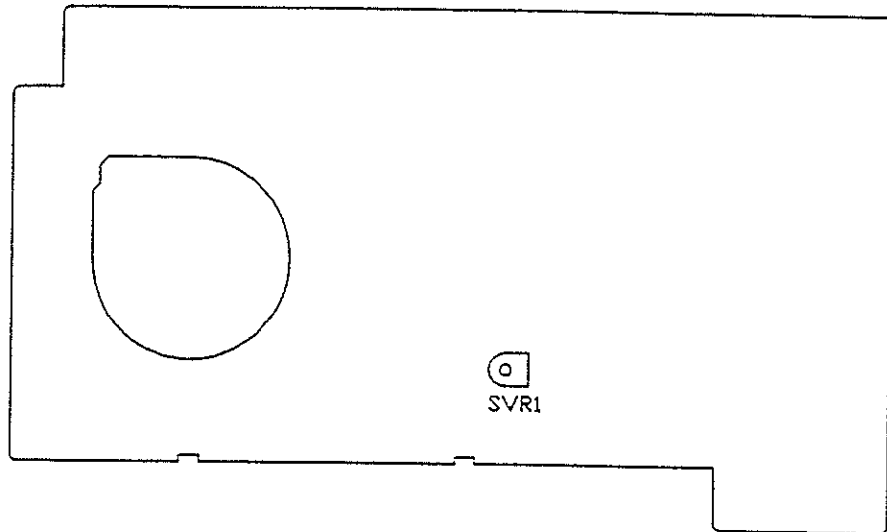

(7) ALIGNMENT FOR FM SENSITIVITY

a. Required Instrument

FM RF Signal Generator (RFSG)

SSVM

b. Alignment Procedure

Setting		Procedure
RECEIVING FREQUENCY	90/106 MHz	(1) Turn the radio to ON and set tone switch to norm. (2) Connect SSVM to the speaker out (TP17). (3) Connect a FM RFSG to the input terminal of the ANT IN (TP20) and GND (TP19). (4) Set the RFSG to 90 MHz with 22.5 kHz deviation and 1kHz modulation. (5) Tune the radio frequency to 90 MHz. Adjust T10 and T11 to have a maximum reading on the SSVM. (6) Return the radio frequency to 106MHz, adjust VC1 and VC2 to have a maximum reading on the SSVM. (7) Repeat steps (5) and (6) until the best sensitivity on these two frequency is formed.
BAND	FM	
TONE	NORM	
STEREO/MONO	STEREO	
ADJUSTMENT	T10, VC1 T11, VC2	

c. Instrument Connection

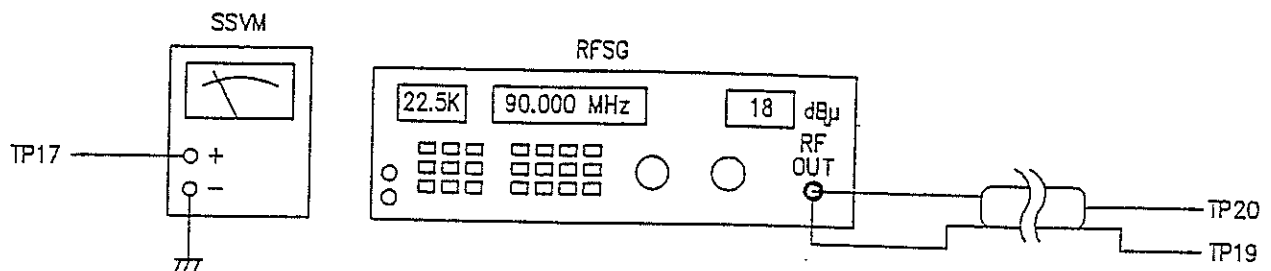
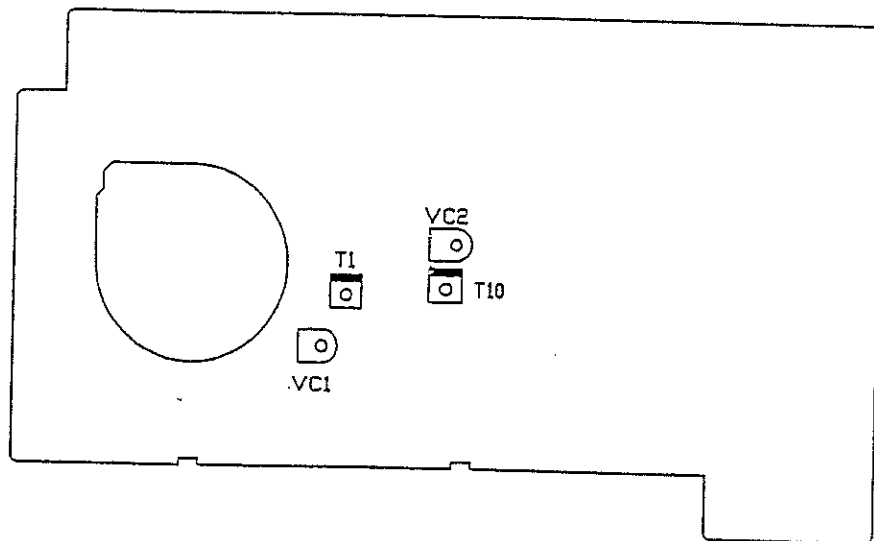

(8) ALIGNMENT FOR FM SIGNAL LEVEL INDICATION

a. Required Instrument
FM RF Signal Generator

b. Alignment Procedure

Setting		Procedure
RECEIVING FREQUENCY	98 MHz	(1) Turn the radio to ON and tune receiving frequency to 98 MHz. (2) Set the RFSG output level to 45 emf/dB μ . (3) Adjust SVR4 to indicating full scale of signal level (4) Reduce the RFSG output level to 43 emf/dB μ . (5) Adjust SVR4 to reach 6 scales of signal level. (6) Repeat step (3)-(5) to meet it's request.
BAND	FM	
TONE	NORM	
STEREO/MONO	STEREO	
ADJUSTMENT	SVR4	

c. Instrument Connection

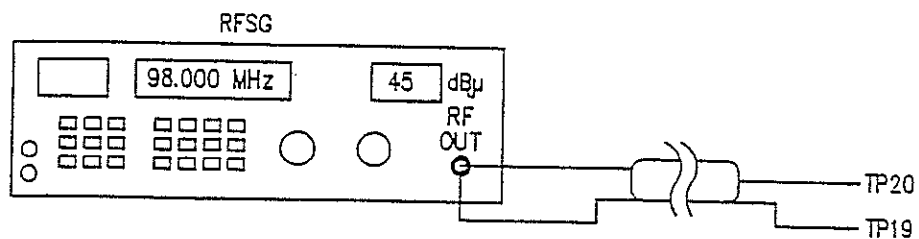
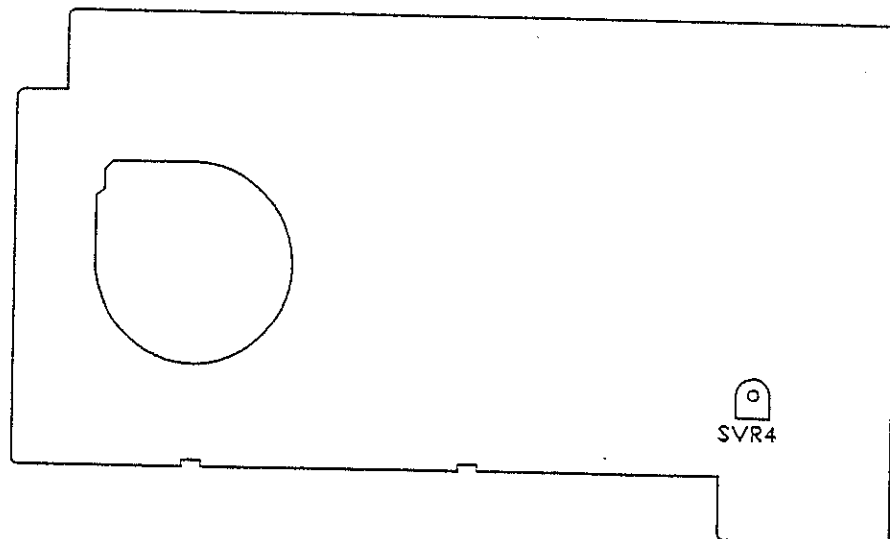

(9) ALIGNMENT FOR FM MPX

a. Required Instrument
Frequency Counter

b. Alignment Procedure

Setting		Procedure
BAND	FM	(1) Turn the radio to ON and set the (MONO/STEREO) switch to STEREO. (2) Turn the radio frequency to a avoid receiving any signal or station. (3) Insert a headphone plug into the headphone jack (JK2) (4) Connect a frequency counter to TP10 and GND. (5) Adjust SVR2 to have a reading of 18.95 kHz ~ 19.05 kHz on the frequency counter.
STEREO/ MONO	STEREO	
ADJUSTMENT	SVR2	

c. Instrument Connection

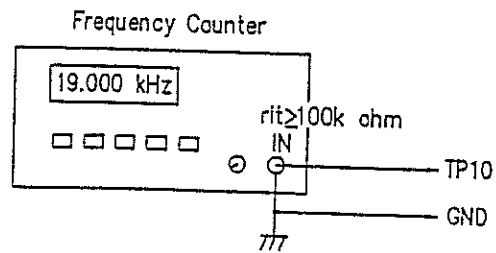
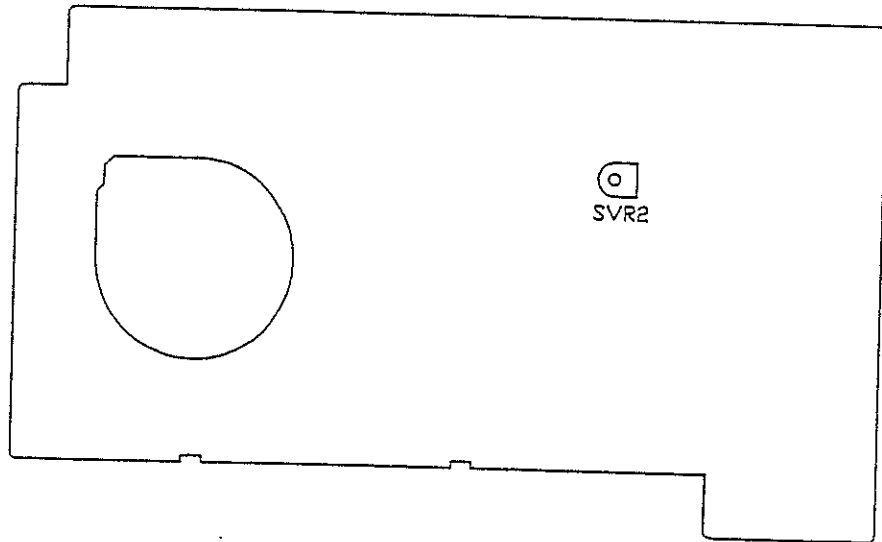

(10) ALIGNMENT FOR AM 2ND LOCAL OSCILATOR

- a. Required Instrument
 RF Signal Generator (RFSG)
 Frequency Counter
 DVM

b. Alignment Procedure

Setting		Procedure
RECEIVING FREQUENCY	15.1 MHz	(1) Set RFSG output level to 80 emi/dB μ and frequency to 55.845 MHz with modulation 1 kHz 30%. (2) Turn the radio to ON and set AM mode to "AM". (3) Turn the radio receiving frequency to 15.1 MHz. (4) Connect RFSG output to ANT IN (TP20). (5) Adjust T14 to get 1 kHz maximum level output of the speaker. (6) Change RFSG output frequency to 55.843MHz. (7) Change AM mode to "LSB" mode. (8) Check TP13 to have a reading on DVM 1.5V \pm 0.05. (9) Set keylock function to ON. (10) Adjust T14 to get the speaker output tone beat below 50 Hz.
BAND	SW	
AM MODE	LSB	
TONE	NORM	
WIDE/NARR. MONO	WIDE	
RF GAIN	MAX.	
ADJUSTMENT	T14	

c. Instrument Connection

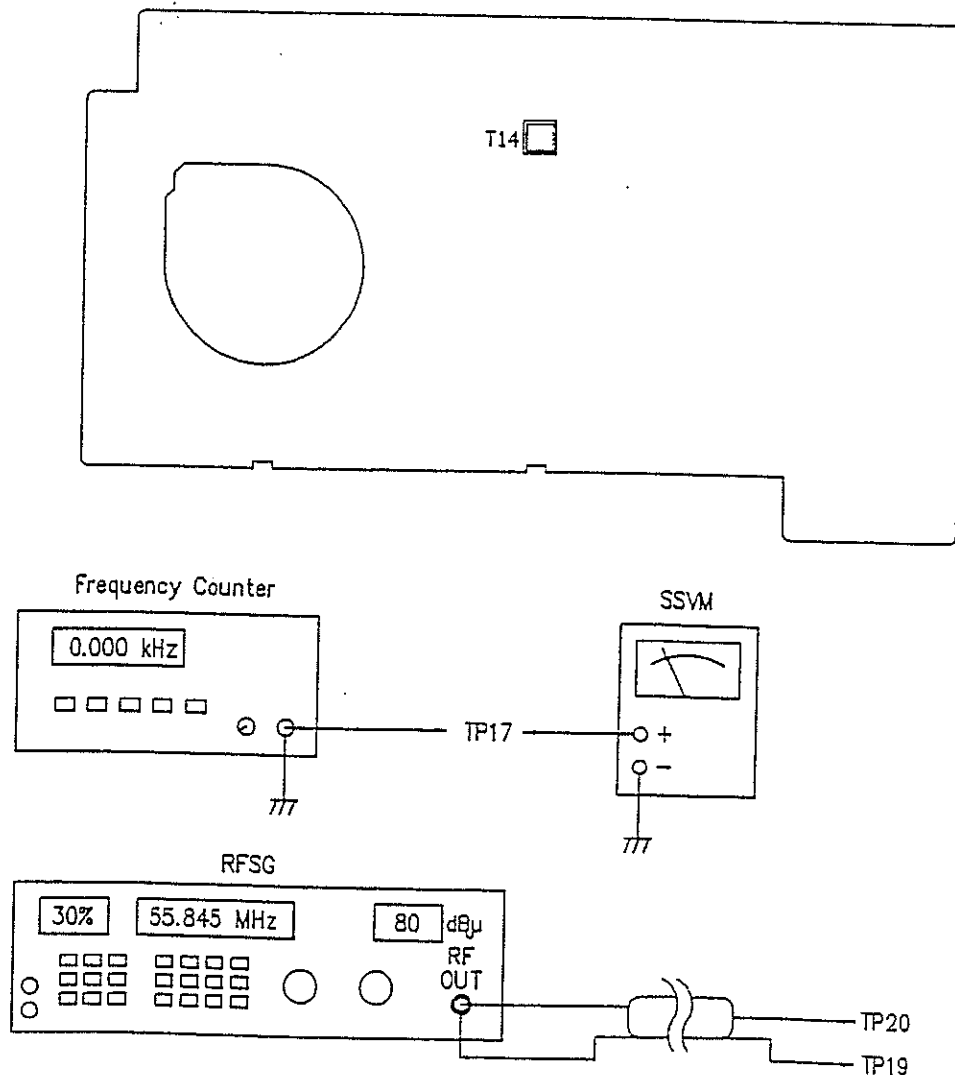

(11) ALIGNMENT FOR AM SENSITIVITY

a. Required Instrument
 RF Signal Generator
 SSVM

b. Alignment Procedure

Setting		Procedure
RECEIVING FREQUENCY	15.1 MHz	(1) Turn the radio to ON and tune receiving frequency to 15.1 MHz. (2) Set RF Gain VR1 to Max. and slide Wide/Narr. switch to WIDE. (3) Feed a signal with 1 kHz 30% modulation from RFSG into ANT IN (TP20). (4) Adjust T4,6,7,8,18 to have maximum 1 kHz output level on SSVM.
BAND	SW	
AM MODE	AM	
TONE	NORM	
RF GAIN	MAX.	
WIDE/NARR.	WIDE	
ADJUSTMENT	T4,6,7,8 T18	

c. Instrument Connection

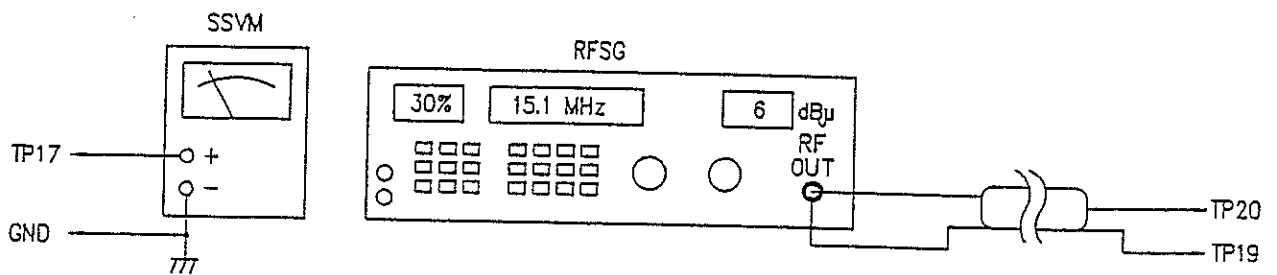
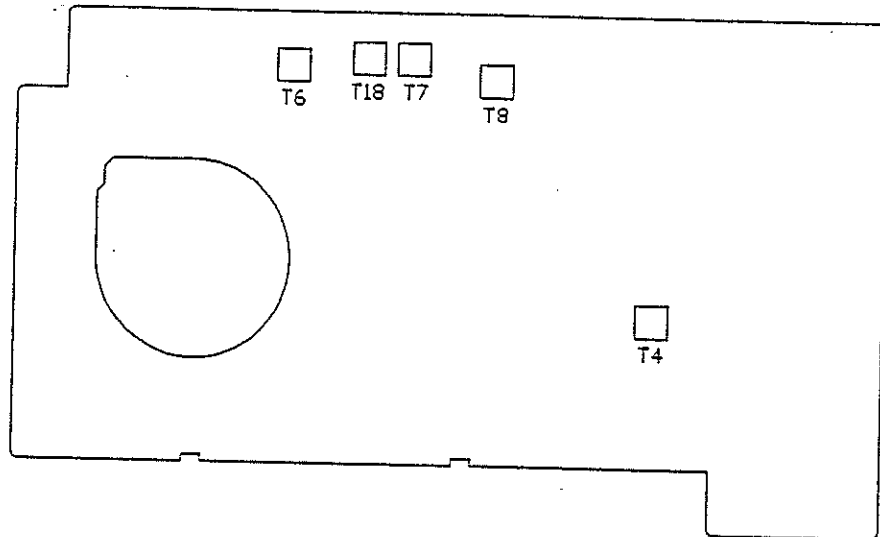

(12) ALIGNMENT FOR 450 kHz TRAP

a. Required Instrument
 RF Signal Generator With Loop Antenna
 SSVM

b. Alignment Procedure

Setting		Procedure
RECEIVING FREQUENCY	450 kHz	(1) Turn the radio ON and tune the receiving frequency to LW 450 kHz. (2) Feed a 450 kHz signal with 1 kHz 30% modulation to loop antenna. (3) Connect a SSVM to speaker output (TP17). (4) Adjust T17 to get minimum reading of SSVM.
BAND	LW	
AM MODE	AM	
tone	NORM	
WIDE/NARR. MONO	WIDE	
RF GAIN	MAX.	
ADJUSTMENT	T17	

c. Instrument Connection

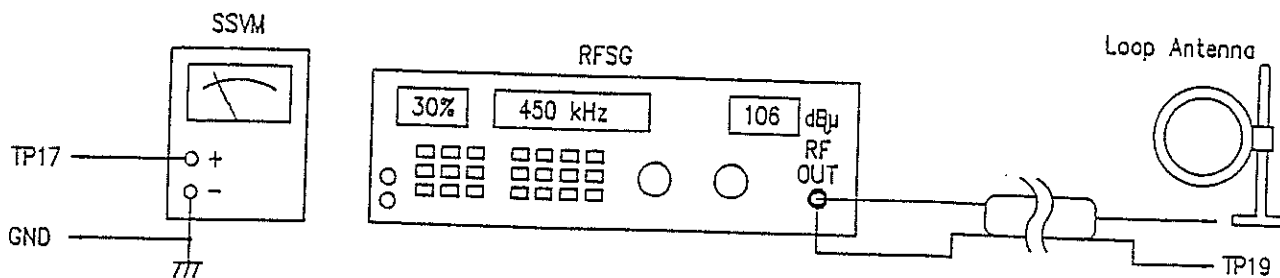
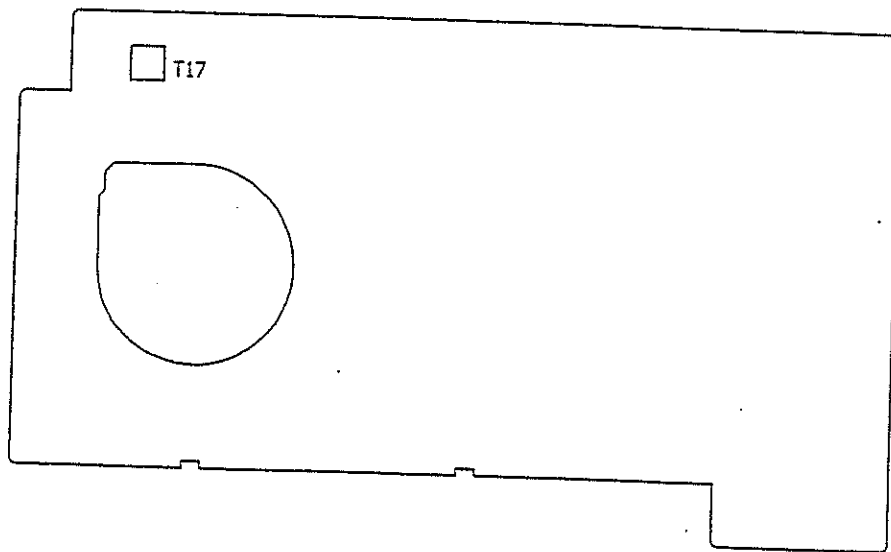

(13) ALIGNMENT FOR TIME BASE OF FREQUENCY

- a. Required Instrument
 RF Signal Generator
 Frequency Counter

b. Alignment Procedure

Setting		Procedure
RECEIVING FREQUENCY	15.1 MHz	(1) Connect a RFSG to ANT IN (TP20) and set frequency to 15.1 MHz and output to 40 emf/dB μ without modulation. (2) Set AM mode to LSB mode and volume turn to maximum. (3) Tune the radio receiving frequency to 15.1 MHz by 10 key or tuning up/down and set keylock to ON. (4) Adjust TC301 to get the speaker output tone beat below 50 Hz.
BAND	SW	
AM MODE	LSB	
TONE	NORM	
WIDE/NARR. MONO	NARR.	
RF GAIN	MAX.	
ADJUSTMENT	TC301	

c. Instrument Connection

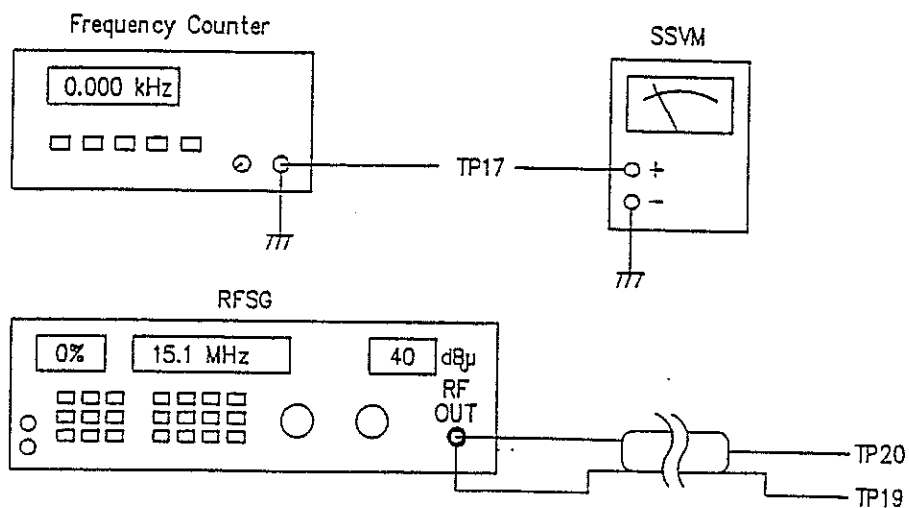
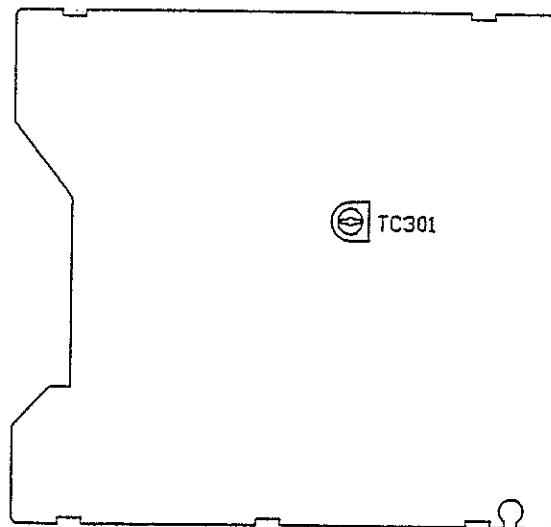

(14) ALIGNMENT FOR USB/LSB FINE TUNING

- a. Required Instrument
 RF Signal Generator
 Frequency Counter
- b. Alignment Procedure

Setting		Procedure
RECEIVING FREQUENCY	15.1 MHz	(1) Turn the radio to on and tune the receiving frequency to 15.1 MHz. (2) Set the AM mode to "USB" mode. (3) Set the tuning step to "SLOW". (4) Connect a RFSG to ANT IN (TP20) and set RF output to 15.1 MHz 40 emf/dB μ without modulation. (5) Connect a frequency counter to speaker output (TP17). (6) Adjust SVR5 to have a reading of 40Hz \pm 10Hz increment while rotary tuning change the receiving frequency from 15.1 MHz to 15.101 MHz.
BAND	SW	
AM MODE	USB	
TONE	NORM	
WIDE/NARR. MONO	NARR.	
RF GAIN	MAX.	
TUNING STEP	SLOW	
VOLUME	CENTER POSITION	
ADJUSTMENT	SVR5	

c. Instrument Connection

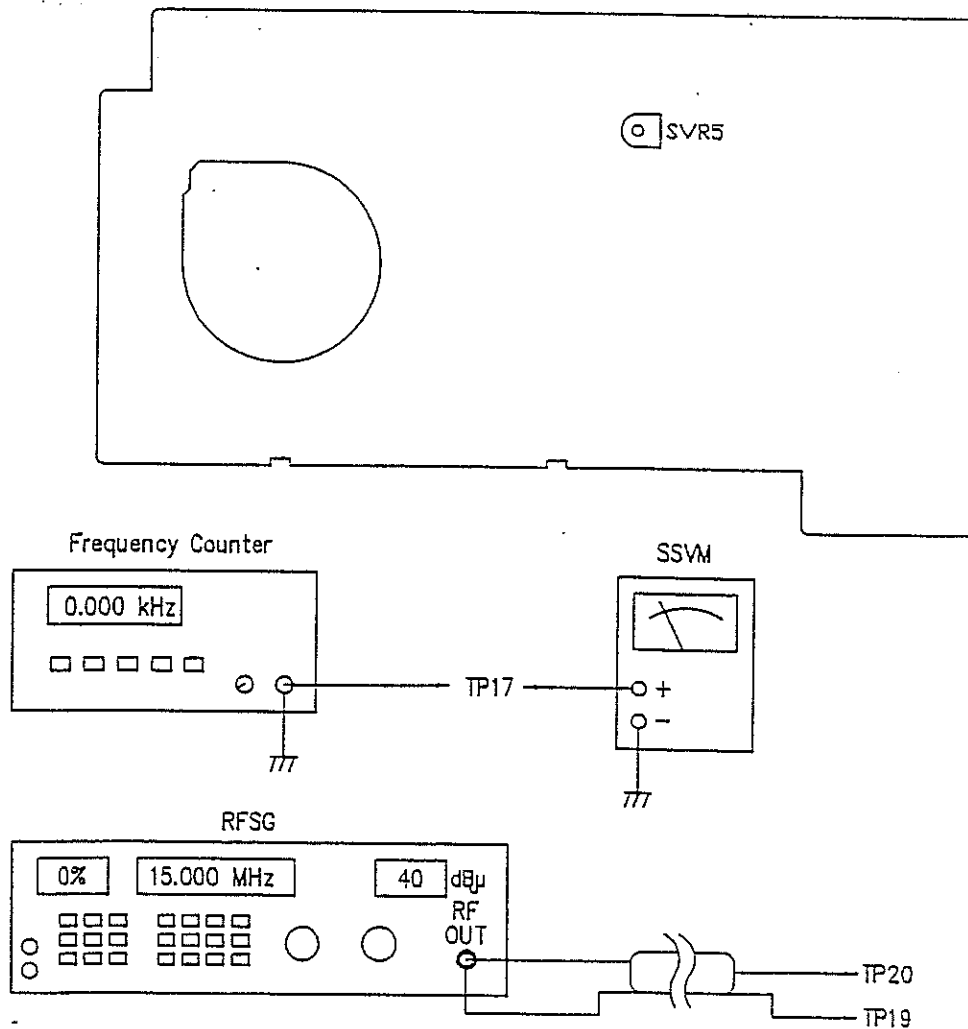

(15) ALIGNMENT FOR AM AGC

- a. Required Instrument
 RF Signal generator
 Digital voltage Meter (DVM)

b. Alignment Procedure

Setting		Procedure
RECEIVING FREQUENCY	15.1 MHz	(1) Tune the radio to ON. (2) Connect the RFSG to ANT IN (TP20) and set frequency to 15.1 MHz with 1kHz modulation. (3) Connect a DVM to TP22. (4) Set RFSG output level to 60 emf/dB μ . (5) Adjust SVR6 to have a reading of 1.58 V ~ 1.62 V on DVM.
BAND	SW	
AM MODE	AM	
TONE	NORM	
WIDE/NARR. MONO	WIDE	
RF GAIN	MAX.	
ADJUSTMENT	SVR6	

c. Instrument Connection

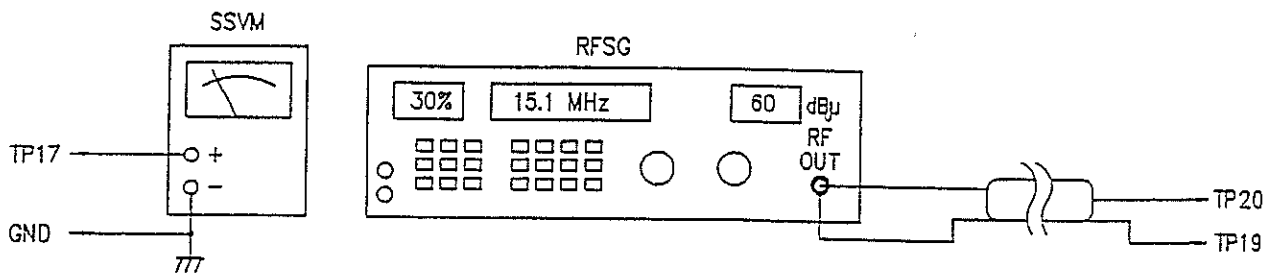
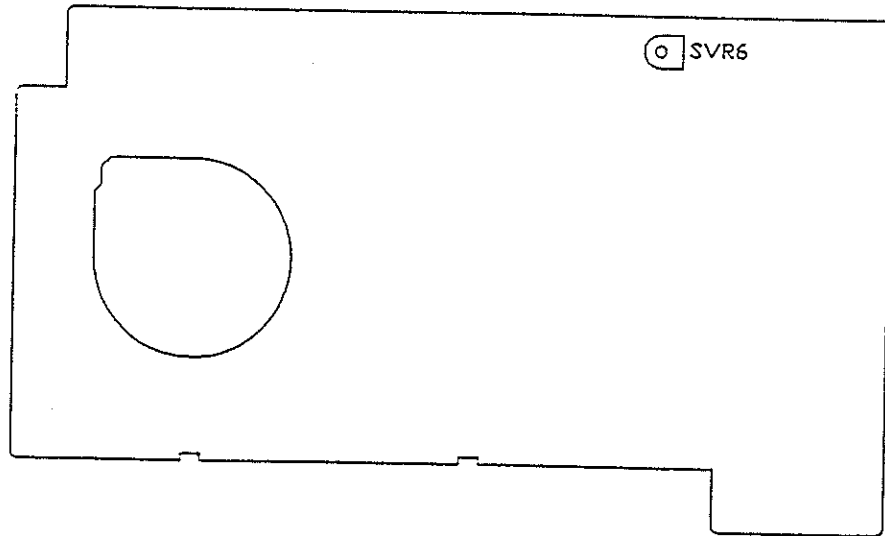

(16) ALIGNMENT FOR AM SIGNAL LEVEL INDICATION

a. Required Instrument
RF Signal Generator

b. Alignment Procedure

Setting		Procedure
RECEIVING FREQUENCY	15.1 MHz	(1) Set the RFSG frequency to 15.1 MHz with 1kHz 30% modulation. (2) Turn the radio to on and tune the receiving frequency to 15.1 MHz. (3) Connect the RFSG to ANT IN (TP20) and set the output level to 12 emf/dB μ . (4) Adjust SVR3 to have 2 scales of all 7 scales on signal level zebra. (5) Check RF input level is 60 emf/dB μ that the signal level zebra should be appear full scale. (6) repeat step (4),(5) to meet it's requested.
BAND	SW	
AM MODE	AM	
TO NE	NORM	
WIDE/NARR. MONO	WIDE	
RF GAIN	MAX.	
ADJUSTMENT	SVR3	

c. Instrument Connection

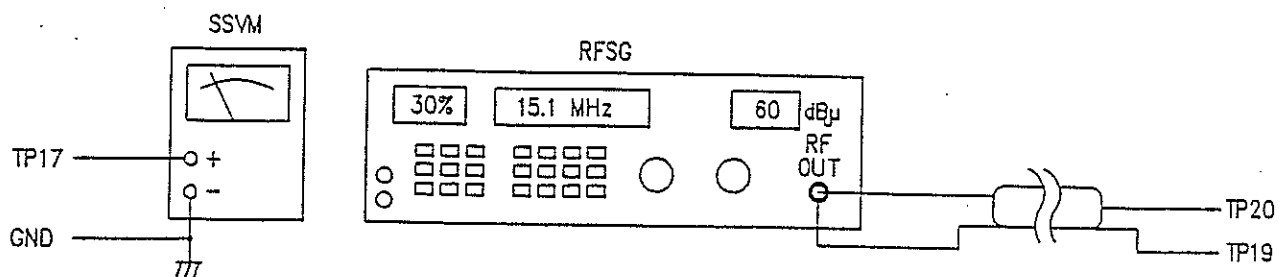
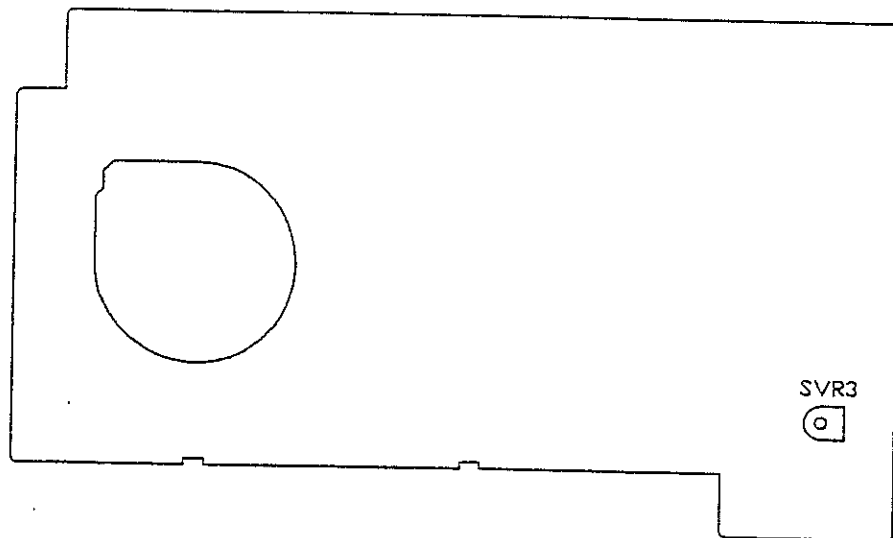

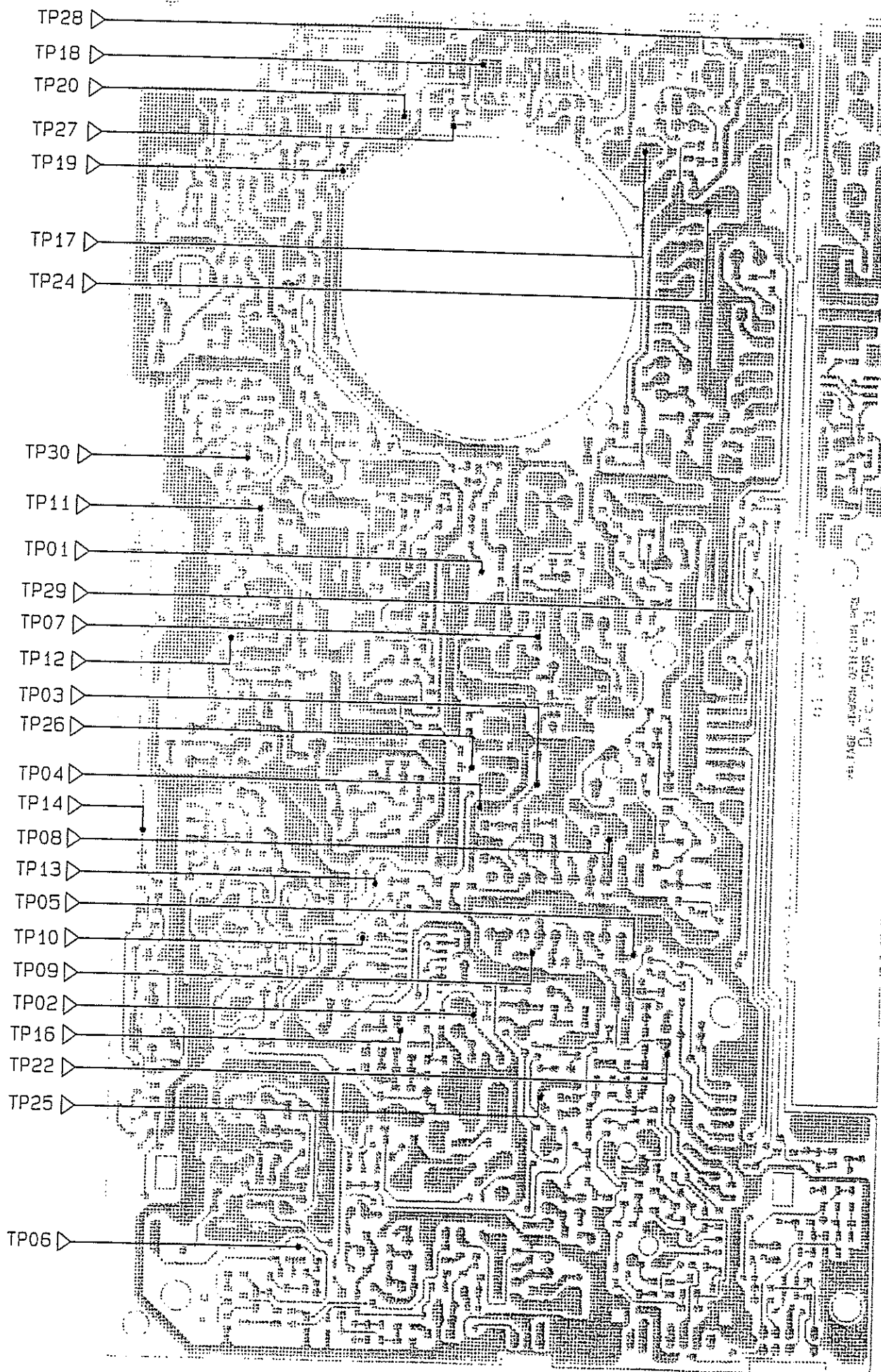

DATE: 1985-07-11
PAGE: DESIGN CHECKLIST-001

TROUBLESHOOTING FLOW CHART

1. The radio power can not turn to ON

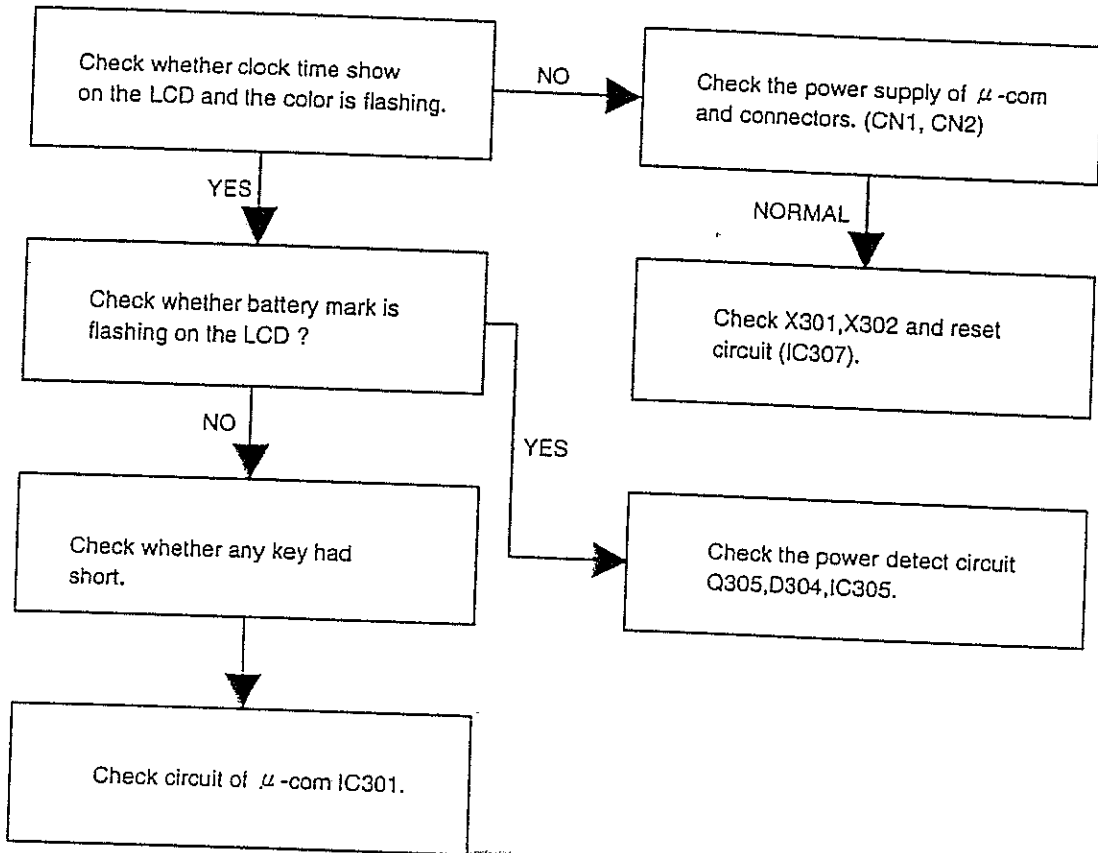

2. PLL do not work in AM band

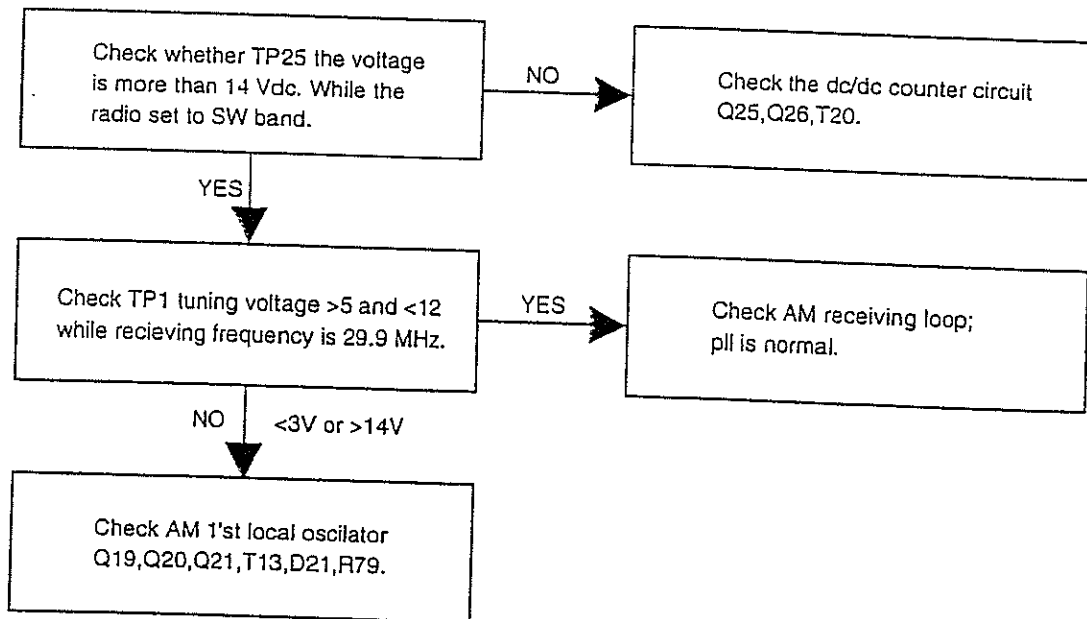

3.SSB function do not work

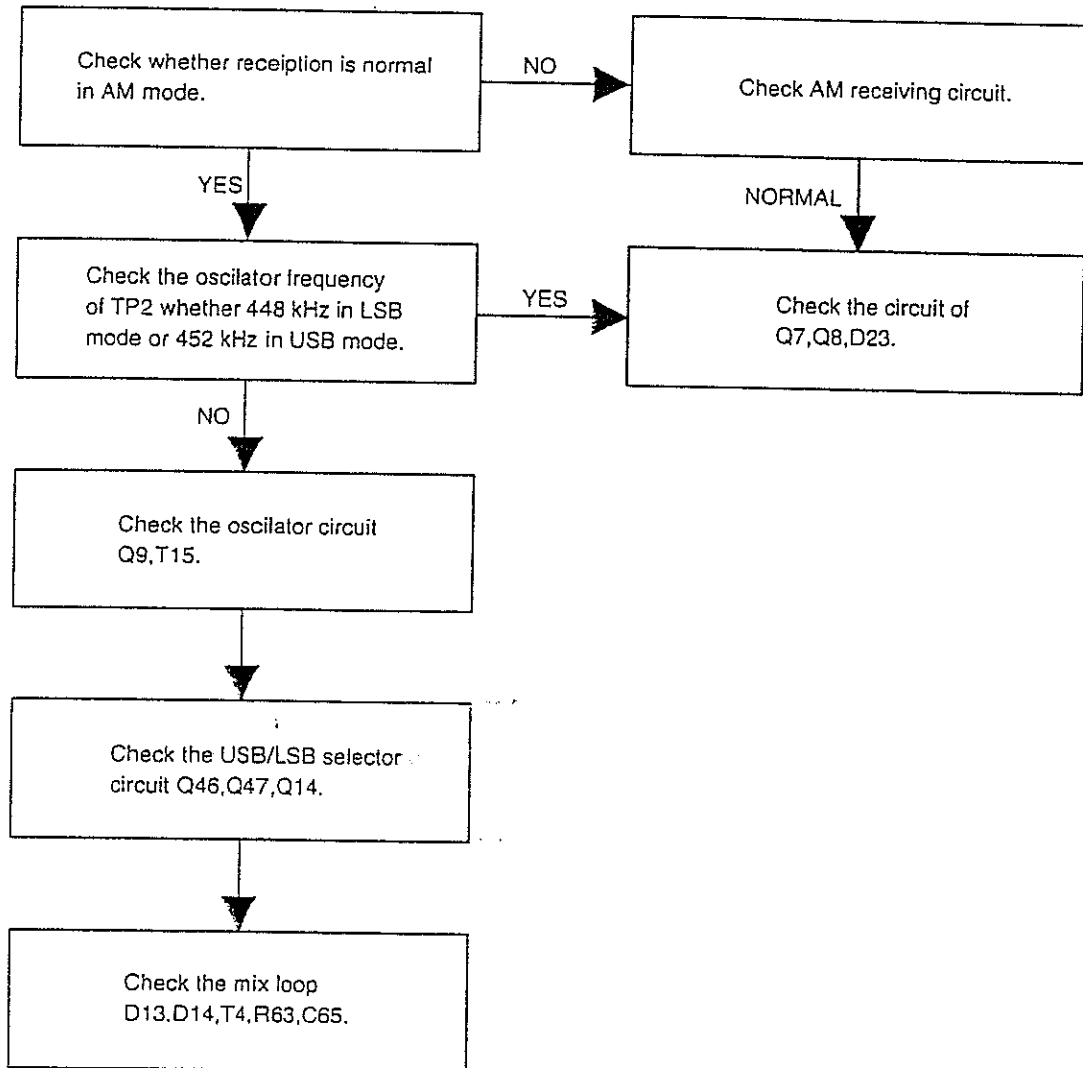

4. Speaker have not voice output

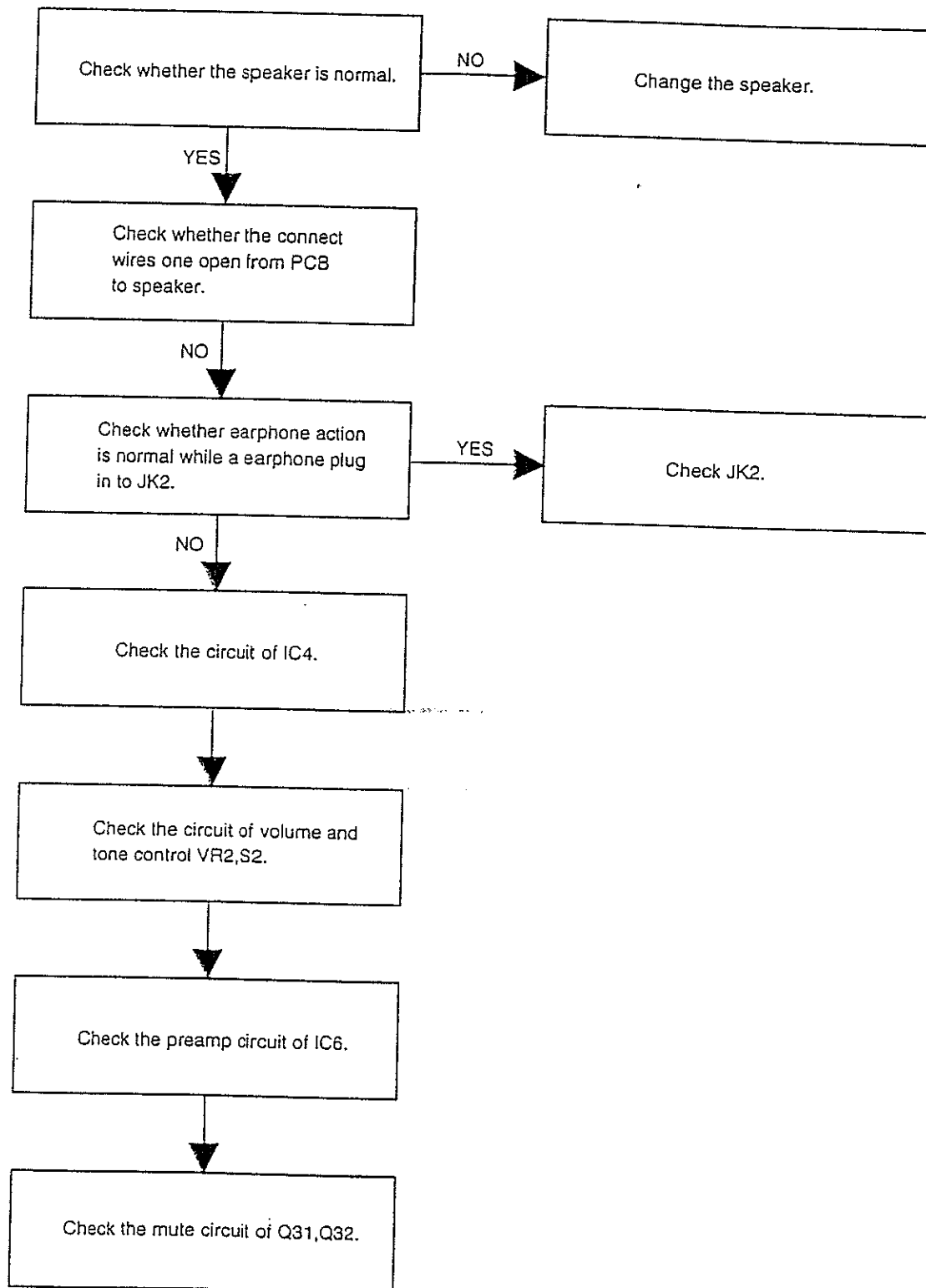

5. Weak sensitivity in AM band

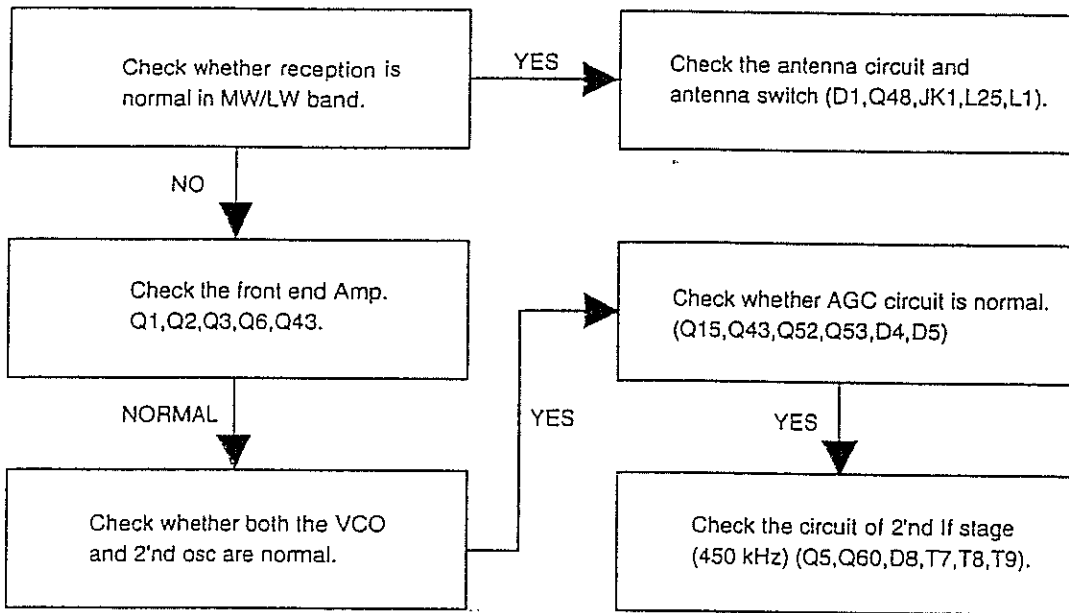

6. PLL do not work on FM band

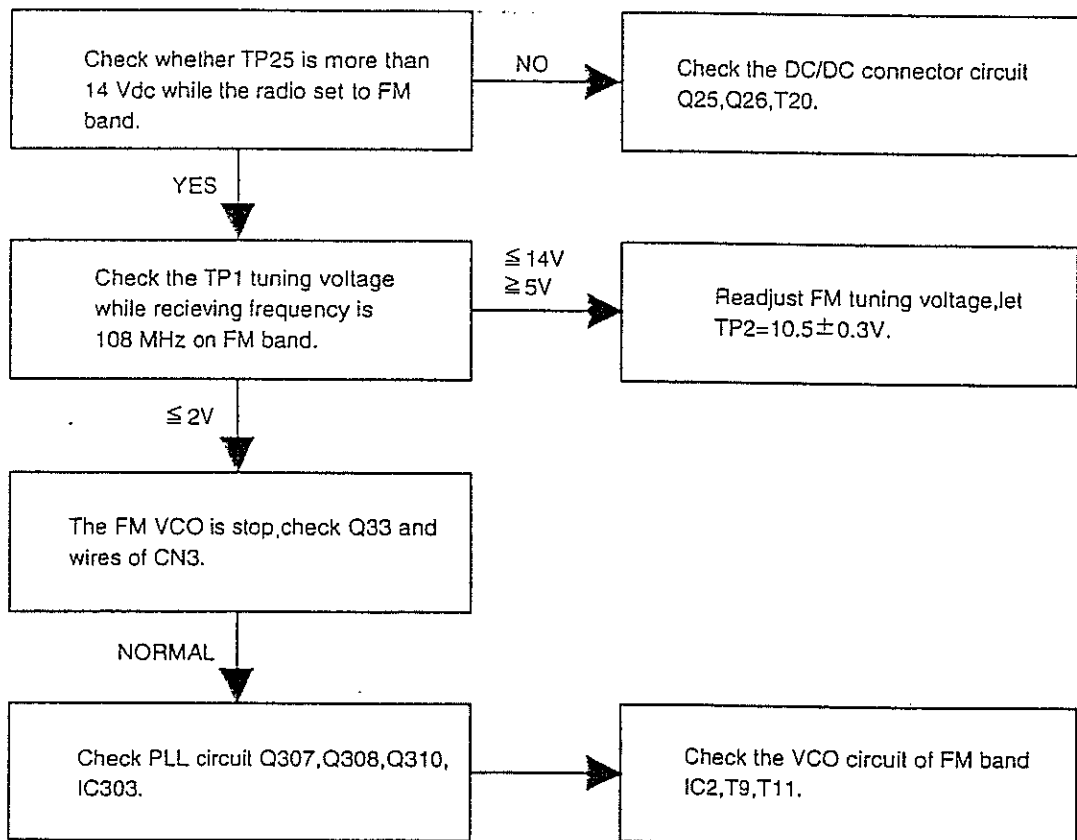

7. Weak R.D.S. reception in FM band

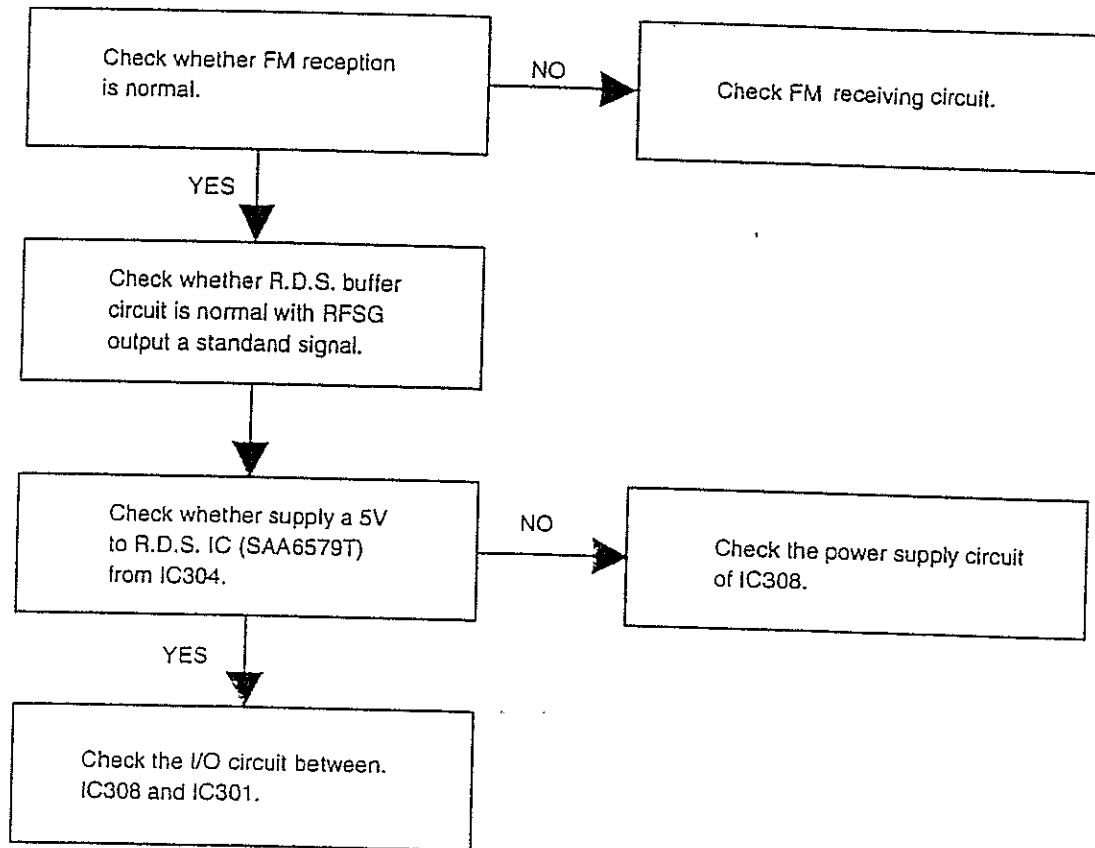

WIRING DIAGRAM

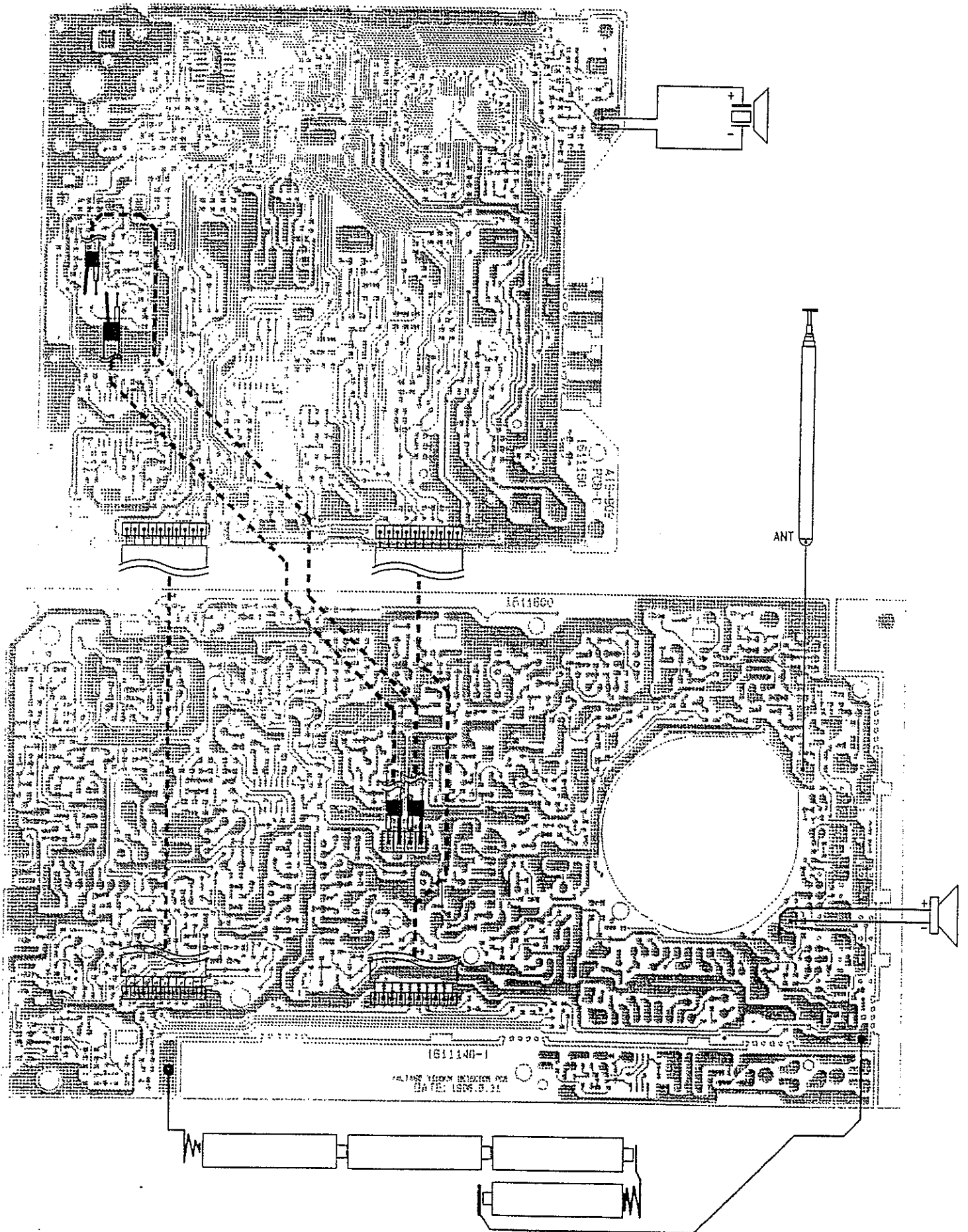

MAIN PCB BOTTOM VIEW

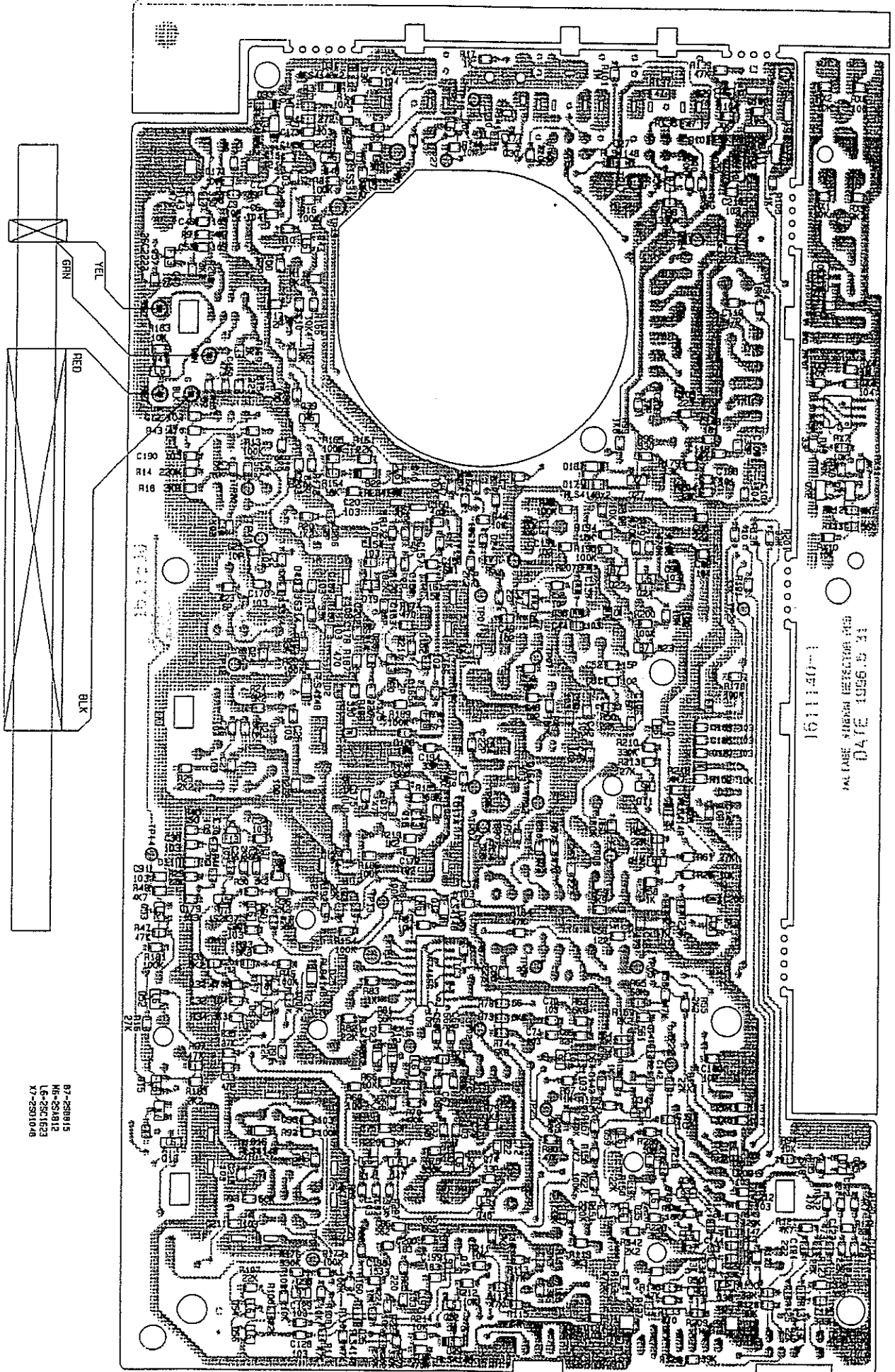

07-289815
16-281812
E21-281823
X7-2810106

1611140-1

PAL BASE #BXNDI EXTRACTOR M16
DATE 1996.9.31

CONTROL PCB TOP VIEW

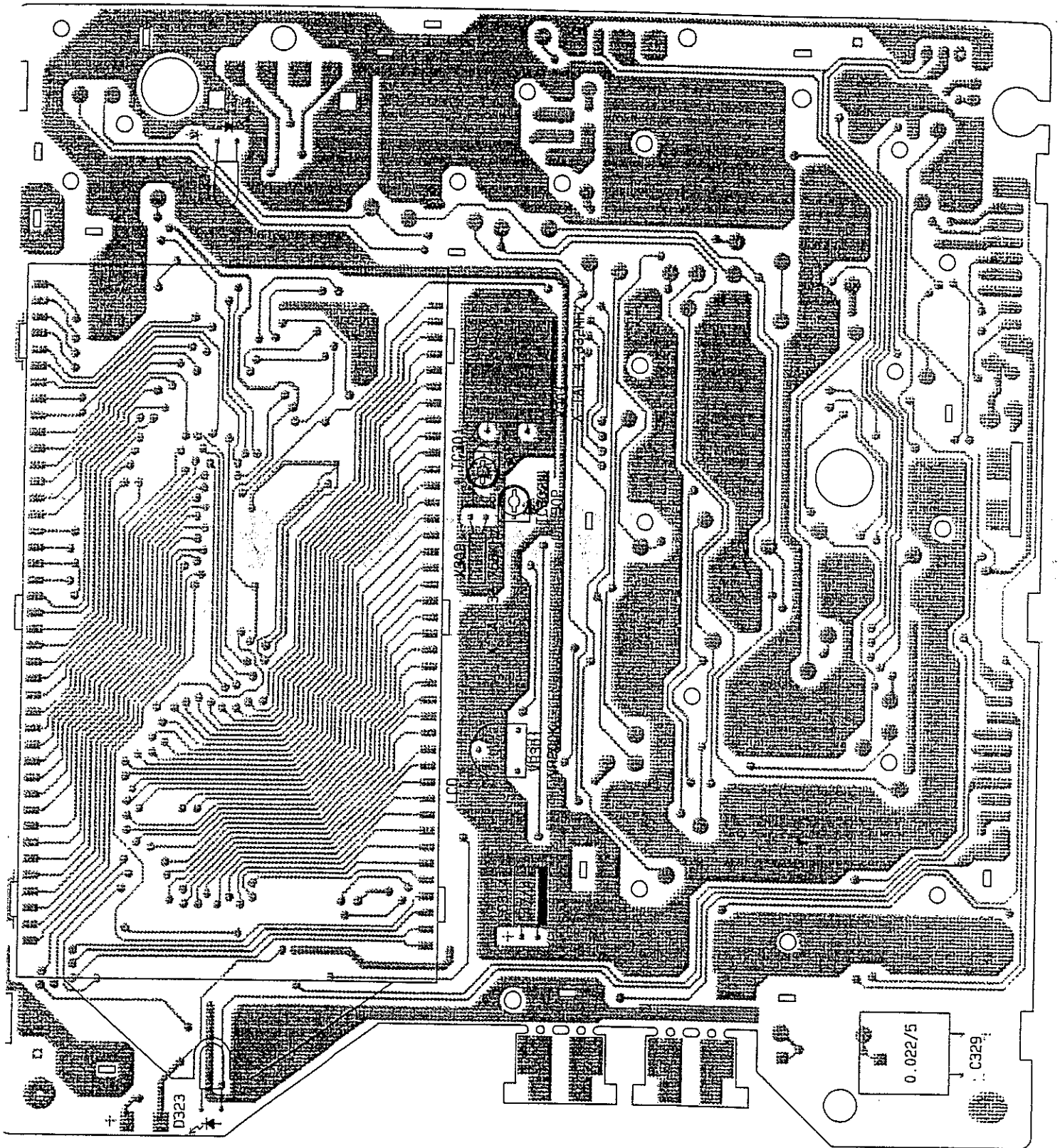



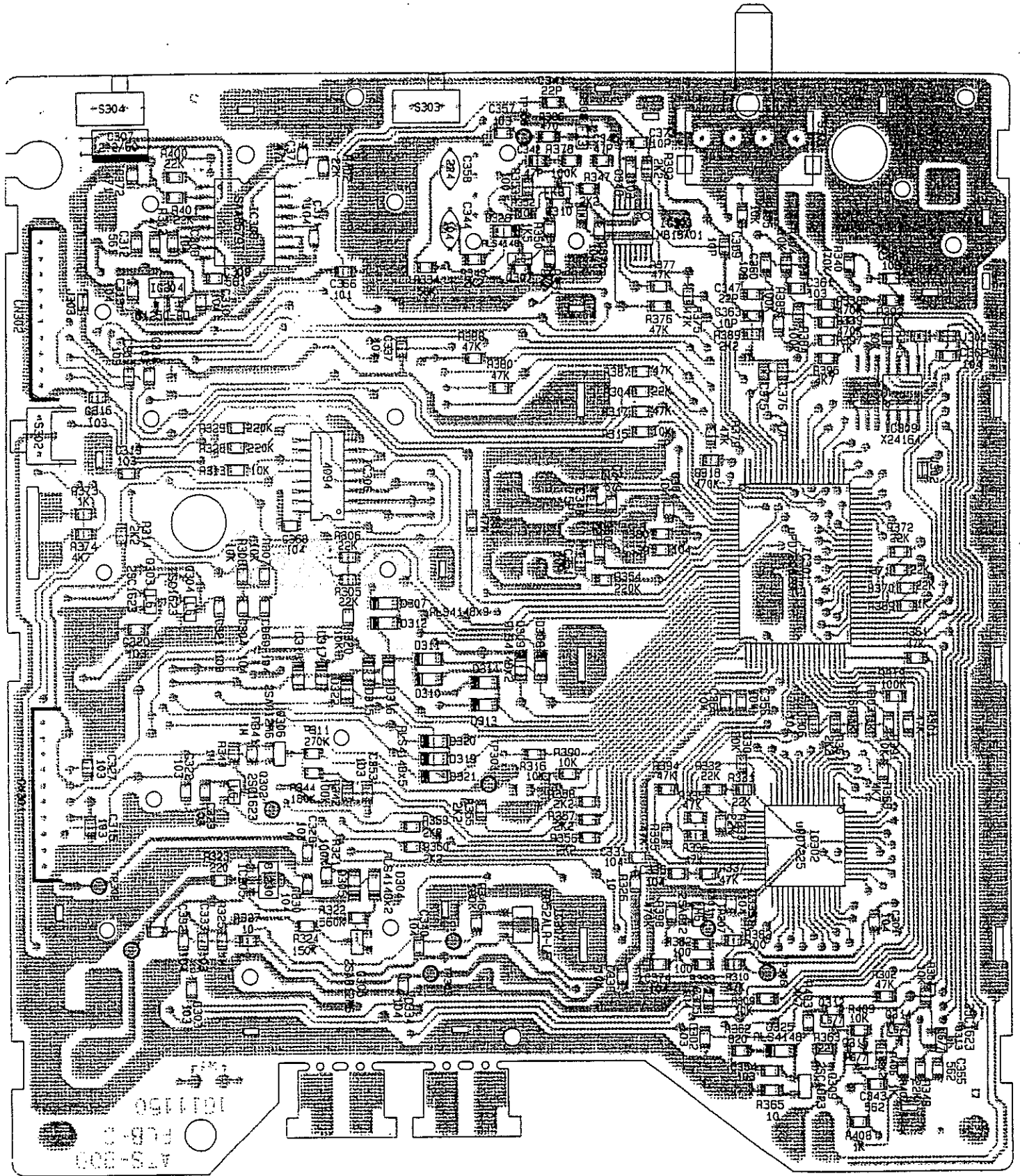





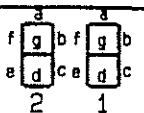

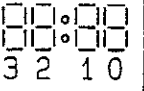
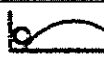

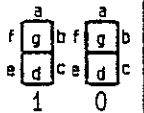







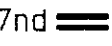

CONTROL PCB BOTTOM VIEW

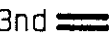
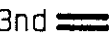

LCD CONFIGURATION

LCD SEGMENT	UPD7225 PIN NO.	COMMON 0 30 pin	COMMON 1 31 pin	COMMON 2 32 pin	COMMON 3 33 pin	DESCRIPTION	REMARK
B0	34	1f	1j	1e		NAME 1st character	
B1	35	1a	1g	1l	1d		
B2	36	1i	1h	1m	1n		
B3	37	1b	1k	1c			
B4	38	2f	2j	2e	"1"	NAME 2st character	
B5	39	2a	2g	2l	2d		
B6	40	2i	2h	2m	2n		
B7	41	2b	2k	2c			
B8	43	3f	3j	3e	"2"	NAME 3st character	
B9	44	3a	3g	3l	3d		
B10	45	3i	3h	3m	3n		
B11	46	3b	3k	3c			
B12	47	4f	4j	4e	"3"	NAME 4st character	
B13	48	4a	4g	4l	4d		
B14	50	4i	4h	4m	4n		
B15	51	4b	4k	4c			
B16	52	5f	5j	5e	"4"	NAME 5st character	
B17	53	5a	5g	5l	5d		
B18	54	5i	5h	5m	5n		
B19	55	5b	5k	5c			
B20	1	6f	6j	6e	"5"	NAME 6st character	
B21	2	6a	6g	6l	5d		
B22	3	6i	6h	6m	5n		
B23	4	6b	6k	6c			
B24	5	7f	7j	7e	"6"	NAME 7st character	
B25	6	7a	7g	7l	7d		
B26	7	7i	7h	7m	7n		
B27	8	7b	7k	7c			
B28	9	8f	8j	8e	"7"	NAME 8st character	
B29	10	8a	8g	8l	8d		
B30	11	8i	8h	8m	8n		
B31	12	8b	8k	8c			

LCD SEGMENT	UPD78063 PIN NO.	COMMON 0 51 pin	COMMON 1 52 pin	COMMON 2 53 pin	COMMON 3 54 pin	DESCRIPTION	REMARK
A0	60	"PAGE"	2b	2a, 2d 2e, 2f	2c	PAGE &NO.	
A1	61	1f	1g	1e	1d	PAGE &NO.	
A2	62	1a	1b	1c	"MEMO"	PAGE &NO.	
A3	63	"FM"	"LM"	"MW"	"SW"	BAND	
A4	64		"HOME"	"WORLD"	 STEREO		
A5	65	 R.D.S.	4b	4a, 4d 4e, 4f	4c	FREQUENCY 10~4	
A6	66	3f	3g	3e	3d	FREQUENCY 10~3	
A7	67	3a	3b	3c	3	FREQUENCY 10~3	
A8	68	2f	2g	2e	2d	FREQUENCY 10~2	
A9	69	2a	2b	2c	2	FREQUENCY 10~2	
A10	70	1f	1g	1e	1d	FREQUENCY 10~1	
A11	71	1a	1b	1c	"MHz"	FREQUENCY 10~1	
A12	72	0f	0g	0e	0d	FREQUENCY 10~0	
A13	73	0a	0b	0c	"KHz"	FREQUENCY 10~0	
A14	74	"SUMMER"	3b	3a, 3d 3e, 3f	3c	HOURS 10~1	
A15	75	2f	2g	2e	2d	HOURS 10~0	
A16	76	2a	2b	2c	:	HOURS 10~0	
A17	77	1f	1g	1e	1d	MINUTE 10~1	
A18	78	1a	1b	1c	"AM"	MINUTE 10~1	
A19	79	0f	0g	0e	0d	MINUTE 10~0	
A20	80	0a	0b	0c	"LSB"	MINUTE 10~0	
A21	81	z z z		"USB"		MINUTE 10~0	
A22	82	1f	1g	1e	1d	METER 10~1	
A23	83	1a	1b	1c	:	METER 10~1	
A24	84	0f	0g	0e	0d	METER 10~0	
A25	85	0a	0b	0c	"m"	METER 10~0	
A26	86		"1"	1- 	6nd 	TIMER	
A27	87		"2"	2- 		BATTERY	
A28	88	 HWS	"3"	3- 	7nd 	SIGNAL LEVEL	
A29	89	FAST 	5nd 	4nd 	3nd 		
A30	90	SLOW 	2nd 	1nd 	"SIGNAL"		
A31	91	STOP 	"9"	9- 	"8"	MEMO POSITION	

MECHANICAL PARTS LIST

ATS-909 (SANGEAN)

Ref. No.	Description	
1	CNT WIRE ASS'Y 1P-A 80mm	1703750
2	LCD LIGHT LENS	2086010
3	ROD ANT HOLDER	2086020
4	KEYBOARD SPACER	2086030
5	PVC FILM	2086040
6	TUNING KNOB SPACER	2086050
7	AM RF GAIN KNOB SPACER	2086060
8	VOLUME KNOB SPACER	2086070
9	BATTERY SPRING (+)(-)	2122010
10	DC/DC SHIELD (UP)	2149020
11	DC/DC SHIELD (DOWN)	2149030
12	SPEAKER FIXER	2149080
13	BATTERY CONTACT (-)	2158040
14	LCD HOLDER	2186010
15	LCD SHIELD PLATE	2186020
16	KEYBOARD SHIELD	2186030
17	CONTROL PCB SHIELD	2186040
18	BATTERY SPRING (-)	2186050
19	POWER SHIELD	2186060
20	VCO SHIELD (UP)	2186070
21	VCO SHIELD (DOWN)	2186080
22	μ-COM SHIELD COVER	2186090
23	RIBBON	2258020
24	HEMELON SHEET	2262020
25	BACK SALON NET	2286010
26	SPACE SPONGE	2312000
27	EVA SPACER	2345020
28	PU FOOT	2473020
29	POWER RUBBER	2486010
30	KEYBOARD RUBBER	2486020
31	CONDUCT RUBBER	2486030
32	BAND KNOB SPACER	2486040
33	POWER KNOB SPACER	2486050
34	NEP SPACER	2486060
35	FRONT CABINET	3018601
36	MIDDLE CHASSIS	3028601
37	BACK COVER	3038601
38	BATTERY COVER	3048601
39	LCD WINDOW	3058601
40	BACK SUPPORTER	3068601
41	POWER KNOB	3108601
42	VOLUME KNOB	3118601
43	TUNING KNOB	3128601
44	FUNCTION KNOB ASS'Y	3158601
45	TEN KEYKNOB ASS'Y	3168601
46	AM RF GAIN KNOB	3178601
47	MANUAL/AUTO KNOB	3188601
48	9K/10K KNOB	3198601
49	FUNCTION SW. KNOB	3208601
50	STEP. KNOB	3218601
51	LIGHT KNOB	3228601
52	TIME SET KNOB	3238601
53	SANGEAN BADGE 26 x 7 mm	3240001
54	ROD ANT 909	3608601
55	SCREW JWK 2.6 x 6 (ZK)	9092061
56	SCREW PTP 2 x 8 (ZK)	9101081
57	SCREW PTP 2.6 x 8 (ZK)	9102081
58	SCREW PTP 2.6 x 30 (ZK)	9202301
59	WASHER INNER GEAR φ 2.8	9910010

MECHANICAL PARTS LIST

RK-777 (SIEMENS)

Ref. No.	Description	
1	CNT WIRE ASS'Y 1P-A 80mm	1703750
2	LCD LIGHT LENS	2086010
3	ROD ANT HOLDER	2086020
4	KEYBOARD SPACER	2086030
5	PVC FILM	2086040
6	TUNING KNOB SPACER	2086050
7	AM RF GAIN KNOB SPACER	2086060
8	VOLUME KNOB SPACER	2086070
9	BATTERY SPRING (+)(-)	2122010
10	DC/DC SHIELD (UP)	2149020
11	DC/DC SHIELD (DOWN)	2149030
12	SPEAKER FIXER	2149080
13	BATTERY CONTACT (-)	2158040
14	LCD HOLDER	2186010
15	LCD SHIELD PLATE	2186020
16	KEYBOARD SHIELD	2186030
17	CONTROL PCB SHIELD	2186040
18	BATTERY SPRING (-)	2186050
19	POWER SHIELD	2186060
20	VCO SHIELD (UP)	2186070
21	VCO SHIELD (DOWN)	2186080
22	μ-COM SHIELD COVER	2186090
23	RIBBON	2258020
24	HEMELON SHEET	2262020
25	BACK SALON NET	2286010
26	SPACE SPONGE	2312000
27	EVA SPACER	2345020
28	PU FOOT	2473020
29	POWER RUBBER	2486010
30	KEYBOARD RUBBER	2486020
31	CONDUIT RUBBER	2486030
32	BAND KNOB SPACER	2486040
33	POWER KNOB SPACER	2486050
34	NEP SPACER	2486060
35	FRONT CABINET	3018631
36	MIDDLE CHASSIS	3028631
37	BACK COVER	3038631
38	BATTERY COVER	3048631
39	LCD WINDOW	3058601
40	BACK SUPPORTER	3068631
41	POWER KNOB	3108601
42	VOLUME KNOB	3118631
43	TUNING KNOB	3128631
44	FUNCTION KNOB ASS'Y	3158631
45	TEN KEYKNOB ASS'Y	3168631
46	AM RF GAIN KNOB	3178631
47	MANUAL/AUTO KNOB	3188601
48	9K/10K KNOB	3198601
49	FUNCTION SW. KNOB	3208601
50	STEP. KNOB	3218631
51	LIGHT KNOB	3228631
52	TIME SET KNOB	3238631
53	SIEMENS BADGE	3240031
54	ROD ANT 909	3608601
55	SCREW JWK 2.6 x 6 (ZK)	9092061
56	SCREW PTP 2 x 8 (ZK)	9101081
57	SCREW PTP 2.6 x 8 (ZK)	9102081
58	SCREW PTP 2.6 x 30 (ZK)	9202301
59	WASHER INNER GEAR φ 2.8	9910010

ELECTRICAL PARTS LIST

ATS-909

P1

Part No.	Description	Q'ty	Remark
1000210	IC μ PD78063GF-095-3BA	1	IC301
1010000	IC AN7117	2	IC4,5
1010031T	IC AN7415S-T	1	IC3
1010140	IC LA5003	1	IC9
1010210	IC TA7358AP	1	IC2
1010300	IC TA7758P	1	IC1
1011360	IC S-81230AG-RB-T2	1	IC305
1011480	IC S-81250HG-RD-T1	1	IC304
1011650	IC S-8052ALR-LF-T1	1	IC307
1011790	IC μ PD7225GB-3B7	1	IC302
1012021T	IC TC4094BF-T	1	IC306
1012071	IC NJM2100L	1	IC6
1012400	IC SAA6579T/V1	1	IC308
1012410	IC MB15A01PFV1-G-BND-EF	1	IC303
1012510T	IC 24LC164/SN-T	1	IC309
1012620	IC PHOTOCOUPLE PC-17T1	1	IC7
1020211	CH TR 2SB815 B7	4	Q22,23,45,58
1020230	CH TR 2SA812 M6	12	Q10,11,13,17,29,39,48,50,301,305,306,315
1020240/1	CH TR 2SC1623 L6/L7	37	Q7-9,12,14,15,18,24,31,32,34-38,40,41,43, 46,47,49,52-56,59,60,62,302-304,307,309, 312-314
1020250T	TR 2SA1020Y	1	Q28
1020260	CH TR 2SC2223 F13	7	Q5,16,19-21,57,308
1022021	TR 2SC3330U	2	Q25,26
1023010/1	CH TR 2SD1048 X6/X7	2	Q27,30
1030070	FET 2SK381A	1	Q33
1030081	FET 2SK715W	1	Q42
1030100	FET 2SK433B KC	1	Q310
1030122	FET 2SK435D	6	Q1-4,6,44
1040040	DIODE 1N60P	3	D13,14,32
1042030	DIODE 1S2837	2	D7,8
1043030	DIODE SVC201SP	4	D3,6,9,10
1043060	VARIABLE SVC203 (AA1/AA2)	1	D21
1045020	DIODE 1SS314	5	D1,4,5,24,26
1045090	ZENER UZ-15BH	1	D15
1046010	CH DIODE RLS4148	32	D2,11,12,16-18,22,23,25,27-31,33-36,304, 305,307-309,313,315,317-321,325,328
1046020	CH DIODE RB110C	1	D20
1046030	CH DIODE RB411	1	D19
1058040M	LED LAMP 3mm	2	D323,324
1110470	BAR & COIL 0470	1	L9
1120950	ADJ. COIL 0950	1	T15
1120990	ADJ. COIL 0990	1	T4
1122211	ADJ. COIL 2211	1	T1
1122220	ADJ. COIL 2220	1	T10
1122231	ADJ. COIL 2231	1	T3
1122250	ADJ. COIL 2250	1	T9
1122260	ADJ. COIL 2260	2	T7,18
1122280	ADJ. COIL 2280	1	T17
1122290	ADJ. COIL 2290	1	T20

Part No.	Description	Q'ty	Remark
1122300	ADJ. COIL 2300	1	T14
1122420	ADJ. COIL 2420	1	T6
1122441	ADJ. COIL 2441	1	T13
1122890	ADJ. COIL 2890	1	T11
1123600	ADJ. COIL 3600	1	J8
1130510C	FIXED COIL 0.22 μ HK	3	L2,4,6
1130810C	FIXED COIL 0.39 μ HK 0204	1	L24
1130920C	FIXED COIL 0.47 μ HK	2	L5,10
1131700	FIXED COIL 2.2 μ HK(A)	2	L12,16
1131710C	FIXED COIL 2.2 μ HK	1	L7
1132003	FIXED COIL 3.9 μ HK 0608	1	L1
1132400	FIXED COIL 8.2 μ HK(A)	1	L11
1133300	FIXED COIL 47 μ HK	2	L23,25
1134500	FIXED COIL 470 μ HK	1	L3
1135100	FIXED COIL 1.5mH	2	L14,15
1135911	FIXED COIL 6.8MH	2	L26,27
1136100	FIXED COIL 10mH	1	T12
1150031	TOROID COIL 12T x 14	1	T5
1210000	TC 20P (A)	2	TC301,302
1210010	TC 10P 2222 808 23109	2	VC1,2
1210030	TC 10P 2222 808 32101	2	VC4,5
1310220	VOL VR 50KA (G)	1	VR2
1310441	R-VR 1KD RK09K1110470-SG	1	VR1
1320100	S.F-VR 10KB(D) TB067A-OC	3	SVR2,4,6
1320130	S.F-VR 100KB (VRZ)	1	SVR1
1320270	S-VR 200KB (A) TB067A-0	1	SVR5
1320380	S.F-VR 5KB TB067A-OC	1	SVR3
1321007	S.F-VR 200KV-8 RIVER	1	VR301
1600270	LCD F5D-13126ACK	1	LCD
1611150	PCB C ATS-909	1	PCB C
1611600	PCB A ATS-909	1	PCB A
1620370/1	SP 3" 8 Ω 3W 77 ϕ x 29.1	1	SPEAKER
1625030	PIEZO BUZZER	1	BUZZER
1630470	SWITCH 2P3C (A)	1	S2
1630530	SWITCH 1P2C (G)	3	S1,303,304
1630560	SWITCH 1P1C (G)	1	S302
1640030	JACK HEADPHONE (D)	2	JK2,5
1647000	DC JACK (A)	1	JK3
1649030	EXT ANT HSJ3062-01-422	1	JK1
1649050	JACK HSJ0838-01-500	1	JK4
1650020	X'TAL 55.405MHz	1	X1
1650041	MFC 55.845MHz	2	CF2,3
1650151	X'TAL 32.768kHz +/- 20PPM	1	X302
1650250	X'TAL 4.332MHz	1	X301
1660170	FILTER SFPS450I	1	CF4
1660360	FILTER SFR450J	1	CF5
1664000	FILTER SFE10.7MS2-A	2	CF6,7
1664100	RESONATOR CSB453E	1	X4
1664110	RESONATOR CSB449E	1	X3
170102A	CONT BASE 2m/m 10PIN	2	CN1,2

Part No.	Description	Q'ty	Remark
1702050	CNT HOUSING 4P(EH)	1	CN3
1703710	UL1354 + UL1533 155(P4+6)	1	WCN3
1703720	UL1061 #28 50(P10+P10)	2	WCN1,2
1730040	ROTARY ENCODER	1	S301
2149120	ANT TERMINAL PIN	1	TP ANT
2171080	SHIELD CASE	2	T9,14
2200150	6 φ GRN LABEL (FTZ)	2	.
4002001	CH CC 020C 50V NPO-A	3	C158,165,206
4003001	CH CC 030C 50V NPO-A	1	C10
4005001	CH CC 050C 50V NPO-A	5	C50,157,196,203,348
4006002	CH CC 060D 50V NPO-A	1	C23
4008001	CH CC 080J 50V NPO-A	2	C24,163
4010002	CH CC 100D 50V NPO-A	7	C9,21,171,351,359,363,373
4012001	CH CC 120J 50V NPO-A	1	C13
4015001	CH CC 150J 50V NPO-A	2	C52,161
4022001	CH CC 220J 50V NPO-A	7	C8,47,54,341,347,349,350
4033001	CH CC 330J 50V NPO-A	5	C2,108,109,194,214
4039001	CH CC 390J 50V NPO-A	1	C7
4047001	CH CC 470J 50V NPO-A	6	C33,119,177,342,345,376
4056001	CH CC 560J 50V NPO-A	2	C63,176
4056016	CH CC 560J 50V NPO-A	1	C175
4082001	CH CC 820J 50V NPO-A	2	C65,75
4010101	CH CC 101J 50V NPO-A	4	C118,148,188,366
4012101	CH CC 121J 50V NPO-A	2	C15,74
4015101	CH CC 151J 50V NPO-A	1	C97
4022101	CH CC 221J 50V NPO-A	3	C66,142,162
4039101	CH CC 391J 50V NPO-A	1	C3
4047101	CH CC 471J 50V NPO-A	2	C371,372
4056101	CH CC 561J 50V NPO-A	3	C141,309,312
4068101	CH CC 681J 50V NPO-A	1	C159
4010261	CH CC 102K 50V X7R-A	10	C42,43,48,49,51,139,160,172,180,191
4012261	CH CC 122K 50V X7R-A	1	C58
4022261	CH CC 222K 50V X7R-A	3	C72,121,122
4027261	CH CC 272K 50V X7R-A	1	C5
4056261	CH CC 562K 50V X7R-A	7	C16,17,69,85,86,343,355
4010362	CH CC 103M 50V X7R-A	82	C1,12,14,18,20,22,25-27,29-31,34-37,40,44-46 53,60,67,68,70,71,76,87,89,90,96,102,128,129 137,140,143,144,146,147,149,154,164,166, 168-170,173,174,178,179,183,185,187,190 201,202,204,209,210,211,302,303,315-323, 327,328,333,346,353,354,357,360,361,367
4015367	CH CC 153K 25V X7R-A	2	C197,198
4018367	CH CC 183K 25V X7R-A	2	C199,200
4022367	CH CC 223K 25V X7R-A	8	C55,61,88,103,105,145,151,156
4033361	CH CC 333K 50V X7R-A	2	C125,126
4047363	CH CC 473M 50V Z5U-A	4	C123,124,150,181
4010471	CH CC 104Z 25V Y5V-A	32	C4,6,32,64,92,104,301,304-306,308,310 311,313,330-332,334-340,356,362,364 365,368-370,374
4110482C	CH 104K 50V R20X7R2L	1	C344

Part No.	Description	Q'ty	Remark
4422460	EL 224M 50V 5 x 11	1	C81
4422461	EL 224M 50V 4 x 7 (1.5)	1	C120
4447461	EL 474M 50V 5 x 11	2	C62,82
4447464	NP 474M 50V 5 x 11 (2)	1	C59
4410561	EL 105M 50V 5 x 11	10	C80,83,84,93,94,106,107,130,131,184
4422560	EL 225M 50V 4 x 7 (1.5)	1	C307
4447562	EL 475M 50V 5 x 11	4	C95,132,133,189
4410632	EL 106M 16V 5 x 11	10	C11,28,77,98,134,135,152,153,155,167
4422622	EL 226M 10V 5 x 11	1	C57
4447601	EL 476M 4V 4 x 7	1	C314
4447620	EL 476M 10V 5 x 11	7	C19,56,78,112,113,127,136
4410722	EL 107M 10V 6.3 x 11.2-2.5	4	C110,111,114,115
4422721	EL 227M 10V 6.3 x 11.5-2.5	5	C99,100,117,192,193
4447721	EL 477M 10V 8 x 11.5 -3.5	2	C116,182
4410831	EL 108M 16V 10 x 20 (5)	1	C101
4501020	PS 102J 50V 5 x 12 (2.5)	1	C73
4504710	PS 471J 50V 4.8 x 12	1	C79
4822460	MP/C 224J 50V 7.5 x 8.5 (5)	1	C358
4922300	SUPER CAP. 223Z 5.5V	1	C329
6010516	RD 1/8W 22JSM5	2	R21,22
6110120	CH RD 1/8W 47J-B	2	R136,137
6110152	CH RD 1/8W 22KJ-B	1	R103
6160112	CH RD 1/10W 10J-A	9	R4,6,52,138,141,326,327,352,365
6160116	CH RD 1/10W 22J-A	1	R363
6160118	CH RD 1/10W 33J-A	1	R3
6160120	CH RD 1/10W 47J-A	2	R10,312
6160121	CH RD 1/10W 56J-A	1	R78
6160122	CH RD 1/10W 68J-A	1	R7
6160123	CH RD 1/10W 82J-A	1	R167
6160124	CH RD 1/10W 100J-A	8	R68,168,172,222,353,382,383,399
6160126	CH RD 1/10W 150J-A	3	R40,51,79
6160128	CH RD 1/10W 220J-A	4	R85,86,175,323
6160130	CH RD 1/10W 330J-A	5	R2,39,71,96,188
6160132	CH RD 1/10W 470J-A	8	R43,57,132,133,143,174,187,386
6160133	CH RD 1/10W 560J-A	1	R54
6160134	CH RD 1/10W 680J-A	2	R53,203
6160135	CH RD 1/10W 820J-A	1	R362
6160136	CH RD 1/10W 1KJ-A	17	R17,58,83,87,105,148,158,169,171,190,303 303,366,369,373,397,407,408
6160137	CH RD 1/10W 1.2KJ-A	2	R20,219
6160138	CH RD 1/10W 1.5KJ-A	1	R350
6160139	CH RD 1/10W 1.8KJ-A	3	R75,77,99
6160140	CH RD 1/10W 2.2KJ-A	25	R25,27,36,38,42,55,142,147,159,183,228,314 347,349,351,355-360,367,389,393,406
6160141	CH RD 1/10W 2.7KJ-A	1	R69
6160142	CH RD 1/10W 3.3KJ-A	7	R12,33,34,41,118,119,206
6160143	CH RD 1/10W 3.9KJ-A	3	R18,19,59
6160144	CH RD 1/10W 4.7KJ-A	13	R9,48,89,104,120,121,156,215,226,368 374,396,403
6160145	CH RD 1/10W 5.6KJ-A	1	R63

Part No.	Description	Q'ty	Remark
6160146	CH RD 1/10W 6.8KJ-A	3	R73,74,95
6160147	CH RD 1/10W 8.2KJ-A	5	R11,23,24,30,31
6160148	CH RD 1/10W 10KJ-A	35	R1,26,44,66,84,94,102,108,109,140,162,163,166 196,211,212,214,223,224,230,307-309,313,315 316,320,345,364,390-392,404,405,409
6160151	CH RD 1/10W 18KJ-A	5	R134,146,164,194,199
6160152	CH RD 1/10W 22KJ-A	34	R28,29,50,62,82,91,106,107,114,115 122-127,150,152,161,192,193,304-306 331-333,348,370-372,400-402
6160153	CH RD 1/10W 27KJ-A	4	R15,35,61,213
6160154	CH RD 1/10W 33KJ-A	13	R64,116,117,130,131,155,180,182,191,201, 227,229,231
6160155	CH RD 1/10W 39KJ-A	2	R128,129
6160156	CH RD 1/10W 47KJ-A	30	R47,56,80,97,110,111-113,139 145,184,218,301,302,310,317, 335-337,361,375-377,379-381 387,388,394,395
6160157	CH RD 1/10W 56KJ-A	3	R81,93,334
6160158	CH RD 1/10W 68KJ-A	3	R65,72,185
6160159	CH RD 1/10W 82KJ-A	2	R170,173
6160160	CH RD 1/10W 100KJ-A	31	R8,13,16,45,46,49,88,90,92,154,160,165,177-179 181,186,189,195,200, 204,217,221,234,319,321,342,346, 378,384,385
6160162	CH RD 1/10W 150KJ-A	1	R324
6160163	CH RD 1/10W 180KJ-A	3	R60,330,344
6160164	CH RD 1/10W 220KJ-A	11	R14,37,100,144,149,151,202,311,328,329, 354
6160166	CH RD 1/10W 330KJ-A	5	R76,98,176,203,210
6160168	CH RD 1/10W 470KJ-A	13	R32,70,153,157,197,198,216,318,322, 338-340,398
6160172	CH RD 1/10W 1MJ-A	6	R67,101,209,325,341,343
6160194	CH RD 1/10W 0J-A	3	J301-303
8000090	W/JUMP 15(10) 0.6mm	1	JP1
8171722	W/PVC 105(6+3) RED	1	WBT
8591720	W/PVC/2T100 (6+6) RED/WHT	1	WSP

IC CIRCUIT BLOCK DIAGRAM

IC1-TA7758P

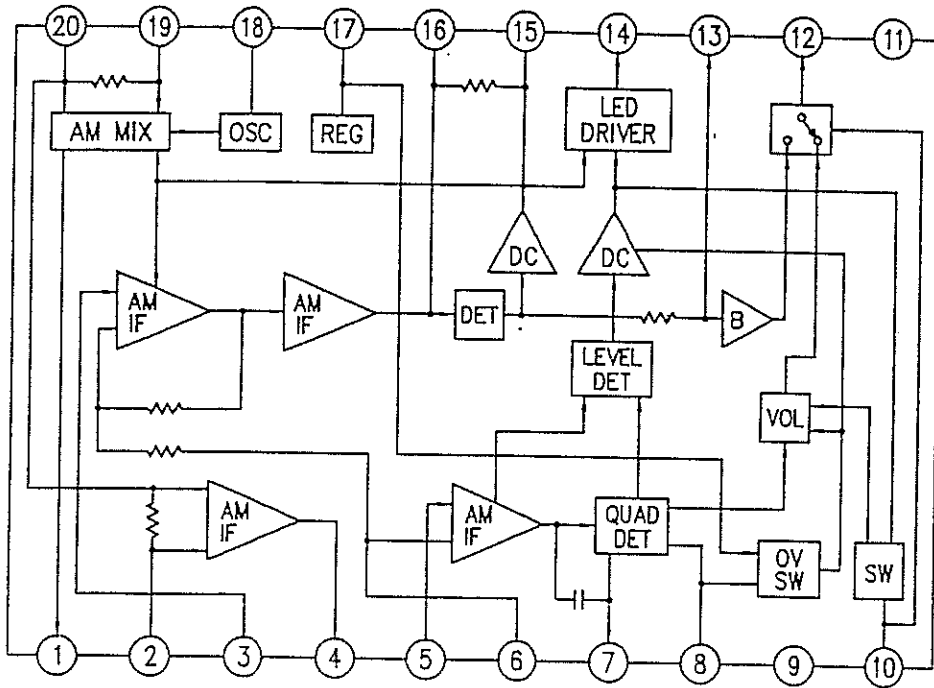

IC2-TA7358AP

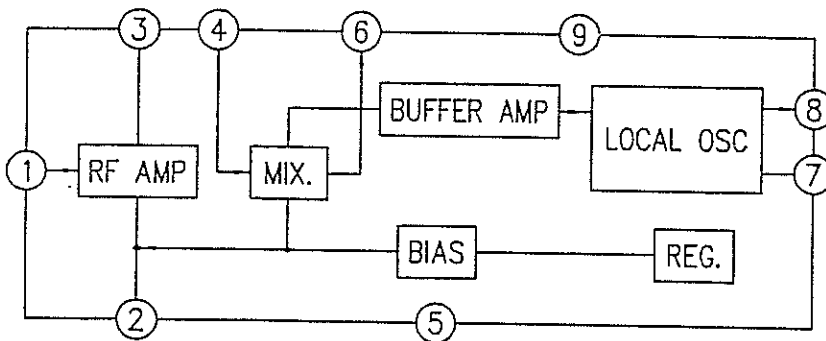

IC6-NJM2100L

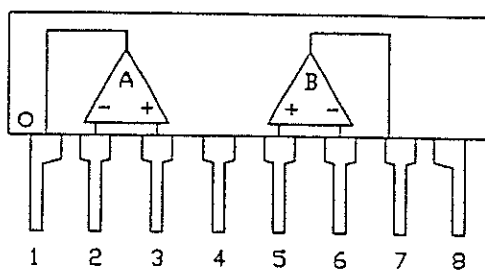

IC3-AN7415S-T

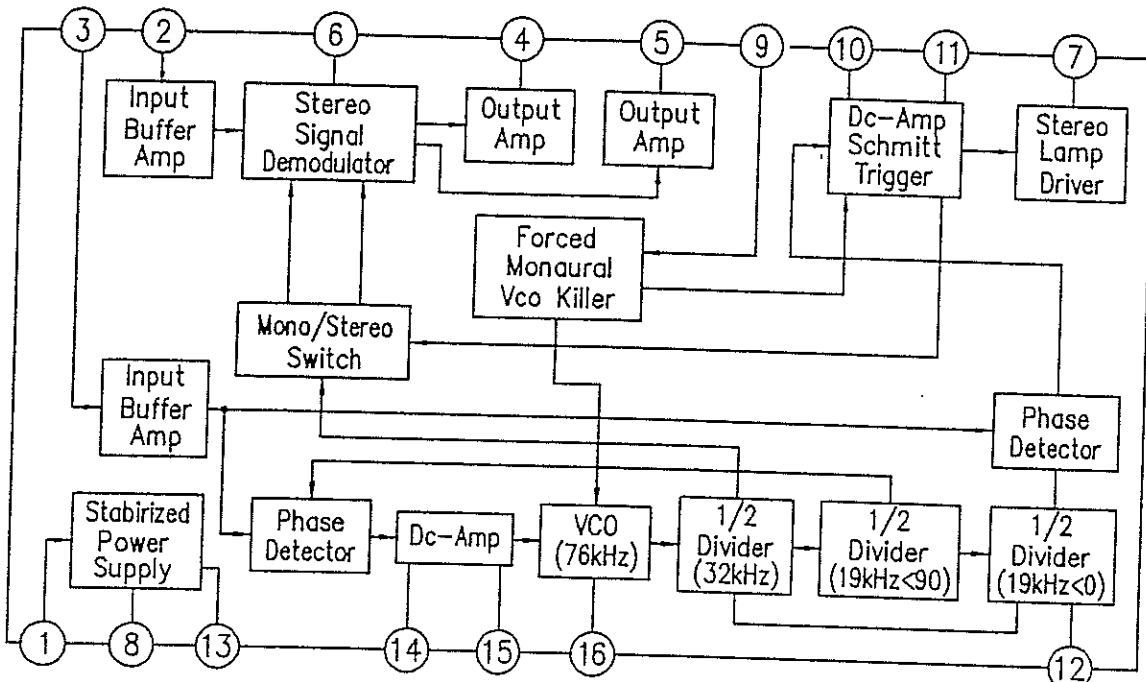

IC4,5-AN7117

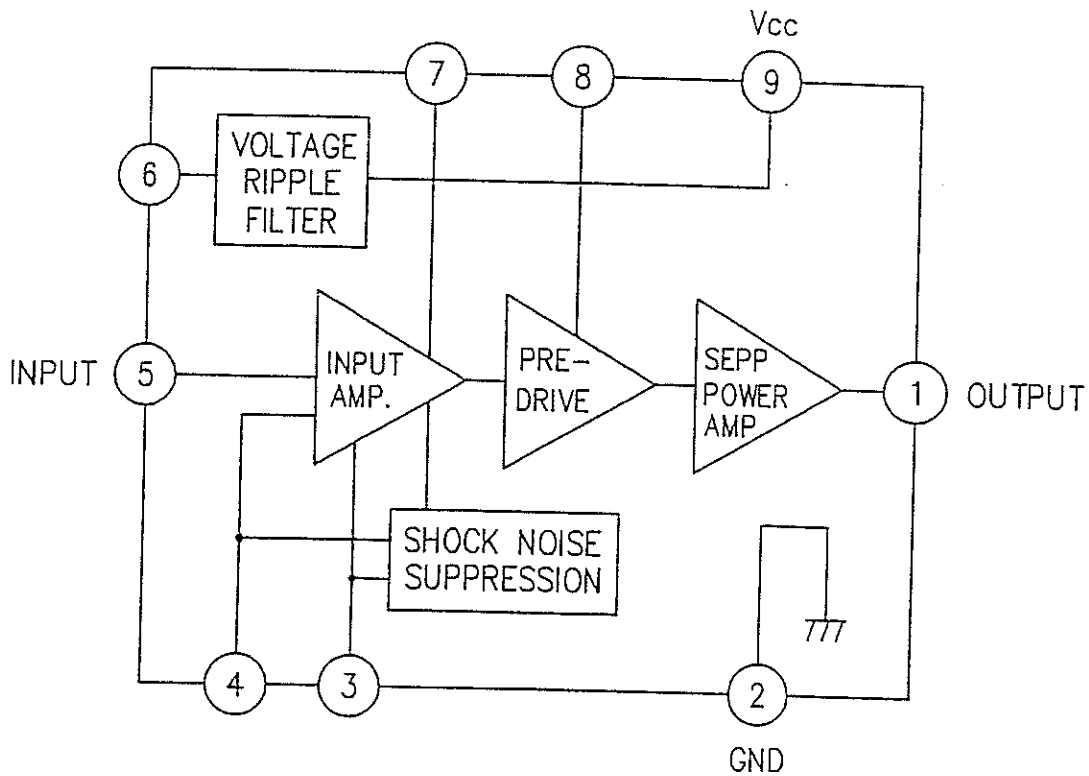

IC7-PHOTOCOUPLE PC-17T1

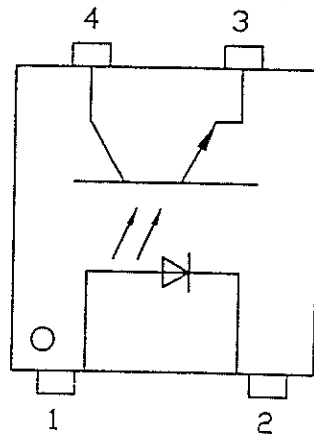

IC9-LA5003

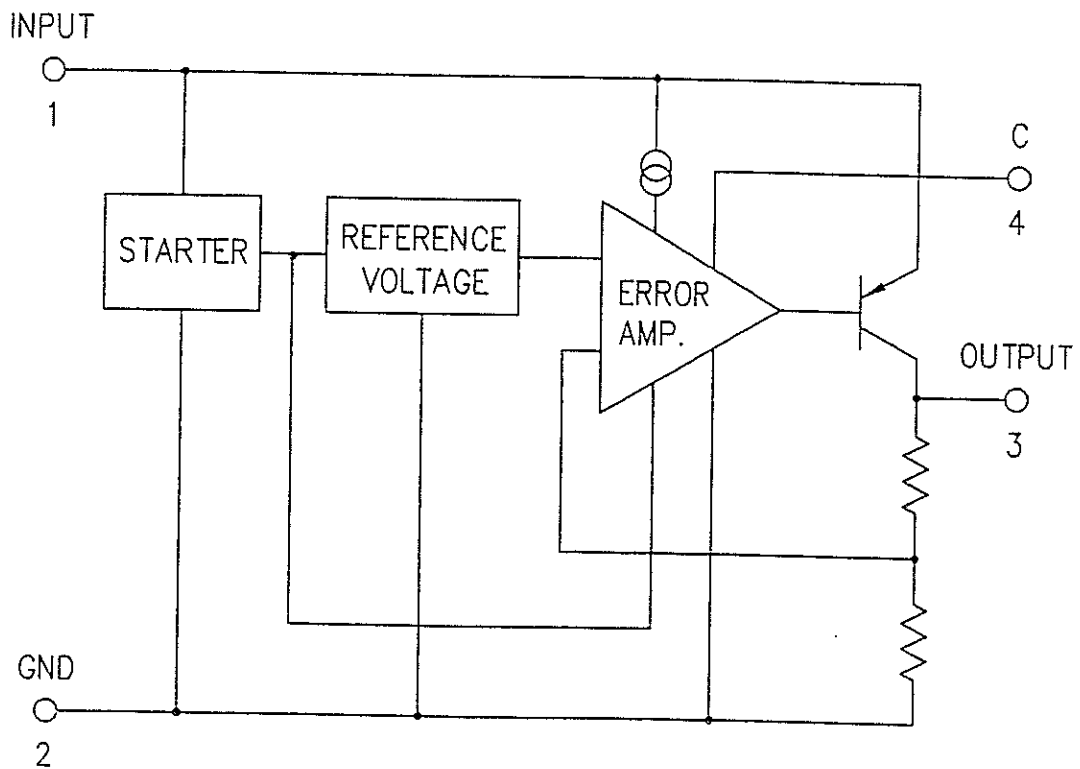

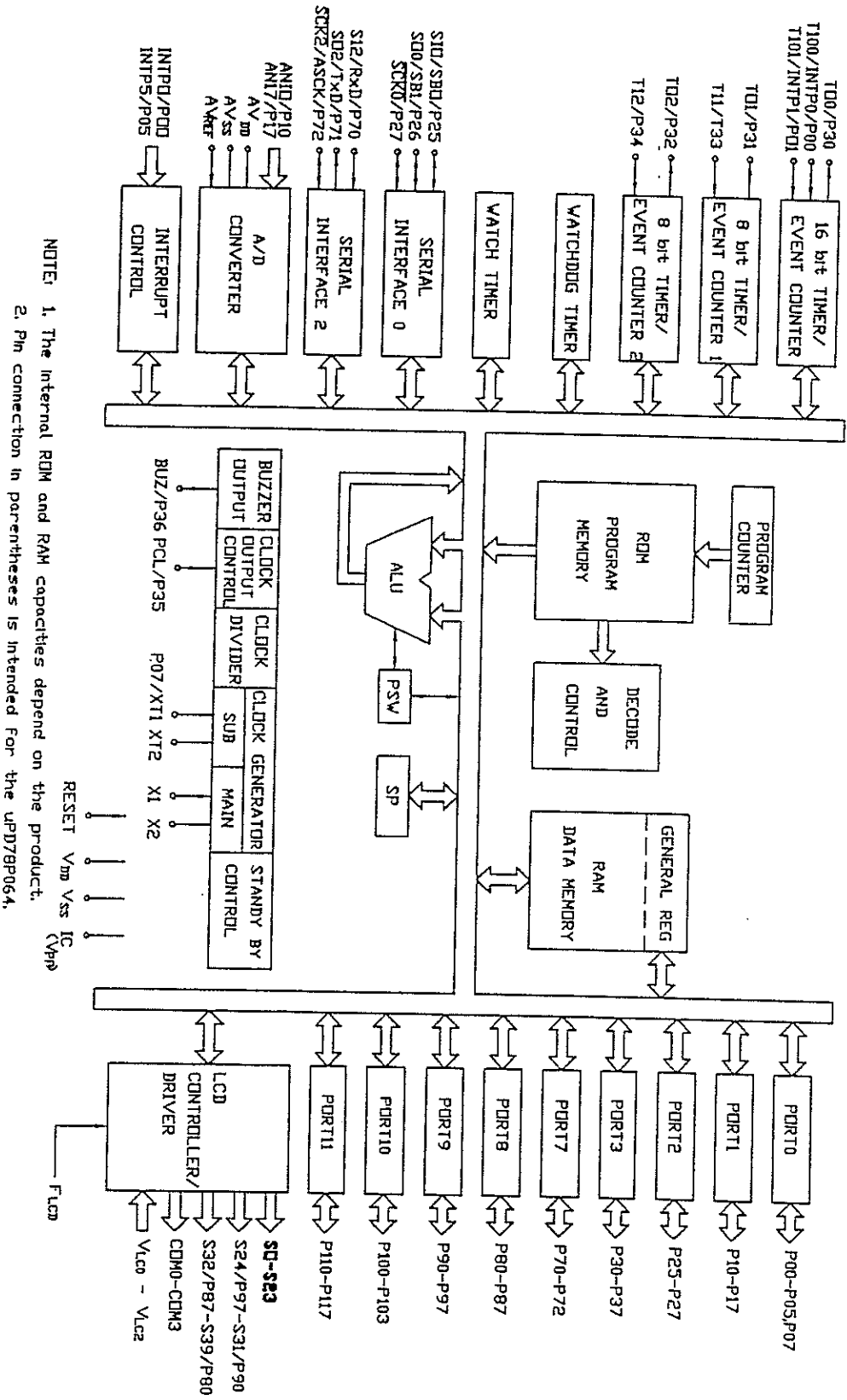

NOTE: 1. The internal ROM and RAM capacities depend on the product.
 2. Pin connection in parentheses is intended for the uPD78P064.

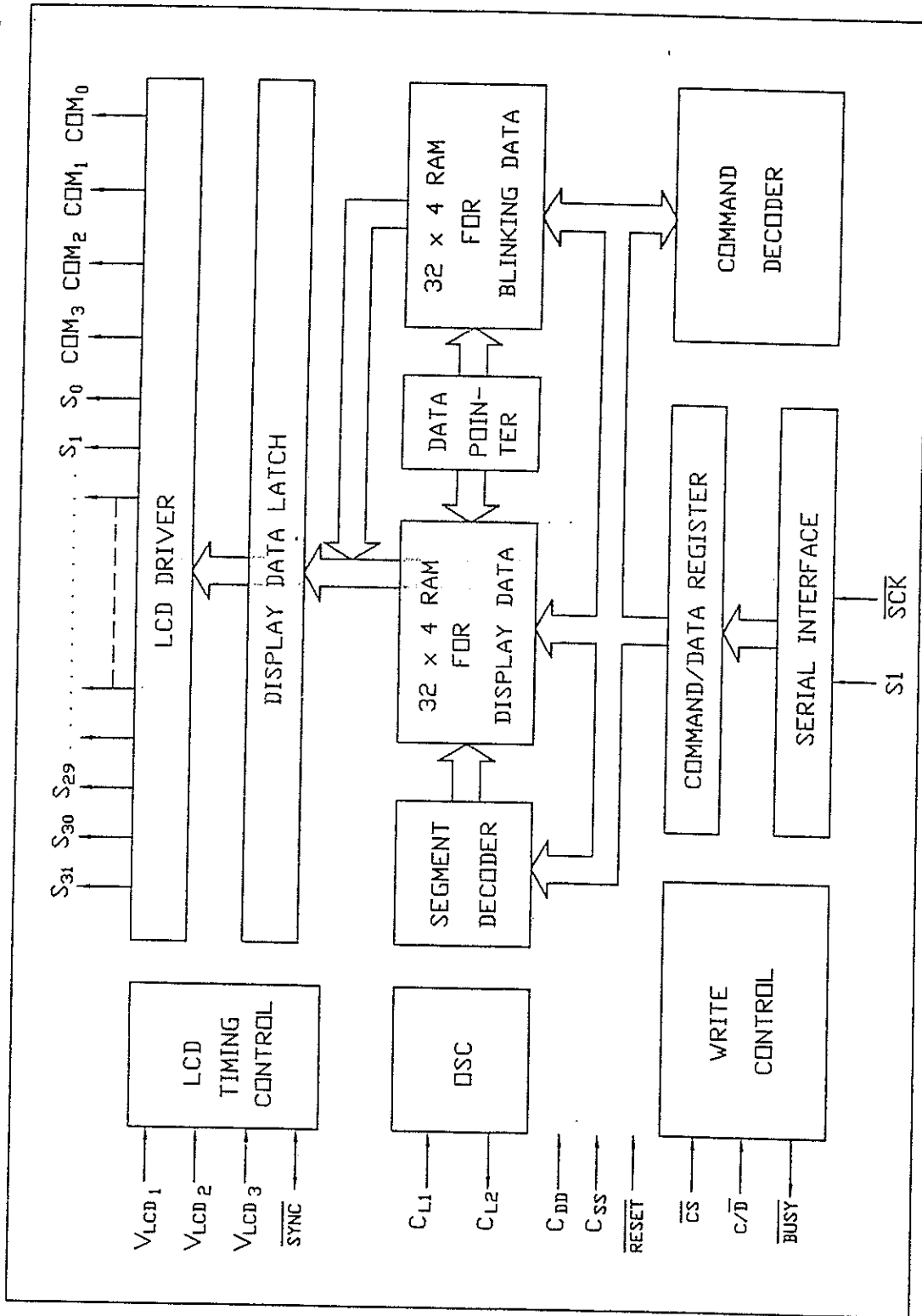

IC303-MB15A01PFV1-G-BND-EF

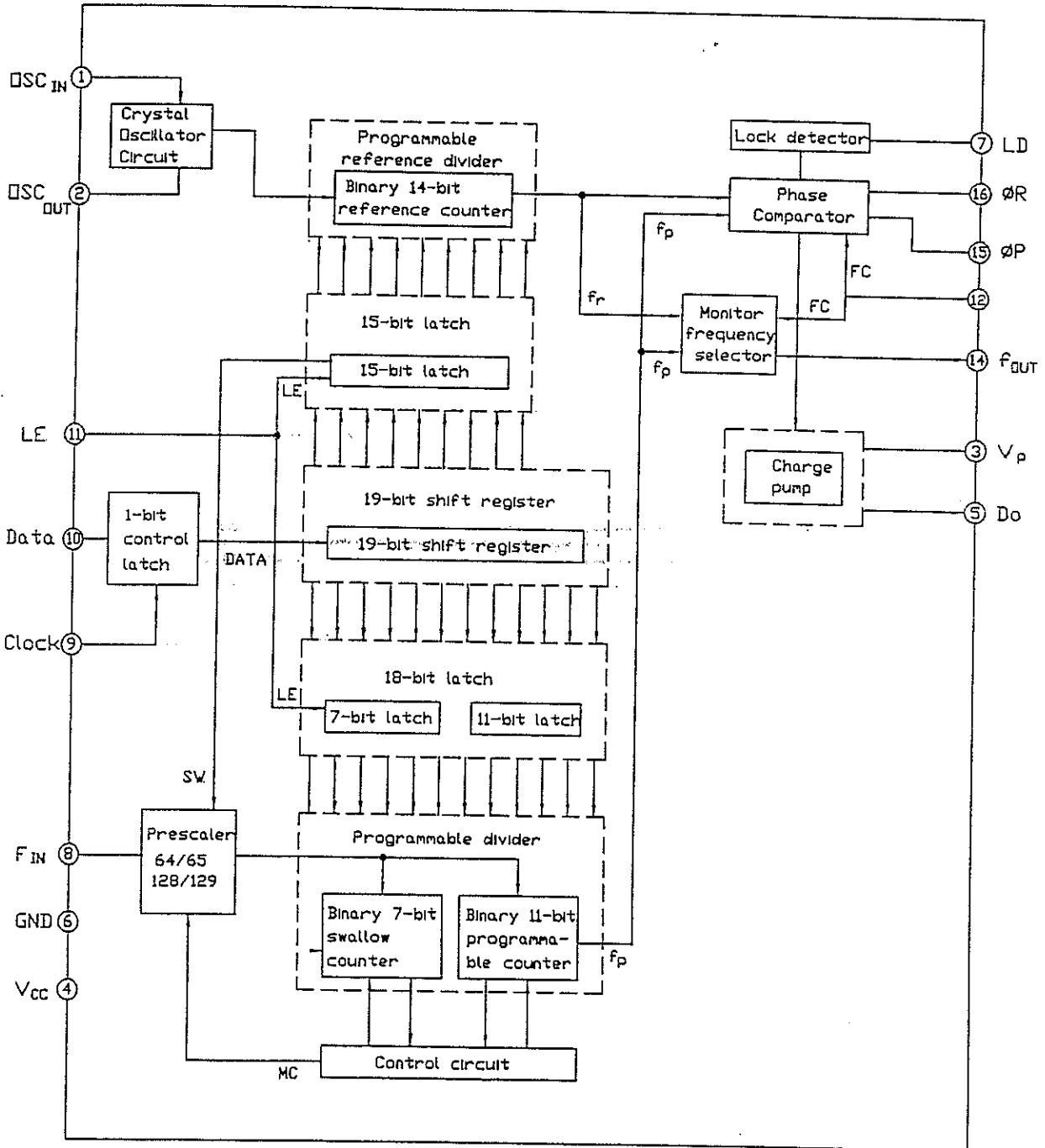

IC304-S-81250HG-RQ-T1

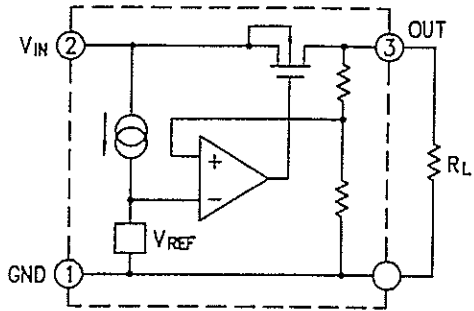

IC307-S-8052ALR-LF-T1

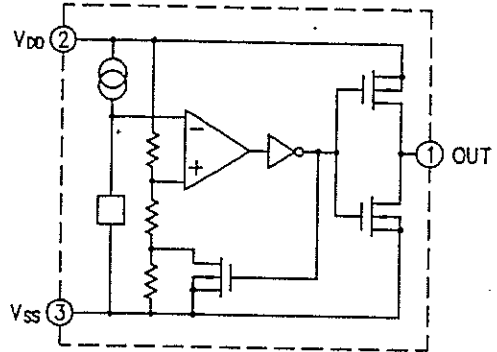

IC305-S-81230AG-RB-T2

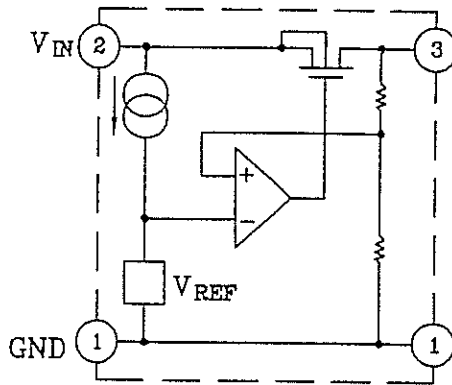

IC306-TC4094BF-T

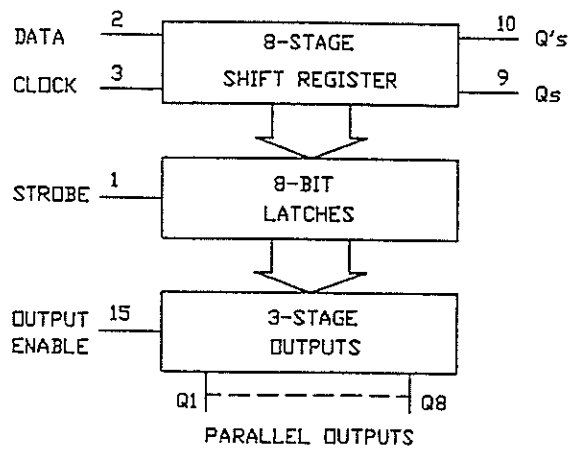

IC308-SAA6579T/V1

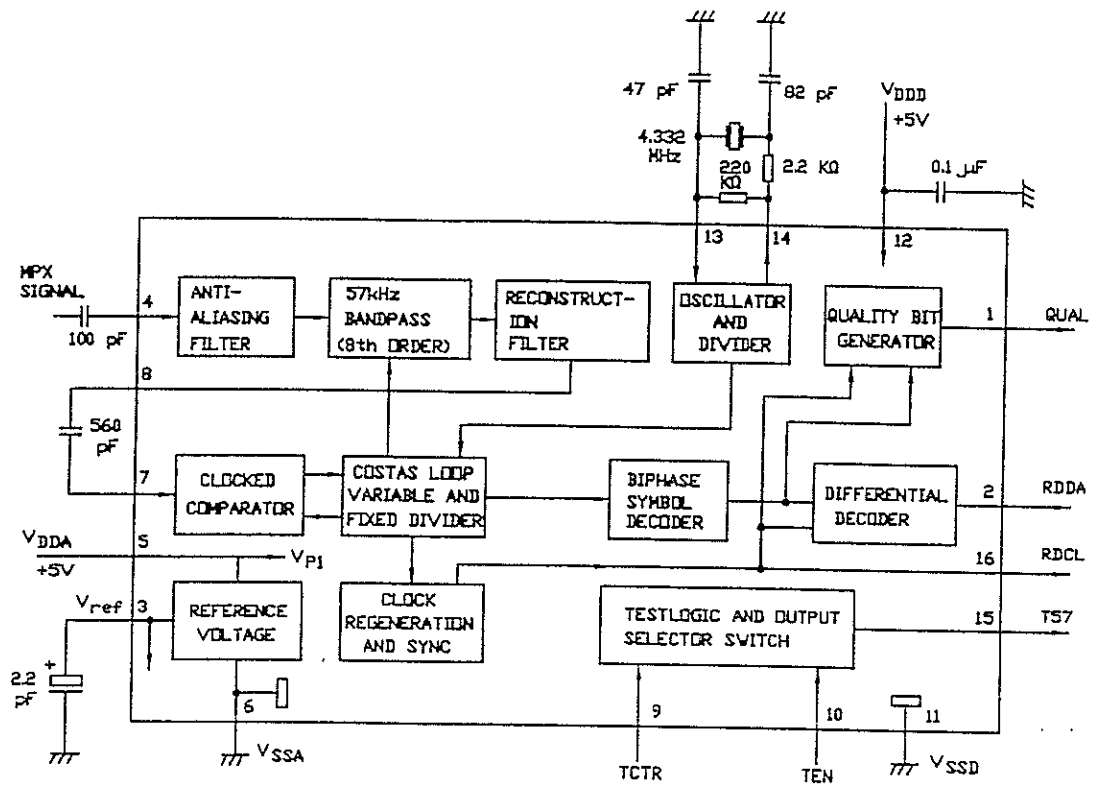

IC309-24LC164/SN-T

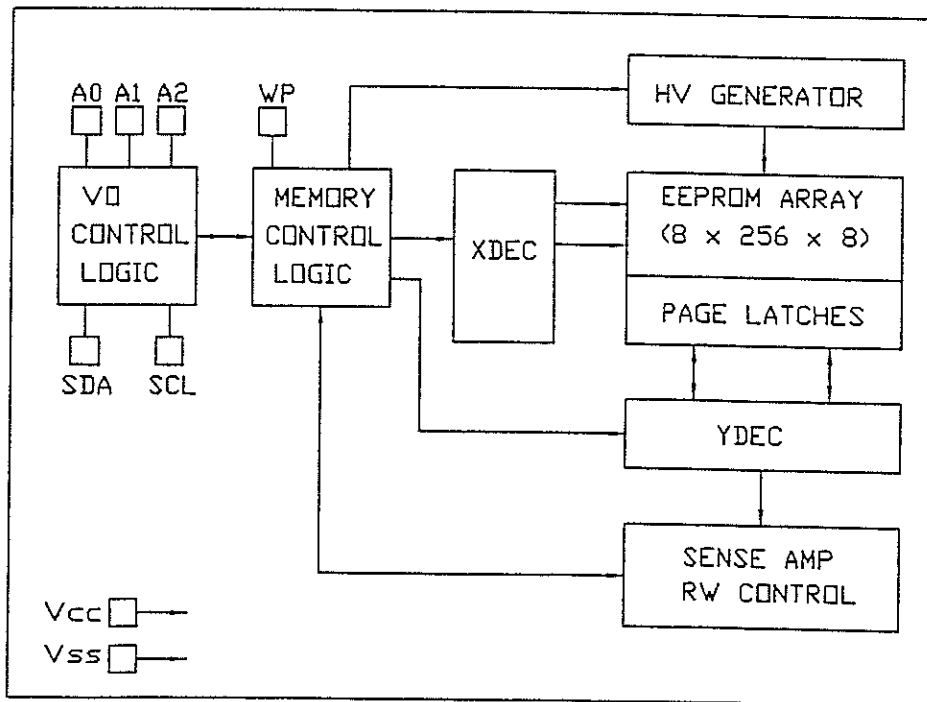

IC AND TRANSISTOR VOLTAGE CHART

IC1

PIN	FM	AM
1	4.47	4.13
2	1.60	1.60
3	1.80	1.56
4	1.25	1.73
5	1.37	1.57
6	1.37	1.56
7	5.3	5.27
8	2.34	2.23
9	5.28	5.27
10	5.26	0
11	0	0
12	1.54	1.53
13	0	2.27
14	0	0
15	1.46	1.40
16	1.47	1.38
17	2.33	2.27
18	1.7	1.42
19	1.61	1.61
20	1.61	1.61

IC2

PIN	FM
1	0.75
2	1.48
3	4.62
4	1.44
5	0
6	4.65
7	3.87
8	4.60
9	4.63

IC3

PIN	FM
1	3
2	0.48
3	0.48
4	1.21
5	0
6	0
7	3.04
8	0
9	1.04
10	0.18
11	0.46
12	1.30
13	1.39
14	1.22
15	1.17
16	0.26

IC4

PIN	FM
1	2.8
2	0
3	2.8
4	2.78
5	2.77
6	5.95
7	4.72
8	3.36
9	6.01
Remark	Headphone

IC7

PIN	FM
1	5.4
2	6
3	0
4	0

IC5

PIN	FM
1	2.8
2	0
3	2.8
4	2.78
5	2.77
6	5.95
7	4.72
8	3.36
9	6.01
Remark	Headphone

IC9

PIN	FM
1	5.28
2	0
3	3.06
4	4.66

IC6

PIN	FM
1	2.66
2	2.66
3	2.65
4	0
5	2.65
6	2.66
7	2.66
8	5.27

IC301

PIN	FM	PIN	FM	PIN	FM
1	0	26	2.76	51	1.39
2	2.77	27	2.76	52	1.39
3	2.63	28	2.76	53	1.39
4	0	29	2.76	54	1.39
5	3.04	30	2.76	55	2.85
6	0	31	0	56	2.80
7	1.42	32	0	57	1.85
8	0.98	33	0	58	0.94
9	2.77	34	0	59	0
10	0.94	35	0	60-91	1.41
11	1.16	36	2.76	92	0
12	2.8	37	2.78	93	2.76
13	0	38	0	94	2.76
14	2.65	39	0	95	2.77
15	2.94	40	0	96	0
16	2.65	41	0	97	0
17	1.72	42	0.08	98	0
18	1.77	43	0.08	99	2.77
19	2.77	44	2.74	100	0.3
20	0	45	3.33		
21	2.76	46	1.53		
22	2.76	47	0		
23	2.76	48	0		
24	2.76	49	0		
25	2.76	50	0		

IC302

PIN	FM
1-13	1.41
14	0.96
15	1.38
16	2.79
17	0
18	0.96
19	0
20	0
21	2.82
22	2.82
23	0
24	2.84
25	0.52
26	2.82
27	2.82
28	1.56
29-56	1.41

IC303

PIN	FM
1	1.27
2	1.16
3	3
4	3
5	0.55
6	0
7	3
8	1.95
9	0
10	0
11	0.75
12	0
13	0
14	0
15	0.81
16	0

IC306

PIN	FM
1	0
2	0
3	2.8
4	2.83
5	0
6	0
7	0
8	0
9	2.83
10	0
11	2.83
12	0
13	0
14	0
15	2.84
16	2.83

IC304

PIN	FM
1	0
2	5.24
3	4.98

IC305

PIN	FM
1	0
2	5.34
3	2.92

IC307

PIN	FM
1	2.89
2	2.89
3	0

IC308

PIN	FM
1	*2.2
2	*2.2
3	2.32
4	2.3
5	4.65
6	0
7	2.3
8	2.35
9	0
10	0
11	0
12	4.64
13	2.10
14	2.47
15	2.32
16	2.32

IC309

PIN	FM
1	0
2	0
3	0
4	0
5	2.87
6	2.87
7	0
8	2.83

Transistors

	MODE	FM	AM
	PIN NAME		
Q1	G	0	0
	S	0	0.72
	D	0	5.2

	MODE	FM	AM
	PIN NAME		
Q2	G	0	0.45
	S	0	1.7
	D	0	4.1

	MODE	FM	AM
	PIN NAME		
Q3	G	0	0.45
	S	0	1.7
	D	0	4.1

	MODE	FM	AM
	PIN NAME		
Q4	G	0	0
	S	0	1.18
	D	0	4.6

	MODE	FM	AM
	PIN NAME		
Q5	B	0.86	0
	C	0.86	0
	E	0.13	0

	MODE	FM	AM
	PIN NAME		
Q6	G	0	0
	S	0	0.72
	D	0	5.2

	MODE	FM	AM
	PIN NAME		
Q7	B	0	0
	C	1.35	1.35
	E	0	0

	MODE	FM	AM (LSB)
	PIN NAME		
Q8	B	0	0.75
	C	0	1.45
	E	0	0.15

	MODE	FM	AM (LSB)
	PIN NAME		
Q9	B	0	0.31
	C	0	1.5
	E	0	0

	MODE	FM	AM
	PIN NAME		
Q10	B	4.06	2.34
	C	0.2	3
	E	3.06	3.05

	MODE	FM	AM (LSB)	AM (USB)
	PIN NAME			
Q11	B	2.74	0.6	0
	C	0	0	0
	E	0.2	0	0

	MODE	FM	AM
	PIN NAME		
Q12	B	0.62	0
	C	0	2.25
	E	0	0

	MODE	FM	AM
	PIN NAME		
Q13	B	2.31	2.31
	C	2.86	2.85
	E	2.91	2.91

	MODE	FM	AM (LSB)	AM (USB)
	PIN NAME			
Q14	B	0	0.6	0
	C	0	0	0.2
	E	0	0	0

	MODE PIN NAME	FM	AM
Q15	B	0.60	1.40
	C	0.05	2.8
	E	0.04	1.22

	MODE PIN NAME	FM	AM
Q22	B	5.21	4.6
	C	0	5.23
	E	5.26	5.26

	MODE PIN NAME	FM	AM
Q29	B	5.43	5.43
	C	6	6
	E	6	6

	MODE PIN NAME	FM	AM
Q36	B	*1.31	*1.26
	C	3.06	3.06
	E	*0.71	*0.69

	MODE PIN NAME	FM	AM
Q16	B	0.6	1.0
	C	0	2.77
	E	0	1.22

	MODE PIN NAME	FM	AM
Q23	B	4.6	5.20
	C	5.22	0
	E	5.26	5.26

	MODE PIN NAME	FM	AM
Q30	B	0	0
	C	0	0
	E	0	0

	MODE PIN NAME	FM	AM
Q37	B	0	*1.07
	C	*1.79	*1.58
	E	*0.45	*0.52

	MODE PIN NAME	FM	AM
Q17	B	0	5.15
	C	0	0
	E	0	5.2

	MODE PIN NAME	FM	AM
Q24	B	0.6	0
	C	0	5.21
	E	0	0

	MODE PIN NAME	FM	AM
Q31	B	0	0
	C	0	0
	E	0	0

	MODE PIN NAME	FM	AM
Q38	B	0	0.5
	C	0	0.5
	E	0	0

	MODE PIN NAME	FM	AM
Q18	B	0	0
	C	0.94	5.1
	E	0	0

	MODE PIN NAME	FM	AM
Q25	B	0.45	0
	C	0.6	0
	E	0	0

	MODE PIN NAME	FM	AM
Q32	B	0	0
	C	0	0
	E	0	0

	MODE PIN NAME	FM	AM
Q39	B	0	4.5
	C	0	5.12
	E	0	5.2

	MODE PIN NAME	FM	AM
Q19	B	0	0.55
	C	0	2.7
	E	0	0

	MODE PIN NAME	FM	AM
Q26	B	0.6	0
	C	3	0
	E	0	0

	MODE PIN NAME	FM	AM
Q33	G	*6.6	*1.8
	S	*6.9	*2.04
	D	15.5	2.84

	MODE PIN NAME	FM	AM
Q40	B	0	0.6
	C	0	0.04
	E	0	0

	MODE PIN NAME	FM	AM
Q20	B	0	1.2
	C	0	2.2
	E	0	0.5

	MODE PIN NAME	FM	AM
Q27	B	5.84	5.84
	C	5.92	5.92
	E	5.24	5.24

	MODE PIN NAME	FM	AM
Q34	B	1.23	0
	C	2.23	0
	E	0.6	0

	MODE PIN NAME	FM	AM
Q41	B	0	0.28
	C	0	0
	E	0	0

	MODE PIN NAME	FM	AM
Q21	B	0	0.55
	C	0	2.4
	E	0	0

	MODE PIN NAME	FM	AM
Q28	B	5.32	5.32
	C	5.97	5.97
	E	6.0	6.0

	MODE PIN NAME	FM	AM
Q35	B	0.6	0
	C	0	0.39
	E	0	0

	MODE PIN NAME	FM	AM
Q42	G	0	0
	S	0	0.4
	D	0	4.3

	MODE PIN NAME	FM	AM
Q43	B	0	0.69
	C	0	0.17
	E	0	0

	MODE PIN NAME	FM	AM
Q50	B	4.37	2.49
	C	0	3.02
	E	3.06	3.06

	MODE PIN NAME	FM	AM
Q58	B		5.82
	C		0.08
	E		6

	MODE PIN NAME	FM	AM
Q44	G		0
	S		1.2
	D		4.6

	MODE PIN NAME	FM	AM
Q52	B	0.12	1.82
	C	0.04	3
	E	0.19	1.21

	MODE PIN NAME	FM	AM
Q59	B	0.5	0.5
	C	0.5	0.5
	E	0	0

	MODE PIN NAME	FM	AM
Q45	B	5.28	5.83
	C	5.94	0.3
	E	5.97	6

	MODE PIN NAME	FM	AM
Q53	B	0	1.47
	C	0.19	2.06
	E	0	3

	MODE PIN NAME	FM	AM
Q60	B	0	0
	C	0.2	2.67
	E	0	0

	MODE PIN NAME	FM	AM
Q46	B	0	0.67
	C	0	0
	E	0	0

	MODE PIN NAME	FM	AM
Q54	B	0	0
	C	0	0
	E	0	0

	MODE PIN NAME	FM	AM
Q62	B		0
	C		5.67
	E		0

	MODE PIN NAME	FM	AM (LSB)	AM (USB)
Q47	B	0	0.62	0
	C	0	0	0.67
	E	0	0	0

	MODE PIN NAME	FM	AM
Q55	B	0.6	0.54
	C	0	0
	E	0	0

	MODE PIN NAME	FM	AM
Q48	B	0	4.75
	C	0	0.52
	E	0	5.20

	MODE PIN NAME	FM	AM
Q56	B	0	0
	C	0	0
	E	0	0

	MODE PIN NAME	FM	AM
Q49	B	*0.85	*0.84
	C	*1.79	*0.43
	E	0.3	*0.39

	MODE PIN NAME	FM	AM
Q57	G	0	1.71
	S	0	4.35
	D	0	0.96

	MODE PIN NAME	FM
Q301	B	2.26
	C	2.85
	E	2.88

	MODE PIN NAME	FM
Q308	B	0.76
	C	2.2
	E	0

	MODE PIN NAME	FM
Q302	B	0.66
	C	0.13
	E	0

	MODE PIN NAME	FM
Q309	B	0.74
	C	1.87
	E	0.07

	MODE PIN NAME	FM
Q303	B	0.61
	C	0.08
	E	0

	MODE PIN NAME	FM
Q310	G	0.56
	S	0.99
	D	3.0

	MODE PIN NAME	FM
Q304	B	0
	C	5.8
	E	0

	MODE PIN NAME	FM
Q312	B	2.76
	C	5.96
	E	2.19

	MODE PIN NAME	FM
Q305	B	2.89
	C	3.43
	E	3.44

	MODE PIN NAME	FM
Q313	B	0
	C	0
	E	0

	MODE PIN NAME	FM
Q306	B	1.41
	C	1.87
	E	1.91

	MODE PIN NAME	FM
Q314	B	0
	C	5.96
	E	0

	MODE PIN NAME	FM
Q307	B	0.59
	C	*5.70
	E	0

	MODE PIN NAME	FM
Q315	B	5.95
	C	0
	E	5.96

MODE	FM MODE	AM MODE
FREQUENCY	100 MHz	1 MHz
RF IN	40 emf/dB μ	74 dB/m
DC IN TO JACK	6.4 V	6.4 V
FUNCTION MODE	MONO	WIDE
LOAD	SPEAKER	SPEAKER

SEMICONDUCTOR LEAD IDENTIFICATIONS

Transistors



2SC2839E
2SD1012G
2SA1317T/U
2SC2999E
2SC3330S/T/U

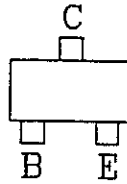

2SA812M6
2SC1623L6
2SB815B6/B7
2SD1048X6/X7
2SC2223F13



2SK381A/B
2SK715W



2SA1020Y



2SK435D

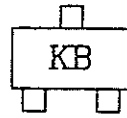

2SK433B



2SK212E

(E:Emitter C:Collector B:Base S:Source G:Gate D:Drain)

Diodes

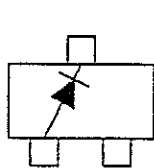
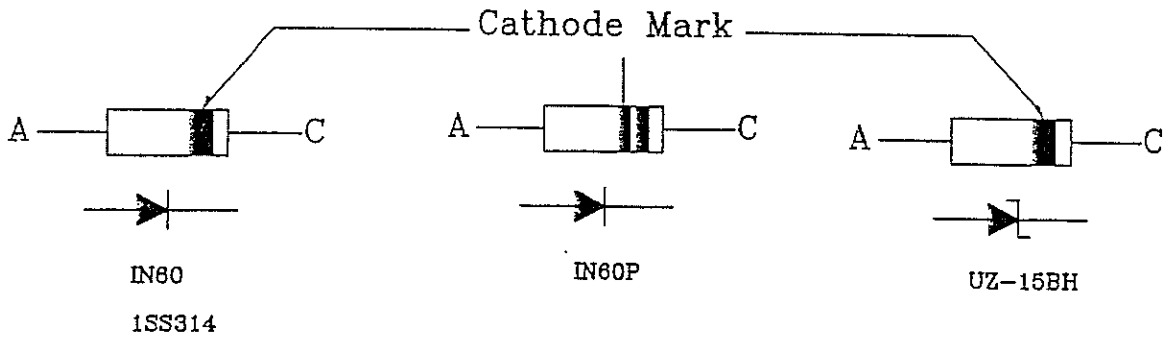

RB411

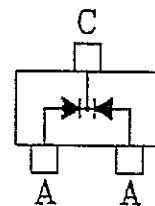

1S2837

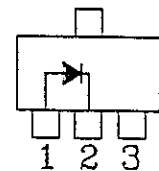

A → C
RB110C

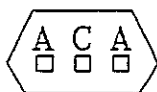

SVC203



SVC201 SP



A → C
RLS4148

(A:Anode C:Cathode)

SCHEMATIC DIAGRAM

REV. NO.	TITLE	DATE	BY	CHKD.
001	SCHEMATIC	01/15/54	J. H. W.	J. H. W.
002	REVISION	01/15/54	J. H. W.	J. H. W.
003	REVISION	01/15/54	J. H. W.	J. H. W.

SANGAN ELECTRONICS, INC.

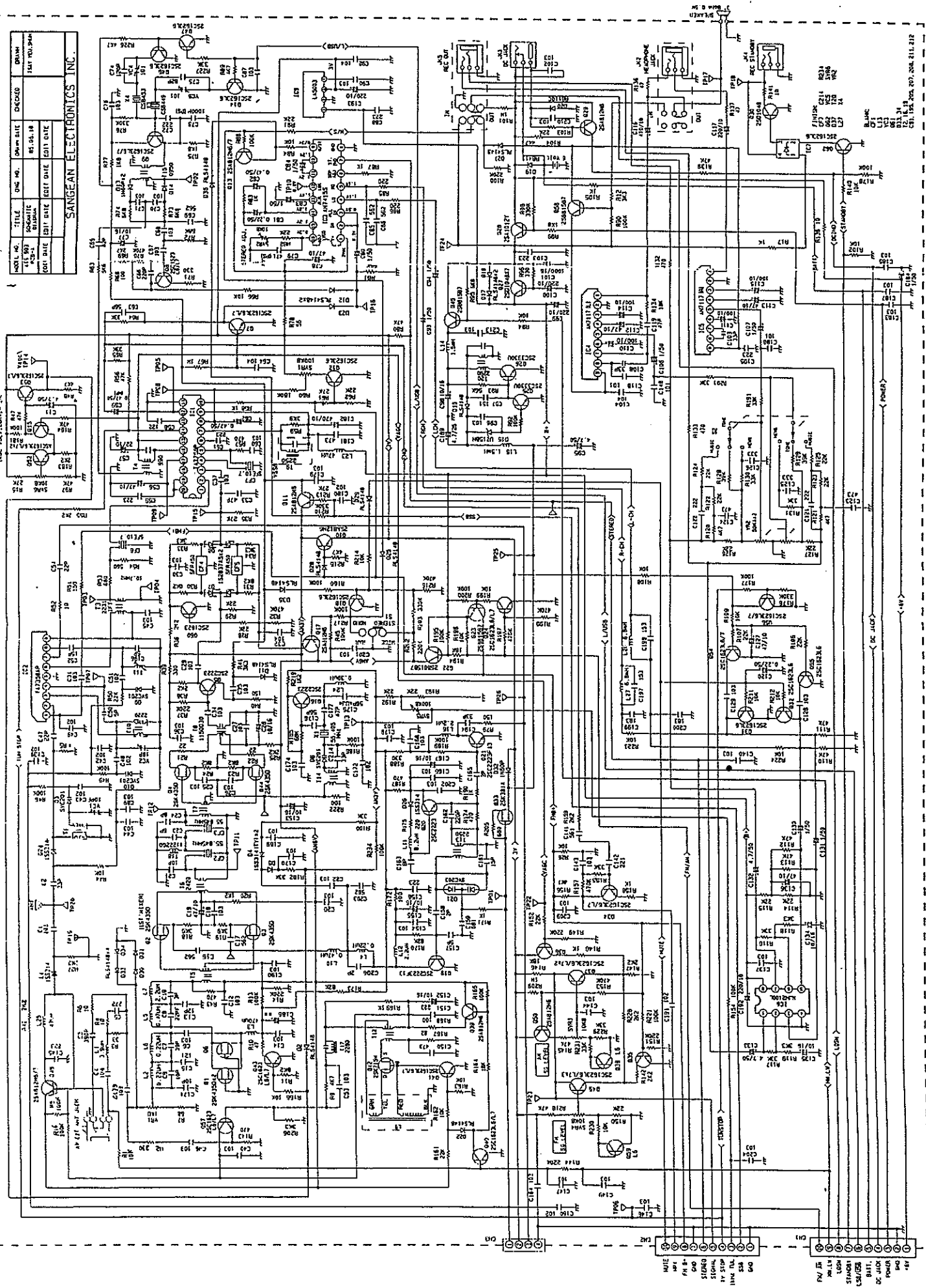

44- 6X4
 45- 6AV6
 46- 6AR5
 47- 100K
 48- 100P
 49- 500MFD 50V
 50- 250V AC
 51- 500K
 52- 100K
 53- 100P
 54- 500MFD 50V
 55- 250V AC
 56- 500K
 57- 100K
 58- 100P
 59- 500MFD 50V
 60- 250V AC
 61- 500K
 62- 100K
 63- 100P
 64- 500MFD 50V
 65- 250V AC
 66- 500K
 67- 100K
 68- 100P
 69- 500MFD 50V
 70- 250V AC
 71- 500K
 72- 100K
 73- 100P
 74- 500MFD 50V
 75- 250V AC
 76- 500K
 77- 100K
 78- 100P
 79- 500MFD 50V
 80- 250V AC
 81- 500K
 82- 100K
 83- 100P
 84- 500MFD 50V
 85- 250V AC
 86- 500K
 87- 100K
 88- 100P
 89- 500MFD 50V
 90- 250V AC
 91- 500K
 92- 100K
 93- 100P
 94- 500MFD 50V
 95- 250V AC
 96- 500K
 97- 100K
 98- 100P
 99- 500MFD 50V
 100- 250V AC

SCHEMATIC DIAGRAM

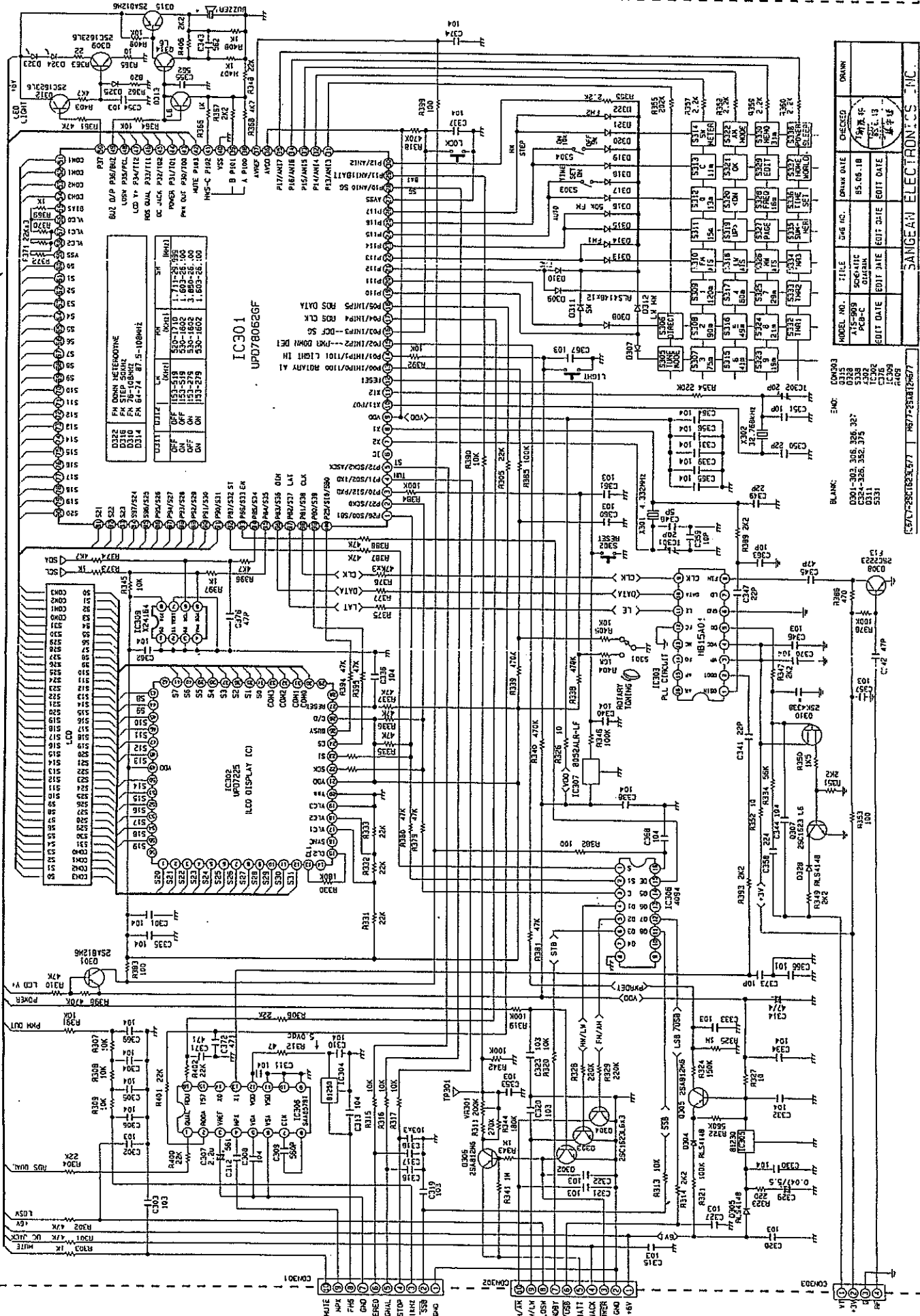

IC301 UPD780626F

FUNCTION	IC301	IC301	IC301	IC301	IC301
D312	FM	FM	FM	FM	FM
D313	FM	FM	FM	FM	FM
D314	FM	FM	FM	FM	FM
D315	FM	FM	FM	FM	FM
D316	FM	FM	FM	FM	FM
D317	FM	FM	FM	FM	FM
D318	FM	FM	FM	FM	FM
D319	FM	FM	FM	FM	FM
D320	FM	FM	FM	FM	FM
D321	FM	FM	FM	FM	FM
D322	FM	FM	FM	FM	FM
D323	FM	FM	FM	FM	FM
D324	FM	FM	FM	FM	FM
D325	FM	FM	FM	FM	FM
D326	FM	FM	FM	FM	FM
D327	FM	FM	FM	FM	FM
D328	FM	FM	FM	FM	FM
D329	FM	FM	FM	FM	FM
D330	FM	FM	FM	FM	FM
D331	FM	FM	FM	FM	FM
D332	FM	FM	FM	FM	FM
D333	FM	FM	FM	FM	FM
D334	FM	FM	FM	FM	FM
D335	FM	FM	FM	FM	FM
D336	FM	FM	FM	FM	FM
D337	FM	FM	FM	FM	FM
D338	FM	FM	FM	FM	FM
D339	FM	FM	FM	FM	FM
D340	FM	FM	FM	FM	FM
D341	FM	FM	FM	FM	FM
D342	FM	FM	FM	FM	FM
D343	FM	FM	FM	FM	FM
D344	FM	FM	FM	FM	FM
D345	FM	FM	FM	FM	FM
D346	FM	FM	FM	FM	FM
D347	FM	FM	FM	FM	FM
D348	FM	FM	FM	FM	FM
D349	FM	FM	FM	FM	FM
D350	FM	FM	FM	FM	FM

MODEL NO.	TITLE	JOB NO.	DRAWN DATE	CHECKED	DRAWN
001-302	FM/AM	85-06-18	85.06.18		
001-303	FM/AM	85.06.18	85.06.18		
001-304	FM/AM	85.06.18	85.06.18		
001-305	FM/AM	85.06.18	85.06.18		
001-306	FM/AM	85.06.18	85.06.18		
001-307	FM/AM	85.06.18	85.06.18		
001-308	FM/AM	85.06.18	85.06.18		
001-309	FM/AM	85.06.18	85.06.18		
001-310	FM/AM	85.06.18	85.06.18		
001-311	FM/AM	85.06.18	85.06.18		
001-312	FM/AM	85.06.18	85.06.18		
001-313	FM/AM	85.06.18	85.06.18		
001-314	FM/AM	85.06.18	85.06.18		
001-315	FM/AM	85.06.18	85.06.18		
001-316	FM/AM	85.06.18	85.06.18		
001-317	FM/AM	85.06.18	85.06.18		
001-318	FM/AM	85.06.18	85.06.18		
001-319	FM/AM	85.06.18	85.06.18		
001-320	FM/AM	85.06.18	85.06.18		

BLANK: 8507
 001-302, 306, 308, 307
 001-303, 305, 315
 001-304, 309, 310, 311, 312, 313, 314, 315, 316, 317, 318, 319, 320

IC301 UPD780626F
 8507-250182-077
 8507-250182-077

SANGEAN ELECTRONICS, INC.

BLOCK DIAGRAM

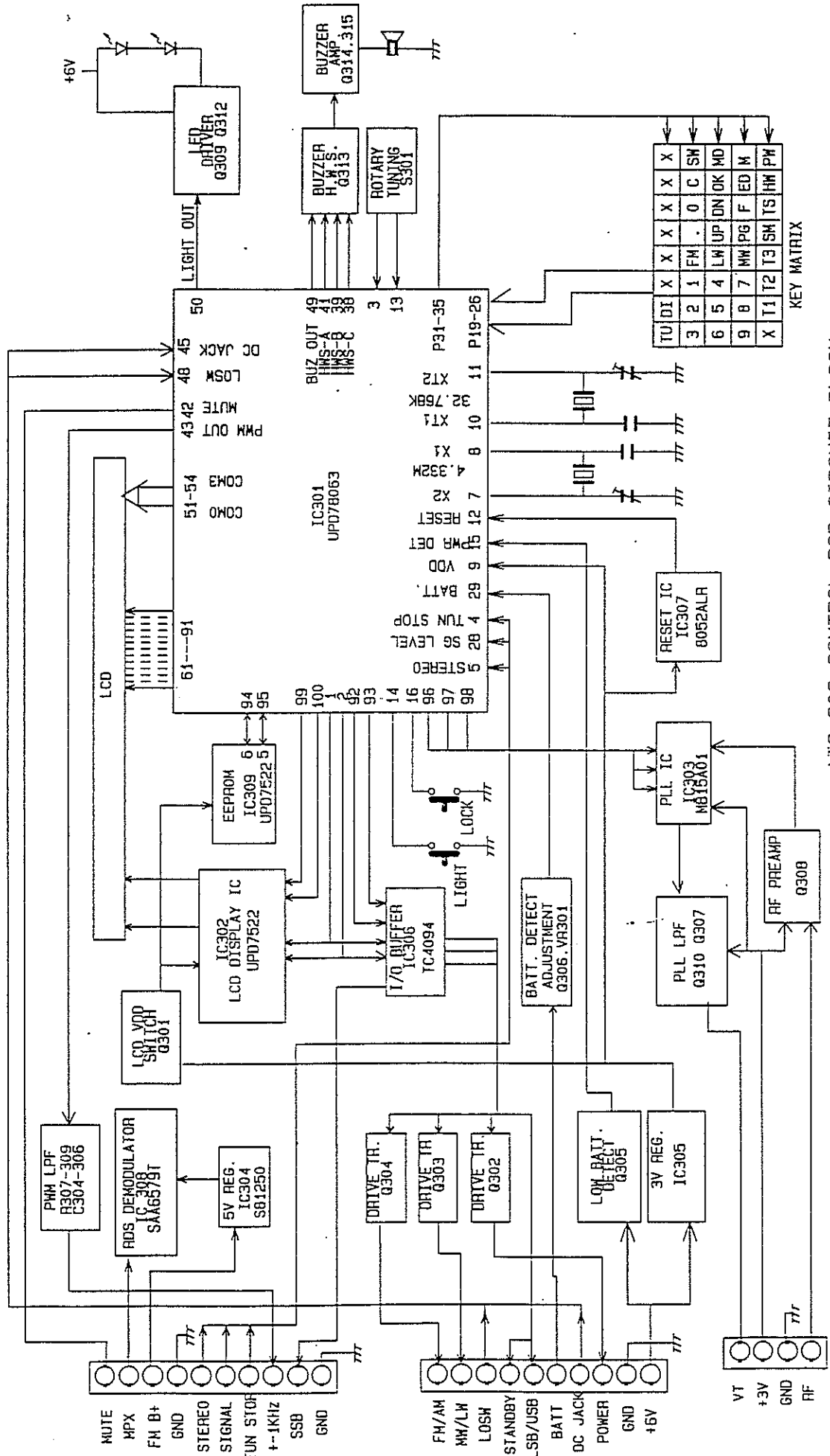

ATS-909 CONTROL PCB CIRCUIT BLOCK

TU	DI	X	X	X	X	X	X	X	X
3	2	1	FM	.	0	C	SW		
6	5	4	LW	UP	DN	OK	MD		
9	8	7	MW	PG	F	ED	M		
X	T1	T2	T3	SM	TS	HM	PW		

KEY MATRIX

SCHEMATIC DIAGRAM

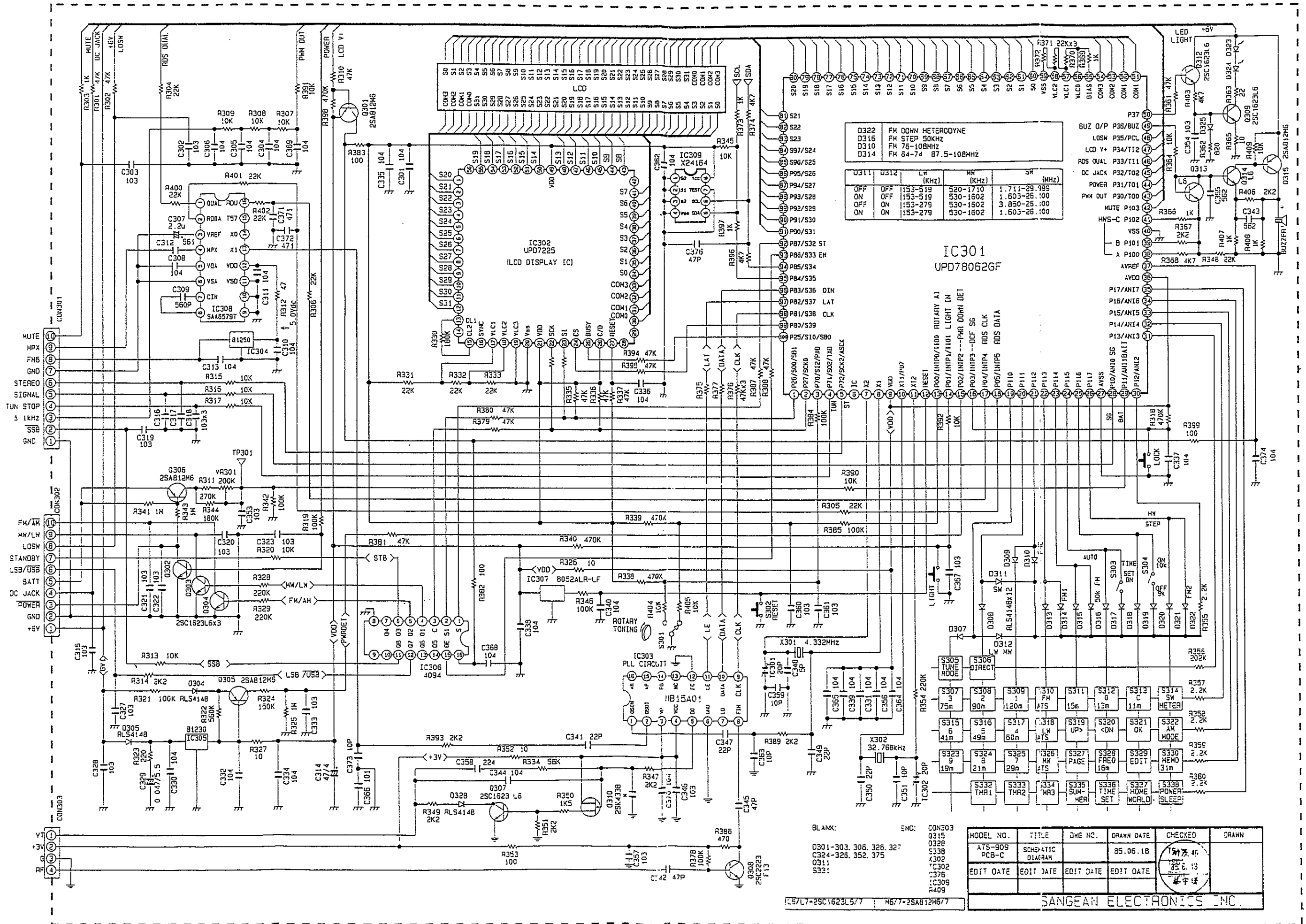

SCHEMATIC DIAGRAM

MODEL NO	TITLE	DWG NO.	DRWN DATE	CHECKED	DRWEN
ATF 503	SCHEMATIC DIAGRAM		85.05.18		TSAY YEU SHAN
ED1 DATE	ED1 DATE	ED1 DATE	ED1 DATE		

SANGHAN ELECTRONICS INC.

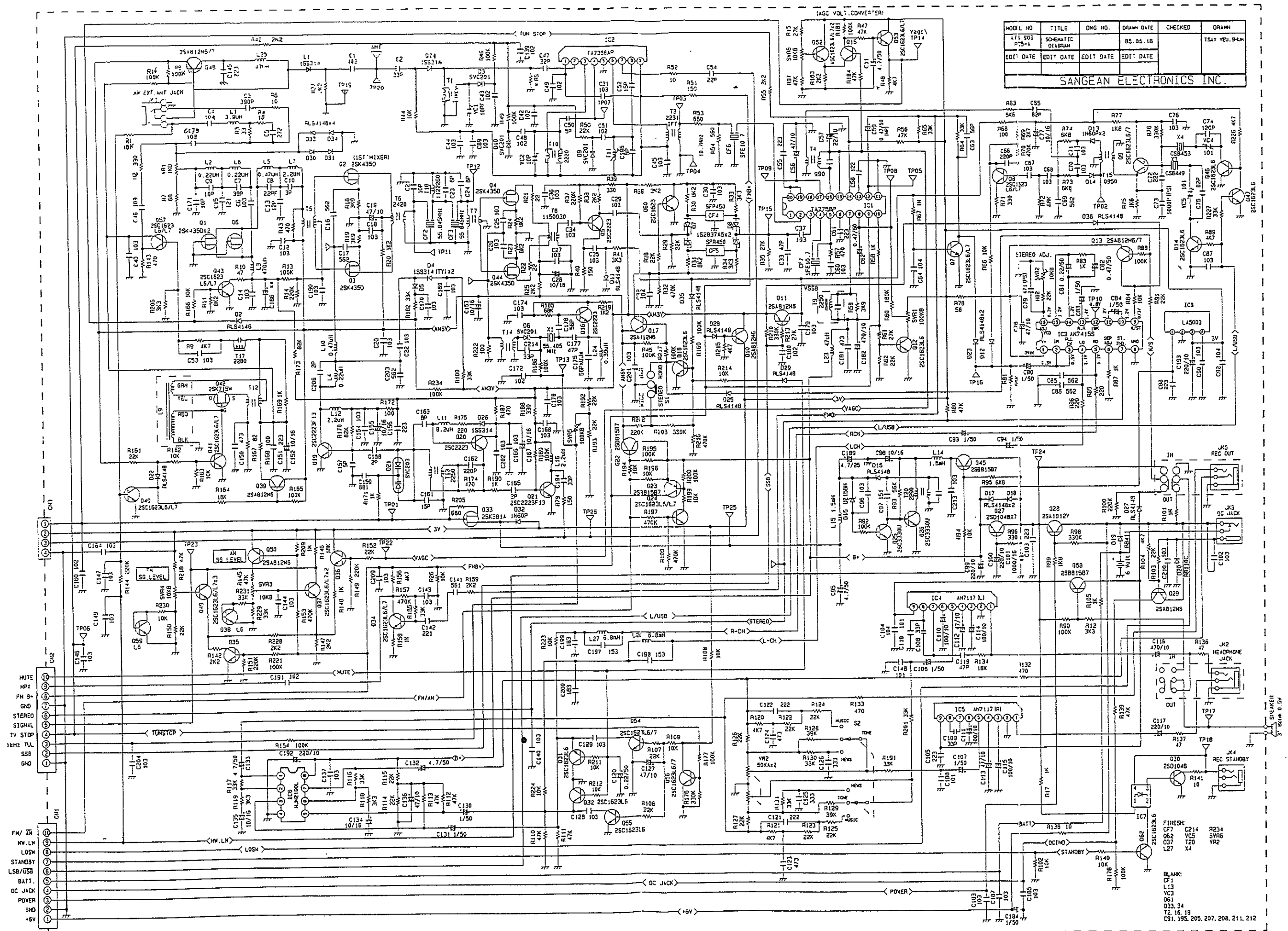

- BLANK:**
- CF7
 - C24
 - 037
 - VC5
 - 061
 - 033, 34
 - T2, 16, 19
 - C91, 195, 205, 207, 208, 211, 212