



BWD ELECTRONICS

539D

**DC to 25 MHz
DUAL TRACE
OSCILLOSCOPE**

INSTRUCTION MANUAL

BWD ELECTRONICS PTY LTD
MILES STREET
MULGRAVE VIC 3170
AUSTRALIA

PO BOX 325
SPRINGVALE 3171

PHONE (03) 561 2888 (3 LINES)

CABLES 'OSCILLOSCOPE'

TELEX AA35115

539D

DC to 25MHz
DUAL TRACE
OSCILLOSCOPE

ISSUE 8

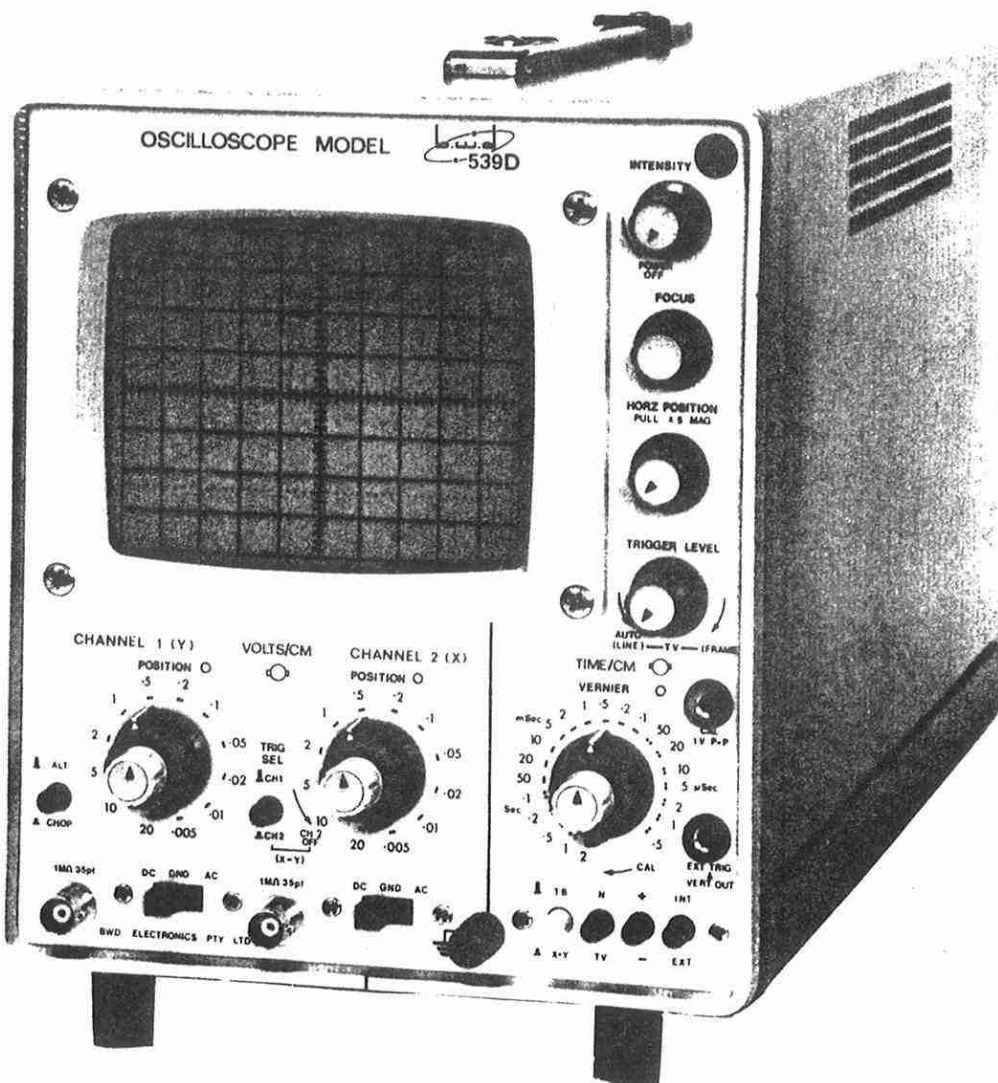

BWD 539D
DUAL TRACE
OSCILLOSCOPE

INDEX

SECTION	PAGE	SUBJECT
1	1	INTRODUCTION
2	2	GUIDE TO CHARACTERISTICS
3	5	DETAILED SPECIFICATION
4	9	FUNCTION OF CONTROLS
5	12	INITIAL CHECKING
6	13	FIRST TIME OPERATION
7	17	MEASUREMENT OF TIME & VOLTAGE
8	21	CIRCUIT DESCRIPTION
9	27	ADJUSTMENTS & MAINTENANCE
10	31	REPLACEMENT PARTS
11	31	WARRANTY
A	1A	PARTS LISTS
		CIRCUIT DIAGRAMS

MODEL BWD 539D

DC - 25MHz DUAL TRACE OSCILLOSCOPE

1. INTRODUCTION:

Model BWD 539D is a portable dual trace oscilloscope providing a measurement capability that is unique in an instrument of its class. The identical vertical amplifiers have a -3db response >25MHz and are useful for signal monitoring to beyond 30MHz. Stable triggering extending to > 30MHz makes the BWD 539D suitable for use with 27MHz C.B. and radio control gear. The two vertical amplifiers may be cascaded for a single channel display over a bandwidth of 12Hz to 100kHz at a sensitivity of 0.5mV/cm.

The time base and trigger facilities complement the vertical amplifier performance with a sweep range from 100nSec/cm to 2.5sec/cm whilst waveforms can be triggered from 2Hz to over 20MHz and presented with complete stability. Video displays are well catered for with an active sync separator supplying frame or line pulses for stable lock even if the signal is almost lost in noise. Additional versatility is provided by the sync separator as it also operates as an AM demodulator enabling double or single sideband displays to be locked to the modulation envelope.

Identical X-Y operation is also incorporated in the 539D and is phase corrected from DC to over 200kHz enabling accurate phase measurements to be made over this range.

Applications requiring accurate phase measurements to power line operated equipment can be readily made on a BWD 539D as it incorporates a zero crossover reference waveform in the calibrator output. When this waveform is used to provide external trigger for the time base, the start of the trace will be within 2° of the power line 0° or 180° cross over points. Thus firing angles of thyristors or triacs can be measured to within 2 or 3°.

Application notes relating to all the oscilloscopes facilities are contained in Section 6 and 7.

To ensure a long and trouble free life certain precautions should always be observed with electronic instruments. If it is left standing for long periods or is used in a dusty atmosphere keep the instrument covered with a plastic dust cover or in a cupboard.

Although this instrument has been designed for reliable long term use and has been subject to environmental tests and heat soaked, it is always advisable to store it away from heat or out of direct intense sunlight to minimise temperature cycling of components and possible premature drying out of electrolytic capacitors. Internal temperature rise of the 539D is low but care should still be taken to ensure that the cabinet has adequate ventilation.

To get the maximum use from your oscilloscope many accessories such as probes, cameras, dust covers, etc., together with a wide range of other BWD instruments are available either direct from B.W.D. Electronics Pty. Ltd., or your local supplier.

2. The following notes can be used in conjunction with the Specifications in Section 3.

2.1 VERTICAL AMPLIFIERS

(a) Bandwidth, Spec.

DC or 2Hz to 25MHz -3db referred to 4cm deflection at 50KHz.

Method of Measurement

Attenuator set to 100mV/cm. Time base at 100 μ Sec and switched to AUTO.

A low distortion sine wave oscillator with an accurately monitored output (at the point of termination) or one with less than 1% change in level is coupled to the input-socket and correctly terminated. Frequency is set to 50KHz and input level adjusted for 4 cm peak to peak deflection.

The oscillator frequency is now increased and the deflection noted until it drops to 2.8 cms or 0.707 of the original level. This will be at 25MHz or higher and is the -3db point.

NOTE: It does not mean a 3db increase in the signal input will return the display back to 4cm. This is due to inherent limitations in amplifier deflection capabilities which largely determine the oscilloscope bandwidth.

Oscilloscope amplifier characteristics to note are:-

(i) The response starts to fall around 30% of the bandwidth, i.e. a -3db 25MHz amplifier starts to roll off around 7MHz and calibration accuracy is only applicable to this point. A chart on p19 gives approximate calibration up to 40MHz and extends the useful measuring range to this limit.

(ii) Full screen deflection is available up to 12MHz. See chart p19

(b) Low Frequency Response

With the input switched to DC, the amplifier response is constant (flat) down to zero frequency, enabling the oscilloscope to be used as a DC voltmeter. If the input is changed to AC, a capacitor (0.1 μ F) is placed in series with the input removing the DC component and attenuating the low frequency AC signal. 2Hz is slightly less than -3db down from the reference level. Square waves display sloping faces below about 200Hz. A 10-1 divider probe will extend this frequency response down by a factor of 10, i.e. -3db at 0.2Hz.

(c) Rise Time, Spec.

14 nSec. over 4cm. 10% to 90% Levels.

Method of Measurement

This is most accurately obtained by interpolation. The formula, based on a step response with less than 2% overshoot or ringing and applicable to all BWD oscilloscopes is -

$$\text{rise time} = \frac{350}{\text{bandwidth (-3db)}} \text{ nano Sec. e.g. } \frac{350}{25} = 14$$

NOTE: The 539D rise time is approximately 14 n Sec. as the amplifier bandwidth is in excess of 25MHz.

A measured rise time on an oscilloscope must also accommodate the input pulse rise time. The formula for this is $t_{\text{display}} = t_{\text{pulse}}^2 + t_{\text{oscilloscope}}^2$. The chart on page 20 provides direct read-out of the values.

NOTE: When measuring near the upper limit of oscilloscope, pulse amplitude should be contained within the limit of the bandwidth reference level, (e.g. 4 cm for above example) for greatest accuracy of rise time.

(d) Input Impedance

This invariably consists of a $1M\Omega$ resistance in parallel with a capacitive component. As the capacitance consists of strays and F.E.T. input capacitance it is measured with the instrument working by a direct reading capacitance meter. Measurements are made at 100mV/cm.

NOTE: As input capacitance is added to lead capacitance when making direct measurements, it is always recommended a 10:1 high impedance probe be used to reduce this capacitive component down to 10-12pf where signal levels permit. (bwd P32 Duo Probe)

2.2 HORIZONTAL AMPLIFIER

General Specifications and measurement techniques are similar to vertical amplifiers and will be referred to where applicable.

(a) Bandwidth, Spec.

DC to 2MHz -3db referred to 6cm at 50KHz at $\times 1$ mag.

Method of Measurement

With X-Y button pressed, Horz. position pushed in for $\times 1$ mag and spot centered. 50KHz sine wave is coupled in to Ch.2 and set to 6cm deflection. Increase input frequency until trace width drops to 4.2cm; this is the -3db point. All notes relative to vertical amplifier section should also be applied to this section, i.e. max. deflection, roll off, rise time, low frequency response etc.

(b) Input Impedance

This is $1M\Omega$ and 35pf as specified for the vert. amplifier.

2.3 TIME BASE

This section is divided into the following sections:-

(i) Time Base; (ii) Magnification; (iii) Triggering;

(a) Time Base, Spec.

0.5 μ Sec to 2 Sec in 21 steps, calibration $<5\%$

Method of Measurement

Set time base to 1mSec and vernier fully clockwise to CAL. Feed in a 1KHz square wave or pulse with better than 0.1% frequency accuracy. When the first pulse is lined up with the first graticule line, then the 10th pulse should be within ± 5 mm of the 10th graticule line. Checks made at all other time base steps with corresponding calibration pulses should be within the same limits.

NOTE: Calibration accuracy is not the accuracy of each individual division but the overall accuracy, where any variation in trace linearity is averaged over the 10cm deflection.

(b) Magnification, Spec.

5% accuracy at X1 and 5% at X5 up to $.2\mu\text{Sec}/\text{cm}$.

Method of Measurement

After calibration check as above at $1\text{mSec}/\text{cm}$ trace is magnified to X5. 1 KHz calibration Pulses should be 5cm apart $\pm 2.5\text{mm}$. With mag. at X5, time base is increased to $2\mu\text{Sec}/\text{cm}$ producing a $.4\mu\text{Sec}/\text{cm}$ magnified sweep. This is the limit of specified calibration although it is normally within spec. at all sweep speeds.

(c) Triggering, Spec.

INT AUTO 1cm defl. 5Hz to $> 16\text{MHz}$.

This implies when the time base is adjusted for convenient viewing of input, i.e. 5-10 sine waves visible across screen 1cm high irrespective of attenuator setting, the time base will present a stable display. Above 20MHz it may be necessary to select + or - slope to obtain the most stable display.

NOTE: All bwd oscilloscopes incorporate an AUTO circuit which varies its rate as the time base range switch is changed, they also have a unique feature which increases the sensitivity of the time base if the trigger level drops at high frequencies - a feature which accounts for their superior triggering characteristics. At low frequencies the AUTO rate may exhibit an intermittent repetition rate. This is quite normal and in no way effects its excellent locking ability when a signal is present.

Level Select

$\pm 4\text{cm}$ range 3Hz to $> 20\text{MHz}$.

If the Select Control is turned clock wise from AUTO, the triggering point can be selected over an 8cm range. At the upper or lower frequencies limits of the trigger range the level range reduces and becomes a little more critical to adjust. Min. Level Select range is less than 1cm.

EXT AUTO 1V P-P 5Hz to 20MHz

EXT LEVEL SELECT $\pm 5\text{V}$ P-P 2Hz to 20MHz

Characteristics are as specified for internal trigger, but refer to an external trigger signal applied to the EXT TRIG socket.

NOTE: Input levels to EXT TRIG socket is limited to 100V P-P or 30V RMS. Do not exceed these limits or failure of input transistor may result.

2.4 Z MODULATION - Spec -20V to modulate at normal intensity.

Set T.B. to $1\text{mSec}/\text{cm}$, feed in a 1KHz sine wave 20V P-P from low Z source. Trace should clearly change brightness level each cm. across the screen. A positive signal brightens trace.

3. DETAILED SPECIFICATION MODEL bwd 539D

3.1. C.R.T.

<u>Type</u>	5" Diameter Type D13-611GH incorporating a spiral PDA & DC coupled Beam blanking
<u>Phosphor</u>	P31 normally supplied. P7(GM)available as Option 04.
<u>EHT</u>	3.3KV
<u>Graticule</u>	8 x 10cm. graticule with 2mm subdivisions on major axis on blue light filter
<u>Deflection</u>	8cm. vertically x 10cm horizontally, both channels with full overlap

3.2. VERTICAL AMPLIFIER (Channel 1 & 2 Identical)

<u>Sensitivity</u>	5mV to 20V per cm. in 12 direct reading steps in a 1,2,5, 10 sequence.
<u>Bandwidth</u>	DC or 2Hz (AC coupled) to 20MHz -3db, referred to 6cm. deflection at 50KHz. Full response curve on p19
<u>Rise Time</u>	17.5nSec over 6 cm deflection.
<u>Input Impedance</u>	1M Ω and 35pf constant.
<u>Input Selection</u>	AC, OPEN or DC.
<u>Calibration</u>	<5% including $\pm 5\%$ line change. Trace drift $< \pm 1$ cm.
<u>Deflection</u>	>8cm up to 12MHz. Over 3cm.available at 30MHz. Maximum deflection to 40MHz is shown on chart, p19
<u>Input Voltage Protection</u>	± 400 V(DC + peak AC.) DC to 1kHz.
<u>Display Mode</u>	Dual trace,alternate switching or chopped at approximately 200KHz. Single trace display of Ch.1 only.
<u>Amplifier Output</u>	When Int. Trig. is selected the signal from the channel selected as the trigger source is available at the Vert. Out socket. Output is approx. 100mV/cm of deflection from a 100K Ω source impedance and bandwidth 12Hz to approx 100kHz-3db into an impedance of 1M Ω paralleled by 35 pf.
<u>Cascaded Operation</u>	A high sensitivity of 0.5 mV/cm is available by cascading Channel 1 into Channel 2 by a single link of wire from the VERT OUT socket to Channel 2 input socket. Bandwidth is 12Hz to 100kHz-3db. By selecting TV trigger the minimum input signal required for triggering is less than 1mV p-p enabling signals at this low level to be displayed with good stability.

3. DETAILED SPECIFICATION MODEL bwd 539D (Cont'd.)

3.3. TIME BASE

Range 0.5 μ S to 2 Sec/cm. in 21 switched ranges with 5-1 vernier extending range down to 10Sec/cm. Calibration <5%.

Magnification X1 & X5 switched calibration <5% at X1 and at X5 up to at least .2 μ Sec/cm.

3.4. TRIGGERING - Channel 1, Channel 2 or Ext. by switch selection.

<u>Selection</u>	<u>Coupling</u>	<u>Slope</u>	<u>Source</u>	<u>Mode</u>
	Norm.	+	Int.	AUTO
	T.V.	-	Ext.	Select Level
<u>Sensitivity:</u>	Int. AUTO	>1cm.defl.5Hz to >16MHz. >25MHz at 2cm. defl. and >30MHz at >2cm deflec. Min. Auto Level <3mm. (<1mm to 100kHz with TV button pressed)		
	Int.Select	<1cm to 8cm defl. 3Hz to >20MHz.		
	Ext.AUTO	>1V p-p 5Hz to 20MHz		
	Ext.Select	1V to 10V p-p 2Hz to 20MHz.		
	Max.Ext.Input	100V p-p Max. or 30V RMS		
	Input Impedance	50K Ω & 20 pf. approx.		
<u>T.V. Sync.</u>	Triggers on line in AUTO position. Triggers on Frame with Trig. Level fully clockwise. (With TV button in and ALT dual trace operation)			
<u>Sensitivity</u>	2cm. to over 8cm. composite video waveform. Displays frame pulses, colour burst, etc.			
<u>Demodulation or HF Reject</u>	T.V. Selection also provides stable locking of modulated R.F. Waveforms and eliminates HF noise from trigger signals below 10KHz approx. and provides an increased sensitivity to <1mm deflection between 100Hz and 100kHz.			
<u>Power Line Trigger</u>	Available by link connection to CAL output. See details regarding phase under calibrator specification.			

3.5. HORIZONTAL AMPLIFIER (Identical X-Y via Channel 2 input)

Sensitivity 5mV to 20V/cm in 12 steps of 1,2,5,10 sequence at X1 mag. Sensitivity increases to 2mV at X5 mag.

Bandwidth DC to 2MHz -3db. (refer 6cm.defl.at 50KHz at X1 mag).

Input Impedance 1M Ω & 35 pf.

Phase Shift 1 $^{\circ}$ to >100KHz. typically <2 $^{\circ}$ at 200KHz.(at X1 Mag.only).

Preset Horizontal Input Both vertical channels may be used (if switched to the CHOP mode) with an external horizontal input if the Int/EXT trigger button is pressed for EXT trigger. The horizontal input is applied via the Ext. Trig. socket. Sensitivity is 100 and 500mV/cm approx. and bandwidth 5Hz to >1MHz -3db.

3.6. GENERAL DETAILS

Z Modulation Input to CRT grid, .01 μ F coupling into 200K Ω load. -30V is required to blank the CRT at normal intensity.

Trace Rotation: Rear panel control enables tilt of trace to be accurately compensated.

3. DETAILED SPECIFICATION MODEL bwd 539D (Cont'd).

<u>Calibrator</u>	Line frequency square wave 1V p-p 1% accuracy. Positive going to ground, 25 μ S rise and fall time into <1M Ω and less than 40 pf. Transition edges of waveform correspond within 2 ^o of zero cross over of input AC power waveform, thus facilitating accurate phase measurements of power line devices when used as a trigger source for the time base.
<u>Time Base Output</u>	0 to 20V positive going sawtooth min. Ref. waveform (J) #1369.
<u>Power Requirements</u>	20 Watts approx. 95V - 135V in 2 ranges) 48-440Hz 190V - 265V in 2 ranges)
<u>Dimensions</u>	25cm high X 19cm wide X 42cm deep overall feet, handle, knobs, etc.
<u>Weight</u>	6.3kg. (14lbs). Domestic/Air Freight Pack: 7.2kg. (15.75lbs) Export Pack 9.1kg. (20lbs).
<u>Optional Accessories</u>	Probes X1 P30 X1 & X10 Switched Duo Probe P32 Demodulator P35 Carrying Case C52 Vinyl Dust Cover C12 Light Shield H46 19" x 8 3/4" Rack Mount Adaptor

NOTE: Characteristics expressed in numerical values with tolerances stated are guaranteed by the factory. Numerical values without tolerances represent the values of an average instrument. data applies in case of nominal mains voltage unless otherwise stated .

Outline Dimensions (in mm).

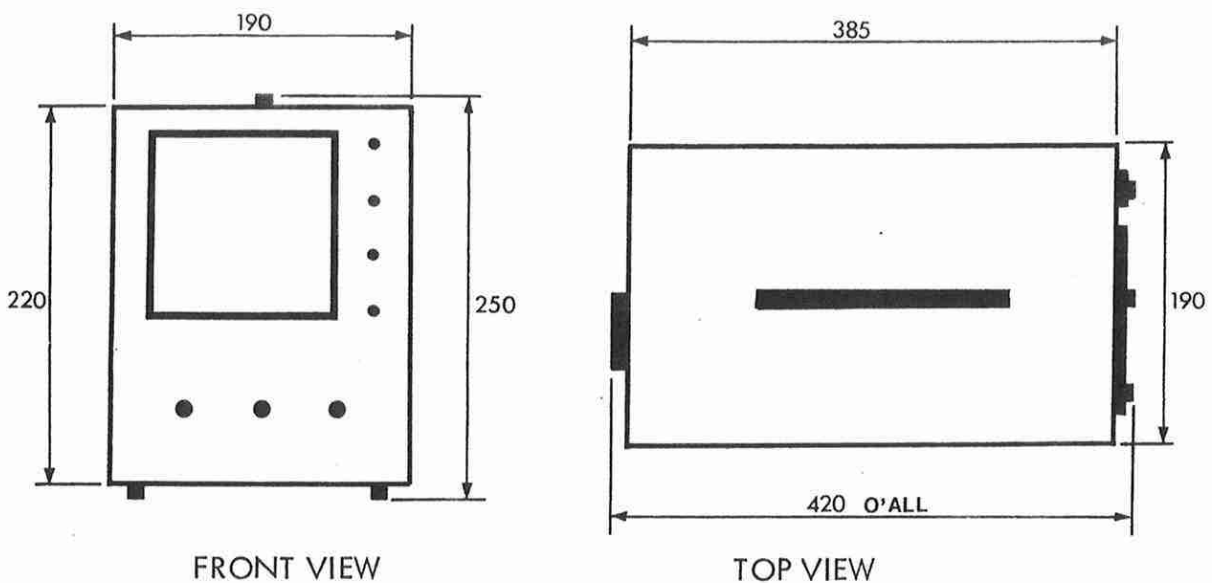

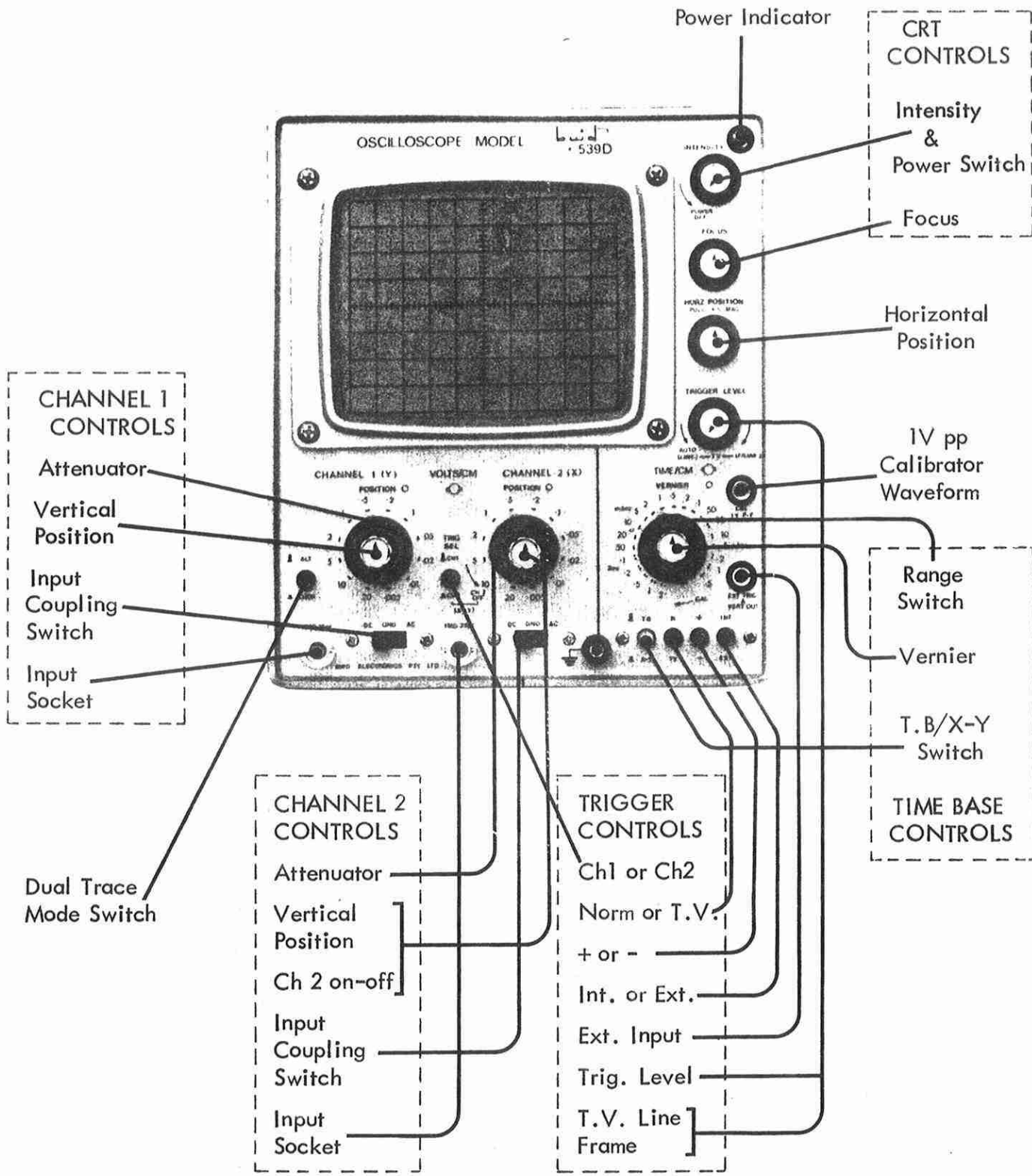

4 FUNCTION OF CONTROLS:

4.1 Front Panel controls are grouped for ease of use and are clearly designated. The functions of these controls are as detailed below:-

Intensity Control: Fully anti-clockwise, this control switches the instrument OFF. When rotated clockwise the instrument is switched ON and further rotation controls the trace intensity (brightness) from zero to max.

Focus: Controls the sharpness of the trace. May require a slight re-adjustment over the full intensity control range.

(Astigmatism): Internal preset control, adjusts beam for optimum shape over entire screen area.

Horz. Position: Moves the trace horizontally on the C.R.T.

Mag x5: When Horz. position knob is pulled out trace speed is increased x5.

Auto/Trigger Level Control: Fully anti-clockwise, and switched to the AUTO position, any signal greater than 0.5cm in amplitude will trigger the time base, however with no signal present, an Automatic trigger pulse is generated to produce a base line, the trigger rate increases as the Time Base Speed range increases, producing a bright reference line at all sweep speeds. When the knob is switched out of the AUTO position it enables the precise level on the displayed waveform to be selected to trigger the Time Base.

T.B.Vernier: Varies the Time Base speed over a range greater than 5:1 to provide a continuously variable range in conjunction with the TIME/CM switch of 0.5 μ Sec to 2.5 Sec/cm.
(co-ax with Time/cm Switch)

Time/cm (Time Base Switch): When the Time Base Vernier control is fully clockwise in the CAL position, the 19 time base speeds on this control will be accurate to within 5%. The switch speeds represent the fastest speed on each range; rotation of the Time Base Vernier Control anti-clockwise will reduce the selected speed over a range greater than 5:1 e.g. on the 1mSec range the vernier will vary the time base from 1mSec. down to 5mSec/cm.

(Push Buttons)

T.B. -X-Y Switch: Out position, the time base produces the horizontal display. When pressed in, the channel selected for trigger (normally Ch. 2) is connected to the horizontal amplifier to provide the horizontal display. Sensitivity range is 10mV-50V/cm enabling identical X and Y displays to be obtained.

Norm -T.V. Switch:

In Norm. position, triggering is controlled by + and - switch and trig. level control. In the T.V. position a sync separator is brought into circuit and the Trig. Level control assumes dual function. In the AUTO position stable LINE lock is provided and when the control is turned fully clockwise very stable FRAME lock is obtained even from noisy video signals. See Section 7 for further details.

5. INITIAL CHECKING:

This section of the Handbook is intended to provide information to allow a user to become familiar with the instrument's power requirements, function of controls and connectors, and also provides some methods of making several measurements of electrical phenomena. Also included is a procedure for checking the instruments calibration.

OPERATING VOLTAGE:

This instrument is designed for operation from a power source with its neutral at or near earth (ground) potential with a separate safety-earth conductor. It is not intended for operation from two phases of a multi-phase system, or across the legs of a single-phase three-wire system.

This instrument can be operated from either a 115-volt or 230-volt nominal line voltage source, 48 to 60 hertz. This instrument may be damaged if operated with the line voltage connected to incorrect positions for the line voltage applied.

The BWD 539D is designed to be used with a three-wire AC power system, with the green/yellow wire connected to ground. Failure to complete the ground system may allow the case of this instrument to be elevated above ground potential and pose a shock hazard.

NOTE: Colour-coding of the cord conductors is as follows:-

Line	Brown
Neutral	Blue
Safety earth (ground)	Green/yellow stripe

The power transformer is provided with primary windings which may be changed by resoldering the links to suit the local power line voltages. The connections are as shown below. A card attached to the power cord or clipped under the handle indicates the tapping in use when the instrument leaves the factory.

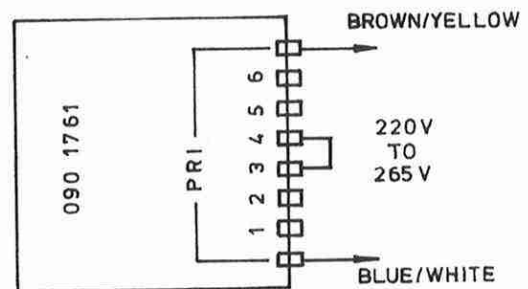
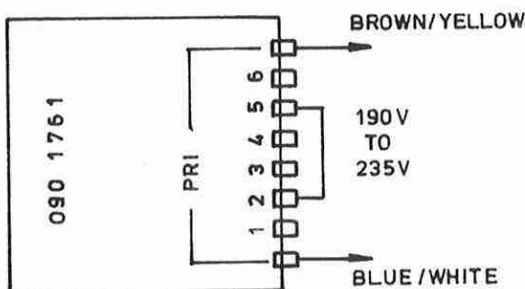
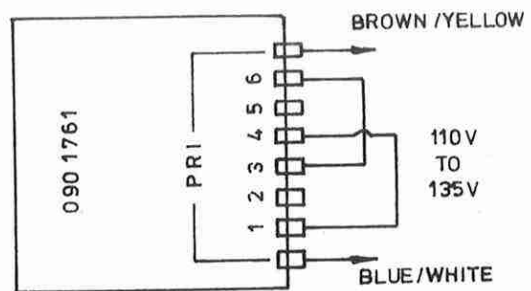
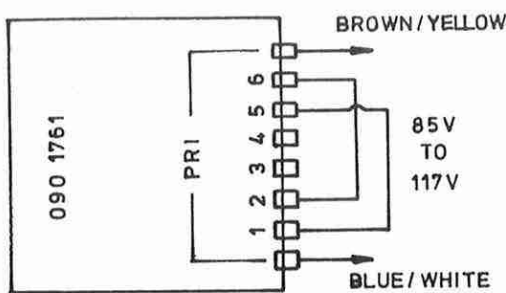

6. FIRST TIME OPERATION:

6.1 For first time operation, if unfamiliar with this class of oscilloscope, set the controls as below and follow the steps outlined until each feature is understood:-

Intensity	- OFF (anti-clockwise)
Focus	- Mid position

Amplifiers 1 & 2:

Attenuator	- 0.2V/cm.
Vertical Position	- Mid position
Input Selectors	- AC
Alt-Chop Switch	- Chop (pushed in)
Ch. 1 or 2 Trig. Sel.	- Ch. 1 (out)

Time Base:

Time Base Range	- 10m Sec/cm
Vernier	- Clockwise (Cal).
Trigger Select	- AUTO switched fully counterclock
T.B. X - Y	- T.B.
Norm - T.V.	- NORM
± Select	- +
INT-EXT.	- INT
HOR. POSITION	- Mid Position
HOR. MAG.	- Pushed In (x1)

6.2 Connect power lead to 48 - 60Hz AC supply (see previous page for tappings) and switch instrument on. Turn intensity control to approximately 2 o'clock position, after a few seconds the traces will appear. Adjust intensity and focus then position them centrally across screen.

Connect a wire from the 1V calibrator socket to Channel 1 input.

The line frequency square wave will be displayed as a 5cm high differentiated square wave. Now switch to DC input - the trace will rise and the bottom of the waveform will correspond with the CRT centreline indicating the input signal is a waveform positive going with respect to ground. Switch to GND, the trace will disappear then after a short time a bright reference base line will appear as the Auto time base operates. The GND switch disconnects the input signal from the amplifier.

Switch back to AC then rotate position control and note display can be moved off CRT above and below.

6.3 Dual Trace Operation:

Set Channel 2 amplifier as for Channel 1. Take a parallel sign from the 1V calibrator output to Channel 2 input (leave Channel 1 signal connected). Reduce attenuator settings on both amplifiers to 0.5V/cm then position them above and below CRT centreline. If Channel 2 is moved up and down the screen it will be noticed no interaction occurs between the displays and trigger is unaffected by the position control. Change the input signals to a 1kHz square wave 1V p-p amplitude. Set time base to 1mSec/cm and the CHOP -ALT button to ALT. With the traces positioned above each other, switch the time base range switch to slower sweep speeds and observe how flicker between the traces increases until at 10mSec/cm., the switching between the traces is readily visible.

This is the useful lower limit of the Alternate switching mode.

Now increase the time base speed, the traces will remain locked to at least 10μ Sec/div., before Auto takes over or right up to max. sweep speed with the Level knob turned to the level select position. Return time base range to 10mSec/cm again and switch the display to CHOP. Trace flicker immediately stops. The slight change in intensity is due to the blanking of about 20% of each trace during the chopping transient.

When the time base frequency is reduced, the two traces now appear simultaneously down to the lowest sweep frequency. If the time base frequency is increased again, at speeds around 100μ Sec/cm the waveforms will start to show the individual chopping sections indicating the useful upper limit of this method of vertical display. As has been seen, a wide overlap exists where both forms of dual trace display can be used satisfactorily.

6.4 Cascaded Amplifier Operation:

A sensitivity of 0.5mV/cm is available by cascading Channel 1 into Channel 2. This is accomplished by connecting a short wire from the VERT OUT socket to Channel 2 input socket. Then select Channel 2 DC input, Channel 1 TRIG SEL., TB., TV., +, INT., Trigger buttons. (TV is used to increase trigger sensitivity and reduce noise although trig. polarity is reversed). Position Channel 1 at the bottom of the screen and centre Channel 2. Set No. 1 attenuator to 0.005V/cm and No. 2 attenuator to 0.01V/cm then apply a 2mV p-p 1kHz signal to Channel 1 input (0.4 cm deflection). Approximately 4cm deflection will now be present on Channel 2 trace, i.e. 0.5 mV/cm sensitivity.

6.5 Time Base Operation:

Replace the input signal to Channel 1 with a 2kHz (approximately) sine wave and adjust attenuator or input for 8cm display. Time Base to 0.2m Sec/cm \pm button in the + (out) position.

6.6 Trigger Level:

Turn the Level Select control clockwise out of the Auto position. The trigger point will move up and down the wavefront. When it reaches the top or bottom extreme of the waveform the trace blanks out when trigger is lost. Now push in the \pm button to select -ve trigger. The waveform will now trigger on the -ve going slope. Clockwise rotation of the level control will increase the trigger point level towards the negative point of the waveform, anticlockwise rotation towards the positive point as for + slope.

Reduce amplitude of display signal, with Level control carefully adjusted, signal can be reduced to less than 5mm and stable lock is still obtained. Return level select to Auto.

6.7 T.B. Vernier:

Turn Vernier anticlockwise - observe approximately x5 the number of waveforms on CRT when fully anticlockwise. Return to Cal position.

6.8 Magnification:

Adjust input frequency to produce one sine wave per cm and locate the peak of each waveform on a vertical graticule line. Pull out the Horz. Position Control to obtain x5 mag. The trace will expand either side of the centre and any portion of it can be viewed by rotating the position control. Return to x1 and recentre trace horizontally.

6.9 Identical X-Y:

Connect a 1kHz sine wave source to Channel 1 and Channel 2 in parallel with both attenuators at the same sensitivity. Depress X - Y and Ch. 2 trig. select buttons and switch Ch. 2 off. A line will appear diagonally across the CRT. The input signal is being applied at identical sensitivity to X and Y systems. Channel 1 is providing the vertical display and Channel 2 the horizontal. To position the horizontal display leave the Channel 2 control fully anticlockwise switched off and use the horizontal position control to do the positioning.

NOTE: X-Y displays should be contained on the 8 x 10cm area to eliminate distortion due to signal overdrive. For Zero phase shift between the two traces at low frequencies it is essential to use DC coupling into amplifiers. The chart following enables phase angles to be read off directly.

6.10 Z Modulation:

Connect 20V p-p 1kHz square wave to Channel 1, switch attenuator to 5V/cm. Set Chop-Alt button to ALT. Set displays one above the other. Now parallel 20V signal into rear panel Z mod. socket. The bottom of each displayed wave will diminish in intensity and the Channel 2 trace will be broken into a series of light and dark sections. A positive going signal increases the trace brightness. Input is AC coupled and will modulate from approximately 100Hz to over 5MHz. Z input is 200K Ω and 20pf in parallel.

6.11 High Impedance Probes:

For high frequency measurements the input loading on circuits particularly capacitance must be kept to minimum levels. The simplest way to achieve this is by use of a high impedance probe which reduces the input signal by a factor of 10:1 or 100:1 but simultaneously reduces the input capacitance to approximately 13pf and increases the input resistance to 10M Ω . The probe available for this model is the BWD P32 Duo-Probe providing both 1:1 & 10:1 division.

To align a probe, couple it to Channel 1 input jack. Set attenuator to 20mV/cm and time base to 5mSec/cm. Place the point of the probe tip on the 1V calibrator socket, a square wave will appear probably with the leading edge over or under compensated. With the small plastic screwdriver supplied adjust the screw in the side of the probe housing until waveform is square. It will remain correct at all attenuator setting.



NOTE:

No adjustment is required when the button on the P32 is pressed for 1:1 operation as no signal division occurs in the probe.

PHASE ANGLE CHART

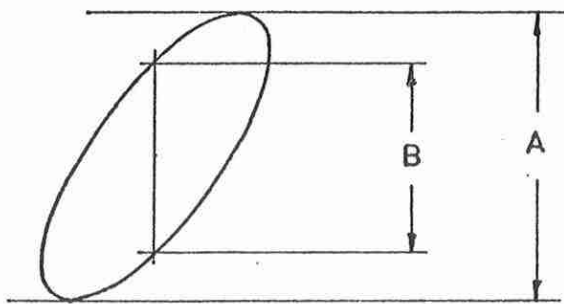
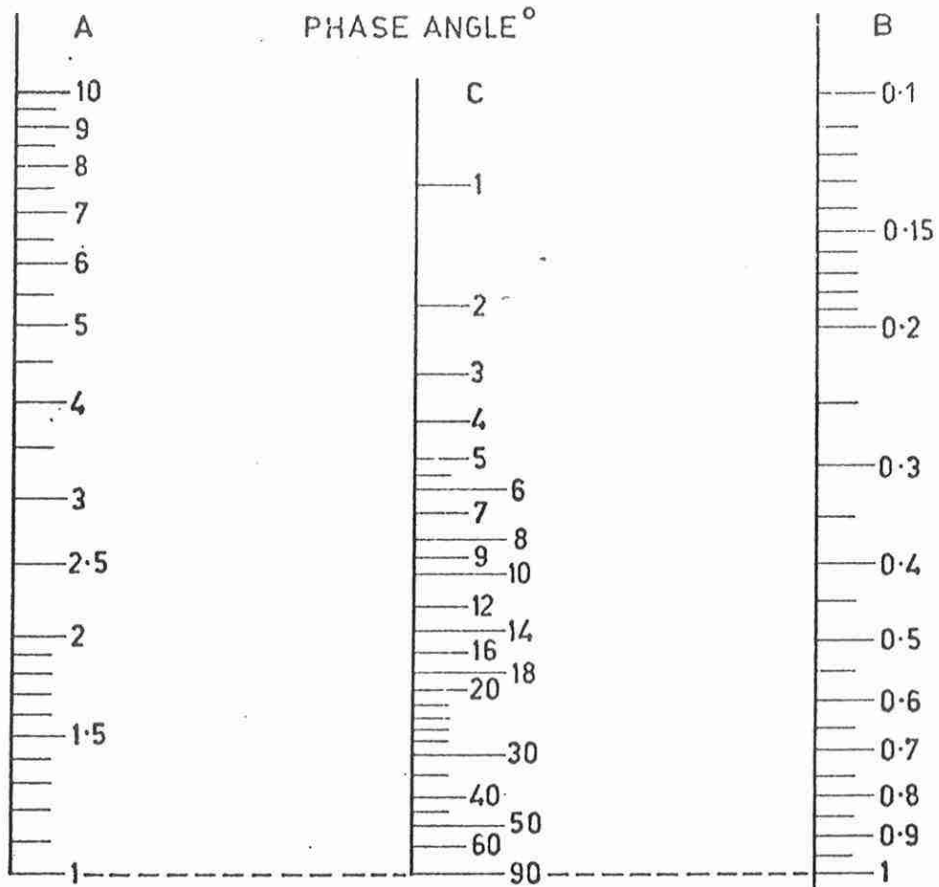

$\text{SIN } \theta = B/A$
(b)

A method of measuring the phase angle between two equal frequency sine waves is to apply one signal to channel 1 and the second input to channel 2 (switched through to X display in the X-Y mode). The phase difference is obtained from the dimensions of the resulting ellipse shown above. The phase angle may be read from the scales above by joining the appropriate points on scales A & B and reading the phase angle on scale C.

7. MEASUREMENT OF VOLTAGE & TIME:

The following sections describe the method making specific measurements with model BWD 539D oscilloscope.

Start with controls set as follows:-

All buttons out, T.B. to 1mSec., Trigger Level to AUTO. Ch. 2 turned to off.

7.1 Measurement of DC (Direct) Voltages:

Switch Channel 1 AC-DC switch to DC. For an initial test take a $1\frac{1}{2}$ V Dry Cell and set the attenuator to 0.5V. Connect the negative end to the Black Common terminal, set the trace to the centre of the graticule, touch a lead from positive end of the battery to the Channel 1 input socket. The trace will move up 3cm., i.e. $3 \times 0.5V = 1.5V$. Now reverse the connection to the battery and note how the trace moves down 3cm. This illustrates how an oscilloscope can display positive or negative voltages or both simultaneously, e.g. when viewing a sine in input or square wave.

NOTE:

The paralleling effect of the $1M\Omega$ input impedance of the oscilloscope with the external load must be taken into account when measuring high impedance points such as the gate of FET's or base of a transistor working with high value loads.

The DC input facility may be used to measure AC waveforms swinging about a DC voltage, as at the collector of a transistor or the anode of a valve to check for bias settings or collector limiting, etc. Maximum DC input should not exceed $\times 10$ input attenuator setting if it is required to recentre the trace to view a signal superimposed on it. If a higher input impedance is required, use a BWD P32 10:1 probe to increase input to $10M\Omega$ and 13pf.

7.2 Measurement of an AC (Alternating) Voltage:

Set the amplifier AC-DC switch to AC and the attenuator to 20V (if the input voltage is unknown). Connect a lead from ground to the ground side of the signal to be measured, then connect a lead from the input socket to the signal source. (Model BWD 112B, 141, 160, 170 or 603B oscillators are suitable for initial experiments in this test).

Increase the Vertical sensitivity by the VOLTS/CM switch until a display between 3 and say 8cm exists. Now adjust the Time Base Switch and Vernier to enable the waveform to be readily seen. To measure the amplitude of a displayed waveform, measure its overall height in cms., by the calibrated graticule, then multiply this by the attenuator setting and the result is in Volts p-p, e.g. if the display is 6cm., high and the attenuator is set to 0.5V then the amplitude is $6 \times 0.5 = 3V$ peak to peak, to convert to RMS voltage for sine waves, divide the 3V by $2\sqrt{2}$ (approximately 2.83).

$$\frac{3.00}{2.83} = 1.06 \text{ Volts RMS}$$

7.3 To measure the Time Period of a waveform set the Time Base Vernier to Cal (clockwise) then switch the TIME/CM switch to a range where the signal can be clearly seen, e.g., if a waveform is 5cm long and the switch is on 100μ Sec., then the duration of the waveform is $5 \times 100\mu$ Sec. The frequency can be determined by dividing 1 Sec., i.e. $1,000,000\mu$ Sec by the duration of the waveform.

$$\frac{1,000,000}{500} = 2,000\text{Hz or } 2\text{kHz}$$

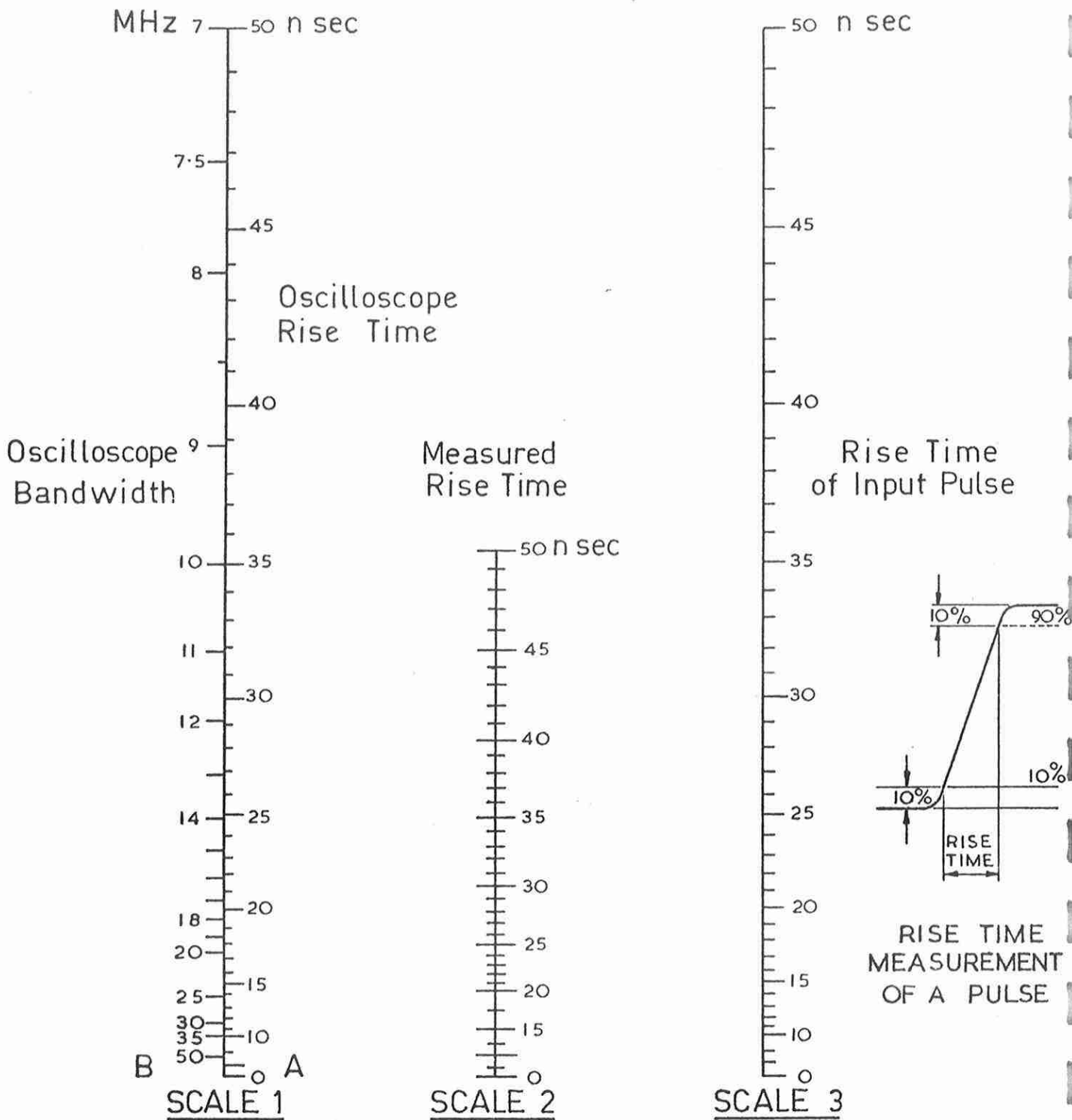

To use the above chart read the rise time of the displayed waveform on the CRT between its 10% and 90% points. Find the point corresponding to this value on Scale 2. Join this with a straight edge to the value corresponding to the oscilloscope bandwidth on Scale 1B, the projection on Scale 3 is the true rise time of the input pulse.

For other rise time ranges Scale 1A, 2 & 3 can be multiplied by a conversion factor, e.g. 2, 5 or 10. Scale 1B must be divided by the same factor.

RISE TIME CHART

8. CIRCUIT DESCRIPTION: (Drg. No. 1368 and 1369)

The circuit description is divided into the following sections:-

- (a) Vertical Amplifiers
- (b) Trigger & X-Y amplifiers
- (c) Time Base and Horizontal amplifiers
- (d) CRT, EHT and Power Supplies

8.1 Vertical Amplifiers, Channel 1:(Drg. No. 1368)

Input signals to Ch. 1 BNC socket are connected to the attenuator via S1. In the DC position signals pass directly to the attenuator or via C1 in the AC position. In the GND centre position the input signal is disconnected but the amplifier input is grounded. The attenuator switch S2A-D is in two sections, S2A-B attenuates the input in a 1,10,100,1000 sequence whilst S2C & D attenuate the signal in a repetitive 1,2,5 sequence. The result of cascading the two sections is to attenuate signals in a 1,2,5,10 sequence over the 12 steps. As no attenuation takes place in the amplifier itself the problems of DC drift affecting the trace position when the attenuator is switched does not occur in the BWD 539D.

Response and constant input capacity is maintained on each attenuator step by adjustable series and shunt capacitors.

The input amplifier is a balanced FET differential stage. Input protection is provided by R17 & C25 and reversed biased diodes D1 and 2 taken to +4.4 and -2.5V to prevent Q1 gate from exceeding these limits. Q1 and 2 are an accurately matched pair to minimise effects of temperature drift and voltage fluctuations on the trace position.

The following stage Q3 and 4 is a series feedback stage which drives the beam switching diodes. Position, gain and trigger take off are also provided by this stage. The position control RV3 varies the emitter resistance in Q3 and Q4 which varies the current symmetrically in each leg and impresses it on the input signal. Gain calibration is set by RV2 located between the emitters and trigger take off is via R25 and 27 to the trigger channel selector switch S91 A and B.

Channel 2 input is identical to channel 1 other than the addition of a switch S53 on the rear of position control RV53 which turns channel 2 off when single beam or X-Y operation is required.

To enable both channels to present displays on the CRT simultaneously the channels are alternatively switched to the common output amplifier stage on an equal time sharing basis. At slow speeds the time sharing is operated in the CHOP mode when the beam switch free runs at approximately 200kHz. At speeds above 1 or 2mSec/cm when persistence of vision eliminates the visible effects of time sharing, the ALTERNATE mode is employed when the channels are changed over during the blanked out return trace period.

The methods of coupling the two input amplifiers to Q98 and Q99 drive amplifier is via diodes. Assuming Channel 1 is being displayed and 2 is cut off. The voltage at the junction of D100 and D101 is pulled down to +12 by the bi-stable switch Q91 and 93, well below the +17 at the base of Q98 and 99 so D100 and 101 are cut off.

Q98 and Q99 are always biased in a conducting condition so the only source of collector current is via the shunt feed back resistors R101 and 105 across Q98 and 99. This puts the coupling diodes D99 and 102 into conduction and completes the amplifier chain. To cut off Channel 2, D91 and D92 are pulled into conduction by the action of the bi-stable switch Q91 and 93 which raises the voltage at the junction of D91 and D92 to approximately +20. This turns off the coupling diodes D93 and 95 preventing any signal transfer to Q98 and Q99. Collector current for Q53 and 54 is now obtained from the bi-stable collector load R110 via D91, 92 and 94. The conduction of D91 and 92 also shunts the collectors Q53 and 54 so minimising feed through of Channel 2 signals.

When the bi-stable switch changes over the above action is reversed Channel 1 is cut off and Channel 2 conducts through D93 and 95.

Q98 and Q99 shunt feed back stage has a low input and output impedance. Because of the low input impedance, capacitive loading of the two amplifiers and diodes gates etc., has little effect on high frequency response. Similarly the low output impedance enables the stage to drive Q100 Q101 cascode drivers directly. The C.R.T. deflection plate drivers are emitter coupled to Q100 and Q101 to minimise capacitive feedback and so maintain a wide bandwidth. H.F. compensation for the stage is provided by RV94, C96 and C97.

8.2 Beam Switch Circuit: (Drg. No. 1368)

Q91 and Q93 are circuited as a bi-stable switch, combining both collector and emitter coupling. In the CHOP mode separate emitter resistors R113 and R116 are connected to ground via S92A and Q94 which is always conducting by the forward bias through R115. C105 between the emitters together with R91, R112 and C104 on one side and R111, C102 and R119 on the other cause the stage to oscillate at a frequency 200kHz. The resulting push-pull square top waves at the collectors gate Channel 1 and 2 off and on. To eliminate the display transient when switching occurs a positive pulse is taken from C106 and C107 junction to Q95. The pulses turn on Q95, pull the collector down producing a sharp negative going pulse which is applied to the C.R.T. grid via C358, 357 and R361 which are located on drg. No. 1369.

When S92A is switched to ALT Q91 and Q93 emitters are coupled together by D106 and D107 and then taken by R114 to the collector of Q94. This sets the circuit as a bi-stable switch. When a negative going pulse is received from the time base. Q94 is cut off, the emitters of Q91 and Q93 rise. If we assume Q91 was conducting, it will cut off, its collector rises and via C102 pulls Q93 base more positive than Q91 base. Therefore, when the pulse to Q94 base is removed it conducts pulling Q93 into conduction before Q91, thereby changing the state of the bi-stable.

When Ch. 2 is turned off, S53B opens allowing the voltage at R109, R121 to fall turning Q92 on. This results in Q92 collector rising to +22V, D105 conducts, pulls Q92 collector up and causes D91, D92, and D94 to conduct disconnecting channel 2. Simultaneously when Q93 collector falls, D100, D101 and D104 disconnect leaving Ch. 1 in circuit.

8.3 Trigger and X-Y Pre-Amplifier: (Drg. Nos 1368 and 1369)

The internal trigger channel switch selector S91 A and B applies the trigger signal via Q104, Q105 emitter followers to the balanced input of U-90 a wide band amplifier.

DC biasing conditions are set by RV92. Gain in the time base mode is set by R90 and C93 or by RV93 alone in the X-Y mode. S201 A is part of the T.B. - XY push button switch. Output from U - 90 on the main P.C. board is taken to S204 INT-EXT switch on the trigger amplifier board. Internal signals are switched via S204 to Q201 whilst external signals are, via R202, C202 and C201, permanently coupled to Q201. This enables the internal trigger signal to be fed out to the EXT socket as an amplified signal for cascade operation. Q201 and 202 are a balanced PNP pair and + or - trigger signals are obtained from each collector by switch S203. In the T.B. mode the selected signal is connected to S202A and applied directly to S202B in the NORM position or via a T.V. sync., separator Q203 and associated circuits in the TV position. The output of Q203 when a video signal is applied, is a sharp negative going frame pulse with about 30% amplitude line sync. In the X-Y mode S203 output is disconnected. Output is now taken via S201C from Q202 collector, by-passing R216 which formed part of the collector load in the TB mode. To centre the spot and to obtain the largest amplitude swing before clipping the circuit bias is set by R209 and R211, switched in by S201D. The X amplifier output via S201C passes through R281, 282, 288 to Q258 horizontal drive amplifier (see section 8.6).

8.4 Trigger Circuit: (Drg. No. 1369)

Signals from S202B are coupled via R251 and C252 to the base of Q251 which with Q252 form a fast switching schmitt trigger.

In the AUTO position S251A is open allowing R252 and 258 to set trigger level. When S251A closes in Trigger Level condition an additional positive or negative voltage from RV251 via R256 over-rides the preset condition and provides a selection level of the trigger waveform.

The schmitt trigger stages Q251 and 252 produces a sharp rectangular output waveform from any shape input.

The action is as follows, with Q251 conducting, its collector will bottom and Q252 will be cut off by the voltage divider action across R259, R257 and RV252 and R255. A negative going input signal from the trigger amplifier will cut off Q251, its collector will rise pulling Q252 base positive, so turning Q252 on, producing a negative pulse at its collector. As the emitters are coupled together, the current through Q252 will now hold Q251 off until its base is driven positive above the common emitter potential and the switching action is reversed. The sharp negative fall across R263 is differentiated by C255 then applied to Q253 base in the time base circuit. Trigger sensitivity is set by RV252.

8.5 Time Base Circuit: (Drg. No. 1369)

The Time Base sawtooth generator consists of Q253 and 255 bi-stable trigger, Q257 Miller sawtooth generator and Q256 emitter follower with associated clamping diodes D253 to 256. The function is as follows:-

Assuming Q253 is conducting, Q254 will be cut off, its collector will be high and D255 will conduct, pulling the gate of Q257 positive. The drain of Q257 will fall to approximately +6V together with Q256 base. At this point diode D256 connected into the emitter load of Q256 passes below zero and starts to conduct pulling D255 to a lower conduction level until a stable static condition is reached.

In this direct coupled quiescent state, the trace will be ready for a trigger input pulse. A negative pulse on Q253 base will cause its collector to rise taking Q255 base positive. This causes current to flow through Q255 into the emitter resistor R276 biasing Q253 off further and a rapid cumulative action occurs in which Q253 cuts off and Q255 saturates. D255 becomes reverse biased, Q257 is left with its gate at -1.5V approximately and connected through the timing resistors R401 to R406 to a negative potential on RV401 which will endeavour to pull Q257 towards cut-off.

Q257 FET presents a high impedance to the charging circuit enabling high value charging resistors to be utilised with small high stability timing capacitors. Q256 emitter follower provides a low output impedance to charge the capacitors and drive the output and gating circuits. As Q257 gate falls its drain rises and via Q256, and D257, a charge is applied to the selected timing capacitor on S401D. The result of this negative feedback is to linearise the charging rate to the timing capacitor by keeping the voltage across the charging resistor constant and thereby the charging current. A positive going sawtooth waveform is generated at the drain of Q257 at the base of Q256 and at low impedance at its emitter.

The sawtooth continues to rise until the potential at the tapping on RV253 reaches approximately -4V. D258 conducts and charges C270 and C403, 405, 407, 413 as selected by S401B. It also takes the base of Q253 positive to its emitter potential and continues positively until Q253 conducts causing its collector to fall cutting off Q255 and at the same time transferring the emitter current from Q255 to Q253. D255 conducts pulling the gate of Q257 positively, its drain falls and the timing capacitor is rapidly discharged until Q256 emitter falls sufficiently to cause D256 to conduct to pull D255 back to a quiescent condition and stabilise the circuit ready for the next trigger pulse. This will initiate the next trace once the hold-off capacitors C270 and C403, 405, 407, 413 as selected by S401B have discharged sufficiently through R267 and the base current of Q253 to allow a trigger pulse to cut Q253 off.

AUTO Time Base operation is obtained by allowing the clamping network for Q253 base to run down at a controlled rate until the time base automatically turns itself on if no trigger pulse arrives during the run down. Q256 clamp discharges C256 and as selected by S401A and holds the top of R264 at -0.7V during the normal sweep period as its base is held negative to its emitter by current through R274 and Q255. During the return trace when Q255 collector rises it cuts off Q256 thus permitting Q256 and C401 - 404 as selected, to charge negatively through R264, 266 and 267. When the junction of R264 and 266 falls below the emitter potential of Q253 it ceases to conduct, its collector rises and the cumulative switching action previously described occurs, with the resultant sawtooth sweep generation. During this period Q256 is pulled into conduction to discharge the AUTO. capacitors in readiness for the next run down.

The progressive reduction in capacitor value as the sweep speed rises results in a bright reference base line at all time base speeds and provides more reliable triggering at very high frequencies.

C.R.T. Blanking by the Time Base Circuit is accomplished by directly coupling the C.R.T. Blanking Electrode to Q254 collector which is driven between the clamping limits of 0V and -60V. Q254 is driven by Q255 via R274 base resistor and conducts during the forward trace; but is biased off during the return trace.

Part of the square wave at Q254 collector is differentiated by C254 and R115 before it is applied to Q94 base to switch the bi-stable beam switch during the return trace period. R115 and Q94 are located on drawing No. 1368.

8.6 Horizontal Amplifier: (Drg. No. 1369)

Three transistors Q258, 259 and 260 amplify the Time Base or X input signal to provide the horizontal deflection voltages. Q 258 is a shunt feedback stage, RV255 switched by S252 (HORZ. MAG.) varies the amount of feedback and hence the stage gain. RV255 presets the maximum gain (x5 Mag.). x1 setting is adjusted by RV253.

The time base sawtooth, the horizontal X input and the horizontal position are all applied to Q258 base via mixing resistors R282, R283 and R285.

The low impedance output from Q258 feeds Q259 and Q260 long tail pair which in turn drive the C.R.T. deflection plates directly. Horizontal centering is preset by RV256.

8.7 C.R.T. and Supplies: (Drg. No. 1369)

Type D13/611 C.R.T. requires approximately a 3 to 1 PDA ratio for correct operation. The negative supply is a half wave rectifier consisting of D354 and 355 rectifier with C353 and 354 filter capacitors. A second stage of filtering R357, C355 and C356 reduces ripple to a low level. C.R.T. potentials are taken from a divider across the -850 supply consisting of R302, RV259 Focus Control, R306, RV351 Intensity Control and RV352 Intensity range preset.

The C.R.T. grid is returned to the -850V rail via R360 and 361 grid resistors. RV351 INTENSITY control varies the impedance of the divider between grid and cathode and so varies the potential between them thus changing the beam current and trace brightness.

Z Modulation is coupled through C360 and R362 to the C.R.T. grid. All other electrode voltages are preset. RV258 Astigmatism control and RV257 Geometry controls are located between low voltage rails.

The PDA supply, is a voltage tripler rectified by D351 to D352 and C353 coupling capacitor and C352 and 361 filters.

8.8 Low Voltage Power Supplies:(Drg. No. 1369)

Two secondary windings provide the main DC supplies. + and -64V is obtained from the 51V windings by half wave rectifying by D265 and 266 followed by three stages of filtering for the various circuits. +110V is obtained by bridge rectifying the 88V winding by D261 to D264. R297, 305, RV260 and trace rotation coil L1 together with C175, C176 and C177 filter the supply for the vertical and horizontal amplifiers.

8.9 Calibrator: (Drg. No. 1368)

Q97 reversed bias transistor operates as a zener diode and supplies +8V approximately for the collector load of Q96. 51V AC is applied to Q96 base via R96 limiting resistor, this alternately drives it hard into conduction or into cut off resulting in a fast rise and fall square wave being developed across the collector load R95. 1V p-p is tapped off by RV91 and supplied to the front panel socket.

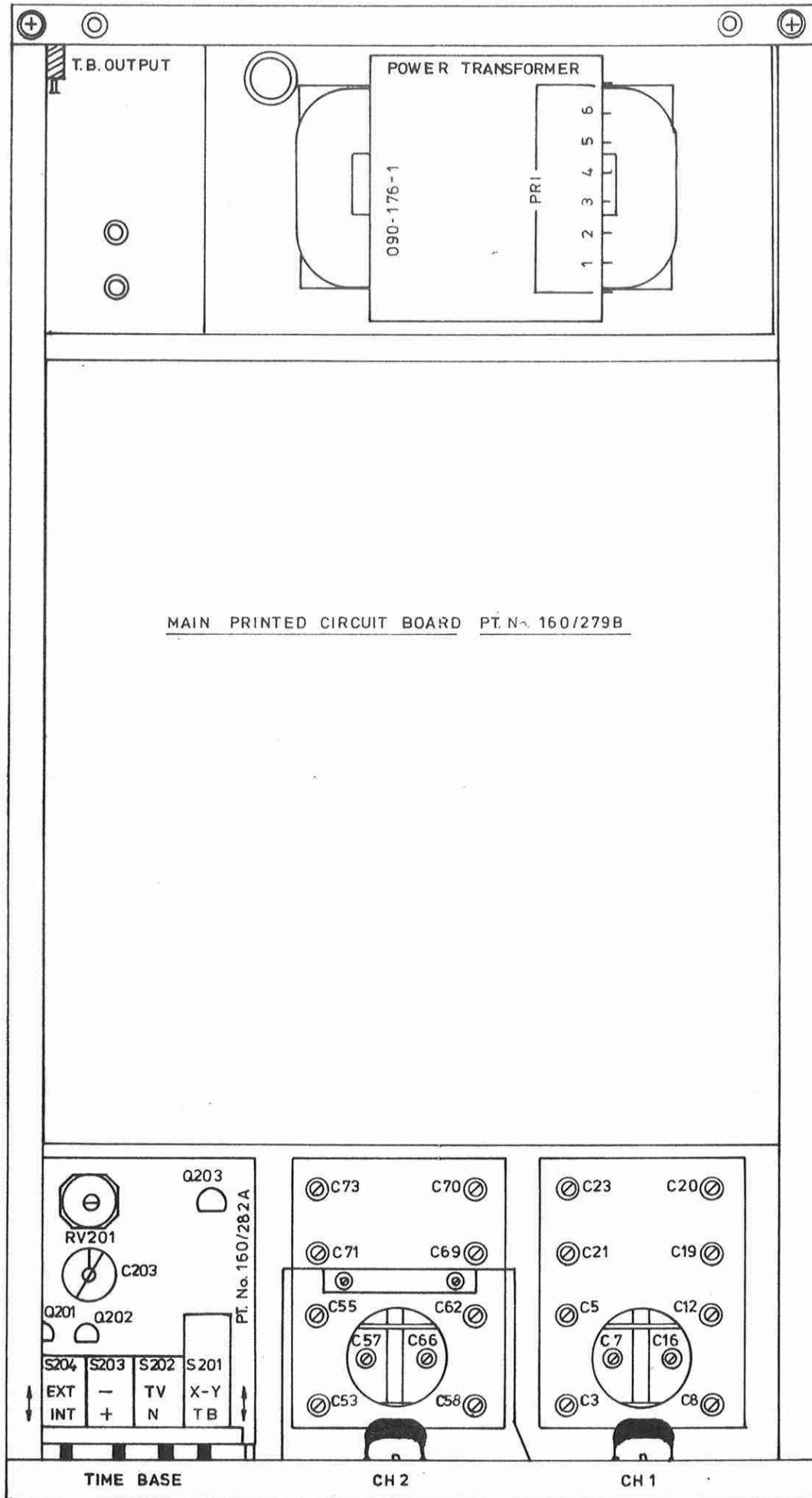

BOTTOM VIEW SHOWING LOCATION OF PRESET CONTROLS, ETC.

9. ADJUSTMENTS AND MAINTENANCE:

A number of preset controls are contained in this instrument which may require periodical adjustments to maintain it in full calibration.

Before removing the top cover, disconnect the instrument from the mains. Remove the two screws holding the handle and withdraw the cover. The bottom cover may be removed by unscrewing the four feet.

To aid fault finding the voltages present at various points are shown on the circuit.

9.1 Alignment Procedure:

Before attempting re-alignment of any section of this oscilloscope, check the instruments general operating characteristics and correct any apparent faults. Also check DC rails as variation in supply voltages caused by a fault may result in miscalibration.

9.2 General check of controls:-

- | | | |
|-----|-------------------|---|
| (a) | Intensity | Linear control over intensity range |
| (b) | Focus | Approx. centre with adjustment either side |
| (c) | x1 - x5 Hor. Mag. | Trace should expand equally either side of centre |
| (d) | Vert. Positions | Traces should move completely off screen above and below centre. |
| (e) | Trigger Level | With atten. at 0.2V and CAL signal fed into Ch.1 & 2 Inputs check AUTO and Level Select operation |
| (f) | + - Switch | Set up as for (e) Trigger point should change over as indicated by switch. |

9.3 C.R.T. Trace Alignment:

Feed a 1,000Hz square wave signal into the Channel 1 and adjust waveform to fill the screen. T.B. to 1mSec VERNIER CAL.

RV258 Internal astigmatism control is adjusted in conjunction with the FOCUS control to obtain the best resolution over the entire screen area at normal viewing intensity.

RV257 at rear of main board adjusts the pattern geometry. It should be set to display vertical and horizontal lines with minimum of pin cushion or barrel distortion. RV258 may need slight re-adjustment after RV257 has been set as some interaction occurs.

9.4 Equipment required for complete calibration:

20,000 Ω /V meter or DVM. Pulse generator <10n Sec rise time. Voltage calibrator 50mV to 100V p-p. 0.5% accuracy. Sine wave generator 1Hz to 1MHz. (BWD 141 or 160). Constant Amplitude generator 50kHz to 50MHz. Time marker generator, 0.5 μ S - 0.5Sec.

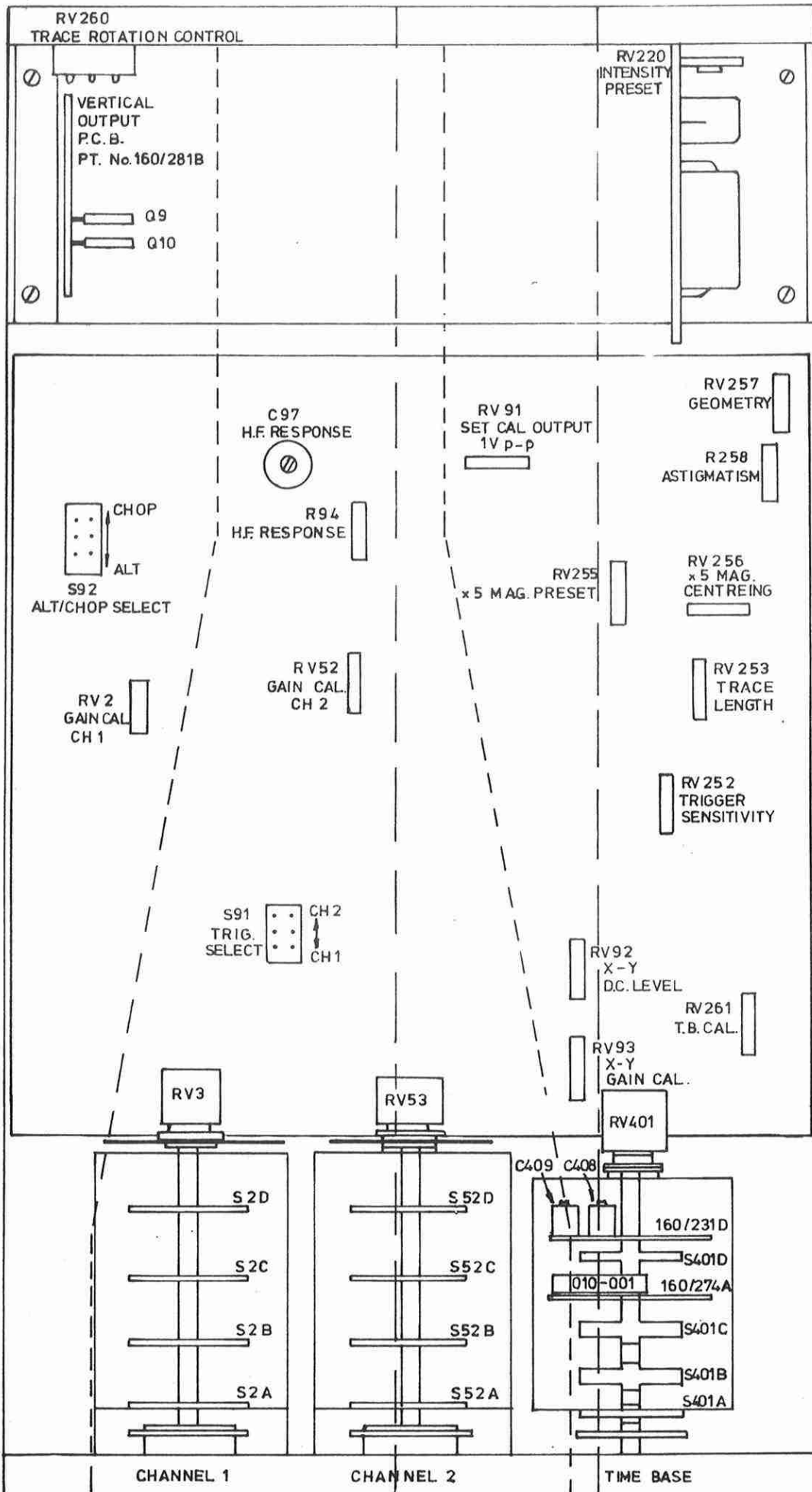

TOP VIEW SHOWING LOCATION OF PRESET CONTROLS, ETC.

9.5 Vertical Alignment:

- (a) If any preset controls have been replaced set them to centre position. Adjust RV92 for 4.4V at pin 5 of 1C-50, 733 IC at front of main board. (For precise adjustment see Para. 9.10 (b)).
- (b) Set both attenuators to 0.01V. Feed in a 50mV p-p 1kHz calibration waveform. Adjust RV2 and 52 for a 5cm display on Ch. 1 and 2 respectively.
- (c) Set both attenuators to 0.1V/cm. Feed in a correctly terminated 1MHz square wave with >10n Sec rise time to Ch. 1. Adjust input amplitude for 6cm deflection. Adjust RV94 and C97 for best square wave response. Repeat for Ch. 2 and optimise RV94, C97 for best result on each channel.
- (d) Bandwidth check. Apply 50kHz reference signal to Ch. 1, set for 4cm deflection. Increase frequency to 25MHz. Level should not drop below 2.8cm. Repeat for Ch. 2.

9.6 Attenuator Alignment: (Figures in brackets are Ch. 2).

<u>Attenuator Setting</u>	<u>Input Voltage</u>	<u>Adjust for Square Wave</u>	<u>Adjust for Input Capacitance</u>
0.005	-	-	-
0.01	50mV	C20 (70)	-
0.02	100mV	C23 (73)	-
0.05	250mV	C 5 (55)	C3 (53)
0.1	0.5V	C19 (69)	-
0.2	1V	C21 (71)	-
0.5	2.5V	C 7 (57)	C8 (58)
5	25V	C16 (66)	C12(62)

9.7 Calibrator Adjustment:

When Ch. 1 is correctly calibrated against an external standard, set its attenuator to 0.2V. Feed in the 1V CAL signal, input switched to DC then adjust RV91 at rear of main board for 5cm deflection.

9.8 Time Base Alignment:

- (a) Set T.B. range switch to 5mSec., Vernier anti-clockwise. Set trace length to 10.2cm (RV253).
- (b) Set T.B. to 1mSec., vernier to CAL (fully clockwise). Feed in 1mSec pulses. Adjust No. 1 pulse to correspond with 1st graticule line. Adjust RV261 (front of main board) for 1 pulse/cm.
- (c) Turn TB to 5mSec/cm, feed in 5mSec pulses. Check for 1 pulse per cm.

- (d) Turn TB to 20μ Sec/cm with 20μ Sec pulses, adjust C409 on rear to TB switch for calibration. Check calibration from 20μ Sec to 1μ Sec and set C409 for best overall calibration accuracy if slight variations are present between steps.
- (e) Turn T.B. to 0.5μ Sec/cm. Adjust C408 on rear of T.B. switch for calibration with $0.5M$ Sec pulses displayed.

9.9 x5 MAG:

- (a) Set T.B. back to $1m$ Sec/cm. Feed in $0.2m$ Sec pulses, centre leading edge of middle pulse at CRT centre line. Pull for x5 mag. If pulse edge moves, recentre with Horz. Position Control, push in for x1 mag., without turning control, recentre pulse with RV256 on main board. Repeat until negligible movement occurs.
- (b) With the T.B. to $1m$ Sec., vernier to CAL, switch to x5 Mag. Feed in $0.2m$ Sec pulses. Adjust RV255 for 1 pulse/cm.

9.10 Trigger and X-Y Adjustment:

As the trigger and X-Y signals use the same amplifiers their adjustments interact at certain points and therefore need adjusting together.

- (a) Trigger centering. Connect AC power input to a variable voltage transformer. Couple on oscilloscope to the green wire connector at the rear of the trigger board. Apply a $50kHz$ signal to Ch.1 input, centre trace then increase signal amplitude to cause the signal present on the green wire to clip. Check for equal clipping. Next switch input to GND, centre trace then turn the variable voltage transformer to vary the input at least $\pm 5\%$ of the nominal AC voltage shown on the power transformer tapping in use. The trace should move less than $1cm$ vertically.
- (b) X-Y Centre. Connect external oscilloscope to blue wire on trigger board. Turn Ch. 2 off, select Ch. 2 trig and depress T.B./XY button. Feed a $50kHz$ signal to Ch. 2 input, check signal on blue wire will exceed $5V$ p-p before clipping. Adjust RV202 for horizontal centering.
- (c) X calibration. Set Ch. 2 attenuator to $0.2V/cm$. Feed in $1V$ CAL waveform. Input selection switched to DC. Set RV93 along-side U90 for $5cm$ horizontal deflection.
- (d) Phase Shift. Feed in constant amplitude generator to both Ch. 1 and Ch. 2. Both attenuators to $0.1V/cm$. Input should be $<50kHz$, set for $6cm$ deflection both vertically and horizontally to produce a diagonal line on the CRT. Increase input frequency to $150kHz$, if trace is not a straight line adjust C203 to produce a straight line indicating 0° phase shift.

Diagonal line should be approximately $2mm$ apart at centre at $200kHz$ indicating approximately 2° phase shift.

- (e) Horz. Bandwidth. Switch Ch. 1 to GND to leave a horizontal line on CRT. Continue to increase input frequency it should not drop below 4.2cm length before 2MHz.

9.11 Trigger Sensitivity:

- (a) Set TB to 10μ Sec/cm AUTO trig. + and NORM selection. Couple 50kHz sine wave to Ch. 1 and adjust amplitude for 4cm deflection. With an external oscilloscope connected to Q122 collector set RV252 for symmetrical waveform.
- (b) Reduce amplitude to 1cm, check stable operation from below 5Hz to over 16MHz. Increase input frequency and amplitude to 2cm and maintain it at this amplitude as the frequency is increased to beyond 25MHz where it should still be locked (T.B. to 0.5μ Sec/cm and x5 Mag. on).
- (c) Check Level Select at 1kHz for operation from below 1cm to over 8cm. Reduce input to 3Hz to check signal will lock (level setting is more critical at upper and lower limits of frequency range). Increase frequency to over 20MHz and check operation.
- (d) Parallel input signal via a T piece to both Ch. 1 and EXT TRIG input socket. Select EXT TRIG button. Adjust input IV p-p. Check ext trig. range on AUTO extend from 5Hz to 20MHz. Level selects operates over the same range from IV p-p to 10V p-p input.

9.12 T.V. Trigger:

Apply a composite video waveform to Ch. 1, adjust amplitude for 2cm deflection, T.B. to 2mSec., TV trigger button selected, Trigger Level control fully clockwise. Frame signal will be displayed, increase amplitude to 10cm, display will still lock. Increase T.B. speed to 10μ Sec and turn Trigger level to AUTO. Line signal will be displayed over an amplitude range of 2cm to 10cm.

9.13 Cascade Operation:

Apply a 5mV p-p signal to the input when connected for cascade operation. Adjust RV201 for 5cm of deflection when both attenuators are set to 10mV.

10. REPLACEMENT PARTS:

Spares are normally available from the manufacturer. When ordering, it is necessary to indicate the serial number of the instrument. If exact replacements are not to hand, locally available alternatives may be used, provided they possess a specification not less than, or physical size not greater than, the original components.

As the policy of the supplier is one of continuing research and development, the Company reserves the right to supply the latest equipment and make amendments to the circuits and parts without notice.

11. WARRANTY:

The equipment is guaranteed for a period of twelve (12) months from the date of purchase against faulty materials and workmanship.

PARTS LIST:

COMPONENT DESIGNATIONS:

A	Assembly	H	Heater	RV	Variable Resistor
B	Lamp	J	Jacket(Socket)	S	Switch
C	Capacitor	L	Indicator	T	Transformer
D	Diode	M	Meter	TH	Thermistor
DL	Delay Line	P	Plug	V	Vacuum Tube
E	Misc. elec. part.	Q	Transistor	VDR	Volt Dependent Resistor
F	Fuse	R	Resistor		

ABBREVIATIONS:

Amp	Ampere	MPC	Metalised Polyester Capacitor
cc	Cracked Carbon	Ne	Neon
c	Carbon	NPO	Zero temperature co-efficient
CDS	Ceramic Disc	ns	Nano-second
cer	Ceramic	p	Peak
DPST	Double Pole Single Throw	pF	Pico Farad = 10^{-12} F
DPDT	Double Pole Double Throw	preset	Internal Preset
elec	Electrolytic	PYE	Polyester
FET	Field Effect Transistor	pot	Potentiometer
HTC	High Temp Coating	PCB	Printed Circuit Board
kHz	kilohertz = 10^3 Hz	PIV	Peak Inverse Voltage
k Ω	Kilohm = 10^3 Ω	PYS	Polystyrene
lin	Linear	p-p	Peak to Peak
Log	Logarithmic Taper	rot	Rotary
m	Milli = $\times 10^{-3}$	rms	Root Mean Squared
MHz	Mega-hertz = 10^6 Hz	si	Silicon
MF	Metal Film	Ta	Tantalum
mA	Milliampere = 10^{-3} Amp	tol	Tolerance
M Ω	Megohm = 10^6 Ω	trim	Trimmer
mfr	Manufacturer	V	Volts
MO	Metal Oxide	var	Variable
MHT	Polyester/Paper Capacitors	W	Watt
		ww	Wire Wound

MANUFACTURERS ABBREVIATIONS:

AC	Allied Capacitors P/L	NS	N. S. Electronics P/L
BWD	BWD Electronics P/L	PH	Philips Industries Ltd.
DAR	Darstan	PI	Piher (Soanar)
ELN	Elna Capacitors (Soanar)	PL	Plessey Pacific
F	Fairchild Aust. P/L	SON	Soanar Electronics P/L
IRH	IRH Components P/L	STE	Stettner Capacitors Ltd.
McM	McMurdo Aust. P/L	THORN	Thorn Atlas

PARTS LIST - MODEL BWD 539D

CCF Ref.	DESCRIPTION				Mfg or Supply	PART NO.
R1	900K	1%	1/4W	HS	IRH	
R2	990K	1%	1/4W	HS	IRH	
R3	111K	1%	1/4W	HS	IRH	
R4	10K	1%	1/4W	HS	IRH	
R5	1K	5%	1/4W	HS	IRH	RG 1/4
R6	33	5%	1/4W	MG	IRH	RG 1/4
R7	1M	1%	1/4W	MG	IRH	RG 1/4
R8	22K	5%	1/4W	MG	IRH	RG 1/4
R9	1K	1%	1/4W	MG	IRH	RG 1/4
R10	22	5%	1/4W	MG	IRH	RG 1/4
R11	750K	1%	1/4W	HS	IRH	RG 1/4
R12	500K	1%	1/4W	HS	IRH	RG 1/4
R13	1M	1%	1/4W	HS	IRH	RG 1/4
R14	10Ω	5%	1/4W	MG	IRH	
R15						
R16	333K	1%	1/4W	HS	IRH	RG 1/4
R17	270K	5%	1/4W	MG	IRH	RG 1/4
R18	1M	1%	1/4W	HS	IRH	RG 1/4
R19	1K2	5%	1/4W	MG	IRH	RG 1/4
R20	33	5%	1/4W	MG	IRH	RG 1/4
R21	1K5	5%	1/4W	MG	IRH	RG 1/4
R22	680	5%	1/4W	MG	IRH	RG 1/4
R23	680	5%	1/4W	MG	IRH	RG 1/4
R24	33	5%	1/4W	MG	IRH	RG 1/4
R25	820	5%	1/4W	MG	IRH	RG 1/4
R26	100	5%	1/4W	MG	IRH	RG 1/4
R27	820	5%	1/4W	MG	IRH	RG 1/4
R28	33	5%	1/4W	MG	IRH	RG 1/4
R29	6K8	5%	1/4W	MG	IRH	RG 1/4
R30	33	5%	1/4W	MG	IRH	RG 1/4
R31	6K8	5%	1/4W	MG	IRH	RG 1/4
R32	220	5%	1/4W	MG	IRH	RG 1/4
R33	220	5%	1/4W	MG	IRH	RG 1/4
R51	900K	1%	1/4W	HS	IRH	
R52	990K	1%	1/4W	HS	IRH	
R53	111K	1%	1/4W	HS	IRH	
R54	10K	1%	1/4W	MG	IRH	RG 1/4
R55	1K	5%	1/4W	HS	IRH	RG 1/4
R56	33	5%	1/4W	MG	IRH	RG 1/4
R57	1M	1%	1/4W	MG	IRH	RG 1/4
R58	22K	5%	1/4W	MG	IRH	RG 1/4
R59	1K	1%	1/4W	MG	IRH	RG 1/4
R60	22	5%	1/4W	MG	IRH	RG 1/4

PARTS LIST - MODEL BWD 539D

CCF Ref.	DESCRIPTION				Mfg or Supply	PART NO.
R61	750K	1%	1/4W	HS	IRH	
R62	500K	1%	1/4W	HS	IRH	
R63	1M	1%	1/4W	HS	IRH	RG 1/4
R64	10Ω	5%	1/4W	MG	IRH	
R65						
R66	333K	1%	1/4W	HS	IRH	RG 1/4
R67	270K	5%	1/4W	MG	IRH	RG 1/4
R68	1M	1%	1/4W	HS	IRH	RG 1/4
R69	1k	5%	1/4W	MG	IRH	RG 1/4
R70	33	5%	1/4W	MG	IRH	RG 1/4
R71	1K5	5%	1/4W	MG	IRH	RG 1/4
R72	680	5%	1/4W	MG	IRH	RG 1/4
R73	680	5%	1/4W	MG	IRH	RG 1/4
R74	33	5%	1/4W	MG	IRH	RG 1/4
R75	820	5%	1/4W	MG	IRH	RG 1/4
R76	100	5%	1/4W	MG	IRH	RG 1/4
R77	820	5%	1/4W	MG	IRH	RG 1/4
R78						
R79	6K8	5%	1/4W	MG	IRH	RG 1/4
R80						
R81	6K8	5%	1/4W	MG	IRH	RG 1/4
R82	220	5%	1/4W	MG	IRH	RG 1/4
R83	220	5%	1/4W	MG	IRH	RG 1/4
R91	15K	5%	1/4W	MG	IRH	RG 1/4
R92	22K	5%	1/4W	MG	IRH	RG 1/4
R93	2K2	5%	1/4W	MG	IRH	RG 1/4
R94	8K2	5%	1/4W	MG	IRH	RG 1/4
R95	18K	5%	1/4W	MG	IRH	RG 1/4
R96	100K	5%	1/4W	MG	IRH	RG 1/4
R97	56K	5%	1/4W	MG	IRH	RG 1/4
R98	100	5%	1/4W	MG	IRH	RG 1/4
R99	10K	5%	1/4W	MG	IRH	RG 1/4
R100	10K	5%	1/4W	MG	IRH	RG 1/4
R101	4K7	5%	1/4W	MG	IRH	RG 1/4
R102	1K5	5%	1/4W	MG	IRH	RG 1/4
R103	2K7	5%	1/4W	MG	IRH	RG 1/4
R104	1K5	5%	1/4W	MG	IRH	RG 1/4

PARTS LIST - MODEL BWD 539D

CCF Ref.	DESCRIPTION				Mfg or Supply	PART NO.
R105	4K7	5%	1/4W	MG	IRH	RG 1/4
R106	180	5%	1/4W	MG	IRH	RG 1/4
R107	1K5	5%	1/4W	MG	IRH	RG 1/4
R108	5K6	5%	1/4W	MG	IRH	RG 1/4
R109	15K	5%	1/4W	MG	IRH	RG 1/4
R110	2K2	5%	1/4W	MG	IRH	RG 1/4
R111	18K	5%	1/4W	MG	IRH	RG 1/4
R112	18K	5%	1/4W	MG	IRH	RG 1/4
R113	2K2	5%	1/4W	MG	IRH	RG 1/4
R114	1K	5%	1/4W	MG	IRH	RG 1/4
R115	270K	5%	1/4W	MG	IRH	RG 1/4
R116	2K2	5%	1/4W	MG	IRH	RG 1/4
R117	3K3	5%	1/4W	MG	IRH	RG 1/4
R118	33K	5%	1/4W	MG	IRH	RG 1/4
R119	15K	5%	1/4W	MG	IRH	RG 1/4
R120	2K2	5%	1/4W	MG	IRH	RG 1/4
R121	100	5%	1/4W	MG	IRH	RG 1/4
R122						
R123	2K2	5%	3W	WW	IRH	
R124						
R125						
R126						
R127	100	5%	1/4W	MG	IRH	RG 1/4
R128	1K	5%	1/4W	MG	IRH	RG 1/4
R129	33	5%	1/4W	MG	IRH	RG 1/4
R130	2K2	5%	3W	WW	IRH	
R131	33	5%	1/4W	MG	IRH	RG 1/4
R132	56	5%	1/4W	MG	IRH	RG 1/4
R133	56	5%	1/4W	MG	IRH	RG 1/4
R134	33	5%	1/4W	MG	IRH	RG 1/4
R135	22K	5%	1/4W	MG	IRH	RG 1/4
R201	3K3	5%	1/4W	MG	IRH	RG 1/4
R202	39K	5%	1/4W	MG	IRH	RG 1/4
R203	470K	5%	1/4W	MG	IRH	RG 1/4
R204	390	5%	1/4W	MG	IRH	RG 1/4
R205	390	5%	1/4W	MG	IRH	RG 1/4
R206	100	5%	1/4W	MG	IRH	RG 1/4
R207	100	5%	1/4W	MG	IRH	RG 1/4
R208	1K5	5%	1/4W	MG	IRH	RG 1/4
R209	47K	5%	1/4W	MG	IRH	RG 1/4
R210	4K7	5%	1/4W	MG	IRH	RG 1/4
R211	10K	5%	1/4W	MG	IRH	RG 1/4

PARTS - LIST MODEL BWD 539D

CCF Ref	DESCRIPTION				Mfg or Supply	PART NO.
R212	10K	5%	1/4W	MG	IRH	RG 1/4
R213	2K2	5%	1/4W	MG	IRH	RG 1/4
R214	22K	5%	1/4W	MG	IRH	RG 1/4
R215	4M7	5%	1/4W	MG	IRH	RG 1/4
R216	2K2	5%	1/4W	MG	IRH	RG 1/4
R217	6K8	5%	1/4W	MG	IRH	RG 1/4
R218	1K5	5%	1/4W	MG	IRH	RG 1/4
R251	100	5%%	1/4W	MG	IRH	RG 1/4
R252	180K	5%	1/4W	MG	IRH	RG 1/4
R253	68K	5%	1/4W	MG	IRH	RG 1/4
R254	18K	5%	1/4W	MG	IRH	RG 1/4
R255	27K	5%	1/4W	MG	IRH	RG 1/4
R256	150K	5%	1/4W	MG	IRH	RG 1/4
R257	10K	5%	1/4W	MG	IRH	RG 1/4
R258	22K	5%	1/4W	MG	IRH	RG 1/4
R259	680	5%	1/4W	MG	IRH	RG 1/4
R260	6K8	5%	1/4W	MG	IRH	RG 1/4
R261	3K3	5%	1/4W	MG	IRH	RG 1/4
R262	10K	5%	1/4W	MG	IRH	RG 1/4
R263	470	5%	1/4W	MG	IRH	RG 1/4
R264	33K	5%	1/4W	MG	IRH	RG 1/4
R265	6K8	5%	1/4W	MG	IRH	RG 1/4
R266	2K2	5%	1/4W	MG	IRH	RG 1/4
R267	220K	5%	1/4W	MG	IRH	RG 1/4
R268	47K	5%	1/4W	MG	IRH	RG 1/4
R269	120K	5%	1/4W	MG	IRH	RG 1/4
R270	15K	5%	1/4W	MG	IRH	RG 1/4
R271	3K3	5%	1/4W	MG	IRH	RG 1/4
R272	33K	5%	1/4W	MG	IRH	RG 1/4
R273	56K	5%	1/4W	MG	IRH	RG 1/4
R274	2K2	5%	1/4W	MG	IRH	RG 1/4
R275	47K	5%	1/4W	MG	IRH	RG 1/4
R276	22K	5%	1/4W	MG	IRH	RG 1/4
R277	22K	5%	1/4W	MG	IRH	RG 1/4
R278	100	5%	1/4W	MG	IRH	RG 1/4
R279	8K2	5%	1/4W	MG	IRH	RG 1/4
R280	82K	5%	1/4W	MG	IRH	RG 1/4
R281	560	5%	1/4W	MG	IRH	RG 1/4
R282	3K3	5%	1/4W	MG	IRH	RG 1/4
R283	18K	5%	1/4W	MG	IRH	RG 1/4
R284	10K	5%	1/4W	MG	IRH	RG 1/4
R285	56K	5%	1/4W	MG	IRH	RG 1/4
R286	180K	5%	1/4W	MG	IRH	RG 1/4

PARTS LIST - MODEL BWD 539D

CCF Ref	DESCRIPTION				Mfg or Supply	PART NO.
R287	330	5%	1/4W	MG	IRH	RG 1/4
R288	470	5%	1/4W	MG	IRH	RG 1/4
R289	1K	5%	1/4W	MG	IRH	RG 1/4
R290	6K8	5%	1/4W	MG	IRH	RG 1/4
R291	1K2	5%	1/4W	MG	IRH	RG 1/4
R292	56K	5%	1/4W	MG	IRH	RG 1/4
R293	10K	5%	1W	MG	IRH	RG 1/4
R294	10K	5%	1W	MG	IRH	RG 1/4
R295	180	5%	1/4W	MG	IRH	RG 1/4
R296	4K7	5%	1W	MG	IRH	RG 1/4
R297	330	5%	1W	MG	IRH	RG 1/4
R298	270	5%	1/4W	MG	IRH	RG 1/4
R299	330	5%	1/4W	MG	IRH	RG 1/4
R300	330	5%	1/4W	MG	IRH	RG 1/4
R301	330	5%	1/4W	MG	IRH	RG 1/4
R302	2M2	5%	1/4W	MG	IRH	RG 1/4
R303						
R304	47K	5%	1/4W	MG	IRH	RG 1/4
R305	1K5	5%	1/4W	MG	IRH	RG 1/4
R306	680K	5%	1/4W	MG	IRH	RG 1/4
R307	1K	5%	1/4W	MG	IRH	RG 1/4
R308						
R351	2M2	5%	1/4W	MG	IRH	RG 1/4
R352	2M2	5%	1/4W	MG	IRH	RG 1/4
R353	1M	5%	1/4W	MG	IRH	RG 1/4
R354	1M	5%	1/4W	MG	IRH	RG 1/4
R355	1M	5%	1/4W	MG	IRH	RG 1/4
R356	1M	5%	1/4W	MG	IRH	RG 1/4
R357	10K	5%	1/4W	MG	IRH	RG 1/4
R358	270K	5%	1/4W	MG	IRH	RG 1/4
R359						
R360	100K	5%	1/4W	MG	IRH	RG 1/4
R361	100K	5%	1/4W	MG	IRH	RG 1/4
R362	10K	5%	1/4W	MG	IRH	RG 1/4
R363	5M6	5%	1/4W	MG	IRH	RG 1/4
R401)					
R402)					
R403)					
R404)					
R405)					
R406A)					
R406B)					
R406C)					
R407)					
	THICK FILM RESISTOR NETWORK				BWD	010-001

PARTS LIST - MODEL BWD 539D

CCF Ref	DESCRIPTION				Mfg or Supply	PART NO.
	<u>CAPACITORS:</u>					
C1	100nF	630V	10%	GREEN CAP	ELN	TYPE N
C2	15pF	500V	10%	NPO	AC	CDS
C3	1-12pF	TRIM			PH	2222-801-20008
C4	5p6	500V	10%	NPO	AC	CDS
C5	1-12pF	TRIM			PH	2222-801-20008
C6	15p	500V	10%	NPO	AC	CDS
C7	0.8-3pF	TRIM			PH	2222-801-20001
C8	1-12pF	TRIM			PH	2222-801-20008
C9	15pF	500V	10%	NPO	AC	CDS
C10	4n7	400V	10%	PYE	PH	2202-315-51472
C11	470pF	500V	5%	SM	PL	MSA
C12	1-12pF	TRIM			PH	2222-801-20008
C13	15pF	500V	10%	NPO	AC	CDS
C14	390pF	500V	10%	PYS	AC	
C15	82pF	500V	10%	N750	AC	CDS
C16	0.8-3pF	TRIM			PH	2222-801-20001
C17	8p2	500V	10%	NPO	AC	CDS
C18	33pF	500V	10%	N750	AC	CDS
C19	1-12pF	TRIM			PH	2222-801-20008
C20	1-12pF	TRIM			PH	2222-801-20008
C21	1-12pF	TRIM			PH	2222-801-20008
C22	3p3	500V	10%	NPO	AC	CDS
C23	1-12pF	TRIM			PH	2222-801-20008
C24	6p8	500V	10%	NPO	AC	CDS
C25	2n2	500V	20%		AC	CDS
C26	100nF	63V			AC	CDS
C27	22pF	500V	10%	NPO	AC	CDS
C51	100nF	630V	10%	GREEN CAP	ELN	TYPE N
C52	15pF	500V	10%	NPO	AC	CDS
C53	1-12pF	TRIM			PH	2222-807-20008
C54	5p6	500V	10%	NPO	AC	CDS
C55	1-12pF	TRIM			PH	2222-801-20001
C56	15pF	500V	10%	NPO	AC	CDS
C57	0.8-3pF	TRIM			PH	2222-801-20001
C58	1-12pF	TRIM			PH	2222-801-20008
C59	15pF	500V	10%	NPO	AC	CDS
C60	4n7	400V	10%	PYE	PH	2203-315-51472
C61	470pF	500V	10%	N750	AC	CDS
C62	1-12pF	TRIM			PH	2222-801-20008
C63	15pF	500V	10%	NPO	AC	CDS

PARTS LIST - MODEL BWD 539D

CCF Ref	DESCRIPTION				Mfg or Supply	PART NO.
C64	390pF	500V	10%	PYS	AC	
C65	82pF	500V	10%	N750	CDS	
C66	0.8-3pF	TRIM			PH	2222-801-20001
C67	8p2	500V	10%	NPO	AC	CDS
C68	33pF	500V	10%	N750	AC	CDS
C69	1-12pF	TRIM			PH	2222-801-20008
C70	1-12pF	TRIM			PH	2222-801-20008
C71	1-12pF	TRIM			PH	2222-801-20008
C72	3p3	500V	10%	NPO	AC	CDS
C73	1-12pF	TRIM			PH	2222-808-20008
C74	6p8	500V	10%	NPO	AC	CDS
C75	2n2	500V	20%		AC	CDS
C76	100nF	63V			AC	CDS
C77	22pF	500V	10%	NPO	AC	CDS
C91	150μF	16V		ELECTR	PH	2222-016-15151
C92	10μF	16V	20%	TANTALUM	SON	TAD OR TAG
C93	220μF	3V	20%	TANTALUM	SON	TAD OR TAG
C94	10pF	500V	10%	NPO	AC	CDS
C95	100pF	100V	5%	N750	AC	CDS
C96	150pF	630V	5%	PYS	AC	
C97	5-60pF	TRIM			PH	2222-808-01004
C98	10pF	63V			AC	CDS
C99	100pF	500V	10%	N750	AC	CDS
C100	150μF	16V		ELECTRO	PH	2222-016-17101
C101	100nF	63V			AC	CDS
C102	100pF	500V	5%	N750	AC	CDS
C103	100μF	40V		ELECTRO N750	PH	2222-016-17101
C104	100pF	500V	5%	N750	AC	CDS
C105	3n3	100V	10%		ELN	TYPE N
C106	100pF	500V	5%	N750	AC	CDS
C107	100pF	500V	5%	N750	AC	CDS
C108	100pF	500V	5%	N750	AC	CDS
C201	220nF	100V	10%		ELN	TYPE N
C202	10pF	500V	10%	NPO	AC	CDS
C203	10-60pF	TRIM			STE	10S-06
C204	200pF	500V	5%	N750	AC	CDS
C205	100nF	63V			AC	CDS
C206	100nF	100V	10%		ELN	TYPE N
C207	2n2	100V	10%		ELN	TYPE N
C251	10nF	500V	5%	N750	AC	CDS
C252	4μ7	40V		ELECTR	PH	2222-015-1722B

PARTS LIST - MODEL BWD 539D

CCF Ref	DESCRIPTION				Mfg or Supply	PART NO.
C253	22pF	500V	5%	N750	AC	CDS
C254	33pF	500V	5%	N750	AC	CDS
C255	10pF	500V	10%	NPO	AC	CDS
C256	10nF	100V	10%		ELN	TYPE N
C257	22pF	500V	5%	N750	AC	CDS
C258	1nF	500V	20%		AC	CDS
C259	100pF	500V	5%	N750	AC	CDS
C260	10pF	500V	10%	NPO	AC	CDS
C261	220pF	630V	5%	PYS	AC	
C262	50μF	150V		ELECTRO	ELN	
C263	50μF	150V		ELECTRO	ELN	
C264	100μF	63V		ELECTRO	PH	2222-017-18101
C265	220μF	63V		ELECTRO	PH	2222-017-18221
C266	220μF	63V		ELECTRO	PH	2222-017-18221
C267	100μF	63V		ELECTRO	PH	2222-017-18101
C268	220μF	63V		ELECTRO	PH	2222-017-18221
C269	220μF	63V		ELECTRO	PH	2222-017-18221
C270	150pF	630V	5%	PYS	AC	
C271	80μF	25V		ELECTRO	ELN	TYPE RT
C272	50μF	150V		ELECTRO	ELN	TYPE RT
C273	33pF	500V	10%	N750	AC	CDS
C351	68nF	2.5KV	CER		PI	CDH
C352	100nF	1.6KV	MHT		PI	
C353	8μF	450V	ELECTRO		ELN	CE02W
C354	8μF	450V	ELECTRO		ELN	CE02W
C355	8μF	450V	ELECTRO		ELN	CE02W
C356	8μF	450V	ELECTRO		ELN	CE02W
C357	330pF	630V	PYS		AC	CE02W
C358	220pF	2.5KV	CER		PI	CDH
C359	100nF	630V	10%		ELN	TYPE N
C360	10nF	2.5KV	CERAMIC		PI	CDH
C361	68nF	2KV	MHT		PI	CDH
C401	100n	100V	10%		ELN	TYPE N
C402	4μ7	63V		ELECTRO	PH	2222-015-18478
C403	1nF	500V	20%		AC	CDS
C404	22μF	25V		ELECTRO	PH	2222-015-16229
C405	47nF	100V	10%		ELN	TYPE N
C406	2μ2	40V		ELECTRO	PH	2222-015-17228
C407	4μ7	63V		ELECTRO	PH	2222-015-18478
C408	10-40pF	CER	TRIM		STE	10S-06-10-40
C409	10-40pF	CER	TRIM		STE	10S-06-10-40
C410	68pF	500V	5%	N750	AC	CDS
C411	10nF	100V	SELECTED	1%	ELN	TYPE N
C412	1μF	100V	SELECTED	1%	ELN	TYPE N

PARTS LIST - MODEL BWD 539D

CCF Ref	DESCRIPTION					Mfg or Supply	PART NO.
C413	470pF	630V	5%	PYS		AC	CDS
RV1							
RV2	500	LIN	PRESET	POT	C	PI	PT 15H
RV3	10K	LIN	POT		C	IRH	
RV51							
RV52	500	LIN	PRESET	POT	C	PI	PT 15H
RV53	10K	LIN	POT WITH DPST			IRH	
RV91	10K	LIN	PRESET	POT	C	PI	PT 15H
RV92							
RV93	470	LIN	PRESET	POT	C	PI	PT 15H
RV94	100	LIN	PRESET	POT	C	PI	PT 15H
RV201	200K	LIN	PRESET	POT	C	PI	PT 15H
RV202	5K	LIN	PRESET	POT	Cermet	S	VYP
RV251	220K	LIN	POT WITH DPST		C	IRH	
RV252	22K	LIN	PRESET	POT	C	PI	PT 15H
RV253	4K7	LIN	PRESET	POT	C	PI	PT 15H
RV254	100K	LIN	POT WITH DPST		C	IRH	p-p SWITCH
RV255	100	LIN	PRESET	POT	C	PI	PT 15H
RV256	50K	LIN	PRESET	POT	C	PI	PT 15H
RV257	470K	LIN	PRESET	POT	C	PI	PT 15H
RV258	100K	LIN	PRESET	POT	C	PI	PT 15H
RV259	1M	LIN	POT		C	IRH	
RV260	2K	WW	POT			DAR	P122
RV261	100K	LIN	PRESET	POT	C	PI	PT 15H
RV351	220K	LIN	POT WITH DPST	SW	C	IRH	
RV352	100K	LIN	PRESET	POT	C	PI	PT 15H
RV401	220K	LIN	POT		C	IRH	
Q3/4	MATCHED PAIR		10%	NPN	SI	F	2N5770
Q53/54	MATCHED PAIR		10%	NPN	SI	F	2N5770

PARTS LIST - MODEL BWD 539D

CCF Ref	DESCRIPTION	Mfg or Supply	PART NO.
Q91	TRANSISTOR NPN SI	F/PH	BC207
Q92	TRANSISTOR NPN SI	F/PH	BC307
Q93	TRANSISTOR NPN SI	F/PH	BC207
Q94	TRANSISTOR NPN SI	F/PH	BC207
Q95	TRANSISTOR NPN SI	F/NS	PN 3642
Q96	TRANSISTOR NPN SI	F/PH	BC207
Q97	TRANSISTOR NPN SI	F/PH	BC207
Q98	TRANSISTOR NPN SI	PH	2N5770
Q99	TRANSISTOR NPN SI	PH	2N5770
Q100	TRANSISTOR NPN SI	PH	2N5770
Q101	TRANSISTOR NPN SI	PH	2N5770
Q102	TRANSISTOR NPN SI	PH	2N5770
Q103	TRANSISTOR NPN SI	PH	2N5770
Q104	TRANSISTOR NPN SI	F	BF469
Q105	TRANSISTOR NPN SI		BF469
Q106	TRANSISTOR NPN SI		BC317
Q107	TRANSISTOR NPN SI		BC317
Q201	TRANSISTOR PNP SI	F/NS	PN4121
Q202	TRANSISTOR PNP SI	F/NS	PN4121
Q203	TRANSISTOR NPN SI	F/PH	BC207
Q251	TRANSISTOR NPN SI	PH	2N5770
Q252	TRANSISTOR NPN SI	PH	2N5770
Q253	TRANSISTOR NPN SI	PH	2N5770
Q254	TRANSISTOR NPN SI	PH	2N3645
Q255	TRANSISTOR PNP SI	PH	2N5770
Q256	TRANSISTOR NPN SI	F/PH	BC207
Q257	N CHANNEL FET	SI NS	MPF106
Q258	TRANSISTOR NPN SI	F/PH	BC207
Q259	TRANSISTOR NPN SI	PH	BF469
Q260	TRANSISTOR NPN SI	PH	BF469
Q261	TRANSISTOR PNP SI	F/PH	BC307
U90	AMPLIFIER 14 PIN	F/NS	733C
U1A&B	N CHANNEL F.E.T. MATCHED PAIR SI	NS	NPD8303
U81A&B	N CHANNEL F.E.T. MATCHED PAIR SI	NS	NPD8303
D1	DIODE	F	FD300
D2	DIODE	F	FD300
D51	DIODE	F	FD300
D52	DIODE	F	FD300
D91/95	DIODE	F	IN4148
D96	ZENER DIODE 33V	PH	BZX79/C33
D97	DIODE	F	IN4148
D99/107	DIODE	F	IN4148
D108	ZENER DIODE 4.7V	PH	BZX79/C4V7

PARTS LIST - MODEL BWD 539D

CCF Ref	DESCRIPTION	Mfg or Supply	PART NO.
D251- D256	DIODE	F	1N4148
D257	ZENER DIODE 6.2V	PH	BZY79/6V2
D258- D260	DIODE	F	1N4148
D261- D266	DIODE		1N4004
D351- D353	DIODE	PH	BY187
D354- D355	DIODE		1N4007
D356	DIODE	F	1N4148
S1 S2A-D	2 POLE 3 POS. SLIDE SWITCH 4 POLE 12 POS. TYPE F ROTARY SWITCH	McM	1299-03-01
S51 S52A-D	2 POLE 3 POS. SLIDE SWITCH 4 POLE 12 POS. TYPE F ROTARY SWITCH	BWD McM	SR73 1299-03-01
S91A-B S53A-B	ISOSTAT SINGLE SECTION SWITCH 2 POLE 2 POS. REAR OF RV53	BWD BWD	SR73 SR80
S92A-B	ISOSTAT SINGLE SECTION SWITCH	BWD	SR80
S201- S204	4 BANK ISOSTAT SWITCH	BWD	100/120/1
S251 S252	2 POLE 2 POS. REAR OF RV251 2 POLE 2 POS. PUSH-PULL SWITCH REAR OF RV254		
S401A- D	4 POLE 19 POS. ROTARY SWITCH WITH P.C. BOARDS Nos. 160/213A & 160/167C	BWD	SR72
S255A- B	2 POLE 2 POS. REAR OF RV351		

PARTS LIST - MODEL BWD 539D

CCF Ref	DESCRIPTION	Mfg or Supply	PART NO.
	<u>SUNDRY:</u>		
L1	TRACE ROTATION COIL	BWD	090-175-1
V251	CRT 5"	THORN	D13/611GH
B251	NEON LAMP	SON	MB227
F251	CARTRIDGE FUSE 0.25A Delay for 240V 0.5A Delay for 115V		
T251	POWER TRANSFORMER	BWD	090-176-1
	CRT MAGNETIC SHIELD	BWD	
TH1)	82Ω THERMISTOR	PH	2322-610-11829
TH5)			
	ALL OTHER ITEMS ORDER BY DESCRIPTION QUOTING BOTH MODEL NUMBER AND SERIAL NUMBER.		

WAVEFORMS

1kHz \sim I/P SIG TO GIVE 4cm DEFLECTION I/P ATTEN=0.1/kcm. D.C. TIME BASE = 0.5ms/cm. TRIG. = AUTO, + CH1 ALT-CHOP = ALT.

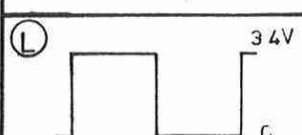
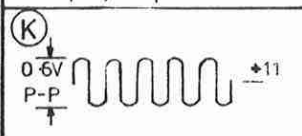
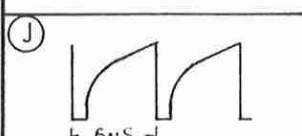
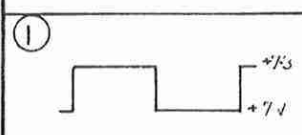
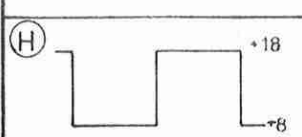
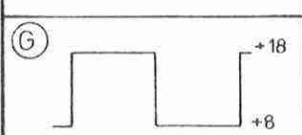
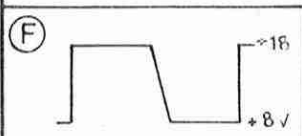
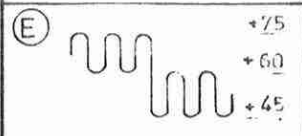
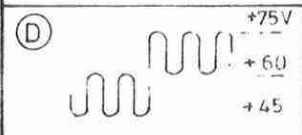
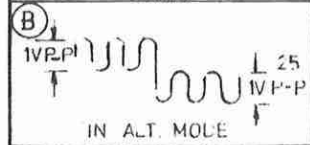
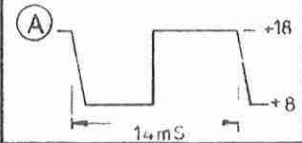

SWITCHES

S1	AC-GND-DC CH1
S2A-D	CH1 ATTENUATOR
S51	AC-GND-DC CH2
S52A-D	CH2 ATTENUATOR
S53	CH2 OFF (REAR RV53)
S91A & B	CH1 or CH2 TRIG. SELECT
S92A	ALT-CHOPPED SELECT
S201A	TB-XY SELECT (PART OF)

CONTROLS

RV 1	D.C. BALANCE CH1.
RV 2	SET GAIN CH1
RV 3	VERT. POSITION CH1
RV 51	DC BALANCE CH 2
RV 52	SET GAIN CH 2
RV 53	VERT. POSITION CH 2
RV 91	SET CAL OUTPUT 1Vp-p
RV 92	X-Y DC LEVEL
RV 93	X-Y GAIN LEVEL
RV 94	H.F. RESPONSE

SWITCHES

S92B	ALT-CHOP SELECTOR
S201B-D	T.B. or X-Y SELECTOR
S202 A & B	N or TV TRIGGER
S203	+ or - TRIGGER
S204	INT or EXT TRIGGER
S251A & B	LEVEL AUTO TRIGGER (REAR RV251)
S252	x1 or x5 HORZ. MAG. (REAR RV254)
S255 A & B	POWER ON-OFF (REAR RV 351)
S401A-D	T.B. RANGE

CONTROLS

RV 201	'Y' OUT CAL (1mV)
RV 202	X-Y CENTREING
RV 251	TRIG. LEVEL SELECT
RV 252	TRIG. SENSITIVITY
RV 253	TRACE LENGTH
RV 254	HORZ. POSITION
RV 255	x5MAG PRESET
RV 256	x 5MAG CENTREING
RV 257	GEOMETRY
RV 258	ASTIGMATISM
RV 259	FOCUS
RV 260	TRACE ROTATION
RV 261	T.B. CALIBRATE
RV 351	INTENSITY CONTROL
RV 352	INTENSITY PRESET
RV401	T.B. VERNIER

WAVEFORMS

CONDITIONS AS FOR
WAVEFORMS # 1368

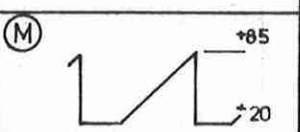
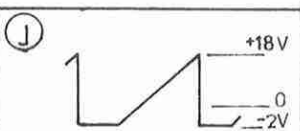
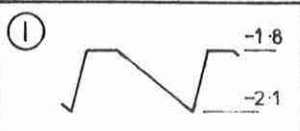
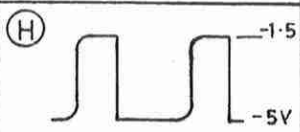
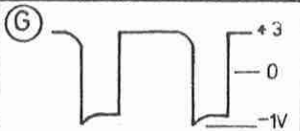
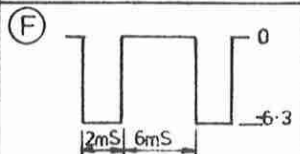
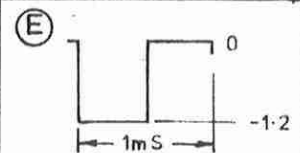
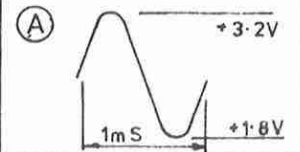

COMPOSITE VIDEO WAVEFORM WITH COLOUR BURST
ATTEN. 0.2V/cm 8cm DEFLECTION TRIG -TV +INT.

