

ALIMENTATION DES FILAMENTS DES LAMPES

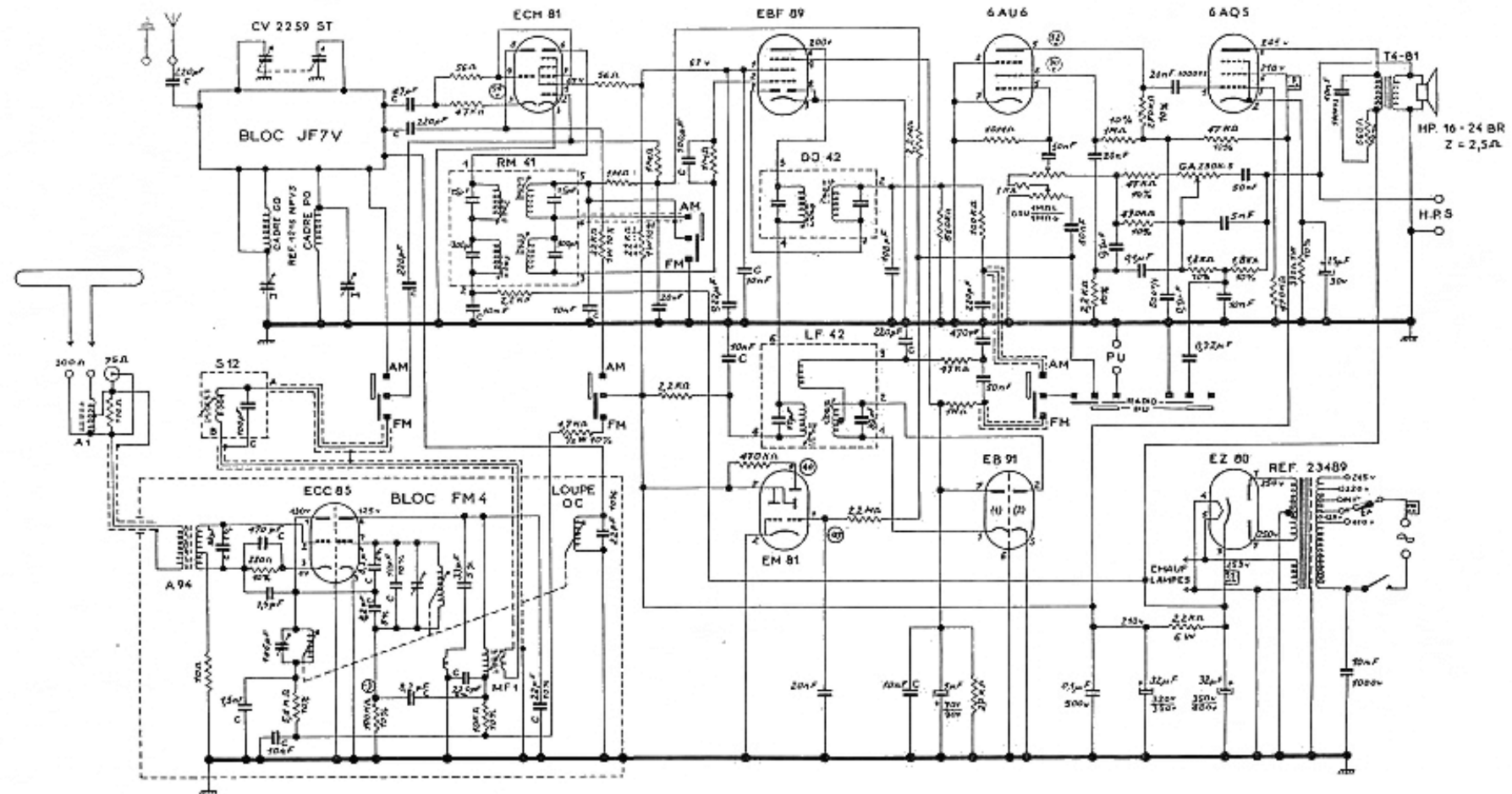

NOTA
 C = CERAMIQUE
 M = MICA
 (C) = TENSION CONTINUE MESUREE AU VOLTMETRE A LAMPES
 210V = TENSION CONTINUE MESUREE AU CONTROLEUR UNIVERSEL
 (I) = INTENSITE MESUREE AU CONTROLEUR UNIVERSEL
 LES RESISTANCES NON SPECIFIEES SONT A 20%

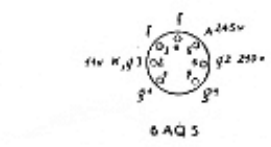
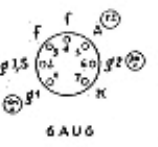
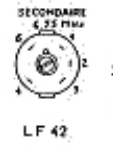
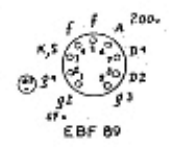
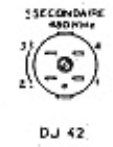
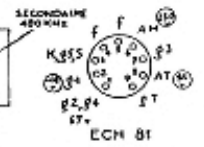
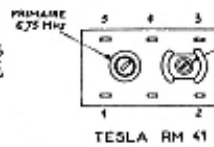
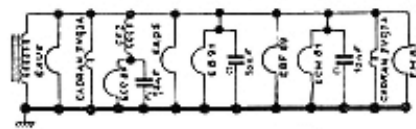
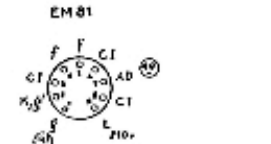
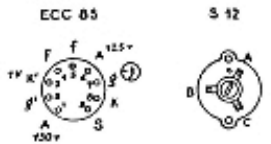

FANDANGO - FM