

KV-20TR23/2160WR/2150R

RM-Y116

SERVICE MANUAL



RM-Y116

US Model

KV-20TR23 Chassis No. SCC-F78C-A

Canadian Model

KV-20TR23 Chassis No. SCC-F79B-A

WP Model

KV-2160WR Chassis No. SCC-F81B-A

E Model

KV-2150R Chassis No. SCC-F80B-A

BA-1 CHASSIS

MODELS OF THE SAME SERIES

KV-20TR23/2160WR/2150R	
KV-20TS29/20TS32	
KV-21STR2/2170RS	

SPECIFICATIONS

Television system	American TV standards	Speaker output	2W (8 ohms)
Channel coverage	VHF: 2-13	Speaker size	Full range 50×90 mm (2×3 ⁵ / ₈ in.)
	UHF: 14-69	Audio frequency	50Hz-20kHz
	CABLE TV: 1-125	response	
Picture tube	Hi-Black Trinitron® tube	Power requirements	120 V AC, 60Hz
	20-inch picture measured diagonally		110-127V or 220-240V AC, 50-60Hz
Antenna	21-inch picture tube measured diagonally		(KV-2160WR only)
	75 ohm external antenna	Power consumption	115W
Input	terminal for VHF/UHF	Standby mode	4W
	VIDEO		5.5W (KV-2160WR only)
	Video (phono jacks) : 1 Vp-p, 75-ohms	Dimensions (w/h/d)	526×488×471.5 mm
	unbalanced, sync negative		(20 ³ / ₄ ×19 ¹ / ₄ ×18 ⁵ / ₈ inches)
	Audio (phono jacks) :	Weight	22.4 kg (49 lbs 6 oz)
	500 mVrms (100% modulation)		
	Impedance : 47 kilohms		

- Continued on next page -



TRINITRON® COLOR TV
SONY®

Supplied accessories	Remote Commander RM-Y116 (1) with 2 size AA (R6) EVEREADY batteries Dipole antenna (1) Antenna connector (1) Power cord plug adaptor * (KV-2160WR only)
Recommended accessories	U/V mixer EAC-66 Connecting cord VMC-810S/820S, VMC-720M YC-15V/30V, RK-74A

* AC power cord connection

If the power cord plug cannot be inserted into the wall outlet, use the supplied power cord plug adaptor.

Design and specifications are subject to change without notice.

WARNING!!

AN ISOLATION TRANSFORMER SHOULD BE USED DURING ANY SERVICE TO AVOID POSSIBLE SHOCK HAZARD, BECAUSE OF LIVE CHASSIS. THE CHASSIS OF THIS RECEIVER IS DIRECTLY CONNECTED TO THE AC POWER LINE.

SAFETY-RELATED COMPONENT WARNING !!

COMPONENTS IDENTIFIED BY SHADING AND MARK Δ ON THE SCHEMATIC DIAGRAMS, EXPLODED VIEWS AND IN THE PARTS LIST ARE CRITICAL TO SAFE OPERATION. REPLACE THESE COMPONENTS WITH SONY PARTS WHOSE PART NUMBERS APPEAR AS SHOWN IN THIS MANUAL OR IN SUPPLEMENTS PUBLISHED BY SONY. CIRCUIT ADJUSTMENTS THAT ARE CRITICAL TO SAFE OPERATION ARE IDENTIFIED IN THIS MANUAL. FOLLOW THESE PROCEDURES WHENEVER CRITICAL COMPONENTS ARE REPLACED OR IMPROPER OPERATION IS SUSPECTED.

ATTENTION!!

AFIN D'EVITER TOUT RISQUE D'ELECTROCUTION PROVENANT D'UN CHÂSSIS SOUS TENSION, UN TRANSFORMATEUR D'ISOLEMENT DOIT ETRE UTILISÉ LORS DE TOUT DÉPANNAGE. LE CHÂSSIS DE CE RÉCEPTEUR EST DIRECTEMENT RACCORDÉ À L'ALIMENTATION SECTEUR.

ATTENTION AUX COMPOSANTS RELATIFS À LA SÉCURITÉ!!

LES COMPOSANTS IDENTIFIÉS PAR UNE TRAME ET PAR UNE MAPQUE Δ SUR LES SCHÉMAS DE PRINCIPE, LES VUES EXPLOSÉES ET LES LISTES DE PIÈCES CONT D'UNE IMPORTANCE CRITIQUE POUR LA SÉCURITÉ DU FONCTIONNEMENT. NE LES REMPLACER QUE PAR DES COMPOSANTS SONY DONT LE NUMÉRO DE PIÈCE EST INDIQUÉ DANS LE PRÉSENT MANUEL OU DANS DES SUPPLÉMENTS PUBLIÉS PAR SONY. LES RÉGLAGES DE CIRCUIT DONT L'IMPORTANCE EST CRITIQUE POUR LA SÉCURITÉ DU FONCTIONNEMENT SONT IDENTIFIÉS DANS LE PRÉSENT MANUEL. SUIVRE CES PROCEDURES LORS DE CHAQUE REMPLACEMENT DE COMPOSANTS CRITIQUES, OU LORSQU'UN MAUVAIS FONCTIONNEMENT EST SUSPECTÉ.

SAFETY CHECK-OUT

(US Model only)

After correcting the original service problem, perform the following safety checks before releasing the set to the customer:

1. Check the area of your repair for unsoldered or poorly-soldered connections. Check the entire board surface for solder splashes and bridges.
2. Check the interboard wiring to ensure that no wires are "pinched" or contact high-wattage resistors.
3. Check that all control knobs, shields, covers, ground straps, and mounting hardware have been replaced. Be absolutely certain that you have replaced all the insulators.
4. Look for unauthorized replacement parts, particularly transistors, that were installed during a previous repair. Point them out to the customer and recommend their replacement.
5. Look for parts which, though functioning, show obvious signs of deterioration. Point them out to the customer and recommend their replacement.
6. Check the line cord for cracks and abrasion. Recommend the replacement of any such line cord to the customer.
7. Check the condition of the monopole antenna (if any).
Make sure the end is not broken off, and has the plastic cap on it. Point out the danger of impalement on a broken antenna to the customer, and recommend the antenna's replacement.
8. Check the B+ and HV to see they are at the values specified. Make sure your instruments are accurate; be suspicious of your HV meter if sets always have low HV.
9. Check the antenna terminals, metal trim, "metallized" knobs, screws, and all other exposed metal parts for AC leakage. Check leakage as described below.

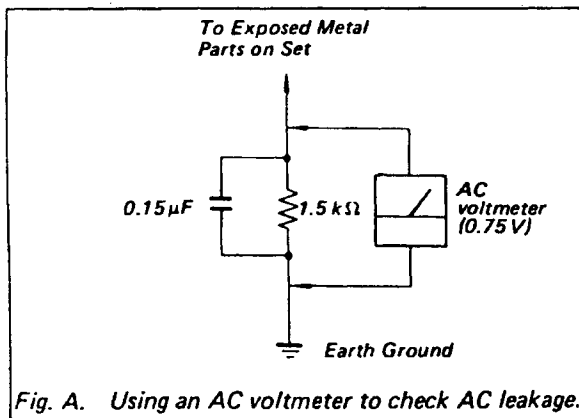
**LEAKAGE TEST**

The AC leakage from any exposed metal part to earth ground and from all exposed metal parts to any exposed metal part having a return to chassis, must not exceed 0.5 mA (500 microamperes). Leakage current can be measured by any one of three methods.

1. A commercial leakage tester, such as the Simpson 229 or RCA WT-540A. Follow the manufacturers' instructions to use these instruments.
2. A battery-operated AC milliammeter. The Data Precision 245 digital multimeter is suitable for this job.
3. Measuring the voltage drop across a resistor by means of a VOM or battery-operated AC voltmeter. The "limit" indication is 0.75 V, so analog meters must have an accurate low-voltage scale. The Simpson 250 and Sanwa SH-63Trd are examples of a passive VOM that is suitable. Nearly all battery operated digital multimeters that have a 2V AC range are suitable. (See Fig. A)

HOW TO FIND A GOOD EARTH GROUND

A cold-water pipe is guaranteed earth ground; the cover-plate retaining screw on most AC outlet boxes is also at earth ground. If the retaining screw is to be used as your earth-ground, verify that it is at ground by measuring the resistance between it and a cold-water pipe with an ohmmeter. The reading should be zero ohms. If a cold-water pipe is not accessible, connect a 60-100 watts trouble light (not a neon lamp) between the hot side of the receptacle and the retaining screw. Try both slots, if necessary, to locate the hot side of the line, the lamp should light at normal brilliance if the screw is at ground potential. (See Fig. B)

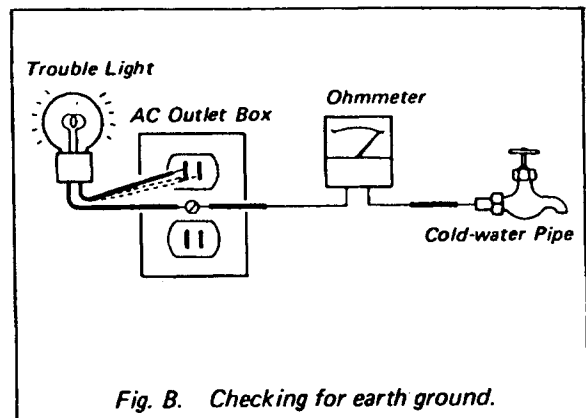

TABLE OF CONTENTS

<u>Section</u>	<u>Title</u>	<u>Page</u>	<u>Section</u>	<u>Title</u>	<u>Page</u>
1.	GENERAL		4.	SAFETY RELATED ADJUSTMENTS	27
1-1.	Identifying Your TV	5	5.	CIRCUIT ADJUSTMENTS	
1-2.	Locating the Controls	6	5-1.	Electrical Adjustment by Remote Commander	29
1-3.	Using the ON-SCREEN Menus	8	5-2.	A Board Adjustments	31
1-4.	Turning the Cable Mode ON or OFF	10	6.	DIAGRAMS	
1-5.	Presetting TV Channels	10	6-1.	Block Diagram	35
1-6.	Connecting Other Equipment	13	6-2.	Circuit Boards Location	39
1-7.	Watching TV Programs	13	6-3.	Printed Wiring Boards and Schematic Diagrams	39
1-8.	Using Convenient Features	14	• A Board	40	
1-9.	Adjusting Picture and Sound Quality	14	• G Board (KV-20TR23/2150R)	47	
1-10.	Using Closed Caption (U.S.A. models only)	15	• G Board (KV-2160WR)	49	
1-11.	Using the Timer-Activated Functions	16	• C Board	52	
1-12.	Customizing the Screen Display	19	• S Board (KV-20TR23(US Model))	55	
1-13.	Troubleshooting	20	6-4.	Semiconductors	57
2.	DISASSEMBLY		7.	EXPLODED VIEW	
2-1.	Rear Cover Removal	21	7-1.	Chassis	58
2-2.	Service Position	21	8.	ELECTRICAL PARTS LIST	59
2-3.	Picture Tube Removal	22			
3.	SET-UP ADJUSTMENTS				
3-1.	Beam Landing	23			
3-2.	Convergence	24			
3-3.	Focus	26			
3-4.	Screen (G2)	26			
3-5.	Method of Setting the Service Adjustment Mode	26			
3-6.	White Barance Adjustments	26			

1-1. IDENTIFYING YOUR TV

SECTION 1 GENERAL

This section is extracted from instruction manual.

Identifying Your TV

Check the model number of your TV set. This manual covers 11 models and there are slight differences among them. Check the table below to see what your TV is equipped with before you start operating it.

Table of models YES: equipped NO: not equipped

	KV-20TR23 KV-2150R KV-2160WR
MTS stereo	NO
Headphones jack	YES*
S video input jack	NO
Front panel AV jacks	NO

* Monaural sound is output by both headphone speakers.

	KV-20TR23	KV-2150R KV-2160WR
Model destination	U.S.A./Canda	Central South America and other area
Closed caption	YES**	NO
Dual Language	NO	YES

** U.S.A. models only.

Design

KV-20TR23 KV-2150R
KV-2160WR

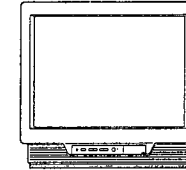

1-2. LOCATING THE CONTROLS

Screen Displays

For details, see the pages indicated by the numbered black circles ●.

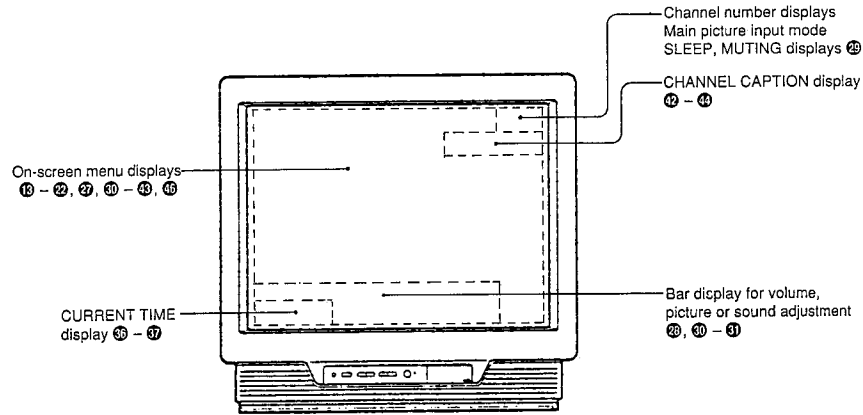

Front Panel

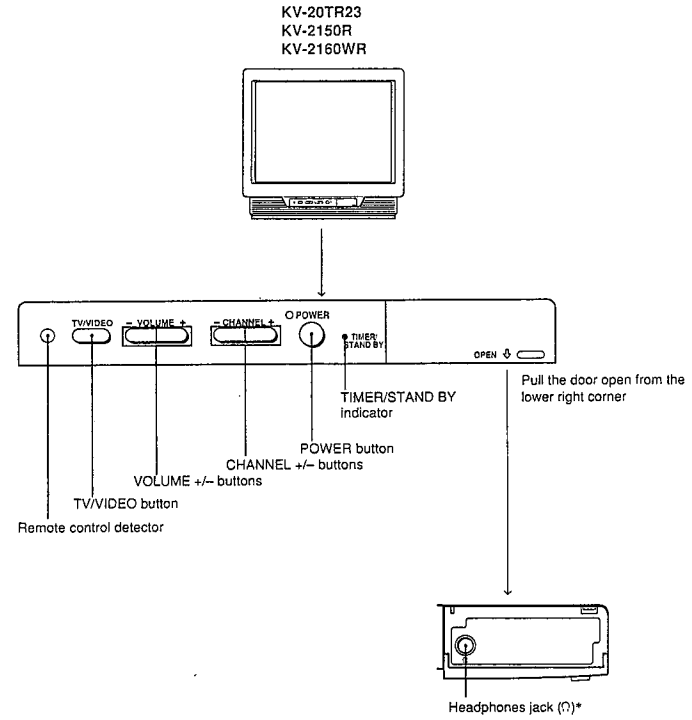

* Monaural sound is output by both headphone speakers.

Rear Panel

For details, see the pages indicated by the numbered black circles ●.

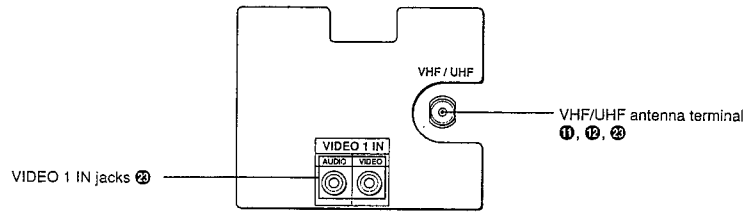

These models are equipped with only one set of video input jacks.

Remote Commander

For details, see the pages indicated by the numbered black circles ●.

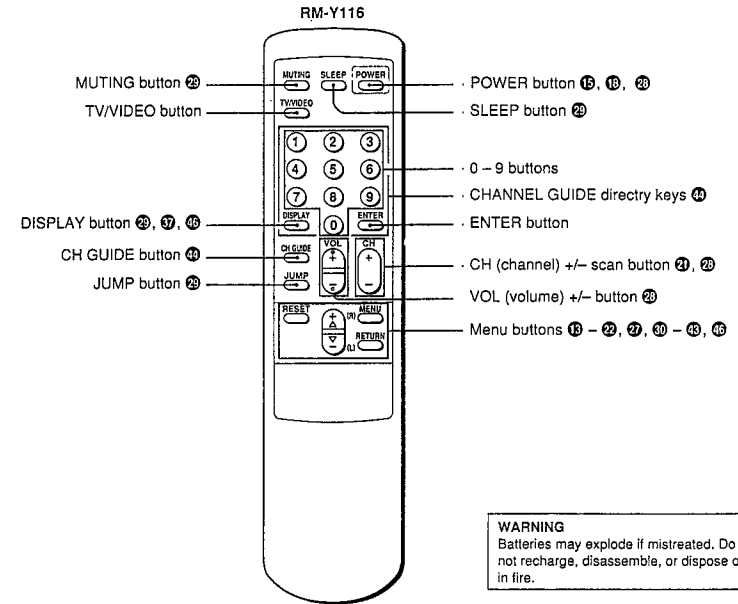

WARNING
Batteries may explode if mistreated. Do not recharge, disassemble, or dispose of in fire.

Installing batteries

- 1 Remove the battery compartment cover.

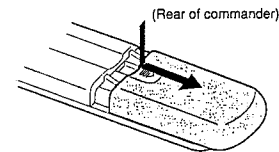

- 2 Insert two size AA (R6) batteries in correct polarity.

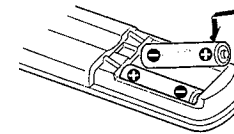

Battery life

With normal operation, batteries will last up to half a year. If the Remote Commander does not operate properly, the batteries might be exhausted. Replace both of them with new ones.

To avoid damage from possible battery leakage

Remove the batteries if you do not plan to use the Remote Commander for a fairly long time.

1-3. USING THE ON-SCREEN MENUS

The following flow chart shows the different levels of on-screen menus that you can use to make various adjustments and settings. See the indicated pages for instructions on using each feature.

For picture quality adjustment

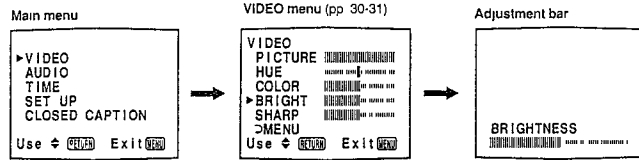

For sound quality adjustment

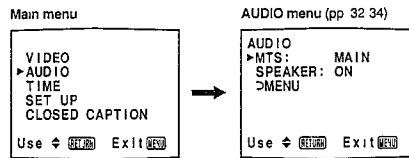

For time-related setting

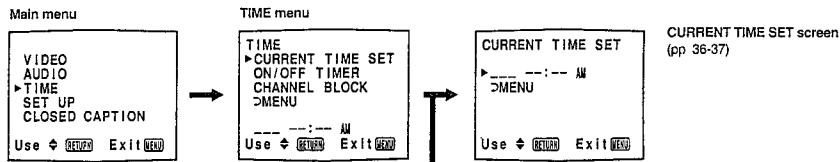

For language setting (pp 15-16)

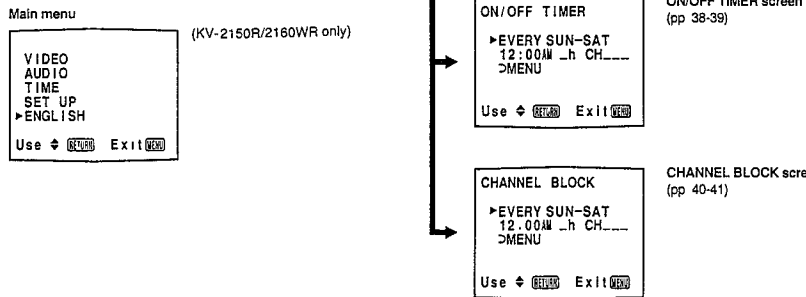

For presetting and other functions

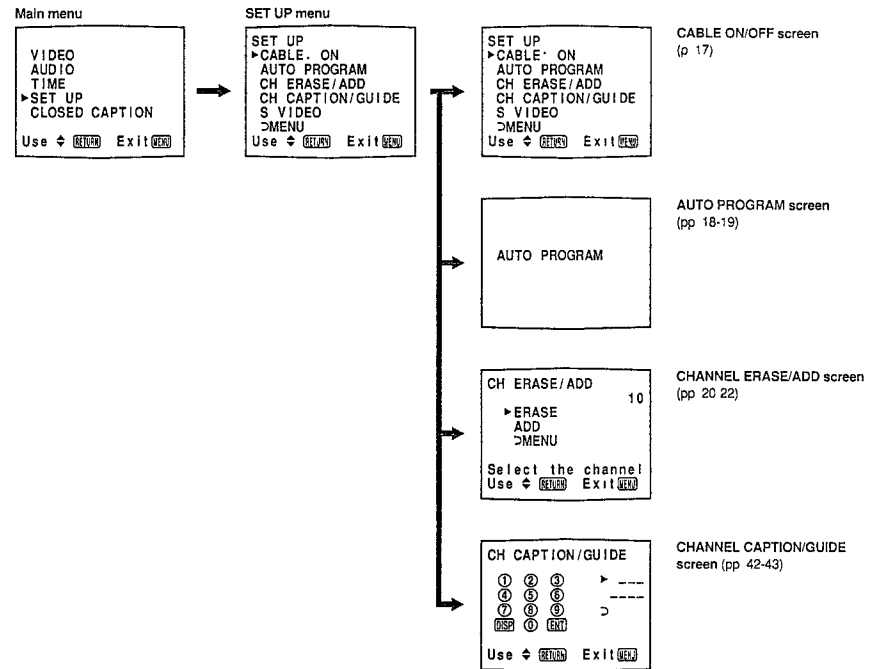

For closed caption setting (p 35)

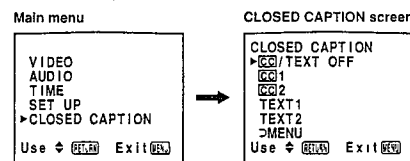

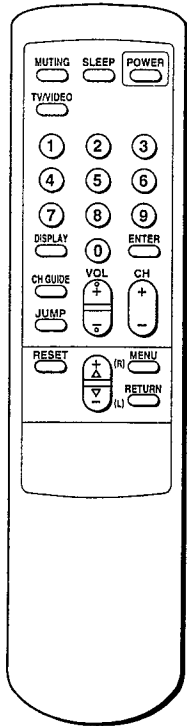

RM-Y116

Navigating Through the Menus

To display the main menu
Press MENU.

To return to the previous menu
Press Δ+ or ▽- to select ◀ MENU.
Then press RETURN.

To return to the main menu
Repeat the above, until you reach the main menu.

To return to the normal screen
Press MENU on the Remote Commander.

Note

The menus disappear automatically if you do not press a button within 90 seconds

Changing the Menu Language

(KV-2150R/2160WR only)

The menu language is factory-set to ENGLISH. Follow these instructions to change the menu language to Spanish or back to English.

1 Press POWER on the TV or the Remote Commander to turn the TV on

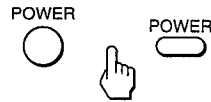

2 Press MENU.
The main menu appears



3 Press the Δ+ or ▽- to select ENGLISH
Then press RETURN

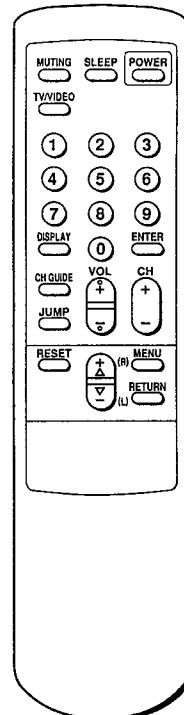
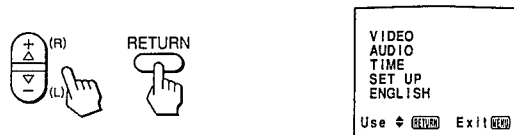

RM-Y116

To return to the normal screen
Press MENU

4 Press Δ+ or ▽- to select the language
Each time you press Δ+ or ▽-, the ESPAÑOL and ENGLISH menus appear

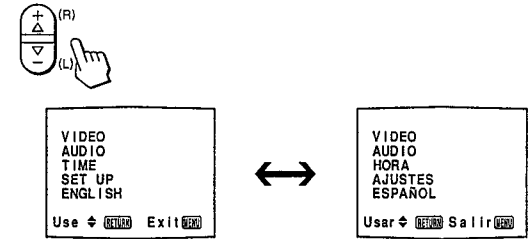

Note

Certain parts of the ESPAÑOL menus remain in English

5 Press RETURN
The language is selected



1-4. TURNING THE CABLE MODE ON OR OFF

All of the controls are on the Remote Commander

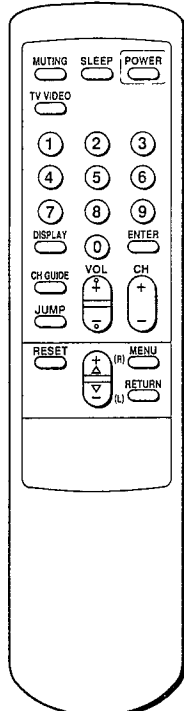

RM-Y116

To return to the normal screen
Press MENU

If you have cable connected to your TV (p 11), follow the steps below to turn the cable connection on or off. CABLE is preset to ON when you use your TV for the first time. Turn CABLE to OFF to preset or watch VHF or UHF channels (pp 18–22, 28)

- 1** Press MENU
The main menu appears



VIDEO
AUDIO
TIME
SET UP
CLOSED CAPTION
Use \blacktriangleleft (MENU) Exit (EXIT)

- 2** Press Δ + or ∇ - to select SET UP

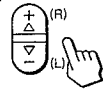

VIDEO
AUDIO
TIME
▶SET UP
CLOSED CAPTION
Use \blacktriangleleft (MENU) Exit (EXIT)

Press RETURN
The SET UP menu appears, and the cursor points to CABLE



SET UP
▶CABLE: ON
AUTO PROGRAM
CH ERASE/ADD
CH CAPTION/GUIDE
S VIDEO
▶MENU
Use \blacktriangleleft (RETURN) Exit (EXIT)

Note

If the CABLE display appears in black, the TV is in video mode and you cannot select CABLE. Press TV/VIDEO to change to TV mode.

- 3** Press RETURN again



Press Δ + or ∇ - to select ON or OFF alternately.

SET UP
CABLE: OFF
AUTO PROGRAM
CH ERASE/ADD
CH CAPTION/GUIDE
S VIDEO
▶MENU
Use \blacktriangleleft (RETURN) Exit (EXIT)



SET UP
▶CABLE: ON
AUTO PROGRAM
CH ERASE/ADD
CH CAPTION/GUIDE
S VIDEO
▶MENU
Use \blacktriangleleft (RETURN) Exit (EXIT)

Press RETURN
The setting is completed

1-5. PRESETTING TV CHANNELS

By presetting TV channels to the TV, you can select channels by pressing CHANNEL +/- on the TV or CH +/- on the Remote Commander

Presetting TV Channels Automatically

Note

Perform auto programming during the day rather than late at night when some channels may not be broadcasting

- 1** Press POWER on the TV or the Remote Commander to turn the TV on

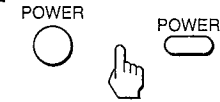

- 2** Turn the cable connection on or off to select the type of channel you want to preset, VHF/UHF or cable TV
(Follow the steps in "Turning the Cable Mode On or Off," p 17)

- 3** Press MENU
The main menu appears



▶VIDEO
AUDIO
TIME
SET UP
CLOSED CAPTION
Use \blacktriangleleft (MENU) Exit (EXIT)

- 4** Press Δ + or ∇ - to select SET UP



VIDEO
AUDIO
TIME
▶SET UP
CLOSED CAPTION
Use \blacktriangleleft (MENU) Exit (EXIT)

Press RETURN
The SET UP menu appears



SET UP
▶CABLE: ON
AUTO PROGRAM
CH ERASE/ADD
CH CAPTION/GUIDE
S VIDEO
▶MENU
Use \blacktriangleleft (RETURN) Exit (EXIT)

Note

If the AUTO PROGRAM display appears in black, the TV is in video mode and you cannot select AUTO PROGRAM. Press TV/VIDEO to change to TV mode.

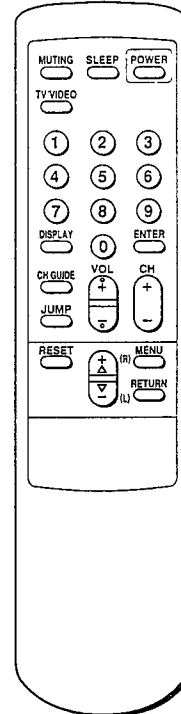
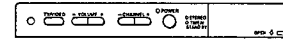

RM-Y116

5 Press Δ + or ∇ - to select AUTO PROGRAM.

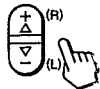

Press RETURN.

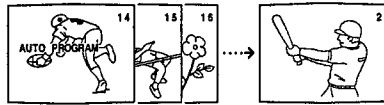

```

SET UP
CABLE: ON
▶ AUTO PROGRAM
CH ERASE/ADD
CH CAPTION/GUIDE
S VIDEO
>MENU
Use  $\Delta$  [RETURN] Exit [EXIT]
    
```

"AUTO PROGRAM" appears on the screen and receivable channels (other than the channels already preset) are preset in numerical sequence. The channels previously preset will not remain in the TV's memory. When no more channels can be found, the programming stops and the lowest numbered channel is displayed.

Receivable channels for this TV
VHF: 2 - 13
UHF: 14 - 69
Cable: 1 - 125

To select TV channels without presetting
Press 0 - 9 and ENTER.

To return to the normal screen
Press MENU.

To erase unnecessary channels, or to add channels that could not be preset automatically because their signal was too weak, follow the steps in "Erasing Unnecessary Channels - CHANNEL ERASE" (pp. 20-21) and "Presetting Only Desired Channels - CHANNEL ADD" (p. 22).

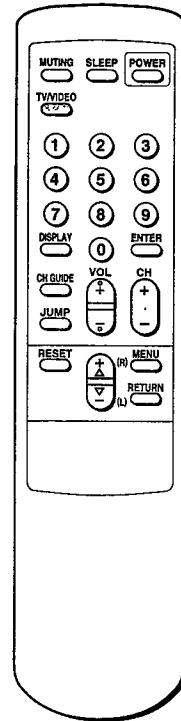

RM-Y116

Erasing Unnecessary Channels - CHANNEL ERASE

Use this feature to erase unnecessary TV channels, so that when you press CH +/-, the channel(s) are skipped.

1 Press MENU.
The main menu appears



```

▶ VIDEO
AUDIO
TIME
SET UP
CLOSED CAPTION
Use  $\Delta$  [RETURN] Exit [EXIT]
    
```

2 Press Δ + or ∇ - to select SET UP.

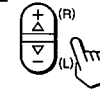

Press RETURN
The SET UP menu appears



```

VIDEO
AUDIO
TIME
▶ SET UP
CLOSED CAPTION
Use  $\Delta$  [RETURN] Exit [EXIT]
    
```

```

SET UP
▶ CABLE: ON
AUTO PROGRAM
CH ERASE/ADD
CH CAPTION/GUIDE
S VIDEO
>MENU
Use  $\Delta$  [RETURN] Exit [EXIT]
    
```

3 Press Δ + or ∇ - to select CH ERASE/ADD

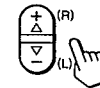

Press RETURN
The CH ERASE/ADD screen appears, and the cursor points to ERASE



```

SET UP
CABLE: ON
AUTO PROGRAM
▶ CH ERASE/ADD
CH CAPTION/GUIDE
S VIDEO
>MENU
Use  $\Delta$  [RETURN] Exit [EXIT]
    
```

```

CH ERASE/ADD 10
▶ ERASE
ADD
>MENU
Select the channel
Use  $\Delta$  [RETURN] Exit [EXIT]
    
```

Note

If the CHANNEL ERASE/ADD display appears in black, the TV is in video mode and you cannot select CHANNEL ERASE/ADD. Press TV/VIDEO to change to TV mode.

4 Press the CH +/- button to select the channel you want to erase
For example, to erase channel 8, press CH + or - until 8 appears

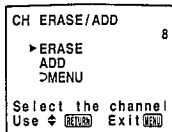
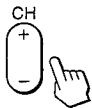

Press RETURN.

A "-" sign appears in front of the channel number display showing that the channel is erased from the channel scan memory

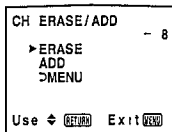

The next time you press the CH +/- buttons, channel 8 will be skipped

To erase other channels
Repeat step 4

To return to the normal screen
Press MENU

Note

If you erase a VHF or UHF channel, the cable TV channel with the same number is also erased, and vice versa

Cable TV channel chart*

Cable TV systems use letters or numbers to designate channels. To tune in a channel, refer to the chart below

Number on this TV	Corresponding cable TV channel
1	A-8
5	A-7
6	A-6
14	A
15	B
16	C
17	D
18	E
19	F
20	G
21	H
22	I
23	J
24	K
25	L
26	M
27	N
28	O
29	P
30	Q
31	R
32	S
33	T
34	U
35	V
36	W
37	W+1
38	W+2
39	W+3
:	:
93	W+57
94	W+58
95	A-5
96	A-4
97	A-3
98	A-2
99	A-1
100	W+59
101	W+60
102	W+61
:	:
123	W+82
124	W+83
125	W+84

* This designation of cable TV channels conforms to the EIA/NCTA recommendation. Check with your local cable TV company for more complete information on the available channels

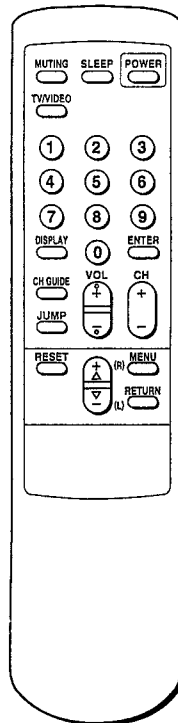

RM-Y116

To return to the normal screen
Press MENU

Note

If you add a VHF or UHF channel, the cable TV channel with the same number is also added, and vice versa

Presetting Only Desired Channels—CHANNEL ADD

Use this feature to add channels one by one to the channel scan memory

1-3 (Follow steps 1-3 in "Erasing Unnecessary Channels – CHANNEL ERASE," p 20)

Note

If CH ERASE/ADD display appears in black, the TV is in video mode and you cannot select CH ERASE/ADD. Press TV/VIDEO to change to TV mode

4 Press Δ + or ∇ - to select ADD

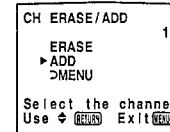
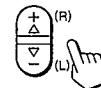

5 Press 0-9 and ENTER to select the channel you want to add. For example, to add channel 25, press 2, 5 and ENTER

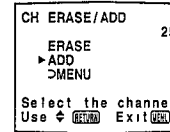
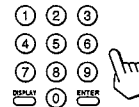

Press RETURN

A "+" sign appears in front of the channel number display showing that the channel is added to the channel scan memory

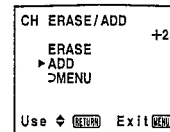

To add other channels
Repeat step 5

1-6. CONNECTING OTHER EQUIPMENT

Connecting Video Equipment

After connecting, you will be able to play back video tapes.

Connecting video equipment to a monaural TV

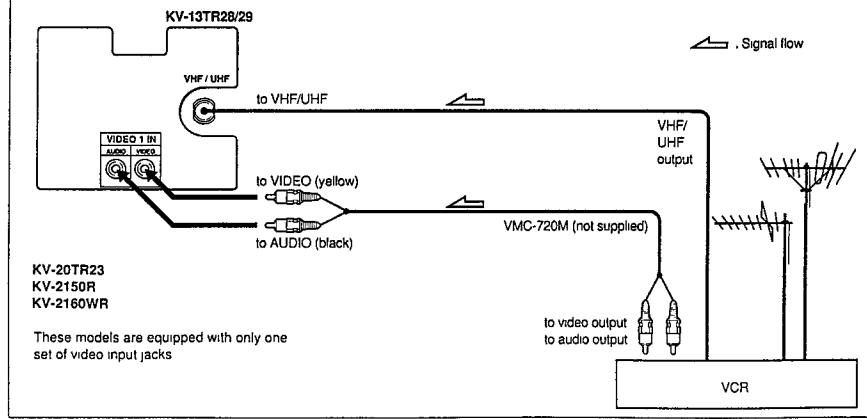

1-7. WATCHING TV PROGRAMS

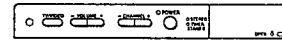

1 Press POWER on the TV or the Remote Commander to turn the TV on

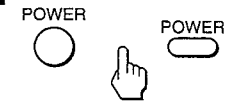

The TIMER/STAND BY indicator blinks until the picture appears on the screen

2 Turn the cable mode on or off to select the type of channel you want to watch, VHF/UHF or cable TV
(Follow the steps in "Turning the Cable Mode On or Off," p 17)

If "VIDEO" or "S VIDEO" is displayed on the screen, press the TV/VIDEO button on the TV or on the Remote Commander so that the channel number appears

3 Select a channel in one of the following two ways:

To scan the preset channels* in numerical sequence
Press CH +/-.

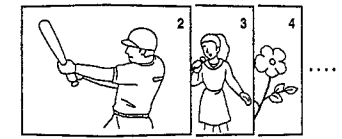
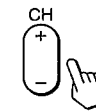

* For more information on presetting channels, see pp 18 - 22

To select a channel directly
Press 0 - 9 and ENTER.

For example, to select channel 14, press 1, 4 and ENTER.

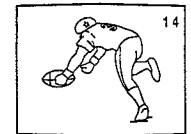

4 Press VOL +/- to adjust the volume.

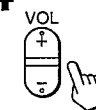

The display will disappear automatically after 3 seconds



Press + to increase the volume
Press - to decrease the volume

To turn off the TV

Press POWER on the TV or the Remote Commander again.

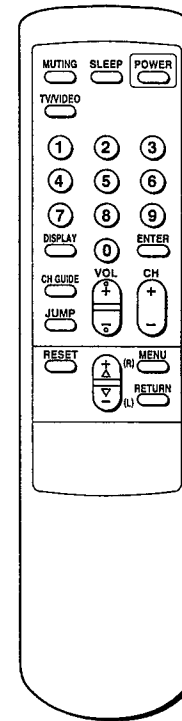

RM-Y116

1-8. USING CONVENIENT FEATURES

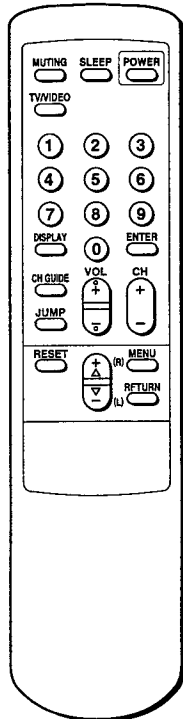

RM-Y116

Muting the Sound — MUTING

Press **MUTING**
The display "MUTING" will appear on the screen



To restore the sound
Press **MUTING** again, or press **VOL +**

Keeping the Displays On-Screen — DISPLAY

To display the channel
Press **DISPLAY**.
All the existing displays appear: channel number, channel caption (if set), MTS mode (SAP only) and the current time ("AM" or "PM" disappears after about three seconds)



To cancel the display
Press **DISPLAY** again.
The channel display will disappear

Setting the Sleep Timer — SLEEP

The sleep timer turns off the TV automatically after the amount of time you select

Press **SLEEP**
Each time you press **SLEEP**, the time increments 30, 60, 90 and OFF mode appear in sequence



SLEEP 30
SLEEP 60
SLEEP 90
SLEEP OFF

The **SLEEP** display appears about one minute before the TV turns off

To cancel the setting
Press **SLEEP** until OFF mode appears
The "SLEEP OFF" display appears for about three seconds
OR
Turn the TV off.
The sleep timer setting is cancelled

Switching Quickly Between Two Channels — JUMP

Press **JUMP** once to recall the channel you were watching previously. Press **JUMP** again to switch back. Use this feature to keep track of two programs alternately



1-9. ADJUSTING PICTURE AND SOUND QUALITY

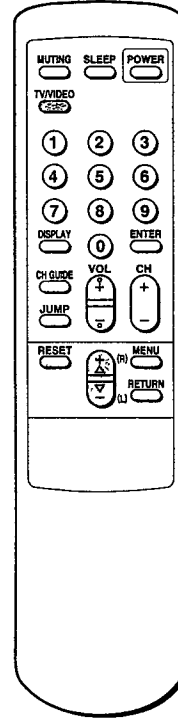

RM-Y116

Adjusting Picture Quality

You can adjust the picture for each input mode (TV, VIDEO) by pressing **TV/VIDEO** to select the input mode before making the adjustments. These adjustments are retained in memory even when you turn off the TV until you change the adjustments again.

1 Press **MENU**.
The main menu appears, and the cursor points to **VIDEO**

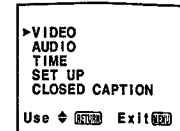

2 Press **RETURN**.
The **VIDEO** menu appears

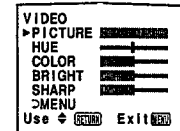

3 Press **Δ+** or **∇-** to select the item you want to adjust.
For example, to adjust the picture brightness, select **BRIGHT**.

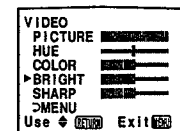
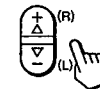

Press **RETURN**.
The adjustment bar appears.



4 Press Δ+ or ∇- to make the adjustment

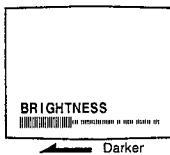

Press RETURN.
The new setting appears in the VIDEO menu



To adjust other items
Repeat steps 3 - 4.

	Press ∇- to	Press Δ+ to
PICTURE	decrease picture contrast with soft color	increase picture contrast with vivid color
HUE	make skin tones become purplish	make skin tones become greenish
COLOR	decrease color intensity	increase color intensity
BRIGHTNESS	darken the picture	brighten the picture
SHARPNESS	soften the picture	sharpen the picture

To return to the normal screen
Press MENU

To restore the factory (mid-level) setting
Go to the VIDEO menu and press RESET
All the settings except for PICTURE will be restored to the mid-level setting

Note

The menus and adjustment bars will disappear automatically after 90 seconds if you do not press any other buttons during that time

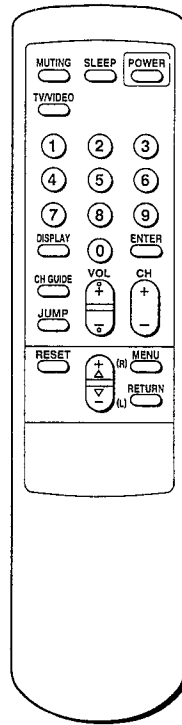

RM-Y116

To return to the normal screen
Press MENU

1-10. USING CLOSED CAPTION (U.S.A. models only)

1 Press MENU.
The main menu appears

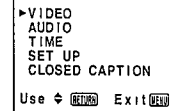

2 Press Δ+ or ∇- to select CLOSED CAPTION
Then press RETURN
The CLOSED CAPTION screen appears

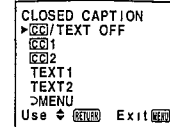

3 Press Δ+ or ∇- to select closed caption mode



Select CC1 or CC2 to view Captions
A Caption is a printed version of the dialogue or sound effects of a program (The mode should be set to CC1 for most programs)

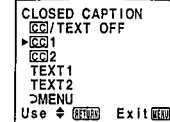

Select TEXT1 or TEXT2 to view Text.
Text is information that is presented using the half to full television screen
It is usually not related to the program

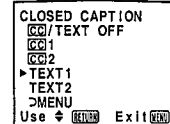

Select CC/TEXT OFF if you do not want to use the CLOSED CAPTION mode

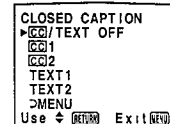

Press RETURN
The Setting is completed



1-11. USING THE TIMER-ACTIVATED FUNCTIONS

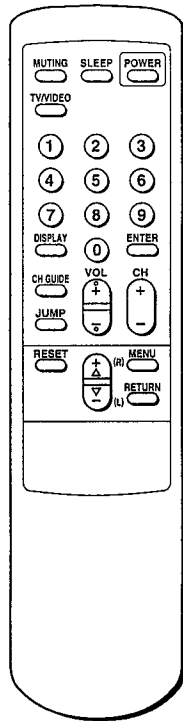

RM-Y116

Setting the Clock – CURRENT TIME SET

Follow these instructions to set the current time. The correct time must be set in order to use the other timer-activated functions (ON/OFF TIMER, CHANNEL BLOCK).

EXAMPLE. Set the time to 3 15 PM, Monday.

1 Press MENU.
The main menu appears

VIDEO
AUDIO
TIME
SET UP
CLOSED CAPTION

Use \leftarrow [RETURN] Exit [EXIT]

2 Press Δ + or ∇ - to select TIME

VIDEO
AUDIO
▶ TIME
SET UP
CLOSED CAPTION

Use \leftarrow [RETURN] Exit [EXIT]

Press RETURN
The TIME menu appears, and the cursor points to CURRENT TIME SET

TIME
▶ CURRENT TIME SET
ON/OFF TIMER
CHANNEL BLOCK
▶ MENU

---:--:-- AM

Use \leftarrow [RETURN] Exit [EXIT]

3 Press RETURN.
The CURRENT TIME SET screen appears

CURRENT TIME SET
▶ ---:--:-- AM
▶ MENU

Use \leftarrow [RETURN] Exit [EXIT]

4 Press RETURN again.
"Set the day" appears on the screen

CURRENT TIME SET
SUN 12:00 AM
▶ MENU

Set the day.
Use \leftarrow [RETURN] Exit [EXIT]

5 Press Δ + or ∇ - to set the day
Each time you press Δ + or ∇ - the day changes consecutively

Press RETURN
"Set the time" appears on the screen

CURRENT TIME SET
MON 12:00 AM
▶ MENU

Set the time.
Use \leftarrow [RETURN] Exit [EXIT]

6 Press Δ + or ∇ - to set the hour
Each time you press Δ + or ∇ -, the hour changes starting with "12 00 AM"

Press RETURN

CURRENT TIME SET
MON 3:00 PM
▶ MENU

Set the time.
Use \leftarrow [RETURN] Exit [EXIT]

7 Press Δ + or ∇ - to set the minutes
Each time you press Δ + or ∇ -, the minutes change in sequence

Press RETURN.
The setting is completed, and the clock starts

CURRENT TIME SET
▶ MON 3:15 PM
▶ MENU

Use \leftarrow [RETURN] Exit [EXIT]

To reset the time
Press RESET while in the CURRENT TIME screen, and repeat steps 4-7

To display the time
Press DISPLAY

To return to the normal screen
Press MENU

Notes

- The internal clock of this TV operates on a 12-hour cycle. If a 24-hour cycle number (for instance, 13 00) is entered, it will be cleared when you press RETURN

12 00 AM stands for midnight
12 00 PM stands for noon

- All the settings including CURRENT TIME SET will be erased if you unplug the TV or a power failure occurs. Reset the current time by following steps 1-7

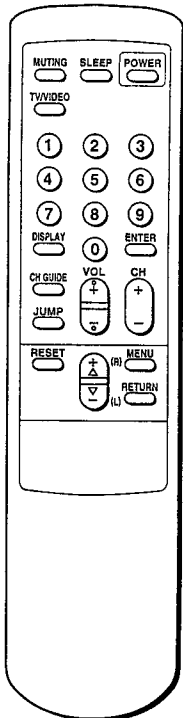

RM-Y116

Setting the ON/OFF TIMER

With this function you can set your favorite program to appear on the screen at the time that you set.

EXAMPLE: Set the timer to turn on the TV every Monday through Friday at 3:15 PM for 2 hours, on channel 21.

- 1 Press MENU.
The main menu appears



▶VIDEO
AUDIO
TIME
SET UP
CLOSED CAPTION
Use \leftarrow (EXIT) Exit (MENU)

- 2 Press Δ + or ∇ - to select TIME.
Then press RETURN.
The TIME menu appears

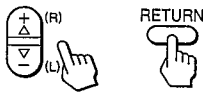

TIME
▶CURRENT TIME SET
ON/OFF TIMER
CHANNEL BLOCK
>MENU
MON 3:15 PM
Use \leftarrow (EXIT) Exit (MENU)

- 3 Press Δ + or ∇ - to select ON/OFF TIMER.
Then press RETURN.
The ON/OFF TIMER screen appears

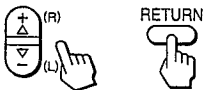

ON/OFF TIMER
▶EVERY SUN-SAT
12:00AM -h CH---
>MENU
Use \leftarrow (EXIT) Exit (MENU)

Note

If the ON/OFF TIMER display appears in black, the current time has not been set and you cannot select ON/OFF TIMER. To set the clock, see "Setting the Clock - CURRENT TIME SET," pp 36-37

- 4 Press RETURN again
"Set the day" appears on the screen



ON/OFF TIMER
EVERY SUN-SAT
12:00AM -h CH---
>MENU
Set the day.
Use \leftarrow (EXIT) Exit (MENU)

- 5 Press Δ + or ∇ - to set the day.
Each time you press Δ + or ∇ -, the days of the week change as shown in Fig 1
Then press RETURN
"Set the time" appears on the screen

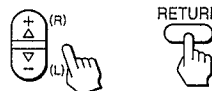

ON/OFF TIMER
EVERY MON-FRI
12:00AM -h CH---
>MENU
Set the time.
Use \leftarrow (EXIT) Exit (MENU)

- 6 Press Δ + or ∇ - to set the hour that you want the TIMER to start.
Each time you press Δ + or ∇ -, the hour changes in sequence
Then press RETURN.

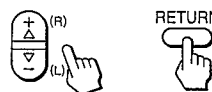

ON/OFF TIMER
EVERY MON-FRI
3:00PM -h CH---
>MENU
Set the time.
Use \leftarrow (EXIT) Exit (MENU)

- 7 Press Δ + or ∇ - to set the minutes.
Each time you press Δ + or ∇ -, the minutes change in sequence
Then press RETURN
"Set the duration" appears on the screen.

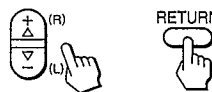

ON/OFF TIMER
EVERY MON-FRI
3:15PM -h CH---
>MENU
Set the duration.
Use \leftarrow (EXIT) Exit (MENU)

- 8 Press Δ + or ∇ - to set the duration of time.
Each time you press Δ + or ∇ -, the duration changes from "1" to "6" in sequence.
Then press RETURN
"Select the channel" appears on the screen



ON/OFF TIMER
EVERY MON-FRI
3:15PM 2h CH---
>MENU
Select the channel
Use \leftarrow (EXIT) Exit (MENU)

- 9 Press Δ + or ∇ - to set the channel that you want the TV to tune in
Each time you press Δ + or ∇ -, the channel number changes from 1 to 125 in sequence



ON/OFF TIMER
EVERY MON-FRI
3:15PM 2h CH 21
>MENU
Select the channel
Use \leftarrow (EXIT) Exit (MENU)

Press RETURN
The setting is completed, and the TIMER indicator on the front of the TV lights up



ON/OFF TIMER
▶EVERY MON-FRI
3:15PM 2h CH 21
>MENU
Use \leftarrow (EXIT) Exit (MENU)

To clear the ON/OFF TIMER setting
Press RESET while in the ON/OFF TIMER screen

To return to the normal screen
Press MENU.

Notes

- While the TIMER is set, the TIMER indicator on the TV is on
- One minute before the timer goes off, the "TV will turn off" display will appear on the screen
- If you have not set the clock correctly, the ON/OFF TIMER will not operate at the proper time. To set the clock, see "Setting the Clock - CURRENT TIME SET," pp 36-37.
- All the settings including ON/OFF TIMER will be erased if you unplug the TV or a power failure occurs. Reset the TIMER by following steps 1-9

Fig. 1

Selecting the day(s) of the week
When you press Δ +, the days of the week appear in the following order.

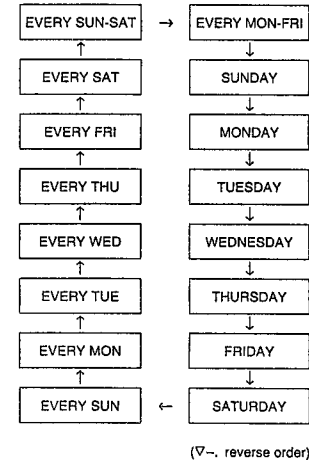

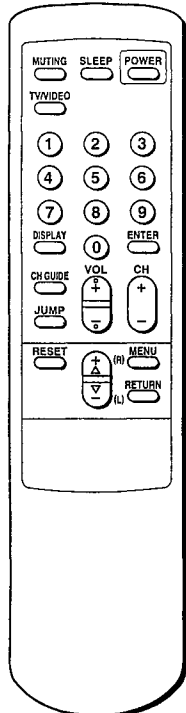

RM-Y116

Setting CHANNEL BLOCK

Use this function to block a channel from appearing on the screen during the time you specify. You can use this function to prevent children from watching undesirable programs.

EXAMPLE Set CHANNEL BLOCK every Sunday at 8 45 PM for one hour, on channel 38

1 Press MENU
The main menu appears

▶ VIDEO
AUDIO
TIME
SET UP
CLOSED CAPTION

Use \leftarrow [RETURN] Exit [EXIT]

2 Press Δ + or ∇ - to select TIME.
Then press RETURN.
The TIME menu appears

TIME
▶ CURRENT TIME SET
ON/OFF TIMER
CHANNEL BLOCK
>MENU

MON 3:15 PM

Use \leftarrow [RETURN] Exit [EXIT]

3 Press Δ + or ∇ - to select CHANNEL BLOCK.
Then press RETURN.
The CHANNEL BLOCK screen appears

CHANNEL BLOCK
▶ EVERY SUN-SAT
12:00PM -h CH---
>MENU

Use \leftarrow [RETURN] Exit [EXIT]

Note

If the CHANNEL BLOCK display appears in black, the current time has not been set and you cannot select CHANNEL BLOCK. To set the clock, see 'Setting the Clock - CURRENT TIME SET,' pp 36-37

4 Press RETURN again.
'Set the day' appears on the screen

CHANNEL BLOCK
EVERY SUN-SAT
12:00PM -h CH---
>MENU

Set the day.
Use \leftarrow [RETURN] Exit [EXIT]

5 Press Δ + or ∇ - to set the day
Each time you press Δ + or ∇ -, the days of the week change as shown in Fig 1 (See p 39)
Then press RETURN
'Set the time' appears on the screen

CHANNEL BLOCK
SUNDAY
12:00PM -h CH---
>MENU

Set the time.
Use \leftarrow [RETURN] Exit [EXIT]

6 Press Δ + or ∇ - to set the hour
Each time you press Δ + or ∇ -, the hour changes in sequence
Then press RETURN

CHANNEL BLOCK
SUNDAY
8:00PM -h CH---
>MENU

Set the time.
Use \leftarrow [RETURN] Exit [EXIT]

7 Press Δ + or ∇ - to set the minutes
Each time you press Δ + or ∇ -, the minutes change in sequence
Then press RETURN
'Set the duration' appears on the screen.

CHANNEL BLOCK
SUNDAY
8:45PM -h CH---
>MENU

Set the duration
Use \leftarrow [RETURN] Exit [EXIT]

8 Press Δ + or ∇ - to set the duration of time that you want the TV remain blocked
Each time you press Δ + or ∇ -, the duration changes from "1" to "6" in sequence
Then press RETURN
'Select the channel' appears on the screen

CHANNEL BLOCK
SUNDAY
8:45PM 1h CH---
>MENU

Select the channel
Use \leftarrow [RETURN] Exit [EXIT]

9 Press Δ + or ∇ - to set the channel that you want to block.
Each time you press Δ + or ∇ -, the channel number changes from 1 to 125 in sequence

CHANNEL BLOCK
SUNDAY
8:45PM 1h CH 38
>MENU

Select the channel
Use \leftarrow [RETURN] Exit [EXIT]

Press RETURN
The setting is completed

CHANNEL BLOCK
▶ SUNDAY
8:45PM 1h CH 38
>MENU

Use \leftarrow [RETURN] Exit [EXIT]

If you select a channel which has been blocked the message of BLOCKED appears

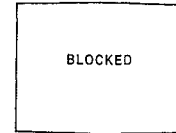

To clear the BLOCK setting
Press RESET while in the CHANNEL BLOCK screen

To return to the normal screen
Press MENU

Notes

- If you set a new CHANNEL BLOCK by following steps 1-9 the original setting will be erased
- If you have not set the clock correctly CHANNEL BLOCK will not operate at the proper time. To set the current time, see "Setting the Clock - CURRENT TIME SET," pp 36-37

1-12. CUSTOMIZING THE SCREEN DISPLAY

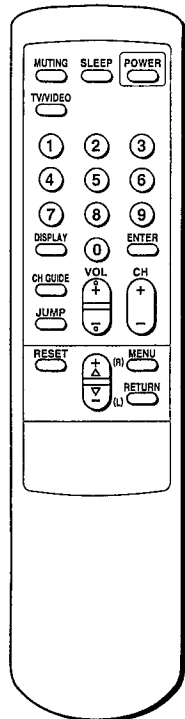

RM-Y116

Setting Channel Captions – CH CAPTION

Use this feature to caption up to 12 channel number displays with the matching channel call letters.

EXAMPLE Caption channel 20 with ESPN at the caption position number 4

- 1 Press MENU
The main menu appears

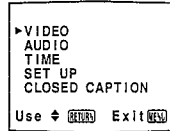

- 2 Press Δ+ or ∇- to select SET UP.
Then press RETURN
The SET UP menu appears

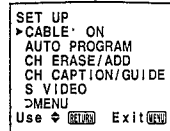
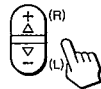

- 3 Press Δ+ or ∇- to select CH CAPTION/GUIDE.
Then press RETURN
The CH CAPTION/GUIDE screen appears

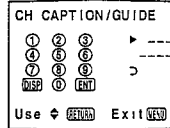
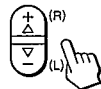

Note

If the CH CAPTION/GUIDE display appears in black, the TV is in video mode and you cannot select CH CAPTION/GUIDE. Press TV/VIDEO to change to TV mode.

- 4 Press RETURN again
"Select a position" appears on the screen

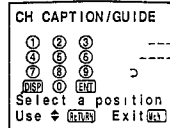

- 5 Press Δ+ or ∇- to select a caption position number
Each time you press Δ+ or ∇-, the caption position number is marked in sequence. Then press RETURN
"Select the channel" appears on the screen

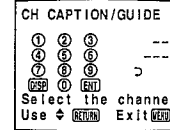

- 6 Press Δ+ or ∇- to select the channel you want to caption.
Each time you press Δ+ or ∇-, the channel number changes from 1 to 125. Then press RETURN.
"Select the letter" appears on the screen

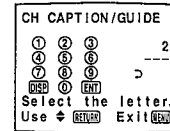

- 7 Press Δ+ or ∇- to select the first letter
Each time you press Δ+ or ∇-, "0-9," "A-Z," "&," "!", "-", and "_" (blank space)" appear in sequence. Then press RETURN

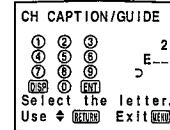

- 8 Repeat step 7 to select each remaining letter
(For a 3-letter caption, leave a space by pressing RETURN only)

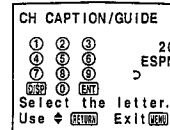

- 9 Press RETURN
The setting is completed

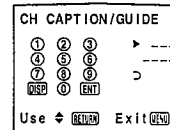

To caption other channels
Repeat steps 4-9

To erase unneeded captions
Call the caption setting screen by following steps 1-5, and press RESET

To return to the normal screen
Press MENU

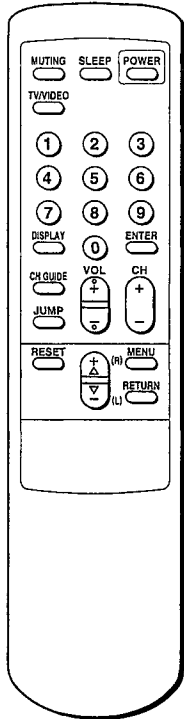

RM-Y116

Viewing the Captioned Channels – CHANNEL GUIDE

Use this feature to display the captions you set, and to select a channel directory for viewing

- 1 Press CH GUIDE.
A directory appears, corresponding to the directory keys on the Remote Commander

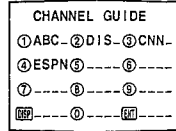

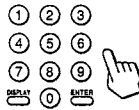

To cancel the CHANNEL GUIDE screen
Press CH GUIDE again

- 2 Press the directory key of the channel you want to watch



1-13. TROUBLESHOOTING

Symptom	Possible causes and remedies
Poor or no picture (screen not lit), good sound	<ul style="list-style-type: none"> • Adjust PICTURE. • Adjust BRIGHTNESS. • Check antenna/cable connections
Good picture, no sound	<ul style="list-style-type: none"> • Press VOLUME + on the TV or VOL + on the Remote Commander • Press MUTE on the Remote Commander. • Check that the MTS setting is set correctly. • Check that the TV/VIDEO button is set correctly. • Check that "SPEAKER ON" is set.
Good picture, no sound from the cordless headphones	<ul style="list-style-type: none"> • Is the battery used up? • Is the cordless headphones power turned on? • Adjust the cordless headphones volume control. • Make sure HEADPHONES is set to ON.
Good picture, noisy sound from the cordless headphones	<ul style="list-style-type: none"> • Is the battery used up? • Remove obstacles between the infrared emitter and the cordless headphones. • Is the infrared detector covered by your hands, hair, etc? • Adjust the direction and the position of the infrared emitter.
No picture (screen not lit), no sound	<ul style="list-style-type: none"> • Is POWER switched on? • Plug the unit into a wall outlet. • Check that the TV/VIDEO button is set correctly. • Make sure S VIDEO is set to on.
No color	<ul style="list-style-type: none"> • Is it a color program? • Adjust COLOR.
Snow and noise only	<ul style="list-style-type: none"> • Is it an active or the correct channel? • Check the CABLE setting. • Check antenna/cable connections.
 Dotted lines or stripes	This is often caused by local interference. (e.g. cars, neon signs, hairdryers etc) Adjust the antenna for minimum interference.
 Double images or ghosts	Reflections from nearby mountains or buildings often cause this problem. A highly directional outdoor antenna or a CATV cable may improve the picture
Try another channel. It could be station trouble.	

If the problem persists, contact your nearest service facility

SECTION 2 DISASSEMBLY

2-1. REAR COVER REMOVAL

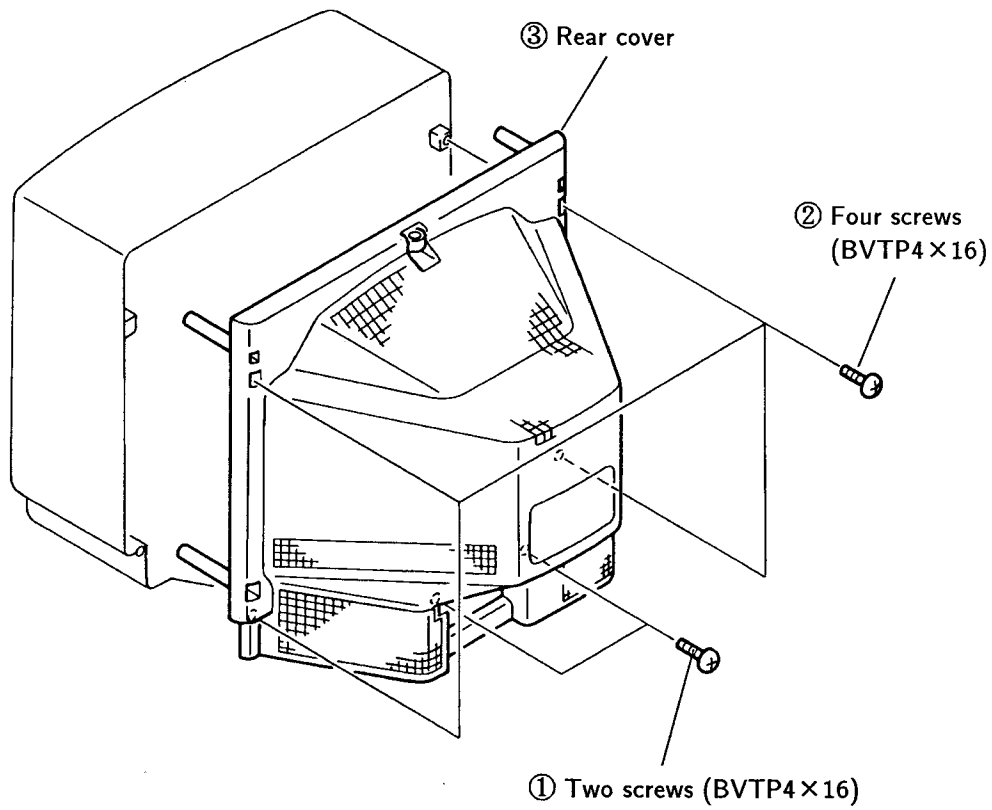

2-2. SERVICE POSITION

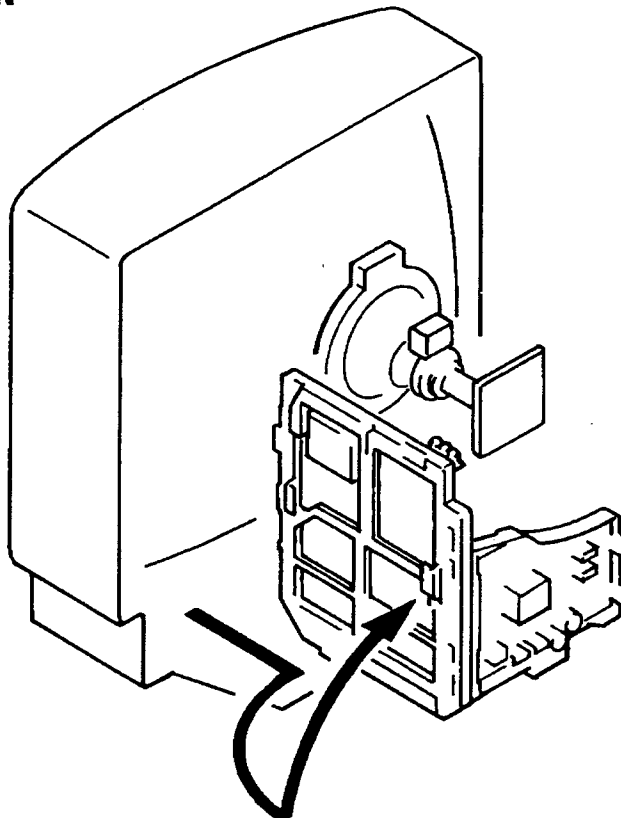

2-3. PICTURE TUBE REMOVAL

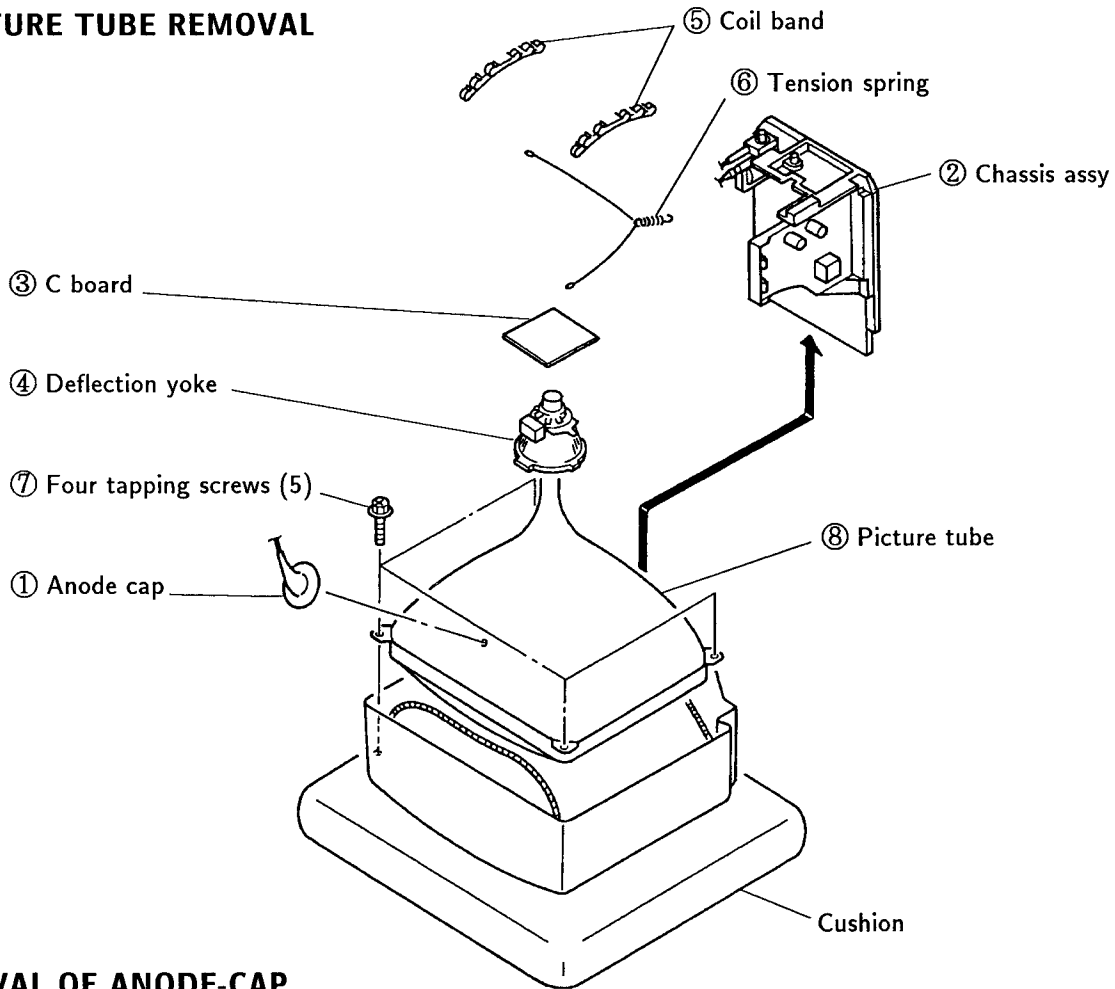

• REMOVAL OF ANODE-CAP

NOTE : Short circuit the anode of the picture tube and the anode cap to the metal chassis, CRT chield or carbon painted on the CRT, after removing the anode.

• REMOVING PROCEDURES

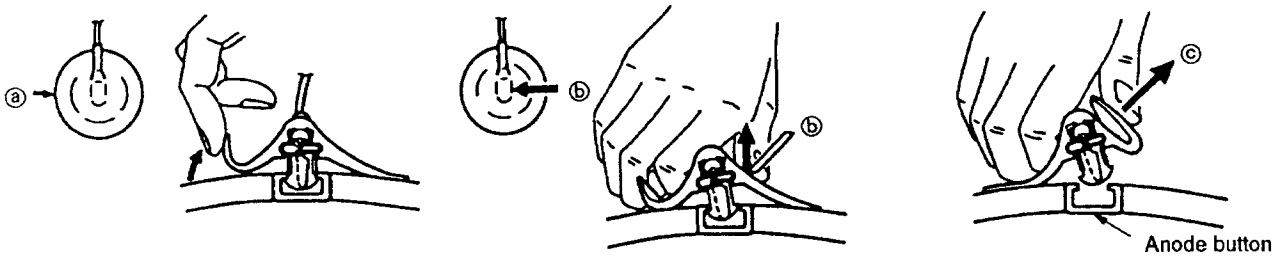

① Turn up one side of the rubber cap in the direction indicated by the arrow (a).

② Using a thumb pull up the rubber cap firmly in the direction indicated by the arrow (b).

③ When one side of the rubber cap is separated from the anode button, the anode-cap can be removed by turning up the rubber cap and pulling up it in the direction of the arrow (c).

• HOW TO HANDLE AN ANODE-CAP

- ① Don't hurt the surface of anode-caps with sharp shaped material!
- ② Don't press the rubber hardly not to hurt inside of anode-caps!
A material fitting called as shatter-hook terminal is built in the rubber.
- ③ Don't turn the foot of rubber over hardly!
The shatter-hook terminal will stick out or hurt the rubber.

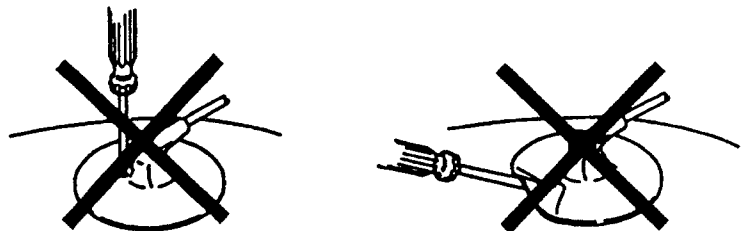

SECTION 3 SET-UP ADJUSTMENTS

- The following adjustments should be made when a complete realignment is required or a new picture tube is installed.
- These adjustments should be performed with rated power supply voltage unless otherwise noted.

The controls and switch should be set as follows unless otherwise noted :

PICTURE control normal
BRIGHTNESS control normal

Preparation:

- Feed in the white pattern signal.
- Before starting, degauss the entire screen.

3-1. BEAM LANDING

1. Input a raster signal with the pattern generator.
2. Loosen the deflection yoke mounting screw, and set the purity control to the center as shown in Fig.2
3. Turn the raster signal of the pattern generator to green.
4. Move the deflection yoke backward, and adjust with the purity control so that green is in the center and red and blue are at the sides evenly. (Fig.3)
5. Move the deflection yoke forward, and adjust so that the entire screen becomes green. (Fig.1)
6. Switch over the raster signal to red and blue and confirm the condition.
7. When the position of the deflection yoke is determined, tighten it with the deflection yoke mounting screw.
8. When landing at the corner is not right, adjust by using the disk magnets. (Fig.4)

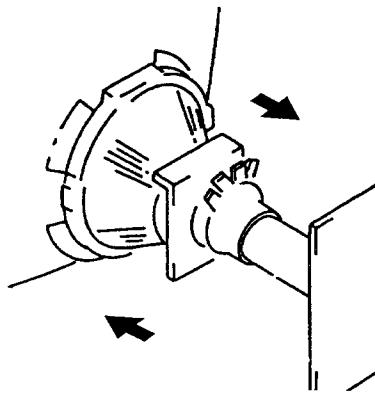

Fig.1

Perform the adjustments in order as follows:

1. Beam Landing
2. Convergence
3. Focus
4. Screen (G 2) and White Balance

Note: Test Equipment Required.

1. Color bar Pattern Generator
2. Degausser
3. DC Power Supply
4. Digital multimeter

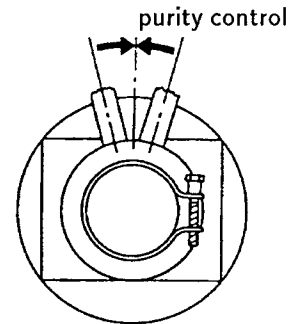

Fig.2

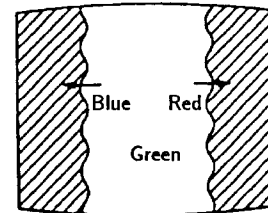

Fig.3

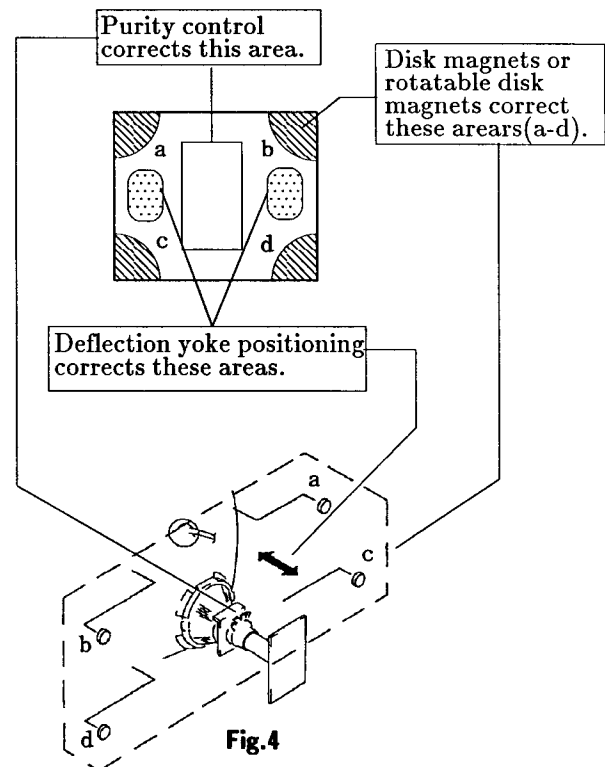

Fig.4

3-2. CONVERGENCE

Preparation:

- Before starting, perform FOCUS, H.SIZE, V.LIN and V.SIZE adjustments.
- Set BRIGHTNESS control to minimum.
- Feed in dot pattern.

(1) Horizontal and Vertical Static Convergence

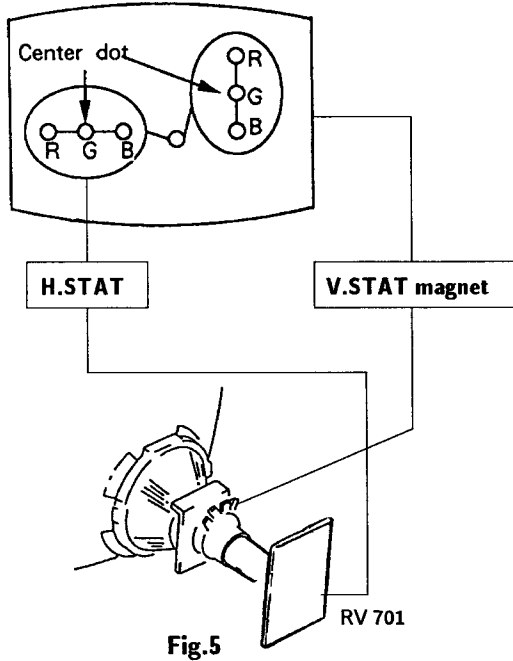
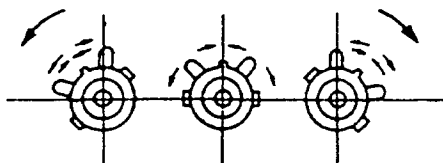
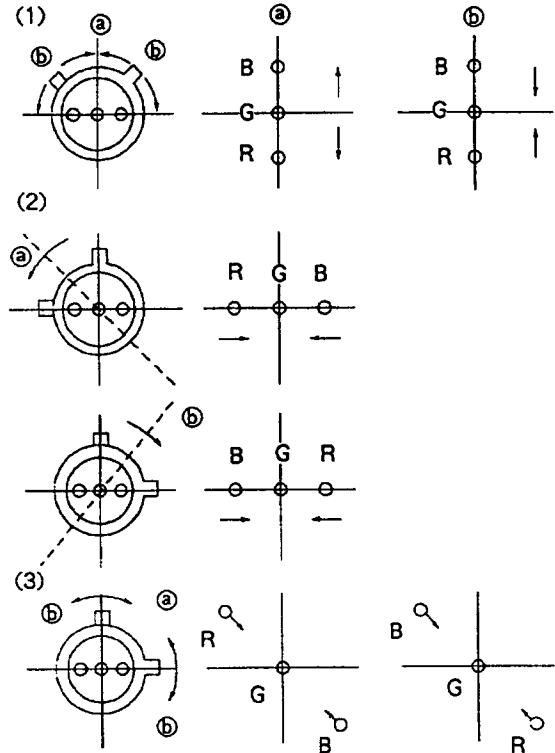

Fig.5

1. Adjust H.STAT VR to converge red, green and blue dots the in center of the screen.(Horizontal movement)
 2. Adjust V. STAT magnet to converge red, green and blue dots in the center of the screen. (Vertical movement)
 3. If the red, green and blue dots do not converge on the center of screen with H.STAT VR, perform horizontal convergence adjustment using H.STAT VR and V.STAT magnet as shown below. (In this case, H.STAT VR and V.STAT magnet effect each other.)
- Tilt the V.STAT magnet and adjust static convergence to open or close the V.STAT magnet.



4. When the V.STAT magnet is moved in the direction of arrow (a) and (b), red, green and blue dots move as shown below.



- If the blue dot does not converge with red and green dots, perform following steps.
- Move BMC magnet (a) to correct insufficient H.static convergence.
 - Rotate BMC magnet (b) to correct insufficient V.static convergence.
- In either case, repeat Beam Landing Adjustment.

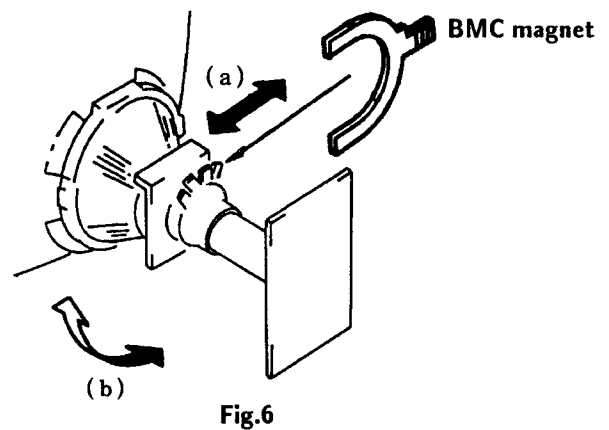

Fig.6

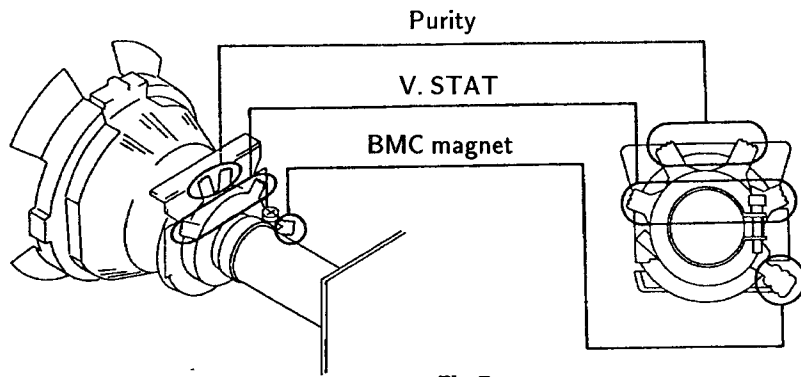

Fig.7

(2) Dynamic Convergence Adjustment

Preparation:

● Before starting perform Horizontal and Vertical static convergence Adjustment.

1. Slightly loosen deflection yoke screw.
2. Remove deflection yoke spacers.
3. Move the deflection yoke for best convergence as shown below.
4. Tighten the deflection yoke screw.
5. Install the deflection yoke spacers.

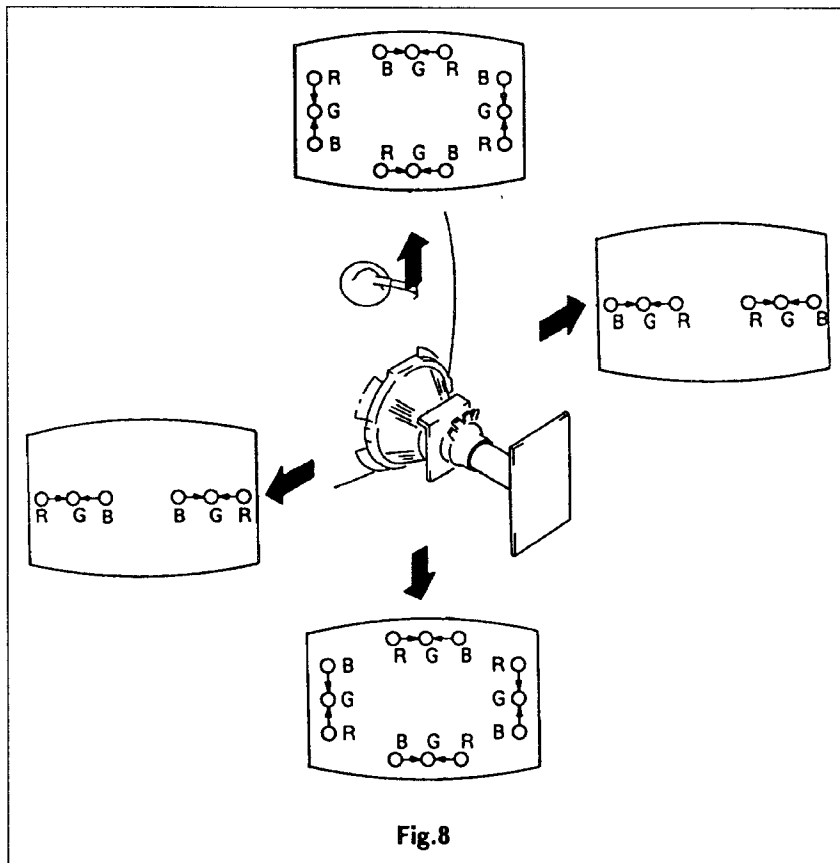

Fig.8

(3) Screen-corner Convergence

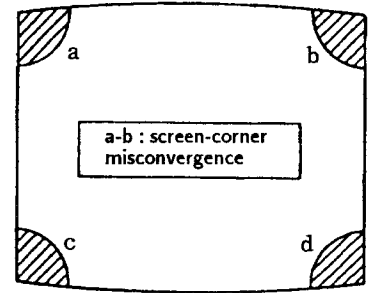
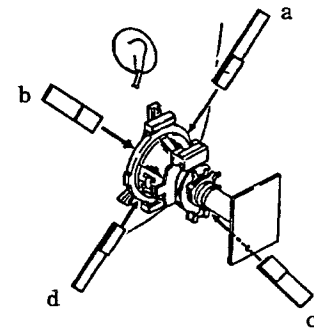

Fig.9



Affix a Permalloy ass'y corresponding to the misconverged areas



Permalloy assembly

3-3. FOCUS

Adjust FOCUS control for best picture.

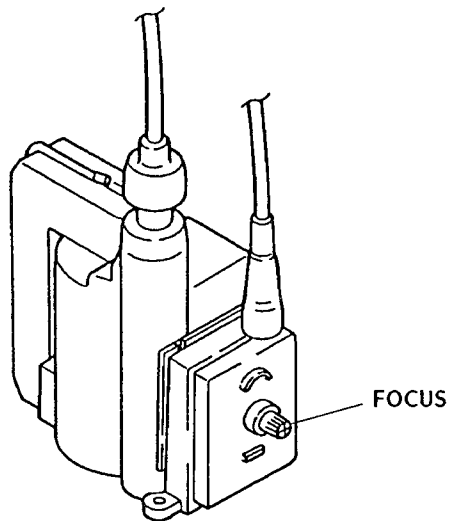

Fig.10

3-4. SCREEN(G 2)

1. Input a dots pattern.
2. Set the PIC, BRT controls at minimum and COLOR control at normal.
3. Adjust BKG VRs so that voltages on the red, green and blue cathodes are 170 V dc with an oscilloscope as shown in Fig.11.
4. Observe the screen and adjust SCREEN (G 2)RV 702 to obtain the faintly visible background of dot signal.

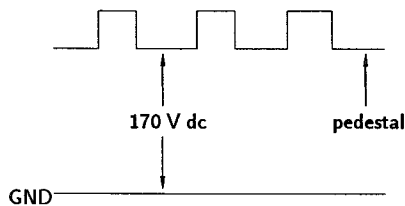

Fig.11

3-5. METHOD OF SETTING THE SERVICE ADJUSTMENT MODE

SERVICE MODE PROCEDURE

1. Standby mode.(Power off)
2. **DISPLAY** → **5** → **VOL (+)** → **POWER** on the Remote Commander. (Press each button within a second.)

SERVICE ADJUSTMENT MODE IN

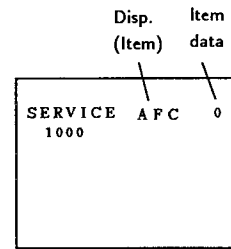

3. The CRT displays the item Being adjusted.
4. Press **1** or **4** on the Remote Commander to select the item.
5. Press **3** or **6** on the Remote Commander to change the data.
6. Press **MUTING** then **ENTER** to write into memory.

SERVICE ADJUSTMENT MODE MEMORY

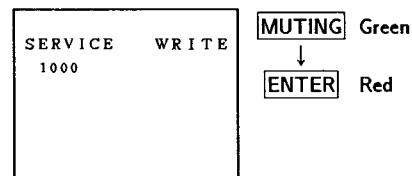

7. Turn set off and on to exit.

3-6. WHITE BALANCE ADJUSTMENTS

1. Input an entire white signal.
2. Set to service adjustment mode.
3. Set the PICTURE and BRIGHT to minimum.
4. Adjust with SBRT if necessary.
5. Select G CUT and B CUT with **1** and **4**.
6. Adjust with **3** and **6** for the best white balance.
7. Set the PICTURE and BRIGHT to maximum.
8. Select GAMP and BAMP with **1** and **4**.
9. Adjust with **3** and **6** for the best white balance.
10. Write into the memory by pressing **MUTING** then **ENTER**.

SECTION 4 SAFETY RELATED ADJUSTMENTS

A BOARD

☒ R537 CONFIRMATION METHOD (HV HOLD-DOWN CONFIRMATION) AND READJUSTMENTS

The following adjustments should always be performed when replacing the following components (marked with ☒ on the schematic diagram).
IC602, D511, C523, C524, R534, R535, R537, R549, R565, R637, PM501, T504, DY

①

1. Preparation before confirmation

- 1) Turn the POWER switch ON, and receive entirely white signal and set the PICTURE and BRIGHT controls to maximum.
- 2) Confirm that the voltage of the check terminal of TP85 is more than 100VDC when the set is operating normally with 120.0 ± 2.0 VAC supply.

2. Hold-down operation confirmation (HV)

- 1) Connect the currentmeter between the 7th pin of FBT (T504) and the land of it with connect polarity.
- 2) Receive White Signal and adjust the ABL current to follows with the PICTURE and the BRIGHT controls.
 $1450 \pm 100 \mu\text{A}$
- 3) Connect the Digital Voltmeter to pin8 of PM501 then read the voltage as A.
- 4) Connect the Digital Voltmeter and DC power Supply via 1SS 119 to TP-85.
- 5) Increase the DC power voltage gradually until the Picture just blanks out.
- 6) Read the digital volymeter indication.
- 7) Turn DC power Source off immediatery.

STANDARD

Less or equal to $A + 16.5$ VDC

- 8) Receive Dot Signal and adjust the ABL current to follows, with the PIX and the BRT controls.
 $150 \pm 100 \mu\text{A}$
- 9) Repeat steps from (3) to (7).

STANDARD

Less or equal to $A + 16.5$ VDC

3. Hold-down readjustment

When step 2 is not satisfied, readjustment should be performed by altering the resistance value of R537 (a component marked with ☒).

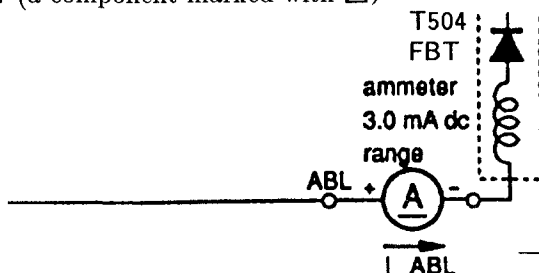

A BOARD

☒ R511 CONFIRMATION METHOD (B+ HOLD-DOWN CONFIRMATION) AND READJUSTMENTS

The following adjustments should always be performed when replacing the following components (marked with ☒ on the schematic diagram).
IC602, C524, R511, R534, R549, R565, R637, PM501

②

1. Hold-Down Operation Voltage (B+)

- 1) Connect the currentmeter between the 7th pin of FBT (T504) and the land of it with connect polarity.
- 2) Receive White Signal and adjust the ABL current to follows with the PICTURE and the BRIGHT controls.
 $1450 \pm 100 \mu\text{A}$
- 3) Connect the Digital Voltmeter and DC power Supply via 1SS 119 to pin8 of PM501.
- 4) Increase the DC power voltage gradually until the Picture just blanks out.
- 5) Read the digital voltmeter indication.
- 6) Turn DC power Source off immediatery.

STANDARD

Less or equal to 130.0 VDC

- 7) Receive Dot Signal and adjust the ABL current to follows, with the PICTURE and the BRIGHT controls.
 $150 \pm 100 \mu\text{A}$
- 8) Repeat steps from (4) to (6).

STANDARD

Less or equal to 132.5 VDC

2. Hold-down readjustment

When step 2 is not satisfied, readjustment should be performed by altering the resistance value of R511 (a component marked with ☒).

G BOARD

B+ VOLTAGE CONFIRMATION

The following adjustments should always be performed when replacing IC602 or R637.

- 1) Supply $130 \pm 2\%$ °V AC to with variable autotransformer.
- 2) Input an entirely monoscope signal.
- 3) Set the PICTURE control and the BRIGHT controls in to initial reset.
- 4) Confirm the voltage of A BOARD ① pin CN651 connector is less than 116.5V DC.
- 5) If step 4) is not satisfied, replace IC602 and R637 repeat above steps.

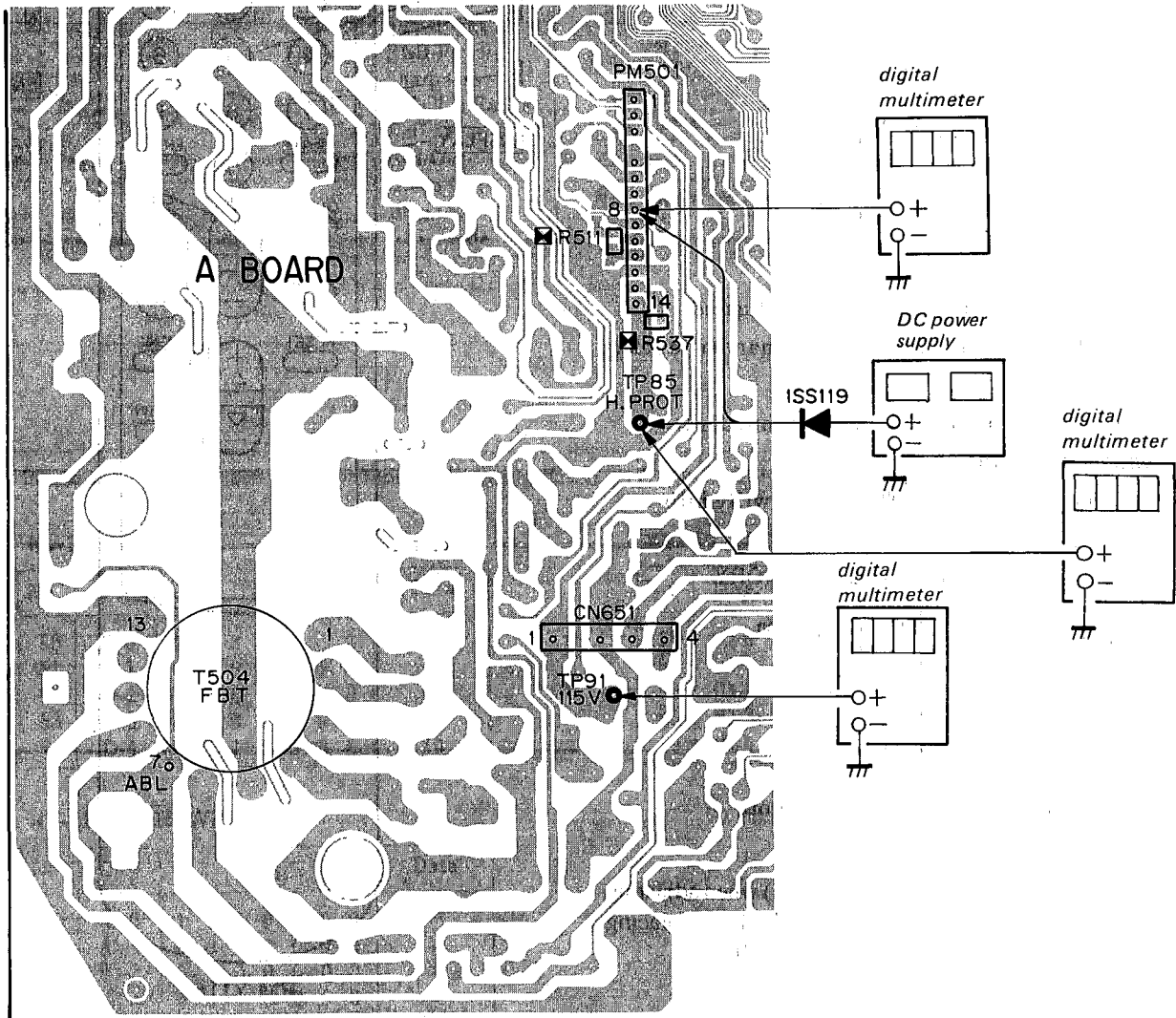
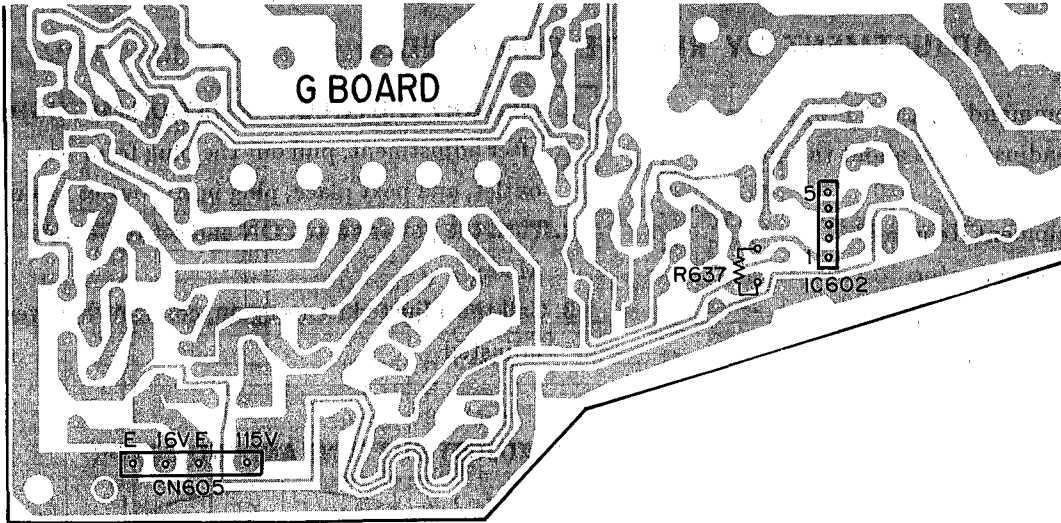

SECTION 5 CIRCUIT ADJUSTMENTS

5-1. ELECTRICAL ADJUSTMENT BY REMOTE COMMANDER

Use of Remote Commander (RM-Y116) can be performed circuit adjustments about this model.

NOTE : Test Equipment Required.

1. Pattern Generator
2. Frequency counter
3. Digital multimeter
4. Audio OSC

1. METHOD OF SETTING THE SERVICE ADJUSTMENT MODE

SERVICE MODE PROCEDURE

1. Standby mode. (Power off)
2. **DISPLAY** → **5** → **VOL (+)** → **POWER** on the Remote Commander. (Press each button within a second.)

SERVICE ADJUSTMENT MODE IN

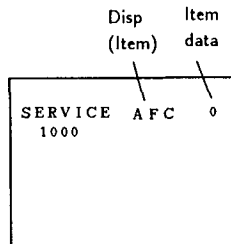

3. The CRT displays the item Being adjusted.
4. Press **1** or **4** on the Remote Commander to select the item.
5. Press **3** or **6** on the Remote Commander to change the data.
6. Press **MUTING** then **ENTER** to write into memory.

SERVICE ADJUSTMENT MODE MEMORY

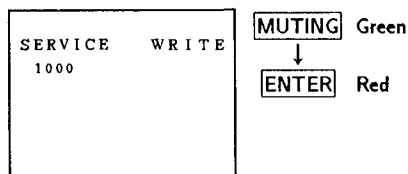

7. Press **8** then **ENTER** on the Remote Commander to initialize.

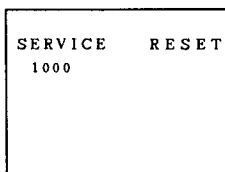

Carry out step 7) when adjusting IDs 0 to 4 and when replacing and adjusting IC102.

Factory original setting

2. MEMORY WRITE CONFIRMATION METHOD

1. After adjustment, pull out the plug from AC outlet, and next place, plug in AC outlet again.
2. Turn the power switch ON and set to Service Mode.
3. Call the adjusted items again, confirm they were adjusted.

3. ADJUST BUTTONS AND INDICATOR

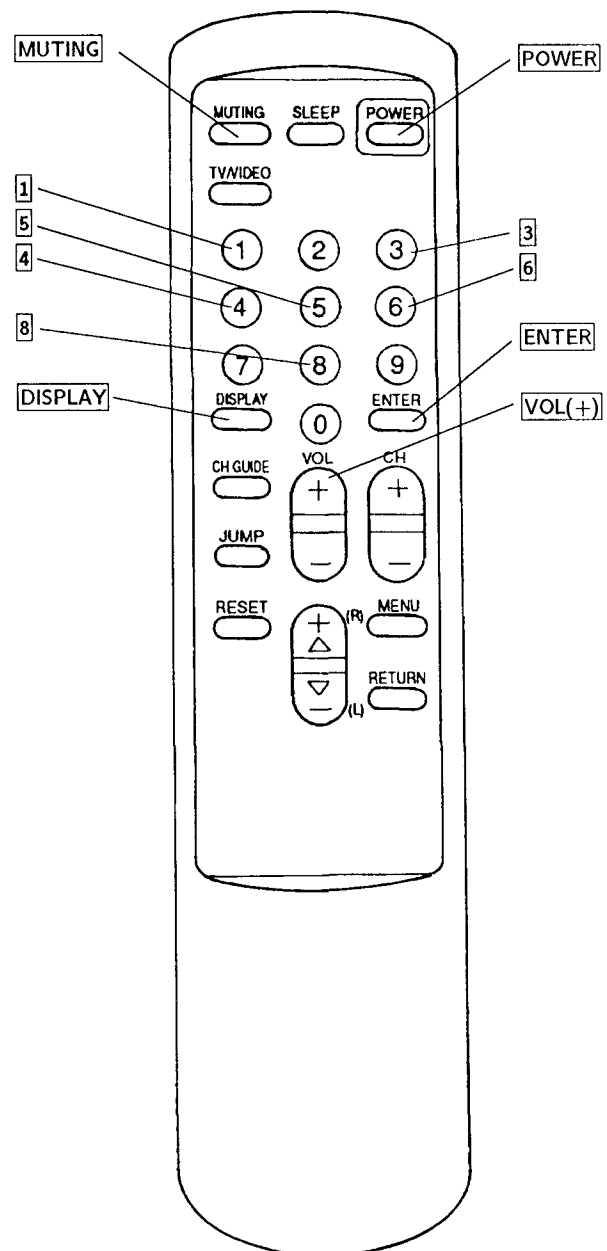

RM-Y116

8. Turn set off and on to exit.

4. AN ITEM OF ADJUSTMENTS

No.	Disp.	Ave. data	Data range	Item
1	AFC	* 0	0~3	AFC Loop Gain
2	HFRE	78	0~127	H. Frequency
3	VFRE	15	0~31	V. Frequency
4	VPOS	20	0~31	V. Center
5	VSIZ	31	0~63	V. Size
6	VLIN	8	0~15	V. Linearity
7	VSCO	6	0~15	V. Correction
8	HPOS	6	0~15	H. Center
9	HSIZ	16	0~31	H. Size
10	PAMP	23	0~31	Pin Amp
11	CPIN	4	0~7	Corner Pin
12	PPHA	7	0~15	Pin Phase
13	VCOM	* 2	0~7	V. Compensation
14	GAMP	21	0~31	Green Amp
15	BAMP	16	0~31	Blue Amp
16	GCUT	6	0~15	Green Cut Off
17	BCUT	7	0~15	Blue Cut Off
18	CROM	26	0~63	Chroma Trap
19	SPIX	32	0~63	Sub Contrast
20	SHUE	25	0~63	Sub Hue
21	SCOL	30	0~63	Sub Color
22	SBRT	34	0~63	Sub Bright
23	RGBP	* 18	0~63	RGB Picture
24	SHAP	* 7	0~15	Sharpness
25	VSMO	* 0	0, 1	V Pull in Range
26	REF	* 2	0~3	Reference line
27	ROFF	1	0, 1	Red Out
28	GOFF	1	0, 1	Green Out
29	BOFF	1	0, 1	Blue Out
30	ABLM	* 0	0, 1	ABL Mode

31	NOTC	* 0	0, 1	Notch On/Off
32	DRGB	* 0	0, 1	OSD intensity
33	VANG	not use	0~63	V. Angle
34	DISP	40	0~63	Display Position
35	SVOL	* 0	0~7	Sub Volume
36	SBAL	not use	0~7	Sub Balance
37	BASS	not use	0~15	Sub Bass
38	TRE	not use	0~15	Sub Treble
39	UYBO	not use	0~63	Upper Y. Bow
40	LYBO	not use	0~63	Lower Y. Bow
41	HAMP	not use	0~63	H. Amp
42	HTIL	not use	0~63	H. Tilt
43	UCBO	not use	0~63	Upper C. Bow
44	UTIL	not use	0~63	Upper Tilt
45	LCBO	not use	0~63	Lower C. Bow
46	LTIL	not use	0~63	Lower Tilt
47	DCSH	not use	0~63	DC. Shift
48	PHPO	not use	0~127	PinP H Position
49	PHUE	not use	0~63	PinP Hue
50	ID-0	* 64	0~127	Model ID
51	ID-1	* 0	0~127	Model ID
52	ID-2	* 64	0~127	KV-20TR23 (US)
	ID-2	* 0	0~127	KV-20TR23 (CND)
	ID-2	* 32	0~127	KV-2150R/2160WR
53	ID-3	* 0	0~127	Model ID
54	ID-4	* 16	0~127	Model ID

Note : No. from 1 to 54 is to show adjustment order.

* : Set-up value

SERVICE	ID 0	64
1000	1000000	

Please adjust the function values as shown below when IC 102 on A board was replaced.

KV-20TR23 (US)

No	Disp.	Disp.	Data
50	ID-0	1 0 0 0 0 0 0	64
51	ID-1	0 0 0 0 0 0 0	0
52	ID-2	1 0 0 0 0 0 0	64
53	ID-3	0 0 0 0 0 0 0	0
54	ID-4	0 0 1 0 0 0 0	16

KV-20TR23 (CND)

No.	Disp.	Disp.	Data
50	ID-0	1 0 0 0 0 0 0	64
51	ID-1	0 0 0 0 0 0 0	0
52	ID-2	0 0 0 0 0 0 0	0
53	ID-3	0 0 0 0 0 0 0	0
54	ID-4	0 0 1 0 0 0 0	16

KV-2150R/2160WR

No.	Disp.	Disp.	Data
50	ID-0	1 0 0 0 0 0 0	64
51	ID-1	0 0 0 0 0 0 0	0
52	ID-2	0 1 0 0 0 0 0	32
53	ID-3	0 0 0 0 0 0 0	0
54	ID-4	0 0 1 0 0 0 0	16

5-2. A BOARD ADJUSTMENTS

RF AGC ADJUSTMENT (IF BLOCK VR)

1. Input a color-bar signal.
2. Adjust AGC VR of TU 101 so that snow noise and cross-modulation disappear from the picture.
3. Confirm them at every channel.

H.FREQUENCY ADJUSTMENT (HFRE)

1. Input a color-bar signal.
2. Set to Service adjustment Mode.
3. Connect a frequency counter to base of Q550 (TP-86 H.DRIVE).
4. Call the item of AFC, set to 3 level (free run).
5. Select HFRE with **[1]** and **[4]**.
6. Adjust with **[3]** and **[6]** for the 15734 ± 60 Hz.
7. Call the item of AFC again, adjust the level "0".
8. Write into the memory by pressing **[MUTING]** then **[ENTER]**.

V.FREQUENCY ADJUSTMENT (VFRE)

1. Select video 1 with no connecting the signal.
2. Set to Service adjustment Mode.
3. Connect the frequency counter across connector VDY (+) (CN501) connector and ground.
4. Select VFRE with **[1]** and **[4]**.
5. Adjust with **[3]** and **[6]** for the 55 ± 0.5 Hz.
6. Write the memory by pressing **[MUTING]** then **[ENTER]**.

CROMA TRAP ADJUSTMENT (CROM)

1. Input a red signal
2. Set to Service adjustment Mode.
3. Connect an oscilloscope CN703 Pin① (R OUT) of C board ground.
4. Select CROM with **[1]** and **[4]**.
5. Adjust with **[3]** and **[6]** for the 0 level.

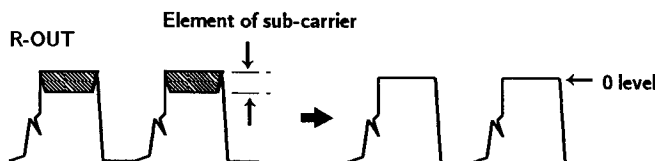

6. Write the memory by pressing **[MUTING]** then **[ENTER]**.

SUB CONTRAST ADJUSTMENT (SPIX)

1. Input a color-bar signal.
2. Set to Service adjustment Mode.
3. Set the conditions as follows.

PICTURE MAX
COLOR MIN
BRIGHT MIN

R OFF ON (1)
G OFF OFF (0)
B OFF OFF (0)

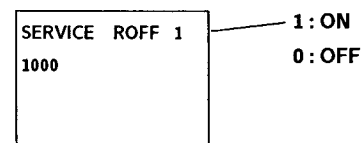

4. Connect an oscilloscope to CN703 Pin① (R OUT) of C board and ground.
5. Select SPIX with **[1]** and **[4]**.
6. Adjust with **[3]** and **[6]** for the 2.0 ± 0.05 Vp-p.

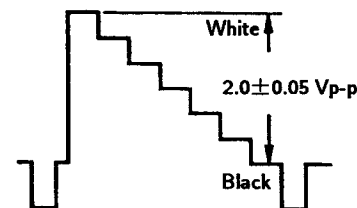

7. Write the memory by pressing **[MUTING]** then **[ENTER]**.
8. Return the following back to normal after adjustment.

PICTURE MAX
BRIGHT CENTER
COLOR CENTER
R OFF ON
G OFF ON
B OFF ON

DISPLAY POSITION ADJUSTMENT (DISP)

1. Input a color-bar signal.
2. Set to service adjustment Mode.
3. Select DISP with **[1]** and **[4]**.
4. Adjust with **[3]** and **[6]** for the bar center.
5. Write the memory by pressing **MUTING** then **ENTER**.

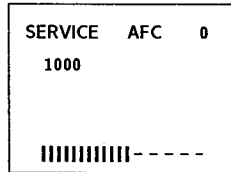

SUB BRIGHT ADJUSTMENT (SBRT)

1. Input a cross-hatch signal.
2. Set to service adjustment mode.
3. Set the PICTURE and BRIGHT to minimum.
4. Select SBRT with **[1]** and **[4]**.
5. Adjust with **[3]** and **[6]** for obtain a faintly visible cross-hatch.
6. Write into the memory by pressing **MUTING** then **ENTER**.

SUB HUE, SUB COLOR ADJUSTMENT (SHUE, SCOL)

1. Input a color-bar signal.
2. Set to service adjustment Mode.
3. Connect an oscilloscope to CN703 Pin③ (B OUT) of C board.
4. Select SHUE and SCOL with **[1]** and **[4]**.
5. Adjust with **[3]** and **[6]** for the $V1=V4$ (SCOR) and $V2=V3$ (SHUE).

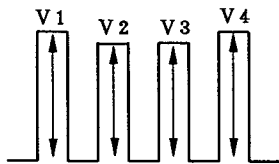

6. Write into the memory by pressing **MUTING** then **ENTER**.

V.SIZE ADJUSTMENT (VSIZ)

1. Input a cross-hatch signal.
2. Set to service adjustment Mode.
3. Select VSIZ with **[1]** and **[4]**.
4. Adjust with **[3]** and **[6]** for the best vertical size.
5. Write into the memory by pressing **MUTING** then **ENTER**.

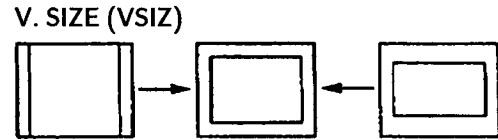

H.SIZE ADJUSTMENT (HSIZ)

1. Input a cross-hatch signal.
2. Set to service adjustment Mode.
3. Select HSIZ with **[1]** and **[4]**.
4. Adjust with **[3]** and **[6]** for best horizontal size.
5. Write into the memory by pressing **MUTING** then **ENTER**.

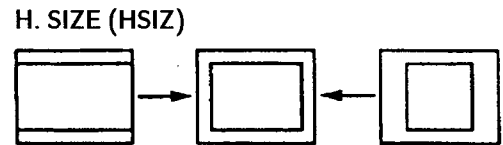

V.CENTER ADJUSTMENT (VPOS)

1. Input a cross-hatch signal.
2. Set to service adjustment Mode.
3. Select VPOS with **[1]** and **[4]**.
4. Adjust with **[3]** and **[6]** for the best vertical center.
5. Write into the memory by pressing **MUTING** then **ENTER**.

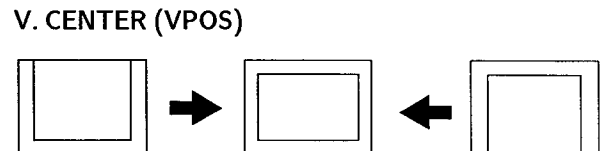

H.CENTER ADJUSTMENT (H POS)

Note: Perform this adjustment after H.FREQUENCY ADJUSTMENT (HFRE) .

1. Input a cross-hatch signal.
2. Set the Service adjustment mode.
3. Select HPOS with **1** and **4** .
4. Adjust with **3** and **6** to the best horizontal center.
5. Write into the memory by pressing **MUTING** then **ENTER** .

H. CENTER (HPOS)



V LINEARITY(VLIN), VS CORRECTION(VSCO), PIN AMP(PAMP), CORNER PIN(CPIN), AND PIN PHASE(PPHA) ADJUSTMENTS

1. Input a cross-hatch signal.
2. Set to Service adjustment Mode.
3. Select VLIN, VSCO, PAMP, CPIN, and PPHA with **1** and **4**.
4. Adjust with **3** and **6** for the best picture.
5. Write the memory by Pressing **MUTING** then **ENTER**.

V LINEARITY (VLIN)



VS CORRECTION (VSCO)



PIN AMP (PAMP)

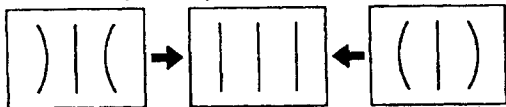

CORNER PIN (CPIN)



PIN PHASE (PPHA)



MEMO

6-2. CIRCUIT BOARDS LOCATION

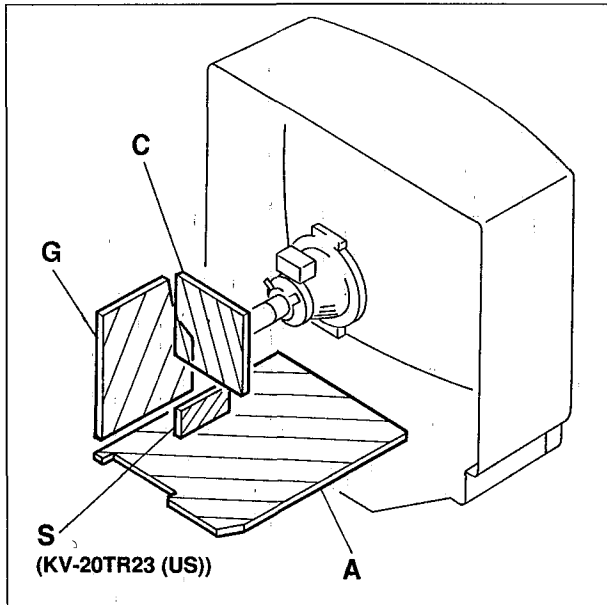

6-3. PRINTED WIRING BOARDS AND SCHEMATIC DIAGRAMS

Note:

- All capacitors are in μF unless otherwise noted.
pF: $\mu\mu\text{F}$ 50VV or less are not indicated except for electrolytic and tantalums.
- All electrolytics are in 50V unless otherwise specified.
- Indication of resistance, which does not have one for rating electrical power, is as follows.

Pitch: 5 mm
Rating electrical power 1/4W

- All resistors are in ohms.
 $k\Omega=1000\Omega$, $M\Omega=1000K\Omega$
- : nonflammable resistor.
- : internal component.
- : panel designation, and adjustment for repair.
- All variable and adjustable resistors have characteristic curve B, unless otherwise noted.
- The components identified by in this manual have been carefully factory-selected for each set in order to satisfy regulations regarding X-ray radiation. Should replacement be required, replace only with the value originally used.
- When replacing components identified by , make the necessary adjustments indicated. If results do not meet the specified value, change the component identified by and repeat the adjustment until the specified value is achieved.
(Refer to R511 and R537 on page 27,28)
- When replacing the part in below table be sure to perform the related adjustment.

Part replaced ()	Adjustment ()
C524, R511, R534, R549, R565, PM501 IC602, R637	A BOARD G BOARD B+ HOLD-DOWN (R511)
D511, C523, C524, R534, R535, R537, R549, R565, T504, PM501, IC602, R637, DY	A BOARD G BOARD HV HOLD-DOWN (R537)

- All voltages are in V.
- Voltage are dc with respect to ground unless otherwise noted.
- Readings are taken with a 10 M Ω digital multimeter.
- Readings are taken with a color-bar signal input.
- Voltage variations may be noted due to normal production tolerance.
- Circled numbers are waveform references.
- : B+ line.
- : signal path.

Reference information

RESISTOR	: RN	METAL FILM
	: RC	SOLID
	: FPRD	NONFLAMMABLE CARBON
	: FUSE	NONFLAMMABLE FUSIBLE
	: RW	NONFLAMMABLE WIREWOUND
	: RS	NONFLAMMABLE METAL OXIDE
	: RB	NONFLAMMABLE CEMENT
	: ※	ADJUSTMENT RESISTOR
COIL	: LF-8L	MICRO INDUCTOR
CAPACITOR	: TA	TANTALUM
	: PS	STYROL
	: PP	POLYPROPYLENE
	: PT	MYLAR
	: MPS	METALIZED POLYESTER
	: MPP	METALIZED POLYPROPYLENE
	: ALB	BIPOLAR
	: ALT	HIGH TEMPERATURE
	: ALR	HIGH RIPPLE

Note: The symbol display is on the component side.

The components identified by shading and mark are critical for safety. Replace only with part number specified.

The symbol indicate fast operating fuse. Replace only with fuse of same rating as marked.

Note: Les composants identifiés par un trame et une marque sont critiques pour la sécurité. Ne les remplacer que par une pièce portant le numéro spécifié.

Le symbole indique une fusible a action rapide. Doit etre remplacee par une fusible de meme valeur, comme maque.

A TUNING CONTROL, Y/C JUNGLE, TUNER + VIF + MTS
VERTICAL DEFLECTION, HORIZONTAL DEFLECTION, AUDIO AMP
AV SWITCHER, AV TERMINAL

— A Board —

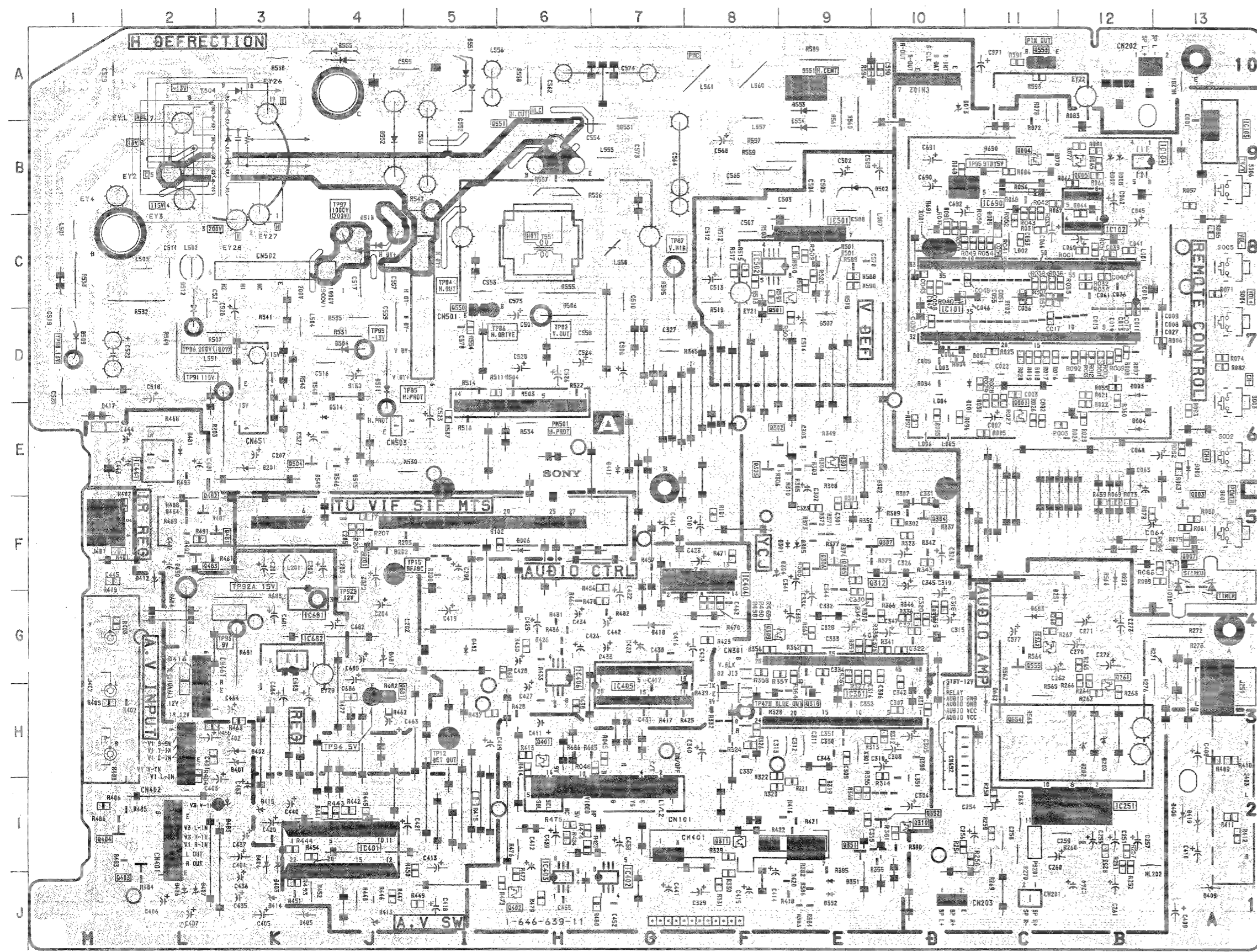

1-646-639-11

— A BOARD —

IC	DIODE
IC101	D-11
IC102	B-12
IC103	B-13
IC251	I-12
IC301	H-8
IC401	I-4
IC501	C-9
IC502	C-8
IC681	G-3
IC682	G-3
IC690	B-11
PM501	E-6

TRANSISTOR	TEST POINT
Q001	E-11
Q004	B-11
Q005	B-12
Q261	G-12
Q262	G-11
Q301	E-9
Q309	G-8
Q310	F-10
Q311	I-8
Q401	H-6
Q402	J-6
Q501	C-9
Q550	C-5
Q551	B-6
Q553	A-11
Q681	H-6

• A BOARD IC301 CXA1465AS

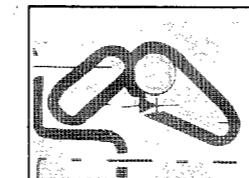
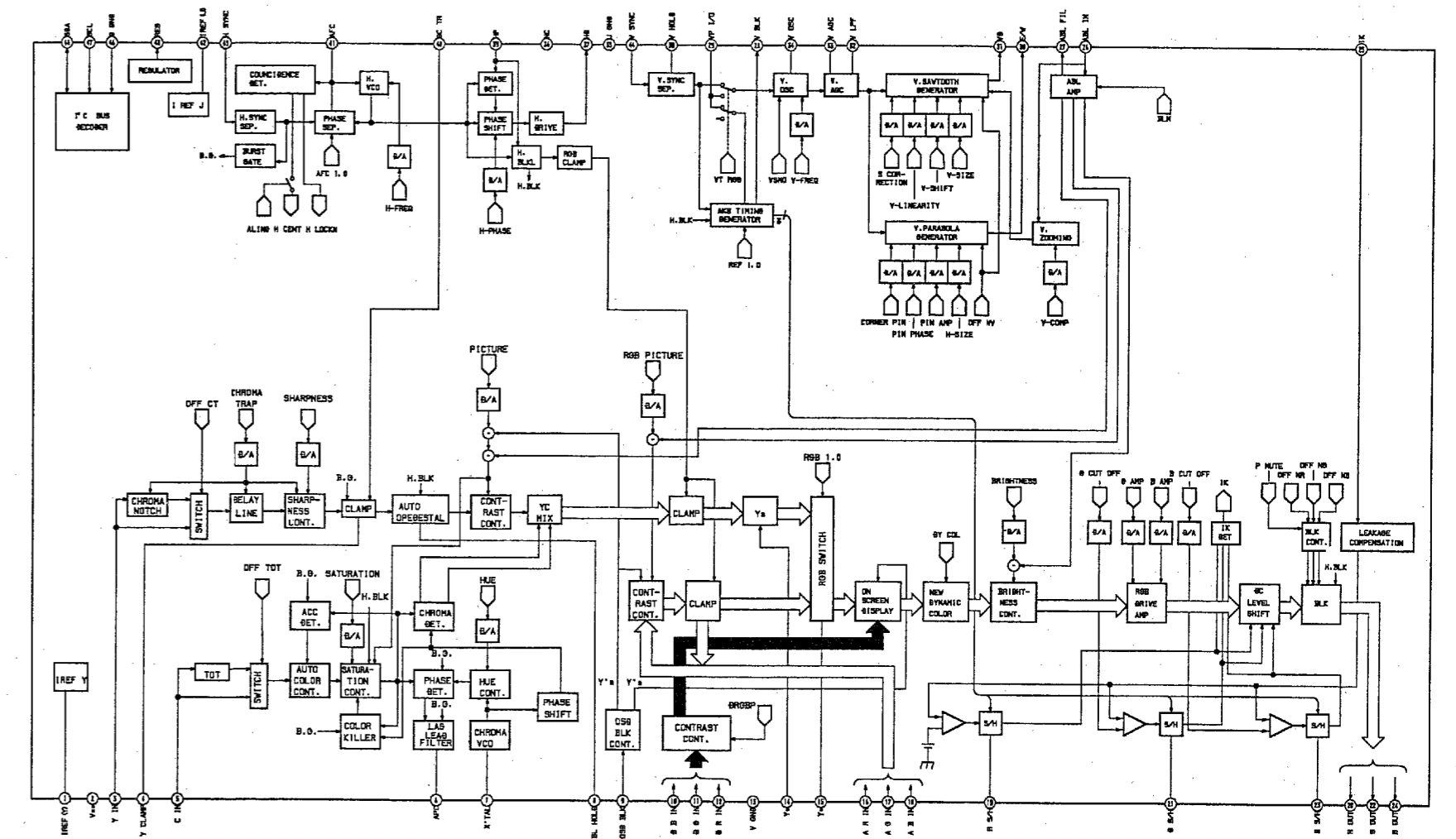

NOTE:
The circuit indicated as left contains high voltage of over 600Vp-p. Care must be paid to prevent an electric shock in inspection or repairing.

A
B
C
D
E
F
G
H
I
J
K
L
M
N
O
P

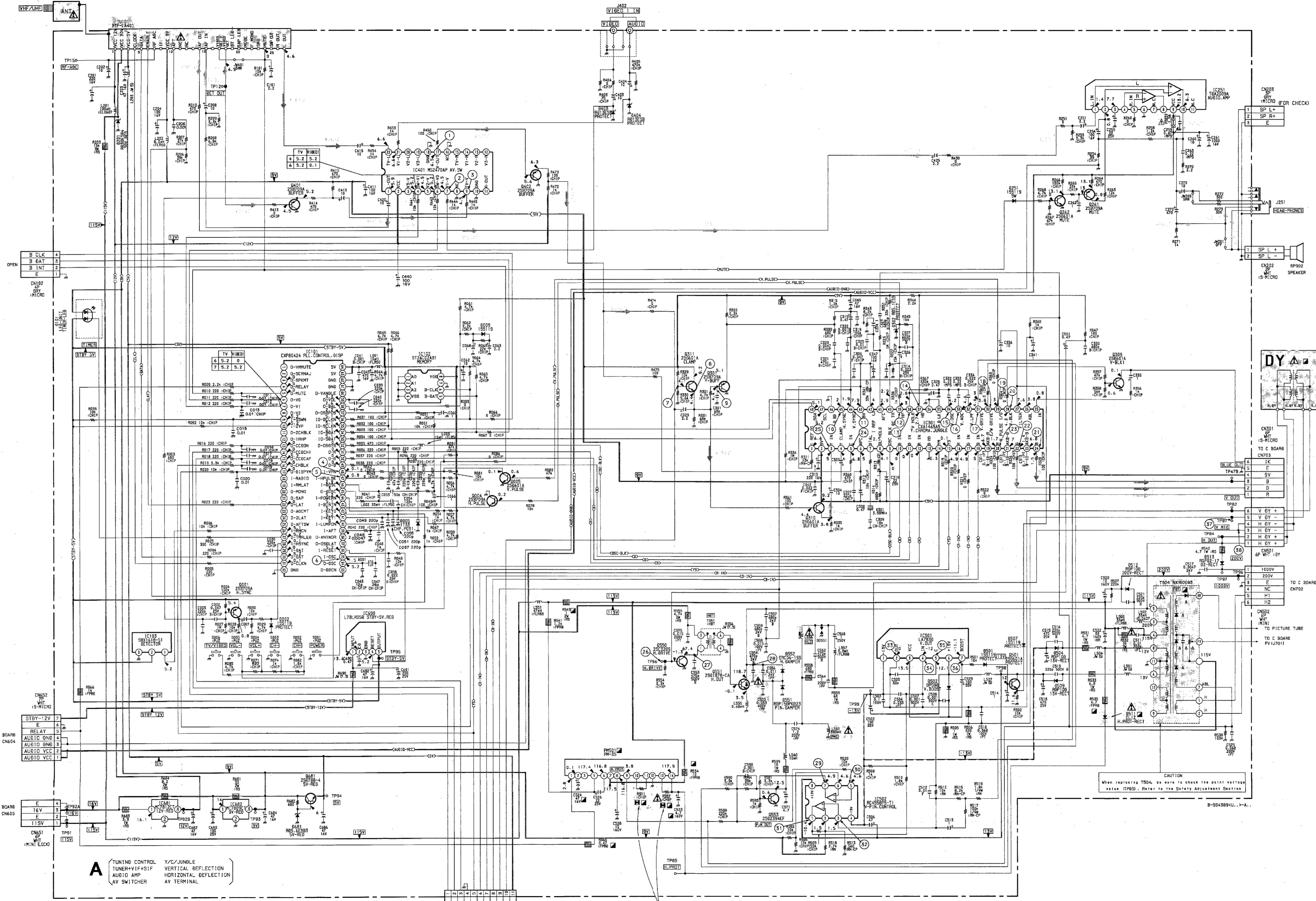

- A Board -

① TV IN 2.6 Vp-p (H)	① VIDEO IN 2.2 Vp-p (H)	② VIDEO 1 1 Vp-p (H)
③ TV IN 1.2 Vp-p (H)	④ 5 Vp-p (V)	⑤ 5 Vp-p (H)
⑥ 5 Vp-p (4.2MHz)	⑦ 0.8Vp-p (H)	⑧ 2.3 Vp-p (H)
⑨ 2 Vp-p (H)	⑩ 1.6 Vp-p (H)	⑪ 1.6 Vp-p (H)
⑫ 5.3 Vp-p (H)	⑬ 0.35Vp-p (V)	⑭ 4 Vp-p (H)
⑮ 1.6 Vp-p (V)	⑯ 2 Vp-p (V)	⑰ 1.3 Vp-p (V)
⑱ 2 Vp-p (V)	⑲ 3.6 Vp-p (V)	⑳ 4.6 Vp-p (V)
㉑ 4.2 Vp-p (H)	㉒ 4 Vp-p (H)	㉓ 4.2 Vp-p (H)
㉔ 2.4 Vp-p (H)	㉕ 2.4Vp-p (H)	㉖ 3.5 Vp-p (H)
㉗ 150 Vp-p (H)	㉘ 880 Vp-p (H)	㉙ 17 Vp-p (V)
㉚ 1 Vp-p (V)	㉛ 4 Vp-p (V)	㉜ 0.5 Vp-p (V)
㉝ 52 Vp-p (V)	㉞ 3.2 Vp-p (V)	㉟ 4.3 Vp-p (V)
㊱ 4.3Vp-p (V)	㊲ 3 Vp-p (V)	㊳ 1.5 Vp-p (V)

• A BOARD IC103 SBX1618-51

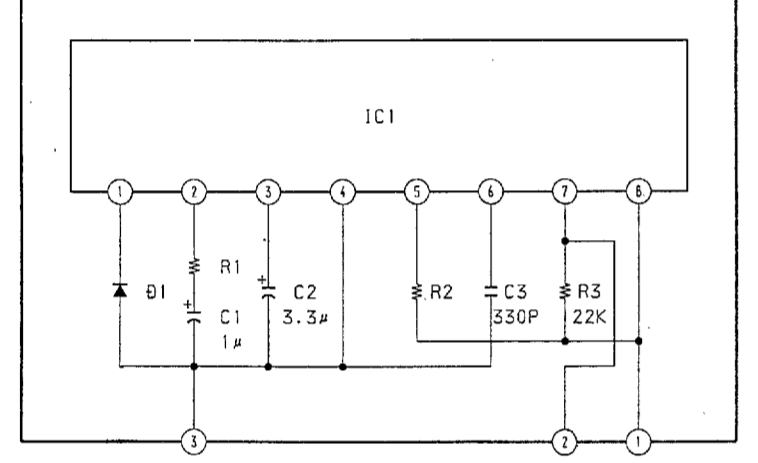

• A BOARD IC401 M52470AP

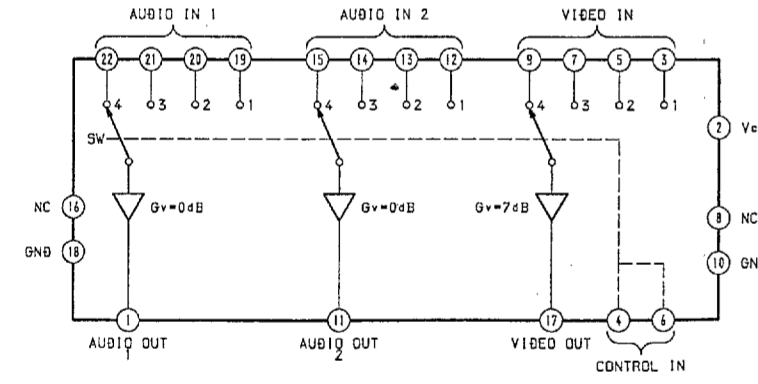

• A BOARD IC501 LA7830

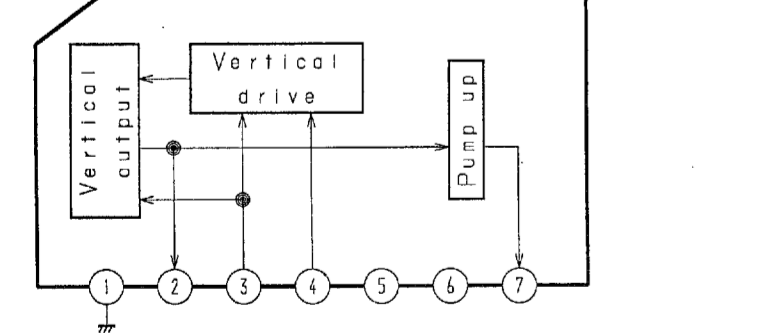

• A BOARD IC690 L78LR05D

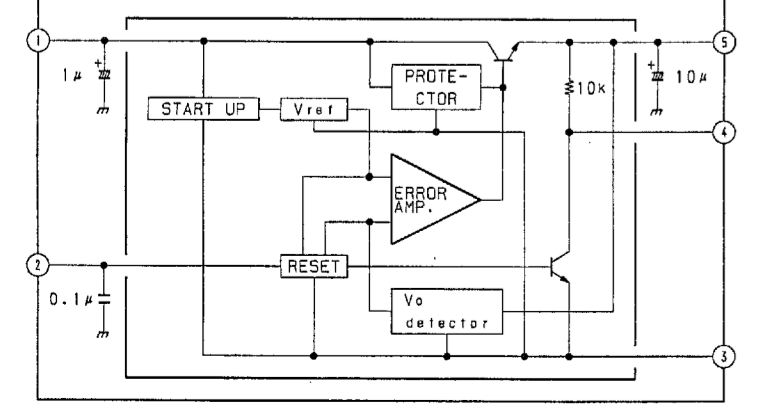

A TUNING CONTROL
TUNER+VIF#3IF
AUDIO AMP
AV SWITCHER

Y/C JUMBLE
VERTICAL DEFLECTION
HORIZONTAL DEFLECTION
AV TERMINAL

CAUTION
When replacing T504, be sure to check the POINT VERTICAL
RETURN (PVED) Relay in the Service Adjustment Section.

KV-20TR23/2150R ONLY

G POWER SUPPLY DEGAUSSING CIRCUIT

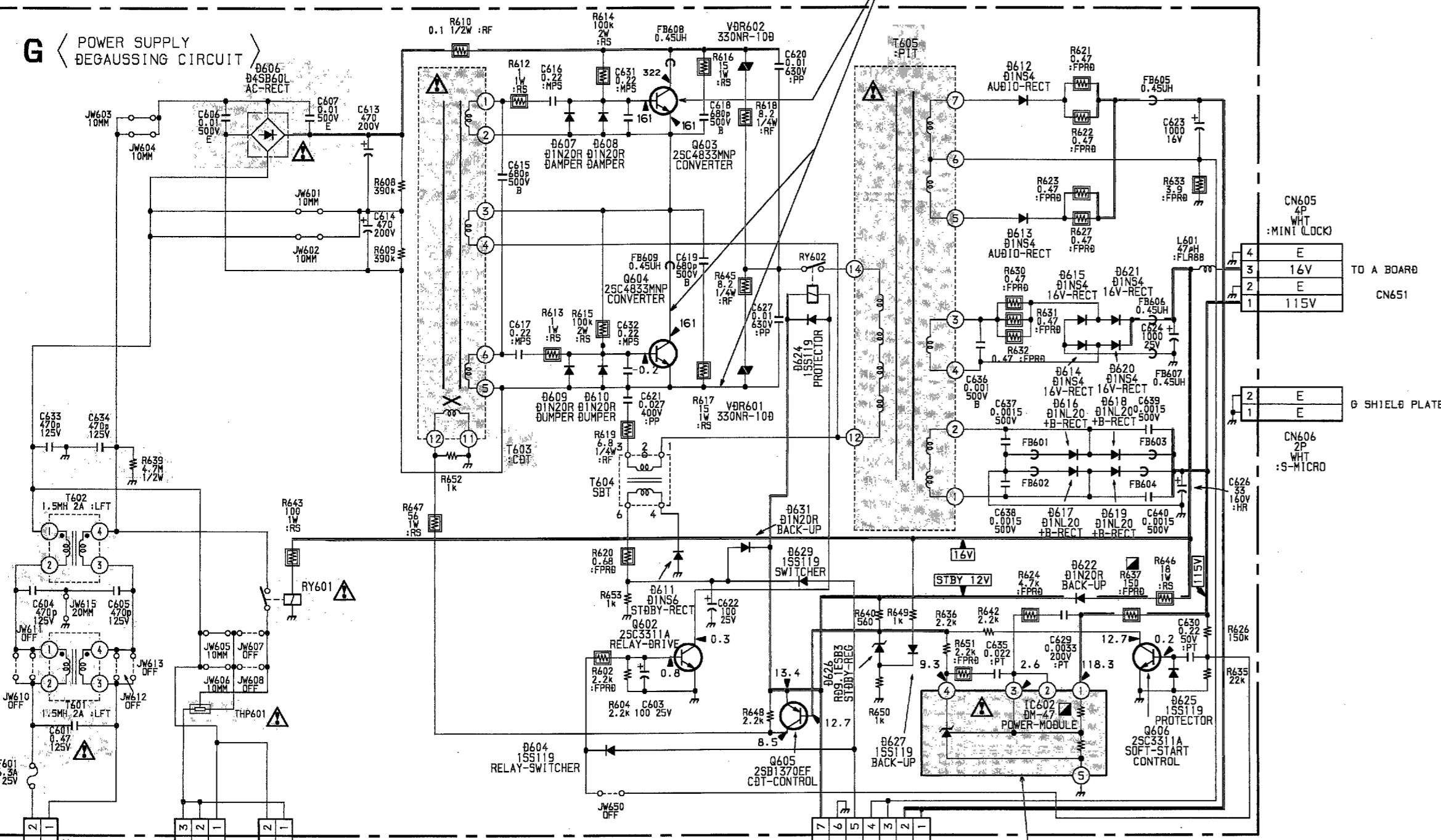

CAUTION
The voltage value of Q603 and Q604 is the reference value between the Q604 emitter

CAUTION
The voltage of Q603 and Q604 is the reference value between the Q604 emitter

TO A BOARD CN651

4	E
3	16V
2	E
1	115V

TO SHIELD PLATE CN606

2	E
1	E

TO A BOARD CN605

4	E
3	16V
2	E
1	115V

TO PICTURE TUBE CN606

2	E
1	E

CAUTION
When replacing IC602, be sure to check the +B line voltage value. Refer to the Safety Adjustment Section

CAUTION (US MODEL ONLY)
This set is equipped with a polarized ac power cord plug (one blade of the plug is wider than the other). When replacing the ac power cord, be sure to connect it with specified port number as shown in this diagram.

KV-2160WR ONLY

G POWER SUPPLY DEGAUSSING CIRCUIT

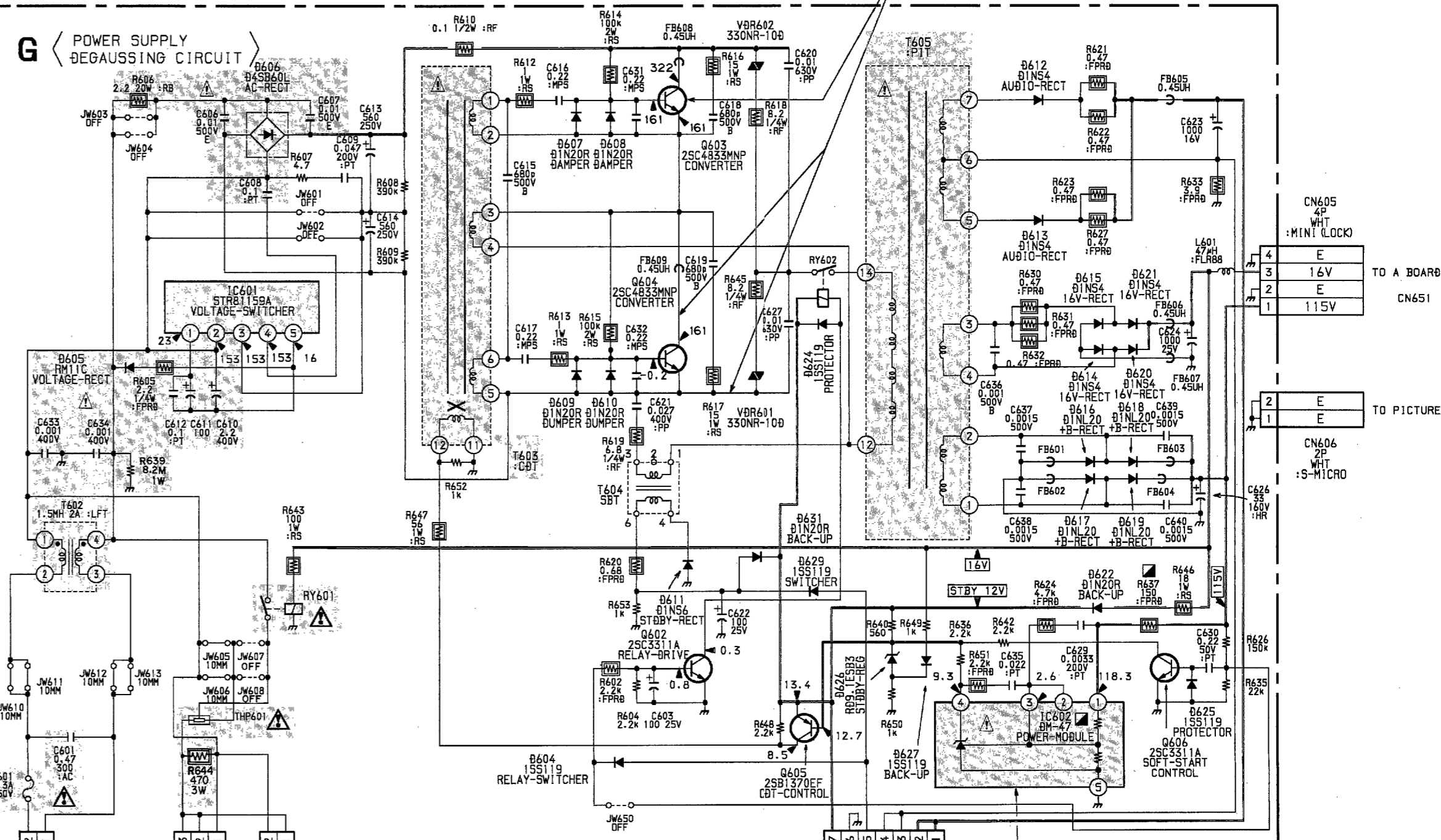

CAUTION
The voltage of Q603 and Q604 is the reference value between the Q604 emitter

TO A BOARD CN651

4	E
3	16V
2	E
1	115V

TO SHIELD PLATE CN606

2	E
1	E

TO A BOARD CN605

4	E
3	16V
2	E
1	115V

TO PICTURE TUBE CN606

2	E
1	E

CAUTION
When replacing IC602, be sure to check the +B line voltage value. Refer to the Safety Adjustment Section

110-127V AC
220-240V AC
50/60Hz

G [POWER SUPPLY, DEGAUSSING CIRCUIT]

— G Board —

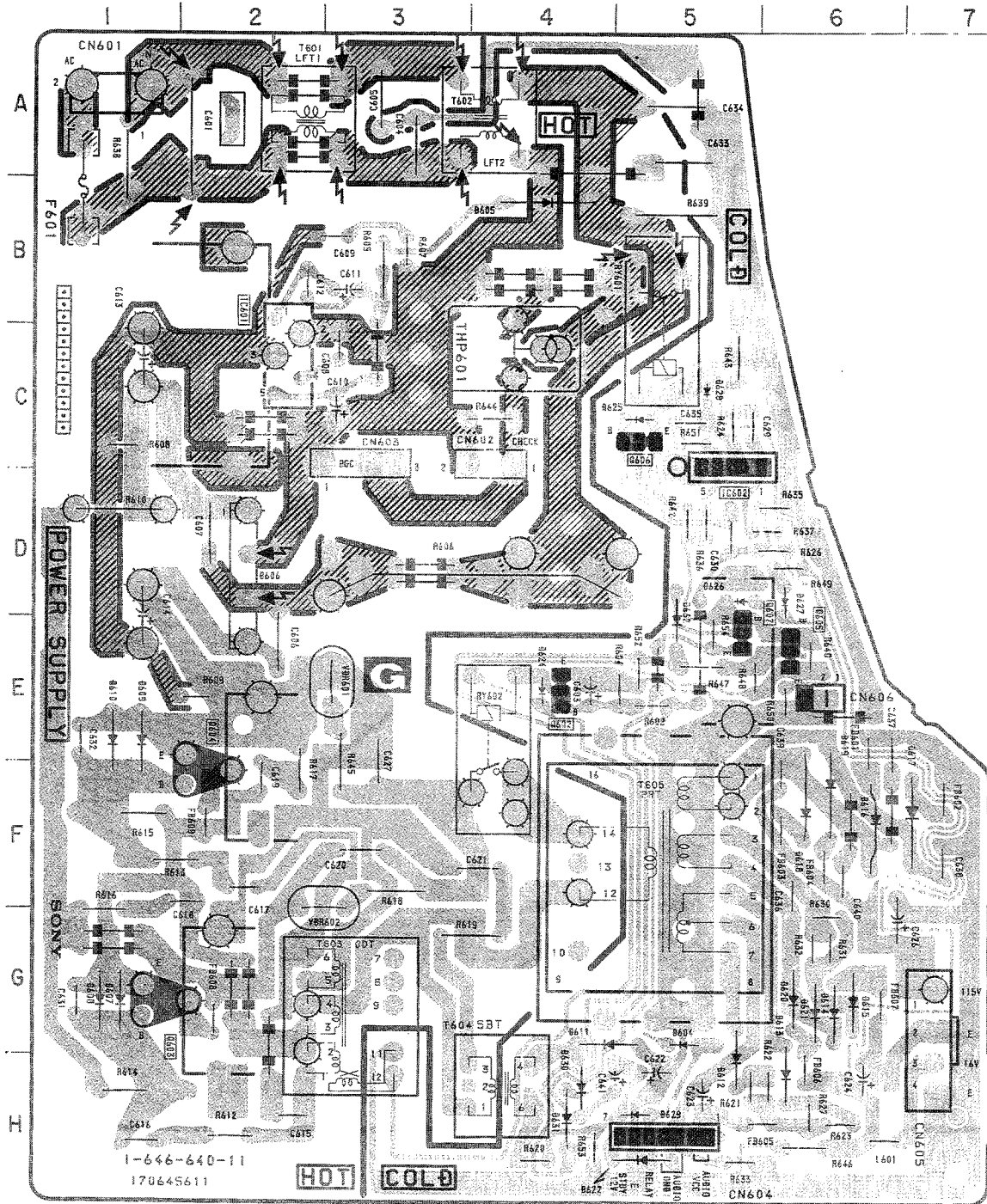

— G Board —

IC	
IC601	B-3
IC602	C-5
TRANSISTOR	
Q602	E-4
Q603	G-1
Q604	F-2
Q605	E-6
Q606	C-5
DIODE	
D604	G-5
D605	B-4
D606	D-2
D607	G-1
D608	G-1
D609	E-1
D610	E-1
D611	G-4
D612	H-5
D613	H-6
D614	G-6
D615	G-6
D616	F-6
D617	F-7
D618	F-6
D619	F-6
D620	G-6
D621	G-6
D622	H-5
D624	E-4
D625	C-5
D626	E-5
D627	D-6
D629	H-5
D631	H-4

NOTE:



The circuit indicated as left contains high voltage of over 600Vp-p. Care must be paid to prevent an electric shock in inspection or repairing.

C [R.G.B. OUT]

— C Board —

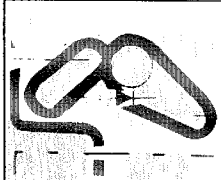
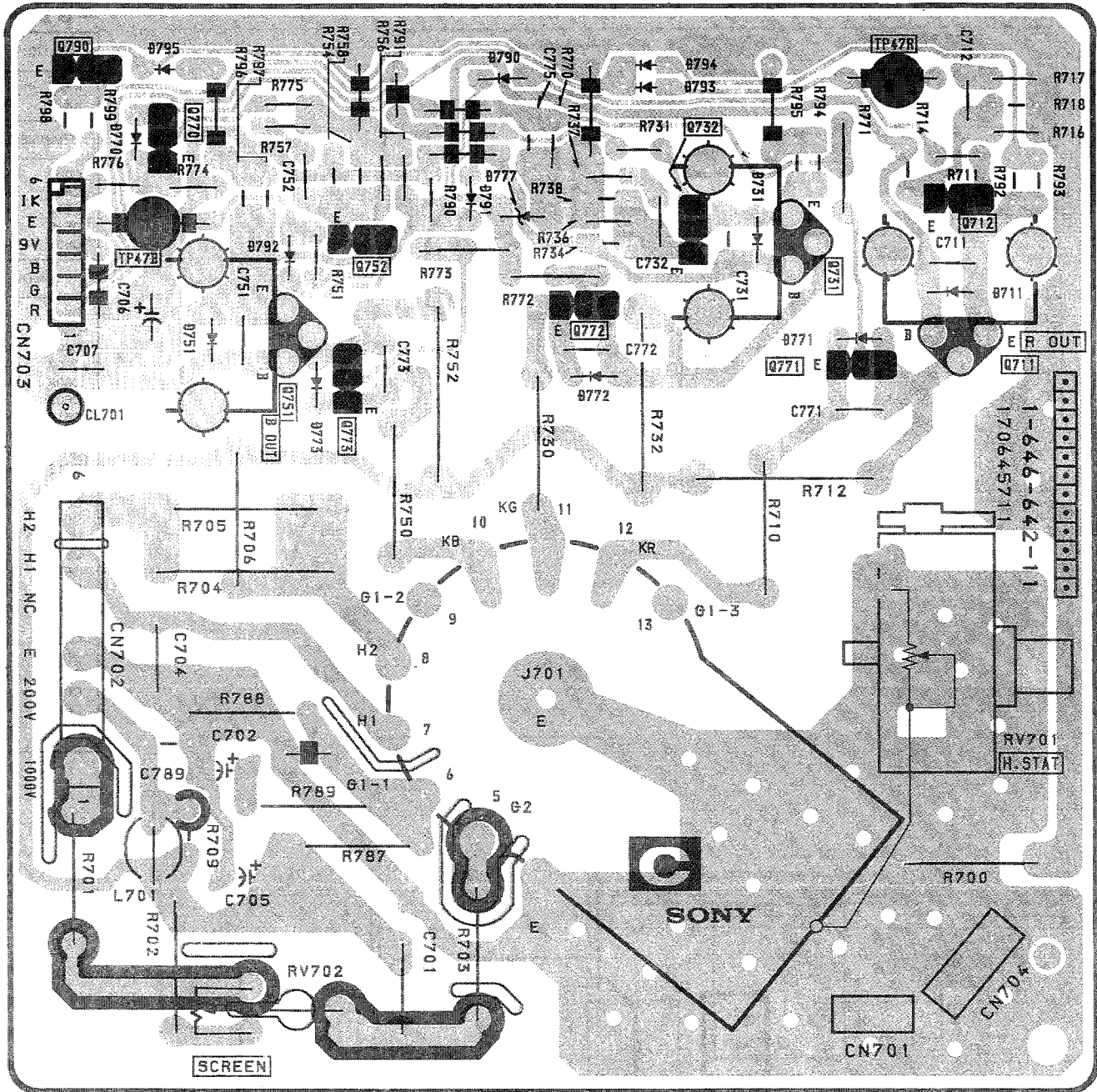

NOTE:
The circuit indicated as left contains high voltage of over 600Vp-p. Care must be paid to prevent an electric shock in inspection or repairing.

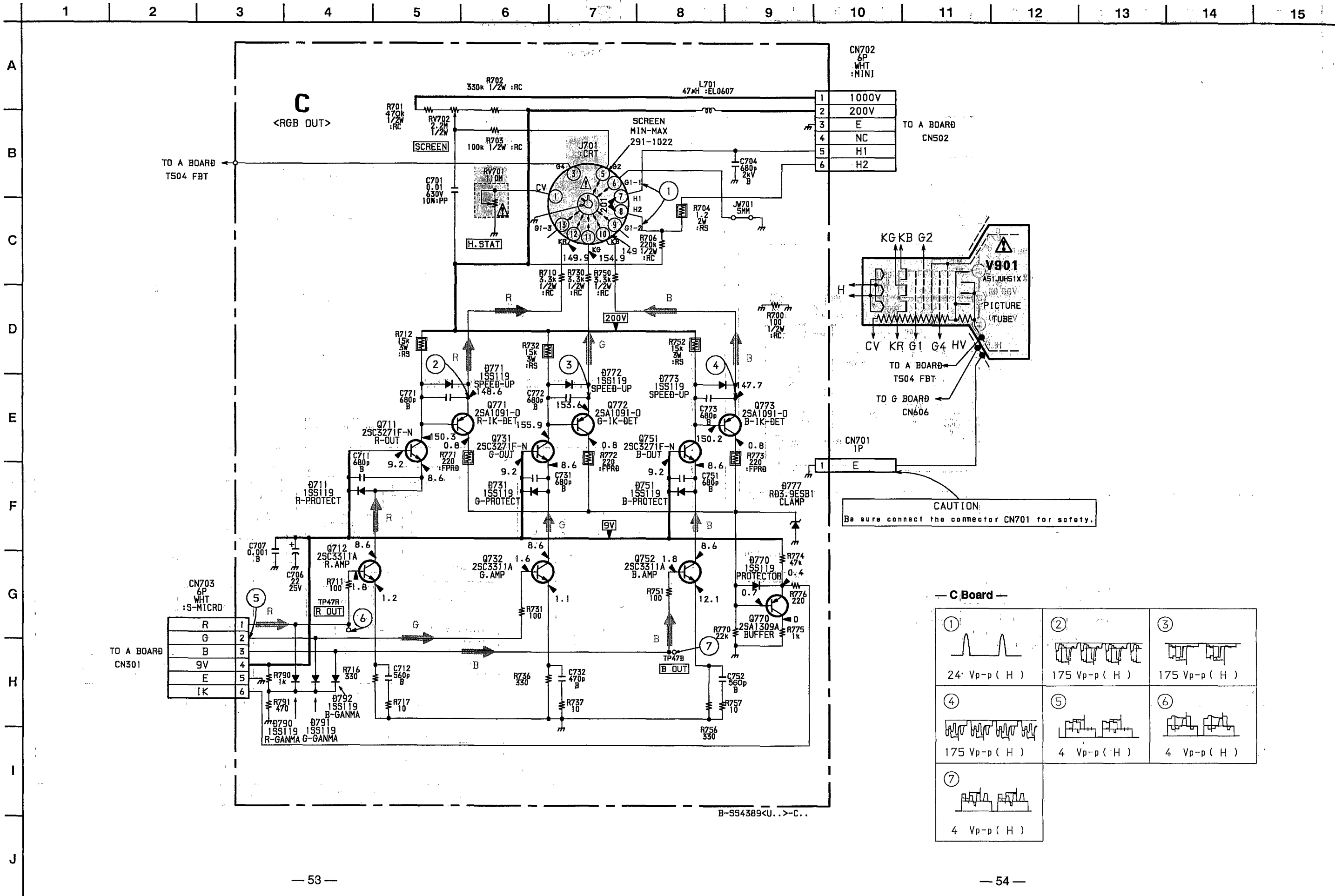

S [CLOSED CAPTION]

— S Board —

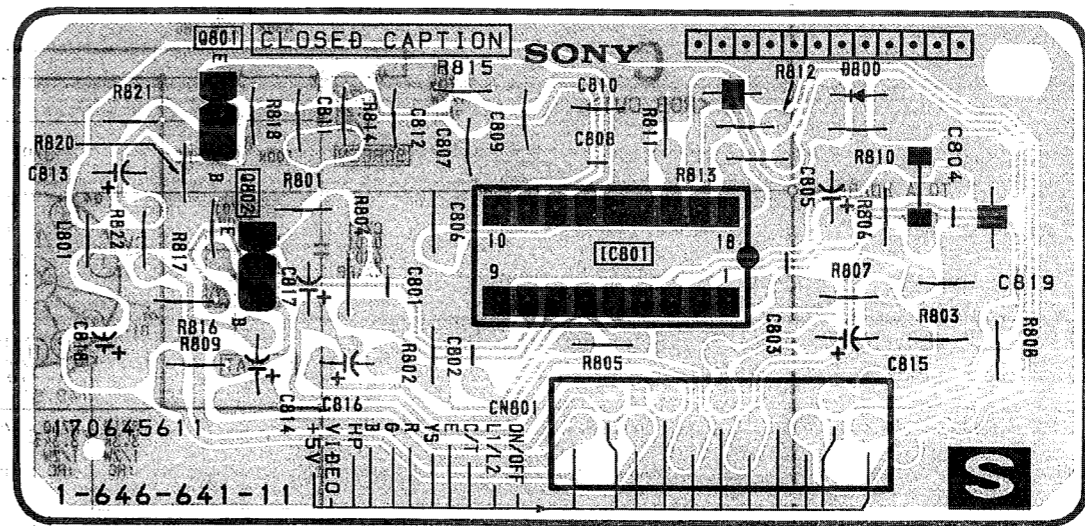

• S BOARD IC801 Z8612812PSC

KV-20TR23 (US Model) ONLY

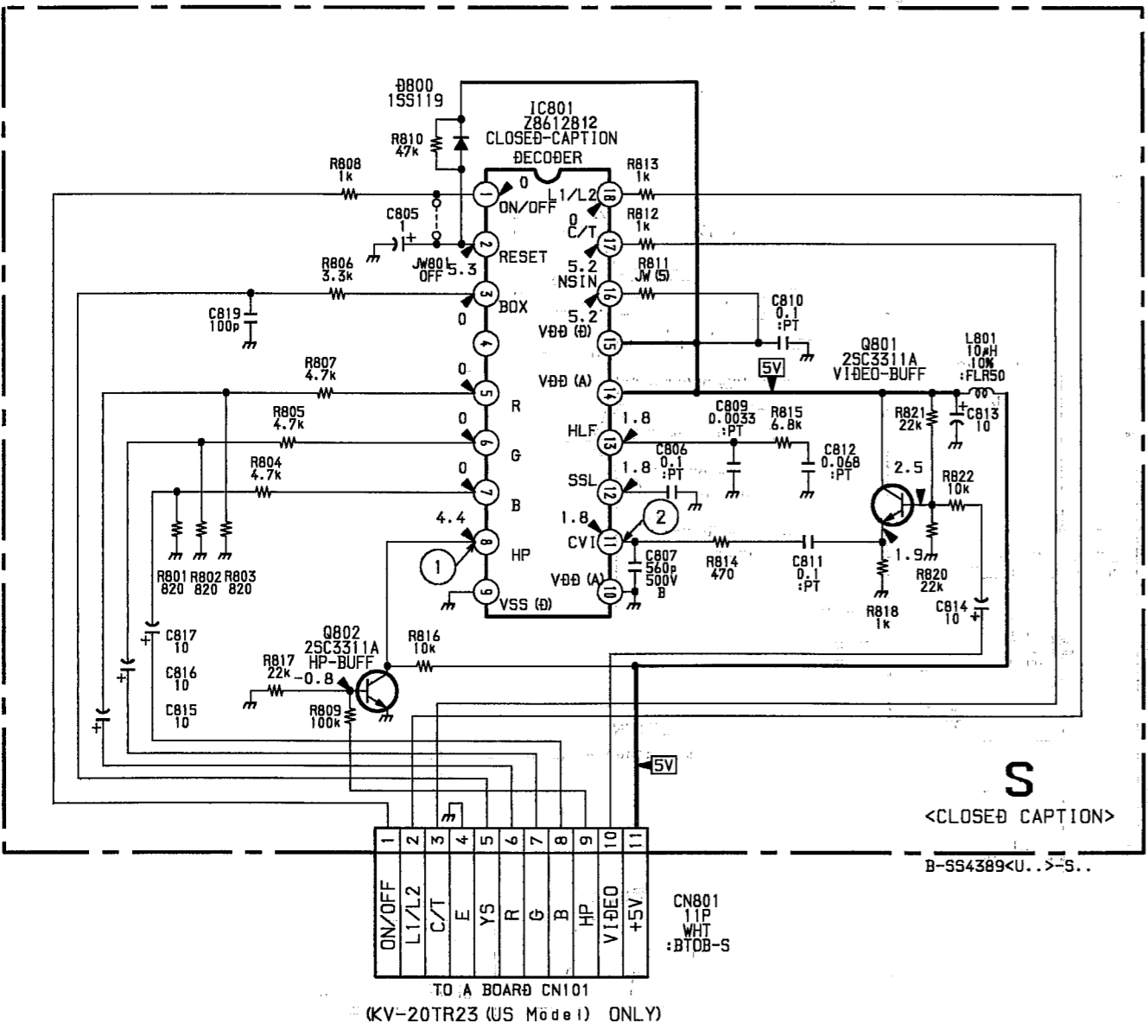

— S Board —

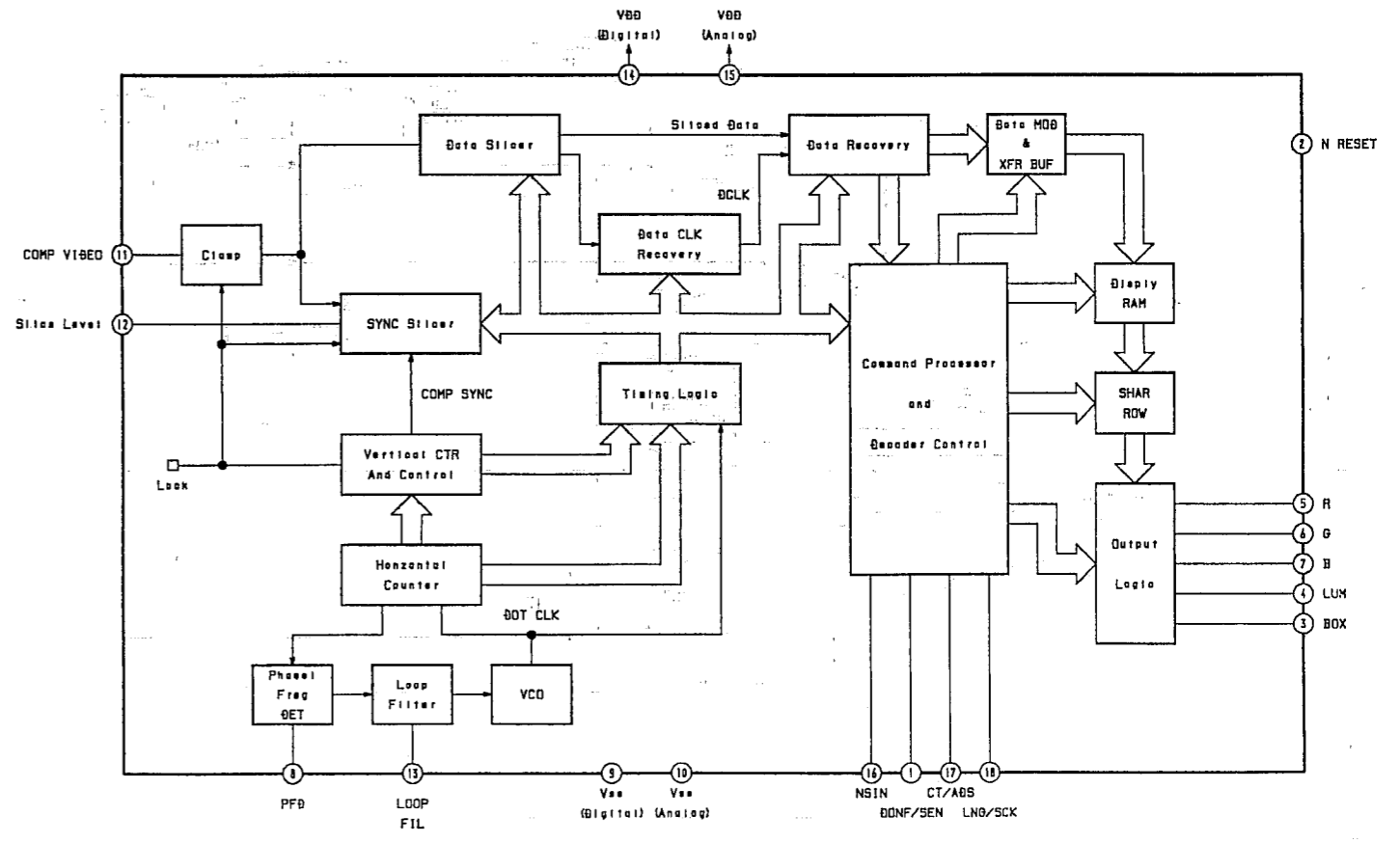
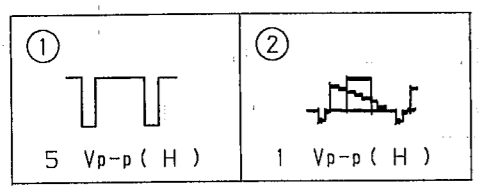



— S Board —

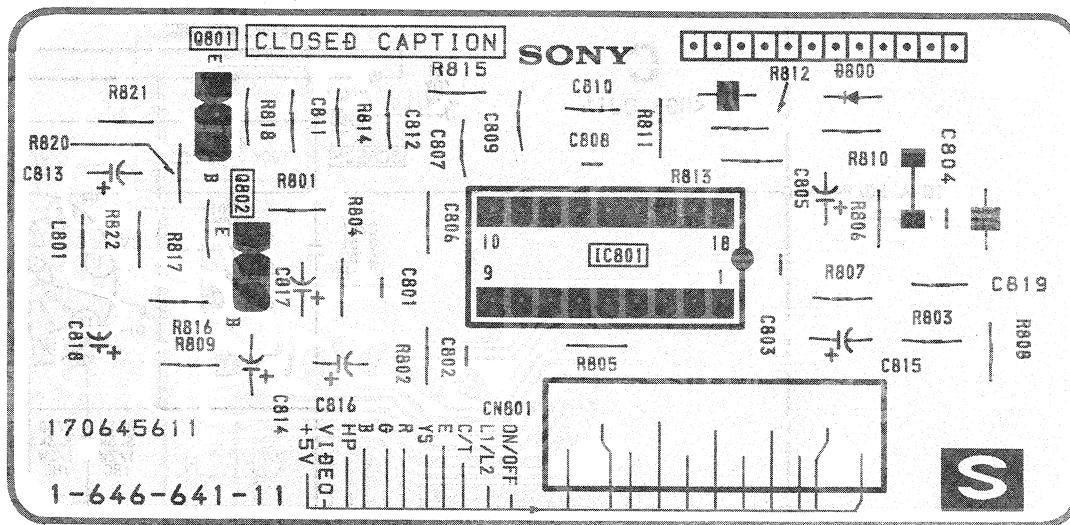

• S BOARD IC801 Z8612812PSC

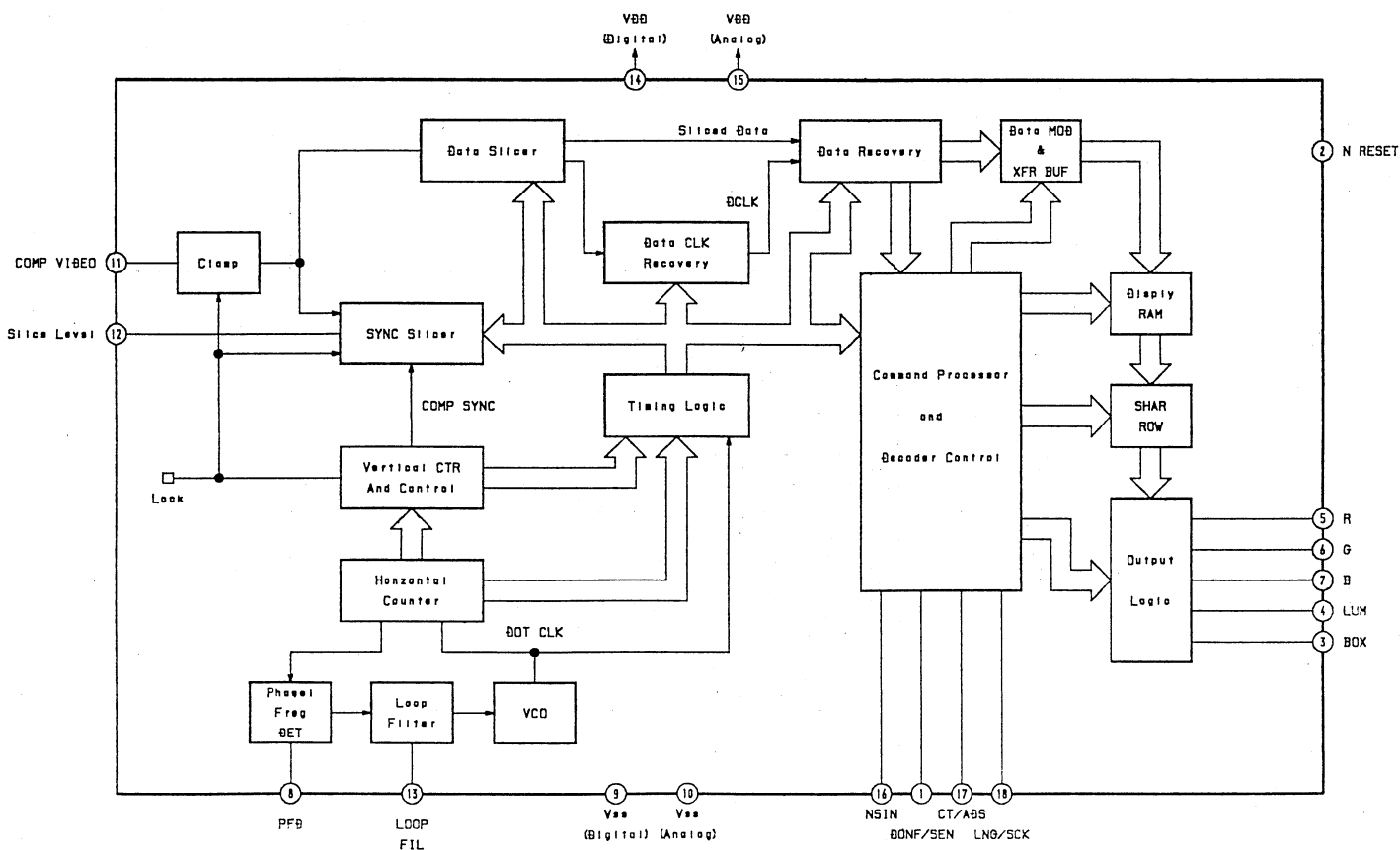

S

(CLOSED CAPTION)

— 8 Board —

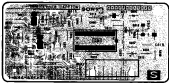

— 8 BOARD WITH ZM10H1P50

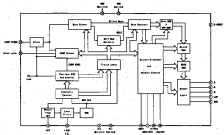



REF. NO.	PART NO.	DESCRIPTION	REMARK	REF. NO.	PART NO.	DESCRIPTION	REMARK
<TRANSISTOR>				R052	1-216-065-00	METAL GLAZE 4.7K 5%	1/10W
Q001	8-729-422-36	TRANSISTOR 2SB709A-Q		R054	1-216-049-00	METAL GLAZE 1K 5%	1/10W
Q004	8-729-422-36	TRANSISTOR 2SB709A-Q		R055	1-216-073-00	METAL GLAZE 10K 5%	1/10W
Q005	8-729-422-27	TRANSISTOR 2SD601A-Q		R056	1-216-065-00	METAL GLAZE 4.7K 5%	1/10W
Q261	8-729-422-36	TRANSISTOR 2SB709A-Q		R057	1-216-065-00	METAL GLAZE 4.7K 5%	1/10W
Q262	8-729-422-27	TRANSISTOR 2SD601A-Q		R059	1-216-065-00	METAL GLAZE 4.7K 5%	1/10W
Q301	8-729-422-36	TRANSISTOR 2SB709A-Q		R061	1-216-073-00	METAL GLAZE 10K 5%	1/10W
Q309	8-729-422-27	TRANSISTOR 2SD601A-Q		R062	1-216-057-00	METAL GLAZE 2.2K 5%	1/10W
Q310	8-729-422-27	TRANSISTOR 2SD601A-Q		R063	1-216-081-00	METAL GLAZE 22K 5%	1/10W
Q311	8-729-422-27	TRANSISTOR 2SD601A-Q		R064	1-216-065-00	METAL GLAZE 4.7K 5%	1/10W
Q401	8-729-422-36	TRANSISTOR 2SB709A-Q		R065	1-216-065-00	METAL GLAZE 4.7K 5%	1/10W
Q402	8-729-422-36	TRANSISTOR 2SB709A-Q		R066	1-216-295-00	METAL GLAZE 0 5%	1/10W
Q501	8-729-422-27	TRANSISTOR 2SD601A-Q		R067	1-216-295-00	METAL GLAZE 0 5%	1/10W
Q550	8-729-140-50	TRANSISTOR 2SC3209LK		R069	1-216-057-00	METAL GLAZE 2.2K 5%	1/10W
Q551	8-729-821-87	TRANSISTOR 2SD1878-CA		R071	1-216-047-00	METAL GLAZE 820 5%	1/10W
Q553	8-729-019-01	TRANSISTOR 2SD2394-EF		R074	1-216-049-00	METAL GLAZE 1K 5%	1/10W
Q681	8-729-378-84	TRANSISTOR 2SD788-5		R078	1-249-429-11	CARBON 10K 5%	1/4W
<RESISTOR>				R081	1-216-073-00	METAL GLAZE 10K 5%	1/10W
R001	1-216-073-00	METAL GLAZE 10K 5%	1/10W	R082	1-216-055-00	METAL GLAZE 1.8K 5%	1/10W
R003	1-216-045-00	METAL GLAZE 680 5%	1/10W	R083	1-249-437-11	CARBON 47K 5%	1/4W
R004	1-216-033-00	METAL GLAZE 220 5%	1/10W	R085	1-216-065-00	METAL GLAZE 4.7K 5%	1/10W
R005	1-216-033-00	METAL GLAZE 220 5%	1/10W	R086	1-216-295-00	METAL GLAZE 0 5%	1/10W
R006	1-216-073-00	METAL GLAZE 10K 5%	1/10W	R091	1-216-089-00	METAL GLAZE 47K 5%	1/10W
R009	1-216-057-00	METAL GLAZE 2.2K 5%	1/10W	R092	1-216-073-00	METAL GLAZE 10K 5%	1/10W
R010	1-216-033-00	METAL GLAZE 220 5%	1/10W	R093	1-216-295-00	METAL GLAZE 0 5%	1/10W
R011	1-216-033-00	METAL GLAZE 220 5%	1/10W	R095	1-216-033-00	METAL GLAZE 220 5%	1/10W
R012	1-216-033-00	METAL GLAZE 220 5%	1/10W	R096	1-216-033-00	METAL GLAZE 220 5%	1/10W
R016	1-216-033-00	METAL GLAZE 220 5%	1/10W	R097	1-216-033-00	METAL GLAZE 220 5%	1/10W
R017	1-216-033-00	METAL GLAZE 220 5%	1/10W	R101	1-216-073-00	METAL GLAZE 10K 5%	1/10W
R018	1-216-033-00	METAL GLAZE 220 5%	1/10W	R203	1-215-924-00	METAL OXIDE 15K 5%	3W F
R019	1-216-061-00	METAL GLAZE 3.3K 5%	1/10W	R206	1-216-689-11	METAL GLAZE 39K 5%	1/10W
R020	1-216-073-00	METAL GLAZE 10K 5%	1/10W	R207	1-216-083-00	METAL GLAZE 27K 5%	1/10W
R023	1-216-033-00	METAL GLAZE 220 5%	1/10W	R208	1-216-069-00	METAL GLAZE 6.8K 5%	1/10W
R025	1-216-039-00	METAL GLAZE 390 5%	1/10W	R209	1-216-061-00	METAL GLAZE 3.3K 5%	1/10W
R026	1-216-097-00	METAL GLAZE 100K 5%	1/10W	R210	1-216-041-00	METAL GLAZE 470 5%	1/10W
R027	1-216-121-00	METAL GLAZE 1M 5%	1/10W	R251	1-216-295-00	METAL GLAZE 0 5%	1/10W
R028	1-216-073-00	METAL GLAZE 10K 5%	1/10W	R253	1-216-061-00	METAL GLAZE 3.3K 5%	1/10W
R029	1-216-065-00	METAL GLAZE 4.7K 5%	1/10W	R254	1-216-015-00	METAL GLAZE 39 5%	1/10W
R030	1-216-073-00	METAL GLAZE 10K 5%	1/10W	R258	1-216-051-00	METAL GLAZE 1.2K 5%	1/10W
R031	1-216-025-00	METAL GLAZE 100 5%	1/10W	R260	1-216-295-00	METAL GLAZE 0 5%	1/10W
R032	1-216-025-00	METAL GLAZE 100 5%	1/10W	R263	1-216-075-00	METAL GLAZE 12K 5%	1/10W
R033	1-216-025-00	METAL GLAZE 100 5%	1/10W	R264	1-216-041-00	METAL GLAZE 470 5%	1/10W
R034	1-216-025-00	METAL GLAZE 100 5%	1/10W	R265	1-216-085-00	METAL GLAZE 33K 5%	1/10W
R035	1-216-041-00	METAL GLAZE 470 5%	1/10W	R266	1-216-085-00	METAL GLAZE 33K 5%	1/10W
R036	1-216-033-00	METAL GLAZE 220 5%	1/10W	R267	1-216-089-00	METAL GLAZE 47K 5%	1/10W
R037	1-216-033-00	METAL GLAZE 220 5%	1/10W	R268	1-216-065-00	METAL GLAZE 4.7K 5%	1/10W
R038	1-216-033-00	METAL GLAZE 220 5%	1/10W	R270	1-249-385-11	CARBON 2.2 5%	1/4W
R040	1-216-033-00	METAL GLAZE 220 5%	1/10W	R271	1-249-417-11	CARBON 1K 5%	1/4W
R041	1-216-033-00	METAL GLAZE 220 5%	1/10W	R272	1-249-411-11	CARBON 330 5%	1/4W
R042	1-216-295-00	METAL GLAZE 0 5%	1/10W	R273	1-249-411-11	CARBON 330 5%	1/4W
R043	1-216-295-00	METAL GLAZE 0 5%	1/10W	R301	1-216-065-00	METAL GLAZE 4.7K 5%	1/10W
R044	1-216-065-00	METAL GLAZE 4.7K 5%	1/10W	R302	1-216-057-00	METAL GLAZE 2.2K 5%	1/10W
R045	1-216-065-00	METAL GLAZE 4.7K 5%	1/10W	R311	1-216-678-11	METAL CHIP 13K 0.50%	1/10W
R046	1-216-065-00	METAL GLAZE 4.7K 5%	1/10W	R312	1-216-079-00	METAL GLAZE 18K 5%	1/10W
R047	1-216-049-00	METAL GLAZE 1K 5%	1/10W	R313	1-216-653-11	METAL CHIP 1.2K 0.50%	1/10W
R048	1-216-073-00	METAL GLAZE 10K 5%	1/10W	R314	1-216-117-00	METAL GLAZE 680K 5%	1/10W
R049	1-216-025-00	METAL GLAZE 100 5%	1/10W	R315	1-216-051-00	METAL GLAZE 1.2K 5%	1/10W
R050	1-216-049-00	METAL GLAZE 1K 5%	1/10W	R319	1-216-295-00	METAL GLAZE 0 5%	1/10W
R051	1-216-073-00	METAL GLAZE 10K 5%	1/10W	R320	1-216-295-00	METAL GLAZE 0 5%	1/10W
				R321	1-216-295-00	METAL GLAZE 0 5%	1/10W
				R322	1-216-295-00	METAL GLAZE 0 5%	1/10W
				R323	1-216-121-00	METAL GLAZE 1M 5%	1/10W
				R324	1-216-025-00	METAL GLAZE 100 5%	1/10W
				R326	1-216-025-00	METAL GLAZE 100 5%	1/10W

SECTION 7 EXPLODED VIEW

NOTE:

- Items with no part number and no description are not stocked because they are seldom required for routine service.
- The construction parts of an assembled part are indicated with a collation number in the remark column.
- Items marked "*" are not stocked since they are seldom required for routine service. Some delay should be anticipated when ordering these items.

The components identified by shading and mark **△** are critical for safety.
Replace only with part number specified.

Les composants identifiés par une trame et une marque **△** sont critiques pour la sécurité.
Ne les remplacer que par une pièce portant le numéro spécifié.

7-1. CHASSIS

- : BVTP3x12 7-685-648-79 (BLACK)
- : BVTP4x16 7-685-663-79
- : BVTP3x12 7-685-648-71

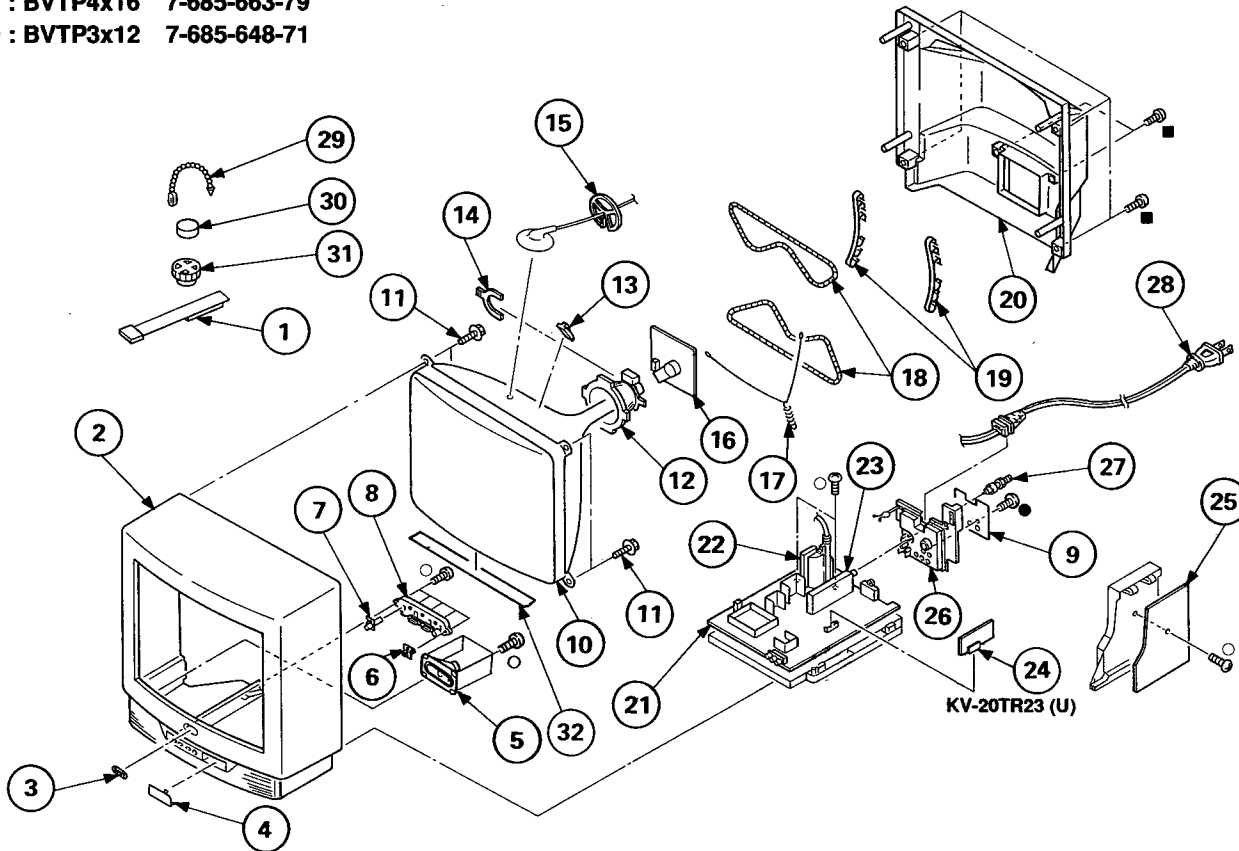

REF. NO.	PART NO.	DESCRIPTION	REMARK	REF. NO.	PART NO.	DESCRIPTION	REMARK
1	X-4308-815-0	PERMALLOY ASSY, CONVERGENCE		19	*4-369-319-00	BAND, COIL	
2	4-039-678-01	CABINET (WITH BEZEL)		20	4-039-603-01	COVER, REAR	
3	4-394-072-01	EMBLEM (NO.8), SONY		21	*A-1297-059-A	A BOARD, COMPLETE	
4	4-039-596-01	DOOR, CONTROL		22	△.1-453-141-11	TRANSFORMER ASSY, FLYBACK (NX-1600A5)	
5	1-504-252-11	SPEAKER (9X5CM)		23	△.8-598-047-00	TUNER (BTF-LA401)	
6	4-039-594-11	GUIDE, LED		24	*A-1394-414-A	S BOARD, COMPLETE (KV-20TR23(U))	
7	4-039-589-01	FILTER, REMOTE		25	*A-1316-146-A	G BOARD, COMPLETE (KV-20TR23(U/C), 2150R)	
8	4-039-595-01	BUTTON, MULTI			*A-1316-148-A	G BOARD, COMPLETE (KV-2160WR)	
9	4-039-677-01	LABEL, TERMINAL		26	△.4-039-601-01	TERMINAL BOARD, ANTENNA	
10	△.8-738-764-05	PICTURE TUBE (A51JUH51X)		27	1-573-657-11	PLUG, F-PIN	
11	4-365-808-01	SCREW (5), TAPPING		28	△.1-751-057-11	CORD, POWER (WITH CONNECTOR) (KV-20TR23(U/C), 2150R)	
12	△.1-451-280-11	DEFLECTION YOKE (Y21PXA2)			△.1-751-056-11	CORD, POWER (WITH CONNECTOR) (KV-2160WR)	
13	3-704-495-01	SPACER, DY		29	4-308-870-00	CLIP, LEAD WIRE	
14	1-452-277-00	MAGNET, BMC		30	1-452-032-00	MAGNET, DISK; 10MM φ	
15	*3-704-372-01	HOLDER, HV CABLE		31	1-452-094-00	MAGNET, ROTATABLE DISK; 15MM φ	
16	*A-1331-246-A	C BOARD, COMPLETE		32	4-385-725-01	SHEET BLOTTING	
17	*4-375-394-01	SPRING, TENSION					
18	△.1-426-358-31	COIL, DEMAGNETIZATION (KV-20TR23(U/C), 2150R)					
	△.1-426-368-11	COIL, DEMAGNETIZATION (KV-2160WR)					

SECTION 8 ELECTRICAL PARTS LIST

A

NOTE:

The components identified by shading and mark **Δ** are critical for safety. Replace only with part number specified.

Les composants identifiés par une trame et une marque **Δ** sont critiques pour la sécurité. Ne les remplacer que par une pièce portant le numéro spécifié.

- Items marked "*" are not stocked since they are seldom required for routine service. Some delay should be anticipated when ordering these items.

- All variable and adjustable resistors have characteristic curve B, unless otherwise noted.

RESISTORS

- All resistors are in ohms
- F: nonflammable

When indicating parts by reference number, please include the board name.

CAPACITORS

- MF: μ F, PF: μ F

COILS

- MMH: mH, UH: μ H

- The components identified by **Δ** in this manual have been carefully factory-selected for each set in order to satisfy regulations regarding X-ray radiation.

Should replacement be required, replace only with the value originally used.

REF. NO.	PART NO.	DESCRIPTION	REMARK	REF. NO.	PART NO.	DESCRIPTION	REMARK
*A-1297-059-A		A BOARD, COMPLETE					

4-382-854-11		SCREW (M3X10), P, SW (+)					
		<CAPACITOR>					
C002	1-163-809-11	CERAMIC CHIP 0.047MF	10% 25V	C254	1-126-101-11	ELECT 100MF	20% 16V
C003	1-163-125-00	CERAMIC CHIP 220PF	5% 50V	C255	1-124-916-11	ELECT 22MF	20% 25V
C007	1-124-903-11	ELECT 1MF	20% 50V	C259	1-136-173-00	FILM 0.47MF	5% 50V
C011	1-163-009-11	CERAMIC CHIP 0.001MF	10% 50V	C260	1-124-907-11	ELECT 10MF	20% 50V
C012	1-163-009-11	CERAMIC CHIP 0.001MF	10% 50V	C261	1-124-360-00	ELECT 1000MF	20% 16V
C013	1-163-009-11	CERAMIC CHIP 0.001MF	10% 50V	C262	1-124-925-11	ELECT 2.2MF	20% 50V
C014	1-163-009-11	CERAMIC CHIP 0.001MF	10% 50V	C263	1-136-169-00	FILM 0.22MF	5% 50V
C015	1-163-009-11	CERAMIC CHIP 0.001MF	10% 50V	C270	1-124-907-11	ELECT 10MF	20% 50V
C016	1-163-009-11	CERAMIC CHIP 0.001MF	10% 50V	C272	1-126-103-11	ELECT 470MF	20% 16V
C017	1-163-009-11	CERAMIC CHIP 0.001MF	10% 50V	C301	1-163-113-00	CERAMIC CHIP 68PF	5% 50V
C018	1-163-009-11	CERAMIC CHIP 0.001MF	10% 50V	C304	1-124-907-11	ELECT 10MF	20% 50V
C019	1-163-009-11	CERAMIC CHIP 0.001MF	10% 50V	C305	1-124-903-11	ELECT 1MF	20% 50V
C020	1-163-009-11	CERAMIC CHIP 0.001MF	10% 50V	C306	1-163-035-00	CERAMIC CHIP 0.047MF	5% 50V
C030	1-163-125-00	CERAMIC CHIP 220PF	5% 50V	C307	1-163-125-00	CERAMIC CHIP 220PF	5% 50V
C039	1-163-125-00	CERAMIC CHIP 220PF	5% 50V	C308	1-124-902-00	ELECT 0.47MF	20% 50V
C040	1-163-125-00	CERAMIC CHIP 220PF	5% 50V	C309	1-163-099-00	CERAMIC CHIP 18PF	5% 50V
C041	1-163-009-11	CERAMIC CHIP 0.001MF	10% 50V	C310	1-124-916-11	ELECT 22MF	20% 25V
C043	1-163-159-00	CERAMIC CHIP 12PF	2% 50V	C311	1-137-399-11	FILM 0.1MF	5% 50V
C045	1-126-103-11	ELECT 470MF	20% 16V	C312	1-137-399-11	FILM 0.1MF	5% 50V
C046	1-163-017-00	CERAMIC CHIP 0.0047MF	10% 50V	C313	1-137-399-11	FILM 0.1MF	5% 50V
C047	1-104-896-91	CERAMIC CHIP 24PF	2% 50V	C314	1-163-037-11	CERAMIC CHIP 0.022MF	10% 25V
C048	1-216-049-00	METAL GLAZE 1K	5% 1/10W	C315	1-124-120-11	ELECT 220MF	20% 16V
C049	1-163-125-00	CERAMIC CHIP 220PF	5% 50V	C318	1-163-117-00	CERAMIC CHIP 100PF	5% 50V
C050	1-163-109-00	CERAMIC CHIP 47PF	5% 50V	C319	1-124-902-00	ELECT 0.47MF	20% 50V
C051	1-163-125-00	CERAMIC CHIP 220PF	5% 50V	C320	1-163-017-00	CERAMIC CHIP 0.0047MF	10% 50V
C052	1-163-125-00	CERAMIC CHIP 220PF	5% 50V	C321	1-163-005-11	CERAMIC CHIP 470PF	10% 50V
C053	1-163-121-00	CERAMIC CHIP 150PF	5% 50V	C322	1-163-011-11	CERAMIC CHIP 0.0015MF	10% 50V
C054	1-163-253-11	CERAMIC CHIP 120PF	5% 50V	C323	1-163-007-11	CERAMIC CHIP 680PF	10% 50V
C055	1-163-125-00	CERAMIC CHIP 220PF	5% 50V	C324	1-124-903-11	ELECT 1MF	20% 50V
C056	1-163-125-00	CERAMIC CHIP 220PF	5% 50V	C325	1-164-232-11	CERAMIC CHIP 0.01MF	10% 50V
C057	1-163-125-00	CERAMIC CHIP 220PF	5% 50V	C326	1-124-903-11	ELECT 1MF	20% 50V
C058	1-163-037-11	CERAMIC CHIP 0.022MF	10% 25V	C327	1-102-244-00	CERAMIC 220PF	10% 500V
C059	1-163-125-00	CERAMIC CHIP 220PF	5% 50V	C328	1-124-902-00	ELECT 0.47MF	20% 50V
C060	1-124-903-11	ELECT 1MF	20% 50V	C329	1-124-925-11	ELECT 2.2MF	20% 50V
C062	1-124-907-11	ELECT 10MF	20% 50V	C330	1-163-007-11	CERAMIC CHIP 680PF	10% 50V
C063	1-124-925-11	ELECT 2.2MF	20% 50V	C332	1-136-169-00	FILM 0.22MF	5% 50V
C066	1-124-903-11	ELECT 1MF	20% 50V	C333	1-136-169-00	FILM 0.22MF	5% 50V
C101	1-124-925-11	ELECT 2.2MF	20% 50V	C334	1-163-037-11	CERAMIC CHIP 0.022MF	10% 25V
C201	1-124-120-11	ELECT 220MF	20% 16V	C335	1-124-903-11	ELECT 1MF	20% 50V
C202	1-124-907-11	ELECT 10MF	20% 50V	C336	1-124-907-11	ELECT 10MF	20% 50V
C203	1-124-477-11	ELECT 47MF	20% 16V	C340	1-126-101-11	ELECT 100MF	20% 16V
C204	1-126-101-11	ELECT 100MF	20% 16V	C341	1-124-903-11	ELECT 1MF	20% 50V
C206	1-163-009-11	CERAMIC CHIP 0.001MF	10% 50V	C342	1-163-033-00	CERAMIC CHIP 0.022MF	5% 50V
C208	1-124-907-11	ELECT 10MF	20% 50V	C345	1-124-477-11	ELECT 47MF	20% 16V
C251	1-124-925-11	ELECT 2.2MF	20% 50V	C347	1-126-101-11	ELECT 100MF	20% 16V
				C403	1-124-907-11	ELECT 10MF	20% 50V
				C404	1-124-903-11	ELECT 1MF	20% 50V
				C413	1-124-907-11	ELECT 10MF	20% 50V
				C419	1-124-903-11	ELECT 1MF	20% 50V
				C420	1-124-907-11	ELECT 10MF	20% 50V

A

Les composants identifiés par une
trame et une marque **Δ** sont
critiques pour la sécurité.
Ne les remplacer que par une pièce
portant le numéro spécifié.

The components identified by
shading and mark **Δ** are critical
for safety.
Replace only with part number
specified.

REF. NO.	PART NO.	DESCRIPTION	REMARK	REF. NO.	PART NO.	DESCRIPTION	REMARK
C425	1-124-925-11	ELECT	2.2MF 20%	50V			
C440	1-126-101-11	ELECT	100MF 20%	16V	D002	8-719-911-19	DIODE 1SS119
C461	1-124-907-11	ELECT	10MF 20%	50V	D005	8-713-300-57	DIODE 1T33
C501	1-124-902-00	ELECT	0.47MF 20%	50V	D009	8-719-911-19	DIODE 1SS119
C502	1-124-916-11	ELECT	22MF 20%	50V	D101	1-810-039-21	LED UNIT
					D201	8-719-110-72	DIODE RD30ES-B2
C504	1-130-489-00	FILM	0.033MF 5%	50V	D251	8-719-911-19	DIODE 1SS119
C505	1-164-058-11	CERAMIC	33PF 5%	50V	D302	8-719-109-84	DIODE RD5.1ES-B1
C506	1-124-916-11	ELECT	22MF 20%	50V	D403	8-719-110-36	DIODE RD13ES-B2
C507	1-102-038-00	CERAMIC	0.001MF 500V		D404	8-719-110-36	DIODE RD13ES-B2
C508	1-102-038-00	CERAMIC	0.001MF 500V		D501	8-719-911-19	DIODE 1SS119
C509	1-124-122-11	ELECT	100MF 20%	35V	D502	8-719-936-82	DIODE GP08DPKG3
C510	1-137-421-91	FILM	0.068MF 10%	100V	D504	8-719-936-84	DIODE RGP10GPKG3
C511 Δ	1-108-421-91	MYLAR	0.01MF 10%	200V	D507	8-719-911-19	DIODE 1SS119
C512	1-164-096-11	CERAMIC	0.01MF 50V		D509	8-719-936-84	DIODE RGP10GPKG3
C513	1-124-903-11	ELECT	1MF 20%	50V	D511 Δ	8-719-302-43	DIODE EL1Z
C514	1-124-903-11	ELECT	1MF 20%	50V	D512	8-719-936-84	DIODE RGP10GPKG3
C515	1-124-480-11	ELECT	470MF 20%	25V	D513	8-719-976-64	DIODE RGP02-17
C516	1-102-244-00	CERAMIC	220PF 10%	500V	D551	8-719-979-85	DIODE EGP20G
C517	1-162-114-00	CERAMIC	0.0047MF 2KV		D552	8-719-945-80	DIODE ERC06-15S
C518	1-124-480-11	ELECT	470MF 20%	25V	D681	8-719-109-90	DIODE RD5.6ES-B3
C519	1-102-244-00	CERAMIC	220PF 10%	500V			<IC>
C520	1-124-046-00	ELECT	10MF 20%	160V	IC101	8-752-841-16	IC CXP80424-0655
C521	1-102-244-00	CERAMIC	220PF 10%	500V	IC102	8-759-043-86	IC ST24C02AB1
C522	1-123-024-21	ELECT	33MF 160V		IC103	8-741-100-62	IC SBX1618-51
C523	1-123-932-00	ELECT	4.7MF 20%	160V	IC251	8-759-980-43	IC TDA2009A
C524	1-124-477-11	ELECT	47MF 20%	16V	IC301	8-752-059-67	IC CXA1465AS
C525	1-106-387-00	MYLAR	0.068MF 10%	200V	IC401	8-759-634-69	IC M52470P
C526	1-124-916-11	ELECT	22MF 20%	25V	IC501	8-759-801-98	IC LA7830
C528	1-124-046-00	ELECT	10MF 20%	160V	IC502	8-759-996-43	IC RC4558PS
C553	1-102-228-00	CERAMIC	470PF 10%	500V	IC681	8-759-701-79	IC NJM7812FA
C554 Δ	1-162-134-91	CERAMIC	470PF 10%	2KV	IC682	8-759-982-10	IC RC7809FA
C555 Δ	1-104-750-91	FILM	0.033MF 5%	400V	IC690	8-759-805-37	IC L78LR05D-MA
C556 Δ	1-136-080-11	FILM	0.011MF 3%	2KV			<JACK>
C557	1-162-116-00	CERAMIC	680PF 10%	2KV	J251	1-750-264-21	JACK
C558	1-137-417-91	FILM	0.015MF 10%	100V	J402	1-750-518-11	JACK BLOCK, PIN 2P
C559	1-162-116-00	CERAMIC	680PF 10%	2KV			<COIL>
C562	1-102-228-00	CERAMIC	470PF 10%	500V	L001	1-410-470-11	INDUCTOR 10UH
C564	1-136-111-00	FILM	1MF 5%	200V	L002	1-410-476-11	INDUCTOR 33UH
C568	1-124-634-11	ELECT	1MF 20%	250V	L003	1-410-470-11	INDUCTOR 10UH
C571	1-124-927-11	ELECT	4.7MF 20%	50V	L201	1-410-645-31	INDUCTOR 100UH
C574	1-136-569-11	FILM	1.2MF 5%	200V	L202	1-408-408-00	INDUCTOR 8.2UH
C575	1-106-371-00	MYLAR	0.015MF 200V		L502	1-410-669-31	INDUCTOR 33UH
C590	1-163-009-11	CERAMIC CHIP	0.001MF 50V		L503 Δ	1-412-531-61	INDUCTOR 33UH
C682	1-124-477-11	ELECT	47MF 20%	16V	L551	1-412-533-61	INDUCTOR 47UH
C683	1-124-478-11	ELECT	100MF 20%	25V	L555	1-422-613-11	COIL, AIR CORE
C684	1-124-477-11	ELECT	47MF 20%	16V	L555 Δ	1-459-769-13	COIL, HORIZONTAL LINEARITY
C686	1-124-477-11	ELECT	47MF 20%	16V	L557	1-412-553-61	INDUCTOR 3.3MMH
C690	1-124-902-00	ELECT	0.47MF 20%	50V	L560	1-459-104-00	COIL, WITH CORE
C691	1-124-120-11	ELECT	220MF 20%	25V	L561 Δ	1-459-390-31	COIL (WITH CORE)
C692	1-124-477-11	ELECT	47MF 20%	16V			<MODULE>
		<CONNECTOR>			PM501	1-810-040-11	PROTECTOR MODULE PM-35
CN101	*1-573-978-11	CONNECTOR, BOARD TO BOARD	11P				<IC LINK>
CN102	*1-560-124-00	PLUG, CONNECTOR (2.5MM)	4P		PS201 Δ	1-532-675-91	LINK, IC 1.5A
CN202	*1-564-505-11	PLUG, CONNECTOR	2P				
CN203	*1-560-123-00	PLUG, CONNECTOR (2.5MM)	3P				
CN301	*1-564-509-11	PLUG, CONNECTOR	6P				
CN501	*1-580-798-11	CONNECTOR PIN (DY)	6P				
CN502	*1-508-768-00	PIN, CONNECTOR (5MM PITCH)	6P				
CN651	*1-691-135-11	PIN, CONNECTOR (PC BOARD)	4P				
CN652	*1-564-510-11	PLUG, CONNECTOR	7P				
		<DIODE>					



REF. NO.	PART NO.	DESCRIPTION	REMARK	REF. NO.	PART NO.	DESCRIPTION	REMARK
<TRANSISTOR>				R052	1-216-065-00	METAL GLAZE 4.7K 5%	1/10W
Q001	8-729-422-36	TRANSISTOR 2SB709A-Q		R054	1-216-049-00	METAL GLAZE 1K 5%	1/10W
Q004	8-729-422-36	TRANSISTOR 2SB709A-Q		R055	1-216-073-00	METAL GLAZE 10K 5%	1/10W
Q005	8-729-422-27	TRANSISTOR 2SD601A-Q		R056	1-216-065-00	METAL GLAZE 4.7K 5%	1/10W
Q261	8-729-422-36	TRANSISTOR 2SB709A-Q		R057	1-216-065-00	METAL GLAZE 4.7K 5%	1/10W
Q262	8-729-422-27	TRANSISTOR 2SD601A-Q		R059	1-216-065-00	METAL GLAZE 4.7K 5%	1/10W
Q301	8-729-422-36	TRANSISTOR 2SB709A-Q		R061	1-216-073-00	METAL GLAZE 10K 5%	1/10W
Q309	8-729-422-27	TRANSISTOR 2SD601A-Q		R062	1-216-057-00	METAL GLAZE 2.2K 5%	1/10W
Q310	8-729-422-27	TRANSISTOR 2SD601A-Q		R063	1-216-081-00	METAL GLAZE 22K 5%	1/10W
Q311	8-729-422-27	TRANSISTOR 2SD601A-Q		R064	1-216-065-00	METAL GLAZE 4.7K 5%	1/10W
Q401	8-729-422-36	TRANSISTOR 2SB709A-Q		R065	1-216-065-00	METAL GLAZE 4.7K 5%	1/10W
Q402	8-729-422-36	TRANSISTOR 2SB709A-Q		R066	1-216-295-00	METAL GLAZE 0 5%	1/10W
Q501	8-729-422-27	TRANSISTOR 2SD601A-Q		R067	1-216-295-00	METAL GLAZE 0 5%	1/10W
Q550	8-729-140-50	TRANSISTOR 2SC3209LK		R069	1-216-057-00	METAL GLAZE 2.2K 5%	1/10W
Q551	8-729-821-87	TRANSISTOR 2SD1878-CA		R071	1-216-047-00	METAL GLAZE 820 5%	1/10W
Q553	8-729-019-01	TRANSISTOR 2SD2394-EF		R074	1-216-049-00	METAL GLAZE 1K 5%	1/10W
Q681	8-729-378-84	TRANSISTOR 2SD788-5		R078	1-249-429-11	CARBON 10K 5%	1/4W
<RESISTOR>				R081	1-216-073-00	METAL GLAZE 10K 5%	1/10W
R001	1-216-073-00	METAL GLAZE 10K 5%	1/10W	R082	1-216-055-00	METAL GLAZE 1.8K 5%	1/10W
R003	1-216-045-00	METAL GLAZE 680 5%	1/10W	R083	1-249-437-11	CARBON 47K 5%	1/4W
R004	1-216-033-00	METAL GLAZE 220 5%	1/10W	R085	1-216-065-00	METAL GLAZE 4.7K 5%	1/10W
R005	1-216-033-00	METAL GLAZE 220 5%	1/10W	R086	1-216-295-00	METAL GLAZE 0 5%	1/10W
R006	1-216-073-00	METAL GLAZE 10K 5%	1/10W	R091	1-216-089-00	METAL GLAZE 47K 5%	1/10W
R009	1-216-057-00	METAL GLAZE 2.2K 5%	1/10W	R092	1-216-073-00	METAL GLAZE 10K 5%	1/10W
R010	1-216-033-00	METAL GLAZE 220 5%	1/10W	R093	1-216-295-00	METAL GLAZE 0 5%	1/10W
R011	1-216-033-00	METAL GLAZE 220 5%	1/10W	R095	1-216-033-00	METAL GLAZE 220 5%	1/10W
R012	1-216-033-00	METAL GLAZE 220 5%	1/10W	R096	1-216-033-00	METAL GLAZE 220 5%	1/10W
R016	1-216-033-00	METAL GLAZE 220 5%	1/10W	R097	1-216-033-00	METAL GLAZE 220 5%	1/10W
R017	1-216-033-00	METAL GLAZE 220 5%	1/10W	R101	1-216-073-00	METAL GLAZE 10K 5%	1/10W
R018	1-216-033-00	METAL GLAZE 220 5%	1/10W	R203	1-215-924-00	METAL OXIDE 15K 5%	3W F
R019	1-216-061-00	METAL GLAZE 3.3K 5%	1/10W	R206	1-216-689-11	METAL GLAZE 39K 5%	1/10W
R020	1-216-073-00	METAL GLAZE 10K 5%	1/10W	R207	1-216-083-00	METAL GLAZE 27K 5%	1/10W
R023	1-216-033-00	METAL GLAZE 220 5%	1/10W	R208	1-216-069-00	METAL GLAZE 6.8K 5%	1/10W
R025	1-216-039-00	METAL GLAZE 390 5%	1/10W	R209	1-216-061-00	METAL GLAZE 3.3K 5%	1/10W
R026	1-216-097-00	METAL GLAZE 100K 5%	1/10W	R210	1-216-041-00	METAL GLAZE 470 5%	1/10W
R027	1-216-121-00	METAL GLAZE 1M 5%	1/10W	R251	1-216-295-00	METAL GLAZE 0 5%	1/10W
R028	1-216-073-00	METAL GLAZE 10K 5%	1/10W	R253	1-216-061-00	METAL GLAZE 3.3K 5%	1/10W
R029	1-216-065-00	METAL GLAZE 4.7K 5%	1/10W	R254	1-216-015-00	METAL GLAZE 39 5%	1/10W
R030	1-216-073-00	METAL GLAZE 10K 5%	1/10W	R258	1-216-051-00	METAL GLAZE 1.2K 5%	1/10W
R031	1-216-025-00	METAL GLAZE 100 5%	1/10W	R260	1-216-295-00	METAL GLAZE 0 5%	1/10W
R032	1-216-025-00	METAL GLAZE 100 5%	1/10W	R263	1-216-075-00	METAL GLAZE 12K 5%	1/10W
R033	1-216-025-00	METAL GLAZE 100 5%	1/10W	R264	1-216-041-00	METAL GLAZE 470 5%	1/10W
R034	1-216-025-00	METAL GLAZE 100 5%	1/10W	R265	1-216-085-00	METAL GLAZE 33K 5%	1/10W
R035	1-216-041-00	METAL GLAZE 470 5%	1/10W	R266	1-216-085-00	METAL GLAZE 33K 5%	1/10W
R036	1-216-033-00	METAL GLAZE 220 5%	1/10W	R267	1-216-089-00	METAL GLAZE 47K 5%	1/10W
R037	1-216-033-00	METAL GLAZE 220 5%	1/10W	R268	1-216-065-00	METAL GLAZE 4.7K 5%	1/10W
R038	1-216-033-00	METAL GLAZE 220 5%	1/10W	R270	1-249-385-11	CARBON 2.2 5%	1/4W
R040	1-216-033-00	METAL GLAZE 220 5%	1/10W	R271	1-249-417-11	CARBON 1K 5%	1/4W
R041	1-216-033-00	METAL GLAZE 220 5%	1/10W	R272	1-249-411-11	CARBON 330 5%	1/4W
R042	1-216-295-00	METAL GLAZE 0 5%	1/10W	R273	1-249-411-11	CARBON 330 5%	1/4W
R043	1-216-295-00	METAL GLAZE 0 5%	1/10W	R301	1-216-065-00	METAL GLAZE 4.7K 5%	1/10W
R044	1-216-065-00	METAL GLAZE 4.7K 5%	1/10W	R302	1-216-057-00	METAL GLAZE 2.2K 5%	1/10W
R045	1-216-065-00	METAL GLAZE 4.7K 5%	1/10W	R311	1-216-678-11	METAL CHIP 13K 0.50%	1/10W
R046	1-216-065-00	METAL GLAZE 4.7K 5%	1/10W	R312	1-216-079-00	METAL GLAZE 18K 5%	1/10W
R047	1-216-049-00	METAL GLAZE 1K 5%	1/10W	R313	1-216-653-11	METAL CHIP 1.2K 0.50%	1/10W
R048	1-216-073-00	METAL GLAZE 10K 5%	1/10W	R314	1-216-117-00	METAL GLAZE 680K 5%	1/10W
R049	1-216-025-00	METAL GLAZE 100 5%	1/10W	R315	1-216-051-00	METAL GLAZE 1.2K 5%	1/10W
R050	1-216-049-00	METAL GLAZE 1K 5%	1/10W	R319	1-216-295-00	METAL GLAZE 0 5%	1/10W
R051	1-216-073-00	METAL GLAZE 10K 5%	1/10W	R320	1-216-295-00	METAL GLAZE 0 5%	1/10W
				R321	1-216-295-00	METAL GLAZE 0 5%	1/10W
				R322	1-216-295-00	METAL GLAZE 0 5%	1/10W
				R323	1-216-121-00	METAL GLAZE 1M 5%	1/10W
				R324	1-216-025-00	METAL GLAZE 100 5%	1/10W
				R326	1-216-025-00	METAL GLAZE 100 5%	1/10W

KV-20TR23/2160WR/2150R

RM-Y116

The components identified by **■** in this manual have been carefully factory-selected for each set in order to satisfy regulations regarding X-ray radiation.

Should replacement be required, replace only with the value originally used.

A

G (KV-20TR23(U/C)/2150R)

Les composants identifiés par une trame et une marque **▲** sont critiques pour la sécurité. Ne les remplacer que par une pièce portant le numéro spécifié.

The components identified by shading and mark **▲** are critical for safety. Replace only with part number specified.

REF. NO.	PART NO.	DESCRIPTION	REMARK	REF. NO.	PART NO.	DESCRIPTION	REMARK
R327	1-216-077-00	METAL GLAZE	15K 5% 1/10W	R534	1-249-393-11	CARBON	10 5% 1/4W F
R328	1-216-025-00	METAL GLAZE	100 5% 1/10W	R535	1-249-389-11	CARBON	4.7 5% 1/4W F
R329	1-216-073-00	METAL GLAZE	10K 5% 1/10W	■R537 ▲		METAL	1/10W
R330	1-216-067-00	METAL GLAZE	5.6K 5% 1/10W	R538	1-249-441-11	CARBON	100K 5% 1/4W
R331	1-216-093-00	METAL GLAZE	68K 5% 1/10W	R541	1-249-418-11	CARBON	1.2K 5% 1/4W F
R335	1-216-049-00	METAL GLAZE	1K 5% 1/10W	R542	1-216-357-00	METAL OXIDE	4.7 5% 1W F
R336	1-216-121-00	METAL GLAZE	1M 5% 1/10W	R549	1-216-369-00	METAL OXIDE	1 5% 2W F
R338	1-216-049-00	METAL GLAZE	1K 5% 1/10W	R554	1-216-061-00	METAL GLAZE	3.3K 5% 1/10W
R339	1-216-045-00	METAL GLAZE	680 5% 1/10W	R555	1-215-896-00	METAL OXIDE	4.7K 5% 2W F
R341	1-216-687-11	METAL CHIP	33K 0.50% 1/10W	R558	1-260-326-71	CARBON	680 5% 1/2W
R343	1-216-071-00	METAL GLAZE	8.2K 5% 1/10W	R559	1-215-862-11	METAL OXIDE	68 5% 1W F
R345	1-249-429-11	CARBON	10K 5% 1/4W	R565	1-249-377-11	CARBON	0.47 5% 1/4W F
R346	1-249-421-11	CARBON	2.2K 5% 1/4W	R566	1-249-417-11	CARBON	1K 5% 1/4W F
R347	1-216-025-00	METAL GLAZE	100 5% 1/10W	R588	1-216-105-00	METAL GLAZE	220K 5% 1/10W
R351	1-216-085-00	METAL GLAZE	33K 5% 1/10W	R590	1-216-063-00	METAL GLAZE	3.9K 5% 1/10W
R356	1-216-049-00	METAL GLAZE	1K 5% 1/10W	R591	1-216-061-00	METAL GLAZE	3.3K 5% 1/10W
R357	1-216-089-00	METAL GLAZE	47K 5% 1/10W	R592	1-216-073-00	METAL GLAZE	10K 5% 1/10W
R358	1-216-091-00	METAL GLAZE	56K 5% 1/10W	R593	1-216-049-00	METAL GLAZE	1K 5% 1/10W
R360	1-216-041-00	METAL GLAZE	470 5% 1/10W	R594	1-216-689-11	METAL GLAZE	39K 5% 1/10W
R361	1-216-025-00	METAL GLAZE	100 5% 1/10W	R595	1-216-073-00	METAL GLAZE	10K 5% 1/10W
R362	1-216-295-00	METAL GLAZE	0 5% 1/10W	R599	1-215-857-11	METAL OXIDE	10 5% 1W F
R363	1-216-295-00	METAL GLAZE	0 5% 1/10W	R681	1-215-883-11	METAL OXIDE	33 5% 2W F
R364	1-216-295-00	METAL GLAZE	0 5% 1/10W	R682	1-249-415-11	CARBON	680 5% 1/4W
R365	1-216-049-00	METAL GLAZE	1K 5% 1/10W	R683	1-216-356-00	METAL OXIDE	3.9 5% 1W F
R367	1-216-109-00	METAL GLAZE	330K 5% 1/10W	R684	1-216-380-11	METAL OXIDE	8.2 5% 2W F
R403	1-216-022-00	METAL GLAZE	75 5% 1/10W	<SWITCH>			
R404	1-216-295-00	METAL GLAZE	0 5% 1/10W	S001	1-571-532-21	SWITCH, TACTIL	
R405	1-216-113-00	METAL GLAZE	470K 5% 1/10W	S002	1-571-532-21	SWITCH, TACTIL	
R413	1-216-295-00	METAL GLAZE	0 5% 1/10W	S003	1-571-532-21	SWITCH, TACTIL	
R414	1-216-041-00	METAL GLAZE	470 5% 1/10W	S004	1-571-532-21	SWITCH, TACTIL	
R415	1-216-041-00	METAL GLAZE	470 5% 1/10W	S005	1-571-532-21	SWITCH, TACTIL	
R430	1-216-295-00	METAL GLAZE	0 5% 1/10W	S006	1-571-532-21	SWITCH, TACTIL	
R441	1-216-073-00	METAL GLAZE	10K 5% 1/10W	<SPARK GAP>			
R443	1-216-073-00	METAL GLAZE	10K 5% 1/10W	SG551	1-519-422-11	GAP, SPARK	
R444	1-216-049-00	METAL GLAZE	1K 5% 1/10W	<TRANSFORMER>			
R445	1-216-049-00	METAL GLAZE	1K 5% 1/10W	T504 ▲	1-453-141-11	TRANSFORMER ASSY, FLYBACK (NX-1600A5)	
R450	1-216-025-00	METAL GLAZE	100 5% 1/10W	T551	1-437-195-11	TRANSFORMER, HORIZONTAL DRIVE	
R453	1-216-049-00	METAL GLAZE	1K 5% 1/10W	<TUNER>			
R454	1-216-049-00	METAL GLAZE	1K 5% 1/10W	TU101 ▲	8-598-047-00	TUNER (BTF-LA401)	
R459	1-216-295-00	METAL GLAZE	0 5% 1/10W	<CRYSTAL>			
R472	1-216-049-00	METAL GLAZE	1K 5% 1/10W	X001	1-579-917-21	VIBRATOR, CRYSTAL	
R473	1-216-025-00	METAL GLAZE	100 5% 1/10W	X301	1-567-505-11	OSCILLATOR, CRYSTAL	
R474	1-216-295-00	METAL GLAZE	0 5% 1/10W	*****			
R475	1-216-025-00	METAL GLAZE	100 5% 1/10W	*A-1316-146-A	G BOARD, COMPLETE (KV-20TR23(U/C),2150R)		
R501	1-249-429-11	CARBON	10K 5% 1/4W	*****			
R502	1-216-073-00	METAL GLAZE	10K 5% 1/10W	1-533-223-11	CLIP, FUSE		
R505	1-216-349-00	METAL OXIDE	1 5% 1W F	4-382-854-11	SCREW (M3X10), P, SW (+)		
R506	1-216-429-00	METAL OXIDE	270 5% 1W F	<CAPACITOR>			
R507	1-247-887-00	CARBON	220K 5% 1/4W	C601 ▲	1-136-311-51	FILM	0.47MF 20% 125V
R508	1-216-049-00	METAL GLAZE	1K 5% 1/10W	*****			
R509	1-216-101-00	METAL GLAZE	150K 5% 1/10W	*****			
R510	1-216-055-00	METAL GLAZE	1.8K 5% 1/10W	*****			
■R511 ▲		METAL	1/10W	*****			
R512	1-215-445-00	METAL	10K 1% 1/4W	*****			
R513	1-216-645-11	METAL CHIP	560 0.50% 1/10W	*****			
R515	1-216-673-11	METAL CHIP	8.2K 0.50% 1/10W	*****			
R517	1-216-699-11	METAL CHIP	100K 0.50% 1/10W	*****			
R518	1-215-431-00	METAL	2.7K 1% 1/4W	*****			
R519	1-215-427-00	METAL	1.8K 1% 1/4W	*****			
R520	1-216-073-00	METAL GLAZE	10K 5% 1/10W	*****			
R530	1-249-419-11	CARBON	1.5K 5% 1/4W	*****			
R531	1-216-357-00	METAL OXIDE	4.7 5% 1W F	*****			
R532 ▲	1-215-880-91	METAL OXIDE	10 5% 2W F	*****			
R533	1-216-359-00	METAL OXIDE	6.8 5% 1W F	*****			

The components identified by shading and mark **Δ** are critical for safety. Replace only with part number specified.

Les composants identifiés par une trame et une marque **Δ** sont critiques pour la sécurité. Ne les remplacer que par une pièce portant le numéro spécifié.

G (KV-20TR23(U/C)/2150R)

REF. NO.	PART NO.	DESCRIPTION	REMARK
C603	1-124-478-11	ELECT 100MF	20% 25V
C604 Δ	1-162-677-51	CERAMIC 470PF	10% 125V
C605 Δ	1-162-677-51	CERAMIC 470PF	10% 125V
C606 Δ	1-102-050-51	CERAMIC 0.01MF	500V
C607 Δ	1-102-050-51	CERAMIC 0.01MF	500V
C613	1-104-759-11	ELECT 470MF	20% 200V
C614	1-104-759-11	ELECT 470MF	20% 200V
C615	1-164-625-11	CERAMIC 680PF	10% 500V
C616	1-136-169-00	FILM 0.22MF	5% 50V
C617	1-136-169-00	FILM 0.22MF	5% 50V
C618	1-164-625-11	CERAMIC 680PF	10% 500V
C619	1-164-625-11	CERAMIC 680PF	10% 500V
C620	1-136-601-11	FILM 0.01MF	10% 630V
C621	1-129-744-91	FILM 0.027MF	10% 400V
C622	1-124-478-11	ELECT 100MF	20% 25V
C623	1-124-360-00	ELECT 1000MF	20% 16V
C624	1-124-557-11	ELECT 1000MF	20% 25V
C626	1-123-024-21	ELECT 33MF	160V
C627	1-136-601-11	FILM 0.01MF	10% 630V
C629	1-106-355-12	MYLAR 0.0033MF	10% 200V
C630	1-136-169-00	FILM 0.22MF	5% 50V
C631	1-136-169-00	FILM 0.22MF	5% 50V
C632	1-136-169-00	FILM 0.22MF	5% 50V
C633 Δ	1-162-677-51	CERAMIC 470PF	10% 125V
C634 Δ	1-162-677-51	CERAMIC 470PF	10% 125V
C635	1-137-372-11	FILM 0.022MF	5% 50V
C636	1-162-318-11	CERAMIC 0.001MF	10% 500V
C637	1-164-735-11	CAP, CERAMIC 1500PF	
C638	1-164-735-11	CAP, CERAMIC 1500PF	
C639	1-164-735-11	CAP, CERAMIC 1500PF	
C640	1-164-735-11	CAP, CERAMIC 1500PF	
<CONNECTOR>			
CN601	*1-580-843-11	PIN, CONNECTOR (POWER)	
CN602	*1-508-786-00	PIN, CONNECTOR (5MM PITCH) 2P	
CN603	*1-508-765-00	PIN, CONNECTOR (5MM PITCH) 3P	
CN604	*1-564-510-11	PLUG, CONNECTOR 7P	
CN605	*1-691-135-11	PIN, CONNECTOR (PC BOARD) 4P	
CN606	*1-564-505-11	PLUG, CONNECTOR 2P	
<DIODE>			
D604	8-719-911-19	DIODE 1SS119	
D606 Δ	8-719-510-53	DIODE D4SB60L	
D607	8-719-510-48	DIODE D1N20R	
D608	8-719-510-48	DIODE D1N20R	
D609	8-719-510-48	DIODE D1N20R	
D610	8-719-510-48	DIODE D1N20R	
D611	8-719-032-13	DIODE D1NS6-TA2	
D612	8-719-510-02	DIODE D1NS4	
D613	8-719-510-02	DIODE D1NS4	
D614	8-719-510-02	DIODE D1NS4	
D615	8-719-510-02	DIODE D1NS4	
D616	8-719-510-26	DIODE D1NL20	
D617	8-719-510-26	DIODE D1NL20	
D618	8-719-510-26	DIODE D1NL20	
D619	8-719-510-26	DIODE D1NL20	
D620	8-719-510-02	DIODE D1NS4	
D621	8-719-510-02	DIODE D1NS4	
D622	8-719-510-48	DIODE D1N20R	
D624	8-719-911-19	DIODE 1SS119	
D625	8-719-911-19	DIODE 1SS119	

REF. NO.	PART NO.	DESCRIPTION	REMARK
D626	8-719-110-14	DIODE RD9.1ES-B3	
D627	8-719-911-19	DIODE 1SS119	
D629	8-719-911-19	DIODE 1SS119	
D631	8-719-510-48	DIODE D1N20R	
<FUSE>			
F601 Δ	1-532-748-11	FUSE, GLASS TUBE 6.3A/125V	
<FERRITE BEAD>			
FB601	1-412-911-11	INDUCTOR, FERRITE BEAD	
FB602	1-412-911-11	INDUCTOR, FERRITE BEAD	
FB603	1-412-911-11	INDUCTOR, FERRITE BEAD	
FB604	1-412-911-11	INDUCTOR, FERRITE BEAD	
FB605	1-410-396-41	FERRITE BEAD INDUCTOR	
FB606	1-410-396-41	FERRITE BEAD INDUCTOR	
FB607	1-410-396-41	FERRITE BEAD INDUCTOR	
FB608	1-410-396-41	FERRITE BEAD INDUCTOR	
FB609	1-410-396-41	FERRITE BEAD INDUCTOR	
<IC>			
IC602 Δ	1-810-050-11	POWER MODULE DM-47	
<COIL>			
L601	1-412-533-61	INDUCTOR 47UH	
<TRANSISTOR>			
Q602	8-729-119-78	TRANSISTOR 2SC2785-HFE	
Q603	8-729-016-15	TRANSISTOR 2SC4833MNP	
Q604	8-729-016-15	TRANSISTOR 2SC4833MNP	
Q605	8-729-924-90	TRANSISTOR 2SB1370-EF	
Q606	8-729-119-78	TRANSISTOR 2SC2785-HFE	
<RESISTOR>			
R602	1-249-421-11	CARBON 2.2K 5%	1/4W F
R604	1-249-421-11	CARBON 2.2K 5%	1/4W F
R608	1-247-893-11	CARBON 390K 5%	1/4W F
R609	1-247-893-11	CARBON 390K 5%	1/4W F
R610	1-202-933-11	FUSIBLE 0.1 10%	1/2W F
R612	1-216-349-00	METAL OXIDE 1 5%	1W F
R613	1-216-349-00	METAL OXIDE 1 5%	1W F
R614	1-215-904-71	METAL OXIDE 100K 5%	2W F
R615	1-215-904-71	METAL OXIDE 100K 5%	2W F
R616	1-215-858-71	METAL OXIDE 15 5%	1W F
R617	1-215-858-71	METAL OXIDE 15 5%	1W F
R618	1-217-386-00	FUSIBLE 8.2 5%	1/4W F
R619	1-212-853-61	FUSIBLE 6.8 5%	1/4W F
R620	1-249-379-11	CARBON 0.68 5%	1/4W F
R621	1-249-377-11	CARBON 0.47 5%	1/4W F
R622	1-249-377-11	CARBON 0.47 5%	1/4W F
R623	1-249-377-11	CARBON 0.47 5%	1/4W F
R624	1-249-425-11	CARBON 4.7K 5%	1/4W F
R626	1-247-883-00	CARBON 150K 5%	1/4W F
R627	1-249-377-11	CARBON 0.47 5%	1/4W F
R630	1-249-377-11	CARBON 0.47 5%	1/4W F
R631	1-249-377-11	CARBON 0.47 5%	1/4W F
R632	1-249-377-11	CARBON 0.47 5%	1/4W F
R633	1-249-388-11	CARBON 3.9 5%	1/4W F
R635	1-249-433-11	CARBON 22K 5%	1/4W F

G (KV-20TR23(U/C)/2150R)

G (KV-2160WR)

Les composants identifiés par une trame et une marque **Δ** sont critiques pour la sécurité. Ne les remplacer que par une pièce portant le numéro spécifié.

The components identified by shading and mark **Δ** are critical for safety. Replace only with part number specified.

REF. NO.	PART NO.	DESCRIPTION	REMARK
R636	1-249-421-11	CARBON 2.2K 5% 1/4W	
R637	1-249-407-11	CARBON 150 5% 1/4W	F
R639 Δ	1-202-892-91	SOLID 4.7M 20% 1/2W	
R640	1-249-414-11	CARBON 560 5% 1/4W	
R642	1-249-421-11	CARBON 2.2K 5% 1/4W	
R643	1-215-863-71	METAL OXIDE 100 5% 1W	F
R645	1-217-386-00	FUSIBLE 8.2 5% 1/4W	F
R646	1-216-422-71	METAL OXIDE 18 5% 1W	F
R647	1-216-425-11	METAL OXIDE 56 5% 1W	F
R648	1-249-421-11	CARBON 2.2K 5% 1/4W	
R649	1-249-417-11	CARBON 1K 5% 1/4W	
R650	1-249-417-11	CARBON 1K 5% 1/4W	
R651	1-249-421-11	CARBON 2.2K 5% 1/4W	F
R652	1-249-417-11	CARBON 1K 5% 1/4W	
R653	1-249-417-11	CARBON 1K 5% 1/4W	
<RELAY>			
RY601 Δ	1-515-684-31	RELAY	
RY602	1-515-684-31	RELAY	
<TRANSFORMER>			
T601 Δ	1-423-585-11	TRANSFORMER, LINE FILTER (LFT)	
T602 Δ	1-423-585-11	TRANSFORMER, LINE FILTER (LFT)	
T603 Δ	1-423-563-11	TRANSFORMER, CONVERTER DRIVE	
T604	1-423-582-11	TRANSFORMER, FERRITE (SBT)	
T605 Δ	1-423-564-11	TRANSFORMER, CONVERTER (PIT)	
<THERMISTOR>			
THP601 Δ	1-808-081-14	THERMISTOR, POSITIVE	
<VARISTOR>			
VDR601	1-810-052-21	VARISTOR	
VDR602	1-810-052-21	VARISTOR	

*A-1316-148-A	G BOARD, COMPLETE (KV-2160WR)		

1-533-223-11	CLIP, FUSE		
4-382-854-11	SCREW (M3X10), P, SW (+)		
<CAPACITOR>			
C601 Δ	1-136-311-61	FILM 0.47MF 20% 300V	
C603	1-124-478-11	ELECT 100MF 20% 25V	
C606 Δ	1-102-050-51	CERAMIC 0.01MF 500V	
C607 Δ	1-102-050-51	CERAMIC 0.01MF 500V	
C608 Δ	1-137-376-91	FILM 0.1MF 5% 50V	
C609	1-106-383-00	MYLAR 0.047MF 200V	
C610 Δ	1-126-406-91	ELECT 2.2MF 20% 400V	
C611 Δ	1-124-122-91	ELECT 100MF 20% 50V	
C612 Δ	1-137-376-91	FILM 0.1MF 5% 50V	
C613	1-104-758-11	ELECT 560MF 20% 250V	
C614	1-104-758-11	ELECT 560MF 20% 250V	
C615	1-164-625-11	CERAMIC 680PF 10% 500V	
C616	1-136-169-00	FILM 0.22MF 5% 50V	
C617	1-136-169-00	FILM 0.22MF 5% 50V	
C618	1-164-625-11	CERAMIC 680PF 10% 500V	
C619	1-164-625-11	CERAMIC 680PF 10% 500V	
C620	1-136-601-11	FILM 0.01MF 10% 630V	
C621	1-129-744-91	FILM 0.027MF 10% 400V	

REF. NO.	PART NO.	DESCRIPTION	REMARK
C622	1-124-478-11	ELECT 100MF 20% 25V	
C623	1-124-360-00	ELECT 1000MF 20% 16V	
C624	1-124-557-11	ELECT 1000MF 20% 25V	
C626	1-123-024-21	ELECT 33MF 160V	
C627	1-136-601-11	FILM 0.01MF 10% 630V	
C629	1-106-355-12	MYLAR 0.0033MF 200V	
C630	1-136-169-00	FILM 0.22MF 5% 50V	
C631	1-136-169-00	FILM 0.22MF 5% 50V	
C632	1-136-169-00	FILM 0.22MF 5% 50V	
C633 Δ	1-164-502-51	CERAMIC 0.001MF 20% 400V	
C634 Δ	1-164-502-51	CERAMIC 0.001MF 20% 400V	
C635	1-137-372-11	FILM 0.022MF 5% 50V	
C636	1-162-318-11	CERAMIC 0.001MF 10% 500V	
C637	1-164-735-11	CAP, CERAMIC 1500PF	
C638	1-164-735-11	CAP, CERAMIC 1500PF	
C639	1-164-735-11	CAP, CERAMIC 1500PF	
C640	1-164-735-11	CAP, CERAMIC 1500PF	
<CONNECTOR>			
CN601	*1-580-843-11	PIN, CONNECTOR (POWER)	
CN602	*1-508-786-00	PIN, CONNECTOR (5MM PITCH) 2P	
CN603	*1-508-765-00	PIN, CONNECTOR (5MM PITCH) 3P	
CN604	*1-564-510-11	PLUG, CONNECTOR 7P	
CN605	*1-691-135-11	PIN, CONNECTOR (PC BOARD) 4P	
CN606	*1-564-505-11	PLUG, CONNECTOR 2P	
<DIODE>			
D604	8-719-911-19	DIODE 1SS119	
D605 Δ	8-719-304-63	DIODE RM11C	
D606 Δ	8-719-510-53	DIODE D4SB60L	
D607	8-719-510-48	DIODE D1N20R	
D608	8-719-510-48	DIODE D1N20R	
D609	8-719-510-48	DIODE D1N20R	
D610	8-719-510-48	DIODE D1N20R	
D611	8-719-032-13	DIODE D1NS6-TA2	
D612	8-719-510-02	DIODE D1NS4	
D613	8-719-510-02	DIODE D1NS4	
D614	8-719-510-02	DIODE D1NS4	
D615	8-719-510-02	DIODE D1NS4	
D616	8-719-510-26	DIODE D1NL20	
D617	8-719-510-26	DIODE D1NL20	
D618	8-719-510-26	DIODE D1NL20	
D619	8-719-510-26	DIODE D1NL20	
D620	8-719-510-02	DIODE D1NS4	
D621	8-719-510-02	DIODE D1NS4	
D622	8-719-510-48	DIODE D1N20R	
D624	8-719-911-19	DIODE 1SS119	
D625	8-719-911-19	DIODE 1SS119	
D626	8-719-110-14	DIODE RD9.1ES-B3	
D627	8-719-911-19	DIODE 1SS119	
D629	8-719-911-19	DIODE 1SS119	
D631	8-719-510-48	DIODE D1N20R	
<FUSE>			
F601 Δ	1-532-506-51	FUSE 6.3A/250V	
<FERRITE BEAD>			
FB601	1-412-911-11	INDUCTOR, FERRITE BEAD	
FB602	1-412-911-11	INDUCTOR, FERRITE BEAD	
FB603	1-412-911-11	INDUCTOR, FERRITE BEAD	

The components identified by shading and mark Δ are critical for safety. Replace only with part number specified.

Les composants identifiés par une trame et une marque Δ sont critiques pour la sécurité. Ne les remplacer que par une pièce portant le numéro spécifié.

G (KV-2160WR) **C**

REF. NO.	PART NO.	DESCRIPTION	REMARK
FB604	1-412-911-11	INDUCTOR, FERRITE BEAD	
FB605	1-410-396-41	FERRITE BEAD INDUCTOR	
FB606	1-410-396-41	FERRITE BEAD INDUCTOR	
FB607	1-410-396-41	FERRITE BEAD INDUCTOR	
FB608	1-410-396-41	FERRITE BEAD INDUCTOR	
FB609	1-410-396-41	FERRITE BEAD INDUCTOR	
<IC>			
IC601 Δ	8-749-923-94	IC STR81159A	
IC602 Δ	1-810-050-11	POWER MODULE DM-47	
<COIL>			
L601	1-412-533-61	INDUCTOR	47UH
<TRANSISTOR>			
Q602	8-729-119-78	TRANSISTOR 2SC2785-HFE	
Q603	8-729-016-15	TRANSISTOR 2SC4833MNP	
Q604	8-729-016-15	TRANSISTOR 2SC4833MNP	
Q605	8-729-924-90	TRANSISTOR 2SB1370-EF	
Q606	8-729-119-78	TRANSISTOR 2SC2785-HFE	
<RESISTOR>			
R602	1-249-421-11	CARBON	2.2K 5% 1/4W F
R604	1-249-421-11	CARBON	2.2K 5% 1/4W
R605 Δ	1-249-451-71	CARBON	2.2 5% 1/4W F
R606 Δ	1-208-294-11	WIREWOUND	2.2 5% 20W
R607	1-249-389-11	CARBON	4.7 5% 1/4W
R608	1-247-893-11	CARBON	390K 5% 1/4W
R609	1-247-893-11	CARBON	390K 5% 1/4W
R610	1-202-933-11	FUSIBLE	0.1 10% 1/2W F
R612	1-216-349-00	METAL OXIDE	1 5% 1W F
R613	1-216-349-00	METAL OXIDE	1 5% 1W F
R614	1-215-904-71	METAL OXIDE	100K 5% 2W F
R615	1-215-904-71	METAL OXIDE	100K 5% 2W F
R616	1-215-858-71	METAL OXIDE	15 5% 1W F
R617	1-215-858-71	METAL OXIDE	15 5% 1W F
R618	1-217-386-00	FUSIBLE	8.2 5% 1/4W F
R619	1-212-853-61	FUSIBLE	6.8 5% 1/4W F
R620	1-249-379-11	CARBON	0.68 5% 1/4W F
R621	1-249-377-11	CARBON	0.47 5% 1/4W F
R622	1-249-377-11	CARBON	0.47 5% 1/4W F
R623	1-249-377-11	CARBON	0.47 5% 1/4W F
R624	1-249-425-11	CARBON	4.7K 5% 1/4W F
R626	1-247-883-00	CARBON	150K 5% 1/4W
R627	1-249-377-11	CARBON	0.47 5% 1/4W F
R630	1-249-377-11	CARBON	0.47 5% 1/4W F
R631	1-249-377-11	CARBON	0.47 5% 1/4W F
R632	1-249-377-11	CARBON	0.47 5% 1/4W F
R633	1-249-388-11	CARBON	3.9 5% 1/4W F
R635	1-249-433-11	CARBON	22K 5% 1/4W
R636	1-249-421-11	CARBON	2.2K 5% 1/4W
R637	1-249-407-11	CARBON	150 5% 1/4W F
R639 Δ	1-247-289-11	CARBON	8.2M 5% 1W
R640	1-249-414-11	CARBON	560 5% 1/4W
R642	1-249-421-11	CARBON	2.2K 5% 1/4W
R643	1-215-863-71	METAL OXIDE	100 5% 1W F
R644 Δ	1-215-915-71	METAL OXIDE	470 5% 3W F
R645	1-217-386-00	FUSIBLE	8.2 5% 1/4W F
R646	1-216-422-71	METAL OXIDE	18 5% 1W F
R647	1-216-425-11	METAL OXIDE	56 5% 1W F

REF. NO.	PART NO.	DESCRIPTION	REMARK
R648	1-249-421-11	CARBON	2.2K 5% 1/4W
R649	1-249-417-11	CARBON	1K 5% 1/4W
R650	1-249-417-11	CARBON	1K 5% 1/4W
R651	1-249-421-11	CARBON	2.2K 5% 1/4W F
R652	1-249-417-11	CARBON	1K 5% 1/4W
R653	1-249-417-11	CARBON	1K 5% 1/4W
<RELAY>			
RY601 Δ	1-515-684-31	RELAY	
RY602	1-515-684-31	RELAY	
<TRANSFORMER>			
T602 Δ	1-423-585-11	TRANSFORMER, LINE FILTER (LFT)	
T603 Δ	1-423-563-11	TRANSFORMER, CONVERTER DRIVE	
T604	1-423-582-21	TRANSFORMER, FERRITE (SBT)	
T605 Δ	1-423-564-11	TRANSFORMER, CONVERTER (PIT)	
<THERMISTOR>			
THP601 Δ	1-808-059-32	THERMISTOR, POSITIVE	
<VARISTOR>			
VDR601	1-810-052-21	VARISTOR	
VDR602	1-810-052-21	VARISTOR	

*A-1331-246-A C BOARD, COMPLETE			

<CAPACITOR>			
C701	1-136-601-11	FILM	0.01MF 10% 630V
C704	1-162-116-00	CERAMIC	680PF 10% 2KV
C706	1-124-916-11	ELECT	22MF 20% 25V
C707	1-164-085-11	CERAMIC	0.001MF 10% 50V
C711	1-164-083-11	CERAMIC	680PF 10% 50V
C712	1-164-082-11	CERAMIC	560PF 10% 50V
C731	1-164-083-11	CERAMIC	680PF 10% 50V
C732	1-164-081-11	CERAMIC	470PF 10% 50V
C751	1-164-083-11	CERAMIC	680PF 10% 50V
C752	1-164-082-11	CERAMIC	560PF 10% 50V
C771	1-164-083-11	CERAMIC	680PF 10% 50V
C772	1-164-083-11	CERAMIC	680PF 10% 50V
C773	1-164-083-11	CERAMIC	680PF 10% 50V
<CONNECTOR>			
CN701	1-695-915-11	TAB (CONTACT)	
CN702	*1-508-768-00	PIN, CONNECTOR (5MM PITCH) 6P	
CN703	*1-564-509-11	PLUG, CONNECTOR 6P	
<DIODE>			
D711	8-719-911-19	DIODE 1SS119	
D731	8-719-911-19	DIODE 1SS119	
D751	8-719-911-19	DIODE 1SS119	
D770	8-719-911-19	DIODE 1SS119	
D771	8-719-911-19	DIODE 1SS119	
D772	8-719-911-19	DIODE 1SS119	
D773	8-719-911-19	DIODE 1SS119	
D777	8-719-109-71	DIODE RD3.9ES-B1	

C **S** (KV-20TR23(U))

Les composants identifiés par une trame et une marque **Δ** sont critiques pour la sécurité. Ne les remplacer que par une pièce portant le numéro spécifié.

The components identified by shading and mark **Δ** are critical for safety. Replace only with part number specified.

REF. NO.	PART NO.	DESCRIPTION	REMARK
D790	8-719-911-19	DIODE 1SS119	
D791	8-719-911-19	DIODE 1SS119	
D792	8-719-911-19	DIODE 1SS119	
<JACK>			
J701	Δ 1-540-071-13	SOCKET, PICTURE TUBE	
<COIL>			
L701	1-410-671-31	INDUCTOR 47UH	
<TRANSISTOR>			
Q711	8-729-926-73	TRANSISTOR 2SC3271F-N	
Q712	8-729-119-78	TRANSISTOR 2SC2785-HFE	
Q731	8-729-926-73	TRANSISTOR 2SC3271F-N	
Q732	8-729-119-78	TRANSISTOR 2SC2785-HFE	
Q751	8-729-926-73	TRANSISTOR 2SC3271F-N	
Q752	8-729-119-78	TRANSISTOR 2SC2785-HFE	
Q770	8-729-119-76	TRANSISTOR 2SA1175-HFE	
Q771	8-729-200-17	TRANSISTOR 2SA1091-0	
Q772	8-729-200-17	TRANSISTOR 2SA1091-0	
Q773	8-729-200-17	TRANSISTOR 2SA1091-0	
<RESISTOR>			
R700	1-202-549-00	SOLID 100 20% 1/2W	
R701	1-202-846-00	SOLID 470K 20% 1/2W	
R702	1-202-844-00	SOLID 330K 20% 1/2W	
R703	1-202-838-00	SOLID 100K 20% 1/2W	
R704	1-216-370-11	METAL OXIDE 1.2 5% 2W	F
R706	1-202-842-11	SOLID 220K 20% 1/2W	
R710	1-202-824-00	SOLID 3.3K 20% 1/2W	
R711	1-249-405-11	CARBON 100 5% 1/4W	
R712	1-215-924-00	METAL OXIDE 15K 5% 3W	F
R716	1-249-411-11	CARBON 330 5% 1/4W	
R717	1-249-393-11	CARBON 10 5% 1/4W	
R730	1-202-824-00	SOLID 3.3K 20% 1/2W	
R731	1-249-405-11	CARBON 100 5% 1/4W	
R732	1-215-924-00	METAL OXIDE 15K 5% 3W	F
R736	1-249-411-11	CARBON 330 5% 1/4W	
R737	1-249-393-11	CARBON 10 5% 1/4W	
R750	1-202-824-00	SOLID 3.3K 20% 1/2W	
R751	1-249-405-11	CARBON 100 5% 1/4W	
R752	1-215-924-00	METAL OXIDE 15K 5% 3W	F
R756	1-249-411-11	CARBON 330 5% 1/4W	
R757	1-249-393-11	CARBON 10 5% 1/4W	
R770	1-249-433-11	CARBON 22K 5% 1/4W	
R771	1-249-409-91	CARBON 220 5% 1/4W	F
R772	1-249-409-91	CARBON 220 5% 1/4W	F
R773	1-249-409-91	CARBON 220 5% 1/4W	F
R774	1-249-437-11	CARBON 47K 5% 1/4W	
R775	1-249-417-11	CARBON 1K 5% 1/4W	
R776	1-249-409-11	CARBON 220 5% 1/4W	
R790	1-249-417-11	CARBON 1K 5% 1/4W	
R791	1-249-413-11	CARBON 470 5% 1/4W	
<VARIABLE RESISTOR>			
RV701	Δ 1-241-656-21	RES, ADJ, METAL FILM 110M	
RV702	1-230-641-11	RES, ADJ, METAL GLAZE 2.2M	

REF. NO.	PART NO.	DESCRIPTION	REMARK
*A-1394-414-A	S	BOARD COMPLETE (KV-20TR23(U))	*****
<CAPACITOR>			
C805	1-124-903-11	ELECT 1MF 20% 50V	
C806	1-137-399-11	FILM 0.1MF 5% 50V	
C807	1-102-157-00	CERAMIC 560PF 10% 500V	
C809	1-137-367-11	FILM 0.0033MF 5% 50V	
C810	1-137-399-11	FILM 0.1MF 5% 50V	
C811	1-137-399-11	FILM 0.1MF 5% 50V	
C812	1-137-375-11	FILM 0.068MF 5% 50V	
C813	1-124-907-11	ELECT 10MF 20% 50V	
C814	1-124-907-11	ELECT 10MF 20% 50V	
C815	1-124-907-11	ELECT 10MF 20% 50V	
C816	1-124-907-11	ELECT 10MF 20% 50V	
C817	1-124-907-11	ELECT 10MF 20% 50V	
C819	1-164-070-11	CERAMIC 100PF 5% 50V	
<CONNECTOR>			
CN801	*1-573-979-11	CONNECTOR, BOARD TO BOARD 11P	
<DIODE>			
D800	8-719-911-19	DIODE 1SS119	
<IC>			
IC801	8-759-084-09	IC Z8612812PSC	
<COIL>			
L801	1-410-470-11	INDUCTOR 10UH	
<TRANSISTOR>			
Q801	8-729-119-78	TRANSISTOR 2SC2785-HFE	
Q802	8-729-119-78	TRANSISTOR 2SC2785-HFE	
<RESISTOR>			
R801	1-249-416-11	CARBON 820 5% 1/4W	
R802	1-249-416-11	CARBON 820 5% 1/4W	
R803	1-249-416-11	CARBON 820 5% 1/4W	
R804	1-249-425-11	CARBON 4.7K 5% 1/4W	
R805	1-249-425-11	CARBON 4.7K 5% 1/4W	
R806	1-249-423-11	CARBON 3.3K 5% 1/4W	
R807	1-249-425-11	CARBON 4.7K 5% 1/4W	
R808	1-249-417-11	CARBON 1K 5% 1/4W	
R809	1-249-441-11	CARBON 100K 5% 1/4W	
R810	1-249-437-11	CARBON 47K 5% 1/4W	
R812	1-249-417-11	CARBON 1K 5% 1/4W	
R813	1-249-417-11	CARBON 1K 5% 1/4W	
R814	1-249-413-11	CARBON 470 5% 1/4W	
R815	1-249-427-11	CARBON 6.8K 5% 1/4W	
R816	1-249-429-11	CARBON 10K 5% 1/4W	
R817	1-249-433-11	CARBON 22K 5% 1/4W	
R818	1-249-417-11	CARBON 1K 5% 1/4W	
R820	1-249-433-11	CARBON 22K 5% 1/4W	
R821	1-249-433-11	CARBON 22K 5% 1/4W	
R822	1-249-429-11	CARBON 10K 5% 1/4W	

The components identified by shading and mark Δ are critical for safety. Replace only with part number specified.

Les composants identifiés par une trame et une marque Δ sont critiques pour la sécurité. Ne les remplacer que par une pièce portant le numéro spécifié.

REF. NO. PART NO. DESCRIPTION REMARK

MISCELLANEOUS

Δ 1-426-358-31 COIL, DEMAGNETIZATION (KV-20TR23(U/C), 2150R)
 Δ 1-426-368-11 COIL, DEMAGNETIZATION (KV-2160WR)
 Δ 1-451-280-11 DEFLECTION YOKE (Y21PXA2)
 1-452-032-00 MAGNET, DISK; 10MM ϕ
 1-452-094-00 MAGNET, ROTATABLE DISK; 15MM ϕ
 1-452-277-00 MAGNET, BMC
 1-573-657-11 PLUG, F-PIN
 Δ 1-751-057-11 CORD, POWER (WITH CONNECTOR) (KV-20TR23(U/C), 2150R)
 Δ 1-751-056-11 CORD, POWER (WITH CONNECTOR) (KV-2160WR)
 SP902 1-504-252-11 SPEAKER (9X5CM)
 V901 Δ 8-738-764-05 PICTURE TUBE (A51JUH51X)

ACCESSORIES AND PACKING MATERIALS

1-417-182-11 CONVERTER (EAC-25)
 1-501-372-41 ANTENNA, TELESCOPIC
 1-569-007-11 ADAPTER, CONVERSION 2P (KV-2160WR)
 3-756-515-21 MANUAL, INSTRUCTION
 3-756-515-31 MANUAL, INSTRUCTION (KV-20TR23(C))
 3-756-515-41 MANUAL, INSTRUCTION (KV-2150R, 2160WR)
 *4-039-627-01 INDIVIDUAL CARTON (KV-20TR23(U/C))
 *4-039-628-01 CUSHION (UPPER) (ASSY)
 *4-039-629-01 CUSHION (LOWER) (ASSY)
 *4-040-688-01 INDIVIDUAL CARTON (KV-2150R, 2160WR)
 *4-380-340-01 BAG, PROTECTION

REMOTE COMMANDER

1-466-966-11 REMOTE COMMANDER (RM-Y116)
 9-903-826-01 COVER, BATTERY (FOR RM-Y116)

