

ALIMENTATION EFFACEMENT LIGNES BARRES - V MELANGEUR TOP SYNCHRON. LIGNES DEPHAS. SIGNAL VIDEO

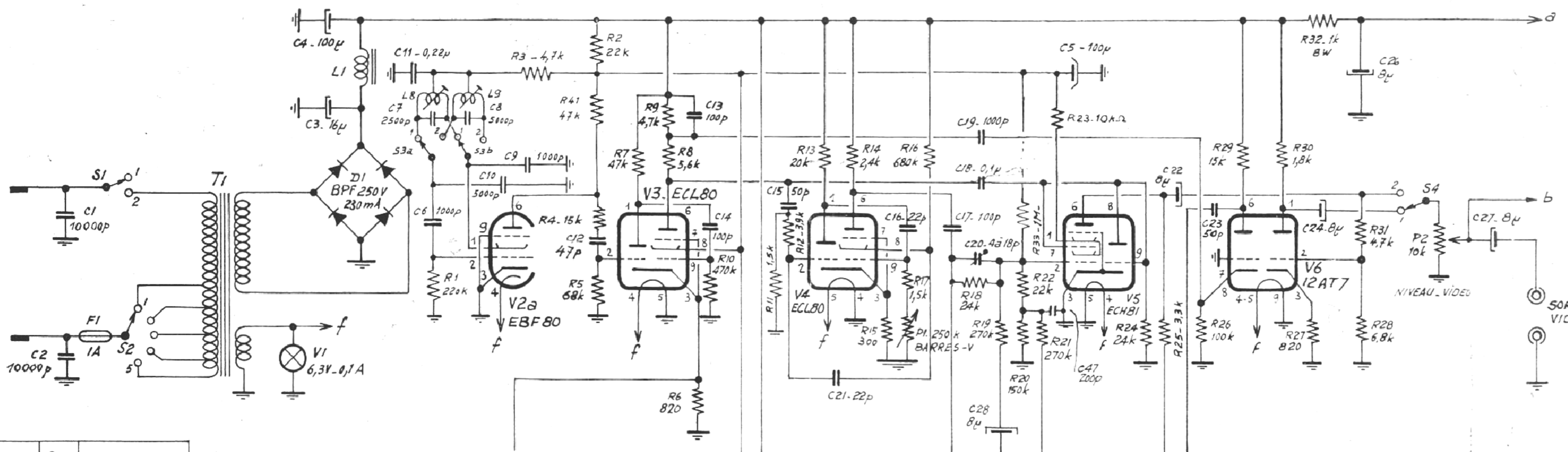

Contacteur	Pos.	Gravure
S1	1	ARRET
	2	MARCHE
S2 SECTEUR	1	115
	2	127
	3	160
	4	220
	5	250V
S3 _a b	1	819
	2	625
S4	1	-
	2	+
S5 DEFINITION M _c /S	1	0
	2	3,5
	3	5
	4	7
	5	10
S6 SYNCHRONISATION	1	INT.
	2	EXT.

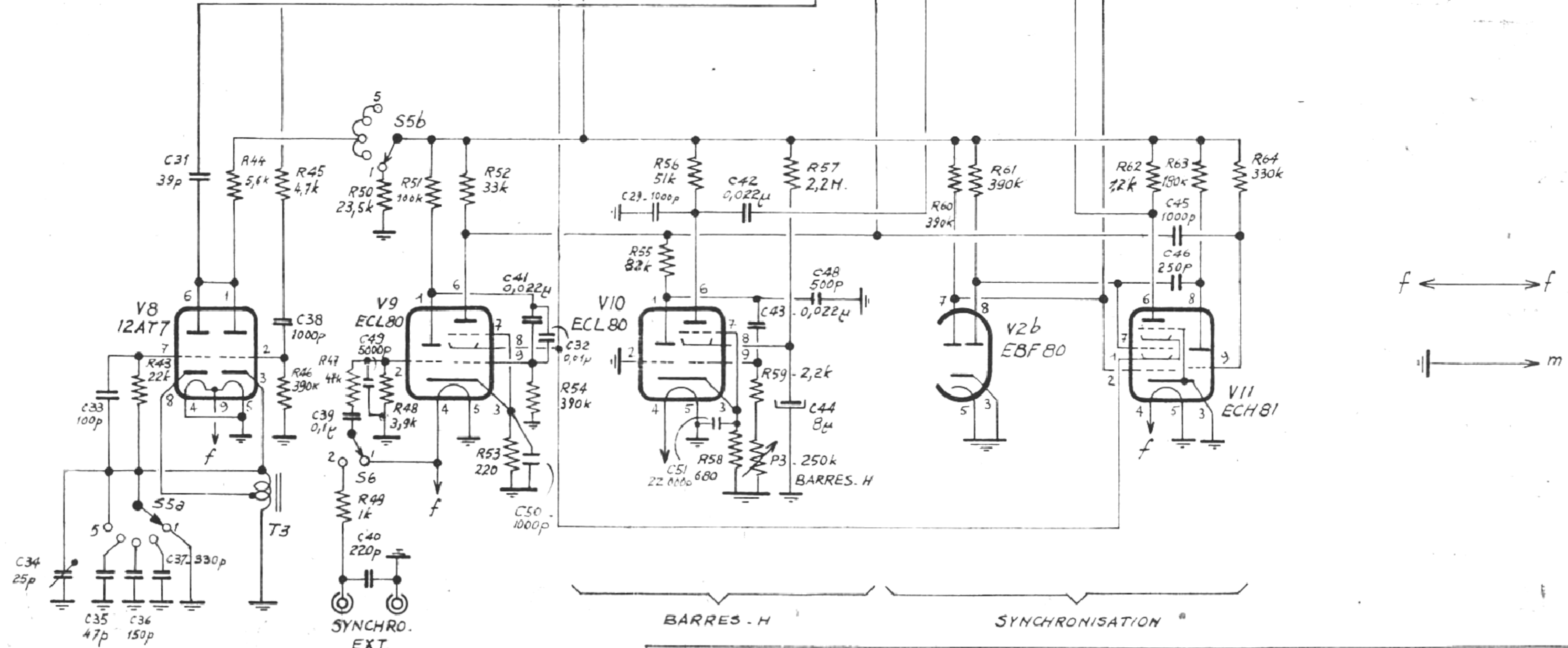
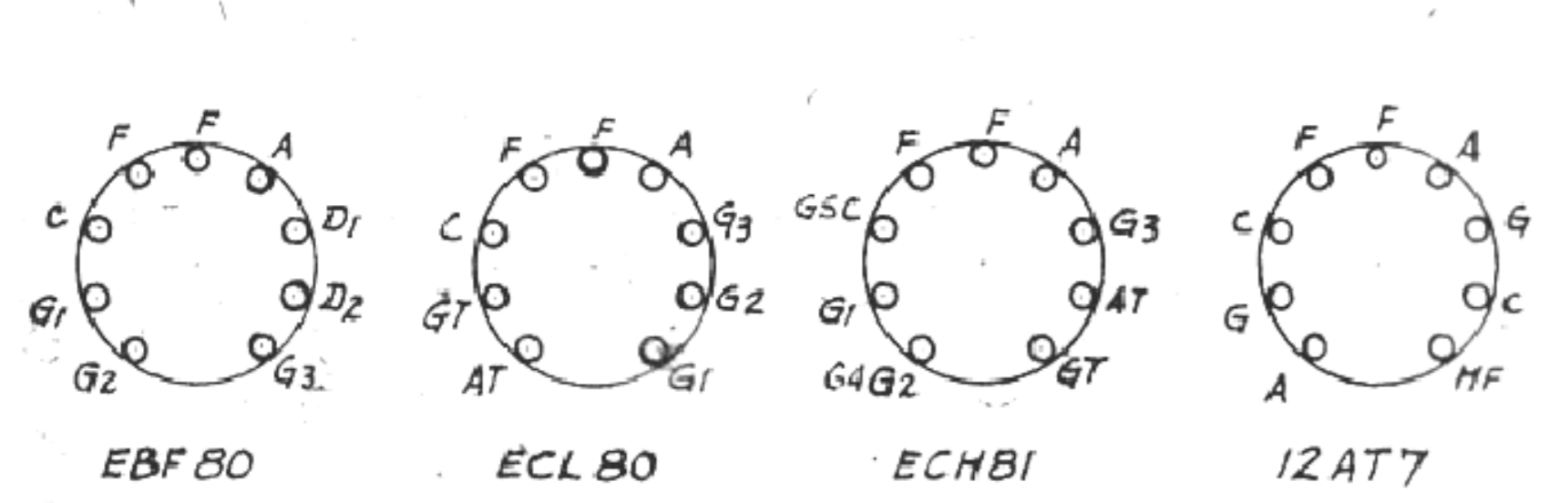

SCHEMA DE PRINCIPLE MIRE 265 METRIX - PARTIE VIDEO -

- Appartir de l'appareil 151incab -

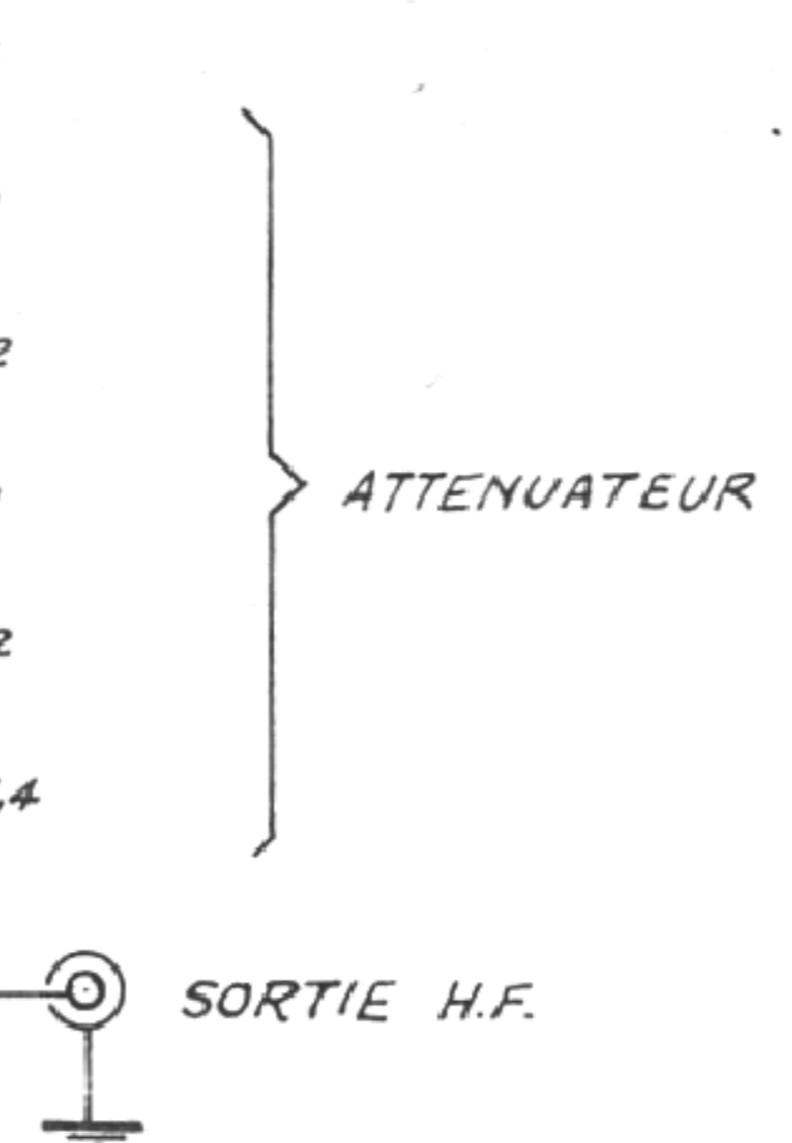
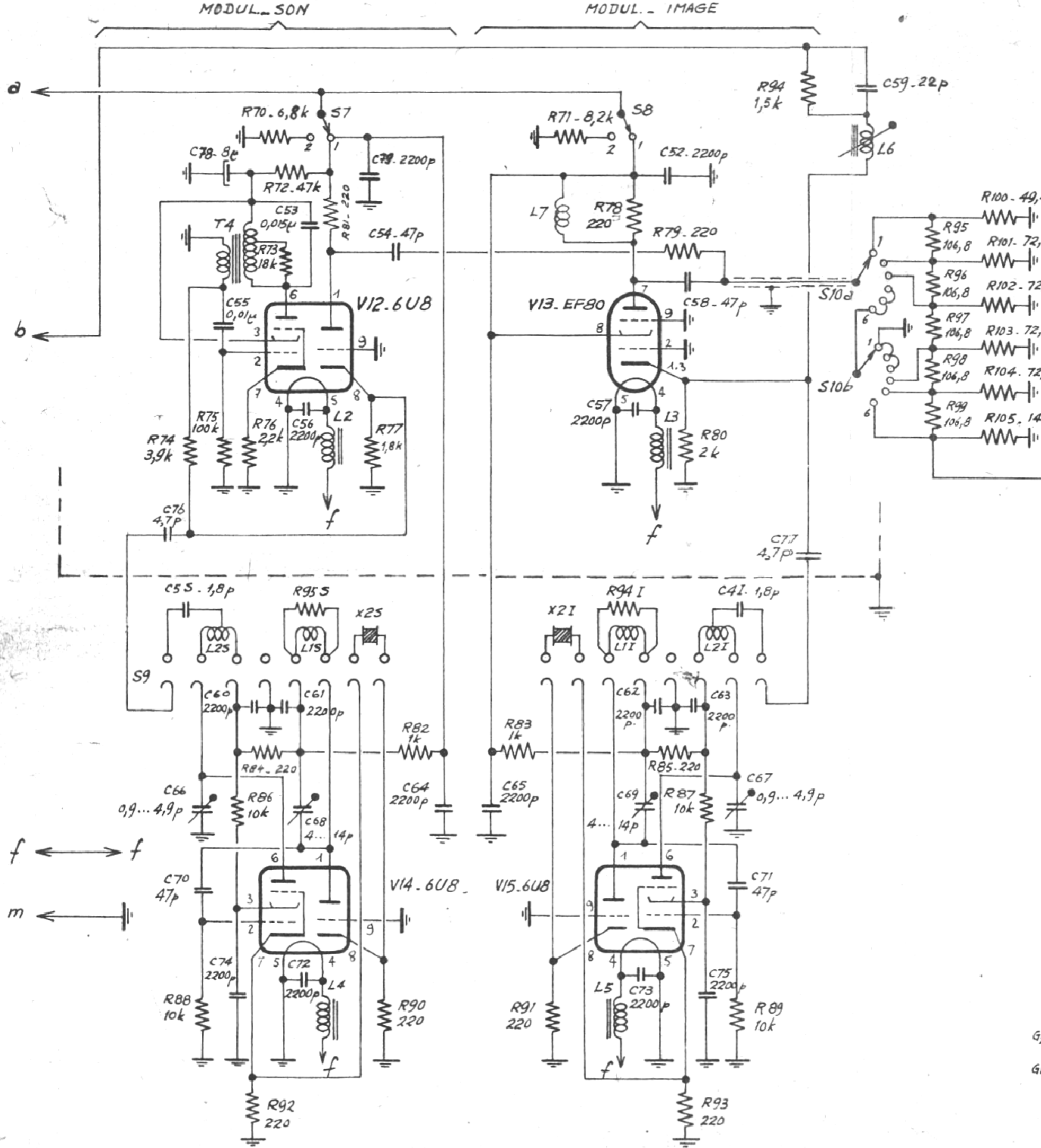

Contacteur	Pos.	Gravure
S7	1	SON
	2	
S8	1	IMAGE
	2	
S9	1	Rotacteur 12 canaux
	2	
	3	
	4	
	5	
	6	
	7	
	8	
	9	
	10	
	11	
	12	

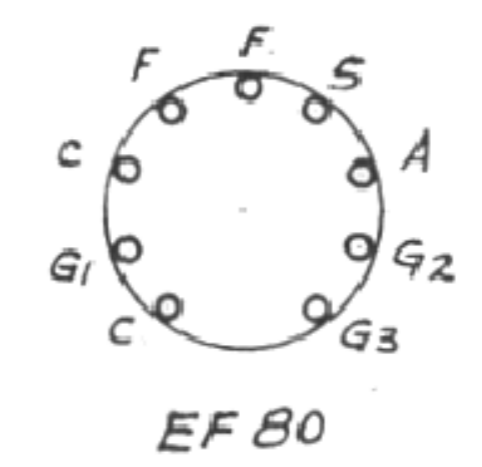
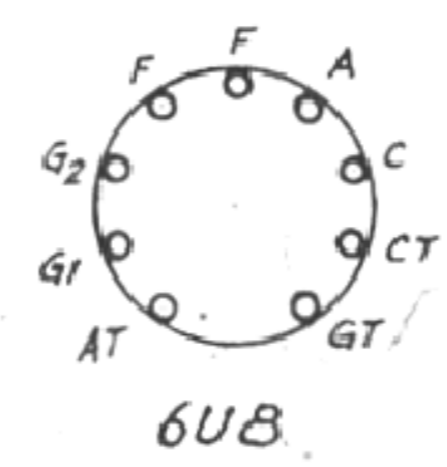

SCHEMA DE PRINCIPE. MIRE 265 METRIX.
PARTIE H.F.

A partir de l'appareil 151 inclus.