

Sears Roebuck & Co.

Model: 4463

Chassis:

Year: Pre October 1937

Power:

Circuit:

IF:

Tubes:

Bands:

Resources

Riders Volume 8 - SEARS 8-13

Riders Volume 8 - SEARS 8-14

Riders Volume 7 - SEARS 7-45

Riders Volume 7 - SEARS 7-46

SEARS-ROEBUCK & CO.

MODELS 1986, 1987, 4403, 4463, 4464, 4484, 4563, 4564, 4584
 Chassis 100150
 Schematic, Socket, Voltage

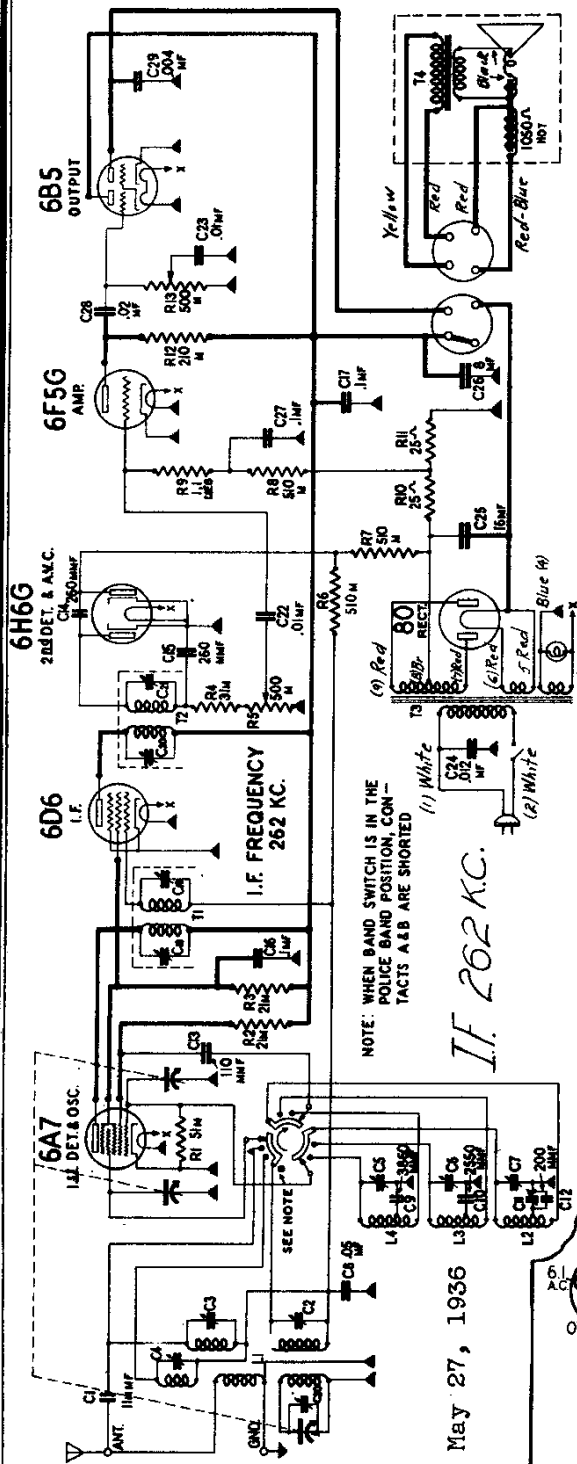

POWER SUPPLY
 All models available.....105-135 volts, 50-60 cycle, 50 watts

FREQUENCY RANGES
 Band A.....525 to 1800 KC.
 Band P.....1760 to 6000 KC.
 Band F.....5800 to 18,100 KC.

ALIGNMENT FREQUENCIES
 1400 KC.; 600 KC. (osc. padder)
 5000 KC.
 16,000 KC.

INTERMEDIATE FREQUENCY.....262 KC

POWER OUTPUT
 Type.....Class A
 Undistorted.....2.5
 Maximum.....3.5 Watts

LOUD SPEAKER
 Type.....Dynamic
 Size.....6" or 8"
 Field Coil Res.....1050 ohms (Hot)
 Field Coil Voltage.....75 volts

OPERATING FEATURES
 Fidelity Range.....50-5000 cycles
 Tone Control.....Variable
 Automatic Volume Control

CHASSIS FEATURES
 Preselector on Bc. Band
 Number of I.F. Stages.....1
 Antenna.....Conventional

May 27, 1936

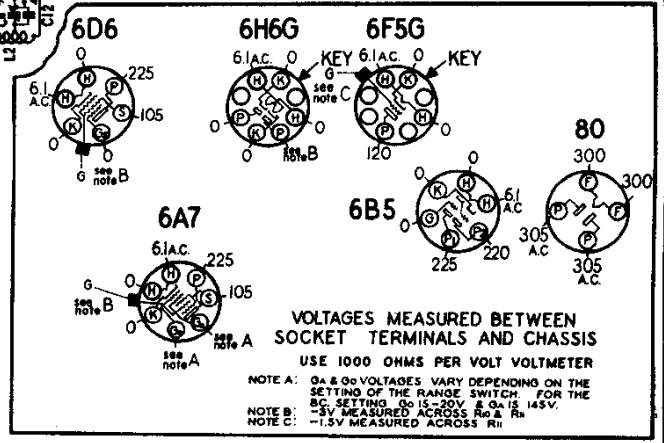

BOTTOM VIEW OF CHASSIS

MODELS 1986, 1987, 4403, 4463
 4464, 4484, 4563, 4564, 4584
 Chassis 100150

SEARS-ROEBUCK & CO.

Socket, Trimmers, Chassis Alignment

ALIGNMENT PROCEDURE

PRELIMINARY

Output meter connections.....Across voice coil leads
 Output meter reading to indicate 1 watt output.....2 volts
 Average sensitivity in microvolts for 1 watt output.....See chart below
 Dummy antenna value to be in series with generator output.....See chart below
 Connection of generator output lead.....See chart below
 Generator modulation.....80%, 400 cycles
 Position of volume control.....full clockwise
 Position of tone control.....full clockwise

BAND SWITCH	POSITION OF * DIAL POINTER	GENERATOR FREQUENCY	DUMMY ANTENNA CONNECTION	GENERATOR CONNECTION	TRIMMERS ADJUSTED (in order shown)	MICRO VOLTS
Band A	1000 KG.	262 KG.	.1 Mrd.	6A7 Grid	C18, C19, C20, C21	125
I.F.	1500 600 (Rock)**	1500 600	.00025 .00025	Ant. Lead Ant. Lead	C7, C30, C2 C11	50 50
Band P	5000 KG.	5000 KG.	400 Ohm	Ant. Lead	*** C6, C4	95
Band F	16000 KG.	16000 KG.	400 Ohm	Ant. Lead	*** C5, C3	90

IMPORTANT ALIGNMENT NOTES

* Before attempting to align the receiver check to see that the dial pointer coincides with the horizontal dividing line of the scale when the gang condenser is in full mesh, and adjust if necessary.

After adjusting the I.F. trimmers C18, C19, C20 and C21, go back and repeat the adjustment, since the setting of each trimmer will have some effect on the others.

** When aligning the broadcast band at 600 KC. it is necessary to adjust trimmer C11 while slowly rocking the gang condenser through a small distance. Rocking the gang is essential if maximum sensitivity is to be obtained.

*** When aligning the short wave bands, care should be observed in adjusting trimmers C6 and C5, since, two possible adjustments of these trimmers will result in signal peaks. The proper peak is that which occurs with the trimmer screw farthest out.

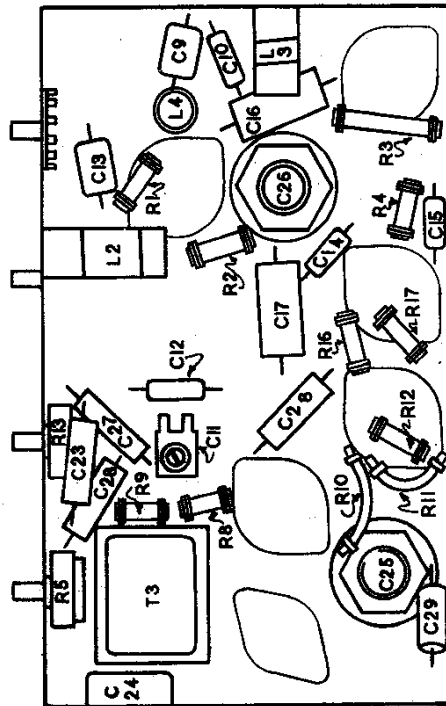
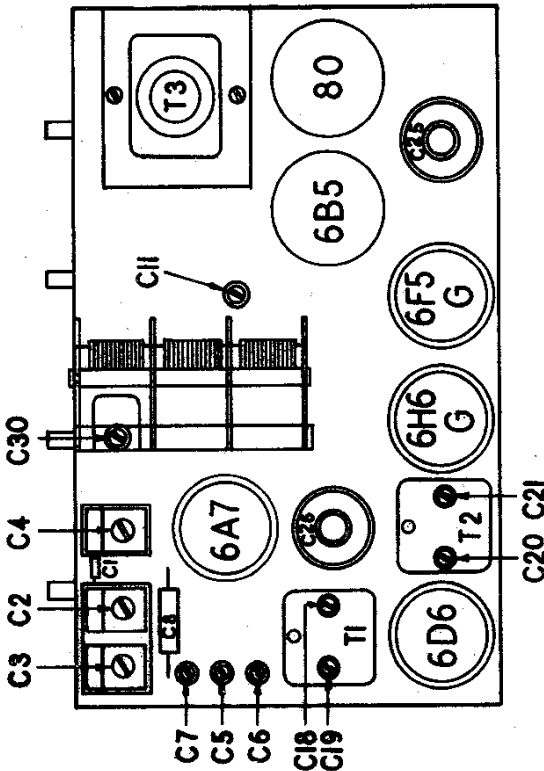

Three Types
Schematics, Voltage

SEARS-ROEBUCK & CO.

MODELS 1986, 1987, 4403, 4463
4484, 4563, 4564, 4584

Parts may be secured direct from the Colonial Radio Corp.,
254 Rano Street, Buffalo, New York.

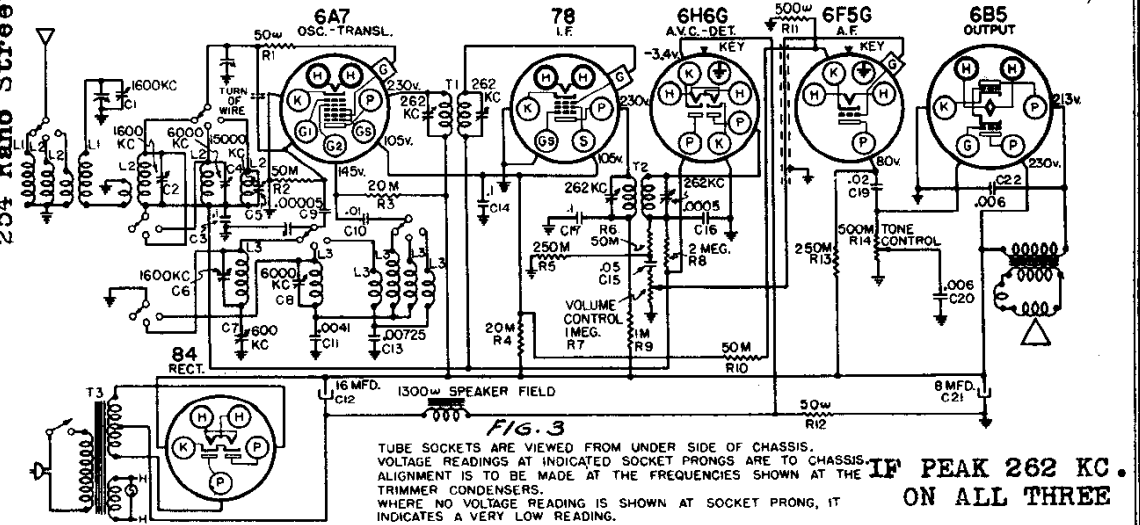
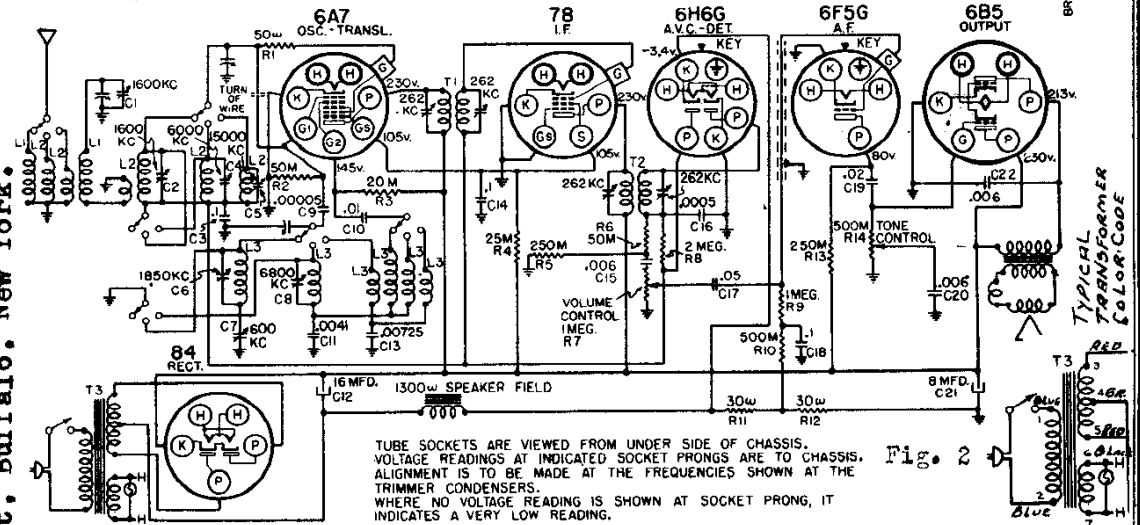
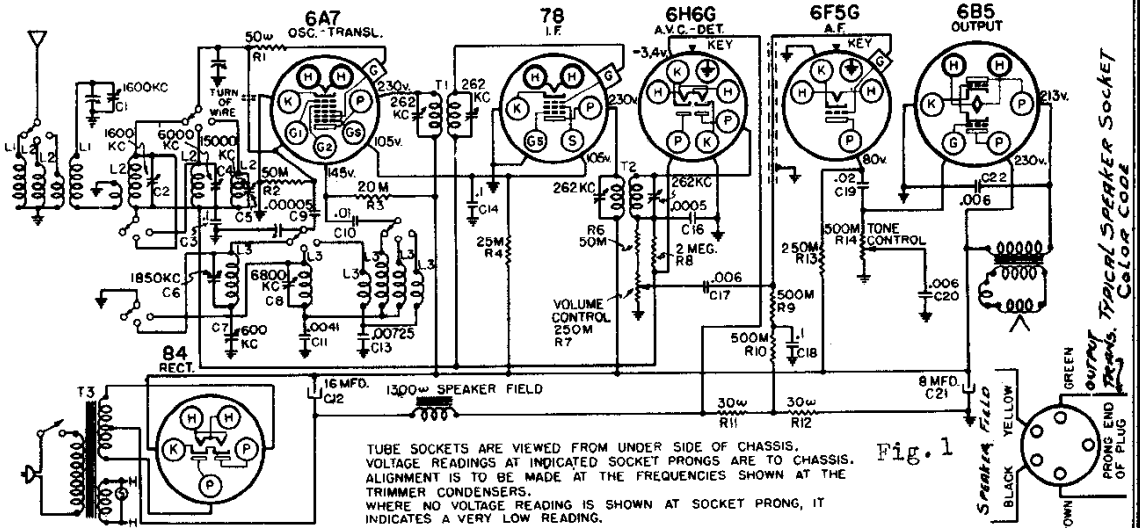

MODELS 1986, 1987, 4403, 4463
4484, 4563, 4564, 4584
Socket, Chassis, Alignment
Change

SEARS-ROEBUCK & CO.

WAVE BAND SWITCH POSITION	GENERATOR FREQUENCY	DUMMY ANTENNA	GENERATOR CONNECTION	TERMINUS ADJUSTER (Screw)	MICROWOLTS
"A" - To fall on center line of dial when variable is fully rotated.	262 kc	.1 mfd.	6A7 Grid	T2, T1	-
"A" - 1600 kc	1600 kc	.0002 mfd.	Antenna Terminal	C3, C2, C1	40
"A" - 600 kc (rook)	600 kc	.0002 mfd.	Antenna Terminal	C7	40
"P" - 6 mc	6 mc	400 ohms	Antenna Terminal	C8	-
"P" - 6 mc (rook)	6 mc	400 ohms	Antenna Terminal	C4	25
"P" - 15 mc (rook)	15 mc	400 ohms	Antenna Terminal	C5	30
"P" - 7 mc	7 mc	400 ohms	Antenna Terminal	Loop at end of L3	80

Set the generator to 1624 kc and tune in the signal image at about 1000 kc on the receiver. The generator should be adjusted for high output (.1 volts). There is a lead running from L1 through a hole in the chassis to the wave switch. Adjust the position of this lead under the chassis for minimum image response.

IMPORTANT ALIGNMENT NOTES

Where indicated by the word, "rook", the variable should be rooked back and forth a degree or two while making the adjustment.

It is advisable to repeat the entire alignment procedure band by band and in the original order to insure greater accuracy.

Always keep the output from the test oscillator at its lowest possible value. As the sensitivity is increased by alignment, the generator output should be reduced correspondingly.

After the alignment procedure has been completed, tune in a broadcast signal at about 1000 mc. If necessary shift the dial pointer so that it indicates this frequency.

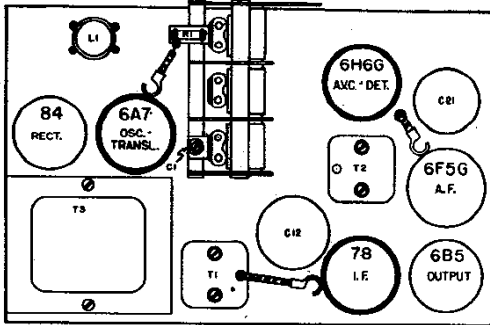

TOP OF CHASSIS - MODEL 101407

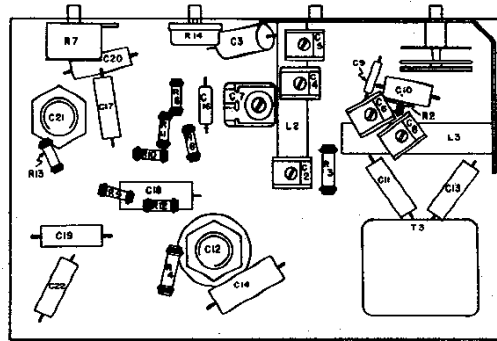

LOCATIONS OF PARTS UNDER CHASSIS - MODEL 101407

ELECTRICAL SPECIFICATIONS

POWER SUPPLY:	105-125 volts, 50-60 cycle, 48 watts
All models available	105-125 volts, 26 cycle, 50 watts
All models available	
FREQUENCY RANGES:	545-1760 kc
Band "A"	1600 kc
Band "P"	6 mc
Band "P"	15 mc
INTERMEDIATE FREQUENCY	455 kc
POWER OUTPUT:	Single Pentode
Undistorted	2.46 watts
Maximum	4 watts
OPERATING FEATURES:	50 - 5000 cycles
Frequency Range	Variable
Automatic Volume Control	Conventional

GENERAL INFORMATION

DIFFERENCES IN VOLUME CONTROL CIRCUITS:

Earlier production used a 250M ohm volume control and the circuit shown in Fig. 1. In later production, shown in the circuit of Fig. 2, the volume control value was changed to 1.2M, 250M ohms were added, the value of C17 was changed from .001 to .002, the R10 diode current from 500 ma to 1000 ma, and the R11 resistor was changed to 100 ohms to remove the DC diode current from the volume control to prevent noisy operation of the control.

CHASSIS MARKED 4077 AND LATER:

Chassis that are rubber stamped 4077 on any label letter incorporate the circuit shown in Fig. 3. The differences as compared to Fig. 2 are:

- C15 changed from .006 mfd. to .05 mfd.
- C17 changed from .006 mfd. to .1 mfd. and its location changed.
- The resistors R9, R10, and R11 shown in Fig. 2 were removed.
- A new 1M ohm resistor was added and R9 designation assigned to it.
- A new 50K ohm resistor was added and R10 designation assigned to it.
- A new 500 ohm resistor was added and R11 designation assigned to it.
- R8 changed from 25K ohms to 50K ohms.

HEATER CIRCUIT:

Earlier production used center tapped power transformer heater winding. Later production omitted the center tap and grounded one end of the heater winding.

MODULATION HUB:

Modulation hub, which occurs only when a station is tuned in, can be eliminated by connecting a .003 mfd. 800 volt condenser from one side of the power transformer primary to ground.

Send Purchase Orders DIRECT to Colonial Radio Corp., 254 Main St., Buffalo, N. Y.

ALIGNMENT PROCEDURE

PRELIMINARY:

- Output meter connections - Across voice coil leads
- Output meter reading to indicate .5 watts output - 1.3 volts
- Average sensitivity in microwolts for .5 watts output - See chart below
- Dummy antenna value to be in series with generator output - See chart below
- Connection of generator output lead - See chart below
- Generator modulation percentage - 50%
- Position of volume control - Fully clockwise
- Position of tone control - Fully clockwise