

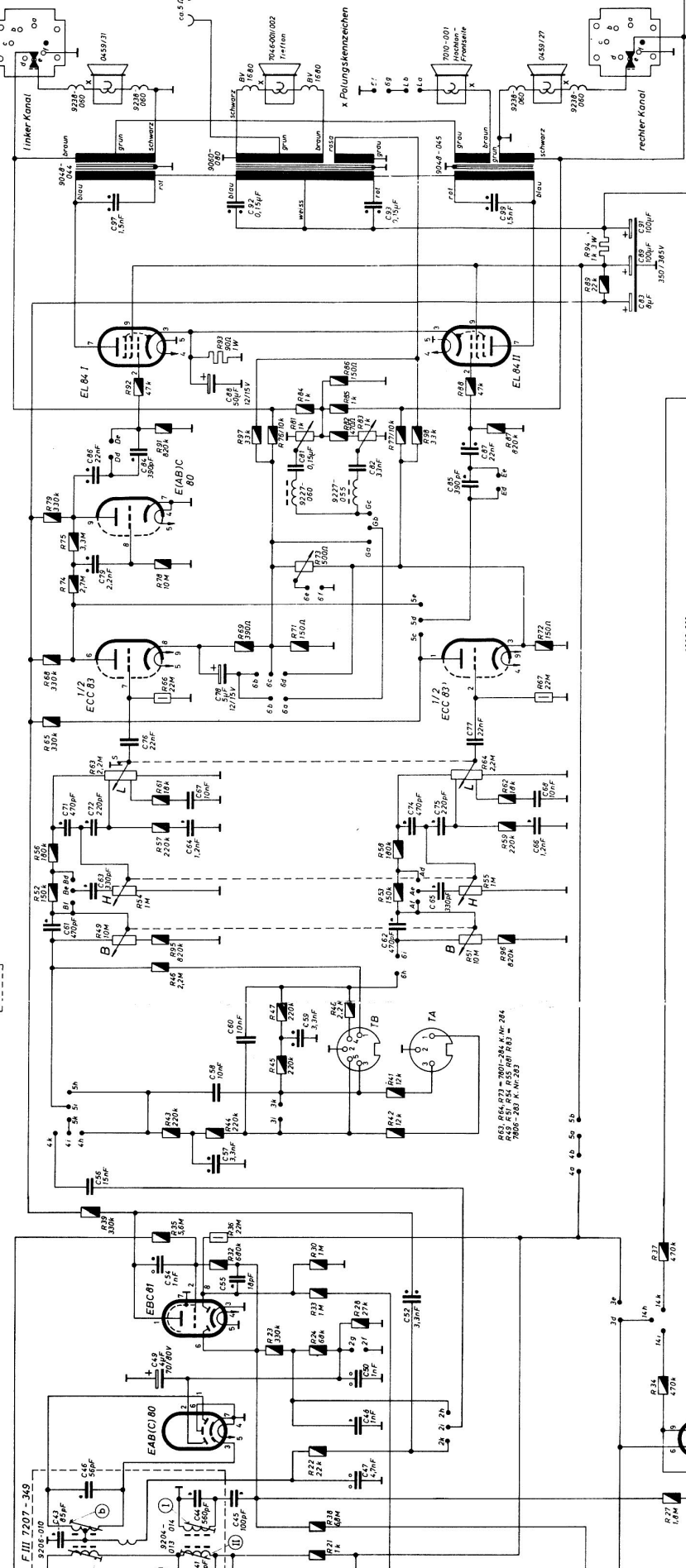

**5016 Stereo** (1166-001)  
**5017 Stereo** (1167-001)  
**5019 Stereo** (1168-001)

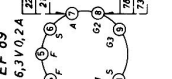
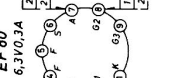
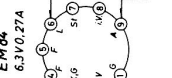
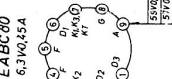
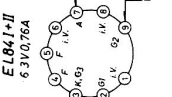

- TB: 1 = Aufnahme Mono  
 2 = Aufnahme Stereo links  
 3 = Masse  
 4 = Wiedergabe Mono links  
 5 = Aufnahme Stereo rechts  
 6 = Wiedergabe Stereo rechts  
 7 = Stereo links  
 8 = Masse links  
 9 = Wiedergabe Mono

Spannungen mit GRUNDIG-Röhren-  
 voltmeter gegen Masse gemessen  
 Maßwerte gelten bei 220V~ auf  
 MW UKW TA ohne Antennensignal.

ÄNDERUNGEN VORBEHALTEN

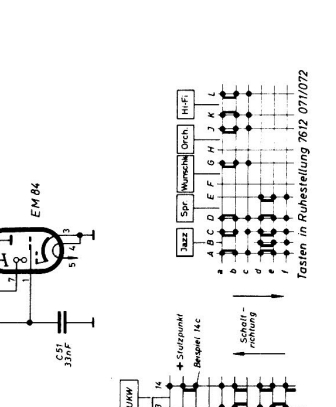

Tasten in Ruhelage bei 612 071072

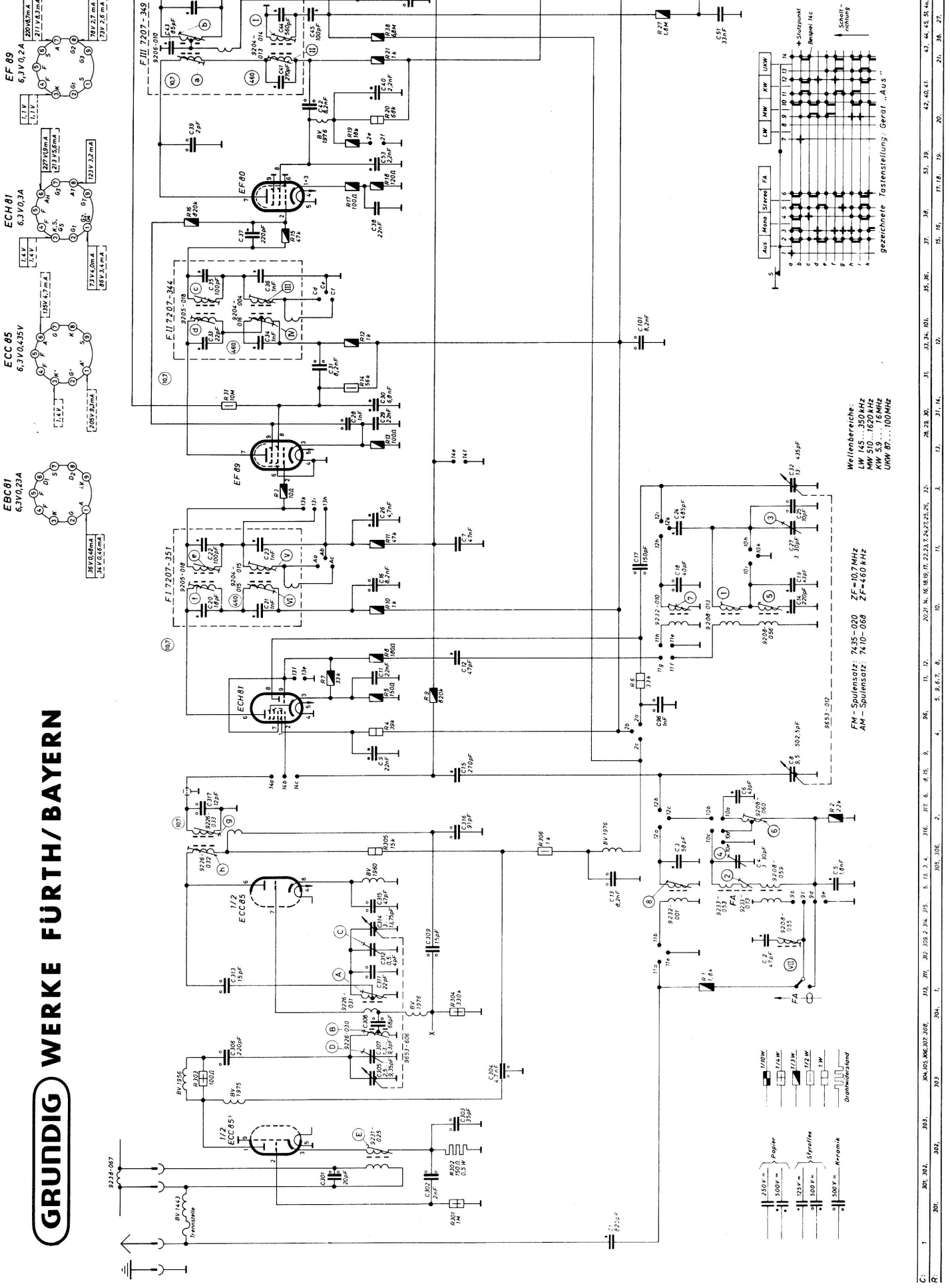

C: 1 301.302. 303. 304. 305. 306. 2. 1. 3. 4. 5. 6. 7. 8. 9. 10. 11. 12. 13. 14. 15. 16. 17. 18. 19. 20. 21. 22. 23. 24. 25. 26. 27. 28. 29. 30. 31. 32. 33. 34. 35. 36. 37. 38. 39. 40. 41. 42. 43. 44. 45. 46. 47. 48. 49. 50. 51. 52. 53. 54. 55. 56. 57. 58. 59. 60. 61. 62. 63. 64. 65. 66. 67. 68. 69. 70. 71. 72. 73. 74. 75. 76. 77. 78. 79. 80. 81. 82. 83. 84. 85. 86. 87. 88. 89. 90. 91. 92. 93. 94. 95. 96. 97. 98. 99. 100.