

# ICF-PRO70/PRO80

## SERVICE MANUAL REVISED

Downloaded by  
RadioAmateur.EU

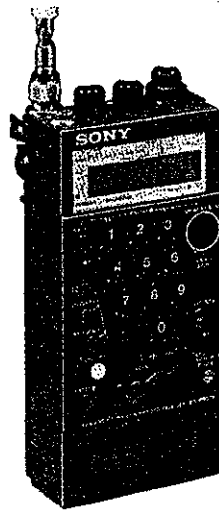

*US Model*  
*Canadian Model*  
*AEP Model*  
*UK Model*  
*E Model*  
*Australian Model*  
*ICF-PRO80*  
*AEP Model*  
*E Model*  
*ICF-PRO70*

Photo: ICF-PRO70

### SPECIFICATIONS

Circuit system	LW/MW/SW/VHF: Dual conversion superheterodyne . . . (ICF-PRO70 Type 1 and ICF-PRO80) LW/MW/SW: Dual conversion superheterodyne . . . (ICF-PRO70 Type 2-4) FM: Superheterodyne	DCC-127A or DCC-120 car battery cord (optional) for use with 12 V car battery DCC-240 car battery cord (optional) for use with 24 V car battery EBP-6 battery case (optional) using four size C (R14) batteries
Frequency coverage	<b>ICF-PRO70</b> Type 1: 150 kHz-108 MHz Type 2: 150-29,995 kHz and 87.6-108 MHz Type 3: 150-26,100 kHz and 87.5-108 MHz Type 4: 150-285 kHz, 531-26,100 kHz and 87.6-108 MHz <b>ICF-PRO80</b> 150 kHz-108 MHz (without using the FRQ-80 frequency converter) 115.15-223 MHz (using the FRQ-80) SW/VHF/FM: Telescopic antenna . . . (ICF-PRO70 Type 1 and ICF-PRO80) SW/FM: Telescopic antenna . . . (ICF-PRO70 Type 2-4) LW/MW: Built-in ferrite bar antenna External antenna connector: TNC connector . . . (except West Germany model)	Battery life Approx. 10 hours using Sony SUM-3(NS) batteries Dimensions Approx. 90 x 182 x 50 mm (w/h/d) (3 5/8 x 7 1/4 x 2 inches) including projecting parts and controls, not including the telescopic antenna Weight Approx. 650 g (1 lb 7 oz) including batteries, shoulder strap and telescopic antenna
Antennas		<b>FRQ-80 frequency converter (supplied with the ICF-PRO80 only)</b> Shift frequency 115 MHz Attenuator 0 dB/-30 dB Power requirements 3 V DC, two size AA (R6) batteries Battery life Approx. 80 hours using Sony SUM-3(NS) batteries Dimensions Approx. 40 x 98 x 31 mm (w/h/d) (1 5/8 x 3 7/8 x 1 1/4 inches) including projecting parts and controls Weight Approx. 120 g (4.2 oz) including batteries
Speaker	7 x 3.5 cm	<b>Accessories supplied</b> Telescopic antenna (1) Earphone (1) Shoulder strap (1) Carrying case (1) Antenna holder (1) Antenna plug adaptor (BNC ↔ TNC) (1) . . . (except West Germany model) FRQ-80 frequency converter (ICF-PRO80 only) (1) Wave Handbook (1)
Power output	400 mW (at 10% harmonic distortion)	
Output jack	Earphone jack (mini) (1) 8 ohm Recording output jack (mini) (1) Output level 0.775 mV (-60 dB) Output impedance 1 kilohm	
Power requirements	6 V DC (for radio/computer backup) Four size AA (R6) batteries or BP-23 rechargeable battery pack (optional) DC IN 6 V jack accepts: AC-D4 AC power adaptor (optional) for use on 100, 120, 220 or 240 V AC depending on the model type of the AC-D4 available in your country	

Classic-Audio-Service  
HiFi-Service-Center  
Heinz Deppermann, Dipl.-Ing.

service@cas-germany.com  
Tel. +49 (0) 2065 - 959085



PLL SYNTHESIZED RECEIVER  
**SONY**®

**FEATURES**

**WORLD-WIDE FREQUENCY COVERAGE**

**No band selector is provided.**  
The entire frequency range is tuned in consecutively. The detection mode is set automatically according to the frequency range to which the tuned frequency belongs.

**Selectable detection modes**  
(Except ICF-PRO70 West Germany and Saudi Arabia model)

The entire frequency coverage is divided into 2 to 4 ranges depending on the model type, and the detection modes, FM, NARROW FM, AM WIDE, AM NARROW and SSB\* can be selected for each range.

\* SSB = Single Side Band

**Frequency converter supplied for wider coverage (ICF-PRO80 only)**

By attaching the supplied FRQ-80 frequency converter, 115.15-223 MHz can also be received.

**VERSATILE TUNING MODES**

<b>Direct tuning (Page 6)</b> by inputting a frequency to be tuned in	• When you know the frequency of the station
<b>Memory tuning (Page 7)</b> by simply pressing one button to tune in the stored station	• For daily listening to your favorite station
<b>Manual tuning (Page 8)</b> by scanning frequencies step by step at a determined interval	• When you do not know the frequency of the station • To tune in precisely a station located by scan tuning or limited scan tuning precisely
<b>Scan tuning (Page 9)</b> by automatically scanning the entire frequency coverage	• When you do not know the frequency of the station
<b>Limited scan tuning (Page 10)</b> by automatically scanning the frequency coverage you have defined	• When you know the frequency range in which the desired station is located (e.g. FM or MW radio broadcasting range, an SW meter band).
<b>Memory scan tuning (Page 10)</b> by automatically scanning the stored (up to 10) stations	• To choose a station from among those stored in a certain memory page
<b>Program memory scan tuning (Page 11)</b> by automatically scanning only the stations you have programmed among all stored in memory (up to 40 stations) in the order programmed	• To choose a station from among those having the specified conditions (e.g. FM broadcasting stations)
<b>Priority tuning (Page 12)</b> by tuning in the specified station every 3 seconds	• To catch a radio communication when you are not sure when it will take place.

**CONVENIENT FUNCTIONS**

<b>Memory of up to 40 stations (Page 7)</b>	Up to 40 stations can be stored on 4 memory pages (10 stations for each page) and tuned in instantly.
<b>Three scan modes selectable (Page 9)</b>	Scanning can be stopped at the first-located station, or be resumed after each station located has been received for several seconds or until the signal of the station stops.
<b>Memory search (Page 7)</b>	The frequencies of the stations stored on one page are displayed in sequence while your desired station is kept tuned in.
<b>Program memory search (Page 11)</b>	The frequencies of the stations programmed are displayed in sequence while your desired station is kept tuned in.
<b>Memory protection (Page 7)</b>	The memory of one page (10 stations stored) is locked so that it cannot be changed inadvertently.
<b>Key protection (Page 8)</b>	The buttons on the front panel are locked so that they cannot be operated by accident.
<b>Squelch control (Page 9)</b>	The receivable signal level can be adjusted so that scanning stops at stations with stronger signals only and noise is suppressed while tuning and while no station signal is present.
<b>Fine tuning (Page 13)</b>	AM (LW, MW and SW) and SSB stations can be tuned in precisely.

**TABLE OF CONTENTS**

<u>Section</u>	<u>Title</u>	<u>Page</u>
	Specifications . . . . .	1
	Features . . . . .	2
<b>1. GENERAL</b>		
	Notes on Model Types and Receivable Frequencies . . . . .	3
	To Change the MW Tuning Interval . . . . .	3
	To Erase All Memory . . . . .	3
	Location and Function of Controls . . . . .	4
	Direct Tuning . . . . .	6
	Memory Tuning . . . . .	7
	Manual Tuning . . . . .	
	Scan Tuning . . . . .	9
	Limited Scan Tuning . . . . .	10
	Memory Scan Tuning . . . . .	10
	Program Memory Scan Tuning . . . . .	11
	Priority Tuning . . . . .	12
	To Select the Detection Mode . . . . .	12
	Fine Tuning . . . . .	13
	To Convert the Frequency Coverage (ICF-PRO80 only) . . . . .	14
<b>2. ELECTRICAL ADJUSTMENTS</b>		
	Reference-Frequency Oscillator (7.2 MHz) Adjustment . . . . .	16
	VCO1 PD-Voltage Adjustment . . . . .	17
	FM-L Tracking Adjustment . . . . .	17
	VCO2 PD-Voltage Adjustment . . . . .	18
	FM-H Tracking Adjustment . . . . .	18
	FM IF Adjustment . . . . .	19
	Second Local Oscillator Adjustment . . . . .	1
	AM 1st and 2nd IF Adjustment . . . . .	20
	NARROW-FM Detector Adjustment . . . . .	20
	AM AGC Adjustment . . . . .	21
<b>3. DIAGRAMS</b>		
	IC Block Diagrams . . . . .	21
	Semiconductor Lead Layouts . . . . .	22
	3-1. Signal, PLL Section Printed Wiring Boards . . . . .	23
	3-2. Schematic Diagram . . . . .	27
	3-3. Converter Board Schematic Diagram . . . . .	30
	3-4. Control Section Printed Wiring Boards . . . . .	30
<b>4. EXPLODED VIEWS</b>		33
<b>5. ELECTRICAL PARTS LIST</b>		36

## SECTION 1 GENERAL

### TO CHANGE THE MW TUNING INTERVAL

- 1 Remove the battery case.
- 2 Switch the MW CH STEP selector.
- 3 Replace the battery case and close the lid.

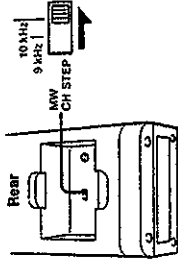

The MW tuning interval is factory preset to 9 kHz or 10 kHz to match the local frequency allocation system.\* If you use the receiver in an area where the frequency allocation system is based on the other interval, change the position of the MW CH STEP selector in the battery compartment as follows.

### TO ERASE ALL MEMORY

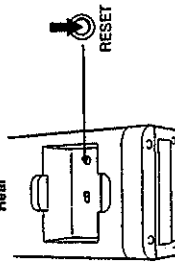

The stations, program, scan mode, etc. stored in the memory are retained even if the power is once turned off or the batteries are replaced (within 3 minutes). To erase all the memory to initialize the unit, press the RESET button in the battery compartment.

### NOTES ON MODEL TYPES AND RECEIVABLE FREQUENCIES

The ICF-PRO70/PRO80 is available in various models which differ mainly in their frequency coverage to match the regulations of different countries.

Model type	Frequency coverage
Type 1 (Swiss, E (except Saudi Arabia) model)	150 kHz 108 MHz LW/MW/SW/VHF/FM
Type 2 (AEP (except Swiss and West Germany) model)	150 kHz 108 MHz 29,995 kHz 87.5 MHz LW/MW/SW FM
Type 3 (West Germany model)	150 kHz 108 MHz 26,100 kHz 87.5 MHz LW/MW/SW FM
Type 4 (Saudi Arabia model)	150 kHz 108 MHz 265 kHz 531 kHz 26,100 kHz 87.5 MHz LW MW/SW FM
ICF-PRO80	150 kHz 108 MHz LW/MW/SW/VHF/FM
Without using the supplied frequency converter	115.15 MHz 223 MHz AIR/PSB/TV (VHF)

Although the models differ in some minor parts in relation to the difference in frequency coverage, the operating procedures of all the units are identical. The differences are clearly described in the text as required. The photos and illustrations used in this manual represent a typical model.

\* The illustrations used in this manual show 9 kHz setting.

## LOCATION AND FUNCTION OF CONTROLS

For details on the use of each control, refer to the pages indicated in the black circles.

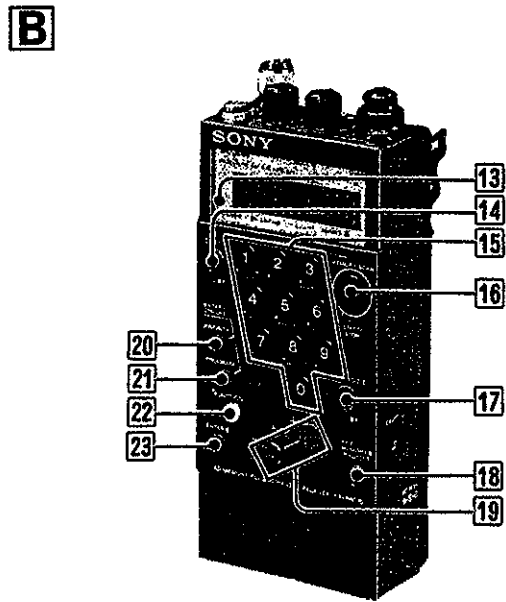
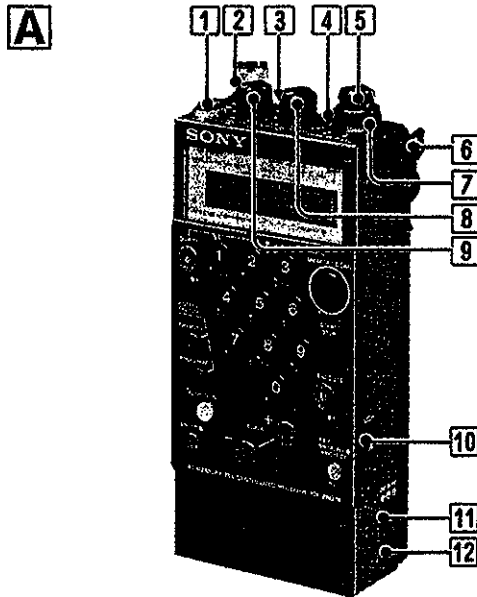

### Front (Photos A and B)

#### 1 POWER switch

#### 2 Antenna connector

#### 3 (earphone) Jack (minijack)

Connect an earphone or an external speaker.

#### 4 (recording output) Jack (minijack)

#### 5 FINE/SSB control

Used for AM and SSB fine tuning.

**FINE:** When AM WIDE or AM NARROW detection mode is selected, press [FUNCTION] + 5 so that the "FINE" indicator appears and fine tune with this control.

**SSB:** When SSB detection mode is selected, fine tune with this control.\*

\*SSB mode is not provided with the ICF-PRO70 type 4 model.

#### 6 Loop for shoulder strap

#### 7 PAGE selector

Select memory page, 1 to 4.

#### 8 SQL (squelch) control

Adjust the squelch level.

▴ **AUTO (depressed):** The signal (and noise) with a lower level than the factory-preset level is cut.

▾ **MANUAL (released):** Adjust manually the level of the signal you want to receive.

#### 9 VOLUME/TONE control

Functions as a volume control and a tone control.

**VOLUME:** Turn to adjust the volume.

**TONE:** Depress (▴ LOW) to emphasize bass, and press to release (▾ HIGH) to emphasize treble.

The volume can be adjusted in either the depressed or released position.

#### 10 LIGHT button

Press to illuminate the display window for approximately 10 seconds. If any button on the front panel is pressed, the illumination will remain for 10 seconds more.

#### 11 DC IN 6 V (external power input) Jack

Connect the optional AC power adaptor or car battery cord.

#### 12 Battery case (rear)

#### 13 RECEIVE Indicator

Lights red when a signal or noise is received.

#### 14 DIRECT button

Press to start direct tuning.

This button is also used in combination with [FUNCTION] or [ENTER].

#### 15 Number buttons

Press to recall the stored station (memory tuning).

Press to input the frequency of a station for direct tuning.

These buttons are also used in combination with [FUNCTION], [ENTER], [PROGRAM] or [PRIORITY].

#### 16 MEMORY SCAN button

Press to start memory scan tuning (with PROGRAM OFF) and program memory scan tuning (with PROGRAM ON).

This button is also used in combination with [FUNCTION].

#### 17 EXECUTE button

Press this button to tune in the frequency for direct tuning.

This button is also used in combination with [FUNCTION] or [ENTER].

#### 18 KEY/MEMORY PROTECT button

Press to activate the key protection function (i.e. the indicator appears). The buttons on the front panel are locked and no longer function. Press again to deactivate the key protection function.

This button is also used in combination with [ENTER].

#### 19 SCAN +/- buttons

Used for manual tuning.

This button is also used to start scan tuning and limited scan tuning.

#### 20 PRIORITY button

Press to activate priority tuning (i.e. [PRIORITY] indicator appears). Press again to deactivate it.

#### 21 PROGRAM button

Press to activate program memory scan tuning and program memory search (i.e. [PROGRAM] indicator appears). Press again to deactivate it.

#### 22 FUNCTION button

When a button with a yellow dot is pressed with this button, the function of the button changes to that indicated on the panel together with the yellow dot.

Buttons to be pressed	Function
[FUNCTION] + 1 (SCAN 1) + 2 (SCAN 2) + 3 (SCAN 3)	To select the scan mode for scan, limited scan, memory scan and program memory scan tuning.
[FUNCTION] + 3 (FM) + 4 (AM WIDE) + 5 (NARROW FM*) + 6 (AM NARROW) + 7 (SSB)**	To select the detection mode.
[FUNCTION] + 8 (FINE ON/OFF)	Press to activate AM fine tuning (i.e. FINE indicator appears). Press again to deactivate it.
[FUNCTION] + 9 (LIMIT ON/OFF)	Press to activate limited scan tuning (i.e. the limited scan indicator appears). Press again to deactivate it.
[FUNCTION] + DIRECT (L1) + EXECUTE (L2)	To display the preset limit frequency.
[FUNCTION] + MEMORY SCAN (SEARCH)	To activate the memory search function (with PROGRAM OFF) or program memory search function (with PROGRAM ON).

\* NARROW FM is not provided with the ICF-PRO70 type 3 and type 4 models.

\*\* SSB is not provided with the ICF-PRO70 type 4 model.

**Note: For power switch (West Germany model only)**

There are two power switches in West Germany model.

1. POWER switch (S203)
2. Switch in antenna connector (S102)

Therefore, power is supplied by installing a telescopic antenna in the antenna connector (S102 turns ON) and turning the POWER switch on.

**C**

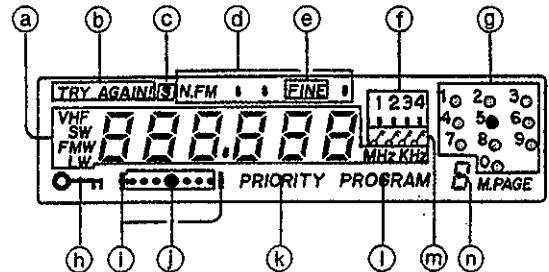

**ENTER button**

When a button with a white dot is pressed with this button, the function of the button changes to that indicated on the panel in white.

Buttons to be pressed	Function
ENTER + ① - ② (PRESET)	To store the station being tuned in on the number buttons ⑦
ENTER + DIRECT (L1) + EXECUTE (L2)	To store the limit frequency. ⑩
ENTER + KEY/MEMORY PROTECT (MEMORY PROTECT)	Press to activate the memory protection function (i.e. ⚡ indicator appears below the PAGE selector setting indicator). Press again to deactivate it. ⑦

**Display window (illustration C)**

- ③ Frequency being received
- ④ TRY AGAIN indicator
- ⑤ S (frequency shift) Indicator (ICF-PRO80 only)
- ⑥ Detection mode indicator
- ⑦ FINE (fine tuning) indicator
- ⑧ PAGE selector setting indicator
- ⑨ Memory station indicator

The dot lights to show that the station stored on the corresponding number button is being received.

- ⑩ Key protection indicator
- ⑪ Limited scan indicator
- ⑫ Scan mode Indicator
- ⑬ PRIORITY indicator
- ⑭ PROGRAM Indicator
- ⑮ Memory protection Indicator
- ⑯ Memory page indicator

**Abbreviations and symbols used in this manual**

DIRECT			□ and ○ represent a button.
FUNCTION + ①		FUNCTION + ①	+ indicates that the latter button is pressed while the former button is kept pressed.
DIRECT → ①			→ indicates that the latter button is pressed after the former button.
(Beep)	Indicates that operation is accepted.		
(Honk)	Indicates that operation is rejected.		

**DIRECT TUNING**

If you know the frequency of a station to be received, you can tune in the station easily by inputting its frequency.

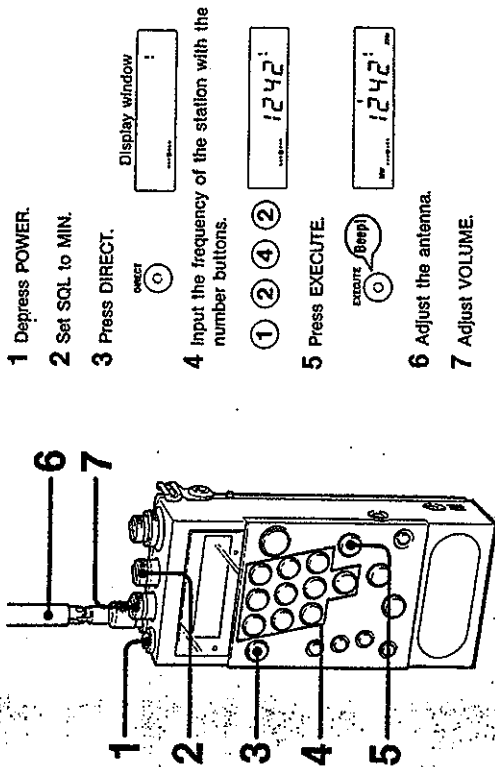

- 1 Depress **POWER**.
- 2 Set **SQL** to **MIN**.
- 3 Press **DIRECT**.
- 4 Input the frequency of the station with the number buttons.
- 5 Press **EXECUTE**.
- 6 Adjust the antenna.
- 7 Adjust **VOLUME**.

After listening, press to release **POWER**.

**TO INPUT A FREQUENCY**

Normally, input the frequency in kHz.	88.5 MHz (= 88,500 kHz)	DIRECT 0 8 5 0 0 EXECUTE (Beep)	88.500 MHz
Righthand 000 can be omitted.	2,000 kHz	DIRECT 0 2 0 0 EXECUTE (Beep)	2000 MHz
	20,000 kHz	DIRECT 0 2 0 0 0 EXECUTE (Beep)	20000 MHz
	90 MHz	DIRECT 0 9 0 0 0 EXECUTE (Beep)	90000 MHz
	108 MHz	DIRECT 0 1 0 8 0 0 EXECUTE (Beep)	108000 MHz

When you input a wrong frequency	Press <b>DIRECT</b> and input the correct frequency.
When a hook sounds	<b>(TRY AGAIN)</b> will disappear after about 5 seconds and the previous station will return.
When <b>(TRY AGAIN)</b> indication blinks	A frequency beyond the receivable frequency coverage has been input.*

\* For the receivable frequency coverage of each model, see page 3.

**Notes**

- After pressing a button, press the next button within 5 seconds. If you do not, the previous station will return.

• With direct tuning, the frequency is displayed in steps of the following intervals.

Frequency coverage	Interval
150 - 528 kHz	3 kHz
531 - 1,802 kHz	9 kHz*
1,805 - 45,985 MHz	5 kHz
50 - 75.985 MHz	5 kHz**
76 - 108 MHz	50 kHz

If you input a frequency between intervals, the frequency at the interval just below will be tuned in and displayed. For example, if you input 92.540 MHz, 92.500 MHz will be tuned in and displayed.

\* The MW tuning interval can be changed to 10 kHz. See page 3.  
 \*\* When the detection mode is FM, the interval of this range will be 50 kHz.

## MEMORY TUNING

Up to 40 stations can be stored on 1 to 4 memory pages (10 stations on each page) and tuned in by pressing a button. The frequency and the detection mode of each station can be stored.

### TO STORE A STATION

- 1 Tune in the desired station by direct, manual, scan or limited scan tuning. If necessary, select the appropriate detection mode. (See page 12.)
- 2 Select the memory page on which the station is to be stored with PAGE.

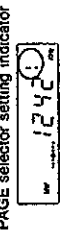

- 3 Keeping ENTER pressed, press one of the number buttons.



Button on which the station is stored

Memory page

Repeat steps 2 and 3 for each number button and for each memory page.

### MEMORY TUNING

- 1 Depress POWER.
- 2 Set SQL to MIN.
- 3 Set PAGE to the memory page on which the desired station is stored.
- 4 Press the number button.

### MEMORY SEARCH—To display the data of stored stations successively

You can check the stations stored on one memory page while you are listening to your desired program.

- 1 Select the memory page with PAGE.
- 2 Keeping FUNCTION pressed, repeatedly press MEMORY SCAN momentarily or press it for more than 0.5 second and release.

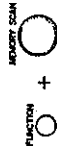

The data of the stored stations will be displayed in the sequence

①→②→...→⑥→①→...

- 3 Release FUNCTION to return the display to the station being received.

### MEMORY PROTECTION—To prevent accidental erasing of the memory

Using this function, new stations cannot be committed to memory on one memory page.

To activate the memory protection function

- 1 Select the memory page with PAGE.
- 2 Keeping ENTER pressed, press KEY/MEMORY PROTECT.



Memory protection indicator

When the memory protection indicator is displayed, a new station cannot be committed to memory on that page. When ENTER and a number button are pressed, a honk sounds.

To deactivate the memory protection function, select the memory page and press ENTER + KEY/MEMORY PROTECT so that the indicator disappears.

**Note**  
The memory protection function remains activated after the power is once turned off.

**MANUAL TUNING**

Use manual tuning when you do not know the frequency of the station you want to tune in, or when you want to tune in a station more precisely after scan tuning or limited scan tuning.

- 1 Depress POWER.
- 2 Set SQL to MIN.
- 3 Keep SCAN + or - pressed until the desired station is received.
- 4 Repeatedly press SCAN + or - momentarily to tune in the station precisely.
- 5 Adjust VOLUME.

For higher frequencies  
+  
For lower frequencies  
-

During manual tuning, the frequency is increased or decreased by the intervals shown in direct tuning (page 6). A beep will sound when the interval is changed with SCAN +/- kept depressed.

While SCAN +/- is kept depressed, the frequency changes continuously even if a station is tuned in.

**KEY PROTECTION**—To avoid accidental operation of the buttons

With the key protection function engaged, the buttons on the front panel will not operate even if they are pressed inadvertently. This is convenient when you carry the set.

To activate the key protection function  
Press KEY/MEMORY PROTECT.

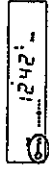

To deactivate the key protection function  
Press KEY/MEMORY PROTECT so that Indicator disappears.



**Note**  
The key protection function will be deactivated when the PAGE selector is turned or the power is disconnected.



## SCAN TUNING

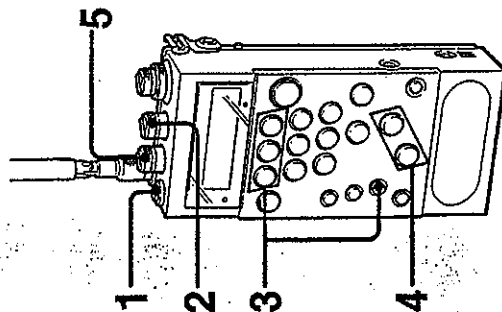

The stations in the entire receivable frequency coverage can be scanned. Scanning stops automatically when a station is received.



- 1 Depress POWER.
- 2 Depress SQL (= AUTO).
- 3 Select the scan mode. (See page 9.)  

- 4 Press SCAN + or - for at least 0.5 second to start scanning.  
 For higher frequencies The frequency changes.  

  
 For lower frequencies  
 When a station is received, the RECEIVE indicator lights. The unit will then operate according to the selected scan mode. (See page 9.)  
 5 Adjust VOLUME.  
 To stop scanning, press SCAN + or - momentarily.



## TO SELECT THE SCAN MODE

There are three scan modes for scan, limited scan, memory scan and program memory scan tuning which differ in the operation of the unit after the first station is located. Select the desired scan mode.

Scan mode	When the first station is located	How to set	Scan mode indicator
SCAN 1	Scanning stops and the first station is received continuously.	FUNCTION ○ + ①	•••••
SCAN 2	The station is received for 2 seconds and scanning is resumed.	FUNCTION ○ + ②	•••••  (during reception)
SCAN 3	The station is received until the station signal stops and then scanning is resumed.	FUNCTION ○ + ③	•••••  (during reception)

## HOW TO USE THE SQUELCH CONTROL

The SQL control adjusts the level of the signal (and noise) so that the signal (and noise) below the adjusted level is suppressed. A station with a lower level signal will not be heard when selected by direct or memory tuning, or scanning will not stop at such a station.

	Adjustment and function of the SQL control	When to use
	Signal below the factory-preset level will be suppressed.	Normally set to this position.
	Turn towards MIN to receive even weaker signal.	<ul style="list-style-type: none"> <li>• When scanning does not stop</li> <li>• When a station is not received by direct or memory tuning</li> </ul>
	Turn towards MAX to receive stronger signals only.	<ul style="list-style-type: none"> <li>• When scanning does not begin</li> <li>• To suppress noise during the interval between broadcasts</li> </ul>

**Note**  
 Turn SQL little by little by observing the RECEIVE indicator. Be careful not to turn it too much.

**Note**  
 During scan tuning, the frequency is increased or decreased by the intervals shown in direct tuning (page 6). A beep will sound when the interval is changed with SCAN +/- kept depressed.

If scanning stops a little before or after a station Tune in the frequency precisely by manual tuning.

If scanning will not start or will not stop at all Adjust SQL. See page 9.

If an unintended frequency range is scanned if the 1 (limited scan) indicator is displayed, limited scan tuning is activated (page 10). Press FUNCTION + so that the limited scan indicator disappears.

**MEMORY SCAN TUNING**

The stations stored on one of the four memory pages can be scanned in the sequence ①→②→③→④→⑤ repeatedly.

- 1 Depress POWER.
- 2 Depress SQL ( $\approx$  AUTO).
- 3 Select the scan mode. See page 9. Keeping FUNCTION pressed, press 1 (2 or 3).
- 4 Select the desired memory page with the PAGE selector.
- 5 Repeatedly press MEMORY SCAN momentarily, or press it for at least 0.5 second and release it.
- 6 Adjust VOLUME.

The stored stations will be scanned continuously in the sequence 1 to 0.

When a station is received, the RECEIVE indicator lights. The unit will then operate according to the selected scan mode. (See page 9.)

To stop scanning, press MEMORY SCAN momentarily.

If scanning is carried out in an unintended sequence if the PROGRAMM Indicator is displayed, program memory scan tuning is activated (page 11). Press PROGRAM so that the PROGRAM Indicator disappears.

If scanning will not start or will not stop at all Adjust SQL. See page 9.

**LIMITED SCAN TUNING**

The stations in the desired frequency range can be scanned by defining the upper limit and lower limit frequencies of the scanning.

- 1 Depress POWER.
- 2 Depress SQL ( $\approx$  AUTO).
- 3 Select the scan mode. See page 9. Keeping FUNCTION pressed, press 1 (2 or 3).
- 4 Store the lower and upper limit frequencies. e.g. To scan between 531-1,602 kHz  
 ① Tune in the lower limit frequency (531 kHz) with direct tuning.  
 ② Keeping ENTER pressed, press DIRECT.  
 Displayed while ENTER and DIRECT are pressed.  
 The lower limit frequency is now stored.  
 ③ Tune in the upper limit frequency (1,602 kHz), and keeping ENTER pressed, press EXECUTE.  
 The upper limit frequency is now stored.
- 5 Set to limited scan mode.
- 6 Press SCAN + or - for at least 0.5 second to start scanning.  
 When a station is received, the RECEIVE indicator lights. The unit will then operate according to the selected scan mode. (See page 9.)
- 7 Adjust VOLUME.

To stop scanning, press SCAN + or - momentarily.

To disengage the limited scan mode, keep FUNCTION pressed and press ① so that the limited scan indicator disappears.

**Notes**

- The upper limit frequency can be stored on DIRECT, and the lower limit frequency on EXECUTE, or vice versa.
- The limited scan mode and the memory of the lower and upper limit frequencies remain even if the power is once turned off.

To check the stored lower and upper limit frequencies Keeping FUNCTION pressed, press DIRECT or EXECUTE. While the buttons are pressed, the lower or upper limit frequency is displayed in the window.

## PROGRAM MEMORY SCAN TUNING

Only required stations among the stored 40 stations can be scanned in the required sequence repeatedly.

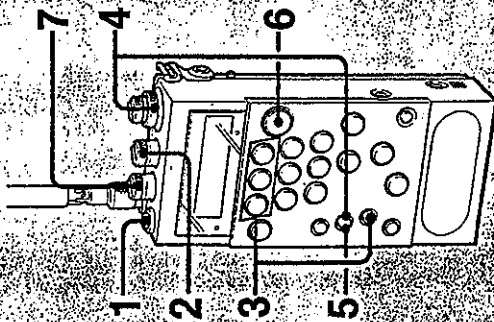

- 1 Depress POWER.
- 2 Depress SQL (≡ AUTO).
- 3 Select the scan mode. See page 9.
- 3 Keeping FUNCTION pressed, press 1 (2 or 3).
- 4 Program the sequence of scanning. (See page 11.)

5 If the PROGRAM indicator is not displayed, press PROGRAM to set to program memory scan mode.

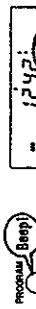

6 Repeatedly press MEMORY SCAN momentarily, or press it for at least 0.5 second and release it.

The stations will be scanned continuously in the programmed sequence.

When a station is received, the RECEIVE indicator lights. The unit will then operate according to the selected scan mode. (See page 9.)



- 7 Adjust VOLUME.
- To stop scanning, press MEMORY SCAN momentarily.

To disengage program memory scan mode, press PROGRAM so that the PROGRAM indicator disappears.

## PROGRAM MEMORY SEARCH—To display the data of the programmed stations successively

You can check the programmed stations while you are listening to your desired station.

- 1 Press PROGRAM to display the PROGRAM Indicator.
- 2 Keeping FUNCTION pressed, repeatedly press MEMORY SCAN momentarily or press it for more than 0.5 second and release.

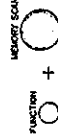

The data of the stations will be displayed successively in the programmed sequence.

- 3 Release FUNCTION to return the display to the station being received.

## TO PROGRAM STATIONS

- 1 Store stations on the number buttons. See page 7.

2 Keeping PROGRAM pressed, press the number buttons in the desired sequence. To program stations on two or more memory pages, switch the PAGE selector as required.

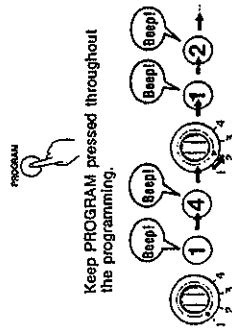

Keep PROGRAM pressed throughout the programming.

The memory station indicators and memory page indicator appear to indicate the programmed buttons.

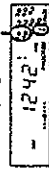

Up to 40 stations can be programmed in the sequence you press the number buttons.

- 3 Release PROGRAM.

If scanning will not start or will not stop at all Adjust SQL. See page 9.

The factory-preset program

and pages 1 to 4.

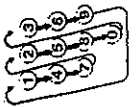

Notes

- The same number button can be programmed twice or more. Each pressing is counted as one station. However, do not press the same number button twice in succession, as programming fails.
- Program memory scan mode and the memory of the programmed sequence remain even if the power is turned off.

**TO SELECT THE DETECTION MODE**

Several detection modes depending on the model type can be selected for each frequency range indicated by I to IV in the following tables.

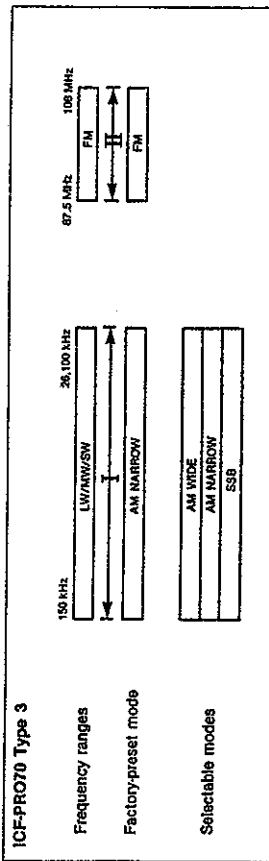
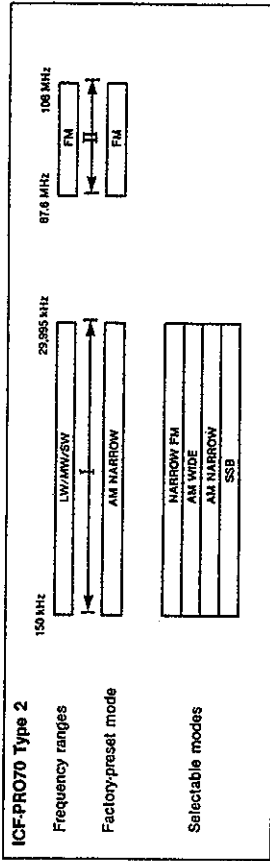
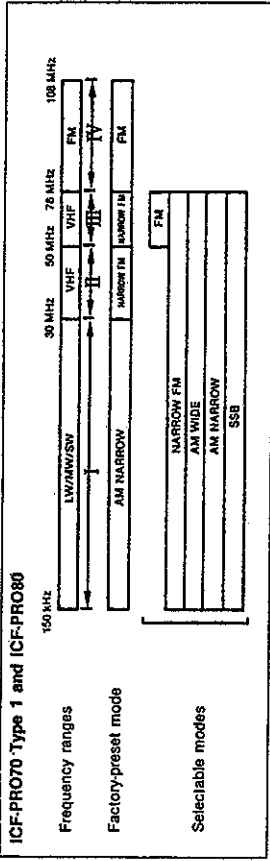

**PRIORITY TUNING**

If a certain station stored as the priority station, the unit automatically tunes to the station every 3 seconds to check whether there is a signal or not. If there is a signal, the priority station is tuned in continuously.

- 1 Depress POWER.
- 2 Depress SQL (= AUTO).
- 3 Select the memory page on which the station you want to designate as the priority station is stored with the PAGE selector.
- 4 Keeping PRIORITY pressed, press the number button to which the desired station is stored.

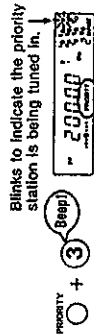

The priority station is tuned in every 3 seconds. If there is a signal, the station will be received continuously. If there is no signal, the previous station will return.

To disengage the priority tuning mode, press PRIORITY so that the PRIORITY indicator disappears. Press PRIORITY again to resume the priority tuning.

**Notes**

- A beep will sound when the priority station is tuned in.
- Priority tuning mode and the memory of the priority station remains even if the power is turned off.

**ICF-PRO70 Type 4**

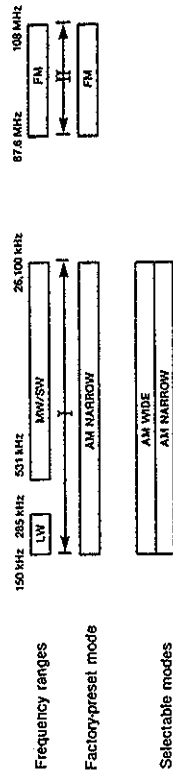

**If the detection mode is incorrect**

- VHF communications cannot be received with AM WIDE, AM NARROW or SSB mode. If they are received with FM mode, the sound volume becomes very low.
- SSB communications can be received with SSB mode only.

**Notes**

- The stations stored on the number buttons can be tuned in with their own detection mode stored.
- When a stored station is tuned in, the detection mode of the corresponding frequency range is automatically set to the stored mode. If necessary, reset the detection mode after listening to that particular station.

**TO SELECT THE DETECTION MODE**

To select the detection mode

- 1 Tune in a frequency within the frequency range for which the detection mode is to be changed.
- 2 Keeping FUNCTION pressed, press number button 4, 5, 7, 8 or 9.

Detection mode indicator

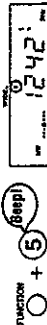

Buttons to be pressed	Detection mode	When to use
FUNCTION + 4	FM	To receive FM broadcasts, and TV (VHF) sound
FUNCTION + 5	AM WIDE	To receive AM (LW, MW and SW) broadcasts, normally set to this mode for dynamic sound.
FUNCTION + 7	NARROW FM	To receive VHF communications, etc. (not provided with the ICF-PRO70 Type 3 and 4)
FUNCTION + 8	AM NARROW	When AM (LW, MW and SW) reception is interrupted or noisy, this mode may improve the reception.
FUNCTION + 9	SSB	To receive SSB communications (not provided with the ICF-PRO70 Type 4)

Other stations in the same frequency range will also be tuned in with direct, scan or limited scan tuning, with the selected detection mode.

**FINE TUNING**

**AM (LW/MW/SW) FINE TUNING**

Fine tune an AM station in the AM WIDE or AM NARROW detection mode.

- 1 Tune in the desired station.
- 2 Keeping FUNCTION pressed, press 6.

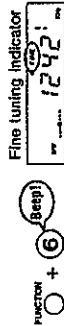

- 3 Turn FINE/SSB for the best possible reception. Fine tuning range is approximately  $\pm 3.5$  kHz.

To disengage fine tuning mode, keep FUNCTION pressed and press 6 so that the FINE indicator disappears.

**SSB FINE TUNING**

In SSB mode, fine tuning is necessary for each station received.

- 1 Select the SSB detection mode and tune in the desired station.
- 2 Turn FINE/SSB for the best possible reception. Fine tuning range is approximately  $\pm 3.5$  kHz.

**Notes**

- The FINE indicator appears only when FUNCTION + 6 are pressed in AM WIDE or AM NARROW mode.
- The FINE/SSB control functions only when the FINE or SSB indicator is displayed.

**TO CONVERT THE FREQUENCY COVERAGE (ICF-PRO80 only)**

The supplied FRQ-80 frequency converter shifts the frequency coverage of the receiver by 115 MHz, i.e. to 115.15-223 MHz, to allow reception of air band, PSB (Public Service Band) and TV VHF channels, etc.

**INSTALLATION OF THE FREQUENCY CONVERTER**

- 1 Insert the two optional size AA (R6) batteries into the converter.
- 2 Detach the telescopic antenna from the receiver.
- 3 Attach the telescopic antenna to the frequency converter, and then the converter to the antenna connector.

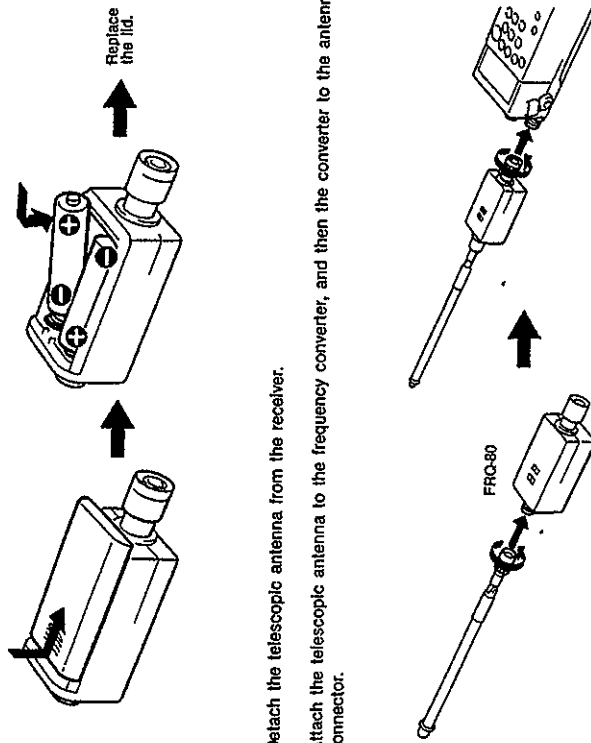

**Battery life**  
Approximately 80 hours of converter operation can be expected with the Sony SUM-3(S) batteries. When the POWER Indicator on the converter becomes dim, replace both batteries.

**Note**  
When the converter is not be used for a long period of time, remove the batteries to avoid damage caused by battery leakage and corrosion.

**TO SHIFT THE FREQUENCY DISPLAY**

- 1 Remove the battery case from the battery compartment of the receiver.
- 2 Set FREQ.DISPLAY inside the battery compartment to SHIFT.
- 3 Replace the battery case.
- 4 Depress POWER. The [S] (shift) indicator and a frequency shifted by 100 MHz will appear in the window. Shift indicator

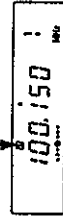

- 5 Keeping PROGRAM pressed, press DIRECT. The [S] indicator will blink.

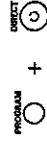

- 6 While the [S] indicator is blinking, input the frequency to be shifted by the converter, 115 MHz, with the number buttons.



- 7 Press EXECUTE.



Now the frequencies 115.150-223.000 MHz can be displayed to match the received station frequencies.

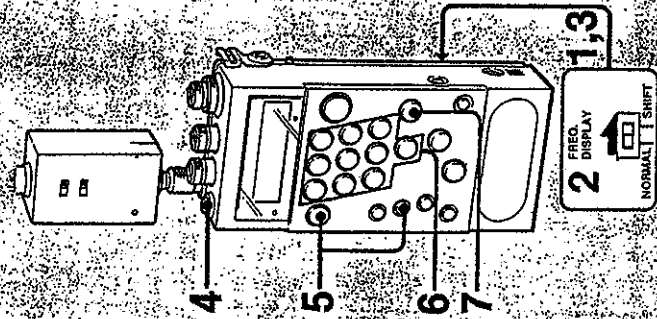

To check the shifted frequency Keeping FUNCTION pressed, press KEY/MEMORY PROTECT. While the buttons are pressed, the shifted frequency is displayed in the window.

TO CONVERT THE FREQUENCY COVERAGE (ICF-PRO30 only)

TUNING

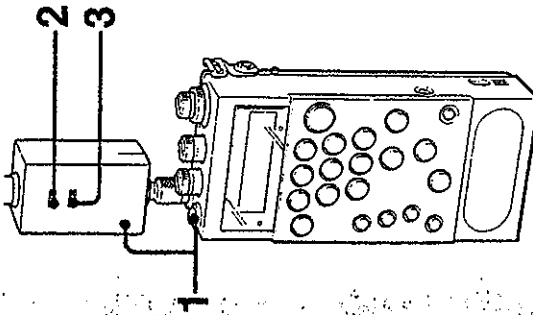

- 1 Depress **POWER** on the receiver. The converter will be turned on automatically and the **POWER** indicator on the converter will light.
- 2 Set the **ATTENUATOR** selector on the converter to 0 dB.
 

ATTENUATOR
0 dB - [     ] - 30 dB
- 3 Set the **FILTER** selector on the converter according to the frequency of the station to be tuned in.
 

FILTER
115.15 - 174 MHz - [     ] - 174 - 223 MHz
- 4 Tune in the desired station with any of the tuning methods on pages 6-12. If necessary, select the appropriate detection mode. See "To select the detection mode" on page 15.

After listening, press to turn off **POWER**.

**Program memory scan tuning**

Do not program the stations in the 115.15-174 MHz range and those in the 174-223 MHz range in a mixed manner. Otherwise, program memory scan tuning may not be carried out correctly because the **FILTER** selector cannot be switched during scanning.

**Direct tuning**

With the converter installed, always input 6 digits of the frequency for direct tuning. Righthand 000 cannot be omitted.

**Memory tuning and memory scan tuning**

Store the stations in the 115.15-174 MHz range and those in the 174-223 MHz range on separate memory pages. If they are stored in a mixed manner on one page, memory scanning may not be carried out correctly because the **FILTER** selector cannot be switched during scanning.

To select the detection mode  
The selectable detection modes in the 115.15-223 MHz range are as follows:

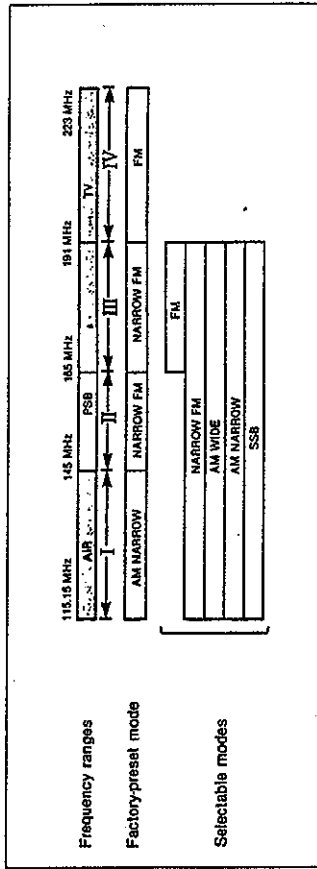

- When tuning in airband, PSB and TV stations, set to the following detection modes.  
 Air band (118-138 MHz) → AM NARROW  
 PSB (146-174 MHz) → NARROW FM  
 TV (174-223 MHz) → FM
  - For other types of broadcasts and radio communications, set to the appropriate detection mode.
- To resume the original frequency coverage of the receiver  
Detach the converter from the antenna connector and replace the telescopic antenna. Set **FREQ. DISPLAY** inside the battery compartment to **NORMAL**.

Tuning intervals in the 115.15-223 MHz range

Frequency coverage	Interval
115.150 - 115.528 MHz	3 kHz
115.531 - 116.802 MHz	9 kHz*
116.805 - 160.995 MHz	5 kHz
165.000 - 190.995 MHz	5 kHz**
191 - 223 MHz	50 kHz

\* The tuning interval can be changed to 10 kHz. See page 3.  
 \*\* When the detection mode is FM, the interval of this range will be 50 kHz.

For improved reception  
If the received sound is distorted or noisy due to interference from an adjacent station, set **ATTENUATOR** on the converter to -30 dB.

## SECTION 2 ELECTRICAL ADJUSTMENT

**Note:** Standard power-supply voltage is 6 VDC unless other wise noted.

Be sure to perform the "VCO1 PD-Voltage Adjustment" and "VCO2 PD-Voltage Adjustment" when the "FM-L Tracking Adjustment" and "FM-H Tracking Adjustment" are performed respectively.

**Before Adjustment: (West Germany model only)**

Solder the lead as shown below and then turn the POWER switch on because there are two power switches in West Germany model. (Refer to page 5 for details.)

After adjustment, unsolder the lead.

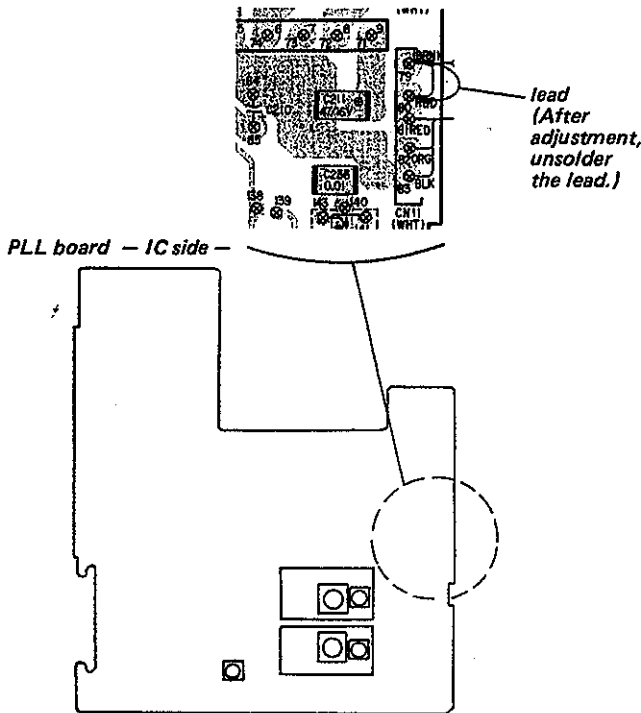

**FM RF SSG Connecting Portion**

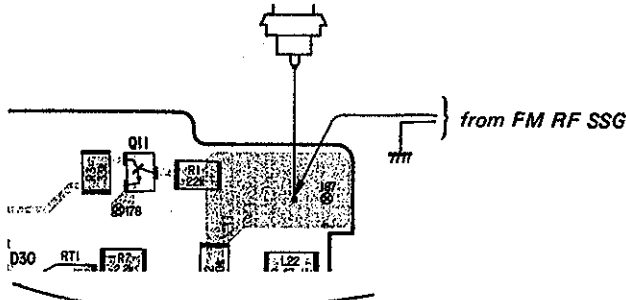

**signal board - IC side -**

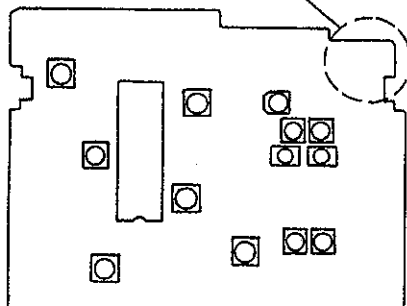

**Reference-Frequency Oscillator (7.2 MHz) Adjustment**

**Procedure:**

1. Connect a frequency counter to the point **A** (output of the VCO).
2. Set the receiving frequency of the receiver to 108 MHz.
3. Adjust CT201 so that the reading on the frequency counter becomes in 118.7 MHz  $\pm$ 100 Hz.

**PLL board - IC side -**

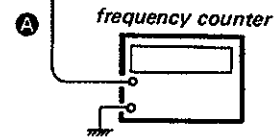
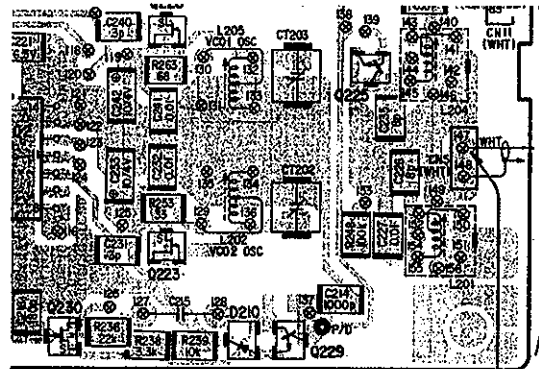

**Adjustment Location:**

**PLL board - IC side -**

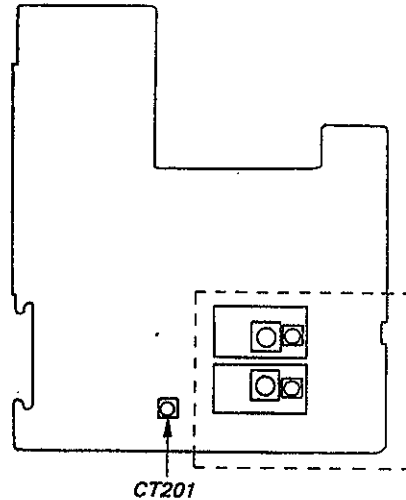



**VCO1 PD-Voltage Adjustment**

**Note:** Be sure to perform the "FM-L Tracking Adjustment" when this adjustment is performed. . . (ICF-PRO70 Type 1 and ICF-PRO80 only)

**Procedure:**

1. Set the receiving frequency of the receiver to 150 kHz.
2. Set CT203 to a slightly meshed position.
3. Adjust L205 so that the reading on the VTVM connected to the point **A** (PD test point) becomes in 1.35 V  $\pm$  0.05 VDC.
4. Change the receiving frequency of the receiver as shown on Table 1 and confirm the reading on the VTVM.

Table 1

	Receiving frequency	Reading on VTVM
ICF-PRO70 Type 1 and ICF-PRO80	75.95 MHz, and set the detection mode to the WIDE FM	14 V $\pm$ 1 VDC
ICF-PRO70 Type 2, Type 3, and Type 4	26.1 MHz	12 V $\pm$ 1 VDC

PLL board - IC side -

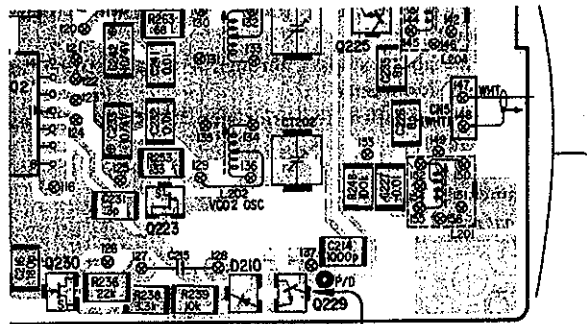

Adjustment Location:  
PLL board - IC side -

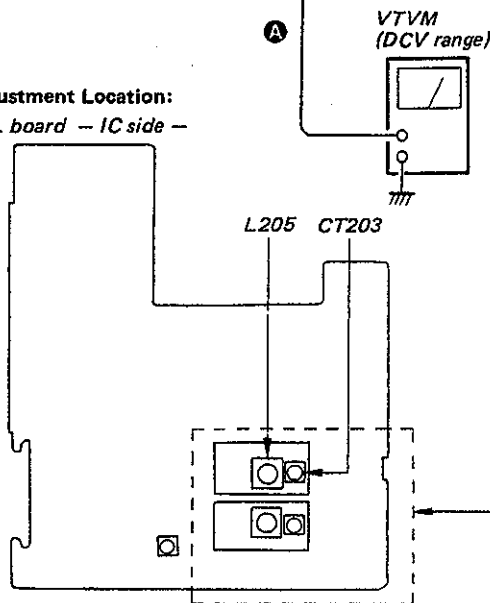

**FM-L Tracking Adjustment (ICF-PRO70 Type 1 and ICF-PRO80 only)**

**Procedure:**

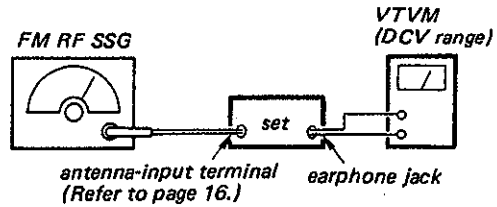

1. Set the frequencies of the SSG and the receiver to 55 MHz.
2. Adjust L3 and T2 to obtain a maximum signal output on the VTVM.
3. Change the frequencies of the SSG and the receiver to 70 MHz.
4. Adjust CT203 and CT2 so that the reading on the VTVM becomes in maximum.
5. Repeat the above steps 1 through 4 several times until no further improvements is obtained.
6. Perform and confirm the prior step "VCO1 PD-Voltage Adjustment".

**Adjustment Location:**

signal board - IC side -

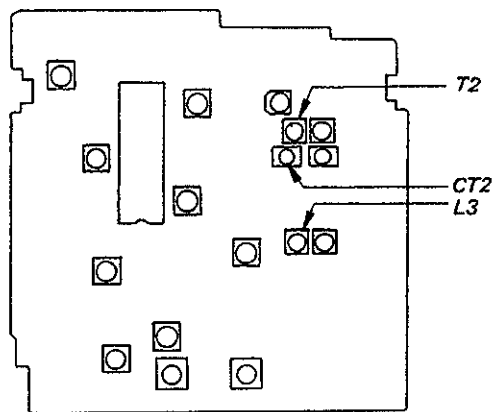

PLL board - IC side -

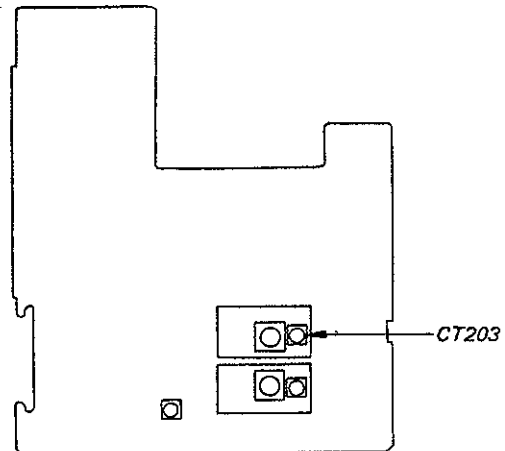

**VCO2 PD-Voltage Adjustment**

**Note:** Be sure to perform the "FM-H Tracking Adjustment" when this adjustment is performed.

**Procedure:**

1. Set the receiving frequency of the receiver as shown on Table 2.

Table 2

	Receiving frequency	Reading on VTVM
ICF-PRO70 Type 1 and ICF-PRO80	30 MHz	1.35 V $\pm$ 0.1VDC
ICF-PRO70 Type 2, Type 3, and Type 4	87.6 MHz	3.6 V $\pm$ 0.3 VDC

2. Set CT202 to its half-meshed or slightly-meshed position.
3. Adjust L202 so that the reading on the VTVM connected to the point A (PD test point) becomes as shown on Table 2.
4. Change the receiving frequency of the receiver as shown on Table 3 and confirm the reading on the VTVM.

Table 3

	Receiving frequency	Reading on VTVM
ICF-PRO70 Type 1 and ICF-PRO80	75.995 MHz, and set the detection mode to the NARROW FM	14 V $\pm$ 1 VDC
ICF-PRO70 Type 2, Type 3, and Type 4	108 MHz	9.5 V $\pm$ 1 VDC

PLL board - IC side -

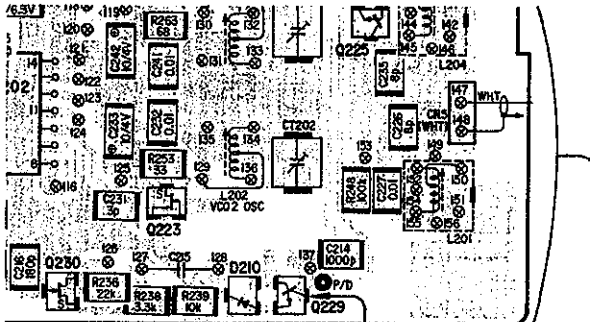

Adjustment Location:  
PLL board - IC side -

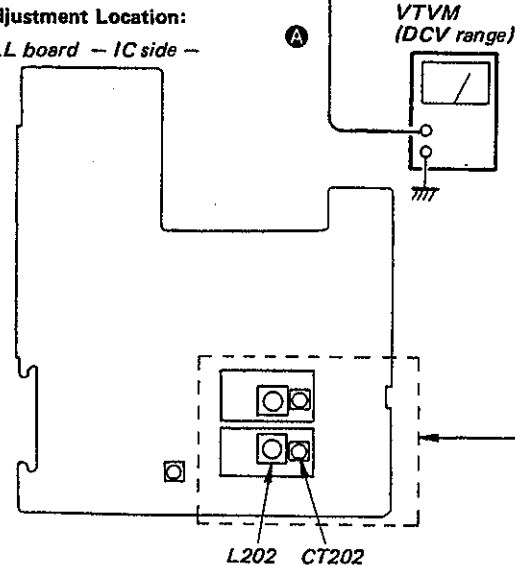

**FM-H Tracking Adjustment**

**Procedure:**

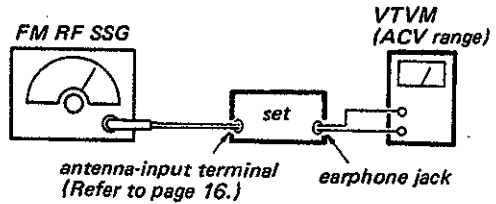

1. Set the receiving frequency of the receiver as shown on Table 4.

Table 4

	Receiving frequency
ICF-PRO70 Type 1 and ICF-PRO80	80 MHz
ICF-PRO70 Type 2, Type 3, and Type 4	87.6 MHz

2. Adjust L2 and T1 to obtain a maximum signal-output on the VTVM.
3. Change the receiving frequency of the receiver to 105 MHz.
4. Adjust CT202 and CT1 to obtain a maximum signal-output level.
5. Repeat the above steps 1 through 4 until no further improvements is obtained.
6. Perform and confirm the prior step "VCO2 PD-Voltage Adjustment".

**Adjustment Location:**

signal board - IC side -

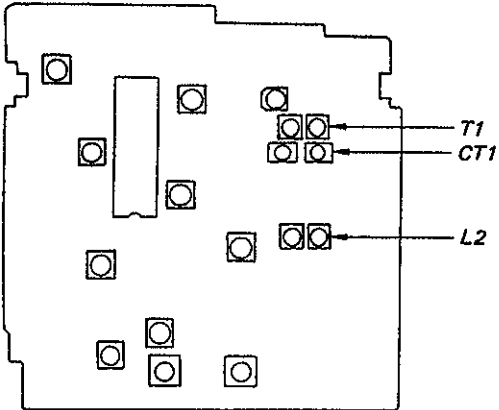

PLL board - IC side -

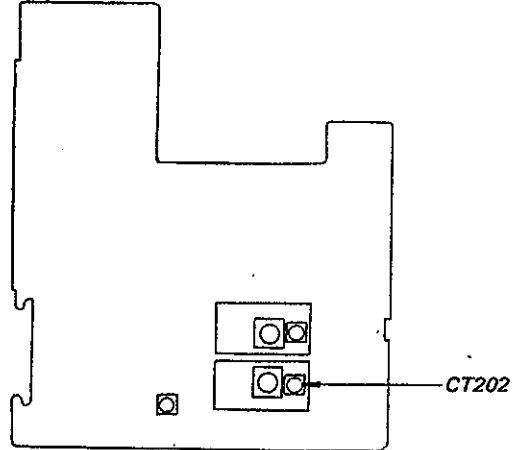

Note:

- All capacitors are in  $\mu\text{F}$  unless otherwise noted.  $\text{pF}$ :  $\mu\text{F}$  and tantalums.
- All resistors are in  $\Omega$  and  $\frac{1}{2}\text{W}$  or less unless otherwise specified.
- Signal path:
  - $\uparrow$  : FM signal path.
  - $\uparrow$  : MW signal path.
  - $\uparrow$  : SW, VHF signal path.
- $\Delta$  : internal component.
- $\text{---}$  : B+ bus.
- Voltages are dc with respect to ground unless otherwise noted.
- Readings are taken under detuned conditions with a VOM (50  $\text{k}\Omega/\text{V}$ ).
- no mark: FM { } : BC N: NARROW FM  
 { } : VHF < > : MW N: AM NARROW  
 { } : SW << >> : LW W: AM WIDE
- Voltage variations may be noted due to normal production tolerances.
- Power voltage : 6 V and fed with regulated dc power supply from battery terminal.
- Waveforms are taken to ground in no-signal mode by using oscilloscope.
- Voltage variations may be noted due to normal production tolerances.

Switch

Ref. No.	Switch	Position
S101	SOL	MANUAL
S102	POWER (West Germany model only)	OFF
S201	TO NE	HIGH
S202	PAGE	1
S203	POWER	OFF
S301	LIGHT	ON
S302	MW CH STEP	9 kHz
S303	FREQ DISPLAY	NORMAL
S304	RESET	OFF
S701	ATTENUATOR	-30 dB
S702	FILTER	115.15-174 MHz
S801	DIRECT L1	OFF
S802	1, SCAN 1	OFF
S803	2, SCAN 2	OFF
S804	3, SCAN 3	OFF
S805	4, FM	OFF
S806	5, AM WIDE	OFF
S807	6, FINE ON/OFF	OFF
S808	7, NARROW FM	OFF
S809	8, AM NARROW	OFF
S810	9, SSB	OFF
S811	MEMORY SCAN, SEARCH START/STOP	OFF
S812	PRIORITY	OFF
S813	PROGRAM	OFF
S814	0, LIMIT ON/OFF	OFF
S815	EXECUTE L2	OFF
S816	FUNCTION	OFF
S817	ENTER	OFF
S818	SCAN/LIMIT START, -	OFF
S819	SCAN/LIMIT START, +	OFF
S820	KEY/MEMORY PROTECT	OFF

8 9 10 11 12 13 14 15 16 17 18 19

COMPUTER BOARD] (IC SIDE)

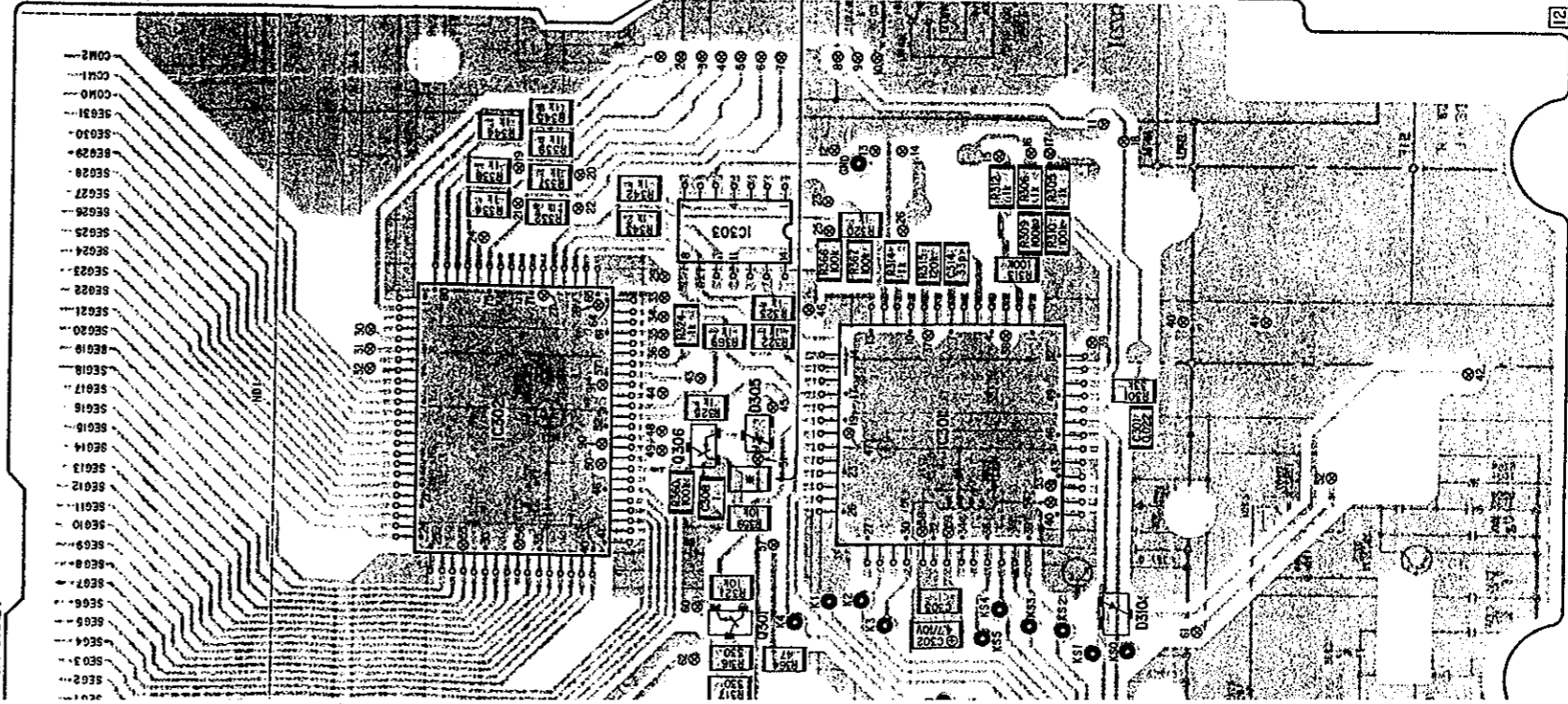

[MICRO COMPUTER BOARD] (SWITCH SIDE)

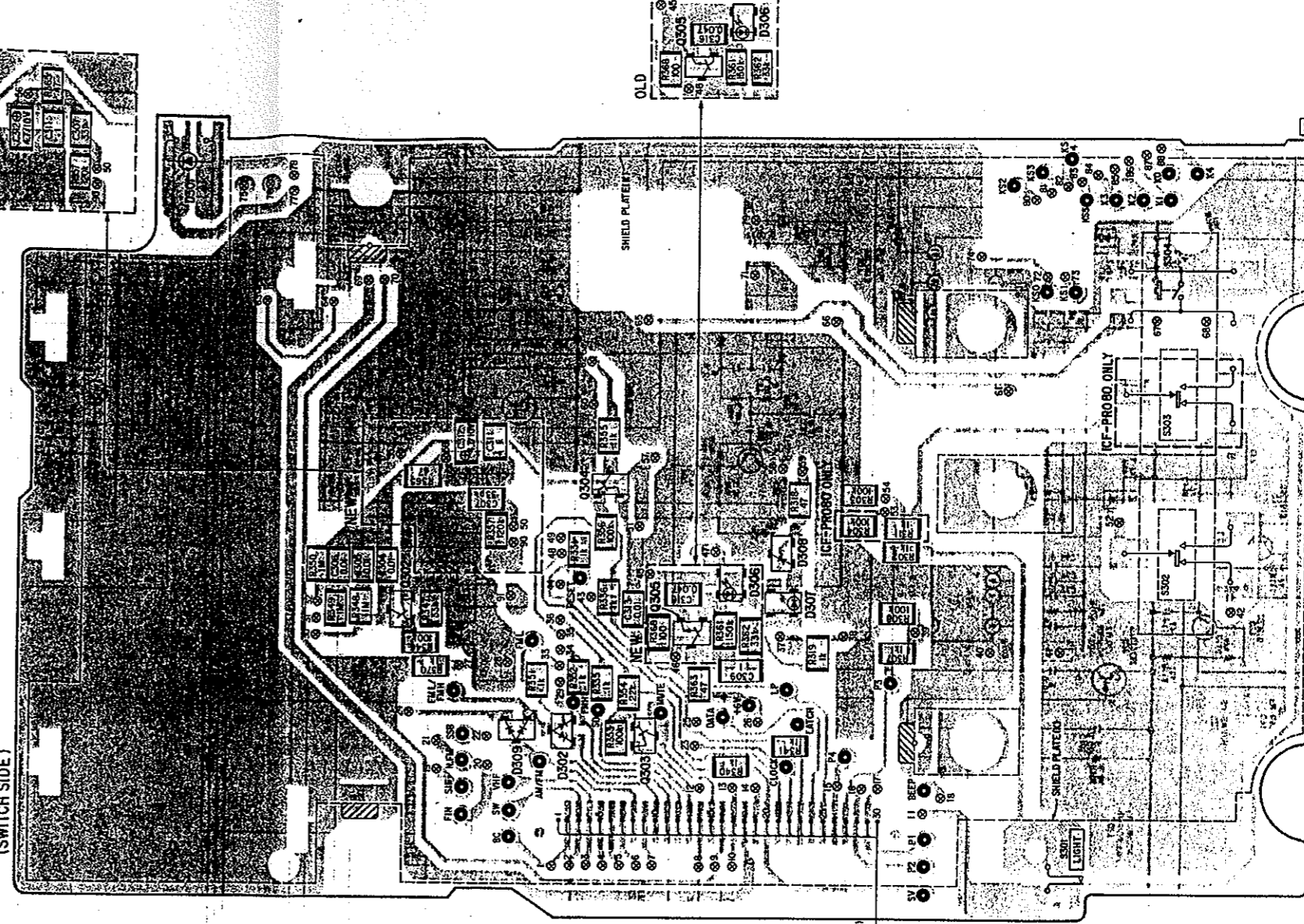

S302 MW CH STEP  
S818  
S303 FREQ DISPLAY  
S304 RESET  
S819  
S820  
NORMAL - SHIFT  
TCF-PROBO ONLY

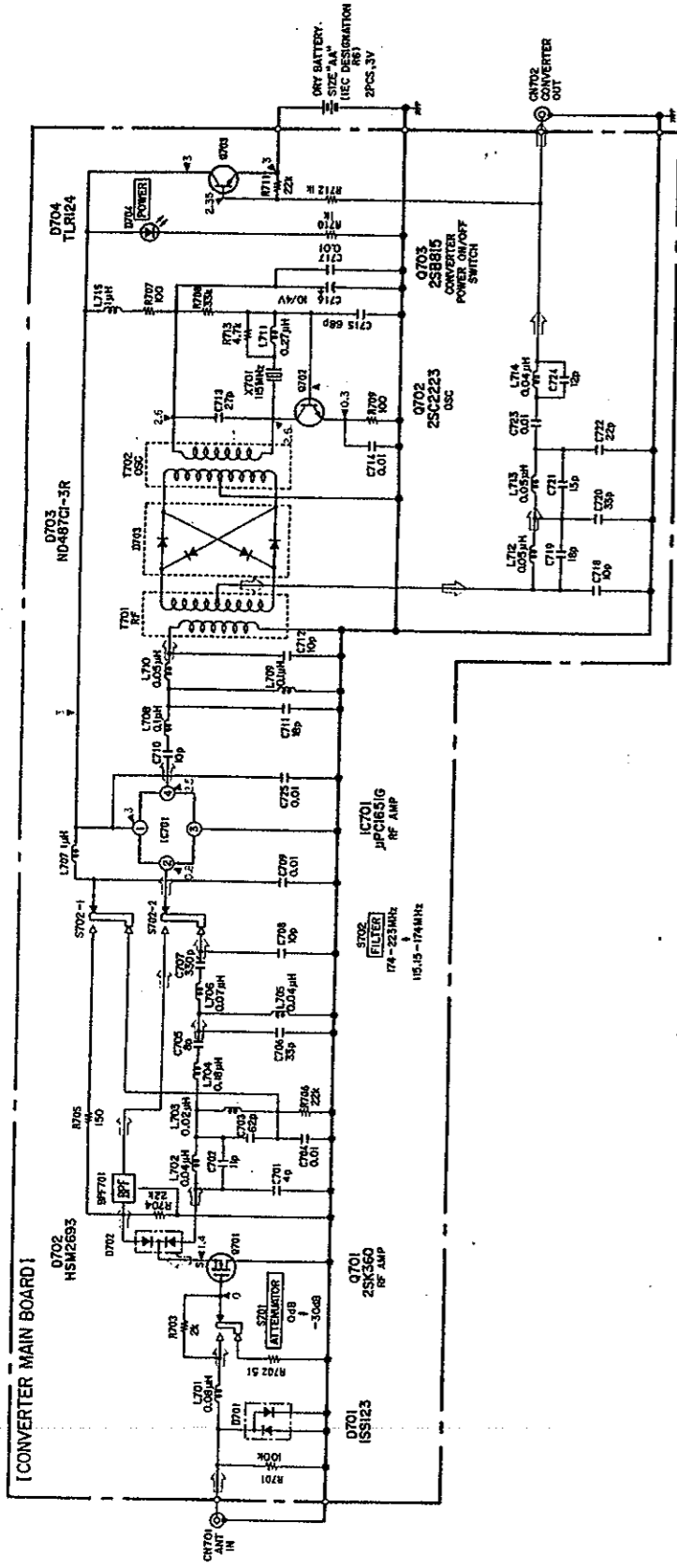

3-4. CONTROL SECTION PRINTED WIRING BOARDS

- See page 22 for Semiconductor Lead Layouts.
- See pages 27 to 29 for Schematic Diagram.

• SEMICONDUCTOR LOCATION

Ref. No.	Location
D301	C-18
D302	E-14
D304	C-6
D305	F-9
D306	G-15
D307	G-15
D308	E-14
D309	H-8
D401	C-3
D402	H-5
D403	I-5
D404	C-2
D405	C-3
D406	C-4
D407	C-2
D408	D-3
IC301	G-9
IC302	D-9
IC303	F-10
Q301	F-8
Q302	D-15
Q303	F-14
Q304	E-16
Q305	F-15
Q306	E-9

Note:  
 \*A - \*C are soldered, or not by receivable frequency coverage of the set as shown below.  
 Refer to "NOTES ON MODEL TYPES AND RECEIVABLE FREQUENCIES" on page 3 for each type of ICF-PRO70.

	*A	*B	*C
TYPE 1	X	X	O
TYPE 2	O	X	O
TYPE 3	X	O	O
TYPE 4	X	O	X
ICF-PRO80	X	X	O

O: soldered X: unsoldered

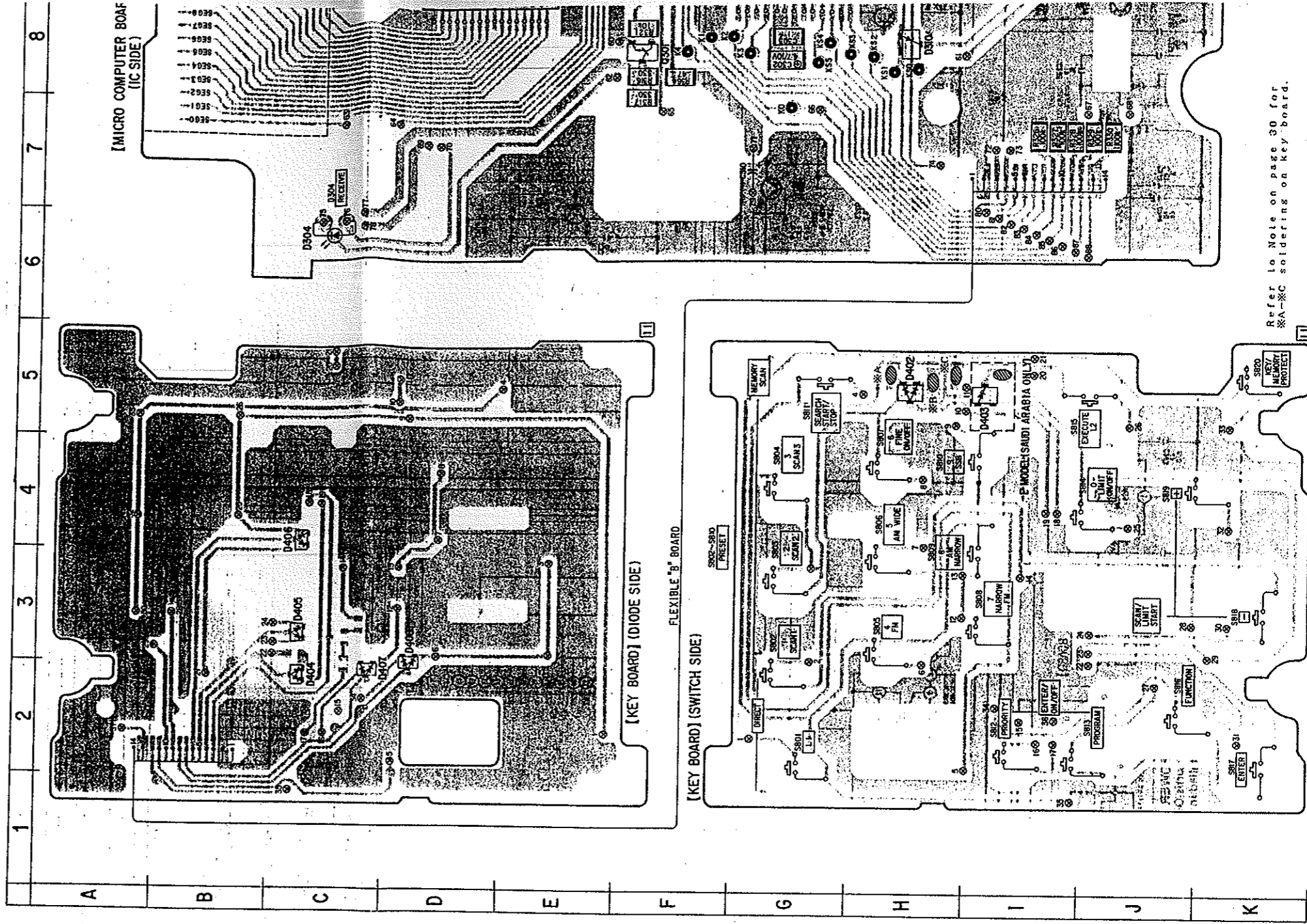

Refer to Note on page 30 for \*A-\*C soldering on key board.

1 2 3 4 5 6 7 8 9 10 11

N-Kanal - MOSFET  
Q1  
ASK 359

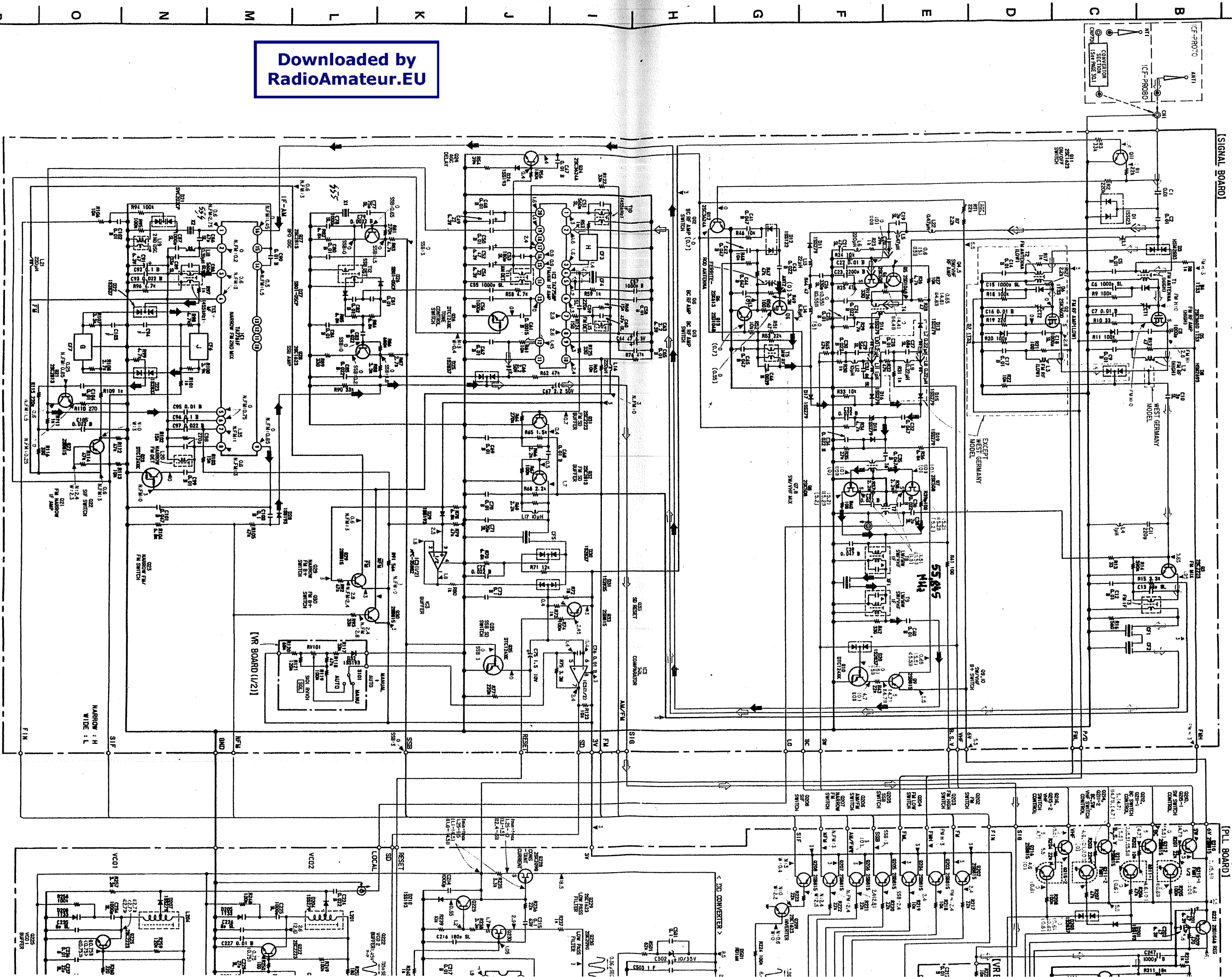

Downloaded by  
RadioAmateur.EU

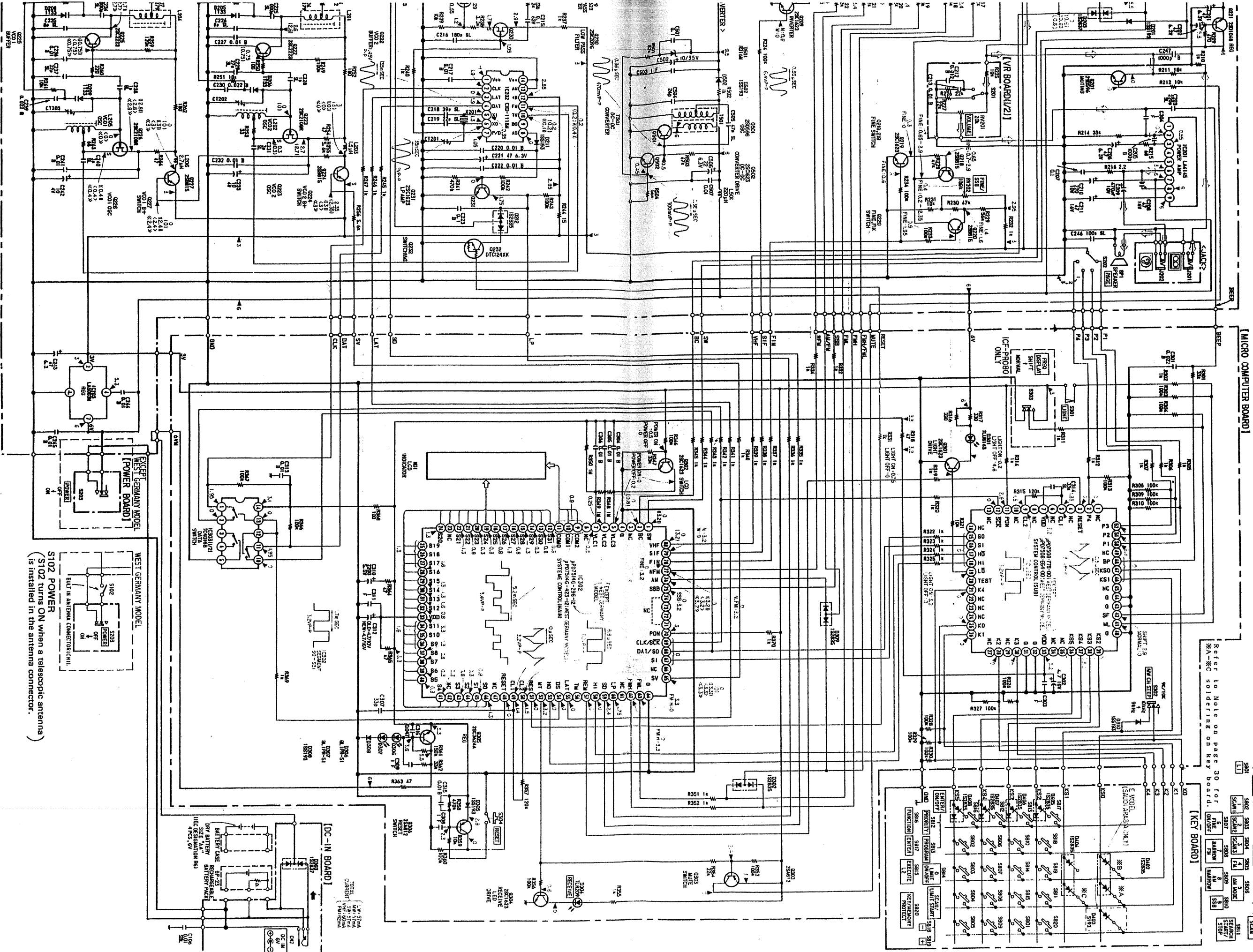

Refer to Note on page 30 for  
 \*K-A\* soldering on key board.

WEST GERMANY MODEL  
 S102 POWER  
 S102 turns ON when a telescopic antenna  
 (is installed in the antenna connector.)

**3-1. SIGNAL, PLL SECTION PRINTED WIRING BOARDS**

- See pages 30 to 32 for Control Section Printed Wiring Boards.
- See page 22 for Semiconductor Lead Layouts.

**Note:**

- Color code or sleeving over the end of the jacket.

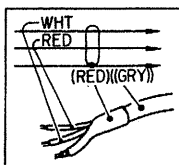

- ○ : parts extracted from the component side.
- ● : parts extracted from the conductor side.
- ■ : part mounted on the conductor side.
- □ : indicates side identified with part number.
- ⊗ : Through hole.

**• SEMICONDUCTOR LOCATION**

Ref. No.	Location	Ref. No.	Location	Ref. No.	Location
D1	E-21	IC1	I-15	Q215	G-13
D3	F-18	IC2	F-16	Q216	G-2
D4	F-21	IC3	E-16	Q218	D-3
D5	G-21	IC201	G-6	Q219	E-4
D6	F-22	IC202	I-4	Q220	E-3
D7	G-22	IC203	F-3	Q221	G-3
D8	H-21	IC701	C-16	Q222	J-9
D11	F-19			Q223	J-5
D12	J-18	Q1	G-19	Q224	I-10
D13	H-19	Q2	G-22	Q225	I-6
D14	H-21	Q3	H-22	Q226	H-5
D15	I-19	Q4	G-21	Q227	I-10
D16	I-21	Q5	G-21	Q228	H-11
D17	I-19	Q6	J-21	Q229	J-6
D18	I-21	Q7	I-22	Q230	J-5
D19	I-22	Q8	I-18	Q231	J-11
D20	J-19	Q9	I-19	Q232	J-3
D21	J-16	Q10	J-19	Q501	G-11
D22	I-17	Q11	E-18	Q502	H-10
D23	I-16	Q12	H-18	Q701	B-25
D24	G-17	Q13	J-22	Q702	B-17
D25	G-14	Q21	H-16	Q703	A-22
D26	F-15	Q22	H-24		
D27	F-25	Q23	H-24		
D28	G-15	Q24	G-17		
D29	E-16	Q26	E-25		
D30	F-18	Q27	E-26		
D31	E-17	Q28	G-14		
D32	B-3	Q29	I-25		
D201	H-2	Q30	H-25		
D203	H-2	Q31	G-23		
D204	J-8	Q32	F-23		
D205	I-9	Q33	E-23		
D206	J-10	Q35	F-22		
D207	I-8	Q201	G-9		
D208	I-9	Q202	F-12		
D209	I-10	Q203	F-12		
D210	J-6	Q204	G-12		
D211	J-11	Q205	G-12		
D212	J-3	Q206	G-12		
D303	B-8	Q207	F-12		
D501	G-11	Q208	F-13		
D502	G-4	Q209	F-13		
D701	C-14	Q210	G-3		
D702	B-24	Q211	G-13		
D703	C-17	Q212	F-2		
D704	D-22	Q214	F-3		

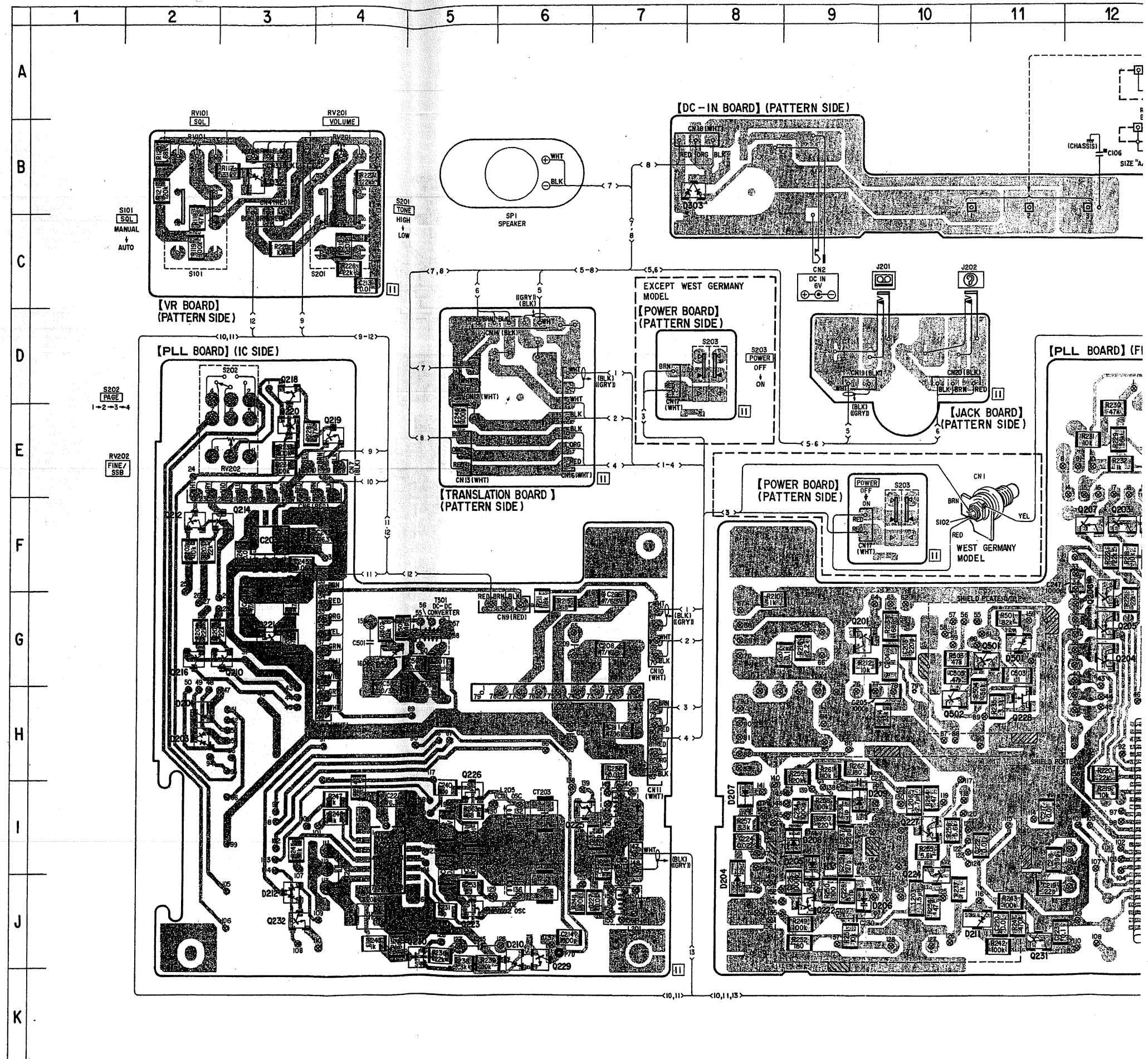

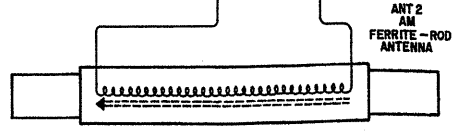
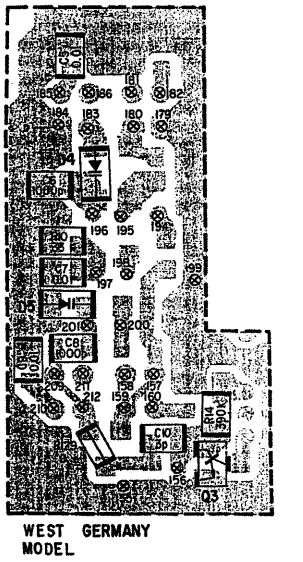
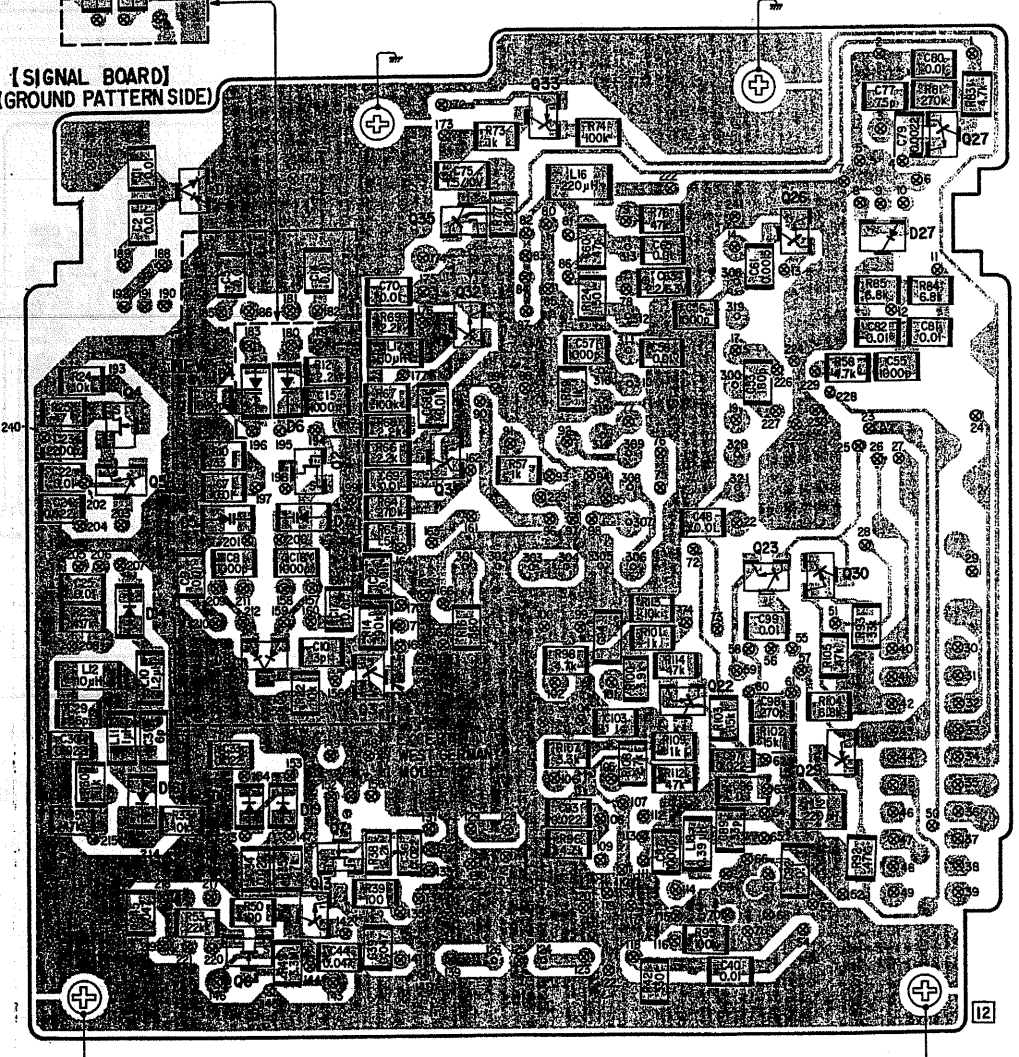
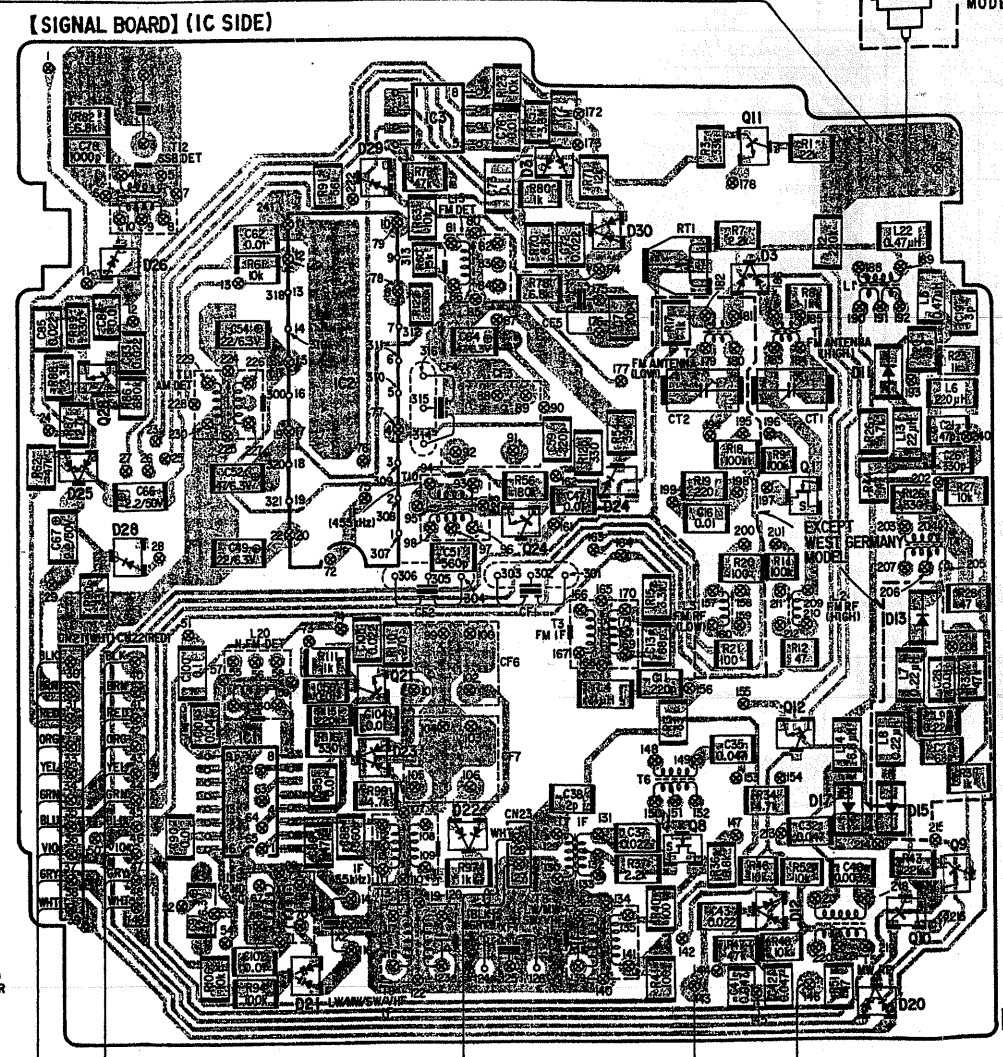
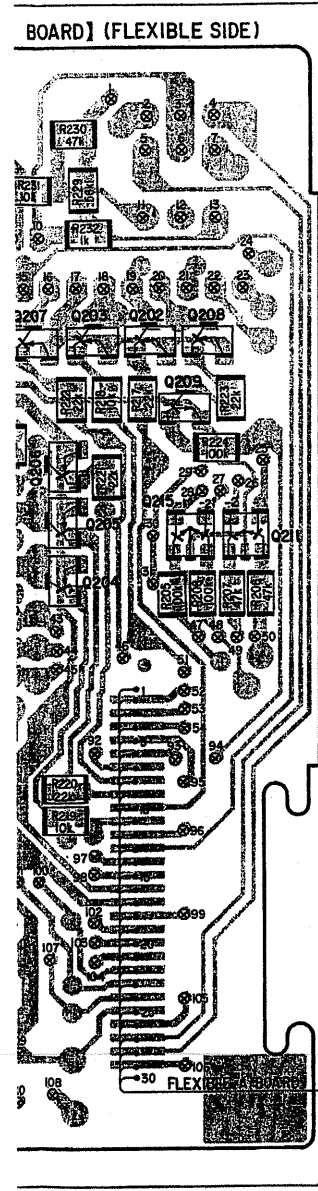
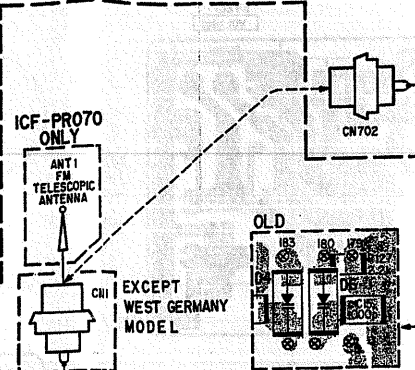
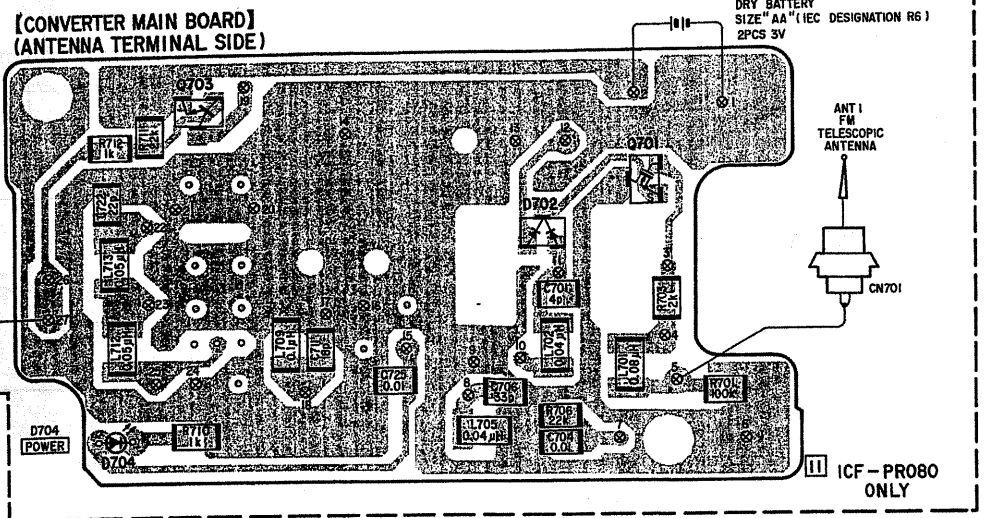
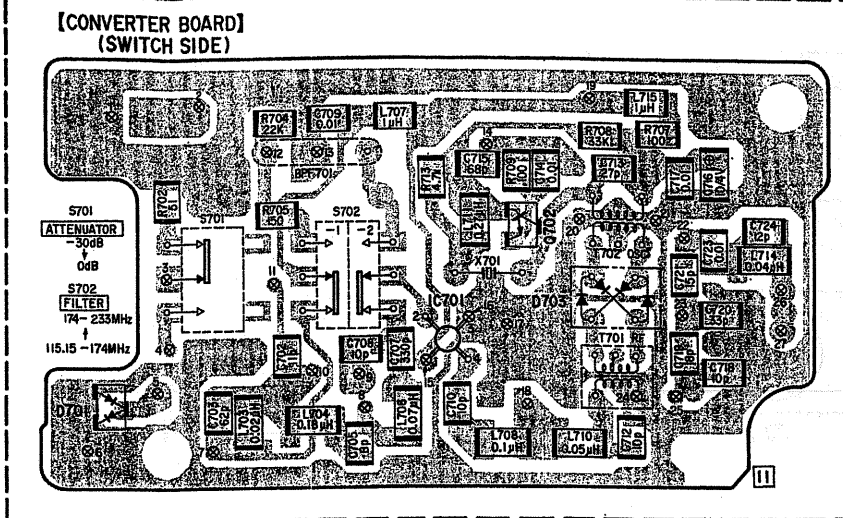
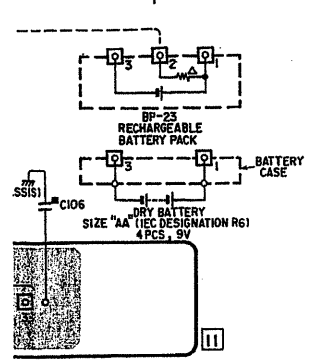



**FM IF Adjustment**

Procedure:

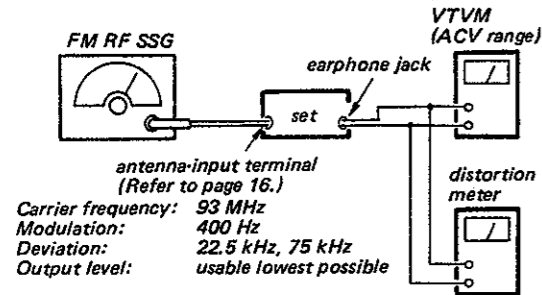

1. Set the frequencies of the SSG and the receiver to 93 MHz.
2. Set the deviation of the SSG to 22.5 kHz.
3. Adjust T3 to obtain a maximum signal-output level on the VTVM.
4. Set the output attenuator of the SSG to 60 dB and the deviation to 75 kHz.
5. Adjust L15 to obtain a minimum distortion of the output signal.

Adjustment Location:

signal board - IC side -

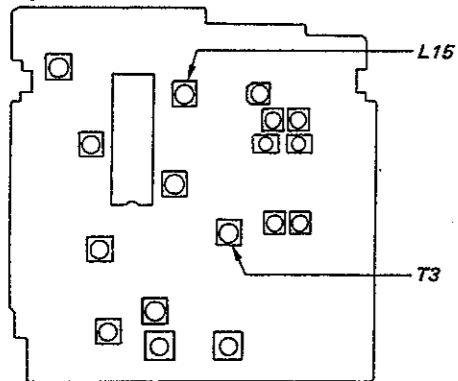

**Second Local Oscillator Adjustment**

Procedure:

1. Set the receiving frequency of the receiver to 11.8 MHz, and the detection mode to the AM NARROW and turn the FINE switch off.
2. Connect a high-input impedance frequency counter to the point ⊕.
3. Adjust L19 so that the reading on the frequency counter becomes in 55.390 MHz  $\pm$ 100 Hz.
4. Turn the FINE switch on and adjust the FINE control to both FINE MIN and FINE MAX ends. The frequency readings at both ends should be  $\pm$ 3.5 to  $\pm$ 4.5 kHz when referred to that obtained in the step 3 above.

signal board - grounding-pattern side -

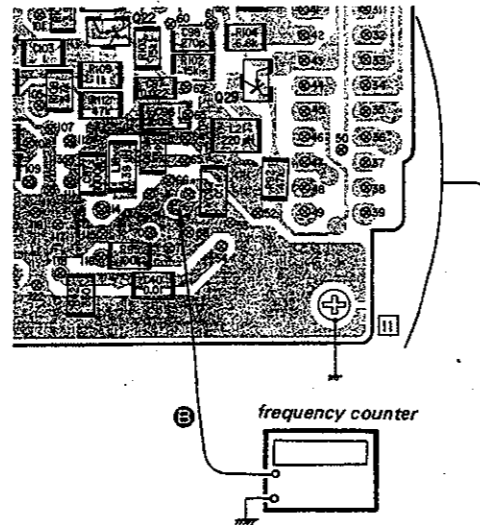

Adjustment Location:

signal board - IC side -

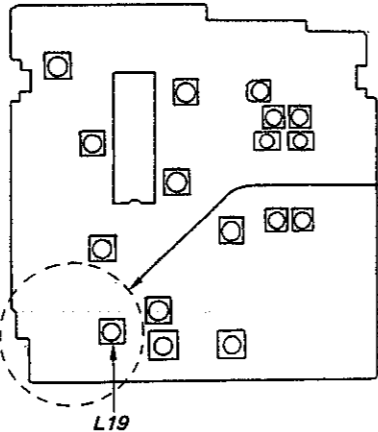

**AM 1st and 2nd IF Adjustment**

Procedure:

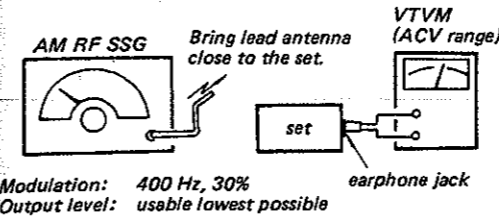

1. AM 1st IF Adjustment:
  - a) Set the frequencies of the SSG and the receiver to 11,800 kHz, and set the detection mode of the receiver to the AM NARROW.
  - b) Adjust T8 and T9 to obtain a maximum output level.
2. AM 2nd IF Adjustment:
  - a) Set the frequencies of the SSG and the receiver to 11,800 kHz, and set the detection mode of the receiver to the AM NARROW.
  - b) Adjust T10 (455 kHz), T11 (AM detector) and T13 (2nd mixer) to obtain a maximum output signal level.

Adjustment Location:

signal board - IC side -

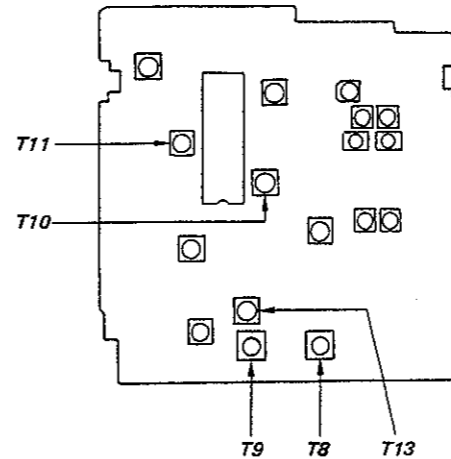

**NARROW-FM Detector Adjustment (Except ICF-PRO70 Type 3 and Type 4)**

Procedure:

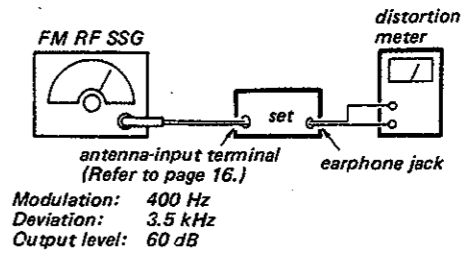

1. Set the frequencies of the SSG and the receiver to 11,800 kHz and the detection mode of the receiver to the FM NARROW.
2. Adjust L20 to obtain a minimum distortion of about 1% of the output signal.

Adjustment Location:

signal board - IC side -

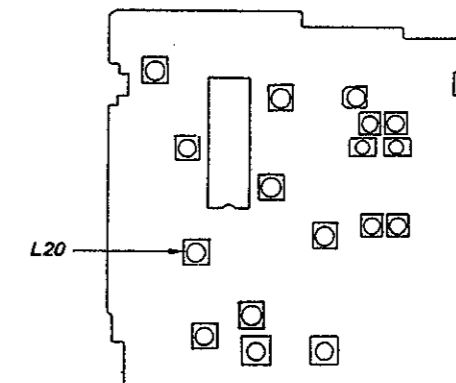

SECTION 3  
DIAGRAMS

AM AGC Adjustment

Procedure:

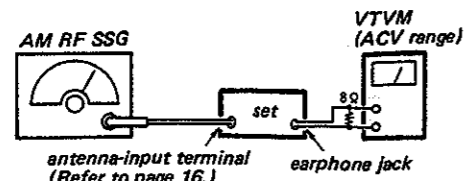

Frequency: 11,800 kHz  
Modulation: no modulation  
Output level: 44 dB

1. Set the frequencies of the SSG and the receiver to 11,800 kHz, and the detection mode of the receiver to the AM NARROW.
2. Adjust the VOLUME control to obtain an output level of approximately 50 mW (0.64 V) across the 8-ohm load.
3. Turn RT1 clockwise in more than one turn and obtain the point where the noise-output level is maximum and the signal-to-noise ratio is approximately 20 dB. This point is the slotted open area of RT1 and the resistance is infinite.
4. Turn RT1 counterclockwise from the point obtained in step 3 above and obtain a point where the noise-output level is minimum, and where the signal-to-noise ratio is approximately some 40 to 50 dB.
5. Further slightly turn RT1 counterclockwise from the minimum-noise point obtained in step 4 above, and set RT1 at the point where the noise level increases in 1 to 2 dB.

Adjustment Location:

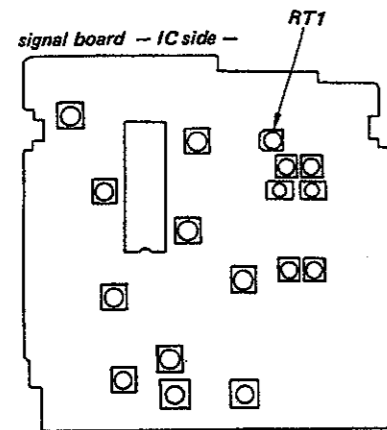

IC BLOCK DIAGRAMS

IC1 TA7761F

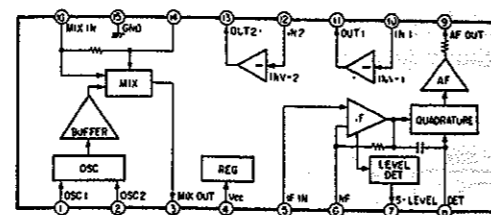

IC2 TA7758P

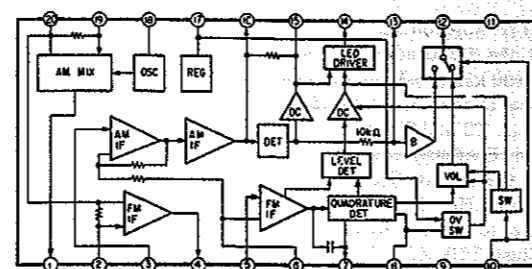

IC3 μPC358G2

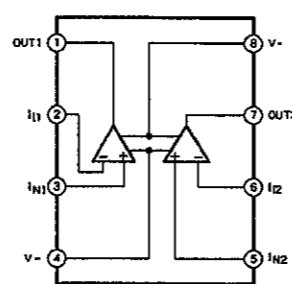

IC201 LA4145

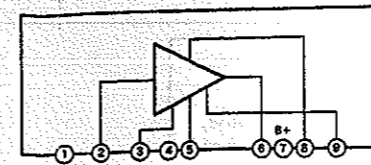

IC202 CXD1118M

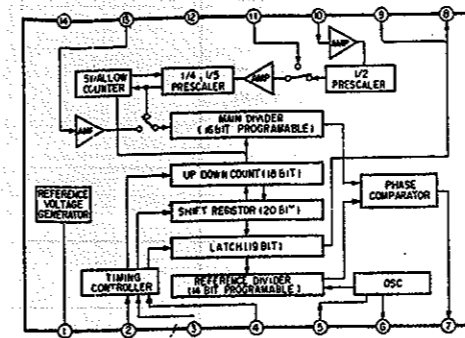

IC203 LA5003M

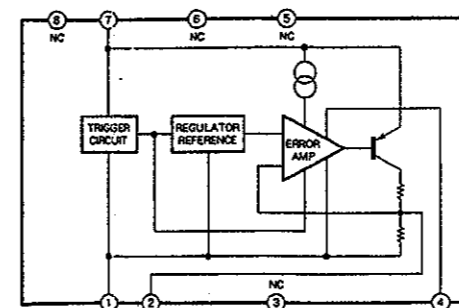

Semiconductor Lead Layouts

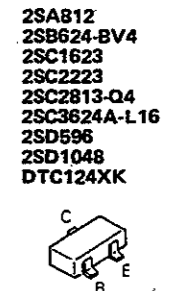
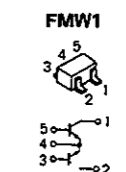
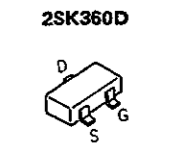
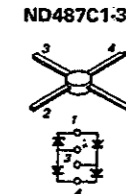
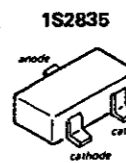
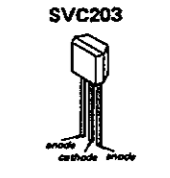
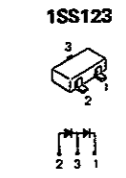
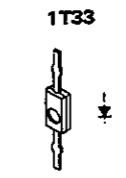
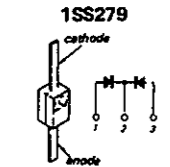
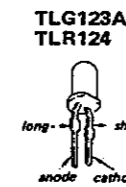
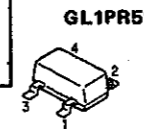
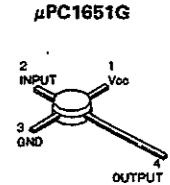
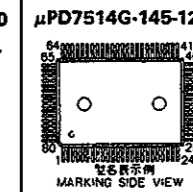
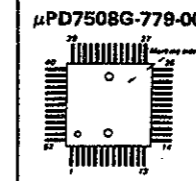
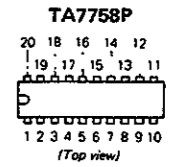
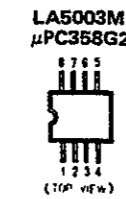
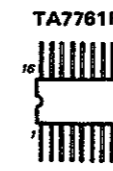

# SECTION 4

# ICF-PRO70/PRO80

## EXPLODED VIEWS

### NOTE:

- The mechanical parts with no reference number in the exploded views are not supplied.
- The construction parts of an assembled part are indicated with a collation number in the remark column.
- Items marked "\*" are not stocked since they are seldom required for routine service. Some delay should be anticipated when ordering these items.
- Due to standardization, parts with part number suffix -XX and -X may be different from the parts specified in the components used on the set.
- Color Indication of Appearance Parts  
Example:  
(RED)...KNOB, BALANCE (WHITE)  
↑ Cabinet's Color                      ↑ Parts' Color

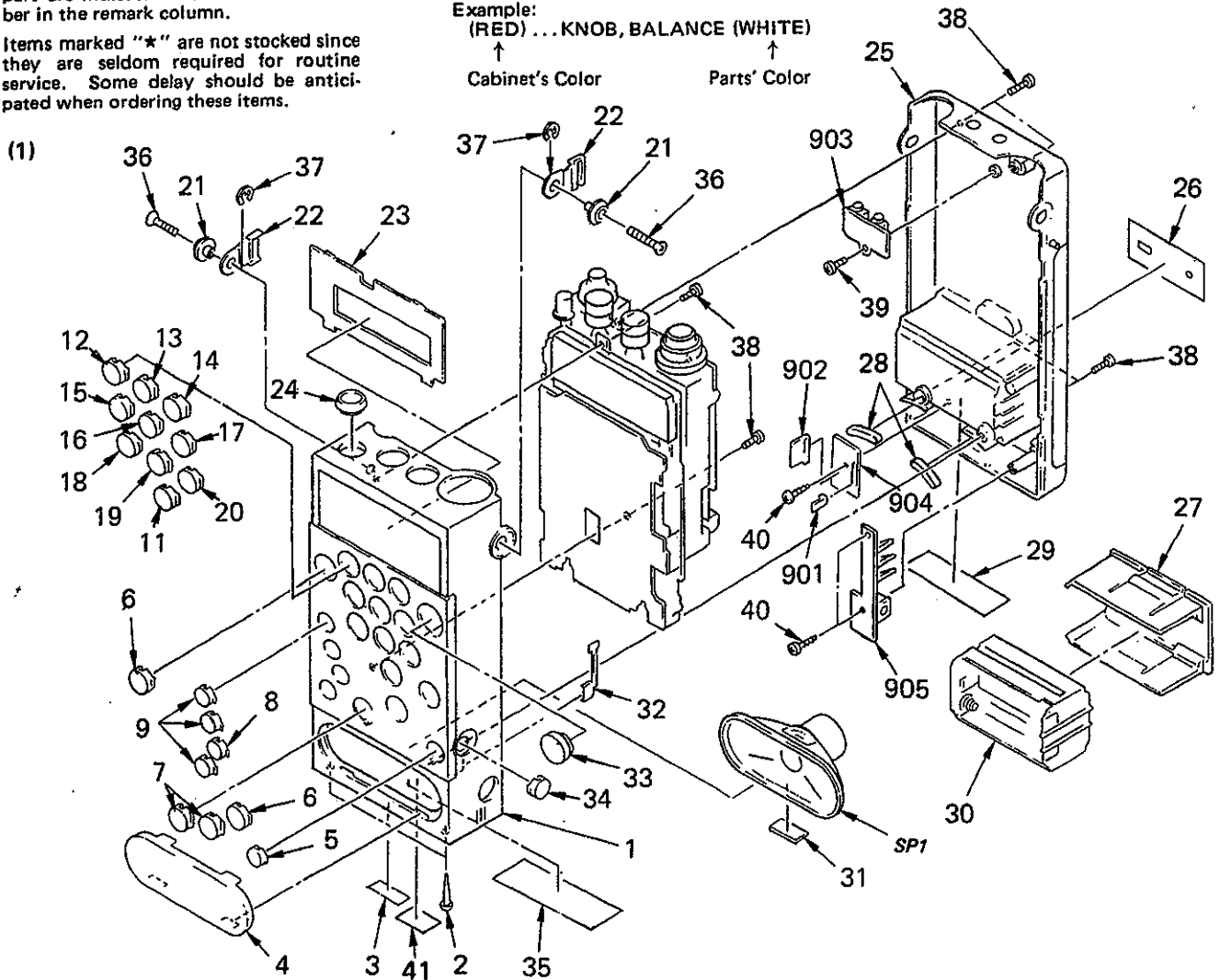

No.	Part No.	Description	Remarks	No.	Part No.	Description	Remarks
1	X-3893-707-1	(ICF-PRO70: Saudi Arabia) ...CABINET (FRONT) ASSY		24	3-893-728-01	RING, POWER	
	X-3898-203-1	(ICF-PRO80).....CABINET (FRONT) ASSY		25	3-898-224-01	LID, REAR, CABINET	
	X-3898-204-1	(ICF-PRO70:E, AEP)...CABINET (FRONT) ASSY		26	*3-898-203-01	(ICF-PRO70)...LABEL, SWITCH	
	X-3897-305-1	(ICF-PRO70: West Germany) ...CABINET (FRONT) ASSY			*3-898-204-01	(ICF-PRO80)...LABEL, SWITCH	
2	3-427-542-00	STOPER		27	3-893-706-01	HOLDER, BATTERY	
3	*3-701-999-00	LABEL, SERIAL NUMBER		28	3-881-931-00	CUSHION, SPEAKER	
4	3-898-226-01	PANEL, SPEAKER		29	3-893-722-01	PLATE, BLIND	
5	3-893-717-01	BUTTON, KP		30	X-3564-820-0	HOLDER ASSY, BATTERY	
6	3-893-704-01	BUTTON (B), MEMORY		31	9-911-838-XX	CUSHION, SPEAKER	
7	3-893-704-11	BUTTON (B), MEMORY		32	*3-898-215-01	SPRING (2)	
8	3-893-716-21	BUTTON, DOUBLE KEY		33	3-893-715-01	BUTTON, S/S	
9	3-893-716-11	BUTTON, DOUBLE KEY		34	3-893-717-11	BUTTON, KP	
11	3-893-703-01	BUTTON (A), MEMORY (0)		35	*3-898-205-01	(ICF-PRO70)...LABEL, MODEL NUMBER (E)	
12	3-893-703-11	BUTTON (A), MEMORY (1)			*3-898-202-01	(ICF-PRO80)...LABEL, MODEL NUMBER (U)	
13	3-893-703-21	BUTTON (A), MEMORY (2)		36	7-621-662-80	SCREW +RK 2.6X12	
14	3-893-703-31	BUTTON (A), MEMORY (3)		37	7-624-109-04	STOP RING 5.0, TYPE -E	
15	3-893-703-41	BUTTON (A), MEMORY (4)		38	7-621-284-30	SCREW +P 2.6X8	
16	3-893-703-51	BUTTON (A), MEMORY (5)		39	7-621-259-25	SCREW +P 2.6X4	
17	3-893-703-61	BUTTON (A), MEMORY (6)		40	7-685-134-19	SCREW +P 2.6X8 TYPE2 SLIT	
18	3-893-703-71	BUTTON (A), MEMORY (7)		901	*1-560-456-00	PIN, CONNECTOR 2P	
19	3-893-703-81	BUTTON (A), MEMORY (8)		902	*1-560-591-00	PIN, CONNECTOR 7P	
20	3-893-703-91	BUTTON (A), MEMORY (9)		904	*1-622-289-11	PC BOARD, TRANSLATION	
21	3-893-726-01	COLLAR, BELT		905	*1-622-288-11	PC BOARD, DC-IN	
22	3-893-730-01	BRACKET, BELT		SP1	1-503-374-11	SPEAKER	
23	3-898-227-01	(ICF-PRO70:E, ICF-PRO80)....PLATE, BACK					
	3-898-227-21	(ICF-PRO70: Saudi Arabia)...PLATE, BACK					
	3-898-227-31	(ICF-PRO70: AEP).....PLATE, BACK					
	3-898-227-12	(ICF-PRO70: West Germany)...PLATE, BACK					

(2)

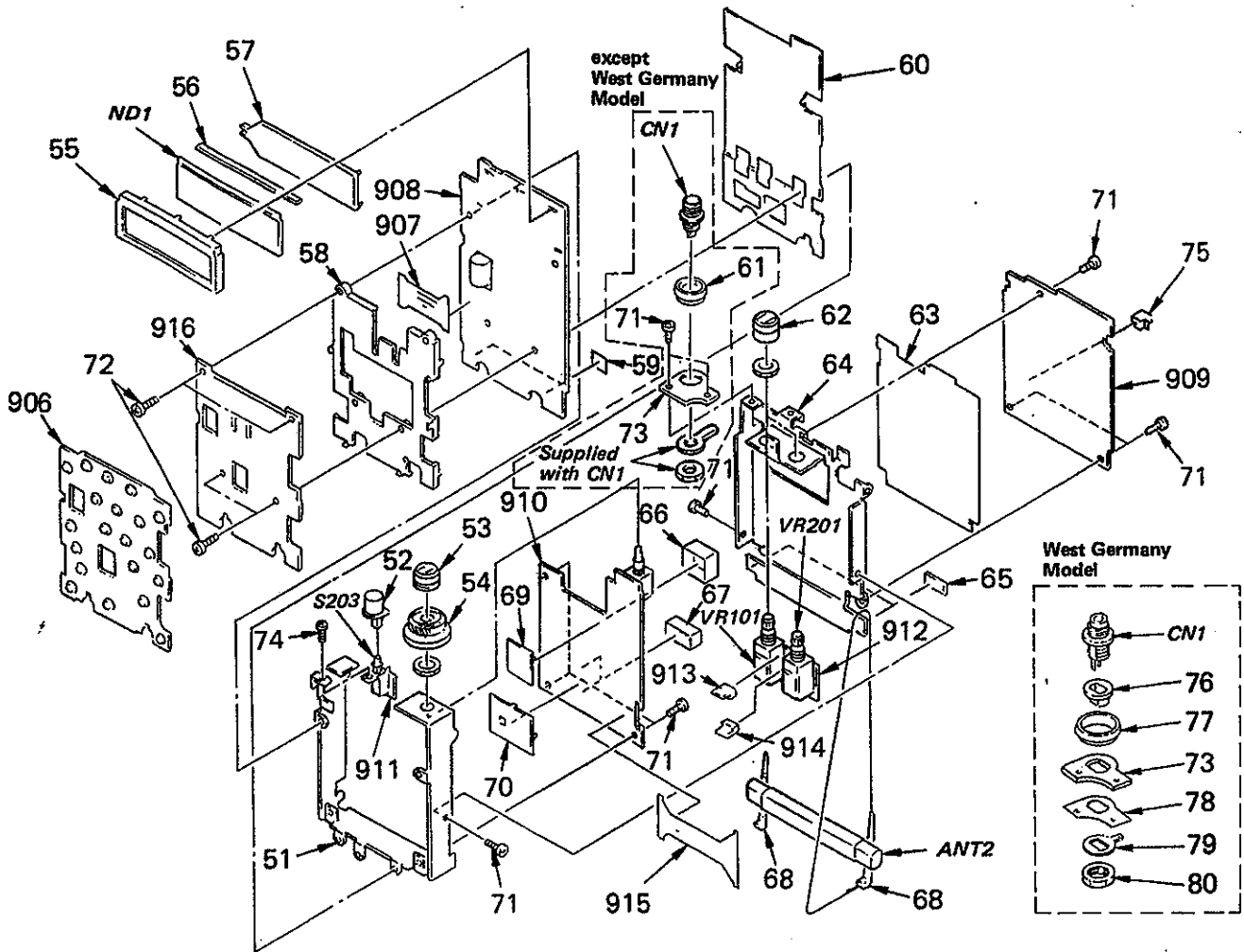

No.	Part No.	Description	Remarks	No.	Part No.	Description	Remarks
51	*3-893-712-01	CHASSIS (B)		903	*1-622-287-11	PC BOARD, JACK	
52	3-893-714-01	BUTTON (POWER)		906	1-571-044-11	SWITCH, RUBBER KEY (S801-820)	
53	3-898-213-01	KNOB (FINE)		907	1-622-336-11	PC BOARD, FLEXIBLE (B)	
54	3-898-214-01	KNOB (PAGE)		908	A-3661-044-A	(ICF-PRO80)...MOUNTED PCB, MICRO COMPUTER	
55	*3-898-216-01	HOLDER, LCD			A-3661-045-A	(ICF-PRO70:EXCEPT West Germany)	
					A-3661-075-A	(ICF-PRO70:West Germany)	
56	1-535-656-11	CONDUCTOR, CONNECTOR				...MOUNTED PCB, MICRO COMPUTER	
57	*3-893-721-01	CHIP, ILLUMINATION		909	A-3660-680-A	(EXCEPT West Germany)	
58	*3-898-223-01	SPACER			A-3660-718-A	(West Germany)...MOUNTED PCB, SIGNAL	
59	*3-893-763-01	SPACER, PC BOARD		910	A-3661-043-A	MOUNTED PCB, PL1	
60	*X-3893-701-1	PLATE (K) ASSY, SHIELD		911	*1-622-285-11	PC BOARD, POWER	
				912	*1-622-286-11	PC BOARD, VR	
61	3-893-719-01	RING, ANTENNA		913	*1-560-466-00	PIN, CONNECTOR 3P	
62	3-893-713-01	KNOB (A)		914	*1-560-466-00	PIN, CONNECTOR 3P	
63	*3-893-755-01	INSULATOR (C)		915	1-622-335-11	PC BOARD, FLEXIBLE (A)	
64	*3-893-711-01	CHASSIS (A)		916	*1-622-284-11	PC BOARD, KEY	
65	9-911-838-XX	CUSHION, SPEAKER		ANT2	1-402-272-11	ANTENNA, FERRITE-ROD	
				CN1	*1-563-956-11	(EXCEPT West Germany)...SOCKET, CONNECTOR	
66	*3-898-220-01	PLATE, SHIELD, D/D,M		CN1	*1-565-451-11	(West Germany)	
67	*3-898-218-01	PLATE (2), SHIELD				...SOCKET, CONNECTOR (WITH SWITCH S102)1P	
68	*3-671-893-00	CLAMP (LOW TYPE)		RV101	1-230-538-11	RES, VAR, CARBON (WITH SW) 50K (SQL)	
69	*X-3898-202-1	PLATE (D/D,P) ASSY, SHIELD		RV201	1-237-670-11	RES, VAR, CARBON (WITH SW) 20K (VOLUME, TONE)	
70	*X-3898-201-1	PLATE (1) ASSY, SHIELD		S203	1-554-957-11	SWITCH, PUSH (1 KEY)(POWER)	
71	7-621-259-25	SCREW +P 2.6X4					
72	7-621-284-30	SCREW +P 2.6X8					
73	*3-893-720-01	HOLDER, ANTENNA					
74	7-621-255-25	SCREW +P 2X4					
75	*3-893-770-01	CASE (CF), SHIELD					
76	3-893-782-01	(West Germany)...COLLAR					
77	3-893-783-01	(West Germany)...RING, ANTENNA					
78	3-893-781-01	(West Germany)...SPACER					
79	3-893-784-01	(West Germany)...LUG					
80	3-897-115-01	(West Germany)...NUT, VOLUME					

(3) Applicable to ICF-PRO80

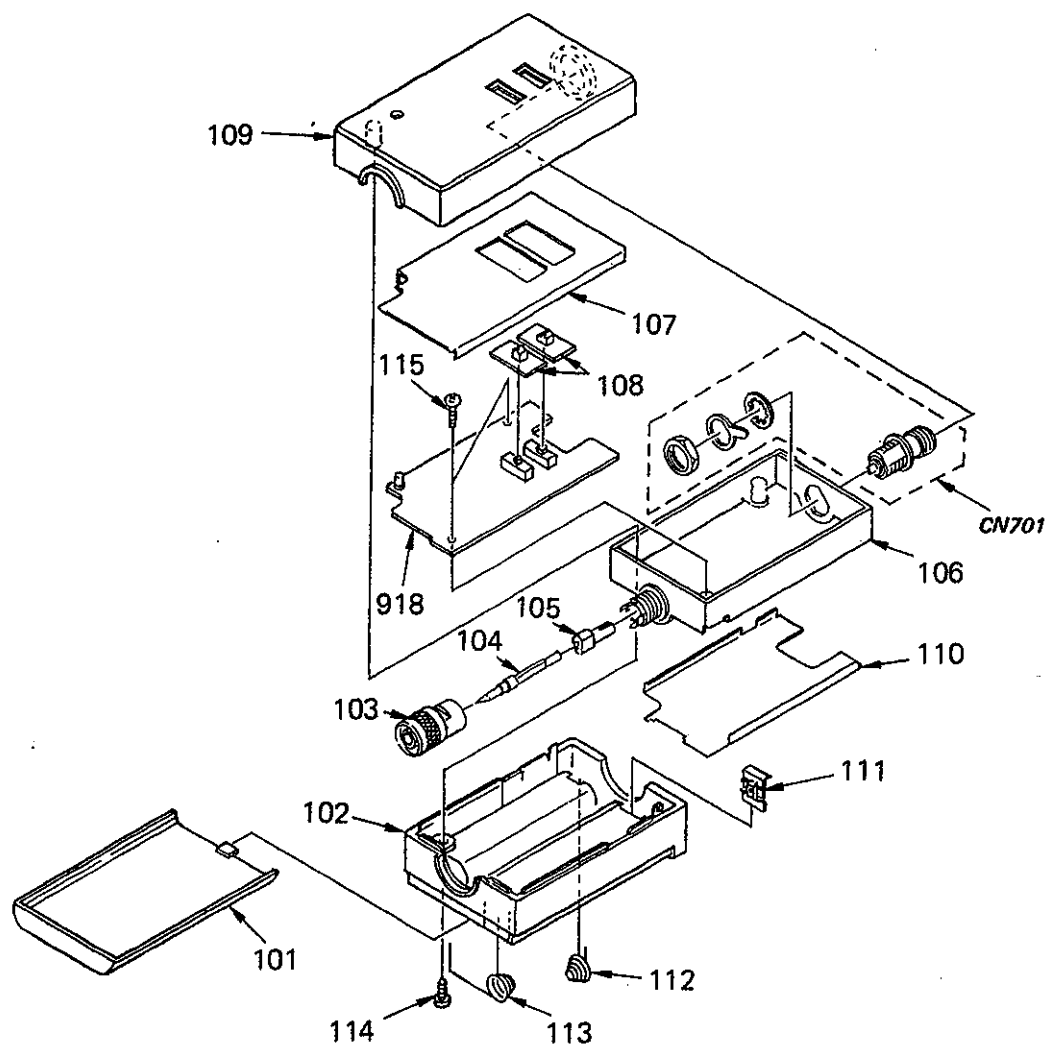

No.	Part No.	Description	Remarks	No.	Part No.	Description	Remarks
101	3-898-234-01	(ICF-PRO80)...LID, BATTERY CASE		110	*3-898-232-01	(ICF-PRO80)...PLATE (B), SHIELD	
102	3-898-242-01	(ICF-PRO80)...COVER (B)		111	3-898-229-01	(ICF-PRO80)...TERMINAL BOARD, PLUS	
103	*3-898-239-01	(ICF-PRO80)...SHELL, TNC-P		112	3-898-230-01	(ICF-PRO80)...SPRING	
104	*3-898-237-01	(ICF-PRO80)...CONTACT		113	3-898-243-01	(ICF-PRO80)...SPRING	
105	*3-898-238-01	(ICF-PRO80)...SLEEVE		114	7-685-134-19	SCREW +P 2.6X8 TYPE2 SLIT	
106	*X-3898-205-1	(ICF-PRO80)...CHASSIS ASSY		115	7-621-259-25	SCREW +P 2.6X4	
107	*3-898-231-01	(ICF-PRO80)...PLATE (A), SHIELD		918	A-3665-026-A	(ICF-PRO80)...MOUNTED PCB, CONVERTER	
108	3-898-235-01	COVER, SWITCH		CN701	*1-563-956-21	(ICF-PRO80)...SOCKET, CONNECTOR	
109	3-898-241-01	(ICF-PRO80)...COVER (A)					

## SECTION 5 ELECTRICAL PARTS LIST

**NOTE:**

- Due to standardization, replacements in the parts list may be different from the parts specified in the diagrams or the components used on the set.
- Items marked "\*" are not stocked since they are seldom required for routine service. Some delay should be anticipated when ordering these items.
- If there are two or more same circuits in a set such as a stereophonic machine, only typical circuit parts may be indicated and capacitors and resistors in other same circuits may be omitted.

**CAPACITORS:**

MF:  $\mu F$ , PF:  $\mu\mu F$ .

**RESISTORS**

- All resistors are in ohms.
- F: nonflammable

**COILS**

- MMH: mH, UH:  $\mu H$

**SEMICONDUCTORS**

In each case, U:  $\mu$ , for example:

UA...:  $\mu A$ ..., UPA...:  $\mu PA$ ...,  
UPC...:  $\mu PC$ , UPD...:  $\mu PD$ ...

Ref.No.	Part No.	Description	Ref.No.	Part No.	Description
901	*1-560-456-00	PIN, CONNECTOR 2P	C18	1-163-141-00	(EXCEPT West Germany) ...CERAMIC CHIP 0.001MF 5% 50V
902	*1-560-591-00	PIN, CONNECTOR 7P	C19	1-163-086-00	CERAMIC CHIP 3PF 0.25PF 50V
903	*1-622-287-11	PC BOARD, JACK	C20	1-163-107-00	CERAMIC CHIP 39PF 5% 50V
904	*1-622-289-11	PC BOARD, TRANSLATION	C21	1-163-109-00	CERAMIC CHIP 47PF 5% 50V
905	*1-622-288-11	PC BOARD, DC-IN	C22	1-163-021-00	CERAMIC CHIP 0.01MF 10% 50V
906	1-571-044-11	SWITCH, RUBBER KEY (S801-820)	C23	1-163-013-00	CERAMIC CHIP 0.0022MF 10% 50V
907	1-622-336-11	PC BOARD, FLEXIBLE (B)	C24	1-163-037-11	CERAMIC CHIP 0.022MF 10% 25V
908	A-3661-045-A	(ICF-PRO70:EXCEPT West Germany) ...MOUNTED PCB, MICRO COMPUTER	C25	1-163-021-00	CERAMIC CHIP 0.01MF 10% 50V
	A-3661-044-A	(ICF-PRO80) ...MOUNTED PCB, MICRO COMPUTER	C26	1-163-129-00	CERAMIC CHIP 330PF 5% 50V
	A-3661-075-A	(ICF-PRO70:West Germany) ...MOUNTED PCB, MICRO COMPUTER	C27	1-163-113-00	(EXCEPT West Germany) ...CERAMIC CHIP 68PF 5% 50V
909	A-3660-680-A	(EXCEPT West Germany) ...MOUNTED PCB, SIGNAL	C28	1-163-021-00	(EXCEPT West Germany) ...CERAMIC CHIP 0.01MF 10% 50V
	A-3660-718-A	(West Germany)...MOUNTED PCB, SIGNAL	C29	1-163-111-00	CERAMIC CHIP 56PF 5% 50V
910	A-3661-043-A	MOUNTED PCB, PLL	C30	1-163-037-11	CERAMIC CHIP 0.022MF 10% 25V
911	*1-622-285-11	PC BOARD, POWER	C31	1-163-089-00	CERAMIC CHIP 6PF 0.25PF 50V
912	*1-622-286-11	PC BOARD, VR	C32	1-163-809-11	CERAMIC CHIP 0.047MF 10% 25V
913	*1-560-466-00	PIN, CONNECTOR 3P	C33	1-163-037-11	CERAMIC CHIP 0.022MF 10% 25V
914	*1-560-466-00	PIN, CONNECTOR 3P	C34	1-163-037-11	CERAMIC CHIP 0.022MF 10% 25V
915	1-622-335-11	PC BOARD, FLEXIBLE (A)	C35	1-163-809-11	CERAMIC CHIP 0.047MF 10% 25V
916	*1-622-284-11	PC BOARD, KEY	C36	1-163-037-11	CERAMIC CHIP 0.022MF 10% 25V
918	A-3665-026-A	(ICF-PRO80)...MOUNTED PCB, CONVERTER	C37	1-163-037-11	CERAMIC CHIP 0.022MF 10% 25V
ANT1	1-501-377-11	(EXCEPT West Germany) ...ANTENNA, TELESCOPIC	C38	1-163-085-00	CERAMIC CHIP 2PF 0.25PF 50V
ANT1	1-501-412-11	(West Germany)...ANTENNA, TELESCOPIC	C39	1-163-809-11	CERAMIC CHIP 0.047MF 10% 25V
ANT2	1-402-272-11	ANTENNA, FERRITE-ROD	C40	1-163-021-00	CERAMIC CHIP 0.01MF 10% 50V
BPF701	1-235-763-11	(ICF-PRO80)...FILTER, BAND PASS	C41	1-163-809-11	CERAMIC CHIP 0.047MF 10% 25V
C1	1-163-021-00	CERAMIC CHIP 0.01MF 10% 50V	C42	1-163-809-11	CERAMIC CHIP 0.047MF 10% 25V
C2	1-163-021-00	CERAMIC CHIP 0.01MF 10% 50V	C43	1-163-037-11	CERAMIC CHIP 0.022MF 10% 25V
C5	1-163-021-00	CERAMIC CHIP 0.01MF 10% 50V	C44	1-163-809-11	CERAMIC CHIP 0.047MF 10% 25V
C6	1-163-141-00	CERAMIC CHIP 0.001MF 5% 50V	C45	1-163-809-11	CERAMIC CHIP 0.047MF 10% 25V
C7	1-163-021-00	CERAMIC CHIP 0.01MF 10% 50V	C46	1-163-016-00	CERAMIC CHIP 0.0039MF 10% 50V
C8	1-163-141-00	CERAMIC CHIP 0.001MF 5% 50V	C47	1-163-021-00	CERAMIC CHIP 0.01MF 10% 50V
C9	1-163-021-00	CERAMIC CHIP 0.01MF 10% 50V	C48	1-163-021-00	CERAMIC CHIP 0.01MF 10% 50V
C10	1-163-086-00	CERAMIC CHIP 3PF 0.25PF 50V	C49	1-124-778-00	ELECT 22MF 20% 6.3V
C11	1-163-125-00	CERAMIC CHIP 220PF 5% 50V	C50	1-163-021-00	CERAMIC CHIP 0.01MF 10% 50V
C12	1-163-021-00	CERAMIC CHIP 0.01MF 10% 50V	C51	1-163-135-00	CERAMIC CHIP 560PF 5% 50V
C13	1-163-113-00	CERAMIC CHIP 68PF 5% 50V	C52	1-126-205-00	ELECT 47MF 20% 6.3V
C14	1-163-021-00	(EXCEPT West Germany) ...CERAMIC CHIP 0.01MF 10% 50V	C53	1-163-123-00	CERAMIC CHIP 180PF 5% 50V
C15	1-163-141-00	(EXCEPT West Germany) ...CERAMIC CHIP 0.001MF 5% 50V	C54	1-124-778-00	ELECT 22MF 20% 6.3V
C16	1-163-021-00	(EXCEPT West Germany) ...CERAMIC CHIP 0.01MF 10% 50V	C55	1-163-141-00	CERAMIC CHIP 0.001MF 5% 50V
C17	1-163-021-00	(EXCEPT West Germany) ...CERAMIC CHIP 0.01MF 10% 50V	C56	1-163-141-00	CERAMIC CHIP 0.001MF 10% 50V
			C57	1-163-141-00	CERAMIC CHIP 0.001MF 10% 50V
			C58	1-163-021-00	CERAMIC CHIP 0.01MF 10% 50V
			C59	1-163-125-00	CERAMIC CHIP 220PF 5% 50V
			C60	1-163-109-00	CERAMIC CHIP 47PF 5% 50V
			C61	1-163-145-00	CERAMIC CHIP 0.0015MF 10% 50V

Downloaded by  
RadioAmateur.EU

Ref.No.	Part No.	Description				Ref.No.	Part No.	Description			
C62	1-163-021-00	CERAMIC CHIP 0.01MF	10%	50V		C214	1-163-141-00	CERAMIC CHIP 0.001MF	5%	50V	
C63	1-135-099-00	TANTAL. CHIP 2.2MF	10%	6.3V		C215	1-130-768-00	FILM 0.1MF	10%	63V	
C64	1-126-205-00	ELECT 47MF	20%	6.3V		C216	1-163-123-00	CERAMIC CHIP 180PF	5%	50V	
C65	1-163-021-00	CERAMIC CHIP 0.01MF	10%	50V		C217	1-163-021-00	CERAMIC CHIP 0.01MF	10%	50V	
C66	1-126-195-00	ELECT 2.2MF	20%	50V		C218	1-163-107-00	CERAMIC CHIP 39PF	5%	50V	
C67	1-126-195-00	ELECT 2.2MF	20%	50V		C219	1-163-101-00	CERAMIC CHIP 22PF	5%	50V	
C68	1-163-021-00	CERAMIC CHIP 0.01MF	10%	50V		C220	1-163-021-00	CERAMIC CHIP 0.01MF	10%	50V	
C69	1-163-021-00	CERAMIC CHIP 0.01MF	10%	50V		C221	1-126-205-00	ELECT 47MF	20%	6.3V	
C70	1-163-021-00	CERAMIC CHIP 0.01MF	10%	50V		C222	1-163-021-00	CERAMIC CHIP 0.01MF	10%	50V	
C71	1-163-100-00	CERAMIC CHIP 20PF	5%	50V		C223	1-163-077-00	CERAMIC CHIP 0.1MF	10%	25V	
C72	1-163-037-11	CERAMIC CHIP 0.022MF	10%	25V		C224	1-163-037-11	CERAMIC CHIP 0.022MF	10%	25V	
C73	1-163-077-00	CERAMIC CHIP 0.1MF	10%	25V		C225	1-163-141-00	CERAMIC CHIP 0.001MF	5%	50V	
C74	1-162-611-00	CERAMIC CHIP 1MF		25V		C226	1-163-091-00	CERAMIC CHIP 8PF	0.25PF	50V	
C75	1-135-095-00	TANTAL. CHIP 1.5MF	10%	10V		C227	1-163-021-00	CERAMIC CHIP 0.01MF	10%	50V	
C76	1-163-021-00	CERAMIC CHIP 0.01MF	10%	50V		C228	1-163-083-00	CERAMIC CHIP 1PF	0.25PF	50V	
C77	1-163-114-00	CERAMIC CHIP 75PF	5%	50V		C229	1-163-103-00	CERAMIC CHIP 27PF	5%	50V	
C78	1-163-141-00	CERAMIC CHIP 0.001MF	5%	50V		C230	1-161-055-00	CERAMIC 0.022MF	20%	25V	
C79	1-163-013-00	CERAMIC CHIP 0.0022MF	10%	50V		C231	1-163-086-00	CERAMIC CHIP 3PF	0.25PF	50V	
C80	1-163-021-00	CERAMIC CHIP 0.01MF	10%	50V		C232	1-163-021-00	CERAMIC CHIP 0.01MF	10%	50V	
C81	1-163-021-00	CERAMIC CHIP 0.01MF	10%	50V		C233	1-135-104-00	TANTAL. CHIP 10MF	10%	4V	
C82	1-163-021-00	CERAMIC CHIP 0.01MF	10%	50V		C234	1-163-141-00	CERAMIC CHIP 0.001MF	5%	50V	
C83	1-163-037-11	CERAMIC CHIP 0.022MF	10%	25V		C235	1-163-091-00	CERAMIC CHIP 8PF	0.25PF	50V	
C84	1-163-021-00	CERAMIC CHIP 0.01MF	10%	50V		C236	1-163-021-00	CERAMIC CHIP 0.01MF	10%	50V	
C85	1-163-037-11	CERAMIC CHIP 0.022MF	10%	25V		C237	1-163-101-00	CERAMIC CHIP 22PF	5%	50V	
C86	1-163-109-00	CERAMIC CHIP 47PF	5%	50V		C238	1-163-083-00	CERAMIC CHIP 1PF	0.25PF	50V	
C87	1-163-141-00	CERAMIC CHIP 0.001MF	5%	50V		C239	1-161-055-00	CERAMIC 0.022MF	20%	25V	
C88	1-163-135-00	CERAMIC CHIP 560PF	5%	50V		C240	1-163-086-00	CERAMIC CHIP 3PF	0.25PF	50V	
C89	1-163-105-00	CERAMIC CHIP 33PF	5%	50V		C241	1-163-021-00	CERAMIC CHIP 0.01MF	10%	50V	
C90	1-163-021-00	CERAMIC CHIP 0.01MF	10%	50V		C242	1-135-157-21	TANTAL. CHIP 10MF	10%	4V	
C91	1-126-205-00	ELECT 47MF	20%	6.3V		C243	1-126-205-00	ELECT 47MF	20%	6.3V	
C92	1-163-077-00	CERAMIC CHIP 0.1MF	10%	25V		C244	1-163-021-00	CERAMIC CHIP 0.01MF	10%	50V	
C93	1-163-037-11	CERAMIC CHIP 0.022MF	10%	25V		C245	1-163-021-00	CERAMIC CHIP 0.01MF	10%	50V	
C94	1-162-638-11	CERAMIC CHIP 1MF		16V		C246	1-163-117-00	CERAMIC CHIP 100PF	5%	50V	
C95	1-163-021-00	CERAMIC CHIP 0.01MF	10%	50V		C247	1-163-141-00	CERAMIC CHIP 0.001MF	10%	50V	
C96	1-163-077-00	CERAMIC CHIP 0.1MF	10%	25V		C301	1-163-037-11	CERAMIC CHIP 0.022MF	10%	25V	
C97	1-163-037-11	CERAMIC CHIP 0.022MF	10%	25V		C302	1-135-096-21	TANTAL. CHIP 4.7MF	10%	10V	
C98	1-163-127-00	CERAMIC CHIP 270PF	5%	50V		C303	1-162-611-00	CERAMIC CHIP 1MF		25V	
C99	1-163-021-00	CERAMIC CHIP 0.01MF	10%	50V		C304	1-163-021-00	CERAMIC CHIP 0.01MF	10%	50V	
C100	1-163-077-00	CERAMIC CHIP 0.1MF	10%	25V		C305	1-163-021-00	CERAMIC CHIP 0.01MF	10%	50V	
C101	1-163-809-11	CERAMIC CHIP 0.047MF	10%	25V		C306	1-163-021-00	CERAMIC CHIP 0.01MF	10%	50V	
C102	1-163-021-00	CERAMIC CHIP 0.01MF	10%	50V		C307	1-163-105-00	CERAMIC CHIP 33PF	5%	50V	
C103	1-162-611-00	CERAMIC CHIP 1MF		25V		C308	1-162-611-00	CERAMIC CHIP 1MF		25V	
C104	1-163-021-00	CERAMIC CHIP 0.01MF	10%	50V		C309	1-162-611-00	CERAMIC CHIP 1MF		25V	
C105	1-163-037-11	CERAMIC CHIP 0.022MF	10%	25V		C310	1-126-166-11	ELECT 2200MF		5.5V	
C106	1-161-051-00	CERAMIC 0.01MF	20%	25V		C311	1-162-611-00	CERAMIC CHIP 1MF		25V	
C201	1-126-205-11	ELECT 47MF	20%	6.3V		C312	1-135-096-21	TANTAL. CHIP 4.7MF	10%	10V	
C202	1-126-205-11	ELECT 47MF	20%	6.3V		C313	1-163-021-00	CERAMIC CHIP 0.01MF	10%	50V	
C203	1-163-125-00	CERAMIC CHIP 220PF	5%	50V		C314	1-163-105-00	CERAMIC CHIP 33PF	5%	50V	
C204	1-162-611-00	CERAMIC CHIP 1MF		25V		C315	1-163-021-00	CERAMIC CHIP 0.01MF	10%	50V	
C205	1-163-141-00	CERAMIC CHIP 0.001MF	10%	50V		C316	1-163-809-11	CERAMIC CHIP 0.047MF	10%	25V	
C206	1-126-205-11	ELECT 47MF	20%	6.3V		C501	1-130-768-00	FILM 0.1MF	10%	63V	
C207	1-163-077-00	CERAMIC CHIP 0.1MF	10%	25V		C502	1-126-200-00	ELECT 10MF	20%	35V	
C208	1-126-204-11	ELECT 47MF	20%	16V		C503	1-162-611-00	CERAMIC CHIP 1MF		25V	
C209	1-124-472-11	ELECT 470MF	20%	10V		C504	1-163-102-00	CERAMIC CHIP 24PF	5%	50V	
C210	1-126-176-11	ELECT 220MF	20%	10V		C505	1-163-109-00	CERAMIC CHIP 47PF	5%	50V	
C211	1-126-204-11	ELECT 47MF	20%	16V		C506	1-124-778-00	ELECT 22MF	20%	6.3V	
C212	1-163-022-00	CERAMIC CHIP 0.012MF	10%	50V		C507	1-163-021-00	CERAMIC CHIP 0.01MF	10%	50V	
C213	1-163-021-00	CERAMIC CHIP 0.01MF	10%	50V							

# ICF-PRO70/PRO80

Ref.No.	Part No.	Description
C701	1-163-087-00	(ICF-PRO80) ...CERAMIC CHIP 4PF 0.25PF 50V
C702	1-163-094-00	(ICF-PRO80) ...CERAMIC CHIP 11PF 5% 50V
C703	1-163-112-00	(ICF-PRO80) ...CERAMIC CHIP 62PF 5% 50V
C704	1-163-021-00	(ICF-PRO80) ...CERAMIC CHIP 0.01MF 10% 50V
C705	1-163-091-00	(ICF-PRO80) ...CERAMIC CHIP 8PF 0.25PF 50V
C706	1-163-105-00	(ICF-PRO80) ...CERAMIC CHIP 33PF 5% 50V
C707	1-163-129-00	(ICF-PRO80) ...CERAMIC CHIP 330PF 5% 50V
C708	1-163-093-00	(ICF-PRO80) ...CERAMIC CHIP 10PF 5% 50V
C709	1-163-021-00	(ICF-PRO80) ...CERAMIC CHIP 0.01MF 10% 50V
C710	1-163-093-00	(ICF-PRO80) ...CERAMIC CHIP 10PF 5% 50V
C711	1-163-099-00	(ICF-PRO80) ...CERAMIC CHIP 18PF 5% 50V
C712	1-163-093-00	(ICF-PRO80) ...CERAMIC CHIP 10PF 5% 50V
C713	1-163-103-00	(ICF-PRO80) ...CERAMIC CHIP 27PF 5% 50V
C714	1-163-021-00	(ICF-PRO80) ...CERAMIC CHIP 0.01MF 10% 50V
C715	1-163-113-00	(ICF-PRO80) ...CERAMIC CHIP 68PF 5% 50V
C716	1-135-157-21	(ICF-PRO80) ...TANTAL. CHIP 10MF 20% 4V
C717	1-163-021-00	(ICF-PRO80) ...CERAMIC CHIP 0.01MF 10% 50V
C718	1-163-093-00	(ICF-PRO80) ...CERAMIC CHIP 10PF 5% 50V
C719	1-163-099-00	(ICF-PRO80) ...CERAMIC CHIP 18PF 5% 50V
C720	1-163-105-00	(ICF-PRO80) ...CERAMIC CHIP 33PF 5% 50V
C721	1-163-097-00	(ICF-PRO80) ...CERAMIC CHIP 15PF 5% 50V
C722	1-163-101-00	(ICF-PRO80) ...CERAMIC CHIP 22PF 5% 50V
C723	1-163-021-00	(ICF-PRO80) ...CERAMIC CHIP 0.01MF 10% 50V
C724	1-163-095-00	(ICF-PRO80) ...CERAMIC CHIP 12PF 5% 50V
C725	1-163-021-00	(ICF-PRO80) ...CERAMIC CHIP 0.01MF 10% 50V
CF1	1-567-389-11	FILTER, CERAMIC
CF2	1-567-389-11	FILTER, CERAMIC
CF3	1-567-844-11	FILTER, CERAMIC
CF4	1-567-389-11	FILTER, CERAMIC
CF5	1-527-483-00	FILTER, CERAMIC
CF6	1-567-846-11	FILTER, CERAMIC
CF7	1-567-845-11	FILTER, CERAMIC
CN1	*1-563-956-11	(EXCEPT West Germany)..SOCKET, CONNECTOR
CN1	*1-565-451-11	(West Germany) ... SOCKET, CONNECTOR (WITH SWITCH S102)1P
CN2	1-507-954-11	JACK, EXTERNAL POWER (DC IN 6V)
CN701	*1-563-956-21	(ICF-PRO80)...SOCKET, CONNECTOR

Ref.No.	Part No.	Description
CT1	1-141-347-11	CAP, VAR, TRIMMER (CHIP)
CT2	1-141-347-11	(EXCEPT West Germany) ...CAP, VAR, TRIMMER (CHIP)
CT201	1-141-311-11	CAP, VAR, TRIMMER (CHIP)
CT202	1-141-311-11	CAP, VAR, TRIMMER (CHIP)
CT203	1-141-347-11	CAP, VAR, TRIMMER (CHIP)
D1	8-719-101-23	DIODE 1SS123
D3	8-719-941-25	DIODE HSM2693
D4	8-713-300-00	DIODE 1T33
D5	8-713-300-00	DIODE 1T33
D6	8-713-300-00	(EXCEPT West Germany)...DIODE 1T33
D7	8-713-300-00	(EXCEPT West Germany)...DIODE 1T33
D8	8-719-941-25	(EXCEPT West Germany)...DIODE HSM2693
D11	8-719-123-79	DIODE 1SS279
D12	8-719-101-23	DIODE 1SS123
D13	8-719-123-79	(EXCEPT West Germany)...DIODE 1SS279
D14	8-719-123-79	DIODE 1SS279
D15	8-719-123-79	(EXCEPT West Germany)...DIODE 1SS279
D16	8-719-123-79	DIODE 1SS279
D17	8-719-123-79	DIODE 1SS279
D18	8-719-123-79	DIODE 1SS279
D19	8-719-123-79	DIODE 1SS279
D20	8-719-100-05	DIODE 1S2837
D21	8-719-939-00	DIODE SVC203CP
D22	8-719-100-05	DIODE 1S2837
D23	8-719-100-05	DIODE 1S2837
D24	8-719-801-48	DIODE 1SS193
D25	8-719-100-05	DIODE 1S2837
D26	8-719-938-72	DIODE SB01-05CP
D27	8-719-938-72	DIODE SB01-05CP
D28	8-719-801-48	DIODE 1SS193
D29	8-719-801-48	DIODE 1SS193
D30	8-719-100-05	DIODE 1S2837
D31	8-719-100-03	DIODE 1S2835
D32	8-719-801-48	DIODE 1SS193
D201	8-719-801-48	DIODE 1SS193
D203	8-719-100-05	DIODE 1S2837
D204	8-719-123-79	DIODE 1SS279
D205	8-713-300-00	DIODE 1T33
D206	8-713-300-00	DIODE 1T33
D207	8-719-123-79	DIODE 1SS279
D208	8-713-300-00	DIODE 1T33
D209	8-713-300-00	DIODE 1T33
D210	8-719-801-48	DIODE 1SS193
D211	8-719-801-48	DIODE 1SS193
D212	8-719-100-03	DIODE 1S2835
D301	8-719-920-05	DIODE TLG123A
D302	8-719-100-03	DIODE 1S2835
D303	8-719-100-05	DIODE 1S2837
D304	8-719-800-67	DIODE TLR209
D305	8-719-801-48	DIODE 1SS193
D306	8-719-940-16	DIODE GL1PR51
D307	8-719-940-16	DIODE GL1PR51
D308	8-719-801-48	DIODE 1SS193
D309	8-719-100-03	DIODE 1S2835
D310	8-719-801-48	DIODE 1SS193
D402	8-719-100-03	DIODE 1S2835



Ref.No.	Part No.	Description	Ref.No.	Part No.	Description
D403	8-719-801-48	(ICF-PRO70:Saudi Arabia)...DIODE 1SS193	L206	1-410-197-11	INDUCTOR CHIP 2.7UH
D404	8-719-100-03	DIODE 1S2835	L501	1-410-220-31	INDUCTOR CHIP 220UH
D405	8-719-100-03	DIODE 1S2835	L701	1-410-806-11	(ICF-PRO80)...INDUCTOR CHIP 0.08UH
D406	8-719-100-03	DIODE 1S2835	L702	1-410-802-11	(ICF-PRO80)...INDUCTOR CHIP 0.04UH
D407	8-719-100-03	DIODE 1S2835	L703	1-410-797-11	(ICF-PRO80)...INDUCTOR CHIP 0.02UH
D408	8-719-100-03	DIODE 1S2835	L704	1-410-732-21	(ICF-PRO80)...INDUCTOR CHIP 0.18UH
D501	8-719-106-98	DIODE RD16M-B3	L705	1-410-802-11	(ICF-PRO80)...INDUCTOR CHIP 0.04UH
D502	8-719-801-48	DIODE 1SS193	L706	1-410-805-11	(ICF-PRO80)...INDUCTOR CHIP 0.07UH
D701	8-719-101-23	(ICF-PRO80)...DIODE 1SS123	L707	1-410-192-51	(ICF-PRO80)...INDUCTOR CHIP 1UH
D702	8-719-941-25	(ICF-PRO80)...DIODE HSM2693	L708	1-410-807-11	(ICF-PRO80)...INDUCTOR CHIP 0.1UH
D703	8-719-118-32	(ICF-PRO80)...DIODE ND487C1-3R	L709	1-410-807-11	(ICF-PRO80)...INDUCTOR CHIP 0.1UH
D704	8-719-812-41	(ICF-PRO80)...DIODE TLR124	L710	1-410-803-11	(ICF-PRO80)...INDUCTOR CHIP 0.05UH
IC1	8-759-208-37	IC TA7761F	L711	1-410-734-11	(ICF-PRO80)...INDUCTOR CHIP 0.27UH
IC2	8-759-208-38	IC TA7758P	L712	1-410-803-11	(ICF-PRO80)...INDUCTOR CHIP 0.05UH
IC3	8-759-100-94	IC UPC358G2	L713	1-410-803-11	(ICF-PRO80)...INDUCTOR CHIP 0.05UH
IC201	8-759-801-65	IC LA4145	L714	1-410-802-11	(ICF-PRO80)...INDUCTOR CHIP 0.04UH
IC202	8-752-323-84	IC CXD1118M	L715	1-410-192-51	(ICF-PRO80)...INDUCTOR CHIP 1UH
IC203	8-759-801-15	IC LA5003M	ND1	1-807-822-11	DISPLAY PANEL, LIQUID CRYSTAL
IC301	8-759-140-45	(EXCEPT West Germany) ....IC UPD7508G-778-00	Q1	8-729-304-13	TRANSISTOR 2SK360D
IC301	8-759-142-58	(West Germany)....IC UPD7508G-E64-00	Q2	8-729-304-13	(EXCEPT West Germany) ...TRANSISTOR 2SK360D
IC302	8-759-140-41	(EXCEPT West Germany)..IC UPD7514G-12	Q3	8-729-102-07	TRANSISTOR 2SC2223-F13
IC302	8-759-142-57	(West Germany)....IC UPD7514G-423-12	Q4	8-729-116-64	TRANSISTOR 2SK508-K51
IC303	8-759-208-13	IC TC4016BFHB	Q5	8-729-800-36	TRANSISTOR 2SD1048
IC701	8-759-107-67	(ICF-PRO80)...IC UPC1651G	Q6	8-769-401-59	TRANSISTOR 2SK613-3
J201	1-507-921-00	JACK (EARPHONE)	Q7	8-729-116-64	TRANSISTOR 2SK508-K51
J202	1-507-921-00	JACK (TAPE)	Q8	8-729-116-64	TRANSISTOR 2SK508-K51
L1	1-426-308-11	TRANSFORMER, HIGH FREQUENCY	Q9	8-729-800-68	TRANSISTOR 2SB815
L2	1-459-720-11	COIL (WITH CORE)	Q10	8-729-901-02	TRANSISTOR DTC124XK
L3	1-459-721-11	(EXCEPT West Germany)..COIL (WITH CORE)	Q11	8-729-271-23	TRANSISTOR 2SC2712
L4	1-410-192-51	INDUCTOR CHIP 1UH	Q12	8-729-107-45	TRANSISTOR 2SC3624A-L16
L5	1-410-188-51	INDUCTOR CHIP 0.47UH	Q13	8-729-800-36	TRANSISTOR 2SD1048
L6	1-410-220-31	INDUCTOR CHIP 220UH	Q21	8-729-801-08	TRANSISTOR 2SC2813Q4
L7	1-410-184-51	(EXCEPT West Germany) ....INDUCTOR CHIP 0.22UH	Q22	8-729-800-68	TRANSISTOR 2SB815
L8	1-410-184-51	(EXCEPT West Germany) ....INDUCTOR CHIP 0.22UH	Q23	8-729-901-02	TRANSISTOR DTC124XK
L9	1-410-184-51	(EXCEPT West Germany) ....INDUCTOR CHIP 0.22UH	Q24	8-729-107-45	TRANSISTOR 2SC3624A-L16
L10	1-410-193-41	INDUCTOR CHIP 1.2UH	Q26	8-729-901-02	TRANSISTOR DTC124XK
L11	1-410-192-51	INDUCTOR CHIP 1UH	Q27	8-729-801-08	TRANSISTOR 2SC2813Q4
L12	1-410-204-31	INDUCTOR CHIP 10UH	Q28	8-729-271-23	TRANSISTOR 2SC2712
L13	1-410-208-41	INDUCTOR CHIP 22UH	Q29	8-729-800-68	TRANSISTOR 2SB815
L14	1-410-202-51	INDUCTOR CHIP 6.8UH	Q30	8-729-800-68	TRANSISTOR 2SB815
L15	1-404-725-11	TRANSFORMER, IF	Q31	8-729-102-07	TRANSISTOR 2SC2223-F13
L16	1-410-220-31	INDUCTOR CHIP 220UH	Q32	8-729-801-08	TRANSISTOR 2SC2813Q4
L17	1-410-204-31	INDUCTOR CHIP 10UH	Q33	8-729-800-68	TRANSISTOR 2SB815
L18	1-410-187-41	INDUCTOR CHIP 0.39UH	Q35	8-729-901-02	TRANSISTOR DTC124XK
L19	1-406-232-11	COIL (OSC)	Q201	8-729-800-36	TRANSISTOR 2SD1048
L20	1-404-728-11	TRANSFORMER, IF	Q202	8-729-800-68	TRANSISTOR 2SB815
L21	1-410-220-31	INDUCTOR CHIP 220UH	Q203	8-729-800-68	TRANSISTOR 2SB815
L22	1-410-188-51	INDUCTOR CHIP 0.47UH	Q204	8-729-800-68	TRANSISTOR 2SB815
L201	1-459-722-11	COIL (WITH CORE)	Q205	8-729-800-68	TRANSISTOR 2SB815
L202	1-459-716-11	COIL (WITH CORE)	Q206	8-729-800-68	TRANSISTOR 2SB815
L203	1-410-194-41	INDUCTOR CHIP 1.5UH	Q207	8-729-800-68	TRANSISTOR 2SB815
L204	1-459-723-11	COIL (WITH CORE)	Q208	8-729-800-68	TRANSISTOR 2SB815
L205	1-459-717-11	COIL (WITH CORE)	Q209	8-729-271-23	TRANSISTOR 2SC2712
			Q210	8-729-800-68	TRANSISTOR 2SB815
			Q211	8-729-903-10	TRANSISTOR FMW1
			Q212	8-729-800-68	TRANSISTOR 2SB815
			Q214	8-729-800-68	TRANSISTOR 2SB815

# ICF-PRO70/PRO80

Ref.No.	Part No.	Description
Q215	8-729-903-10	TRANSISTOR FMW1
Q216	8-729-800-68	TRANSISTOR 2SB815
Q218	8-729-800-68	TRANSISTOR 2SB815
Q219	8-729-271-23	TRANSISTOR 2SC2712
Q220	8-729-800-68	TRANSISTOR 2SB815
Q221	8-729-800-36	TRANSISTOR 2SD1048
Q222	8-729-102-07	TRANSISTOR 2SC2223-F13
Q223	8-729-208-47	TRANSISTOR 2SK210GR
Q224	8-729-800-68	TRANSISTOR 2SB815
Q225	8-729-102-07	TRANSISTOR 2SC2223-F13
Q226	8-729-208-47	TRANSISTOR 2SK210GR
Q227	8-729-800-68	TRANSISTOR 2SB815
Q228	8-729-220-93	TRANSISTOR 2SK209G
Q229	8-729-271-23	TRANSISTOR 2SC2712
Q230	8-729-220-93	TRANSISTOR 2SK209G
Q231	8-729-271-23	TRANSISTOR 2SC2712
Q232	8-729-901-02	TRANSISTOR DTC124XK
Q301	8-729-100-66	TRANSISTOR 2SC1623
Q302	8-729-100-66	TRANSISTOR 2SC1623
Q303	8-729-100-76	TRANSISTOR 2SA812
Q304	8-729-100-66	TRANSISTOR 2SC1623
Q305	8-729-107-45	TRANSISTOR 2SC3624A-L16
Q306	8-729-100-76	TRANSISTOR 2SA812
Q501	8-729-800-36	TRANSISTOR 2SD1048
Q502	8-729-271-23	TRANSISTOR 2SC2712
Q701	8-729-304-13	{ICF-PRO80}...TRANSISTOR 2SK360D
Q702	8-729-102-07	{ICF-PRO80}...TRANSISTOR 2SC2223-F13
Q703	8-729-162-45	{ICF-PRO80}...TRANSISTOR 2SB624-BV5
R1	1-216-081-00	METAL CHIP 22K 5% 1/10W
R2	1-216-105-00	METAL CHIP 220K 5% 1/10W
R3	1-216-085-00	METAL CHIP 33K 5% 1/10W
R7	1-216-057-00	METAL CHIP 2.2K 5% 1/10W
R8	1-216-049-00	METAL CHIP 1K 5% 1/10W
R9	1-216-097-00	METAL CHIP 100K 5% 1/10W
R10	1-216-013-00	METAL CHIP 33 5% 1/10W
R11	1-216-097-00	METAL CHIP 100K 5% 1/10W
R12	1-216-017-00	METAL CHIP 47 5% 1/10W
R13	1-216-013-00	METAL CHIP 33 5% 1/10W
R14	1-216-111-00	METAL CHIP 390K 5% 1/10W
R15	1-216-061-00	METAL CHIP 3.3K 5% 1/10W
R16	1-216-043-00	METAL CHIP 560 5% 1/10W
R17	1-216-049-00	(EXCEPT West Germany) ...METAL CHIP 1K 5% 1/10W
R18	1-216-097-00	(EXCEPT West Germany) ...METAL CHIP 100K 5% 1/10W
R19	1-216-033-00	(EXCEPT West Germany) ...METAL CHIP 220 5% 1/10W
R20	1-216-097-00	(EXCEPT West Germany) ...METAL CHIP 100K 5% 1/10W
R21	1-216-025-00	(EXCEPT West Germany) ...METAL CHIP 100 5% 1/10W
R22	1-216-073-00	METAL CHIP 10K 5% 1/10W
R23	1-216-049-00	METAL CHIP 1K 5% 1/10W
R24	1-216-073-00	METAL CHIP 10K 5% 1/10W
R25	1-216-017-00	METAL CHIP 47 5% 1/10W
R26	1-216-065-00	METAL CHIP 4.7K 5% 1/10W
R27	1-216-073-00	METAL CHIP 10K 5% 1/10W
R28	1-216-017-00	METAL CHIP 47 5% 1/10W
R29	1-216-065-00	METAL CHIP 4.7K 5% 1/10W
R30	1-216-049-00	METAL CHIP 1K 5% 1/10W

Ref.No.	Part No.	Description
R31	1-216-049-00	(EXCEPT West Germany) ...METAL CHIP 1K 5% 1/10W
R32	1-216-089-00	(EXCEPT West Germany) ...METAL CHIP 47K 5% 1/10W
R33	1-216-073-00	METAL CHIP 10K 5% 1/10W
R34	1-216-065-00	METAL CHIP 4.7K 5% 1/10W
R35	1-216-083-00	METAL CHIP 27K 5% 1/10W
R36	1-216-069-00	METAL CHIP 6.8K 5% 1/10W
R37	1-216-057-00	METAL CHIP 2.2K 5% 1/10W
R38	1-216-057-00	METAL CHIP 2.2K 5% 1/10W
R39	1-216-025-00	METAL CHIP 100 5% 1/10W
R40	1-216-025-00	METAL CHIP 100 5% 1/10W
R41	1-216-025-00	METAL CHIP 100 5% 1/10W
R42	1-216-037-00	METAL CHIP 330 5% 1/10W
R43	1-216-081-00	METAL CHIP 22K 5% 1/10W
R44	1-216-017-00	METAL CHIP 47 5% 1/10W
R45	1-216-089-00	METAL CHIP 47K 5% 1/10W
R46	1-216-073-00	METAL CHIP 10K 5% 1/10W
R47	1-216-089-00	METAL CHIP 47K 5% 1/10W
R48	1-216-073-00	METAL CHIP 10K 5% 1/10W
R49	1-216-133-00	METAL CHIP 3.3M 5% 1/10W
R50	1-216-025-00	METAL CHIP 100 5% 1/10W
R51	1-216-017-00	METAL CHIP 47 5% 1/10W
R52	1-216-073-00	METAL CHIP 10K 5% 1/10W
R53	1-216-081-00	METAL CHIP 22K 5% 1/10W
R54	1-216-748-11	METAL CHIP 39K 5% 1/10W
R56	1-216-103-00	METAL CHIP 180K 5% 1/10W
R57	1-216-049-00	METAL CHIP 1K 5% 1/10W
R58	1-216-065-00	METAL CHIP 4.7K 5% 1/10W
R59	1-216-049-00	METAL CHIP 1K 5% 1/10W
R60	1-216-077-00	METAL CHIP 15K 5% 1/10W
R61	1-216-073-00	METAL CHIP 10K 5% 1/10W
R62	1-216-089-00	METAL CHIP 47K 5% 1/10W
R63	1-216-073-00	METAL CHIP 10K 5% 1/10W
R64	1-216-107-00	METAL CHIP 270K 5% 1/10W
R65	1-216-053-00	METAL CHIP 1.5K 5% 1/10W
R66	1-216-057-00	METAL CHIP 2.2K 5% 1/10W
R67	1-216-097-00	METAL CHIP 100K 5% 1/10W
R68	1-216-057-00	METAL CHIP 2.2K 5% 1/10W
R69	1-216-057-00	METAL CHIP 2.2K 5% 1/10W
R70	1-216-069-00	METAL CHIP 6.8K 5% 1/10W
R71	1-216-075-00	METAL CHIP 12K 5% 1/10W
R72	1-216-121-00	METAL CHIP 1M 5% 1/10W
R73	1-216-049-00	METAL CHIP 1K 5% 1/10W
R74	1-216-097-00	METAL CHIP 100K 5% 1/10W
R75	1-216-133-00	METAL CHIP 3.3M 5% 1/10W
R76	1-216-089-00	METAL CHIP 47K 5% 1/10W
R77	1-216-105-00	METAL CHIP 220K 5% 1/10W
R78	1-216-069-00	METAL CHIP 6.8K 5% 1/10W
R79	1-216-089-00	METAL CHIP 47K 5% 1/10W
R80	1-216-049-00	METAL CHIP 1K 5% 1/10W
R81	1-216-107-00	METAL CHIP 270K 5% 1/10W
R82	1-216-069-00	METAL CHIP 6.8K 5% 1/10W
R83	1-216-065-00	METAL CHIP 4.7K 5% 1/10W
R84	1-216-069-00	METAL CHIP 6.8K 5% 1/10W
R85	1-216-069-00	METAL CHIP 6.8K 5% 1/10W
R86	1-216-117-00	METAL CHIP 680K 5% 1/10W
R87	1-216-059-00	METAL CHIP 2.7K 5% 1/10W
R88	1-216-061-00	METAL CHIP 3.3K 5% 1/10W

Ref.No.	Part No.	Description								
R89	1-216-037-00	METAL CHIP	330	5%	1/10W					
R90	1-216-085-00	METAL CHIP	33K	5%	1/10W					
R91	1-216-091-00	METAL CHIP	56K	5%	1/10W					
R92	1-216-089-00	METAL CHIP	47K	5%	1/10W					
R93	1-216-085-00	METAL CHIP	33K	5%	1/10W					
R94	1-216-097-00	METAL CHIP	100K	5%	1/10W					
R95	1-216-097-00	METAL CHIP	100K	5%	1/10W					
R96	1-216-065-00	METAL CHIP	4.7K	5%	1/10W					
R97	1-216-049-00	METAL CHIP	1K	5%	1/10W					
R98	1-216-065-00	METAL CHIP	4.7K	5%	1/10W					
R99	1-216-065-00	METAL CHIP	4.7K	5%	1/10W					
R100	1-216-063-00	METAL CHIP	3.9K	5%	1/10W					
R101	1-216-049-00	METAL CHIP	1K	5%	1/10W					
R102	1-216-077-00	METAL CHIP	15K	5%	1/10W					
R103	1-216-077-00	METAL CHIP	15K	5%	1/10W					
R104	1-216-069-00	METAL CHIP	6.8K	5%	1/10W					
R105	1-216-089-00	METAL CHIP	47K	5%	1/10W					
R106	1-216-073-00	METAL CHIP	10K	5%	1/10W					
R107	1-216-061-00	METAL CHIP	3.3K	5%	1/10W					
R108	1-216-059-00	METAL CHIP	2.7K	5%	1/10W					
R109	1-216-049-00	METAL CHIP	1K	5%	1/10W					
R110	1-216-035-00	METAL CHIP	270	5%	1/10W					
R111	1-216-049-00	METAL CHIP	1K	5%	1/10W					
R112	1-216-089-00	METAL CHIP	47K	5%	1/10W					
R113	1-216-073-00	METAL CHIP	10K	5%	1/10W					
R114	1-216-089-00	METAL CHIP	47K	5%	1/10W					
R115	1-216-105-00	METAL CHIP	220K	5%	1/10W					
R116	1-216-037-00	METAL CHIP	330	5%	1/10W					
R117	1-216-085-00	METAL CHIP	33K	5%	1/10W					
R118	1-216-089-00	METAL CHIP	47K	5%	1/10W					
R119	1-216-097-00	METAL CHIP	100K	5%	1/10W					
R120	1-216-093-00	METAL CHIP	68K	5%	1/10W					
R121	1-216-099-00	METAL CHIP	120K	5%	1/10W					
R122	1-216-085-00	METAL CHIP	33K	5%	1/10W					
R123	1-216-073-00	METAL CHIP	10K	5%	1/10W					
R124	1-216-029-00	METAL CHIP	150	5%	1/10W					
R125	1-216-037-00	METAL CHIP	330	5%	1/10W					
R126	1-216-037-00	METAL CHIP	330	5%	1/10W					
R127	1-216-057-00	(EXCEPT West Germany) ...METAL CHIP	2.2K	5%	1/10W					
R129	1-216-295-00	(West Germany) ...METAL CHIP	0	5%	1/10W					
R201	1-216-081-00	METAL CHIP	22K	5%	1/10W					
R202	1-216-073-00	METAL CHIP	10K	5%	1/10W					
R203	1-216-081-00	METAL CHIP	22K	5%	1/10W					
R204	1-216-081-00	METAL CHIP	22K	5%	1/10W					
R205	1-216-097-00	METAL CHIP	100K	5%	1/10W					
R206	1-216-089-00	METAL CHIP	47K	5%	1/10W					
R207	1-216-089-00	METAL CHIP	47K	5%	1/10W					
R208	1-216-097-00	METAL CHIP	100K	5%	1/10W					
R209	1-216-041-00	METAL CHIP	470	5%	1/10W					
R210	1-216-049-00	METAL CHIP	1K	5%	1/10W					
R211	1-216-079-00	METAL CHIP	18K	5%	1/10W					
R212	1-216-073-00	METAL CHIP	10K	5%	1/10W					
R213	1-216-045-00	METAL CHIP	680	5%	1/10W					
R214	1-216-085-00	METAL CHIP	33K	5%	1/10W					
R215	1-216-021-00	METAL CHIP	68	5%	1/10W					
R216	1-216-298-00	METAL CHIP	2.2	5%	1/10W					
R217	1-216-081-00	METAL CHIP	22K	5%	1/10W					
R218	1-216-073-00	METAL CHIP	10K	5%	1/10W					
R219	1-216-073-00	METAL CHIP	10K	5%	1/10W					
R220	1-216-081-00	METAL CHIP	22K	5%	1/10W					
R221	1-216-081-00	METAL CHIP	22K	5%	1/10W					
R222	1-216-081-00	METAL CHIP	22K	5%	1/10W					
R223	1-216-081-00	METAL CHIP	22K	5%	1/10W					
R224	1-216-097-00	METAL CHIP	100K	5%	1/10W					
R225	1-216-073-00	METAL CHIP	10K	5%	1/10W					
R226	1-216-081-00	METAL CHIP	22K	5%	1/10W					
R227	1-216-081-00	METAL CHIP	22K	5%	1/10W					
R228	1-216-089-00	METAL CHIP	47K	5%	1/10W					
R229	1-216-091-00	METAL CHIP	56K	5%	1/10W					
R230	1-216-089-00	METAL CHIP	47K	5%	1/10W					
R231	1-216-073-00	METAL CHIP	10K	5%	1/10W					
R232	1-216-049-00	METAL CHIP	1K	5%	1/10W					
R233	1-216-097-00	METAL CHIP	100K	5%	1/10W					
R234	1-216-097-00	METAL CHIP	100K	5%	1/10W					
R235	1-216-061-00	METAL CHIP	3.3K	5%	1/10W					
R236	1-216-081-00	METAL CHIP	22K	5%	1/10W					
R237	1-216-049-00	METAL CHIP	1K	5%	1/10W					
R238	1-216-061-00	METAL CHIP	3.3K	5%	1/10W					
R239	1-216-073-00	METAL CHIP	10K	5%	1/10W					
R240	1-216-049-00	METAL CHIP	1K	5%	1/10W					
R241	1-216-113-00	METAL CHIP	470K	5%	1/10W					
R242	1-216-097-00	METAL CHIP	100K	5%	1/10W					
R243	1-216-097-00	METAL CHIP	100K	5%	1/10W					
R244	1-216-005-00	METAL CHIP	15	5%	1/10W					
R245	1-216-049-00	METAL CHIP	1K	5%	1/10W					
R246	1-216-049-00	METAL CHIP	1K	5%	1/10W					
R247	1-216-049-00	METAL CHIP	1K	5%	1/10W					
R248	1-216-097-00	METAL CHIP	100K	5%	1/10W					
R249	1-216-097-00	METAL CHIP	100K	5%	1/10W					
R250	1-216-025-00	METAL CHIP	100	5%	1/10W					
R251	1-216-073-00	METAL CHIP	10K	5%	1/10W					
R252	1-216-031-00	METAL CHIP	180	5%	1/10W					
R253	1-216-013-00	METAL CHIP	33	5%	1/10W					
R254	1-216-017-00	METAL CHIP	47	5%	1/10W					
R255	1-216-067-00	METAL CHIP	5.6K	5%	1/10W					
R256	1-216-067-00	METAL CHIP	5.6K	5%	1/10W					
R257	1-216-061-00	METAL CHIP	3.3K	5%	1/10W					
R258	1-216-097-00	METAL CHIP	100K	5%	1/10W					
R259	1-216-099-00	METAL CHIP	120K	5%	1/10W					
R260	1-216-033-00	METAL CHIP	220	5%	1/10W					
R261	1-216-073-00	METAL CHIP	10K	5%	1/10W					
R262	1-216-031-00	METAL CHIP	180	5%	1/10W					
R263	1-216-021-00	METAL CHIP	68	5%	1/10W					
R264	1-216-017-00	METAL CHIP	47	5%	1/10W					
R301	1-216-085-00	METAL CHIP	33K	5%	1/10W					
R302	1-216-049-00	METAL CHIP	1K	5%	1/10W					
R303	1-216-097-00	METAL CHIP	100K	5%	1/10W					
R304	1-216-097-00	(ICF-PRO80)...	METAL CHIP	100K	5%	1/10W				
R305	1-216-049-00	METAL CHIP	1K	5%	1/10W					
R306	1-216-049-00	METAL CHIP	1K	5%	1/10W					
R307	1-216-049-00	METAL CHIP	1K	5%	1/10W					
R308	1-216-097-00	METAL CHIP	100K	5%	1/10W					

# ICF-PRO70/PRO80

Ref.No.	Part No.	Description			
R309	1-216-097-00	METAL CHIP	100K	5%	1/10W
R310	1-216-097-00	METAL CHIP	100K	5%	1/10W
R311	1-216-049-00	(ICF-PRO80)...METAL CHIP	1K	5%	1/10W
R312	1-216-049-00	METAL CHIP	1K	5%	1/10W
R313	1-216-097-00	METAL CHIP	100K	5%	1/10W
R314	1-216-049-00	METAL CHIP	1K	5%	1/10W
R315	1-216-099-00	METAL CHIP	120K	5%	1/10W
R316	1-216-037-00	METAL CHIP	330	5%	1/10W
R317	1-216-037-00	METAL CHIP	330	5%	1/10W
R318	1-216-017-00	METAL CHIP	47	5%	1/10W
R319	1-216-049-00	METAL CHIP	1K	5%	1/10W
R320	1-216-049-00	METAL CHIP	1K	5%	1/10W
R321	1-216-073-00	METAL CHIP	10K	5%	1/10W
R322	1-216-049-00	METAL CHIP	1K	5%	1/10W
R323	1-216-049-00	METAL CHIP	1K	5%	1/10W
R324	1-216-049-00	METAL CHIP	1K	5%	1/10W
R325	1-216-049-00	METAL CHIP	1K	5%	1/10W
R326	1-216-097-00	METAL CHIP	100K	5%	1/10W
R327	1-216-097-00	METAL CHIP	100K	5%	1/10W
R328	1-216-097-00	METAL CHIP	100K	5%	1/10W
R329	1-216-097-00	METAL CHIP	100K	5%	1/10W
R330	1-216-097-00	METAL CHIP	100K	5%	1/10W
R331	1-216-049-00	METAL CHIP	1K	5%	1/10W
R332	1-216-049-00	METAL CHIP	1K	5%	1/10W
R334	1-216-049-00	METAL CHIP	1K	5%	1/10W
R335	1-216-049-00	METAL CHIP	1K	5%	1/10W
R336	1-216-049-00	METAL CHIP	1K	5%	1/10W
R337	1-216-049-00	METAL CHIP	1K	5%	1/10W
R338	1-216-049-00	METAL CHIP	1K	5%	1/10W
R339	1-216-049-00	METAL CHIP	1K	5%	1/10W
R340	1-216-049-00	METAL CHIP	1K	5%	1/10W
R341	1-216-049-00	METAL CHIP	1K	5%	1/10W
R342	1-216-049-00	METAL CHIP	1K	5%	1/10W
R343	1-216-049-00	METAL CHIP	1K	5%	1/10W
R344	1-216-049-00	METAL CHIP	1K	5%	1/10W
R345	1-216-049-00	METAL CHIP	1K	5%	1/10W
R346	1-216-097-00	METAL CHIP	100K	5%	1/10W
R347	1-216-085-00	METAL CHIP	33K	5%	1/10W
R348	1-216-121-00	METAL CHIP	1M	5%	1/10W
R349	1-216-121-00	METAL CHIP	1M	5%	1/10W
R350	1-216-121-00	METAL CHIP	1M	5%	1/10W
R351	1-216-049-00	METAL CHIP	1K	5%	1/10W
R352	1-216-049-00	METAL CHIP	1K	5%	1/10W
R353	1-216-097-00	METAL CHIP	100K	5%	1/10W
R354	1-216-081-00	METAL CHIP	22K	5%	1/10W

Ref.No.	Part No.	Description			
R355	1-216-049-00	METAL CHIP	1K	5%	1/10W
R356	1-216-097-00	METAL CHIP	100K	5%	1/10W
R357	1-216-099-00	METAL CHIP	120K	5%	1/10W
R358	1-216-113-00	METAL CHIP	470K	5%	1/10W
R359	1-216-073-00	METAL CHIP	10K	5%	1/10W
R360	1-216-097-00	METAL CHIP	100K	5%	1/10W
R361	1-216-101-00	METAL CHIP	150K	5%	1/10W
R362	1-216-085-00	METAL CHIP	33K	5%	1/10W
R363	1-216-017-00	METAL CHIP	47	5%	1/10W
R364	1-216-017-00	METAL CHIP	47	5%	1/10W
R365	1-216-017-00	METAL CHIP	47	5%	1/10W
R366	1-216-097-00	METAL CHIP	100K	5%	1/10W
R367	1-216-097-00	METAL CHIP	100K	5%	1/10W
R368	1-216-025-00	METAL CHIP	100	5%	1/10W
R369	1-216-049-00	METAL CHIP	1K	5%	1/10W
R370	1-216-049-00	METAL CHIP	1K	5%	1/10W
R401	1-216-295-00	METAL CHIP	0	5%	1/10W
R402	1-216-295-00	METAL CHIP	0	5%	1/10W
R403	1-216-295-00	METAL CHIP	0	5%	1/10W
R404	1-216-295-00	METAL CHIP	0	5%	1/10W
R405	1-216-295-00	METAL CHIP	0	5%	1/10W
R406	1-216-295-00	METAL CHIP	0	5%	1/10W
R407	1-216-295-00	METAL CHIP	0	5%	1/10W
R501	1-216-095-00	METAL CHIP	82K	5%	1/10W
R502	1-216-049-00	METAL CHIP	1K	5%	1/10W
R503	1-216-089-00	METAL CHIP	47K	5%	1/10W
R504	1-216-091-00	METAL CHIP	56K	5%	1/10W
R701	1-216-097-00	(ICF-PRO80)...METAL CHIP	100K	5%	1/10W
R702	1-216-018-00	(ICF-PRO80)...METAL CHIP	51	5%	1/10W
R703	1-216-056-00	(ICF-PRO80)...METAL CHIP	2K	5%	1/10W
R704	1-216-081-00	(ICF-PRO80)...METAL CHIP	22K	5%	1/10W
R705	1-216-029-00	(ICF-PRO80)...METAL CHIP	150	5%	1/10W
R706	1-216-081-00	(ICF-PRO80)...METAL CHIP	22K	5%	1/10W
R707	1-216-025-00	(ICF-PRO80)...METAL CHIP	100	5%	1/10W
R708	1-216-085-00	(ICF-PRO80)...METAL CHIP	33K	5%	1/10W
R709	1-216-025-00	(ICF-PRO80)...METAL CHIP	100	5%	1/10W
R710	1-216-049-00	(ICF-PRO80)...METAL CHIP	1K	5%	1/10W
R711	1-216-081-00	(ICF-PRO80)...METAL CHIP	22K	5%	1/10W
R712	1-216-049-00	(ICF-PRO80)...METAL CHIP	1K	5%	1/10W
R713	1-216-065-00	(ICF-PRO80)...METAL CHIP	4.7K	5%	1/10W
RT1	1-237-406-21	RES, ADJ, METAL GLAZE	22K		
RV101	1-230-538-11	RES, VAR, CARBON (WITH SW S101)	50K(SQL)		
RV201	1-237-670-11	RES, VAR, CARBON (WITH SW S201)	20K (VOLUME, TONE)		
RV202	1-237-651-11	RES, VAR, CARBON (WITH SW S202)	100K (FINE/SSB, PAGE)		

Ref.No.	Part No.	Description
S203	1-554-957-11	SWITCH, PUSH (1 KEY)(POWER)
S301	1-554-956-11	SWITCH, LEAF (LIGHT)
S302	1-553-977-31	SWITCH, SLIDE (WM CH STEP)
S303	1-553-977-31	(ICF-PRO80)...SWITCH, SLIDE (FREQ DISPLAY)
S304	1-554-371-51	SWITCH, TACT (RESET)
S701	1-554-903-21	(ICF-PRO80)...SWITCH, SLIDE(ATTENUATOR)
S702	1-554-903-21	(ICF-PRO80)...SWITCH, SLIDE (FILTER)
SP1	1-503-374-11	SPEAKER
T1	1-459-718-11	COIL (WITH CORE)
T2	1-459-719-11	(EXCEPT West Germany)..COIL (WITH CORE)
T3	1-404-729-11	TRANSFORMER, IF
T4	1-426-309-11	TRANSFORMER, HIGH FREQUENCY
T5	1-426-311-11	TRANSFORMER, HIGH FREQUENCY
T6	1-426-308-11	TRANSFORMER, HIGH FREQUENCY
T7	1-426-310-11	TRANSFORMER, HIGH FREQUENCY
T8	1-404-731-11	TRANSFORMER, IF
T9	1-404-730-11	TRANSFORMER, IF
T10	1-404-727-11	TRANSFORMER, IF
T11	1-404-648-11	TRANSFORMER, IF
T12	1-404-726-11	TRANSFORMER, IF
T501	1-406-231-11	COIL (OSC)
T701	1-426-312-11	(ICF-PRO80) ...TRANSFORMER, HIGH FREQUENCY
T702	1-406-236-11	(ICF-PRO80)...COIL (OSC)
X1	1-567-841-11	VIBRATOR, CERAMIC
X2	1-567-843-11	VIBRATOR, CRYSTAL
X201	1-567-847-11	VIBRATOR, CRYSTAL
X701	1-567-871-11	(ICF-PRO80)...VIBRATOR, CRYSTAL
XF1	1-567-842-11	FILTER, CRYSTAL

ACCESSORY & PACKING MATERIAL

1-501-377-11	(EXCEPT West Germany)...ANTENNA, TELESCOPIC
1-501-412-11	(West Germany)...ANTENNA, TELESCOPIC
1-504-059-11	MAGNETIC EARPHONE(ME-20H)
1-566-456-11	(EXCEPT West Germany)...ADAPTOR, PLUG (TNC-BNC)
*3-764-869-11	(ICF-PRO70)...INSTRUCTION, DBP CAUTION
*3-701-616-00	BAG, POLYETHYLENE
3-890-830-00	BAG, POLYETHYLENE
*3-701-617-00	(ICF-PRO80)...BAG, POLYETHYLENE, STANDARD
3-887-285-07	(ICF-PRO70:Saudi Arabia) ...GUIDE BOOK, RADIO WAVE
3-893-708-01	BELT, CARRYING
3-893-761-01	(ICF-PRO70:E,Saudi Arabia,West Germany ICF-PRO80:US,Canadian,UK,E).....SPACER
3-893-771-01	(EXCEPT West Germany) ...HOLDER, TELESCOPIC ANTENNA
3-893-802-04	(EXCEPT Saudi Arabia)..GUIDE BOOK, RADIO WAVE
3-898-209-01	CUSHION
3-898-240-01	CASE, CARRYING
3-898-206-01	(ICF-PRO70)...CARTON, INDIVIDUAL
3-898-210-01	(ICF-PRO80)...CARTON, INDIVIDUAL
3-990-095-11	(ICF-PRO70:E,AEP,ICF-PRO80) ...MANUAL, INSTRUCTION
3-990-095-41	(ICF-PRO70:AEP,ICF-PRO80:AEP) ...MANUAL, INSTRUCTION
3-990-095-51	(ICF-PRO70:Saudi Arabia) ...MANUAL, INSTRUCTION
3-990-095-71	(ICF-PRO70:West Germany) ...MANUAL, INSTRUCTION

