

77  
84

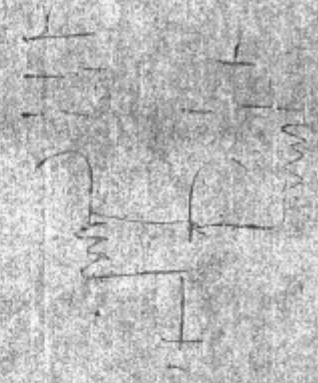

10  
11  
12  
13  
14  
15  
16  
17  
18  
19  
20  
21  
22  
23  
24  
25  
26  
27  
28  
29  
30  
31  
32  
33  
34  
35  
36  
37  
38  
39  
40  
41  
42  
43  
44  
45  
46  
47  
48  
49  
50  
51  
52  
53  
54  
55  
56  
57  
58  
59  
60  
61  
62  
63  
64  
65  
66  
67  
68  
69  
70  
71  
72  
73  
74  
75  
76  
77  
78  
79  
80  
81  
82  
83  
84  
85  
86  
87  
88  
89  
90  
91  
92  
93  
94  
95  
96  
97  
98  
99  
100



---

**COMPAGNIE GÉNÉRALE DE MÉTROLOGIE**

---

ANNECY

FRANCE

**COMPAGNIE  
GÉNÉRALE DE MÉTROLOGIE**

ANNECY - FRANCE



**BON DE GARANTIE**

Modèle ..... 210 ..... N° ..... 210 457 .....

L'appareil ci-dessus a subi avec satisfaction les essais et contrôles aux différents stades de sa fabrication.

Il est garanti pendant UN AN, à dater de sa sortie d'usine, contre tout vice de construction ou de matière première, à l'exclusion des lampes et redresseurs.

Cette garantie comprend le remplacement ou la réparation gratuite à notre Usine de toute pièce ou partie de montage reconnue défectueuse. Les frais de port et éventuellement de l'emballage restent à la charge de nos clients.

En cas de réparation par les soins de nos dépanneurs officiels, les pièces de rechange sous garantie sont fournies gratuitement ; seule la main d'œuvre sera facturée à prix réduit.

Nous déclinons notre responsabilité en cas de mal-façons survenues lors de l'utilisation ou à la suite de modifications ou réparations non conformes effectuées sur nos appareils pendant le délai de garantie.

Après l'expiration du délai d'un an, nous restons, ainsi que nos Agences, à l'entière disposition de notre clientèle pour toute remise en état aux meilleures conditions.

TELEVISION WOBULATOR Type 210

---

C O N T E N T S

|                                      | Pages     |
|--------------------------------------|-----------|
| I - GENERAL .....                    | 1         |
| II - DESCRIPTION .....               | 1 - 2     |
| III- WORKING INSTRUCTIONS.....       | 2 - 3 - 4 |
| IV - TECHNICAL CHARACTERISTICS ..... | 4         |
| V - REPLACEABLE PARTS LIST .....     | 5 - 6     |

ANNEX :     SCHEMATIC DIAGRAM, 210  
              SCHEMATIC DIAGRAMS, PROBES & FILTER

## TELEVISION WOBULATOR Type 210

---

### I - GENERAL -

This instrument has been designed for production lines and research on wide band amplifiers such as those used in television and frequency modulation receivers. Its outstanding performance is due to the incorporation of original ideas specially adapted to this new technique.

In particular the range 5 - 220 Mc/s is covered on a single scale without switching. All I.F. stages can therefore be aligned, whatever may be their working frequencies, and so can R.F. and local oscillator stages up to and including 220 Mc/s.

This very wide frequency range is obtained by using the difference in frequency between two oscillators, one being swept about a fixed frequency and the other being unmodulated but variable. Both frequencies are always higher than 220 Mc/s.

A great advantage of this system is that only the wanted frequency can act on the circuit under test, all other frequencies being higher. This result is not possible if the sum of the internal oscillator frequencies is used.

Other features are:

Frequency sweeping is obtained by a system of variable permeability. Neither mechanical parts nor electronic tubes are used, this leading to stability and linearity.

The high attenuable output allows the use of any oscilloscope provided with a horizontal amplifier, even if the oscilloscope is not very sensitive or the receiver out of alignment.

### II - DESCRIPTION -

(See circuit diagram)

A) R.F. group : V2 is an oscillator whose frequency is swept about the fixed frequency of 260 Mc/s. The sweep is obtained by the use of a ferrite core in the oscillator coil. A permanent magnet provides a stable polarizing field which fixes the working point and a coil wound on a stack of A.F. iron stampings provides an alternating field which sweeps the permeability of the ferrite core about the working point. The polarizing field determines the centre frequency and the alternating field, which may be controlled from the front panel, determines the sweep width, 1 to 20 Mc/s in 5 steps.

V 4 is an unmodulated Lecher line oscillator whose frequency is variable from 260 to 480 Mc/s. The line length, hence the frequency, is controlled from the main dial.

V 3 is a mixer to whose grid the outputs of V2 and V4 are fed. The output of V3, which includes the range 5 to 220 Mc/s, is fed to an attenuator whose output impedance is 75 Ohms in all positions.

.../...

B) Oscilloscope Horizontal sweep.-

Transformer T 1, which provides the modulation current to the R.F. section, also delivers a voltage whose phase is adjustable with respect to the modulation and which is used for the oscilloscope horizontal sweep.

Curves should be taken with the return trace blanked, the R.F. output being suppressed during the return trace.

C) Power supply -

A normal power supply feeds the oscillators and mixer.

D) Stray radiation suppression -

The principal screen is that over the R.F. section with filters in all outgoing leads. A second screen is the metal case and front panel with filters in the horizontal sweep output and in the power line.

III - WORKING INSTRUCTIONS.-

Overall response curve of a receiver -

Before connecting the power supply make sure that the power supply voltage switch is in the correct position for the power supply in use and that the power supply frequency is 50 - 60 c/s.

Connect the output of the 210 to the input of the receiver under test by means of the unmatched 75 Ohms cable supplied.

Connect the oscilloscope vertical amplifier to the detector load resistance of the receiver.

Connect the oscilloscope horizontal amplifier to binding posts  
← and 

Set the oscilloscope horizontal amplitude so that the whole of the trace appears on the screen.

Set the TRACE switch to ADJUST.

Set the main dial to the required centre frequency and the SWEEP WIDTH switch to the width required.

The curve may then be made to appear conveniently on the oscilloscope screen by a judicious use of :

- the 210 attenuator,
- the receiver contrast control, and
- the oscilloscope vertical amplitude control.

The use of these three controls will usually be sufficient to produce a conveniently sized trace without any sign of "noise" or saturation. If, however, the 210 attenuator steps of 10 are too widely spaced, the 10 dB coaxial attenuator interposed in the output cable will give intermediate steps.

.... / ....

Superpose the forward and return trace curves by means of the ADJUST PHASE control.

Set the trace in the centre of the oscilloscope screen by adjusting the main dial.

If necessary retouch the oscilloscope vertical amplitude control and the phase adjustment.

Set the TRACE switch to RETURN BLANKED to produce a single curve with a base line.

Marker in pass band.-

The main dial is engraved in centre frequencies, i.e. the frequency to which the centre of the trace corresponds when the phase is correctly set, but generally this is not sufficiently accurate to evaluate frequency and a marker is necessary.

If the output of an unmodulated R.F. generator, the METRIX 936 for instance, is injected into the coaxial MARKER jack a pip appears on the curve traced on the oscilloscope screen. To avoid deforming the curve the marker output should be reduced to the minimum consistent with adequate visibility of the pip, (50 to 100 mV).

If the pip should appear too wide on the curve the pass band of the oscilloscope amplifier should be reduced by connecting a small condenser in parallel with the input. Since the sides of the curve to be observed correspond to relatively long rise times the pip will be reduced in width but the curve will not be deformed.

Remarks.-

Stray radiation by marker.-

Under certain conditions when the receiver gain is set to maximum, measurements may be rendered difficult by stray radiation of the swept frequency from the cable connecting the marker generator to the 210.

To avoid this effect disconnect the marker from the 210 and connect an unscreened lead to the marker output.

Bring the open end of this lead near the receiver input. Coupling to the receiver will take place by radiation or stray capacity.

Use of the coaxial 10 dB attenuator.-

The input impedance of certain circuits may be far from the 75 Ohms resistance necessary to match the 210 output cable and, although this may not deform the response curve obtained, the circuit and cable may become sensitive to the approach of the hand. To avoid this state of affairs connect the 10 dB attenuator at the end of the 210 output cable and connect the output of the attenuator to the circuit under test by shortest possible connections.

Stage by stage measurements.-

Whether the amplifier is stagger tuned or contains over coupled circuits there are times when stage by stage measurements become

... / ...

necessary. An overall check does not directly reveal which circuit to adjust if the amplifier is out of alignment. Since the circuits of these amplifiers are tuned by extremely small capacities, often stray wiring and interelectrode tube capacities, it is impossible to make connections to them without producing detuning.

Nevertheless, with the two probes available the 210 can be used to produce a response curve for an single circuit. The injector probe (see circuit diagram) matches the 210 output cable and connects to the grid of the tube preceding the circuit under test. The condenser avoids short circuiting any D.C. voltages present whilst the 75 ohms resistance renders the grid circuit aperiodic. The detector probe connects to the plate of the tube following the circuit under test. The condenser blocks any D.C. voltages and the 75 ohms resistance renders this plate circuit aperiodic. By this means the circuit under test is not perturbed and all other tuned circuits are so heavily damped that their response curves cannot disturb the measurement.

Use of the filter.-

In a few cases the presence of unwanted frequencies may render an adjustment difficult ; this may be so with neutralised R.F. stages or with certain receivers whose image frequency is 260 Mc/s (frequency of oscillator V2).

To suppress these unwanted frequencies a low pass filter is available, cut-off frequency 230 Mc/s, which is connected in the 210 output cable.

Miscellaneous precautions -

Line and frame frequency generators in a television receiver produce high amplitude signals, very rich in harmonics, which may be picked up directly by the oscilloscope vertical amplifier and its connections.

Where possible it is a good thing to disconnect these generators as long as this does not radically change the amplifier B supply voltage.

Another advantage of doing this is that the picture tube high tension disappears and so there is no need for the excessive precautions which otherwise are necessary.

IV - TECHNICAL CHARACTERISTICS -

Frequency : 5 to 220 Mc/s in one range

Accuracy : That of the marker generator (o.g. METRIX 936)

Output : Not less than 100 mV attenuable in steps of 10 down to 10 uV.

Sweep width : 1 - 2 - 5 - 10 - 20 Mc/s.

Linearity : 10 % at sweep width 10 Mc/s.

Amplitude modulation : Less than 10 % at sweep width 10 Mc/s.

Power supply : I10 - I30 - 220 V, 50 - 60 c/s  
130 V may be replaced by 160 V } on demand.  
220 V. may be replaced by 240 }

Power input : 35 VA approx.

Tubes used : 2 x EC 81 - 1 x 6 J 6 - 1 x 6 x 4.

Weight : 20 lbs 8 ozs (9,300 Kg)

Dimensions : 20 x 11 1/2 x 7 5/8 ins. (510 x 295 x 195 mm) overall

REPLACEABLE PARTS LIST

| Symbol               | Value             | DESCRIPTION            | METRIX PART N° |
|----------------------|-------------------|------------------------|----------------|
| <u>RESISTANCES</u>   |                   |                        |                |
| R 1                  | 1 K Ω             | + 5 % PE IO MCB        |                |
| R 3                  | 0,1 M Ω           | 1/2 W. IO %            |                |
| R 4                  | 70 K Ω            | 1/2 W. IO %            |                |
| R 5                  | 20 K Ω            | 1/2 W. IO %            |                |
| R 6                  | 75 K Ω            | 1 W. IO %              |                |
| R 7                  | 10 K Ω            | 1 W. IO %              |                |
| R 8                  | 300 Ω             | 1/2 W. IO %            |                |
| R 9                  | 100 Ω             | 1/2 W. IO %            |                |
| R 10                 | 371 Ω             | 1/4 W. I %             |                |
| R 11                 | 371 Ω             | 1/4 W. I %             |                |
| R 12                 | 371 Ω             | 1/4 W. I %             |                |
| R 13                 | 371 Ω             | 1/4 W. I %             |                |
| R 14                 | 41 Ω              | 1/4 W. I %             |                |
| R 15                 | 45,8 Ω            | 1/4 W. I %             |                |
| R 16                 | 45,8 Ω            | 1/4 W. I %             |                |
| R 17                 | 45,8 Ω            | 1/4 W. I %             |                |
| R 18                 | 91,7 Ω            | 1/4 W. I %             |                |
| R 19                 | 200 Ω             | 1/2 W. 3 %             |                |
| R 20                 | 20 K Ω            | 1/2 W. IO %            | UE 29          |
| R 21                 | 1 K Ω             | 1/2 W. IO %            |                |
| R 22                 | 2 K Ω             | 1 W. IO %              |                |
| <u>POTENTIOMETER</u> |                   |                        |                |
| R 2                  | 50 K Ω            | ALTER Type VC 45       | UA 60          |
| <u>CONDENSERS</u>    |                   |                        |                |
| C 1                  | 15 μ F            | Electrolytic 500-550 v |                |
| C 2                  | 16 μ F            | Electrolytic 500-550 v |                |
| C 3                  | Filter            | Mica                   |                |
| C 4                  | 30.000 pF approx. | Paper 500/1500 V       |                |
| C 5                  | 1 μ F approx.     | Paper 500/1500 V       |                |
| C 6                  | 0,5 μ F           | 10 % Paper 500/1500 V  |                |
| C 7                  | Filter            | Mica                   |                |
| C 8                  | Filter            | Mica                   |                |
| C 9                  | Filter            | Mica                   |                |
| C 10                 | Filter            | mica                   |                |
| C 11                 | Filter            | mica                   |                |
| C 12                 | 22 pF             | 20 % ceramic RT        |                |
| C 13                 | 1,8 pF            | 20 % ceramic RT        |                |
| C 14                 | Filter            | mica                   |                |
| C 15                 | 1000 pF           | 10 % mica              |                |
| C 16                 | 50 pF             | ALTER button type      |                |
| C 17                 | Filter            | mica                   |                |

... / ...



| Symbol | Value           | Description         | METRIX PART N° |
|--------|-----------------|---------------------|----------------|
|        |                 | <u>TRANSFORMER</u>  |                |
| T I    |                 | Power supply        | LA 87          |
|        |                 | <u>FILTERS</u>      |                |
| L I    |                 | Power supply        | LC 46          |
| L 2    |                 | Power supply        | LC 46          |
| L 3    |                 | Oscillo sweep       | LC 8I          |
| L 4    |                 | R. F.               | LC 46          |
| L 5    |                 | R. F.               | LC 46          |
| L 6    |                 | R. F.               | LC 46          |
| L 7    |                 | R. F.               | LC 46          |
| L 8    |                 | R. F.               | LC 46          |
| L 9    |                 | <u>SWEEP WIDTH</u>  | LB 27          |
|        |                 | <u>SWITCHES</u>     |                |
| A      |                 | Power supply        | KE 70          |
| B      |                 | Sweep width         | KE 93          |
| C      |                 | Attenuator          | KE 74          |
|        |                 | <u>FUSE</u>         |                |
| F I    | I.5 A           |                     | AA 44          |
|        |                 | <u>TUBES</u>        |                |
| V I    | 6 B X 4 (6 X 4) | Rectifier           |                |
| V 2    | E C 8I          | Swopt oscillator    |                |
| V 3    | 6 J 6           | Mixer               |                |
| V 4    | E C 8I          | Variable oscillator |                |

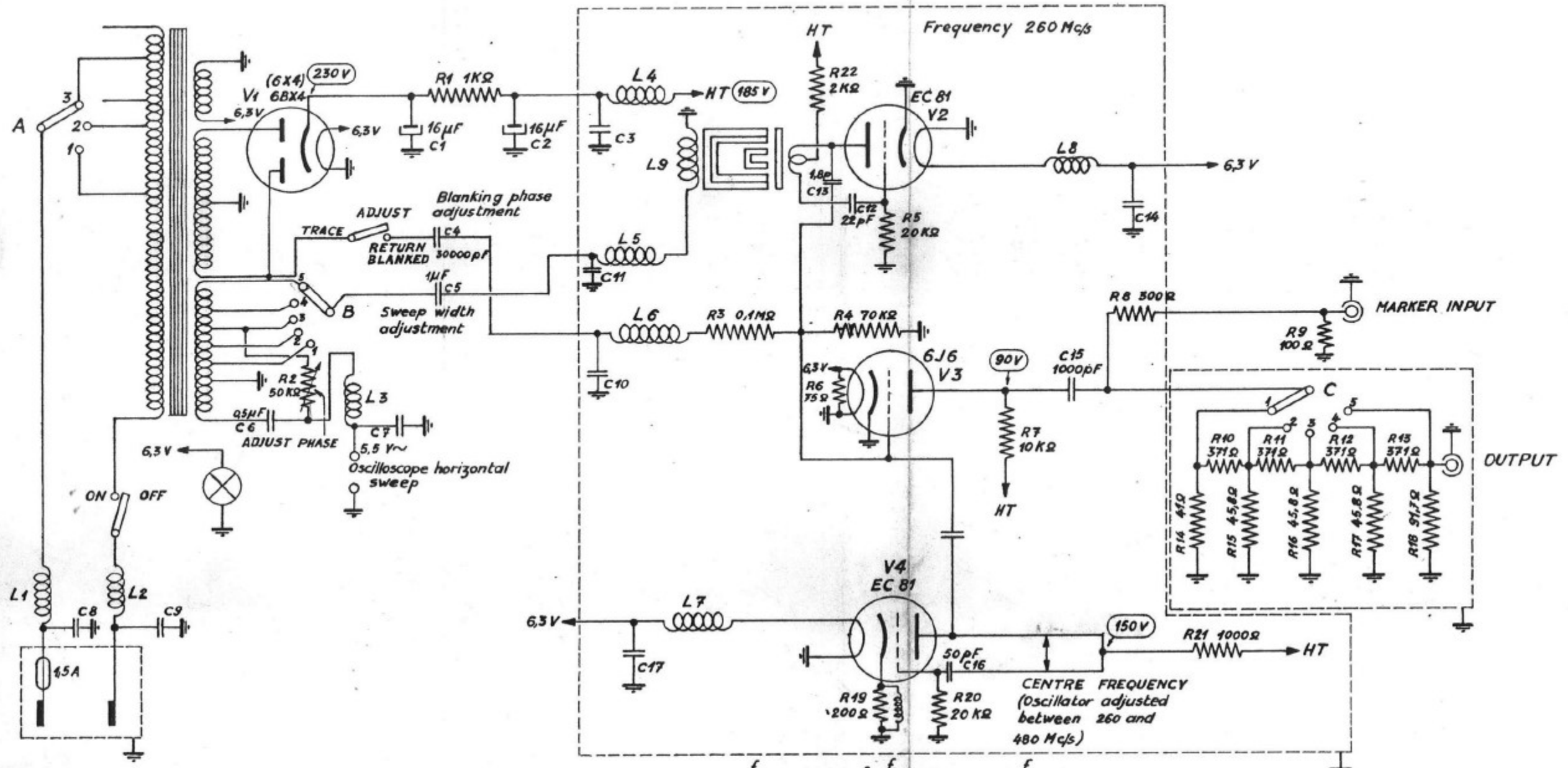

- Switch A  
 pos 1 = 110 V  
 pos 2 = 130V (160V)  
 pos 3 = 220V (240V)
- Switch B  
 pos 1 = 1 Mc/s  
 pos 2 = 2 Mc/s  
 pos 3 = 5 Mc/s  
 pos 4 = 10 Mc/s  
 pos 5 = 20 Mc/s
- Switch C  
 pos 1 = 10 μV  
 pos 2 = 100 μV  
 pos 3 = 1 mV  
 pos 4 = 10 mV  
 pos 5 = 100 mV

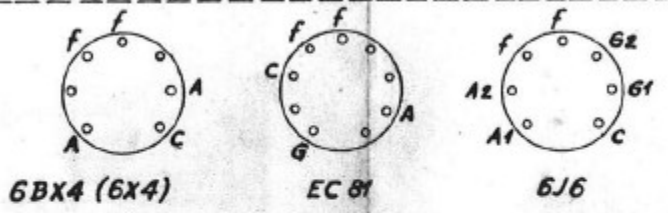

Voltages measured with METRIX 476 on range giving greatest deviation.

Wobulator type 210 Schematic Diagram

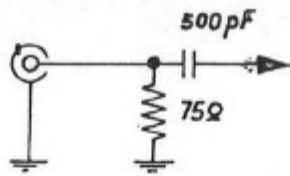

*Injection Probe*

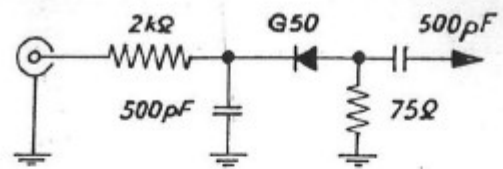

*Detector Probe*

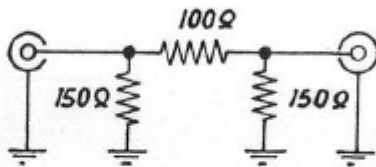

*10 dB Attenuator*

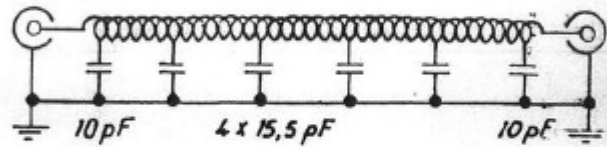

*Low-pass Filter,  $f_0 = 230 \text{ Mc/s}$*

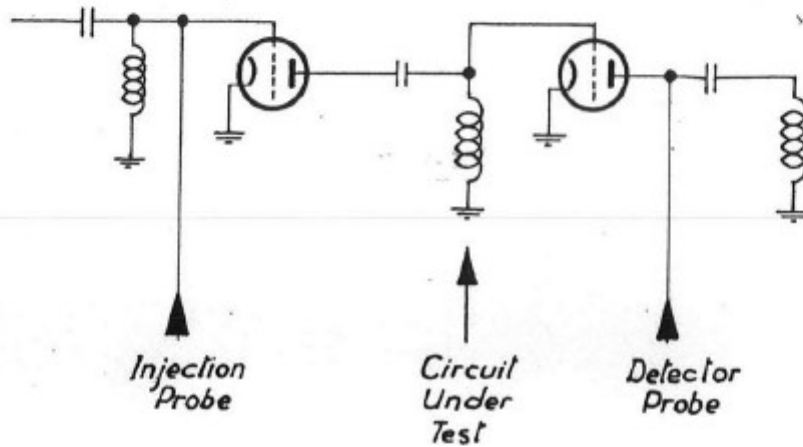

### LIST OF ACCESSORIES

| Quantity | Designation                               | Metrix N° |
|----------|---|-----------|
| 1        | Wobulator type 210                        |           |
| 1        | Power cord                                | AG 1      |
| 1        | Output cable                              | HB 73     |
| 1        | Marker cable                              | HB 73     |
| 1        | 10 dB attenuator                          | AA 92     |
| 1        | Injection probe                           | HA 164    |
| 1        | Detector probe                            | HA 165    |
| 1        | Detector probe cable                      | HA 166    |
| 1        | Low-pass filter, $f_0 = 230 \text{ Mc/s}$ | HA 167    |
| 1        | Filter cable                              | HA 168    |

## Accessories 210