

OPERATING INSTRUCTIONS

TYPE 1211-B UNIT OSCILLATOR



A
GR
UNIT
INSTRUMENT

... SINCE 1915
*manufacturers of
electronic apparatus
for science and industry*



GENERAL RADIO COMPANY
CAMBRIDGE 39, MASSACHUSETTS, USA

K4XL's **BAMA**

This manual is provided **FREE OF CHARGE** from the "BoatAnchor Manual Archive" as a service to the Boatanchor community.

It was uploaded by someone who wanted to help you repair and maintain your equipment.

If you paid anyone other than BAMA for this manual, you paid someone who is making a profit from the free labor of others without asking their permission.

You may pass on copies of this manual to anyone who needs it. But do it without charge.

Thousands of files are available without charge from BAMA. Visit us at <http://bama.sbc.edu>

SPECIFICATIONS

FREQUENCY RANGE	0.5 to 50 Mc in two ranges.		
FREQUENCY CALIBRATION ACCURACY	± 2 percent at no load.		
FREQUENCY CONTROLS	A two-position range switch, a six-inch dial with calibration approximately logarithmic vs angular rotation, and a slow-motion dial to indicate frequency increments of 0.2 percent per dial division.		
OUTPUT SYSTEM	Output available at a coaxial connector at rear of instrument. Adjacent ground terminal also permits connection by Type 274-M Plug. Output is controlled by a dial calibrated in arbitrary units.		
OUTPUT POWER	At least 200 milliwatts with a 50-ohm load at any frequency within the range. For the 0.5 - 5-Mc range, output power is in the order of 2 watts.		
MODULATION	Direct amplitude modulation over the audio-frequency range can be obtained with an external audio oscillator. Impedance at the modulation jack is about 8000 ohms, and 25-percent modulation is obtained with about 45 volts. Under these conditions, envelope distortion is in the order of three percent, and is a function of carrier-frequency setting. The audio source must be capable of carrying the 50-ma direct current of the carrier oscillator. For amplitude modulation free from incidental fm, a Type 1000-P6 Crystal Diode Modulator can be used at carrier frequencies above 10 Mc.		
CIRCUIT	Hartley oscillator coupled directly to output. Tuning capacitance and core position are simultaneously changed for frequency tuning.		
POWER SUPPLY REQUIREMENTS	300 volts at 50 ma dc. 6.0 volts at 0.75 amperes ac or dc.		
POWER SUPPLY RECOMMENDED	Standard	Type 1203 Unit Power Supply	115-v, 50-60-cps line
	Stabilized plate voltage	Type 1201-A Unit Regulated Power Supply	105-125-v, 50-60-cps line
	Battery operation	Type 1202-A Unit Vibrator Power Supply	6- or 12-v battery or 115-v 50-60-cps line
	Adjustable plate voltage	Type 1204-B Unit Variable Power Supply	115-v, 60-cps line
	Constant output level vs frequency	Type 1263-A Amplitude-Regulating Power Supply with Type 874-VR Voltmeter Rectifier, Type 874-Q6 Adaptor, and Type 274-NF Patch Cord.	115-v or 230-v, 50-60-cps line
TUBE	Type 5763 miniature vhf beam-power amplifier (supplied)		
MOUNTING	Oscillator mounted on aluminum casting and shielded with a spun aluminum cover. Assembly mounted on an L-shaped panel and chassis, finished in black-crackle lacquer.		
ACCESSORIES SUPPLIED	Type 874-R22 Patch Cord, Type 874-PB58 Panel Connector, Type 874-Q2 Adaptor, Type CDMS-18-4 Multipoint Connector, and Telephone Plug.		
DIMENSIONS	7 by 8 by 12 inches, over-all.		
WEIGHT	11-1/2 lb		

GENERAL RADIO EXPERIMENTER reference: Vol XXVIII No. 4, September 1953

U. S. Patent No. 2, 548, 457

OPERATING INSTRUCTIONS

TYPE 1211-B UNIT OSCILLATOR

Form 802-D
March, 1958

GENERAL RADIO COMPANY

CAMBRIDGE 39



MASSACHUSETTS

Printed in U.S.A.

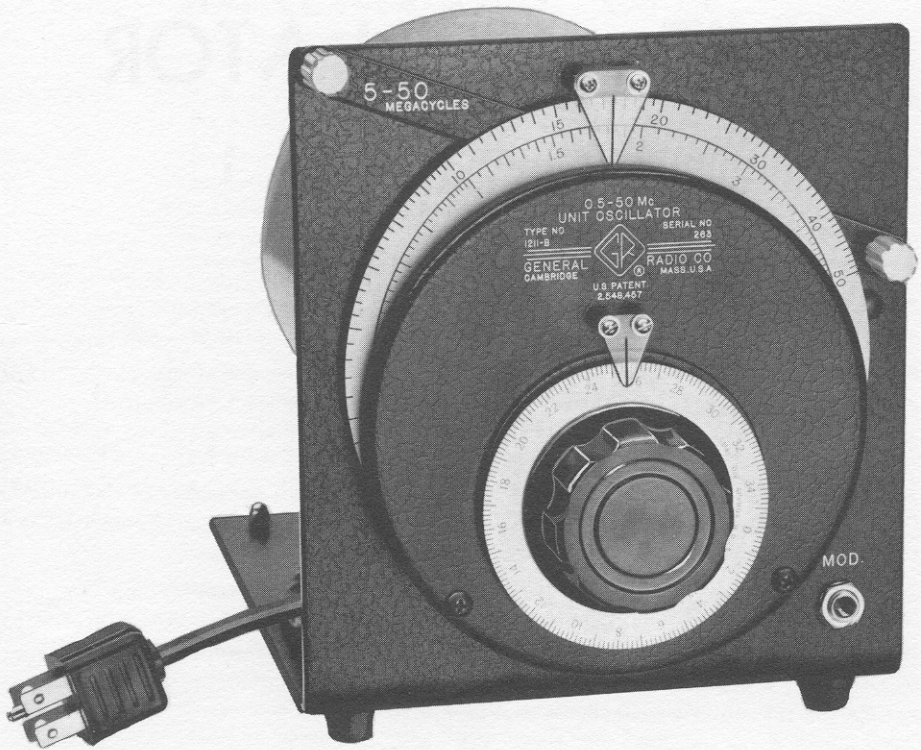

Figure 1. Panel View, Type 1211-B Unit Oscillator.

TYPE 1211-B UNIT OSCILLATOR

Section 1 INTRODUCTION

1.1 GENERAL. The Type 1211-B Unit Oscillator (Figure 1) is a small, shielded, general-purpose oscillator of moderate power output, covering the frequency range of 0.5 to 50 megacycles. It can be amplitude modulated from an external source. It is designed for operation with the Type 1203 Unit Power Supply, but it can be operated with any adequate power supply.

1.2 DESCRIPTION.

1.2.1 FREQUENCY CONTROLS. The range switch is operated by a long rocking arm above the main dial. There are two positions, indicated by the ranges marked on the arm: 0.5 to 5 Mc and 5 to 50 Mc.

The main frequency dial carries a separate calibration for each range.

The small slow-motion dial that drives the main dial is calibrated to indicate directly small percentage increments in frequency. Each division of this dial corresponds approximately to a 0.2-percent change in frequency, except at the ends of the main frequency dial.

1.2.2 OUTPUT CONTROLS AND TERMINALS. The output is controlled by a small dial at the rear of the instrument. The dial is calibrated in arbitrary units, with maximum output at full clockwise rotation of the dial. Typical characteristic curves of output voltage with a 50-ohm load are shown in Figure 2. If the load is excessive, the instrument may stop oscillating unless the output control is set back far enough to reduce the coupling to the load.

The output terminals are at the rear of the instrument, near the output control. The output connector is a Type 874 Coaxial Outlet with a grounding terminal beside it. Output accessories include a Type 874-R22 three-foot shielded Patch Cord, a Type 874-PB58 Panel Connector, and a Type 874-Q2 Adaptor. The Adaptor can be plugged either into the output connector or into the output end of the cable, and permits direct connection either by wire leads or by standard banana-plug connections. When the Type 874-PB58 Panel Con-

GENERAL RADIO COMPANY

nector is mounted in the load equipment, the use of the Type 874-R22 Patch Cord permits continuous coaxial connections from the oscillator to the load for more complete shielding.

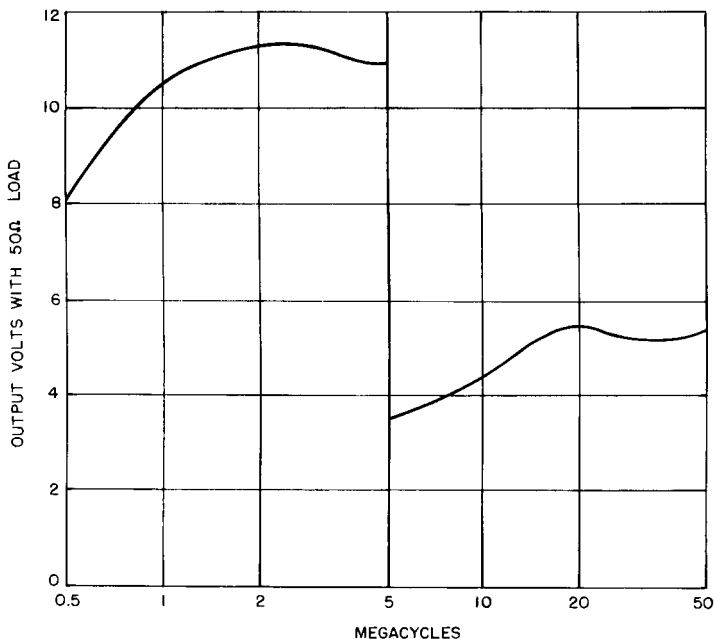

Figure 2. Typical Characteristic Curves.

1.2.3 MODULATION. An audio oscillator can be used to provide direct amplitude modulation over the audio-frequency range. The audio-oscillator circuit must supply a d-c path and be capable of carrying 50 ma dc. Connect the audio oscillator into the cathode circuit at the MOD JACK on the right side of the instrument. Recommended is the Type 1214-A Unit Oscillator, which delivers about 45 volts at either 400 or 1000 cycles and yields about 25-percent modulation at full output¹. A telephone plug is supplied for connection to the MOD JACK.

Direct cathode modulation of the oscillator introduces some incidental frequency modulation. Amplitude modulation essentially free from frequency modulation can be obtained at carrier frequencies above 10 Mc by the use of a Type 1000-P6 Crystal Diode Modulator².

¹ At high line voltage, the output control of the Type 1214-A Unit Oscillator, should be set at full output or at less than 80 percent of full output to avoid overheating its 10-kilohm potentiometer.

TYPE 1211-B UNIT OSCILLATOR

1.2.4 POWER SUPPLY. A multipoint plug connector at the end of the shielded power cable provides direct connection to a General Radio Unit Power Supply. The Type 1203 Unit Power Supply will usually be found satisfactory for line-voltage operation.

If a supply other than a Unit Power Supply is to be used, connect the multipoint jack connector (supplied) to the power supply so that the oscillator and power supply can easily be disconnected. The correct connections are: terminals No. 13 and 14 for heaters, No. 15 for B+ and No. 16 for B-. The power supply, which may consist of batteries, must be capable of supplying 6.0 volts at 0.75 ampere ac or dc for the heaters, and about 300 volts for the plate circuit. The plate current does not exceed 50 ma.

The Type 1201-A Unit Regulated Power Supply is recommended if line-voltage fluctuations are excessive. The Type 1202-A Unit Vibrator Power Supply operates from either a 6- or 12-volt storage battery or a 115-volt, 50- to 60-cycle line.

In some applications, it is desirable that the output level remain constant as the frequency is varied. The Type 1263-A Amplitude-Regulating Power Supply automatically controls the plate voltage to keep the oscillator output at a constant level of two volts or less. The following parts are required to couple the output of the Type 1211-B Unit Oscillator to the Type 1263-A Amplitude-Regulating Power Supply: a Type 874-VR Voltmeter Rectifier, a Type 874-Q6 Adaptor, and a Type 274-NF Patch Cord.

1.2.5 SWEEP AND DIAL DRIVES. The frequency dial of the Type 1211-B Unit Oscillator can be mechanically swept back and forth by the Type 1750-A Sweep Drive, the Type 908-P Synchronous Dial Drive, or the Type 908-R X-Y Dial Drive.

The Sweep Drive can be coupled either to the slow-motion dial or to the main frequency dial of the Unit Oscillator. When the main frequency dial is coupled to the Sweep Drive, the sweep rate should be restricted to one excursion per second or less. The slow-motion dial can be driven at rates up to 5 cycles per second. The magnitude and center position of the sweep arc, as well as the sweep rate, can be set by controls on the Sweep Drive panel. The Sweep drive also provides horizontal deflection voltage, proportional to shaft rotation, for an oscilloscope. A blanking contactor eliminates the return trace.

The Type 908-P Synchronous Dial Drive is useful with graphic recorders that are running at constant speed. The Type 908-R X-Y Dial Drive produces a sweep voltage proportional to shaft rotation to drive the independent variable axis of an x-y plotter or of an oscilloscope.

²W. F. Byers, "An Amplitude Modulator for Video Frequencies," GENERAL RADIO EXPERIMENTER, March, 1950.

GENERAL RADIO COMPANY

The combination of a Type 1211-B Unit Oscillator, Sweep or Dial Drive, and Type 1263-A Amplitude-Regulating Power Supply comprises a complete sweep generator for recording or oscilloscopic display of frequency characteristics.

When the Type 1211-B Unit Oscillator is driven by a sweep or dial drive, all moving parts in the oscillator must be lubricated in accordance with paragraph 4.5.

1.2.6 ACCESSORIES. The following table lists those accessories recommended for use with the Type 1211-B Unit Oscillator.

TABLE OF ACCESSORIES

Accessory and Function	Instrument	Remarks
POWER SUPPLIES		
Standard	Type 1203 Unit Power Supply	115-v, 50-60-cps line
Stabilized plate voltage	Type 1201-A Unit Regulated Power Supply	105-125-v, 50-60-cps line
Battery operation	Type 1202-A Unit Vibrator Power Supply	6- or 12-v battery or 115-v, 50-60-cps line
Adjustable plate voltage	Type 1204-B Unit Variable Power Supply	115-v, 60-cps line
Constant output level vs frequency	Type 1263-A Amplitude-Regulating Power Supply with Type 874-VR Voltmeter Rectifier, Type 874-Q6 Adaptor, and Type 274-NF Patch Cord	115- or 230-v, 50-60-cps line
MODULATORS		
Plate modulation	Type 1214-A Unit Oscillator	400 and 1000 cps output, 115-v, 40-60-cps line
Absorption modulation with no incidental fm	Type 1000-P6 Crystal-Diode Modulator	Requires modulation source. Carrier range starts at 10 Mc. Maximum output 10 mv.
SWEEP DRIVE		
Automatic frequency sweep	Type 1750-A Sweep Drive Type 908-P Synchronous Dial Drive Type 908-R X-Y Dial Drive	Type 1263-A Amplitude-Regulating Power Supply recommended to keep oscillator output level constant.
RELAY-RACK PANEL		
	Type 480-P4UC1	For Types 1203 and 1211-B or for 1201-A and 1211-B.
ADAPTORS - available for connecting Type 874 coaxial output terminals of oscillator to Types N, BNC, C, UHF, and HN coaxial systems.		

TYPE 1211-B UNIT OSCILLATOR

Section 2 PRINCIPLES OF OPERATION

2.1 **CIRCUIT.** (See Figure 4.) The Hartley oscillator circuit is used in the Type 1211-B Unit Oscillator. The output control is tapped across a portion of the tuned circuit for the low-frequency range, and is coupled to the tuned circuit by a pickup coil for the high-frequency range. The tube is a Type 5763 nine-pin miniature beam-power amplifier tube.

The capacitance and inductance of the tuned circuit are varied simultaneously to afford the wide frequency span for each range. A double-sickle-shaped arrangement of tapered iron-dust core and aluminum core is mounted to turn with the tuning-capacitor shaft. As the frequency dial is rotated, the active core material within the inductor varies smoothly from the full dust core for maximum inductance through a minimum core to a full aluminum core for minimum inductance. The shapes of the core and capacitor plate are designed for approximately logarithmic frequency change with angular rotation over the ten-to-one range.

Modulation can be obtained by the connection of an audio-frequency source into the cathode circuit of the oscillator.

2.2 **SHIELDING.** All leads except the output lead are taken out through a system of filters in a shielded cavity to reduce the external field to a minimum. The cable to the power supply is shielded, and the cylindrical cover that fits over the unit is clamped tightly by a metal strap.

Section 3 OPERATING PROCEDURE

3.1 **GENERAL.** The instrument is shipped, with tube installed, and is ready for operation when connected to the Unit Power Supply. For operation with other power supplies, refer to paragraph 1.2.4.

Section 4 SERVICE AND MAINTENANCE

4.1 **GENERAL.** This service information, together with the information given in other sections, should enable the user to locate and correct ordinary difficulties resulting from normal use.

Major service problems should be referred to our Service Department, which will cooperate as much as possible by furnishing information and instructions, as well as by supplying any replacement parts needed. When

GENERAL RADIO COMPANY

notifying our Service Department of any difficulties in operation or service, specify the serial and type numbers of the instrument. Also give a complete report of the trouble encountered and steps taken to eliminate the trouble.

Before returning an instrument or parts for repair, please write to our Service Department, requesting a Returned Material Tag, which includes shipping instructions. Use of this tag will insure proper handling and identification. A purchase order covering repair of material returned should also be forwarded to avoid any unnecessary delay.

4.2 ACCESS TO COMPONENTS. With the shield cover removed, all but the components of the r-f filters are accessible, and they can be checked with an ohmmeter without opening the filter cavity. When replacing the shield cover, tighten the shield strap to insure low leakage.

4.3 PANEL REMOVAL. For direct access to the r-f filter components, remove the frequency dials and the panel. When replacing the dials, set the main dial at its reference line (long line below the lowest frequency calibrations) with the tuning-capacitor plates at full mesh.

4.4 VACUUM-TUBE DATA. The following table gives tube socket voltages, measured from socket pin to ground. The d-c voltages were measured with a 20,000-ohm-per-volt meter whose full-scale ranges were 10, 50, 250, and 1000 volts. Voltages can be expected to vary $\pm 20\%$. Data were obtained with the instrument supplied by a Type 1203 Unit Power Supply from a 115-volt, 60-cycle power line. The frequency controls were set at 0.5 Mc.

<u>Tube Pin</u>	<u>Volts to Ground</u>
1	+ 250 v dc
2	0
3	0
4	0
5	6.3 v ac
6	+ 180 v dc
7	+ 15 v dc
8	-9.0 v dc
9	-9.0 v dc

4.5 LUBRICATION. When the Type 1211-B Unit Oscillator is driven by a Sweep or Dial Drive, it is imperative that all moving parts in the oscillator be properly lubricated. Proper lubrication includes an occasional drop of light oil at the ball bearings, and occasional relubrication of the pinion gear in the dial assembly. Wipe off old lubricants completely before applying new lubrication. A recommended lubricant is Lubrico MD-T-419, Master Lubricant Company, Philadelphia.

TYPE 1211-B UNIT OSCILLATOR

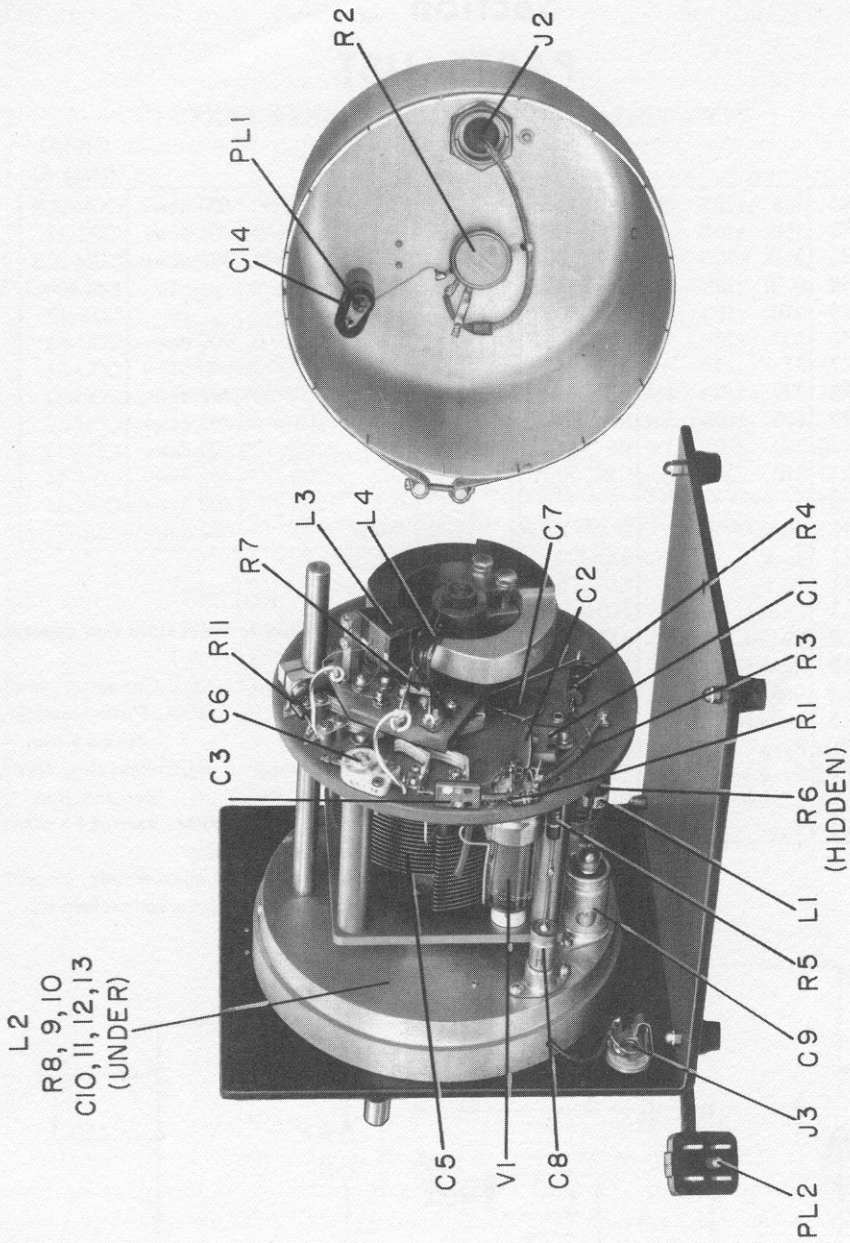

Figure 3. Interior View, Type 1211-B Unit Oscillator.

Section 5 PARTS LIST

		GR NO. (Note A)				GR NO. (Note A)			
RESISTORS (NOTE B)	R1	10k	±10%	½w	REC-20BF	C1	100μμf ±10%	500 dcwv	COM-20B
	R2	250	±10%		POSC-12	C2	0.01 +100%-0	500 dcwv	COC-63
	R3	2.2k	±10%	½w	REC-20BF	C3	75μμf ±5%	500 dcwv	COM-20B
	R4	8.2k	±10%	2w	REC-41BF	C5	21-820μμf		848-404-3
	R5	220	±10%	1w	REC-30BF	C6	7-45μμf		COT-12
	R6	330	±10%	1w	REC-30BF	C7	0.01 +100%-0	500 dcwv	COC-63
	R7	27	±5%	½w	REC-20BF	C8	0.01 +25%-10%	600 dcwv	COU-31
	R8	220	±10%	1w	REC-30BF	C9	0.2 +20%-10%	400 dcwv	COU-32
	R9	680	±10%	2w	REC-41BF	C10	0.2 +20%-10%	400 dcwv	COU-32
	R10	330	±10%	1w	REC-30BF	C11	0.01 +20%-10%	600 dcwv	COU-33
	R11	510	±10%	½w	REC-20BF	C12	0.2 +20%-10%	400 dcwv	COU-34
MISCELLANEOUS	J1	Jack			BUMT-135A	C13	0.2 +20%-10%	400 dcwv	COU-34
	J2	Jack			874-404	C14	0.047 ±10%	600 dcwv	COL-71
	J3	Jack			CDSJ-10				
	L1	Choke, 20μh			ZCHA-29				
	L2	Choke, 20μh			ZCHA-29				
	L3	Inductor			1211-27				
	L4	Inductor			1211-86				
	L5	Inductor			1211-801				
	PL1	Plug			274-360				
	PL2	Plug and Cable			1211-33				
	S1	Switch			Built in				
V1	Tube			5763					

NOTES

- (A) Type designations for resistors and capacitors are as follows:
- | | |
|-------------------------|-----------------------------|
| COC- Capacitor, ceramic | COU-Capacitor, unclassified |
| COL- Capacitor, oil | POSC-Potentiometer, |
| COM- Capacitor, mica | composition |
| COT- Capacitor, trimmer | REC-Resistor, fixed, |
| | composition |
- (B) All resistances are in ohms, except as otherwise specified by k (kilohms).
- (C) All capacitances are in microfarads, except as otherwise indicated by μμf (micromicrofarads).

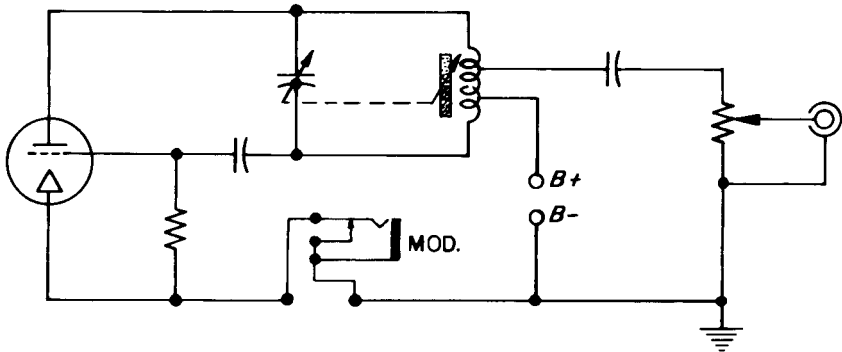

Figure 4. Elementary Schematic Diagram.

NOTE: RESISTANCE IN OHMS UNLESS
OTHERWISE SPECIFIED.

$K = 1000$ OHMS

CAPACITANCE IN MICROFARADS
UNLESS OTHERWISE SPECIFIED

$\mu\mu f = \text{MICROMICROFARADS}$

5-50
MEGACYCLES

0.5-5
MEGACYCLES

ENGRAVING FOR S-1

S1 Shown in 0.5-5 Mc Position

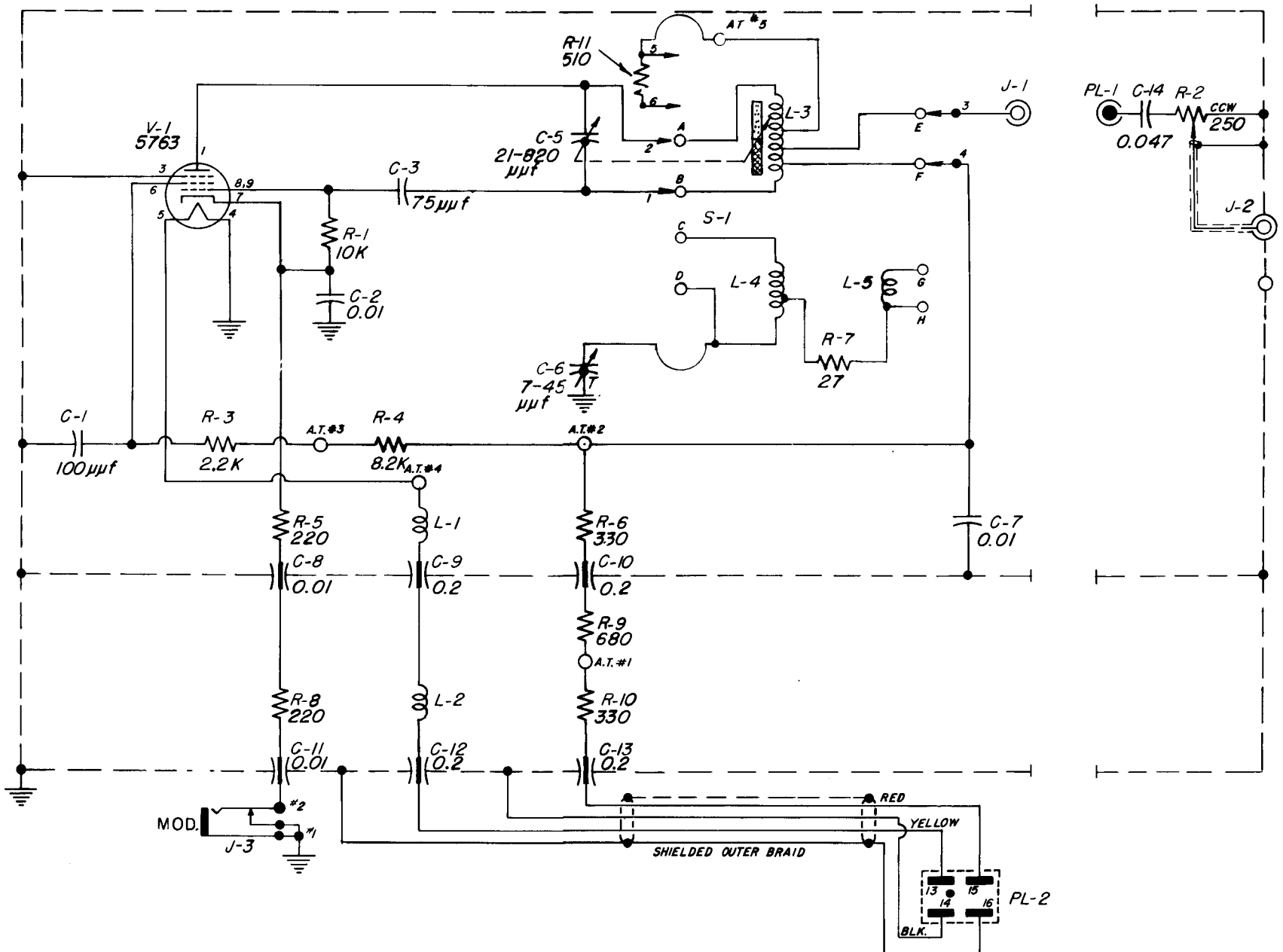

Figure 5. Schematic Diagram, Type 1211-B Unit Oscillator.

NOTE: RESISTANCE IN OHMS UNLESS OTHERWISE SPECIFIED.

K = 1000 OHMS

CAPACITANCE IN MICROFARADS UNLESS OTHERWISE SPECIFIED

$\mu\mu f$ = MICROMICROFARADS

5-50
MEGACYCLES

0.5-5
MEGACYCLES

ENGRAVING FOR S-1

S1 Shown in 0.5-5 Mc Position

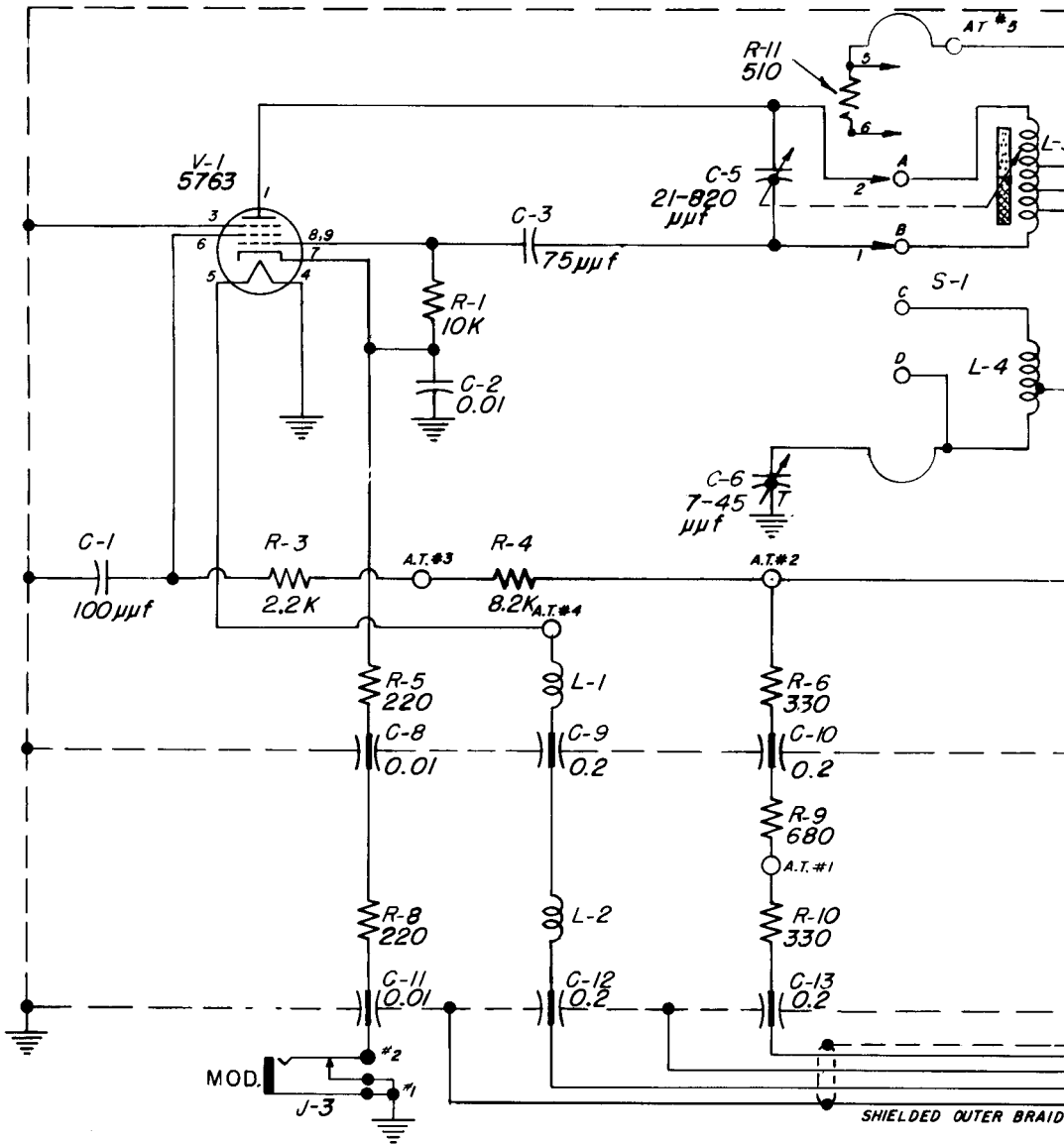
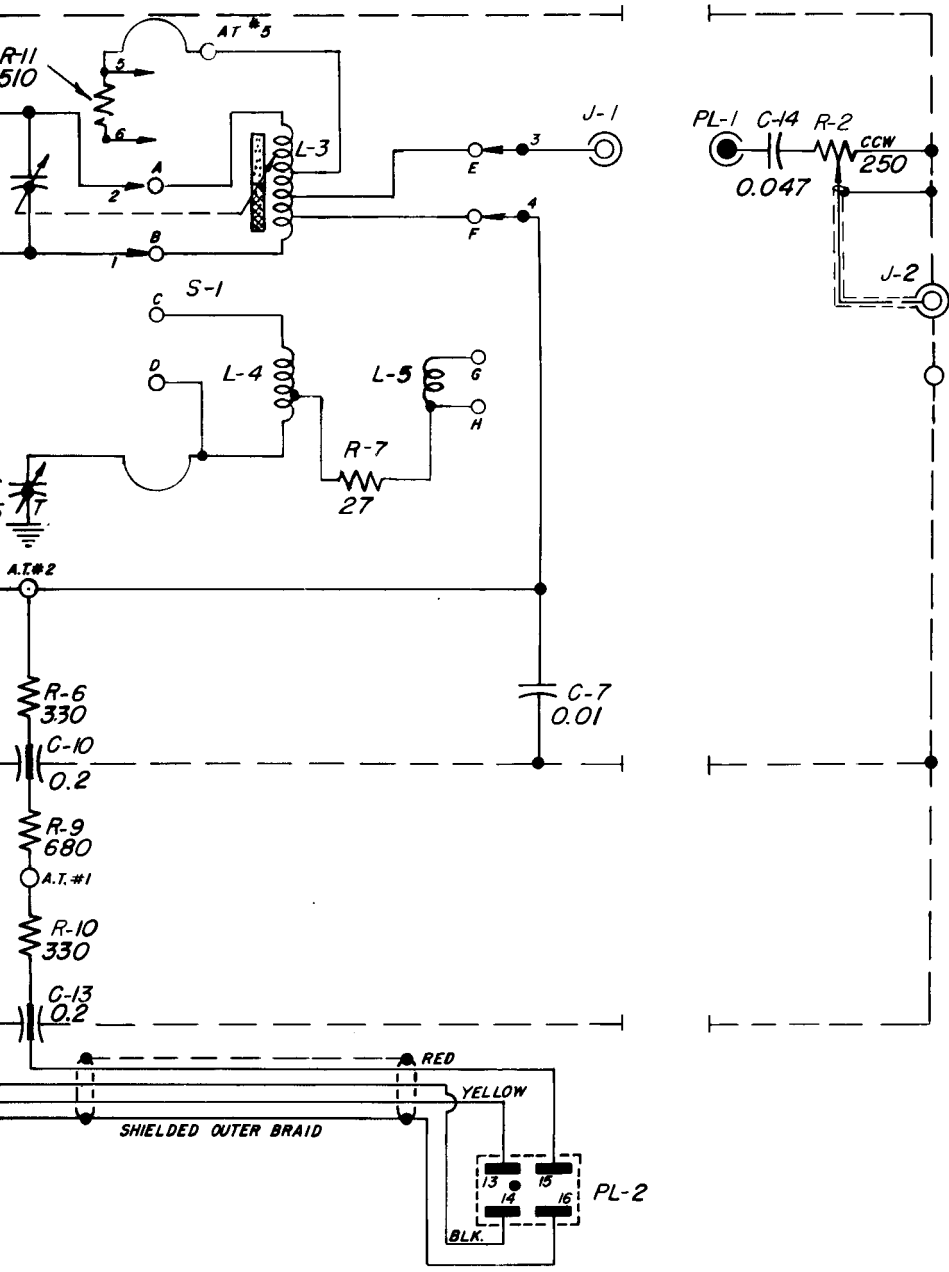

Figure 5. Schematic Diagram, Type 1211-B Unit

S
 0.5-5
 MEGACYCLES
 16 FOR S-1

in 0.5-5 Mc Position



Diagram, Type 1211-B Unit Oscillator.

GENERAL RADIO COMPANY

275 MASSACHUSETTS AVENUE, CAMBRIDGE 39, MASS.

TRowbridge 6-4400

DISTRICT OFFICES

NEW YORK

Broad Ave. at Linden, Ridgefield, N. J.

Telephone N.Y. WOrth 4-2722

N.J. WHitney 3-3140

PHILADELPHIA

1150 York Rd., Abington, Penna.

Telephone HAncock 4-7419

WASHINGTON

8055 13th St., Silver Spring, Md.

Telephone JUniper 5-1088

CHICAGO

6605 West North Ave., Oak Park, Ill.

Telephone VillAge 8-9400

LOS ANGELES

1000 N. Seward St., Los Angeles 38,
Calif.

Telephone HOLlywood 9-6201

SAN FRANCISCO

1182 Los Altos Ave., Los Altos, Calif.

Telephone WHitecliff 8-8233

CANADA

99 Floral Pkwy., Toronto 15, Ont.

Telephone CHerry 6-2171

REPAIR SERVICES

EAST COAST

General Radio Company

Service Department

22 Baker Ave., W. Concord, Mass.

Telephone EMerson 9-4400

MIDWEST

General Radio Company

Service Department

6605 West North Ave., Oak Park, Ill.

Telephone VillAge 8-9400

WEST COAST

Western Instrument Co.

826 N. Victory Blvd., Burbank, Calif.

Telephone Victoria 9-3013

CANADA

Bayly Engineering, Ltd.

First Street, Ajax, Ontario

Telephone Toronto EMpire 8-6866

