

RCA Radiola 48

SERVICE NOTES

VOLUME CONTROL DIAL STATION SELECTOR OPERATING SWITCH

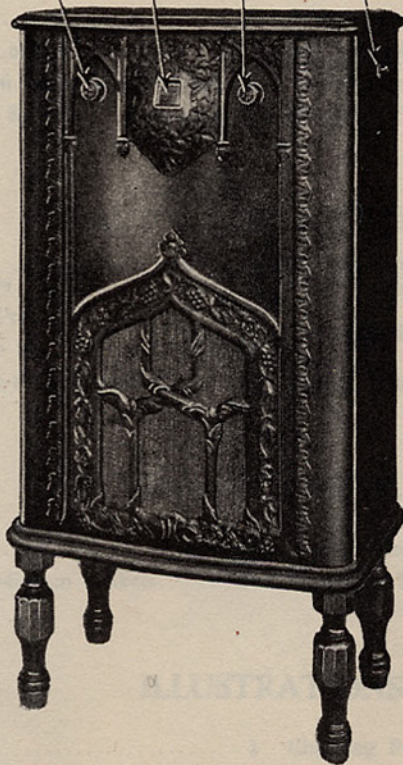

{ Second Edition—2M }
March, 1931

RCA Victor Company, Inc.

RADIOLA DIVISION

Camden, New Jersey

REPRESENTATIVES IN PRINCIPAL CITIES

*Property of the RCA Victor Company, Inc. Confidential and to be used only by its
Authorized Distributors and Dealers in furnishing service in connection
with its apparatus*

Copyright 1930—RCA Victor Company, Inc.

CONTENTS

	Page
Electrical Specifications.....	5
Physical Specifications.....	5
Introduction.....	5
Electrical Description of Circuit.....	6

PART I—INSTALLATION

Antenna and Ground.....	8	Adjustment for Low Line Voltages.....	9
Radiotrons	8	Removal of Shipping Blocks and Screws.....	9
Location	8	Magnetic Pick-up Connections.....	9
Jerky Action of Station Selector.....	9		

PART II—SERVICE DATA

Antenna System Failures.....	10	Line-up Adjustment of Gang Condenser.....	12
Radiotron Sockets and Prongs.....	10	Replacing Reproducer Cone	13
Broken Condenser Drive Cord.....	10	Service Data Chart.....	13
Adjustment of R.F. Line-up Condensers.....	10		

PART III—ELECTRICAL TESTS

Voltage Supply System.....	15	Voltage Reading Service Data Chart.....	16
Voltage Readings at Radiotron Sockets.....	17	Continuity Tests	20

ILLUSTRATIONS

Front Cabinet View.....	1	Checking Position of Dial.....	11
Rear Interior Cabinet View.....	4	Dial Indicator	12
Schematic Circuit Diagram.....	6	Gang Condenser Adjustment Positions.....	13
Front View of Chassis and Reproducer.....	7	Schematic of Voltage Supply System.....	15
Rear Interior Cabinet View with Shields Removed	8	Internal Connections and Color Scheme of Cable	15
Connections for Magnetic Pick-up.....	9	Simplified Schematic Circuit.....	17
Drive Cord Arrangement.....	10	Complete Layout and Wiring Diagram...18 and 19	

RECEIVER ASSEMBLY

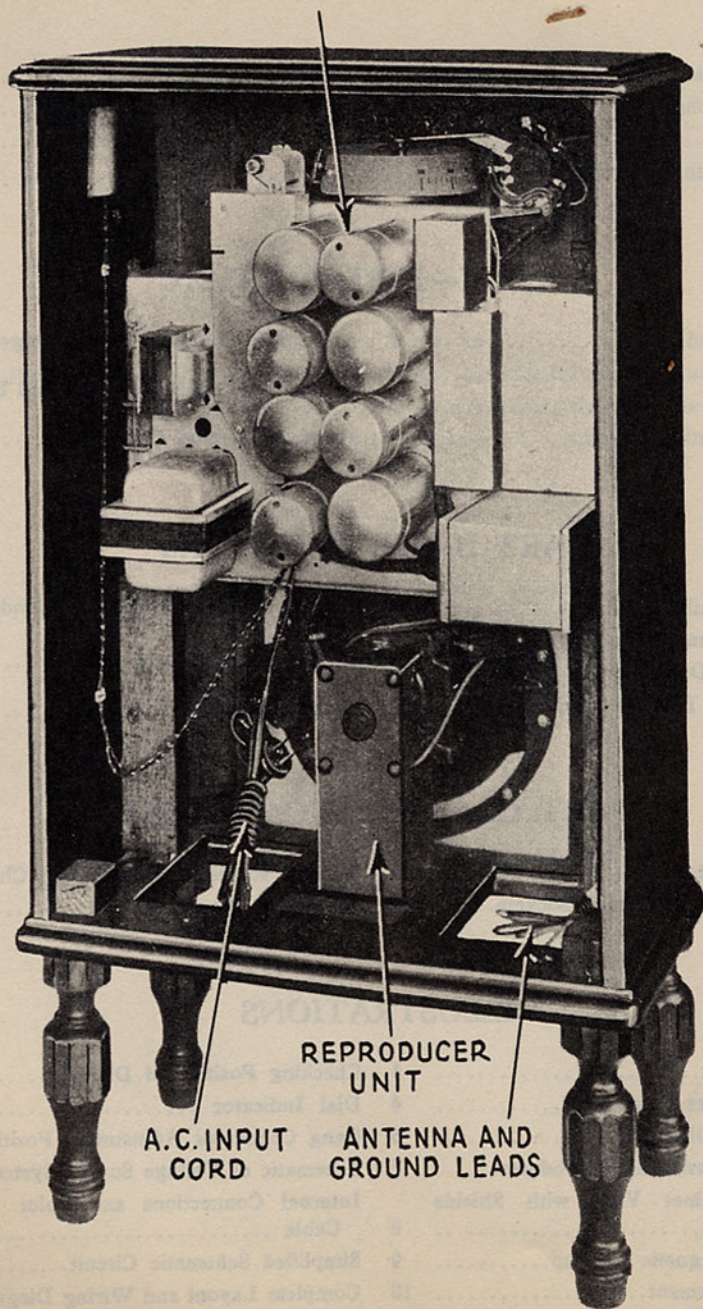

REPRODUCER
UNIT

A.C. INPUT
CORD

ANTENNA AND
GROUND LEADS

Figure 1—Rear interior cabinet view

RCA RADIOLA 48

SERVICE NOTES

ELECTRICAL SPECIFICATIONS

Voltage Rating.....	105—125 Volts
Frequency Rating.....	25-40 and 50-60 Cycles
Power Consumption.....	115 Watts
Recommended Antenna Length.....	25-75 Feet
Type of Circuit.....	A.C. Screen Grid T.R.F.
Type and Number of Radiotrons.....	4 UY-224, 2 UX-245, 1 UX-280
Number of R. F. Stages.....	3
Type of Detector.....	Power Grid Bias
Number of Audio Stages.....	1 (Push-Pull)
Type of Volume Control....	Compound type (Changes input R.F. voltage to first tube and screen grid voltage to R.F. amplifiers simultaneously)
Type of Rectifier.....	Full Wave, UX-280
Type of Loudspeaker.....	Electro-Dynamic
Wattage Dissipation in L.S. Field.....	10 Watts (110 V. 85 M. A.)
Undistorted Output.....	2.5 Watts

PHYSICAL SPECIFICATIONS

Height.....	35 Inches
Depth.....	13 Inches
Width.....	20½ Inches
Weight (Packed for Shipment).....	95 Lbs.
Packing Case Dimensions.....	17½" x 26" x 40"

INTRODUCTION

RCA Radiola 48 is a seven-tube A.C. operated screen grid type tuned radio frequency receiver. Excellent and uniform selectivity, sensitivity and fidelity are secured throughout the broadcast band. Included in the same cabinet is an improved electro-dynamic type loudspeaker which, together with the receiver, gives a very excellent quality of reproduction.

A feature of Radiola 48 is the calibrated kilocycle dial. This dial is very accurate and greatly facilitates the location of stations of known frequency, even though not previously received. Another unique feature is the compound type volume control. This performs the function of two types of volume control operating simultaneously and gives a positive control of volume without distortion on signals of any intensity.

The receiver uses four Radiotrons UY-224, three as R.F. amplifiers and one as a detector; two Radiotrons UX-245 as a push-pull audio stage; and one Radiotron UX-280 as a full wave rectifier for converting the alternating current into direct current which, after suitable filtering, is used as a plate and grid supply to all Radiotrons.

Figure 1 shows a rear interior cabinet view and Figure 2 the schematic circuit diagram.

ELECTRICAL DESCRIPTION OF CIRCUIT

A unit type of construction is used; that is, the receiver and power parts are all built into a single unit, see Figures 3 and 4. Numerous advantages are present in this type of construction. The gang condenser is mounted on one side of a center plate in a vertical position. The coils and Radiotron sockets are directly opposite on the other side of the center plate. This makes the leads from the sockets to the coils and to the gang condenser very short. Individual shields are placed over each Radiotron and coil and individual compartments over each unit of the gang condenser so that a very complete system of shielding is present. The heater type tubes are mounted in a horizontal position and the filament type in a vertical position. Mounting the heater type

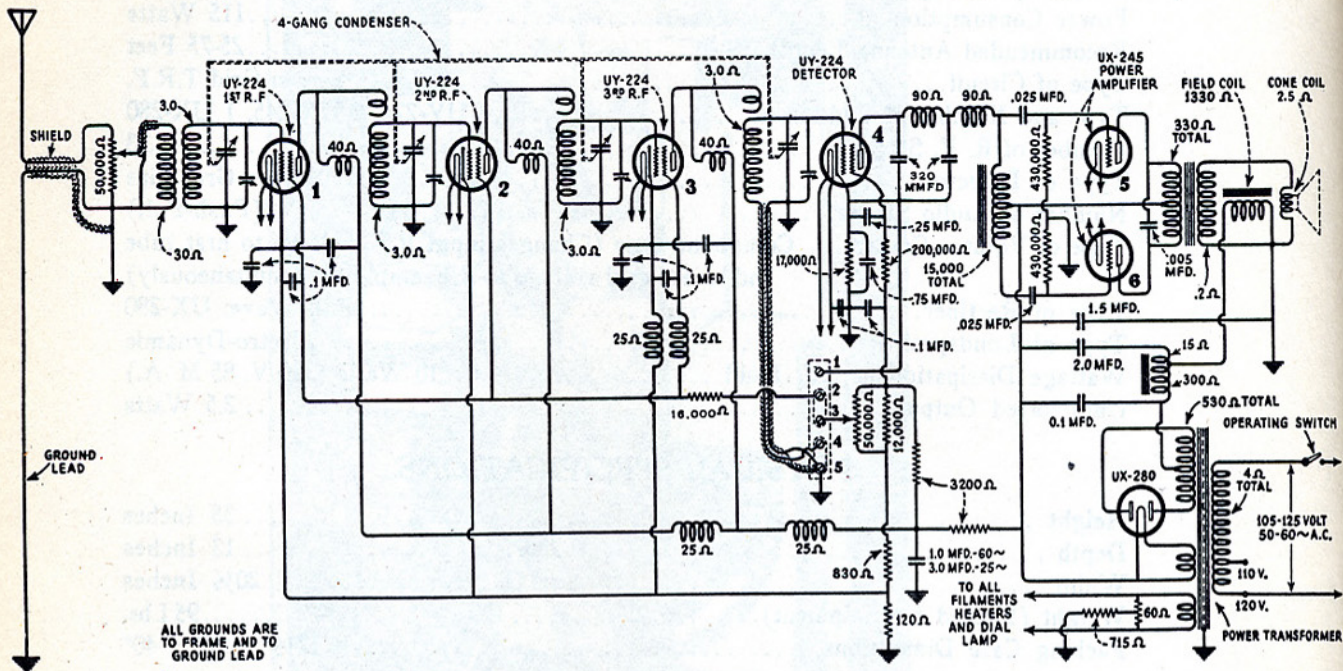

Figure 2—Schematic circuit diagram.

tubes in a horizontal position has no detrimental effect on their life, as the elements are rigid and held in place. However, it is important to mount the filament type tubes in a vertical position, as the elements may sag and short if mounted horizontally.

Examining the circuits we find the following functions taking place. See Figure 2.

The antenna and ground are connected to each side of a 50,000-ohm potentiometer. The moving contact of the potentiometer is connected to one side of the primary of the first R.F. transformer, the other side being connected to ground. The action of this potentiometer constitutes one-half the action of the volume control, the other half being discussed later. The secondary of the R.F. transformer is connected to the grid circuit of the first R.F. Radiotron UY-224, which is tuned by the first unit of the gang condenser. The plate circuit of this tube contains a high impedance coil located inside the grid coil of the second R.F. transformer. This plate coil is of the correct impedance to match the UY-224 and is at right angles to the grid coil in which it is located. This is done so that the inductive coupling between these circuits is at a minimum. A single turn at one end of the grid coil is connected to the plate of the UY-224 and provides capacitive coupling between the circuits.

The reason for using capacitive instead of inductive coupling is due to the fact that the primaries of the R.F. transformer resonate at about 350 K.C. with receiver capacitance and tend to increase the sensitivity at the low end of the range. Capacitive coupling has less reactance to high frequencies than to low frequencies, thereby increasing the effective coupling at the high frequency end. A combination of the two gives about an equal gain throughout the tuning range.

The following two R.F. circuits function in the same manner as the one already described. The screen grid voltage of these three Radiotrons is varied by means of the second section of the volume control. This action occurring simultaneously with the variation of input voltage to the first tube gives a positive control of volume without distortion.

The detector circuit functions as a biased-grid, power detector operating at a high plate voltage so that an output sufficient to swing the two Radiotrons UX-245 to maximum output is obtained. The detector tube is operated at 250 volts plate potential and 10 volts negative grid bias.

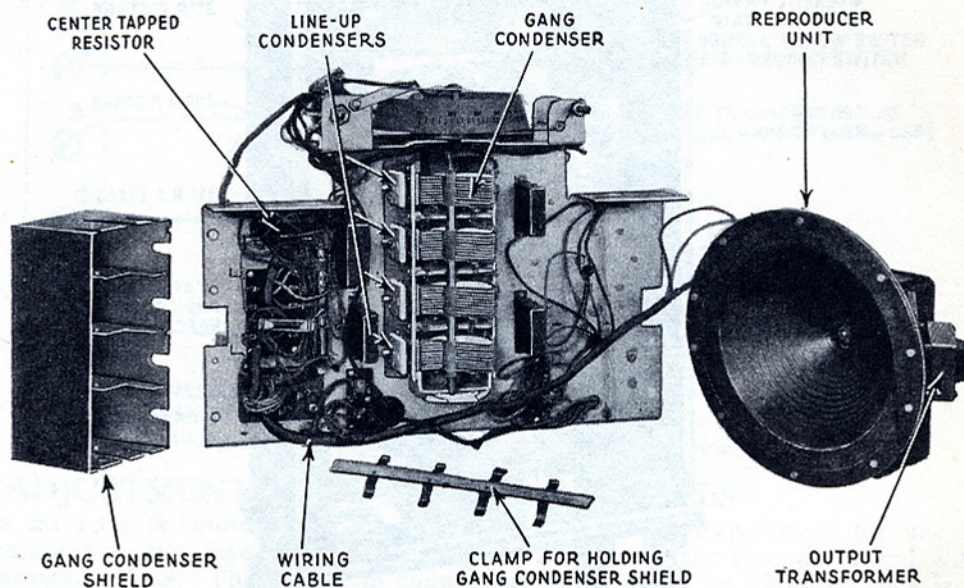

Figure 3—Front view of chassis and reproducer, showing parts.

As the detector is a Radiotron UY-224 and must therefore work into a high impedance, a transformer would not be suitable for coupling it to the grid circuit of two Radiotrons UX-245. Impedance coupling is therefore used, one-half of a tapped reactor being in the plate circuit of the detector. This reactor is of quite high impedance and functions as an auto transformer. Two coupling condensers are used to pass the A.C. component of the detector output to the grid of the Radiotrons UX-245. Two high resistance units are used so that the proper grid bias may also be impressed on these tubes.

The output of the Radiotrons UX-245 is coupled to the cone coil of the electro-dynamic speaker through a center-tapped primary, step-down transformer.

A full wave rectifying circuit employing Radiotron UX-280 is used to provide the direct current voltages necessary for plate and grid supply to all Radiotrons and also for field current supply to the electro-dynamic loudspeaker. The filter circuit is of the type employed in the Super-Heterodyne models with the exception that a .1 mfd. condenser is used to by-pass any high frequency ripple that may be present in the rectified output. An explanation of the action of this filter is contained in the Radiola 80 Service Notes.

PART I—INSTALLATION

(1) ANTENNA AND GROUND

Instructions for erecting a good antenna and ground system, together with hints for special installations in noisy locations, are contained in the Radiola 80 Service Notes. The reader is therefore referred to Part I, Sections 1, 2, 3 and 4 of that booklet.

(2) RADIOTRONS

This receiver uses a total of seven Radiotrons, four Radiotrons UY-224, two Radiotrons UX-245 and one Radiotron UX-280. The Radiotrons should be placed in their correct sockets as indicated on the instruction card accompanying each set. The proper

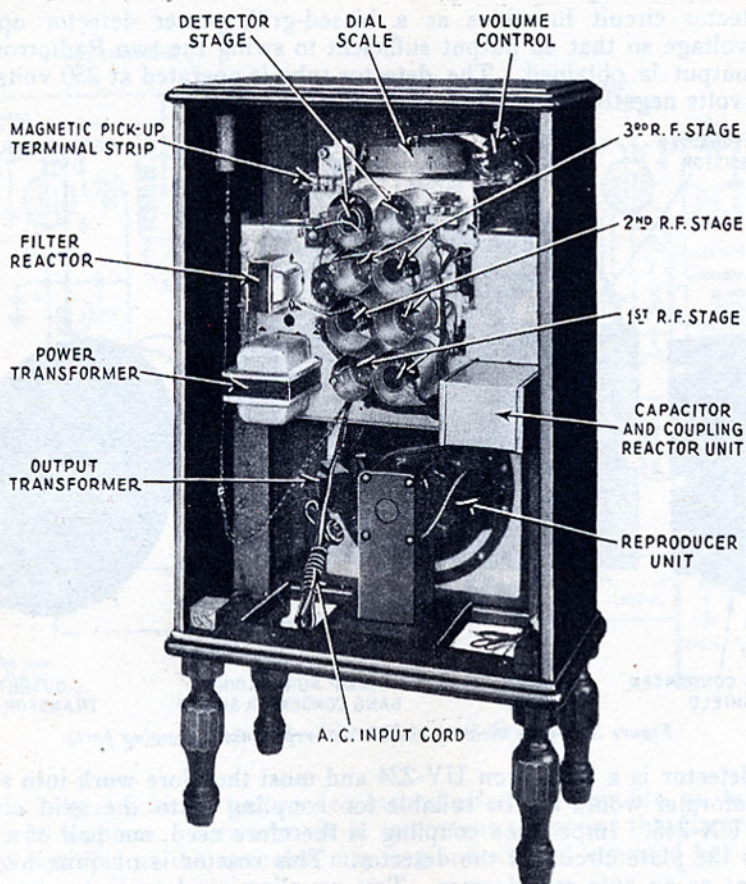

Figure 4—Rear interior cabinet view with shields removed.

location for the Radiotrons UY-224 is shown on the top of the shields which covers them after being inserted in the sockets. These four tubes are mounted horizontally. The Radiotrons UX-280 and UX-245 are mounted vertically, the proper marking being placed adjacent to each socket.

The detector Radiotron should be chosen from the other Radiotrons UY-224 for the tube that will give the greatest output with the volume control advanced to its maximum undistorted position. Then interchange the remaining Radiotrons UY-224 until best results are obtained.

(3) LOCATION

This receiver should be tried in various locations in the room in which it is to be operated and the location giving the best acoustical results used. However, the eight-

foot A.C. cord may prove a limiting factor if an A.C. outlet is not within its radius. An extension cord may be used in cases of this kind, as the better results usually justify its small cost.

The antenna and ground leads should be separated as much as possible until they connect to the receiver, otherwise a reduction in signal strength will result, due to the capacity between leads.

(4) JERKY ACTION OF STATION SELECTOR

Should operation of the station selector be stiff or jerky, a little oil dropped on each condenser bearing will effectively remedy this condition. When experiencing this trouble it is also well to check the cable tension spring to make sure that suitable tension is being applied to the condenser drive cable.

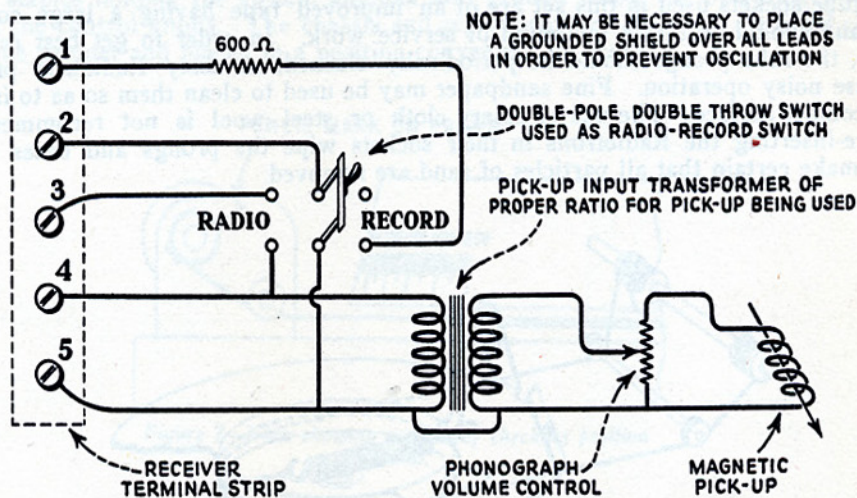

Figure 5—Connections for attaching a magnetic pick-up.

(5) ADJUSTMENT FOR LOW LINE VOLTAGES

An extra tap is connected to the primary of the power transformer for use when line voltages do not exceed 115 volts. Figure 13A shows the terminal board with its normal connections. The change in connection to be made for 110-volt lines is indicated by a dotted line.

(6) REMOVAL OF SHIPPING BLOCKS AND SCREWS

Four metal clamps are placed between the chassis and its cabinet mounting strips to hold the chassis securely during shipment. After unpacking the set, remove the four red screws and withdraw the clamps. Do not replace the screws.

(7) MAGNETIC PICK-UP CONNECTIONS

Figure 5 shows the correct connections for attaching a magnetic pick-up.

When connecting a magnetic pick-up to Radiola 48, if the distance from the set to the phonograph is more than several feet, certain precautions to prevent oscillation must be taken other than shielding the leads. These precautions are to mount the "Radio-Record" switch and the input transformer inside the cabinet. The volume control may or may not be located on the phonograph, any place being satisfactory. Two additional contacts should be provided on the switch so that when the switch is in the "radio" position, both sides of the pick-up input line to the transformer will be open. Unless this is done serious oscillation will occur which will be very difficult to remedy. The leads from the switch and transformer should be shielded and the shield grounded.

With certain input transformers, a slight hum may be obtained during record reproduction. Shunting a 5,000-ohm resistor across the secondary of the transformer will remedy this trouble.

PART II—SERVICE DATA

(1) ANTENNA SYSTEM FAILURES

A grating noise may be caused by a poor lead-in connection to the antenna, or the antenna touching some metallic surface such as the edge of a tin roof, drain pipe, etc. By disconnecting and shorting the antenna and ground leads the service man can soon determine whether the cause of complaint is within or external to the receiver and plan his service work accordingly.

(2) RADIOTRON SOCKETS AND PRONGS

The tube sockets used in this set are of an improved type having a large contact surface and should require a minimum of service work. In order to get best results, however, the tube prongs should be periodically cleaned, as dirty Radiotron prongs may cause noisy operation. Fine sandpaper may be used to clean them so as to insure a good contact surface. The use of emery cloth or steel wool is not recommended. Before re-inserting the Radiotrons in their sockets wipe the prongs and bases carefully to make certain that all particles of sand are removed.

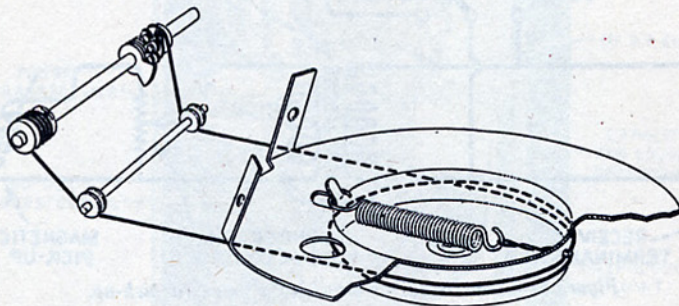

Figure 6—Drive cord arrangement.

(3) BROKEN CONDENSER DRIVE CORD

The gang condenser is driven from the station selector knob by means of a cord arrangement that also functions as a vernier control. This cord is of rugged construction and a spring is used to maintain an even tension at all times. Should the cord become disengaged from the drum or a new cord be required, follow the arrangement indicated in Figure 6 for the correct position of the cord on the drum, otherwise the cord length will be incorrect or the stops on the shaft will engage at the wrong time.

(4) ADJUSTMENT OF R.F. LINE-UP CONDENSERS

Four small adjustable condensers, connected in parallel to the main tuning condensers, are provided to line-up the circuits at the high frequency end of the scale and also to allow a line-up that will cause the dial to read accurately. A need for readjustment of these condensers is indicated by insensitivity of the receiver not due to other causes. Also if the dial scale reads incorrectly and cannot be adjusted for correct reading by slipping it, an adjustment of these condensers is necessary. A step by step procedure for making such adjustment follows:

1. Procure the following material:

An end wrench that will fit the hex heads of the line-up condensers. A special wrench listed in the Replacement Parts Catalog is designed for this purpose.

A modulated R.F. oscillator giving a signal at 600 K.C. and 1400 K.C. It is important that these points be accurately known within 10 K.C., otherwise the dial of the receiver will not read accurately after the set is aligned.

An output meter. This may be any of the usual devices such as a 0-5 milliammeter placed in the plate circuit of the detector, a thermo galvanometer substituted for the cone coil or a disc rectifier meter used across the cone coil leads.

2. Turn the dial scale to 600 K.C. and mark the position of the pin that holds the drive cord to the drum so that this position may be checked after the chassis is removed from the cabinet. See Figure 7.
3. Remove the chassis and loudspeaker from the cabinet. This can be done by removing the four chassis mounting screws, the two reproducer mounting bolts, the staples holding the switch, antenna and ground leads, the operating switch and the control knobs. The chassis and reproducer unit may now be lifted clear of the cabinet and placed in a position convenient for work.

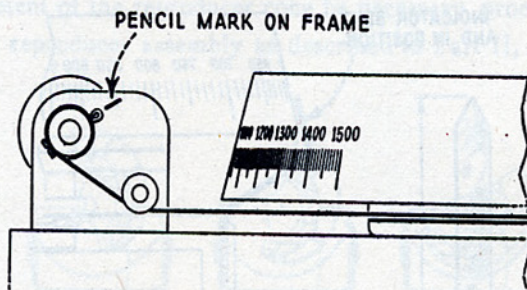

Figure 7—View showing method of checking position of dial.

4. Take a small piece of metal about $2\frac{1}{2}$ " long by $\frac{3}{8}$ " wide and point one end of it. Bend as indicated in Figure 8 and then slip it under the gang condenser shield clamp so that it will act as an indicator for the dial. With the pencil mark and the pin coinciding as before removal of the chassis from the cabinet, set the indicator so that it will read 600 K.C. on the scale. From now on be careful not to disturb the indicator and recheck its position if in doubt as to its accuracy.
5. Set the scale so that an equal amount of adjustment will be possible in either direction by loosening its clamping screws.
6. Place the receiver in operation and couple the output of the oscillator to the antenna lead. Place the oscillator in operation at 1400 K.C. Connect the output meter in the circuit.
7. Turn the station selector until the dial reads exactly 1400 K.C. Now adjust the detector, 3rd R.F., 2nd R.F. and 1st R.F., line-up condensers until a maximum deflection is obtained in the output meter. Adjust the volume control so that overloading does not occur and the output meter needle does not go beyond its scale.
8. Set the oscillator at exactly 600 K.C. Tune in the signal on the receiver. It should read within one division of 600 K.C. If it does not read within one unit of 600 K.C. shift the scale to the opposite side of 600 K.C. $\frac{1}{2}$ the difference between the scale reading and 600 K.C. For example, if the scale reads 610 K.C. at maximum output, set the scale at 595 K.C. Or if the scale reads 590 K.C., set it at 605 K.C.

9. Shift the oscillator frequency to 1400 K.C. and set the selector at the point where the dial reads exactly 1400 K.C. Now adjust the four line-up condensers in the order given until maximum output is obtained. The receiver calibration should now read quite accurately at all frequencies through the broadcast range.
10. Remove the temporary dial indicator and return the chassis to the cabinet in the reverse manner of that used to remove it.

(5) LINE-UP ADJUSTMENT OF GANG CONDENSER

The gang condenser is mounted in an inaccessible position when the chassis is mounted in the cabinet. Unless tampered with adjustments will not be needed. However, if tampering has occurred, the following procedure may be used for realigning it.

1. Procure the following material:

Modulated R.F. Oscillator, the output of which is continuously variable throughout the broadcast band.

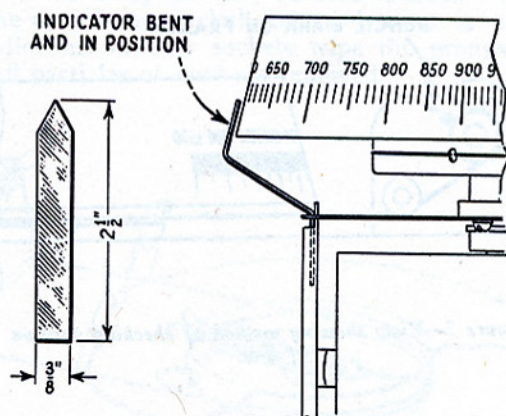

Figure 8—Dial indicator.

Output meter. This may be a thermo-galvanometer, or a disc type A.C. voltmeter having about a 0-5 volt range.

A Small End Wrench for adjusting the condenser vane screws. A wrench listed in the Replacement Parts Catalog is especially designed for this purpose.

2. Remove the receiver from the cabinet as described in Part II, Section 4. Place the receiver in operation and make the R.F. line-up condenser adjustments as described in Part II, Section 4. Then remove the gang condenser shield clamp and shield. Shift the black with yellow tracer wire connected to the arm of the antenna potentiometer to the black antenna lead connected to one side of this potentiometer. Couple the oscillator output to the antenna (black) lead of the receiver. Adjust the selector knob until the first vanes of the gang condenser fully mesh with the stator plates and the next set is free. This is shown in Figure 9A.
3. Adjust the oscillator until a deflection is obtained in the output meter. This will be at about 1120 K.C. Adjust the volume control so that oscillation will not occur. Now adjust the four vanes that are engaged with the stator until a maximum deflection is obtained. If the variation is not sufficiently great to permit this, make a slight readjustment of the line-up condenser in the circuit under test. After adjusting the first group of vanes, if the line-up condensers have been altered, return to them and readjust as described in Part II, Section 4, making sure the shields are in place.

4. After adjusting the line-up condensers if necessary, shift the gang condenser so that the first and second sections of the end rotor plates are meshed with the stator plates.

Shift the oscillator frequency and adjust the second group of vanes until a maximum deflection is obtained and the adjustable vanes still make a satisfactory clearance of the stator plates. Due to slight inaccuracies of the coils it may not be possible to exactly peak each vane, as a sufficient capacity variation is not present. However, adjusting for a maximum output reading while still maintaining clearance will give as good, or better, an adjustment as was originally present in the receiver.

5. Follow the same procedure as that used with the second for each of the various groups of vanes. After all adjustments are made it is good practice to realign the line-up condensers, also checking the dial scale as given in Part II, Section 4.

(6) REPLACING REPRODUCER CONE

Should replacement of the reproducer cone be necessary, proceed as follows:

1. Remove the reproducer assembly as described in Part II, Section 4.

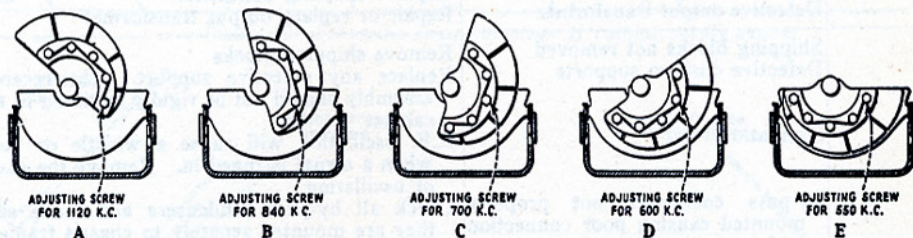

Figure 9—Gang condenser adjustment positions.

2. Remove the ten nuts, screws and lock washers that hold the metal ring and cone edge in place. Remove the cone centering screw. The cone coil is connected by means of two soldered terminals located adjacent to the cone bracket. Unsolder these leads. The cone may now be removed.
3. Place the new cone in the position occupied by the old one, and replace cone ring, the ten screws, nuts and the lock washers. Do not tighten the screws.
4. Place three pieces of cardboard the thickness of a visiting card and approximately $1\frac{1}{2}$ " x $\frac{1}{4}$ " in size in the space between the inside of the cone coil and the pole piece.
5. Now replace the cone centering screw and tighten.
6. Tighten the ten screws that hold the cone edge and replace the felt ring.
7. Remove the pieces of cardboard and solder the cone coil leads in place.

(7) SERVICE DATA CHART

The following Service Data Chart gives the cause and remedy of the most common indications of a defective receiver. If following the suggestions in this chart does not remedy any trouble that occurs, then the Voltage Reading Service Data Chart should be used to isolate the trouble. See Part III, Section 3.

Before making any tests or repairs, check the condition of all the Radiotrons. A defective tube can be the cause of practically any indication that might be observed.

SERVICE DATA CHART

Indication	Cause	Remedy
No Reception	No current at Outlet Defective Operating Switch Open cone or field coil in reproducer Defective parts in chassis	Turn line current "On" Repair or replace operating switch Repair or replace defective part in reproducer unit Test by means of voltage readings or continuity tests and repair or replace any defective parts
Low Volume	Poor antenna system Shorted field coil in reproducer unit R.F. stages not properly aligned Defective parts in chassis	Install antenna system as suggested on instruction card Repair any defect in reproducer Realign circuits as suggested in Part II, Sections 4 and 5 Test by means of voltage readings or continuity test and repair or replace any defective parts
Poor Quality	Receiver not properly tuned Receiver improperly aligned Defective coupling reactor Defective coupling condenser Defective output transformer	Tune in station properly Align receiver properly as given in Part II, Sections 4 and 5 Replace coupling reactor unit Replace coupling condenser Repair or replace output transformer
Audio Howl	Shipping blocks not removed Defective cushion supports Oscillation By-pass condenser not properly mounted causing poor connection to frame Open by-pass condenser Broadcasting station heterodyne	Remove shipping blocks Replace any defective support. The receiver assembly should not be rigidly mounted to the cabinet R.F. oscillation will cause a whistle or howl when a signal is tuned in. Remove the cause of oscillation Check all by-pass condensers and make sure they are mounted securely to chassis frame Repair or replace any open by-pass condenser This is caused by transmitting stations and is no fault of the receiver
Oscillation	Poor ground Shields not in place Shield clips broken or bent Open or shorted by-pass condenser Radiotron Screen grid resistor	Connect set to good ground Make sure all shields are tightly in their proper positions The gang condenser shield has a number of small clips for maintaining contact between the shield and the condenser shaft. Make sure they are all making good, clean contact to the shaft. Replace any that might be broken Replace any defective condenser or repair any poor connections A defective Radiotron UY-224 may cause oscillation and should be replaced by one known to be in good operating condition Make sure screen grid resistor is 16,000 ohms
Hum	Defective Radiotron UX-280 Shorted field coil Grounded heater lead Loose laminations in filter reactor Shorted by-pass condenser from C4 to ground.	Replace defective Radiotron Repair or replace field coil Remove the cause of any grounds Tighten filter reactor clamping screw Replace defective condenser
Noisy Volume Control	Poor contact of arm	Work contact arm back and forth several times If trouble does not clear up, replace volume control
Dial Scale Reads Incorrectly	Scale shifted Set not properly aligned	Adjust scale by loosening clamping screws and setting correctly. Then tighten clamping screws Realign receiver as described in Part II, Section 4.

VOLTAGE READING SERVICE DATA CHART

Volume Control at Maximum

VOLTAGE CHARACTERISTIC	TUBE 1 1st R. F.			TUBE 2 2nd R. F.			TUBE 3 3rd R. F.			TUBE 4 DETECTOR			TUBE 5 POWER A. F.		TUBE 6 POWER A. F.		Cause of Incorrect Reading												
	C.G. Volts	S.G. Plate Volts	Plate M.A.	C.G. Volts	S.G. Plate Volts	Plate M.A.	C.G. Volts	S.G. Plate Volts	Plate M.A.	C.G. Volts	S.G. Plate Volts	Plate M.A.	Grid Volts	Plate M.A.	Grid Volts	Plate M.A.													
Normal	2.5	85	160	3.0	2.5	6.0	0	80	150	6.0	0	75	150	5.5	0	15	190	1.5	1.0	200	25	1.0	200	25	Open Secondary of 1st R.F. Transformer				
No C.G. Voltage on Tube No. 1	0	80	150	6.0	0	0	0	0	0	0	0	0	0	0	0	0	0	0	0	0	0	0	0	0	0	0	Open Secondary of 2nd R.F. Transformer		
No C.G. Voltage on Tube No. 2	0	0	0	0	0	0	0	0	0	0	0	0	0	0	0	0	0	0	0	0	0	0	0	0	0	0	Open Secondary of 3rd R.F. Transformer		
No C.G. Voltage on Tube No. 3	0	0	0	0	0	0	0	0	0	0	0	0	0	0	0	0	0	0	0	0	0	0	0	0	0	0	Open Secondary of 4th R.F. Transformer or Link on Term. Strip		
No C.G. Voltage on Tube No. 4	0	0	0	0	0	0	0	0	0	0	0	0	0	0	0	0	0	0	0	0	0	0	0	0	0	0	Open Primary of 2nd R.F. Transformer		
No Plate Voltage on Tube No. 1	2.5	80	0	0	2.5	80	0	0	0	0	0	0	0	0	0	0	0	0	0	0	0	0	0	0	0	0	Open Primary of 3rd R.F. Transformer		
No Plate Voltage on Tube No. 2	0	0	0	0	0	0	0	0	0	0	0	0	0	0	0	0	0	0	0	0	0	0	0	0	0	0	Open Primary of 4th R.F. Transformer		
No Plate Voltage on Tube No. 3	0	0	0	0	0	0	0	0	0	0	0	0	0	0	0	0	0	0	0	0	0	0	0	0	0	0	Open Primary of 1st R.F. Transformer		
No Plate Voltage on Tube No. 4	0	0	0	0	0	0	0	0	0	0	0	0	0	0	0	0	0	0	0	0	0	0	0	0	0	0	Open Primary of 2nd R.F. Transformer		
No Plate Voltage on Tube No. 5	0	0	0	0	0	0	0	0	0	0	0	0	0	0	0	0	0	0	0	0	0	0	0	0	0	0	Open Primary of 3rd R.F. Transformer		
No Plate Voltage on Tube No. 6	0	0	0	0	0	0	0	0	0	0	0	0	0	0	0	0	0	0	0	0	0	0	0	0	0	0	Open Primary of 4th R.F. Transformer		
No Plate Voltage on Tubes Nos. 1 and 2	2.3	60	0	0	2.0	60	0	0	2.0	60	175	1.5	6.0	12	175	1.5	0	0	0	0	0	0	0	0	0	0	0	Open Coupling Reactor or Detector R.F. Choke	
No S.G. Voltage on Tube No. 3	2.5	100	155	4.5	2.5	100	155	4.5	2.5	0	165	0	6.5	60	210	1.0	0	0	0	0	0	0	0	0	0	0	0	Open Primary of Output Transformer	
No Voltage on Tube No. 3	2.5	80	170	3.0	2.5	100	165	5.0	18*	0	0	0	6.5	60	220	0.5	0	0	0	0	0	0	0	0	0	0	0	Open Primary of Output Transformer	
No Plate Voltage on Tubes Nos. 1, 2 and 3	2.1	60	0	0	2.1	60	0	0	2.1	60	0	0	10	60	220	0.5	0	0	0	0	0	0	0	0	0	0	0	Open R.F. Plate Supply Choke	
No C.G. Voltage on Tubes Nos. 1, 2 and 3	0	80	150	4.5	0	65	160	3.5	0	75	150	4.5	30	8.0	195	1.5	0	0	0	0	0	0	0	0	0	0	0	Open R.F. Choke Connected to Cathode of Tube No. 3	
No C.G. Voltage on Tubes Nos. 1, 2 and 3	0.4	75	150	3.5	0.4	70	160	3.0	0	80	155	4.5	30	2.0	185	1.5	0	0	0	0	0	0	0	0	0	0	0	Open R.F. Plate Supply Choke	
No S.G. Voltage on Tubes Nos. 1, 2 and 3	2.5	0	180	0	2.5	0	180	0	2.5	0	180	0	0	0	0	0	0	0	0	0	0	0	0	0	0	0	0	Open R.F. Plate Supply Choke	
No Plate Voltage on Tubes Nos. 1, 2 and 3	7.0	1.0	0	0	7.5	1.0	0	0	8.0	0	0	0	1.0	175	0	0	0	0	0	0	0	0	0	0	0	0	0	Shorted 0.1 Mfd. Condenser from Plate No. 3 to Cathode	
No Plate Voltage on Tubes Nos. 1, 2 and 3	7.0	1.0	0	0	7.0	1.0	0	0	7.0	1.0	0	0	0	1.0	175	0	0	0	0	0	0	0	0	0	0	0	0	Shorted 0.1 Mfd. Condenser from Cathode No. 1 to Cathode	
No C.G. Voltage on Tube No. 4	0	0	0	0	0	0	0	0	0	0	0	0	0	0	0	0	0	0	0	0	0	0	0	0	0	0	0	Shorted 0.75 Mfd. Condenser across Detector Bias Resistor	
No S.G. Voltage on Tubes Nos. 1, 2 and 3	0	0	0	0	0	0	0	0	0	0	0	0	0	0	0	0	0	0	0	0	0	0	0	0	0	0	0	Shorted 0.25 Mfd. Condenser from S.G. to Cathode Tube No. 4	
No C.G. Voltage on Tube No. 4	0	0	0	0	0	0	0	0	0	0	0	0	0	0	0	0	0	0	0	0	0	0	0	0	0	0	0	Shorted 0.1 Mfd. Condenser from Ground to Volume Control	
No S.G. Voltage on Tubes Nos. 1, 2 and 3	0	0	0	0	0	0	0	0	0	0	0	0	0	0	0	0	0	0	0	0	0	0	0	0	0	0	0	Shorted 0.1 Mfd. Condenser from Ground to Volume Control	
Low Plate and S.G. Voltages on Tubes Nos. 1, 2, 3 and 4	1.2	38	80	0.8	1.5	38	82	0.8	1.4	30	80	1.5	4.5	9	105	0.5	0	0	0	0	0	0	0	0	0	0	0	Shorted 0.1 Mfd. Condenser from Ground to No. 4 Heater	
No Voltage on Tube No. 4	2.8	60	170	0.75	3.0	50	160	1.4	2.8	60	165	3.8	20*	0	0	0	0	0	0	0	0	0	0	0	0	0	0	Open 17,000-Ohm Resistor	
No S.G. Voltage or Plate M.A. on Tube No. 4	2.5	80	165	2.0	2.8	90	165	2.5	3.0	60	165	3.8	5.5	0	220	0	0	0	0	0	0	0	0	0	0	0	0	Open 200,000-Ohm Resistor	
High C.G. and Low S.G. Volts on Tube No. 4	0	0	0	0	0	0	0	0	0	0	0	0	19	24	210	1.25	0	0	0	0	0	0	0	0	0	0	0	Open 12,000-Ohm Resistor Across Volume Control	
No Voltages on Tubes Nos. 1, 2 and 3	0	0	0	0	0	0	0	0	0	0	0	0	0	0	0	0	0	0	0	0	0	0	0	0	0	0	0	Open 3,200-Ohm Section of Voltage Dividing Resistor	
No C.G. or S.G. Voltages on Tubes Nos. 1, 2, 3 and 4	0	0	265	0	0	0	265	0	0	0	0	0	0	0	260	0	0	0	0	0	0	0	0	0	0	0	0	Open 3,200-Ohm S.G. Supply Resistor	
High C.G. Voltage on Tube No. 4	2.6	65	170	1.1	2.6	83	165	2.5	2.8	60	165	4.0	16	50	210	1.2	0	0	0	0	0	0	0	0	0	0	0	Open S.G. Voltage Section of Volume Control	
High C.G. Voltage on Tube No. 4	2.0	80	190	2.2	2.2	100	183	4.0	2.6	75	180	5.8	20	70*	205	1.3	0	0	0	0	0	0	0	0	0	0	0	Open 830-Ohm Section of Voltage Dividing Resistor	
Very High C.G. Voltage on Tubes Nos. 1, 2 and 3	255*	0	0	0	255*	0	0	0	255*	0	0	0	16	145	245	1.0	0	0	0	0	0	0	0	0	0	0	0	Open 120-Ohm Section of Voltage Dividing Resistor	
No S.G. Voltage on Tubes Nos. 1, 2 and 3	1.8	0	195	4.0	1.8	0	195	0	1.8	0	195	0	7.4	85	230	0.5	0	0	0	0	0	0	0	0	0	0	0	0	Open Volume Control Arm or 12,000-Ohm Resistor
High Plate Current on Tube No. 5	0	0	0	0	0	0	0	0	0	0	0	0	0	0	0	0	0	0	0	0	0	0	0	0	0	0	0	Open 480,000-Ohm Resistor	
High Plate Current on Tube No. 6	0	0	0	0	0	0	0	0	0	0	0	0	0	0	0	0	0	0	0	0	0	0	0	0	0	0	0	Open 480,000-Ohm Resistor	
High Plate Current on Tube No. 5	0	0	0	0	0	0	0	0	0	0	0	0	0	0	0	0	0	0	0	0	0	0	0	0	0	0	0	Shorted .025 Mfd. Condenser	
High Plate Current on Tube No. 6	0	0	0	0	0	0	0	0	0	0	0	0	0	0	0	0	0	0	0	0	0	0	0	0	0	0	0	Shorted .025 Mfd. Condenser	

*Caused by meter connection. No voltage present in operation.

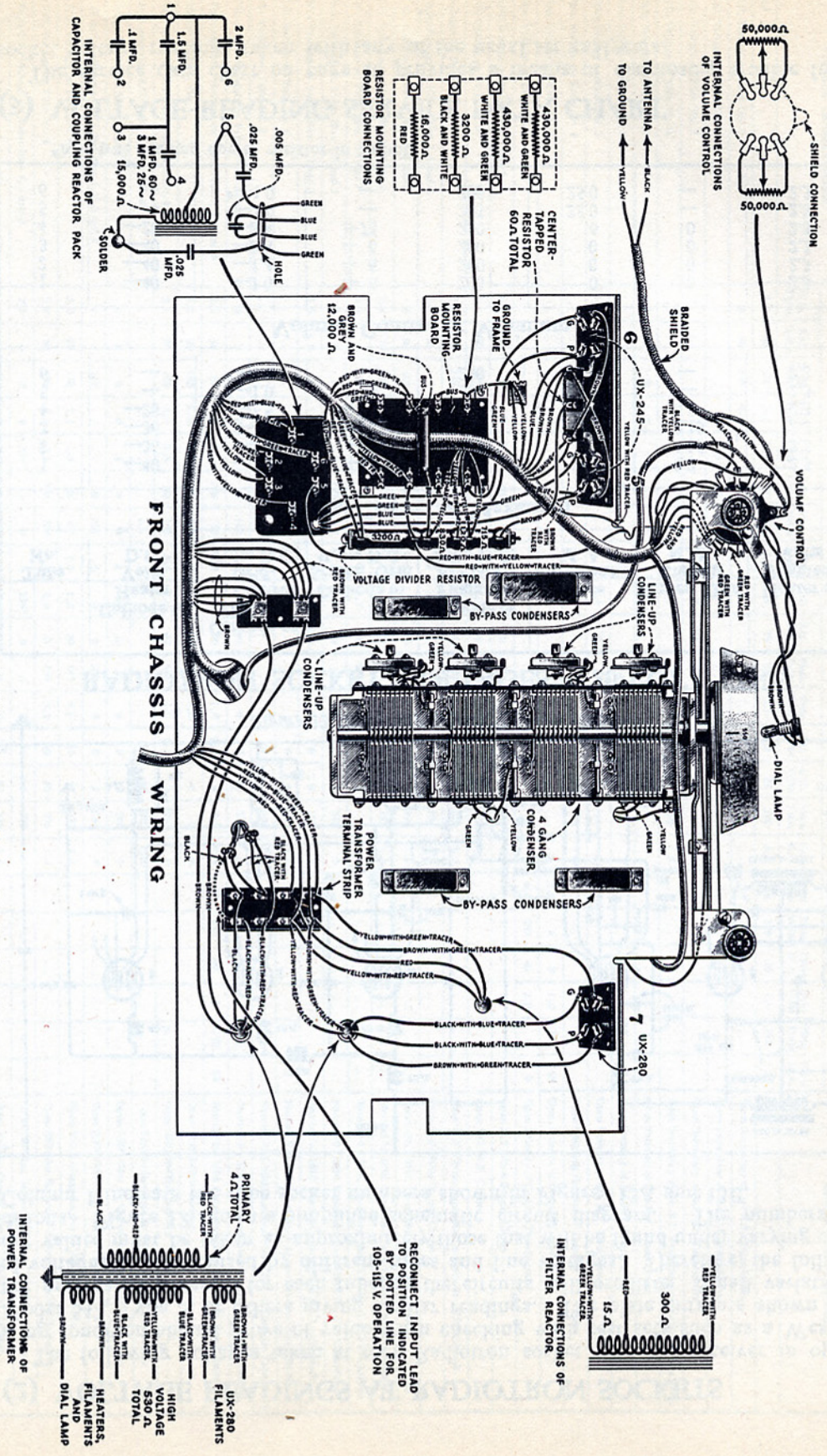

Figure 13A—Layout and wiring diagram of the chassis (front)

(4) CONTINUITY TESTS

The following tests will show complete continuity for the receiver assembly of this instrument. Disconnect the antenna and ground leads, and the A.C. supply cord at its outlet.

A pair of headphones with at least $4\frac{1}{2}$ volts in series, or a voltmeter with sufficient battery to give a good deflection when connected across the battery terminals, should be used in making these tests.

The resistance of the various circuits are shown in the column titled "Correct Effect." Checking the resistance of the circuits adds an additional check on their correct functioning. This may be done by means of a direct reading "Ohmmeter," a resistance bridge, the voltmeter-ammeter method or the method suggested in the Radiola 80 Service Notes.

Radiotron socket numbers used in making these tests are shown in Figures 13A and 13B. The schematic diagram, Figure 2, gives the values of the parts of the various circuits. Figure 12, the simplified schematic circuit diagram, is useful when making these tests.

Terminals	Correct Effect	Incorrect Effect	
		Indication	Caused By
Ant. lead to Ground lead (Vol. Cont. at "Min")	Closed (50,000 ohms)	Open	Open section of volume control
Ant. lead to Ground lead (Vol. Cont. at "Max")	Closed (30 ohms)*	Closed (50,000 ohms)	Open primary of 1st R.F. transformer
C1 to Ground	Closed (120 ohms)	Open Short Closed (21 ohms)	Open 120-ohm section of voltage divider resistor Shorted 0.1 mfd. condenser from C1 to Ground Shorted 0.1 mfd. condenser from C3 to Ground
CG1 to Ground	Closed (3 ohms)	Open Short	Open secondary of 1st R.F. transformer Shorted 1st tuning or line-up condenser
SG1 to C1, (Vol. Cont. at "Min")	Closed (16,830 ohms)	Open Short Closed (50 ohms)	Open 16,000-ohm resistor or 830-ohm section of voltage divider resistor Shorted 0.1 mfd. condenser from SG1 to C1 Short 0.1 mfd. condenser from SG3 to C3
SG1 to SG2	Closed	Open	Open connection
C1 to C2	Closed	Open	Open connection

* This may be higher on some sets due to the volume control arm not covering the full range of the resistance unit.

CONTINUITY TESTS—Continued

Terminals	Correct Effect	Incorrect Effect	
		Indication	Caused By
P1 to P2	Closed (80 ohms)	Open	Open primary of 2d or 3d R.F. transformers or connections
P1 to Ground	Closed (14,000 ohms)	Open	Open primary of 2d R.F. transformer R.F. choke, 3,200-ohm resistor, 12,000-ohm resistor and volume control, 830-ohm or 120-ohm section of voltage divider.
		Closed (160 ohms)	Shorted 0.1 mfd. condenser from C1 to plate supply
		Closed (210 ohms)	Shorted 0.1 mfd. condenser from C3 to plate supply
		Closed (54,240 ohms)	Open 12,000-ohm resistor across volume control
		Closed (16,240 ohms)	Open volume control
		Closed (90 ohms)	Shorted 1.0 mfd. condenser
C2 to Ground	Closed (120 ohms)	Open	Open 120-ohm section of voltage divider resistor
		Short	Shorted 0.1 mfd. condenser from C1 to Ground
		Closed (21 ohms)	Shorted 0.1 mfd. condenser from C3 to Ground
CG2 to Ground	Closed (3 ohms)	Open	Open secondary of 2d R.F. transformer
		Short	Shorted 2d tuning or line-up Cond.
SG2 to C2 (Vol. Cont. at "Min")	Closed (16,830 ohms)	Open	Open 16,000-ohm resistor or 830-ohm section of voltage divider resistor
		Short	Shorted 0.1 mfd. condenser from SG1 to C1
		Closed (50 ohms)	Shorted 0.1 mfd. condenser from SG3 to C3
SG2 to SG3	Closed (25 ohms)	Open	Open R.F. Choke
C2 to C3	Closed (25 ohms)	Open	Open R.F. Choke
P2 to P3	Closed (105 ohms)	Open	Open primary of 3d or 4th R.F. transformer or R.F. Choke

CONTINUITY TESTS—Continued

Terminals	Correct Effect	Incorrect Effect	
		Indication	Caused By
P2 to Ground	Closed (14,000 ohms)	Open Closed (160 ohms) Closed (210 ohms) Closed (54,240 ohms) Closed (16,240 ohms) Closed (90 ohms)	Open primary of 3d R.F. transformer, R.F. Choke, 3,200-ohm resistor, 12,000-ohm resistor and volume control, 830-ohm or 120-ohm section of voltage divider Shorted 0.1 mfd. condenser from C1 to plate supply Shorted 0.1 mfd. condenser from C3 to plate supply Open 12,000-ohm resistor across volume control Open volume control Shorted 1.0 mfd. condenser
C3 to Ground	Closed (155 ohms)	Open Short Closed (21 ohms)	Open R.F. choke or 120-ohm section of voltage divider Short 0.1 mfd. condenser from C3 to ground Short 0.1 mfd. condenser from C1 to Ground
CG3 to Ground	Closed (3 ohms)	Open Short	Open secondary of 3d R.F. transformer Shorted 3d tuning or line-up condenser
SG3 to C3 (Vol. Cont. at "Min")	Closed (16,880 ohms)	Open Short Closed (50 ohms)	Open cathode or S.G. choke, 16,000-ohm resistor or 830-ohm section of voltage divider resistor Shorted 0.1 mfd. condenser from C3 to SG3 Shorted 0.1 mfd. condenser from C1 to SG1
SG3 to Terminal No. 2	Closed (16,025 ohms)	Open	Open R.F. choke or 16,000-ohm resistor
P3 to Ground	Closed (13,940 ohms)	Open Closed (185 ohms) Closed (54,215 ohms) Closed (16,215 ohms) Closed (65 ohms)	Open primary of 4th R.F. transformer, R.F. choke, 3,200-ohm resistor and volume control, 830-ohm or 120-ohm section of voltage divider Shorted 0.1 mfd. condenser from C3 to plate supply or from C1 to plate supply Open 12,000-ohm resistor across volume control Open volume control Shorted 1.0 mfd. condenser

CONTINUITY TESTS—Continued

Terminals	Correct Effect	Incorrect Effect	
		Indication	Caused By
C4 to Ground	Closed (17,000 ohms)	Open Short	Open 17,000-ohm resistor Shorted 0.75 mfd. condenser across 17,000-ohm resistor
CG4 to Ground	Closed (3 ohms)	Open Short	Open secondary of 4th R.F. trans- former or open link at terminal strip Shorted 4th tuning or line-up con- denser
SG4 to Terminal 3 (Vol. Cont. at "Max")	Closed (200,000 ohms)	Open	Open 200,000-ohm resistor
C4 to P4	Closed (41,707 ohms)	Short	Shorted 320 mmfd. condenser
Terminal 3 to P4 (Vol. Cont. at "Max")	Closed (14,080 ohms)	Open	Open R.F. choke, coupling reactor or either 3,200-ohm resistor
P4 to either F7	Closed (7,680 ohms)	Open	Open R.F. choke, or one-half of coupling reactor
P4 to G5	Open	Closed (180 ohms)	Shorted .025 mfd. coupling con- denser
P4 to G6	Open	Closed (15,180 ohms)	Shorted .025 mfd. condenser
G5 to Ground	Closed (430,000 ohms)	Open	Open 430,000-ohm resistor
G6 to Ground	Closed (430,000 ohms)	Open	Open 430,000-ohm resistor
P5 to P6	Closed (330 ohms)	Open Short	Open primary of output transformer Shorted .005 mfd. condenser
Across secondary of output transformer (cone coil disconnected)	Closed (.2 ohms)	Open	Open secondary of output trans- former
Across cone Coil (Output transformer disconnect- ed)	Closed (2.5 ohms)	Open	Open cone coil

CONTINUITY TESTS—Continued

Terminals	Correct Effect	Incorrect Effect	
		Indication	Caused By
G7 to P7	Closed (530 ohms)	Open	Open high voltage winding of power transformer
G7 or P7 to Ground	Closed (1,895 ohms)	Open	Open high voltage winding of power transformer, filter reactor or reproducer field coil
Across F7 contacts	Closed (Short)	Open	Open UX-280 filament winding
Either side of filament contacts of Sockets 1, 2, 3, 4, 5 or 6	Closed (745 ohms)	Open Short	Open 60-ohm center tapped resistor or 715-ohm bias resistor Shorted 0.1 mfd. condenser from heater to ground of Socket No. 4
Across A.C. input plug	Closed (4 ohms)	Open	Open primary of power transformer
Either F7 to Ground	Closed (17,350 ohms)	Open Closed (57,350 ohms) Closed (19,350 ohms) Closed (3,200 ohms) Closed (1,345 ohms) Closed (1,630 ohms) Short	Open either 3,200-ohm resistor, 12,000-ohm resistor and volume control, 830- or 120-ohm section of voltage divider Open 12,000-ohm resistor across volume control Open volume control Shorted 1.0 mfd. condenser Shorted 2.0 mfd. condenser Shorted .1 mfd. condenser Shorted 1.5 mfd. filter condenser
Terminal No. 2 to F7 (Vol. Cont. in Max. Position)	Closed (6,400 ohms)	Open	Open 3,200-ohm resistor