

# JVC

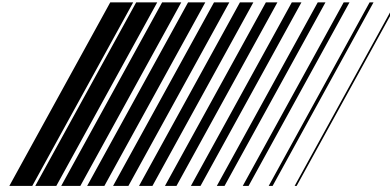

SR-VS30U

## Mini DV/S-VHS VIDEO CASSETTE RECORDER

# SR-VS30U

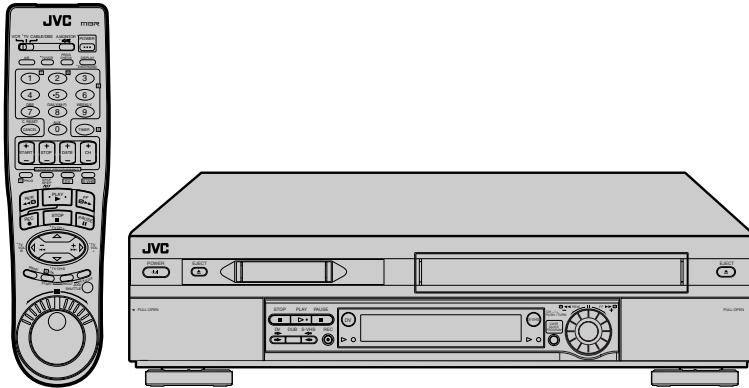

**S VHS**  
Mini **DV** NTSC  
*Hi-Fi*  
**VCR plus+<sup>®</sup>**  
CABLE BOX CONTROL  
**Super VHS ET**

## INSTRUCTIONS

**For Customer Use:**

Enter below the Model No. and Serial No. which are located on the rear of cabinet. Retain this information for future reference.

Model No. \_\_\_\_\_



Serial No. \_\_\_\_\_

## 2 EN

**Dear Customer,**

Thank you for purchasing the JVC Mini DV/S-VHS video cassette recorder. Before use, please read the safety information and precautions to ensure safe use of your new VCR.

### CAUTIONS

	<b>CAUTION</b> RISK OF ELECTRIC SHOCK DO NOT OPEN	
<p><b>CAUTION:</b> TO REDUCE THE RISK OF ELECTRIC SHOCK, DO NOT REMOVE COVER (OR BACK). NO USER-SERVICEABLE PARTS INSIDE. REFER SERVICING TO QUALIFIED SERVICE PERSONNEL.</p>		



The lightning flash with arrowhead symbol, within an equilateral triangle, is intended to alert the user to the presence of uninsulated "dangerous voltage" within the product's enclosure that may be of sufficient magnitude to constitute a risk of electric shock to persons.



The exclamation point within an equilateral triangle is intended to alert the user to the presence of important operating and maintenance (servicing) instructions in the literature accompanying the appliance.

**WARNING:**

**TO PREVENT FIRE OR SHOCK HAZARD, DO NOT EXPOSE THIS UNIT TO RAIN OR MOISTURE.**

**CAUTION:**

This video cassette recorder should be used with AC 120V~, 60Hz only.

To prevent electric shocks and fire hazards, DO NOT use any other power source.

**CAUTION:**

TO PREVENT ELECTRIC SHOCK, MATCH WIDE BLADE OF PLUG TO WIDE SLOT, FULLY INSERT.

**ATTENTION:**

POUR ÉVITER LES CHOCS ÉLECTRIQUES, INTRODUIRE LA LAME LA PLUS LARGE DE LA FICHE DANS LA BORNE CORRESPONDANTE DE LA PRISE ET POUSSER JUSQU'AU FOND.

**Note to CATV system installer:**

This reminder is provided to call the CATV system installer's attention to Article 820-40 of the NEC that provides guidelines for proper grounding and, in particular, specifies that the cable ground shall be connected to the grounding system of the building, as close to the point of cable entry as practical.

**CAUTION:**

Changes or modifications not approved by JVC could void user's authority to operate the equipment.

**Failure to heed the following precautions may result in damage to the VCR, Remote or video cassette.**

- DO NOT place the VCR . . .**
  - ...in an environment prone to extreme temperatures or humidity.
  - ...in direct sunlight.
  - ...in a dusty environment.
  - ...in an environment where strong magnetic fields are generated.
  - ...on a surface that is unstable or subject to vibration.
- DO NOT block the VCR's ventilation openings.**
- DO NOT place heavy objects on the VCR or on the Remote.**
- DO NOT place anything which might spill on the top of the VCR or on the Remote.**
- AVOID violent shocks to the VCR during transport.**

**MOISTURE CONDENSATION**

Moisture in the air will condense on the VCR when you move it from a cold place to a warm place, or under extremely humid conditions—just as water droplets form on the surface of a glass filled with cold liquid. Moisture condensation on the head drum will cause damage to the tape. In conditions where condensation may occur, keep the VCR's power turned on for a few hours to let the moisture dry before inserting a tape.

VCR Plus+, C<sup>3</sup> and PlusCode are registered trademarks of Gemstar Development Corporation. The VCR Plus+ system is manufactured under license from Gemstar Development Corporation.

DSS™ is an official trademark of DIRECTV, Inc., a unit of GM Hughes Electronics. PRIMESTAR is a registered service mark of Primestar Partners, L.P. DISH Network™ is a trademark of EchoStar Communications Corporation.



- Cassettes marked "S-VHS" and "VHS" can be used with this video cassette recorder. However, S-VHS recordings are possible only with cassettes marked "S-VHS". By using the S-VHS ET function, it is possible to record and play back with S-VHS picture quality on VHS cassettes with this VCR.
- Cassettes marked "Mini DV" can be used with the DV deck of this VCR. The DV deck can play back and record only NTSC signals.

This product incorporates copyright protection technology that is protected by method claims of certain U.S. patents and other intellectual property rights owned by Macrovision Corporation and other rights owners. Use of this copyright protection technology must be authorized by Macrovision Corporation, and is intended for home and other limited viewing users only unless otherwise authorized by Macrovision Corporation. Reverse engineering or disassembly is prohibited.

## IMPORTANT PRODUCT SAFETY INSTRUCTIONS

Electrical energy can perform many useful functions. But improper use can result in potential electrical shock or fire hazards. This product has been engineered and manufactured to assure your personal safety. In order not to defeat the built-in safeguards, observe the following basic rules for its installation, use and servicing.

### ATTENTION:

Follow and obey all warnings and instructions marked on your product and its operating instructions. For your safety, please read all the safety and operating instructions before you operate this product and keep this booklet for future reference.

## INSTALLATION

### 1. Grounding or Polarization

(A) Your product may be equipped with a polarized alternating-current line plug (a plug having one blade wider than the other). This plug will fit into the power outlet only one way. This is a safety feature.

If you are unable to insert the plug fully into the outlet, try reversing the plug. If the plug should still fail to fit, contact your electrician to replace your obsolete outlet. Do not defeat the safety purpose of the polarized plug.

(B) Your product may be equipped with a 3-wire grounding-type plug, a plug having a third (grounding) pin. This plug will only fit into a grounding-type power outlet. This is a safety feature.

If you are unable to insert the plug into the outlet, contact your electrician to replace your obsolete outlet. Do not defeat the safety purpose of the grounding-type plug.

### 2. Power Sources

Operate your product only from the type of power source indicated on the marking label. If you are not sure of the type of power supply to your home, consult your product dealer or local power company. If your product is intended to operate from battery power, or other sources, refer to the operating instructions.

### 3. Overloading

Do not overload wall outlets, extension cords, or integral convenience receptacles as this can result in a risk of fire or electric shock.

### 4. Power Cord Protection

Power supply cords should be routed so that they are not likely to be walked on or pinched by items placed upon or against them, paying particular attention to cords at plugs, convenience receptacles, and the point where they exit from the product.

### 5. Ventilation

Slots and openings in the cabinet are provided for ventilation. To ensure reliable operation of the product and to protect it from overheating, these openings must not be blocked or covered.

- Do not block the openings by placing the product on a bed, sofa, rug or other similar surface.
- Do not place the product in a built-in installation such as a bookcase or rack unless proper ventilation is provided or the manufacturer's instructions have been adhered to.

### 6. Wall or Ceiling Mounting

The product should be mounted to a wall or ceiling only as recommended by the manufacturer.

## ANTENNA INSTALLATION INSTRUCTIONS

### 1. Outdoor Antenna Grounding

If an outside antenna or cable system is connected to the product, be sure the antenna or cable system is grounded so as to provide some protection against voltage surges and built-up static charges. Article 810 of the National Electrical Code, ANSI/NFPA 70, provides information with regard to proper grounding of the mast and supporting structure, grounding of the lead-in wire to an antenna discharge unit, size of grounding connectors, location of antenna discharge unit, connection to grounding electrodes, and requirements for the grounding electrode.

### 2. Lightning

For added protection for this product during a lightning storm, or when it is left unattended and unused for long periods of time, unplug it from the wall outlet and disconnect the antenna or cable system. This will prevent damage to the product due to lightning and power-line surges.

### 3. Power Lines

An outside antenna system should not be located in the vicinity of overhead power lines or other electric light or power circuits, or where it can fall into such power lines or circuits. When installing an outside antenna system, extreme care should be taken to keep from touching such power lines or circuits as contact with them might be fatal.

EXAMPLE OF ANTENNA GROUNDING AS PER NATIONAL ELECTRICAL CODE, ANSI/NFPA 70

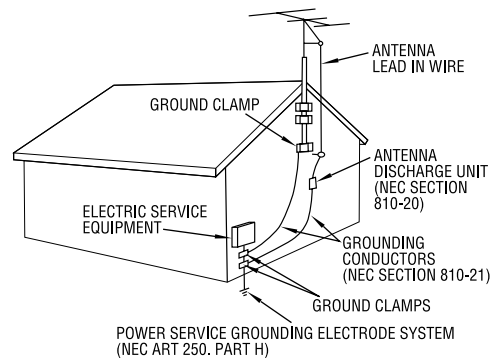

NEC - NATIONAL ELECTRICAL CODE

# 4 EN

## USE

### 1. Accessories

To avoid personal injury:

- Do not place this product on an unstable cart, stand, tripod, bracket, or table. It may fall, causing serious injury to a child or adult, and serious damage to the product.
- Use only with a cart, stand, tripod, bracket, or table recommended by the manufacturer or sold with the product.
- Use a mounting accessory recommended by the manufacturer and follow the manufacturer's instructions for any mounting of the product.
- Do not try to roll a cart with small casters across thresholds or deep-pile carpets.

### 2. Product and Cart Combination

A product and cart combination should be moved with care. Quick stops, excessive force, and uneven surfaces may cause the product and cart combination to overturn.

PORTABLE CART WARNING  
(Symbol provided by RETAC)



### 3. Water and Moisture

Do not use this product near water—for example, near a bath tub, wash bowl, kitchen sink or laundry tub, in a wet basement, or near a swimming pool and the like.

### 4. Object and Liquid Entry

Never push objects of any kind into this product through openings as they may touch dangerous voltage points or short-out parts that could result in a fire or electric shock. Never spill liquid of any kind on the product.

### 5. Attachments

Do not use attachments not recommended by the manufacturer of this product as they may cause hazards.

### 6. Cleaning

Unplug this product from the wall outlet before cleaning. Do not use liquid cleaners or aerosol cleaners. Use a damp cloth for cleaning.

### 7. Heat

The product should be situated away from heat sources such as radiators, heat registers, stoves, or other products (including amplifiers) that produce heat.

## SERVICING

### 1. Servicing

If your product is not operating correctly or exhibits a marked change in performance and you are unable to restore normal operation by following the detailed procedure in its operating instructions, do not attempt to service it yourself as opening or removing covers may expose you to dangerous voltage or other hazards. Refer all servicing to qualified service personnel.

### 2. Damage Requiring Service

Unplug this product from the wall outlet and refer servicing to qualified service personnel under the following conditions:

- When the power supply cord or plug is damaged.
- If liquid has been spilled, or objects have fallen into the product.
- If the product has been exposed to rain or water.
- If the product does not operate normally by following the operating instructions. Adjust only those controls that are covered by the operating instructions as an improper adjustment of other controls may result in damage and will often require extensive work by a qualified technician to restore the product to its normal operation.
- If the product has been dropped or damaged in any way.
- When the product exhibits a distinct change in performance—this indicates a need for service.

### 3. Replacement Parts

When replacement parts are required, be sure the service technician has used replacement parts specified by the manufacturer or which have the same characteristics as the original part. Unauthorized substitutions may result in fire, electric shock or other hazards.

### 4. Safety Check

Upon completion of any service or repairs to this product, ask the service technician to perform safety checks to determine that the product is in safe operating condition.

## HOW TO USE THIS INSTRUCTION MANUAL

- All major sections and subsections are listed in the Table Of Contents on page 5. Use this when searching for information on a specific procedure or feature.
- The Index on pages 6 – 11 lists frequently-used terms, and the number of the page on which they are used or explained in the manual. This section also illustrates the controls and connections on the front and rear panel, the front display panel and the remote control.
- The  mark signals a reference to another page for instructions or related information.
- Operation buttons necessary for the various procedures are clearly indicated through the use of illustrations at the beginning of each major section.

## BEFORE YOU INSTALL YOUR NEW VCR . . .

. . . please read the sections/literature listed below.

- "CAUTIONS" on page 2
- "IMPORTANT PRODUCT SAFETY INSTRUCTIONS" on pages 3 – 4

**CONTENTS**

EN **5**

<b>INDEX</b> .....	<b>6</b>	<b>PLAYBACK/RECORDING ON DV DECK</b> .....	<b>36</b>
FRONT VIEW .....	6	<b>Basic Playback</b> .....	<b>36</b>
REAR VIEW .....	7	<b>Basic Recording</b> .....	<b>37</b>
FRONT DISPLAY PANEL .....	8	<b>Playback Features</b> .....	<b>38</b>
REMOTE .....	9	Still Picture/Frame-By-Frame Playback (On the VCR) .....	38
How To Use .....	9	Slow Motion (On the VCR) .....	38
ON-SCREEN DISPLAY (for VHS deck) .....	10	High-Speed (Turbo) Search (On the VCR) .....	38
ON-SCREEN DISPLAY (for DV deck) .....	11	Variable Speed Search (On the VCR) .....	38
<b>INSTALLING YOUR NEW VCR</b> .....	<b>12</b>	Still Picture/Frame-By-Frame Playback (On the Remote) .....	39
<b>Basic Connections</b> .....	<b>12</b>	Slow Motion (On the Remote) .....	39
<b>S-VIDEO Connection</b> .....	<b>13</b>	High-Speed (Turbo) Search (On the Remote) .....	39
<b>INITIAL SETTINGS</b> .....	<b>14</b>	Variable Speed Search (On the Remote) .....	39
<b>Plug &amp; Play Set</b> .....	<b>14</b>	Next Function Memory .....	40
<b>Language</b> .....	<b>15</b>	Soundtrack Selection .....	40
<b>Clock Set</b> .....	<b>16</b>	<b>Recording Features</b> .....	<b>41</b>
Preparations .....	16	Second Audio Recording .....	41
Semiauto Clock Set .....	17	Record One Program While Watching Another .....	41
Manual Clock Set .....	17	Instant Timer Recording (ITR) .....	41
<b>Tuner Set</b> .....	<b>18</b>	Time Code .....	41
Auto Channel Set .....	18	<b>TIMER RECORDING</b> .....	<b>42</b>
Manual Channel Set .....	19	<b>VCR Plus+™ Timer Programming</b> .....	<b>42</b>
<b>Cable Box Control Setting</b> .....	<b>20</b>	<b>Changing VCR Plus+™ Setting</b> .....	<b>44</b>
Installing Controller .....	20	Guide Channel Number Set .....	44
Setting cable box's brand and channel .....	21	Guide Channel Number .....	45
<b>DBS Receiver Control Setting</b> .....	<b>23</b>	<b>Express Timer Programming</b> .....	<b>46</b>
Installing Controller .....	23	<b>24HR Quick Programming</b> .....	<b>48</b>
Setting DBS receiver's brand and channel .....	24	Check, cancel and change programs .....	50
<b>PLAYBACK/RECORDING ON VHS DECK</b> .....	<b>26</b>	To cancel or change a program... ..	50
<b>Basic Playback</b> .....	<b>26</b>	When programs overlap each other .....	51
<b>Basic Recording</b> .....	<b>27</b>	<b>EDITING</b> .....	<b>52</b>
<b>Playback Features</b> .....	<b>28</b>	<b>Tape Dubbing (from DV to VHS)</b> .....	<b>52</b>
Still Picture/Frame-By-Frame Playback (On the VCR) .....	28	Dubbing An Entire Cassette .....	52
Slow Motion (On the VCR) .....	28	<b>Tape Dubbing (from VHS to DV)</b> .....	<b>53</b>
High-Speed (Turbo) Search (On the VCR) .....	28	Dubbing An Entire Cassette .....	53
Variable Speed Search (On the VCR) .....	28	<b>Normal Dubbing (from DV to VHS)</b> .....	<b>54</b>
Still Picture/Frame-By-Frame Playback (On the Remote) .....	29	<b>Normal Dubbing (from VHS to DV)</b> .....	<b>55</b>
Slow Motion (On the Remote) .....	29	<b>Edit From A Camcorder</b> .....	<b>56</b>
High-Speed (Turbo) Search (On the Remote) .....	29	<b>Edit To Or From Another VCR/PC</b> .....	<b>58</b>
Variable Speed Search (On the Remote) .....	29	<b>Audio Dubbing</b> .....	<b>60</b>
Repeat Playback .....	30	VHS Audio Dubbing .....	60
Index Search .....	30	DV Audio Dubbing .....	60
Next Function Memory .....	30	<b>Insert Editing</b> .....	<b>62</b>
Manual Tracking .....	31	VHS Insert Editing .....	62
Soundtrack Selection .....	31	DV Insert Editing (SP mode only) .....	62
<b>Recording Features</b> .....	<b>32</b>	AV Insert Editing (VHS deck only) .....	63
Record One Program While Watching Another .....	32	<b>Random Assemble Editing</b> .....	<b>64</b>
Instant Timer Recording (ITR) .....	32	64-program Editing Memory (8 programs x 8 scenes) .....	64
Elapsed Recording Time Indication .....	33	<b>REMOTE CONTROL FUNCTIONS</b> .....	<b>66</b>
Tape Remaining Time .....	33	Remote A/B Code Switching .....	66
Retake .....	34	TV Multi-Brand Remote Control .....	67
Second Audio Recording .....	34	Cable Box Multi-Brand Remote Control .....	68
<b>Active Video Calibration</b> .....	<b>35</b>	DBS Receiver Multi-Brand Remote Control .....	69
Playback .....	35	<b>SUBSIDIARY SETTINGS</b> .....	<b>70</b>
Recording .....	35	<b>Mode Set</b> .....	<b>70</b>
		<b>TROUBLESHOOTING</b> .....	<b>77</b>
		<b>QUESTIONS AND ANSWERS</b> .....	<b>81</b>
		PLAYBACK .....	81
		RECORDING .....	81
		TIMER RECORDING .....	81
		<b>SPECIFICATIONS</b> .....	<b>82</b>
		<b>INDEX</b> .....	<b>83</b>

6 EN

INDEX

FRONT VIEW

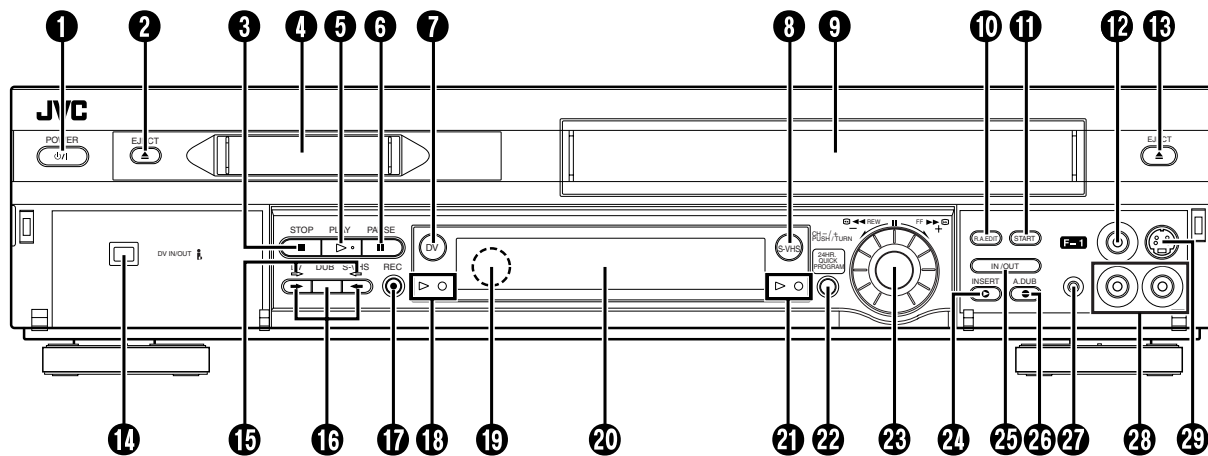

- ❶ POWER Button ☞ pg. 15
- ❷ DV Eject (EJECT ▲) Button ☞ pg. 36, 37
- ❸ STOP ■ Button ☞ pg. 26, 27, 36, 37
- ❹ Mini DV Cassette Loading Slot
- ❺ PLAY ► Button ☞ pg. 26, 36
- ❻ PAUSE || Button ☞ pg. 27, 28, 37, 38
- ❼ DV Button ☞ pg. 36, 37
- ❽ S-VHS Button ☞ pg. 26, 27
- ❾ VHS Cassette Loading Slot
- ❿ Random Assemble Edit (R.A.EDIT) Button ☞ pg. 64
- ⓫ Random Assemble Edit START Button ☞ pg. 65
- ⓬ VIDEO Input Connector ☞ pg. 56, 62
- ⓭ VHS Eject (EJECT ▲) Button ☞ pg. 26, 27
- ⓮ DV IN/OUT connector (i.Link\*) ☞ pg. 56
- \* i.Link refers to the IEEE1394-1995 industry specification and extensions thereof. The  logo is used for products compliant with the i.Link standard.
- ⓯ Dubbing Direction (DV ⇄/⇄ S-VHS) Indicators ☞ pg. 52, 53
- ⓰ Dubbing (DUB) Button ☞ pg. 52, 53
- ⓱ Dubbing Direction (→/←) Buttons ☞ pg. 52, 53
- ⓲ REC ● Button ☞ pg. 27, 37
- ⓳ DV mode Indicators ☞ pg. 36, 37
- ⓴ Remote Sensor
- ⓵ Front Display Panel ☞ pg. 8
- ⓶ VHS mode Indicators ☞ pg. 26, 27
- ⓷ 24HR QUICK PROGRAM Button ☞ pg. 48
- ⓸ ADVANCED JOG Dial ☞ pg. 26, 36, 48
- ⓹ INSERT Button ☞ pg. 63
- ⓺ Random Assemble Edit IN/OUT Button ☞ pg. 64
- ⓻ Audio Dubbing (A.DUB) Button ☞ pg. 61
- ⓼ Remote PAUSE Connector ☞ pg. 56
- ⓽ AUDIO Input Connectors ☞ pg. 56, 60, 62
- ⓾ S-VIDEO Input Connector ☞ pg. 56, 62

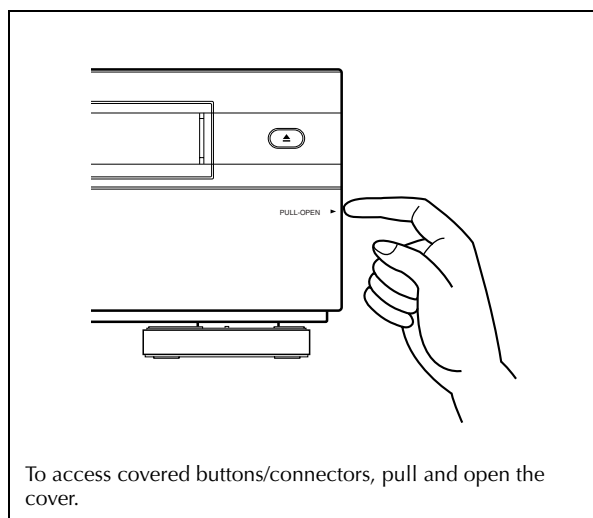

## REAR VIEW

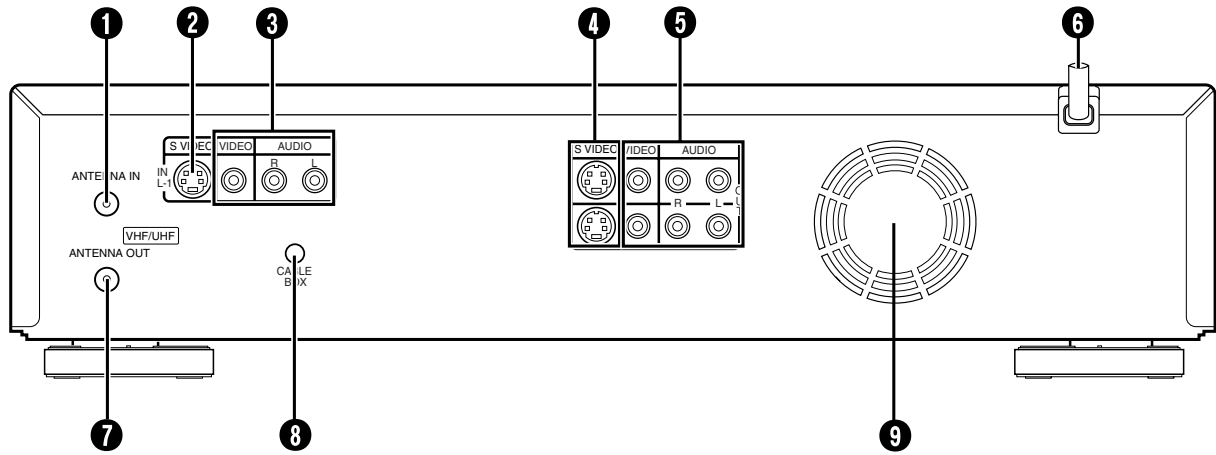

- 1** ANTENNA IN Connector [pg. 12](#)
- 2** S VIDEO IN Connector [pg. 56, 58](#)
- 3** VIDEO/AUDIO IN Connectors [pg. 56, 58](#)
- 4** S VIDEO OUT Connectors [pg. 13, 58](#)
- 5** VIDEO/AUDIO OUT Connectors [pg. 58](#)
- 6** AC Power Cord [pg. 12](#)

- 7** ANTENNA OUT Connector [pg. 12](#)
- 8** CABLE BOX Connector [pg. 20, 23](#)
- 9** Cooling fan
  - This prevents the temperature from rising inside the VCR. Do not remove it.
  - Install the VCR so as not to block the area around the fan.
  - The fan may be activated even if the VCR is turned off.

# FRONT DISPLAY PANEL

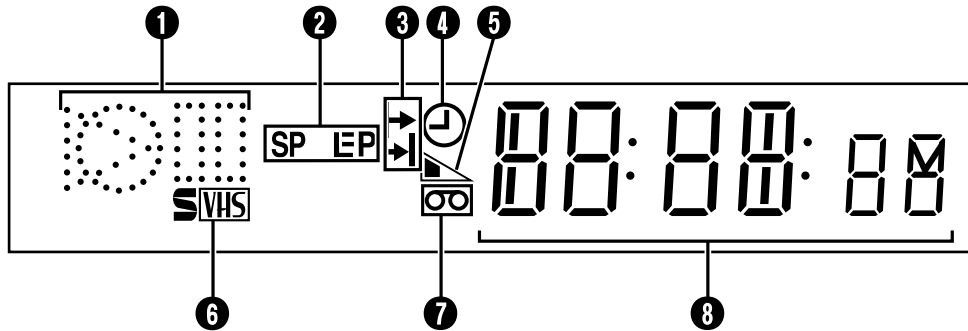

**1** Symbolic Mode Indicators

PLAY: FF/REW VARIABLE SEARCH:	▶	STILL: SLOW:	▶
		RECORD:	○
		RECORD PAUSE:	○
AUDIO DUBBING:			☀
AUDIO DUBBING PAUSE:			☀
INSERT:			⊙
INSERT PAUSE:			⊙
AV INSERT:			☀
AV INSERT PAUSE:			☀

- 2** Tape Speed Indicators ☞ pg. 27, 37
- 3** Start Time Indicator (▶) ☞ pg. 48
- Stop Time Indicator (▶) ☞ pg. 48
- 4** "Timer" Indicator ☞ pg. 43, 47, 48
- 5** Tape Remaining Time Indicator (VHS deck only) ☞ pg. 33
- 6** S-VHS Indicator (VHS deck only) ☞ pg. 72
- 7** "Cassette Loaded" Mark
- 8** Counter/Remain Display (VHS deck only) ☞ pg. 33
- Time Code Display (DV deck only) ☞ pg. 41
- Channel/Mode Display (L-1 or F-1) ☞ pg. 14
- Clock Display ☞ pg. 14



# REMOTE

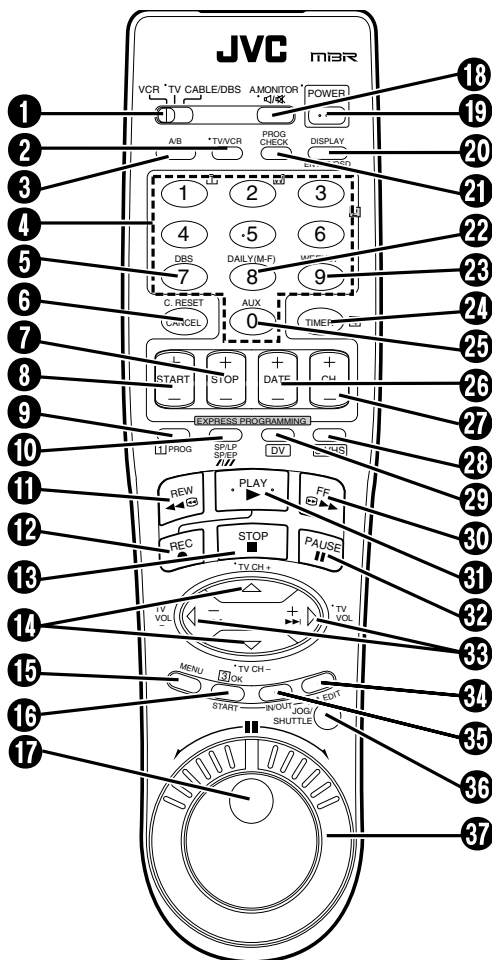

- 1 VCR/TV/CABLE/DBS Switch ☞ pg. 67, 68, 69
- 2 TV/VCR Button ☞ pg. 67
- 3 A/B Code Button ☞ pg. 66
- 4 Number Keys ☞ pg. 27, 37
- 5 DBS Button ☞ pg. 47
- 6 CANCEL Button ☞ pg. 50
- 7 STOP +/- Button ☞ pg. 46
- 8 START +/- Button ☞ pg. 46
- 9 PROG Button ☞ pg. 46
- 10 Auto Tracking  $\mathbb{I}$  Button ☞ pg. 31
- 11 Rewind (REW ◀◀) Button ☞ pg. 26, 36
- 12 REC ● Button ☞ pg. 27, 37
- 13 STOP ■ Button ☞ pg. 26, 36
- 14 △ ▽ Button ☞ pg. 15
- 15 TV CH +/- Button ☞ pg. 67
- 16 MENU Button ☞ pg. 15
- 17 OK Button ☞ pg. 15
- 18 Random Assemble Edit START Button ☞ pg. 65
- 19 JOG dial ☞ pg. 29, 39
- 20 A. MONITOR Button ☞ pg. 31, 40
- 21 ◄/Ⓜ (TV Muting) Button ☞ pg. 67
- 22 POWER Button ☞ pg. 15
- 23 DISPLAY Button ☞ pg. 33
- 24 ENTER Button ☞ pg. 67
- 25 On-Screen Display (OSD) Button ☞ pg. 10, 11
- 26 PROG CHECK Button ☞ pg. 50
- 27 DAILY (M-F) Button ☞ pg. 43, 47
- 28 WEEKLY Button ☞ pg. 43, 47
- 29 TIMER Button ☞ pg. 43, 47
- 30 AUX Button ☞ pg. 56
- 31 DATE +/- Button ☞ pg. 47
- 32 CH +/- Button ☞ pg. 27, 37
- 33 S-VHS Button ☞ pg. 26, 27
- 34 DV Button ☞ pg. 36, 37
- 35 Fast Forward (FF ▶▶) Button ☞ pg. 26, 36
- 36 PLAY ▶ Button ☞ pg. 26, 36
- 37 PAUSE || Button ☞ pg. 27, 37
- 38 ◀ ▶ Button ☞ pg. 29, 39
- 39 TV Volume (VOL) +/- Button ☞ pg. 67
- 40 Random Assemble Edit (R.A.EDIT) Button ☞ pg. 64
- 41 Random Assemble Edit (IN/OUT) Button ☞ pg. 64
- 42 JOG/SHUTTLE Button ☞ pg. 29, 39
- 43 SHUTTLE Ring ☞ pg. 29, 39

Buttons with a small dot on the left side of the name can also be used to operate your TV with the **VCR/TV/CABLE/DBS** switch set to TV. (☞ pg. 67)

### How To Use

Before use, insert two AA size batteries into the Remote with the polarity (⊕ and ⊖) matched correctly as indicated on the battery compartment or on the lid.

The Remote can operate most of your VCR's functions, as well as basic functions of TV sets, cable boxes and DBS receivers.

- Point the Remote toward the remote sensor on the target component.
- The maximum operating distance of the remote control is about 8 m.

**NOTE:**  
 If the Remote does not work properly, remove its batteries, wait for a few seconds, replace the batteries and then try again.

## ON-SCREEN DISPLAY (for VHS deck)

If you press **DISPLAY/OSD** on the Remote when "SUPERIMPOSE" is set to "ON" (pg. 71), various operational indicators appear on the TV screen.

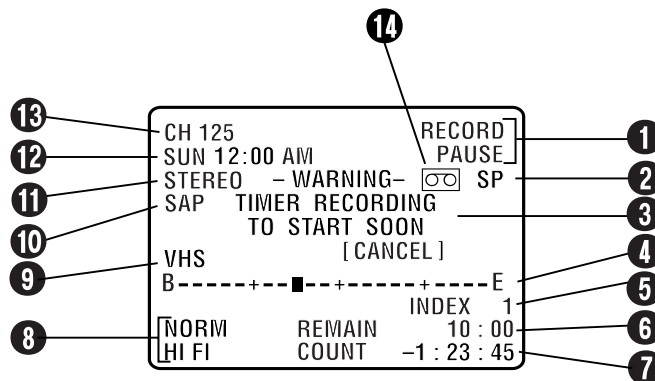

**1** Operation Mode Indicators

**2** Tape Speed SP/EP

**3** Timer Warning Display

A warning appears on the TV screen to tell you that the timer-recording is to start in 5 minutes if you're not in the Timer mode at that time. The warning blinks for the entire 5 minutes leading up to the start of timer recording. To clear the display, press **CANCEL** on the Remote.

**4** Tape Position Indicator

The tape position indicator appears on the TV screen when you press **REW** (◀◀) or **FF** (▶▶) from the Stop mode or perform an Index Search (pg. 30). The position of "█" in relation to "B" (beginning) or "E" (end) shows you where you are on the tape.

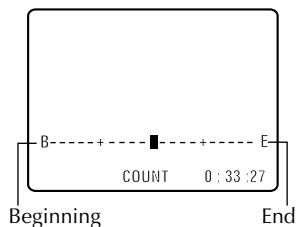

**NOTE:**

Depending on the type of tape being used, the tape position indicator may not appear correctly.

**5** Index number pg. 30

**6** Tape Remaining Time Indicator

**7** Counter Display pg. 33

**8** Audio Mode Display pg. 31

**9** VHS Indicator

**10** SAP Indicator pg. 34

**11** Stereo program Indicator pg. 34

**12** Day/Clock Display

**13** Channel Position Number/

Auxiliary Input Indicator (L-1 or F-1)

Dubbing Direction Indicators

(DV → VHS) pg. 52

**14** "Cassette Loaded" Mark

**To recall an indication**

**1** Press **DISPLAY/OSD**.

- All indications corresponding to the current status are displayed for 5 seconds. After that, the counter information and RECORD/PAUSE if in the Record Pause mode, remain on the screen.

**2** Press **DISPLAY/OSD** again to clear the display.

- The RECORD/PAUSE indication remains on the screen.

## ON-SCREEN DISPLAY (for DV deck)

If you press **DISPLAY/OSD** on the Remote when "SUPERIMPOSE" is set to "ON" (pg. 71), various operational indicators appear on the TV screen.

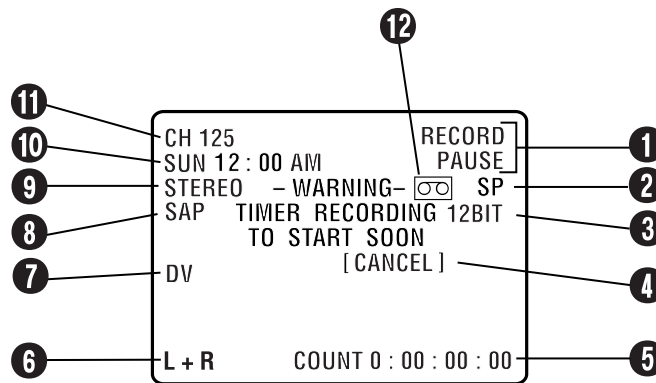

**1** Operation Mode Indicators

**2** Tape Speed SP/LP

**3** Sound Mode Display (pg. 76)

**4** Timer Warning Display

A warning appears on the TV screen to tell you that the timer-recording is to start in 5 minutes if you're not in the Timer mode at that time. The warning blinks for the entire 5 minutes leading up to the start of timer recording. To clear the display, press **CANCEL** on the Remote.

**ERROR** Indicator\*

\* *ERROR* indicator appears when you start dubbing a tape with a copy protection signals or when Audio Dubbing or Insert Editing is not possible depending on the condition.

**5** Time Code Display (pg. 41, 76)

**6** Audio Mode Display (pg. 40)

**7** DV Indicator

**8** SAP Indicator (pg. 41)

**9** Stereo program Indicator (pg. 41)

**10** Day/Clock Display

**11** Channel Position Number/  
Auxiliary Input Indicator (L-1 or F-1)  
Dubbing Direction Indicators

(VHS → DV) (pg. 53)

**12** "Cassette Loaded" Mark

**To recall an indication**

**1** Press **DISPLAY/OSD**.

•All indications corresponding to the current status are displayed for 5 seconds. After that, the counter information and RECORD/PAUSE if in the Record Pause mode, remain on the screen.

**2** Press **DISPLAY/OSD** again to clear the display.

•The RECORD/PAUSE indication remains on the screen.

# 12<sub>EN</sub>

## INSTALLING YOUR NEW VCR

# Basic Connections

It's essential that your VCR be properly connected.

THESE STEPS MUST BE COMPLETED BEFORE ANY VIDEO OPERATION CAN BE PERFORMED.

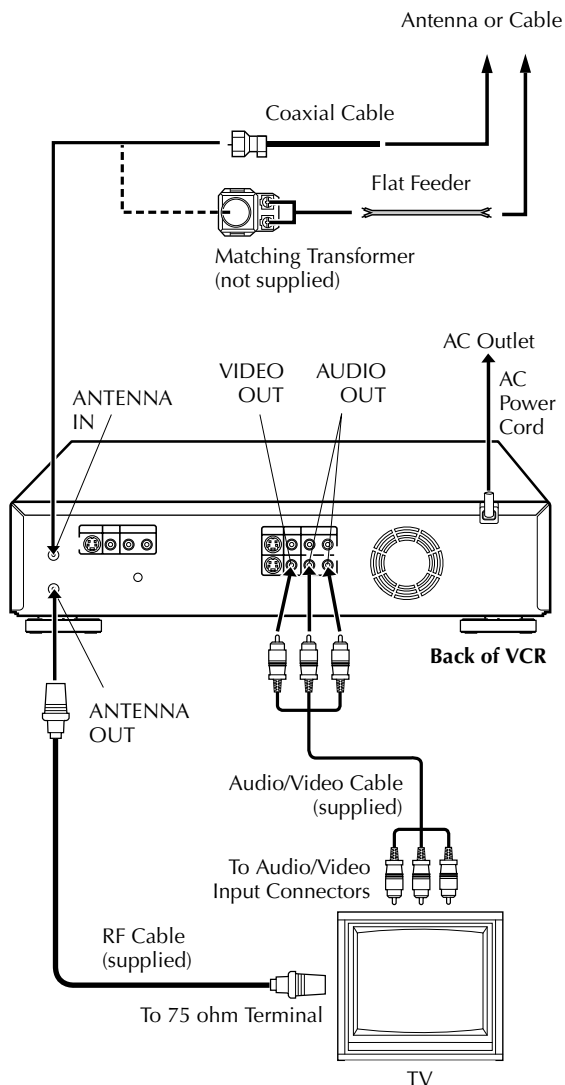

### 1 Check the contents.

Make sure the package contains all of the accessories listed in "SPECIFICATIONS" on page 82.

### 2 Situate the VCR.

Place the VCR on a stable, horizontal surface.

### 3 Connect the VCR to TV.

- 1 Disconnect the TV antenna from the TV.
  - 2 Connect the TV antenna cable to the ANTENNA IN connector on the rear panel of the VCR.
  - 3 Connect the supplied RF cable between the ANTENNA OUT connector on the rear panel of the VCR and the TV's antenna terminal.
  - 4 Connect the supplied Audio/Video cable between the AUDIO/VIDEO OUT connectors on the rear of the VCR and the Audio/Video input connectors on the TV.
- Set your TV to AV mode.
  - For switching the TV's mode, refer to the instruction manual of your television.
  - To obtain high-quality S-VHS pictures, you can also use the S-VIDEO connection described on page 13.

### 4 Connect the VCR to power source.

- Plug the end of the AC power cord into an AC outlet.
- The clock and tuner channels will automatically be set when the antenna is connected and when the AC power cord is first connected to an AC outlet (see pg. 14). (If "Auto" or "CH" is displayed on the front display panel before the VCR is powered on, the clock and tuner channels are being set automatically. Wait for the time to be displayed on the front display panel before turning on the VCR.)

# S-VIDEO Connection

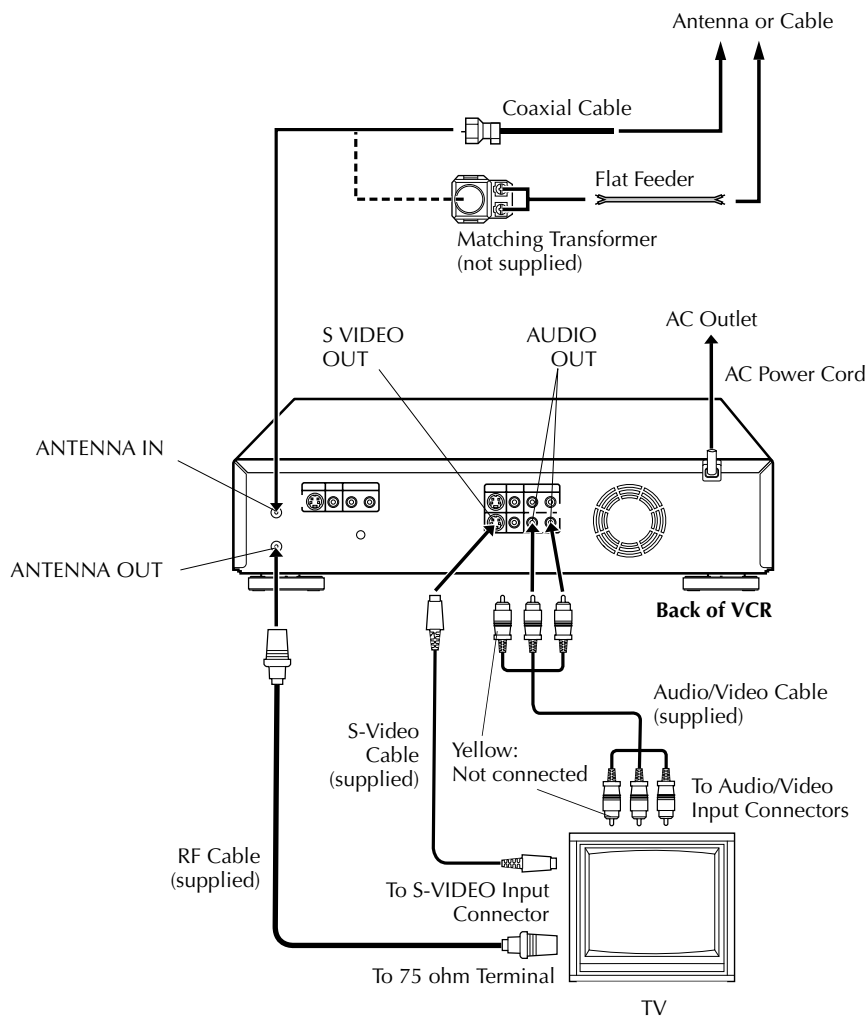

■ To connect to a TV with S-VIDEO/AUDIO input connectors . . .

## 1 Connect the VCR to TV.

- 1 Connect the antenna, VCR and TV as per "Basic Connections" (pg. 12).
- 2 Connect the VCR's S VIDEO OUT connector to the TV's S-VIDEO input connector.
- 3 Connect the VCR's AUDIO OUT connectors to the TV's AUDIO input connectors.

## 2 Connect the VCR to power source.

Plug the end of the AC power cord into an AC outlet.

- The clock and tuner channels will automatically be set when the antenna is connected and when the AC power cord is first connected to an AC outlet (pg. 14). (If "Auto" or "CH" is displayed on the front display panel before the VCR is powered on, the clock and tuner channels are being set automatically. Wait for the time to be displayed on the front display panel before powering on the VCR.)

### NOTES:

- You can obtain high-quality S-VHS pictures.
- To operate the VCR with your TV using the S-VIDEO connection, set your TV to its AV mode. You can also use the **TV/VCR** button on the VCR's Remote to set your TV to the AV mode. (pg. 67)
- For switching the TV's mode, refer to the instruction manual of your television.

# Plug & Play Set

## Auto Clock Set/Auto Tuner Set

### ATTENTION:

- If you use a cable box, Plug&Play will not function; set the clock and tuner channels separately. (☞ pg. 16 – 19)
- Depending on areas or reception conditions, the VCR may not receive the Auto clock setting data from the PBS channel. If this function is taking a considerable amount of time, it may be necessary to perform the Semiauto or Manual Clock Set procedure.

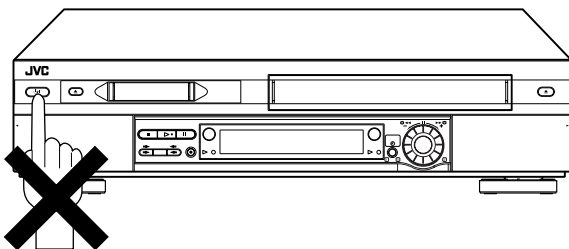

This VCR sets the clock and tuner channels automatically when AC power cord is first connected to an AC outlet. The antenna cable must be connected for the Plug & Play setting.

The time and date can be set automatically by the clock setting data transmitted from one of the regular TV broadcast channels. We call this TV channel the “host channel” and it is a PBS channel in your area.

### 1 Perform Plug & Play setup.

Connect the antenna cable to the VCR (☞ pg. 12). Then connect the AC power cord to an AC outlet. Do not turn on the VCR.

The clock and tuner channels will be set automatically.

### NOTES:

- *Auto Clock Set is performed first. “Auto” blinks on the front display panel during Auto Clock Set.*
- *Auto Channel Set is performed next. Auto Channel Set scans all the channels that are receivable by your VCR. During Auto Channel Set, the channel numbers are displayed as they are scanned and set.*
- *When Plug & Play setting has been complete successfully, the correct clock time is displayed. If you perform Plug & Play setting successfully, there is no need to perform “Clock Set” (☞ pg. 16) and “Tuner Set” (☞ pg. 18). If, however, you want to add or delete channels, refer to “Manual Channel Set” (☞ pg. 19).*

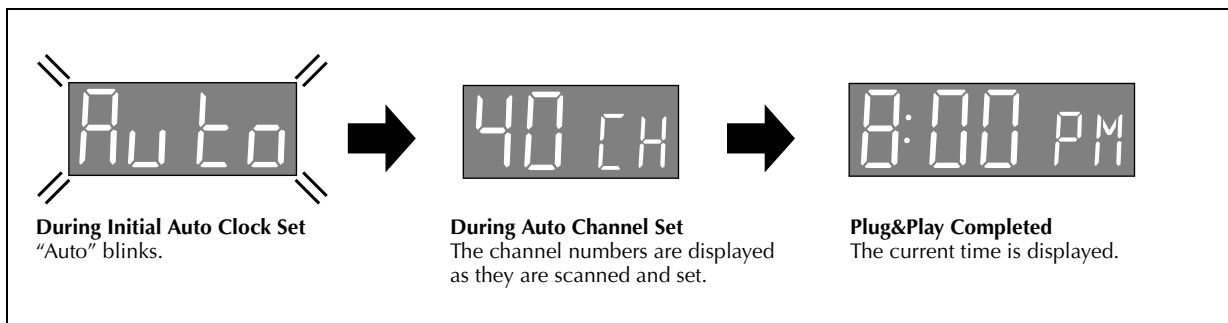

\* If an incorrect clock time or “- :- -” appears on the display panel, see “What to do if Plug & Play setting failed” below.

### INFORMATION

- If “AUTO CLOCK” is set to “ON” (☞ pg. 17), the clock will be adjusted automatically by the host channel every hour (except 11:00 PM, midnight, 1:00 AM and 2:00 AM) using the incoming PBS channel clock setting data. (This automatic clock adjustment can only be performed when the VCR is turned off. The clock will be adjusted just on these hours — on the time displayed on the front display panel, not on the actual real time.) The default setting of “AUTO CLOCK” is “ON”. (☞ pg. 17)
- If the memory backup fails, because a power outage occurs or because the AC power cord is unplugged, Plug & Play will be performed when power is restored to the VCR.

### What to do if Plug & Play setting failed

- If an incorrect time is displayed on the front display panel, you may be receiving the clock setting data of a PBS channel from an adjacent time zone, or an incorrect PBS channel from a cable TV system. In this case, perform “Semiauto Clock Set” (☞ pg. 17) or “Manual Clock Set” (☞ pg. 17).
- If “- :- -” appears on the front display panel, your antenna cable may not be connected to the VCR or there may not be a Host PBS signal available in your area. Ensure that the antenna cable is connected correctly. Then turn on and off the VCR; the Plug & Play setting will be automatically reactivated. If Plug & Play setting is not performed though the antenna cable is connected correctly, perform “Manual Clock Set” (☞ pg. 17) and “Auto Channel Set” (☞ pg. 18) or “Manual Channel Set” (☞ pg. 19).

# Language

Turn on the TV and select the AV mode.

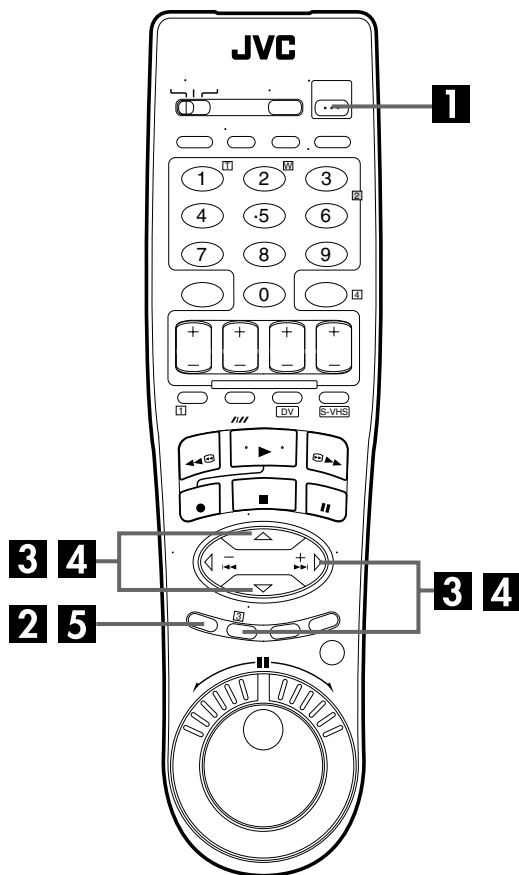

This VCR offers you the language choice to view menus and some messages — in English, Spanish or French. The default setting is “ENGLISH”.

## 1 Turn on the VCR.

Press **POWER**.

## 2 Access the Main Menu screen.

Press **MENU**.

## 3 Access the Initial Set screen.

Press  $\Delta$ / $\nabla$  to move the highlight bar (arrow) to “INITIAL SET”, then press **OK** or  $\triangleright$ .

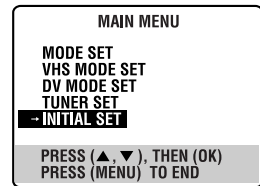

## 4 Select the language.

Press  $\Delta$ / $\nabla$  to move the highlight bar (arrow) to “LANGUAGE”, then press **OK** or  $\triangleright$  repeatedly until the desired language is selected.

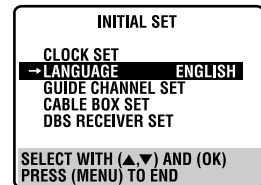

## 5 Return to the normal screen.

Press **MENU**.

16<sup>EN</sup>

INITIAL SETTINGS (cont.)

# Clock Set

Turn on the TV and select the AV mode.

Perform clock setting only if the clock has not been set correctly by the Plug&Play setting or if you use a cable box.

## Preparations

### 1 Turn on the VCR.

Press **POWER**.

### 2 Access the Main Menu screen.

Press **MENU**.

### 3 Access the Initial Set screen.

Press  $\Delta$ / $\nabla$  to move the highlight bar (arrow) to "INITIAL SET", then press **OK** or  $\triangleright$ .

### 4 Access the Clock Set screen.

Press  $\Delta$ / $\nabla$  to move the highlight bar (arrow) to "CLOCK SET", then press **OK** or  $\triangleright$ .

- "CABLE BOX USERS SET CLOCK MANUALLY" appears on the screen for about 5 seconds, then the Clock Set screen appears.

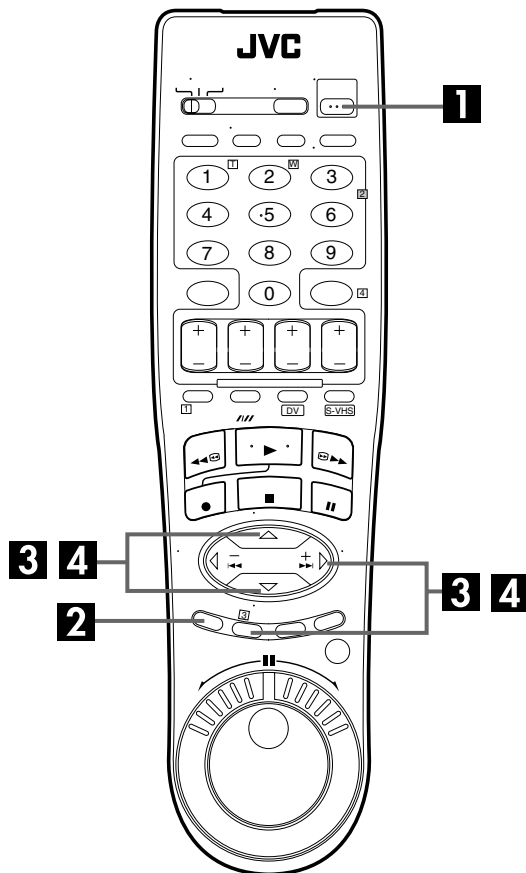



## Semiauto Clock Set

You can change the host channel/D.S.T. (Daylight Saving Time)/time zone setting manually. First follow steps 1 to 4 in "Preparations" (pg. 16), then go to the following steps.

### NOTE:

The time set previously will be erased when "AUTO CLOCK", "HOST CH", "D.S.T." or "TIME ZONE" setting is changed.

### 1 Set "Auto Clock" to "ON".

Press **OK** or **▷** repeatedly to move the highlight bar to "AUTO CLOCK", then press **△▽** so that "ON" is selected.

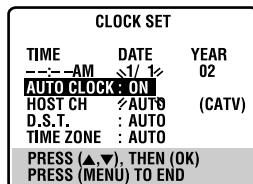

### 2 Select the host channel.

You can either select "AUTO" or enter a PBS channel number.

Press **OK** or **▷** to move the highlight bar to "HOST CH", then press **△▽** repeatedly until "AUTO" or the desired PBS channel number is selected.

### NOTE:

Some PBS channels do not transmit clock setting data.

### 3 Select the D.S.T. mode.

Press **OK** or **▷** to move the highlight bar to "D.S.T.", then press **△▽** repeatedly until the desired setting is selected.

**AUTO:** Select if you want to adjust your VCR's clock automatically by the incoming signal from the host channel. Be sure to select the correct time zone manually in step 4.

**ON:** Adjustment will be made by the built-in clock itself.

**OFF:** Select when Daylight Saving Time does not apply to you.

### 4 Select the time zone.

Press **OK** or **▷** to move the highlight bar to "TIME ZONE", then press **△▽** repeatedly until "AUTO" or the desired time zone is selected. Each time you press the button, the time zone changes as follows:

- ↔ AUTO ↔ ATLANTIC ↔ EASTERN ↔ CENTRAL
- ↔ MOUNTAIN ↔ PACIFIC ↔ ALASKA ↔ HAWAII
- ↔ (back to the beginning)

### NOTE:

If an incorrect time is displayed by the Plug & Play function, you may be receiving the clock setting data of a PBS channel from an adjacent time zone or from an incorrect PBS channel from a cable TV system. If you selected "AUTO" for the host channel in step 2, be sure to select the correct time zone manually.

### 5 Complete the Semiauto Clock Set.

Press **MENU** to return to normal screen.

### IMPORTANT

Turn off the VCR after performing Semiauto Clock. "Auto" will appear on the display panel while the clock is being set. The current clock time will appear automatically when the clock setting is complete.

### AUTO DAYLIGHT SAVING TIME

This function enables automatic adjustment of the VCR's clock at the start and end of Daylight Saving Time.

With Auto DST activated, . . .

. . . on the first Sunday of April at 2:00 AM, the clock is adjusted to 3:00 AM.

. . . on the last Sunday of October at 2:00 AM, the clock is adjusted to 1:00 AM.

## Manual Clock Set

First follow steps 1 to 4 in "Preparations" (pg. 16), then go to the following steps.

### 1 Set time, date and year.

Press **△▽** until the desired time appears, then press **OK** or **▷**. Set the date and year in the same way.

- Holding **△▽** changes the time in 30-minute intervals, or changes the date in 15-day intervals.

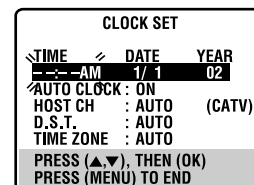

### 2 Select D.S.T. mode.

Press **OK** or **▷** to move the highlight bar to "D.S.T.", then press **△▽** to select the desired setting.

**ON:** Adjustment will be made by the built-in clock itself.

**OFF:** Select when Daylight Saving Time does not apply to you.

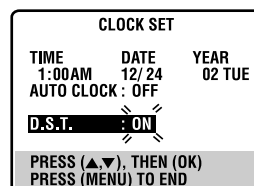

### 3 Start clock.

Press **MENU** and normal screen appears.

### To make corrections any time during the process

Press **OK** or **▷** repeatedly until the item you want to change blinks, then press **△▽**.

# Tuner Set

Turn on the TV and select the AV mode.

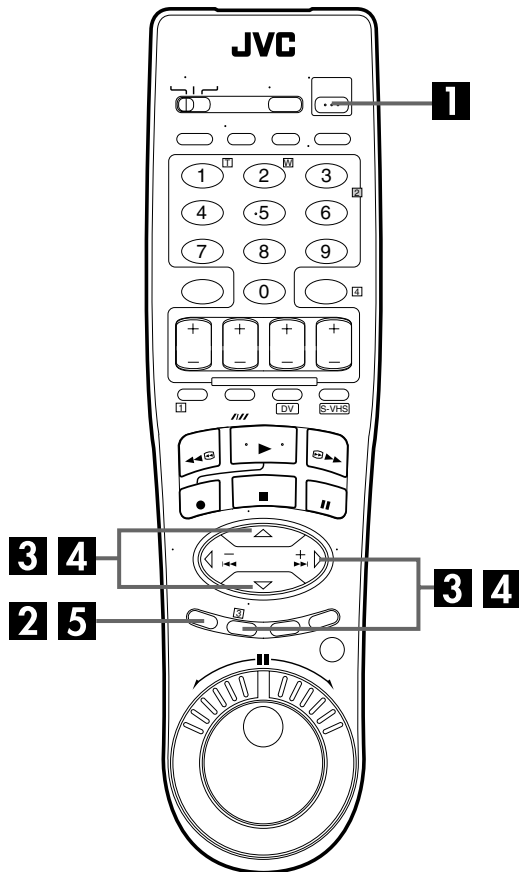

**INFORMATION**  
 The VCR selects the correct band (TV or CATV) automatically during Auto Channel Set. The selected band will be displayed on the right side of "BAND" on the Tuner Set screen.

## Auto Channel Set

Perform Auto Channel Set only if channels have not been set correctly by the Plug&Play setting.

### 1 Turn on the VCR.

Press **POWER**.

### 2 Access the Main Menu screen.

Press **MENU**.

### 3 Access the Tuner Set screen.

Press  $\Delta$ / $\nabla$  to move the highlight bar (arrow) to "TUNER SET", then press **OK** or  $\triangleright$ .

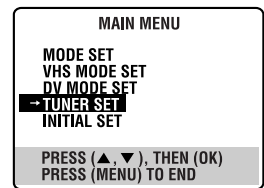

### 4 Perform Auto Channel Set.

Press  $\Delta$ / $\nabla$  to move the highlight bar (arrow) to "AUTO CH SET", then press **OK** or  $\triangleright$ . You can automatically set the receivable channels in your area in the order of their frequencies.

- When Auto Channel Set is complete, "SCAN COMPLETED" appears on the TV screen.
- If the scan was unsuccessful, "SCAN COMPLETED-NO SIGNAL-" appears on screen. Check the connections and start again.

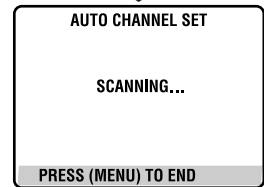
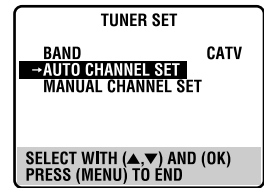

### 5 Return to the normal screen.

Press **MENU**.

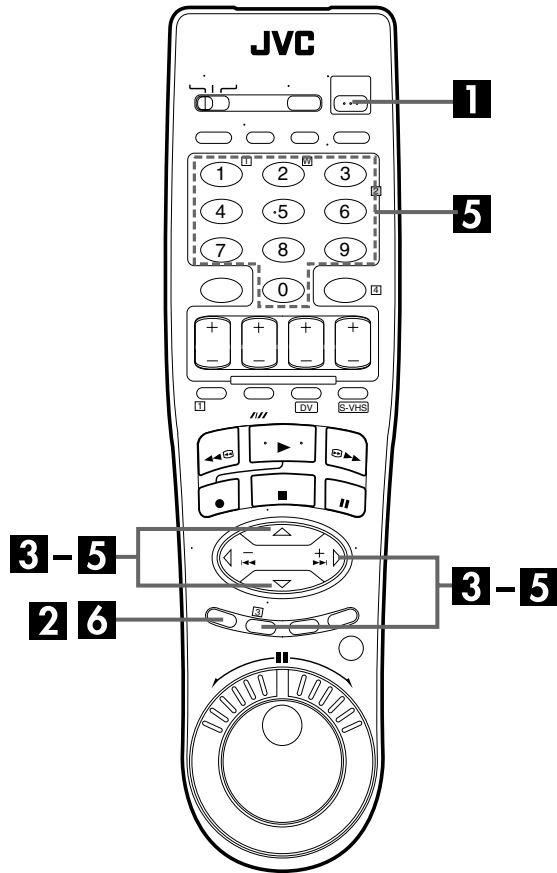

## Manual Channel Set

You can add the channels you want or delete the channels you do not want manually.

### 1 Turn on the VCR.

Press **POWER**.

### 2 Access the Main Menu screen.

Press **MENU**.

### 3 Access the Tuner Set screen.

Press  $\Delta$ / $\nabla$  to move the highlight bar (arrow) to "TUNER SET", then press **OK** or  $\triangleright$ .

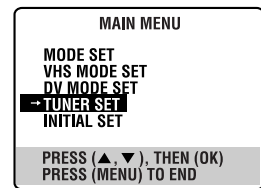

### 4 Access the Manual Channel Set screen.

Press  $\Delta$ / $\nabla$  to move the highlight bar (arrow) to "MANUAL CHANNEL SET", then press **OK** or  $\triangleright$ .

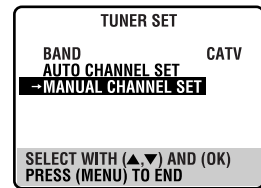

### 5 Add or skip the desired channels.

#### To add channels

- 1 Press the **number keys** to input a channel number you want to add.
- 2 Press **OK** or  $\triangleright$  to set to "ADD".
- 3 Repeat 1 to 2 to add other channels.

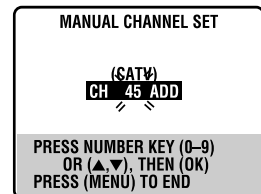

#### To skip channels

- 1 Press  $\Delta$ / $\nabla$  or the **number keys** to select a channel number you want to skip.
- 2 Press **OK** or  $\triangleright$  to set to "SKIP".
- 3 Repeat 1 and 2 to skip other channels.

### 6 Return to the normal screen.

Press **MENU**.

# Cable Box Control Setting

Place the cable box on top of the VCR. Attach the VCR's Controller to the top of the VCR with the Controller's transmitter pointed towards the cable box's remote sensor.

**ATTENTION:**

*The Controller can also control a DBS receiver. If both a cable box and a DBS receiver are used, position the Controller so its signal reaches the remote sensors of both the cable box and DBS receiver.*

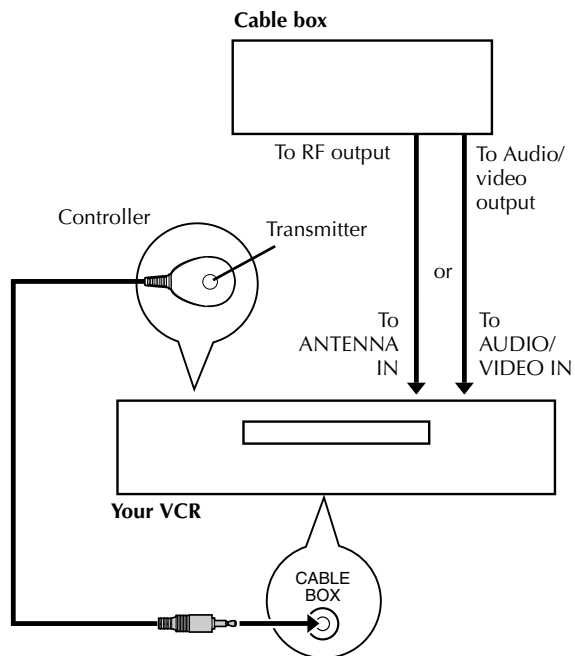
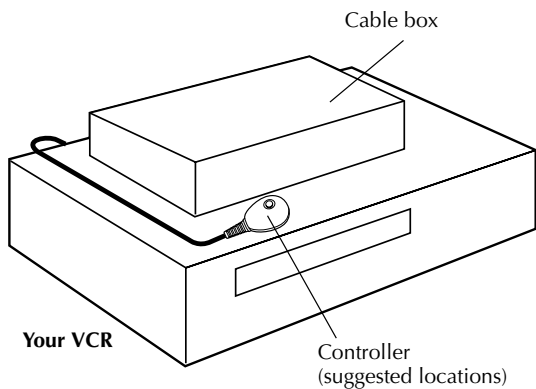

The following procedure is required if you receive your TV channels through a cable box (descrambler). The Controller allows the VCR to automatically switch the cable box channel during timer recording. The Controller is effective for recording broadcasts that have been programmed using "VCR Plus+" Timer Programming" (pg. 42) or "Express Timer Programming" (pg. 46).

## Installing Controller

**1 Situate the Controller.**

Place the Controller so that the path between its transmitter and the cable box's remote sensor is unobstructed.

**2 Attach the Controller.**

Fix securely using the adhesive strip attached on the back of the Controller.

**3 Make connections.**

**If your cable box does not have audio/video output connectors**

Connect the RF output connector on the cable box to the ANTENNA IN connector on the rear of your VCR.

**If your cable box has audio/video output connectors**

Connect an audio/video cable between the AUDIO/VIDEO IN connectors on the rear of the VCR and the audio/video output connectors on the cable box.

**NOTE:**

*When connecting your cable box, refer to its instruction manual.*

**4 Connect the Controller to VCR.**

Connect the Controller to the CABLE BOX connector on the rear panel.

**How to control the cable box**

This VCR has two separate methods to control your cable box.

- The VCR's wireless Remote can control your cable box. This eliminates the need for a separate cable box's Remote.
- The VCR's Controller can also control your cable box. This allows the VCR to change your cable box's channel number during timer recording.

Each method must be set up separately. To set up the VCR's Remote, refer to page 68. To set up the Controller, go to page 21.

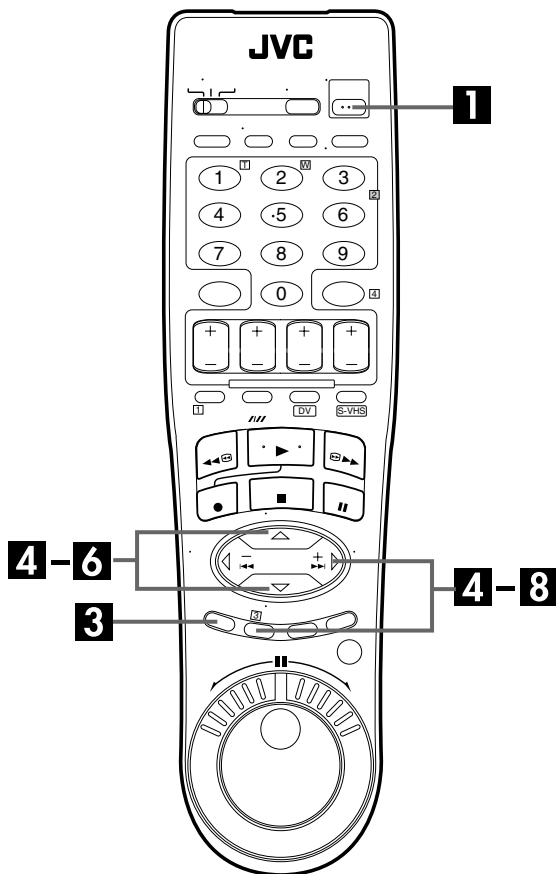

#### 4 Access the Initial Set screen.

Press  $\Delta$ / $\nabla$  to move the highlight bar (arrow) to "INITIAL SET", then press **OK** or  $\triangleright$ .

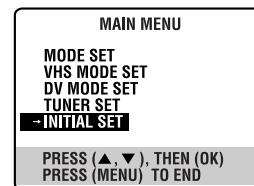

#### 5 Access the Cable Box Set screen.

Press  $\Delta$ / $\nabla$  to move the highlight bar (arrow) to "CABLE BOX SET", then press **OK** or  $\triangleright$ .

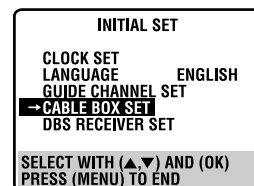

#### 6 Select the cable box's channel.

Your selection depends on how the cable box is connected to your VCR.

**If the cable box is connected to your VCR's ANTENNA IN connector on the rear panel,** press  $\Delta$ / $\nabla$  until the channel number representing the cable box's output (CH2 – CH9) appears on the screen.

**If the cable box is connected to your VCR's AUDIO/VIDEO IN connectors on the rear panel,** press  $\Delta$ / $\nabla$  until "ON L-1 (REAR)" appears on the screen.

**If you do not use a cable box,** press  $\Delta$ / $\nabla$  until "OFF" appears on the screen.

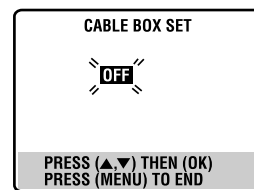

## Setting cable box's brand and channel

After installation, set the cable box's brand and channel correctly; otherwise, the Controller cannot work correctly.

Turn on the TV and select the AV mode.

### 1 Turn on the VCR.

Press **POWER**.

### 2 Turn on the cable box.

Turn on the cable box's power.

### 3 Access the Main Menu screen on the VCR.

Press **MENU**.