

NF 4 - NF-Platte  
R 314 / 1314

Ruhestromeinstellung 30 mA; Kollektorkreis T 307 / 1307

No-signal current control 30 milli-amps; Collector line of transistor T 307 or T 1307

Réglage du courant sans signal 30 mA; circuit collecteur du T 307 resp. du T 1307

Ruststroom-instelling 30 mA; collector-leiding van de T 307 resp. T 1307

R 307 / R 1307

Mittelpunktspannung

Adjustment of centre-point voltage

Réglage de la tension moyenne

Instelling van de middelpunt spanning

18,2 V

M 301

[C 311 — R 321 — R 322]

bzw.

or

resp.

M 1301

[C 1311 — R 1321 — R 1322]

Wellenbereiche / Wave ranges  
Gammes d'ondes / Golfbereiken

UKW/VHF/FM	87,6 — 104 MHz (mc)
KW/SW	5,9 — 16 MHz (mc) (51 — 18,7 m)
MW	520 — 1620 kHz (kc)
LW	150 — 350 kHz (kc)

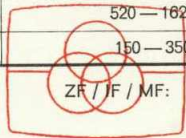

gegen Plus  
against positiv  
pole  
contre  
pôle positif  
tegen plus

# TELEFUNKEN Concertino hifi 201 V

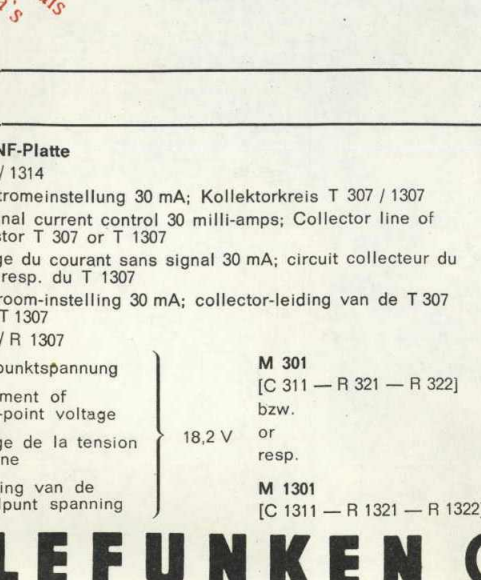
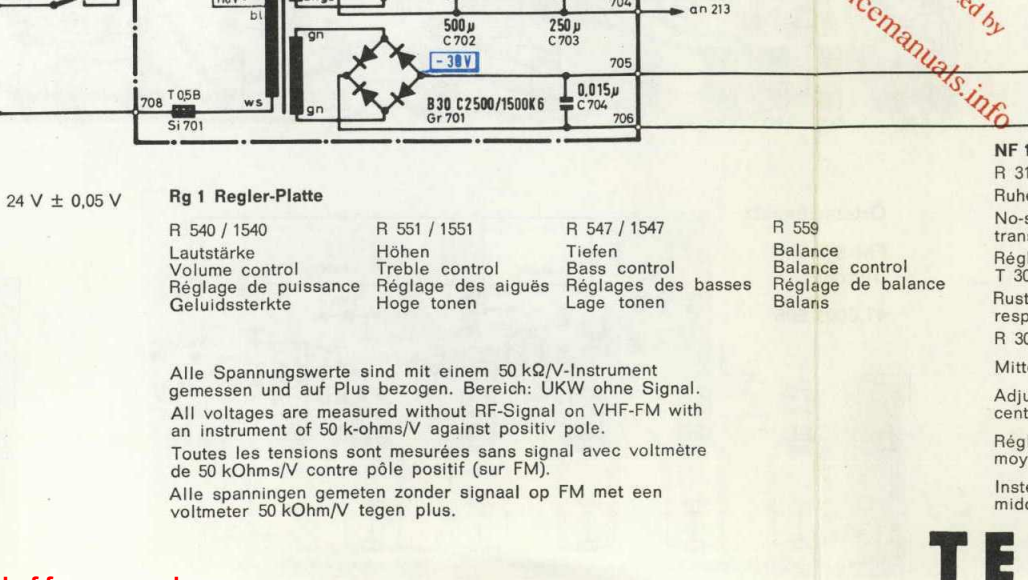
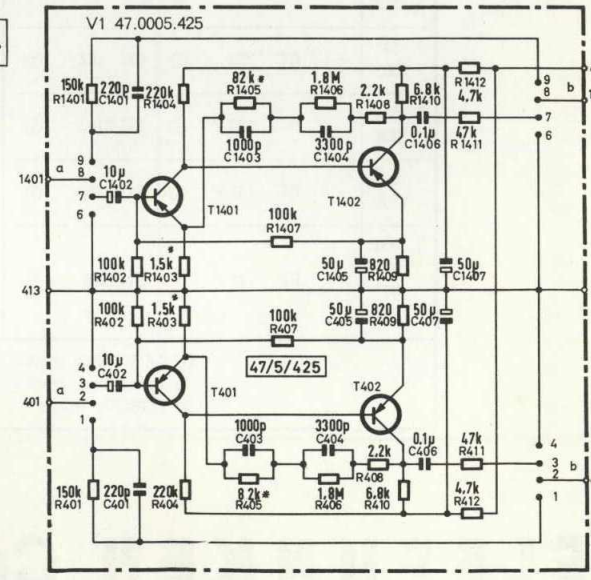
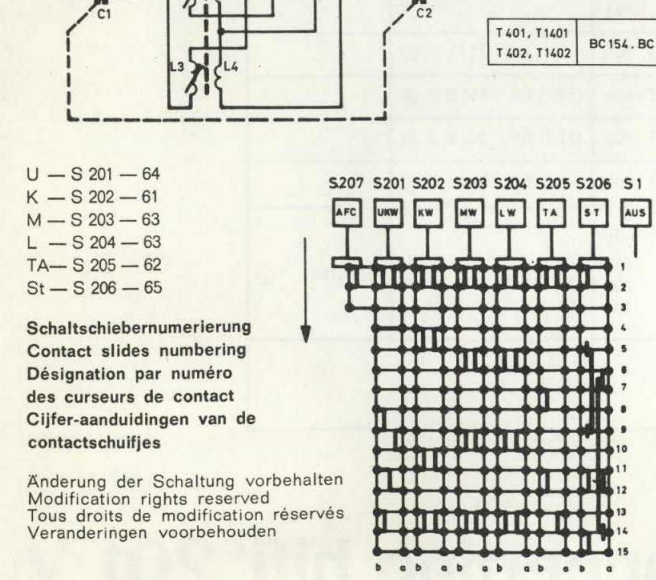
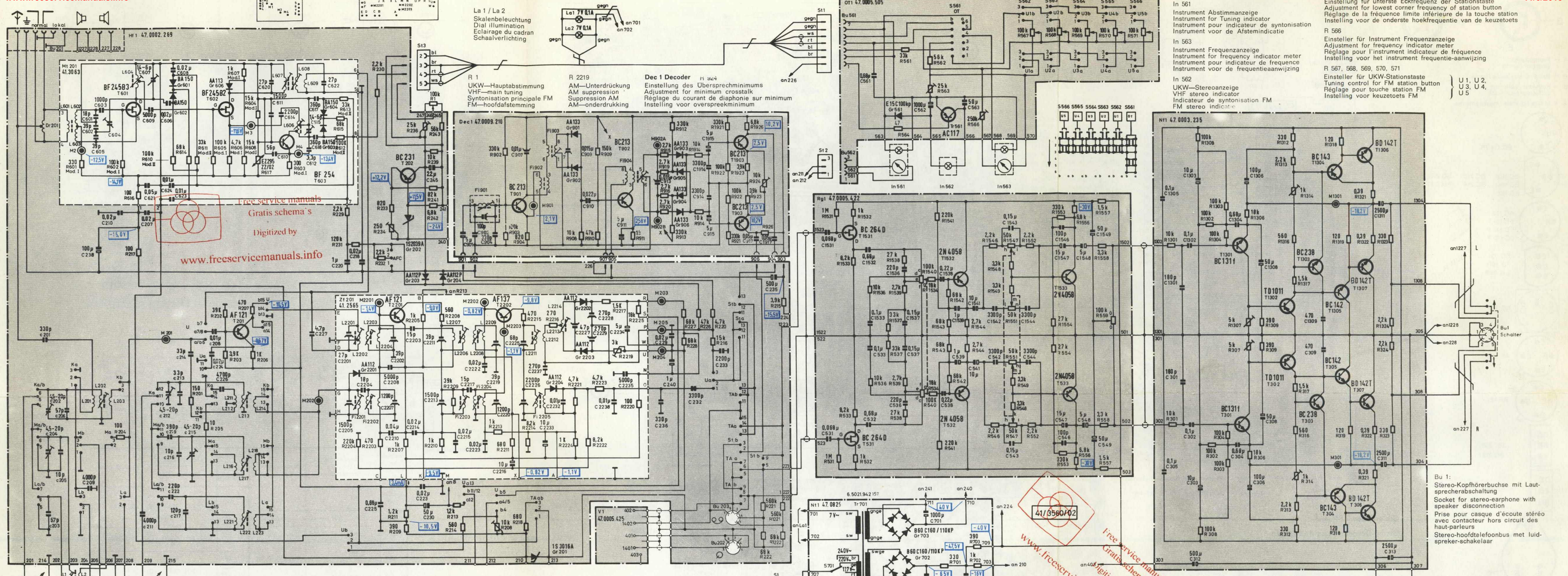

Wellenbereiche / Wave ranges Gammas d'ondes / Golfbereiken	
UKW/VHF/FM	87,6—104 MHz (mc)
KW/SW	5,9—16 MHz (mc) (51—18,7 m)
MW	520—1620 kHz (kc)
LW	150—350 kHz (kc)

ZF / IF / MF: FM = 10,7 MHz (mc)  
AM = 460 kHz (kc)

gegen Plus / against positiv pole / contre pôle positif / tegen plus

M 301 [C 311 — R 321 — R 322] bzw. / or resp. / M 1301 [C 1311 — R 1321 — R 1322]

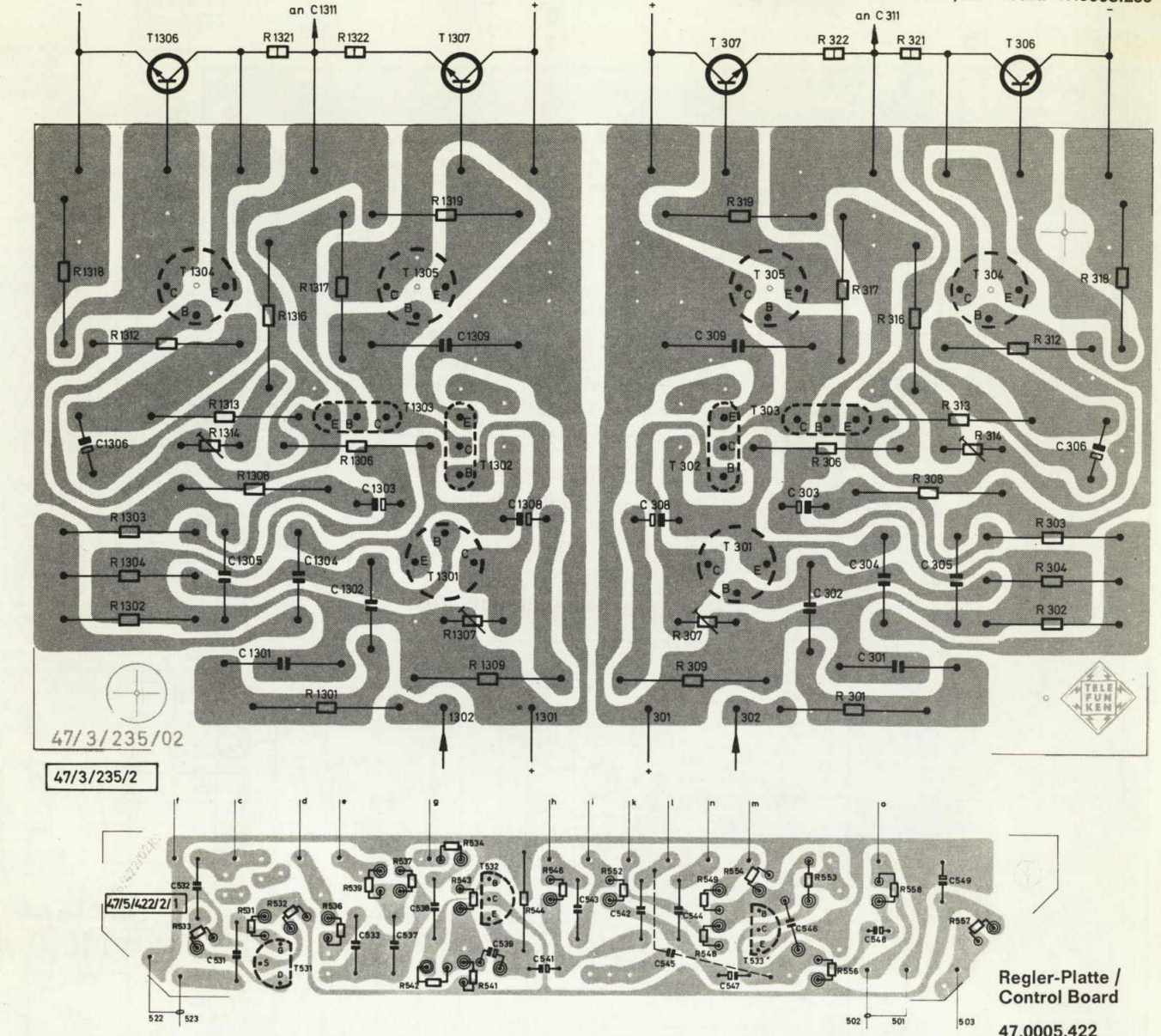
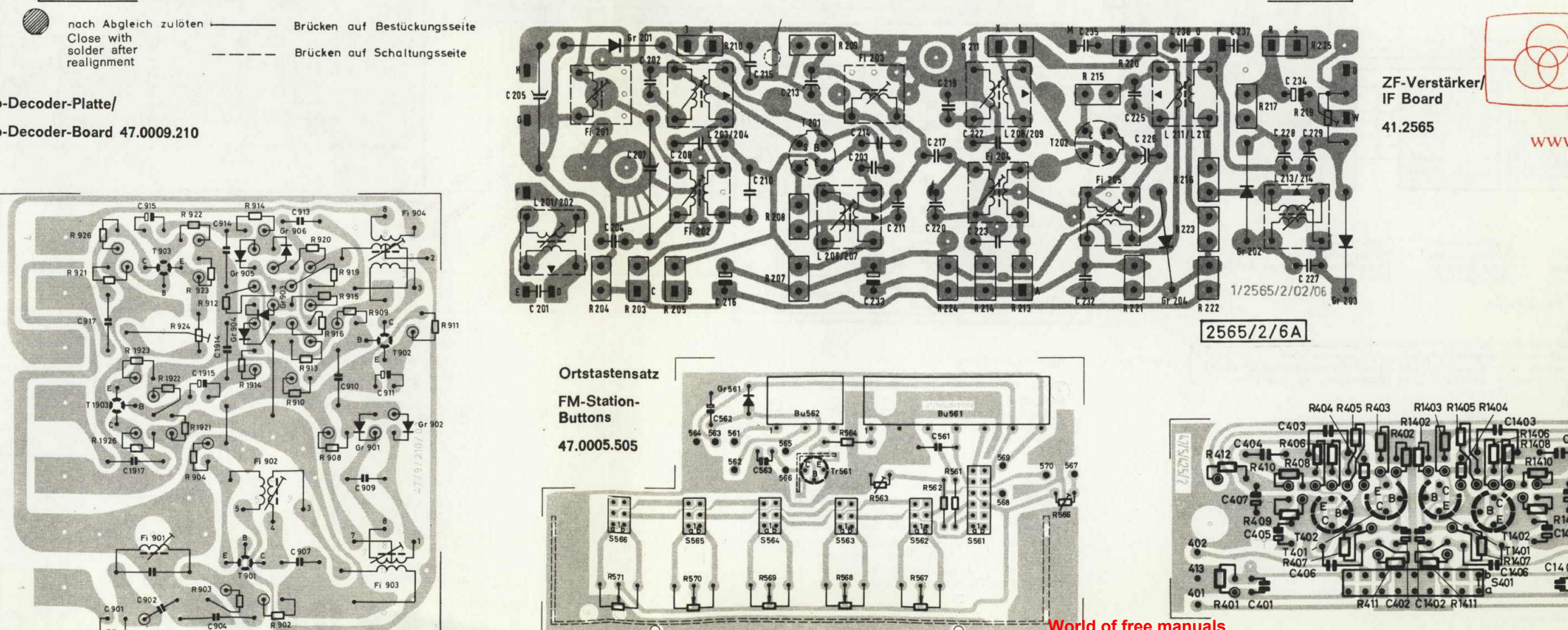
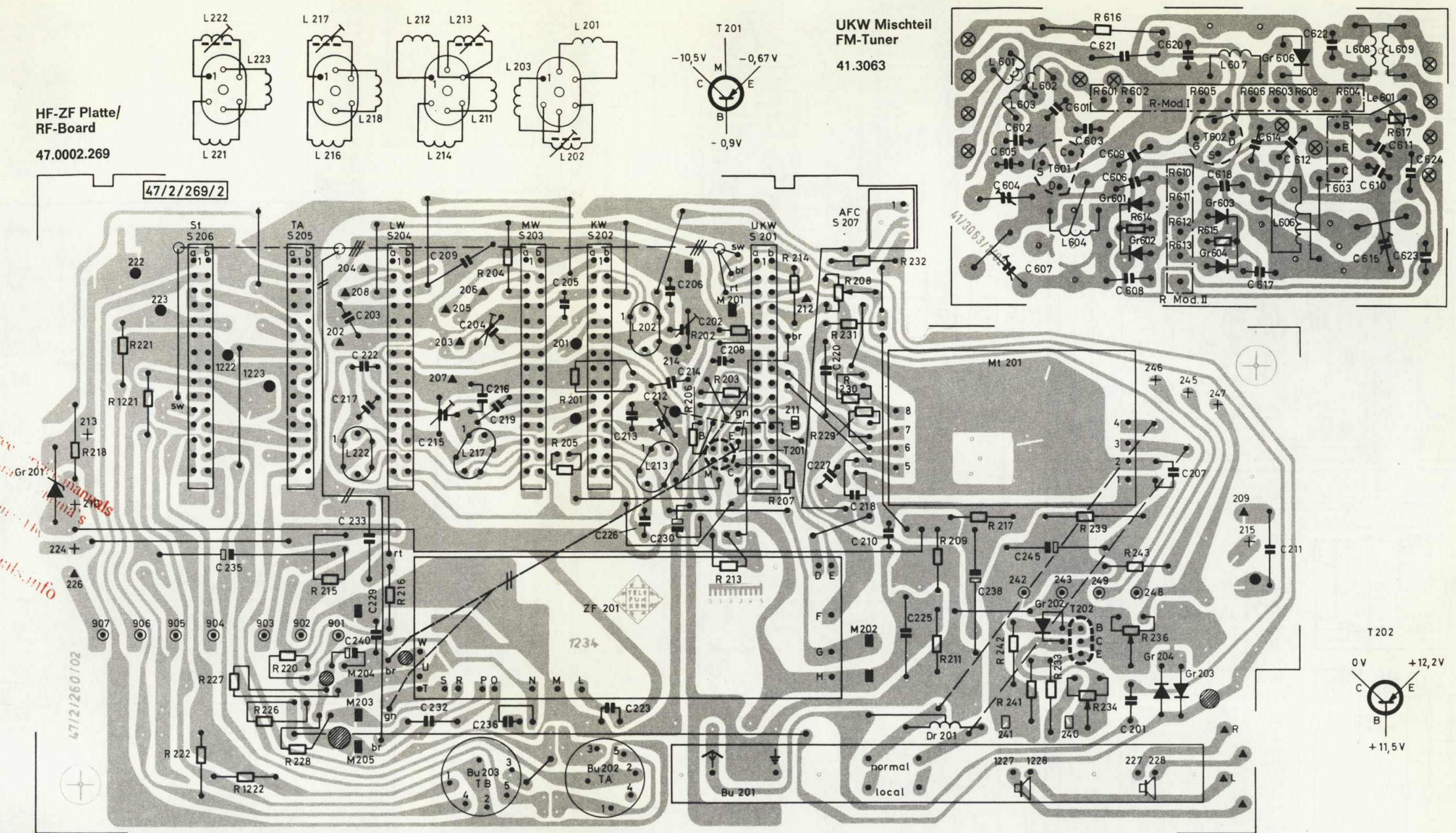
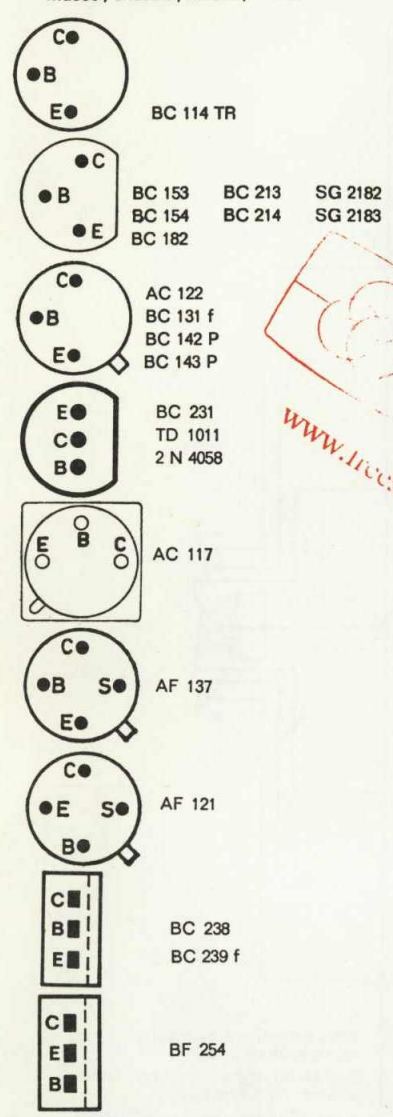
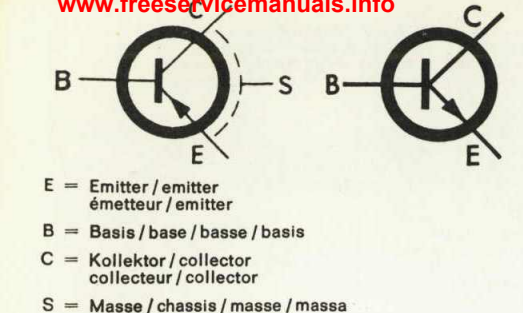

Transistorbestückung

Position im Stromlaufplan	Bestückung nach Stromlaufplan	Ausweichtyp	Position im Stromlaufplan	Bestückung nach Stromlaufplan	Ausweichtyp
T 201	AF 121	①	T 401	BC 154	③
T 202	BC 231	③	1401	BC 214	③
T 2202	AF 137	①	402		
T 301	BC 131 f	①	1402		
T 302	TD 1011	③	T 531	(FET) BC 264 D	③
T 302	BC 238	①	1531		
T 303	BC 182	③	T 532	2 N 4058	③
T 303	BC 239 f	①	1532		
T 304	BC 143 P	④	533		
T 304	SG 2183	③	1533		
T 305	BC 142 P	④	T 561	AC 117	①
T 305	SG 2182	③	T 601	(FET) BF 245 B 3	③
T 306	BD 142 T	④	T 602	(FET) BF 245 B 2	③
1306	2 N 5037	⑤	T 603	BF 254	①
1307			T 901		
			902	BC 213	③
			903	BC 153	④
			1903		

① AEG-TELEFUNKEN  
 ② Texas Instruments  
 ③ RCA  
 ④ SGS Fairchild  
 ⑤ ATES