

EM 34
6BA6

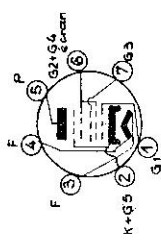

EK 90
6BE6

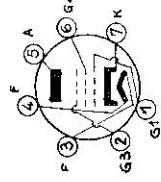

EF 93
6BA6

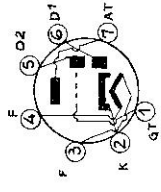

EBC 91
6AV 6

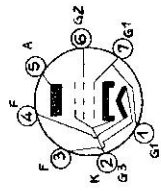

EL 84
6B05

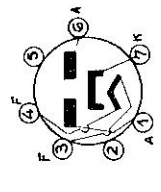

EZ 80
6V4

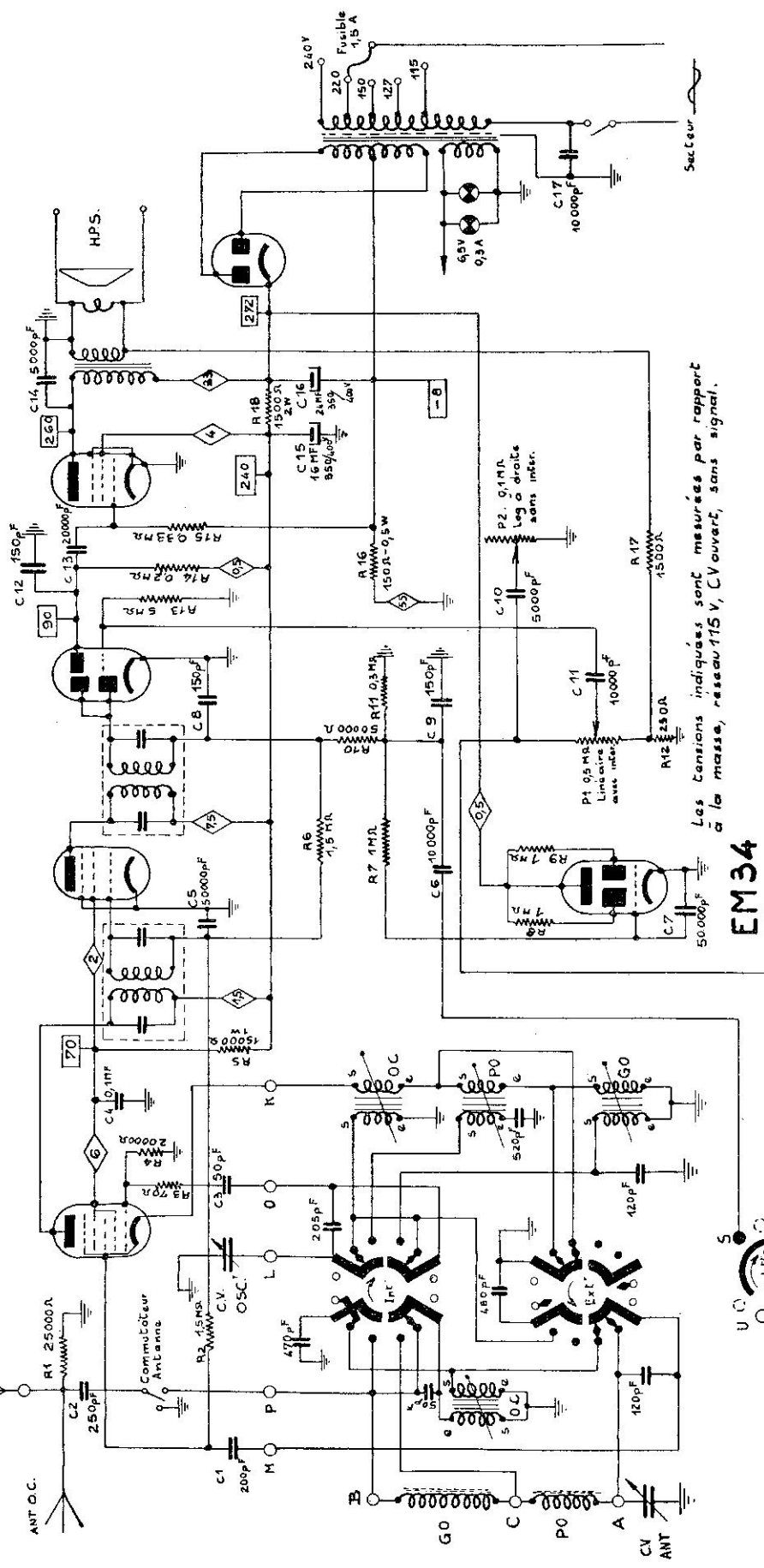

Les tensions indiquées sont mesurées par rapport à la masse, réseau 115 V, CV ouvert, sans signal.

EM 34

Gammas couvertes	
1	OC à 20 Mc
2	P0 à 1600 Kc
3	G0 à 340 Kc
4	BE à 6,4 Mc
5	PU

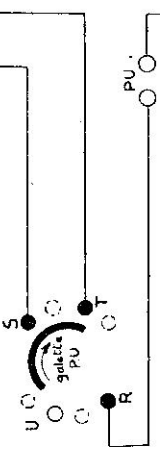

Commutateur représenté sur la position OC