

TENSIONES RF APLICADAS 455 kc/s MOD 30% 400 c/s

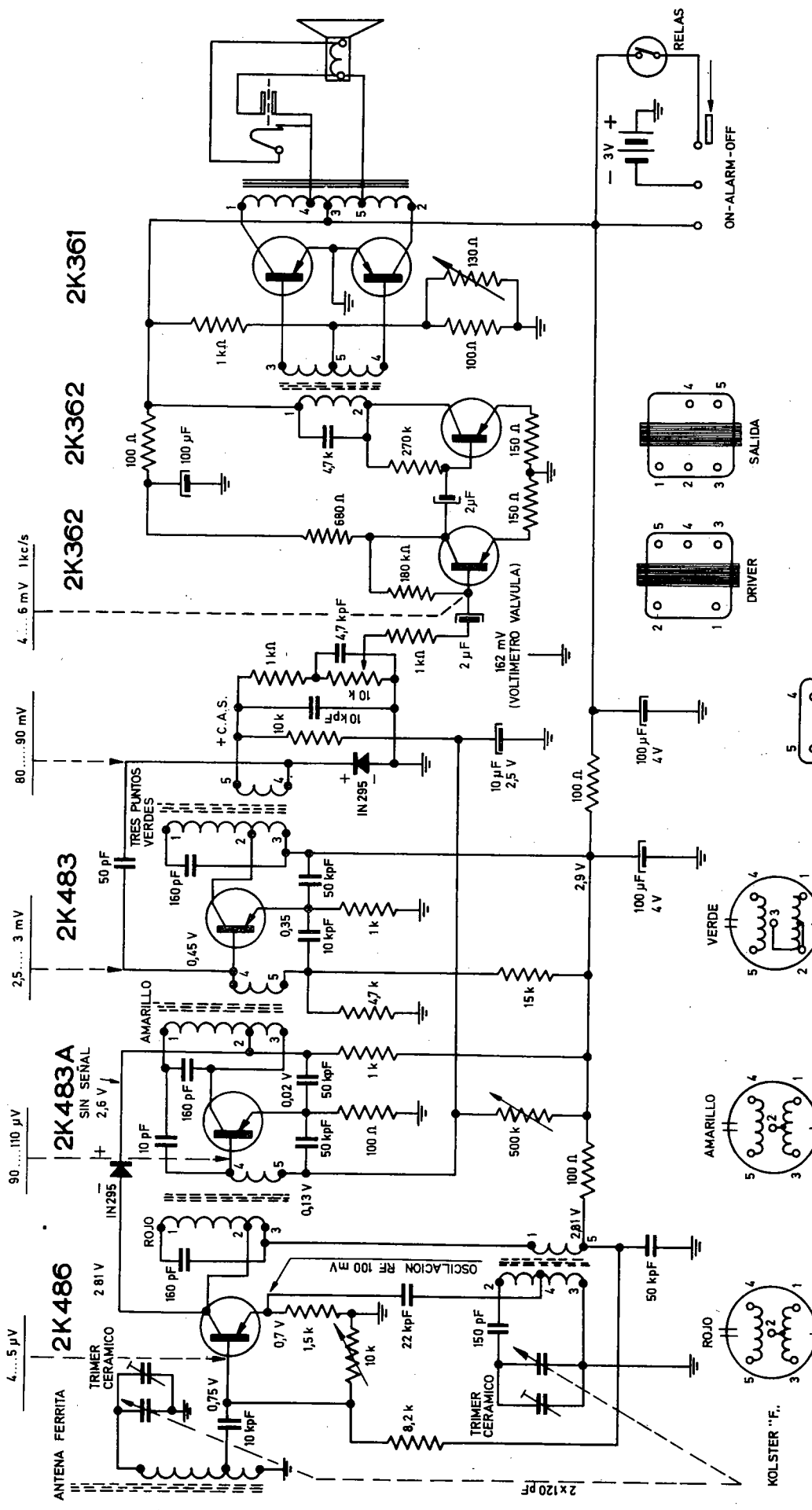

KOLSTER IBERICA MOD. 200

OSCILADORA

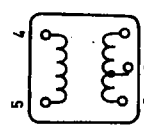
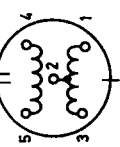
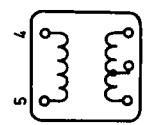
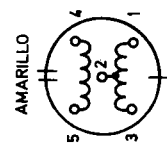
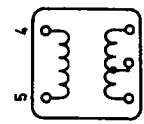
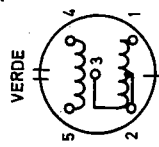
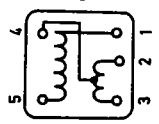

BOBINAS VISTAS POR LADO ESPIGAS

3º-NEGRO

2º-BIANCO

1º-AMARILLO

KOLSTER "F."

KOLSTER "J."