

Grundlg 4010 W und 4010/TB/Ph

(I. Teil des Schaltbildes)

ECH 81

EF 41

EC 92

EF 80

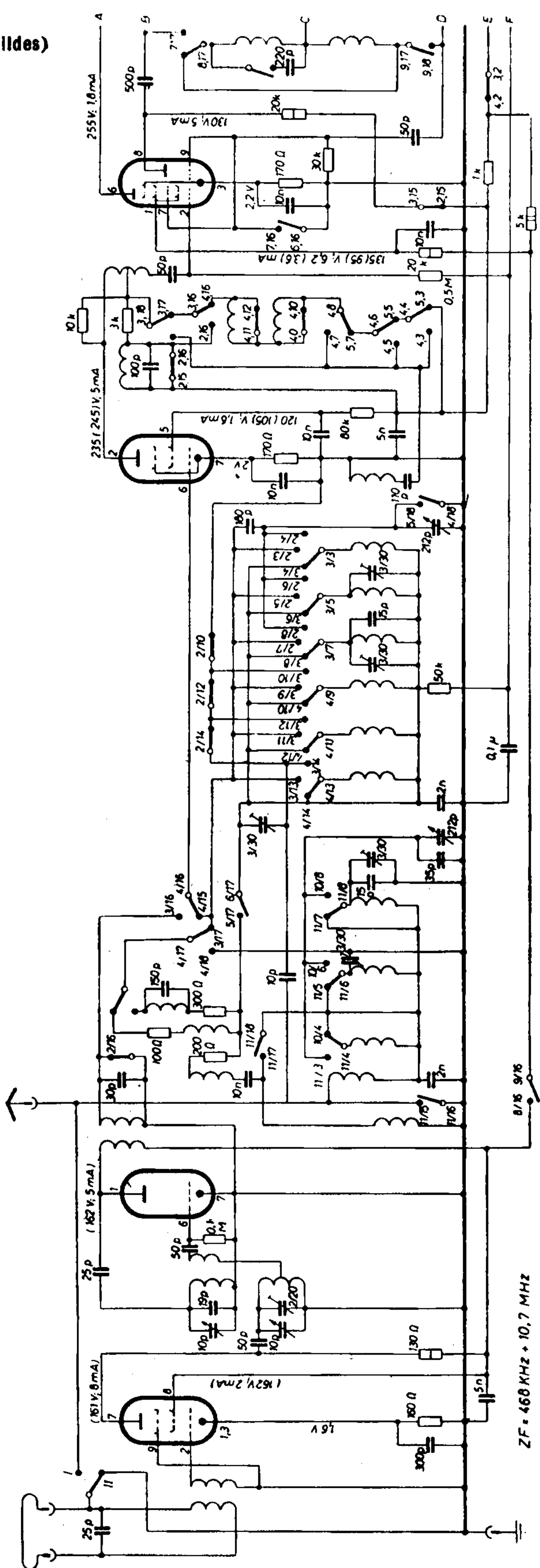

Ⓢ 800 Ω / V; Meßwerte bei MW (UKW)

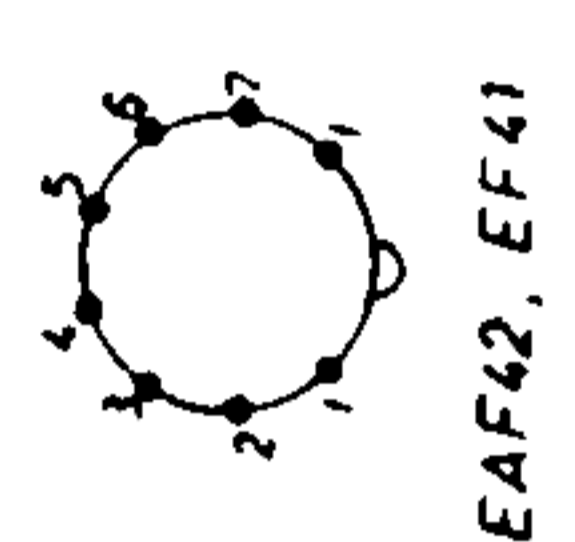
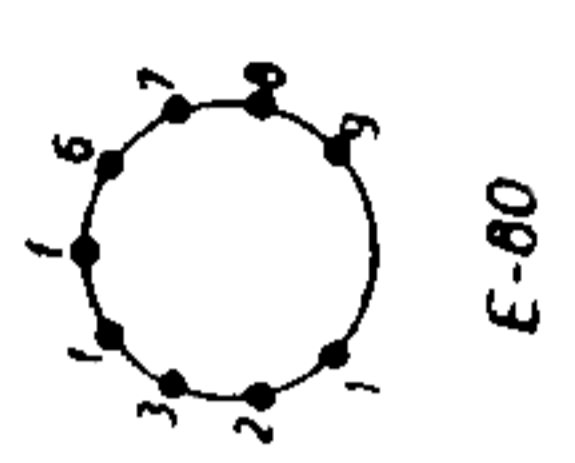
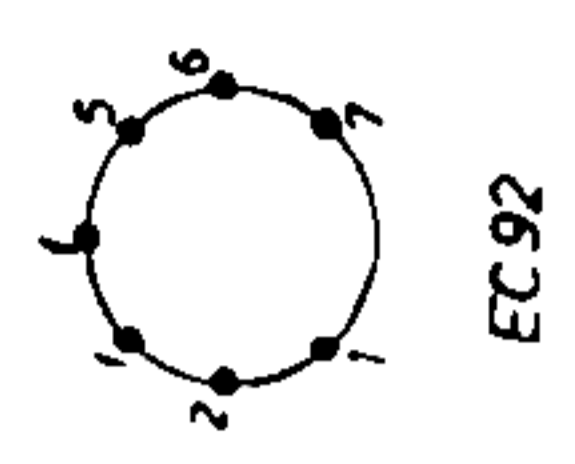
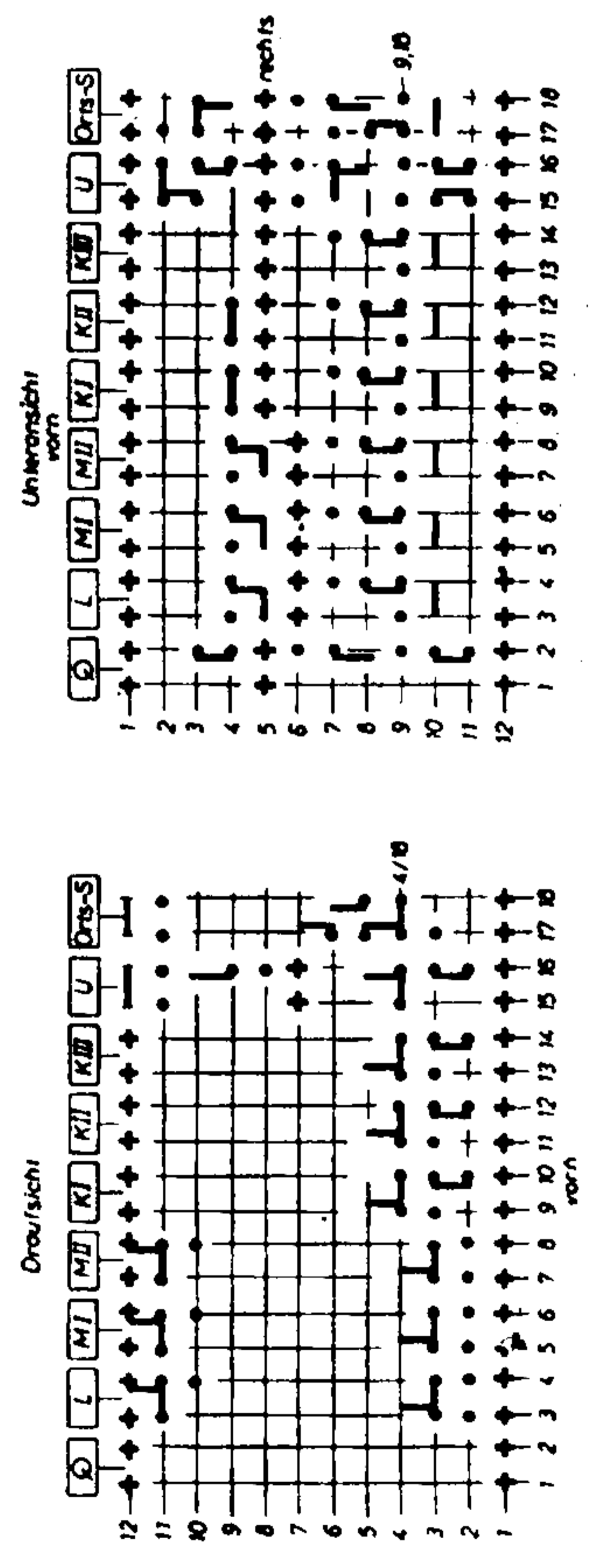

(2. Teil des Schaltbildes)

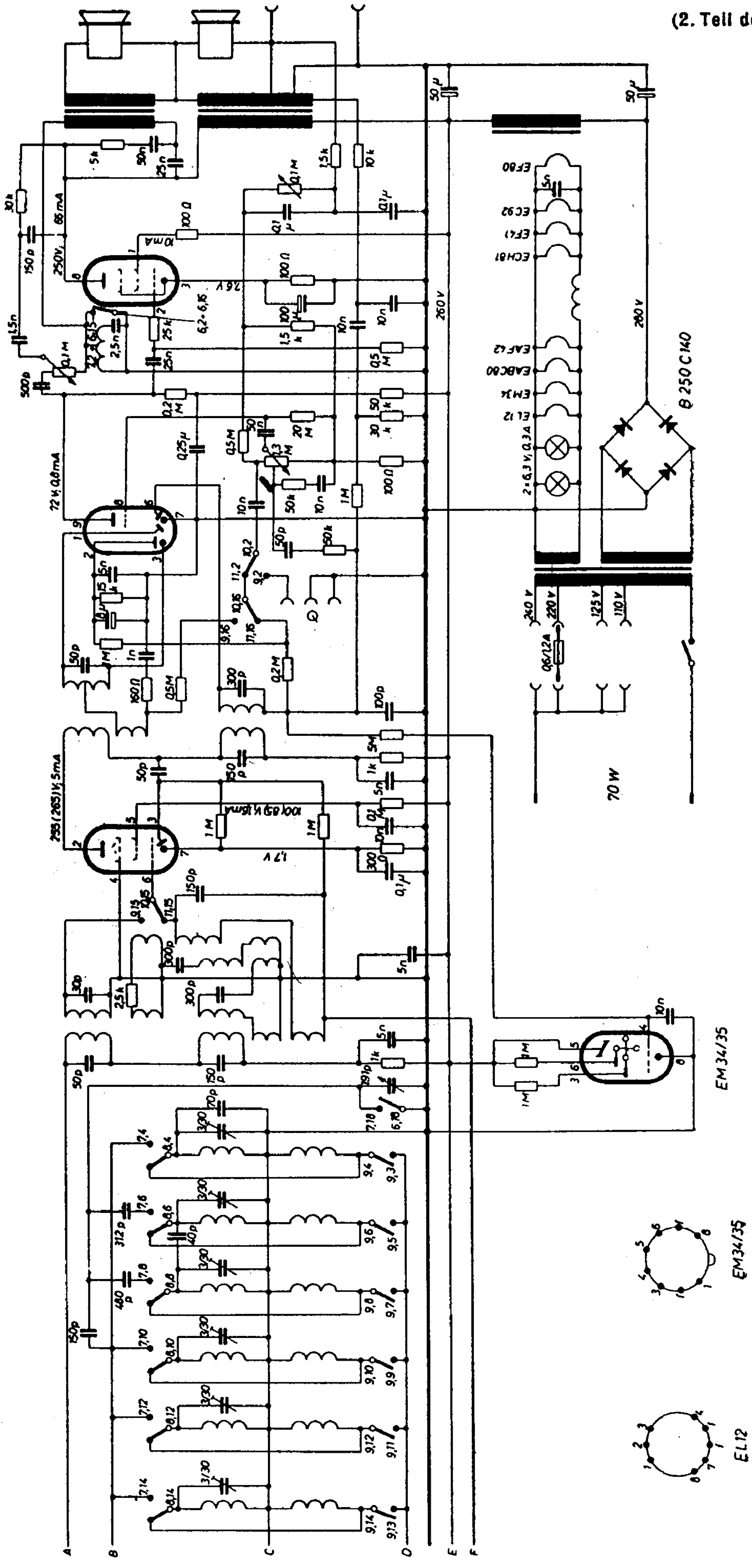

EM34/35

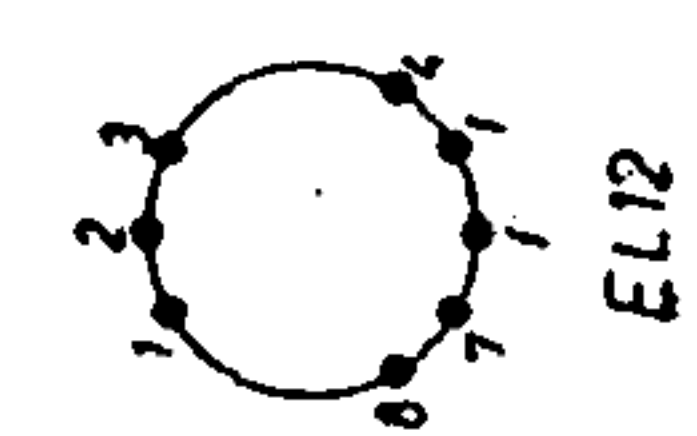

EL12

EM34/35