

220 VA and 1200 VA Power Amplifiers

types 2707 and 2708

FEATURES:

- Direct coupled solid state
- Front panel control for Low or High output impedance
- Front panel control for DC centering of exciter table
- High AC power output and large DC capability in a small cabinet
- Multi-range precise current and voltage monitoring meters
- Low distortion over wide frequency range
- Adjustable exciter displacement limit
- Adjustable RMS (including DC) output current limit
- Internally protected against current overload
- Extensive built-in protection with six indicator lights

- External protection possible
- Automatic shut-down for malfunction in single and multiple systems
- Switchable phase reversal of output signal for mode studies
- Front panel oscilloscope monitor points

USES:

- Single and multiple exciter applications: Power Amplifier Type 2707 drives Exciter Body Type 4801 to full rating. Can also drive Exciter Body Type 4802
Power Amplifier Type 2708 drives Exciter Body Type 4802 to full rating. Can also drive Exciter Body Type 4801
- Powerful variable frequency source in combination with frequency generator

Introduction

The Power Amplifiers Types 2707 and 2708 have been designed to drive vibration exciters, particularly the B&K Exciter Bodies Types 4801 and 4802 together with their associated interchangeable heads.

The Power Amplifiers have a useable frequency range from DC to 100 kHz. The full AC output is 220 VA over the range 40 Hz to 10 kHz for Type 2707, and 1200 VA over the range 5 Hz to 5 kHz for Type 2708. Harmonic distortion content of the output is small as heavy negative feedback is used.

The amplifier and the exciter head driving coil are directly coupled to provide static table centering and to exclude bulky output transformers.

As well as power amplification the 2707 and 2708 provide system control, metering and protective functions. During operation the driver coil voltage and current RMS values are continuously shown on front panel meters and their waveforms can be monitored using the oscilloscope monitor points provided.

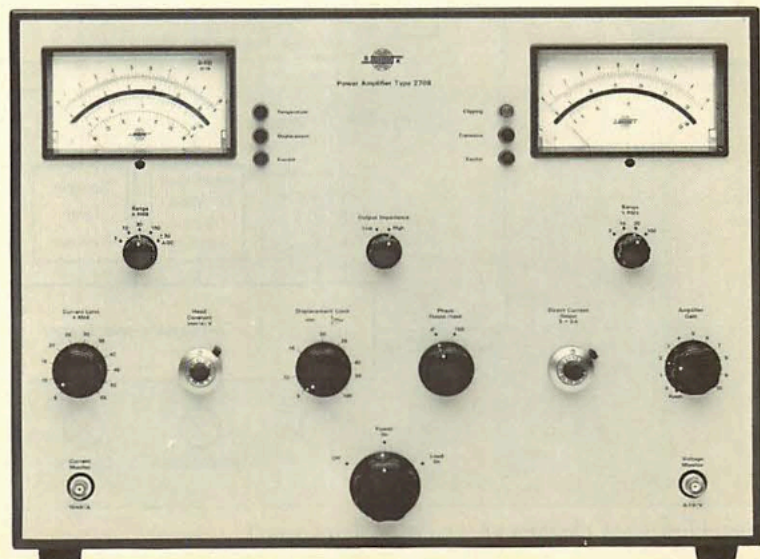
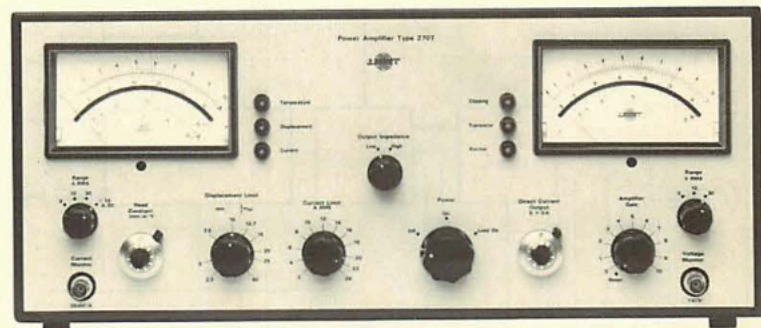

Fast acting protective circuitry gates-off the signal input to the amplifier if pre-set driving coil current and exciter head displacement limits are exceeded. In addition excessive transistor temperature and failure of fan cooling in the vibration exciter also cause the removal of the amplifier input signal. Front panel lamps indicate the operation of these four protective functions as well as voltage clipping due to excessive signal amplitude and

also possible malfunction of any output power transistor.

The amplifiers can be used as voltage generators with low output impedance and a flat voltage to frequency response, or as current generators with high output impedance and a flat current to frequency response. In both modes they are high power, low distortion vibration-exciter drivers providing good protection from overtesting

and system component failure. The feedback modes are switchable and the amplifiers can be used in single- or multiple-vibration exciter applications.

A balanced preamplifier together with monolithic operational amplifiers and silicon transistors has resulted in good temperature and supply line variation rejection.

Description

The block diagram for the various circuit functions is found in Fig.1. Certain features of the amplifiers have been omitted for simplicity. Types 2707 and 2708 are of the same construction and differ mainly in power dissipation and physical size.

Input

Two inputs are provided, connected via the amplifier gain control and a FET gate to the preamplifier stage. The AC input is capacitively coupled and the DC input is direct-coupled.

The DC static centering signal is applied to the preamplifier stage through a similar FET gate. Under normal working conditions the gates allow the signal to pass through. When the protection circuitry is activated the gates are triggered and disconnect

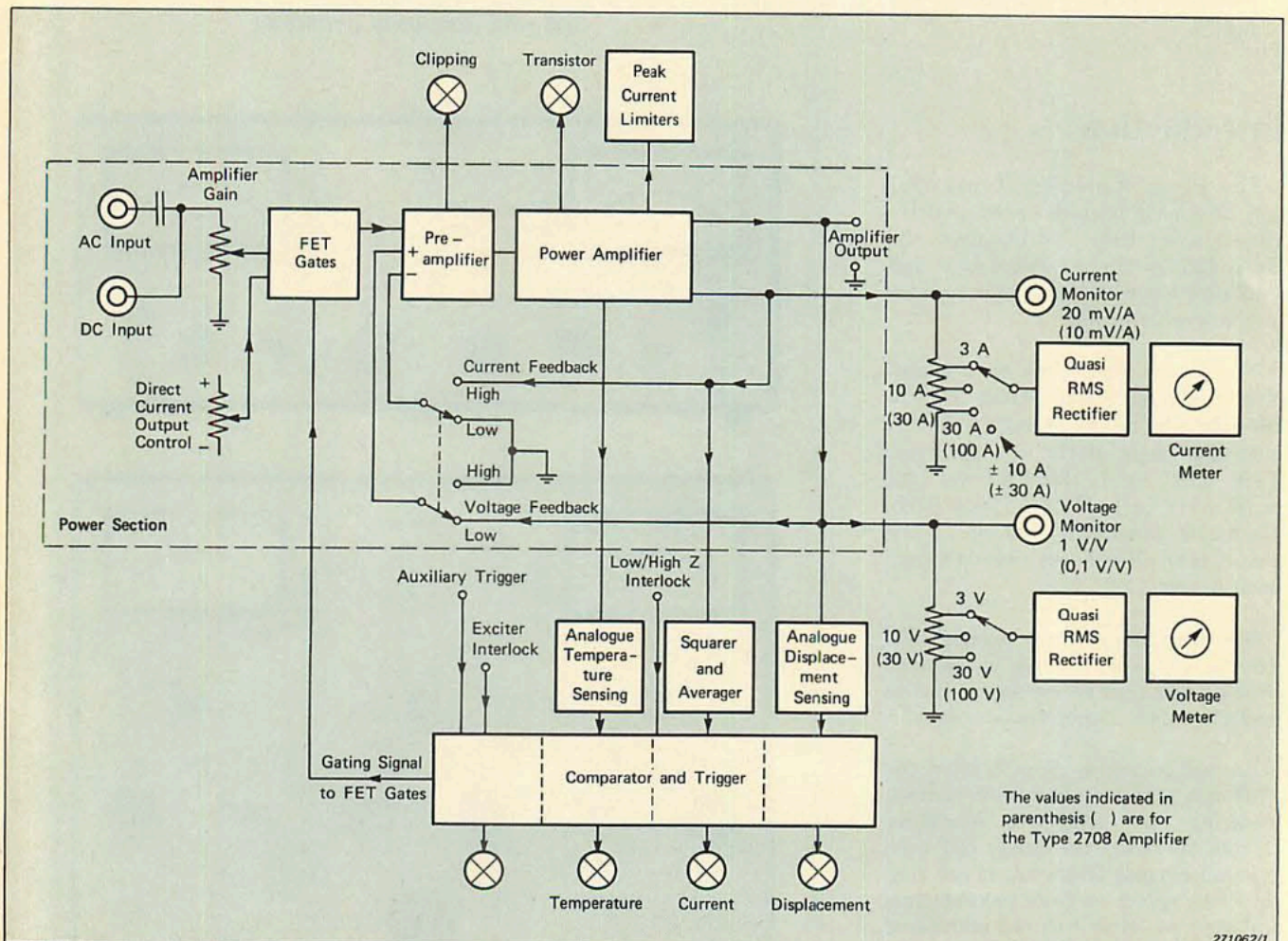

Fig. 1. Simplified block diagram of the Power Amplifiers

the preamplifier stage input from the static centering and amplifier drive signal.

The gate controlling the static deflection signal is purposely made slow-acting. This ensures that large static offsets in table position are not transmitted to the test object as fast transients when the equipment is switched on or when the protection circuitry triggers. Resetting is simply made by turning the amplifier gain control fully counter-clockwise and back again.

Preamplifier Section

The type of feedback from the output to the preamplifier stage is selected by the output impedance switch. Voltage feedback is used in the low impedance mode giving constant output voltage and very low output impedance. Feedback proportional to the current flowing in the load is used in the high impedance mode resulting in constant output current and high output impedance.

Impedance versus frequency curves are shown in Figs.2 and 3. In the high impedance mode even higher output impedance can be obtained above 10 Hz by an internal shorting link.

Excessive signal levels at the input will saturate the amplifier and cause clipping of the output waveform. This will trigger the clipping detector which lights the yellow CLIPPING lamp on the front panel. The Power Amplifier will remain operative.

The preamplifier stage is followed by a high gain driver stage with 6dB/octave roll-off ensuring high stability and high loop gain.

Power Output Section

The power output stage is protected by fast-acting fuses designed for semiconductor protection. Transistor failure will blow one or more fuses and light the TRANSISTOR warning lamp. Transistor failure also activates a relay which removes the three phase power line from the power output section and from the connected Exciter Body.

Peak current limiting circuitry is arranged to provide limitation of instantaneous positive and negative output current peaks.

The small signal frequency response across a load is shown in Fig.4. The

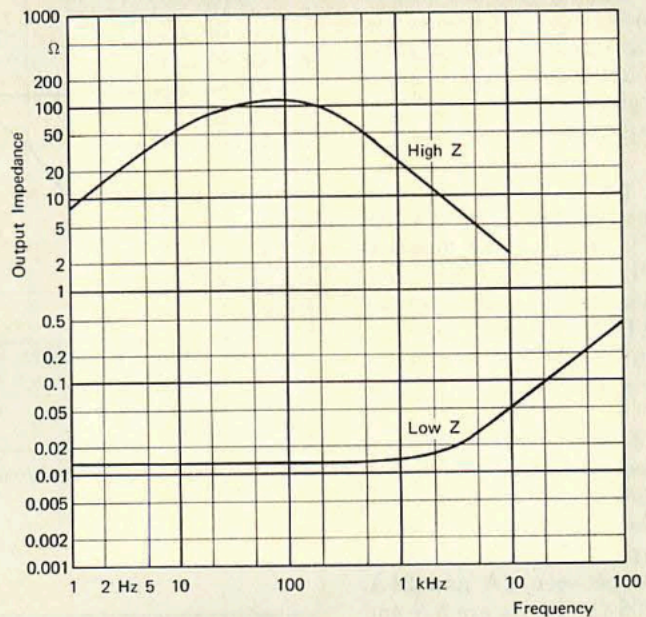

Fig. 2. Typical output impedance curves for Type 2707

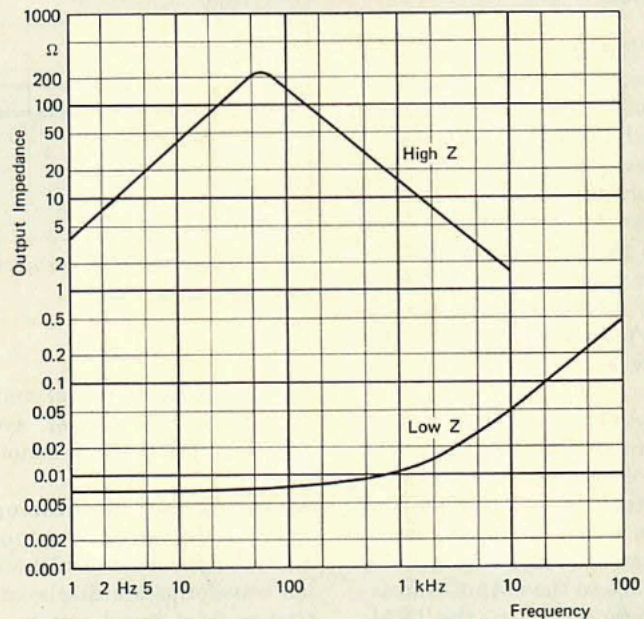

Fig. 3. Typical output impedance curves for Type 2708

load is 0,5Ω for Type 2707 and 0,6Ω for Type 2708. Typical distortion curves in the high and low impedance modes are shown in Fig.5.

Protection

The Power Amplifiers Types 2707 and 2708 contain extensive protective functions for the Power Amplifiers

themselves and the connected vibration exciters. When triggered they turn off the two FET gates at the input thus disconnecting the drive and DC centering signals. Each triggered protective circuit also lights a red lamp which gives an indication of the reason for equipment shutdown.

Overload protection is provided against excessive coil drive current (CURRENT), exciter table displacement (DISPLACEMENT) and transistor junction temperature increase (TEMPERATURE). A malfunction in the vibration exciter will trigger the EXCITER circuitry.

CURRENT. A front panel control is used to pre-set the true RMS output current including the DC component at which the CURRENT circuitry trips. On Type 2707 the limit can be set anywhere between 2A and 24A. For Type 2708 the limits are 5A and 55A. The time constant of the averaging circuitry is 50 seconds, matching the minimum thermal time constant of the Exciter Head used. This permits short-term current overload and means that the exciter system can be used in a pulsed mode. The averaging time constant can be simply reduced to 2,5 seconds if a snap-action current trip is required.

DISPLACEMENT. The front panel control is used to pre-set the peak-to-peak level of exciter table displacement at which the DISPLACEMENT circuitry trips. The control is continuously variable and can be set anywhere between 2,5 and 50 mm (0,1 and 2 inches) on the 2707. On Type 2708 the limits are 5 and 100 mm (0,2 and 4 inches). The circuit provides protection for both positive and negative displacement peaks.

TEMPERATURE. Abnormal load conditions, failure of the heat sink cooling fan, or high ambient temperature could result in output transistor temperatures in excess of design limits and subsequent transistor failure. To prevent damage to the output transistors under these conditions the TEMPERATURE protective circuitry will trigger.

EXCITER. This protective circuitry is built-in to protect the connected vibration exciter. It is triggered by the following functions: Activation of the overtemperature thermostat, attempted operation of the Exciter Head separate from the Exciter Body, and open-

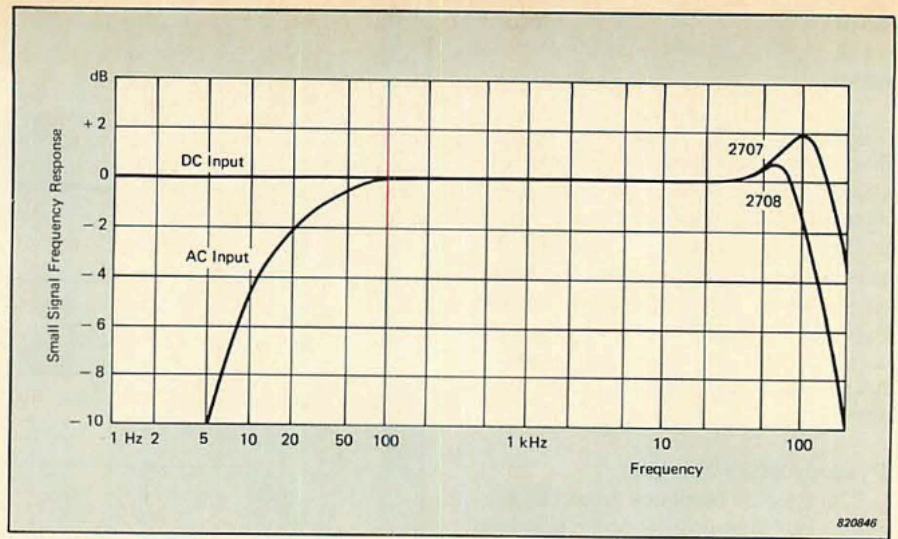

Fig. 4. Typical small signal frequency response curves

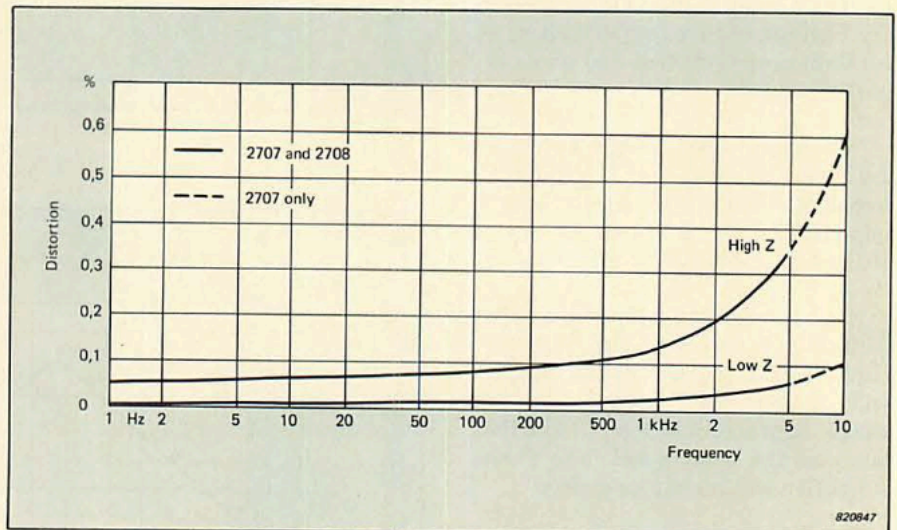

Fig. 5. Typical distortion curves

ing of an external pair of contacts connected to the exciter system for accessory protective functions.

Metering and Monitoring

The RMS values of output current and voltage for sinusoidal and Gaussian waveforms are displayed on multirange front panel meters. An additional zero-centre DC current scale is provided for Exciter Head centering purposes. The output voltage and current waveforms can be monitored at front panel BNC sockets.

Use in Multiple Exciter-Amplifier Systems

In multiple systems the Power Amplifiers are interconnected in such a

way that a trigger signal in any amplifier will remove the input signal from all the other amplifiers as well.

The high impedance mode is particularly suitable when multiple exciters are used for resonant mode determination of structures. The forces generated by the exciters are in phase or shifted 180° by a switch if desired, adjustable in magnitude and are insensitive to changes in impedance of the structure as frequency is swept. In this respect the operation is similar to that of multiple exciters connected in series and driven by a single amplifier, but it provides greater flexibility in adjusting the relative forces generated by the exciters.

Use in Single Exciter Systems

The low impedance mode keeps the voltage applied to the exciter independent of test object changes. This mode provides the best acceleration waveform and is therefore preferable for most single exciter applications. However, the low impedance mode is also useful for multiple exciter systems in the lower frequency range when the same motion is desired from each exciter. An example is the use of one exciter to push and another to pull on a model of a bridge.

Power Required

The Power Amplifiers require a three phase power supply of nominal

voltage as indicated in the specifications. For switching convenience the power supply for the Exciters is also routed via the amplifiers power switch. The Power Amplifiers will be supplied from the factory with mains cables attached and fitted with a CEE plug JP 0512 on the free end.

System Interconnection

Interconnection between the Amplifiers and Exciters is made using three cables; the power supply and interlock cables to the Exciter Body, and drive cable to the Exciter Head. Both Type 2707 and 2708 Amplifiers and Type 4801 and 4802 Exciter Bodies are fully compatible i.e. the larger Amplifier

can be used to power the smaller Exciter and the smaller Amplifier to power the larger Exciter. However, if this is the case then the drive cable from the Amplifier to the Exciter Head must be obtained on special order from B & K.

Specifications 2707 and 2708

Power Amplifier	Type 2707		Type 2708	
Capacity	220 VA into 0,5Ω exciter or resistor load		1200 VA into 0,6Ω exciter or resistor load	
Voltage	10 V RMS DC to 10kHz		27 V RMS DC to 5kHz 13,5 V RMS at 10kHz	
Current	10 A DC 11 A RMS at and below 5 Hz 22 A RMS 40Hz to 10kHz		20 A DC 25 A RMS at and below 0,1 Hz 45 A RMS 5 Hz to 10kHz	
Frequency Range				
Full capacity	40 Hz to 10 kHz		5 Hz to 5 kHz	
Reduced capacity	DC to 100 kHz		DC to 100 kHz	
Frequency Response	Typical small signal response, low impedance mode			
DC input	DC to 10 kHz ± 0,5 dB DC to 100 kHz ± 3 dB		DC to 10 kHz ± 0,5 dB DC to 100 kHz ± 3 dB	
AC input	15 Hz to 100 kHz ± 3 dB		15 Hz to 100 kHz ± 3 dB	
Input Impedance	at least 10 kΩ		at least 10 kΩ	
Gain at 1 kHz	Low Impedance	High Impedance	Low Impedance	High Impedance
	5 V/V ± 1 dB	14 A/V ± 2 dB	13,5 V/V ± 1 dB	24 A/V ± 2 dB
Output Impedance	< 0,02 Ω DC to 1 kHz < 0,05 Ω 1 kHz to 10 kHz	> 20 Ω 5 Hz to 1 kHz > 50 Ω 20 Hz to 300 Hz > 80 Ω 40 Hz to 100 Hz	< 0,01 Ω DC to 1 kHz < 0,05 Ω 1 kHz to 10 kHz	> 10 Ω 2,5 Hz to 1,5 kHz > 20 Ω 5 Hz to 700 Hz > 70 Ω 20 Hz to 200 Hz
Harmonic Distortion	0,5Ω resistive load		0,6Ω resistive load	
Full capacity	< 0,1% DC to 5 kHz < 0,5% 5 kHz to 10 kHz	< 0,2% DC to 2 kHz < 0,7% 2 kHz to 10 kHz	< 0,2% DC to 5 kHz < 0,4% 5 kHz to 10 kHz	< 0,3% DC to 2 kHz < 0,7% 2 kHz to 5 kHz
Noise and Hum below full output	at least 85 dB		at least 70 dB	

Power Amplifier	Type 2707	Type 2708		
DC Stability	For + 5% to -15% variation of mains supply from nominal, and for 10 to 40°C (50 to 104°F) variation in ambient temperature			
	Less than 50mV drift		Less than 100mV drift	
Direct Current Output	Available at output socket, variable by front panel control			
	at least ± 2 V		at least ± 5 V	
Metering	Quasi-RMS indication rectifier circuits correct for sinusoidal and Gaussian inputs			
	Voltmeter	Ammeter	Voltmeter	Ammeter
	Scales	3, 10, 30 A RMS ± 10 A DC	3, 10, 30, 100 V RMS	3, 10, 30, 100 A RMS ± 30 A DC
	Response	$\pm 2\%$ 20 Hz to 10 kHz $\pm 5\%$ 5 kHz to 10 kHz	$\pm 2\%$ 20 Hz to 10 kHz	$\pm 2\%$ 20 Hz to 5 kHz $\pm 5\%$ 5 kHz to 10 kHz
	Accuracy at 1 kHz	$\pm 2\%$ of full scale	$\pm 4\%$ of full scale	$\pm 2\%$ of full scale $\pm 4\%$ of full scale
Protection	Input signal is removed and an indicator lamp is lit when the following parameters exceed preset limits: Exciter Displacement — limit adjustable Driver Coil Current — true RMS (including DC) adjustable limit Power Transistor Junction Temperature Heat Sink Temperature Loss of field or cooling motor voltage, attempted operation of Exciter Head separate from Exciter Body, phase failure on three phase line Power transistor fuse blown			
	Front panel indication is provided when the following occurs (no shut-down): Output signal clipping Power transistor fuse blown (only Type 2707)			
Other Features	Electronic peak current limiting Selectable output phase, 0° or 180° Voltage and Current Monitor points (front panel) Safety interlocks remove signal upon mis-operation of controls Multiple Exciter-Amplifier operation. Cross interlocking between Amplifiers Exciter power switching, system control			
Temperature Range	5 to 40°C (41 to 104°F)			
AC Power Requirements 47 to 63 Hz	Three phase 380 V, 440 V, $\pm 10\%$, RMS 700 VA $\pm 10\%$ at full output		Three phase 200, 220, 240, 340, 380, 420, 440 480 V RMS, $\pm 5\%$, 3 kVA at full output	
	Amplifiers comply with safety class 1 of IEC 348 Almost full output voltage capability down to -15% of nominal mains supply. Exciter Body power is additional.			
Cabinet	Supplied as model A (light-weight metal cabinet) or C (as A but with flanges for standard 19" racks)			
Dimensions	A-model excluding connectors			
	Height	177 mm (7,0 in)	311 mm (12,3 in)	
	Width	430 mm (16,9 in)	430 mm (16,9 in)	
	Depth	500 mm (19,7 in)	500 mm (19,7 in)	
Weight (A-model)	27,9 kg (61,4 lb)		59 kg (130 lb)	
Accessories Included	1 screened BNC 75 Ω plug (JP 0035) 1 6-pin plug (JP 1005) Various lamps and fuses Mains cable		1 screened BNC 75 Ω plug (JP 0035) Various lamps and fuses 1 Mains cable (5 m) AG 0015	

