

Service Manual

THE FISHER[®]

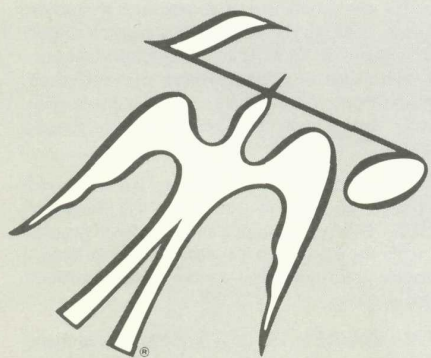
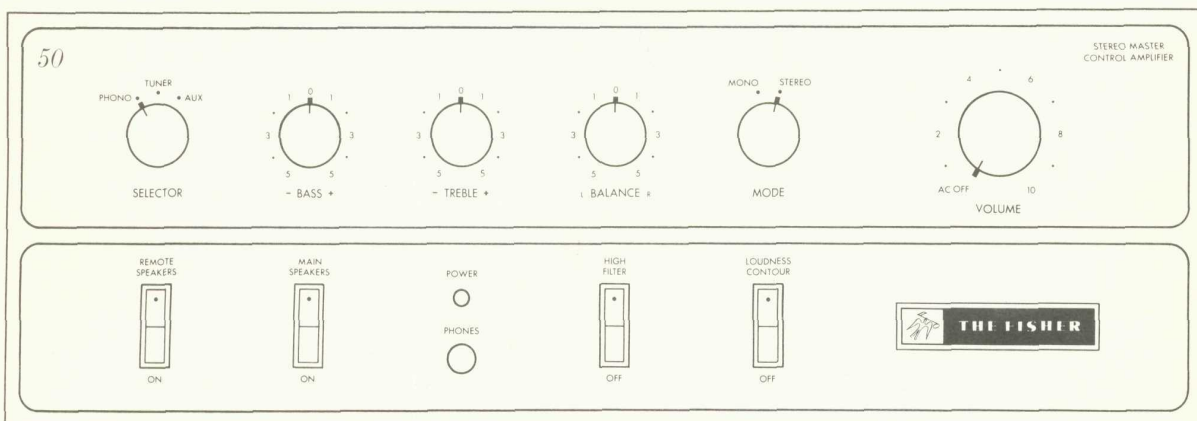

TX-50TM

CHASSIS SERIAL NUMBERS
BEGINNING 10001

PRICE \$1.00

REQUIRED TEST EQUIPMENT

The following equipment is required to completely test and align modern high-fidelity amplifiers, tuners, and receivers.

Line Voltage Autotransformer or Voltage Regulator	10.7 MHz Sweep Generator
DC Vacuum Tube Volt ohmmeter	Multiplex Generator (preferably with RF output – FISHER 300)
Accurately Calibrated AC Vacuum Tube Voltmeter	455 kHz Sweep Generator
Oscilloscope ((Flat to 100 kHz Minimum)	Ferrite Test Loop Stick
Low-Distortion Audio (Sine Wave) Generator	2 – Full Range Speakers for Listening Tests
Intermodulation Distortion Analyzer	Stereo Source – Turntable, Tape Recorder, etc.
Harmonic Distortion Analyzer	Soldering Iron with Small Tip, Fully Insulated from AC Line
2 – Load resistors, 8-Ohms, 100 Watt (Minimum Rating)	Suction Desoldering Tool
AM/FM Signal Generator	

CAUTION: This precision high-fidelity instrument should be serviced only by qualified personnel, trained in the repair of transistor equipment and printed circuitry.

Many of these items are included only as a reminder – they are normal procedures for experienced technicians. Shortcuts may be taken, but these often cause additional damage to transistors, circuit components, or printed circuit boards.

SOLDERING: A well-tinned, hot, clean soldering iron tip will make soldering easier, without causing damage to the printed circuit board or the components mounted on it. Regular use of a sponge cleaner will maintain a clean soldering surface. The heat available at the tip, (not the wattage of the iron) is important. Some 50-watt irons reach temperatures of 1,000° F, while others will hardly melt solder. Small-diameter tips should be used for single solder connections, pyramid and chisel tips for large areas.

Always disconnect the AC power cord from the line when soldering. Turning the power switch OFF is not sufficient. Power-line leakage paths, through the heating element of the iron, may destroy transistors.

PARTS REMOVAL: If a part is not being returned for in-warranty factory replacement, it may be cut in half (with diagonal cutting pliers) to make removal easier. Multiple terminal parts, such as IF transformers, or electrolytic capacitors, should be removed using special de-soldering tips made especially for this purpose. Removing solder from terminals, reduces the possibility of breaking the printed circuit board when the part is removed.

ACCIDENTAL SHORTS: A clean working area, free of metal particles, screws, etc., is an important preventive in avoiding servicing problems. Screws, removed from the chassis during servicing, should be stored in a box until needed. While a set is operating, it takes only an instant for a base-to-collector short to destroy a transistor (and others direct-coupled to it). In the time it takes for a dropped machine screw, washer, or screwdriver, to contact a pair of socket terminals (or terminal and chassis), a transistor can be ruined.

SOLID-STATE DEVICES: Integrated Circuits contain the equivalent of many circuit parts, including transistors, diodes, resistors, and capacitors. The preferred troubleshooting procedure requires isolating the trouble to one stage using AC signal tracing methods. Once the suspected stage is located, the DC voltages at the input and output leads are measured to give an accurate indication of the operating conditions of the IC. DO NOT use an ohmmeter to check continuity with the IC mounted on the printed circuit board. Forward biasing the internal junctions within the IC may burn out the transistors. Do not replace a defective IC until all external resistors, capacitors, and transformers are checked first, to prevent the replacement IC from failing immediately due to a defect in the connecting components. Solder and unsolder each lead separately using a pliers or other heat sink on the lead to prevent damage from excessive heat. Check that the leads are

connected to the correct locations on the printed circuit board before turning the set on.

Whenever possible, a transistor tester should be used to determine the condition of a transistor or diode. Ohmmeter checks do not provide conclusive data, and may even destroy the junction(s) within the device.

Never attempt to repair a transistor power amplifier module until the power supply filter-capacitors are fully discharged.

If an output or driver transistor becomes defective (opens or shorts), always check ALL direct-coupled transistors and diodes in that channel. In addition, check the bias pot., and other parts in the bias network, before installing replacement transistors. All output and driver transistors in one channel may be destroyed if the bias network is defective. After parts replacement, always check the bias adjustment for specified idling current.

In some applications, replacement of transistors must be made from the same beta group as the original type. The beta group is indicated by a colored marking on the transistor. Be sure to include this information when ordering replacement transistors.

When mounting a replacement power transistor, be sure the bottom of the flange, mica insulator, and the surface of the heat sink, are free of foreign matter. Dust and grit will prevent flat contact, reducing heat transfer to the heat sink. Metallic particles can puncture the insulator, cause a short, and destroy the transistor.

Silicone grease must be used between the transistor and the mica insulator, and between the mica and the heat sink, for best heat transfer. Use Dow-Corning DC-3, or an equivalent compound made for power transistor heat conduction.

Use care when making connections to speakers and output terminals. To reduce the possibility of shorts, lugs should be used on the exposed ends, or stranded wire should be tinned to prevent frayed wire ends. Current in the speakers and output circuitry is quite high – poor contacts, or small sized wire, can cause significant power losses in the system. For wire lengths greater than 30 feet, 16 AWG, or heavier, should be used.

VOLTAGE MEASUREMENTS: All voltages are measured with the line voltage adjusted to 120 volts. All measured voltages are $\pm 10\%$. DC voltages are measured to ground with a VTVM, with no signal input unless otherwise noted. AC signal voltages are measured under the conditions specified on the schematic.

ALIGNMENT PROCEDURES: DO NOT attempt realignment unless the required test equipment is available, and the alignment procedure is thoroughly understood.

BECAUSE ITS PRODUCTS ARE SUBJECT TO CONTINUOUS IMPROVEMENT, FISHER RADIO CORPORATION RESERVES THE RIGHT TO MODIFY ANY DESIGN OR SPECIFICATION WITHOUT NOTICE AND WITHOUT INCURRING ANY OBLIGATION.

SERVICE PROCEDURES

REMOVING DRESS PANEL

- (1) Gently pry off the front panel nameplate. Be careful to avoid scratching the finish of the panel or nameplate. Remove the screw which was hidden by the nameplate.
- (2) Gently pull all knobs from the control shafts on the upper insert of the front panel. Remove the hex nuts from the shafts and remove the front panel.
- (3) Reverse the procedure for reassembly.

REPLACING POWER INDICATOR LAMP

- (1) Remove the screws which hold the top cover to the chassis and remove the cover.
- (2) Remove the front dress panel. Refer to REMOVING DRESS PANEL procedure.
- (3) Remove the bayonet lamp and lamp sleeve. Insert the replacement lamp and slide the sleeve over the lamp.
- (4) Replace the dress panel and top cover.

CLEANING FRONT PANEL

WARNING: Use only plain lukewarm water for moistening a freshly laundered, soft lint-free cloth to clean the front control panel.

REMOVING P.C. BOARDS

To remove a board from its nylon mounts, squeeze the loop of each mounting clip (using pliers), and lift each corner of the board. To remount the board, align the mounting holes over the clips, and press firmly.

POWER AMPLIFIER CENTER VOLTAGE TEST

- Turn VOLUME control to minimum. Set MAIN SPEAKERS switch to ON.
- (1) Connect an 8-ohm load resistor across the LEFT SPKRS MAIN and COMMon terminals.
 - (2) Connect two 10k $\pm 1\%$ resistors in series across capacitor C953 (2000 μF on Power Supply board). Connect the common lead of a DC VTVM to the junction of the two resistors.
 - (3) Connect the probe of the DC VTVM to Test Point 8S (junction of R835 and R837) on left channel of power amplifier module. Meter should read 0 volt (± 1.5 volts).

- (4) Connect the probe of the DC VTVM to Test Point 8DD (junction of R836 and R838) on right channel of power amplifier module. Meter should read 0 volt (± 1.5 volts).
- (5) Disconnect the two 10k resistors.

POWER AMPLIFIER IDLING CURRENT ADJUSTMENT

- Turn VOLUME control to minimum.
- (1) Connect DC VTVM across resistor R835 (0.47-ohm) on left channel of power amplifier module. Meter should read between 15mV and 35mV.
 - (2) If necessary, adjust OUTPUT BIAS ADJUST pot. R825 (on Predriver/Driver board) for reading between 15mV and 35mV on DC VTVM. Optimum amplifier performance will be achieved with 15mV setting.
 - (3) Connect DC VTVM across resistor R836 on right channel of power amplifier module. Meter should read between 15mV and 35mV.
 - (4) If necessary, adjust R826 pot. (on Predriver/Driver board) for reading between 15mV and 35mV on DC VTVM.

POWER OUTPUT MEASUREMENT

The output amplifier of this unit is designed to deliver its full-rated power with program material (voice or music) into 8-ohm loads for an indefinite period of time. When a constant audio tone is used as a signal to measure the maximum continuous RMS power output, the following precautions must be taken:

- (1) Measure the power output of one channel at a time.
- (2) Limit the measurement period to 10 minutes with a load resistance of 8 ohms.
- (3) Use a load resistor with a power rating of at least 50 watts.

WARNING: If the power output of both channels is measured simultaneously, use a load of 8 ohms per channel and limit measurements to a period not longer than 5 minutes.

HARMONIC DISTORTION TEST

- Set BASS, TREBLE, and BALANCE controls to their center (0) positions. Turn SELECTOR switch to AUX, and MODE switch to STEREO. Set MAIN SPEAKERS, and REMOTE SPEAKERS switches to ON. Set HIGH FILTER, and LOUDNESS CONTOUR switches to OFF. Unplug AC power cord.
- (1) Connect a low-distortion audio sine-wave generator, set for 1,000 Hz, to the LEFT AUX IN jack.
 - (2) Connect an 8-ohm load resistor (50-watt minimum rating) between the LEFT SPKRS MAIN and COMMon terminals. In parallel with the load resistor, connect the input leads of an HD analyzer and the input leads of an accurately calibrated AC VTVM.
 - (3) Connect AC power cord and rotate VOLUME control to maximum.
 - (4) Increase audio generator level for 20 watts output (12.6 V RMS across 8-ohm load). HD meter should read 0.5% or less.
 - (5) Repeat preceding steps for right channel.

CHASSIS LAYOUT

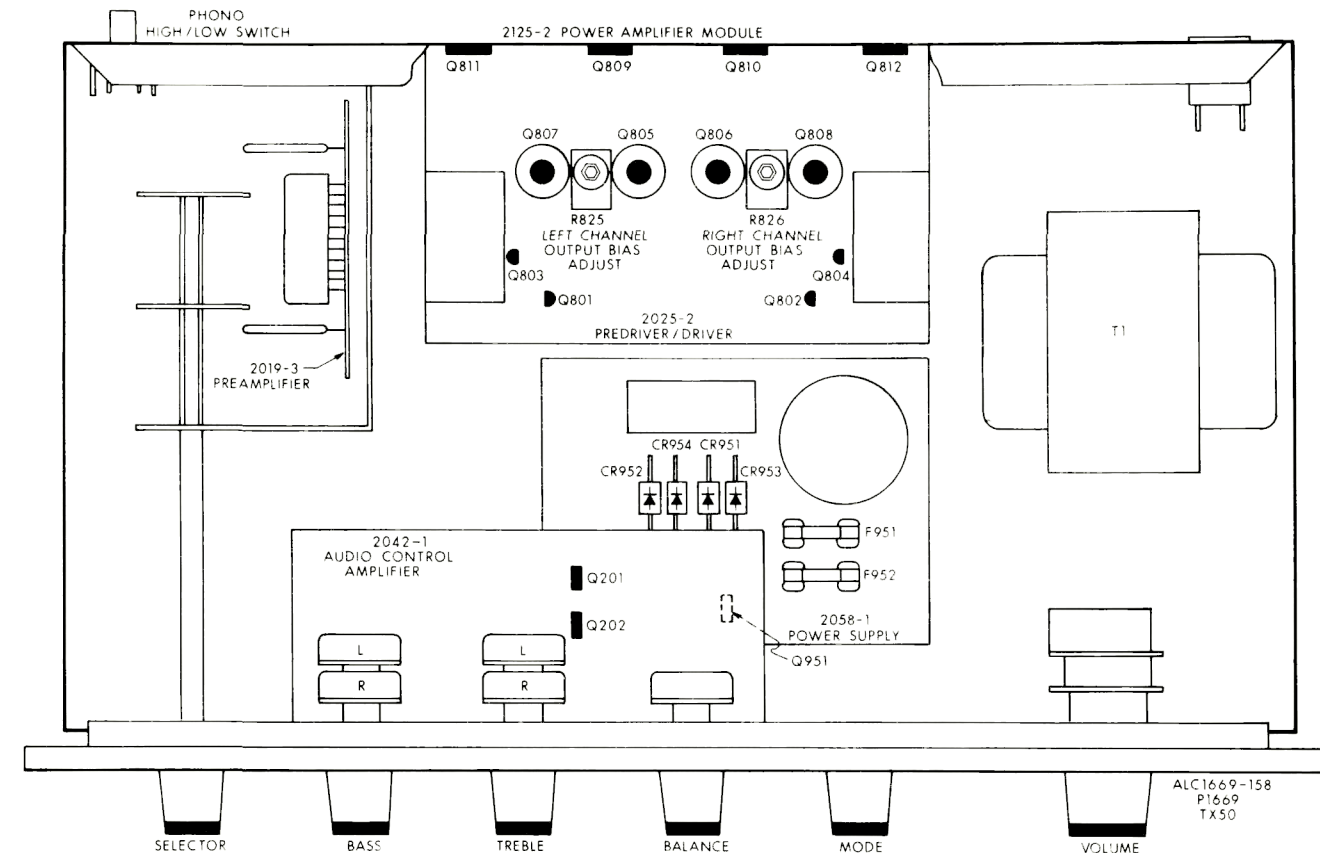

INTERMODULATION DISTORTION TEST

- Set BASS, TREBLE, and BALANCE controls to their center (0) positions. Turn SELECTOR switch to AUX, and MODE switch to STEREO. Set MAIN SPEAKERS, and REMOTE SPEAKERS switches to ON. Set HIGH FILTER, and LOUDNESS CONTOUR switches to OFF. Unplug AC power cord.
- (1) Connect IM-analyzer generator output to the LEFT AUX IN jack. Set level of IM-analyzer generator for 600 mV output.

- (2) Connect an 8-ohm load resistor (50-watt minimum rating) between the LEFT SPKRS MAIN and COMMon terminals. In parallel with the load resistor, connect the input leads of an IM distortion analyzer and the input leads of an accurately calibrated AC VTVM.
 - (3) Connect AC power cord and adjust VOLUME control for 20 watts output (10.3 V RMS across 8-ohm load). IM meter should read 1.0% or less.
 - (4) Repeat preceding steps for right channel.
- NOTE:** If this procedure differs from those in the IM analyzer manual, it is best to follow the instructions in the manual. If a load resistor (with 50-watt minimum rating) is built into the IM analyzer, a separate load resistor is not required.

2019-3 PREAMPLIFIER

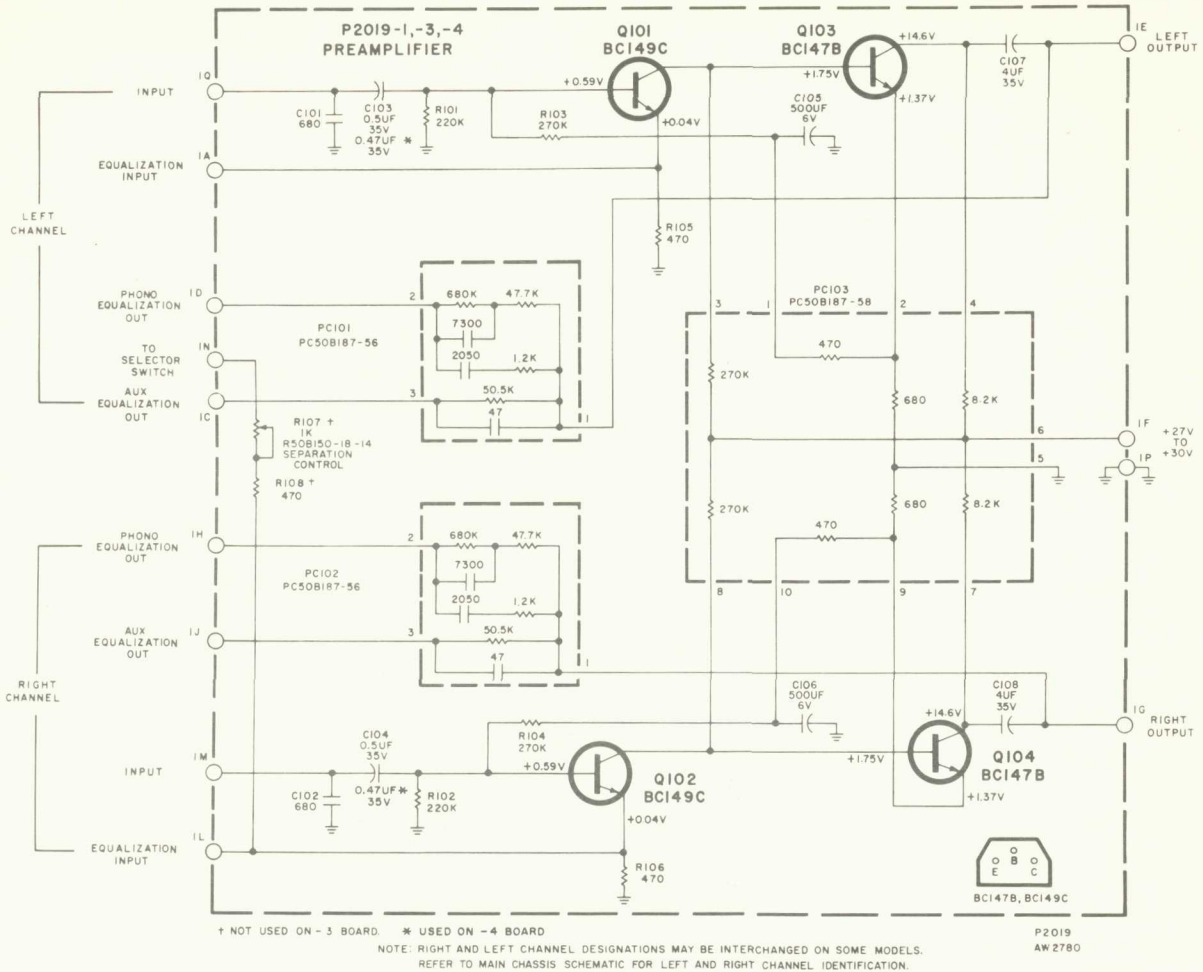

BOARD VIEWED FROM COMPONENT SIDE

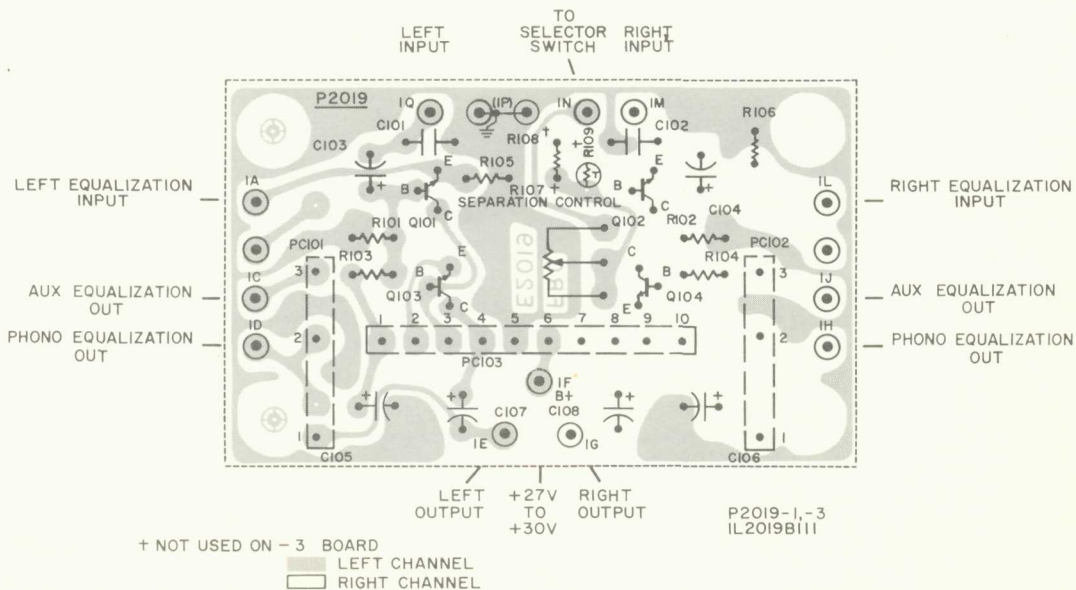

2042-1 AUDIO CONTROL AMPLIFIER

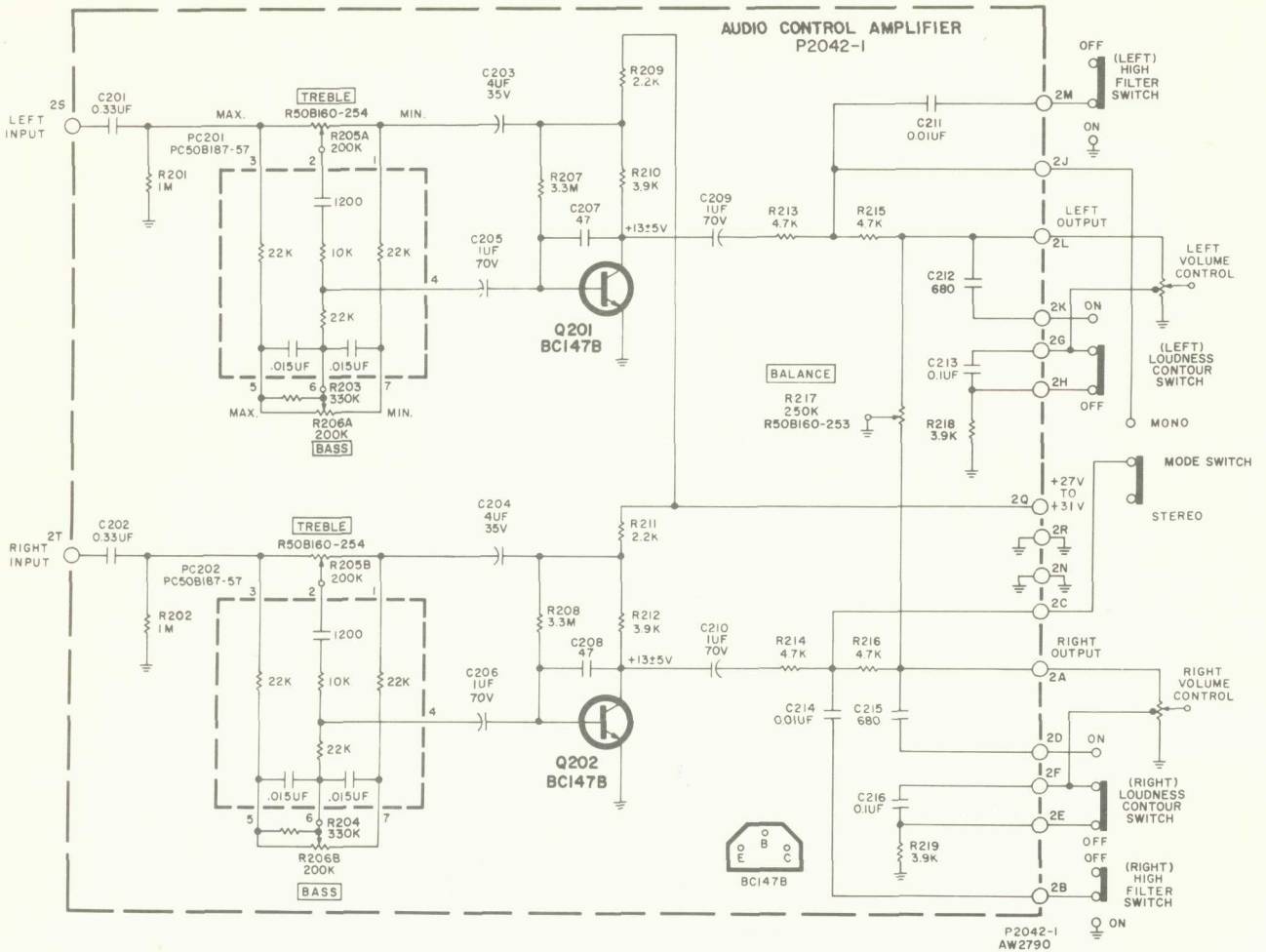

BOARD VIEWED FROM COMPONENT SIDE

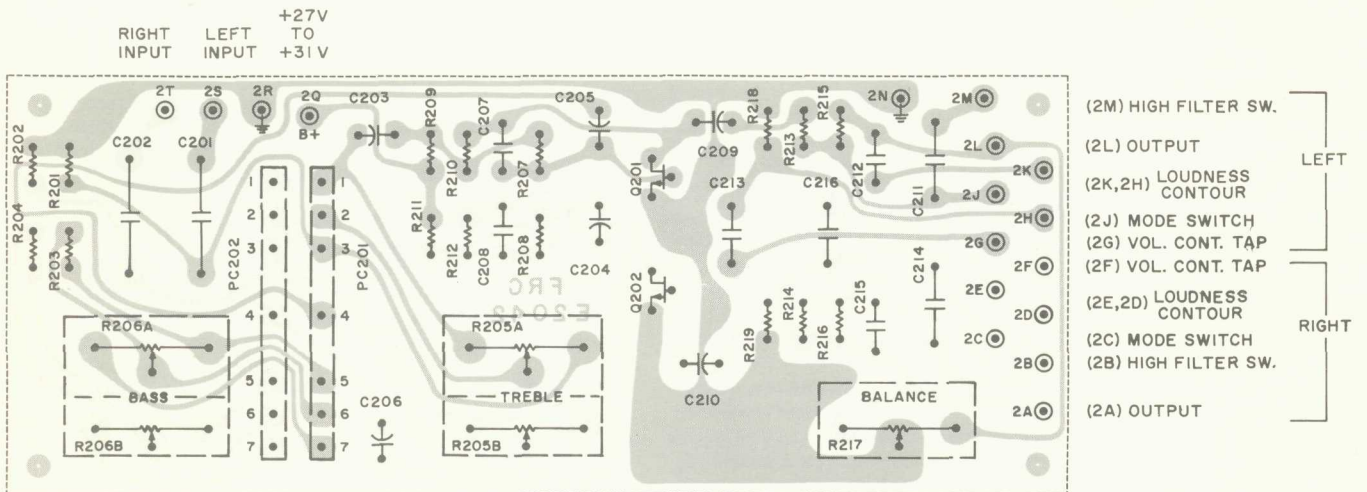

IL2042B111
P2042-1

RIGHT CHANNEL
 LEFT CHANNEL

2125-2 POWER AMPLIFIER MODULE

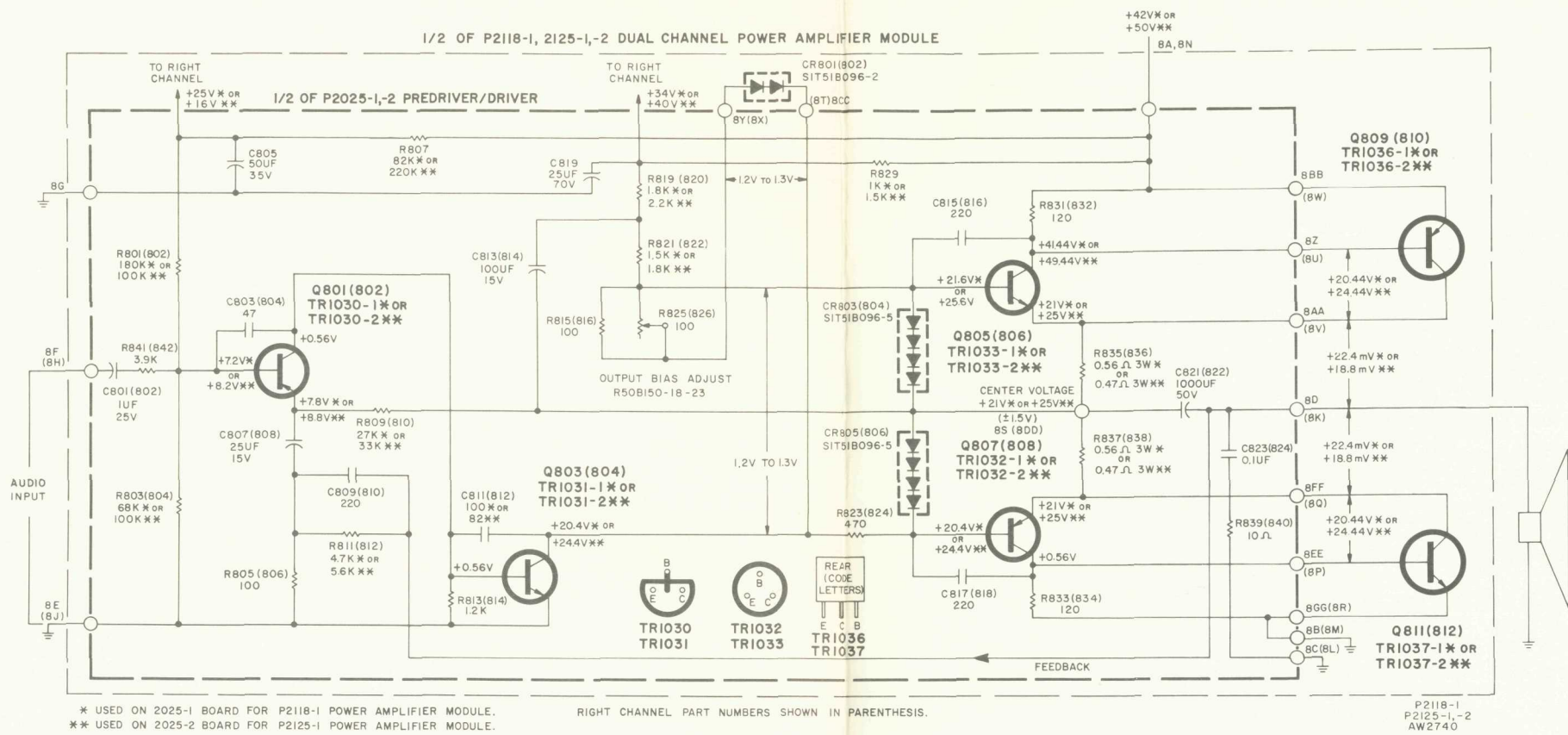

BOARD VIEWED FROM COMPONENT SIDE

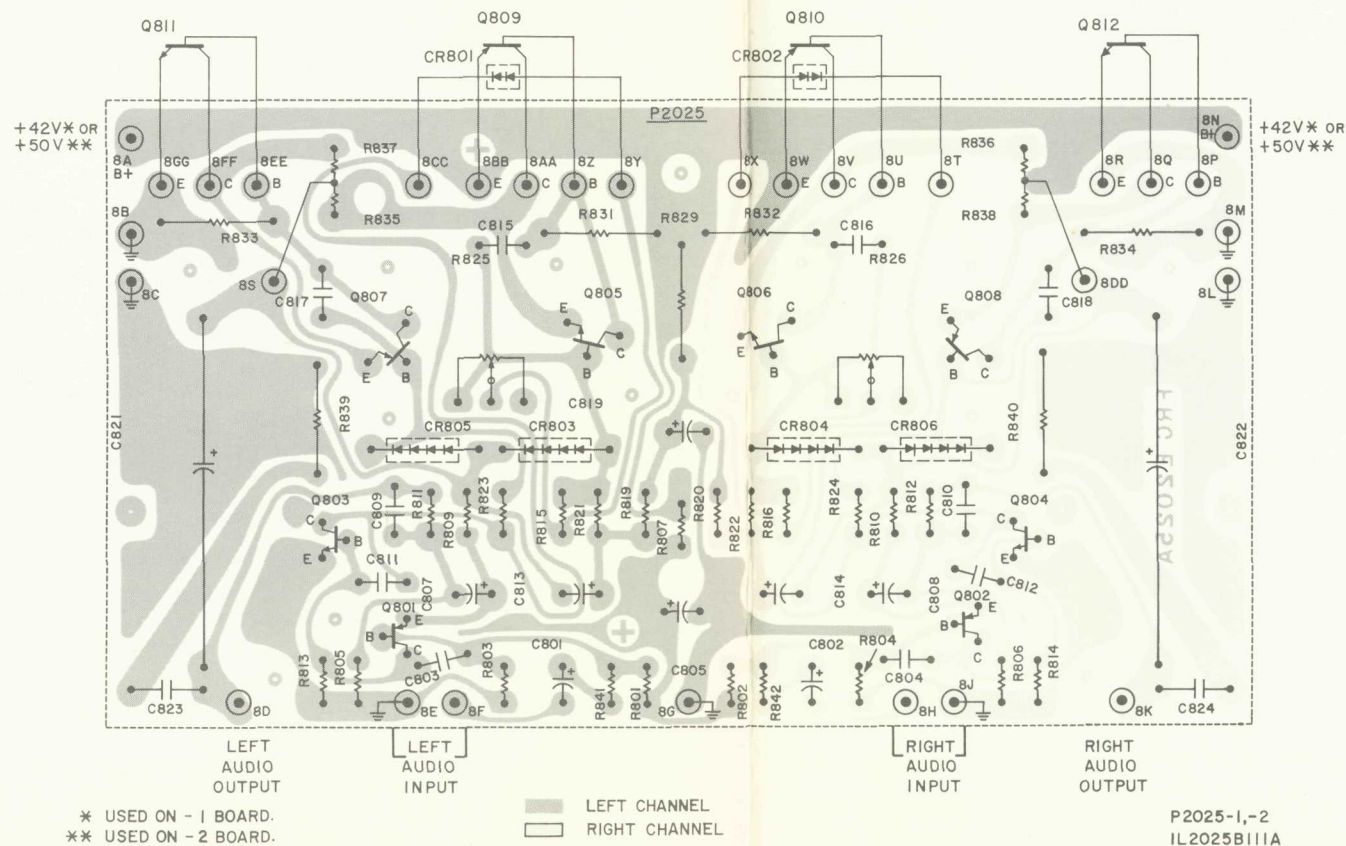

MAIN CHASSIS

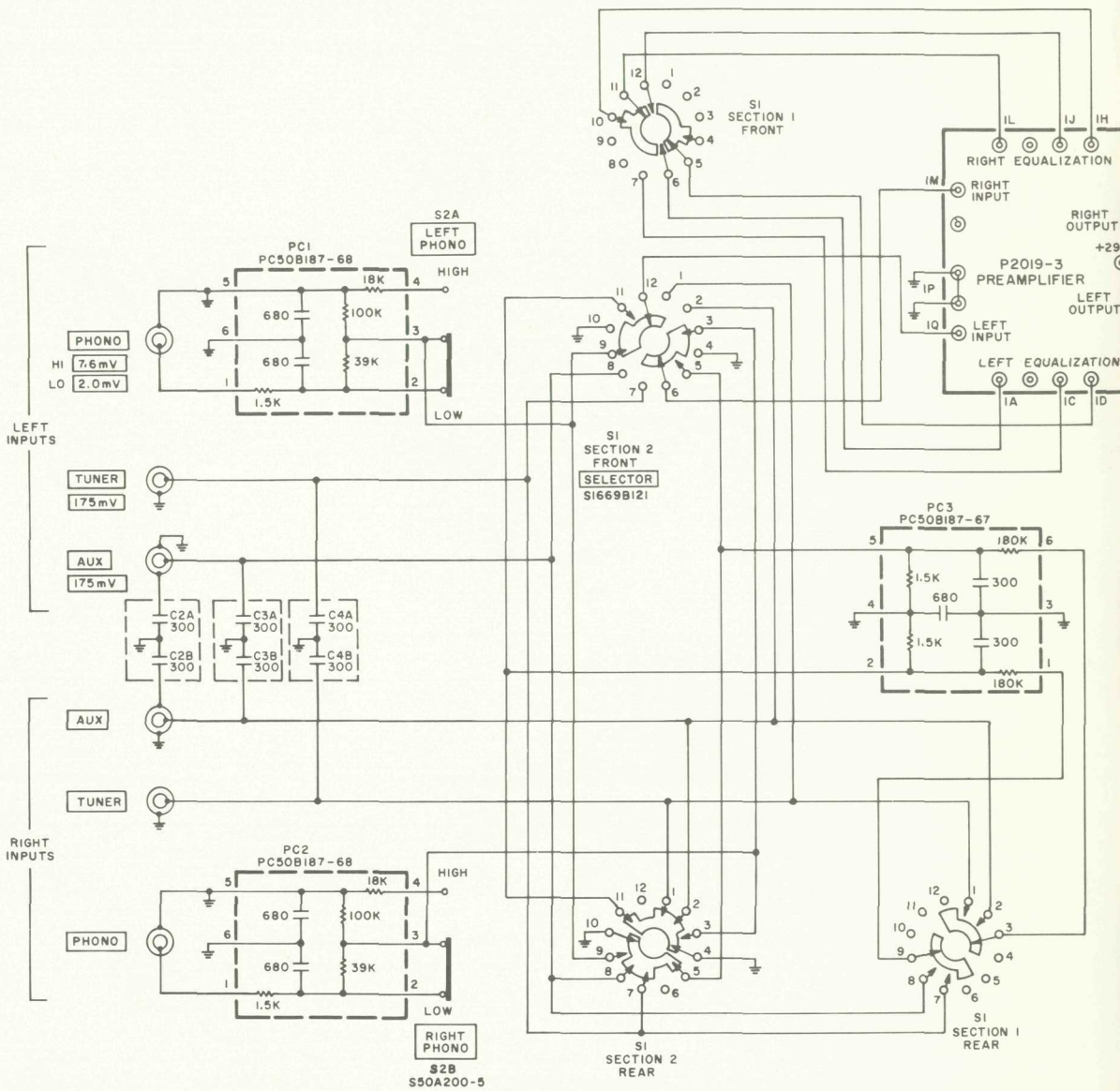

- NOTES:**
- FISHER PART NUMBER LISTED FOR PARTS SPECIALLY SELECTED FOR FISHER RADIO CORP. 1/2 WATT, 5% COMPOSITION RESISTORS MAY BE USED FOR RESISTOR REPLACEMENTS, EXCEPT AS NOTED.
 - ALL ROTARY SWITCHES SHOWN IN MAXIMUM CCW POSITION No. 1, ALL OTHER CONTROLS AND SWITCHES SHOWN IN NORMAL OPERATING POSITIONS.
 - FOR ALL VOLTAGE MEASUREMENTS, LINE VOLTAGE 120VAC. ALL DC VOLTAGES MEASURED WITH DC VTVM TO CHASSIS WITH NO SIGNAL INPUT.
 - INDICATES 1kHz SIGNAL LEVELS FROM AUDIO INPUTS TO POWER AMPLIFIER OUTPUT (18W 12V RMS ACROSS 8Ω LOAD) MEASURED WITH AC VTVM. VOLUME CONTROL MAXIMUM, ALL OTHER CONTROLS AND SWITCHES NORMAL.
 - + USED ONLY ON EXPORT UNITS.
 - * NOT USED ON EXPORT UNITS.

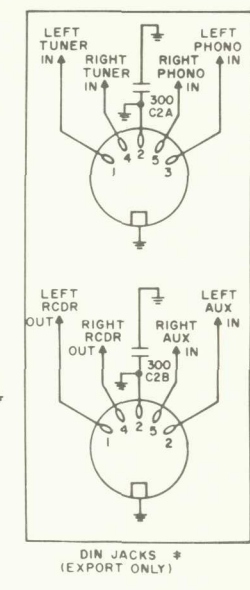
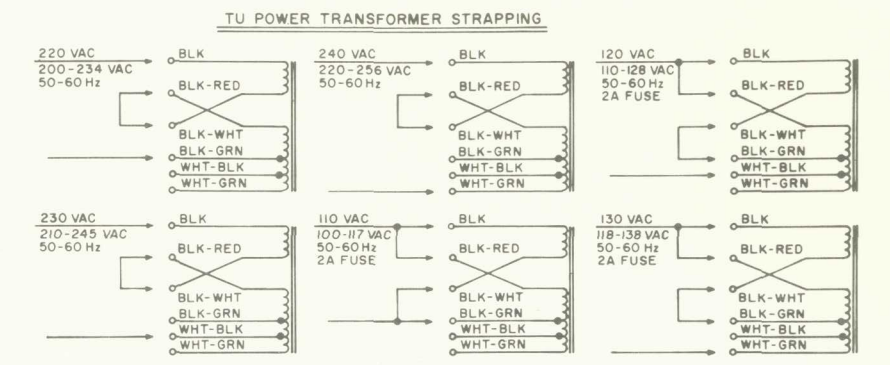
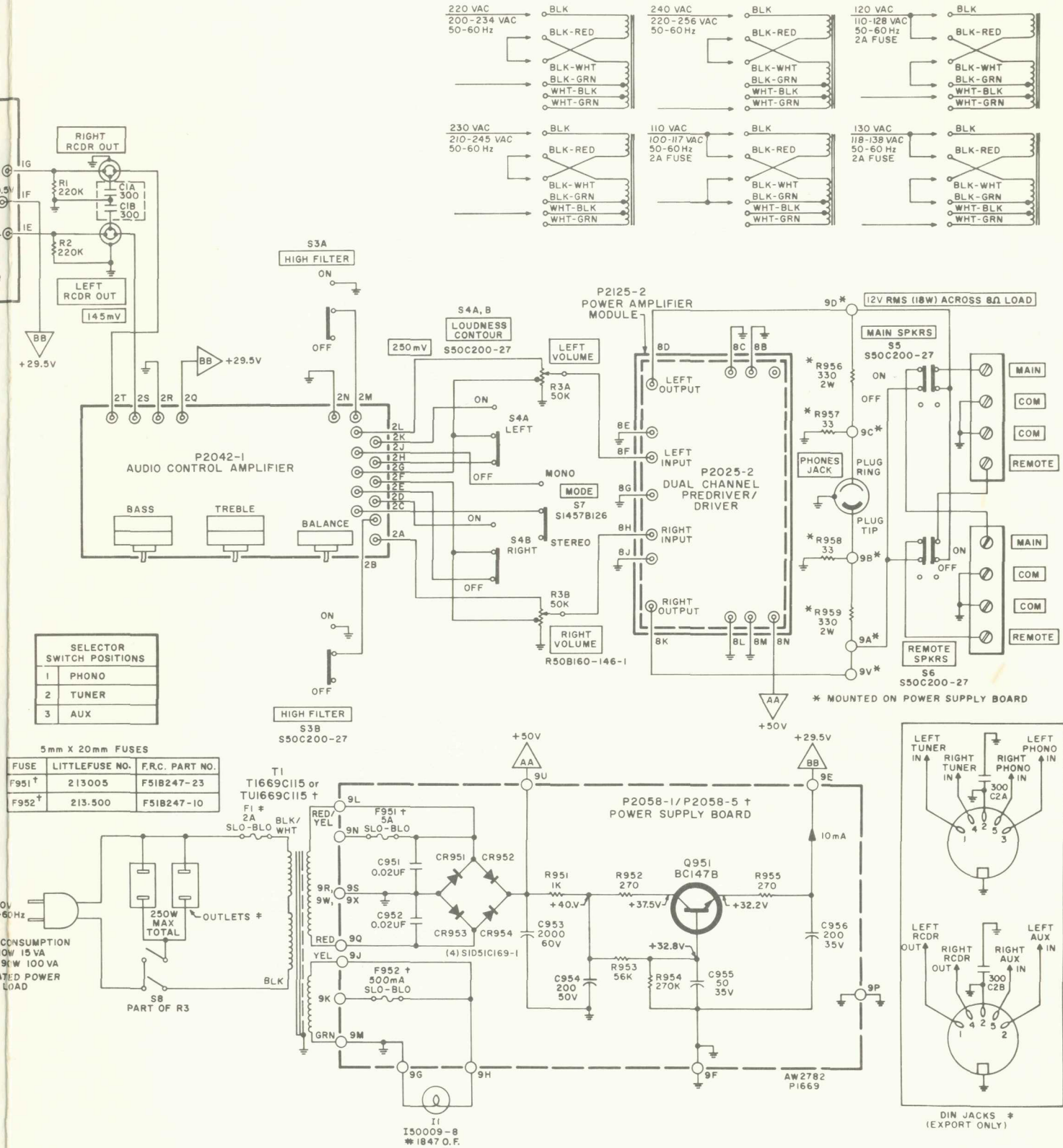

2058-1 POWER SUPPLY

SCHEMATIC SHOWN ON MAIN CHASSIS DIAGRAM

BOARD VIEWED FROM COMPONENT SIDE

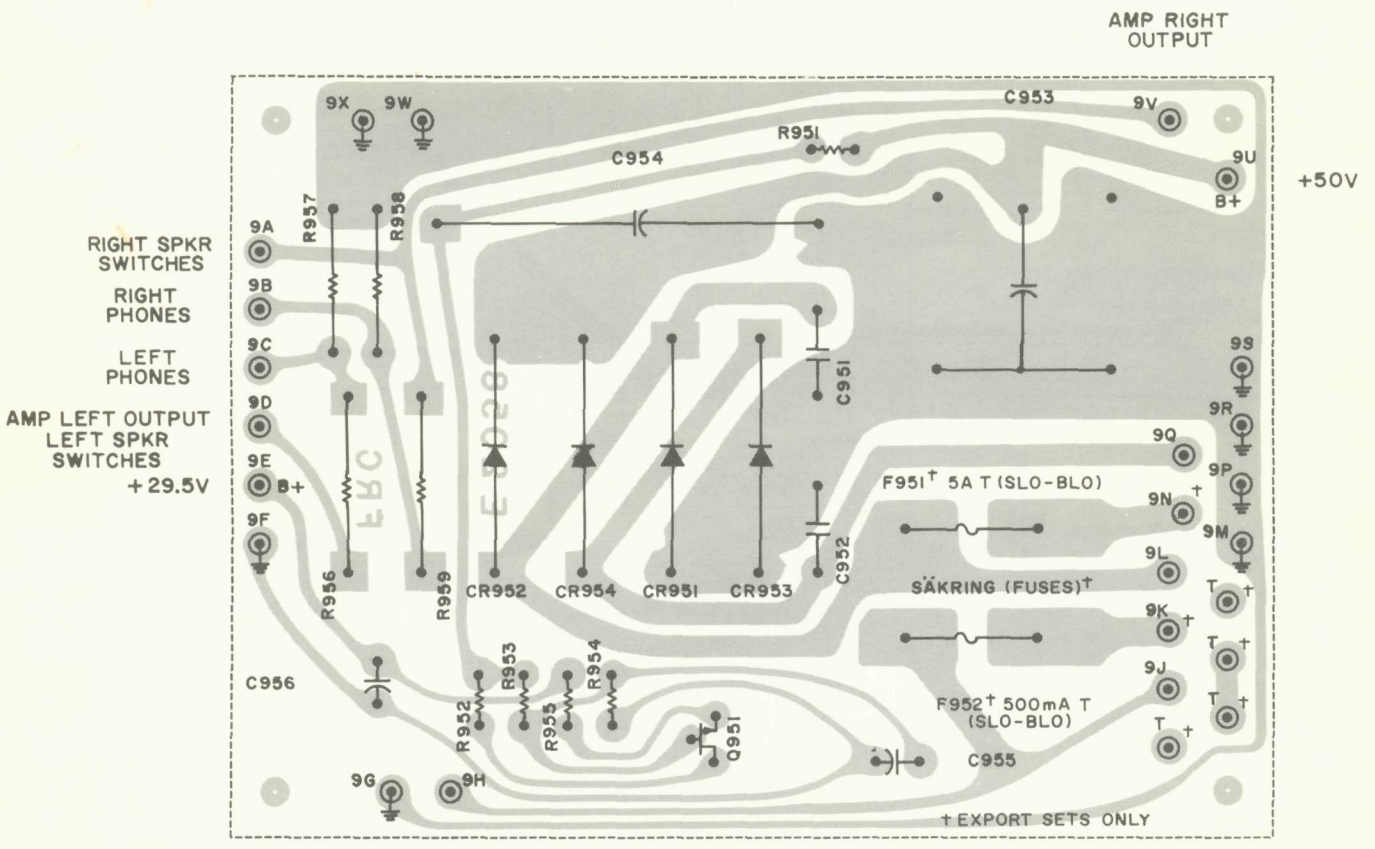

T= TERMINAL TIE LUG USED FOR EASE IN WIRING

IL2058BIII
P2058

COMPONENT CONNECTIONS

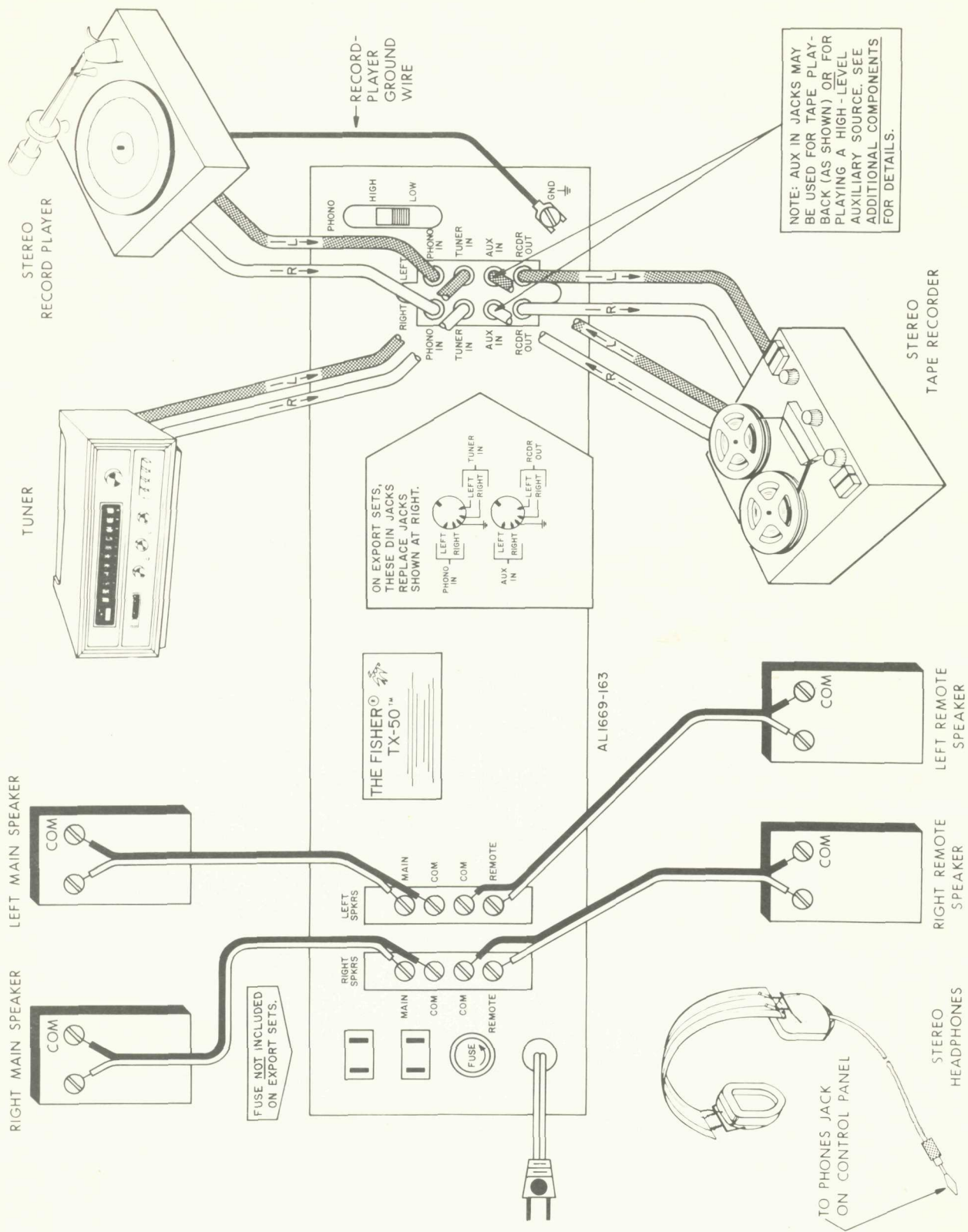

FISHER RADIO CORPORATION • NEW YORK