

# MERCURY ARC POWER RECTIFIERS

THEORY AND PRACTICE

BY

OTHMAR K. MARTI

*Chief Engineer,  
American Brown Boveri Co., Inc.*

AND

HAROLD WINOGRAD

*Rectifier Engineer,  
American Brown Boveri Co., Inc.*

FIRST EDITION

McGRAW-HILL BOOK COMPANY, INC.

NEW YORK: 370 SEVENTH AVENUE

LONDON: 6 & 8 BOUVERIE ST., E. C. 4

1930

COPYRIGHT, 1930, BY THE  
MCGRAW-HILL BOOK COMPANY, INC.

---

PRINTED IN THE UNITED STATES OF AMERICA

*All rights reserved. This book, or  
parts thereof, may not be reproduced  
in any form without permission of  
the publishers.*

THE MAPLE PRESS COMPANY, YORK, PA.

## PREFACE

The increasing use of steel-enclosed mercury arc rectifiers for supplying direct-current power to railways, electro-chemical plants, and other applications involving the conversion of alternating current to direct current, has created an interest in the subject among operating, designing, and consulting engineers, and others concerned with the use of direct current.

This book is intended to explain the operation of the rectifier, to derive the mathematical relations of currents and voltages in rectifier circuits, and to outline the present-day practice in the application of steel-enclosed rectifiers, with emphasis on their employment in railway service. The theoretical treatment of the rectifier circuits is supplemented by tables, curves, and oscillograms, in order to make it convenient for reference, and to give a clearer understanding of the circuit relations. In several instances it was necessary to make simplifying assumptions to avoid unnecessary complications in the mathematical treatment. These assumptions, however, do not have any practical effect on the accuracy of the results.

The introductory chapter outlines briefly the history of the development of steel-enclosed rectifiers. Chapters II and III explain the physical processes of rectification, and certain phenomena occurring in the operation of rectifiers. In Chapters IV and V are derived the general equations for the currents, voltages, power factor, etc., in rectifier circuits. In the mathematical derivations of Chapter IV the same method was followed as that used by W. Daellenbach and E. Gerecke in their paper published in 1924 (see reference 224, Bibliography).

Chapter VI deals with theoretical circuit relations of rectifier transformers, the practical design of transformers, and the load characteristics of rectifiers as affected by the type of transformer connection used. Detailed calculations are given for several of the more important types of transformer connections, illustrating the methods used for calculating the currents, ratings, etc. Similar methods can be applied to any other type of transformer connection.

In Chapters VII and VIII are described and illustrated the design and construction of various types of rectifiers and rectifier

auxiliaries. Since considerable development is still being carried on in this field, it is to be expected that changes have been and will be made in certain details of construction, and the reader is advised to follow current literature to keep abreast of new developments.

Chapters IX, X, and XI relate to the practical considerations in the application, installation, and operation of rectifiers. Besides general information on the operating characteristics of rectifiers, layout of substations, control, etc., details are given of a number of typical rectifier installations, as the authors believe that such information will be of value to any one planning a rectifier installation.

Chapter XII describes methods used for controlling the direct-current voltage of rectifiers. Chapter XIII discusses the problem of interference with communication circuits caused by rectifiers and methods used for eliminating it. Chapter XIV describes some testing methods.

A copious Bibliography on rectifier literature is appended to the book. The items of the Bibliography are numbered serially, and in the text of the book reference to any article is indicated by the number enclosed in parentheses.

In arranging the material of the book, an effort was made to make each chapter self-contained as far as possible, for convenience in making reference. This necessitated a certain amount of repetition. Those not wishing to study through the mathematics of Chapters IV, V, and VI may omit those parts without loss of continuity.

Most of the symbols used are explained on page 49. Others are explained where used.

The authors are indebted to the various manufacturing and operating companies for some of the material and illustrations used in this book. Thanks are due to Messrs. I. K. Dortort, D. Journeaux, and W. C. Sealey, engineers of the American Brown Boveri Co., Inc., for their assistance and many useful suggestions, and to Mr. R. G. McCurdy of the American Telephone and Telegraph Co., who reviewed the Chapter on Interference and offered many helpful suggestions.

OTHMAR K. MARTI.  
HAROLD WINOGRAD.

CAMDEN, N. J.,  
August, 1930.

## CONTENTS

	PAGE
PREFACE. . . . .	v
CHAPTER	
I. INTRODUCTION . . . . .	1
II. THEORETICAL PRINCIPLES AND PHYSICAL PROPERTIES OF MERCURY ARC RECTIFIERS . . . . .	10
III. ELEMENTARY PRINCIPLES OF RECTIFICATION AND RECTIFIER PHENOMENA . . . . .	29
IV. THEORY. . . . .	44
V. THEORY ( <i>Continued</i> ). . . . .	83
VI. RECTIFIER TRANSFORMERS: THEIR CONNECTIONS AND CHARACTERISTICS . . . . .	103
VII. DESIGN AND CONSTRUCTION OF MERCURY ARC RECTIFIERS . . . . .	210
VIII. DESIGN AND CONSTRUCTION OF RECTIFIER AUXILIARIES . . . . .	242
IX. OPERATION OF MERCURY ARC RECTIFIERS . . . . .	284
X. APPLICATION OF MERCURY ARC RECTIFIERS. . . . .	307
XI. SUBSTATIONS. . . . .	329
XII. VOLTAGE CONTROL AND REGULATION. . . . .	385
XIII. INTERFERENCE WITH COMMUNICATION CIRCUITS . . . . .	403
XIV. METHODS OF TESTING RECTIFIERS AND THEIR AUXILIARIES . . . . .	426
BIBLIOGRAPHY . . . . .	443
INDEX. . . . .	463

# MERCURY ARC POWER RECTIFIERS

## CHAPTER I

### INTRODUCTION

Although alternating current possesses many advantages over direct current, it is well known that there are numerous fields of application of electric power where the use of direct current is either desirable or necessary. The most important of these are electric railways (trolley lines, subways, main-line railroads); electrolysis for the production of zinc, aluminum, hydrogen, etc.; and special industrial drives, as for steel mills. It is usually not advantageous to produce the power required for these purposes by means of direct-current generators at the site of its application; further, it is not economical to generate direct current and to transmit it over considerable distances. Generally, the most efficient method for obtaining a direct-current power supply is to transmit alternating-current power over high-voltage transmission lines and convert it into direct current at or near the site of application. The conversion from alternating to direct current for the applications mentioned above may be accomplished by any of the following types of converting apparatus:

Motor-generator set, consisting of two separate machines, *i.e.*, a motor driving a direct-current generator. The performance characteristics of such a set depend on the characteristics of the individual machines comprising it, and the efficiency of the set is the product of the efficiencies of the two individual machines.

Synchronous converter, or rotary converter, which is a combination of a synchronous machine and a direct-current machine with a common armature and field structure.

Cascade converter, or motor converter, which is a combination of induction motor and synchronous converter, the secondary circuit of the former feeding directly into the armature of the latter.

Mercury arc rectifier, which is a stationary apparatus consisting of a cathode and a number of anodes located in an evacuated chamber, which may be either of glass or of steel. The conversion from alternating to direct current is accomplished by the valve action of the mercury arc in vacuum, which permits current to flow through the rectifier only in one direction, from the anodes to the cathode.

The steel-enclosed type of mercury arc rectifier is an outgrowth of the glass-bulb rectifier which came into use about 25 years ago. As can be seen from the bibliography at the end of this book, considerable work was done during the years from 1892 to 1913, but this was mainly in connection with glass-bulb rectifiers. The theory of single-phase rectification was dealt with particularly by Steinmetz and Cooper-Hewitt. As at present developed, the steel-enclosed rectifier is water cooled, may have 6 to 24 anodes, and is built for currents up to 16,000 amp. A vacuum pump is used to maintain the high vacuum required in the arc chamber.

**Development of the Steel-enclosed Rectifier.**—It was found impossible to build glass-bulb rectifiers for large outputs on account of the low mechanical strength of glass, the difficulty of dissipating the losses, and the difficulty of obtaining an efficient anode seal. It was, therefore, found necessary to use steel containers for rectifiers of large capacities. The development of steel-enclosed rectifiers, however, also encountered a number of difficulties, chief among which were: the difficulty of obtaining an efficient air-tight seal for the anodes and the cathode, since both the anodes and the cathode have to be insulated from the cylinder; the occurrence of back fires; guiding the mercury vapor within the tank, and draining the condensed mercury; etc. All these difficulties have now been overcome, however, thus making possible the present metal-enclosed mercury arc rectifier. It would make a very interesting bit of history to record all the phases of development of this device in Europe and on this continent, but that would be beyond the scope of this book, so only a brief outline will be given for the sake of completeness.

In this country, the first steel-enclosed rectifiers were built by Peter Cooper-Hewitt and Frank Conrad, during the years 1905 to 1908, while, in 1910, the first large steel-enclosed rectifiers were built by Bela Schaefer in Europe. From that time a very intensive study of the apparatus was made by both European and American concerns. A number of reasons, however, led the American companies to cease active development work on these rectifiers for a period of about ten years; while in Europe, on the other hand, the work was continued, and considerable progress was made during and after the World War towards a commercial steel-enclosed rectifier.

One of the first American rectifiers, of the year 1908, and of very small size, consisted of a nickel-steel casting with cooling fins. There were three openings at the top: two for the anodes, and one for both the cathode lead and for the connection to the vacuum pump. The mercury cathode was contained in an insulated cup at the bottom of the cylinder, similar to the present designs. As in the glass-bulb rectifiers, the two anodes were made of graphite with steel leads passing through porcelain bushings. All joints were ground to a fit, and were sealed with mercury. Although some trouble was experienced with this rectifier, development work was continued further.

The next units to be developed had steel tanks some two feet in diameter, with three anodes mounted in the covers. The cathode was of the same design as in the first model. The seals, however, were considerably improved mechanically, and mercury was again used as the sealing medium. The whole cylinder was immersed in a tank of water. Although the rectifiers could be operated continuously for short periods by keeping the vacuum pump running, they were still impracticable for commercial use because of leakage through the casting itself.

The rectifier designed by Bela Schaefer consisted of a double-walled water-cooled cylindrical steel vessel, with an internal diameter of 170 mm., and was built in the shops of Hartmann and Braun in Frankfurt, Germany, and later by the Gleichrichter-Gesellschaft of that city.

The rectifier had a single anode which had its connection brought out at the top through a porcelain bushing, sealed in by means of asbestos rings and mercury. The mercury cathode was located at the bottom and was not insulated from the tank. The comparatively large cathode receptacle had a porcelain



tube mounted over it in such a way that the cathode spot was confined in its movements to a small area. An ignition anode, operated by a solenoid, and an auxiliary excitation anode were also provided. This tank was connected only to one phase, and, consequently, two such tanks were needed for full-wave rectification of alternating current. Such a rectifier group, composed of two tanks, rectified successfully 300 amp. direct current. If the cooling water was circulated at a more rapid rate than usually feasible, it was even possible to rectify currents up to 500 amp. The seals were so effective that the vacuum pump had to operate only about half a day every 4 weeks.

The main difficulty encountered when the individual tanks were combined into one, was the frequent occurrence of back fires, which are failures of the valve action of the rectifier. To correct this trouble, various types of anode sleeves and baffles were employed, similar to those in use in the various types of rectifiers described in Chap. VII

The General Electric Company developed a rectifier consisting of two single-anode tanks and later developed a two-anode rectifier. The two-tank rectifier, dating from the year 1912, had anode insulators of porcelain, sealed by concentric rings of either lead and rubber or lead and asbestos. The tanks were cooled by water which was circulated by means of a pump between the double walls of the tanks and a reservoir. It was possible to rectify up to 80 kw. in each of the single-anode tanks, while only 30 kw. could be obtained from the two-anode rectifier, owing to incomplete control of the arc phenomena.

Another design, developed by the Westinghouse Company, in the year 1910, was made of sheet steel with welded joints, formed into the general shape of a glass-bulb rectifier, that is, with the anodes located in arms branching out from the main condensing chamber. Development work on rectifiers of this design was carried on simultaneously in Europe, and the Allgemeine Elektrizitaets Gesellschaft in Berlin continued its research on rectifiers of this kind until 1918.

A glance at the patent literature of this period shows that the early designers were groping in an unknown field, whose phenomena are, even now, not yet mastered to the extent to which the phenomena of other conversion machines are. Every effort was made to solve the design problems encountered with the types mentioned above.

Much work was done in the direction of obtaining currents of commercial magnitudes from the rectifiers, and particularly at voltages higher than those possible up to that time. Water-cooled steel anodes were tried out with good results, and it subsequently became possible to obtain several hundred amperes at voltages going into the hundreds of volts. In a similar way, other developments were successfully carried out. For instance, a great many types of anode shields were tested, and their functioning observed through glass windows in the steel cylinders. Over a hundred such shields were tried out, some of them being cooled by means of water. Various shapes and sizes of anodes were also tested, as well as a number of different cooling arrangements. The voltage drop in the rectifying arc, as well as the inverse current during the period of negative anode potential, were measured by special devices.

Further investigations were made with seals. Numerous metal seals were tried out, but these could be made to fit tightly the surfaces of the porcelain insulators only with great difficulty. Asbestos seals, likewise, presented problems in being made sufficiently tight. Ordinary rubber seals were objectionable because of the vapors they emitted when subjected to high temperatures. Soldered joints were found to give good results provided the solder could be protected from the amalgamating action of the mercury in the rectifier. Welded joints were not as effective as soldered ones, owing to the presence of minute porous slag pockets in the welded metal. It was found that seals could be obtained with certain enamels, varnishes, and the like, under favorable conditions. One type of seal, of baked enamel, seemed to show particularly good results, and two receptacles sealed with it held their vacuum for a whole year. Several kinds of cements were also tried, and some new ones developed. In Europe, together with the first steel rectifiers, Bela Schaefer developed a mercury seal which is, in its basic principle, still used by the Brown Boveri companies.

The problem of occluded gases complicated matters still further, and systematic forming, or degassing, processes had to be developed in order to expel the gases occluded in the metal parts of the rectifier as quickly as possible during evacuation. In order to conduct this process intelligently, better vacuum-measuring devices had to be developed. The familiar McLeod mercury column gage used so far measured the pressure of per-

fect gases only, because its principle is based on Boyle's law, and in obtaining a measurement the vapors are condensed by compression. A recently developed gage, however, measures the pressures of all the gases and vapors which the cylinder may contain and indicates the pressure directly on a switchboard instrument. The latest improvements in the operation of the rectifiers were to some extent due to the possibility of easily

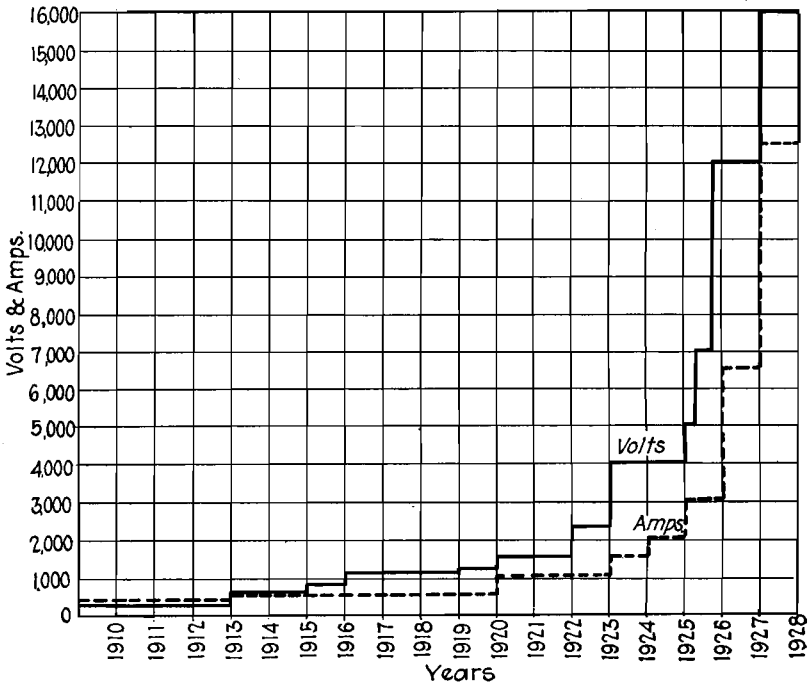

FIG. 1.—Graph showing increase of direct-current voltage and capacities of rectifiers.

and accurately measuring vacua by the use of this new gage. The degree of vacuum during forming and operation can now very readily be observed by an operating engineer, and in the case of automatic installations this requires no attention whatever, since the pumps are controlled by the vacuum-measuring devices. For the same reason any imperfections in the seals no longer have troublesome effects.

Several of the first mercury arc rectifiers were equipped only with a rotary pump, and no mercury vacuum pump; such rec-

tifiers are still in operation in Europe. From 1918 and 1919 on, however, Brown Boveri equipped all their rectifiers with both rotary and mercury vacuum pumps.

While the first steel-enclosed rectifiers were of a capacity below 100 kw., and of low direct-current voltage, the latest developments allow of building them for any practicable voltage and size. A number of installations of 3,000 volts, direct current, have been in successful operation for several years. In 1926, a rectifier was installed in an industrial plant in Germany for 12,000 volts direct current, and in 1929 a rectifier for 13,000 volts direct current was installed at Chelmsford, England, for radio. Units with a continuous capacity as high as 4,500 kw., which is about fifty times the capacity of the first steel-enclosed units, have been placed in operation. In Fig. 1 is shown the increase in the direct-current voltages and currents successfully used with rectifiers during the last 18 years. Recent extensive load tests with standard rectifiers at 16,000 volts direct current indicate that a somewhat modified design could be used for still higher direct-current voltages which may be suitable for power-transmission purposes over long distances. Such a scheme of power transmission may become practicable at some future date since experimental apparatus has already been built for converting high-voltage direct current into alternating current.<sup>1</sup> Much can therefore be expected of the future of mercury arc rectifiers, both with respect to greater capacity and higher voltages.

**Early Applications of Steel-enclosed Rectifiers.**—During the period of development to which reference has been made, a number of rectifier installations were set up for the purpose of determining the reliability of the cylinders and their auxiliaries, as well as to acquire general operating experience. One of these installations, made in Europe, is shown in Fig. 2. It was made in 1915, and was the beginning of the commercial application, in Europe, of steel-enclosed rectifiers to interurban street-car service. It consisted of two cylinders with a rating of 150 kw. each, at 600 volts, direct current. The first two steel rectifiers in Europe were installed in a foundry near Frankfurt, Germany, in the year 1911, where they are still in operation. Each of the cylinders is rated at 150 amp., 230 volts, and has 18 anodes.

<sup>1</sup> See *The Electrician*, Vol. 92, pp. 567, 601, 1924; PRINCE, *General Electric Rev.*, pp. 676-681, October, 1925; HULL, *ibid.*, pp. 398-399, 1929.

One of the earliest American installations was in the Shadyside Works of the Westinghouse Electric and Manufacturing Company. Here the rectifier operated in parallel with gas-engine driven, 250-volt, direct-current generators. The equipment was installed early in 1913 and was in operation for about 5 years. The load varied from 50 to 300 amp. No vacuum

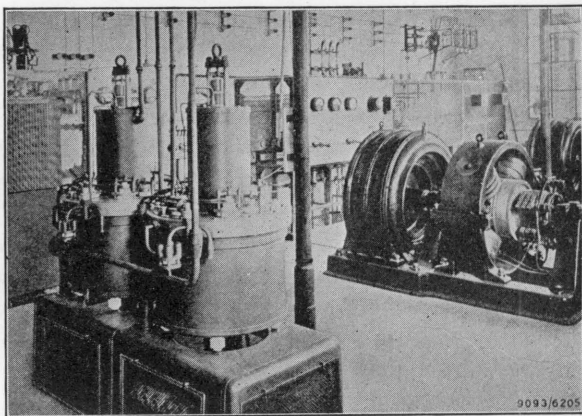

FIG. 2.—Brown Boveri rectifiers in the Schlieren Substation of the Limmattal Tramways, near Zuerich, Switzerland, installed in 1915.

pump was installed; instead, when a cylinder needed to be evacuated it was temporarily removed. Most of the failures of the vacuum were due to mechanical faults in the rectifier tank. Several of the tanks operated for 5 and 6 months before they required to be evacuated again (309).<sup>1</sup>

A second installation, made to determine the applicability of rectifiers to single-phase railway service when mounted on motor cars or locomotives, was made in 1913. In May of that year two single-phase steel-enclosed rectifiers with auxiliaries, transformers, and control apparatus were mounted on a motor car of the Pennsylvania Railroad. This car was equipped with four 200-h.p., 600-volt, direct-current motors. The main auxiliary was a water-circulating system consisting of an automobile-type radiator, tank, and pump. A vacuum pump was added later. After satisfactory preliminary tests at the factory, the car was placed in service on the New Canaan branch of the New York, New Haven & Hartford Railroad. It covered about 240 miles

<sup>1</sup> References are to the Bibliography at end of book.

per day, hauling its own weight of 72 tons and a trailing load of two 32-ton coaches. The load peaks varied between 500 and 800 amp. After the service had been discontinued for a time, the car was again placed in service in the spring of 1915. In all, it covered about 13,400 miles of regular revenue service.

In May, 1915, a 5,000-volt rectifier was installed at the Grass Lake substation of the Michigan United Traction Company. Three single-phase rectifiers were connected in series on the direct-current side, each one being connected to one phase of the three-phase power supply. A closed circulating cooler and an electric heater to prevent the anodes from reaching too low a temperature in extremely cold weather marked this installation. The rectifiers gave satisfactory service, some of them going for periods of 28 days before they required reevacuation. There being only one car on this branch, however, which was fitted for 5,000-volt operation, and that car becoming seriously damaged in a wreck, the use of that voltage was discontinued thereafter.

There are now a total of some 2,000 rectifier sets installed throughout the world, with a total capacity amounting to more than 1,500,000 kw. The distribution of these units by fields of application is given in Chap. X.

## CHAPTER II

### THEORETICAL PRINCIPLES AND PHYSICAL PROPERTIES OF MERCURY ARC RECTIFIERS

The basis of the operation of the mercury arc rectifier is that characteristic of the mercury arc in vacuum which permits current to flow only in one direction, namely, from the anode to the mercury cathode. The phenomena and characteristics of the mercury arc in vacuum have been treated in great detail in various scientific publications.<sup>1</sup> The subject will be considered briefly in this chapter in order to explain the process of rectification.

**Principles of Rectification.**—According to the generally accepted theory of matter, an atom consists of a positively charged nucleus around which revolve one or more negative particles, known as *electrons*, which carry the negative charge. The electrons are held by the positive charge of the nucleus, the force of attraction and the number of electrons varying with the different elements. At a high temperature, or under the influence of an electric field, the force of attraction between the electrons and the positive nucleus can be overcome, and the electrons liberated, thus becoming free electrons. The ease with which electrons may be dissociated from atoms depends on the structure of the atom, the pressure, the temperature, and the strength of the electric field. The total negative charge of an atom having its normal quota of electrons is equal to its total positive charge, and it is then said to be a *neutral atom*. An atom from which an electron has been dislodged has an excess of positive charge and is called a *positive ion*. An atom which has acquired an extra electron has an excess of negative charge and is called a *negative ion*. The process in which electrons are dissociated from atoms is called *ionization*, and the atoms are said to be *ionized*.

When subjected to the influence of an electric field, such as that existing between two electrodes having a difference of

<sup>1</sup> See Bibliography.

potential between them, the free electrons travel along the lines of force of the electric field toward the positive electrode, that is, toward the electrode which is at the higher potential. The motion and behavior of the electrons in the electric field are influenced by the voltage gradient of the field, the gas or vapor pressure in their path, and the presence of other positively or negatively charged particles. The higher the voltage gradient, the greater is the force accelerating the electrons, and, therefore, the higher is their speed. The pressure of a gas or a vapor is due to the density of its molecules and their motion. At higher pressure, the number or motion of the molecules is greater, which increases the resistance in the path of the electrons on account of more frequent collisions, and thus reduces their speed. The presence of negatively charged particles, such as negative ions or electrons, in the space between the electrodes, produces a negative space charge, which exerts a repelling force on the electrons, thereby modifying the influence of the electric field. Similarly, the presence of positive ions produces a positive space charge, which exerts a force of attraction on the electrons and may compensate for the effect of the negative space charge. Furthermore, some of the electrons may combine with positive ions, thus forming neutral atoms.

If an electron, while moving at high speed, collides with a neutral atom of gas or vapor, it may liberate an electron by the impact of collision. The electron thus liberated also moves along the lines of force of the electric field toward the positive electrode. The atom from which an electron has been dislodged by the collision consequently becomes a positive ion and moves along the lines of the electric field toward the negative electrode. The liberation of electrons as a result of collisions between electrons and neutral atoms or molecules is called *ionization by collision*. Due to these collisions the electrons are deflected from the straight course along the lines of the electric field and acquire components of motion at right angles to the field. As previously stated, some of the positive ions may recombine with electrons and form neutral molecules.

The movement of electrons toward the positive electrode and of positive ions toward the negative electrode constitutes a flow of current between the electrodes. The magnitude of the current is measured by the total quantity of charge passing per second across a plane perpendicular to the electric field. Each electron



and positive ion carries a charge of  $1.59 \times 10^{-19}$  coulomb, so that a total of  $629 \times 10^{16}$  electrons and positive ions would have to pass across the plane per second for each ampere (1 amp. = 1 coulomb per second) of current. The conduction of current in gases and vapors, as, for example, in a vacuum tube and in a mercury arc rectifier, is effected by the movement of electrons and positive ions, as described above. Since the mass of an electron is much smaller than that of a positive ion, the ratio being 1/370,000 for mercury (see Table I at end of this chapter), the electrons travel at a much higher speed than the ions, and practically the entire current in a rectifier is carried by electrons. The positive ions act largely to compensate for the negative space charge of the electrons (407).

If the negative electrode is made to emit electrons, by raising its temperature or by imposing a sufficiently high voltage gradient at its surface, these electrons, together with any electrons liberated as a result of ionization of the gas by collision, will travel toward the positive electrode and thus produce a current flow, provided the voltage between the electrodes is sufficiently high. If the voltage becomes zero or is reversed, the movement of electrons, and consequently the flow of current, ceases. Such an electronic current conduction between two electrodes, one of which is made to emit electrons, has the characteristics of a current valve, since current can flow only when the electron-emitting electrode is at a lower potential than the other electrode.

The voltage required between electrodes for such a conduction of current depends to a large extent on the gas or vapor pressure. The effect of the pressure is as follows: If the pressure is very low, considering, as an example, the limiting case of zero pressure, all the current must be carried by the electrons emitted from the negative electrode, since no gas molecules are then present for producing ionization by collision. In such a case, the negative space charge produced by the electrons is not compensated for, and a relatively high voltage is required between the electrodes to overcome this space charge and maintain conduction. If the pressure is high, the electrons encounter a high resistance in their path and a high voltage is necessary to overcome this resistance. At some intermediate pressure, which is generally quite low, the voltage between the electrodes is a minimum. This optimum pressure corresponds to the condition at which only enough gas molecules are present for producing, through

ionization by collision, sufficient electrons for current conduction and sufficient positive ions to compensate for the negative space charge of the electrons.

Figure 3 shows a closed vessel with two electrodes, an electrode emitting electrons,  $c$ , called the *cathode*, and an electrode not emitting electrons,  $a$ , called the *anode*. By imposing an electric field on the electrodes by means of a battery, as shown in Fig. 3, so that the anode is positive with respect to the cathode, electrons liberated at  $c$  will travel along the lines of force of the electric field towards the anode, which is at a positive potential. In accordance with the accepted convention of current flow,

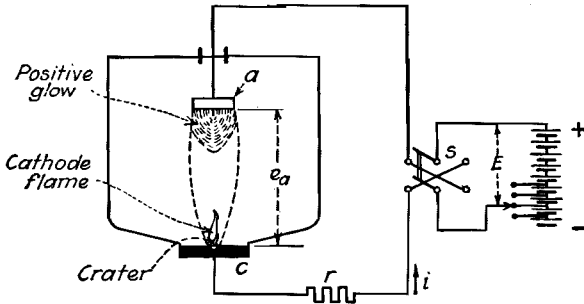

FIG. 3.—Elementary diagram of a rectifier.

however, the current is considered as flowing from the anode to the cathode.

As already stated, the electrons may be liberated from the cathode by raising the temperature of the cathode to a sufficiently high value or by imposing a sufficiently high voltage, or both. If the cathode consists of a material in which the electrons are loosely bound to the nuclei, the electrons are more readily dissociated. If now this vessel is evacuated to a relatively high degree of vacuum, the electrons can travel without encountering much resistance.

When the electric field between the two electrodes becomes zero, or is reversed, so that the anode becomes negative with respect to the cathode, as could be done by means of a reversing switch  $s$ , shown in Fig. 3, the movement of electrons is stopped, so that the current flow ceases. The vessel thus constitutes a current valve, which permits current to flow in one direction only. Such a current valve is called a *rectifier*.

**Voltage Characteristics of the Mercury Arc.**—The mechanism of rectification may also be explained by means of the voltage characteristic of the mercury arc in vacuum, shown in Fig. 4.

Referring to Fig. 3, if a variable direct-current potential is applied to the rectifier circuit, and an attempt were made to start the rectifying arc between *a* and *c* by means of a high voltage, it would be found that by increasing the potential to a certain value,  $e_1$ , a slight discharge or corona effect, of the order of magnitude of a few milliamperes, takes place between the two electrodes (see Fig. 4). The magnitude of this voltage,  $e_1$ , depends on the degree of vacuum, and will vary between 400 and 15,000 volts for pressures between 0.1 and 0.0005 mm. mercury column. If the voltage is now further increased, it will be found that the discharge current is increased very slightly, and at a potential of 20,000 to 50,000 volts the current does not increase much above 10 milliamperes. In case the potential between the electrodes is increased still further, the character of the discharge changes abruptly; the current increases suddenly, and a heavy current can be maintained by a relatively low voltage  $e_a$ , as given in Figs. 4 and 6. This abrupt change in the character of the mercury arc at a certain voltage is due to instability of the arc on the downward slope of the arc characteristic shown in Fig. 4. This instability may be explained as follows:

Referring to Fig. 3, an arc can exist in the rectifier when the current is such that there is a balance of voltages in the circuit, that is, if the voltage drop in the arc  $e_a$  at a given current  $i$  is equal to the applied battery voltage  $E$  minus the  $ir$  drop in the external circuit. This may be expressed by the equation

$$e_a = E - ir.$$

By plotting this equation in Fig. 4 for a given constant value of  $r$  and different values of  $E$ , a series of straight lines is obtained, one line for each value of  $E$  assumed. The inclination of these lines towards the current axis is equal to the resistance  $r$ . These lines serve as a criterion of the stability condition of the rectifying arc. The points where these resistance lines intersect the characteristic of the arc give the condition under which it is possible for the arc to exist, because at these points the voltage drop of the arc is equal to  $E$  minus  $ir$ . The arc is unstable when a slight increase of the current  $i$  causes a greater reduction in the voltage drop in the arc than the corresponding increase in  $ir$  drop for the

same current, because the excess voltage increases the current still further, and this continues until a stable condition is reached.

In general, this will hold true when the slope of the arc characteristic is steeper than the resistance characteristic and is inclined in the same direction. The straight line  $q$ , corresponding to a battery voltage  $E_1$ , intersects the voltage curve of the arc at the points 1, 2, 3, at which a balance of voltages is obtained in the rectifying circuit (see Fig. 4). At point 1, the arc is stable because an increase of current would cause an increase of the voltage drop

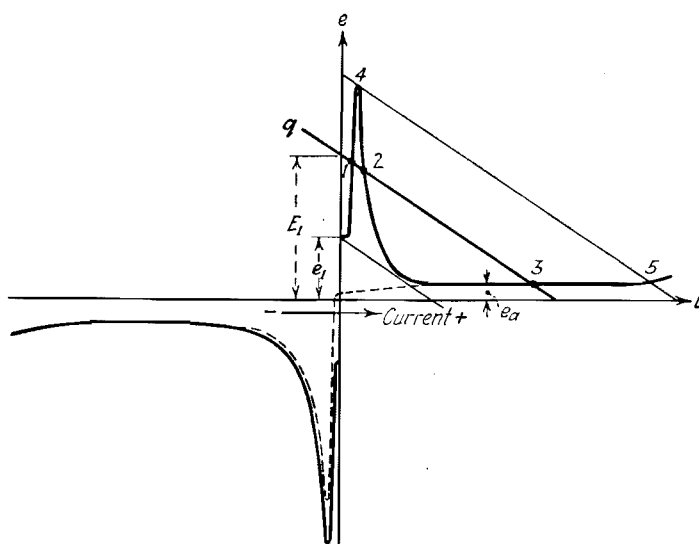

FIG. 4.—Voltage characteristic of a mercury arc in vacuum.

in the arc; at point 2, the arc is unstable owing to the fact that an increase in current reduces the voltage drop in the arc by a greater amount than the corresponding increase in  $ir$  drop, thus producing an excess voltage which causes a further increase in current until point 3 is reached, where a balance of voltages is again obtained. Point 3 is stable because a slight increase in current causes an  $ir$  drop in excess of the reduction in the voltage drop in the arc.

If the voltage is gradually increased from zero, the small corona discharge takes place, as already described, until the voltage at the top of the curve is reached. At this point the arc is unstable, and the current changes abruptly from a few

milliamperes at point 4 to a large value, corresponding to point 5 of the  $ir$  characteristic. At this point a stable arc can exist.

If the voltage  $E$  is gradually diminished the values of  $e$  and  $i$  follow the same characteristic, but in the opposite sense. Once the apex of the curve has been surmounted, the region of the corona effect is again reached and the arc ceases somewhat below the potential at which the discharge began. If, now, we go over to negative values of voltage  $E$ , that is, if we make the iron the cathode and the mercury the anode, a similar sequence occurs, with the only difference that all the voltages are slightly greater.

If, however, instead of starting the arc by applying a high potential, an auxiliary arc is ignited at the surface of the mercury, thus liberating electrons and evaporating mercury, the arc from the cathode  $c$  to the anode  $a$  will start at a very low potential (see Fig. 3) because the auxiliary arc facilitates the start of the ionization process. The arc will then have the characteristic shown by the dotted curve in Fig. 4. It is seen from this curve that while the arc will start at a low voltage when the anode is positive with respect to the cathode, a very high voltage is still required to start the arc in the reverse direction, that is, with anode negative and the cathode positive. The voltages normally used for rectifiers are much lower than this voltage and the rectifier arc, therefore, conducts in one direction only, with the mercury as cathode, and thus acts as a current valve.

The auxiliary arc in a rectifier is usually started by immersing an ignition anode into the mercury and then withdrawing it, thus striking an arc at the surface. The various methods used for starting and maintaining an arc in steel-enclosed rectifiers are discussed in Chap. VIII.

When an auxiliary arc is maintained in a rectifier, the rectifier is in a condition to deliver currents of very low magnitudes from the main anodes, even as low as those required by a voltmeter.

Every rectifier requires the following necessary parts: a highly evacuated vessel, an electron-emitting cathode, a non-electron-emitting anode, air-tight and insulated conductors for the current to the anode and the cathode, and an ignition arrangement.

**Cathode.**—The cathode of the rectifier may be made of any one of a number of different materials. In a thermionic rectifier, for example, the cathode consists of a filament of tungsten or

other metal with a high melting point, which is brought to incandescence in order to liberate the electrons. Such a filament, however, would deteriorate too rapidly if required to deliver any appreciable amount of current, because it cannot be renovated. In a rectifier, if the vacuum were perfect, all the electrons constituting the flow of current would have to be liberated from the cathode. In order to obtain an appreciable flow of current the cathode would have to be brought to a very high temperature and a very high voltage would have to be imposed. If, however, the rectifier vessel has some residual gases or vapors along the path of the electrons, the electrons derived from the cathode will collide with the molecules of the residual gas, liberating other electrons by the force of their impact, thus increasing the number of free electrons.

If mercury is used as the cathode, a number of advantages accrue. The electrons of the mercury atoms are loosely held by the positive charge, so that a lower temperature and a lower voltage are required to emit electrons than would be the case if another metal were used for the cathode. Mercury vaporized from the cathode offers the means for the production of electrons by collision. Furthermore, the mercury vapor which is not ionized condenses and returns to the cathode, so that the cathode is continually and automatically renovated. The ionized atoms of mercury vapor (that is, those atoms from which electrons have been dislodged) are attracted to the cathode, which is at a negative potential. The force with which they strike the mercury produces more heat. Some of these particles combine with electrons at the surface of the cathode and in other parts of the arc chamber and become neutral atoms.

The presence of positive charges above the surface of the cathode creates a positive space charge, which helps to withdraw electrons from the mercury. The ionization of the mercury molecules at the surface of the cathode is effected by intense heat concentrated in a luminous spot, called the "cathode spot." This spot moves around irregularly over the surface of the mercury, which motion is produced by the pressure of mercury vapor vaporized by the heat of the cathode spot. This pressure also depresses the mercury surface at the spot. The temperature of this spot has been variously given by different investigators at values ranging between 1000 and 3000° C. Spectrum analysis showed that the temperature cannot be as high as 3000° C.,

since such a temperature would result in a continuous spectrum rather than in a line spectrum, as was observed. Measurements recently made in the Brown Boveri laboratories by means of the Holborn and Kurlbaum optical pyrometer gave the temperature of the spot as 2087° C. The maximum possible error in this measurement was found to be 25° C. The mean temperature of the mercury forming the cathode is only about 100° C., and does not greatly influence the behavior of the arc. The cathode spot becomes very unstable at low currents, and is easily extinguished. A minimum current of approximately 5 amp. is required to maintain a stable cathode spot; this value is practically the same for all sizes of cylinders. The circuit for maintaining an auxiliary or excitation arc in the cylinder, as previously

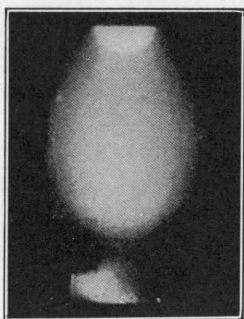

FIG. 5.—Photograph of a mercury vapor arc in vacuum.

mentioned, is such as to supply a current of approximately 5 to 10 amp. to this arc.

The part of the arc nearest the cathode spot has a velvety light and is called the "cathode flame." In addition to this, there is a so-called "positive glow," which is much more extensive and which stretches, at low gas pressures, some distance along the path between the anode and the cathode. Figure 5 shows such a mercury vapor arc, and the various parts enumerated are clearly distinguishable.<sup>1</sup>

**Voltage Drop in the Mercury Arc.**—The voltage drop in a mercury arc in vacuum is composed of three portions: the drop at the surface of the cathode, the drop in the arc proper, and the drop at the surface of the anode.

The total arc drop in the rectifier can be measured quite accurately by a number of methods, such as the calorific absorption by the cooling water, the wattmeter method, and the oscillographic method (see Chap. XIV). Accurate data are, therefore, available on the total voltage drop in glass- and steel-enclosed rectifiers. This voltage drop is found to vary with the dimen-

<sup>1</sup> For further details on the ionization of mercury vapor, the reader is referred to special books on the conduction of electricity through gases, and to numerous articles in physical periodicals. See, for instance, Dr. I. Langmuir's articles on the nature of the mercury arc in the *General Electric Rev.* Vol. 26, p. 73, 1923; Vol. 27, pp. 449, 538, 616, 762, and 810, 1924.

sions of the rectifier cylinder, the arrangement of the electrodes, the type of anodes used, the temperature of the vessel, and the degree of vacuum. It is also found to vary with the load, particularly in large-capacity rectifiers. The voltage drop is also found to be higher for a dynamic arc (*i.e.*, a moving arc as produced in a rectifier fed by an alternating-current supply) than for a static arc (*i.e.*, one produced by a constant direct current).

Various investigators of the mercury arc have made measurements to determine the three components of the total arc drop, and their variation with the conditions in the cylinder (216, 219, 278). The published data of these investigations do not quite agree as it is very difficult to measure accurately these component values. The best-known method for making these measurements is by the use of an exploring electrode in the arc path, and this method is subject to errors due to accumulation of charges on the surface of the exploring electrode (276, 407). The results, however, indicate the following general relations:

The cathode drop is practically constant for all types of mercury arc rectifiers, and seems to be practically independent of the conditions in the cylinder and of the load. This drop, as given by a number of investigators, is in the range of from 6 to 9 volts. This voltage drop represents energy which is consumed in liberating electrons, in evaporating mercury, in heat conducted to the cathode container, and in radiation. Guenther-Schulze (278) gives the following values, in watts per ampere, for the distribution of this energy in a glass-bulb rectifier:

	Watts
Radiation (based on 2000° C. cathode-spot temperature)	0.04
Vaporization of mercury	2.20
Heat conduction to cathode	2.68
Energy carried away by electrons	2.29
Total	7.21

Investigations made on a 1,000-amp., steel-enclosed rectifier with a water-cooled cathode gave values of 3.2 watts per ampere for the heat consumed in vaporization of mercury, and 0.9 watt per ampere conducted to the cathode, or a total of 4.1 watts per ampere, as compared with 4.88 watts as given by Guenther-Schulze. It was also found that by fixation of the cathode spot the proportion of the heat conducted away by



vaporization and by conduction to the cathode can be made to vary over wide limits, although the total cathode drop remains practically unchanged. This indicates that the total cathode drop is probably constant, while the proportion of heat carried away by the vaporized mercury and by the cathode is not constant, but depends on the method of cooling and on the condition of the cathode. (A recent study of the voltage drop at the cathode is given in 402.)

The voltage drop in the arc itself has a value of 0.05 to 0.2 volt per centimeter of its length. These values apply to steel-enclosed rectifiers at normal operation. The voltage drop in the arc itself is less for a direct-current arc, and was measured to be 0.02 to 0.05 volt per centimeter in an experimental steel-enclosed rectifier. This voltage drop represents energy consumed in ionization of mercury vapor by collision. The value of the arc drop increases as the vacuum in the cylinder is decreased. It also increases at higher temperatures on account of the increase in pressure at higher temperatures. The arc drop also varies with the current; as the current is increased from zero, the arc drop at first decreases, reaches a minimum, and then increases again. The probable reason for this is that an increase in current at first facilitates ionization, resulting in a decrease in the voltage drop; then, as the current increases further, the density of the arc increases, because it is restricted and cannot expand in its cross-section, which results in an increase in the voltage drop in the arc.

The voltage drop at the surface of the anode has a value of approximately 5 volts. This drop represents energy used in overcoming the electric field of electrons crowding around the anode and in collision with the anode surface, which energy is converted into heat. The anode drop varies with the material of the anode (steel, carbon, etc.) and with the shape of the anode. It also increases as the degree of vacuum is lowered. The specific current-carrying capacity of the anodes for normal operation lies between 8 and 25 amp. per square centimeter, depending on the size of the anode, its shape, and its material.

It has also been found by certain investigators that above a certain value of current density on the anode surface the anode drop increases rapidly with the current. It has been observed that at small currents the arc does not cover the entire surface but only a portion of it. As the current increases, more and

more of the surface is covered, until a value of current is reached at which the entire anode surface is covered by the arc. As the current is increased beyond this point, the anode drop has been found to increase. The probable explanation of this phenomenon is as follows: When the anode is carrying current, a layer of electrons is formed near the anode surface, as was previously explained. The electrons taking part in the current conduction must overcome the negative space charge of this layer, resulting in a voltage drop. At smaller currents, the arc is free to expand over the surface of the anode, thereby maintaining a lower current density. When the current has reached such a value that the entire anode surface is covered by the arc, the current density increases with the current, which results in an increased negative space charge, and, consequently, in an increased anode drop.

On the basis of the data given above, on the component parts of the arc drop, the total voltage drop under average operating conditions, in a rectifier having an arc length of 1 meter, and with a cathode drop of 7 volts, an arc drop of 0.1 volt per centimeter, and an anode drop of 5 volts, would be

$$7 + 5 + (100 \times 0.1) = 22 \text{ volts.}$$

In Fig. 6 are shown the arc-voltage characteristics of three steel-enclosed rectifiers. Figure 6a shows the voltage drop of an experimental rectifier with an unusually short arc length. The upper curve of Fig. 6b shows the voltage drop of a small rectifier (diameter 12 in., height 20 in.), and the curves in Fig. 6c show that of a large commercial rectifier under different operating conditions, as explained below.

The voltage drop in a rectifier is a function of the anode current. Thus, if the total rectifier current is kept constant and the amplitude of the anode currents is reduced by making more anodes carry current in parallel, the voltage drop is also reduced. This is due to the lower anode and arc drops at lower current densities.

The effect of the amplitude of the anode currents on the voltage drop is illustrated by curves *C* and *D* of Fig. 6c in connection with Fig. 7.

In this figure, a six-anode rectifier is shown delivering a direct current *I*. If the connections of the rectifier transformer are such that each anode operates during one-sixth of a cycle (connec-

tion *D*, see Fig. 65), the amplitude of the anode currents is equal to the cathode current, and the rectifier will have a voltage drop as shown by curve *D* of Fig. 6c. If, however, the transformer

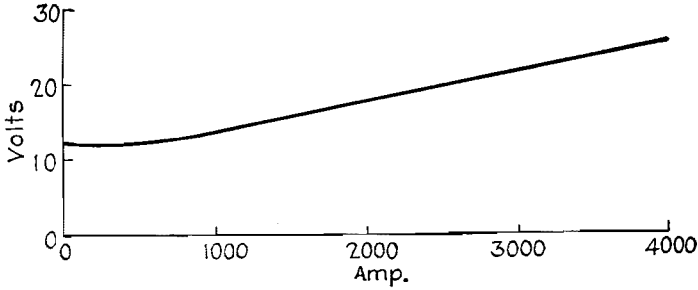

(6a)

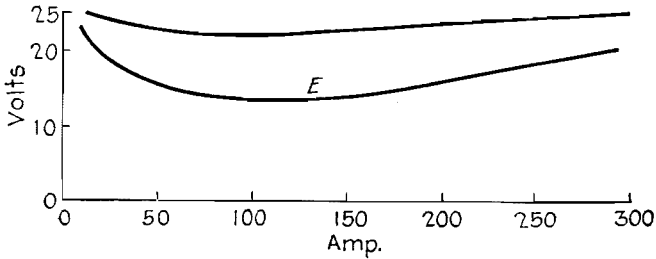

(6b)

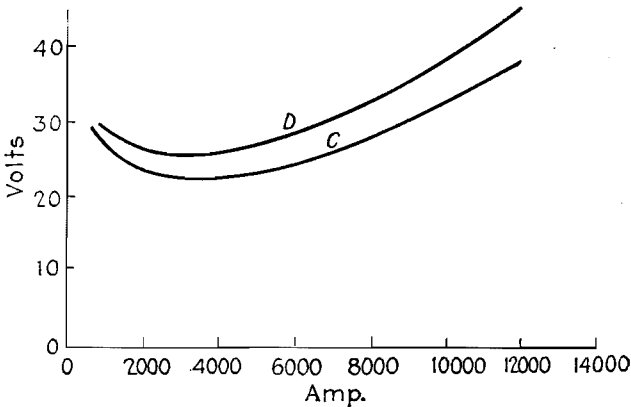

(6c)

FIG. 6.—Arc-drop characteristics of steel-enclosed rectifiers.

connections are such that each anode operates during one-third of a cycle, so that two anodes carry current simultaneously at all times (connection *C*), and the amplitude of the anode currents

is equal to one-half of the cathode current, the rectifier will have a voltage drop as shown by curve *C* of Fig. 6c.

The pronounced difference in the voltage drop curves *C* and *D* of the rectifier for these two types of connections is due to strong variation of the voltage drop with the current. For small-capacity rectifiers, in which the voltage drop is practically constant over the whole current range, as shown in Fig. 6b, there will be practically no difference in the voltage drop for the two types of transformer connections.

Before large-capacity rectifiers were developed the voltage drop of a rectifier was generally considered constant over the

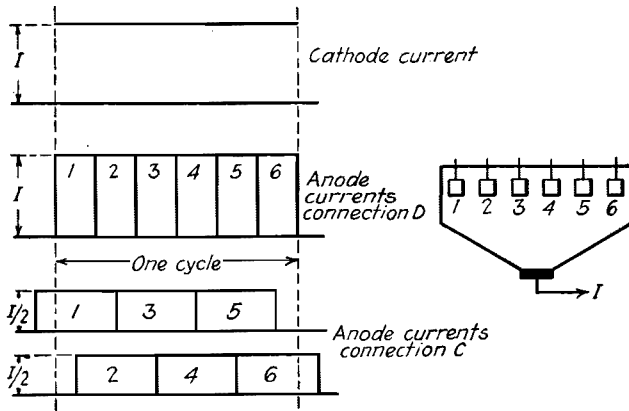

FIG. 7.—Wave shapes of anode currents for different transformer connections, resulting in different arc-drop characteristics, as shown in Fig. 6c.

whole load range, on account of the relatively small variation of this drop in smaller capacity rectifiers.

The voltage drop in a mercury arc is reduced slightly by the presence in close proximity of another arc in which ionization is taking place. For this reason, in polyphase rectifiers, where this condition exists during the period of overlapping of two consecutive phases, the anodes should be arranged in cyclic order, so that the arc passes from one anode to the next without skipping. The influence of an arc in a rectifier on the voltage drop of a neighboring arc is shown by curve *E* of Fig. 6b. This curve shows the voltage drop between the excitation anodes and the cathode of a rectifier, in function of the load current of the main anodes, the excitation current being constant. The upper

curve of Fig. 6*b* is the voltage drop in the main arc of the same rectifier.

From a consideration of the voltage drop in a rectifier which is independent of the direct-current voltage used, it is readily seen that in a high-voltage rectifier, for, say, 3,000 volts direct current, the arc drop represents a relatively small part of the total voltage, while in a low-voltage circuit the drop in voltage, and therefore the percentage of energy loss, is quite appreciable.

**Physical Properties.**—The following table and Figs. 8, 9, 10, and 11 give the various properties of mercury, mercury vapor, and the mercury arc and may be useful for the design and investigation of steel-enclosed rectifiers.

TABLE I.—PROPERTIES OF MERCURY AND OF THE MERCURY ARC IN LARGE STEEL-ENCLOSED RECTIFIERS

Specific gravity of mercury, at 20° C	13.546
Atomic weight.....	200.61
Atomic number.....	80
Melting point.....	-38.85° C.
Boiling point.....	357.25° C.
Latent heat of vaporization at boiling point, in kilo-joules per gram-atom.....	59.3
Surface tension in vacuo:	
At 0° C.....	480 dynes per centimeter
At 60° C.....	467 dynes per centimeter
Electrical resistivity in ohm-centimeter, at 20° C.....	$95.8 \times 10^{-6}$
Specific heat, in joules per gram-atom, at 20° C.....	27.9
Number of molecules of vapor striking 1 cm. <sup>2</sup> at 25° C. and 1 barye <sup>1</sup>	$10.85 \times 10^{15}$
Mean free path of molecules at 0° C. and 1 barye.....	3.24 cm.
Micrograms of vapor striking 1 cm. <sup>2</sup> at 25° C. and 1 barye.....	35.89
Negative charge of electron.....	$1.59 \times 10^{-19}$ coulomb
Mass of electron.....	$8.98 \times 10^{-28}$ gram
Mass of atom.....	Atomic weight $\times 1.66 \times 10^{-24}$ gram
Cathode voltage drop (approximate)	7 volts
Anode voltage drop (approximate)	5 volts
Anode plus cathode voltage drop (of direct-current arc) <sup>2</sup> .....	10 to 13 volts

<sup>1</sup> 1 barye is  $0.75 \times 10^{-3}$  mm. Hg column pressure.

<sup>2</sup> Measured in a small steel tank with direct current.

TABLE I.—PROPERTIES OF MERCURY AND OF THE MERCURY ARC IN LARGE STEEL-ENCLOSED RECTIFIERS.—(Continued)

Arc voltage drop (alternating-current arc) (approximate).....	0.05 to 0.2 volt per centimeter
Arc voltage drop (direct-current arc) (approximate).....	0.02 to 0.05 volt per centimeter
Anode temperature (approximate)...	600 to 800° C.
Cathode spot temperature (approximate).....	2000° C.
Temperature of mercury forming the cathode.....	100 to 200° C.
Arc temperature.....	1000 to 10,000° C.
Velocity of cathode spot (motion due to vapor blast) (approximate)	1,000 centimeters per second
Velocity of mercury-vapor stream	20,000 centimeters per second
Evaporation rate of mercury.....	$7.2 \times 10^{-3}$ gram per ampere-second
Area of cathode spot.....	$2.53 \times 10^{-4}$ cm. <sup>2</sup> per ampere
Current density in cathode spot....	4,000 amp. per cm. <sup>2</sup>
Ionization voltage of mercury vapor	10.4 volts
Radiation from cathode spot.....	0.111 watt-sec. per ampere-second
Working pressure in rectifier.....	0.0005 to 0.015 mm. Hg column
Working temperature of vessel.....	up to 60° C.
Pressure of mercury vapor in rectifier tank (approximate).....	0.2 to 0.3 mm. Hg
Inverse current.....	1 to 100 milliamperes

## THERMAL PROPERTIES OF MERCURY

Temperature, degrees Centigrade	Sensible heat, British thermal units per pound	Latent heat, British thermal units per pound
0	0	132.97
21.1	1.27	132.6
93.4	5.57	131.34
164	12.14	129.4
316	18.8	127.5
373	22.1	126.6
482	28.9	125.3
538	32.4	124.6

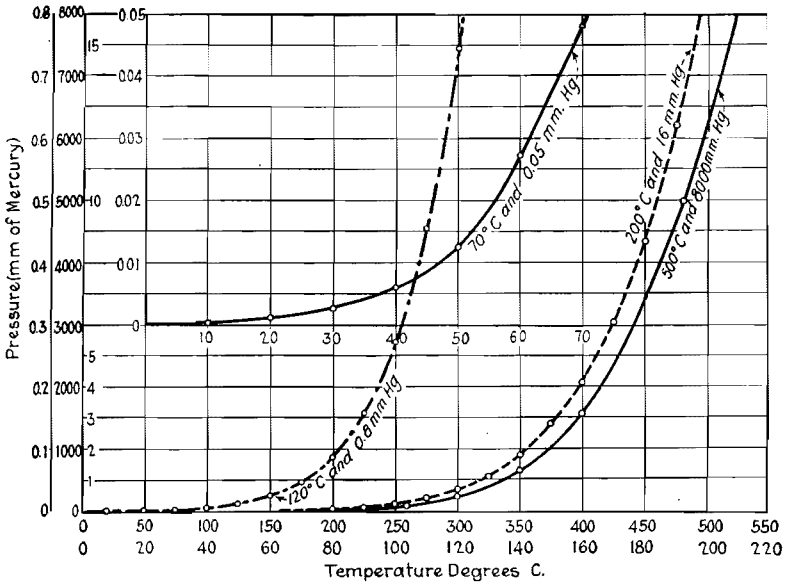

FIG. 8.—Pressure-temperature relations of saturated mercury vapor. Portions of the curve have been drawn to larger scales.

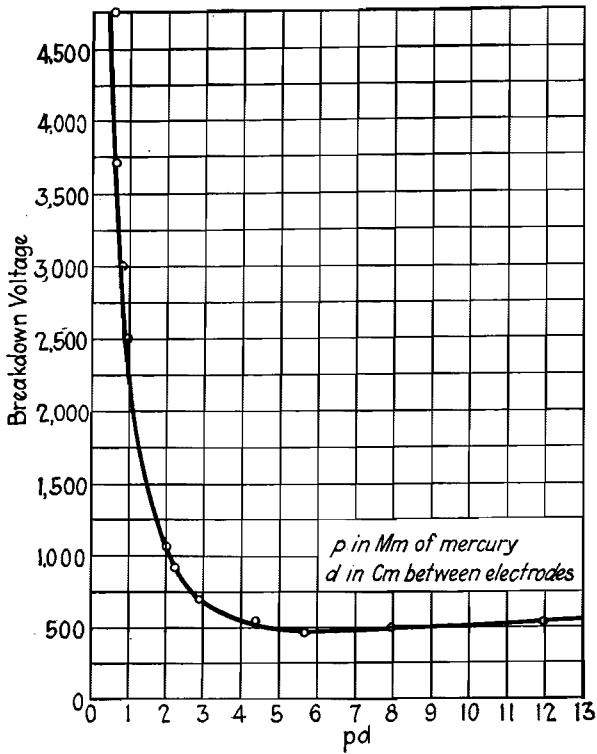

FIG. 9.—Curve showing the breakdown voltage of mercury vapor as a function of the vapor pressure and the distance between electrodes (349).



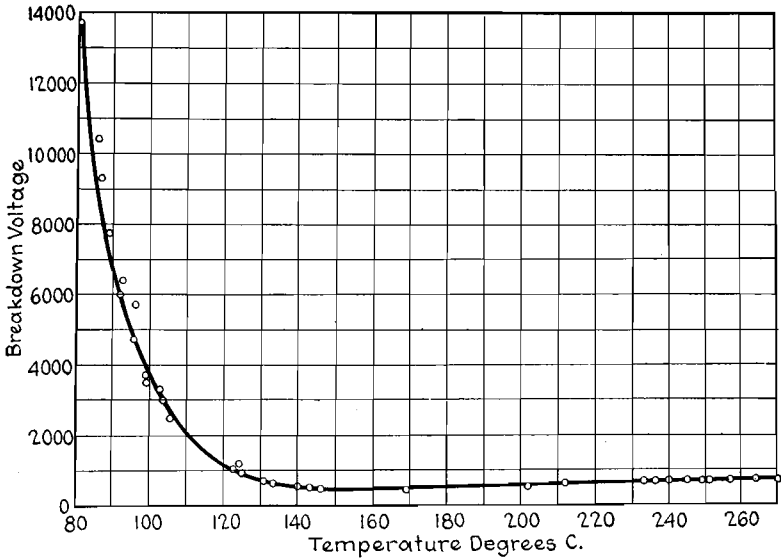

FIG. 10.—Curve showing the breakdown voltage of saturated mercury vapor as a function of the temperature for a distance of 2.3 centimeters between electrodes (349).

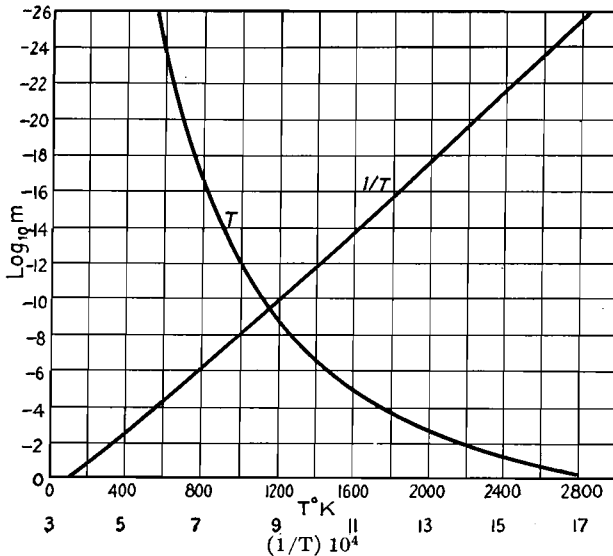

FIG. 11.—Rate of evaporation,  $m$ , of iron, in grams per square centimeter per second in vacuum, as function of the temperature in degrees Kelvin (335). (Degrees Kelvin = degrees C. + 273.13 degrees C.)

## CHAPTER III

### ELEMENTARY PRINCIPLES OF RECTIFICATION AND RECTIFIER PHENOMENA

If the source of continuous current, in Fig. 3, is replaced by an alternating-current supply, as shown in Figs. 12 and 13, the electric field between the anode and the cathode is no longer constant, but changes from instant to instant, and the anode potential is positive during one half-cycle and negative during the other half-cycle. Due to the valve action of the arc, current can flow over the anode during the positive half-cycle only.

Referring to Fig. 14,  $E$  represents the alternating voltage of the primary supply of a single-anode, single-phase rectification circuit, and  $e_a$  is the voltage drop in the rectifying arc produced by the current  $i$  shown in the lower curve.

The negative portion of the current wave is exaggerated in order to show it more clearly in the figure. This current is actually only a few milliamperes. When the anode is carrying current the voltage across the arc is small, as given by the curves in Fig. 6. During the negative portion of the alternating-current voltage wave the voltage from anode to cathode is equal to the alternating-current voltage, since there is no current flowing in the circuit to cause any voltage drop.

**Single-phase Rectification.**—In Fig. 12 is shown a two-anode, single-phase, rectifying circuit. With a sinusoidal alternating-current voltage impressed on the primary of the transformer, the anodes will be positive during alternate half-cycles.

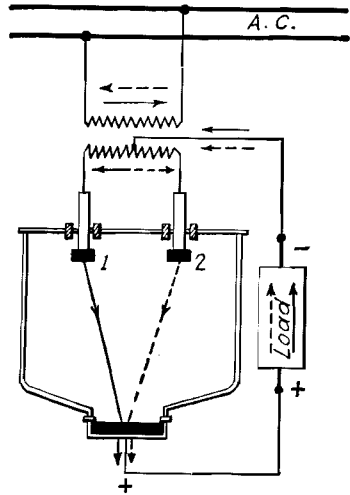

FIG. 12.—Diagram of single-phase, full-wave rectifier circuit.

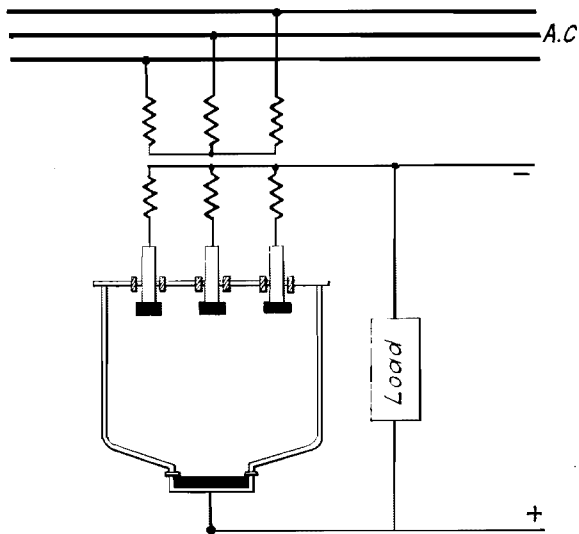

FIG. 13.—Diagram of three-phase rectifier circuit.

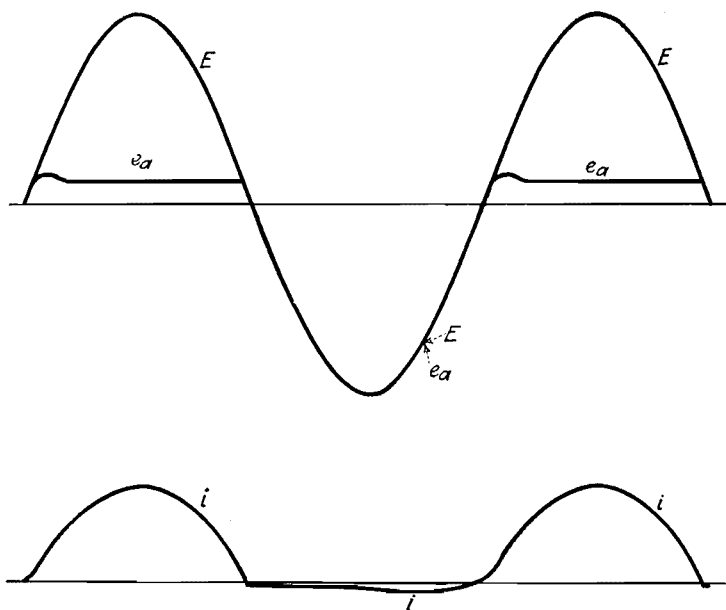

FIG. 14.—Voltage and current waves of a single-phase, half-wave rectifier.

During the half-cycle when anode 1 is positive, current will flow from the anode to the cathode through the load circuit and back to the neutral, as indicated by the solid arrows. During the half-cycle when anode 2 is positive, current will flow from this anode to the cathode and load circuit, as shown by dotted arrows. Thus the current through the load circuit flows in the same direction during both half-cycles, while the current in the primary of the transformer is alternating.

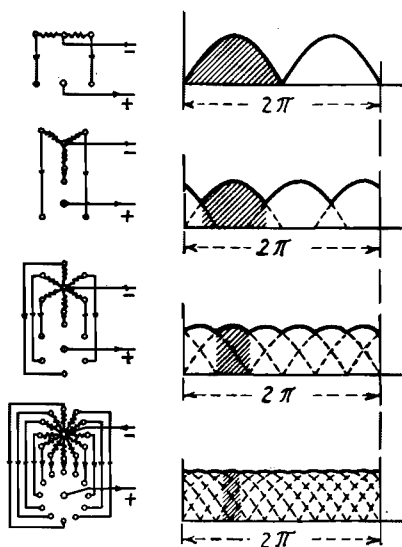

FIG. 15.—Current waves of single-phase and polyphase rectifiers.

If two or more anodes in a rectifier are at positive potential simultaneously, the current will flow from the anode having the most positive potential. Thus, for instance, in the three-phase connection shown in Fig. 13, the anodes reach maximum positive potential one after another; they will, therefore, send current through the rectifier in succession, so that each anode carries current during one-third of a cycle (see Chap. IV).

**Polyphase Rectification.**—In Fig. 15 are illustrated the current waves of 2-, 3-, 6-, and 12-phase rectifier circuits. The primary winding of the transformer is not shown in the figure. It can be seen that the undulations of the direct current decrease as the number of phases is increased.

For the above reason, and also for constructional reasons, 6- and 12-phase rectifiers are ordinarily used for commercial

operation. The undulations shown in the figure are usually considerably reduced in commercial installations due to the inherent inductance of the load circuits. It can also be observed from Fig. 15 that the time interval during which each anode and the corresponding secondary phase are under load decreases with a greater number of phases, as shown by the relative sizes of the cross-hatched areas. The wave shapes of the currents and voltages, and the relations between them are further elaborated in Chaps. IV and V.

The potentials of the various parts of a polyphase (6-phase) rectifier circuit when in operation are shown by the curves in

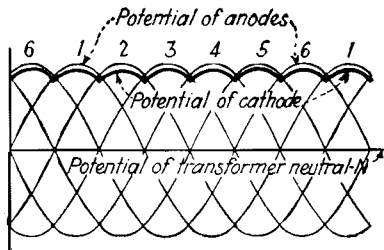

FIG. 16.—Potentials of anodes and cathode of a polyphase rectifier.

Fig. 16. The potential of the transformer neutral  $N$  is used as the reference line. The potentials of the anodes are sine waves. The potential of the cathode, shown in heavy lines, is equal to the potential of the working anode less the voltage drop in the rectifier.

It is evident from Fig. 16 that each anode has a small positive potential with respect to the cathode (equal to the voltage drop in the rectifier) only during the working period of the anode, while during the rest of the cycle the anode is negative with respect to the cathode. When the anode voltage reaches a maximum negative value, its potential to the cathode is equal to twice the amplitude of the anode voltage, less the voltage drop in the rectifier.

Thus, for example, in a 6-phase, 600-volt rectifier, such as shown in Fig. 15, having an arc voltage drop of 25 volts, the amplitude of the anode voltage to neutral is approximately 650 volts (see Chaps. IV and VI). The potential of a working anode to the cathode is +25 volts; the maximum negative potential between an anode and the cathode is

$$2 \times 650 - 25 = 1,275 \text{ volts.}$$

From a consideration of Fig. 16 it is readily seen why only the anode having the highest potential carries current, while the other anodes are idle. When anode 1, for example, is carrying current, the cathode potential is equal to the potential of this anode less the voltage drop in the arc. During this period the other anodes are at a negative potential to the cathode; the electric field from these anodes to the cathode is therefore in the reverse direction from that required for the flow of electrons towards the anodes or the flow of positive ions to the cathode, which constitutes the current flow in a rectifying arc; consequently, no current can flow from these anodes.

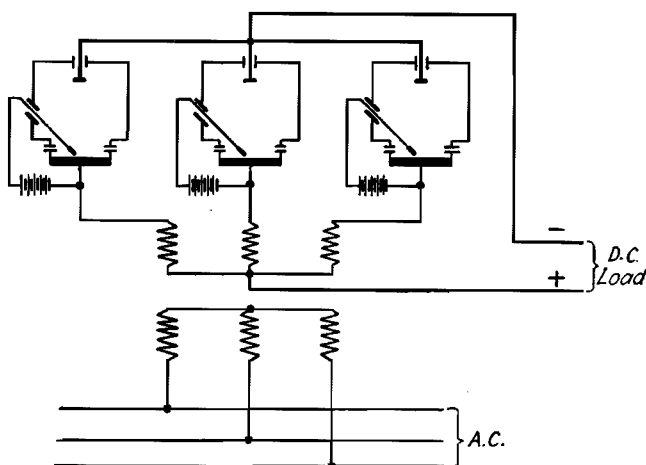

FIG. 17.—Alternative arrangement of anodes and cathode for polyphase rectification.

The usual arrangement of rectifier circuits is to connect the anodes to the free ends of the transformer secondary phases, as shown in Figs. 12 and 13. The cathode then forms the positive pole of the rectifier system, and the neutral of the transformer secondary the negative pole.

This arrangement of anodes and cathode could, however, be reversed, as shown in Fig. 17. In this figure, the free ends of the transformer secondary phases are shown connected to the cathodes of several single-anode rectifiers, while the anodes are connected together. The transformer neutral now forms the positive pole, while the common anode connection forms the negative pole. Each rectifier cylinder of Fig. 17 is provided with

an auxiliary anode, supplied by a battery, for maintaining an auxiliary arc, since each main anode carries current only during a portion of the cycle, and the main arc is, therefore, extinguished during the remaining portion of the cycle.

The conditions regarding the currents and voltages in the circuit shown in Fig. 17 will be substantially the same as for the normal arrangement shown in Fig. 13.

**Current Conduction by Rectifier Cylinder.**—The elements composing a steel-enclosed polyphase mercury arc rectifier are shown in Fig. 13. It consists of a vacuum-tight steel vessel, anodes, and cathode. The anodes are insulated from the tank, since they are at different potentials. The cathode must also be insulated to prevent the walls of the cylinder from conducting part of the current.

In Chap. II it was stated that the current in a mercury arc consists of a flow of electrons towards the anodes and a flow of positive ions towards the cathode. If the cathode were not insulated from the cylinder, the latter would be at the cathode potential; a portion of the positive ions would then be attracted towards the walls of the cylinder, and a current would flow through the metallic walls to the cathode. This conduction takes place without the presence of any cathode spot on the walls of the cylinder. The magnitude of the current thus conducted increases as the load current is increased, on account of the presence of a larger number of ions and the greater dispersion resulting from this.

In Fig. 18 are shown curves of the current  $I_L$  conducted by the cylinder walls of 250-, 600-, and 2,000-amp. rectifiers, in function of the total current  $I_t$ . These measurements were obtained by making a solid connection from the tank to the cathode, and measuring the current flowing in this conductor. The tests showed that the location of the point at which the connection was made on the cylinder did not affect the results.

The flow of current in the walls of the cylinder causes it to heat up and liberate gases, which are detrimental to the operation of the rectifier and may cause internal flashovers. Furthermore, at higher load currents the mercury arc sometimes jumps from the mercury cathode to the walls of the cylinder, which are usually covered with drops of mercury, forming a cathode spot; at the same time, the cathode spot in the mercury of the cathode is extinguished.

In order to avoid current conduction by the walls of the rectifier cylinder, and the consequent troubles, the cathode of present types of rectifiers is insulated from the cylinder. The methods of insulating the cathode are given in Chap. VII. The

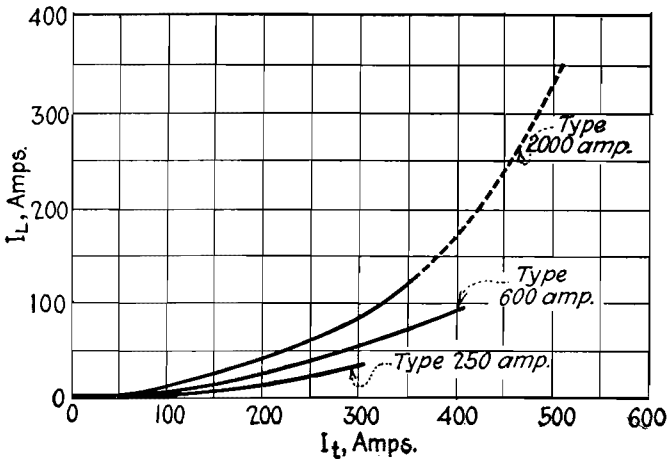

FIG. 18.—Curves showing conduction of current by the walls of a rectifier cylinder when not insulated from the cathode. (The dotted portion of the upper curve represents unstable conditions, and is the average value of a number of readings. The high values of  $I_L$  are probably due to the formation of cathode spots on the cylinder wall.)

potential difference between the cylinder and the cathode is small, and very little insulation is required.

### BACK FIRES

Perhaps the most disturbing phenomenon occurring in rectifiers, and which has been the greatest obstacle in the development of large-capacity rectifiers, is the so-called “back fire” or “arc-back.” At the present time, the design and rating of rectifiers are so directed as to limit the possibility of recurrent back fires. For this reason it is important to understand the nature of back fires, their probable causes, and means for their elimination.

A back fire results from the failure of the valve action of one or more anodes. It was brought out in the preceding chapter that the operation of a rectifier is based on the valve action of a mercury arc in a vacuum, which allows the current to flow only from anode to cathode. If, however, a cathode spot should for any reason develop on one of the anodes, as shown on anode 1,



in Fig. 19, this anode will act as a cathode, and current from the other anodes will flow to the back-firing anode. This current is limited only by the resistance and reactance of the transformer windings, and is, therefore, in effect, a short circuit on the transformer. The conditions in the back-firing phases are more

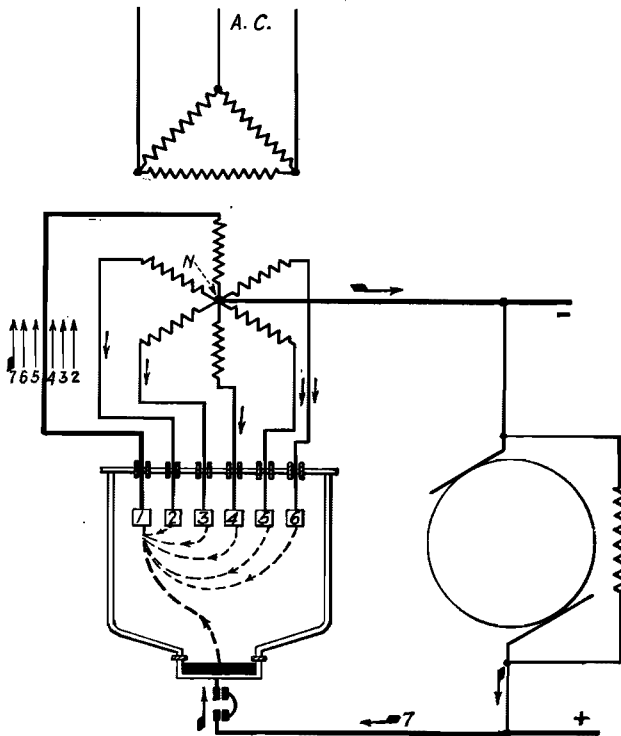

FIG. 19.—Flow of currents in a rectifier during a back fire. The rectifier is shown operating in parallel with a direct-current rotating machine.

severe than during an alternating-current short circuit on the transformer.

In Fig. 32 is shown an oscillogram of the current in a back-firing anode, the direct-current voltage during the back fire, and the primary current. This oscillogram was taken during a test on a 1,200-kw. rectifier.

If the rectifier is connected in parallel with a source of direct current, there will be an additional backfeed current from the positive pole of the direct-current source into the back-firing

anode, as indicated by the fan-tailed arrows in Fig. 19, due to the loss of the valve action and the drop of the direct-current voltage of the rectifier (see also Chaps. IV, VI, XI, and XIV).

Unless quickly interrupted by protective apparatus, the high current flowing in the faulty anode will cause the anode to overheat; this overheating may pit the anode and make it susceptible to back-firing again. A prolonged back fire would also lower the vacuum in the rectifier, on account of the gases liberated from the overheated anode. With the usual protective apparatus provided for rectifier installations, back fires do not have any harmful effects, and the rectifier can be put back into operation immediately after the back fire.

In spite of the many investigations of back-fire phenomena made over a large number of years, the exact causes of back fires and the conditions under which they occur are not yet definitely known.

**Inverse Current.**—During the part of a cycle when an anode is idle, and is at a negative potential to the cathode, a small current, amounting to a few milliamperes, flows in the anode circuit in the reverse direction from the normal flow of load current. This current may be called the *inverse* current. It has been observed that the inverse current is highest under conditions at which the susceptibility of a rectifier to back fire is greatest, and that corrective means used to eliminate back fires also reduce the magnitude of the inverse current. For this reason it is thought that the inverse current is either a cause of back fires or a symptom of conditions leading to back fires.

The inverse current consists of two components. The first component is produced by the movement of positive ions from the ionized mercury vapor toward the idle anode which is at a negative potential to the cathode. This component attains a maximum value immediately after the anode has ceased working (410), due to absorption of ions from the space about the anode, and then gradually declines to zero. The second component is the result of a glow discharge between the idle anode and the cathode, which is produced by the voltage difference between them.

The relative magnitudes of the two components of the inverse current depend on the magnitudes of the current and voltage. The first component is generally much higher at the voltages now in general use. Methods used for measuring the inverse current are described in Chap. XIV.

As was stated in Chap. II, in connection with Fig. 4, when a voltage is applied between two electrodes, a glow discharge takes place between them when the voltage has reached a certain minimum value, and as the voltage is further increased the discharge current increases slightly, until a point is reached, at a certain value of the voltage, when the glow discharge changes suddenly to an arc discharge, which amounts in effect to a breakdown of the space between the electrodes, with the negative electrode as the cathode. The value of the breakdown voltage, as well as the value of the glow-discharge voltage, depend on the nature of the gases or vapors present, and are also functions of the product of the pressure and the distance between electrodes. The variation of the breakdown voltage of mercury vapor with this product is shown in Fig. 9. It is seen from this figure that for a certain value of  $pd$  the breakdown voltage is a minimum and has a value of approximately 450 volts, which is within the working range of the majority of steel-enclosed rectifiers. The minimum breakdown voltage is even lower when other gases are present, particularly alkaline vapors.

**Causes of Back Fires.** *Current and Voltage Conditions.*—It has been observed that the loss of the valve action of an anode, which produces back fires, generally occurs shortly after the anode has ceased working. This fact, together with the fact that back fires usually occur at certain currents and voltages, leads to a plausible explanation of the cause of back fires.

The occurrence of back fires in steel-enclosed rectifiers, while influenced by current and voltage, is not as definite a function of these quantities as is the case with glass-bulb rectifiers, on account of the greater variations of pressure, temperature, etc. This is due to the larger size of the rectifier, the use of a metal container, insulators, packing material, and anodes which may liberate gases due to excessive local heating, as well as to expansion and contraction of sealed joints. In glass-bulb rectifiers, which are more or less free from foreign gases, the occurrence of back fires is found to be a definite function of the current and voltage. If the glass bulb is cooled by blowing air on it, the limits of current and voltage for the occurrence of back fires are raised; however, the general shape of the curve showing this relationship remains the same. It is found that neither the reactance of the alternating-current source nor its frequency

within the commercial limits have any noticeable effect on the occurrence of this phenomenon (324).

When an anode is carrying current, the space about the anode and in the arc path between anode and cathode is filled with electrons and positive ions which are produced by the ionization of the mercury vapor, and which constitute the current flow of the arc. As soon as an anode ceases to work, due to transfer of the arc to another anode having a higher potential, there remains a residue of ions and electrons in the vicinity of the first anode. Some of the ions and electrons will combine to form neutral atoms; the remainder will follow the electric field. Since the anode which has ceased working is negative with respect to the cathode and the working anode (see Fig. 16) so that the electric field to the cathode is reversed, the electrons will be repelled from the anode and ions will be attracted. This reversal of the direction of the flow of electrons and ions from that in the rectifying arc produces the first component of the inverse current. The ions striking the surface of the anode produce heating, and under certain conditions this heating may develop a cathode spot and produce a back fire.

At higher currents, there is a greater number of ions in the space about the anode so that more ions strike the anode surface, thus producing greater heating and, consequently, increasing the susceptibility to back fire. Furthermore, with higher currents, the anode surface is at a higher temperature when it ceases to work and the conditions for producing hot spots by the bombardment of ions are therefore more favorable.

At higher voltages, the gradient of the electric field at the anode, when it ceases to work, is greater, so that the ions strike the surface with greater force, thereby producing greater heating. For this reason, the susceptibility of an anode to produce a back fire is increased at higher voltages.

Another possible source of back fires is the glow discharge produced by the potential between anode and cathode or between anodes, which may lead to a breakdown of the space between the electrodes. This discharge is from cathode to anode, and constitutes the second component of the inverse current in the anode when it is at a negative potential to the cathode. The discharge is a function of the voltage, the pressure, and the nature of the gases in the rectifier, as has already been discussed.

As was pointed out previously, the voltage at which the breakdown takes place has a definite relation to the product of the pressure and the distance between anode and cathode. In a rectifier the spacing of the anodes and the cathode is such that for the operating range of the pressure, the operating voltage of the rectifier is below the voltage required to produce breakdown. If, however, the vacuum should drop for any reason to a low value, or if foreign gases are liberated for the reasons given above, the breakdown voltage may be reduced to a figure as low as the operating voltage of the rectifier, and a discharge may, therefore, take place. Such a discharge may also occur at a high vacuum on account of a voltage surge.

Back fires produced by a glow discharge are not dependent on the load, except in so far as the load increases the pressure in the rectifier by the evaporation of mercury or by the liberation of gases from the metal or packing of the cylinder or from the anodes. Such back fires are particularly apt to occur during the forming<sup>1</sup> of the rectifier, when the pressure is low and foreign gases are present. For this reason it is advantageous to form the rectifier with low voltages.

On account of the greater susceptibility of rectifiers to back fire at higher voltages, the current rating of rectifiers is reduced as the direct-current operating voltage is increased. The relation of the current and voltage ratings of several types of rectifiers is shown by the curves of Fig. 154. Thus, for instance, a rectifier rated at 1,600 amp. at 300 volts has a rating of 850 amp. at 3,000 volts, and 600 amp. at 5,000 volts.

The current and voltage limits for the occurrence of back fires are of course related to the rated current and voltage capacity of the rectifier, and, consequently, to the dimensions of the anodes and their spacing. For larger anodes, the heating of the anodes, which is a primary source of back fires, is a function of the current density at the anode surface. With a larger surface, more rectified current can be carried without overheating, and more ions can be permitted to strike the surface.

The effect of the load current on the occurrence of back fires was recently investigated by observing the anode space of a glass rectifier through a stroboscopic disk (361). This made it possible to "slow up" or to "fix" any recurring phenomena

<sup>1</sup> The terms forming, degassing, and bake-out refer to the same process (see Chap. IX).

which it is otherwise impossible to observe due to the extremely short period of their duration and the strong light of the arc. This investigation disclosed the presence of a violet glow in the arm of the anode, which appears immediately after the anode ceases carrying current, and then gradually disappears. It was observed that this glow increases when the load current of the anode is increased, and that an increase of the current and glow increases the possibility of back fires. It was also found that this glow is not a glow discharge due to voltage, as it was observed to disappear even when the negative voltage on the anode was increasing. This glow is of the same color as the cathode flame and the glow appearing in the condensing dome of the rectifier. The glow in the condensing dome was found in the past to be produced by the presence of ionized mercury vapor, consisting of free electrons and positive ions. This seems to indicate that such free electrons and ions are also present in the anode space when the anode arc is extinguished, and that back fires are probably caused by the bombardment of the anode surface by the positive ions, as was previously explained.

*Condition of Anodes.*—Back fires are primarily due to the development of a hot spot on the surface of the anode. Besides the effect of the load in producing a hot spot, this may be aggravated by the following abnormal conditions:

1. Mercury may condense and form a drop on the surface of the anode when cold. This may cause the arc to concentrate and establish a cathode spot which emits electrons. To avoid this, shields and baffles are provided in the rectifier, to divert the stream of mercury vapor from the anode surface, as shown in Figs. 87, 90, 94, 96, etc. in Chap. VII, where they are denoted by *F*.

2. Impurities or dirt on the surface of the anode may have a similar effect as a drop of mercury. A particle of foreign matter contained in the anode material, and capable of emitting electrons at a lower temperature than pure iron, may cause a back fire when the iron becomes hot. Such a particle may evaporate in a very short time and the back fire may disappear of itself before the circuit can be interrupted by the circuit breakers. Such back fires are known as "silent" back fires.

3. Unevenness of the anode surface, which may be due to previous back fires, also may have the same effect.

*Vacuum Conditions.*—Since a low vacuum, or the presence of foreign gases in a rectifier, may cause a back fire, due to the lower-

ing of the glow discharge and breakdown voltages as explained above, any factor that would produce this condition is likely to produce a back fire. The vacuum in a rectifier may be impaired by any one of the following causes: A leak may occur, due to a broken insulator or seal, a poorly welded joint, or corrosion of the cylinder. The vacuum may also be reduced by the liberation of occluded gases from the anodes, the cylinder walls, the material used for the seals, or from impure mercury. Furthermore, some internal parts of the rectifier may be loosened and may fall into the path of the arc stream or into the cathode, and the heat of the arc will liberate vapor from these parts.

**Prevention of Back Fires.**—Since the danger of frequent back fires is the limiting factor in the rating of rectifiers, any means which would minimize this possibility would of course improve the operation of rectifiers, and make it possible to increase their ratings.

So far, no absolute preventive for back fires has been found. However, means have been found to reduce considerably the frequency of their occurrence and to reduce the magnitude and duration of the resulting disturbance when they do occur. This has been accomplished by interposing a metallic screen in the arc stream near the anode. The screens are supported inside the anode shields as shown in Fig. 101. In order to be effective, the screens must be of the proper material, of correct shape, and must be located at a certain distance from the anode.

Two practical arrangements of the screens are used in the Brown Boveri rectifiers: (1) non-energized, and (2) energized.

*Non-energized Screens.*—With this arrangement the screens are connected to the anode shields. Their action may be explained as follows: When the anode is carrying current, the screen assumes the potential of the arc, which is then more negative than the anode. As soon as the anode is extinguished, the shield retains its potential and, therefore, remains negative with respect to the anode for a short instant, until the anode potential has dropped further. The screen thus acts as a negative shield for the anode during the period when the anode is most susceptible to back fire, as was previously brought out, and prevents an instantaneous reversal of the electric field.

One effect of this shielding is to prevent the emission of electrons from any hot spots that may have been formed on the anode, thus permitting them to cool. Another effect is to delay

the movement of the free ions toward the anode and to facilitate their recombination with electrons along the surface of the screen, thus reducing the number of ions reaching the anode surface, which is considered a source of back fires.

*Energized Screens.*—With this arrangement, the screens are insulated from the anode shields and are provided with connections to an external source of potential. The screens may be so connected that a negative potential is applied to them when the anode ceases working. This has an effect similar to that of non-energized screens, but it is more pronounced, since a higher negative potential can be applied and maintained for a longer time.

The screens may be left disconnected during normal operation; they would then act as non-energized screens. Should a back fire occur for any reason, however, a negative potential is applied to the screens of all the anodes. This prevents the non-back-firing anodes from picking up the arc once they are idle, and, thus, prevents them from feeding to the back-firing anode (see Fig. 19); as a result, the back fire is interrupted in a fraction of a cycle without the opening of the alternating-current supply circuit, and the service is, therefore, not disturbed.



## CHAPTER IV

### THEORY

The principles underlying the operation of mercury arc rectifiers, as well as the phenomena of rectification, were considered in the preceding chapters. In this and the two following chapters the theory dealing with the relations of currents and voltages in rectifier circuits will be taken up.

**Elementary Considerations.**—In considering the voltage and current relations in rectifier circuits, it should be understood that circuits used in connection with rectifiers are electrical circuits and are subject to the electric and magnetic laws applying to any other electric circuit, with the special conditions resulting from the characteristics of a mercury arc in vacuum, namely:

1. That in the rectifier cylinder the current can flow in one direction only, from anode to cathode, provided the anode is positive with respect to the cathode.
2. That, if there is more than one anode in the cylinder, the current will flow over the anode having the most positive potential. If two or more anodes are at the same potential, they will carry current simultaneously.
3. That the voltage drop in the arc, which is nearly constant over a wide range of current values (see Fig. 6), has the characteristic of a back e.m.f. similar to that of a battery.

If a rectifier is connected in a circuit with a battery and a load, as shown in Fig. 20*a*, and the arc in the rectifier has been started by any of the means described in Chap. VIII, the current flowing in the circuit is equal to

$$\frac{\text{Voltage of battery} - \text{voltage drop in arc}}{\text{Load resistance}}$$

If the battery voltage in the circuit is increased by connecting in more cells, the current will increase in proportion to the increase of the net voltage ( $E_b - E_r$ ). If the circuit has resistance only, the current will come up to its new value instantly. If there is inductance also in the circuit, the current in changing from its former value to its new value will go through a transient state determined by the relative values of inductance and

resistance (see curve of current  $I$  in Fig. 20a). In Fig. 20b a single-anode rectifier is shown connected to an alternating-current supply having a sinusoidal voltage wave  $e_{10}$ . It is assumed that

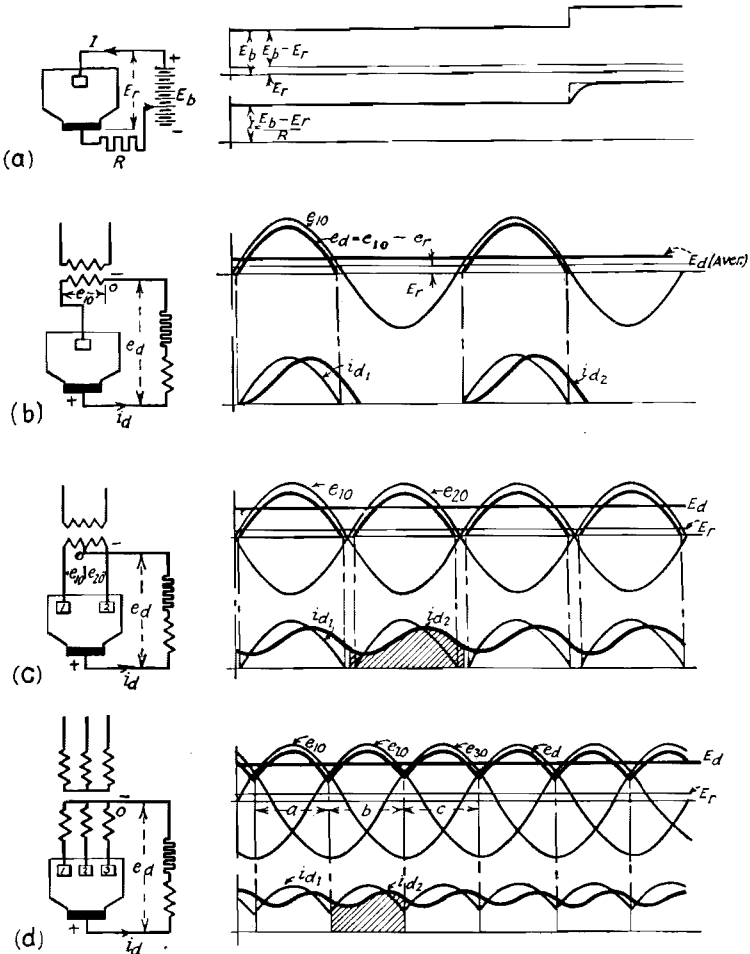

FIG. 20.—Voltage and current waves of rectifiers (neglecting the transformer reactance).

an auxiliary arc is maintained in the rectifier. With a resistance load only, the direct-current voltage  $e_d$ , at the terminals of the load, is equal to the positive half-wave of the alternating-current voltage less the voltage drop in the rectifier. Due to the valve action of the rectifier, the direct-current voltage during the nega-

tive half-cycle is zero. The direct current is at every instant equal to the ratio of voltage to resistance, and will have a shape shown by curve  $i_{d1}$ . If the circuit contains inductance as well as resistance, the variations in the current will lag behind the voltage variations and the current will be as shown by curve  $i_{d2}$ . Due to the inductance, a time lag is introduced in the rise and decline of the current. In Fig. 20c is shown a two-anode rectifier, connected to a single-phase alternating-current supply. With this connection, the anodes are positive during alternate half-cycles. The alternating-current voltages between anodes and transformer neutral are given by curves  $e_{10}$  and  $e_{20}$ . The direct-current voltage with resistance load only is shown by curve  $e_a$ , and is equal to the positive half-waves of the alternating-current voltages less the voltage drop in the arc. It is 0 when the alternating-current voltage is equal to or less than the voltage drop in the arc. The direct-current waves in each of the anode circuits, without inductance, are similar to those shown in Fig. 20b. With inductance in the circuit the load current (shown in heavy outline) does not go down to zero.

In Fig. 20d, a three-anode rectifier is shown connected to a three-phase, alternating-current supply. The three phase voltages,  $e_{10}$ ,  $e_{20}$ ,  $e_{30}$ , lag behind one another by 120 electrical degrees. With a resistance load (and neglecting the effect of the transformer reactance), each anode will carry the current during one-third of a cycle, when its potential is more positive than that of the other anodes. Thus, referring to Fig. 20d, anode 1 will carry current during the period  $a$ , anode 2 during period  $b$ , and anode 3 during period  $c$ . The direct-current voltage at any instant is equal to the voltage of the anode carrying the current at that instant minus the voltage drop in the arc, and is shown by curve  $e_a$ . The direct-current wave, with resistance load, is shown by curve  $i_{d1}$ . With an inductive load, the current wave will have the shape shown by curve  $i_{d2}$ .

In Fig. 20, the rectifier is shown connected to a single alternating-current source, which is the usual condition in practice. It is possible, however, to connect one rectifier to separate alternating-current sources, which may be out of phase or of different frequencies.

In Fig. 21a, two anodes of the rectifier are connected to an alternating-current source  $A$ , and two to source  $B$ . On the direct-current side the two sources have a common neutral and

feed a common load. In curve 1 is represented the direct-current voltage  $e_d$ , if the alternating-current voltages of the two sources are out of phase by  $90^\circ$  and are of equal magnitude. Curve 2 shows the direct-current voltage if the alternating-current voltages are of different magnitudes. Curve 3 shows the direct-current voltage if the voltages of the sources *A* and *B* are of

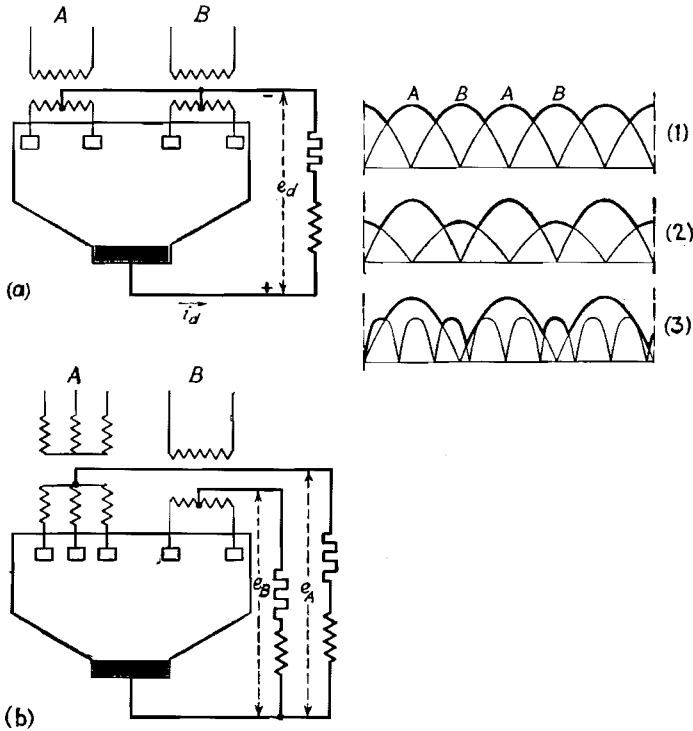

FIG. 21.—Connections and voltage waves of rectifiers supplied from two alternating-current sources.

different frequencies and different magnitudes. The way these direct-current voltage curves are produced is self-evident from the explanation given for the curves of Fig. 20.

Instead of having a common neutral, the transformer secondaries may have independent neutrals, as shown in Fig. 21b. The two systems may then have different direct-current voltages and separate load circuits, the cathode being common to both systems. This arrangement is actually used in rectifiers provided with an alternating-current excitation system as described in Chap. VIII.

From Fig. 20 it is seen that as the number of phases is increased the current and voltage waves of a rectifier approach nearer to the straight-line curves of direct current and voltage, as obtained from a battery. For a given magnitude of alternating-current phase voltage, as the number of phases is increased, the direct-current voltage increases and approaches nearer to the maximum value of the alternating-current voltage wave. Thus, with a theoretically infinite number of phases the direct-current voltage would be equal to the maximum value of phase voltage. The above points out a way for controlling the voltage of a rectifier. Should it be possible to change the number of working phases of a rectifier, smoothly, keeping the primary voltage constant, the direct-current output voltage could be regulated. For instance, by changing the number of phases from two to three (see Fig. 20, *c* and *d*, respectively), the direct-current output voltage  $E_d$  would be changed 30 per cent (see also Table II below). The variation of the direct-current voltage with the number of phases is actually utilized for controlling the direct-current voltage of rectifiers (See Chap. XII).

The presence of inductance in the direct-current circuit of a rectifier smooths the direct-current wave. With a relatively large number of phases (6 or 12), and with a considerable amount of inductance in the circuit, the direct-current wave of a rectifier becomes practically a straight line.

With a single-anode rectifier, the anode current is, of course, the same as the current in the external circuit. With two-anode single-phase, and with polyphase rectifiers, the inductance of the transformer affects the shape of the anode current. With an ideal transformer having no inductance, the anodes carry current singly, *i.e.*, the anode having the highest potential carries the full direct current until the point of intersection of its voltage wave with that of the next anode, when the current is instantly transferred to the next anode, as shown in Fig. 20. The leakage inductance, unavoidably present in transformers, prevents the anode currents from rising and falling instantly. This causes two successive anodes to carry current simultaneously for a short time interval. The total current is then equal to the sum of the two anode currents.

The operation during which two anodes carry current simultaneously while the current is transferred from one to the other is termed *overlapping*; the period during which this occurs is

termed the *angle of overlap*, and will be designated by  $u$ . The angle of overlap is a function of the reactance, the current, and the phase voltage.

The overlapping due to inductance in the anode circuits reduces the average value of the direct-current voltage under load, giving the rectifier a drooping direct-current voltage characteristic.

The calculation of the angle of overlap and its effect upon the shape of the anode current and direct-current voltage waves will be considered in greater detail later.

The current and voltage relations of a rectifier will now be considered, with the following simplifying assumptions:

1. The direct-current wave is assumed to be a straight line.
2. The voltage drop in the arc is assumed to be constant at all loads.
3. The rectifier transformer ratio is assumed to be 1:1.
4. The magnetizing current of the transformer is neglected.

In most cases, these assumptions represent a close approximation to actual conditions, and lead to results sufficiently accurate for most practical purposes. With these assumptions, the current and voltage relations of the rectifier will be derived:

1. Neglecting the resistance and reactance of the transformer and line.
2. Considering the effect of the reactance of the transformer secondary.

Following is a list of the symbols used and their explanations:

- $A$  = effective value of anode current.
- $E$  = effective value of phase voltage, primary and secondary.
- $E_d$  = average value of direct-current voltage.
- $I$  = constant direct current.
- $I_p$  = effective value of primary current.
- $L$  = inductance per phase of transformer secondary.
- $P$  = average direct-current power.
- $P_1$  = rating of transformer primary.
- $P_2$  = rating of transformer secondary.
- $X = 2\pi fL$  = reactance per phase of transformer secondary.
- P.F. = power factor in line.
- $a_1, a_2$ , etc. = instantaneous values of anode currents.
- $d$  = average value of direct-current voltage drop.
- $e_1, e_2$ , etc. = instantaneous values of phase voltages.
- $e_a$  = voltage drop in the rectifying arc.
- $e_d$  = instantaneous value of direct-current voltage.
- $f$  = frequency of alternating-current supply.
- $i_1, i_2$ , etc. = instantaneous values of transformer primary currents.
- $p$  = number of secondary phases = number of anodes.
- $t$  = time.
- $u$  = angle of overlap.
- $x = \omega t = 2\pi ft$ .

### 1. VOLTAGE AND CURRENT RELATIONS WITH ZERO TRANSFORMER REACTANCE

We shall consider the general case of a  $p$ -phase rectifier, delivering a constant direct current  $I$  and connected to a transformer having a voltage  $E$  (r.m.s.) per phase. The transformer is assumed to have zero reactance. The anodes then burn in sequence, one at a time, and each anode delivers the current  $I$

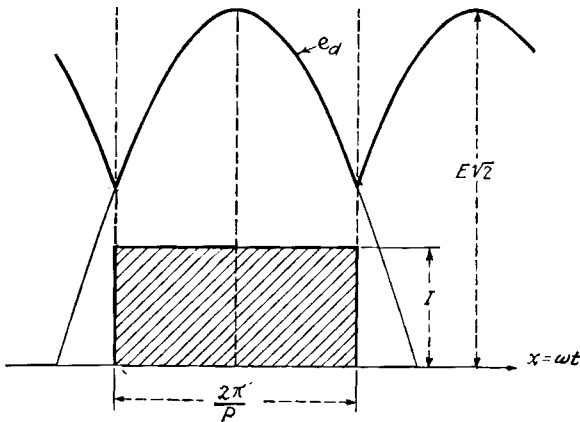

FIG. 22.—Direct-current voltage and current waves of a  $p$ -phase rectifier.

for an interval of  $2\pi/p$ . The anode current has the rectangular shape shown in Fig. 22. Its average value is  $I/p$  and its effective value

$$A = \sqrt{\frac{1}{2\pi} \cdot \frac{2\pi}{p} I^2} = \frac{I}{\sqrt{p}} \quad (1)$$

The direct-current voltage, including the drop in the arc and the cathode choke coil, is equal to the voltage between the transformer neutral and the momentarily burning anode. Since the reactance drop is assumed to be zero, the direct-current voltage wave has the form shown in heavy outline in Fig. 22, and its average value, derived by integrating the voltage wave over the angle  $2\pi/p$ , and using the point of maximum value as the origin, is

$$E_d = \frac{1}{2\pi/p} \int_{-\pi/p}^{+\pi/p} E\sqrt{2} \cos x dx = \frac{E\sqrt{2} \sin \frac{\pi}{p}}{\pi/p} \quad (2)$$

For various numbers of phases, this equation gives the following values for the ratio  $E_d/E$ :

TABLE II

$p =$	2	3	4	6	12	$\infty$
$E_d/E =$	0.9	1.17	1.27	1.35	1.40	1.41

The average direct-current power

$$P = E_d I = EI\sqrt{2} \frac{\sin \frac{\pi}{p}}{\pi/p} \quad (3)$$

The rating of the transformer secondary windings

$$P_2 = pEA = EI\sqrt{p} = \frac{\pi \sqrt{p}}{p \sqrt{2}} P \quad (4)$$

For a given transformer connection, the transformer primary and line current waves can be constructed from the anode currents. The effective values of the currents as well as the transformer primary rating can then be computed.

For illustration we shall compute the voltages, currents, and transformer ratings of a single-phase rectifier and of a 6-phase rectifier with a 3Y/6-phase transformer, using the diametrical connection of secondaries.

**Single-phase Rectifier.**—

In a single-phase rectifier, Fig. 23, each anode carries the current  $I$  for half a cycle. Neglecting the magnetizing

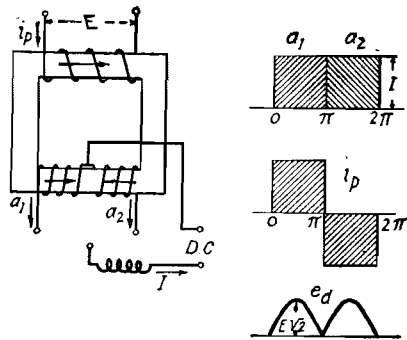

FIG. 23.—Current and voltage relations of two-anode single-phase rectifier.

and magnetomotive force, the sum of the magnetomotive forces in the closed magnetic circuit of the transformer core is equal to 0, and with an assumed 1:1 transformation ratio we can write

$$i_p = a_1 - a_2,$$



from which the primary current wave can be constructed as shown in Fig. 23. From the diagram in Fig. 23 we obtain

$$\begin{aligned}
 A &= \sqrt{\frac{1}{2\pi} \cdot \pi I^2} = \frac{I}{\sqrt{2}} \\
 I_p &= I. \\
 E_d &= \frac{1}{\pi} \int_0^\pi E\sqrt{2} \sin x dx = \frac{2\sqrt{2}}{\pi} E. \\
 P &= E_d I = \frac{2\sqrt{2}}{\pi} EI. \\
 P_2 &= 2EA = EI\sqrt{2} = \frac{\pi}{2} P. \\
 P_1 &= EI_p = EI = \frac{\pi}{2\sqrt{2}} P. \\
 \text{P.F.} &= \frac{P}{P_1} = \frac{2\sqrt{2}}{\pi} = 0.90.
 \end{aligned}$$

**Six-phase Rectifier with 3-phase Y-connected Transformer Primary.**—Figure 24 shows a 3Y/6-phase transformer connected to a 6-phase rectifier. The numeral subscripts of the anode currents correspond to the order in which the anodes will burn. The currents  $i_1, i_2, i_3$ , and  $a_1, a_2, a_3$ , etc. are the instantaneous values of primary and secondary currents, respectively, without regard to their wave shapes, duration, or sequence. With the assumption of zero magnetizing m.m.f., the sums of the m.m.f.s on the three legs of the transformer core are equal to each other, since the ends of the three legs meeting in the yoke are at the same magnetic potential. The following equations may be written for the equality of m.m.f.s:

$$N_1 i_1 + N_2 (a_1 - a_4) = N_1 i_2 + N_2 (a_3 - a_6) = N_1 i_3 + N_2 (a_5 - a_2). \quad (5)$$

On the assumption of a 1:1 ratio of transformation,  $N_1 = N_2$ ; the  $N$  factors are then cancelled from the above equation, giving

$$i_1 + a_1 - a_4 = i_2 + a_3 - a_6 = i_3 + a_5 - a_2. \quad (6)$$

Also, by Kirchhoff's first law, applied to the neutral point of the transformer primary,

$$i_1 + i_2 + i_3 = 0. \quad (7)$$

Solving Eqs. (6) and (7), simultaneously for  $i_1$ ,  $i_2$ , and  $i_3$ , we obtain

$$i_1 = -\frac{2}{3}a_1 - \frac{1}{3}a_2 + \frac{1}{3}a_3 + \frac{2}{3}a_4 + \frac{1}{3}a_5 - \frac{1}{3}a_6. \quad (8)$$

$$i_2 = \frac{1}{3}a_1 - \frac{1}{3}a_2 - \frac{2}{3}a_3 - \frac{1}{3}a_4 + \frac{1}{3}a_5 + \frac{2}{3}a_6. \quad (9)$$

$$i_3 = \frac{1}{3}a_1 + \frac{2}{3}a_2 + \frac{1}{3}a_3 - \frac{1}{3}a_4 - \frac{2}{3}a_5 - \frac{1}{3}a_6. \quad (10)$$

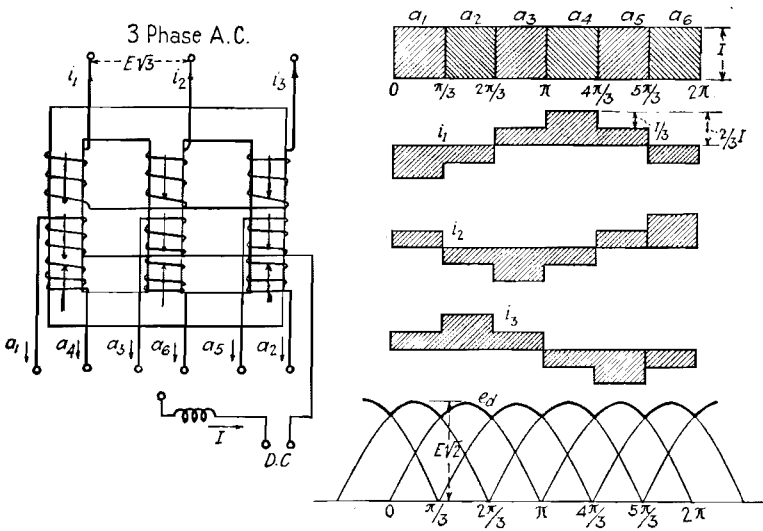

FIG. 24.—Current and voltage relations of six-anode rectifier with 3Y/6-phase transformer.

A summation of the m.m.f.s on any leg of the transformer core gives a residual m.m.f. having the value,

$$m = (i_1 + a_1 - a_4)N = (\frac{1}{3})(a_1 - a_2 + a_3 - a_4 + a_5 - a_6)N. \quad (11)$$

In deriving Eqs. (8), (9), and (10), no assumptions were made regarding the wave shapes or time sequence of the currents. These equations are, therefore, general and can be applied to a transformer connected as in Fig. 24, regardless of the wave shape of the currents.

From these expressions the primary current curves have been constructed in Fig. 24. From Eqs. (1) and (2) and from the diagram of Fig. 24,

$$A = \frac{I}{\sqrt{p}} = \frac{I}{\sqrt{6}}$$

$$E_d = E\sqrt{2} \frac{\sin \frac{\pi}{p}}{\pi/p} = E\sqrt{2} \frac{\sin \frac{\pi}{6}}{\pi/6} = \frac{3\sqrt{2}}{\pi} E.$$

$$I_p = \sqrt{\frac{1}{\pi} \cdot \frac{\pi}{3} \left[ \left(\frac{1}{3}I\right)^2 + \left(\frac{2}{3}I\right)^2 + \left(\frac{1}{3}I\right)^2 \right]} = \frac{\sqrt{2}}{3} I.$$

$$P = E_d I = \frac{3\sqrt{2}}{\pi} EI.$$

$$P_2 = pEA = EI\sqrt{6} = \frac{\pi}{\sqrt{3}} P.$$

$$P_1 = 3EI_p = EI\sqrt{2} = \frac{\pi}{3} P.$$

$$\text{P.F.} = \frac{P}{P_1} = \frac{3}{\pi} = 0.955.$$

In deriving the current and voltage relations for the 6-phase rectifier transformer connection shown in Fig. 24, the effect of the residual third-harmonic m.m.f. has been neglected, which is the condition approximated at small loads. The effect of the third-harmonic m.m.f. and the actual current and voltage relations of this connection at higher loads are treated in Chap. VI.

For other transformer connections the values of currents, voltages, and transformer ratings can be computed similarly. These values for various transformer and rectifier connections are given in Table V, Chap. VI.

## 2. EFFECT OF REACTANCE IN TRANSFORMER SECONDARY

We shall return to the general case of a  $p$ -phase rectifier. Each phase of the transformer secondary now has an inductance  $L$ . (This inductance  $L$  includes the inductance of the secondary winding, as well as the equivalent inductances of the primary windings and the alternating-current line, reduced to the secondary. The equivalent secondary inductance of the primary and line inductances depends on the type of transformer connection used, and is considered in Chap. VI.) Due to this inductance, the anode currents can no longer build up and die down instantly as was previously assumed, but the currents of two consecutive phases overlap. Two adjoining anodes, therefore, have their arcs going simultaneously for a short interval, constituting an

electrical connection between the open ends of the windings of the overlapping phases. This condition is shown in Fig. 25a.

Anode 1 carries the full current  $I$  until the point of intersection of the voltage waves  $e_1$  and  $e_2$ , when anode 2 strikes its arc. The instant of this occurrence will be used as the origin for the expression of the voltages and currents.

Applying Kirchhoff's second law to the closed circuit formed by phases 1 and 2, Fig. 25a,

$$e_1 - L \frac{di_1}{dt} + L \frac{di_2}{dt} - e_2 = 0. \quad (12)$$

(Since the voltage drops in the two arcs are equal they cancel each other and, therefore, do not enter into the above expression).

Also,

$$\begin{aligned} i_1 + i_2 &= I. & (13) \\ e_1 &= E\sqrt{2} \cos \left( \omega t + \frac{\pi}{p} \right). \\ e_2 &= E\sqrt{2} \cos \left( \omega t - \frac{\pi}{p} \right). \end{aligned}$$

Substituting the above for  $e_1$  and  $e_2$  in Eq. (12) and solving Eqs. (12) and (13) simultaneously for  $i_1$  and  $i_2$ , we obtain,

$$i_1 = I - \frac{E\sqrt{2} \sin \frac{\pi}{p}}{X} (1 - \cos \omega t), \quad (14)$$

$$i_2 = I - i_1 = \frac{E\sqrt{2} \sin \frac{\pi}{p}}{X} (1 - \cos \omega t), \quad (15)$$

where,

$$X = \omega L.$$

To derive the shape of the current waves  $i_1$  and  $i_2$  during overlapping, Eqs. (14) and (15) will be separated into their component

parts, replacing the factor  $-\frac{E\sqrt{2} \sin \frac{\pi}{p}}{X}$  by  $I_s$ :

$$i_1 = I - I_s + I_s \cos \omega t. \quad (14a)$$

$$i_2 = I_s - I_s \cos \omega t. \quad (15a)$$

These currents are composed of direct-current components and a sinusoidal alternating-current component  $i_s = I_s \cos \omega t$ . As shown in Fig. 25b, the alternating-current components (shown

dotted) have their axes displaced from the zero-axis of the anode currents.

The alternating current  $i_s$  is equal to the current produced by short-circuiting anodes 1 and 2, and is equal to the difference of the phase voltages divided by the sum of the phase reactances.

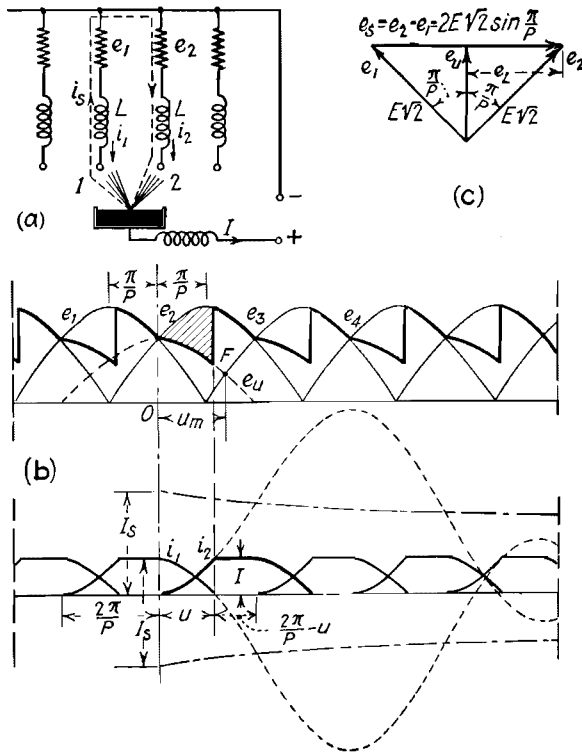

FIG. 25.—Current and voltage relations of a  $p$ -phase rectifier, with inductance in the transformer secondary producing overlapping of anode currents.

The difference of the phase voltages producing this current is

$$e_s = e_2 - e_1 = 2 E \sqrt{2} \sin \frac{\pi}{p} \sin \omega t$$

and is shown in the vector diagram of Fig. 25c.

$$i_s = \frac{e_s}{2X} = - \frac{E \sqrt{2} \sin \frac{\pi}{p}}{X} \cos \omega t.$$

The current is a cosine function since the circuit is reactive and the current  $i_s$  lags behind the voltage  $e_s$  by  $90^\circ$ .

The alternating-current component  $i_s$  flows in the closed circuit of the overlapping phases, as indicated by the dotted lines in Fig. 25a, and does not appear in the direct-current circuit.

The overlapping of the currents lasts until  $i_1$  becomes 0, since the valve action of the arc prevents it from having a negative value.

The angle of overlap  $u$  can, therefore, be determined by equating to zero the expression for  $i_1$ , Eq. (14), with  $\omega t$  replaced by  $u$ .

$$i_1 = I - \frac{E\sqrt{2} \sin \frac{\pi}{p}}{X} (1 - \cos u) =$$

from which

$$\cos u = 1 - \frac{IX}{E\sqrt{2} \sin \frac{\pi}{p}}. \quad (16)$$

From Eq. (16),

$$\frac{E\sqrt{2} \sin \frac{\pi}{p}}{X} = \frac{I}{1 - \cos u}.$$

Substituting in Eqs. (14) and (15) and replacing  $\omega t$  by  $x$ , we obtain.

$$i_1 = I \left( 1 - \frac{1 - \cos x}{1 - \cos u} \right), \quad (17)$$

$$i_2 = I \cdot \frac{1 - \cos x}{1 - \cos u}. \quad (18)$$

As seen from Fig. 25b, the anode current consists of three parts: one part extending over angle  $u$  and expressed by Eq. (18), a second part extending over angle  $(2\pi/p - u)$  and having a square shape of amplitude  $I$ , and a third part extending over angle  $u$  and expressed by Eq. (17).

The effective value  $A$  of the anode current may, therefore, be computed from the diagram in Fig. 25, and expressions (17) and (18).

$$2\pi A^2 = \int_0^u i_2^2 dx + I^2 \left( \frac{2\pi}{p} - u \right) + \int_0^u i_1^2 dx.$$

Substituting Eqs. (17) and (18) for  $i_1$  and  $i_2$ , and integrating the functions and combining the terms,

$$A = \frac{I}{\sqrt{p}} \sqrt{1 - p \cdot \frac{1}{\pi} \int_0^u \left[ \frac{1 - \cos x}{1 - \cos u} - \left( \frac{1 - \cos x}{1 - \cos u} \right)^2 \right] dx},$$

$$A = \frac{I}{\sqrt{p}} \sqrt{1 - p \left[ \frac{(2 + \cos u) \sin u - (1 + 2 \cos u)u}{2\pi(1 - \cos u)^2} \right]},$$

or

$$A = \frac{I}{\sqrt{p}} \sqrt{1 - p \psi(u)} \quad (19)$$

where

$$\psi(u) = \frac{1}{\pi} \int_0^u \left[ \frac{1 - \cos x}{1 - \cos u} - \left( \frac{1 - \cos x}{1 - \cos u} \right)^2 \right] dx$$

$$\psi(u) = \frac{(2 + \cos u) \sin u - (1 + 2 \cos u)u}{2\pi(1 - \cos u)^2}. \quad (20)$$

To facilitate calculations, Eq. (20) may be expressed as a series.

$$\psi(u) = \frac{2u}{15\pi} \left( 1 + \frac{u^2}{84} + \dots \right). \quad (20a)$$

From a comparison of Eqs. (19) and (1) it is seen that the effective value of the current without overlapping may be corrected for overlapping by the factor  $\sqrt{1 - p \psi(u)}$ . This factor, for 2, 3, 6, and 12 phases, as well as the quantity  $\psi(u)$ , are plotted in Fig. 48, with  $u$  as abscissa.

The rating of the secondary winding of the transformer as given by Eq. (4), but corrected for overlapping, is

$$P_2 = pEA = EI\sqrt{p} \sqrt{1 - p \psi(u)}. \quad (21)$$

**Direct-current Voltage and Voltage Drop.**—The direct-current voltage without overlapping is equal to the voltage of the working phase, as shown in Fig. 22, and its average value is given by Eq. (2). During the overlapping period, when two phases are connected together by the arc, the direct-current voltage wave will lie between the sinusoidal voltage waves of the two overlapping phases, and is equal to the induced phase voltage  $e_2$  less the inductive drop produced by the current  $i_2$  in the inductance  $L$ . The equation for the inductive voltage drop is

$$e_L = L \frac{di_2}{dt}.$$

Substituting for  $i_2$  from Eq. (15), and differentiating,

$$e_L = \frac{\omega L E \sqrt{2} \sin(\pi/p) \sin \omega t}{X}$$

Replacing  $\omega L$  by  $X$  and  $\omega t$  by  $x$ ,

$$e_L = E \sqrt{2} \sin\left(\frac{\pi}{p}\right) \sin x.$$

The vector of  $e_L$  is indicated in Fig. 25c, and is equal to

$$\frac{1}{2}(e_2 - e_1).$$

The net direct-current voltage during overlapping

$$\begin{aligned} e_u &= e_2 - e_L \\ &= E \sqrt{2} \cos\left(x - \frac{\pi}{p}\right) - E \sqrt{2} \sin\left(\frac{\pi}{p}\right) \sin x \\ &= E \sqrt{2} \cos\left(\frac{\pi}{p}\right) \cos x. \end{aligned}$$

The voltage wave  $e_u$  is shown in Figs. 25b and c and is equal to the mean value of voltages  $e_1$  and  $e_2$ . As soon as the overlapping period is over, the direct-current voltage assumes the value of the working phase.

The direct-current voltage wave as affected by overlapping is shown in heavy outline in Fig. 25b and differs from the no-load direct-current voltage (without overlapping, Fig. 22) by the cross-hatched area shown in Fig. 25b. The average value of the direct-current voltage as given by Eq. (2) is, therefore, reduced by the average ordinate  $d$  of the cross-hatched area. The ordinate  $d$  may be computed by integrating  $e_L$  over the angle  $u$ .

$$\begin{aligned} d &= \frac{1}{2\pi} \int_0^u e_L dx \\ &= \frac{1}{2\pi} \int_0^u E \sqrt{2} \sin\left(\frac{\pi}{p}\right) \sin x dx \\ &= \frac{E \sqrt{2} \sin(\pi/p)}{2\pi} (1 - \cos u). \end{aligned} \quad (22)$$

Substituting from Eq. (16) for  $\cos u$ ,

$$d = \frac{IX}{2\pi}. \quad (22a)$$



The average direct-current voltage, considering the voltage drop, is determined from Eqs. (2) and (22),

$$\begin{aligned}
 E_d &= \frac{E\sqrt{2} \sin \frac{\pi}{p}}{\frac{\pi}{p}} - \frac{E\sqrt{2} \sin \frac{\pi}{p}}{2\frac{\pi}{p}} (1 - \cos u) \\
 &= \frac{E\sqrt{2} \sin \frac{\pi}{p}}{\pi/p} \left( 1 - \frac{1 - \cos u}{2} \right) \\
 &= \frac{E\sqrt{2} \sin \frac{\pi}{p}}{\pi/p} \cos^2 \frac{u}{2}
 \end{aligned} \tag{23}$$

or

$$E_d = \frac{E\sqrt{2} \sin \frac{\pi}{p}}{\frac{\pi}{p}} - \frac{IX}{2\frac{\pi}{p}}. \tag{23a}$$

It is seen from Eq. (23a) that the voltage drop due to overlapping is directly proportional to the current  $I$ . It is also a function of the number of phases  $p$  and the reactance of the transformer. The voltage regulation obtained for different connections of rectifier transformers will be considered in Chap. VI.

In addition to the voltage drop produced by overlapping, the voltage regulation of rectifiers is influenced also by the resistance drop in the transformer and the variation of the arc drop in the rectifier. These additional factors will also be considered in Chap. VI.

The direct-current output is

$$P = E_d I = \frac{EI\sqrt{2} \sin \frac{\pi}{p}}{\pi/p} \cos^2 \frac{u}{2}. \tag{24}$$

The transformer primary and line current waves can be constructed from the anode currents as was done previously. For a 3Y/6-phase transformer the primary current waves can be constructed from the anode currents, using Eqs. (8), (9), and (10). The effective value of the primary current and the rating of the transformer primary can then be calculated.

The above relations of currents and voltages have been derived for a rectifier supplied by a transformer with a 6-phase secondary having diametrical connection of windings. This is the simplest

connection of polyphase rectifier transformers. There are a number of other connections used for rectifier transformers, which have certain advantages over this connection. These will be discussed in Chap. VI on Transformers.

**CURRENT AND VOLTAGE RELATIONS FROM NO LOAD TO SHORT CIRCUIT**

In the preceding section, the general current and voltage relations in the circuits of a  $p$ -phase rectifier were derived under the condition that the currents in two successive phases overlap due to the transformer reactance. The angle of overlap  $u$ , as given by Eq. (16), increases as the load current is increased, and the direct-current voltage wave during the period of overlap, as shown in Fig. 25, follows the sine wave  $e_u$  which is the mean of the overlapping phase voltages. It is seen from Fig. 25 that as the angle of overlap is increased, a point  $F$  is reached where the voltage  $e_3$  of anode 3 becomes equal to the voltage  $e_u$  of the working anodes. At still higher loads, when the angle of overlap extends beyond point  $F$ , anode 3 ignites at point  $F$  before anode 1 is extinguished, so that three phases carry current simultaneously until anode 1 is extinguished. The relations previously derived for the overlapping of two phases, therefore, no longer apply. The maximum angle of overlap of two phases,  $u_m$ , may be determined by equating the expressions for  $e_u$  and  $e_3$ , with  $x$  replaced by  $u_m$ .

$$\begin{aligned}
 e_u &= e_3 \\
 E\sqrt{2} \cos \frac{\pi}{p} \cos u_m &= E\sqrt{2} \cos \left( u_m - \frac{3\pi}{p} \right) \\
 \tan u_m &= \frac{\cos \frac{\pi}{p} - \cos \frac{3\pi}{p}}{\sin \frac{3\pi}{p}}. \tag{25}
 \end{aligned}$$

Below are given the values of  $u_m$ , as computed by Eq. (25), for 3, 6, and 12 phases.

$p$	$u_m$ .
3.....	90°.
6.....	40° 54'.
12.....	20° 7'.

As the load current increases, the operating time of each phase is increased, and more phases conduct current simultaneously, until, under theoretical short-circuit conditions, each phase operates over a complete cycle and all phases carry current

simultaneously (see Fig. 29j). Actually, the latter condition cannot be attained on account of the arc drop in the rectifier and the copper losses in the transformer and connecting leads.

In the following, the general current and voltage relations of a  $p$ -phase rectifier will be considered for various loads up to short circuit, involving various numbers of simultaneously operating phases. In these considerations the same assumptions will be made as in the preceding sections, that the direct current is a straight line and that each phase of the transformer secondary has a reactance  $X$  (inductance  $L$ ).

**Direct-current Voltage.**—The phase voltages of the  $p$ -phase rectifier, as heretofore, have the amplitude  $E\sqrt{2}$ , and are displaced from each other by the phase angle  $2\pi/p$ . These phase voltages may, therefore, be expressed as follows:

$$\left. \begin{aligned} e_1 &= E\sqrt{2} \sin x. \\ e_2 &= E\sqrt{2} \sin \left[ x - \frac{2\pi}{p} \right]. \\ e_3 &= E\sqrt{2} \sin \left[ x - 2\frac{2\pi}{p} \right]. \\ &\dots\dots\dots \\ e_p &= E\sqrt{2} \sin \left[ x - (p-1)\frac{2\pi}{p} \right]. \end{aligned} \right\} \quad (26)$$

The instantaneous value of the direct-current voltage will again be denoted by  $e_d$  and the instantaneous values of the anode currents by  $a_1, a_2, a_3, \dots, a_p$ . The direct-current voltage at any instant is equal to the voltage between the working anode and the transformer neutral; it is, therefore, equal to the no-load phase voltage, minus the voltage drop due to the anode current and phase reactance  $X$ . Under load conditions when  $n$  anodes (anodes 1 to  $n$ ) carry current simultaneously, all the working anodes are at the same potential, and the following equations may be written for the individual phases:

$$\left. \begin{aligned} e_d &= e_1 - X \frac{da_1}{dx} \\ e_d &= e_2 - X \frac{da_2}{dx} \\ &\dots\dots\dots \\ e_d &= e_n - X \frac{da_n}{dx} \end{aligned} \right\} \quad (27)$$

Adding these equations,

$$ne_d = (e_1 + e_2 + \dots + e_n) - X \frac{d(a_1 + a_2 + \dots + a_n)}{dx}.$$

Since the direct current  $I = a_1 + a_2 + \dots + a_n$  and is constant,

$$\frac{d(a_1 + a_2 + \dots + a_n)}{dx} = 0,$$

so that

$$e_d = \frac{(e_1 + e_2 + \dots + e_n)}{n} = \frac{1}{n} \sum_{k=1}^n e_k. \quad (28)$$

That is, the direct-current voltage at any instant is equal to the arithmetic mean of the voltages of the simultaneously operating phases. This relation, found previously for the case of two overlapping phases, therefore applies to any number of overlapping phases.

The shape of the direct-current voltage wave may be determined by means of Eq. (28) if the phase voltages and the number of overlapping phases are known. Since the voltages  $e_1, e_2$ , etc. are sinusoidal functions, the voltage  $e_d$  consists of portions of sine waves and may, therefore, be represented by vectors.

In Fig. 26 are shown the voltage vectors  $e_1, e_2$ , etc., of a poly-phase rectifier. The time axis  $OT$  of the vector diagram is assumed to be rotating in a clockwise direction (equivalent to the conventional counter-clockwise rotation of the vectors), and the projections of the vectors on this axis represent the instantaneous values of the voltages. The vertical position of the time axis, *i.e.*, when  $e_1 = 0$ , is taken as its zero position. Let it be assumed that at a certain instant anodes 9, 10, 11, and 12 are carrying current. The direct-current voltage wave is then generated by vector  $OS_1$ , which is the average of vectors  $e_9$  to  $e_{12}$ . These 4 anodes will carry the current until the voltage  $e_1$  of anode 1 (the next anode to join the conducting group) becomes equal to the voltage  $OS_1$ , when anode 1 starts carrying current. This occurs at an angle  $\alpha$  when the time axis is perpendicular to the line joining the termini of vectors  $OS_1$  and  $e_1$ , since the projections of these vectors on the time axis are then equal. Angle  $\alpha$  is called the *ignition angle*, and is the angle from the point at which the voltage of an anode crosses the zero axis to the point at which the anode ignites. The direct-current voltage wave is

now generated by vector  $OS_2$ , which is the average of the voltages  $e_9$ ,  $e_{10}$ ,  $e_{11}$ ,  $e_{12}$ , and  $e_1$ .

The current of anode 9 decreases and becomes equal to zero at some point after anode 1 ignites. This occurs at some angle  $\beta$  from the zero position of the time axis. When anode 9 has extinguished, the direct-current voltage wave is generated by

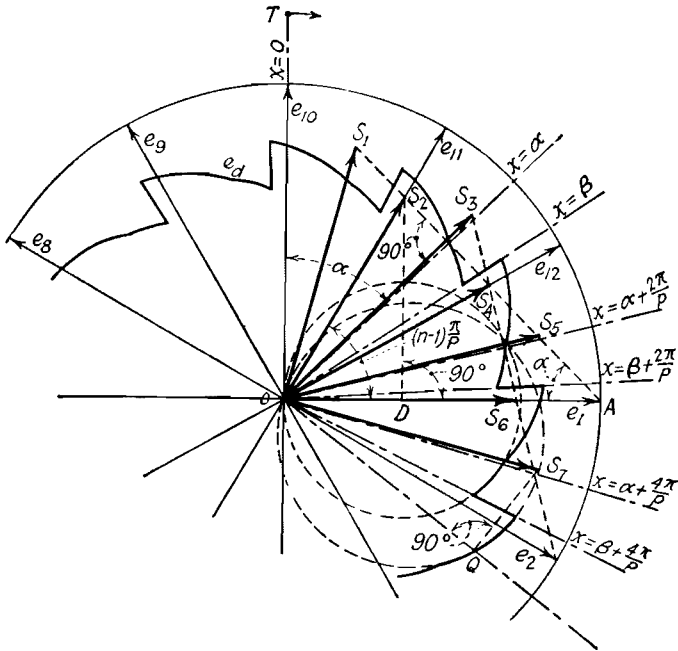

FIG. 26.—Vector diagram for constructing the direct-current voltage wave of a rectifier.

vector  $OS_3$ , which is the average of the voltages  $e_{10}$ ,  $e_{11}$ ,  $e_{12}$ , and  $e_1$  of the conducting anodes. At an angle  $\gamma = \alpha + \frac{2\pi}{p}$  the voltage  $e_2$  becomes equal to  $OS_3$  and anode 2 ignites. The generating vector of the direct-current voltage is then  $OS_4$ , which is the average of vectors  $e_{10}$ ,  $e_{11}$ ,  $e_{12}$ ,  $e_1$ , and  $e_2$ . Anode 10 is extinguished at an angle  $\delta = \beta + \frac{2\pi}{p}$ .

This process continues for the whole cycle. The direct-current voltage wave is generated by vectors  $OS_1$ ,  $OS_2$ ,  $OS_3$ , etc., and

may be drawn from the projections of these vectors on the rotating time axis within the proper angular limits. This is conveniently accomplished in polar coordinates, as shown in Fig. 26, by describing circles about the vectors. The circumferences of these circles, within the proper angles, are the loci of the direct-current voltage wave. This can be readily seen, since the line drawn from the terminus of a vector to a point on the circumference of its circumscribed circle is perpendicular to the time axis through that point, so that the radial distance from point  $O$  to the point on the circumference is equal to the projection of the vector on the time axis. Thus, when the time axis passes through a point  $Q$ , the direct-current voltage is equal to  $OQ$ , since  $OQ$  is perpendicular to  $S_7Q$ , and is, therefore, the projection of the generating vector  $OS_7$  on the time axis passing through  $Q$ .

For the conditions shown in Fig. 26,  $n$  of Eq. (28) has the value 5, since five phases carry current simultaneously. It is seen from the preceding considerations that the conducting group consists alternately of  $n$  and  $(n - 1)$  phases.

The expression for the ignition angle  $\alpha$  may be determined from Fig. 26 by drawing a line from  $S_2$  perpendicular to  $OA$ . Angle  $OAS_2 = \alpha$ .

$$\text{Tan } \alpha = \frac{DS_2}{AD} = \frac{OS_2 \sin (n - 1) \frac{\pi}{p}}{OA - OS_2 \cos (n - 1) \frac{\pi}{p}}$$

$$OA = E\sqrt{2}.$$

From Eq. (28),

$$OS_2 = \frac{E\sqrt{2} \sin n \frac{\pi}{p}}{n \sin \frac{\pi}{p}}$$

(The above expression for  $OS_2$  may be derived from Eq. (28) by drawing the voltage vectors of the  $n$  phases end to end. These vectors then constitute  $n$  sides of a  $p$ -sided polygon, and their sum is the chord of a circle circumscribing the polygon.)

$$\text{Tan } \alpha = \frac{\sin n \frac{\pi}{p} \sin (n - 1) \frac{\pi}{p}}{n \sin \frac{\pi}{p} - \sin n \frac{\pi}{p} \cos (n - 1) \frac{\pi}{p}} \quad (29)$$

Below are given the values of the ignition angle  $\alpha$  for 3- and 6-phase connections, and different numbers of overlapping phases:

$p$	$n$	$\alpha$
3	2	30°
3	3	0°
6	2	60°
6	3	40° 54'
6	4	23° 25'
6	5	8° 57'
6	6	0°

**Anode Currents.**—Writing Eq. (27) for any one phase, say the  $s$ th phase,

$$e_d = e_s - X \frac{da_s}{dx}$$

From which

$$a_s = \frac{1}{X} \int (e_s - e_d) dx + C. \quad (30)$$

Equation (30) may be used for determining the shape of the anode currents. It is seen from this equation that the anode current follows the integral of the difference between the no-load phase voltage and the instantaneous value of the direct-current voltage. Since the direct-current voltage, as shown in Fig. 26, is generated during successive periods by vectors  $OS_1$ ,  $OS_2$ , etc., the expression for  $a_s$  is not a continuous function over the entire working period of the anode, and the integration must be performed for each of the generating vectors within the angular limits over which they operate. The constant of integration  $C$  for each of these integrating operations is determined by the value of the anode current at the start of the particular period.

Since the instantaneous values of  $e_s$  and  $e_d$  are equal to the projections of their generating vectors  $e_s$  and  $OS_1$ ,  $OS_2$ , etc. on the time axis, the value of  $(e_s - e_d)$  in Eq. (30) at any instant is equal to the projection on the time axis of the vector drawn from the points  $S_1$ ,  $S_2$ , etc. (corresponding to the particular  $OS$  vector in effect during the period under consideration) to the terminus of vector  $e_s$ . Thus, for example, in Fig. 26, for the period between  $x = \alpha$  and  $x = \beta$ ,  $(e_1 - e_d)$ , for the phase 1, is represented by vector  $S_2A$ . Since the integral of a sine function

is another sine function lagging behind it by  $90^\circ$ ,  $\int(e_s - e_d)dx$  may be represented by a vector equal to vector  $(e_s - e_d)$  but displaced from it by  $90^\circ$  in the lagging direction; or the same result will be obtained by displacing the time axis by  $90^\circ$  in its lagging direction.

It can be seen from the above discussion that the shape of the anode current wave, as expressed by Eq. (30), may be determined graphically from the voltage vector diagram by drawing the vector differences between the no-load phase voltage and the generating vectors of the direct-current voltage, and by displacing the time axis  $90^\circ$  lagging behind its position in the voltage vector diagram.

For illustration, the direct-current voltage and anode current waves of a 6-phase rectifier are constructed in Figs. 27 and 28. In this example the load condition is taken when there is an overlapping of three phases ( $n = 3$ ). For this condition, the ignition angle  $\alpha = 40^\circ 54'$ . The angle  $\beta$  is assumed to be equal to  $70^\circ$ . In Fig. 27, the phase voltages  $e_1$  to  $e_6$  are represented by vectors  $O1, O2, O3$ , etc. The generating vectors of the direct-current voltage wave are designated by  $OA, OB, OC$ , etc., and the angles through which these vectors operate are indicated by  $a, b, c$ , etc. Thus, phases 5, 6, and 1 operate in parallel over angle  $a$ , and the direct-current voltage wave for this angle is generated by vector  $OA$ , which is the average of the voltages  $e_5, e_6$ , and  $e_1$ ; only phases 6 and 1 operate over angle  $b$ , and the generating vector for this angle is  $OB$ , the average of  $e_6$  and  $e_1$ . The direct-current voltage wave  $e_d$  is constructed by means of these vectors as was explained in connection with Fig. 26.

The current in anode 1, in accordance with Eq. (30), is

$$a_1 = \left(\frac{1}{X}\right) \int (e_1 - e_d) dx + C. \quad (30 a)$$

This current is constructed in Fig. 28a by the method previously outlined. For this purpose the vectors  $A1, B1, C1$ , etc., representing the differences between the voltage vector of phase 1 and the generating vectors of  $e_d$ , have been drawn in their proper magnitudes and phase positions, as determined in Fig. 27. To integrate these vectors, the positions of the time axis in Fig. 28 have been shifted  $90^\circ$  in the lagging direction from the positions in Fig. 27. The term  $\int(e_1 - e_d)dx$  in Eq. (30 a) is then equal to the projections, on the revolving time axis, of the vectors  $A1, B1$



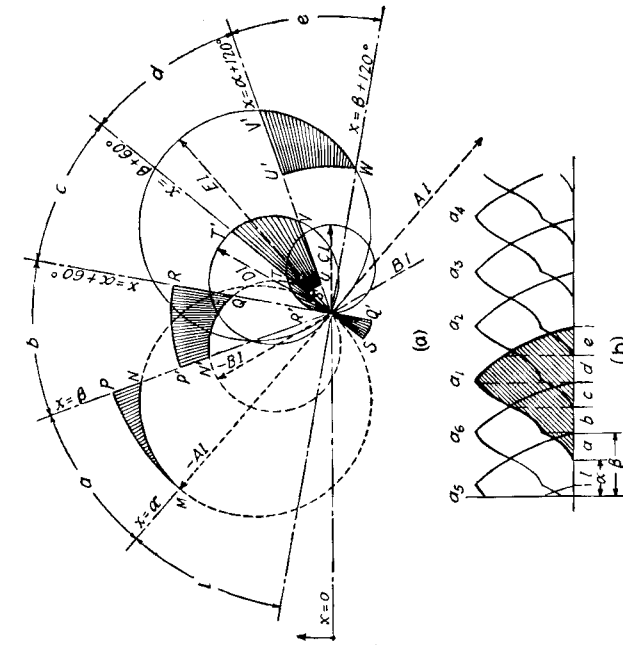

FIG. 28.—Polar diagram for constructing anode current wave of a 6-phase rectifier with three overlapping phases (224).

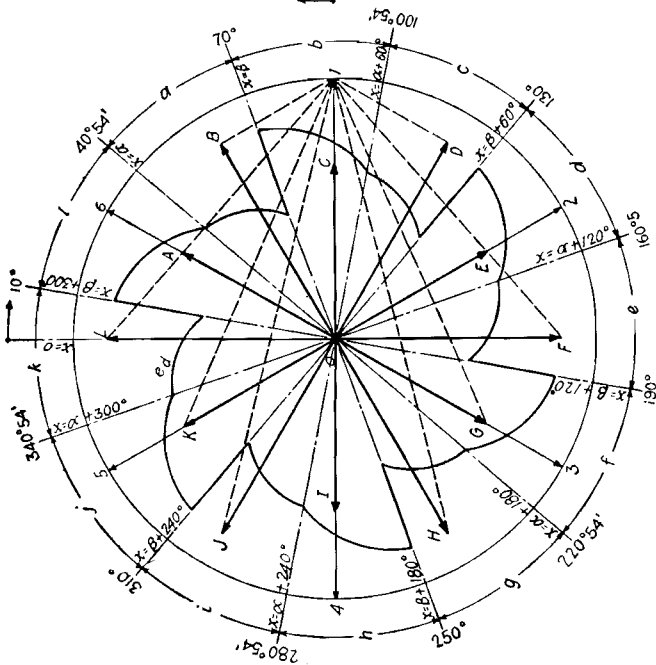

FIG. 27.—Polar diagram for constructing direct-current voltage wave of a 6-phase rectifier with three overlapping phases ( $n = 3$ ).

etc. within their respective angles  $a, b, c$ , etc. These projections, taken to the proper scale as given by the factor  $(1/X)$ , therefore represent the alternating-current components, and determine the shape of the current wave. The actual magnitude of the current at any instant is determined also by the constant  $C$ .

The loci of the projections of the vectors  $A1, A2$ , etc., may be represented by circles circumscribed about these vectors, as was done in the construction of the voltage wave in Fig. 26.

Anode 1 ignites at angle  $\alpha$ . For the angle  $a$  the generating vector  $A1$  is negative and the current wave is bounded by a circle circumscribed about  $-A1$ . Since  $a_1$ , the current of anode 1, is equal to 0 at angular position  $\alpha$  of the time axis, the constant of integration is represented by a circle drawn about the origin of the vector diagram as a center, and passing through point  $M$ . The shaded area bounded by the two circles represents the magnitude of the anode current, measured radially along the revolving time axis. At angle  $\beta$  the current has reached the magnitude  $NP$ . For the angle  $b$  the locus of the current wave is a circle circumscribed about the vector  $-B1$ . The constant of integration is represented by a circle drawn with the origin of the vector diagram as a center and passing through point  $P'$ , where  $N'P' = NP$ .

At the angle  $\alpha + 60^\circ$  the current has the value  $QR$ . For angle  $c$  the locus of the current wave is a circle circumscribed about vector  $C1$ , which is positive. The circle for the constant of integration passes through point  $Q'$ , where  $Q'R' = QR$ .

The rest of the current wave is similarly constructed, the shaded areas representing the magnitude of the current for angles  $d$  and  $e$  being bounded by the circles circumscribed about the vectors  $D1$  and  $E1$ , respectively, and by the circles representing the constants of integration, which are determined by the values of the current reached at the end of the preceding period. At point  $W$  the current of anode 1 becomes equal to zero, and the anode stops working.

The anode current wave as constructed in the polar diagram of Fig. 28*a* has been transferred to linear coordinates in Fig. 28*b*.

In Fig. 29 (*a* to *j*) are shown the anode current and the direct-current voltage waves of a 6-phase rectifier connection for various load conditions from light load, involving the overlapping of two phases ( $n = 2$ ), to short-circuit load, when all the phases carry current simultaneously ( $n = 6$ ), and each phase operates

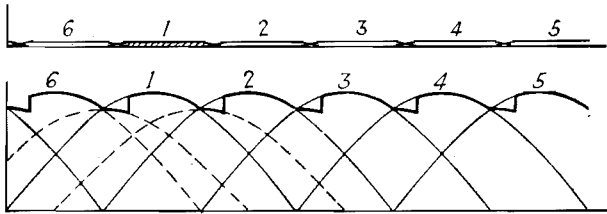

$$n = 2$$

$$I/I_k = 0.0032$$

$$E_d/E\sqrt{2} = 0.935$$

(a)

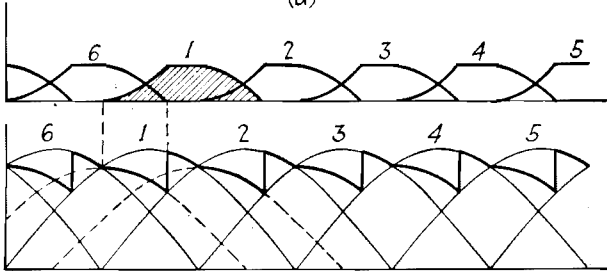

$$n = 2$$

$$I/I_k = 0.020$$

$$E_d/E\sqrt{2} = 0.838$$

(b)

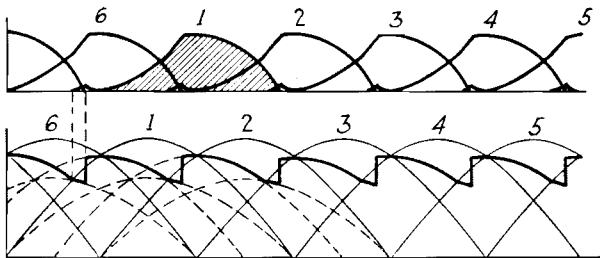

$$n = 3$$

$$I/I_k = 0.030$$

$$E_d/E\sqrt{2} = 0.783$$

(c)

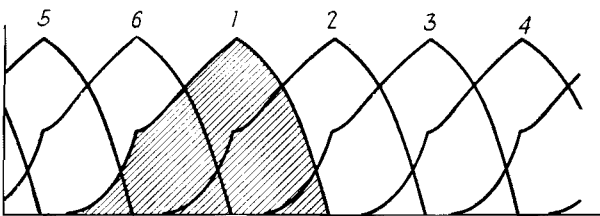

$$n = 3$$

$$I/I_k = 0.125$$

$$E_d/E\sqrt{2} = 0.604$$

(d)

FIGS. 29a to d.

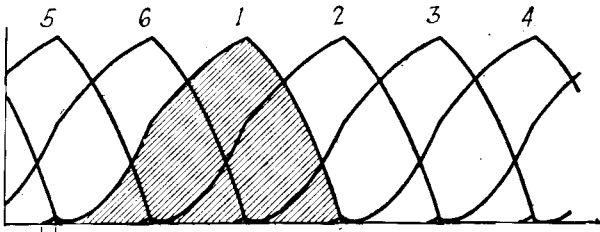

$n = 4$   
 $I/I_k = 0.165$   
 $E_d/E\sqrt{2} = 0.537$

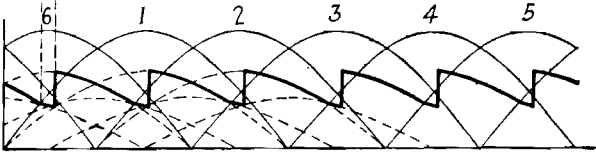

(e)

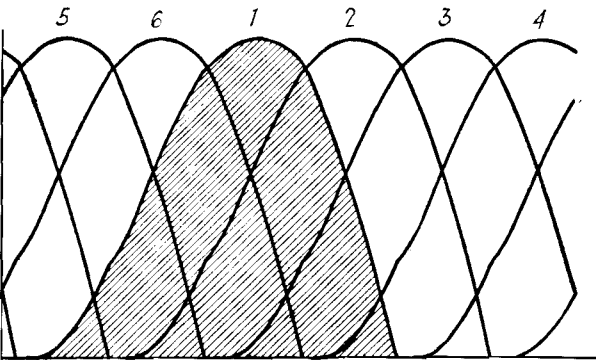

$n = 4$   
 $I/I_k = 0.385$   
 $E_d/E\sqrt{2} = 0.326$

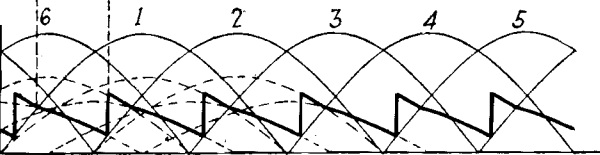

(f)

FIGS. 29e and f.

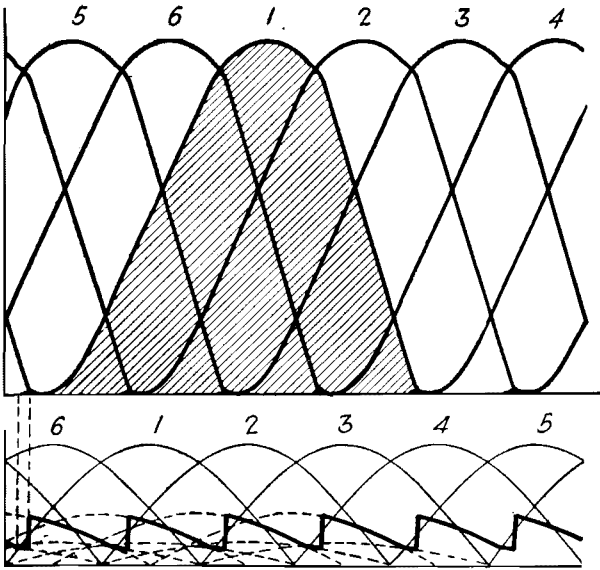

$$n = 5$$

$$I/I_k = 0.398$$

$$E_a/E\sqrt{2} = 0.304$$

FIG. 29g.

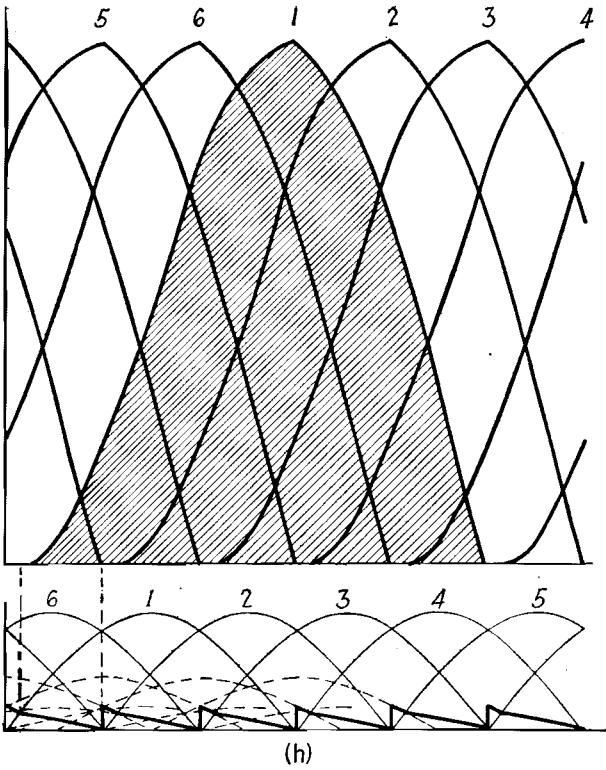
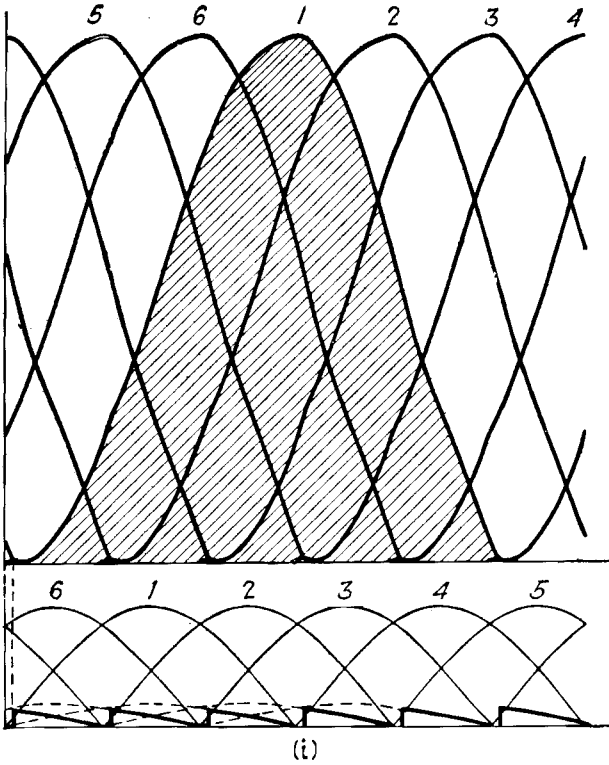

FIG. 29h.



$n = 6$   
 $I/I_k = 0.785$   
 $E_d/E\sqrt{2} = 0.082$

FIG. 29i.

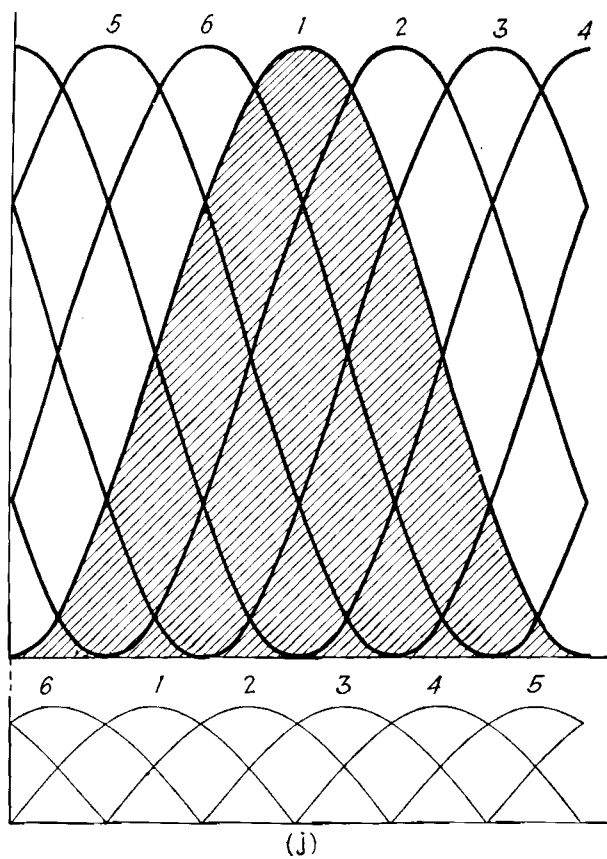

FIG. 29j.



over a complete cycle. These voltage and current waves have been constructed by the method shown in Figs. 27 and 28.

The upper traces of Figs. 29*a* to *j* show the anode current waves, the lower traces show the direct-current voltages. The no-load phase voltages are shown by light, solid lines. The dotted lines are construction lines. The relative values of direct-current voltage and current for each of the figures are indicated alongside the figure (see pages 77 and 79.)

**Short-circuit Current.**—Under theoretical short-circuit conditions the direct-current voltage  $e_d$  is equal to zero over the whole cycle. It can be seen from Eq. (28) that under these conditions all the phases must partake in current conduction over the whole cycle, since the sum of *all* the voltages of a symmetrical  $p$ -phase rectifier is equal to zero. With all the phases operating simultaneously  $n = p$ , and according to Eq. (29) the ignition angle  $\alpha = 0$ .

From the assumption made in deriving  $\alpha$  in Fig. 26, this means that each anode ignites at the point at which its phase voltage crosses the zero axis while changing from negative to positive.

Writing Eq. (30) for the anode current under short-circuit conditions, when  $e_d$  is equal to zero,

$$a_{sk} = \left(\frac{1}{X}\right) \int e_s dx + C_k \quad (31)$$

in which  $C_k$  is the constant of integration for short-circuit conditions. Since  $e_s$  is a continuous function,  $C_k$  has the same value over the whole cycle.

Writing Eq. (31) for the current in phase 1, and substituting for  $e_1$  its value from Eq. (26),

$$\begin{aligned} a_{1k} &= \left(\frac{1}{X}\right) \int E\sqrt{2} \sin x dx + C_k \\ a_{1k} &= -\frac{E\sqrt{2}}{X} \cos x + C_k. \end{aligned} \quad (32)$$

To determine the value of  $C_k$ , the conditions at the ignition point of anode 1 will be substituted in Eq. (32). This anode ignites at the point  $x = 0$ , and its current at that point is zero.

$$\begin{aligned} 0 &= -\frac{E\sqrt{2}}{X} + C_k \\ C_k &= \frac{E\sqrt{2}}{X}. \end{aligned} \quad (33)$$

Substituting this value of  $C_k$  in Eq. (32),

$$a_{1k} = -\frac{E\sqrt{2}}{X} \cos x + \frac{E\sqrt{2}}{X}. \quad (34)$$

The anode current wave as given by this equation is shown in Fig. 29j. This current wave has an amplitude equal to  $2E\sqrt{2}/X$ .

Writing Eq. (31) for all the anodes, and substituting for  $C_k$  its value from Eq. (33),

$$\left. \begin{aligned} a_{1k} &= \left(\frac{1}{X}\right) \int e_1 dx + \left(\frac{E\sqrt{2}}{X}\right) \\ a_{2k} &= \left(\frac{1}{X}\right) \int e_2 dx + \left(\frac{E\sqrt{2}}{X}\right) \\ &\dots\dots\dots \\ a_{pk} &= \left(\frac{1}{X}\right) \int e_p dx + \left(\frac{E\sqrt{2}}{X}\right). \end{aligned} \right\} \quad (35)$$

The total direct current  $I_k$ , on short circuit, is equal to the sum of all the anode currents.

$$I_k = a_{1k} + a_{2k} + \dots + a_{pk} = \left(\frac{1}{X}\right) \int (e_1 + e_2 + \dots + e_p) dx + \left(\frac{pE\sqrt{2}}{X}\right). \quad (36)$$

Since the sum of all the phase voltages is equal to zero, the term under the integral in the above equation becomes zero, and

$$I_k = \frac{pE\sqrt{2}}{X}. \quad (37)$$

Equation (37) is the expression for the theoretical short-circuit current of a rectifier. Actually, the current can never reach this value on account of the voltage drop in the rectifying arc and the copper losses in the rectifier transformer and in the other parts of the rectifier circuit, which prevent the direct-current voltage  $e_d$  from reaching zero.

**Current-voltage Relations.**—Since the direct-current voltage wave is periodic, repeating itself at intervals of  $2\pi/p$ , as can be seen from Fig. 26, its average value  $E_d$  may be determined by integration over the angle  $2\pi/p$ .

$$E_d = \frac{1}{2\pi/p} \int_{\alpha}^{\alpha + \frac{2\pi}{p}} e_d dx. \quad (38)$$

Between the angles  $\alpha$  and  $\beta$ ,  $n$  phases participate in the current conduction; between the angles  $\beta$  and  $\alpha + 2\pi/p$ ,  $(n - 1)$  phases carry current. Substituting Eq. (28) for  $e_d$ , Eq. (38) may therefore be written as follows:

$$E_d = \frac{1}{2\pi/p} \left[ \int_{\alpha}^{\beta} \frac{1}{n} \sum_{k=1}^n e_k dx + \int_{\beta}^{\alpha + \frac{2\pi}{p}} \frac{1}{n-1} \sum_{k=1}^{n-1} e_k dx \right] \quad (39)$$

The relation between the direct-current voltage  $E_d$  and the direct current  $I$  can be derived with the aid of Eq. (30), since this equation expresses the relationship between the anode currents and the direct-current voltage, and the direct current is at every instant equal to the sum of the anode currents. The sum of the anode currents at any instant, say at the ignition angle  $\alpha$  of anode 1, may be written as the sum of the successive values of the current of anode 1 at intervals of  $2\pi/p$ , since all the anode currents have a similar shape and are displaced from each other by the angle  $2\pi/p$ . Expressing analytically by means of Eq. (30) the current values of anode 1 at  $\alpha$ ,  $\alpha + (2\pi/p)$ ,  $\alpha + 2(2\pi/p)$ ,  $\dots$ ,  $\alpha + (n-1)(2\pi/p)$ , in an analogous manner as used in the construction of Fig. 28, and taking their sum, the following equation will be obtained (224):

$$IX = \sum_{k=1}^n (n-k) \int_{\alpha + (k-1)\frac{2\pi}{p}}^{\alpha + k\frac{2\pi}{p}} (e_1 - e_d) dx \quad (40)$$

$$IX = \sum_{k=1}^n (n-k) \int_{\alpha + (k-1)\frac{2\pi}{p}}^{\alpha + k\frac{2\pi}{p}} e_1 dx - \sum_{k=1}^n (n-k) \int_{\alpha + (k-1)\frac{2\pi}{p}}^{\alpha + k\frac{2\pi}{p}} e_d dx \quad (41)$$

$$\begin{aligned} \sum_{k=1}^n (n-k) \int_{\alpha + (k-1)\frac{2\pi}{p}}^{\alpha + k\frac{2\pi}{p}} e_1 dx &= \sum_{k=1}^n (n-k) \int_{\alpha + (k-1)\frac{2\pi}{p}}^{\alpha + k\frac{2\pi}{p}} E\sqrt{2} \sin x dx \\ &= 2E\sqrt{2} \sin \frac{\pi}{p} \sum_{k=1}^n (n-k) \sin \left( \alpha + \frac{2k-1}{p} \pi \right). \end{aligned}$$

Since the shape of the direct-current voltage wave repeats itself at intervals of  $2\pi/p$ , the limits of integration for the second term of Eq. (41) may be replaced by  $\alpha$  and  $\alpha + 2\pi/p$ .

$$\sum_{k=1}^n (n-k) \int_{\alpha}^{\alpha + \frac{2\pi}{p}} e_d dx = \frac{n(n-1)}{2} \int_{\alpha}^{\alpha + \frac{2\pi}{p}} e_d dx = \frac{n(n-1)}{p/\pi} E_d,$$

the value of  $E_d$  being substituted from Eq. (38). Substituting

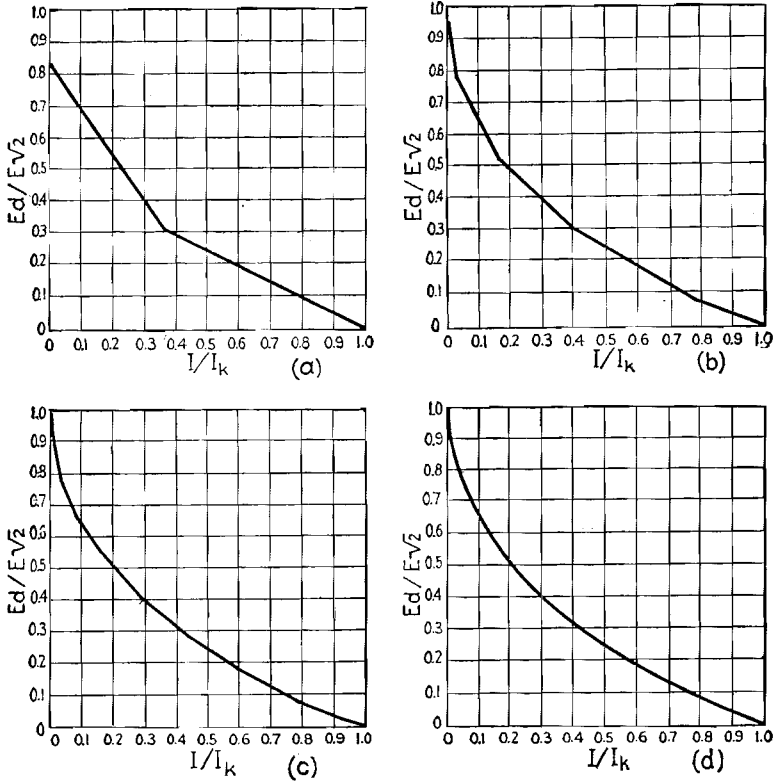

FIG. 30.—Curves showing current-voltage characteristics of rectifiers from no load to short circuit, with reactance in the secondary phases of the transformers: (a) three-phase connection; (b) six-phase connection; (c) twelve-phase connection; (d)  $\infty$ -phase connection.

the above expressions in Eq. (41), and replacing  $X$  by its value from Eq. (37), Eq. (42) is obtained (418):

$$\frac{E_d}{E\sqrt{2}} = \frac{p}{n(n-1)\pi} \left[ 2 \sin \frac{\pi}{p} \sum_{k=1}^n (n-k) \sin \left( \alpha + \frac{2k-1}{p} \pi \right) - p \frac{I}{I_k} \right] \quad (42)$$

Equation (42) is the general expression for the current-voltage relationship of a  $p$ -phase rectifier from no load to short circuit (224). The direct-current voltage is expressed as a fraction of  $E\sqrt{2}$ , the amplitude of the no-load phase voltage. The direct current is expressed as a fraction of the short-circuit current  $I_k$ .

In Fig. 30 are shown the current-voltage characteristics from no load to short circuit of rectifiers with 3, 6, 12, and  $\infty$  phases.

### CURRENTS AND VOLTAGES DURING BACK FIRES

The phenomenon of back fires and the conditions under which they may occur were discussed in Chap. III. Briefly, a back fire takes place when a cathode spot is formed on one of the anodes. This anode then acts as a cathode, emitting electrons, and current flows from the remaining anodes to this anode. The

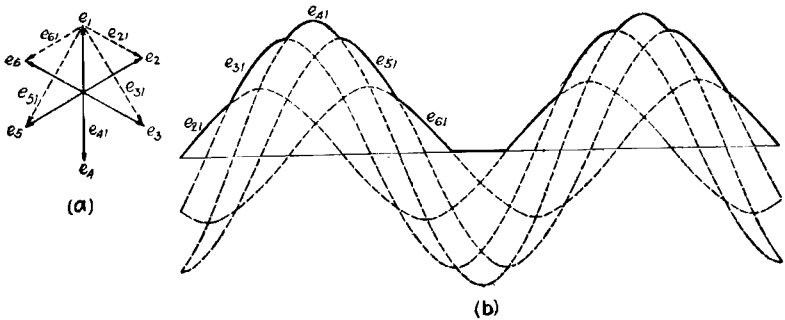

FIG. 31.—No-load wave shape of the voltage producing the flow of current in a back-firing phase.

current flowing to the back-firing anode from the other anodes is produced by the voltage difference between them. This voltage difference for a 6-phase rectifier when anode 1 is back-firing is shown in Fig. 31. In Fig. 31a is shown the vector diagram of the phase voltages  $e_1, e_2$ , etc., and of the voltage difference between phase 1 and the other phases,  $e_{21}, e_{31}$ , etc. The sine waves of the latter voltages have been drawn in Fig. 31b in their correct phase relation as determined from the vector diagram.

As is the case in the normal operation of the rectifier, the anode having the highest potential to the back-firing anode carries current. The envelope of the positive portions of the sine waves, shown in solid outline in Fig. 31b, therefore represents the

resultant voltage, producing the current flow in the back-firing phase. This voltage is seen to be a pulsating direct-current voltage. If the back-firing phase had a relatively high resistance, each of the non-back-firing phases would operate during one-sixth of a cycle, the current wave would have the same shape as the voltage wave, and the current would be zero during the one-sixth cycle when the voltage is zero. Actually, the resistance of the transformer winding is very small, and its reactance relatively high; for this reason, the current in the back-firing phase does not drop to zero, and consists of a direct-current component on which is superimposed an alternating-current component. Furthermore, the non-back-firing anodes do not operate singly, but there is considerable overlapping between them. Since phase 4 is generally on the same transformer leg with phase 1, its voltage is reduced by mutual induction from the short-circuit current in phase 1, thus leaving a depression at the top of the voltage wave in Fig. 31*b*, which is reflected in the shape of the current wave.

In Fig. 32 is shown an oscillogram of the direct-current voltage, the current in the back-firing phase, and the primary line current of a rectifier during a back fire. The rectifier was supplied from a 2,300-volt, 60-cycle, alternating-current supply, through a 4,000-kva. transformer having the primary connected in delta and the secondary in 6-phase diametrical. The oscillogram was taken with an artificial back fire imposed on the rectifier circuit by connecting one anode to the cathode (see Chap. XIV). With this connection, the current and voltage conditions in the transformer circuits are the same as during an actual back fire.

It is seen from the oscillogram that the anode current is unidirectional and consists of direct-current and alternating-current components. It may be noted that when the alternating-current circuit breaker is opened (at the point when the primary current becomes zero), disconnecting the transformer from the alternating-current supply, the current in the back-firing phase does not drop to zero instantly, but declines gradually. This is due to the fact that when the breaker is opened a closed circuit exists between the back-firing phase and one or more of the other phases which happen to be feeding into the back fire at the moment, through the rectifying arc; the current in this closed circuit therefore declines to zero at a rate determined by the ratio of the inductance to the resistance of the circuit.

The direct-current voltage, before the back fire is imposed, has the characteristic wave shape of a 6-phase rectifier connection. During the back fire, the direct-current voltage is actually the terminal voltage across the back-firing phase, which is affected by the resistive and reactive drop of the short-circuit current in that phase, and follows in general the wave shape of that current. The higher frequency oscillations of the voltage wave are produced by the successive starting up and extinction of the non-back-firing anodes which supply current to the back-firing phase.

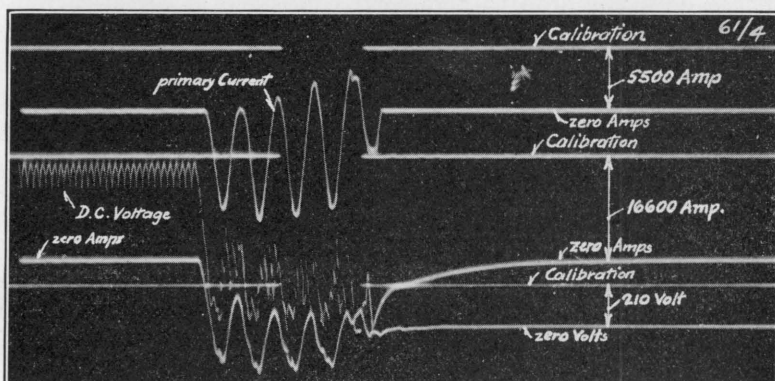

FIG. 32.—Oscillogram showing the primary current, the direct-current voltage, and the current in the back-firing phase during a back fire in a 6-phase rectifier.

If a rectifier is connected to a direct-current network which is also supplied from other direct-current machines (rectifiers or rotating machines), the cathode is at the potential of the positive pole of the system, and when a back fire occurs in the rectifier the cathode is at a higher potential than the back-firing anode, as can be realized from Fig. 32. The cathode therefore acts as an anode, causing current to flow from the network into the back-firing phase in the reverse direction from the normal current flow; this is shown in Fig. 19. Since the voltage across the back-firing phase is pulsating, as can be seen from Fig. 32, the difference between the voltage of the direct-current network and this voltage, which produces the flow of current from the network, is also pulsating, and the reverse current flowing into the cathode from the network, therefore, has an alternating-current component.

The flow of reverse current into a rectifier during a back fire is used in the selective protection of rectifier substations for disconnecting the rectifier from the direct-current and alternating-current buses, as described in Chap. XI.

## CHAPTER V

### THEORY (*Continued*)

In the preceding chapter, the current and voltage relations in circuits of polyphase rectifiers were derived on the assumption that the direct-current wave is a straight line. While this assumption leads to results sufficiently accurate for all practical purposes, in so far as the relations of voltage, current, and power on the direct- and alternating-current sides of the rectifier are concerned, and is entirely justified when there is a considerable amount of inductance on the direct-current side, yet in some cases the undulations in the direct-current voltage and current waves become a factor worth considering.

**Voltage Wave.**—In a polyphase rectifier, the load current at any instant is carried by the anode having the highest positive potential with respect to the neutral of the transformer secondary. The direct-current voltage at no load has the form shown in oscillogram 1 of Fig. 44. The undulation of the voltage wave is formed by the caps of the sine waves of the transformer secondary phase voltages. As each phase assumes a maximum positive potential once during every cycle, the number of pulsations per cycle must be equal to the number of phases, and the frequency of pulsation, or the number of pulsations per second, must be equal to the product of the frequency of the alternating-current supply and the number of secondary phases.

As already stated, if the transformer, the alternating-current supply line, and the generator supplying the rectifier were free of reactance, each anode of a  $p$ -phase rectifier would carry the whole direct current during the angle of  $2\pi/p$  radians only; thus, in Fig. 33*a*, the whole load current would be transferred instantly from phase 2 to phase 3 at  $m$ , and from phase 3 to phase 4 at  $n$ . Under such conditions, the direct-current voltage wave under load would have the same form as at no load.

Due to the unavoidable reactance present in the transformer, two adjoining phases are caused to overlap, and the angle of overlap  $u$  is given by Eq. (16). As a result of the overlapping,



the rectifier direct-current voltage wave under load now has the form shown in Fig. 33b and in oscillogram 2 of Fig. 44. The higher the current, the greater is the overlap. The effect of a change in the load on the shape of the voltage and current curves is illustrated in Fig. 29a to j and in Fig. 34. The oscillogram in this figure was taken on a rectifier connected to a resistance load, when the load current was changed suddenly from 140 to 560 amp.

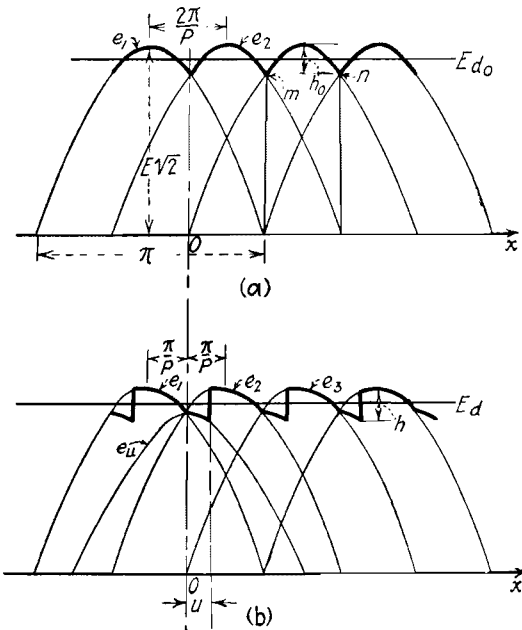

FIG. 33.—Wave shape of the direct-current voltage: (a) at no load; (b) under load.

The magnitude of the angle of overlap, and, therefore, the shape of the direct-current voltage wave under load depend somewhat on the nature of the load. Equation (16) was derived on the assumption that the current wave is a straight line. The angle  $u$  will be greater or less than that given by Eq. (16) depending on whether the current during the period of overlap is greater or less than the average current. The difference, however, is negligible, and the voltage wave is assumed to be independent of the character of the load.

The total height  $h$  of the ripple in the voltage wave is equal to the difference between the maximum and minimum ordinates

of the wave. From Fig. 33*b*, it is readily seen that for values of  $u < \pi/p$ , the maximum ordinate is equal to the amplitude of  $e_2$ , while the minimum ordinate is equal to the value of  $e_u$  for  $x = u$ . (The expression for  $e_u$  was derived in Chap. IV, page 59.)

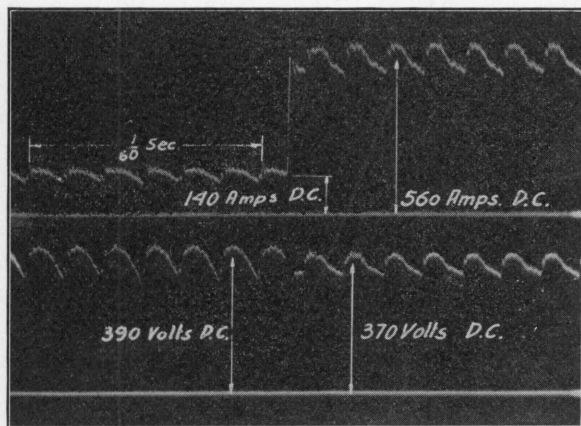

FIG. 34.—Oscillogram showing change in the wave shape of the direct-current voltage of a rectifier when the load is increased.

Therefore,

$$\begin{aligned} h &= E\sqrt{2} - E\sqrt{2} \cos \frac{\pi}{p} \cos u \\ &= E\sqrt{2} \left( 1 - \cos \frac{\pi}{p} \cos u \right). \end{aligned} \quad (43)$$

Expressing  $h$  as a fraction  $a$  of the average direct-current voltage at no load, given by Eq. (2),

$$\begin{aligned} a &= \frac{h}{E\sqrt{2} \frac{\sin \pi/p}{\pi/p}} \\ &= \frac{E\sqrt{2} \left( 1 - \cos \frac{\pi}{p} \cos u \right)}{E\sqrt{2} \frac{\sin \pi/p}{\pi/p}} \\ &= \frac{1 - \cos \frac{\pi}{p} \cos u}{\frac{\sin \pi/p}{\pi/p}}. \end{aligned} \quad (44)$$

For values of  $u > \pi/p$ , the maximum ordinate is equal to the value of  $e_2$  for  $x = u$ , and the minimum ordinate to the value of  $e_u$  for  $x = u$ . Therefore,

$$\begin{aligned} h &= E\sqrt{2} \cos\left(u - \frac{\pi}{p}\right) - E\sqrt{2} \cos\frac{\pi}{p} \cos u \\ &= E\sqrt{2} \sin\frac{\pi}{p} \sin u. \end{aligned} \quad (45)$$

$$a = \frac{E\sqrt{2} \sin\frac{\pi}{p} \sin u}{E\sqrt{2} \frac{\sin\pi/p}{\pi/p}} = \frac{\pi}{p} \sin u. \quad (46)$$

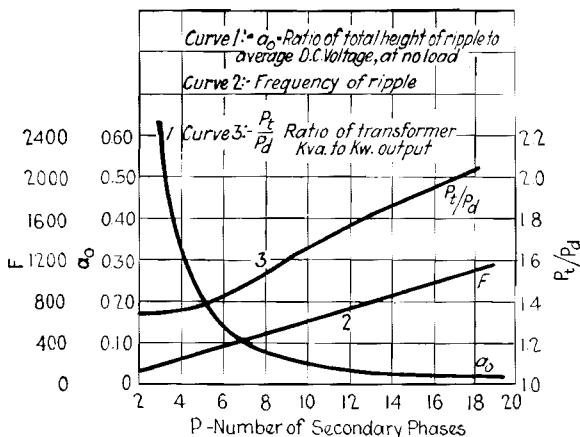

FIG. 35.—Curves showing the influence of the number of secondary phases on the height of the voltage ripple, the frequency of the ripple (for 60-cycle alternating-current power supply), and the rating of the transformer.

The variation of the ripple in the direct-current voltage wave with the number of phases, at no load, is shown by curve 1 in Fig. 35. In the same figure are plotted the frequency of the main ripple and the ratio of the transformer rating to the direct-current load, to show the effect of the number of phases on these quantities. (In regard to curve 3, see Table V, Chap. VI.) The magnitude of the ripple naturally decreases as the number of phases is increased; but to counterbalance, the size of the transformer increases with the number of phases.

In Fig. 36 is shown the variation of the voltage ripple of a 6-phase rectifier with the load on the rectifier. The curves have been plotted from Eqs. (44) and (46). The load is expressed

as a ratio,  $I/I_s$ . This ratio is deduced by rewriting Eq. (16) as follows:

$$\cos u = 1 - \frac{I}{\frac{E\sqrt{2}}{X} \sin \frac{\pi}{p}} = 1 - \frac{1}{\sin \frac{\pi}{p}} \cdot \frac{I}{I_s} \quad (47)$$

where

$$I_s = \frac{E\sqrt{2}}{X}$$

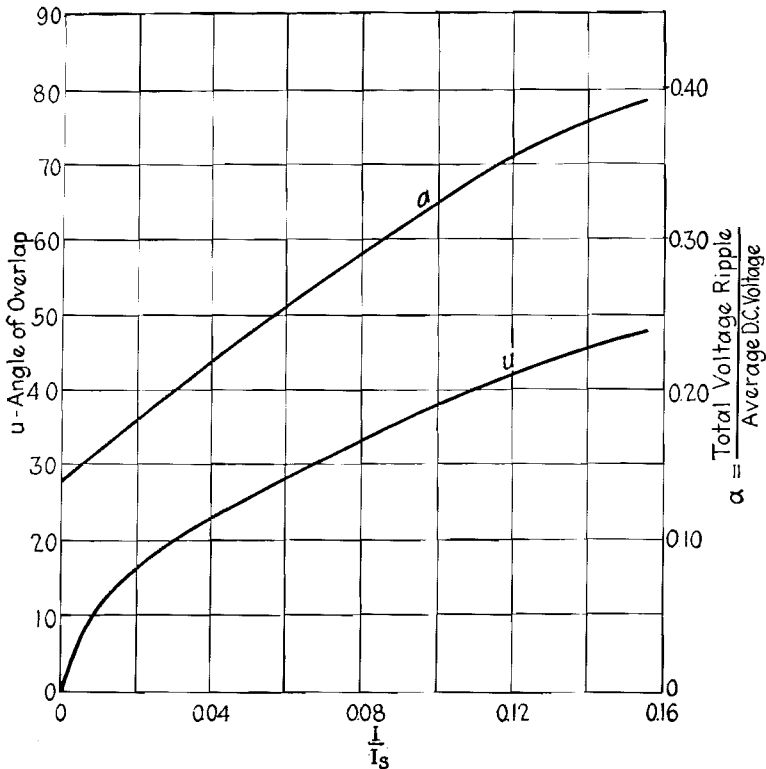

FIG. 36.—Curves showing the relation between the load current, the angle of overlap, and the height of the voltage ripple of a 6-phase rectifier connection.

The point on the abscissa corresponding to full-load current of a rectifier is determined by the value of  $X$ , and therefore depends upon the design of the transformer. The smaller the value of  $X$  for a given transformer rating, the larger is  $I_s$  and, therefore, the smaller the ratio  $I/I_s$  at full load. The value of  $I/I_s$  corresponding to full load is approximately 0.05.

It was shown above that the form of the rectifier direct-current voltage wave depends on the number of phases used and on the design of the transformer, and that it varies with the magnitude of the load, but is practically independent of the nature of the load. The wave consists of a direct-current component equal to the average value of the voltage, on which is superimposed an alternating component made up of the upper portions of sinusoidal waves. The alternating component is irregular in shape and cannot be expressed by a continuous function. It may be resolved into harmonic components by means of a Fourier series. The first harmonic has a frequency equal to the product of the frequency of the alternating-current supply and the number of phases used; it is, therefore, the  $p$ th harmonic with respect to the alternating-current voltage supplied to the rectifier. The frequencies of the higher harmonics are multiples of the frequency of the first harmonic and since the positive and negative portions of the wave are not symmetrical, there are even multiples as well as odd. Thus, the direct-current voltage wave of a 6-phase rectifier supplied by a 60-cycle system has an alternating component consisting of sinusoidal waves of frequencies 360, 720, 1,080, etc., cycles.

The general equation of the direct-current voltage of a  $p$ -phase rectifier, expressed by a Fourier series, is

$$e_d = E_d + A_{p1} \sin px + A_{p2} \sin 2px + A_{p3} \sin 3px + \dots \\ + A_{pn} \sin npx + \dots + B_{p1} \cos px + B_{p2} \cos 2px + \\ + B_{p3} \cos 3px + \dots + B_{pn} \cos npx + \dots \quad (48)$$

The voltage curve may be analyzed to determine the amplitudes of the various harmonics by any one of the well-known methods of analysis.

A theoretical analysis of the direct-current voltage wave under load to determine the general expression for the  $A$  and  $B$  coefficients of any harmonic in the above series is given below. This analysis is carried out over the angle  $2\pi/p$ , which corresponds to 360 electrical degrees, or 1 cycle, for the first harmonic.

In analyzing a periodic wave expressed by a Fourier series, such as Eq. (48), the amplitude of the sine component of any harmonic may be determined by multiplying both sides of the equation by the sine function of that harmonic, and integrating the equation. By this integration all the terms on the right-hand side of the equation are cancelled, with the exception of the sine

term of the harmonic under consideration, which makes it possible to solve for the amplitude of that harmonic. The amplitude of the cosine component of the harmonic may be determined similarly by multiplying both sides of the equation by the cosine function and integrating. If the wave being analyzed can be expressed by some function of its abscissa, the expression on the left-hand side of the equation may be integrated analytically. If it cannot be expressed by any function, the integration may be performed graphically by the method of ordinates, or mechanically.

Employing the method outlined above for determining the  $A$  and  $B$  coefficients of the  $n$ th harmonic in the direct-current voltage wave, expressed by the Fourier series of Eq. (48),

$$\int_0^{2\pi/p} e_d \sin pnxdx = \int_0^{2\pi/p} A_{pn} \sin^2 pnxdx,$$

from which

$$\frac{\pi}{p} A_{pn} = \int_0^{2\pi/p} e_d \sin pnxdx. \quad (49)$$

Similarly,

$$\int_0^{2\pi/p} e_d \cos pnxdx = \int_0^{2\pi/p} B_{pn} \cos^2 pnxdx,$$

$$\frac{\pi}{p} B_{pn} = \int_0^{2\pi/p} e_d \cos pnxdx. \quad (50)$$

For integrating Eqs. (49) and (50),  $e_d$ , the direct-current voltage wave under load, as shown in Fig. 37, may be expressed in terms of the no-load voltage and the voltage drop due to overlapping. Considering the point of intersection of the no-load voltage waves of two adjoining phases as the origin, the no-load voltage is given by the expression

$$E\sqrt{2} \cos\left(x - \frac{\pi}{p}\right)$$

and the voltage drop during the period of overlap by the expression  $E\sqrt{2} \sin(\pi/p) \sin x$  (see equation of  $e_L$ , page 59). The direct-current voltage  $e_d$  may be represented by two expressions, one for the period of overlap  $u$ , the other for the rest of the period  $2\pi/p$ .

$$e_d = \left[ E\sqrt{2} \cos\left(x - \frac{\pi}{p}\right) - E\sqrt{2} \sin \frac{\pi}{p} \sin x \right]_0^u + \left[ E\sqrt{2} \cos\left(x - \frac{\pi}{p}\right) \right]_u^{2\pi/p}.$$

For purposes of integration, the above equation may be grouped as follows:

$$e_d = \left[ E\sqrt{2} \cos \left( x - \frac{\pi}{p} \right) \right]_0^{2\pi/p} - \left[ E\sqrt{2} \sin \frac{\pi}{p} \sin x \right]_0^u.$$

The limits of integration for the various terms are equivalent in the two equations.

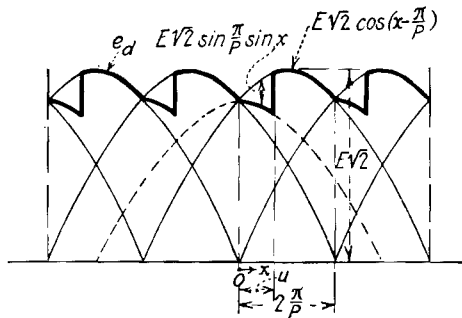

FIG. 37.—Direct-current voltage wave of a  $p$ -phase rectifier under load, used in deriving the general equations for analyzing the direct-current voltage.

Substituting the above expression for  $e_d$  in Eqs. (49) and (50),

$$\frac{\pi}{p} A_{pn} = \int_0^{2\pi/p} E\sqrt{2} \cos \left( x - \frac{\pi}{p} \right) \sin pnxdx - \int_0^u E\sqrt{2} \sin \frac{\pi}{p} \sin x \sin pnxdx.$$

Integrating and solving for  $A_{pn}$ ,

$$\begin{aligned} A_{pn} &= \frac{1}{2} \cdot \frac{E\sqrt{2} \sin(\pi/p)}{\pi/p} \left[ \frac{\sin(np+1)u}{np+1} - \frac{\sin(np-1)u}{np-1} \right] \\ &= \frac{E_{d0}}{2} \left[ \frac{\sin(np+1)u}{np+1} - \frac{\sin(np-1)u}{np-1} \right]. \end{aligned}$$

$E_{d0} = \frac{E\sqrt{2} \sin(\pi/p)}{\pi/p}$  is the average value of the no-load direct-current voltage, as was given by Eq. (2).

The ratio of the amplitude  $A_{pn}$  to the no-load direct-current voltage is

$$\alpha_{pn} = \frac{A_{pn}}{E_{d0}} = 0.5 \left[ \frac{\sin(np+1)u}{np+1} - \frac{\sin(np-1)u}{np-1} \right]. \quad (51)$$

Similarly,

$$\begin{aligned} \frac{\pi}{p} B_{pn} &= \int_0^{2\pi/p} E\sqrt{2} \cos\left(x - \frac{\pi}{p}\right) \cos pnxdx - \\ &\int_0^u E\sqrt{2} \sin \frac{\pi}{p} \sin x \cos pnxdx, \\ B_{pn} &= \frac{1}{2} E_{do} \left[ \frac{\cos (np+1)u}{np+1} - \frac{\cos (np-1)u}{np-1} \right] - \frac{E_{do}}{n^2 p^2 - 1}, \\ \beta_{pn} = \frac{B_{pn}}{E_{do}} &= 0.5 \left[ \frac{\cos (np+1)u}{np+1} - \frac{\cos (np-1)u}{np-1} \right] - \frac{1}{n^2 p^2 - 1}. \end{aligned} \quad (52)$$

The amplitude of the  $n$ th harmonic is equal to

$$\begin{aligned} C_{pn} &= \sqrt{A_{pn}^2 + B_{pn}^2} \\ \gamma_{pn} = \frac{C_{pn}}{E_{do}} &= \sqrt{\alpha_{pn}^2 + \beta_{pn}^2}. \end{aligned} \quad (53)$$

The r.m.s. value of the  $n$ th harmonic is

$$\begin{aligned} H_{pn} = \frac{C_{pn}}{\sqrt{2}} &= \frac{\sqrt{A_{pn}^2 + B_{pn}^2}}{\sqrt{2}} \\ \lambda_{pn} = \frac{H_{pn}}{E_{do}} &= \frac{\gamma_{pn}}{\sqrt{2}} = \frac{\sqrt{\alpha_{pn}^2 + \beta_{pn}^2}}{\sqrt{2}}. \end{aligned} \quad (54)$$

The r.m.s. value of the total ripple voltage is

$$E_h = \sqrt{H_p^2 + H_{2p}^2 + H_{3p}^2 + \dots \text{etc.}} \quad (55)$$

As seen from Eqs. (51) and (52), the ratios  $\alpha$ ,  $\beta$ ,  $\gamma$ , and  $\lambda$  are functions of the number of phases, the order of the harmonic, and the angle of overlap, but are independent of the direct-current voltage. In Figs. 38, 39, and 40 are plotted the curves of the r.m.s. values of several harmonics as percentages of the no-load direct-current voltage, in function of the angle of overlap  $u$ , for 3-, 6-, and 12-phase connections, respectively. The frequency of any of the harmonics shown in these figures is equal to the product  $pnf$ , in which  $p$  is the number of phases,  $n$  the order of the harmonic, and  $f$  the frequency of the alternating-current supply to the rectifier.

At no load,  $u$  is equal to zero;  $A_{pn}$  is then also equal to zero, while  $B_{pn} = -\frac{2E_{do}}{n^2 p^2 - 1}$ . That is, the expression for the direct-current voltage wave at no load contains only cosine functions.



A consideration of the direct-current voltage wave at no load will show that this is to be expected. At no load, the voltage wave is symmetrical about the point of intersection of the phase voltages, which was used as the origin in Fig. 37; the harmonic waves must, therefore, also be symmetrical about that point, which requires that they be cosine waves with reference to that point.

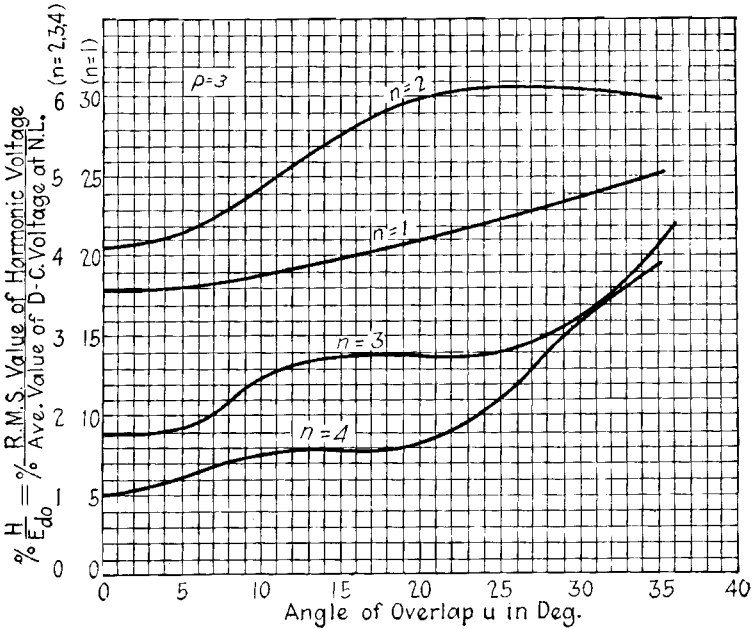

Fig. 38.—Curves showing the relation between the angle of overlap  $u$  and the first four harmonic components of the direct-current voltage of a 3-phase rectifier connection.

In the tables on page 94 are given analyses, obtained with a wave analyzer, of the alternating components in the direct-current line voltage waves of rectifiers operating on railway loads. Table III gives the analysis for a 900-kw., 600-volt, 6-phase, 60-cycle rectifier, both with and without a series reactor on the direct-current side. Table IV gives the analysis of a 1,500-kw., 1,500-volt, 6-phase, 60-cycle rectifier: (a) when connected directly to the line, (b) with a 3-mh. series reactor on the direct-current side, (c) with a 3-mh. reactor and with a synchronous converter operating in parallel with the rectifier.

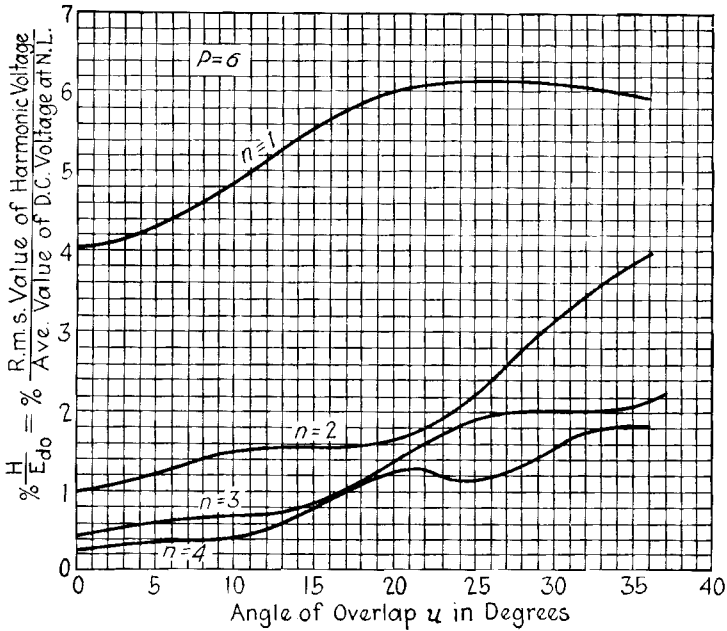

FIG. 39.—Curves showing the relation between the angle of overlap  $u$  and the first four harmonic components of the direct-current voltage of a 6-phase rectifier connection.

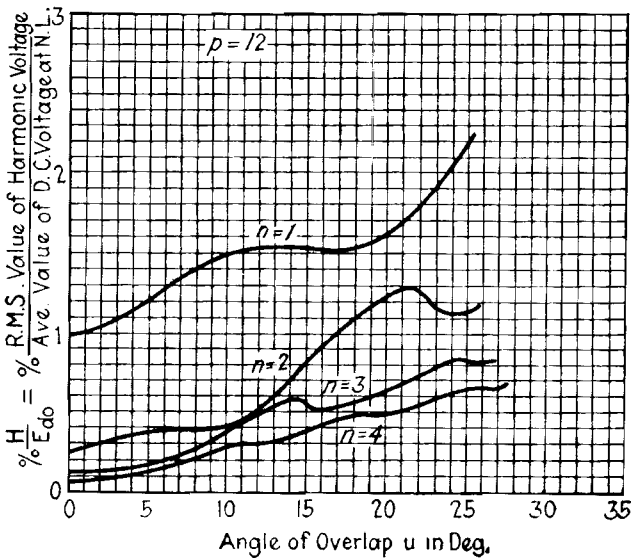

FIG. 40.—Curves showing the relation between the angle of overlap  $u$  and the first four harmonic components of the direct-current voltage of a 12-phase rectifier connection.

TABLE III.—900-kw., 600-VOLT, 6-PHASE, 60-CYCLE RECTIFIER

Order of harmonic	Frequency in cycles per second	Percentage root-mean-square value of harmonic to direct-current voltage	
		Without reactor	With 3-mh. reactor
First.....	360	5.9	1.74
Second.....	720	1.25	0.35
Third.....	1,080	0.73	0.17
Fourth.....	1,440	0.78	0.14
Fifth.....	1,800	0.53	0.08
Sixth.....	2,160	0.43	0.05
Seventh.....	2,520	0.33	0.05
Eighth.....	2,880	0.28	0.05

TABLE IV.—1,500-kw., 1,500-VOLT, 6-PHASE, 60-CYCLE RECTIFIER

Order of harmonic	Frequency in cycles per second	Percentage root-mean-square value of harmonic to direct-current voltage		
		Rectifier directly on line	Rectifier with 3-mh. reactor	Rectifier with reactor and synchronous converter in parallel
First.....	360	4.8	2.00	0.80
Second.....	720	1.33	0.60	0.26
Third.....	1,080	0.90	0.33	0.067
Fourth.....	1,440	0.72	0.30	0.075
Fifth.....	1,800	0.69	0.30	0.070

The difference in the magnitudes of the harmonics in the two tables when operating without a reactor is due to the difference in the loads at which the measurements were made, and also to the variation in load while the measurements were being made, which caused the angle of overlap to vary (see also Tables XI and XII).

**Current Wave.**—When the voltage wave with its direct- and alternating-current components is known, the shape of the current wave may readily be determined when the constants of the load are known.

The shape of a rectifier current wave and the degree to which it approaches the average value or the ideal straight line, such as

obtained from a battery, depends on the type of the load; the larger the inductance in the load circuit the more closely will the current wave approach a straight line. The degree of rectification is arbitrarily defined as the ratio

$$DR = \frac{\text{average value of the direct current}}{\text{root-mean-square value of the direct current}}$$

This factor is equal to the ratio of the reading obtained with a permanent-magnet type direct-current ammeter to the reading obtained with a dynamometer-type alternating-current ammeter.

A 6-phase rectifier with a generalized direct-current load is shown in Fig. 41. The load may consist of any one of the following:

1. Resistance only ( $R$ ).
2. Resistance and back-e.m.f. ( $R + E_b$ ).
3. Resistance and inductance ( $R + L$ ).
4. Resistance, inductance, and back-e.m.f. ( $R + L + E_b$ ).

1. *Resistance Only.*—With a load consisting of resistance only, such as a lighting or heating load, the current

wave has the same shape as the voltage wave; *i.e.*, the harmonic components in the ripple bear the same ratios to the average value of current as in the voltage wave.

2. *Resistance and Back-e.m.f.*—With a load consisting of a resistance  $R$  and a constant back-e.m.f.  $E_b$ , such as is obtained in battery charging, the average value of direct current is equal to the ratio of the net voltage,  $E_d - E_b$ , in the circuit to the resistance  $R$  of the load (battery):

$$I = \frac{E_d - E_b}{R}$$

The value of alternating current, however, remains the same as in a circuit without back-e.m.f., as considered under 1, and is equal to  $E_h/R$ ,  $E_h$  being the alternating-current component as given by Eq. (55). Since in the case of resistance load the direct current was  $E_d/R$ , we see that the presence of the back-e.m.f.

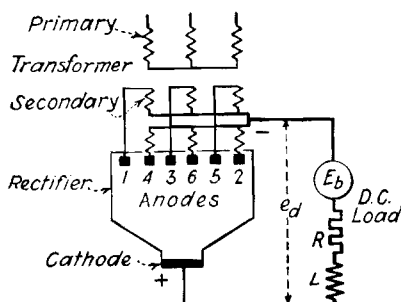

FIG. 41.—Rectifier connected to generalized direct-current load.

increases the percentage of ripple in the current from  $E_h/E_a$  to  $E_h/(E_a - E_b)$ , the ratio of the two values being  $E_a/(E_a - E_b)$ .

3. *Resistance and Inductance.*—With a load consisting of resistance and inductance, such as a lighting or heating load fed over a line having a certain amount of inductance, or with a series reactor connected into the direct-current circuit for smoothing out the wave, the average direct current is equal to the ratio of average direct-current voltage to the resistance:  $I = E_d/R$ . The magnitude of the  $n$ th harmonic in the current ripple, however, is equal to the magnitude of the corresponding harmonic in the voltage ripple divided by the impedance of the circuit to that harmonic:

$$I_{pn} = \frac{H_{pn}}{\sqrt{R^2 + X_{pn}^2}}$$

From the above,

$$\begin{aligned} \frac{I_{pn}}{I} &= \frac{R}{\sqrt{R^2 + X_{pn}^2}} \cdot \frac{H_{pn}}{E_d} \\ &= \frac{1}{\sqrt{1 + \frac{X_{pn}^2}{R^2}}} \cdot \frac{H_{pn}}{E_d}, \end{aligned} \quad (56)$$

*i.e.*, the percentage of the  $n$ th harmonic in the current wave is less than that of the corresponding harmonic in the voltage wave by the ratio of  $1/\sqrt{1 + X_{pn}^2/R^2}$ , in which  $X_{pn} = p\omega L$  is the reactance of the circuit to the  $n$ th harmonic. It is seen from

the above that the inductance has a smoothing effect upon the current wave, and the smoothing action is greater for the higher harmonics.

4. *Resistance, Inductance, and Back-e.m.f.*—This type of load is by far the most common load supplied by rectifiers, as it is characteristic of all direct-current

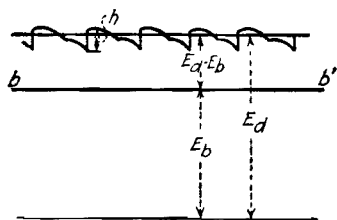

FIG. 42.—Voltage conditions for a load circuit having a back-e.m.f.

motors. While starting, when the speed of the motor is zero, the back-e.m.f. is also zero, and the load conditions are as given under 3. When the motor is running, a back-e.m.f. is generated, in opposition to the applied e.m.f.; the voltage conditions are then as shown in Fig. 42. The current is produced by the portion of the voltage curve lying above line  $bb'$ , as for load 2.

The load here, however, is inductive and the current wave is consequently smoothed. The average direct current is

$$I = \frac{E_a - E_b}{R}$$

The magnitude of the  $n$ th harmonic in the current wave,

$$\begin{aligned} I_{pn} &= \frac{H_{pn}}{\sqrt{R^2 + X_{pn}^2}} \\ \frac{I_{pn}}{I} &= \frac{R}{\sqrt{R^2 + X_{pn}^2}} \cdot \frac{H_{pn}}{E_a - E_b} \\ &= \frac{1}{\sqrt{1 + \frac{X_{pn}^2}{R^2} \cdot \left(1 - \frac{E_b}{E_a}\right)}} \cdot \frac{H_{pn}}{E_a} \end{aligned} \quad (57)$$

From Eq. (57) it is seen that the percentage of the  $n$ th harmonic in the current wave differs from the corresponding harmonic of the voltage wave in the proportion of

$$\frac{1}{\sqrt{1 + \frac{X_{pn}^2}{R^2} \cdot \left(1 - \frac{E_b}{E_a}\right)}}$$

the symbols having the same meaning as in Eq. (56).

**Effect of Load on Current Wave.** *Railway Load (Series Motors).*—The series direct-current motor used for railways, hoists, etc. is the most common load fed by rectifiers; in fact it is the favorable characteristics of the series direct-current motor for traction purposes that have brought about the present large-scale conversion of power from alternating to direct current. The series motor is also the most favorable load for smoothing out the ripples in the current wave, due to the inductance of the series field of the motor. Whatever residual undulations remain in the current wave will produce useful torque, since the same current flows through both the armature and the field. Measurements made on series motors fed by 6-phase rectifiers did not show any increase in losses on account of this residual alternating-current component of the direct current. In oscillogram 3, Fig. 44, are shown the voltage and current waves of a rectifier supplying a railway load. The oscillogram was taken on a 1,500-volt rectifier at 200 per cent of the rated load, when the voltage ripple is greater than at rated load, and shows the smoothing effect of the series motor on the current wave.

A further smoothing out of the current, and also of the voltage wave supplied to the line, can be effected by connecting a reactor in the direct-current circuit of the rectifier. The smoothing of the voltage wave is produced by the alternating-current voltage drop across the reactor, due to the ripple in the current. The effect of the reactor on the current and voltage waves supplied to the line by a rectifier is shown in oscillogram 4, Fig. 44. The oscillogram was taken at approximately the same load and under the same conditions as oscillogram 3, except that a series reactor of approximately 3 millihenrys was connected into the circuit when oscillogram 4 was taken.

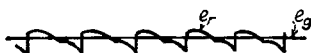

FIG. 43.—Voltage conditions when a rectifier operates in parallel with a rotary converter or a direct-current generator.

When a rectifier operates in parallel with a rotary converter or a direct current generator which has a smoother voltage wave than the rectifier, the resultant line voltage and current waves are smoother than those of a rectifier alone. This condition is shown in Fig. 43. In this figure,  $e_r$  is the voltage wave of the rectifier and  $e_g$  that of the rotary machine. For the sake of simplicity, the commutator ripples of the rotary machine are not shown. The smoothing of the voltage wave is produced by the interchange of a small alternating current between the rectifier and the rotary machine.

The interchange current is produced by the alternating component in the difference of the two voltage waves. The alternating-current voltage drop in the leakage reactance of the rectifier transformer, produced by the alternating current component flowing between the rectifier and rotary machine, reduces the ripple in the voltage wave of the rectifier. In this respect, the rotary acts somewhat as a shunt filter across the rectifier in that it absorbs an alternating current component (Chap. XIII).

When a series reactor is connected into the direct-current lead of a rectifier operating in parallel with a rotary, the wave of line

voltage is improved on account of the additional drop in the reactor due to the alternating interchange current.

The above conditions are clearly shown in oscillograms 5 and 6, Fig. 44. Oscillogram 5 was taken with a rectifier operating in parallel with a rotary in the same station. Oscillogram 6 was

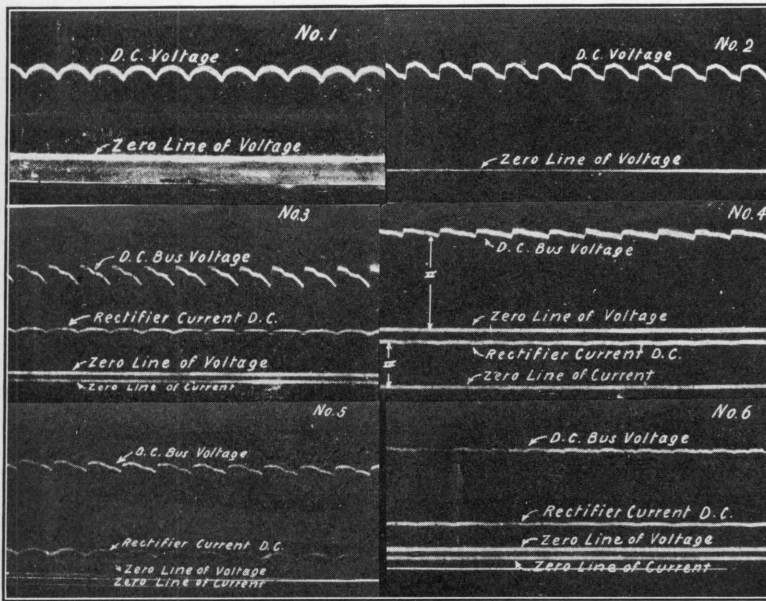

FIG. 44.—Oscillograms of direct current and voltage waves of a 1500-kw., 1500-volt railway rectifier under various operating conditions: 1. Direct-current voltage wave at no load. 2. Direct-current voltage wave under load. 3. Waves of voltage and current supplied to railway load, rectifier operating alone. 4. Waves of voltage and current supplied to railway load, rectifier operating alone, with a series reactor in the circuit. 5. Waves of voltage and current supplied to railway load, rectifier operating in parallel with rotary converter in the same station. 6. Waves of voltage and current supplied to railway load, rectifier operating in parallel with rotary converter in the same station, and with a series reactor in the rectifier circuit.

taken at about the same current and under the same conditions as oscillogram 5, except that there was a series reactor in the rectifier circuit.

*Shunt Motors.*—In shunt-wound motors, the field is connected in parallel with the armature across the supply line. Due to the high inductance of the field coils, the current in these coils is smoothed out, so that the flux produced by the field has no pulsations. The alternating-current component in the recti-



fier voltage will in turn produce an alternating current in the armature. This current cannot produce any useful torque, but will produce  $I^2R$  losses in the armature, thereby affecting the efficiency.

*Lighting and Heating Load.*—With a lighting or heating load the effective (r.m.s.) values of the voltage and current waves must be considered, since both alternating- and direct-current components are converted into useful energy.

*Electrolytic Cells.*—Cells in which metallic salts are decomposed electrolytically are characterized by a resistance  $R$  and by a polarization voltage or back-e.m.f.  $E_b$ . This applies to cells where the salts are fused by the application of heat as well as to cells where they are dissolved in a suitable solvent. Whether the cells are fed by a source of constant direct current or by a rectifier, the direct current will be  $(E_a - E_b)/R$ , and will produce in the cells an ohmic loss of

$$\frac{(E_a - E_b)^2}{R} = I^2R.$$

If a rectifier is used, the alternating-current component of the current produces additional losses in the cell, without having any electrolytic action. If  $E_h$  is the r.m.s. value of the ripple voltage having the height  $h$ , this loss will be  $E_h^2/R$ , and may reach a considerable value in cells or banks of cells having a very low resistance. In some electrolytic processes the cells have to be heated in order to obtain a satisfactory deposit of metal. In the electrolytic production of aluminum, for example, a considerable part of even the direct current is used for maintaining the electrolyte in a molten state. In such processes the loss due to the ripple current will not be detrimental to the efficiency of the plant, and may even be desirable as convenient means for heating the cells. The electrolytic efficiency of electrolytic cells may be increased by the presence of an alternating-current component in the current, due to its effect on the polarization of the electrodes.<sup>1</sup>

When using rectifiers for electrolytic processes in which the ripple loss cannot be utilized, it is usually advantageous to reduce the ripple by introducing a reactor into the circuit, particularly

<sup>1</sup>COCKS, H. C., "Applications of A.C. to Electro-deposition," *Elec. Rev.*, pp. 39 *f.*, July 5, 1929; ALLMAN and ELLINGHAM, "The Principles of Applied Electrochemistry," Chap. VIII, pp. 147 *ff.*

with cells of very low resistance, since a reactor of relatively low inductance will reduce the ripple current to a small fraction of its former value. In first approximation, assuming that  $R$  is much smaller than  $X$ , we see that the ripple current will be  $E_h/X$ , where  $X$  is the effective reactance of the reactor, and the loss in the cells is equal to  $E_h^2R/X^2$  instead of  $E_h^2/R$ , giving a reduction in the ratio of  $X^2:R^2$ . The reduction found is slightly better when the exact current relation is considered. On the other hand, the resistance of the reactor increases the losses. Let  $R_1$  be the direct-current resistance of the reactor; then the direct-current loss in the reactor will be  $I^2R_1$ . The resistance  $R_2$  of the reactor at ripple frequency may be considerably higher than  $R_1$ , especially in the case of reactors made of solid conductor. Let it also be assumed that the ripple is sinusoidal. The ripple current in the circuit will then be

$$I_h = \frac{E_h}{\sqrt{X^2 + (R + R_2)^2}}$$

causing a loss

$$W_h = \frac{E_h^2(R + R_2)}{X^2 + (R + R_2)^2} \quad (58)$$

Equation (58) may be written in the following form:

$$X^2 + \left[ (R + R_2) - \frac{E_h^2}{2W_h} \right]^2 = \frac{E_h^4}{4W_h^2} \quad (58a)$$

It can be readily seen that, considering  $X$  (or the inductance  $L$  of the reactor) as the variable of the ordinate and  $(R + R_2)$  as the variable of the abscissa in a system of linear coordinates, Eq. (58a) represents a circle of radius  $E_h^2/2W_h$ , passing through the origin and with its center on the axis of the abscissa. Assuming a constant value of  $E_h$  and variable values of  $W_h$ , a family of circles will be obtained, one circle for each value of  $W_h$  assumed.

The loss  $W_h$  may therefore be determined from a chart as shown in Fig. 45, where the abscissæ are the resistance in the circuit and the ordinates are the reactance in the circuit. A point having for its coordinates the constants of the circuit will be located on a circle marked with the ripple loss in the circuit. For convenience, this chart was computed for a ripple voltage  $E_h$  of 0.08 volt, corresponding to 1 volt of direct-current voltage

for a 6-phase rectifier. The loss read must therefore be multiplied by the square of the direct-current voltage at the load considered.

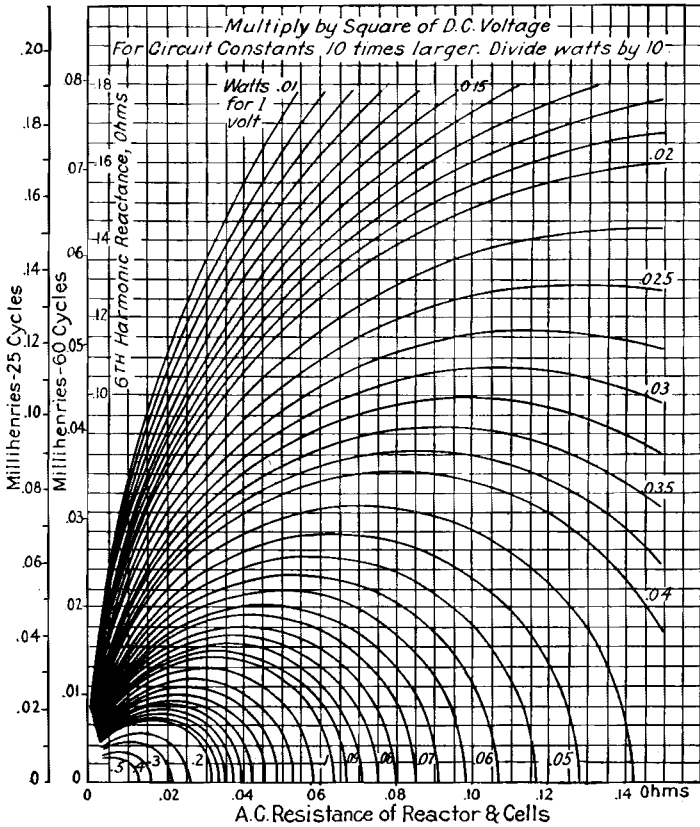

FIG. 45.—Chart for determining the losses in the circuit of electrolytic cells, due to the ripple in the direct-current voltage of a 6-phase rectifier.

The distribution of the output of the rectifier may then be tabulated as follows:

Chemical energy.....	$IE_b$ computed
Losses:	
Direct-current loss in cells.....	$I^2R$ computed
Direct-current loss in reactor.....	$I^2R_1$ computed
Alternating-current loss in reactor and cells	$\frac{E_h^2(R + R_2)}{\bar{X}^2 + (R + R_2)^2}$ from chart.

The alternating-current losses in the reactor and in the cells may be segregated, being in the ratio of  $R_2 : R$ .

## CHAPTER VI

### RECTIFIER TRANSFORMERS: THEIR CONNECTIONS AND CHARACTERISTICS

**General.**—In order to obtain from the rectifier a direct-current voltage of required value and of good wave form, a multiphase alternating-current supply, usually of six phases or more, of a voltage having a definite relation to the direct-current voltage, must be applied to the anodes of the rectifier.

Usually, the rectifier is supplied from a 3-phase (sometimes 2-phase) alternating-current system, having a voltage quite different from that required for the anodes. For this reason a transformer is required for the rectifier, to transform the available alternating-current supply to the proper voltage and number of phases required for the anodes.

The general principles underlying the design of power transformers apply to rectifier transformers as well. The voltages applied to a rectifier transformer are sinusoidal, and the design of core and windings as regards induction, core losses, and volts per turn is the same as for other transformers.

Rectifier transformers differ from ordinary power transformers, used for transforming alternating-current power of one voltage to alternating-current power of another voltage, in respect to the character of the load on the secondary. The load of ordinary power and distribution transformers generally has a practically constant impedance per phase, over the whole cycle of alternating-current voltage, and draws a sinusoidal current from the transformer. Due to the valve action of the rectifier, each anode operates only during part of the cycle, so that each phase of the transformer secondary carries current only during part of the cycle (see Fig. 15, Chap. III).

As a result of this, the kilovolt-ampere rating of the transformer is higher than the kilowatt output from the rectifier, and, unlike ordinary power transformers, the kilovolt-ampere rating of the secondary winding is higher than that of the primary. The currents flowing in the windings of a rectifier transformer are

irregular in shape, and not sinusoidal as for power transformers. The r.m.s. value of the current in each winding must be considered for the design of the windings and for the calculation of the copper losses. The reactive voltage drop in the transformer, produced by the non-sinusoidal currents, affects the wave shape of the secondary terminal voltage, and, therefore, the direct-current voltage characteristic of the rectifier.

The leakage reactance of a rectifier transformer has a much greater effect on the regulation of the rectifier direct-current voltage than for an alternating-current power transformer operating at the same power factor. For this reason it is usually desirable to have as low a leakage reactance as possible for rectifier transformers. The transformer must, however, be so designed as to be self-protecting in case of short circuit. On account of the unsymmetrical load imposed on the secondary windings, these windings must be so arranged and distributed with reference to the primary windings and to each other that balanced conditions exist with regard to the leakage reactance and stresses under normal as well as abnormal working conditions.

The secondary windings of rectifier transformers may also be subjected to high voltage surges, and for this reason the secondary windings and connections must be insulated for a higher voltage than required for power transformers of the same voltage rating.

Rectifier transformers are generally of the 3-phase core-type construction. The primaries are connected in Y or in delta. The secondaries are connected for 3, 6, or 12 phases, as required.

The load characteristics of a rectifier and the rating of the transformer depend largely on the type of transformer connection used. These characteristics for various transformer connections will be considered in the present chapter, and are tabulated in Table V.

#### SELECTION OF TRANSFORMER CONNECTIONS

In deciding on the type of transformer connection to be used, the following factors must be considered:

1. Wave shape of direct-current voltage and current.
2. Direct-current voltage regulation.
3. Efficiency of rectifier.
4. Utilization factor of transformer.
5. Simplicity of internal transformer connections.
6. Power factor at primary terminals of transformer.

These factors will now be discussed.

1. The direct-current voltage wave of a rectifier, as explained in the preceding chapters, is undulating. The frequency and magnitude of the undulations depend on the number of phases used; the larger the number of phases, the closer does the voltage wave approach a straight line. The undulations of the voltage wave and of the resulting current wave in the load circuit may affect the operating characteristics of the load circuit, and may produce interference in communication circuits exposed to the load circuit. The effects of the undulations on the characteristics of the load circuit for various types of loads were considered in Chap. V; the influence on communication circuits will be considered in Chap. XIII. These considerations indicate that, consistent with the other factors affecting the selection of transformer connections, it is generally desirable to have a relatively smooth voltage wave, and, consequently, a transformer with a large number of phases.

2. The rectifier has inherently a shunt (drooping) voltage characteristic. It is often desirable to obtain a certain voltage regulation curve to suit the load conditions on the direct-current system, or to facilitate parallel operation with other machines. The voltage characteristic is determined largely by the type of transformer connection and the number of phases used. It may also be desirable to use special means to obtain a "compound" voltage characteristic. In selecting a transformer connection, consideration must also be given to the voltage rise at no load produced by certain voltage regulation characteristics, which may affect the equipment on a railway system. This must be considered particularly for direct-current voltages above 1,500 volts.

3. The arc voltage drop in the rectifier cylinder is influenced by the shape of the anode currents as obtained from different types of transformer connections, as was pointed out in Chap. II (Fig. 7). The influence of the voltage drop on the overall efficiency of the rectifier is particularly noticeable for low direct-current voltages; the effect of efficiency upon the choice of transformer connections is, therefore, particularly important for low direct-current voltages.

4. The size of the transformer, *i.e.*, its kilovolt-ampere rating, varies considerably for different types of connections, being in general greater for larger numbers of phases. This factor must, therefore, be considered from the economical standpoint.

5. It is, in general, desirable to have the transformer connections as simple as possible, in order to reduce the cost of manufacture, and to avoid insulation and mechanical troubles that may occur during short circuits and back fires.

6. The power factor at the primary terminals of the transformer differs for the different types of connections, and is a factor worth considering, particularly when the rectifier load constitutes a large portion of the load of the alternating-current system.

#### CALCULATION OF RECTIFIER TRANSFORMERS

**Leakage Reactances.**—When a voltage is applied to the primary of a transformer, with the secondary open circuited, *i.e.*, at no load, the transformer core carries a magnetic flux required to induce a counter-c.m.f. in the primary windings to balance the applied voltage. This flux is produced by the magnetizing current flowing in the transformer primary. When the transformer is connected to a load, the load currents flowing in the secondary windings induce currents in the opposite direction in the primary windings. The combined m.m.f.s of the load currents in the primary and secondary windings produce additional fluxes, called “leakage fluxes,” which also induce voltages in the windings, and are represented by the leakage reactances of the windings. If the m.m.f.s of the load current in the primary and secondary windings compensate each other completely, so that there is no residual m.m.f. on the transformer core (except the no-load magnetizing m.m.f.), the only leakage flux present is that between the primary and secondary windings, part of which links with the primary winding only and part with the secondary winding only. The reactance produced by this leakage flux is generally called the “short-circuit reactance of the transformer.” If, however, there is a residual m.m.f. on the core of the transformer, this m.m.f. produces additional leakage fluxes which link with both windings.

In a polyphase power transformer, connected to a symmetrical load, the primary and secondary m.m.f.s on each leg of the transformer balance each other, so that in calculations of such transformers only the reactance due to the leakage flux between the primary and secondary windings is considered. In rectifier transformers, however, in which the secondary phases carry current intermittently, the secondary and primary m.m.f.s may or may not balance each other, depending on the type of transformer

connection used; for this reason, the leakage flux produced by the residual m.m.f. must be considered in calculating the voltages and currents of rectifier transformers.

In Fig. 46 is shown a cross-section through a leg of a rectifier transformer, with the leakage fluxes indicated. The primary winding  $P$  links with the leakage flux  $\phi_1$ , which produces in this winding the reactance  $X_1$ . The secondary winding  $S$  links with the leakage flux  $\phi_2$ , which produces in  $S$  the reactance  $X_2$ . The leakage flux  $\phi_0$ , produced by the residual m.m.f. on the leg, flows in the core of the transformer, and its circuit is completed through the air and the walls of the transformer tank, since it is generally in phase in all the legs. This flux links with both the primary and secondary windings, and introduces reactances in those windings in proportion to the square of the number of turns.

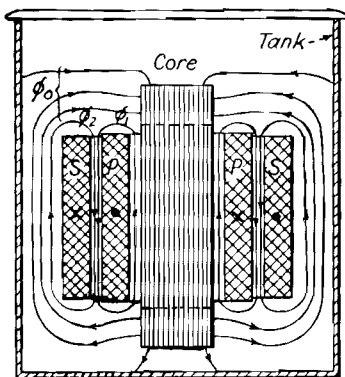

FIG. 46.—Cross-section of a rectifier transformer, showing the leakage fluxes.

Since the currents flowing in the windings of the transformer are non-sinusoidal, the leakage flux  $\phi_0$  produced by them is also non-sinusoidal. For some transformer connections considered in this chapter, this flux is of triplen<sup>1</sup> frequency and produces losses in the core and the transformer tank; for some connections this flux is unidirectional and causes additional core losses due to partial saturation of the core.

The leakage inductance of the windings of a rectifier transformer may be calculated similarly as for any other transformer. The general expression for the leakage inductance is

$$L = N^2 \phi \times 10^{-8}.$$

In this expression,  $L$  is the inductance of the winding in henries,  $N$  is the number of turns in the winding linking with the flux, and  $\phi$  is the permeance of the leakage path in perms.<sup>2</sup>

<sup>1</sup> The term "triplen" denotes frequencies which are multiples of 3.

<sup>2</sup> See, for example, KARAPETOFF, V., "The Magnetic Circuit."



The voltage induced in the winding by the leakage flux is in a direction so as to oppose the change of current producing this flux, and is given by the expression

$$e = -L \frac{di}{dt} = -\omega L \frac{di}{d\omega t} = -X \frac{di}{dx},$$

in which  $\omega = 2\pi f$ ;  $X$  is the reactance in ohms;  $x = \omega t$  is the angular variable in radians; and  $i$  is the current producing the leakage flux. For calculating the voltage induced by the leakage flux  $\phi_0$ , which is produced by the residual m.m.f. on the core, the current  $i$  in the above expression is therefore proportional to the residual m.m.f., and is equal to the ratio  $m/N$ ,  $m$  being the residual m.m.f. and  $N$  the number of turns in the winding under consideration.

**Secondary Currents.**—The currents in the secondary windings of a rectifier transformer are determined by the voltage conditions in the secondary circuit, based upon the fundamental characteristic of a rectifier that current can normally flow only in the direction from anode to cathode, and that the anode having the highest positive potential to neutral carries current, and upon the assumption that the current flowing from the rectifier is a smooth direct current. Subject to these conditions, two or more anodes may carry current simultaneously. At the point where the voltages of an operating and a non-operating anode intersect, the current is transferred from the one to the other during a period of overlap, during which their voltages become equalized by the transformer reactance.

**Primary and Line Currents.**—For rectifier transformers connected to a single-phase alternating-current supply, the secondary currents are balanced at every instant by current in the primary, the condition being that the sum of the m.m.f.s on the transformer core is zero. For a polyphase rectifier transformer, the relation between secondary and primary currents depends on the type of primary connection used. In either case, the current relations are subject to the condition that the primary current cannot have any direct-current component, *i.e.* the average value of the current over a cycle must be equal to zero, because, under steady-state conditions, a direct current cannot be induced in the primary winding.

The primary windings of polyphase rectifier transformers are generally connected in one of the four ways shown in Fig.

47: (a) mesh connection; (b) star connection with isolated neutral; (c) star connection with closed-circuited tertiary; (d) star connection with neutral return. Connections (a) and (b) are the ones most commonly used. Below are given the general transformer relations used for determining the primary and line currents from the secondary currents. The assumption is made that the transformer magnetizing m.m.f.s and the resistance of the windings are negligible. The results obtained on this assumption may be corrected in any specific application for the magnetizing current, although the error introduced is usually negligible for practical purposes.

(a) *Mesh-connected Primary*.—Examples of this type of connection are the delta connection of a 3-phase system and the quarter-phase mesh connection. The former is of course the more important, since the majority of alternating-current systems are 3-phase. The following relationships are used for determining the primary currents of this connection:

1. The sums of the m.m.f.s (amperes  $\times$  turns) on the several legs of the transformer core are equal to each other, since the ends of the legs joined by the yoke may be considered to be at equal magnetic potential.

$$\Sigma M_1 = \Sigma M_2 = \Sigma M_3 = \dots = m$$

$\Sigma M_1$ ,  $\Sigma M_2$ , etc. are the sums of the m.m.f.s on legs 1, 2, etc., and  $m$  is the residual m.m.f. on each leg.

(For rigid deduction, the net m.m.f.s, which are equal to the sum of the ampere-turns less the m.m.f.s consumed for magnetization of the core with both the main and leakage fluxes, should be used in the above equations. As was previously stated, the magnetizing m.m.f.s are neglected in order to simplify the calculations, since the resulting error is usually small. The primary currents may be corrected for the magnetizing current of the main flux by adding the no-load magnetizing current to the primary load currents.)

2. The sum of all the voltages in the closed mesh of the primary is zero.

As a concrete example, the primary and line currents will be calculated for the transformer connection shown in Fig. 47a, with the primary connected in 3-phase delta and the secondary in double 3- or 6-phase. Let  $e_1$ ,  $e_2$ , and  $e_3$  be the impressed sinusoidal no-load voltages in the three primary phases; let

$X_1$  be the leakage reactance per primary phase due to the primary leakage flux and  $X_0$  the leakage reactance per primary phase due to the residual m.m.f.,  $m$ ; and let the ratio of turns between each primary and secondary phase be 1:1.

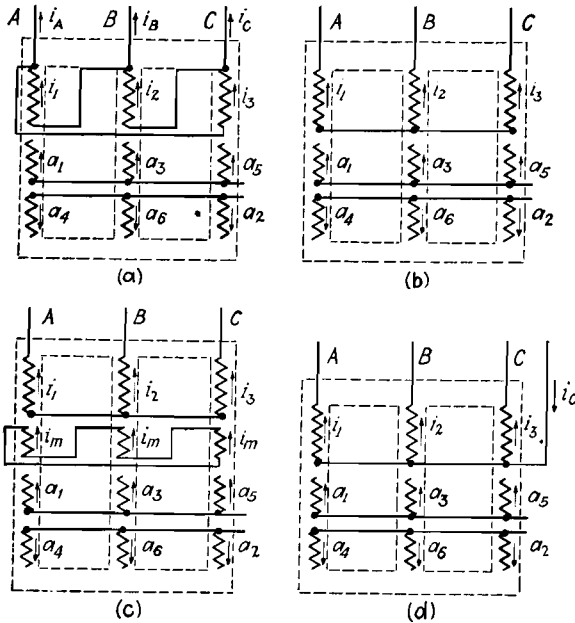

FIG. 47.—Connections of polyphase rectifier transformers: (a) mesh-connected primary; (b) star-connected primary with isolated neutral; (c) star-connected primary with isolated neutral and closed-circuited tertiary; (d) star-connected primary with neutral return.

Applying the first relationship, that the sums of the m.m.f.s on the three legs are equal,

$$i_1 + a_1 - a_4 = i_2 + a_3 - a_6 = i_3 + a_5 - a_2 = \frac{m}{N}, \quad (59)$$

$N$  being the number of turns in each winding.

Applying the second relationship, that the sum of the voltages in the closed delta circuit is zero,

$$\begin{aligned} e_1 - X_1 \frac{di_1}{dx} - X_0 \frac{d(i_1 + a_1 - a_4)}{dx} + e_2 - X_1 \frac{di_2}{dx} - \\ X_0 \frac{d(i_2 + a_3 - a_6)}{dx} + e_3 - X_1 \frac{di_3}{dx} - \\ X_0 \frac{d(i_3 + a_5 - a_2)}{dx} = 0. \end{aligned}$$

Combining the various terms in the above expression,

$$e_1 + e_2 + e_3 - (X_1 + X_0) \frac{d(i_1 + i_2 + i_3)}{dx} - X_0 \frac{d(a_1 - a_2 + a_3 - a_4 + a_5 - a_6)}{dx} = 0.$$

The sum of the applied no-load voltages,  $e_1 + e_2 + e_3$ , is equal to zero. Integrating the remainder of the equation with respect to  $x$ , and dividing through by  $X_0$ , we obtain

$$\frac{X_1 + X_0}{X_0} (i_1 + i_2 + i_3) + (a_1 - a_2 + a_3 - a_4 + a_5 - a_6) = 0. \quad (60)$$

Solving Eqs. (59) and (60), simultaneously, for  $i_1$ ,  $i_2$ , and  $i_3$ ,

$$i_1 = -(a_1 - a_4) + \frac{k}{3}(a_1 - a_2 + a_3 - a_4 + a_5 - a_6). \quad (61)$$

$$i_2 = -(a_3 - a_6) + \frac{k}{3}(a_1 - a_2 + a_3 - a_4 + a_5 - a_6). \quad (62)$$

$$i_3 = -(a_5 - a_2) + \frac{k}{3}(a_1 - a_2 + a_3 - a_4 + a_5 - a_6). \quad (63)$$

In the above equations,

$$k = \frac{X_1}{X_1 + X_0}.$$

The residual m.m.f. per leg is

$$m = (i_1 + a_1 - a_4)N = \frac{k}{3}(a_1 - a_2 + a_3 - a_4 + a_5 - a_6)N. \quad (64)$$

This residual m.m.f. is in phase on the three legs and appears in the form of a circulating current  $i_m$  in the delta primary.

If the leakage reactance  $X_0$  is very large compared to  $X_1$ , the factor  $k$  is practically zero, and the circulating current  $i_m$  is also practically zero. If  $X_0$  is very small compared to  $X_1$ , the factor  $k$  is practically unity, and the circulating current is a maximum.

The wave shape and frequency of the residual m.m.f. are determined by the factor  $(a_1 - a_2 + a_3 - a_4 + a_5 - a_6)$  in Eq. (64), *i.e.*, by the duration and shape of the secondary currents. For a diametrical 6-phase secondary connection, the residual m.m.f. has a triplen frequency. For the 6-phase connection with interphase transformer the residual m.m.f. is practically zero. For the 3-phase connection the currents  $a_2$ ,  $a_4$ , and  $a_6$  are absent, and the residual m.m.f. is unidirectional. For these connections, see Table V.

The line currents shown in Fig. 47a are as follows:

$$i_A = i_1 - i_3 = -(a_1 - a_4) + (a_5 - a_2). \quad (65)$$

$$i_B = i_2 - i_1 = -(a_3 - a_6) + (a_1 - a_4). \quad (66)$$

$$i_C = i_3 - i_2 = -(a_5 - a_2) + (a_3 - a_6). \quad (67)$$

For a transformation ratio different from 1:1, the above expressions for the currents should be multiplied by the ratio of secondary to primary turns.

If the currents in the three phases of the delta primary are sinusoidal and displaced from each other by  $120^\circ$ , the r.m.s. values of the line currents are equal to  $\sqrt{3}$  times the primary currents. The same relation applies to the primary currents of a rectifier transformer, if they are composed of a fundamental and non-triplen harmonics, because these harmonics are displaced from each other by 120 harmonic degrees in the three phases of the primary. If, however, the primary currents contain triplen harmonics, these harmonics circulate in the delta primary and do not appear in the line currents; the ratio of the r.m.s. values of the line to primary currents is then less than  $\sqrt{3}$ . This ratio, therefore, gives an indication of the presence of triplen harmonic currents in the delta primary. The presence of even harmonics is indicated by the unsymmetry of the positive and negative half-cycles of the current wave.

(b) *Star-connected Primary with Isolated Neutral.*—Examples of this type of connection are the Y-connection of a 3-phase system, and the star connection of a 2-phase 4-wire (quarter-phase) system. The following general relations are used for determining the primary currents of this connection:

1. The sums of the m.m.f.s on the several legs of the transformer core are equal to each other;

$$\Sigma M_1 = \Sigma M_2 = \Sigma M_3 = \dots = m.$$

2. The sum of the primary currents at the neutral point of the star connection is equal to zero.

In Chap. IV is given an example of the calculation of the primary currents of a Y-connected transformer primary and a 6-phase secondary. The equations of the primary currents as derived there are as follows:

$$i_1 = -\frac{2}{3}a_1 - \frac{1}{3}a_2 + \frac{1}{3}a_3 + \frac{2}{3}a_4 + \frac{1}{3}a_5 - \frac{1}{3}a_6. \quad (68)$$

$$i_2 = \frac{1}{3}a_1 - \frac{1}{3}a_2 - \frac{2}{3}a_3 - \frac{1}{3}a_4 + \frac{1}{3}a_5 + \frac{2}{3}a_6. \quad (69)$$

$$i_3 = \frac{1}{3}a_1 + \frac{2}{3}a_2 + \frac{1}{3}a_3 - \frac{1}{3}a_4 - \frac{2}{3}a_5 - \frac{1}{3}a_6. \quad (70)$$

The residual m.m.f. on each leg of the core for that connection has the value

$$m = \frac{1}{3}(a_1 - a_2 + a_3 - a_4 + a_5 - a_6)N. \quad (71)$$

The currents of the Y-connected 3-phase primary with isolated neutral do not have any triplen harmonic components, since there is no return circuit for the flow of these harmonics.

(c) *Star-connected Primary with Closed-circuited Tertiary.*—For some transformer connections which have residual m.m.f.s on the core, such as the diametrical 6-phase connection with Y-connected primary, mentioned in the last paragraph, a closed-circuited tertiary is added to permit the flow of a circulating current to compensate for the residual m.m.f., which produces undesirable leakage fluxes. For determining the currents in the primary and tertiary windings the same relations may be used as for the two preceding connections, *viz.*:

1. The sums of the m.m.f.s on the legs of the transformer core are equal to each other.
2. The sum of the currents at the neutral point of the star primary is equal to zero.
3. The sum of the voltages in the closed circuit of the tertiary is equal to zero.

(d) *Star-connected Primary with Neutral Return.*—This connection may be used for 3-phase 4-wire systems. This connection is equivalent to individual single-phase primaries, since current may flow in each phase to the neutral return, independently of the other phases. The secondary currents on each leg of the transformer core are, therefore, balanced at every instant by current in the primary, and the only relation required for determining the primary currents is that the sum of the alternating-current m.m.f.s on each leg of the core is equal to zero.

#### GENERAL EQUATIONS

In Chap. IV, equations were derived for currents, voltages, and transformer ratings of a general  $p$ -phase rectifier, and examples were given for single- and 6-phase connections. For simplicity, a 6-phase diametrically connected transformer secondary was used for the 6-phase connection. While this is the simplest 6-phase connection of a transformer, it is rarely used, as there are other connections having the advantages of better

utilization of the transformer, and resulting in better characteristics as to voltage regulation, efficiency, etc.

Some of the general equations derived in Chap. IV may be adapted for calculating different types of transformer connections, and are repeated below, both with and without overlapping of the currents. For general purposes, the correction factor for overlapping may be neglected without any appreciable error.

*Without Overlapping.*—

Anode current (r.m.s.)

$$A = \frac{I}{\sqrt{p}} \text{ amp.} \quad (1)$$

Average direct-current voltage

$$E_d = \frac{E\sqrt{2} \sin \frac{\pi}{p}}{\pi/p} \text{ volts.} \quad (2)$$

Direct-current output

$$P = \frac{EI\sqrt{2} \sin \frac{\pi}{p}}{\pi/p} \text{ watts.} \quad (3)$$

*With Overlapping.*—

Angle of overlap,

$$\cos u = 1 - \frac{IX}{E\sqrt{2} \sin \frac{\pi}{p}} \quad (16)$$

Anode current (r.m.s.),

$$A = \frac{I}{\sqrt{p}} \sqrt{1 - p\psi(u)} \text{ amp.} \quad (19)$$

Factor,

$$\psi(u) = \frac{(2 + \cos u) \sin u - (1 + 2 \cos u)u}{2\pi(1 - \cos u)^2}, \quad (20)$$

$$= \frac{2u}{15\pi} \left( 1 + \frac{u^2}{84} + \dots \right). \quad (20a)$$

The factors  $\psi(u)$  and  $\sqrt{1 - p\psi(u)}$  are plotted in Fig. 48 in function of  $u$ .

Average direct-current voltage drop,

$$d = \frac{E\sqrt{2} \sin \frac{\pi}{p}}{2 \frac{\pi}{p}} (1 - \cos u) \text{ volts.} \quad (22)$$

Average direct-current voltage,

$$E_d = \frac{E\sqrt{2} \sin \frac{\pi}{p}}{\pi/p} \cdot \cos^2 \frac{u}{2} \text{ volts.} \quad (23)$$

Direct-current output,

$$P = \frac{EI\sqrt{2} \sin \frac{\pi}{p}}{\pi/p} \cdot \cos^2 \frac{u}{2} \text{ watts.} \quad (24)$$

In using the above equations for calculating the various types of transformer connections, the following points must be kept in mind:

1. The direct-current output voltage  $E_d$  and output power  $P$  are the ideal outputs, including the arc voltage drop in the rectifier and neglecting the copper losses in the transformer.

2. The secondary phase voltage  $E$  is the voltage between anode terminal and neutral.

3. The quantity  $p$ , in general, represents the number of phases. However, care must be taken in assigning values to  $p$ , as for some types of transformer connections  $p$  has different values for different parts of the circuits and for different quantities calculated. Thus, for example, for a fork-connected transformer, shown in Fig. 65, in calculating the direct-current voltage  $E_d$  by means of Eq. (23),  $p$  has the value 6, since the phase voltages from the neutral to the anode terminals correspond to a 6-phase system. In calculating the currents in the outer secondary windings by means of Eq. (19),  $p$  has the value 6, since each of these windings carries current during one-sixth of a cycle. In calculating the currents in the inner secondary windings,  $p$  has the value 3, since each of these windings carries current during one-third of a cycle.

4. In calculating the angle of overlap by means of Eq. (16),  $I$  is the magnitude of the current being transferred between the overlapping phases;  $X$  is the effective reactance per secondary phase, causing overlapping. This reactance includes the equiv-



alent secondary reactance of the primary and line reactances, as determined for the different types of connections.

In the calculation of the various transformer connections which follows, a 1:1 transformation ratio will be used between each primary and secondary phase. The various quantities may be reduced to the basis of any other desired ratio by the usual

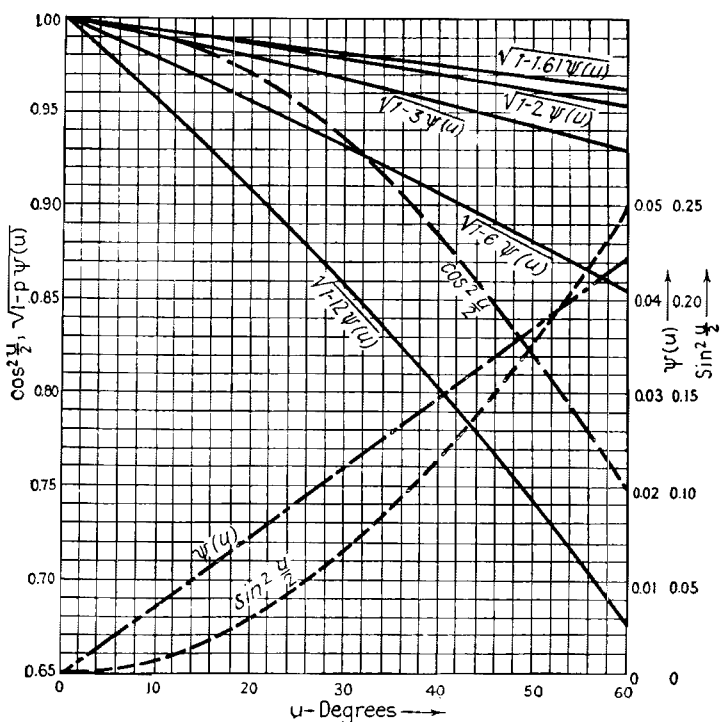

FIG. 48.—Curves giving values of various factors involving the angle of overlap  $u$ , in function of  $u$ .

transformer relations, namely: the voltages are proportional to the ratio of turns; the currents are inversely proportional to the ratio of turns; the resistances and reactances vary in proportion to the square of the ratio of turns.

The transformer magnetizing currents and copper losses, and the influence of the arc drop will be neglected in order to simplify the calculations. The effect of these factors is considered in later sections of this chapter.

DIAMETRICAL 6-PHASE CONNECTION WITH DELTA PRIMARY

The diametrical connection is the simplest 6-phase connection of rectifier transformers, but has the disadvantages of a lower utility factor for the transformer, higher voltage regulation, and lower rectifier efficiency than other connections to be described later (see 6-phase connections, Figs. 55 and 65). For these reasons, it is not used except for test purposes or for installations where a high voltage regulation is required. This transformer connection also comes into consideration when a

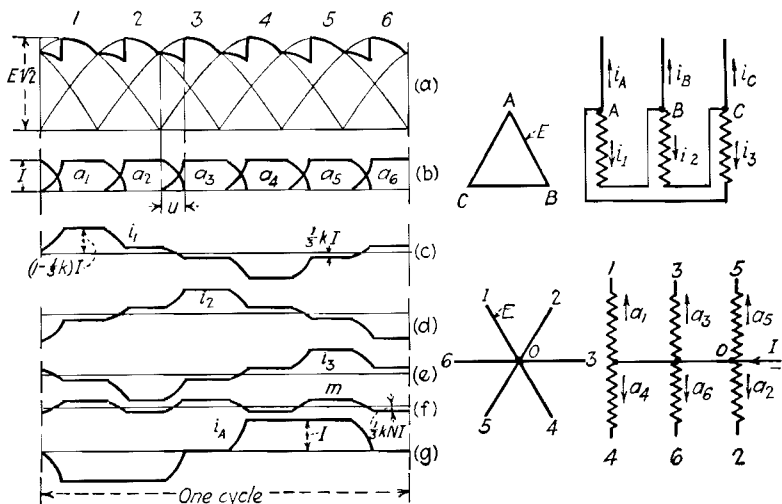

FIG. 49.—Diametrical 6-phase connection with delta primary.

rectifier is compounded by means of a saturated interphase transformer.

In Fig. 49 are shown the diagram of connections, vector diagram, and the voltage and current curves for this transformer connection. Each anode operates during one-sixth of a cycle, with periods of overlap when the current is transferred between the anodes. The average direct-current voltage at no load, as obtained from Eq. (2), is

$$E_{d0} = \frac{E\sqrt{2} \sin(\pi/6)}{\pi/6} = 1.35E. \tag{72}$$

The direct-current voltage under load, according to Eq. (23), is

$$E_d = 1.35E \cos^2 \frac{\mu}{2}. \tag{73}$$

The angle of overlap, as determined from Eq. (16), is

$$\cos u = 1 - \frac{IX}{E\sqrt{2} \sin(\pi/6)} = 1 - 1.41 \frac{IX}{E}. \quad (74)$$

The direct-current voltage drop under load, as determined by Eq. (22), is

$$d = \frac{E\sqrt{2} \sin(\pi/6)}{\pi/6} \left( \frac{1 - \cos u}{2} \right) = 0.955IX. \quad (75)$$

The direct-current output, including the losses in the rectifier, is

$$P = E_d I = 1.35EI \cos^2 \frac{u}{2}. \quad (76)$$

The r.m.s. value of the anode current, as given by Eq. (19), is

$$A = \left( \frac{I}{\sqrt{6}} \right) \sqrt{1 - 6\psi(u)} = 0.408I \sqrt{1 - 6\psi(u)}. \quad (77)$$

The primary currents for this connection were drawn in Fig. 49c,  $d$ , and  $e$ , from Eqs. (61), (62), and (63). The r.m.s. value of the primary current, calculated from these curves, is

$$I_p = \frac{I}{\sqrt{3}} \sqrt{(1 - \frac{2}{3}k + \frac{1}{3}k^2) - 6(1 - \frac{4}{3}k + \frac{2}{3}k^2)\psi(u)}. \quad (78)$$

The factor  $k$ , in Eq. (78), is equal to  $\frac{X_1}{X_1 + X_0}$ , in which  $X_1$  is the primary reactance due to the leakage flux  $\phi_1$  linking with the primary winding only, and  $X_0$  is the primary reactance due to the leakage flux  $\phi_0$  between the yokes of the transformer (see Fig. 46). The reactance  $X_0$  is usually considerably higher than  $X_1$  on account of the greater permeance of the magnetic path for  $\phi_0$ , and  $k$  may be considered as practically equal to zero. With this assumption, the primary current wave will have the shape shown in Table V-D, and the r.m.s. value of this current is

$$I_p = \left( \frac{I}{\sqrt{3}} \right) \sqrt{1 - 6\psi(u)} = 0.577I \sqrt{1 - 6\psi(u)}. \quad (79)$$

The wave shape of the line current, as expressed by Eq. (65), is shown in Fig. 49g, and its r.m.s. value is

$$I_L = \left( \frac{I\sqrt{2}}{\sqrt{3}} \right) \sqrt{1 - 3\psi(u)} = 0.817I \sqrt{1 - 3\psi(u)}. \quad (80)$$

The volt-ampere rating of the transformer secondary is

$$\begin{aligned} P_2 &= 6EA = 2.44EI\sqrt{1 - 6\psi(u)} \\ &= \frac{1.81P\sqrt{1 - 6\psi(u)}}{\cos^2 \frac{u}{2}}. \end{aligned} \quad (81)$$

The volt-ampere rating of the transformer primary is

$$\begin{aligned} P_1 &= 3EI_p = 1.73EI\sqrt{1 - 6\psi(u)} \\ &= \frac{1.28P\sqrt{1 - 6\psi(u)}}{\cos^2 \frac{u}{2}}. \end{aligned} \quad (82)$$

The average value of the transformer rating is

$$\begin{aligned} P_{av} &= \frac{P_1 + P_2}{2} = 2.09EI\sqrt{1 - 6\psi(u)} \\ &= \frac{1.55P\sqrt{1 - 6\psi(u)}}{\cos^2 \frac{u}{2}}. \end{aligned} \quad (83)$$

The line volt-amperes are

$$\begin{aligned} P_L &= \frac{3EI_L}{\sqrt{3}} = 1.41EI\sqrt{1 - 3\psi(u)} \\ &= \frac{1.045P\sqrt{1 - 3\psi(u)}}{\cos^2 \frac{u}{2}}. \end{aligned} \quad (84)$$

The line power factor is

$$\text{P.F.} = \frac{P}{P_L} = 0.955 \frac{\cos^2 \frac{u}{2}}{\sqrt{1 - 3\psi(u)}}. \quad (85)$$

#### DIAMETRICAL 6-PHASE CONNECTION WITH Y-PRIMARY

The diametrical 6-phase connection with Y-primary has been considered in Chap. IV, and the equations for the currents and transformer ratings were derived there. The direct-current voltage and the anode and primary current waves were shown in Fig. 24 neglecting the transformer reactance.

In Fig. 50 are shown the diagram of transformer connections, the vector diagram, and the wave shapes of the direct-current voltage (*a*), anode currents (*b*), and primary currents (*c*), (*d*), and (*e*), taking into account the overlapping of the anode currents

due to the transformer reactance, and on the basis of a 1:1 transformation ratio. Figure 50f shows the residual m.m.f.,  $m$ , on each leg of the transformer core, obtained by a summation of the primary and secondary m.m.f.s and expressed by Eq. (11) (Chap. IV). This m.m.f. is of triplen frequency, has an amplitude equal to  $NI/3$ , and is in phase on all three legs. Unless compensated, it produces triplen harmonic leakage fluxes in the transformer core with their magnetic circuit closed through the air, as is shown by  $\phi_0$  in Fig. 46.

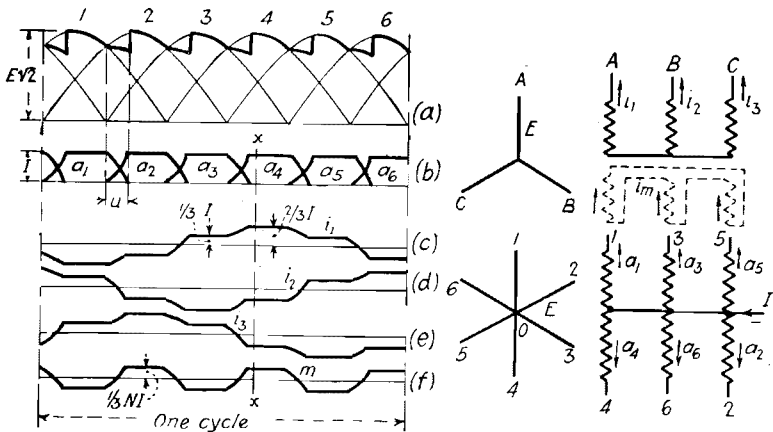

Fig. 50.—Diametrical 6-phase connection with Y-primary.

**With Tertiary Winding.**—The triplen harmonic residual m.m.f.s and the leakage fluxes produced by them may be eliminated by providing the transformer with a delta-connected tertiary winding, shown dotted in Fig. 50. A circulating triplen harmonic current,  $i_m = m/N = I/3$ , flows in this winding and balances the residual m.m.f. The expressions for the various quantities derived in Chap. IV for this transformer connection, as corrected for overlapping, are as follows:

Anode current (r.m.s.),

$$A = \frac{I}{\sqrt{6}} \sqrt{1 - 6\psi(u)}. \tag{86}$$

Direct-current voltage (average),

$$E_d = \frac{3\sqrt{2}}{\pi} E \cos^2 \frac{u}{2}. \tag{87}$$

The r.m.s. value of the primary current may be computed from the wave of Fig. 50c, which may be divided into sections, some of which are rectangular and some consisting of sinusoidal portions that may be expressed with the aid of Eqs. (17) and (18),

$$\begin{aligned} \pi I_p^2 &= \left(\frac{\pi}{3} - u\right) \left[ 2\left(\frac{I}{3}\right)^2 + \left(\frac{2I}{3}\right)^2 \right] + \int_0^u \left[ -\frac{I}{3} + \right. \\ &\quad \left. \frac{2I}{3} \left( \frac{1 - \cos x}{1 - \cos u} \right) \right]^2 dx + \int_0^u \left[ \frac{I}{3} + \frac{I}{3} \left( \frac{1 - \cos x}{1 - \cos u} \right) \right]^2 dx + \\ &\quad \int_0^u \left[ \frac{I}{3} \left( 1 - \frac{1 - \cos x}{1 - \cos u} \right) + \frac{I}{3} \right]^2 dx \\ I_p &= \frac{\sqrt{2}}{3} I \sqrt{1 - 3} \cdot \frac{1}{\pi} \int_0^u \left[ \frac{1 - \cos x}{1 - \cos u} - \left( \frac{1 - \cos x}{1 - \cos u} \right)^2 \right] dx \\ &= \frac{\sqrt{2}}{3} I \sqrt{1 - 3\psi(u)}. \quad (88) \end{aligned}$$

The value of  $\psi(u)$  is given by Eq. (20a) (Chap. IV). The r.m.s. value of the current in the tertiary winding, similarly computed, is

$$\begin{aligned} I_m &= \sqrt{\frac{1}{\pi/3} \left[ \left(\frac{\pi}{3} - u\right) \left(\frac{I}{3}\right)^2 + \int_0^u \left( -\frac{I}{3} + \frac{2I}{3} \cdot \frac{1 - \cos x}{1 - \cos u} \right)^2 dx \right]} \\ &= \frac{I}{3} \sqrt{1 - 12\psi(u)}. \quad (89) \end{aligned}$$

$$\text{The direct-current output } P = E_d I = \frac{(3\sqrt{2})}{\pi} EI \cos^2 \frac{u}{2}. \quad (90)$$

The volt-ampere ratings of the transformer are:

$$\text{Primary } P_1 = 3EI_p = EI \sqrt{2} \sqrt{1 - 3\psi(u)}. \quad (91)$$

$$\text{Secondary } P_2 = 6EA = EI \sqrt{6} \sqrt{1 - 6\psi(u)}. \quad (92)$$

$$\text{Tertiary } P_3 = 3EI_m = EI \sqrt{1 - 12\psi(u)}. \quad (93)$$

$$\text{Power Factor (P.F.)} = \frac{P}{P_1} = \frac{3}{\pi} \frac{\cos^2(u/2)}{\sqrt{1 - 3\psi(u)}}. \quad (94)$$

**Without Tertiary Winding.**—If no tertiary winding is provided to compensate for the residual triplen harmonic m.m.f. on the core, the fluxes produced by this m.m.f. induce triplen harmonic voltages in the primary and secondary windings of the transformer. The voltages induced in the primary windings cause a variation in the potential of the primary neutral, producing what is known as an “oscillating neutral.”

The voltages induced in the secondary windings alter the wave shape of the secondary terminal voltage to neutral and affect the working period of the anodes, as shown in Fig. 51. Curve  $e_t$  in Fig. 51a shows the voltage induced in the windings by the triplen harmonic leakage flux at an angle of overlap of approximately  $30^\circ$ . The shape of the secondary terminal voltages as modified by the voltage  $e_t$  is shown by curve  $e_s$ . The reactance  $X_0$  due to the triplen harmonic leakage flux  $\phi_0$  (Fig. 46) is considerably higher than the reactances  $X_1$  and  $X_2$  of the primary and secondary windings due to the leakage fluxes  $\phi_1$  and  $\phi_2$ , on account of the higher permeance of the magnetic path of  $\phi_0$ ;  $X_0$ , therefore, accounts for the major part of the overlapping between the anode currents and causes high overlapping at relatively low currents. The voltage  $e_t$  induced by the flux  $\phi_0$  is, therefore, nearly equal to the voltage drop due to overlapping, shown shaded in Fig. 51a. As a result of this, the terminal voltage of an idle phase becomes equal to the terminal voltage of two overlapping phases at an angle of overlap somewhat above  $30^\circ$ . Thus, the voltage wave  $e_s$  in Fig. 51a meets the voltage of the overlapping phases 1 and 2 at point  $Q$ . As the load current is further increased and the angle of overlap is extended beyond this point, the anode connected to the idle phase, being equal in potential to the two working anodes, is ignited and the three phases operate in parallel for a short period until anode 1 is extinguished. The triplen harmonic leakage flux thus has the effect of making the anodes start carrying current at practically  $30^\circ$  before the point of intersection of the no-load voltage waves.

Within a certain load range the anode is extinguished shortly after it is ignited, and is then reignited at the point of intersection of its no-load voltage wave with that of the preceding anode, as shown in Fig. 51b. The anode is extinguished after the first ignition because there is not sufficient current to produce the necessary triplen harmonic magnetizing m.m.f. required for the complete equalization of the voltages of the overlapping phases.

When the load current is sufficiently high for the production of the magnetizing m.m.f. required to induce full equalizing voltages in the two simultaneously operating phases, the anode continues to carry current from its first ignition until the ignition of the anode displaced from it by 120 electrical degrees, when its current is transferred to that anode during a short period of overlapping. A condition is thus reached, as shown in Fig. 51c,

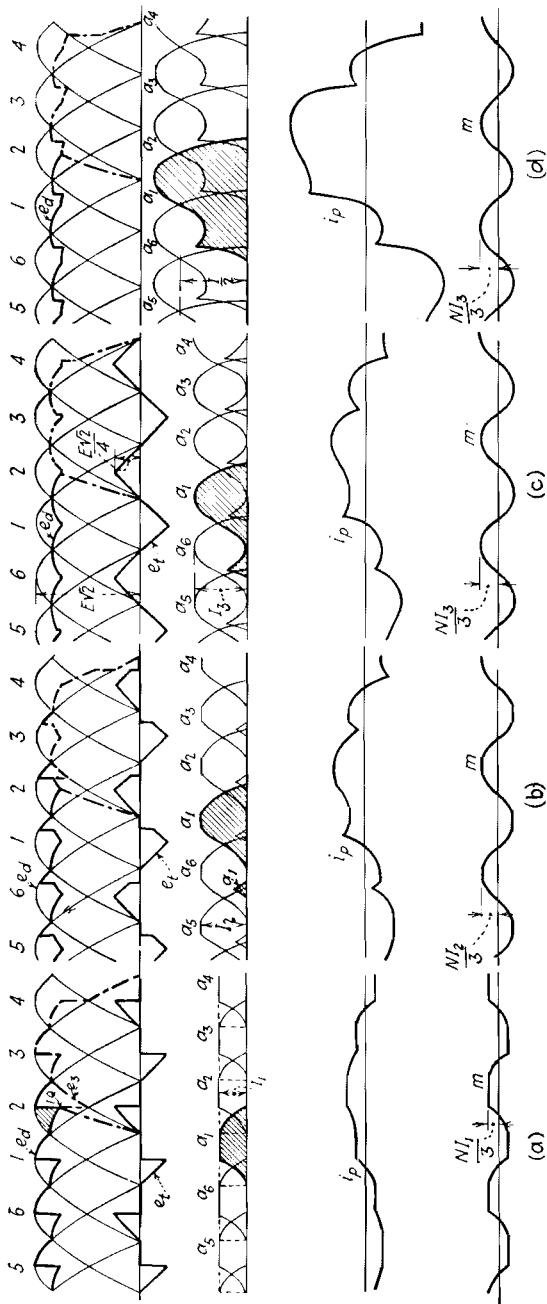

FIG. 51.—Waves of voltages, anode currents, primary currents, and triplen-harmonic residual m.m.f.s for a rectifier transformer having a diametrical 6-phase connection of the secondary and a Y-connected primary, without a tertiary winding. Sections *a*, *b*, *c*, and *d* illustrate successive stages in the development of the waves as the load current is increased. The primary current  $i_p$  and the residual m.m.f.  $m$  have been constructed from the anode currents in accordance with Eqs. (70) and (71), respectively.



that each anode operates over a period of  $120^\circ$ , so that two anodes work in parallel all the time with short overlapping periods when three anodes carry current simultaneously.

The wave shapes of the current and voltage waves at higher load currents are shown in Fig. 51*d*. It is seen from this figure that after the conditions shown in Fig. 51*c* are reached, the overlapping occurs between phases displaced from each other by  $120^\circ$ , and the operation is similar to that of the 6-phase connection with interphase transformer, considered later in this chapter. The magnetizing m.m.f.,  $m$ , remains unchanged, and the triplen harmonic leakage reactance  $X_0$  has no influence on the overlapping of the phases.

Since the amplitude of  $m/N$  in Fig. 51*a*, *b*, and *c* is one-third the amplitude of the load current, the condition shown in Fig. 51*c* is obtained at a load current equal to three times the amplitude of the triplen harmonic current required to produce in the core the leakage flux  $\phi_0$  necessary for inducing the full voltage  $e_t$  in the transformer secondary. If the magnetic path of this leakage flux has a high permeance, this current is relatively small.

The voltage wave  $e_t$  may be approximated by a sinusoidal voltage wave having the same amplitude as  $e_t$ , which is equal to one-fourth the amplitude of the no-load phase voltage. Since this third-harmonic voltage is equal to one-fourth the no-load phase voltage, and has a frequency equal to three times the fundamental frequency, the third-harmonic leakage flux in the core has to be one-twelfth of the fundamental flux. If the permeance of the leakage path is known, the current required to produce this flux may readily be determined.

The direct-current voltage at no load, as determined by Eq. (2), has the value

$$E_{d0} = \frac{E\sqrt{2} \sin(\pi/6)}{\pi/6} = 1.35E. \quad (95)$$

When the condition shown in Fig. 51*c* is reached, the direct-current voltage is

$$E_{d1} = \frac{\left(E\sqrt{2} \cos \frac{\pi}{6}\right) \sin \frac{\pi}{6}}{\pi/6} = 1.17E. \quad (96)$$

At higher loads, the direct-current voltage, corrected for overlapping, is

$$E_d = 1.17 E \cos^2 \frac{u}{2}. \quad (97)$$

The change of the direct-current voltage from  $E_{do}$  to  $E_{dt}$  occurs within a relatively short load range (see Fig. 52), on account of the high value of the triplen harmonic leakage reactance  $X_0$ , resulting in a steep current-voltage characteristic. Beyond this load range, reduction of the direct-current voltage with load is caused by overlapping between two phases displaced from each other by  $120^\circ$ , and the current transferred during this overlapping

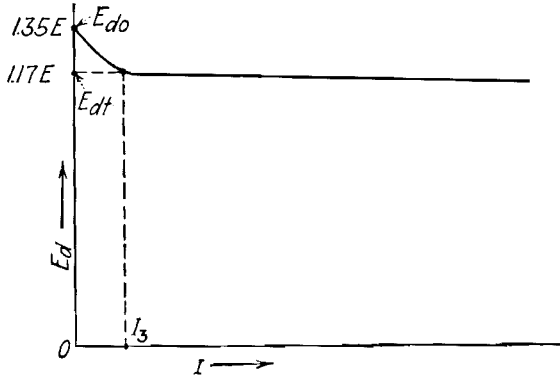

FIG. 52.—Current-voltage characteristic for diametrical 6-phase connection, with Y-connected primary, without tertiary.

is equal to one-half the load current. The angle of overlap is, therefore, the same as for a 3-phase connection carrying the current  $I/2$ , and as determined by Eq. (16), has the value

$$\cos u = 1 - \frac{(I/2) X}{E\sqrt{2} \sin(\pi/3)} = 1 - \frac{IX}{E\sqrt{6}}$$

Substituting this value in Eq. (22) for the voltage drop,

$$d = \frac{E\sqrt{2} \sin(\pi/3)}{2\pi/3} \cdot \frac{IX}{E\sqrt{6}} = 0.239IX. \quad (98)$$

This voltage drop is one-fourth that obtained for the diametrical 6-phase connection with delta primary, and the second part of the voltage regulation curve, therefore, has a small inclination. The shape of the voltage regulation curve is shown in Fig. 52.

The above relations for the direct-current voltage are the same as for the 6-phase connection with interphase transformer. If the effects of the undulations in the anode and the primary currents due to the triplen harmonic component, as shown in Fig. 51*d*, are neglected, the equations for the r.m.s. values of the

currents and for the transformer ratings are the same as those derived for the 6-phase connection with interphase transformer. For any particular case the results obtained by means of those equations may be corrected for this component when its magnitude has been determined.

**Transformer Core with Magnetic Shunt.**—It is usually desirable to have a practically constant direct-current voltage for a rectifier over the entire working range, and the rise in the voltage characteristic of the diametrical 6-phase connection with Y-primary, as shown in Fig. 52, is found objectionable when the rectifier is operating at light loads. For this reason it is

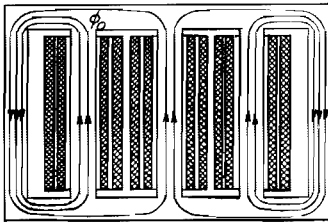

FIG. 53.—Polyphase rectifier transformer with five legs.

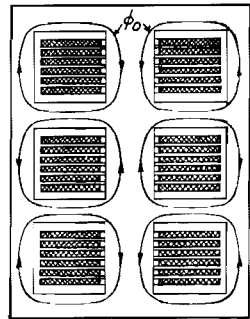

FIG. 54.—Shell-type polyphase rectifier transformer.

desirable to have the bend in the regulation curve at as low a load as possible in order that the rectifier may operate beyond this bend for the greater part of the load range. This may be attained by providing the core of the transformer with a magnetic shunt, which increases the permeance of the path for the triplen harmonic leakage flux. This reduces the magnetizing m.m.f. required to induce the voltage  $e_r$  for Fig. 51c and, consequently, reduces the load current at which the bend of the regulation curve occurs.

One type of construction for obtaining a magnetic shunt is shown in Fig. 53, in which the transformer core consists of five legs; the two outside legs have no windings and function as magnetic shunts. The paths of the triplen harmonic leakage fluxes  $\phi_0$  are indicated in the figure.

Another type of construction is that of a shell type polyphase transformer shown in Fig. 54. For this type of transformer the polarity of the middle phase is reversed in order to obtain uniform flux distribution in the core. The direction of the triplen har-

monic leakage flux for the middle phase is, therefore, opposite to that of the other two phases, and the paths of the leakage fluxes are as indicated in the figure (351).

The current and voltage relations for the types of transformers shown in Figs. 53 and 54 are the same as shown in Fig. 51, with the exception that the undulations in the anode and primary currents are smaller. The operation of these transformers therefore approaches more nearly that of the 6-phase connection with interphase transformer, considered in the next section, and the equations derived there for the voltages, currents, transformer ratings, etc., may be used for these transformers.

**Three Single-phase Transformers.**—When a rectifier operates with three single-phase transformers having their primaries connected in Y and their secondaries in diametrical 6-phase, the same results are obtained as with the five-legged and shell-type transformers shown in Figs. 53 and 54. The triplen harmonic leakage fluxes circulate in the core of each transformer. The equations of currents, voltages, etc. are the same as for the 6-phase connection with interphase transformer (343).

#### SIX-PHASE CONNECTION WITH INTERPHASE TRANSFORMER

The transformer connection most widely used at the present time is the 6-phase connection with interphase transformer (absorption reactance coil) (see Fig. 55). With this connection, the rectifier operates as a double 3-phase rectifier, although the voltage wave has the same shape as that of a 6-phase system.

By making the rectifier circuit operate as 3-phase, so that each anode and transformer phase can carry current during one-third of a cycle, instead of only during one-sixth of a cycle, the following advantages are obtained over the straight 6-phase connection:

1. The transformer is utilized to greater advantage, since each phase operates during one-third of a cycle (see Table V).
2. The voltage regulation of the rectifier is reduced, since the voltage drop is proportional to the number of phases, as seen from Eqs. (22) and (22a) in Chap. IV.
3. The amplitude of the anode currents is reduced, thereby reducing the anode voltage drop in the rectifier (see Chap. II, Figs. 6 and 7).

In Fig. 55 is shown the diagram of connections of a 3-phase transformer with interphase transformer. The transformer secondary consists of two 3-phase, Y-connected groups, inter-

connected by the interphase transformer. The secondary windings are so arranged that for each primary phase there is a phase in each secondary group; thus phases 1 and 4 of the secondary are on the same transformer leg as primary phase A, and are displaced from each other by  $180^\circ$ . The two secondary groups may be considered as displaced from each other by  $60^\circ$ , and the sequence of the phases corresponds to their numerical notation.

If the interphase transformer were not used, and the neutrals of the two groups were tied together to form the negative pole, the transformer secondary would operate as a 6-phase connection. The current and voltage relations would then be as indicated in Fig. 51.

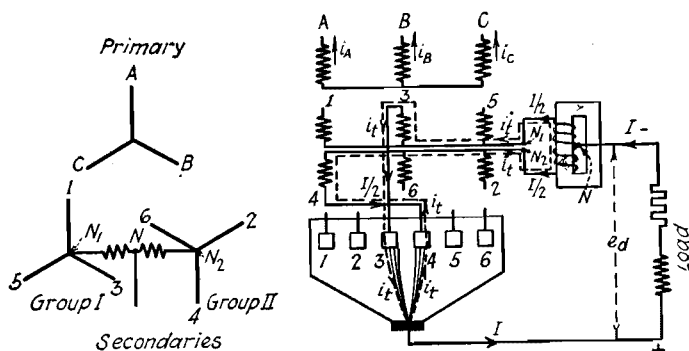

FIG. 55.—Six-phase connection with interphase transformer.

If the two groups were operated with their neutrals isolated from each other, each group would operate as an independent 3-phase system, and each anode would carry current during one-third of a cycle. The direct-current voltage waves of the two groups would then be as shown in Fig. 56, *a* and *b*. As seen from this figure, the maximum points of the sine waves of the two groups are displaced by  $60^\circ$ .

By interconnecting the two groups with an interphase transformer, as shown in Fig. 55, the two groups are made to operate in parallel, and the interphase transformer acts as a voltage equalizer between them. The voltage relations resulting from this interconnection are shown by curve *c* of Fig. 56. The phase voltages to the neutrals of the two groups are unchanged. The voltage difference between the two groups, which must be equalized by the interphase transformer, is shown in heavy outline in curve *c*. This voltage difference,  $e_i$ , is also plotted in

curve  $d$ , considering this voltage difference as positive when Group I is at a higher potential than Group II. To equalize the voltages of the two groups, so as to bring the neutral  $N$  to the same potential with respect to the anodes of the two groups which are working in parallel, the voltage difference between the two groups must be absorbed by the winding of the interphase transformer, one-half of this voltage by winding  $N - N_1$ , and the other half by winding  $N - N_2$ . The potential of  $N$  is intermediate between the potentials of  $N_1$  and  $N_2$ ; as a result of this, the potential between the minus and the plus terminals of the rectifier circuit will be as shown by the curve  $e_d$  of Fig. 56c, which is drawn intermediate between the phase voltages of the two groups. As will be explained later, this terminal voltage  $e_d$  is composed of portions of sine waves, having their peaks at the intersection of the phase voltages of the two groups.

**Principle of Operation.**—To understand the action of the interphase transformer, let it be assumed that the transformer is energized at point  $X - X$ , and anode 1, being at the highest potential, is ignited. As the current in this anode rises, the winding  $N_1 - N$ , through which this current flows, produces a magnetic field in the core of the interphase transformer. This field induces an e.m.f. in winding  $N_1 - N_2$ , in such a direction as to reduce the potential of Group I to  $N$ , and to increase the potential of Group II to  $N$  by an equivalent amount. This reduces the potential of anode 1 to  $N$  and increases the potential of anode 2 to  $N$  by equal amounts, until their potentials meet at an intermediate point  $y$ , so that anode 2 of Group II is made to operate in parallel with anode 1 of Group I. In this manner, successive anodes of the two groups are forced to operate in parallel all the time. If the impedances of the two groups of transformer windings are made equal, the load current will divide equally between the two groups. The two groups are, therefore, in stable parallel operation, at a terminal voltage intermediate between the potentials of the two groups, and each group carries one-half of the total direct current.

Each 3-phase group operates in the same manner as a 3-phase rectifier. Thus, phase 1 carries current until the point of intersection of its voltage wave with that of phase 3; the current is then transferred from phase 1 to phase 3, with a period of overlapping  $u$  between the two phases, as determined by their reactances.

The shapes of the voltage waves, taking into account the overlapping between adjoining phases within each group, is shown in Fig. 57. The effect of the overlapping is to increase the voltage difference between the two groups, which must be absorbed by the interphase transformer. The shape of the

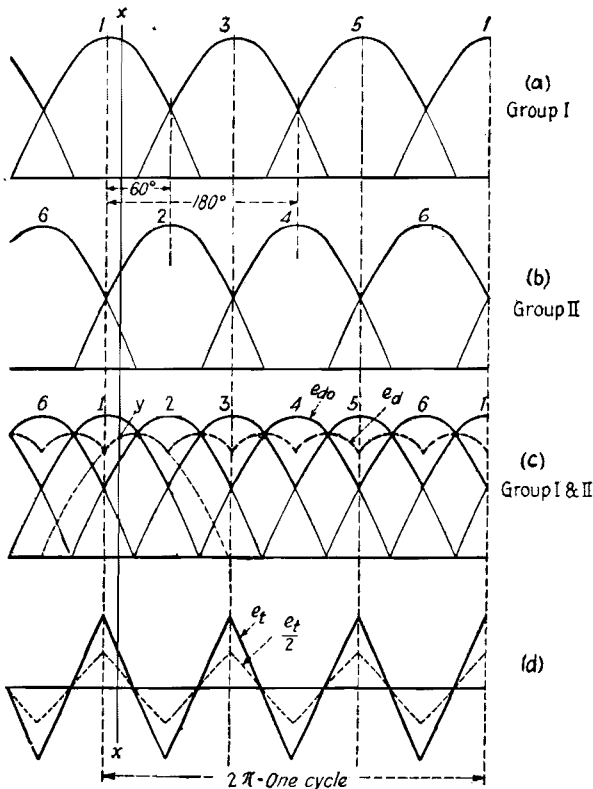

FIG. 56.—Voltage relations of the 6-phase connection with interphase transformer (without overlapping).

voltage wave  $e_t$  across the winding of the interphase transformer, as shown in Fig. 57, therefore differs from that shown in Fig. 56 by the additional voltage  $q$  due to overlapping. The terminal voltage  $e_d$ , being equal to the average of the voltages of the two groups, now has the shape shown in Fig. 57, and differs from the shape shown in Fig. 56c by one-half of the voltage  $q$ .

**Voltage and Current Relations.**—As seen from Fig. 57, the voltage  $e_t$  has a fundamental frequency equal to three times the

frequency of the alternating-current supply to the rectifier. It also contains higher harmonics of the triplen frequency. For the design of the interphase transformer, the wave  $e_t$  may be closely approximated by a sinusoidal wave  $e_t'$ , having the same amplitude as  $e_t$ . To absorb the voltage  $e_t$  in the winding  $N_1 - N_2$  of the interphase transformer, a third-harmonic magnetizing current  $i_t$  must flow in this winding, lagging the voltage by 90 third-harmonic degrees. The current  $i_t$  flows through the closed circuit formed by parallel operating phases of the two groups, and is superimposed upon the normal load currents (see Fig. 55).

The anode currents without the third-harmonic magnetizing current are shown in dotted lines in Fig. 57c and d. These currents have the same shapes as shown in Fig. 25 (Chap. IV). The successive anode currents of the two groups are displaced from each other by  $60^\circ$ , since the two groups operate as 3-phase systems displaced from each other by  $60^\circ$ . The actual anode currents, with the third-harmonic current  $i_t$  superimposed, are shown in heavy outline in Fig. 57c and d.

In Fig. 55 are shown the paths of the currents at a certain instant  $z - z$ .

The currents in the neutrals of the two groups are equal to  $I/2$ , on which is superimposed the current  $i_t$ . It is evident that if the load component of the anode and neutral currents did not exist, the third-harmonic current  $i_t$  could not flow due to the valve action of the anodes. Therefore, in order that the full value of  $i_t$  may flow, the anode and neutral currents  $I/2$  must be at least equal to the amplitude of  $i_t$ . The load current at which this occurs may be called the *transition current*.

At no load, there is no voltage drop in the interphase transformer, since there is no current flowing in the winding  $N_1 - N_2$ , and the direct-current voltage across the rectifier terminals is as shown by curve  $e_{a0}$  in Fig. 57a, which is the same as for the 6-phase rectifier shown in Fig. 24.

During the transition period, *i.e.*, between zero current and the transition current, the interphase transformer acts as an additional high reactance in the circuits of the anodes, producing overlapping between the adjoining phases of the 6-phase system.

The manner in which this transition takes place between no load and full load is shown in Fig. 59. The notation of the voltages and currents is the same as shown in Figs. 56 and 57. The following successive stages are represented in Fig. 59:



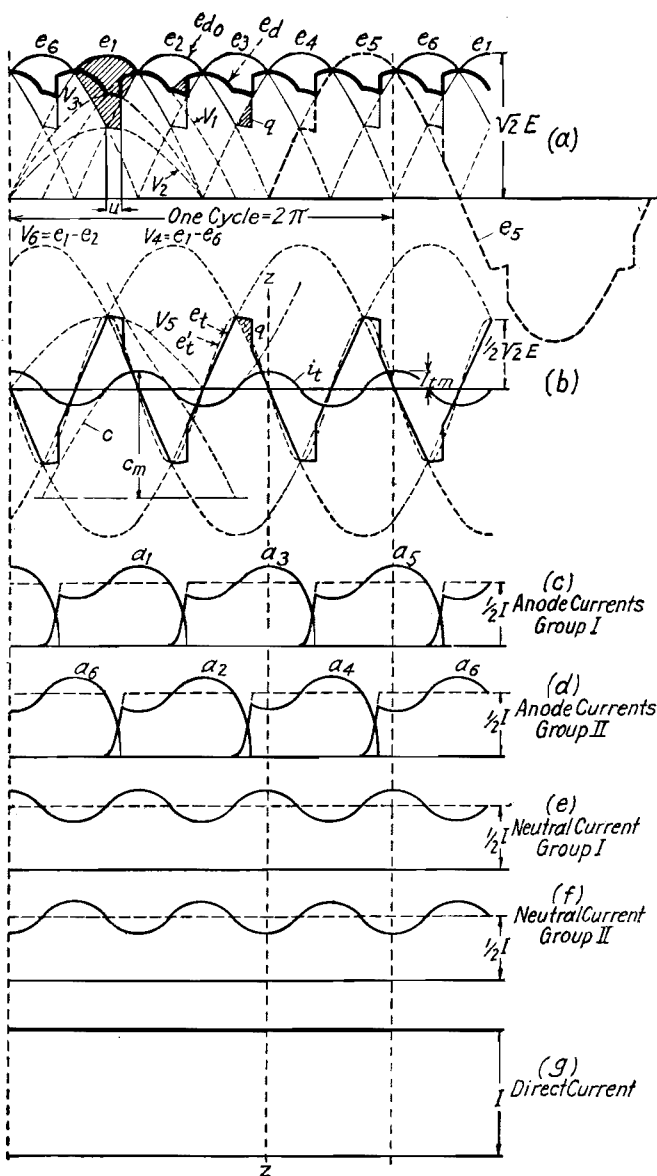

FIG. 57.—Waves of voltages and currents in the circuits of a rectifier having a 6-phase connection with interphase transformer, as shown in Fig. 55.

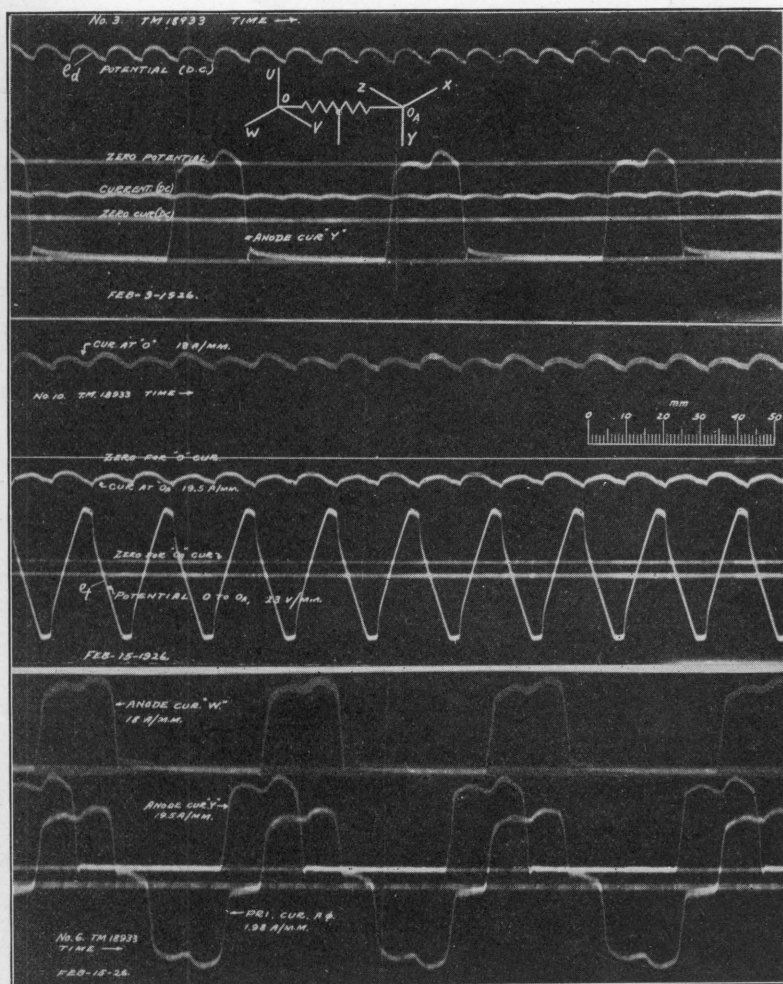

FIG. 58.—Oscillograms of voltages and currents taken on a 600-kw., 621-volt rectifier unit having a 6-phase transformer connection with interphase transformer, and supplied from a 12,000-volt, 3-phase, 60-cycle alternating-current system.

Section A.—No load.

Section B.—Load current producing overlapping less than  $30^\circ$ .

Section C.—Load current producing overlapping between  $30$  and  $60^\circ$ .

Section D.—Transition point;  $60^\circ$  overlapping between groups.

Section E.—Full-load operation.

The operation during the transition period, when the interphase transformer winding acts as a reactor, differs from the normal 6-phase operation with reactances in each phase, as explained in Chap. IV, in that the interphase transformer is a common

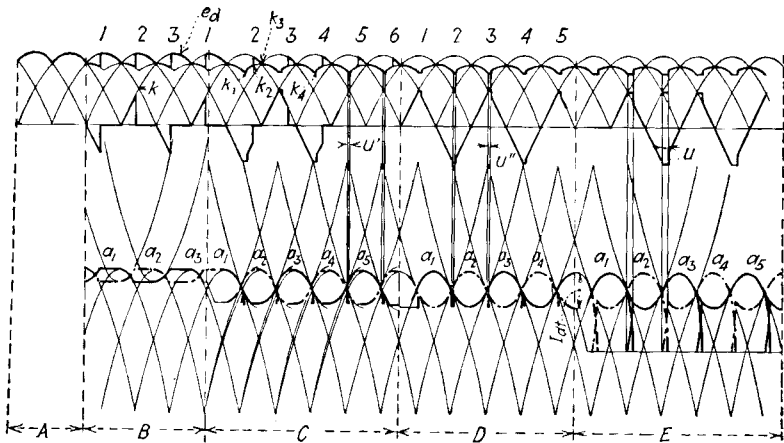

FIG. 59.—Voltage and current waves of the 6-phase connection with interphase transformer, showing the transition from no load to full load. (The zero axes of the anode currents are shown shifted downward in the successive sections of the figure.)

external high reactance for all three phases of each group, with the result that the relation between the phases of each group is not affected by this reactance.

Up to an overlapping of  $30^\circ$ , the anodes operate as though the reactance were in each phase. At an overlap of  $30^\circ$ , the potentials of two anodes of one group to its neutral  $N_1$  or  $N_2$  become equal; thus, at point  $k$  the potentials of anodes 1 and 3 of Group I become equal. As the period of overlap between the two groups exceeds  $30^\circ$ , the current is transferred from one anode to the next anode of the same group; thus, at point  $k_1$ , the current of Group I is transferred from anode 1 to anode 3, with a slight overlap  $u'$  between them, due to the transformer reactance. Anode 3 carries current from  $k_1$  until  $k_2$ , which is at the end of the period of overlap between the two groups, and is

then extinguished. Anode 3 ignites again at point  $k_3$  and carries current until point  $k_4$ , when the current is transferred to anode 5. At the end of the transition period, shown in Sec. D of Fig. 59, when the overlapping between the groups has reached  $60^\circ$ , *i.e.*, when the load current is sufficient to produce full magnetization of the interphase transformer, the anodes work, without extinguishing, over a period of  $120^\circ$ . Beyond the transition period (Sec. E), the operation is as already described in connection with Fig. 57.

The development of the magnetizing current and voltage drop across the interphase transformer is clearly seen from Fig. 59. It is seen from this figure that there is a considerable change in the average value of the direct-current voltage between no load, shown in Sec. A, and the transition load, shown in Sec. D. Since the transition load is a very small percentage of the rated load, this results in a steep drop of the voltage regulation curve, as shown in Fig. 61.

The shape of the secondary phase voltage between an anode and the neutral of one group, when the rectifier is carrying load, is shown by curve  $e_5$  in Fig. 57a. The irregularity in the positive half of this wave is produced by overlapping between phase 5 and phases 3 and 1. The irregularity in the negative half of the wave is produced by mutual induction from phase 2, which is on the same leg with phase 5, and which is positive and carries current when the voltage of phase 5 is negative.

In Fig. 58 are shown oscillograms of voltages and currents taken on a rectifier connected to a 6-phase transformer with interphase transformer. The rectifier unit is rated at 600 kw., 621 volts direct current. The transformer primary is connected in Y and is supplied from a 12,000-volt, 3-phase, 60-cycle system. The oscillograms were made with the rectifier in normal service and carrying approximately full-load current.

These oscillograms show the same characteristics as the theoretical curves of Fig. 57. The effect of the magnetizing current  $i_i$  on the shape of the anode, neutral, and primary currents is brought out in the oscillograms by the difference in the amplitudes of the successive ripples. The difference between the shape of the currents in the oscillograms and the corresponding curves in Fig. 57 is due to the fact that the direct current wave shown in oscillogram 3 is undulating, and not a straight line as assumed for the theoretical waves of Fig. 57; also, the current  $i_i$  was

shown in greater relative proportion in Fig. 57, in order to show its effect more clearly.

**Quantitative Analysis.**—The construction of the voltage waves is indicated in Fig. 57 and vector diagram Fig. 60. The voltage waves  $e_d$  and  $e_t$ , being derived from sums and differences of

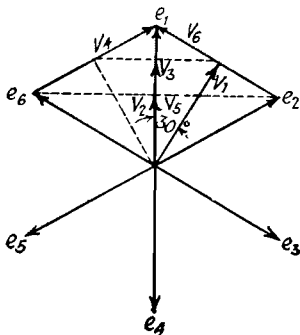

FIG. 60.—Vector diagram for constructing the voltage waves  $e_d$  and  $e_t$  in Fig. 57.

sinusoidal waves, are made up of sections of sine waves, whose relative magnitudes and phase positions to the alternating-current voltages are shown in the figures. Wave  $v_2$ , produced by the overlapping of phases 2 and 6, is equal to the mean of voltages  $e_2$  and  $e_6$ . One portion of the wave  $e_d$  is equal to the mean of  $e_1$  and  $v_2$ , and, therefore, lies on wave  $v_3$ . Another portion is equal to the mean of  $e_1$  and  $e_2$ , and, therefore, lies on the wave  $v_1$ , which is that mean.

One section of  $e_t$  is equal to  $e_1$  minus  $e_6$ , and, therefore, lies on wave  $v_4$ , which is in phase with  $e_2$ . A second section is equal to  $e_1$  minus  $v_2$ , and, therefore, lies on sine wave  $v_5$  which is in phase with and equal to  $v_2$ . A third section of voltage  $e_t$  is equal to  $e_1$  minus  $e_2$  and, therefore, lies on wave  $v_6$ , which is equal to and in phase with  $e_6$ .

Similarly, the magnetizing current  $i_t$  of voltage  $e_t$  is composed of portions of sinusoidal current waves, as required to induce the voltages  $v_4$ ,  $v_5$ , and  $v_6$  in the winding of the interphase transformer, therefore lagging behind these voltages by  $90^\circ$ .

The equations of the various voltage waves mentioned above are readily deduced from Fig. 60 and are as follows:

$$E_m = E\sqrt{2}.$$

$$e_1 = E_m \cos \omega t.$$

$$e_2 = E_m \cos \left( \omega t - \frac{\pi}{3} \right).$$

.....

$$v_1 = \frac{E_m \sqrt{3}}{2} \cos \left( \omega t - \frac{\pi}{6} \right).$$

$$v_2 = v_5 = \frac{E_m}{2} \cos \omega t.$$

$$v_3 = \frac{3E_m}{4} \cos \omega t.$$

$$v_4 = E_m \cos \left( \omega t - \frac{\pi}{3} \right).$$

$$v_6 = E_m \cos \left( \omega t + \frac{\pi}{3} \right).$$

In order to determine the duty imposed on the interphase transformer, the magnitudes of the currents, voltages, and flux will be considered.

As previously stated, for purposes of design calculation the voltage  $e_t$  across the winding  $N_1-N_2$  may be approximated by a sinusoidal curve  $e_t'$  which has an amplitude equal to  $0.5E_m$ , an effective value  $0.5E$ , and a frequency equal to three times the frequency of the alternating-current supply; thus, for a 60-cycle alternating-current supply,  $e_t'$  will have a frequency of 180 cycles.

The expressions for  $e_t'$  and its magnetizing current  $i_t'$  are:

$$e_t' = \frac{E\sqrt{2}}{2} \cos 3\omega t$$

$$i_t' = I_t' \sqrt{2} \cos \left( 3\omega t - \frac{\pi}{2} \right),$$

$I_t'$  being the r.m.s. value of the magnetizing current. The winding  $N_1-N_2$  must carry the current  $0.5I$ . The interphase transformer must, therefore, have a rating of

$$P_t = 0.5E \times 0.5I = 0.25EI. \quad (99)$$

Since the direct currents in the two halves of the winding  $N_1 - N_2$  flow in opposite directions, their m.m.f.s cancel and do not produce any magnetization of the core. The core is magnetized only by the third-harmonic current, producing a third-harmonic flux.

The load current at the transition point is the minimum direct current which will permit the flow of the full value of the magnetizing current  $i_t$ . As seen from Fig. 57, the current  $i_t$  is carried by one-half the load current. The load current,  $I_{dt}$ , at the transition point (see Figs. 59 and 61), must, therefore, be equal to twice the amplitude of  $i_t$ .

The current  $i_t$  is the upper portion of a sinusoidal current wave  $c$  required to produce a voltage  $v_6$  in the winding of the interphase transformer. The amplitude  $C_m$  of the wave  $c$  is equal to

the amplitude of  $v_6$  divided by the reactance  $\omega L$  of the interphase transformer.

$$C_m = \frac{E\sqrt{2}}{\omega L}.$$

The amplitude of  $i_t$  is

$$\begin{aligned} I_{tm} &= C_m - C_m \cos 30^\circ \\ &= C_m \left(1 - \frac{\sqrt{3}}{2}\right) \\ &= \frac{E\sqrt{2}}{\omega L} \left(1 - \frac{\sqrt{3}}{2}\right) = 0.19 \frac{E}{\omega L}. \\ I_{dt} &= 2I_{tm} = 0.38 \frac{E}{\omega L}. \end{aligned}$$

This current is indicated in Fig. 61, and usually has a magnitude of 0.5 to 2 per cent of the full-load current, its magnitude depending upon the inductance, and, therefore, on the design, of the interphase transformer. This corresponds to an amplitude  $I_{tm}$  of the magnetizing current  $i_t$  in the range of 0.25 to 1 per cent of the full-load current.

In making calculations from design data, it is more convenient to express  $I_{tm}$  and  $I_{dt}$  in terms of the *sinusoidal* magnetizing current  $I_t'$  required to induce the third-harmonic voltage  $E_t'$  in the winding of the interphase transformer, rather than in terms of the inductance  $L$ . The reactance of the interphase transformer at the third-harmonic frequency is

$$\begin{aligned} X_t &= 3\omega L = \frac{E_t'}{I_t'} = \frac{0.5E}{I_t'} \\ \omega L &= \frac{0.5E}{3I_t'}. \end{aligned}$$

Substituting this value of  $\omega L$  in the expressions for  $I_{tm}$  and  $I_{dt}$ ,

$$I_{tm} = 1.14I_t'. \quad (100)$$

$$I_{dt} = 2.28I_t'. \quad (101)$$

The relationship for determining the ampere-turns for the interphase transformer is

$$E_t' = 0.5E = 4.44N \times 3f_1\phi \times 10^{-8}, \quad (102)$$

in which  $N$  is the number of turns,  $f_1$  the fundamental frequency of the alternating-current supply, and  $\phi$  the third-harmonic flux.

The core must be designed for the third-harmonic flux, and, in order to have the same loss distribution as for the supply frequency, the flux density will have to be about one-half of that used for the supply frequency, as derived below:

$$\text{Iron losses} = KB_1^{1.6}f_1 = KB_3^{1.6}3f_1$$

$$\frac{B_3}{B_1} = \sqrt[1.6]{\frac{1}{3}} = 0.5, \quad (103)$$

$B_1$  being the flux density at the fundamental frequency, and  $B_3$  the flux density at the third-harmonic frequency.<sup>1</sup>

For determining the rating of the interphase transformer, based on a normal two-winding transformer at the supply frequency, the following should be considered:

At the supply frequency, the current rating remains unchanged. Only one-half the winding must be considered. The frequency is reduced to one-third. The flux density is doubled. The voltage in one-half the winding is, therefore, one-third the voltage of the interphase transformer. The rating of the interphase transformer at the supply frequency is, therefore,

$$\frac{1}{3}P_t = \frac{0.25}{3}EI = 0.083EI. \quad (104)$$

**Direct-current Voltages and Voltage Regulation.**—The average value of the no-load direct-current voltage, as computed by Eq. (2) for a 6-phase rectifier, is

$$E_{do} = E\sqrt{2} \frac{\sin \frac{\pi}{6}}{\pi/6} = 1.35E. \quad (105)$$

At the transition point, the amplitude of the direct-current voltage, as given by wave  $v_1$ , is equal to

$$\frac{E_m\sqrt{3}}{2} = \frac{E\sqrt{6}}{2},$$

and the average direct-current voltage is, therefore,

$$E_{dt} = \frac{E\sqrt{6}}{2} \frac{\sin \frac{\pi}{6}}{\pi/6} = 1.17E. \quad (106)$$

<sup>1</sup> Eq. (103) should be considered only as an approximate relation, because in deriving the equation the eddy-current losses, which are proportional to the square of the flux density, were not considered, and the exponent 1.6 for the hysteresis losses is an average experimental factor, which may vary for different grades of laminations.



The percentage voltage drop from no load to the transition load is, therefore,

$$\frac{E_{do} - E_{dt}}{E_{dt}} = \frac{1.35E - 1.17E}{1.17E} = 15.4 \text{ per cent.}$$

This high voltage rise between the transition load and no load is sometimes found objectionable, as it may cause burning out of lamps or may damage other equipment which is subjected to this voltage. Since this voltage rise is produced by the lack of third-harmonic magnetizing current  $i_u$ , it may be eliminated or reduced to a harmless value by exciting the interphase transformer with a third-harmonic current from an external source, which may be obtained from a saturated auxiliary transformer (see Chap. XII).

As the load is increased beyond the transition point, there is a further drop in the direct-current voltage, produced by the overlapping of the phases within each group.

The angle of overlap  $u$  (Fig. 57a) may be determined from Eq. (16).

The overlapping occurs between two phases of a 3-phase system, carrying the current  $I/2$ . Therefore,

$$\cos u = 1 - \frac{(I/2)X}{E\sqrt{2}\sin(\pi/3)} = 1 - 0.408\frac{IX}{E}. \quad (107)$$

The drop in the direct-current voltage is produced by the reduction of the voltage  $e_d$  by the portion shown shaded in Fig. 57a. This shaded area is bounded by curves  $v_1$  and  $v_3$ . The average value of this drop, taken for one-sixth of a cycle, is

$$\begin{aligned} d &= \frac{1}{\pi/3} \int_0^u (v_1 - v_3) d\omega t \\ &= \frac{E\sqrt{6}/4}{\pi/3} \int_0^u \sin \omega t d\omega t \\ &= \frac{E\sqrt{6}}{4\pi/3} (1 - \cos u) = 1.17E \sin^2 \frac{u}{2}. \end{aligned} \quad (108)$$

Substituting for  $\cos u$  the value obtained above,

$$d = 0.239IX, \quad (109)$$

and the average direct-current voltage beyond the transition point is

$$E_d = E_{dt} - d = 1.17E - 0.239IX = 1.17E \cos^2 \frac{u}{2}. \quad (110)$$

For a rectifier with a diametrically connected 6-phase transformer, as shown in Fig. 49, and the same current  $I$  and reactance per phase  $X$ , the voltage drop as given by Eq. (75) is  $0.955IX$ , which is four times the value given by Eq. (109). It is seen from this that by the use of the interphase transformer the voltage drop is reduced to one-fourth of the value obtained with a diametrical 6-phase transformer connection.

The voltage regulation curves of a 6-phase rectifier, with and without an interphase transformer, are shown in Fig. 61. These curves will come into consideration in a later section in connection with the compounding of rectifiers.

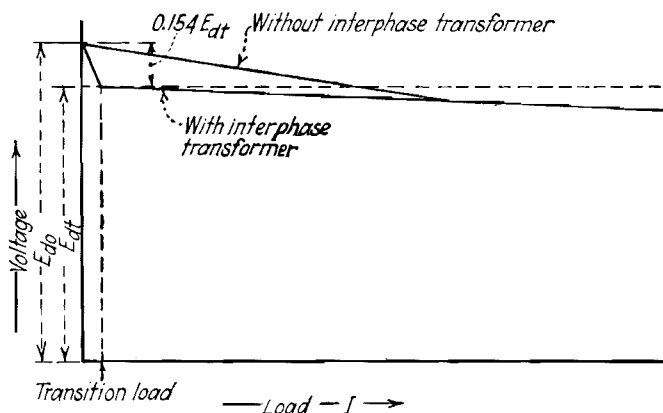
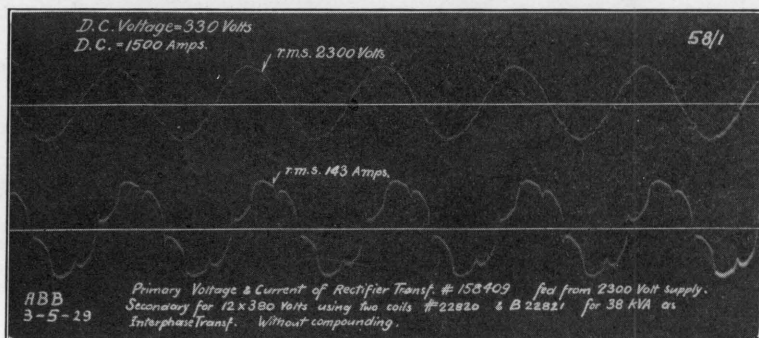
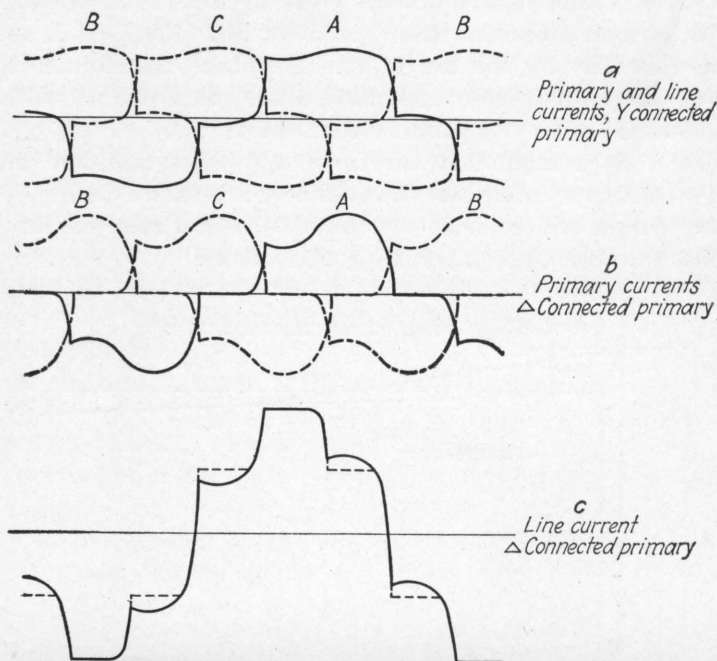

FIG. 61.—Voltage regulation curves for 6-phase connection of rectifier transformer, with and without interphase transformer.

**Primary and Line Currents.**—In Fig. 62 are shown the primary and line currents for the transformer connection with interphase transformer, as shown in Fig. 55. These currents were derived from the anode current waves of Fig. 57.

Figure 62a shows the primary and line currents for a Y-connected primary. These currents were derived from the anode currents of Fig. 57 by the use of Eqs. (68), (69), and (70). A summation of the primary and secondary m.m.f.s on the transformer legs by means of Eq. (71) will show that there is a residual third-harmonic m.m.f. on each leg, of an amplitude equal to two-thirds the amplitude of  $i_1 N$ . These m.m.f.s are in phase on all three legs and produce third-harmonic fluxes, the magnetic circuit of which is closed through the air. These fluxes are

relatively small on account of the relatively small magnitude of  $i_i$ , and the high reluctance of the magnetic circuit for this flux.



*d*

FIG. 62.—Wave shapes of primary and line currents for 6-phase connection with interphase transformer.

The wave shape of the primary current for a Y-connected primary is shown in oscillogram 6, Fig. 58. Its similarity to the theoretical wave of Fig. 62*a* is readily seen. The shape of the current wave in the oscillogram is also affected to some extent

by the magnetizing current of the transformer, which was disregarded in deriving the theoretical curves of Fig. 62.

The effect of the magnetizing current on the wave shape of the primary current is shown in Fig. 63. For simplicity, the load current  $i_p$  is shown without the component of the magnetizing current  $i_t$  of the interphase transformer. The magnetizing current  $i_o$  of the main transformer is shown as a sine wave lagging behind the phase voltage by  $90^\circ$ . The resultant primary current, consisting of the load component  $i_p$  and the magnetizing current  $i_o$ , is shown by curve  $i_p'$ . The magnetizing current  $i_o$  is practically constant, and its effect on the wave shape of the primary currents is less noticeable at higher loads.

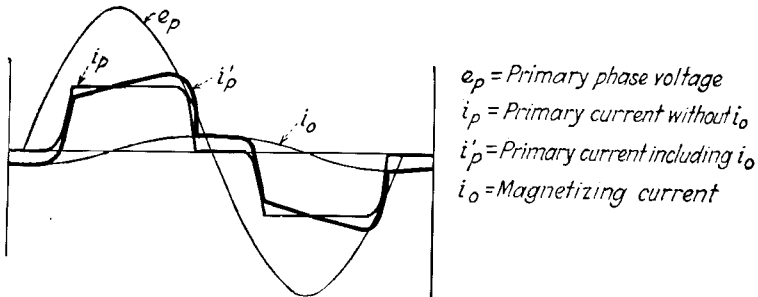

FIG. 63.—Effect of transformer magnetizing current on wave shape of primary current.

Figure 62b shows the primary phase currents of a delta-connected primary. These currents have the same shape as the secondary currents, since the factor  $k$  in Eqs. (61), (62), and (63) is practically zero, and there is no residual m.m.f. Figure 62c shows one of the line currents for a delta-connected primary. These currents are equal to the difference of the primary phase currents and can readily be derived from them. It can be noted that the third-harmonic current  $i_t$  introduces some irregularity into the line current. The shape of the line current, if the third-harmonic were not present, is shown in dotted lines. Since the magnetizing third-harmonic current  $i_t$  remains practically constant at all loads beyond the transition point, its influence on the shape of the currents is less at higher loads.

Figure 62d shows an oscillogram of the alternating-current line voltage and current for a 6-phase connected rectifier with interphase transformer and primary in delta. The third-harmonic current of the interphase transformer was relatively large com-

pared to the load current, and its influence on the line-current wave is pronounced.

**Transformer Rating.**—Each phase of the transformer secondary carries the current  $I/2$ , during one-third of a cycle. Assuming a square wave shape for the anode currents, without overlapping and without the third-harmonic magnetizing current, the effective value of the anode current, as determined by Eq. (1) for a 3-phase connection is

$$A = \frac{I/2}{\sqrt{3}} \quad (111)$$

The volt-ampere rating of the transformer secondary having a phase voltage  $E$  is therefore

$$P_2 = 6EA = \frac{6EI}{2\sqrt{3}} = 1.73EI.$$

The direct-current output (including the voltage drop in the arc and neglecting the voltage regulation) is

$$P = E_d I = 1.17EI \quad (112)$$

from which the relation of the secondary volt-ampere rating to the direct-current output is

$$P_2 = 1.481P. \quad (113)$$

The primary current is derived from Fig. 62, and on the basis of a 1:1 transformation ratio, has an effective value of

$$I_p = A\sqrt{2} = \frac{I}{\sqrt{6}}.$$

The volt-ampere rating of the primary

$$\begin{aligned} P_1 &= 3EI_p = \frac{3EI}{\sqrt{6}} = 1.225EI \\ &= 1.047P \end{aligned} \quad (115)$$

The average transformer volt-amperes

$$P_{av} = \frac{P_1 + P_2}{2} = \frac{(1.047 + 1.481)P}{2} = 1.264P. \quad (116)$$

$$\text{P.F.} = \frac{P}{P_1} = \frac{P}{1.047P} = 0.955. \quad (117)$$

The above values for the volt-amperes and currents may be corrected for overlapping by the factor  $\sqrt{1 - 3\psi(u)}$  as given by Eq. (19) for a 3-phase connection. The direct-current output  $P$

may be corrected for overlapping by replacing  $E_{at}$  in Eq. (112) by the value of the direct-current voltage under load,  $E_d$ , from Eq. (110). Below are given the various quantities as corrected for overlapping. The correction factors may be determined from Fig. 48.

$$A = \frac{I}{2\sqrt{3}} \sqrt{1 - 3\psi(u)} \quad (111a)$$

$$P = 1.17 EI \cos^2 \frac{u}{2} \quad (112a)$$

$$P_2 = 1.481 P \frac{\sqrt{1 - 3\psi(u)}}{\cos^2 \frac{u}{2}} \quad (113a)$$

$$I_p = \frac{I}{\sqrt{6}} \sqrt{1 - 3\psi(u)} \quad (114a)$$

$$P_1 = 1.047 P \frac{\sqrt{1 - 3\psi(u)}}{\cos^2 \frac{u}{2}} \quad (115a)$$

$$P_{av} = 1.264 P \frac{\sqrt{1 - 3\psi(u)}}{\cos^2 \frac{u}{2}} \quad (116a)$$

$$\text{P.F.} = \frac{0.955 \cos^2 \frac{u}{2}}{\sqrt{1 - 3\psi(u)}} \quad (117a)$$

**Voltage Control with Saturated Interphase Transformer.**—The direct-current voltage regulation curve for the transformer connection with interphase transformer, as shown in Fig. 61, is characterized by a bend and a steep voltage rise at light loads. As brought out in the preceding section, this bend occurs at the transition load, which is the minimum load current required for magnetizing the interphase transformer to induce in it the voltage  $e_t$  shown in Fig. 57*b*. As already stated, this transition load generally has a value of 0.5 to 2 per cent of the full-load current.

Should the core of the interphase transformer be magnetized with a constant direct current so as to make it operate on the saturated part of its magnetization curve, a higher load current would be required to induce the voltage  $e_t$ ; that is, the transition point of the voltage regulation curve in Fig. 61 would be moved to the right. The higher the direct-current magnetization of

the core, the higher would be the transition load. In Fig. 64 is shown a series of such regulation curves for different values of direct-current magnetization of the core, starting with zero magnetization. It is seen that for a very high magnetization the voltage curve approaches the curve for the diametrical 6-phase connection without interphase transformer, as shown in Fig. 61.

This offers a means for regulating the direct-current voltage of a rectifier between the voltage limits set by the voltage regulation curves of transformer connections with and without interphase transformer. If the direct-current magnetization of the core

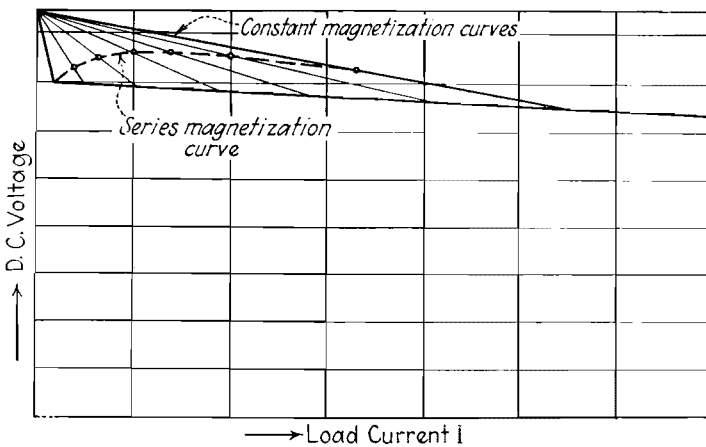

FIG. 64.—Voltage regulation curves for 6-phase connection with direct-current magnetization of the interphase transformer, explaining method used for "compounding" rectifiers.

is made proportional to the load current, by means of a magnetizing winding connected in series with the load, the effect is that as the load increases the direct-current magnetization also increases, and the operating point shifts from one constant magnetization curve to the next, producing a voltage regulation curve as shown by dotted lines in Fig. 64. Such an arrangement therefore gives automatic compounding of a rectifier similar to the compounding of a rotary converter by means of a series field winding. The automatic voltage regulation of a rectifier through a saturated interphase transformer may also be effected by means of a voltage regulator which regulates the direct current in an exciting winding of the interphase transformer. Connection diagrams for regulating the direct-current voltage of a

rectifier by means of a saturated interphase transformer are shown in Chap. XII.

When the interphase transformer is saturated, the main rectifier transformer operates as with the diametrical 6-phase connection without interphase transformer, and the relations of currents, transformer ratings, copper losses, and power factor are then the same as apply for that transformer connection, with the following results:

The average transformer ratings as previously derived for 6-phase connections without and with interphase transformer on the basis of the same direct-current output are in the ratio of  $1.55P/1.264P = 1.23$ ; so that if compounding with saturated interphase transformer is used, the transformer capacity must be increased by 23 per cent. The transformer primary must be connected in delta or in Y with a delta-connected tertiary winding in order to eliminate the third-harmonic fluxes in the core which would result from the use of a Y-connected primary for the diametrical 6-phase secondary, as was previously shown. The power factor at the primary terminals of the transformer is reduced, as seen from Fig. 73. The rectifier efficiency is also reduced on account of the higher amplitude of the anode currents, as was explained in Chap. II.

It is evident from the above that compounding of a rectifier by means of a saturated interphase transformer is not economical, and it is used only when the load conditions demand a "compound" voltage characteristic.

#### SIX-PHASE FORK CONNECTION (DOUBLE ZIG-ZAG)

**Diagram of Connections and Ratio of Windings.**—The fork connection of the rectifier transformer is widely used in Europe, and is also used in a number of installations on this continent. In Fig. 65 are shown the diagram of connections of the fork-connected transformer, the vector diagram of the voltages, and the wave shape of the direct-current voltage and the currents in the various windings.

The transformer primary is shown Y-connected. The secondary consists of 3 star windings, each of which is connected to branch windings on the other phases. The neutral of the star windings forms the negative pole of the rectifying system. The voltages of all the secondary windings are equal, so that the



voltages from the neutral to the anode terminals are displaced from each other by  $60^\circ$ , and constitute a 6-phase system.

With this connection, each rectifier anode and branch winding of the transformer secondary carries the full value of direct current  $I$  during one-sixth of a cycle, and each of the star windings carries the current  $I$  for one-third of a cycle. The shapes of the current waves  $a$  and  $s$ , in the branch and star windings, respectively, are shown in Fig. 65.

With a voltage  $E$  for the primary windings and a voltage  $E/\sqrt{3}$  for the secondary windings, the transformation ratio

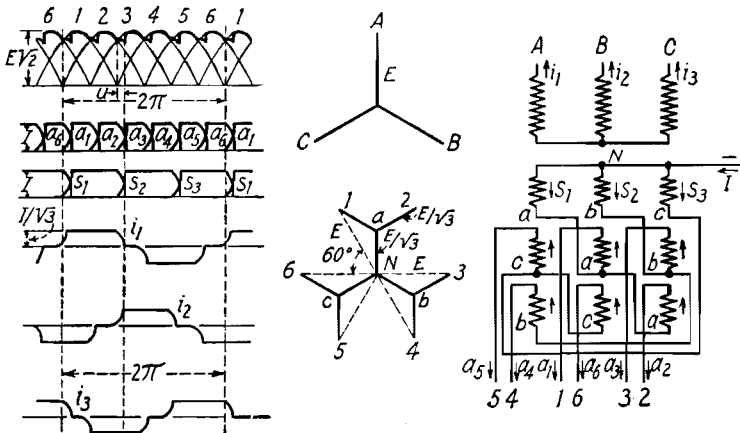

FIG. 65.—Diagram of connections, vector diagram, and voltage and current waves of 6-phase fork-connected rectifier transformer.

between each primary and secondary winding is  $\sqrt{3}:1$ , and the amplitude of the primary currents is  $I/\sqrt{3}$ . The primary currents are shown in Fig. 65 by curves  $i_1, i_2$ , and  $i_3$ .

**Direct-current Voltage and Voltage Regulation.**—The direct-current voltage wave is shown in Fig. 65, and has the same shape as for any other 6-phase rectifier connection having the same voltage from neutral to anodes.

In Fig. 66 is shown an oscillogram of the direct-current and primary voltages and of the anode and primary currents for a fork-connected transformer. The wave of the primary current shown in the oscillogram departs from the theoretical wave, shown in Fig. 65, on account of the magnetizing current of the transformer, as was explained in connection with Fig. 63. The

magnetizing current was neglected in deriving the primary current wave of Fig. 65.

If the voltage from the neutral  $N$  to each of the anode terminals is  $E$ , the direct-current voltage, as determined by Eq. (23),

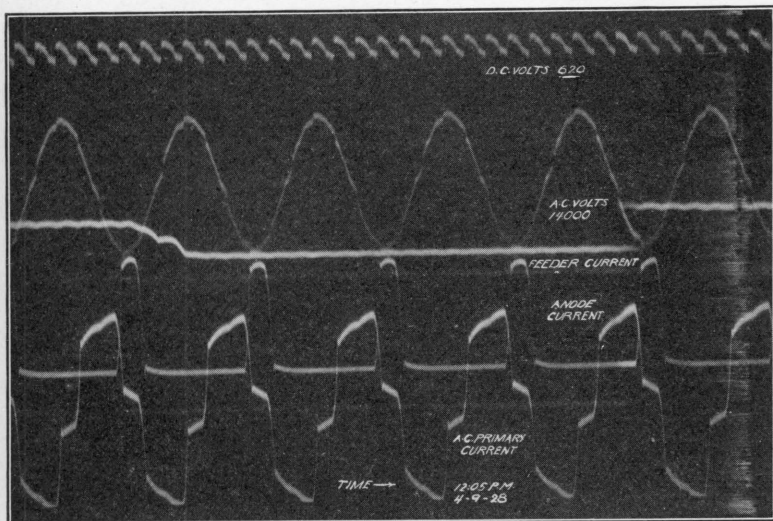

FIG. 66.—Oscillogram of voltages and currents taken on a 1,200-kw. rectifier unit with a fork-connected transformer, at approximately 75 per cent of rated load.

Chap. IV, for a 6-phase connection, and taking into account the voltage drop due to overlapping, is

$$E_d = \frac{E\sqrt{2} \sin \frac{\pi}{6}}{\pi/6} \left( 1 - \frac{1 - \cos u}{2} \right)$$

$$= 1.35E - 1.35E \left( \frac{1 - \cos u}{2} \right). \quad (118)$$

$$= 1.35E \cos^2 \frac{u}{2} \quad (118a)$$

The first term of Eq. (118) represents the average direct-current voltage at no load,  $E_{d0}$ ; the second term represents the voltage drop  $d$  due to overlapping when carrying load.

To determine the angle of overlap  $u$ , let it be assumed that the transformer has an effective leakage reactance  $X$ , corresponding to the voltage  $E$  from neutral to anode terminals. Since the reactance is proportional to the square of the number of turns,

and, therefore, to the square of the voltage, the reactance of each winding of the fork connection, having a voltage  $E/\sqrt{3}$ , is

$$X' = \frac{(E/\sqrt{3})^2}{E^2} X = \frac{X}{3}. \quad (119)$$

In computing the angle of overlap only the reactance  $X'$ , as given by Eq. (119), comes into consideration. This may be explained as follows: Referring to Fig 65, when the current  $I$  is transferred from anode 1 to anode 2, the leakage flux of winding  $a1$  is reduced to 0, while the leakage flux of winding  $a2$  is built up to the full value corresponding to current  $I$ . During this transfer there is no change in the current or leakage field of winding  $Na$ , and the reactance of this winding, therefore, does not affect the overlapping. When the current is transferred from anode 2 to anode 3, the leakage field of winding  $Na$  is reduced to 0, while the leakage field of winding  $Nb$  is built up to the full value corresponding to the current  $I$ . Since windings  $a2$  and  $b3$  are on the same leg of the transformer, and are interlaced, they have a common leakage field; there is, therefore, no change in the leakage fields of these windings when the current is transferred from one to the other, and the reactance of these windings does not affect the overlapping during the transfer of the current from anode 2 to anode 3.

From the above it is seen that for calculating the overlap of the fork connection, the current  $I$  may be considered as being transferred every one-sixth cycle between two windings, each having a reactance  $X'$ . Therefore, the angle of overlap for the fork connection, as determined from Eq. (16), is

$$\cos u = 1 - \frac{IX'}{E\sqrt{2} \sin \frac{\pi}{6}} = 1 - 1.41 \frac{IX'}{E} = 1 - 0.471 \frac{IX'}{E}. \quad (120)$$

Substituting Eq. (120) in the second term of Eq. (118), the voltage drop

$$d = 0.955IX' = 0.318IX. \quad (121)$$

**Transformer Rating.**—The direct-current output from the rectifier, including the arc voltage drop, and neglecting the voltage regulation produced by overlapping, is

$$P = E_d I = 1.35EI. \quad (122)$$

The r.m.s. value of the anode currents shown in Fig. 65, but neglecting overlapping, is

$$A = \frac{I}{\sqrt{6}}. \quad (123)$$

The r.m.s. value of the star currents, neglecting overlapping, is

$$S = \frac{I}{\sqrt{3}}. \quad (124)$$

The r.m.s. value of the primary currents, neglecting overlapping, is

$$I_p = \frac{(I/\sqrt{3})\sqrt{2}}{\sqrt{3}} = \frac{I\sqrt{2}}{3}. \quad (125)$$

The volt-ampere rating of the transformer secondary is

$$\begin{aligned} P_2 &= 6 \frac{E}{\sqrt{3}} \cdot A + 3 \frac{E}{\sqrt{3}} \cdot S = 6 \frac{E}{\sqrt{3}} \cdot \frac{I}{\sqrt{6}} + 3 \frac{E}{\sqrt{3}} \cdot \frac{I}{\sqrt{3}} \\ &= 2.41EI = 1.79P. \end{aligned} \quad (126)$$

The rating of the transformer primary is

$$P_1 = 3EI_p = 3E \cdot \frac{I\sqrt{2}}{3} = 1.41EI = 1.047P. \quad (127)$$

The average transformer rating is

$$P_{av} = \frac{P_1 + P_2}{2} = 1.91EI = 1.418P. \quad (128)$$

$$\text{P.F.} = \frac{P}{P_1} = \frac{P}{1.047P} = 0.955. \quad (129)$$

**Effect of Overlapping.**—To take into account the overlapping of the currents, correction factors, as determined from Eqs. (19) and (20), must be used. The corrected values of the currents and transformer ratings would then be as follows:

$$P = E_d I = 1.35EI \cos^2 \frac{u}{2} \quad (122a)$$

$$A = \frac{I}{\sqrt{6}} \sqrt{1 - 6\psi(u)}. \quad (123a)$$

$$S = \frac{I}{\sqrt{3}} \sqrt{1 - 3\psi(u)}. \quad (124a)$$

$$I_p = \frac{I\sqrt{2}}{3} \sqrt{1 - 3\psi(u)}. \quad (125a)$$

$$P_2 = \frac{6E}{\sqrt{3}} \cdot \frac{I}{\sqrt{6}} \sqrt{1 - 6\psi(u)} + \frac{3E}{\sqrt{3}} \cdot \frac{I}{\sqrt{3}} \sqrt{1 - 3\psi(u)}. \quad (126a)$$

$$P_1 = 3E \cdot \frac{I\sqrt{2}}{3} \sqrt{1 - 3\psi(u)}. \quad (127a)$$

$$\text{P.F.} = \frac{P}{P_1} = 0.955 \frac{\cos^2 \frac{u}{2}}{\sqrt{1 - 3\psi(u)}}. \quad (129a)$$

### TWELVE-PHASE CONNECTION WITH INTERPHASE TRANSFORMER

The 12-phase transformer connection with interphase transformer is the most commonly used 12-phase connection, because it gives a lower voltage regulation and a better utilization of the transformer than any other 12-phase connection. This connection was first used in 1922, on the 1,500-volt system of the Midi Railway in France, with two 6-anode rectifiers connected to one transformer. It is now also used in a number of rectifier installations in this country.

The transformer connections and vector diagram are shown in Fig. 67. The current and voltage waves are shown in Fig. 68. This connection actually consists of two parallel 6-phase systems with interphase transformers, which are displaced from each other by 30 electrical degrees. Each 6-phase system operates similarly to a 6-phase system with interphase transformer previously described and shown in Fig. 55, except that the secondary phase voltages in Fig. 67 are displaced by 15° with reference to the primary phase voltages, in order to obtain a displacement of 30° between the two 6-phase systems. The two 6-phase systems are made to operate in parallel by means of the third interphase transformer, which is connected between the neutrals,  $N_A$  and  $N_B$ , of the interphase transformers of the two systems, and absorbs the voltage difference between them. The neutral  $N$  of the third interphase transformer is, therefore, at a potential intermediate between the potentials of  $N_A$  and  $N_B$ .

In Fig. 68a are shown the alternating-current voltages, 1, 2, 3, . . . 12, between the neutrals,  $N_1, N_2, N_3, N_4$ , and the anode terminals. The direct-current voltage of 6-phase system  $A$ , between the neutral  $N_A$  and the cathode, is shown by wave  $e_{dA}$  and is derived from the phase voltages 1, 3, 5, 7, 9, and 11 in the same way as for the 6-phase connection with interphase trans-

former, shown in Fig. 57. The direct-current voltage  $e_{dB}$  for the 6-phase system  $B$  is similarly derived from the phase voltages 2, 4, 6, 8, 10, and 12. The resultant direct-current voltage between the neutral  $N$  and the cathode is shown by wave  $e_a$ , and is the mean of the voltages  $e_{dA}$  and  $e_{dB}$ . As seen from the figure, the voltage  $e_a$  has the wave shape of a 12-phase system. The anode currents are shown in Fig. 68c and d. The total

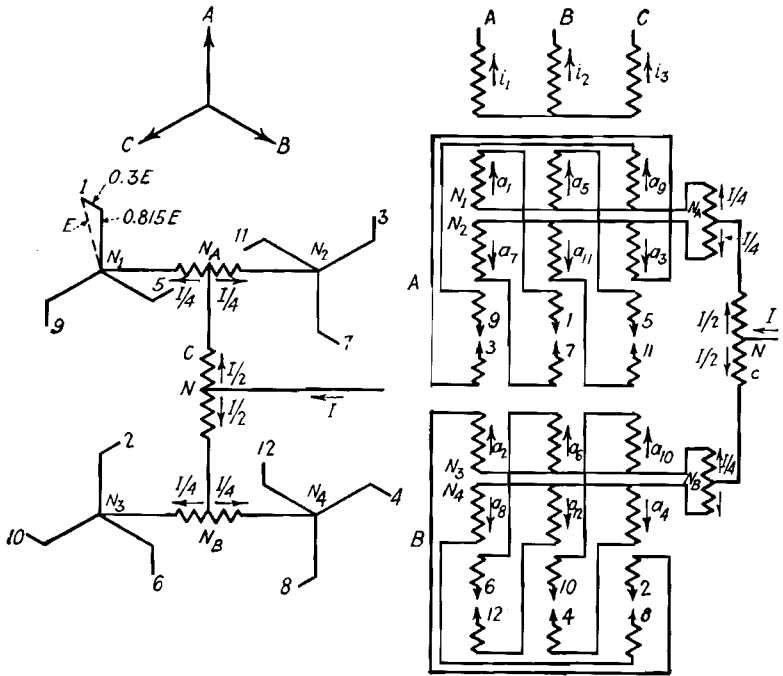

Fig. 67.—Transformer connections and vector diagram of 12-phase connection with interphase transformer.

direct current  $I$  is carried in parallel by the two 6-phase systems, so that the current in each system is  $I/2$ . The two 3-phase groups of each system operate in parallel, as in the 6-phase connection with interphase transformer, so that each group carries the current  $I/4$ , and this current is carried by each phase for approximately one-third of a cycle. Thus, for example, phase 1 carries the current  $I/4$  until the point of intersection  $P$  between its voltage wave and the voltage wave of the adjoining phase 5 of the same group; the current  $I/4$  is then transferred

to phase 5 during an angle of overlap  $u$  between the two phases. The third-harmonic magnetizing currents of the interphase transformers of the two systems appear in the anode currents, as in Fig. 57.

**Interphase Transformers.**—The voltages of the interphase transformers are shown in Fig. 68*b*. The waves  $e_{tA}$  and  $e_{tB}$  represent the voltages of the interphase transformers of the systems  $A$  and  $B$ , respectively, and have the same shapes as the voltage  $e_t$  of Fig. 57 for the 6-phase connection with interphase transformer. The wave  $e_{tC}$  represents the voltage across the third interphase transformer  $C$  and is equal to the difference of the direct-current voltages  $e_{dA}$  and  $e_{dB}$ . The fundamental frequency of voltage  $e_{tC}$  is double the frequency of voltages  $e_{tA}$  and  $e_{tB}$ , or six times the frequency of the alternating-current supply. This voltage is produced by a sixth-harmonic magnetizing current, which is superimposed on the direct current flowing in the interphase transformer  $C$ . This magnetizing current is similar to the third-harmonic magnetizing current  $i_t$  shown in Fig. 57, and flows in the circuit between simultaneously operating anodes of systems  $A$  and  $B$ , without appearing in the direct-current circuit. The shape of the anode currents will be affected slightly by the sixth-harmonic magnetizing current, but this effect is negligible on account of the small magnitude of this current.

For determining the rating of the interphase transformer  $C$ , the voltage wave  $e_{tC}$  may be approximated by a sinusoidal wave  $e'_{tC}$  having the same amplitude as  $e_{tC}$ . The amplitude  $M$  of  $e_{tC}$ , as determined from Fig. 68*a*, is

$$M = E\sqrt{2} \cos 30^\circ - E\sqrt{2} \cos^2 30^\circ = 0.164E.$$

The r.m.s. value of this voltage is

$$E'_{tC} = \frac{M}{\sqrt{2}} = 0.116E. \quad (130)$$

The coil  $C$  carries the current  $I/2$  and its volt-ampere rating is, therefore,

$$P_{tC} = 0.116E \times 0.5I = 0.058EI. \quad (131)$$

The rating of the interphase transformers  $A$  and  $B$  is one-half the rating of the interphase transformer for the 6-phase connec-

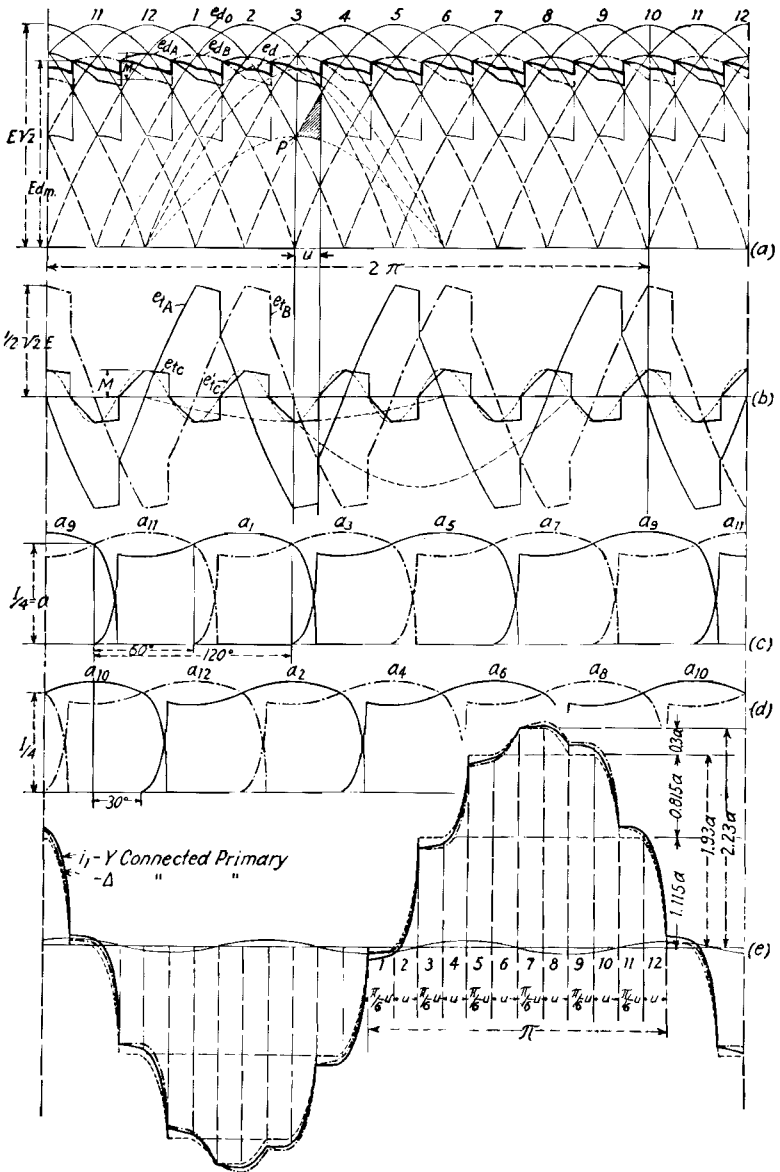

FIG. 68.—Voltage and current waves of 12-phase connection with interphase transformer.



tion as given by Eq. (99), since they carry only half as much current.

$$P_{tA} = P_{tB} = 0.5E \times 0.25I = 0.125EI. \quad (132)$$

The interphase transformer *C* is considerably smaller than the interphase transformers *A* and *B*, both on account of its lower

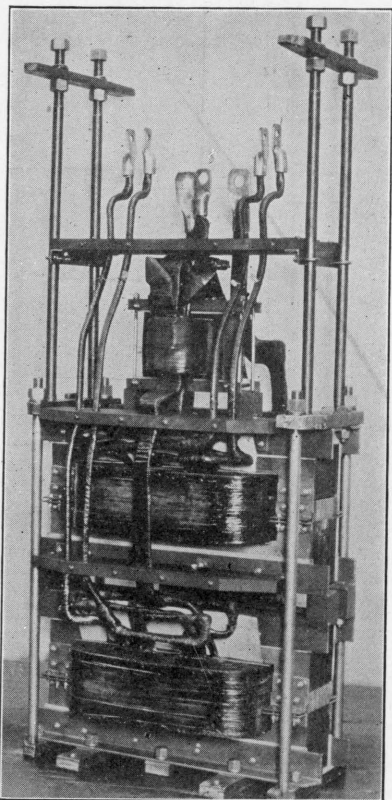

FIG. 69.—Group of interphase transformers for a General Electric, 1,000-kw., 600-volt rectifier unit having a 12-phase connection.

nominal rating and its higher frequency. In Fig. 69 is shown a group of General Electric interphase transformers for a 1,000-kw., 600-volt rectifier unit having a 12-phase connection. The relative sizes of the three interphase transformers are evident from the figure.

**Direct-current Voltage and Voltage Regulation.**—At no load the interphase transformers are not effective, since there is no

magnetizing current flowing through them, and the no-load direct-current voltage wave  $e_{do}$  is composed of the caps of the sinusoidal phase voltages. The average value of the no-load voltage, as determined by Eq. (2) for a 12-phase rectifier, is

$$E_{do} = E\sqrt{2} \frac{\sin(\pi/12)}{(\pi/12)} = 1.40E. \quad (133)$$

The transition from the no-load voltage wave  $e_{do}$  to the voltage wave  $e_d$ , under load, occurs in a manner similar to that shown in Fig. 59. As for the 6-phase connection with interphase transformer, the transition to the voltage  $e_d$  takes place at a load current which permits the flow of the full value of the magnetizing currents of the interphase transformers. The direct-current voltage at the transition point, *i.e.*, the voltage wave  $e_d$  for  $u = 0$ , has an amplitude

$$E_{dm} = E\sqrt{2} \cos 30^\circ \cos 15^\circ = 1.18E. \quad (134)$$

The average value of the direct-current voltage at the transition point, as determined by Eq. (2), is

$$E_{dt} = 1.18E \frac{\sin(\pi/12)}{(\pi/12)} = 1.17E. \quad (135)$$

The percentage voltage drop from no load to the transition load is

$$\frac{E_{do} - E_{dt}}{E_{dt}} = \frac{1.40E - 1.17E}{1.17E} = 19.6 \text{ per cent.}$$

It should be noted that the relation of the direct-current voltage  $E_{dt}$  at the transition point, to the phase voltage  $E$  is the same as for the 6-phase connection with interphase transformer, while the no-load voltage for the 12-phase connection is higher, resulting in a voltage rise of 19.6 per cent from the transition load to no load, as compared with 15.4 per cent for the 6-phase connection.

The direct-current voltage drop, produced by overlapping of the phases, may be determined by Eq. (22), replacing the amplitude  $E\sqrt{2}$  by  $E_{dm}$ , the amplitude of  $e_d$  given by Eq. (134).

$$d = \frac{E_{dm} \sin \frac{\pi}{p}}{2 \frac{\pi}{p}} (1 - \cos u)$$

$$\begin{aligned}
 &= \frac{1.18E \sin \frac{\pi}{12}}{2 \frac{\pi}{12}} (1 - \cos u) \\
 &= 0.586E(1 - \cos u). \quad (136)
 \end{aligned}$$

The average value of the direct-current voltage under load, taking into account the voltage drop, may be determined similarly by means of Eq. (23).

$$\begin{aligned}
 E_d &= \frac{E_{dm} \sin \frac{\pi}{p}}{\pi/p} \left( \cos^2 \frac{u}{2} \right) \\
 &= 1.17E \cos^2 \frac{u}{2}. \quad (137)
 \end{aligned}$$

The overlapping occurs between two phases of a 3-phase system carrying the current  $I/4$ . With a reactance  $X$  per phase, the angle of overlap, as obtained from Eq. (16) (Chap. IV), is

$$\cos u = 1 - \frac{(I/4)X}{E\sqrt{2} \sin \frac{\pi}{3}} = 1 - 0.204 \frac{IX}{E}. \quad (138)$$

Substituting this value in Eq. (136), the voltage drop is

$$d = 0.586E \left( 0.204 \frac{IX}{E} \right) = 0.12IX. \quad (139)$$

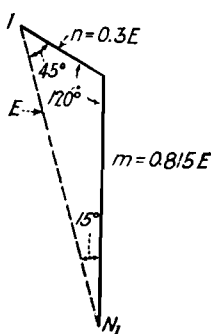

FIG. 70.—Vector diagram showing relation of the phase windings of the 12-phase connection.

This value of  $d$  is one-half that obtained for the 6-phase connection with interphase transformer as given by Eq. (109), because the current per phase of the 12-phase connection is one-half the current of the 6-phase connection, while the value of  $p$  used for calculating the angle of overlap is 3 for both connections.

**Transformer Secondary Voltages.**—The relationship of the voltages of the transformer secondary windings is shown in Fig. 70. The phase voltage  $E$  is produced by two windings which are placed on different transformer legs and have the voltages  $m$  and  $n$ . These voltages are displaced from each other by  $120^\circ$  and form angles of  $15^\circ$  and  $45^\circ$  with the voltage vector  $E$ . By the law of sines, the

relationship of the three sides of the triangle formed by these voltages is

$$\frac{E}{\sin 120^\circ} = \frac{m}{\sin 45^\circ} = \frac{n}{\sin 15^\circ}.$$

From which

$$m = 0.815E; \quad n = 0.3E. \quad (140)$$

**Currents and Transformer Ratings.**—The currents in the Y-connected primary of the transformer may be derived from the anode currents by the following relationships:

The sum of the currents at the neutral of the primary is equal to zero.

$$i_1 + i_2 + i_3 = 0. \quad (141)$$

The sums of the m.m.f.s on the three legs of the transformer are equal to each other (see Fig. 67).

$$\begin{aligned} i_1 + 0.815(a_1 + a_2 - a_7 - a_8) + \\ 0.3(a_3 - a_6 - a_9 + a_{12}) = \\ i_2 + 0.815(a_5 + a_6 - a_{11} - a_{12}) + \\ 0.3(-a_1 + a_4 + a_7 - a_{10}) = \\ i_3 + 0.815(-a_3 - a_4 + a_9 + a_{10}) + \\ 0.3(-a_2 - a_5 + a_8 + a_{11}). \end{aligned} \quad (142)$$

Solving the above equations for  $i_1$ ,  $i_2$ , and  $i_3$ , we have

$$\begin{aligned} i_1 = 0.643(-a_1 - a_2 + a_7 + a_8) + \\ 0.472(-a_3 + a_6 + a_9 - a_{12}) + \\ 0.172(-a_4 + a_5 + a_{10} - a_{11}). \end{aligned} \quad (143)$$

$$\begin{aligned} i_2 = 0.643(-a_5 - a_6 + a_{11} + a_{12}) + \\ 0.472(a_1 - a_4 - a_7 + a_{10}) + \\ 0.172(a_2 - a_3 - a_8 + a_9). \end{aligned} \quad (144)$$

$$\begin{aligned} i_3 = 0.643(a_3 + a_4 - a_9 - a_{10}) + \\ 0.472(a_2 + a_5 - a_8 - a_{11}) + \\ 0.172(a_1 + a_6 - a_7 - a_{12}). \end{aligned} \quad (145)$$

The current  $i_1$ , as derived from the anode currents by means of Eq. (143), is shown in Fig. 68e. The currents  $i_2$  and  $i_3$  have the same shape as  $i_1$ , but are displaced from  $i_1$  by  $120^\circ$ . The summation of the m.m.f.s on each transformer leg shows that

there is a residual third-harmonic m.m.f.,  $m_3$ , which is produced by the presence of the magnetizing currents of the interphase transformers in the anode currents, and is in phase on the three legs of the transformer. The residual m.m.f. on each leg is given by the expression

$$m_3 = 0.172N(a_1 + a_2 - a_3 - a_4 + a_5 + a_6 - a_7 - a_8 + a_9 + a_{10} - a_{11} - a_{12}),$$

$N$  being the number of turns in the primary phase winding, corresponding to the phase voltage  $E$ . The wave of  $m_3/N$  is shown in Fig. 68e and has an amplitude equal to 0.51 times the amplitude of the third-harmonic magnetizing current of the interphase transformer used in connection with one of the 6-phase systems in Fig. 67.

The dotted wave in Fig. 68e shows the shape of the current  $i_1$  if the magnetizing currents of the interphase transformers appearing in the anode currents are neglected.

The r.m.s. value  $I_1$  of the primary current  $i_1$  (dotted wave) is calculated below, taking into account the overlapping of the anode currents, but neglecting the magnetizing currents of the interphase transformers. To facilitate the calculations, the current wave in Fig. 68e is divided into Secs. 1 to 12. The amplitudes of the current for the different sections are given in terms of the amplitude  $a$  of the anode currents. Sections 2, 4, and 6 of the current wave have the same shape as the initial part of the anode current wave, which is expressed by Eq. (18). Sections 8, 10, and 12 have the same shape as the last part of the anode current wave, which is expressed by Eq. (17). In the following calculation, these sections of the current wave are expressed by means of Eqs. (17) and (18), the factor  $I$  of these equations being replaced by the particular values applying to the different sections, as given in Fig. 68e. The

term  $\frac{1 - \cos x}{1 - \cos u}$  has been replaced by  $w$  for the sake of brevity.

The remaining sections of the current wave have a rectangular shape. The r.m.s. value of the current is calculated below in the usual way by integrating the square of the current wave over one-half of a cycle.

$$\pi I_1^2 = \int_0^\pi i_1^2 dx = \quad (146)$$

SECTION

1.  $0 +$
2.  $\int_0^u (1.115aw)^2 dx +$
3.  $(1.115a)^2 \left(\frac{\pi}{6} - u\right) +$
4.  $\int_0^u (1.115a + 0.815aw)^2 dx +$
5.  $(1.93a)^2 \left(\frac{\pi}{6} - u\right) +$
6.  $\int_0^u (1.93a + 0.3aw)^2 dx +$
7.  $(2.23a)^2 \left(\frac{\pi}{6} - u\right) +$
8.  $\int_0^u [1.93a + 0.3a(1 - w)]^2 dx +$
9.  $(1.93a)^2 \left(\frac{\pi}{6} - u\right) +$
10.  $\int_0^u [1.115a + 0.815a(1 - w)]^2 dx +$
11.  $(1.115a)^2 \left(\frac{\pi}{6} - u\right) +$
12.  $\int_0^u [1.115a(1 - w)]^2 dx.$

Combining and adding the above terms,

$$\pi I_1^2 = a^2 \left[ 14.9 \frac{\pi}{6} - 4 \int_0^u (w - w^2) dx \right]. \quad (147)$$

Replacing  $a$  by  $I/4$ , and rearranging the terms,

$$I_1^2 = 0.155I^2 \left[ 1 - 1.61 \frac{1}{\pi} \int_0^u (w - w^2) dx \right].$$

In accordance with Eq. (20),

$$\frac{1}{\pi} \int_0^u (w - w^2) dx = \frac{1}{\pi} \int_0^u \left[ \frac{1 - \cos x}{1 - \cos u} - \left( \frac{1 - \cos x}{1 - \cos u} \right)^2 \right] dx = \psi(u).$$

Therefore,

$$I_1 = 0.395I \sqrt{1 - 1.61\psi(u)}. \quad (148)$$

The primary currents with a delta-connected primary may be derived from the anode currents by equating to zero the sum of the m.m.f.s of each transformer leg. The primary currents thus determined have the following values:

$$\left. \begin{aligned} i_1 &= 0.815(-a_1 - a_2 + a_7 + a_8) + \\ &\quad 0.3(-a_3 + a_6 + a_9 - a_{12}). \\ i_2 &= 0.815(-a_5 - a_6 + a_{11} + a_{12}) + \\ &\quad 0.3(a_1 - a_4 - a_7 + a_{10}). \\ i_3 &= 0.815(a_3 + a_4 - a_9 - a_{10}) + \\ &\quad 0.3(a_2 + a_5 - a_8 - a_{11}). \end{aligned} \right\} \quad (149)$$

The primary current  $i_1$  for a delta-connected primary is shown in Fig. 68e by a dot-and-dash curve. This curve practically coincides with the current curve for the Y-connected primary and differs from it only in so far as the currents are affected by the magnetizing currents of the interphase transformers. If these magnetizing currents are disregarded, the currents for Y and delta primaries will be identical, and will have the shape shown by the dotted curve in Fig. 68e, the r.m.s. value of which is given by Eq. (148).

The r.m.s. value of the anode currents may be determined by means of Eq. (19), replacing  $I$  by  $I/4$  and  $p$  by 3, since each anode carries the current  $I/4$  during one-third of a cycle.

$$\begin{aligned} A &= \frac{I/4}{\sqrt{3}} \sqrt{1 - 3\psi(\bar{u})} \\ &= 0.144I \sqrt{1 - 3\psi(\bar{u})}. \end{aligned} \quad (150)$$

The direct-current output is

$$P = E_d I = 1.17EI \cos^2 \frac{u}{2}. \quad (151)$$

The volt-ampere rating of the transformer secondary is

$$\begin{aligned} P_2 &= 12(0.815E + 0.3E)A \\ &= 1.93EI \sqrt{1 - 3\psi(u)} \\ &= 1.65P \frac{\sqrt{1 - 3\psi(u)}}{\cos^2 \frac{u}{2}}. \end{aligned} \quad (152)$$

The volt-ampere rating of the transformer primary is

$$P_1 = 3EI_1 = 3E \times 0.395I \sqrt{1 - 1.61\psi(u)}$$

$$\begin{aligned}
 &= 1.185EI\sqrt{1 - 1.61\psi(u)} \\
 &= 1.01P\frac{\sqrt{1 - 1.61\psi(u)}}{\cos^2 \frac{u}{2}}. \tag{153}
 \end{aligned}$$

$$\text{P.F.} = \frac{P}{P_1} = 0.988 \frac{\cos^2 \frac{u}{2}}{\sqrt{1 - 1.61\psi(u)}}. \tag{154}$$

In the foregoing equations, the effect of overlapping of the anode currents is taken into consideration. If overlapping is neglected, *i.e.*, if  $u$  is zero, the various quantities previously derived will have the following values:

The direct-current voltage.....	$E_d = 1.17E.$
The primary current.....	$I_1 = 0.395I.$
The anode current.....	$A = 0.144I.$
The direct-current output.....	$P = 1.17EI.$
The secondary volt-amperes.....	$P_2 = 1.93EI = 1.65P.$
The primary volt-amperes.....	$P_1 = 1.185EI = 1.01P.$
The average volt-amperes.....	$P_{av} = \frac{P_1 + P_2}{2} = 1.33P.$

NOTE.—The 12-phase connection with interphase transformers has been considered in detail in order to illustrate the application of the general methods and formulæ for the solution of currents, transformer ratings, etc., of rectifier transformers. These methods and formulæ may be applied similarly to any other type of transformer connection.

#### VOLTAGE REGULATION

It was shown in Chap. IV that when the rectifier is carrying load there is a reduction of the direct-current voltage from its value at no load on account of the transformer reactance which causes overlapping of the anode currents. The voltage drop due to the overlapping is a function of the angle of overlap  $u$ , which, in turn, is a function of the load current and the transformer reactance. The general expression for the voltage drop is given by Eqs. (22) and (22a). The equations for the angle of overlap and the voltage drop were derived in the present chapter for the several transformer connections considered. It is seen from Eq. (22a) that the voltage drop due to the reactance is directly proportional to the load current, resulting in a straight-line voltage-current characteristic. Besides the voltage drop due to the transformer reactance, there is an additional drop due to the copper losses of the transformer and the variation



of the arc drop in the rectifier with the load. These will be considered presently.

**Voltage Drop Due to Reactance.**—The reactance of a transformer is usually expressed as the reactive voltage drop in the transformer, at rated primary current, taken as a percentage of the rated no-load voltage. It is measured by short-circuiting the secondary and applying to the primary a sinusoidal voltage of a value required to supply rated primary current. The reactive voltage drop is obtained from this voltage by subtracting the in-phase component as given by the measured copper losses.

The percentage reactance is, therefore,

$$X\% = \frac{I_p X_p}{E_p} \times 100 \quad (155)$$

in which  $I_p$  is the rated primary current,  $X_p$  the equivalent secondary reactance per phase (considered in determining the angle of overlap and the voltage drop) referred to the primary, and  $E_p$  is the rated primary phase voltage.

In the calculations of the several transformer connections in this chapter the angle of overlap and the voltage drop were expressed in function of the direct current  $I$  and the equivalent reactance  $X$  per secondary phase. For convenience in calculation and in making comparisons, these quantities will be expressed as functions of the percentage of reactance for the four transformer connections commonly used for rectifiers. To simplify the calculations, the overlap correction factors for the primary currents will be neglected.

1. *Diametrical 6-phase Connection with Delta Primary.*—For this connection, the rated primary current  $I_p = I/\sqrt{3}$ ; the primary phase voltage  $E_p = E$ ; the equivalent secondary reactance referred to the primary  $X_p = X$ .

The angle of overlap given by Eq. (74) is

$$\begin{aligned} \cos u &= 1 - 1.41 \frac{IX}{E} \\ &= 1 - 2.45 \frac{I_p X_p}{E_p} = 1 - 2.45 \frac{X\%}{100}. \end{aligned} \quad (156)$$

The direct-current voltage drop, as given by Eq. (75), taken as a percentage of the no-load voltage is

$$\begin{aligned} d\% &= \frac{d}{E_{do}} \times 100 = \frac{0.955IX}{1.35E} \times 100 \\ &= 1.23 \frac{I_p X_p}{E_p} \times 100 = 1.23X\%. \end{aligned} \quad (157)$$

2. *Six-phase Connection with Interphase Transformer.*—For this connection  $I_p = I/\sqrt{6}$ ;  $E_p = E$ ;  $X_p = X$ .

The angle of overlap given by Eq. (107) is

$$\begin{aligned}\cos u &= 1 - 0.408 \frac{IX}{E} \\ &= 1 - \frac{I_p X_p}{E_p} = 1 - \frac{X\%}{100}.\end{aligned}\quad (158)$$

From the point of view of regulation, the direct-current voltage  $E_{di}$ , at the transition load, may be considered as the no-load voltage for this transformer connection. The direct-current voltage drop, as given by Eq. (109), taken as a percentage of this voltage is

$$\begin{aligned}d\% &= \frac{d}{E_{di}} \times 100 = \frac{0.239IX}{1.17E} \times 100 \\ &= 0.5 \frac{I_p X_p}{E_p} \times 100 = 0.5X\%.\end{aligned}\quad (159)$$

Equations (158) and (159) may also be used for calculating the angle of overlap and percentage of direct-current voltage drop of rectifier transformers with diametrical 6-phase secondary and Y-primary having a 5-leg core or shell-type construction as shown in Figs. 53 and 54, the current and voltage relations of which are the same as for the 6-phase connection with interphase transformer.

3. *Six-phase Fork Connection.*—For this connection

$$I_p = \frac{I\sqrt{2}}{3}; E_p = E; X_p = X.$$

The angle of overlap, as given by Eq. (120), is

$$\begin{aligned}\cos u &= 1 - 0.471 \frac{IX}{E} \\ &= 1 - \frac{I_p X_p}{E_p} = 1 - \frac{X\%}{100}.\end{aligned}\quad (160)$$

The direct-current voltage drop, as given by Eq. (121), expressed as a percentage of the no-load voltage, is

$$d\% = \frac{d}{E_{do}} \times 100 = \frac{0.318IX}{1.35E} \times 100 = 0.5 \frac{I_p X_p}{E_p} \times 100 = 0.5X\%.\quad (161)$$

4. *Twelve-phase Connection with Interphase Transformer.*—For this connection, the primary current, given by Eq. (148), is

$$I_p = 0.395I; X_p = X; E_p = E.$$

The angle of overlap given by Eq. (138) is

$$\begin{aligned}\cos u &= 1 - 0.204 \frac{IX}{E} \\ &= 1 - 0.516 \frac{I_p X_p}{E_p} = 1 - 0.516 \frac{X\%}{100}.\end{aligned}\quad (162)$$

For expressing the percentage of the direct-current voltage drop, the direct-current voltage  $E_{dt}$ , at the transition load, may

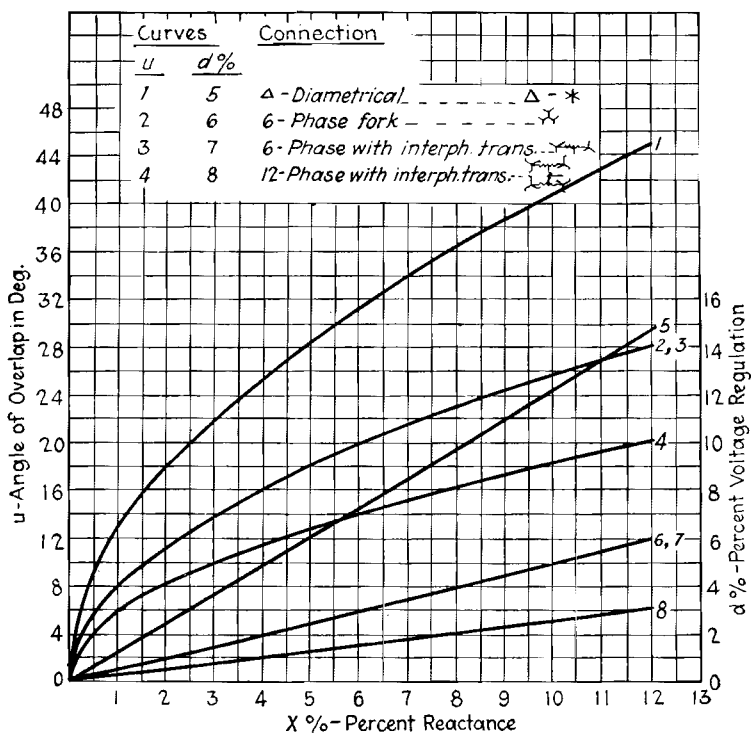

FIG. 71.—Curves of the angle of overlap and the percentage of direct-current voltage regulation, due to the transformer reactance, for four types of transformer connections. (Regulation based on no-load voltage.)

be taken as the no-load voltage. The direct-current voltage drop, as given by Eq. (139), expressed as a percentage of  $E_{dt}$ , is

$$\begin{aligned}d\% &= \frac{d}{E_{dt}} \times 100 = \frac{0.12IX}{1.17E} \times 100 \\ &= 0.26 \frac{I_p X_p}{E_p} \times 100 = 0.26X\%.\end{aligned}\quad (163)$$

In Fig. 71 are plotted the curves of the angle of overlap and the percentage of voltage regulation due to the transformer reactance, in function of the percentage of reactance, for the several types of transformer connections as given by Eqs. (156) to (163). It should be kept in mind that the voltage regulation  $d\%$  is expressed as a percentage of the no-load direct-current voltage at the terminals of the transformer for the 6-phase diametrical and fork connections, and as a percentage of the direct-current voltage at the transition load for the 6- and 12-phase connections with interphase transformers. The curves of Fig. 71 may also be used for determining the regulation and angle of overlap at loads other than full load by using for  $X\%$  a value proportional to the load.

**Voltage Drop Due to Copper Losses.**—In deriving the equations of the average direct-current voltage  $E_a$  and the direct-current output  $P$  for the various types of transformer connections, the voltage drop in the arc was assumed to be included in the voltage  $E_a$ .  $E_a$  and  $P$ , therefore, represent the direct-current voltage and power output, respectively, at the terminals of the transformer secondary. Furthermore, the copper losses in the transformer were neglected, so that  $P$  represents also the watts input at the transformer primary terminals (neglecting the core losses).

If the transformer copper losses are taken into consideration, the power output at the terminals of the transformer secondary will be reduced by the amount of those losses. The copper losses are caused by the resistance of the transformer windings. This resistance has practically no effect on the currents, but it reduces the secondary phase voltages by the  $ir$  voltage drop in the windings. The reduction of the secondary power output by the transformer copper losses is, therefore, represented entirely by a reduction of the direct-current voltage. If  $W_c$  designates the transformer copper losses in watts, the drop  $e_c$  in the direct-current voltage produced by these losses is equal to the ratio of  $W_c$  to the direct current  $I$ .

$$e_c = \frac{W_c}{I} \text{ volts.} \quad (164)$$

If any other current-carrying apparatus, such as interphase transformers or anode reactors, are used in connection with the rectifier transformer, their copper losses should be included in  $W_c$ .

The copper losses are proportional to the square of the load current  $I$ ; the voltage drop  $e_c$  is therefore directly proportional to the load current.

The voltage drop due to the copper losses expressed as a percentage of the direct-current output voltage is equal to the percentage ratio of the copper losses to the power output.

**Direct-current Terminal Voltage.**—The net direct-current voltage,  $E_{dl}$ , at the load terminals of the rectifier under load, is equal to the no-load (or transition-load) direct-current voltage at the secondary terminals of the transformer, minus the voltage drop due to the transformer reactance and copper losses and the voltage drop in the arc,  $e_a$

$$\begin{aligned} E_{dl} &= E_{do} - d - e_c - e_a \\ &= E_{do} \left( 1 - \frac{d\%}{100} \right) - e_c - e_a. \end{aligned} \quad (165)$$

$$E_{do} = \frac{E_{dl} + e_c + e_a}{1 - \frac{d\%}{100}}. \quad (166)$$

The terminal direct-current voltage at no load is

$$E_{dn} = E_{do} - e_a. \quad (167)$$

For transformer connections with interphase transformers  $E_{do}$  is replaced by  $E_{dt}$ , the direct-current voltage at the transition load.

In the expression (165) for the terminal direct-current voltage under load, the quantities  $d$  and  $e_c$  vary in direct proportion with the load current  $I$ . The direct-current voltage regulation characteristics as affected by these quantities would, therefore, be straight sloping lines. The arc voltage drop in the rectifier,  $e_a$ , as seen from Fig. 6, has a concave shape and produces a slight droop in the voltage regulation curve.

The voltage regulation of a machine is generally defined as the voltage drop between no load and full load, expressed as a percentage of the full-load voltage. The no-load and full-load direct-current terminal voltages of a rectifier may be calculated by means of Eqs. (165) and (167) above, and by the relations between the direct- and alternating-current transformer secondary voltages previously derived for the several transformer connections considered. The voltage regulation may then be computed. As an approximation, it may be taken as the per-

centage of voltage drop due to reactance as given by the curves of Fig. 71 plus the percentage of copper losses to the direct-current output.

Equation (166) may be used for determining the secondary alternating-current voltage of the rectifier transformer required to produce a desired full-load direct-current voltage at the rectifier terminals. As an example, the secondary alternating-current voltage will be computed for a 6-phase fork-connected rectifier transformer required to produce a direct-current terminal voltage of 3,000 volts at 3,000 kw., when connected to a rectifier having an arc voltage drop of 25 volts at 1,000 amp. The transformer reactance is assumed to be 6 per cent, and the copper loss 30 kw. From Fig. 71 the voltage regulation due to the transformer reactance is,  $d\% = 3.0$  per cent. The direct-current voltage drop due to copper losses is  $e_c = \frac{30 \times 1,000}{1,000} = 30$  volts. From Eq. (166) the direct-current no-load voltage at the secondary terminals of the transformer is

$$E_{do} = \frac{3,000 + 30 + 25}{1 - 0.03} = 3,149 \text{ volts.}$$

The secondary alternating-current voltage is

$$E = \frac{E_{do}}{1.35} = \frac{3,149}{1.35} = 2,333 \text{ volts.}$$

The direct-current terminal voltage at no load is equal to  $E_{do} - e_a = 3,149 - 25 = 3,124$  volts. The voltage regulation is equal to  $\frac{3,124 - 3,000}{3,000} = 4.1$  per cent.

#### POWER FACTOR

The power factor at the primary terminals of a transformer is the ratio of watts to volt-amperes. If both the currents and the voltages are sinusoidal, the ratio is equal to the cosine of the phase angle, or angle of displacement, between the line currents and the phase voltages (voltages to neutral).

At the primary terminals of a rectifier transformer, the voltage is generally sinusoidal, while the current is non-sinusoidal and may be resolved into a number of sinusoidal components consisting of a fundamental wave of the same frequency as the voltage and of higher harmonic waves of frequencies which are

multiples of the fundamental frequency. The r.m.s. value of the line current is the square root of the sum of the squares of the component currents, and is, therefore, higher than the fundamental component. Only the fundamental component of the current carries power; the higher harmonic components cannot carry power since there are no voltages of corresponding frequencies. The fundamental component of the current may be displaced in phase from the phase voltage.

If the r.m.s. value of the line current is  $I_L$ , the r.m.s. value of its fundamental component  $I_1$ , the phase voltage to neutral  $E_p$ , and the phase angle between  $E_p$  and  $I_1$  is  $\phi$ , the watts input at the line terminals of the transformer is

$$W_L = 3E_p I_1 \cos \phi. \quad (168)$$

The volt-ampere input is

$$P_L = 3E_p I_L. \quad (169)$$

The power factor is

$$\text{P.F.} = \frac{W_L}{P_L} = \frac{3E_p I_1 \cos \phi}{3E_p I_L} = \frac{I_1}{I_L} \cdot \cos \phi. \quad (170)$$

From Eq. (170) it is seen that the power factor is the product of two factors: the first factor is  $I_1/I_L$ , the ratio of the r.m.s. value of the fundamental component of the current to the r.m.s. value of the total current. This factor indicates the distortion of the current wave due to higher harmonics, and may be termed the *distortion factor*  $v$ . The higher the factor  $v$ , the more nearly does the current approach a sine wave. If the current were sinusoidal,  $v$  would be equal to 1. The second factor,  $\cos \phi$ , represents the phase displacement between the fundamental component of the line current and the phase voltage, and may be termed the *displacement factor*.

The power factor obtained at the line terminals of a rectifier transformer depends on the type of transformer connection used. The theoretical direct-current watts output  $P$ , considered in the calculations of the different transformer connections, includes the losses in the rectifier (since  $P = E_d I$ , and  $E_d$  includes the voltage drop in the rectifier), as well as the transformer copper losses as was explained in the section on Voltage Regulation.  $P$ , therefore, represents the watts input at the primary terminals of the rectifier transformer. The effect of the core losses and magnetizing current will be neglected for the present. The power

factor is, therefore, the ratio of the direct-current output  $P$  to the volt-amperes  $P_L$  at the line terminals of the transformer.

$$\text{P.F.} = \frac{P}{P_L} \quad (171)$$

The values of the power factor have been computed by means of Eq. (171) for the various transformer connections considered in this chapter, and were given with the transformer calculations

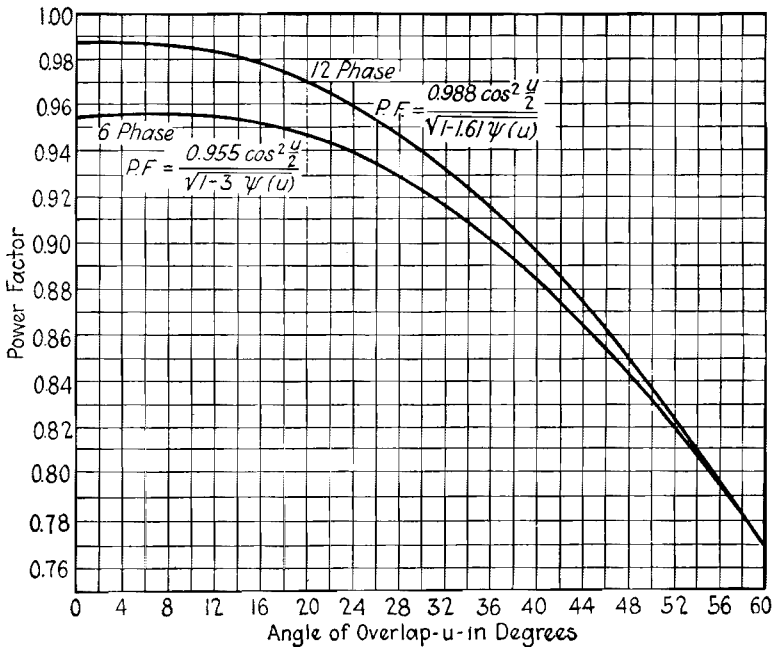

FIG. 72.—Power-factor curves for 6-phase and 12-phase transformer connections, plotted as a function of the angle of overlap from Eqs. (85), (117a), (129a), and (154).

(see Eqs. (85), (117a), (129a), (154), and Table V). The power factor for these connections has the general equation

$$\text{P.F.} = K \frac{\cos^2 \frac{u}{2}}{\sqrt{1 - c\psi(u)}}, \quad (172)$$

in which the constants  $K$  and  $c$  are characteristic of the type of connection used, and  $\psi(u)$  has the value given in Eq. (20).



It is seen from the equations of the power factor that the power factor is a function of the angle of overlap  $u$  and is therefore a function of the load. The effect of the angle of overlap on the distortion and displacement factors is as follows:

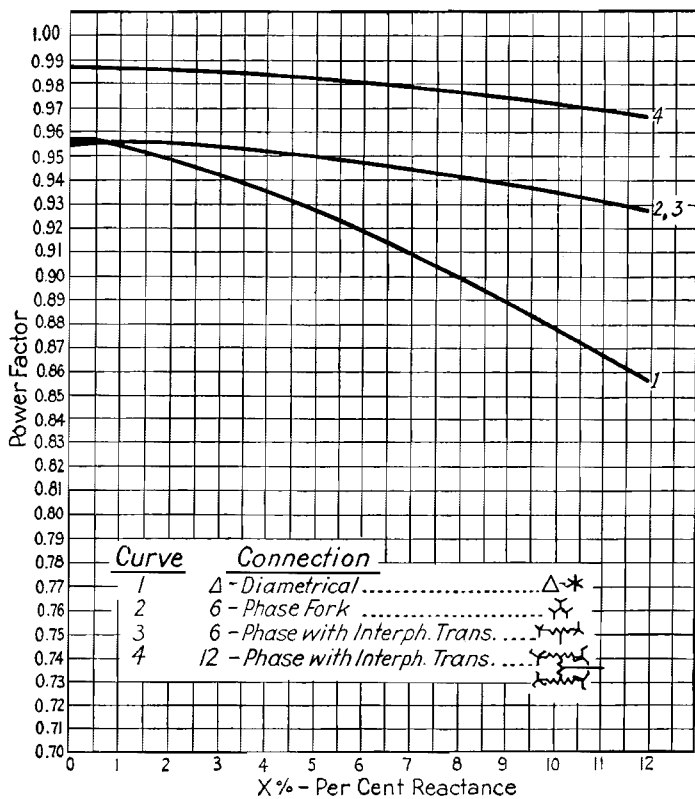

FIG. 73.—Power-factor curves for four types of transformer connections, plotted as a function of the transformer reactance.

If the angle of overlap is 0, the condition approximated at light load, the current wave is of rectangular shape and has the greatest deviation from the sinusoidal shape. The distortion factor is therefore a minimum, and is equal to the constant  $K$  in Eq. (172). For  $u$  equal to 0, the fundamental component of the line current wave is in phase with the phase voltage, and

the displacement factor is 1. The power factor is therefore equal to the distortion factor.

As  $u$  increases, *i.e.*, as the load is increased, the current wave approaches more nearly the shape of a sine wave, so that the distortion factor increases. At the same time the current wave shifts in the lagging direction with respect to the phase voltage, as can be seen from the diagrams of the current waves for the different transformer connections, so that the displacement factor decreases.

In Fig. 72 are shown the power factor curves for 6- and 12-phase transformer connections in function of the angle of overlap  $u$ , as given by the equations previously derived for the several transformer connections considered. In Fig. 73 are shown the power factor curves for the several transformer connections, in function of the transformer reactance. These curves have been derived from the curves of Figs. 71 and 72. The power factor for loads other than full load may be obtained from Fig. 73 by using for the reactance a value proportional to the load for which the power factor is required. Thus, the power factor at one-half load for a transformer having a rated reactance of 6 per cent would be read on the curves for a reactance of 3 per cent.

The effect of the transformer magnetizing current and core loss is the same as for any other transformers. The magnetizing current, being of low power factor, reduces the power factor of the resultant line current. The magnetizing current being constant at all loads, its effect on the power factor decreases as the load is increased, and usually becomes negligible above approximately 25 per cent load.

The power factor at the line terminals of a rectifier transformer may be determined by dividing the watts input, as measured with a wattmeter, by the volt-ampere input as measured with an ammeter and a voltmeter. A dynamometer type of power-factor meter will indicate only the displacement factor, since such a meter indicates only the phase displacement between current and voltage of the same frequency.

The displacement factor,  $\cos \phi$ , may be determined from the power measurements obtained by the two-wattmeter method. The readings  $P_A$  and  $P_B$  of the two wattmeters have the following values:

$$P_A = E_L I_L v \cos(30^\circ - \phi).$$

$$P_B = E_L I_L v \cos(30^\circ + \phi).$$

$$P_A - P_B = 2E_L I_L v \sin \phi \sin 30^\circ.$$

$$P_A + P_B = 2E_L I_L v \cos \phi \cos 30^\circ.$$

$$\frac{P_A - P_B}{P_A + P_B} = \tan \phi \tan 30^\circ.$$

$$\tan \phi = \sqrt{3} \frac{P_A - P_B}{P_A + P_B}.$$

$$\cos \phi = \frac{1}{\sqrt{1 + \tan^2 \phi}} = \frac{P_A + P_B}{2\sqrt{P_A^2 + P_B^2 - P_A P_B}}. \quad (173)$$

The distortion factor  $v$  may now be determined by dividing the power factor by  $\cos \phi$ .

#### TABLES OF TRANSFORMER CONNECTIONS

The several transformer connections which generally come into consideration in connection with rectifiers were considered in detail in this chapter. The following tables contain data on the characteristics of these connections as well as of other transformer connections which may be used with rectifiers. In these tables the expressions for various quantities are given, neglecting overlapping, followed by correction factors for overlapping. The correction factors may be evaluated with the aid of the curves in Fig. 48.

TABLE V

Below is given an explanation of the symbols and lines used in the tables of transformer connections. A tabulated index of the tables, with notes pertaining to several of the connections, is also given. Some of the connections shown in the tables are not of practical importance, but were included for the sake of theoretical interest.

#### EXPLANATION OF SYMBOLS AND LINES

I.P.T.—Interphase transformer.

$E$ —Secondary phase voltage (r.m.s.).

$I$ —Direct current.

$P$ —Direct-current output, including losses.

$u$ —Angle of overlap.

$f$ —Frequency of alternating-current supply.

$\psi(u)$ —Factor, determined from Fig. 48.

—————Vectorial representation of the voltages of transformer windings.

-----Electrical connections.

^ ^ ^ ^—Interphase transformers.

INDEX OF TABLE V

Table	Connection				
V-A	Primary	Single-phase	2-phase	2-phase	2-phase (4-wire)
	Secondary	Single-phase full-wave	Quarter-phase	Quarter-phase with I.P.T.	6-phase with I.P.T.
V-B	Primary	3-phase Y	3-phase $\Delta$	3-phase Y with tertiary <sup>1</sup>	3-phase Y grounded
	Secondary	3-phase star	3-phase star	3-phase star	3-phase star
V-C	Primary	3-phase Y	3-phase $\Delta$	3-phase Y	3-phase $\Delta$
	Secondary	3-phase zig-zag	3-phase zig-zag	6-phase fork	6-phase fork
V-D	Primary	3-phase Y	3-phase $\Delta$	3-phase Y with tertiary	3-phase Y grounded
	Secondary	6-phase star <sup>2</sup>	6-phase star	6-phase star	6-phase star
V-E	Primary	3-phase Y	3-phase $\Delta$	3-phase Y with tertiary	3-phase Y grounded
	Secondary	6-phase with 3-phase I.P.T.	6-phase with 3-phase I.P.T.	6-phase with 3-phase I.P.T.	6-phase with 3-phase I.P.T.
V-F	Primary	3-phase Y	3-phase $\Delta$	3-phase Y	3-phase $\Delta$
	Secondary	6-phase polygon	6-phase polygon	6-phase with I.P.T.	6-phase with I.P.T.
V-G		Three single-phase transformers		Five-leg transformer	
	Primary	3-phase Y	3-phase $\Delta$	3-phase Y	3-phase $\Delta$
	Secondary	6-phase star	6-phase star	6-phase star	6-phase star
V-H	Primary	3-phase Y	3-phase $\Delta$	3-phase Y with tertiary	3-phase Y grounded
	Secondary	12-phase fork	12-phase fork	12-phase fork	12-phase fork
V-I	Primary	3-phase Y	3-phase $\Delta$	3-phase $\Delta$ with tertiary	3-phase Y grounded
	Secondary	12-phase split star	12-phase split star	12-phase split star	12-phase split star
V-J	Primary	3-phase Y	3-phase $\Delta$	3-phase Y	3-phase $\Delta$
	Secondary	12-phase with three I.P.T.'s	12-phase with three I.P.T.'s	12-phase with 4-phase I.P.T. <sup>3</sup>	12-phase with 4-phase I.P.T. <sup>3</sup>
V-K	Primary	3-phase, parallel Y- $\Delta$ <sup>4</sup>	3-phase, parallel Y- $\Delta$ <sup>4</sup>	3-phase, series Y- $\Delta$ <sup>4</sup>	3-phase, series Y- $\Delta$ <sup>4</sup>
	Secondary	12-phase double star	12-phase double fork	12-phase double star	12-phase double fork

<sup>1</sup> The tertiary winding does not carry any current; it therefore has no effect on the transformer relations.

<sup>2</sup> The transformer relations given in the table apply to small loads. The relations at higher loads were derived on pages 119 to 126.

<sup>3</sup> The interphase transformer consists of two cores, the windings of which are interconnected.

<sup>4</sup> The transformer consists of two cores, with the phase voltages of their primary windings displaced by 30 degrees.

MERCURY ARC POWER RECTIFIERS

TABLE V.—A

TYPE OF CONNECTION	SINGLE PHASE FULL WAVE		2-QUARTER PHASE		2-QUARTER PHASE WITH I.P.T.		2-6 PHASE WITH TERTIARY & I.P.T.	
	PRIM	SEC.	PRIM	SEC.	PRIM	SEC.	PRIM	SEC.
NUMBER OF PHASES	1	2	2	4	2	4	2	6
VECTOR DIAGRAM								
ANODE CURRENT	WAVE FORM							
	AVERAGE	$\frac{1}{2} I = 0.500 I$	$\frac{1}{4} I = 0.250 I$	$\frac{1}{4} I = 0.250 I$	$\frac{1}{6} I = 0.167 I$	$\frac{1}{6} I = 0.167 I$	$\frac{1}{6} I = 0.167 I$	$\frac{1}{6} I = 0.167 I$
	R.M.S.	$\frac{1}{\sqrt{2}} I = 0.707 I$	$\frac{1}{2} I = 0.500 I$	$\frac{1}{2} I = 0.500 I$	$\frac{1}{\sqrt{2}} I = 0.707 I$	$\frac{1}{\sqrt{2}} I = 0.707 I$	$\frac{1}{\sqrt{2}} I = 0.707 I$	$\frac{1}{\sqrt{2}} I = 0.707 I$
	CORRECTION FOR OVERLAP	$\sqrt{1-2\psi(u)}$	$\sqrt{1-4\psi(u)}$	$\sqrt{1-4\psi(u)}$	$\sqrt{1-2\psi(u)}$	$\sqrt{1-2\psi(u)}$	$\sqrt{1-2\psi(u)}$	$\sqrt{1-3\psi(u)}$
SECONDARY CURRENT	WAVE FORM	SAME AS ANODE CURRENT	SAME AS ANODE CURRENT	SAME AS ANODE CURRENT	SAME AS ANODE CURRENT	SAME AS ANODE CURRENT	SAME AS ANODE CURRENT	SAME AS ANODE CURRENT
	R.M.S.	"	"	"	"	"	"	"
	CORRECTION FOR OVERLAP	"	"	"	"	"	"	"
	FORM FACTOR	"	"	"	"	"	"	"
PRIMARY CURRENT	WAVE FORM							
	R.M.S.	$I$	$\frac{\sqrt{2}}{2} I = 0.707 I$	$\frac{1}{2} I = 0.500 I$	$\frac{1}{2} I = 0.500 I$	$\frac{1}{2} I = 0.500 I$	$\frac{1}{2} I = 0.500 I$	$\frac{1}{2} I = 0.500 I$
	CORRECTION FOR OVERLAP	$\sqrt{1-4\psi(u)}$	$\sqrt{1-4\psi(u)}$	$\sqrt{1-4\psi(u)}$	$\sqrt{1-4\psi(u)}$	$\sqrt{1-4\psi(u)}$	$\sqrt{1-4\psi(u)}$	$\sqrt{1-3\psi(u)}$
	FORM FACTOR (u=0)	1	$\sqrt{2} = 1.41$	1	1	1	1	$\frac{3}{\sqrt{3}} = 1.10$
LINE CURRENT	WAVE FORM	SAME AS PRIMARY CURRENT	FOR MIDDLE WIRE ONLY	FOR MIDDLE WIRE ONLY	FOR MIDDLE WIRE ONLY	FOR MIDDLE WIRE ONLY	SAME AS PRIMARY CURRENT	SAME AS PRIMARY CURRENT
	R.M.S.	"	$I$	$\frac{1}{2} I = 0.707 I$	$\frac{1}{2} I = 0.707 I$	$\frac{1}{2} I = 0.707 I$	"	"
	CORRECTION FOR OVERLAP	"	$\sqrt{1-4\psi(u)}$	$\sqrt{1-4\psi(u)}$	$\sqrt{1-4\psi(u)}$	$\sqrt{1-4\psi(u)}$	"	"
	FORM FACTOR (u=0)	"	1	$\sqrt{2} = 1.41$	1	1	"	"
TERTIARY OR G-ROUNDING M-RESIDUAL	WAVE FORM							
	R.M.S.	0	0	0	0	0	$\frac{\sqrt{2}}{2} I = 0.149 I$	$\frac{1}{2} I = 0.149 I$
	CORRECTION FOR OVERLAP	0	0	0	0	0	$\sqrt{1-3\psi(u)}$	$\sqrt{1-3\psi(u)}$
	FORM FACTOR (u=0)	0	0	0	0	0	$\frac{1}{\sqrt{3}} = 0.577$	$\frac{1}{\sqrt{3}} = 0.577$
RATING OF TRANSFORMER	PRIMARY	$\frac{\pi}{2\sqrt{2}} = 1.11 P$	$\frac{\pi}{2\sqrt{2}} = 1.11 P$	$\frac{\pi}{2\sqrt{2}} = 1.11 P$	$\frac{\pi}{2\sqrt{2}} = 1.11 P$	$\frac{\pi}{2\sqrt{2}} = 1.11 P$	$\frac{\pi(1+\sqrt{3})}{3\sqrt{2}} = 1.17 P$	$\frac{\pi(1+\sqrt{3})}{3\sqrt{2}} = 1.17 P$
	CORRECTION FOR OVERLAP	$\frac{\sqrt{1-4\psi(u)}}{\cos^2 \frac{u}{2}}$	$\frac{\sqrt{1-4\psi(u)}}{\cos^2 \frac{u}{2}}$	$\frac{\sqrt{1-4\psi(u)}}{\cos^2 \frac{u}{2}}$	$\frac{\sqrt{1-4\psi(u)}}{\cos^2 \frac{u}{2}}$	$\frac{\sqrt{1-4\psi(u)}}{\cos^2 \frac{u}{2}}$	$\frac{\sqrt{1-3\psi(u)}}{\cos^2 \frac{u}{2}}$	$\frac{\sqrt{1-3\psi(u)}}{\cos^2 \frac{u}{2}}$
	SECONDARY	$\frac{\pi}{2} = 1.57 P$	$\frac{\pi}{2} = 1.57 P$	$\frac{\pi}{2} = 1.57 P$	$\frac{\pi}{2} = 1.57 P$	$\frac{\pi}{2} = 1.57 P$	$\frac{\sqrt{2}\pi}{3} = 1.48 P$	$\frac{\sqrt{2}\pi}{3} = 1.48 P$
	CORRECTION FOR OVERLAP	$\frac{\sqrt{1-2\psi(u)}}{\cos^2 \frac{u}{2}}$	$\frac{\sqrt{1-4\psi(u)}}{\cos^2 \frac{u}{2}}$	$\frac{\sqrt{1-4\psi(u)}}{\cos^2 \frac{u}{2}}$	$\frac{\sqrt{1-2\psi(u)}}{\cos^2 \frac{u}{2}}$	$\frac{\sqrt{1-2\psi(u)}}{\cos^2 \frac{u}{2}}$	$\frac{\sqrt{1-3\psi(u)}}{\cos^2 \frac{u}{2}}$	$\frac{\sqrt{1-3\psi(u)}}{\cos^2 \frac{u}{2}}$
RATING OF TRANSFORMER	TERTIARY	—	—	—	—	—	$\frac{\pi(\sqrt{3}-1)}{6} = 0.383 P$	$\frac{\pi(\sqrt{3}-1)}{6} = 0.383 P$
	CORRECTION FOR OVERLAP	—	—	—	—	—	$\frac{\sqrt{1-3\psi(u)}}{\cos^2 \frac{u}{2}}$	$\frac{\sqrt{1-3\psi(u)}}{\cos^2 \frac{u}{2}}$
	AVERAGE	$\frac{1.11+1.57}{2} = 1.34 P$	$\frac{1.11+1.57}{2} = 1.34 P$	$\frac{1.11+1.57}{2} = 1.34 P$	$\frac{1.11+1.57}{2} = 1.34 P$	$\frac{1.11+1.57}{2} = 1.34 P$	$\frac{1.17+1.48+0.38}{2} = 1.52 P$	$\frac{1.17+1.48+0.38}{2} = 1.52 P$
	AS HARMONIC CHOKE COIL	—	—	—	0.555 P (2f)	0.555 P (2f)	0.214 P (3f)	0.214 P (3f)
RATING OF TRANSFORMER	AS EQUIVALENT TRANS.	—	—	—	$0.555 \frac{1}{4} = 0.139$	$0.555 \frac{1}{4} = 0.139$	$0.214 \frac{1}{4} = 0.054$	$0.214 \frac{1}{4} = 0.054$
	POWER FACTOR IN LINE	$\frac{2\sqrt{2}}{\pi} = 0.90 \cos^2 \frac{u}{2}$	$\frac{2\sqrt{2}}{\pi} = 0.90 \cos^2 \frac{u}{2}$	$\frac{2\sqrt{2}}{\pi} = 0.90 \cos^2 \frac{u}{2}$	$\frac{2\sqrt{2}}{\pi} = 0.90 \cos^2 \frac{u}{2}$	$\frac{2\sqrt{2}}{\pi} = 0.90 \cos^2 \frac{u}{2}$	$\frac{3\sqrt{2}}{\pi} = 0.856 \cos^2 \frac{u}{2}$	$\frac{3\sqrt{2}}{\pi} = 0.856 \cos^2 \frac{u}{2}$
D.C. VOLTAGE	$\frac{2\sqrt{2}}{\pi} = 0.9 \text{Ecos}^2 \frac{u}{2}$	$\frac{4}{\pi} = 1.27 \text{Ecos}^2 \frac{u}{2}$	$\frac{4}{\pi} = 1.27 \text{Ecos}^2 \frac{u}{2}$	$\frac{2\sqrt{2}}{\pi} = 0.9 \text{Ecos}^2 \frac{u}{2}$	$\frac{2\sqrt{2}}{\pi} = 0.9 \text{Ecos}^2 \frac{u}{2}$	$\frac{2\sqrt{2}}{\pi} = 0.9 \text{Ecos}^2 \frac{u}{2}$	$\frac{3}{\pi} \sqrt{3} = 1.17 \text{Ecos}^2 \frac{u}{2}$	









TABLE V.—E

TYPE OF CONNECTION	Y-STAR WITH 3 PHASE I.P.T.		Δ-STAR WITH 3 PHASE I.P.T.		Y-STAR WITH TERTIARY & 3 PHASE I.P.T.		GROUNDED Y-STAR WITH 3 PHASE I.P.T.	
	PRIM.	SEC.	PRIM.	SEC.	PRIM.	SEC.	PRIM.	SEC.
NUMBER OF PHASES	3	6	3	6	3	6	3	6
VECTOR DIAGRAM								
ANODE CURRENT	WAVE FORM							
	AVERAGE	$\frac{1}{6} I = 0.167 I$	$\frac{1}{6} I = 0.167 I$	$\frac{1}{6} I = 0.167 I$	$\frac{1}{6} I = 0.167 I$			
	R.M.S. x CORRECTION FOR OVERLAP	$\frac{1}{\sqrt{2}} I = 0.236 I$ $\sqrt{1-2\psi(u)}$	$\frac{1}{\sqrt{2}} I = 0.236 I$ $\sqrt{1-2\psi(u)}$	$\frac{1}{\sqrt{2}} I = 0.236 I$ $\sqrt{1-2\psi(u)}$	$\frac{1}{\sqrt{2}} I = 0.236 I$ $\sqrt{1-2\psi(u)}$			
SECONDARY CURRENT	WAVE FORM	SAME AS ANODE CURRENT	SAME AS ANODE CURRENT	SAME AS ANODE CURRENT	SAME AS ANODE CURRENT			
	R.M.S. x CORRECTION FOR OVERLAP	"	"	"	"			
	FORM FACTOR (u=0)	"	"	"	"			
PRIMARY CURRENT	WAVE FORM							
	R.M.S. x CORRECTION FOR OVERLAP	$\frac{2\sqrt{2}}{3} I = 0.314 I$ $\sqrt{1-3\psi(u)}$	$\frac{1}{3} I = 0.333 I$ $\sqrt{1-4\psi(u)}$	$\frac{2\sqrt{2}}{3} I = 0.314 I$ $\sqrt{1-3\psi(u)}$	$\frac{1}{3} I = 0.333 I$ $\sqrt{1-4\psi(u)}$			
	FORM FACTOR (u=0)	$\frac{3}{2\sqrt{2}} = 1.06$	1.00	$\frac{3}{2\sqrt{2}} = 1.06$	1.00			
	CREST FACTOR (u=0)	$\sqrt{2} = 1.41$	1.00	$\sqrt{2} = 1.41$	1.00			
LINE CURRENT	WAVE FORM	SAME AS PRIMARY CURRENT		SAME AS PRIMARY CURRENT	SAME AS PRIMARY CURRENT			
	R.M.S. x CORRECTION FOR OVERLAP	"	$\frac{2}{\sqrt{3}} I = 0.544 I$ $\sqrt{1-3\psi(u)}$	"	"			
	FORM FACTOR (u=0)	"	$\sqrt{\frac{3}{2}} = 1.23$	"	"			
	CREST FACTOR (u=0)	"	$\sqrt{\frac{3}{2}} = 1.23$	"	"			
TERTIARY OR G-GROUND M-RESIDUAL M.M.F.	WAVE FORM							
	R.M.S. x CORRECTION FOR OVERLAP	$\frac{1}{3} I = 0.111 I$ $\sqrt{1-12\psi(u)}$	0	$\frac{1}{3} I = 0.111 I$ $\sqrt{1-12\psi(u)}$	$\frac{1}{3} I = 0.333 I$ $\sqrt{1-12\psi(u)}$			
	FORM FACTOR (u=0)	$\frac{\pi}{3\sqrt{2}} = 1.05 P$	$\frac{\pi}{2\sqrt{2}} = 1.11 P$	$\frac{\pi}{3} = 1.05 P$	$\frac{\pi}{2\sqrt{2}} = 1.11 P$			
RATING OF TRANSFORMER	PRIMARY x CORRECTION FOR OVERLAP	$\frac{\pi}{3} = 1.05 P$ $\frac{\sqrt{1-3\psi(u)}}{\cos^2 \frac{\psi}{2}}$	$\frac{\pi}{2\sqrt{2}} = 1.11 P$ $\frac{\sqrt{1-4\psi(u)}}{\cos^2 \frac{\psi}{2}}$	$\frac{\pi}{3} = 1.05 P$ $\frac{\sqrt{1-3\psi(u)}}{\cos^2 \frac{\psi}{2}}$	$\frac{\pi}{2\sqrt{2}} = 1.11 P$ $\frac{\sqrt{1-4\psi(u)}}{\cos^2 \frac{\psi}{2}}$			
	SECONDARY x CORRECTION FOR OVERLAP	$\frac{\pi}{2} = 1.57 P$ $\frac{\sqrt{1-2\psi(u)}}{\cos^2 \frac{\psi}{2}}$	$\frac{\pi}{2} = 1.57 P$ $\frac{\sqrt{1-2\psi(u)}}{\cos^2 \frac{\psi}{2}}$	$\frac{\pi}{2} = 1.57 P$ $\frac{\sqrt{1-2\psi(u)}}{\cos^2 \frac{\psi}{2}}$	$\frac{\pi}{2} = 1.57 P$ $\frac{\sqrt{1-2\psi(u)}}{\cos^2 \frac{\psi}{2}}$			
	TERTIARY x CORRECTION FOR OVERLAP	—	—	$\frac{\pi}{6\sqrt{2}} = 0.37 P$ $\frac{\sqrt{1-12\psi(u)}}{\cos^2 \frac{\psi}{2}}$	—			
	AVERAGE	$\frac{1.05 + 1.57}{2} = 1.31 P$	$\frac{1.11 + 1.57}{2} = 1.34 P$	$\frac{1.05 + 1.57 + 0.37}{2} = 1.50 P$	$\frac{1.11 + 1.57}{2} = 1.34 P$			
	AS HARMONIC CHOKER COIL AS EQUIVALENT TRANS.	$\frac{0.50\pi(2)^{1/2}}{4} = 0.193 P$	$\frac{0.50\pi(2)^{1/2}}{4} = 0.193 P$	$\frac{0.50\pi(2)^{1/2}}{4} = 0.193 P$	$\frac{0.50\pi(2)^{1/2}}{4} = 0.193 P$			
POWER FACTOR IN LINE	$\frac{3}{\pi} = \frac{.955 \cos^2 \frac{\psi}{2}}{\sqrt{1-3\psi(u)}}$	$\frac{3}{\pi} = \frac{.955 \cos^2 \frac{\psi}{2}}{\sqrt{1-3\psi(u)}}$	$\frac{3}{\pi} = \frac{.955 \cos^2 \frac{\psi}{2}}{\sqrt{1-3\psi(u)}}$	$\frac{2\sqrt{2}}{\pi} = \frac{.9 \cos^2 \frac{\psi}{2}}{\sqrt{1-4\psi(u)}}$				
D.C. VOLTAGE	$\frac{2\sqrt{2}}{\pi} = 0.9 E \cos^2 \frac{\psi}{2}$	$\frac{2\sqrt{2}}{\pi} = 0.9 E \cos^2 \frac{\psi}{2}$	$\frac{2\sqrt{2}}{\pi} = 0.9 E \cos^2 \frac{\psi}{2}$	$\frac{2\sqrt{2}}{\pi} = 0.9 E \cos^2 \frac{\psi}{2}$				

TABLE V.—F

TYPE OF CONNECTION	Y-6 PHASE POLYGON		Δ-6 PHASE POLYGON		Y-STAR WITH I.P.T.		Δ-STAR WITH I.P.T.	
	PRIM.	SEC.	PRIM.	SEC.	PRIM.	SEC.	PRIM.	SEC.
NUMBER OF PHASES	3	6	3	6	3	6	3	6
VECTOR DIAGRAM								
ANODE CURRENT	WAVE FORM							
	AVERAGE	$\frac{1}{2} I = 0.167 I$	$\frac{1}{2} I = 0.167 I$	$\frac{1}{2} I = 0.167 I$	$\frac{1}{2} I = 0.167 I$	$\frac{1}{2} I = 0.167 I$	$\frac{1}{2} I = 0.167 I$	$\frac{1}{2} I = 0.167 I$
	R.M.S. x CORRECTION FOR OVERLAP	$\frac{1}{\sqrt{6}} I = 0.408 I$ $\sqrt{1-6\psi(u)}$	$\frac{1}{\sqrt{6}} I = 0.408 I$ $\sqrt{1-6\psi(u)}$	$\frac{1}{\sqrt{6}} I = 0.408 I$ $\sqrt{1-6\psi(u)}$	$\frac{1}{\sqrt{6}} I = 0.408 I$ $\sqrt{1-3\psi(u)}$	$\frac{1}{\sqrt{6}} I = 0.408 I$ $\sqrt{1-3\psi(u)}$	$\frac{1}{\sqrt{6}} I = 0.408 I$ $\sqrt{1-3\psi(u)}$	$\frac{1}{\sqrt{6}} I = 0.408 I$ $\sqrt{1-3\psi(u)}$
SECONDARY CURRENT	WAVE FORM				SAME AS ANODE CURRENT	SAME AS ANODE CURRENT	SAME AS ANODE CURRENT	SAME AS ANODE CURRENT
	R.M.S. x CORRECTION FOR OVERLAP	$\frac{5\sqrt{3}}{6\sqrt{2}} I = 0.219 I$ $\frac{1}{\sqrt{36.5/36}} I = 0.165 I$ $\sqrt{1-2.22\psi(u)}$ $\sqrt{1-6.30\psi(u)}$	$\frac{5\sqrt{3}}{6\sqrt{2}} I = 0.219 I$ $\frac{1}{\sqrt{36.5/36}} I = 0.165 I$ $\sqrt{1-1.87\psi(u)}$ $\sqrt{1-6.56\psi(u)}$	$\frac{5\sqrt{3}}{6\sqrt{2}} I = 0.219 I$ $\frac{1}{\sqrt{36.5/36}} I = 0.165 I$ $\sqrt{1-1.87\psi(u)}$ $\sqrt{1-6.56\psi(u)}$	"	"	"	"
	AVERAGE	$.667 I$ , $.333 I$	$.667 I$ , $.333 I$	$.667 I$ , $.333 I$	$.500 I$	$.500 I$	$.500 I$	$.500 I$
PRIMARY CURRENT	WAVE FORM							
	R.M.S. x CORRECTION FOR OVERLAP	$\frac{1}{\sqrt{3}} I = 0.471 I$ $\sqrt{1-3\psi(u)}$	$\frac{1}{\sqrt{3}} I = 0.471 I$ $\sqrt{1-3.18\psi(u)}$	$\frac{1}{\sqrt{3}} I = 0.471 I$ $\sqrt{1-3.18\psi(u)}$	$\frac{1}{\sqrt{3}} I = 0.408 I$ $\sqrt{1-3\psi(u)}$	$\frac{1}{\sqrt{3}} I = 0.408 I$ $\sqrt{1-3\psi(u)}$	$\frac{1}{\sqrt{3}} I = 0.408 I$ $\sqrt{1-3\psi(u)}$	$\frac{1}{\sqrt{3}} I = 0.408 I$ $\sqrt{1-3\psi(u)}$
	FORM FACTOR (u=0)	$\frac{3}{2\sqrt{2}} = 1.06$	$\frac{3\sqrt{3}}{2} = 1.02$	$\frac{3\sqrt{3}}{2} = 1.02$	$\sqrt{\frac{3}{2}} = 1.23$	$\sqrt{\frac{3}{2}} = 1.23$	$\sqrt{\frac{3}{2}} = 1.23$	$\sqrt{\frac{3}{2}} = 1.23$
	CREST FACTOR (u=0)	$\sqrt{2} = 1.41$	$\frac{3\sqrt{3}}{\sqrt{2}} = 1.26$	$\frac{3\sqrt{3}}{\sqrt{2}} = 1.26$	$\sqrt{\frac{3}{2}} = 1.23$	$\sqrt{\frac{3}{2}} = 1.23$	$\sqrt{\frac{3}{2}} = 1.23$	$\sqrt{\frac{3}{2}} = 1.23$
LINE CURRENT	WAVE FORM	SAME AS PRIMARY CURRENT		SAME AS PRIMARY CURRENT	SAME AS PRIMARY CURRENT	SAME AS PRIMARY CURRENT		
	R.M.S. x CORRECTION FOR OVERLAP	"	$\frac{1}{\sqrt{3}} I = 0.815 I$ $\sqrt{1-3\psi(u)}$	"	"	"	$\frac{1}{\sqrt{3}} I = 0.707 I$ $\sqrt{1-3\psi(u)}$	
	FORM FACTOR (u=0)	"	$\sqrt{\frac{3}{2}} = 1.23$	"	"	"	$\frac{3}{2\sqrt{2}} = 1.06$	
	CREST FACTOR (u=0)	"	$\sqrt{\frac{3}{2}} = 1.23$	"	"	"	$\sqrt{2} = 1.41$	
TERTIARY (OR GROUND) WAVEFORM	WAVE FORM							
	R.M.S. x CORRECTION FOR OVERLAP	0	0	0	0	0	0	
RATING OF TRANSFORMER	PRIMARY x CORRECTION FOR OVERLAP	$\frac{\pi}{3} = 1.05 P$ $\frac{\sqrt{1-3\psi(u)}}{\cos^2 \frac{\psi}{4}}$	$\frac{\pi}{3} \sqrt{\frac{3}{2}} = 1.06 P$ $\frac{\sqrt{1-3.18\psi(u)}}{\cos^2 \frac{\psi}{4}}$	$\frac{\pi}{3} \sqrt{\frac{3}{2}} = 1.06 P$ $\frac{\sqrt{1-3.18\psi(u)}}{\cos^2 \frac{\psi}{4}}$	$\frac{\pi}{3} = 1.05 P$ $\frac{\sqrt{1-3\psi(u)}}{\cos^2 \frac{\psi}{4}}$	$\frac{\pi}{3} = 1.05 P$ $\frac{\sqrt{1-3\psi(u)}}{\cos^2 \frac{\psi}{4}}$	$\frac{\pi}{3} = 1.05 P$ $\frac{\sqrt{1-3\psi(u)}}{\cos^2 \frac{\psi}{4}}$	
	SECONDARY x CORRECTION FOR OVERLAP	$\frac{\pi}{36} (5\sqrt{3} + \sqrt{7}) = 1.71 P$ $\frac{5\sqrt{3}}{36} \sqrt{1-2.22\psi(u)} + \frac{\sqrt{7}}{36} \sqrt{1-6.30\psi(u)}$ $(5\sqrt{3} + \sqrt{7}) \cos^2 \frac{\psi}{4}$	$\frac{\pi}{36} (\sqrt{37} + \sqrt{23}) = 1.71 P$ $\frac{5\sqrt{3}}{36} \sqrt{1-1.87\psi(u)} + \frac{\sqrt{7}}{36} \sqrt{1-6.56\psi(u)}$ $(\sqrt{37} + \sqrt{23}) \cos^2 \frac{\psi}{4}$	$\frac{\pi}{36} (\sqrt{37} + \sqrt{23}) = 1.71 P$ $\frac{5\sqrt{3}}{36} \sqrt{1-1.87\psi(u)} + \frac{\sqrt{7}}{36} \sqrt{1-6.56\psi(u)}$ $(\sqrt{37} + \sqrt{23}) \cos^2 \frac{\psi}{4}$	$\frac{\sqrt{2}}{36} \pi = 1.48 P$ $\frac{\sqrt{1-3\psi(u)}}{\cos^2 \frac{\psi}{4}}$	$\frac{\sqrt{2}}{36} \pi = 1.48 P$ $\frac{\sqrt{1-3\psi(u)}}{\cos^2 \frac{\psi}{4}}$	$\frac{\sqrt{2}}{36} \pi = 1.48 P$ $\frac{\sqrt{1-3\psi(u)}}{\cos^2 \frac{\psi}{4}}$	$\frac{\sqrt{2}}{36} \pi = 1.48 P$ $\frac{\sqrt{1-3\psi(u)}}{\cos^2 \frac{\psi}{4}}$
	TERTIARY x CORRECTION FOR OVERLAP	—	—	—	—	—	—	—
	AVERAGE	$1.05 + 1.71 = 1.38 P$	$1.06 + 1.71 = 1.39 P$	$1.06 + 1.71 = 1.39 P$	$1.05 + 1.48 = 1.26 P$	$1.05 + 1.48 = 1.26 P$	$1.05 + 1.48 = 1.26 P$	$1.05 + 1.48 = 1.26 P$
RATING OF I.P.T.	AS HARMONIC CHOKER COIL	—	—	—	$0.214 P - (3f)$	$0.214 P (3f)$	$0.214 P (3f)$	
	AS EQUIVALENT TRANS.	—	—	—	$\frac{0.214(3)}{6} P = 0.071 P$	$\frac{0.214(3)}{6} P = 0.071 P$	$\frac{0.214(3)}{6} P = 0.071 P$	
POWER FACTOR IN LINE	$\frac{3}{\pi} = .955 \cos^2 \frac{\psi}{4}$ $\frac{3}{\pi} \sqrt{1-3\psi(u)}$	$\frac{3}{\pi} = .955 \cos^2 \frac{\psi}{4}$ $\frac{3}{\pi} \sqrt{1-3\psi(u)}$	$\frac{3}{\pi} = .955 \cos^2 \frac{\psi}{4}$ $\frac{3}{\pi} \sqrt{1-3\psi(u)}$	$\frac{3}{\pi} = .955 \cos^2 \frac{\psi}{4}$ $\frac{3}{\pi} \sqrt{1-3\psi(u)}$	$\frac{3}{\pi} = .955 \cos^2 \frac{\psi}{4}$ $\frac{3}{\pi} \sqrt{1-3\psi(u)}$	$\frac{3}{\pi} = .955 \cos^2 \frac{\psi}{4}$ $\frac{3}{\pi} \sqrt{1-3\psi(u)}$	$\frac{3}{\pi} = .955 \cos^2 \frac{\psi}{4}$ $\frac{3}{\pi} \sqrt{1-3\psi(u)}$	
D.C. VOLTAGE	$\frac{3\sqrt{2}}{\pi} = 1.35 E \cos^2 \frac{\psi}{2}$	$\frac{3\sqrt{2}}{\pi} = 1.35 E \cos^2 \frac{\psi}{2}$	$\frac{3\sqrt{2}}{\pi} = 1.35 E \cos^2 \frac{\psi}{2}$	$\frac{3\sqrt{2}}{\pi} = 1.17 E \cos^2 \frac{\psi}{2}$	$\frac{3\sqrt{2}}{\pi} = 1.17 E \cos^2 \frac{\psi}{2}$	$\frac{3\sqrt{2}}{\pi} = 1.17 E \cos^2 \frac{\psi}{2}$	$\frac{3\sqrt{2}}{\pi} = 1.17 E \cos^2 \frac{\psi}{2}$	

TABLE V.—G

TYPE OF CONNECTION	3 TRANSFORMERS Y-STAR		3 TRANSFORMERS Δ-STAR		5-LEG TRANSFORMER Y-STAR		5-LEG TRANSFORMER Δ-STAR		
	PRIM.	SEC.	PRIM.	SEC.	PRIM.	SEC.	PRIM.	SEC.	
NUMBER OF PHASES	3	6	3	6	3	6	3	6	
VECTOR DIAGRAM									
ANODE CURRENT	WAVE FORM								
	AVERAGE	$\frac{1}{6} I = 0.167 I$		$\frac{1}{6} I = 0.167 I$		$\frac{1}{6} I = 0.167 I$		$\frac{1}{6} I = 0.167 I$	
	R. M. S. x CORRECTION FOR OVERLAP	$\frac{1}{2\sqrt{3}} I = 0.289 I$		$\frac{1}{\sqrt{6}} I = 0.408 I$		$\frac{1}{2\sqrt{3}} I = 0.289 I$		$\frac{1}{\sqrt{6}} I = 0.408 I$	
		$\sqrt{1-3\psi(u)}$		$\sqrt{1-6\psi(u)}$		$\sqrt{1-3\psi(u)}$		$\sqrt{1-6\psi(u)}$	
SECONDARY CURRENT	WAVE FORM	SAME AS ANODE CURRENT		SAME AS ANODE CURRENT		SAME AS ANODE CURRENT		SAME AS ANODE CURRENT	
	R. M. S. x CORRECTION FOR OVERLAP	"		"		"		"	
		"		"		"		"	
		"		"		"		"	
PRIMARY CURRENT	WAVE FORM								
	R. M. S. x CORRECTION FOR OVERLAP	$\frac{1}{\sqrt{6}} I = 0.408 I$		$\frac{1}{\sqrt{3}} I = 0.577 I$		$\frac{1}{\sqrt{6}} I = 0.408 I$		$\frac{1}{\sqrt{3}} I = 0.577 I$	
	FORM FACTOR (u=0)	$\sqrt{\frac{3}{2}} = 1.23$		$\sqrt{3} = 1.73$		$\sqrt{\frac{3}{2}} = 1.23$		$\sqrt{3} = 1.73$	
	CREST FACTOR (u=0)	$\sqrt{\frac{3}{2}} = 1.23$		$\sqrt{3} = 1.73$		$\sqrt{\frac{3}{2}} = 1.23$		$\sqrt{3} = 1.73$	
LINE CURRENT	WAVE FORM	SAME AS PRIMARY CURRENT				SAME AS PRIMARY CURRENT			
	R. M. S. x CORRECTION FOR OVERLAP	"		$\sqrt{\frac{3}{2}} = 0.815 I$		"		$\sqrt{\frac{3}{2}} = 0.815 I$	
	FORM FACTOR (u=0)	"		$\sqrt{\frac{3}{2}} = 1.23$		"		$\sqrt{\frac{3}{2}} = 1.23$	
	CREST FACTOR (u=0)	"		$\sqrt{\frac{3}{2}} = 1.23$		"		$\sqrt{\frac{3}{2}} = 1.23$	
TERTIARY CUR. G-GROUND W-RESIDUAL M.M.F.	WAVE FORM								
	R. M. S. x CORRECTION FOR OVERLAP	0		0		0		0	
		0		0		0		0	
		0		0		0		0	
RATING OF TRANSFORMER	PRIMARY x CORRECTION FOR OVERLAP	$\frac{\pi}{3} = 1.05 P$		$\frac{\sqrt{3}\pi}{8} = 1.28 P$		$\frac{\pi}{3} = 1.05 P$		$\frac{\pi}{\sqrt{6}} = 1.28 P$	
		$\frac{\sqrt{1-3\psi(u)}}{\cos^2 \frac{\psi}{2}}$		$\frac{\sqrt{1-6\psi(u)}}{\cos^2 \frac{\psi}{4}}$		$\frac{\sqrt{1-3\psi(u)}}{\cos^2 \frac{\psi}{2}}$		$\frac{\sqrt{1-6\psi(u)}}{\cos^2 \frac{\psi}{4}}$	
	SECONDARY x CORRECTION FOR OVERLAP	$\frac{\sqrt{3}\pi}{3} = 1.48 P$		$\frac{\pi}{\sqrt{3}} = 1.81 P$		$\frac{\sqrt{3}\pi}{3} = 1.48 P$		$\frac{\pi}{\sqrt{3}} = 1.81 P$	
		$\frac{\sqrt{1-3\psi(u)}}{\cos^2 \frac{\psi}{2}}$		$\frac{\sqrt{1-6\psi(u)}}{\cos^2 \frac{\psi}{4}}$		$\frac{\sqrt{1-3\psi(u)}}{\cos^2 \frac{\psi}{2}}$		$\frac{\sqrt{1-6\psi(u)}}{\cos^2 \frac{\psi}{4}}$	
RATING OF I.P.T.	TERTIARY x CORRECTION FOR OVERLAP	—		—		—		—	
		—		—		—		—	
	AVERAGE	$\frac{1.05+1.48}{2} = 1.26 P$		$\frac{1.28+1.81}{2} = 1.55 P$		$\frac{1.05+1.48}{2} = 1.26 P$		$\frac{1.28+1.81}{2} = 1.55 P$	
RATING OF I.P.T.	AS HARMONIC CHOSE COIL	—		—		—		—	
	AS EQUIVALENT TRANS.	—		—		—		—	
POWER FACTOR IN LINE	$\frac{3}{\pi} = \frac{955 \cos^2 \frac{\psi}{2}}{\sqrt{1-3\psi(u)}}$		$\frac{3}{\pi} = \frac{955 \cos^2 \frac{\psi}{4}}{\sqrt{1-3\psi(u)}}$		$\frac{3}{\pi} = \frac{955 \cos^2 \frac{\psi}{2}}{\sqrt{1-3\psi(u)}}$		$\frac{3}{\pi} = \frac{955 \cos^2 \frac{\psi}{4}}{\sqrt{1-3\psi(u)}}$		
D. C. VOLTAGE	$\frac{3}{\pi} \sqrt{\frac{3}{2}} = 1.17 E \cos^2 \frac{\psi}{2}$		$\frac{3\sqrt{3}}{\pi} = 1.35 E \cos^2 \frac{\psi}{4}$		$\frac{3}{\pi} \sqrt{\frac{3}{2}} = 1.17 E \cos^2 \frac{\psi}{2}$		$\frac{3\sqrt{3}}{\pi} = 1.35 E \cos^2 \frac{\psi}{4}$		



TABLE V.—I

TYPE OF CONNECTION	Y-SPLIT STAR		Δ-SPLIT STAR		Y-SPLIT STAR WITH TERTIARY		GROUNDED Y-SPLIT STAR	
	PRIM.	SEC.	PRIM.	SEC.	PRIM.	SEC.	PRIM.	SEC.
NUMBER OF PHASES	3	12	3	12	3	12	3	12
VECTOR DIAGRAM								
ANODE CURRENT	WAVE FORM							
	AVERAGE	$\frac{1}{12} I = 0.083 I$	$\frac{1}{12} I = 0.083 I$	$\frac{1}{12} I = 0.083 I$	$\frac{1}{12} I = 0.083 I$			
	R.M.S. x CORRECTION FOR OVERLAP	$\frac{1}{2\sqrt{3}} I = 0.289 I$ $\sqrt{1-12\psi(u)}$	$\frac{1}{2\sqrt{3}} I = 0.289 I$ $\sqrt{1-12\psi(u)}$	$\frac{1}{2\sqrt{3}} I = 0.289 I$ $\sqrt{1-12\psi(u)}$	$\frac{1}{2\sqrt{3}} I = 0.289 I$ $\sqrt{1-12\psi(u)}$			
SECONDARY CURRENT	WAVE FORM							
	R.M.S. x CORRECTION FOR OVERLAP	$\frac{1}{\sqrt{6}} I = 0.408 I$ $\sqrt{1-6\psi(u)}$	$\frac{1}{\sqrt{6}} I = 0.408 I$ $\sqrt{1-6\psi(u)}$	$\frac{1}{\sqrt{6}} I = 0.408 I$ $\sqrt{1-6\psi(u)}$	$\frac{1}{\sqrt{6}} I = 0.408 I$ $\sqrt{1-6\psi(u)}$			
	FORM FACTOR (u=0)	$\frac{3\sqrt{2}}{2\sqrt{3}} = 1.14$	$\frac{\sqrt{30}}{2+\sqrt{3}} = 1.47$	$\frac{3\sqrt{2}}{2+\sqrt{3}} = 1.14$	$\frac{\sqrt{30}}{2+\sqrt{3}} = 1.47$			
PRIMARY CURRENT	WAVE FORM							
	R.M.S. x CORRECTION FOR OVERLAP	$\frac{\sqrt{2}}{3} I = 0.471 I$ $\sqrt{1-1.61\psi(u)}$	$\frac{\sqrt{3}}{3\sqrt{2}} I = 0.527 I$ $\sqrt{1-3.68\psi(u)}$	$\frac{\sqrt{2}}{3} I = 0.471 I$ $\sqrt{1-1.61\psi(u)}$	$\frac{\sqrt{3}}{3\sqrt{2}} I = 0.527 I$ $\sqrt{1-3.68\psi(u)}$			
	FORM FACTOR (u=0)	$\frac{3\sqrt{2}}{2\sqrt{3}} = 1.14$	$\frac{\sqrt{30}}{2+\sqrt{3}} = 1.47$	$\frac{3\sqrt{2}}{2+\sqrt{3}} = 1.14$	$\frac{\sqrt{30}}{2+\sqrt{3}} = 1.47$			
	CREST FACTOR (u=0)	$\sqrt{2} = 1.41$	$\frac{6}{\sqrt{10}} = 1.90$	$\sqrt{2} = 1.41$	$\frac{6}{\sqrt{10}} = 1.90$			
	LINE CURRENT	SAME AS PRIMARY CURRENT			SAME AS PRIMARY CURRENT		SAME AS PRIMARY CURRENT	
R.M.S. x CORRECTION FOR OVERLAP	"		$\frac{\sqrt{3}}{3} I = 0.815 I$ $\sqrt{1-1.61\psi(u)}$	"		"		
	"		$\frac{3\sqrt{2}}{2+\sqrt{3}} = 1.14$	"		"		
	"		$\sqrt{2} = 1.41$	"		"		
	"			"		"		
TERTIARY CURRENT	WAVE FORM							
	R.M.S. x CORRECTION FOR OVERLAP	$\frac{1}{3\sqrt{2}} I = 0.236 I$ $\sqrt{1-12\psi(u)}$	0	$\frac{1}{3\sqrt{2}} I = 0.236 I$ $\sqrt{1-12\psi(u)}$	$\frac{1}{\sqrt{2}} I = 0.707 I$ $\sqrt{1-12\psi(u)}$			
	PRIMARY x CORRECTION FOR OVERLAP	$\frac{\pi\sqrt{2}}{6(\sqrt{3}-1)} = 1.01 P$ $\sqrt{1-1.61\psi(u)}$	$\frac{\pi\sqrt{3}}{6\sqrt{2}(\sqrt{3}-1)} = 1.13 P$ $\sqrt{1-3.68\psi(u)}$	$\frac{\pi\sqrt{2}}{6(\sqrt{3}-1)} = 1.01 P$ $\sqrt{1-1.61\psi(u)}$	$\frac{\pi\sqrt{3}}{8\sqrt{2}(\sqrt{3}-1)} = 1.13 P$ $\sqrt{1-3.68\psi(u)}$			
	SECONDARY x CORRECTION FOR OVERLAP	$\frac{\pi(\sqrt{2}+\sqrt{3})}{6(\sqrt{3}-1)} = 2.25 P$ $\frac{\sqrt{2}(\sqrt{2}-\sqrt{3})\sqrt{2}\sqrt{1-12\psi(u)}}{(\sqrt{2}+\sqrt{3})\cos^2 \frac{\psi}{2}}$	$\frac{\pi(\sqrt{2}+\sqrt{3})}{6(\sqrt{3}-1)} = 2.25 P$ $\frac{\sqrt{2}(\sqrt{2}-\sqrt{3})\sqrt{2}\sqrt{1-12\psi(u)}}{(\sqrt{2}+\sqrt{3})\cos^2 \frac{\psi}{2}}$	$\frac{\pi(\sqrt{2}+\sqrt{3})}{6(\sqrt{3}-1)} = 2.25 P$ $\frac{(\sqrt{2}+\sqrt{3})\cos^2 \frac{\psi}{2}}{(\sqrt{2}+\sqrt{3})\cos^2 \frac{\psi}{2}}$	$\frac{\pi(\sqrt{2}+\sqrt{3})}{6(\sqrt{3}-1)} = 2.25 P$ $\frac{\sqrt{2}(\sqrt{2}-\sqrt{3})\sqrt{2}\sqrt{1-12\psi(u)}}{(\sqrt{2}+\sqrt{3})\cos^2 \frac{\psi}{2}}$			
RATING OF TRANSFORMER	TERTIARY x CORRECTION FOR OVERLAP	—	—	$\frac{\pi}{6\sqrt{2}(\sqrt{3}-1)} = 0.51 P$ $\sqrt{1-12\psi(u)}$	—			
	AVERAGE	$1.01 + 2.25 = 16.3 P$	$1.13 + 2.25 = 16.9 P$	$1.01 + 2.25 = 16.3 P$	$1.13 + 2.25 = 16.9 P$			
	AS HARMONIC CHOKE COIL AS EQUIVALENT TRANS.	—	—	—	—			
POWER FACTOR IN LINE	$\frac{6(\sqrt{3}-1)}{\pi} = 1.40 \cos^2 \frac{\psi}{2}$	$\frac{6(\sqrt{3}-1)}{\pi} = 1.40 \cos^2 \frac{\psi}{2}$	$\frac{6(\sqrt{3}-1)}{\pi} = 1.40 \cos^2 \frac{\psi}{2}$	$\frac{6(\sqrt{3}-1)}{\pi} = 1.40 \cos^2 \frac{\psi}{2}$				
D.C. VOLTAGE	$\frac{6(\sqrt{3}-1)}{\pi} = 1.40 E \cos^2 \frac{\psi}{2}$	$\frac{6(\sqrt{3}-1)}{\pi} = 1.40 E \cos^2 \frac{\psi}{2}$	$\frac{6(\sqrt{3}-1)}{\pi} = 1.40 E \cos^2 \frac{\psi}{2}$	$\frac{6(\sqrt{3}-1)}{\pi} = 1.40 E \cos^2 \frac{\psi}{2}$				

# RECTIFIER TRANSFORMERS

TABLE V.—J

TYPE OF CONNECTION	Y-12 PHASE ZIGZAG WITH 3 I.P.T.S.		Δ-12 PHASE ZIGZAG WITH 3 I.P.T.S.		Y-12 PHASE ZIGZAG WITH 4-PHASE I.P.T.		Δ-12 PHASE ZIGZAG WITH 4-PHASE I.P.T.	
	PRIM.	SEC.	PRIM.	SEC.	PRIM.	SEC.	PRIM.	SEC.
NUMBER OF PHASES	3	12	3	12	3	12	3	12
VECTOR DIAGRAM								
ANODE CURRENT								
	WAVE FORM		WAVE FORM		WAVE FORM		WAVE FORM	
	AVERAGE $\frac{1}{2} I = 0.083 I$		AVERAGE $\frac{1}{2} I = 0.083 I$		AVERAGE $\frac{1}{2} I = 0.083 I$		AVERAGE $\frac{1}{2} I = 0.083 I$	
SECONDARY CURRENT	R.M.S. CORRECTION FOR OVERLAP $\frac{4}{\sqrt{3}} I = 0.144 I$		R.M.S. CORRECTION FOR OVERLAP $\frac{4}{\sqrt{3}} I = 0.144 I$		R.M.S. CORRECTION FOR OVERLAP $\frac{4}{\sqrt{3}} I = 0.144 I$		R.M.S. CORRECTION FOR OVERLAP $\frac{4}{\sqrt{3}} I = 0.144 I$	
	WAVE FORM		WAVE FORM		WAVE FORM		WAVE FORM	
	R.M.S. CORRECTION FOR OVERLAP		R.M.S. CORRECTION FOR OVERLAP		R.M.S. CORRECTION FOR OVERLAP		R.M.S. CORRECTION FOR OVERLAP	
PRIMARY CURRENT	WAVE FORM		WAVE FORM		WAVE FORM		WAVE FORM	
	R.M.S. CORRECTION FOR OVERLAP $\frac{3\sqrt{2}}{4\sqrt{3}} I = 0.395 I$		R.M.S. CORRECTION FOR OVERLAP $\frac{3\sqrt{2}}{4\sqrt{3}} I = 0.395 I$		R.M.S. CORRECTION FOR OVERLAP $\frac{3\sqrt{2}}{4\sqrt{3}} I = 0.395 I$		R.M.S. CORRECTION FOR OVERLAP $\frac{3\sqrt{2}}{4\sqrt{3}} I = 0.395 I$	
	FORM FACTOR $\frac{3\sqrt{2}}{\sqrt{3}+2} = 1.14$		FORM FACTOR $\frac{3\sqrt{2}}{\sqrt{3}+2} = 1.14$		FORM FACTOR $\frac{3\sqrt{2}}{\sqrt{3}+2} = 1.14$		FORM FACTOR $\frac{3\sqrt{2}}{\sqrt{3}+2} = 1.14$	
	CREST FACTOR $\sqrt{2} = 1.41$		CREST FACTOR $\sqrt{2} = 1.41$		CREST FACTOR $\sqrt{2} = 1.41$		CREST FACTOR $\sqrt{2} = 1.41$	
	FORM FACTOR $\frac{3\sqrt{2}}{\sqrt{3}+2} = 1.14$		FORM FACTOR $\frac{3\sqrt{2}}{\sqrt{3}+2} = 1.14$		FORM FACTOR $\frac{3\sqrt{2}}{\sqrt{3}+2} = 1.14$		FORM FACTOR $\frac{3\sqrt{2}}{\sqrt{3}+2} = 1.14$	
LINE CURRENT	WAVE FORM		WAVE FORM		WAVE FORM		WAVE FORM	
	R.M.S. CORRECTION FOR OVERLAP		R.M.S. CORRECTION FOR OVERLAP		R.M.S. CORRECTION FOR OVERLAP		R.M.S. CORRECTION FOR OVERLAP	
	FORM FACTOR $\frac{3\sqrt{2}}{\sqrt{3}+2} = 1.14$		FORM FACTOR $\frac{3\sqrt{2}}{\sqrt{3}+2} = 1.14$		FORM FACTOR $\frac{3\sqrt{2}}{\sqrt{3}+2} = 1.14$		FORM FACTOR $\frac{3\sqrt{2}}{\sqrt{3}+2} = 1.14$	
	CREST FACTOR $\sqrt{2} = 1.41$		CREST FACTOR $\sqrt{2} = 1.41$		CREST FACTOR $\sqrt{2} = 1.41$		CREST FACTOR $\sqrt{2} = 1.41$	
TERTIARY CURRENT TO GROUND OR RESIDUAL M.M.F.	WAVE FORM		WAVE FORM		WAVE FORM		WAVE FORM	
	R.M.S. CORRECTION FOR OVERLAP		R.M.S. CORRECTION FOR OVERLAP		R.M.S. CORRECTION FOR OVERLAP		R.M.S. CORRECTION FOR OVERLAP	
RATING OF TRANSFORMER	PRIMARY		PRIMARY		PRIMARY		PRIMARY	
	CORRECTION FOR OVERLAP		CORRECTION FOR OVERLAP		CORRECTION FOR OVERLAP		CORRECTION FOR OVERLAP	
	SECONDARY		SECONDARY		SECONDARY		SECONDARY	
	CORRECTION FOR OVERLAP		CORRECTION FOR OVERLAP		CORRECTION FOR OVERLAP		CORRECTION FOR OVERLAP	
	TERTIARY		TERTIARY		TERTIARY		TERTIARY	
CORRECTION FOR OVERLAP		CORRECTION FOR OVERLAP		CORRECTION FOR OVERLAP		CORRECTION FOR OVERLAP		
AVERAGE		AVERAGE		AVERAGE		AVERAGE		
RATING OF I.P.T. TRANSFORMER	AS HARMONIC CHOKE COIL		AS HARMONIC CHOKE COIL		AS HARMONIC CHOKE COIL		AS HARMONIC CHOKE COIL	
	AS EQUIVALENT TRANS.		AS EQUIVALENT TRANS.		AS EQUIVALENT TRANS.		AS EQUIVALENT TRANS.	
POWER FACTOR IN LINE		POWER FACTOR IN LINE		POWER FACTOR IN LINE		POWER FACTOR IN LINE		
D.C. VOLTAGE		D.C. VOLTAGE		D.C. VOLTAGE		D.C. VOLTAGE		

TABLE V.—K

TYPE OF CONNECTION	PARALLEL YA-2 CORE - DOUBLE STAR		PARALLEL YA-2 CORE - DOUBLE FORK		SERIES YA-2 CORE - DOUBLE STAR		SERIES YA-2 CORE - DOUBLE FORK		
	PRIM.	SEC.	PRIM.	SEC.	PRIM.	SEC.	PRIM.	SEC.	
NUMBER OF PHASES	2 x 3 12		2 x 3 12		2 x 3 12		2 x 3 12		
VECTOR DIAGRAM									
ANODE CURRENT	WAVE FORM								
	AVERAGE	$\frac{1}{2} I = 0.083 I$		$\frac{1}{2} I = 0.083 I$		$\frac{1}{2} I = 0.083 I$		$\frac{1}{2} I = 0.083 I$	
	R.M.S. CORRECTION FOR OVERLAP	$\frac{1}{2\sqrt{3}} I = 0.289 I$		$\frac{1}{2\sqrt{3}} I = 0.289 I$		$\frac{1}{\sqrt{3}} I = 0.578 I$		$\frac{1}{2\sqrt{3}} I = 0.289 I$	
SECONDARY CURRENT	WAVE FORM	SAME AS ANODE CURRENT				SAME AS ANODE CURRENT			
	AVERAGE	"		$\frac{1}{\sqrt{3}} I = 0.408 I$		"		$\frac{1}{\sqrt{3}} I = 0.268 I$	
	R.M.S. CORRECTION FOR OVERLAP	"		$\frac{1}{\sqrt{3}} I = 0.408 I$		"		$\frac{1}{\sqrt{3}} I = 0.268 I$	
PRIMARY CURRENT	WAVE FORM								
	AVERAGE	$\frac{1}{2} I = 0.083 I$		$\frac{1}{2} I = 0.083 I$		$\frac{1}{2} I = 0.083 I$		$\frac{1}{2} I = 0.083 I$	
	R.M.S. CORRECTION FOR OVERLAP	$\frac{1}{2\sqrt{3}} I = 0.289 I$		$\frac{1}{2\sqrt{3}} I = 0.289 I$		$\frac{1}{\sqrt{3}} I = 0.578 I$		$\frac{1}{2\sqrt{3}} I = 0.289 I$	
	FORM FACTOR (u=0)	$\frac{3\sqrt{2}}{2} = 2.45$		$\frac{3\sqrt{2}}{2} = 2.45$		$\frac{3\sqrt{2}}{2} = 2.45$		$\frac{3\sqrt{2}}{2} = 2.45$	
	CREST FACTOR (u=0)	$\sqrt{2} = 1.41$		$\sqrt{2} = 1.41$		$\sqrt{2} = 1.41$		$\sqrt{2} = 1.41$	
LINE CURRENT	WAVE FORM					SAME AS PRIMARY "Y" CURRENT		SAME AS PRIMARY "Y" CURRENT	
	AVERAGE	$\frac{1}{2} I = 0.083 I$		$\frac{1}{2} I = 0.083 I$		"		"	
	R.M.S. CORRECTION FOR OVERLAP	$\frac{1}{2\sqrt{3}} I = 0.289 I$		$\frac{1}{2\sqrt{3}} I = 0.289 I$		"		"	
	FORM FACTOR (u=0)	$\frac{3\sqrt{2}}{2} = 2.45$		$\frac{3\sqrt{2}}{2} = 2.45$		"		"	
	CREST FACTOR (u=0)	$\sqrt{2} = 1.41$		$\sqrt{2} = 1.41$		"		"	
TERTIARY (OR G-GROUND OR M-RESIDUAL)	WAVE FORM	$M_y, M_\Delta = 0$		$M(\text{y and } \Delta)$		$M_y, M_\Delta = 0$		$M(\text{y and } \Delta)$	
	AVERAGE	0		0		0		0	
	R.M.S. CORRECTION FOR OVERLAP	0		0		0		0	
RATING OF TRANSFORMER	PRIMARY CORRECTION FOR OVERLAP	$\frac{\pi \sqrt{3} (V_2 + 2)}{12(V_2 - 1)} = 1.59 P$		$\frac{\pi}{3(V_2 - 1)} = 1.43 P$		$\frac{\pi \sqrt{3} (V_2 + 1)}{6(V_2 - 2)} = 1.09 P$		$\frac{\pi \sqrt{3}}{2(V_2 - 2)} = 1.03 P$	
	SECONDARY CORRECTION FOR OVERLAP	$\frac{\pi}{\sqrt{3}(V_2 - 1)} = 2.48 P$		$\frac{\pi (12 + 1)}{3\sqrt{2}(V_2 - 1)} = 2.44 P$		$\frac{2\sqrt{1.61}(V_2 + 1) + 1.7 \cdot 3.68 P}{(1 + \sqrt{3}) \cos^2 \frac{\mu}{2}} = 1.63 P$		$\frac{\pi (V_2 + \sqrt{2})}{2(V_2 - 2)} = 1.67 P$	
	TERTIARY CORRECTION FOR OVERLAP	0		0		0		0	
	AVERAGE	$1.59 + 2.48 = 2.04 P$		$1.43 + 2.44 = 1.94 P$		$1.09 + 1.63 = 1.36 P$		$1.03 + 1.67 = 1.35 P$	
	RATING OF IFT	As Harmonic Choke Coil		As Equivalent Trans.		As Harmonic Choke Coil		As Equivalent Trans.	
POWER FACTOR IN LINE	$\frac{6(V_2 - 1)}{\pi \sqrt{2}} \cos^2 \frac{\mu}{2}$		$\frac{6(V_2 - 1)}{\pi \sqrt{2}} \cos^2 \frac{\mu}{2}$		$\frac{(V_2 + 1)\sqrt{3}}{\pi} \cos^2 \frac{\mu}{2}$		$\frac{(V_2 + 1)\sqrt{3}}{\pi} \cos^2 \frac{\mu}{2}$		
D.C. VOLTAGE	$\frac{6(V_2 - 1)}{\pi} = 1.40 E \cos^2 \frac{\mu}{2}$		$\frac{6(V_2 - 1)}{\pi} = 1.40 E \cos^2 \frac{\mu}{2}$		$\frac{4}{\pi} = 1.27 E \cos^2 \frac{\mu}{2}$		$\frac{4}{\pi} = 1.27 E \cos^2 \frac{\mu}{2}$		

## PARALLEL CONNECTION OF ANODES

Rectifiers are now built with 6, 12, 18, and 24 anodes in one tank. When a 6-anode rectifier is connected to a transformer with a 6-phase secondary, each anode operates on a separate phase. When a 12-anode rectifier is connected to a 6-phase transformer, two anodes operate in parallel on each phase. When a 24-anode rectifier is connected to a 6-phase transformer, 4 anodes operate in parallel on each phase. Similar operation occurs when two 6- or 12-anode rectifiers are connected in parallel to one transformer.

When two or more anodes operate in parallel on one phase, provision must be made to insure equal division of current among the parallel operating anodes, in order to prevent overloading of some of the anodes.

One method of accomplishing this is by connecting the parallel operating anodes to each phase of the transformer secondary through a balancing anode choke coil, as shown in Fig. 74. The windings of the choke coil are so connected that their m.m.f.s buck each other. When the currents of the two anodes are equal, there is no flux in the core of the choke coil. Any unbalance in the currents of the anodes will produce a flux in the core which will induce a bucking voltage in the winding carrying the higher current, and a boosting voltage in the winding carrying the smaller current. These voltages will tend to equalize the currents of the two anodes (141) (244).

Another method for maintaining equal current distribution among parallel anodes is to provide each secondary phase of the transformer with individual windings for the several parallel anodes. With such an arrangement, any tendency of an anode to take a higher current than the other anodes is opposed by a lowering of the terminal voltage of that anode due to a greater voltage drop in the leakage reactance of its winding when carrying a higher current. In order that this method be effective, the parallel windings of each phase should be so arranged on the core in relation to each other that their leakage fields do not overlap; in other words, these windings should have a high reactance to each other. This is necessary because if these windings had a

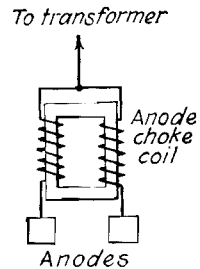

FIG. 74. - Anode choke coil for parallelizing two anodes on one secondary phase of a rectifier transformer.



common leakage field, the leakage flux would affect equally all the windings and a difference in their currents would not produce any equalizing voltage difference.

One arrangement of the windings for accomplishing this is shown in Fig. 80 for a transformer having a double 6-phase connection with interphase transformers. The transformer in this figure is wound with sectional coils. The primary consists of two parallel sections, each occupying one-half of the core. One of the parallel secondary windings is placed opposite one of the primary sections, so that the coils of two parallel operating phases are isolated from each other and their leakage fields do not overlap.

Another arrangement for accomplishing this, using the cylindrical type of windings, is to place the windings of one 6-phase system on the inside of the primary and the windings of the second 6-phase system on the outside of the primary.

For the double 6-phase transformer connection with interphase transformer, a common interphase transformer may be used for the parallel operating phases, or a separate interphase transformer may be provided for each of the parallel 6-phase systems. The latter arrangement affords better distribution of the current among the parallel operating anodes, on account of the higher resistance in the individual circuits of these anodes.

For 6-phase fork-connected transformers, completely independent secondary windings may be used for each of the parallel anodes, or only individual branch windings may be used for each anode, the star windings being common for a pair of parallel anodes.

Anode choke coils are rarely used now for paralleling anodes, transformer connections with individual windings for each anode being used almost exclusively.

#### EFFECT OF BACK FIRES ON TRANSFORMER WINDINGS

Rectifier transformers are subjected to very high stresses during a back fire. The phenomenon of back fires was explained in Chap. III, and the flow of current was indicated in Fig. 19 of that chapter. From Figs. 19 and 32, it can be seen that a very high current flows in the phase of the transformer in which the back fire occurs. This current is considerably higher than the anode current flowing during a short circuit on the direct-current

side. During a direct-current short circuit all the anodes feed into the short circuit in the normal direction (anode to cathode), and the conditions are similar to those under normal operation of the rectifier, except that the currents in the secondary phases are higher and of longer duration due to greater overlapping between phases. During a back fire, on the other hand, the current in the back-firing phase is in the reverse direction, and all the other phases feed into this phase. Furthermore, if the rectifier operates in parallel with other direct-current machines, direct current will flow from the positive pole of the direct-current network, through the cathode, to the back-firing anode, as shown in Fig. 19.

**Actual Tests.**—Back-fire as well as short-circuit tests were carried out on a 1,200-kw., 600-volt, 12-anode rectifier unit, with a fork-connected transformer. The oscillogram in Fig. 32, which was taken during these tests, shows a peak current of about 17,000 amp. in the back-firing anode. This oscillogram was obtained by metallicly connecting one anode with the cathode, this method being an artificial reproduction of a back fire, since it is very difficult to obtain an oscillographic record of an actual back fire. The rectifier was isolated on the direct-current side; there was, therefore, no backfeed from that side, and this test consequently does not represent the worst condition, which would be obtained if the rectifier were connected to a direct-current system.

A direct-current short-circuit test made on the same rectifier and transformer gave a direct-current peak current of about 23,000 amp., which would mean a maximum anode current of about 5,000 amp. The current in the back-firing phase is, therefore, three to four times the current obtained during a direct-current short circuit. If connected to a direct-current system, fed by other direct-current machines, the ratio of the currents during the two conditions would be even higher, on account of the additional backfeed current from the direct-current side.

From this it can be realized that the design and manufacture of rectifier transformers require greater consideration than ordinary power transformers. Particular attention must be given to the bracing of the coils and the arrangement of the secondary windings. In order to prevent excessive electrodynamic stresses in the secondary windings, each of the secondary windings

carrying current during a back fire must be distributed along the entire length of the corresponding primary winding.

In Fig. 75 is shown the flow of currents during a back fire on one anode of a 12-anode rectifier connected to a double

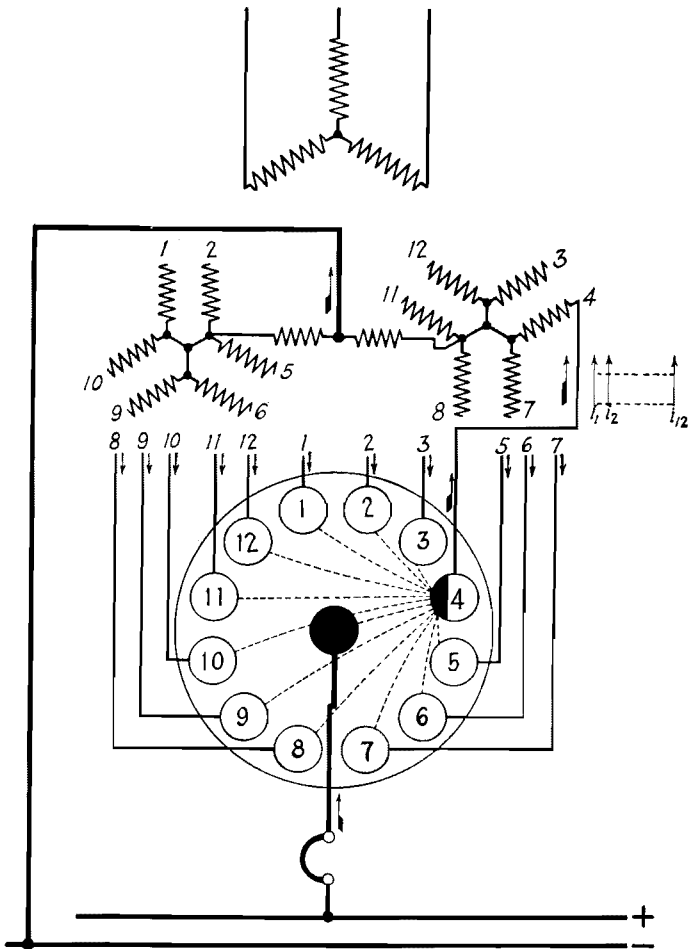

FIG. 75.—Flow of currents during a back fire in a 12-anode rectifier connected to a double 6-phase transformer with absorption-reactance coil (inter-phase transformer).

6-phase transformer with absorption-reactance coil. Currents from the remaining anodes flow into the back-firing anode 4 and, therefore, into the secondary winding 4 of the transformer.

Under normal operation of the rectifier, or during a direct-current short circuit, windings 3 and 4 operate in parallel, and the currents in the two windings are equal and in the same direction. The arrangement of the windings on one leg of the transformer, as shown in Fig. 76a, would be satisfactory for such conditions, since there is a balanced distribution of ampere-turns along the entire leg. However, during a back fire on anode 4, winding 4 carries a considerably higher current than the other windings on the leg, and the current in winding 4 is in the opposite direction from normal; there would, therefore, be a high leakage flux

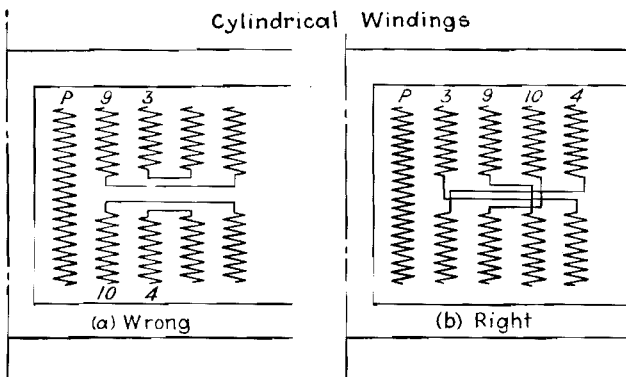

FIG. 76.—Arrangement of the primary and secondary windings on one of the legs of a rectifier transformer connected as shown in Fig. 75.

between the winding 4 and the primary winding, and the resulting electrodynamic forces would be in a direction tending to force coil 4 downward and would crush the coil and injure the insulation.

It can be seen from the preceding, that in order to minimize and balance the forces acting on the windings during a back fire, each winding must be distributed along the entire length of the core, as shown in Fig. 76b for cylindrical-type coils. With such an arrangement of the secondary windings, the electrical centers of the primary and secondary windings are symmetrical with respect to each other under normal conditions as well as during a back fire.

#### DETERMINATION OF TRANSFORMER COPPER LOSSES

The copper losses in a rectifier transformer may be calculated by adding the  $i^2r$  losses in the primary and secondary windings,

using the r.m.s. values of the currents and the effective alternating-current resistances of the various windings. The r.m.s. values of the currents may be calculated from the direct current by means of the equations which have been derived for the several transformer connections considered in this chapter. The effective alternating-current resistances of the windings may be determined from copper-loss tests on the transformer. The copper-loss tests are made by short circuiting the whole or part of the secondary and applying a reduced alternating-current voltage to the primary, sufficient to produce rated current in the primary windings of the transformer. With a sinusoidal alternating-current voltage, the currents flowing in the windings during such tests are also sinusoidal, and the effective alternating-

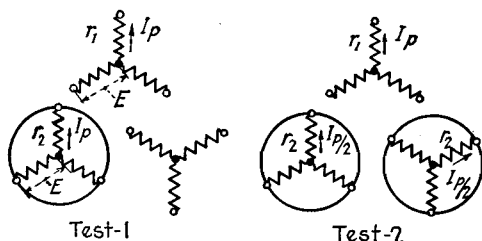

FIG. 77.—Tests for determining the copper losses of a rectifier transformer having a 6-phase connection with interphase transformer. (The resistances  $r_1$  and  $r_2$  are represented in Eqs. (174) to (178) by  $r_p$  and  $r_s$ , respectively.)

current resistances of the windings obtained from such tests would, therefore, differ somewhat from their effective resistance for the non-sinusoidal currents obtained when operating with the rectifier. The error involved, however, is usually small, and may be neglected.

Below are given calculations of the copper losses for the most commonly used transformer connections as determined from copper-loss tests with sinusoidal alternating-current power supply.

**Six-phase Connection with Interphase Transformer.**—For this connection the rated primary current corrected for overlapping, as was previously derived, is

$$I_p = \left( \frac{I}{\sqrt{6}} \right) \sqrt{1 - 3\psi(u)}.$$

Two short-circuit tests are required, as shown in Fig. 77, to determine the effective primary and secondary resistances. In the first test the copper losses are measured with rated current

in the primary and with one secondary winding short circuited. With a 1:1 transformation ratio the secondary current is equal to the primary current. In the second test the losses are measured with both secondaries short circuited, and with rated current in the primary. The current in each secondary phase is then equal to one-half the primary current. The copper losses  $W$ , measured by a wattmeter in each of the tests, are as follows:

$$W_1 = 3I_p^2 r_p + 3I_p^2 r_s. \quad (174)$$

$$W_2 = 3I_p^2 r_p + 6(I_p/2)^2 r_s. \quad (175)$$

Solving these equations simultaneously for  $r_p$  and  $r_s$ ,

$$r_p = \frac{2W_2 - W_1}{3I_p^2}. \quad (176)$$

$$r_s = \frac{W_1 - W_2}{1.5I_p^2}. \quad (177)$$

When operating with a rectifier, the r.m.s. values of the primary and secondary currents, as corrected for overlapping, are

$$I_p = \left( \frac{I}{\sqrt{6}} \right) \sqrt{1 - 3\psi(u)}$$

$$A = \left( \frac{I}{2\sqrt{3}} \right) \sqrt{1 - 3\psi(u)} = \frac{I_p \sqrt{2}}{2},$$

and the copper losses are

$$W_r = 3I_p^2 r_p + 6A^2 r_s.$$

Substituting Eqs. (176) and (177) for  $r_p$  and  $r_s$

$$W_r = (2W_2 - W_1) + 2(W_1 - W_2) = W_1. \quad (178)$$

It is seen from Eq. (178) that the total transformer copper losses when operating with a rectifier are equal to the losses measured in test 1, with one secondary short circuited. The segregated primary and secondary losses are given by the terms in Eq. (178).

For a transformation ratio other than 1:1, the secondary resistance  $r_s$  is proportional to the square of the ratio of the secondary to the primary voltages.

**Six-phase Fork Connection.**—For this connection three resistances must be determined: the resistance  $r_p$  of the primary windings, the resistance  $r_s$  of the star windings of the secondary, and the resistance  $r_b$  of the branch windings of the secondary. Three copper-loss tests are therefore required, for different combinations

of short-circuited secondaries, in order to set up three equations for determining these resistances. Three such test combinations are shown in Fig. 78. In the figure are indicated the values of the secondary currents for the different tests, with rated current  $I_p$  flowing in the primary, and with a transformation ratio of 1:1 between each primary and secondary winding (*i.e.*, a ratio of  $1:\sqrt{3}$  between primary and secondary phase voltages).

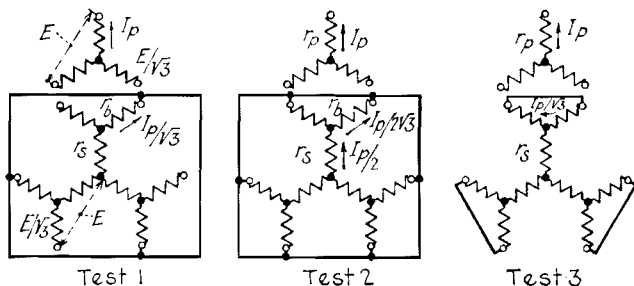

FIG. 78.—Tests for determining the copper losses of a 6-phase fork-connected rectifier transformer.

The copper losses measured for the three test arrangements shown in Fig. 78 are as follows:

$$W_1 = 3I_p^2 r_p + 3\left(\frac{I_p}{\sqrt{3}}\right)^2 (r_b + r_s). \quad (179)$$

$$W_2 = 3I_p^2 r_p + 3\left(\frac{I_p}{2}\right)^2 r_s + 6\left(\frac{I_p}{2\sqrt{3}}\right)^2 r_b. \quad (180)$$

$$W_3 = 3I_p^2 r_p + 6\left(\frac{I_p}{\sqrt{3}}\right)^2 r_b. \quad (181)$$

Solving Eqs. (179), (180), and (181) simultaneously for  $r_p$ ,  $r_s$ , and  $r_b$ , the following values are obtained:

$$r_p = \frac{-(2/3)W_1 + (8/9)W_2 + (1/9)W_3}{I_p^2}. \quad (182)$$

$$r_s = \frac{2W_1 - (4/3)W_2 - (2/3)W_3}{I_p^2}. \quad (183)$$

$$r_b = \frac{W_1 - (4/3)W_2 + (1/3)W_3}{I_p^2}. \quad (184)$$

The r.m.s. values of the currents in the transformer windings when operating with the rectifier, as given in Table V-C, but

corrected for a transformation ratio of  $1:\sqrt{3}$  between primary and secondary phase voltages, are as follows:

Primary current

$$I_p = \frac{I\sqrt{2}}{\sqrt{3}}\sqrt{1 - 3\psi(u)}.$$

Secondary current in star windings,

$$S = \frac{I}{\sqrt{3}}\sqrt{1 - 3\psi(u)} = \frac{I_p}{\sqrt{2}}.$$

Secondary current in branch windings,

$$\begin{aligned} A &= \frac{I}{\sqrt{6}}\sqrt{1 - 6\psi(u)} \\ &= \frac{I_p}{2}\sqrt{\frac{1 - 6\psi(u)}{1 - 3\psi(u)}}. \end{aligned}$$

The transformer copper losses when operating with the rectifier are:

$$\begin{aligned} W_r &= 3I_p^2 r_p + 3S^2 r_s + 6A^2 r_b \\ &= 3I_p^2 r_p + \frac{3I_p^2}{2} r_s + \frac{6I_p^2}{4} \left( \frac{1 - 6\psi(u)}{1 - 3\psi(u)} \right) r_b \\ &= I_p^2 \left[ 3r_p + 1.5r_s + 1.5r_b \left( \frac{1 - 6\psi(u)}{1 - 3\psi(u)} \right) \right]. \end{aligned} \quad (185)$$

For an angle of overlap of  $20^\circ$ , corresponding approximately to full-load conditions, the ratio  $\frac{1 - 6\psi(u)}{1 - 3\psi(u)}$  in Eq. (185) has

the value 0.95. If this ratio is assumed to be unity, there would be an error of 5 per cent in the calculated copper losses of the secondary branch windings, or an error of about 1.8 per cent in the total transformer copper losses, since the branch windings represent approximately 37 per cent of the transformer kilovolt-ampere rating. For commercial copper-loss tests this error may be neglected, and this ratio may be assumed to be equal to unity. With this assumption, and substituting in Eq. (185) the values of Eqs. (182), (183), and (184) for the resistances, we obtain

$$W_r = \left(\frac{5}{2}\right)W_1 - \left(\frac{4}{3}\right)W_2 - \left(\frac{1}{6}\right)W_3. \quad (186)$$

**Twelve-phase Connection with Interphase Transformer.**—For this connection, the expressions for the primary and second-



ary currents when operating with a rectifier, as given by Eqs. (148) and (150), are

$$I_p = 0.395I\sqrt{1 - 1.61\psi(u)}$$

$$A = 0.144I\sqrt{1 - 3\psi(u)} = 0.364I_p\sqrt{\frac{1 - 3\psi(u)}{1 - 1.61\psi(u)}}$$

Since all the secondary phases are symmetrical, their resistances are equal, and only two tests are necessary for determining the effective primary and secondary resistances per phase. In order not to overload the secondary windings too much, at least

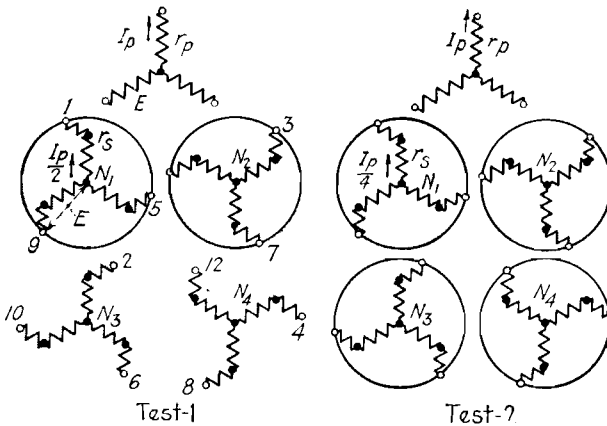

FIG. 79.—Tests for determining the copper losses of a rectifier transformer having a 12-phase connection with interphase transformer.

two secondary groups should be short circuited in these tests. The test connections are shown in Fig. 79.

In the first test, the copper losses are measured with rated sinusoidal current in the primary and two secondaries short circuited, the secondaries denoted by neutrals  $N_1$  and  $N_2$ , for instance. With a 1:1 transformation ratio, the current in each secondary phase is then equal to one-half the primary current, and the copper losses measured by a wattmeter are

$$W_1 = 3I_p^2r_p + 6\left(\frac{I_p}{2}\right)^2r_s. \tag{187}$$

In the second test, the copper losses are measured with all the secondaries short circuited. The current in each secondary is then one-quarter the primary current, and the measured copper losses are

$$W_2 = 3I_p^2 r_p + 12 \left( \frac{I_p}{4} \right)^2 r_s. \quad (188)$$

Solving Eqs. (187) and (188) simultaneously for  $r_p$  and  $r_s$ ,

$$r_p = \frac{2W_2 - W_1}{3I_p^2}. \quad (189)$$

$$r_s = \frac{W_1 - W_2}{0.75I_p^2}. \quad (190)$$

When operating with a rectifier, the transformer copper losses are

$$\begin{aligned} W_r &= 3I_p^2 r_p + 12A^2 r_s \\ &= 3I_p^2 r_p + 12r_s (0.364I_p)^2 \left( \frac{1 - 3\psi(u)}{1 - 1.61\psi(u)} \right). \end{aligned}$$

With a transformer reactance of 6 per cent, the angle of overlap  $u$  is approximately 15 degrees, and the ratio  $\frac{1 - 3\psi(u)}{1 - 1.61\psi(u)}$  has a value of 0.988. This ratio may, therefore, be considered as unity for all practical purposes, and

$$W_r = 3I_p^2 r_p + 1.59I_p^2 r_s. \quad (191)$$

Substituting in Eq. (191) the values of  $r_p$  and  $r_s$  from Eqs. (189) and (190),

$$\begin{aligned} W_r &= (2W_2 - W_1) + 2.12(W_1 - W_2) \\ &= 1.12W_1 - 0.12W_2. \end{aligned} \quad (192)$$

#### DESIGN OF RECTIFIER TRANSFORMERS

The following example of the design of a rectifier transformer will illustrate the design procedure followed, and the application of the equations and curves contained in this chapter.

**Data.**—The transformer is to be used with a 12-anode rectifier having an arc voltage drop characteristic as given by curve *C*, Fig. 6c, for a full-load output of 3,000 kw., 600 volts, direct current. The primary supply is 13,200 volts, 3-phase, 60-cycle. The transformer is to be Y-connected on the primary side and is to have a double 6-phase connection with interphase transformer on the secondary side. The secondary is to consist of two independent 6-phase windings, each provided with an interphase transformer. The diagram of connections is shown in Fig. 81.

**Calculations.**—The transformer is to be designed with a reactance  $X\% = 6$  per cent.

The total copper loss  $W_c$  in the main and interphase transformers is assumed to be 30 kw.

The full-load direct current of the rectifier is

$$I = \frac{3,000 \times 1,000}{600} = 5,000 \text{ amp.}$$

According to curve *C*, Fig. 6c, the arc voltage drop in the rectifier at full load is

$$e_a = 23 \text{ volts.}$$

The drop in the direct-current voltage between no-load and full-load due to the copper losses  $W_c$  is

$$e_c = \frac{W_c}{I} = \frac{30 \times 1,000}{5,000} = 6 \text{ volts.}$$

According to curve 7, Fig. 71, the drop in the direct-current voltage between no load and full load due to the transformer reactance is  $d\% = 3$  per cent of the voltage at the transition load.

The direct-current voltage of the transformer secondary at the transition load (which may be considered as practically no load) is, in accordance with Eq. (166),

$$E_{dt} = \frac{E_{dt} + e_a + e_c}{1 - \frac{d\%}{100}} = \frac{600 + 23 + 6}{1 - 0.03} = 648 \text{ volts.}$$

The no-load alternating-current voltage per phase of the transformer secondary is, according to Eq. (106),

$$E_s = \frac{E_{dt}}{1.17} = 554 \text{ volts.}$$

According to curve 3, Fig. 71, the angle of overlap at full load for a transformer reactance of 6 per cent is  $u = 20^\circ$ .

The transformer has 12 secondary windings, one for each anode, with two anodes operating in parallel on each phase. The r.m.s. value of the anode current is

$$\begin{aligned} A &= \frac{1}{2} \cdot \frac{I}{2\sqrt{3}} \sqrt{1 - 3\psi(u)} \\ &= \frac{1}{2} \times \frac{5,000}{2\sqrt{3}} \times 0.978 = 706 \text{ amp.} \end{aligned}$$

The kilovolt-ampere rating of the transformer secondary is

$$P_2 = \frac{12E_s A}{1,000} = \frac{12 \times 554 \times 706}{1,000} = 4,694 \text{ kva.}$$

The voltage per primary phase is

$$E_p = \frac{13,200}{\sqrt{3}} = 7,622 \text{ volts.}$$

The primary current is

$$\begin{aligned} I_p &= \frac{I}{\sqrt{6}} \sqrt{1 - 3\psi(u)} \cdot \frac{E_s}{E_p} \\ &= \frac{5,000}{\sqrt{6}} \times 0.978 \times \frac{554}{7,622} = 145 \text{ amp.} \end{aligned}$$

The primary kilovolt-ampere rating,

$$P_1 = \frac{3E_p I_p}{1,000} = \frac{3 \times 7,622 \times 145}{1,000} = 3,316 \text{ kva.}$$

The average kilovolt-ampere rating,

$$P_{av} = \frac{4,694 + 3,316}{2} = 4,005 \text{ kva.}$$

The average kilovolt-ampere rating gives an indication of the size of transformer parts to be used.

**Design.**—The transformer is to be designed for a primary of 7,622 volts and 145 amp. per phase, and a secondary of 554 volts, 706 amp.

A certain amount of adjusting of the various factors and dimensions is necessary to obtain the desired characteristics. The following figures represent a typical design for the above rating:

From the design of similar transformers, the proper value of volts per turn to produce the desired characteristics is chosen. For this transformer a value of 34.6 volts per turn will be used.

The number of turns per secondary phase is  $554/34.6 = 16$ .

The number of turns per primary phase is  $7,622/34.6 = 220$ .

(When the low-voltage winding has only a very small number of turns, as in this instance, the number of possibilities for the volts per turn value is greatly reduced.)

From the expression for induced voltage ( $E = 4.44Nf\phi \cdot 10^{-8}$ ) the magnetic flux in each leg of the core is

$$\begin{aligned} \phi &= \frac{\text{volts per turn}}{4.44 \times \text{frequency}} \times 10^8 \\ &= \frac{34.6}{4.44 \times 60} \times 10^8 = 13 \times 10^6 \text{ lines.} \end{aligned}$$

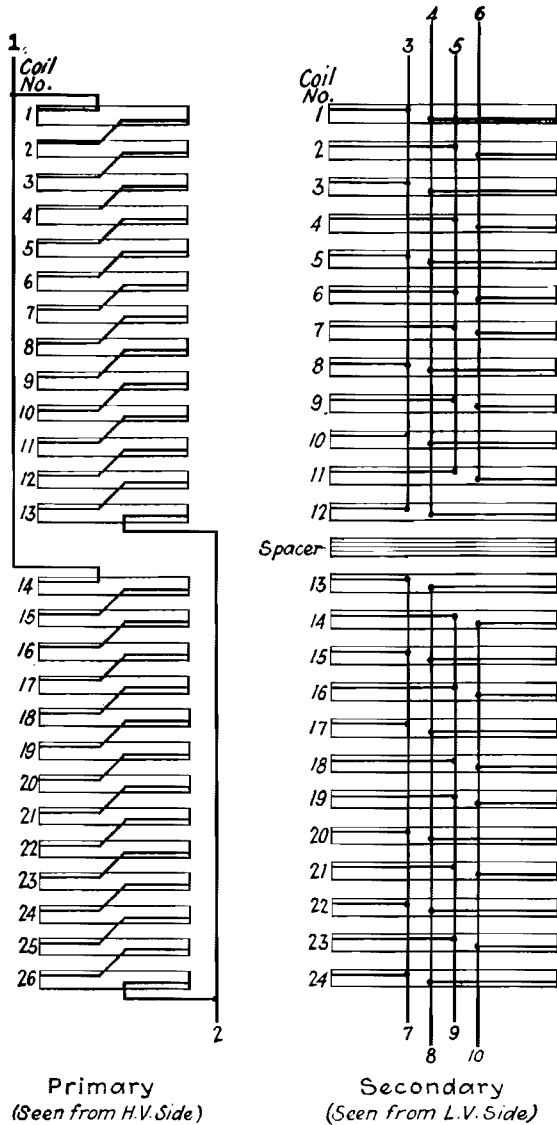

FIG. 80.—Arrangement and connection of primary and secondary windings on one leg of a 3-phase/ $2 \times 6$ -phase transformer designed for a 3,000-kw., 600-volt, 12-anode rectifier unit.

Using a value of 12,600 gauss (81,200 lines per square inch) for the induction in the iron, the net cross-section of the core is

$$\frac{13 \times 10^6}{81,200} = 160 \text{ sq. in.}$$

All the coils are made circular in form to provide ample mechanical strength. The core is made of cruciform cross-section to reduce the size of the circumscribed circle.

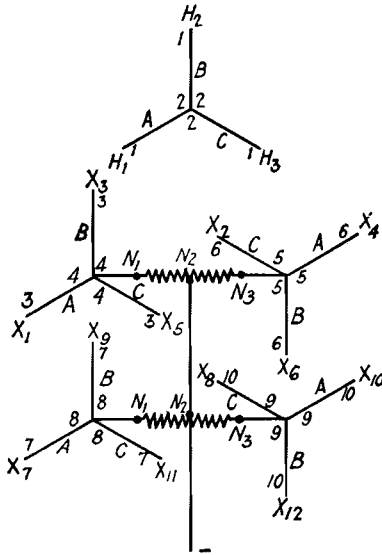

Fig. 81.—Polarity diagram of connections for the rectifier transformer shown in Fig. 80.

The arrangement and connection of the coils for each leg of the transformer are shown in Fig. 80. In Fig. 81 is shown the polarity diagram of connections.

The primary winding is arranged in two parallel portions, each traversing one-half of the core. The secondary windings are so arranged that the windings of one of the parallel operating 6-phase groups are placed opposite one of the parallel sections of the primary. With this arrangement good division of current between the parallel operating anodes is obtained, since the windings connected to a pair of parallel anodes, such as windings 3-4 and 7-8 in Figs. 80 and 81, are placed on opposite halves of the core, so that their leakage fields do not overlap (see Parallel

Connection of Anodes). With this arrangement the value of the current flowing during a back fire in the rectifier is also reduced, since the winding connected to a back-firing anode occupies only one-half of the core, so that its effective reactance to the primary is higher.

Both the primary and secondary are wound in sectional coils. The copper for the primary is chosen as copper strap of 0.120 by 0.450 in., wrapped with paper tape and braid-covered. The primary has 26 coils, 13 in each of the parallel portions. The copper for the secondary is 0.18 by 0.45 in. copper strap, covered with paper tape and braid. The secondary has 24 coils, 6 coils being connected in parallel to supply one anode.

The copper loss may be calculated from the physical dimensions of the windings. The iron loss may be calculated from the weight of the iron and the induction. A summary of the design data and the calculation of the copper and iron losses is given below:

## PRIMARY

Primary voltage.....	7,622 volts per phase, 60 cycles
Primary current.....	145 amp.
Volts per turn.....	34.6
Total turns.....	220 × 3, effective
Number of coils per phase.....	20    4    2
Turns per coil.....	18    12    16
Layers per coil.....	9    6    8
Turns per layer.....	2    2    2
Size of conductor.....	0.120 by 0.450 in. copper strap, insulated with paper tape and braid; two conductors in parallel
Mean length of turn.....	62 in.
Total length.....	$\frac{220 \times 3 \times 62}{12} = 3,410$ ft. of two parallel conductors 0.120 by 0.450 in.
Weight of copper.....	3,410 ft. × (2 × 0.12 in. × 0.45 in.) × 3.85 = 1,420 lb.
Resistance at 75° C. (direct-current).....	$\frac{3,410 \text{ ft.} \times 9.9 \times 10^{-6}}{2 \times (0.12 \text{ in.} \times 0.45 \text{ in.})} = 0.313$ ohm
$I^2R$ loss at 75° C.....	6,600 watts
Wattmeter loss at 75° C. with alternating current (from previous experience).....	8,500 watts

## SECONDARY

Secondary voltage.....	554 volts per phase
Secondary current.....	706 amp.
Total turns.....	$16 \times 4 \times 3$ , effective
Number of coils.....	24
Turns per coil.....	16
Layers per coil.....	8
Turns per layer.....	2
Size of conductor.....	0.180 by 0.450 in. copper strap, insulated with paper tape and braid; six conductors in parallel
Mean length of turn.....	84 in.
Total length.....	$\frac{16 \times 4 \times 3 \times 84}{12} = 1,344$ ft. of six parallel conductors 0.180 by 0.450 in., or approximately 1,370 ft., making allowances for connections
Weight of copper.....	$1,370$ ft. $\times$ (6 $\times$ 0.18 in. $\times$ 0.45 in.) $\times$ 3.85 = 2,560 lb.
Resistance at 75° C. (direct current).....	$\frac{1,370 \text{ ft.} \times 9.9 \times 10^{-6}}{6 \times (0.18 \text{ in.} \times 0.45 \text{ in.})} = 0.0279$ ohm
$I^2R$ loss at 75° C.....	13,900 watts
Wattmeter loss at 75° C. with alternating current (from previous experience).....	18,000 watts

## CORE

Net induction.....	12,600 gauss
Net cross-section.....	160 sq. in.
Tongue.....	15 in.
Opening.....	15 by 40 in.
Weight.....	11,500 lb.
Watt loss per pound.....	1.2 watts
Total iron loss.....	13,800 watts

## SUMMARY

Iron loss.....	13.8 kw.
Copper loss.....	26.5 kw.
Weight of copper.....	3,980 lb.
Weight of iron.....	11,500 lb.
Total weight of active part.....	15,500 lb. (approximately)

**Interphase Transformers.**—Since two interphase transformers are used, each of them has to carry one-half of the direct current, or 2,500 amp. Each half of the winding of one interphase transformer carries 1,250 amp. As a close approximation, the alternat-



ing-current voltage across the interphase transformer is equal to one-half the secondary phase voltage of the main transformer, or 277 volts, and is of triple frequency (180 cycles). The following tabulation shows a typical design of an interphase transformer for this rating:

## WINDING

Alternating-current voltage.....	277 volts, 180 cycles
Current.....	1,250 amp., direct current
Volts per turn.....	13.85
Total turns.....	$\frac{277}{13.85} = 20$ turns
Number of coils.....	4
Turns per coil.....	5
Layers per coil.....	1
Turns per layer.....	5
Size of conductor.....	16 (0.105 × 0.600 in.) double cotton covered
Total length.....	62 ft.
Weight of copper.....	62 ft. × 16 × (0.105 in. × 0.600 in.) × 3.85 = 241 lb.
Resistance at 75° C.....	$\frac{62 \text{ ft.} \times 9.9 \times 10^{-6}}{16 \times (0.105 \text{ in.} \times 0.6 \text{ in.})} = 0.00061$ ohm
$I^2R$ loss at 75° C.....	953 watts
Wattmeter loss at 75° C.....	1,000 watts

## CORE

Net induction.....	5,500 gauss
Net cross-section.....	49.0 sq. in.
Total weight.....	1,100 lb.
Watt loss per pound.....	1.0 watt
Total core loss.....	1,100 watts
Magnetizing volt-amperes per pound.....	2.0
Total magnetizing volt-amperes.....	2,200
Magnetizing current.....	$\frac{2,200}{277} = 7.9$ amp.

For the two interphase transformers, the total copper loss is 2.0 kw. and the total iron loss 2.2 kw.

The arrangement and connection of the windings of each interphase transformer are shown in Fig. 82. Two coils are placed on each leg. The inner coil of one leg is connected in series with the outer coil of the other leg, to form one-half the winding. By this interconnection of the coils the following results are obtained:

1. The ohmic resistances of the two halves of the winding of the interphase transformer are equal. This is necessary to produce equal division of current between them.

2. The sum of the direct-current ampere-turns on each leg is equal to zero, which prevents saturation of the core by the direct current.

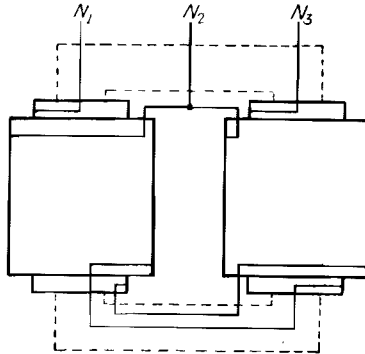

FIG. 82.—Arrangement and connection of coils on the interphase transformers designed for the rectifier transformer shown in Figs. 80 and 81.

**Load Characteristics.**—Below are tabulated the calculations of the load characteristics for the 3,000-kw., 600-volt rectifier unit:

EFFICIENCY				
Percentage of load.....	25	50	75	100
Load current.....	1,250	2,500	3,750	5,000
Arc voltage drop.....	25	23	22.5	23.2
Losses in rectifier, kilowatts.....	31.3	57.5	84.5	116.0
Iron losses in main and interphase transformers, kilowatts.....	16.0	16.0	16.0	16.0
Copper losses in main and interphase transformers, kilowatts.....	1.8	7.1	16.3	28.5
Total losses, kilowatts.....	49.1	80.6	116.8	160.5
Output, kilowatts.....	750	1,500	2,250	3,000
Input, kilowatts.....	799.1	1,580.6	2,366.8	3,160.5
Percent efficiency.....	93.8	94.8	95.0	94.9

#### VOLTAGE REGULATION

Alternating-current voltage of transformer secondary =  $E_s = 554$  volts

Direct-current voltage at transformer secondary at N.L. =  $E_{dc} = 1.35E_s = 748$  volts

Direct-current voltage at transformer secondary at transition load =  $E_{dt} = 1.17E_s = 648$  volts

Total magnetizing current of the two interphase transformers =  $I'_1 = 2 \times 7.9 = 15.8$  amp.

Direct current at transition point, according to Eq. (101) =  $2.28I'_1 = 2.28 \times 15.8 = 36$  amp., which is 0.7 per cent of full-load current.

Transformer reactance =  $X\% = 6$  per cent

Voltage drop at F.L. due to reactance =  $d\% \times E_{dt} = 0.5X\% \times E_{dt} = 0.03 \times 648 = 19.5$  volts

Copper losses =  $W_c = 28,500$  watts

Voltage drop at F.L. due to copper losses =  $\frac{W_c}{I} = \frac{28,500}{5,000} = 5.7$  volts

The voltage drop due to reactance or copper losses, at different loads, is proportional to the load.

Percent load	$E_{do}$	$E_{dt}$	Arc voltage drop	Voltage drop due to reactance	Voltage drop due to Cu loss, $e_c$	Total voltage drop	Net direct-current terminal voltage, $E_{dt}$
0	748	...	27	0	0	27	721
Transition	...	648	27	approx. 0	approx. 0	27	621
25	...	648	25	4.9	1.4	31.3	617
50	...	648	23	9.8	2.9	35.7	612
75	...	648	22.5	14.6	4.3	41.4	607
100	...	648	23.2	19.5	5.7	48.4	600

### CONSTRUCTION OF RECTIFIER TRANSFORMERS

Rectifier transformers are generally of the 3-phase core-type construction. The windings may be made of sectional coils or cylindrical coils. The type of coils used depends on the voltage and the capacity of the transformer, and on the particular practice of the manufacturer.

Due to the high unbalanced currents which flow during a back fire, great care must be taken in the design of the transformer to avoid any unbalanced stresses. The coils and connecting leads should be well braced. The secondary windings and connections should be well insulated to prevent breakdown due to the voltage surges occurring on the secondary side of the transformer.

In Fig. 83 is shown a Brown Boveri transformer for a 3,000-kw., 600-volt rectifier unit. The transformer has a double 6-phase connection with interphase transformer, and is constructed of sectional coils. The coils are held under compression

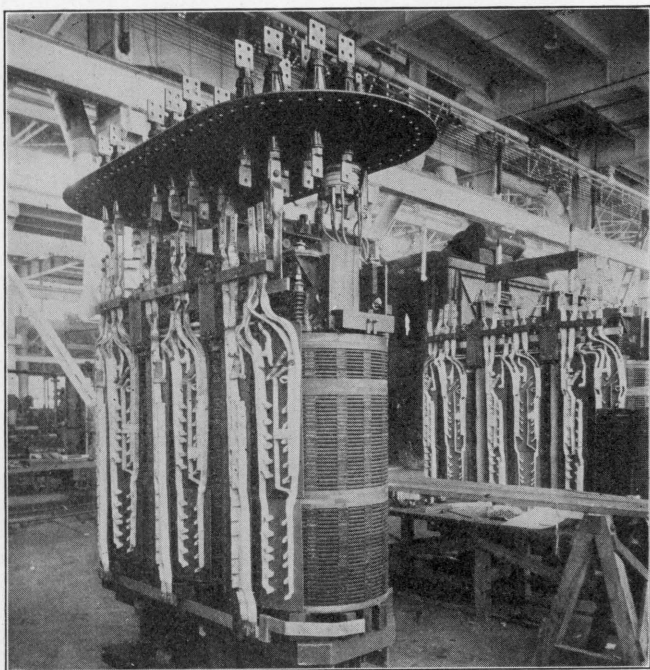

FIG. 83.—Brown Boveri transformer for 3,000-kw., 600-volt, 12-anode rectifier unit. The transformer is shown untanked.

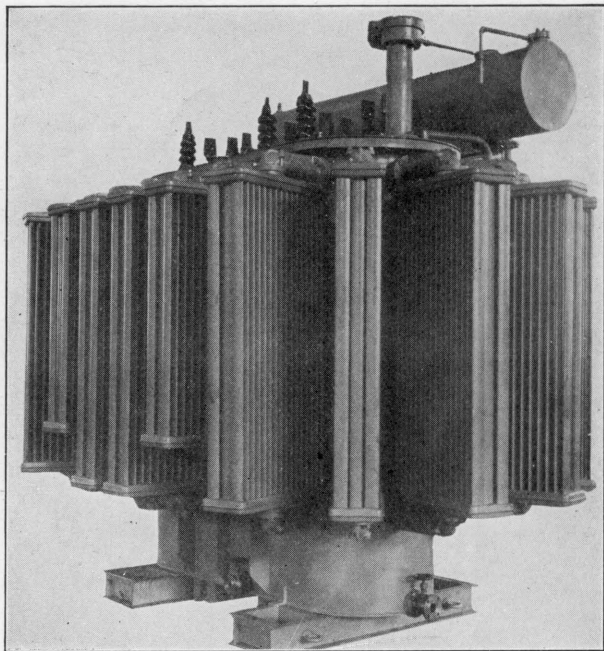

FIG. 84.—Rectifier transformer of Fig. 83 in tank.

by springs bearing against end rings at the top of the coil stacks. An external view of this transformer is shown in Fig. 84.

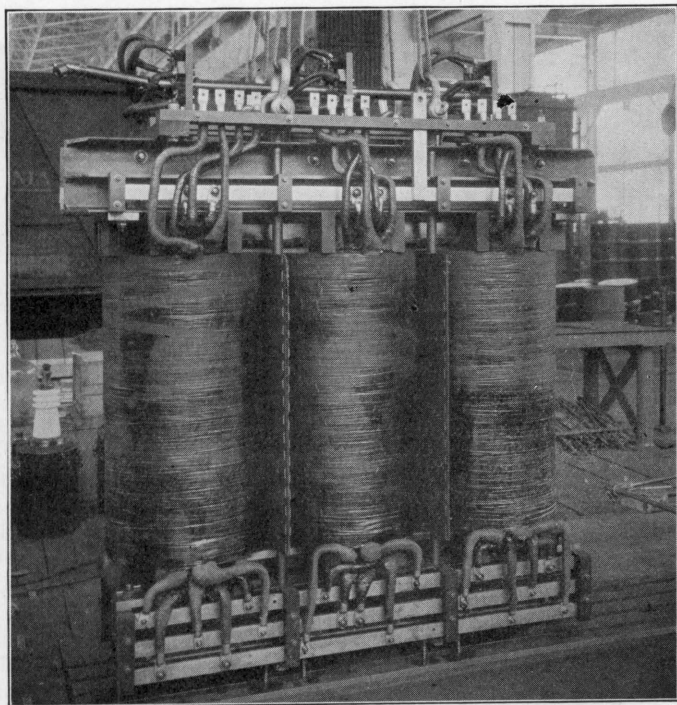

FIG. 85.—Fork-connected rectifier transformer for 1,000-kw., 600-volt, 12-anode rectifier unit.

In Fig. 85 is shown a fork-connected transformer for a 1,000-kw. rectifier. The transformer is constructed of cylindrical windings. A tap changer, operated at no load, is seen at the top of the transformer.

## CHAPTER VII

### DESIGN AND CONSTRUCTION OF MERCURY ARC RECTIFIERS

**General.**—Since this book deals only with the steel-enclosed type of mercury arc rectifiers, the description of the construction will be limited to this type, and only little reference will be made to the glass-bulb type of rectifier.

Before going into details in regard to the design and construction of power rectifiers, the simplest possible arrangement of a rectifier and its auxiliaries will be explained with the aid of Fig. 86. The main transformer is connected, on the primary side, to the alternating-current supply over a circuit breaker, while the ends of the secondary windings terminate at the rectifier anodes. The neutral of the transformer secondary is connected to the negative bus of the direct-current system. The cathode is connected to the positive bus over a direct-current breaker. The auxiliary equipment for starting and maintaining the operation of the rectifier is shown on the right-hand side of the figure, while the power circuit is shown on the left-hand side.

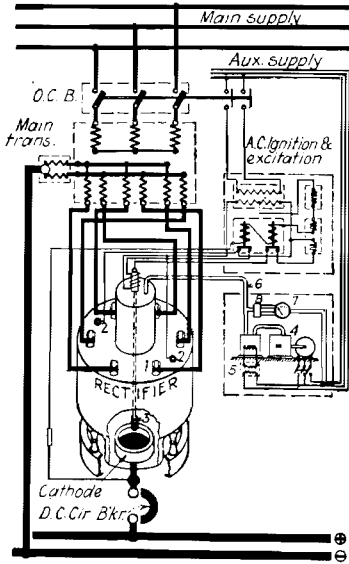

- |                         |                 |
|-------------------------|-----------------|
| 1- Main anodes          | 5-Heating trans |
| 2-Excitation anodes     | 6-Vacuum piping |
| 3-Ignition anode        | 7-Vacuum meter  |
| 4-Two-stage vacuum pump | 8-Vacuum gauge  |

FIG. 86.—Simplified diagram of connections of rectifier unit and auxiliaries.

The rectifier is shown in perspective view with the lower part cut away to show the interior, and the receptacle filled with

The rectifier is shown in perspective view with the lower part cut away to show the interior, and the receptacle filled with

mercury (which constitutes the cathode) at the bottom. From the top of the rectifier a connection 6 is made to a two-stage vacuum pump 4, which is used for maintaining a good vacuum in the cylinder. The vacuum is indicated by a vacuum meter 7, connected to a vacuum gage 8. An ignition and excitation set, consisting of a transformer, resistances, and relays, is used for starting an arc in the rectifier by means of ignition anode 3, and for maintaining an auxiliary arc on excitation anodes 2. The rectifier auxiliaries are operated from an auxiliary alternating-current supply. The operation of the auxiliaries is explained in Chap. VIII. The rectifier is put into operation as follows:

The circuit breaker, when closed, connects the main transformer to the alternating-current supply, and at the same time the auxiliary switch connecting the ignition and excitation transformer to the auxiliary power supply is closed. This auxiliary circuit will ignite and excite the rectifier, and will put it into such a condition that if there is any load demand on the direct-current side the main anodes will supply the necessary current.

The phenomena which take place in a rectifier cylinder during operation were fully described in Chaps. II and III. In this chapter will be described only the practical construction of various makes of rectifiers.

### RECTIFIER CYLINDERS

**Rectifier Design.**—The design of rectifiers is still largely empirical. As in the case of other devices, the aim of the designer is to produce a machine of simple and economical construction that is reliable in operation and efficient. On account of the great influence of certain details on the operation and characteristics of a rectifier, the design and construction of a successful cylinder require a background of considerable research and development work, and of long experience in the manufacture and operation of rectifiers. At the present time, the limiting factor in the rating of rectifiers is the occurrence of back fires, and the efforts of designers are directed mainly toward eliminating back fires at the loads and under the operating conditions to which the rectifier is subjected.

Unlike other types of electrical apparatus, the same rectifier cylinder can be used over a wide range of direct-current voltages



and for any frequency used in alternating-current power circuits. For this reason, a manufacturer of rectifiers can standardize on a limited number of sizes to cover the entire field of application, and he can manufacture them for stock, in quantities.

A rectifier consists of a vacuum-tight tank and of a cathode and anodes which are insulated from it. In addition to these basic parts, a rectifier is provided with devices for starting and maintaining the rectifying arc, with various shields and baffles for controlling the mercury vapor, and with means for cooling and regulating the temperature of the tank and anodes. In the design of rectifiers the following points must be considered:

The rectifier tank should be so constructed that it can readily be opened for inspection or repairs. The materials used inside the rectifier should be able to withstand the temperatures to which they are subjected and should not give off any gases. All the joints must be made vacuum tight. The seals should be of a type that will remain tight under variations of temperature. The anodes and cathode must be so spaced that no flash-overs will occur between them within the operating range of voltages and pressures. The anodes must be shielded from the mercury vapor coming from the cathode. The mercury vapor should be directed toward the cool walls of the tank, where it may condense. The condensed mercury should be guided to the cathode and should be filtered before entering the cathode receptacle. The cooling system of the rectifier should be so designed that the mercury may readily condense and the tank temperature and pressure may be kept below the point at which back fires may occur. The anodes should be cooled to conduct away the anode losses and prevent the formation of hot spots on their surfaces.

A general idea of the design and construction of rectifier cylinders can be gained from the photographs and cross-sections of the various types shown in Figs. 87 to 99, inclusive. Figure 87 shows a cross-section of a rectifier of the Brown Boveri type, with an air-cooled anode on the left-hand side, and a water-cooled anode on the right. In Fig. 88 is shown a 12-anode rectifier of this type with water-cooled anodes and a vacuum pump. The nominal rating of this cylinder is 3,000 kw. at 600 volts, with water-cooled anodes as shown, and 3,500 kw. at 1,500 volts with air-cooled anodes. Figure 89 is a picture of another Brown Boveri rectifier, having a nominal rating of 4,000 kw. at 600 volts, direct-current.

Figure 90 shows a cross-section of a 6-anode, General Electric rectifier cylinder, of a nominal rating of 500 kw. at 600 volts,

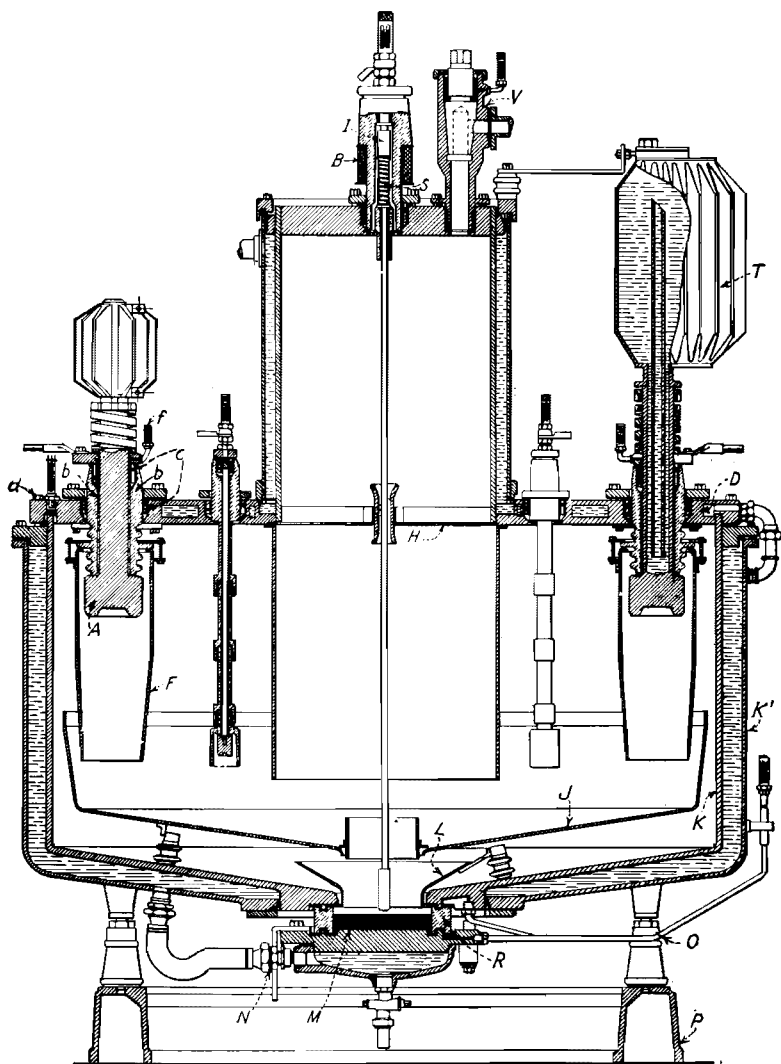

FIG. 87.—Cross-section of a Brown Boveri rectifier, showing water-cooled and air-cooled anodes.

or 750 kw. at 1,500 volts. A photograph of this cylinder is given in Fig. 91. Figure 92 shows a larger rectifier, with 12 anodes, rated at 1,000 kw., 600 volts. A rectifier of similar construc-

tion, and of the same capacity, but with graphite anodes, which are insulated and sealed with mycalex,<sup>1</sup> is shown in Fig. 93. The construction of these anodes is shown in Fig. 106.

In Fig. 94 is shown a view of an Allgemeine Elektrizitaets Gesellschaft rectifier cylinder, while Fig. 95 is a detailed section of the ignition arrangement. The excitation anodes are not shown in Fig. 94; they are usually similar to those shown in Fig. 87, but are nearer the cathode. They are made of graphite and are housed in protecting metal tubes. Figure 96 is a cross-section of a Siemens-Schuckert rectifier, with a built-on vacuum pump, while Fig. 97 is a detailed section of the ignition arrangement. Figure 98 is a cross-section of a Westinghouse cylinder, and Fig. 99 a cross-section of a Bergmann rectifier.

The cross-sections of rectifier cylinders shown in these illustrations indicate that there are differences in design between the different makes which are greater than in the case of other types of converting apparatus. The rectifiers shown differ in the shapes of their tanks, the arrangements of their condensing chambers, the cooling of the tanks, the anode plates, the cathodes, the anodes and their seals and insulation, as well as in respect to the material of the latter, etc. The various seals and methods of insulation of the anodes and the cathode are described later on in this chapter.

**Cooling of Tank.**—It is necessary to provide cooling means to conduct away the heat losses from the tank, the cathode, and the anodes, in order to prevent excessive heating which might be injurious to the seals and insulators and which might also result in too high a mercury vapor pressure in the tank. Besides, the vicinity of the anodes has to be kept below a certain temperature, as otherwise the valve action may be destroyed. The tank *K* is placed inside a water jacket *K'*, through which the cooling water is circulated (see Figs. 87, 90, 94, 96, and 100). The rectifier is usually supported on insulating feet, which are attached to the cooling jacket. A water jacket is also provided for the cathode; the water enters below the cathode plate *M*, and is led into the cylinder water jacket through a rubber hose connected at *N*. The purpose of this hose, indicated in Figs. 87 and 100, is to insulate the cathode from the cylinder. (See Chap. III, Fig. 18.) In a system with the negative pole grounded, the

<sup>1</sup>See W. W. Brown, "Mycalex—A Machinable Insulation," *American Machinist*, Dec. 12, 1929.

water connection to the cathode plate must also be made through an insulating rubber hose. This hose, *i.e.*, the water column which it contains, must be of appreciable length in order to have a high resistance, as the voltage to ground is equal to the direct-current terminal voltage of the rectifier and because the leakage current from the cathode to ground must be kept down to a few milliamperes in order to prevent electrolytic corrosion. For a

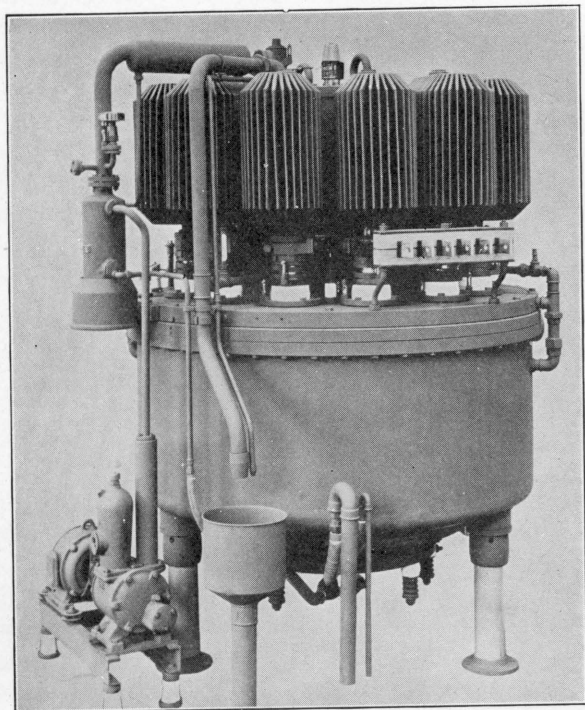

FIG. 88.—Brown Boveri 12-anode rectifier, of a nominal rating of 3,000 kw. at 600 volts.

600-volt installation the rubber hose is usually from 10 to 15 ft. long. The length of this rubber hose is determined by the ohmic resistance of the water column, and is therefore a function of the diameter—*i.e.*, of the amount of water—as well as of its chemical composition. It can be seen that for a 3,000-volt installation with a grounded negative terminal this rubber hose would have to be of considerable length, and for this reason, as well as for reasons of general safety, installations for voltages

above 1,500 volts are equipped with recirculating cooling sets which are completely insulated from ground (see Chap. VIII).

After passing through the water jacket of the cathode, the water flows around the cylinder, and through the hollow cover, or anode plate, thus cooling the whole rectifier and dissipating the heat liberated by the condensation of the mercury on the anode plate. Figures concerning the actual quantities of

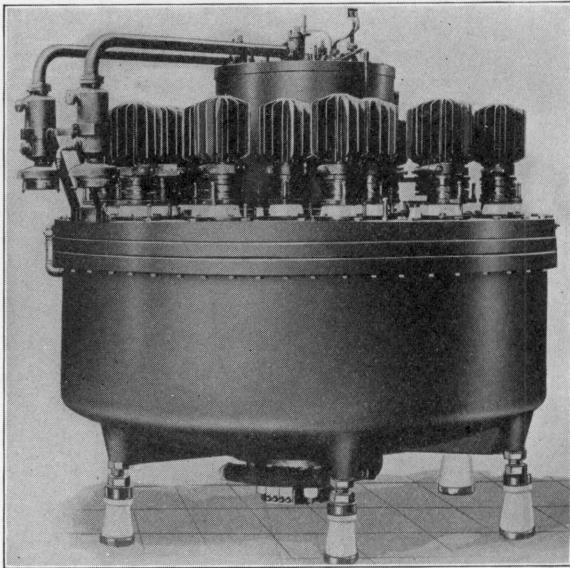

FIG. 89.—Brown Boveri 24-anode rectifier, with air-cooled anodes, of a nominal rating of 4,000 kw. at 600 volts.

water required for cooling are given in Chap. VIII, in the section on Cooling Apparatus. There are two to four water inlets from the water jacket to the cover plate. From there, the water circulates around the condensing dome, and is finally led off, either to a drain, or to the recirculating forced-draft cooling system to be cooled and used over again.

In order to remove the vacuum tank from the water jacket, it is necessary, in the design shown in Fig. 87, merely to unscrew a few bolts holding the tank to the walls of the water jacket. The rectifier can then be lifted out of the jacket by means of the hooks provided on the top of the condensing dome.

In order to make the cooling of the cylinder as effective as possible, and also to improve the flow of the mercury vapor inside the rectifier tank, some of the cylinders are fitted inside with water-cooling cylinders *W*, or with cooling pipes *W*, as shown in Figs. 96 and 98, for instance. The rectifiers that have no such special cooling means, and no condensing domes, have a very efficient cooling of the anode plate of the rectifier tank.

**Rectifying Cylinder.**—The cylinder or tank in which the rectifying action takes place and which holds the vacuum is the important part of the rectifier. This tank contains the anodes and the cathode and all other important working parts constituting the rectifier. The form of the tank and its size for a given capacity vary for each manufacturer. The diameter depends on the number and size of the anodes, and on their arrangement; it is given below for a number of cylinders of different ratings:

Rating of 600-volt Rectifier, Kilowatts	Diameter of Tank, Feet
500	3 to 4
1,000	4 to 5
2,000	5 to 6
3,000	6 to 7
4,500	8 to 9
6,500	9 to 10

The distance from the anodes to the center of the cathode in a 500-kw. unit varies between 25 and 35 in.; in a 2,000-kw. unit it lies between 35 and 45 in. The height of the tank is from 2 to 4 ft., depending on a number of factors, such as the use of a condensing dome, the type of cooling employed, etc. The current-carrying capacity of a tank at a given voltage depends not only on the size of the tank but also on the method of cooling the tank and the anodes, as well as on the shape and size of the latter. The tank itself generally is made of rolled steel, and its inner surface is sand-blasted and thoroughly cleaned.

The tanks *K* of some types of rectifiers are spun into their final shapes, while other types have the bottom plates welded to the cylindrical tanks. The welding on the cylinders has to be done carefully. Some manufacturers anneal the tanks after welding. The surface of the tank exposed to water should be painted in order to avoid corrosion, particularly if the negative pole of the direct-current system is grounded.

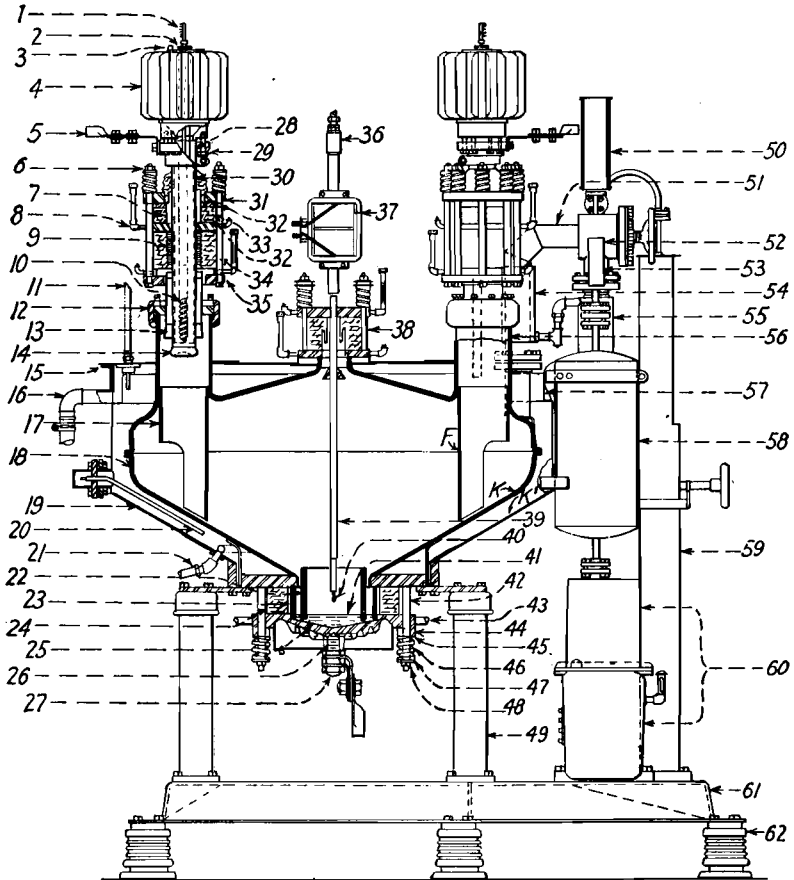

FIG. 90.—Cross-section of General Electric 6-anode rectifier.

- |  |  |  |
|--|--|--|
| 1. Anode heater terminal.                          | 24. Cathode porcelain insulator.                 | 44. Large insulating washer.               |
| 2. Anode heater gland.                             | 25. Quartz ring holding clips.                   | 45. Large steel washer.                    |
| 3. Anode cooler plug.                              | 26. Cathode.                                     | 46. Clamping spring, cathode.              |
| 4. Anode cooler.                                   | 27. Cathode connection.                          | 47. Small steel washer, cathode.           |
| 5. Anode connection.                               | 28. Anode cooler gasket.                         | 48. Clamping nut, cathode.                 |
| 6. Insulator bolt.                                 | 29. Anode cooler clamping nut.                   | 49. Tank-supporting legs.                  |
| 7. Upper mica anode insulating tube.               | 30. Porcelain dirt shield.                       | 50. Vacuum gage.                           |
| 8. Mercury seals with header gages.                | 31. Upper anode clamping flange.                 | 51. Exhaust line.                          |
| 9. Anode insulator.                                | 32. Asbestos washers.                            | 52. Exhaust line vacuum valve.             |
| 10. Anode heater with heater protecting tube.      | 33. Upper porcelain anode insulator.             | 53. Mercury trap.                          |
| 11. Cover thermometer.                             | 34. Fiber tube anode bolt insulator.             | 54. Exhaust line water jacket.             |
| 12. Anode clamp ring.                              | 35. Lower anode clamping flange.                 | 55. Mercury condensation high vacuum pump. |
| 13. Anode shroud.                                  | 36. Starting anode.                              | 56. Anode tank neck.                       |
| 14. Anode.   | 37. Starting anode solenoid.                     | 57. Water over-flow trough.                |
| 15. Rectifier cover.                               | 38. Starting anode insulator.                    | 58. Gas receiving tank.                    |
| 16. Jacket water outlet.                           | 39. Starting anode housing.                      | 59. McLeod gage.                           |
| 17. Anode shield.                                  | 40. Starting anode plunger.                      | 60. Rotary vacuum pump.                    |
| 18. Vacuum tank.                                   | 41. Cathode mercury.                             | 61. Rectifier base.                        |
| 19. Rectifier water jacket.                        | 42. Fiber tube cathode bolt insulator.           | 62. Rectifier base insulators.             |
| 20. Jacket heaters (used in automatic substation). | 43. Nipple on cooling water connection, cathode. | 63. Rubber hose (Fig. 91).                 |
| 21. Jacket water inlet.                            |  | 64. Rectifier insulators (Fig. 91).        |
| 22. Inner quartz cathode ring.                     |  |  |
| 23. Outer quartz cathode ring.                     |  |  |

In addition to the main anodes, of which there may be 6, 12, 18 or 24, the cylinder cover carries, in some makes, excitation anodes, as shown in Figs. 87 and 99. As can be seen from the various cross-sections, some of the rectifiers are so constructed, that their anode plates, with the anodes (see for instance Fig.

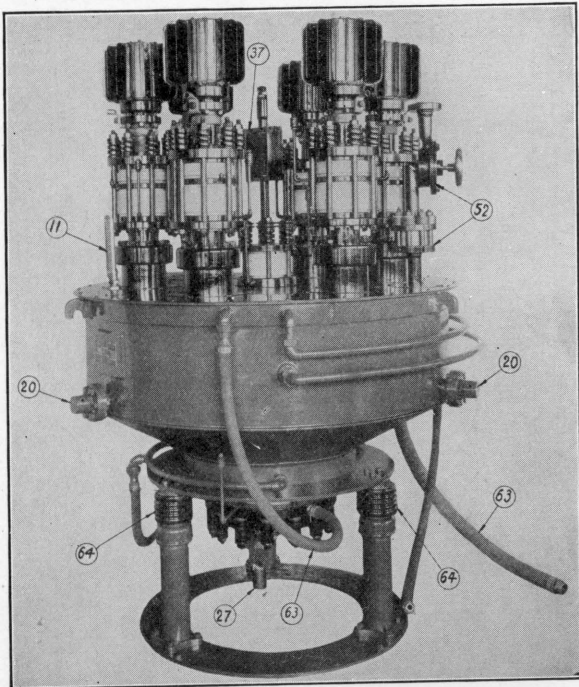

FIG. 91.—General Electric 6-anode rectifier, of a nominal rating of 500 kw. at 600 volts. Nomenclature for numbers same as in Fig. 90.

87, the Brown Boveri rectifier), can be removed by loosening a few bolts. It can also be seen that some of the rectifiers can be removed from their water jackets. This type of construction makes it possible to inspect the interior of the rectifier in case of trouble, and to examine the outside of the tank, which is exposed to water and should therefore be cleaned and repainted at intervals of one or two years.

In all these rectifiers the anodes are sealed into the cover or upper part of the tank, and the sealing against vacuum, which is an essential part of the construction, is effected by seals of various types, to be described later.



Although the mercury arc rectifier is past the development stage, the construction of the vacuum tank in connection with the anode arrangement, etc. of the various makes differs widely, as has been noted before. At the present writing considerable research is being carried on by the various manufacturers for the purpose of improving the efficiency and operating character-

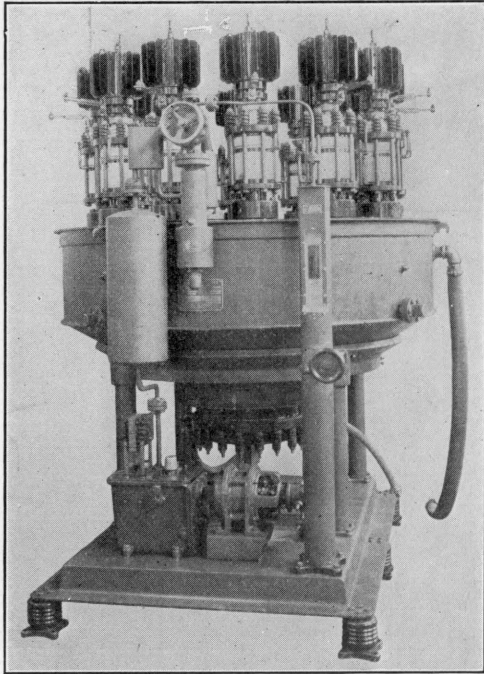

FIG. 92.—General Electric 12-anode rectifier, rated at 1000 kw., 600 volts.

istics of their rectifiers; the result of this work may be that the manufacturers will finally arrive at a still more advantageous form of the vacuum tank and the anodes. Figures 87 to 99 illustrate the various designs now in use. Considerable effort has been directed to the elimination of back fires, which are, in effect, short circuits between anodes. The phenomena of back-backs are fully described in Chaps. II and III, and their effect on the operation of the rectifier is given in Chaps. XI and XIV.

**Means for Controlling the Mercury Vapor and the Arc.**—For this purpose one type of rectifier has sheet-metal funnels mounted on the bottom, others have quartz cylinders, etc., while all of

them have sheet-metal shields *F* around the anodes. These shields are usually cylindrical and are insulated from the tanks proper. Some of the first rectifiers built had shields made of porcelain or other insulating materials.

Mercury is evaporated from the cathode, during the operation of the rectifier, at a rate of about 5 to 10 g. per second, per 1,000

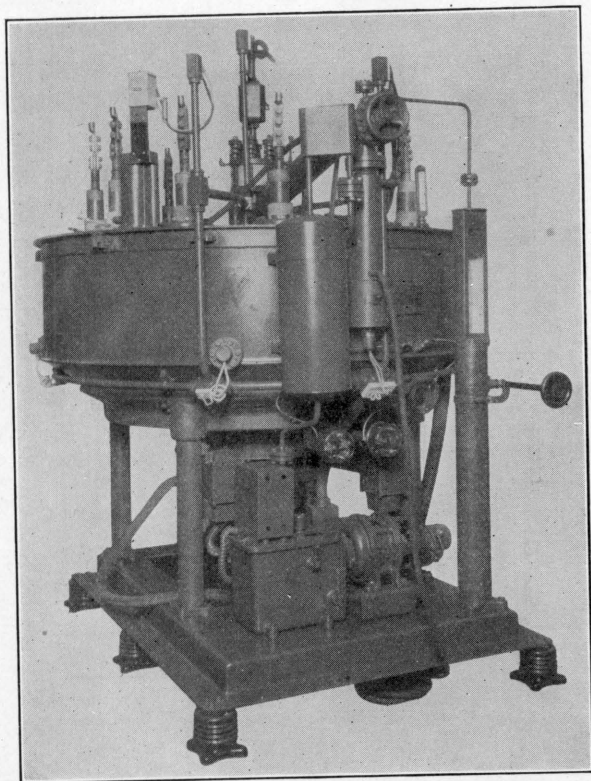

FIG. 93.—General Electric 12-anode rectifier, provided with Mycalex anode seals.

amp., which is considerably in excess of the amount actually necessary for conducting the current. In the high degree of vacuum ordinarily existing in a rectifier cylinder, this vapor travels at a very high rate of speed, approximately 20,000 cm. per second. It can thus be seen that the interior of a rectifier is filled with turbulent mercury vapor. If this vapor enters the space around the anodes, mercury may condense on the surface

of the anodes, and this condensed mercury may be the cause of an arc-back or back fire. Furthermore, the accumulation of vapor in the path of the arc increases the pressure and conse-

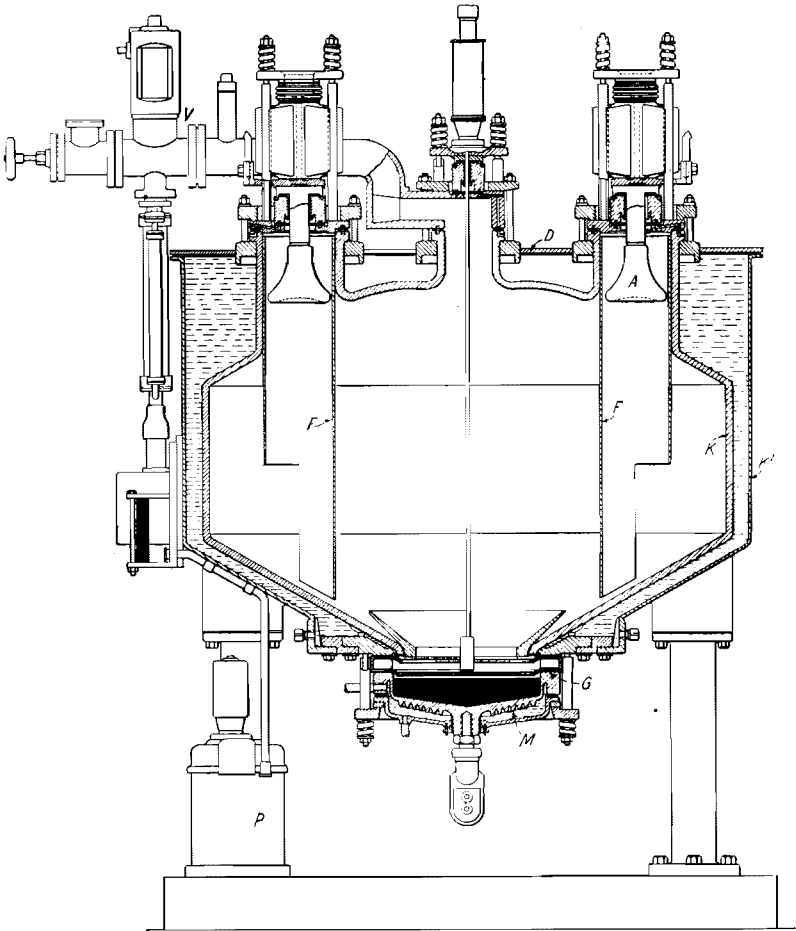

FIG. 94.—Cross-section of a rectifier of the Allgemeine Elektrizitaets Gesellschaft (Germany).

quently the voltage drop and the losses; it also reduces the breakdown voltage between the cathode and the anodes.

These facts were already realized by the builders of glass rectifiers, who put the anodes into narrow glass arms bent at an angle, thus protecting the anodes from a too direct influence of

the mercury vapor. The same principle is applied to some extent in the construction of the metal-tank rectifiers, by using funnels and anode shields. Some of these shields even have

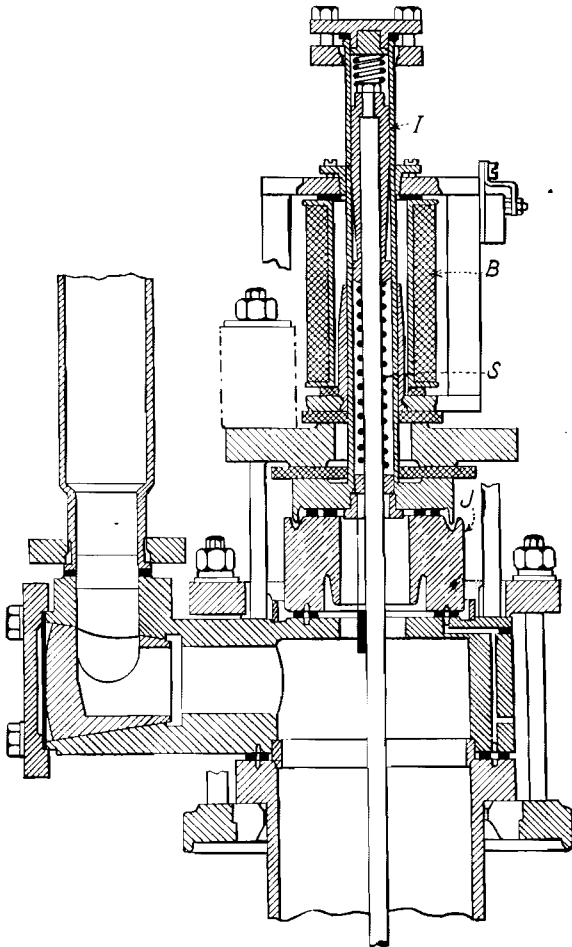

FIG. 95.--Ignition apparatus of the rectifier shown in Fig. 94.

baffles or other means of preventing the mercury vapor from having direct access to the anodes.

Means also have to be provided for leading the condensed mercury back into the cathode pool in such a way that the mercury does not interfere with the operation of the rectifier.

Should mercury accumulate in too large quantities while flowing down to the mercury pool, cathode spots might be produced in those locations outside the cathode receptacle.

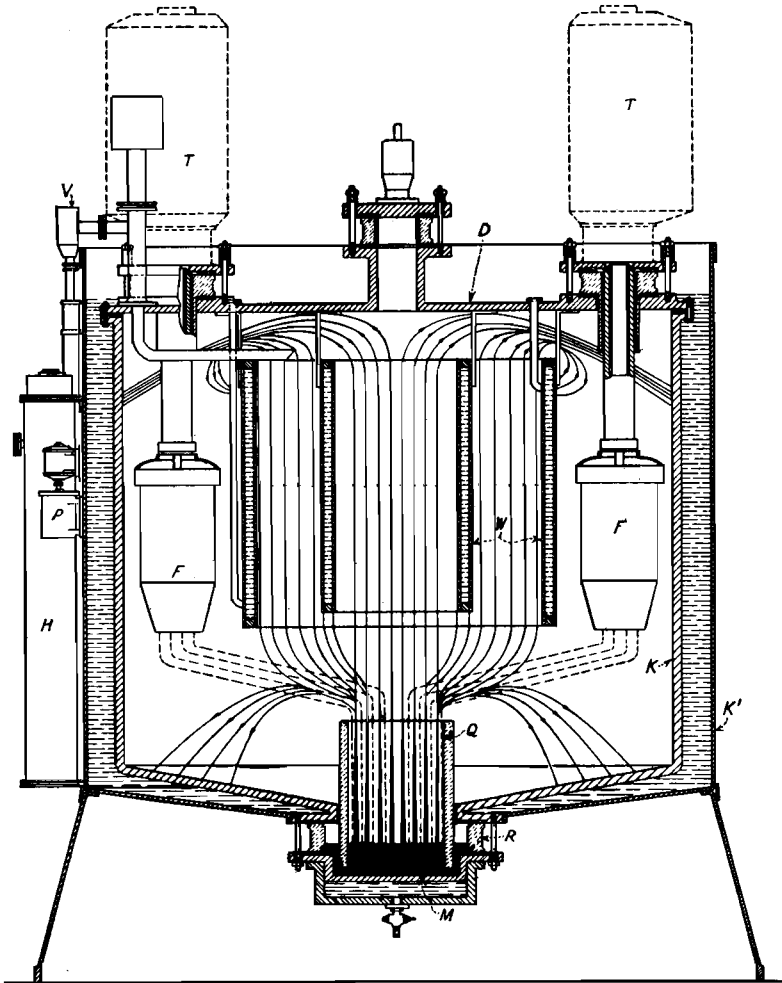

FIG. 96.—Cross-section of a Siemens-Schuckert (Germany) rectifier.

Means are also provided for preventing too much mercury from being evaporated from the cathode. This is accomplished by cooling the mercury of the cathode, or by sectionalizing the cathode by means of a metal mesh or a metal ring. It is claimed

by some manufacturers that the restriction of the movement of the cathode spot results in a lower voltage drop and in easier ignition. A filter is usually located above the cathode which prevents impurities that might be loosened from the cylinder walls from flowing into the cathode pool. The level of the mercury in the cathode has practically no influence on the rate of evaporation.

In Fig. 96, the path of the mercury vapor is indicated by arrows, and that of the arc by dotted lines. The vapor is directed away from the cathode, by means of quartz cylinder *Q*, towards the cylindrical coolers *W*. Enough space is left between the anode plate and these coolers so that the vapor can continue on its path to the walls of the tank. It may be pointed out that in these rectifiers the main anodes are inserted quite deep into the cylinders, the upper part of the cylinders being used as a condensing space, without the addition of a separate dome or cylindrical part for the purpose.

**Cathode.**—The cathode is formed by a receptacle filled with mercury located in the bottom of the rectifier cylinder. The minimum amount of mercury necessary for the cathode can theoretically be determined from the rates at which the mercury evaporates and condenses at maximum load. The amount of mercury remaining in the cathode must be sufficient to permit reliable operation of the ignition device.

In all the rectifier cylinders shown the cathode is insulated from the tank. The reason for doing this is explained in Chap. III, and it is effected by an insulator *R* between the tank and the cathode plate *M*, which contains the mercury forming the cathode. This insulating ring is usually made of porcelain, and is sealed to the cathode plate on the lower side, and to the bottom of the tank at its upper edge, in the manner indicated. Although the voltage difference between tank and cathode is only 5 to 25 volts, at full load, care must be taken in the arrangement of the cathode insulation. The reason is that the condensed mercury must be led back to the cathode without bridging the insulator; otherwise, the rectifying arc might travel upwards, along the mercury which is flowing down, and might come to rest on the walls of the tank and in doing so might cause the insulator ring to break, as well as injure the rectifier. In order to prevent the occurrence of such troubles, some manufacturers insert quartz cylinders *Q* into the rectifier, as can be seen in

Figs. 90, 96, and 98. In Fig. 94 no insulating ring is provided, and the sealing is effected by means of rubber rings *G* between the cathode plate and the tank bottom. These rings are so arranged that a large creeping distance is obtained between the tank and the cathode plate. The cathode plate is pressed against the insulating ring by means of springs and insulated bolts, as shown in Figs. 88 and 90.

In Fig. 99 is shown an arrangement of the cathode which is somewhat different from those used in all other rectifiers. The connection to the cathode is made by means of an insulated bar, which passes through the anode plate and is bolted at its lower end to a metal plate immersed in the mercury of the cathode.

The pool of mercury in the cathode is only a few centimeters deep, and varies in area between 100 and 1,000 sq. cm. The size of the cathode varies with the volume of the cylinder, and also with the efficiency of the condensing and cooling arrangements. The amount of mercury used varies with the different makes: Brown Boveri uses about 2 to 3 lb. per 100 amp.; General Electric uses about 5 to 10 lb. per 100 amp.

In the General Electric design of rectifiers, shown in Figs. 90, 91, 92, and 93, the diameter of the cathode is determined primarily by the fact that its opening is used as a manhole for inspection and repair.

**Main Anodes.**—The anodes *A* are arranged in a circle—on the cylinder cover, or anode plate *D*, from which they are insulated. In rectifiers of large capacity with a large number of anodes, the latter are sometimes placed in two circles and are so arranged that the arc length is the same for all the anodes.

Two types of anodes are now in use: steel anodes and graphite anodes. The shape of the anodes differs for the various types of rectifiers. The anode consists, in general, of an anode head and a shaft. In some rectifiers the anode shaft is hollow for the purpose of cooling or heating the anodes (see Figs. 87 and 90). The lower surface of the steel anodes, as shown, for example, in Fig. 87, is concave, in order to distribute the arc more uniformly over the surface and to prevent the formation of hot spots. Some types of anodes have corrugated surfaces. The entire surface of the steel anodes must be clean and highly polished. The anodes are made of special steel, which must be free of impurities. The graphite anode shown in Fig. 106 has a fluted

surface and is fastened to a threaded shaft. The binder for the graphite must be of such a quality that the anode will not disintegrate under the action of the arc. The temperature of the anode surface, at normal load, is approximately  $600^{\circ}\text{C}$ ., which is dull-red heat. At this temperature the anodes will give off metal and carbon vapors. The surface of the anodes facing toward the cathode is usually of such size that the specific current density of the anode is between 5 and 10 amp. per square centimeter of projected area.

The anodes are surrounded by metal shields *F*. In some types of rectifiers the shields are supported from the anode insulators; in other types they are supported from the tank cover. The main function of the anode shields is to protect the anodes from the mercury-vapor stream. The length, the shape, and the size of the opening of the shields exert a great influence on the operation of the rectifier. Larger shields will produce a smaller arc drop, but will admit more mercury vapor; the size used is determined by a compromise between these two factors.

A recent development in connection with steel-enclosed rectifiers was the introduction of anode screens, or grids, into the arc path within the shields. This addition has improved the operating characteristics of rectifiers and has aided in the development of large-capacity rectifiers. The action of these anode screens was discussed in Chap. III.

Several types of screens have been developed, some consisting of concentric cylinders, others of radial plates. In Fig. 101 are shown two designs of screens. In some rectifiers the screens are insulated from the shields and are energized from a source of

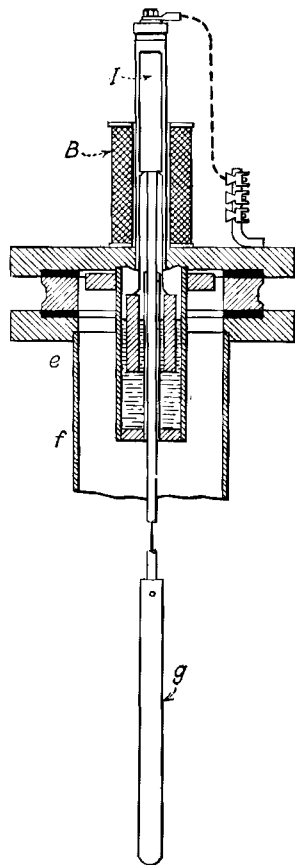

FIG. 97.—Ignition apparatus of the rectifier shown in Fig. 96.



potential. In one design, a close-meshed grid is placed close to the anode surface and is insulated from the shield, while an uninsulated screen is mounted in the shield at some distance from the anode (431).

The anodes are insulated from the tank cover by means of insulating bushings. The insulating material must be dense

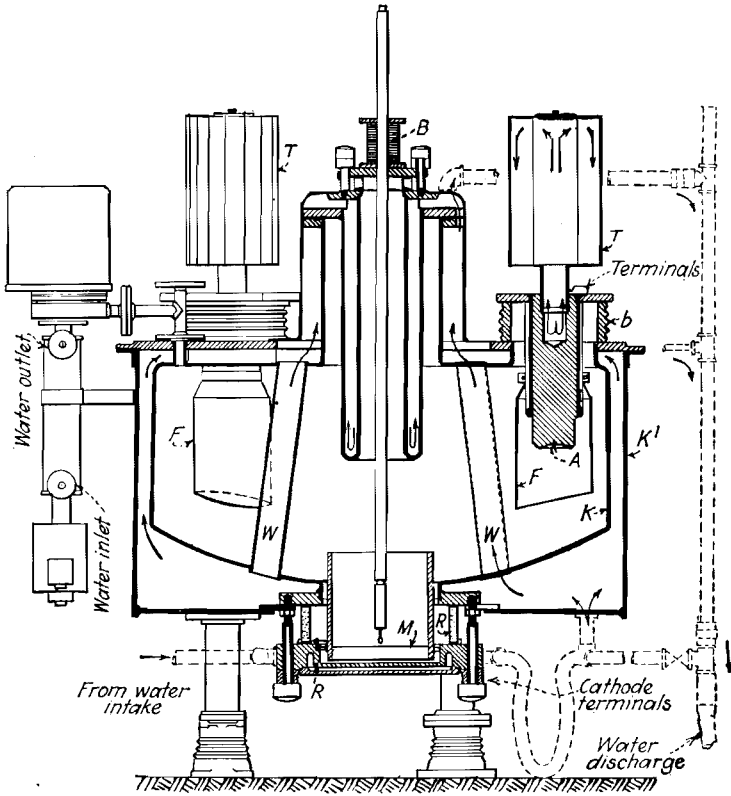

FIG. 98.—Cross-section of a Westinghouse rectifier.

and vacuum tight, and must be able to withstand the high temperatures of the rectifier. The insulating bushings must also be strong mechanically to withstand the shocks during transportation and erection, as well as the stresses caused by expansion and contraction due to temperature variations. The insulators are made of porcelain or some similar insulating material which has the requisite properties. The joints between

the anodes and bushings and between the bushings and the tank cover must be made vacuum tight by means of seals. The various types of seals used are described later. The anode shown in Fig. 106 is insulated by means of Mycalex, which also acts as the sealing medium.

The assembly of the anode and insulator must be of such design that the contraction and expansion of the metal parts will not impose mechanical stresses on the insulator, and will not affect the seals. This end is generally accomplished by means of springs which maintain a constant pressure between the component parts, as is illustrated in Figs. 87, 90, and 94.

The losses at the anodes were considered in Chap. II. The heat produced by these losses is dissipated partly by radiation from the anode surface and partly by conduction through the anode shaft. Some rectifiers are so designed that the greater part of the anode losses are conducted away by the shaft. To accomplish this, the anode shaft is provided with a radiator which may have corrugations or fins. Two types of radiators are shown on the rectifier in Fig. 87. The larger radiator, shown at the right of the figure, is filled with water, the water being circulated on the thermo-siphon principle. The smaller radiator, shown at the left of the figure, has no water, and the heat is transmitted from the anode to the radiator through the metal of the anode shaft. The anodes provided with water-filled radiators have an appreciably higher current capacity than the anodes with the smaller type of radiator. In the anode design shown in Fig. 106, the outside of the anode housing is provided with cooling fins. The heat radiated from the anode is transmitted through the walls of the housing to the fins, which are cooled by the water circulating through the water jacket of the rectifier cylinder.

**Anode Heaters.**—In some designs of rectifiers the anodes are hollow, and are filled with mercury into which electric heaters are inserted. The anodes of the cylinders shown in Figs. 90, 91, and 92, for instance, are thus equipped with heaters immersed in mercury inside the anode shaft.

In Fig. 106 the anode heater is placed around the anode shaft assembly, outside the tank. The heater is covered by an insulating cap through which the terminal lead of the heater is brought out. In another rectifier design, of the same make, the heaters are placed in the cooling jacket near the anodes.

These heaters are used to keep the anodes warm at all times, *i.e.*, to heat the anodes during periods of light or no loads, so as to prevent mercury from condensing on the anode surfaces, which is considered one of the causes of back fires. The manufacturers

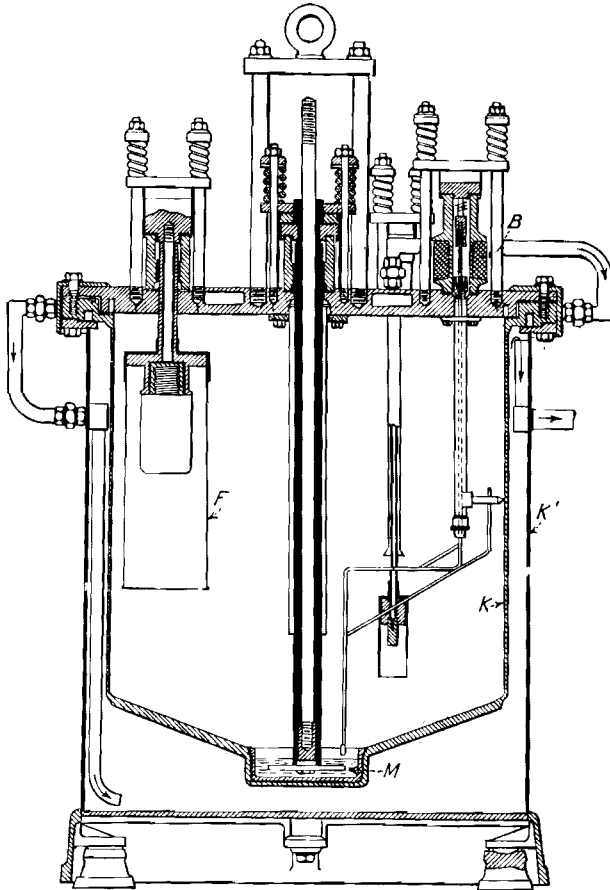

FIG. 99.—Cross-section of a Bergmann (Germany) rectifier.

also state that these heaters must be in operation while the rectifier is being baked out.

**Ignition and Excitation Anodes.**—All the rectifiers considered in this chapter are provided with ignition anodes for starting the arc at the surface of the cathode. In some types of rectifiers the ignition anode is also used for maintaining an auxiliary, or

excitation, arc in the rectifier. In other types, separate auxiliary anodes are used for maintaining the excitation arc. The arrangement and connection of the two types of ignition and excitation systems are shown in Fig. 133 and will be described later. The ignition and excitation anodes are connected to a supply of low voltage through a small auxiliary load.

The construction and arrangement of the excitation anodes are illustrated in Figs. 87 and 99. Being of low current capacity and low voltage, these anodes are smaller than the main anodes and

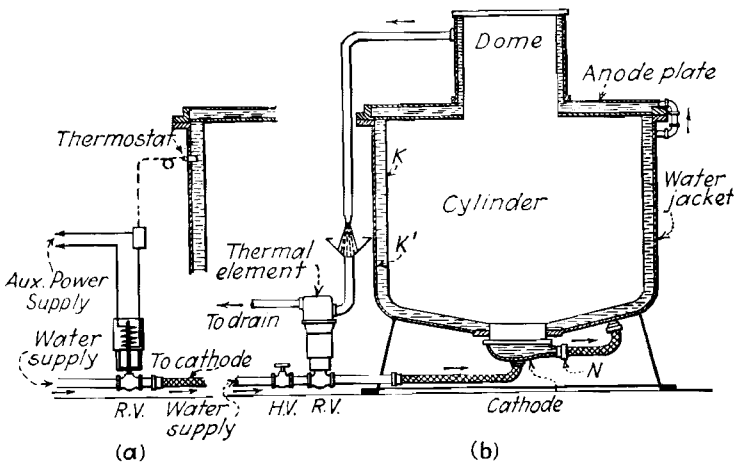

FIG. 100. Cooling system of a rectifier.

are located closer to the cathode. The excitation anodes and their shafts are shielded by metal or porcelain shields. The shafts are brought through the tank cover and are insulated from it by means of insulating bushings like the main anodes.

The ignition anode is usually made of heat-resistive material, such as tungsten or molybdenum, and is located at a short distance from the cathode surface. The construction and operation of the mechanism operating the ignition anode is as follows:

The ignition anode is connected by a rod to a plunger *I*, operated by a solenoid *B*, which is mounted on the top of the condensing dome, or on top of the tank. The length of this rod is adjustable by means of a link. The plunger *I* is normally kept in the upper position shown in Figs. 87, 95, and 97; in Figs. 87 and 95, by the spring *S*, or by the buoyancy of the cylinder *e* in the mercury (Fig. 97). In the construction illustrated in

Fig. 87, the ignition coil *B* is mounted on a porcelain insulator, which is sealed from the cover of the dome by a mercury seal.

Still another way of igniting the rectifier is to use a stationary ignition anode, and have the mercury of the cathode, or a small portion of it, brought into contact with the ignition anode. This can be accomplished in the following way: In Fig. 102, *P* is the bottom plate of the cathode, *A* is the ignition anode, and *M* is the mercury which constitutes the cathode. *N* is the upper end of U-shaped tube *D*, filled with mercury, and *F* is a magnetic

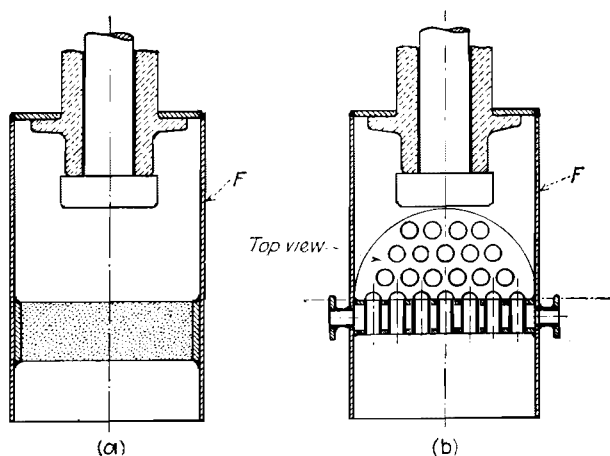

FIG. 101.—Two designs of screens mounted in the anode shield of a rectifier.

float in the other end of the tube, which is expanded into a displacement chamber. This float *F* is subject to the magnetic action of the coil *C*. To ignite the rectifier it is necessary only to send current through the coil; the float is pulled down, forcing mercury through the nozzle *N* and up against the ignition anode *A*, closing the ignition circuit temporarily. When the mercury falls back, an arc is formed and the rectifier is started; the float returns to its original position, and the rectifier ignition system is ready for another operation.

In reference 361 is described another scheme for starting a mercury arc rectifier. It consists essentially of a small bimetallic strip immersed at an angle into the mercury cathode, in such a way that when current passes through it the unequal expansion of the metals bends the strip so that the end is lifted out of the mercury, thus breaking the circuit, starting a small

arc, and thereby igniting the rectifier. A glass tube, movable with the bimetallic strip, may be affixed over it to prevent condensation of mercury on the strip and consequent jumping of the main arc over to it, which would melt it down in short order. This scheme is illustrated in Fig. 2 of the reference mentioned.

**Exhaust Connections and Apparatus.**—The connection from the vacuum pump to the cylinder is usually made from the highest point in the cylinder. For instance, in Fig. 87 it is made from the top of the dome, and is controlled by a manually operated valve *V*. In Fig. 96, it is brought to the top of the cooling cylinders *W*, and is controlled by the valve *V*. In some rectifiers

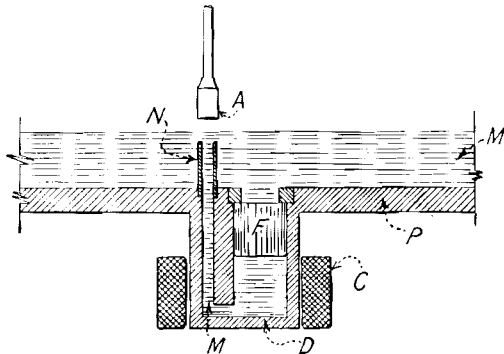

FIG. 102.—An ignition arrangement using a stationary ignition anode.

the valve is remote controlled by means of gears and shafts connected to a handwheel. In the rectifiers illustrated in Figs. 94 and 96, the vacuum pumps, namely, the roughing pump *P*, driven by a vertical motor, and the mercury vapor pump *H*, are attached directly to the water jacket, in this way making possible a short connection from the pump to the control valve *V*. Another advantage of such an arrangement lies in the fact that no erection work has to be done on site in connection with the vacuum pump, since the whole unit can be assembled in the factory before shipment.

### SEALS

As already pointed out, one condition of satisfactory operation of mercury arc rectifiers is the maintenance of a good vacuum in the cylinder, of the order of magnitude of 1/100 to 1/1,000 mm. mercury column, which is almost 1/1,000,000 of the pressure of

the atmosphere. In the case of glass rectifiers the problem is simpler because no insulating medium has to be introduced between the anode shafts and the glass bulb, the latter being in

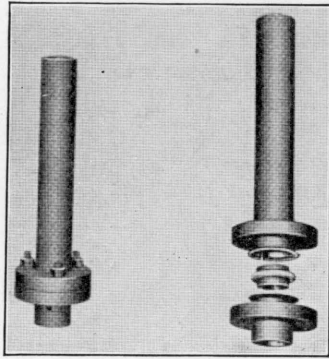

FIG. 103.—Rubber seals for pipe connections.

itself an insulator. Furthermore, it is easily possible to fuse the anode shaft into the glass. In the case of the steel-enclosed rectifier, however, it is necessary to introduce an insulating bushing between the anode shaft and the tank, as can be seen in Fig. 87, which makes it necessary to have a perfect vacuum-tight seal between the porcelain bushing and the tank as well as between the metallic anode shaft and the porcelain bushing. In a large rectifier there may be several hundred linear inches of joints to

be sealed, and these seals have to withstand temperatures of nearly  $100^{\circ}$  C. without deterioration and without giving off vapors. Furthermore, these seals must not be affected by the large quantities of mercury vapor produced by the arc, and they must be sufficiently rugged to withstand handling during transportation and erection.

Although small air leaks can readily be taken care of by the latest types of mercury-vapor pumps, it is essential that as little air as possible enter the rectifier tank. The reason is that even such a minute quantity of air as would not impair the action of the rectifier from the standpoint of imperfect vacuum would cause oxidation at the high temperatures existing in the rectifier, causing deposits of impurities on the inner parts of the rectifier.

A good seal for steel-enclosed rectifiers must be able to meet the following conditions: (a) must be air tight; (b) should be free from occluded gases; (c) must withstand high temperatures; and (d) must have a safe and uniform stress distribution. From a practical point of view, the seals must also be designed to meet the following requirements: (1) simple assembly and ready accessibility; (2) long life, which means no wear nor deterioration; (3) no maintenance; (4) good insulating properties, when required; and (5) easy detection of leakage.

In Fig. 104 *a*, *b*, and *c* are shown schematically several well-known types of detachable seals, while the seals *d* to *h* are designed for use in steel-enclosed rectifiers. Views *a* to *c* show seals long known to physics. View *a* is the ordinary seal used for the connection of two glass tubes which are joined by a ground cone, while a seal of mercury *Q* covers joint *S* to prevent the air from passing the cone. View *b* is an old leading-in seal for vacuum apparatus, illustrating how glands carrying the leading-in conductors can be sealed against the vessel by a cover of mercury. The conductors are wires denoted by *D* and fused into

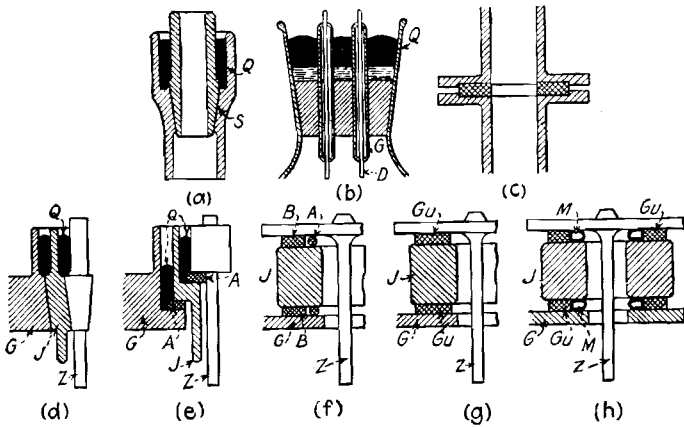

FIG. 104.—Schematic construction of several types of seals.

glass tubes *G*, which also insulate the conductors from the mercury. View *c* shows the well-known packing between two pipe flanges. The designs of seals *d* and *e* for steel rectifiers are based on the cone type of seal *a* and vessel packing *c*, but it became necessary to duplicate the sealing surfaces on account of the insulation between the conductors and the metal surface of the rectifier tank.

In *d* the insulator *J* is fixed into the tank cover or anode plate, and the conductor *Z* into the insulator, by means of ground conical surfaces, while in the case of the seal *e*, the so-called "mercury seal," the insulator *J* is set into the tank cover *G*, and the conductor *Z* into the insulator, on compressed gaskets *A* of rubber or asbestos which are covered by the mercury *Q*. A more detailed section of such a seal is described later and shown in Fig. 107. The packings of *f*, *g*, and *h* are developments of the flange packing



*c, f* being an arrangement where the packing consists of an ordinary lead ring *B*, which is protected by an aluminum ring *A* against the mercury, while *g* and *h* are packings with rubber rings. In *g* only a rubber ring *Gu* is used as packing, while in *h* the escape of gas from the rubber is prevented by metal ring *M* similarly as in *f*. The applications of these seals to steel rectifiers are shown in Figs. 87, 90, 94, 96 and 99, and below are described the designs of some of them. The more important

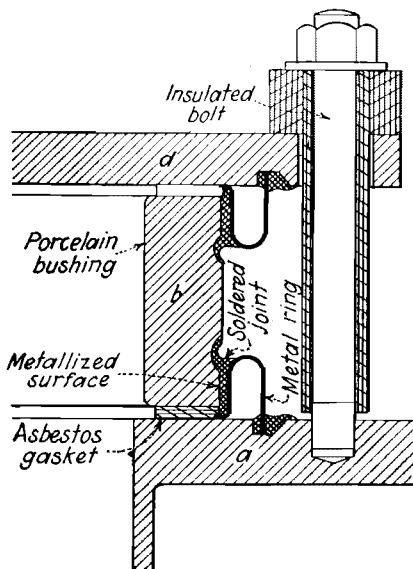

FIG. 105.—Fused seal used in the rectifier shown in Fig. 98.

types of seals to be discussed are fused, mercury, two-stage, and rubber seals.

**Fused Seals.**—Naturally the most ideal seal would be formed by fusing the various parts into one unit, as is done in glass rectifiers. This method is also possible in the case of steel-enclosed rectifiers by the use of fusible alloys and a metallized surface on the porcelain of the insulator. Many methods for accomplishing this are known, but their use has been very limited so far. In Fig. 105 is shown the construction of such a fused seal, with solder as the bonding material. Due to the difference of thermal expansion between the two materials, the porcelain is not directly connected to the steel tank, but a light flexible

metal ring is forced between the two to prevent any excessive stresses from this cause. The seal is made between this metal ring and the porcelain bushing, and the ring is then soldered into the groove prepared in the surface of the steel tank or electrode, thus completing the composite joint. In order to prevent any concentrated stresses in the porcelain a resilient setting is effected by means of an asbestos gasket. This asbestos gasket also

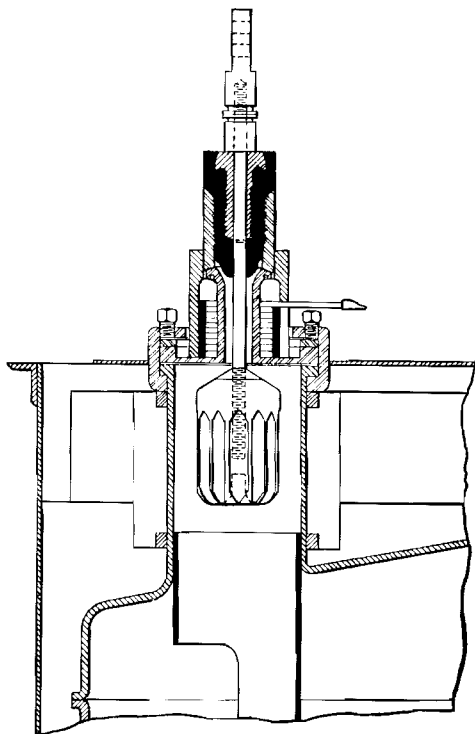

FIG. 106.—Assembly of graphite anode with Mycalex seal and heater, as used in the rectifier of Fig. 93. The Mycalex is shown in black near the upper end of the anode shaft.

provides a barrier which is impervious to mercury vapor, thus protecting the susceptible parts of the seal from becoming amalgamated (334).

The Société Alsacienne de Constructions Mécaniques uses an anode insulator which is built up of metal plates coated with glass, which are heated to a high temperature and then fused under pressure. The glass used has a coefficient of expansion

equal to that of the metal plates. This construction not only takes care of the insulator but also of the seal (392). The cathode insulator can be built up similarly.

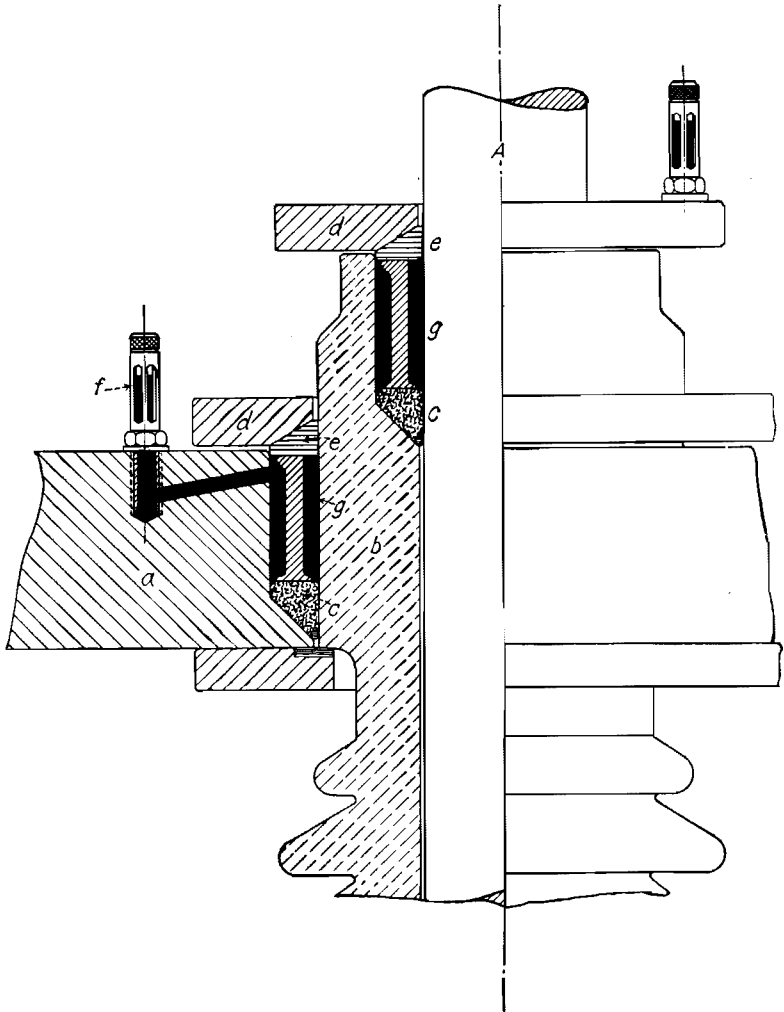

FIG. 107.—Mercury seal, as used in the rectifier of Fig. 87.

The General Electric Company uses a so-called "Mycalex seal" in the latest rectifiers. A cross-section of this seal is shown in Fig. 106, and the upper part of the anode seal and the connection can be seen in Fig. 93. Mycalex is a composition

of ground mica and lead borate. It is light gray in color and has a metallic "ring," and is said to have better insulating qualities than porcelain. It is made plastic by heating to a dull redness, in which condition it can be formed into any desired shape by compression in steel molds closed under hydraulic pressure. It is mechanically stronger than porcelain, except under pressure, but it is not so heat-resistant as either porcelain or mica. Metal parts can be combined with this material during the molding process, making a very tight and strong combination. It can be drilled, filed, sawed, polished, and similarly treated by usual machining methods.

**Mercury Seals.**—In Fig. 107 is shown the construction of an anode mercury seal based on the seal *e* in Fig. 104; its application to the rectifier can be seen in Fig. 87.

In Fig. 107, *b* represents the insulator which is also denoted by *b* in Fig. 87 and by *J* in Fig. 104. In Fig. 107, *c* are gaskets, which may be asbestos, rubber, or any other material which forms a tight seal against mercury. This gasket is placed in a machined recess of the anode plate *a*. As can be seen in Fig. 87, the insulator *b*, holding the anode shaft *A*, is pressed against the gaskets by means of springs. Mercury is poured through the gage *f* into the space *g* over the packing,

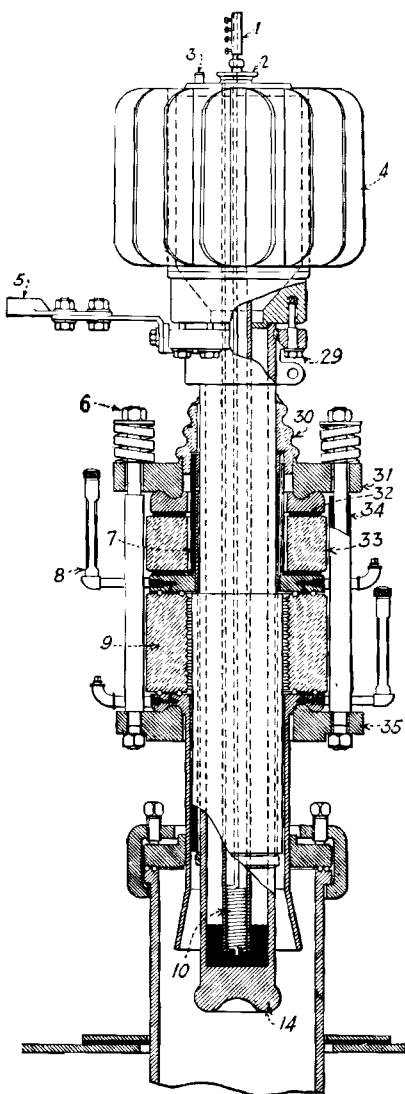

FIG. 108.—Assembly of anode used in the rectifier of Fig. 90, showing mercury seals.

and it is prevented from running into the cylinder by the gaskets *c*, thus forming a perfect air-tight seal. The mercury is shut off from the atmosphere by another gasket *e* of asbestos, rubber, or other material which is tightened against the insulator surface by means of flange *d*.

The anodes of the General Electric rectifier in Fig. 90 are also provided with mercury seals, similar in principle to the seals described above, but of somewhat different design. A detailed cross-section of this anode, showing the construction of the mercury seal, is given in Fig. 108.

**Two-stage Seals.**—The Allgemeine Elektrizitäts Gesellschaft employs a composite packing of aluminum and lead. The seal is a so-called "cascade joint," and is shown in Figs. 94 and 95, and in schematic form in Fig. 109. The porcelain insulator *b*, as well as the surfaces of the flanges *d*, are accurately ground. The insulator is grooved, and lead rings which are surrounded by thin aluminum rings, are placed both inside and outside the grooves. As can be seen from Fig. 94, this composite packing is put under high pressure by means of helical springs. The aluminum rings are used to prevent the lead from spreading. The grooves are connected by means of metal pipes to an

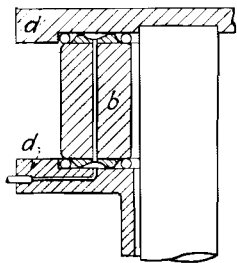

Fig. 109.—Two-stage seal used in the rectifier of Fig. 94.

intermediate space which is itself evacuated, and which serves to distribute the pressure in such a way that each seal has to resist only part of the total difference in pressure. If air should leak in from the outside, it would have to pass the grooves, and would therefore be removed before passing the second barrier, as the intermediate space is connected directly to the vacuum pump. For inspection and testing, however, each seal must be fitted with a vacuum pipe, and, in case of a leaky cylinder, each vacuum pipe must be connected, in turn, to the gage, in order to discover the faulty seal.

**Rubber Seals.**—In the rectifier shown in Fig. 96, rubber seals similar in principle to that shown in Fig. 104*h* are used. The rubber rings which form the seal are protected by the iron rings *M*, which seal off the rubber from the effect of the mercury vapor. The rubber used was especially developed for this purpose, and has the following special properties: it does not

give off much gas or occluded air during temperature increases; it resists high temperatures and high pressures. It is claimed that the iron rings not only protect the rubber rings but also prevent the giving off of gases and air, because very little surface is exposed to the interior of the rectifier tank.

Rubber seals are also used in other types of rectifiers for seals undergoing small temperature variations. A rubber seal used widely for making joints between vacuum pipes is shown in Fig. 103.

**General.**—Numerous other types of seals have been developed, with varying degrees of success. All such seals were relatively short lived, however. The seals using metal are not substantial because of the aging of the metal, which causes them to lose all inner elasticity after a relatively short time, after which tightening will not remedy the trouble any longer. Rubber and similar packings will deteriorate rapidly, because of frequent changes in temperature, accelerating the processes of aging and decomposition to which such materials are subject.

It is easy to see that the simplest seal would be a solid seal, if it could be made to withstand the shocks of transportation and erection, and if means could be developed to facilitate the determination of a leak. Since in modern power rectifiers there may be as many as fifty joints to be sealed, it is highly important that there be means quickly to determine a leaky seal, in order to make it possible to effect repairs without delay.

The great advantage of the mercury seal lies in the fact that an incipient leak will be indicated by the slow sinking of the mercury level in the mercury gage. By increasing the pressure on the gaskets, which can be done by tightening the nuts and the screws, the incipient leak can be stopped. Any mercury which may have leaked through the gaskets, into the rectifier cylinder, can readily be replaced without any interruption of the service, and what has entered the cylinder will only flow into the cathode and be added to the mercury there.

The auxiliary anodes usually have the same kind of seal as the main anodes. In some of the rectifiers shown the cathode also has the same kind of a seal as the main anodes. The construction of the cathode seal is, however, much simpler, for the reason that the cathode is at a very small difference of potential in relation to the tank, and thus requires much less complicated insulation (see Figs. 87, 90, and 94).

## CHAPTER VIII

### DESIGN AND CONSTRUCTION OF RECTIFIER AUXILIARIES

#### VACUUM PUMPING MACHINERY

**General.**—All steel-enclosed power rectifiers are equipped with one or two vacuum pumps, which are used for pumping or exhausting whenever it is found necessary. The better the vacuum is maintained in the cylinder the higher is the safety of

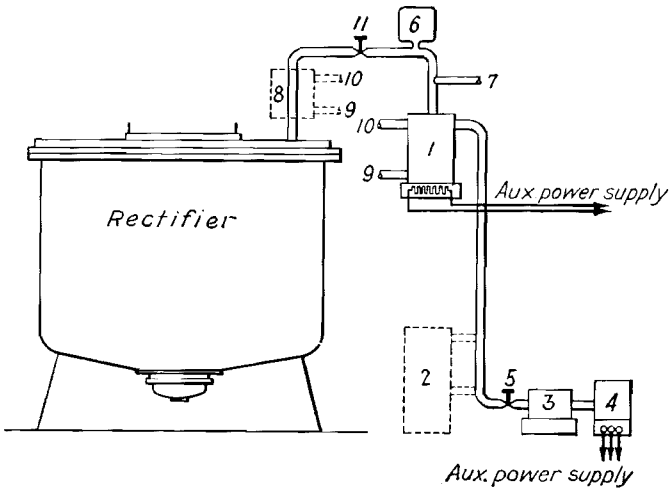

Fig. 110.—Schematic arrangement of vacuum pumping system.

- |                         |                                |
|-------------------------|--------------------------------|
| 1. High-vacuum pump     | 7. Test connection             |
| 2. Interstage reservoir | 8. Water jacket of vacuum pipe |
| 3. Rotary vacuum pump   | 9. Water inlet                 |
| 4. Motor of rotary pump | 10. Water outlet               |
| 5. Valve                | 11. Vacuum valve               |
| 6. Vacuum gage          |                                |

operation, as well as the efficiency of the rectifier. The presence of foreign gases increases the voltage drop in the arc and increases the possibility of back fires, that is, of the failure of the valve action. The vacuum pumps are designed so that they are not

only able to take care of the various occluded gases which are gradually released by the metal parts of the rectifier when they are heated under vacuum, but that they can also take care of very small leaks which may be caused by a loosening of the seals at the joints in the rectifier proper or in the vacuum piping.

A schematic arrangement of the auxiliaries for the vacuum pumping or exhaust system is shown in Fig. 110.

The usual pumping equipment consists of a rotary preliminary or roughing pump, an electrically heated diffusion or condensation high-vacuum pump, an interstage reservoir, and a valve between the two stages. Valve 5 is introduced into the system in order to prevent oil from being forced back into the rectifier cylinder through atmospheric pressure in case the pump fails to work, which might be caused by failure of the power supply driving the pump motor. Since such an occurrence might put the rectifier out of operation, it is essential to have a reliable non-return valve. Valve 11 is hand operated and makes it possible to isolate the tank when testing the line for leaks and when making repairs or adjustments to the gages or pumping equipment.

It has not been possible so far to build the roughing pump for producing a degree of vacuum high enough for the satisfactory operation of rectifiers of larger sizes, because vacuums only as high as 0.01 mm. Hg could be obtained under good conditions. On the other hand, it has not been possible to design a high-vacuum pump (of the mercury-vapor type, described below) that could by itself serve to establish the necessary degree of vacuum, because it has not been possible to date to build such a pump that would be able to work against atmospheric pressure. By connecting two or more such pumps in cascade, the pressure against which such a type of pump can work satisfactorily can be increased to about 10 to 20 mm. Hg column. The latter pressure will, therefore, have to be established by the roughing pump. As already pointed out, the combination of two pumps has been found most suitable, namely, a rotating pump and a mercury-vapor pump operating in series, the first reducing the pressure to about 20 mm. Hg or less, and the other from that value to about 0.0001 mm. Hg.

The suction speed of the present types of diffusion pumps amounts to more than 10 liters per second, and vacuums from 0.001 to 0.000001 mm. Hg can be obtained. The modern



types of rectifiers can be equipped with automatically controlled vacuum pumps: as soon as the pressure increases to a certain value the pump set is placed in operation and is disconnected again when the proper degree of vacuum has been obtained. The pumps are controlled by means of vacuum meters described elsewhere in this chapter.

The rotary, or roughing pump, has to raise the pressure of the air-gas mixture in the tank to that of the outside air, the

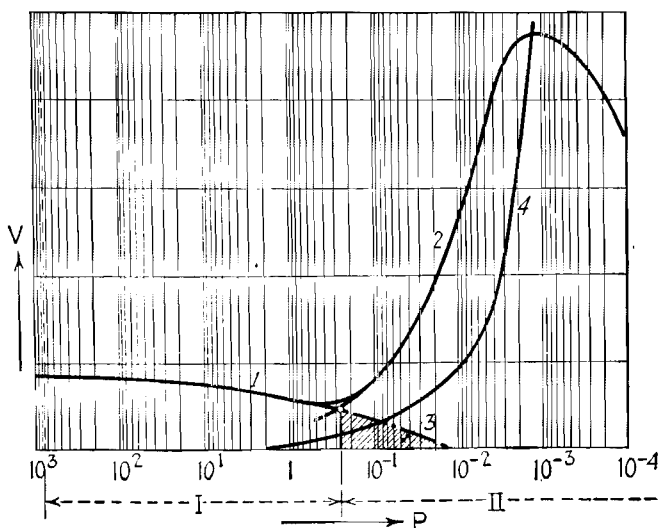

FIG. 111.—Curves of volumetric capacity of mercury and rotary vacuum pumps, in function of the pressure in millimeters mercury column.

mixture being previously compressed by the mercury vacuum pump. Besides the consideration of capacity, it is of importance that the two pump stages, the roughing and the mercury pumps, overlap sufficiently in their ranges of operation to prevent any interruptions of service on that account.

The characteristics of a typical rotary oil pump and of a mercury pump are shown in Fig. 111. The pressure range of the roughing pump is indicated by I, and that of the mercury pump by II. Figure 111 also shows the range of overlapping. The ordinates give the volumetric exhausting speed of the pumps, while the abscissæ give the pressure in millimeters Hg absolute. Curve 4 is a theoretical  $pv$  curve for the optimum of the mercury pump, which naturally cannot be obtained in practice.

## PRELIMINARY PUMPS

**Rotating or Roughing Pump.**—The use of a rotating pump has sometimes been considered a disadvantage for a rectifier. However, considering the simplicity of action and reliability of operation of the present rotary pumps, their use cannot be considered a drawback. Typical constructions of such pumps are shown in Figs. 112, 113, and 114, in each of which is shown a rotor 9, placed eccentrically in a cylindrical space and driven by a

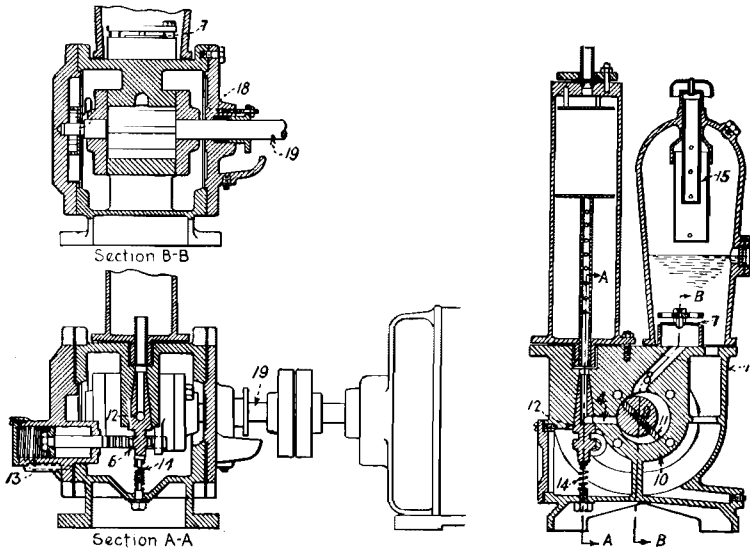

FIG. 112.—Brown Boveri rotary vacuum pump, with automatic oil pressure valve.

motor through shaft 19. In a slot through rotor 9 are located two plates or vanes 11, kept separated by springs and free to move in the slot. As rotor 9 revolves, the turning of vanes 11 produces a suction at the opening 4 of the vacuum cock, and the gases sucked into the pump casing 10 are swept by the vanes through passage 8 and check valve 7, through the oil and the breather 15, into the atmosphere. The purpose of the breather is to prevent the oil from absorbing moisture from the atmosphere.

The limit of the vacuum obtainable with the rotary pump depends upon the vapor pressure and the temperature of the sealing fluid and amounts to  $2.5 \times 10^{-2}$  to  $1.5 \times 10^{-2}$  mm.

Hg absolute, at a normal temperature of 20° C. This limiting vacuum can be strongly influenced by the partial pressure of water vapor, according to the moisture contained in the oil, so that under certain circumstances the preliminary vacuum produced may not be sufficient to ensure the proper working of the high-vacuum pump which runs in series with the preliminary pump. In order to exclude this as far as possible, the use of a

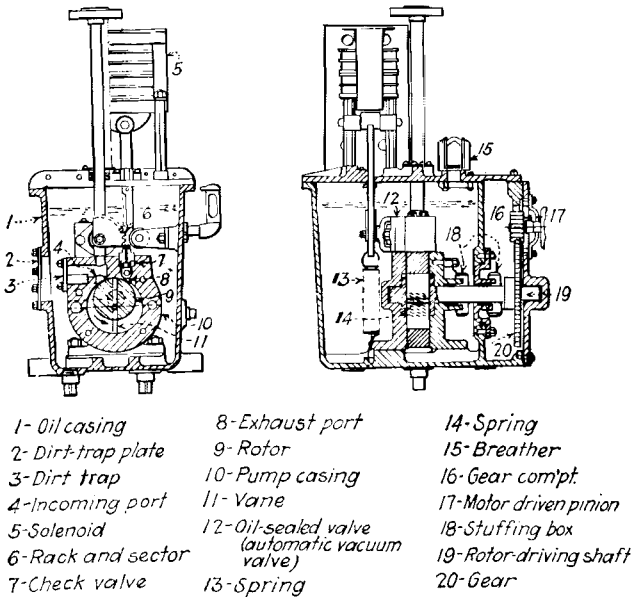

FIG. 113.—General Electric rotary vacuum pump, with solenoid-operated valve.

vacuum sealing gland in the interior of the pump may be done away with, so that the complete pump may be constructed as an enclosed type. All these pumps are made with a double casing to make sure that a possible leak in the inner casing does not admit air, but only oil, which can do no harm.

Any moisture expelled from the apparatus collects on the bottom of the exhaust dome, and from there reaches the outer casing by means of a suitable opening. The water can do no damage in the outer casing, and owing to its greater density collects at the bottom of the casing, whence it can run off from time to time without interfering with the continuity of service.

**Automatic Vacuum Valves.**—The rotary vacuum pumps are provided with vacuum-tight valves on the suction side, for the purpose of closing the opening when the rotary pump is at rest and thus preventing the passage of oil into the mercury vacuum pump. The rotary pump shown in Fig. 114 has a hand-operated valve. The rotary pumps of Figs. 112 and 113 are provided with automatically operated valves, 12, which open when the pump is started and close when the pump is stopped.

The vacuum valve of the Brown Boveri pump, Fig. 112, is controlled by oil pressure. The valve 12 is operated by a gear sector and rack 6, which is connected to a piston in a control cylinder. The piston is controlled by oil pressure from a small gear-type oil pump connected to the shaft of the rotary pump. When the vacuum pump is started, the oil pressure from the gear pump moves the piston against the spring 13, causing the valve to open. When the pump stops, the oil pressure disappears, and spring 13 returns the piston to its former position, closing the valve.

The valve is held in its seat by spring 14. On the suction side of the pump, above the valve 12, is mounted a cylindrical tank, which is provided with baffle plates. The purpose of this tank is to trap the oil and prevent it from entering the mercury vacuum pump, should the valve fail to close for some reason. It also serves as a condenser for the oil vapor, to prevent it from going into the mercury pump and rectifier.

The General Electric rotary vacuum pump, shown in Fig. 113, is provided with a solenoid-operated vacuum valve on the suction side, at the opening leading to the interstage reservoir. The valve is operated by solenoid 5 through a gear rack and sector 6, and is controlled by a centrifugal switch on the shaft of the pump motor. When the motor approaches normal speed, the centrifugal switch energizes the solenoid, causing the valve to open. When the motor stops, the solenoid is de-energized, and the valve is closed by spring 13.

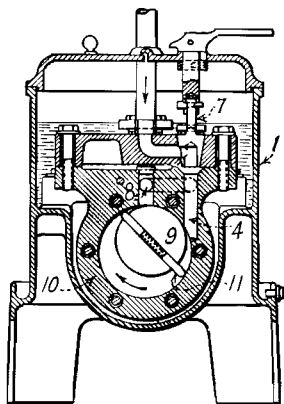

FIG. 114.—Rotary vacuum pump of the Allgemeine Elektrizitäts Gesellschaft.

In Fig. 88, Chap. VII, are shown the locations of the roughing and mercury pumps. The roughing pump is mounted on an insulated frame located close to the rectifier cylinder. The mercury pump is mounted directly on the cylinder. In Figs. 90 and 92, Chap. VII, is shown another arrangement. The roughing pump, with motor, is mounted on the same base as the rectifier, and the mercury pump on the rectifier cylinder. In addition to these pumps there is a gas receiver tank (interstage reservoir) between the mercury and roughing pumps. The purpose of this receiver is to store the gases exhausted by the mercury pump in order to reduce the operating time of the rotary pump.

#### MERCURY VACUUM PUMPS

There are several types of molecular pumps, all of which use a stream of mercury vapor, which is usually produced by means of an electric heater. The pumps which are used in connection with mercury arc rectifiers are usually built in steel casings, while the smaller types used for laboratory purposes are built of glass tubes.

**Diffusion Pumps.**—The Gaede diffusion pump is constructed on the principle of the diffusion of gases in mercury vapor through capillary action. A Gaede pump is shown in Fig. 115. It consists of a glass vessel *B*. Inside the vessel is a steel cylinder *C* which has an adjustable slit *S*, and its opening is immersed in a mercury pool *G*. The size of the slit can be adjusted by means of set screws *H*. At the bottom of the vessel *B* is a pool of mercury *A* into which is immersed cylinder *D*. The vessel to be evacuated is connected at *F* and the preliminary vacuum pump is connected at *V*. The mercury at *A* is heated and the mercury vapor rises on the outside of the cylinder *D* into the cylindrical vessel *C*. At the slit *S* the gases to be exhausted diffuse into the mercury vapor, while the mercury vapor diffuses into the gases on the outside of the cylinder *C*, and is condensed by cooling water in the jacket *K*, circulated through the openings *K*<sub>1</sub> and *K*<sub>2</sub>. The gases which are diffused into the mercury through the slit *S* are drawn into the cylinder *D*, then through *E* and opening *V* into the preliminary vacuum pump. On the outside of the arm *E* is a water jacket *L* cooled by water circulating through *K*<sub>3</sub> and *K*<sub>4</sub>, in order to condense the mercury vapor which may enter *E*. In order that the pump may operate at the maximum

efficiency, the mercury vapor must be maintained at a nearly constant temperature, depending on the size of the slit *S*. For this reason a thermometer *T* is placed above the cylinder *D* in order to indicate the temperature of the mercury vapor.

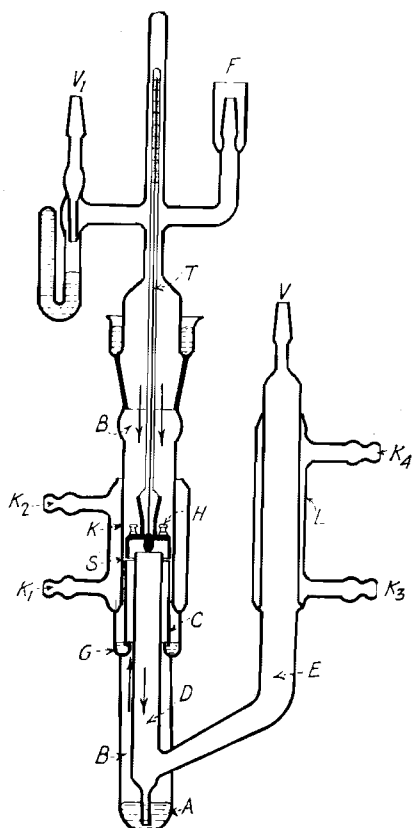

FIG. 115.—Gaede diffusion-type mercury vacuum pump.

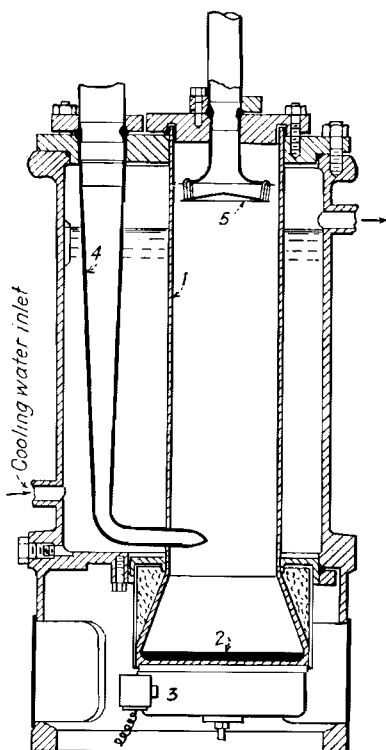

FIG. 116.—Brown Boveri mercury vacuum pump.

The pump shown in Fig. 116 is based in principle on the Gaede pump (Fig. 115), and is used in rectifier installations of the Brown Boveri companies. The pump consists of a water-jacketed steel cylinder, at the bottom of which is a quantity of mercury used for generating the mercury vapor stream. The heating device is located in the base of the apparatus, and comprises a heating plate, a self-contained unit, which can easily be replaced. The operation of the pump is as follows: When the

heater is energized, vapor will rise from the boiling mercury and suck the gases down through the pipe 4 connected to the rectifier. As the mixture of vapor and gases rises in the cylinder of the mercury pump, the mercury vapor coming into contact with the cool walls of the cylinder is condensed and drops into the mercury

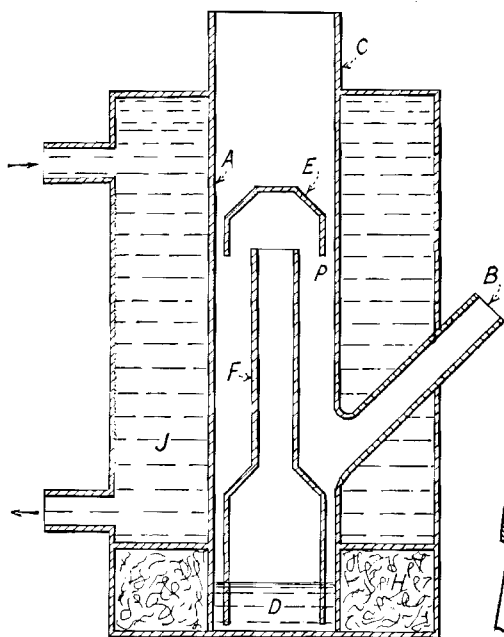

FIG. 117.—Schematic construction of Langmuir mercury-condensation vacuum pump.

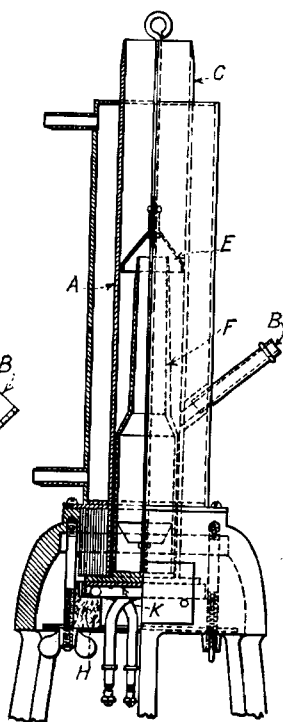

FIG. 118.—Actual construction of Langmuir vacuum pump.

pool, while the gases are drawn through a baffle plate 5 into the receiving chamber of the roughing pump, usually located as close as possible to the mercury pump. The heating plate of the pump consumes 500 watts. A Brown Boveri high-vacuum pump of more recent design and of larger capacity (see Fig. 88) requires a 1,000-watt heating plate.

In Fig. 121 is shown a mercury pump operating on the injection principle. The mercury pool is heated by induction by means of coils energized by alternating current. The core surrounds the

mercury container and the mercury pool constitutes the short-circuited secondary. The heating of the mercury causes it to boil and liberate mercury vapor. This passes through the nozzle *S* into the tube leading to the outlet *A*. The suction caused by the jet of mercury vapor draws the air from opening *E*, which enters the stream of mercury vapor and is forced out through the outlet *A*. The mercury vapor is condensed by the water jacket *W* and returns to the vessel *D* through the pipe *R*. The outlet tube of the pump is provided with baffles in order to prevent the mercury vapor from escaping through the outlet *A*.

**Condensation Pumps.**—The Langmuir condensation high-vacuum pump is shown in principle in Fig. 117, while an actual construction of such a pump is shown in Fig. 118. The pump consists of a metal cylinder *A* with two openings, one at the top *C* leading to the vessel to be evacuated and another opening *B* leading to the interstage reservoir or to the rotary pump. Cylinder *A* is surrounded by a water jacket through which cooling water is circulated. At the bottom of cylinder *A* is a pool of mercury into which is immersed a nozzle *F*. Above this nozzle is a deflector *E*. The lower end of cylinder *A* is surrounded by insulating material *H*. An electric heater *K* is located below the pool of mercury.

The operation of the pump is as follows: The mercury pool is heated by means of the above mentioned electric heater, liberating mercury vapor which rises in the nozzle *F*, strikes the deflector *E*, and is caused to deflect downward. In passing downward along the opening between the deflector *E* and the vessel *A* the mercury vapor draws the gases from *C* with it. The mercury vapor in coming into contact with the walls of the cylinder *A* is condensed and drops down into the mercury pool, while the gases are drawn through the opening *B* by the roughing vacuum pump which exhausts them into the atmosphere. The small type of pump requires about 500 g. mercury, and the electric heater consumes about 300 watts. Approximately one liter of water per minute is required by the condenser. This pump has a theoretical capacity of about five liters per second. Sizes of much larger outputs can be built, the heat and the cooling water required as well as the amount of mercury being larger accordingly.

**Two-stage Pump.**—The pump shown in Fig. 119 is based on the same principle as those shown in Figs. 117 and 118, and is



used by the General Electric Company. This pump is of the two-stage type, by means of which pressures below 0.1 micron can be obtained in connection with the roughing pump shown in Fig. 113. The roughing pump can produce pressures as low as 15 to 50 microns. The mercury vapor passes through *F* and the two

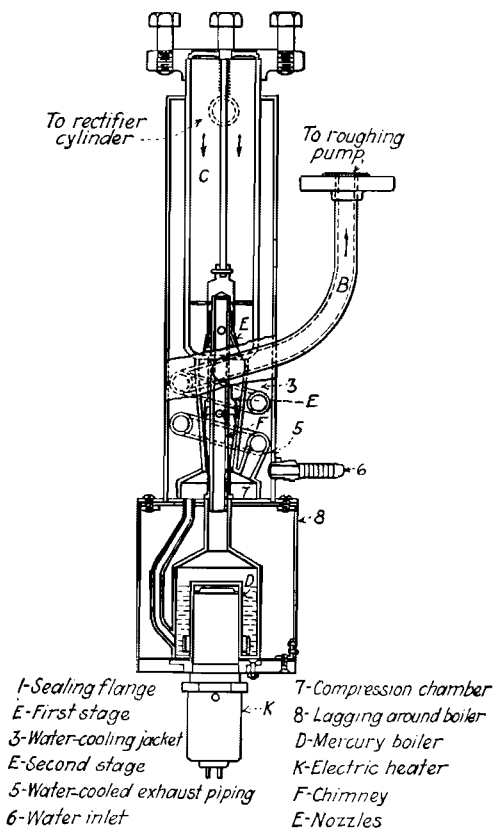

FIG. 119.—Two-stage, mercury-condensation vacuum pump of the General Electric Company.

orifices *E*, *E*, whence it is deflected downward, taking with it the gases from the rectifier cylinder which come in through opening *C*, similarly as in the pump shown in Fig. 118.

**Three-stage Pump.**—The mercury pump shown in Fig. 120 is a three-stage condensation pump. The mercury receptacle, which is annular in shape, rests on the inner leg of a shell-type

transformer *H*. The transformer is provided with a primary winding, which is connected to the auxiliary alternating-current supply. The mercury *Q* thus forms a short-circuited secondary winding of one turn. Through the action of the heat generated in it, the mercury evaporates and flows through the central tube 1 to the upper nozzle 2, whence it is deflected downward. The sucking action produced in this way evacuates the space *V* which is connected to the rectifier as shown in Fig. 94, Chap. VII. This action is facilitated by the nozzles 3 and 4. Part of the mercury vapor rising in tube 1 passes through these nozzles and thus assists the action of nozzle 2 in bringing the gases to passage *D* leading to the interstage reservoir. Nozzles 2, 3, and 4 operate in series, as can be seen from the figure. The condensed mercury gathers at the bottoms of the various compartments, and flows back into its receptacle through the pipe *E*. The gases pumped out in this way pass into the preliminary vacuum chamber, called

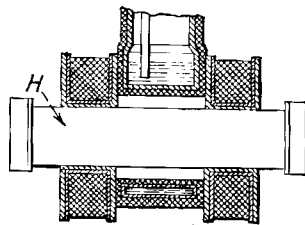
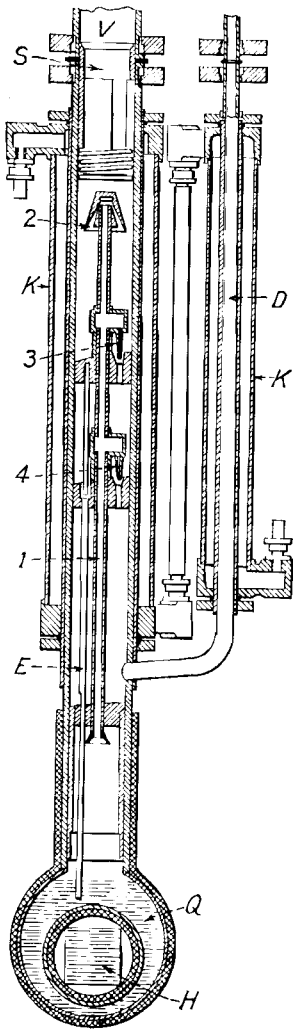

FIG. 120.—Three-stage, mercury-condensation vacuum pump of the Allgemeine Elektrizitaets Gesellschaft.

an *interstage reservoir* above, which is connected with the pump through a double vacuum cock and a non-return valve. The evacuation of the interstage reservoir is effected by means of a two-stage rotary oil pump. The mercury pump housing and

the pipe *D* are surrounded by jackets *K*, *K* through which cooling water is circulated.

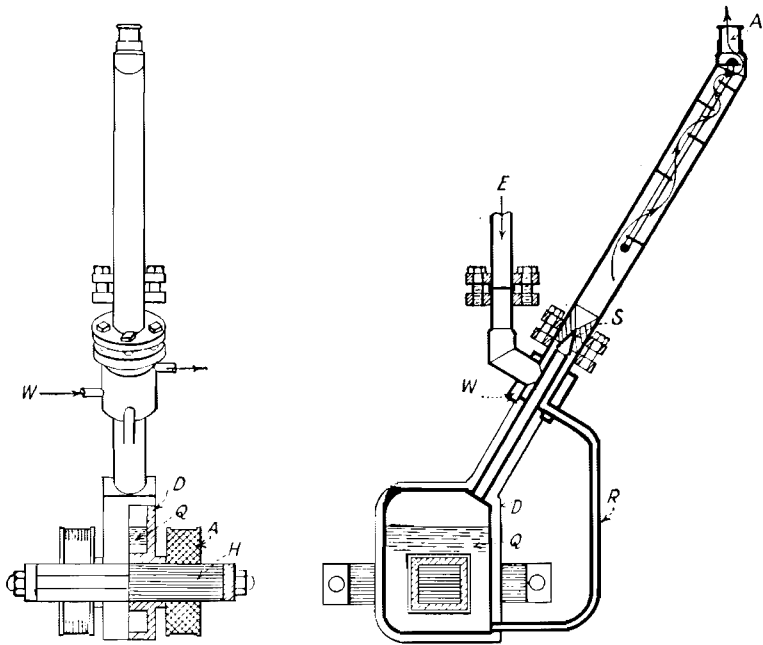

FIG. 121.—Mercury vacuum pump designed on the injector principle.

**Characteristics of High-vacuum Pumps.**—The characteristics of some of the most important pumps are tabulated below:

	Volume capacity ( $\text{cm.}^3$ per second)	Back pressure, millimeters	Attainable pressure, millimeters
Gaede rotary mercury.....	100	10	$10^{-4}$
Gaede molecular.....	1,400	0.01	$10^{-6}$
Gaede diffusion.....	80	0.01	$10^{-6}$
Langmuir condensation (metal):			
Single stage.....	4,000	0.27	$10^{-6}$
Double stage.....	4,000	2.00	$10^{-6}$
Gaede two-stage (metal).....	60,000	20	$10^{-6}$
Brown Boveri condensation:			
Single stage:			
Old.....	2,500	0.1	$10^{-6}$
New.....	30,000	0.45	$10^{-6}$

VACUUM GAGES

**McLeod Gage.**—This type of vacuum gage is well known and is used extensively in laboratory work. Its operation is based on the principle of Boyle's law for perfect gases, that pressure times volume equals a constant. It consists of a glass tube connected at one end by a rubber hose to a cup of mercury

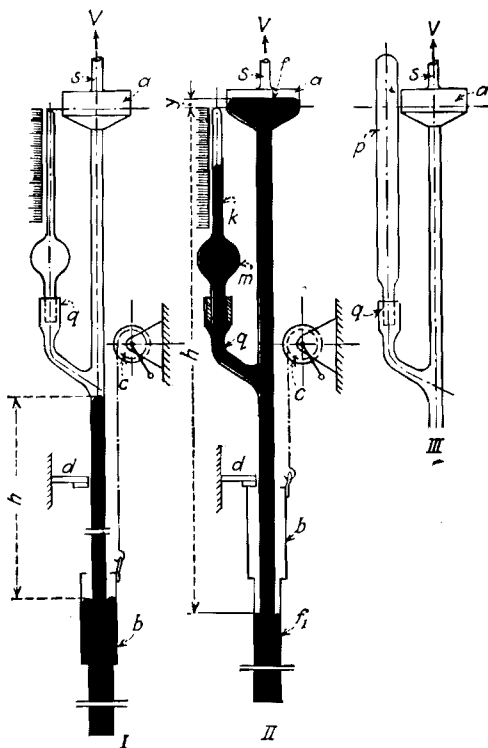

FIG. 122.—McLeod vacuum gage of the Brown Boveri Company.

open to the atmosphere, and at the other end to the vacuum chamber. Before making measurements the mercury cup is lowered and the measuring bulb is filled with the gases from the chamber whose vacuum is to be measured. To measure the vacuum the cup is raised until the mercury in the main tube is at the level of the highest graduation of the scale on the measuring tube, which is graduated in 1/1000 mm. Hg pressure, termed "microns." Due to the pressure of the trapped gas in the meas-

uring tube the mercury level in that tube is below the level in the main tube; the difference between the levels of the two tubes is a measure of the gas pressure in the vacuum chamber and is, therefore, a measure of the degree of the vacuum. This type of gage has several disadvantages, as many adjustments are necessary and, furthermore, the barometric tube as well as the measuring bulb and capillary tube have to be made of glass which, being easily broken, may be a source of trouble in practical applications. An improved gage of this type is shown in Fig. 122.

The principal feature of this improved vacuum gage, shown in Fig. 122, is that the barometric tube is widened at its upper end at the level of the top of the capillary tube. This enlargement  $a$  is of section  $f$ , which is large as compared to that of the annular surface  $f_1$  of the mercury in contact with the outer air. This design renders the setting of the mercury receptacle, which is necessary in order to adjust the height of the mercury column in the barometric tube, practically independent of the height of the installation above sea level, the fluctuations of atmospheric pressure, and the variations of the temperature of the surrounding air. The mercury receptacle  $b$  is simply raised by the lifting device  $c$  until it touches a stop  $d$ , and this movement results in the mercury in capillary tube  $k$  rising to the exact height which corresponds to the vacuum existing when the measurement is made. In order to compensate for the meniscus, the surface of the mercury at  $f$  is raised by a corresponding amount  $y$ .

To take a reading:

1. Raise the mercury receptacle  $b$  as far as the stop  $d$ , by slowly turning the hand wheel.
2. When this position has been reached (measuring position, Fig. 122), the pressure can be read on the scale alongside the capillary tube in millimeters of mercury column, or in microns.
3. Release handle, and the mercury will fall back to its normal position of its own accord, under the action of gravity.

The improvements introduced enable the principal parts of the apparatus to be made of metal, with the exception of the measurement bulb and the capillary tube; it is no longer necessary that the level of the mercury in the barometric tube be observed, which is very advantageous from the technical point of view. The operation of the apparatus is quite simple and requires no special attention or expert knowledge, as the mercury in the capillary tube reaches the exact level automatically.

Such a vacuum gage, connected to the vacuum pump set, is shown in several of the figures in Chaps. VII, X, and XI.

The outstanding disadvantages of the McLeod vacuum gage are the fact that no direct readings can be made with it, and that no automatic equipment can be used with it for starting and stopping the vacuum pump set, depending on the degree of vacuum. Furthermore, the McLeod gage is delicate and cumbersome, and does not indicate the presence of easily condensable vapors. In steel-enclosed rectifiers water vapor is sometimes present, and it is very important that its amount can be determined. This can be done by means of gages which have recently been developed, in conjunction with the above gage.

The following types of gages lend themselves to this purpose:

1. Hot-wire gage with resistance or temperature variation.
2. Ionization gage.
3. Static viscosity gage.
4. Glow discharge gage.

In order that gages built on the above principles can be used in connection with large steel-enclosed rectifier installations, they must meet the following conditions:

Simplicity of construction to assure reliable operation.

Insensitivity to changes in room temperature.

Adaptability to full automatic substation control.

Ability to withstand action of mercury vapor.

**Hot-wire Gage.**—If a filament, which is enclosed in a bulb containing a gas, is heated by passing a current through it, the electric energy put into the filament must equal that lost by radiation and that conducted away by the gas. It is well known that for pressures near atmospheric pressure the heat conductivity of a gas is practically independent of the pressure. However, when the pressure is reduced to such a value that the mean free path of the molecules is large compared to the distance of the filament from the walls of the vessel, the heat conductivity of the gas decreases rapidly with decreasing pressure, and hence provides a means for measuring that pressure. This physical property makes possible a number of devices for establishing a relation between the pressure of a gas and the heat conductivity of the gas. All such devices must be so constructed, however, that the losses due to radiation are small compared to the losses by conduction through the gas, and the influence of the room temperature must also be compensated. There are several

methods for measuring pressure by means of such a device, which is usually called a hot-wire gage or resistor manometer. In all these methods, a wire, exposed to the gas whose pressure is measured, is heated by passing current through it, and the change in the temperature of the wire is used as an indication of the pressure. The most important of these methods are:

1. Two wires exposed to atmospheric pressure, and two to the pressure under observation, are connected so that they form a Wheatstone bridge. The current may be kept constant, and the change in voltage used as an indication of the pressure.

2. With connections as under 1, the voltage may be kept constant, and the current used as an indication of the pressure.

3. A single wire in a glass bulb exposed to the pressure to be measured can operate as follows:

- a. The voltage across the wire may be maintained constant, and the change in current used as an indication of the pressure.
- b. A thermocouple may be located near the wire, and its voltage used as an indication of the pressure.
- c. The current through the wire may be maintained constant, and the change in resistance used as an indication of the pressure.

There are other methods of using a hot wire for measuring degrees of vacuum, but all are very sensitive and not suited for the operation of control relays.

**Brown Boveri Hot-wire Gage.**—The Brown Boveri hot-wire gage, shown in Fig. 123, consists of four resistances of platinum wire, which are connected in the form of a Wheatstone bridge. Two of the resistances, *AB* and *DC*, are exposed to atmospheric pressure, and two, *AD* and *BC*, are exposed to the vacuum which the gage is to indicate and control. Any reduction of the pressure surrounding the wires *AD* and *BC* automatically reduces the heat conductivity of the imprisoned gas. If heat energy is constantly applied, the resistance of the arms *AD* and *BC* is increased, and hence also the potential between *A* and *C*. The potential is thus a means for determining the pressure. The four arms of the Wheatstone bridge have the same ohmic resistance at atmospheric pressure, and there is then no potential between *A* and *C*. Fluctuations in the surrounding temperature

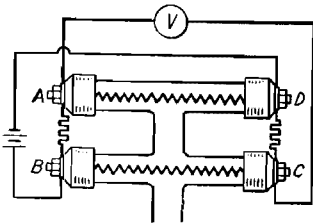

FIG. 123.—Elementary connection of Brown Boveri hot-wire vacuum gage.

of the surrounding temperature

is increased, and hence also the potential between *A* and *C*. The potential is thus a means for determining the pressure. The four arms of the Wheatstone bridge have the same ohmic resistance at atmospheric pressure, and there is then no potential between *A* and *C*. Fluctuations in the surrounding temperature

have practically no influence on the reading of this gage, because all the arms of the bridge connection have exactly the same temperature coefficient, and are subject uniformly to the surrounding temperature, hence there can be no changes in potential on this account. Figure 124 shows the variation of potential between the points *A* and *C* as a function of the gas pressure.

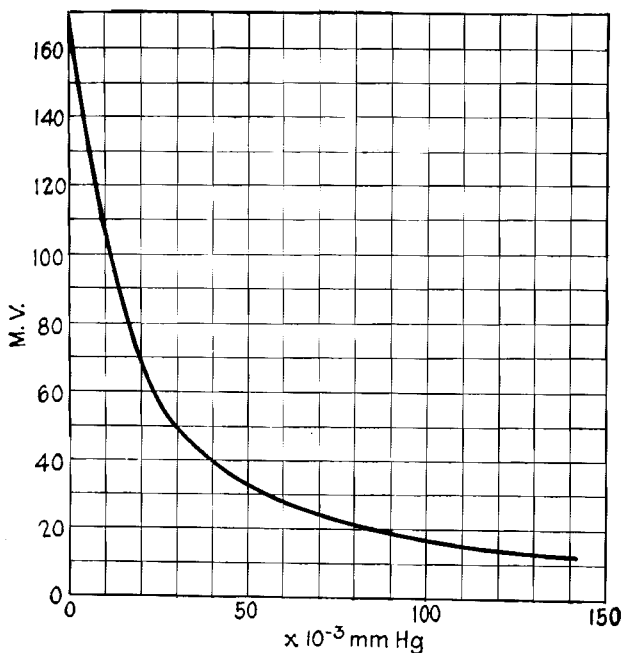

FIG. 124.—Calibration curve (millivolts-pressure) of Brown Boveri hot-wire vacuum gage.

Figure 123 also shows the practical form of this instrument, diagrammatically. The glass tubes, in the shape of an H, and containing the platinum spirals in vacuo, are cemented into a stamped holder. The two outer platinum resistances exposed to the air are wound on press pan and joined to the two inner arms to form the Wheatstone bridge. The whole instrument is protected from damage by an aluminum cover screwed to the stamped holder. Figure 125 shows the external appearance, as well as the method of mounting, of two types of Brown Boveri hot-wire vacuum gages. All hot-wire gages are calibrated by



means of a standard gage. The method of calibration is described in Chap. XIV.

This direct-reading gage may be used with either direct or alternating current. Figure 126 is the diagram of connections when direct current is used. Terminals *B* and *D* of the Wheatstone bridge 1 are connected in the circuit comprising battery 2, fuse 3, resistances 4 and 5, and shunt 6. The direct-current millivoltmeter 8 may be connected by means of a two-pole plug and plug receptacles 7 either to the shunt 6 for measuring

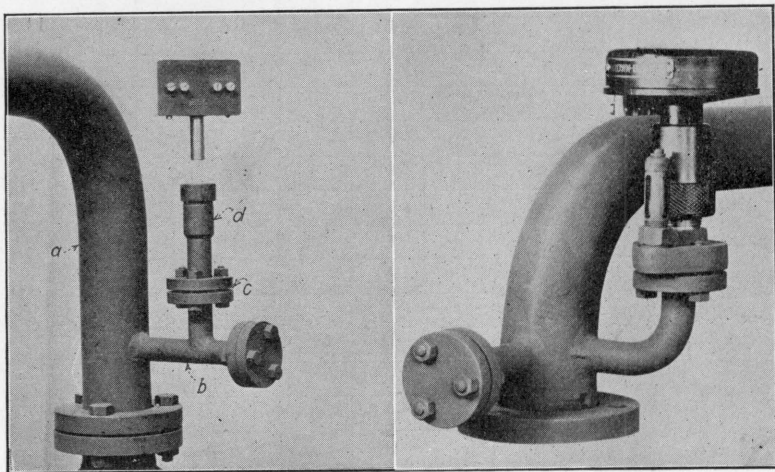

FIG. 125.—Two types of Brown Boveri hot-wire vacuum gages, shown connected to vacuum pipe lines between rectifier and mercury vacuum pump. The gage on the right is of more recent design, with the bridge element enclosed in a moulded bakelite holder. In the figure on the left, *a* is the vacuum pipe, *b* a pipe extension, *c* a rubber-sealed joint, and *d* a fitting containing a mercury seal.

the current supplied to the bridge or to terminals *A* and *C* of the bridge for measuring the vacuum.

Before each pressure measurement the plug is inserted into receptacle 2 to check the current in the gage, and if necessary the resistance 5 is adjusted to give the correct value of current, as indicated by a red mark on the instrument. The plug is then transferred to position 1 and the instrument is read. The scale of the instrument may be calibrated to read directly the degree of vacuum in microns, or the vacuum may be determined by means of the calibration curve (Fig. 124).

While the hot-wire gage itself requires no attention, it is of course necessary to recharge the storage battery from time to time.

In order to avoid the necessity of charging the battery and the frequent readjustment of the heating current, for some time past the instrument has been supplied for use with alternating current, resulting in a considerable improvement. The connections are shown in Fig. 127. The alternating-current instrument,

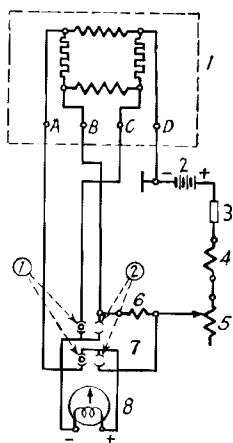

FIG. 126.—Connection diagram of Brown Boveri direct-current hot-wire vacuum gage.

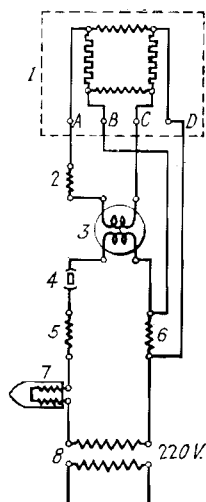

FIG. 127.—Connection diagram of Brown Boveri alternating-current hot-wire vacuum gage, with ballast lamp to compensate for voltage variations.

a dynamometer-type meter with mechanical damping, is similar to a direct-current moving-coil instrument, with the exception that an electromagnet is fitted in place of the permanent magnet; current is supplied from the secondary of the transformer and flows through the circuit consisting of the shunt 6, the field coil of the instrument, fuse 4, resistance 5, and iron ballast resistance 7. From the shunt connection 6, the current flows through the vacuum gage by way of the terminals B and D, and heats the four arms of the bridge. With falling pressure, as the resistances of the arms AD and BC increase, the potential between A and C also increases, which causes a current to flow through the moving

system of the galvanometer. This, together with the field of the electromagnet, produces the torque which deflects the moving coil and pointer.

The alternating-current galvanometer is suitable for indicating the pressure only if the current supplied by the transformer remains constant. Any voltage fluctuations in the supply are regulated by the iron resistance 7, which has a high temperature coefficient, thus giving a constant current.

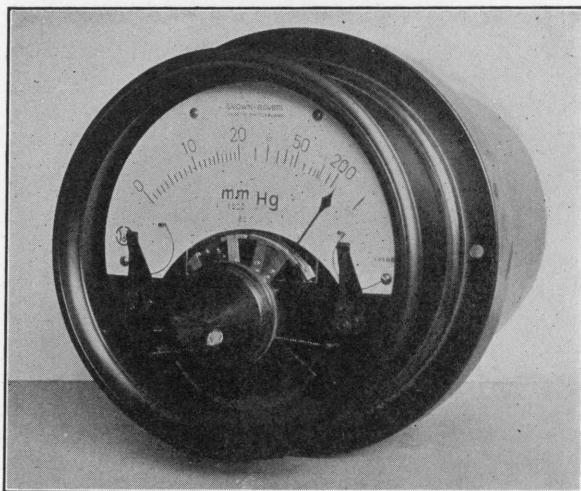

FIG. 128.— Brown Boveri contact-making vacuum meter.

There are several other ways to produce a constant current: (a) saturated-core transformers; (b) saturated and unsaturated transformers having their primaries connected in series, and their secondaries in series with subtractive polarity (see Fig. 129).

The galvanometer is shown in Fig. 128 and is calibrated in  $1/1,000$  millimeter of mercury column, *i.e.*, in microns. Figure 129 shows the application of the same galvanometer and the same hot-wire gage in an improved circuit. This instrument also serves as a contact-making device. Its operation in that capacity for automatic control will be dealt with in the chapter on Substations.

The direct-reading vacuum gage, which may be supplied with either direct or alternating current, has proved to be of great value in actual service. Unless special reasons exist, the

alternating-current method is always preferable, since no battery is required, as is necessary with the direct-current system (401).

Other similar hot-wire gages are also in use. For instance, there is one having only one branch of the Wheatstone bridge placed in the vacuum to be measured. Still others are described in (362).

This vacuum gage is not merely a special instrument for use with mercury arc power rectifiers, but is applicable for measuring the high vacua (0.1 to 0.001 mm. Hg) which occur in many industrial processes. It is, therefore, of considerable interest where very high vacua must be maintained, as, for example, in incandescent lamp manufacture and in similar processes.

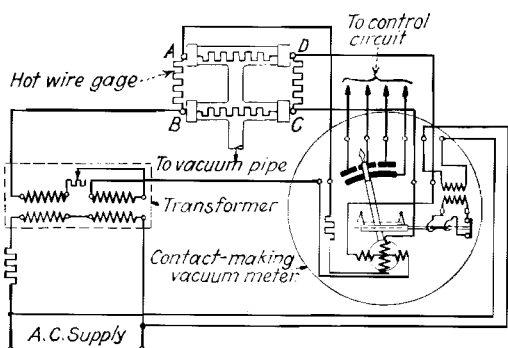

FIG. 129.—Connection diagram of Brown Boveri hot-wire vacuum gage, with constant-current transformer and contact-making meter.

**General Electric Hot-wire Gage (Thermal Vacuum Gage).**—

The operation of this gage is similar to that described above and is based on the same principle. The hot-wire gage, shown in Fig. 130, consists of a resistor manometer, a compensating tube, two fixed resistors, and a potentiometer for adjustment, connected so as to form a Wheatstone bridge (see Fig. 132). An indicating galvanometer is used in connection with this gage in manually operated substations, and a contact-making instrument (vacuum regulator), shown in Fig. 131, is used in automatic substations. The coil of the galvanometer or vacuum regulator is connected across the bridge in place of the usual bridge galvanometer. The so-called "resistor manometer," which forms a branch of the Wheatstone bridge, consists of a wire resistance unit sealed inside a glass bulb which is connected with the interior of the rectifier by means of a connecting tube. The so-called

“compensating tube,” also a part of the Wheatstone bridge, consists of a similar resistance unit in a glass tube, entirely sealed up. The other two arms consist of fixed resistors. The bridge is energized by a small storage battery charged by a tungar rectifier.

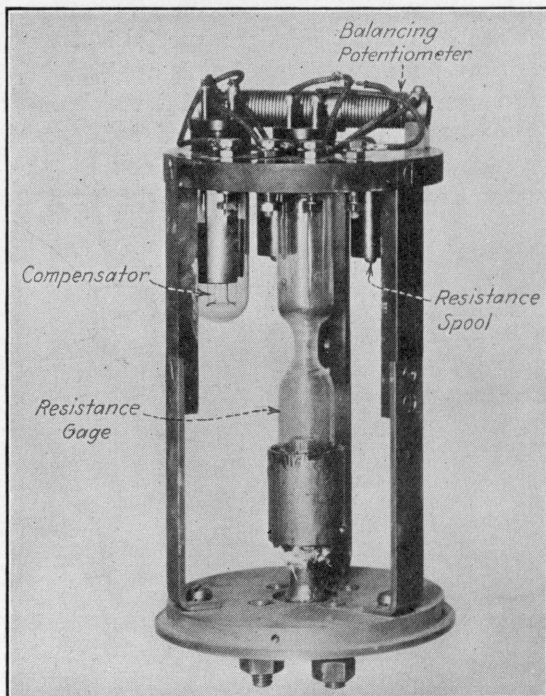

FIG. 130.—General Electric hot-wire vacuum gage.

The vacuum-regulating galvanometer shown in Fig. 131 has three contacts, two for regulating the vacuum in the rectifier and one for its protection against too low vacuum. A small synchronous motor and a cam mechanism operate the contacts at regular intervals, usually 30 sec. For further information on the operation of these devices see Chap. XI.

**Ionization and Glow-discharge Gages.**—These types of gages have not as yet found any practical applications in steel-enclosed rectifier installations, and the reader is therefore referred to (362) where a short description of such gages is given.

One such method is based on the principle that there is a definite relation between the vapor pressure in the rectifier

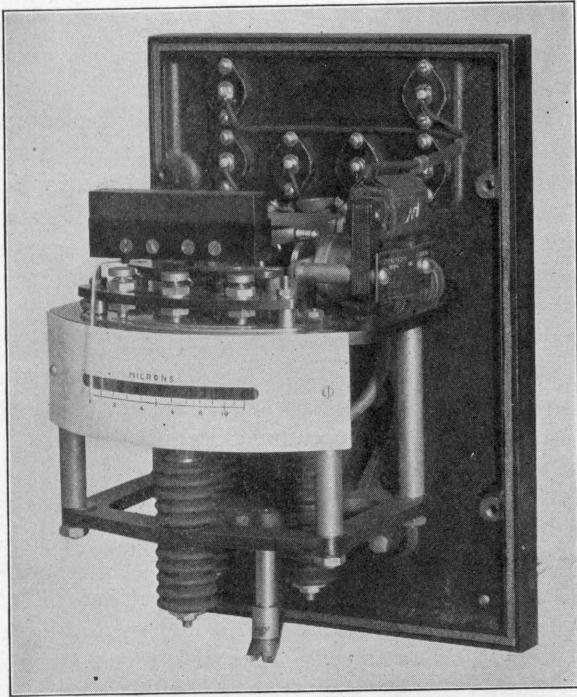

FIG. 131.—Contact-making galvanometer (vacuum regulator) for General Electric hot-wire gage.

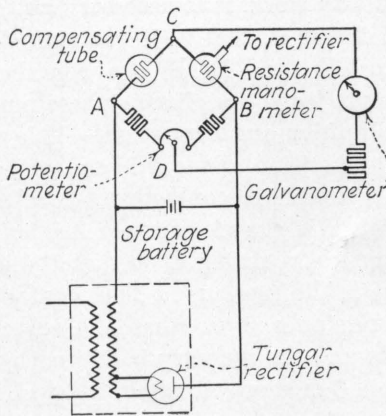

FIG. 132.—Connection diagram of General Electric hot-wire gage.

cylinder and the electrical conductivity of mercury vapor. The arrangement consists of a small auxiliary transformer furnishing alternating current to an auxiliary anode, and a connection made to a voltmeter which can be calibrated to read directly in millimeters of pressure. The principle as well as the equipment is very simple. The indications of the apparatus are not altogether independent of the rectifier load, however, and the application of this device has thus far not proved successful commercially.

Another such method is based on practically the same principle, but uses an arc gap in the above-mentioned circuit. At low pressures the gap offers infinitely high resistance, while at high pressures a discharge can traverse the gap and the flow of electricity in the circuit can then be used for operating a meter calibrated in degrees of vacuum. This scheme, although relatively very simple, has the same drawbacks as the last one mentioned above.

#### IGNITION AND EXCITATION

In order to start a rectifier a cathode spot has to be produced on the surface of the cathode. In a glass rectifier this is accomplished by tilting the whole glass bulb, which establishes a circuit between the ignition anode and the cathode and strikes an arc when interrupting this circuit.

This could not be done in the case of large steel rectifiers, and other methods have to be used. Furthermore, in order that the main anodes may operate at the very low loads which sometimes occur in railway work, it is necessary not only to start an arc but also to maintain it, that is, to maintain the cathode spot at those very small loads. Below are described a number of typical arrangements for accomplishing these purposes.

**Direct-current Ignition and Excitation.**—This system is shown in Fig. 133*a*. The ignition anode 1 is connected by a metallic rod to plunger 2, which is controlled by solenoid 3. When push-button switch 7 is closed, solenoid 3 is energized, pulling down plunger 2 against a spring 4, so that the ignition anode 1 makes contact with the mercury. This contact short circuits solenoid 3 and resistance 6, so that the current which flows through the anode and the mercury is limited by a resistance 5. As soon as solenoid 3 is short circuited, anode 1 is pulled out of the mercury into its initial position, about one inch above the surface of the mercury, by spring 4. This operation strikes an

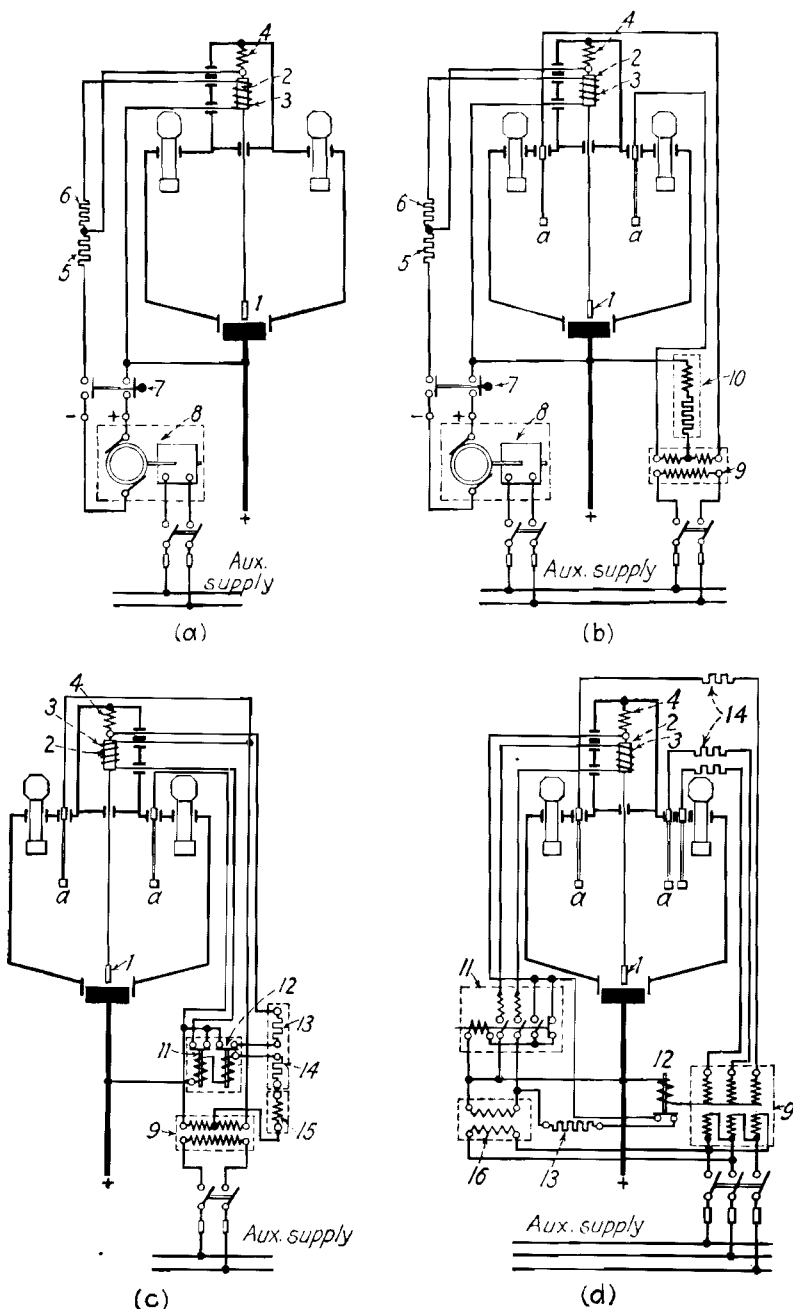

FIG. 133.—Connection diagrams of four types of ignition-excitation systems.



arc between the mercury and anode 1, thus producing a cathode spot. As long as the circuit is closed by switch 7 an excitation arc is maintained. If the load is of a nature that an excitation arc is not necessary, switch 7 may be opened again after the rectifier has started to carry the load. Only a few seconds are required to establish an arc, and the resistances in the circuit and the resistance of the solenoid are so adjusted that the maximum current which can flow when the arc is struck is about 5 amp. at 116 volts. This ignition current is furnished by a small converter set 8, which is a part of the auxiliaries of a rectifier station, when direct-current ignition is used. It comprises an induction motor directly connected to a direct-current generator, the latter being insulated from the bed-plate and from the motor; the insulation from the motor is effected by an insulating coupling. Some manufacturers design this converter set for 90 or 65 volts, and 12 to 15 or 5 to 7 amp., respectively. Some makes have a differential compound winding, which gives a voltage characteristic of 90 volts at no load to 20 volts at full load.

Direct-current ignition and excitation systems, similar to that described above, are shown in the diagrams of Figs. 134 and 146.

In Fig. 134 are shown the connections of a rectifier of the Allgemeine Elektrizitäts Gesellschaft. This rectifier has 12 anodes and is connected to a 6-phase, fork-connected transformer. Two anodes of the rectifier operate in parallel on each phase, and anode reactors are used to divide the load equally between each pair of anodes.

Ignition and excitation is effected by direct current furnished by a separate converter for each cylinder. This converter consists of a 3-phase motor, a direct-current generator, and an exciter for the latter. The generator is counter-compounded and delivers a no-load voltage of 110 volts which drops to 16 volts at a full-load current of 10 amp. No excitation anodes are provided; when, however, the rectifier is required to run at no load at frequent intervals, the ignition converter is continuously operated. During such times as the rectifier carries a considerable load almost continuously, the converter is disconnected, and is only started up by an automatic ignition device whenever the rectifier arc is extinguished.

The ignition relay consists of an electromagnet magnetized by a voltage coil, between the poles of which is suspended a

copper loop which carries part of the load current. When the load current drops to a small value or to zero, the loop closes the right-hand contact of the relay, actuating relay *A* which in turn operates relay *C*, starting the motor-generator set. When the voltage of the exciter has built up, relay *B* closes its contacts, applying the generator voltage to the ignition anode and sole-

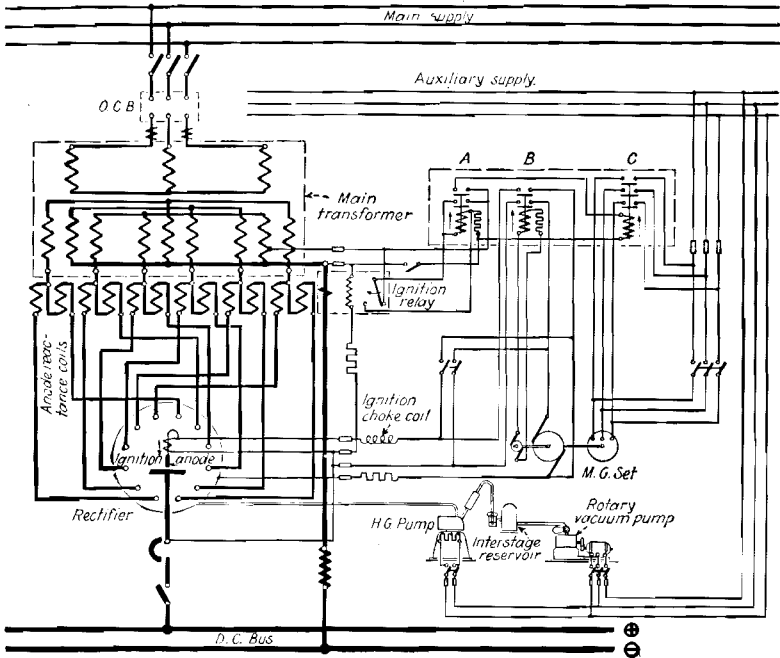

Fig. 134.—Connection diagram for a rectifier unit of the Allgemeine Elektrizitäts Gesellschaft (Germany), showing equipment and circuit for igniting arc.

noid. The ignition solenoid withdraws the ignition anode from the mercury, starting an arc. When the load current is increased, the left-hand contact of the ignition relay is closed, short-circuiting the coil of relay *A*. This causes relay *C* to open, disconnecting the motor-generator set from the auxiliary supply. Knife switches are provided for operating the ignition system manually when desired; these switches are open when the ignition is operated automatically.

Another ignition and excitation scheme is illustrated in Fig. 137. The only material difference in this scheme lies in the pro-

vision of a small glass rectifier for the ignition and excitation supply.

**Direct-current Ignition and Alternating-current Excitation.**—The method of ignition and excitation as described above caused considerable trouble due to the surges produced by the sudden interruption of the arc, which affected the commutation of the small converter set. In order to overcome this trouble to some extent, the method described below was developed. Ignition is effected in the same way as in the first method. The excitation, however, is accomplished by two excitation anodes supplied by a single-phase transformer. The diagram of connections is shown in Fig. 133*b*. The single-phase transformer 9 and the two excitation anodes *a, a* constitute a single-phase, full-wave rectification system, which supplies a small load 10, consisting of a resistance and a reactance.

**Alternating-current Ignition and Excitation.**—The most satisfactory method for igniting and exciting a rectifier is shown in Fig. 133*c* and in Fig. 86. The energy is taken from the station auxiliary alternating-current supply for both the ignition and the excitation circuits. The starting of the rectifier is, therefore, effected by only one operation, the closing of a switch connecting the ignition-excitation set to the auxiliary supply. When the primary switch of the auxiliary transformer 9 is closed, solenoid 3 is energized by the secondary of the transformer through the contacts of relay 11, pulling the ignition anode 1 down until it touches the mercury cathode of the rectifier. As soon as the contact is made between the ignition anode and the mercury, the circuit from the left-hand terminal of the transformer secondary through contacts of relay 12, resistance 13, ignition anode, cathode, coils of relays 11 and 12, resistance 14, choke coil 15, to the midpoint of the auxiliary transformer secondary, is completed. The current flowing in this circuit causes relay 11 to open its contacts, de-energizing coil 3 (but due to higher setting, relay 12 is not operated), whereupon the ignition anode is drawn up by the spring, striking an arc at the point of rupture with the mercury. Since the excitation anodes *a, a* are energized through the secondary of the auxiliary transformer 9, an arc is started between them and the cathode. The excitation current flowing from the cathode through the coils of relays 11 and 12, resistance 14, choke coil 15, to the midpoint of transformer 9, now causes relay 12 to open its contacts, thus interrupting the circuit to the

ignition anode. The contacts of relays 11 and 12 remain open as long as the excitation arc exists; should this arc be extinguished the contacts will be closed, and the ignition process will be repeated. The time required for putting a rectifier into service by means of this method is about 1 or 2 sec. The arc from the main anodes starts immediately after ignition, as soon as the load is connected to the rectifier.

The ignition of a rectifier with the system of Fig. 133c is recorded in the oscillogram of Fig. 135. The middle curve shows

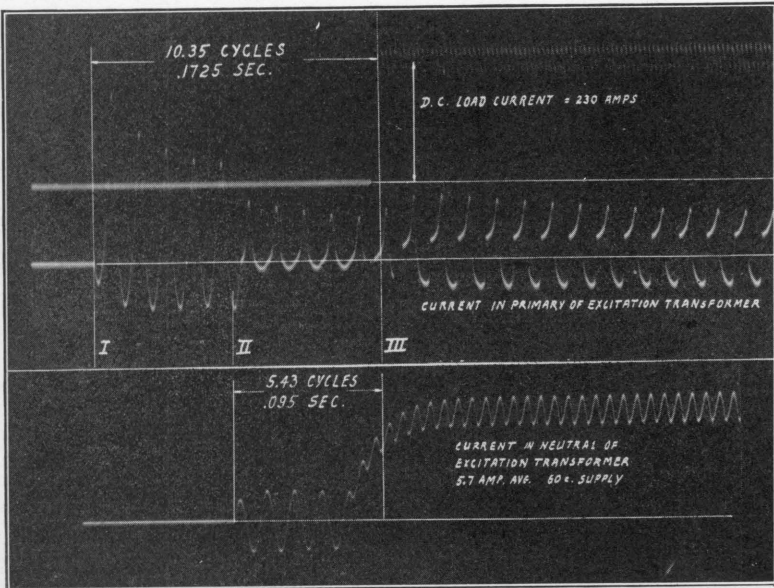

FIG. 135.—Oscillogram showing ignition of arc in rectifier with ignition and excitation system of Fig. 133c.

the current in the excitation transformer primary, while the upper curve shows the load current of the rectifier. The lower curve shows the current in the neutral of the excitation transformer, namely, the ignition and excitation currents, respectively. At point I the switch connecting the excitation transformer to the auxiliary supply is closed, and an alternating current with a transient component flows in the primary, due to the energizing of ignition solenoid 3. At II the ignition anode makes contact with the mercury of the cathode, and at III the main anodes pick up the load. The building up of the excitation current can

be seen very clearly in the lower curve, taking place after four cycles. The total time which elapsed from the moment the excitation transformer was connected to the auxiliary supply, until the main anodes picked up the load was only 10.35 cycles, or 0.1725 sec., and the time which elapsed from the instant the ignition anode struck the mercury cathode until the excitation anodes picked up was four cycles.

As can be seen from Fig. 86, the switch of the excitation transformer is usually interlocked with the primary circuit

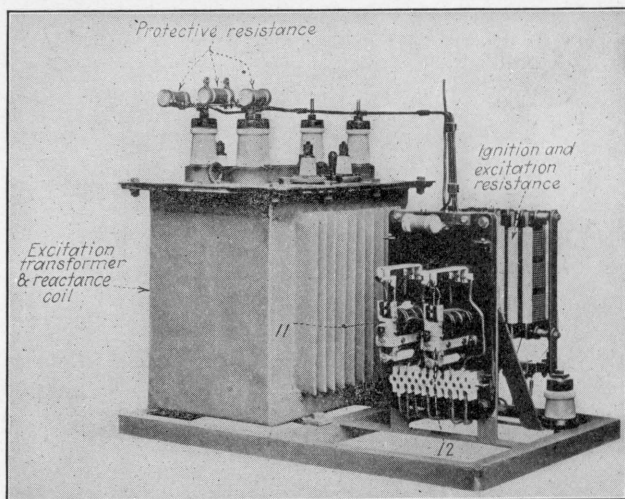

FIG. 136.—Brown Boveri ignition and excitation set, of the type shown in Fig. 133c.

breaker of the rectifier transformer, so that as soon as the main breaker is closed the excitation transformer is also energized and ignition and excitation take place automatically, practically instantaneously. The capacity of the transformer supplying the excitation current is about 1.5 kva., and the voltage of the secondary is  $2 \times 116$  volts. A reactance coil is used in order to reduce the undulations in the excitation current, and a resistance is provided to limit its magnitude. Both the reactance coil and the excitation transformer are located in one tank, together with the transformer for the heating plate of the vacuum pump. A complete ignition and excitation outfit of the type described above is shown in Fig. 136.

In Fig. 133*d* is shown the diagram of connections of an alternating-current ignition and excitation system, for a rectifier provided with three excitation anodes, which are connected to a three-phase auxiliary alternating-current supply.

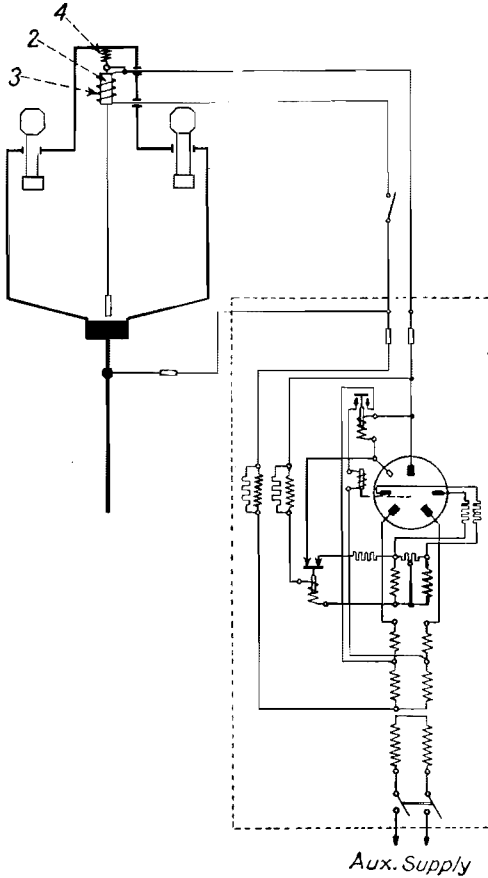

FIG. 137.—Connection diagram of direct-current ignition system, using an auxiliary rectifier for supplying power to the ignition circuit.

For further information in regard to operation in conjunction with automatic plants, the reader is referred to Chap. XI, where complete diagrams of connections are given.

The construction of the auxiliary anodes, and the ignition rod and solenoid, is given in Chap. VII.

Recently new schemes were developed for establishing a cathode spot. One of them is explained in Chap. VII. The method used for operation is practically the same as used in the schemes shown above.

### COOLING APPARATUS

The mercury arc rectifier being a stationary converter, there are no mechanical rotating parts to carry away the losses by natural ventilation, as with rotary converters. The heat produced in the rectifier must therefore be dissipated by external means. In Chap. II reference was made to the losses produced by the voltage drop in the arc. The surface of the rectifier cylinder will usually be found to be too small to enable the rectifier to transfer the liberated heat to the surrounding air without exceeding the permissible temperature. The admissible temperature of the anode plate of the rectifier is usually limited to between 50 and 75° C., depending on the size and make.

The standard practice is to carry away the losses by means of water. A small part of the losses, however, will be dissipated from anode radiators and the cylinder walls. In Chap. VII (Fig. 100), the arrangement for leading the water through the cylinder was described, and this section will be confined only to the external cooling equipment.

In considering the various cooling systems and the quantity of water required for cooling, the following points must be taken into account:

1. The losses produced in the arc. These losses may be converted from electrical to thermal units by the expression

$$\text{kilogram-calories per hour} = I \cdot e_a \times 0.86$$

in which  $I$  is the direct current, and  $e_a$  is the voltage drop in the rectifying arc.

2. The area of the surface of the cylinder and its temperature.
3. The ambient temperature, the altitude, and other local conditions.
4. The inlet and outlet temperatures of the water.

The heat to be carried away by the water will be from 50 to 90 per cent of the heat liberated, depending on the conditions enumerated above. One kilowatt loss will raise 3.8 gal. of water 1°C. per minute. Thus, for example, in a rectifier cylinder carrying a load of 1,000 amp. and having an arc voltage drop of 20 volts, there will be needed 3 gal. cooling water per minute, if the inlet temperature is 20° C., and the outlet temperature is

45° C., or a temperature rise for the water of 25° C. If the heat dissipation due to radiation and convection is taken into account less water than specified above will be required. An approximate figure for cooling water required in practically all makes of rectifiers at an inlet temperature of 15° C. is  $\frac{1}{5}$  to  $\frac{1}{3}$  gal. per hundred amperes of current per minute.

There are at present four methods of cooling in use, all using water as a cooling medium:

- Direct cooling by means of a continuous water supply.
- Indirect cooling by means of a continuous water supply.
- Recirculating cooling by means of natural or forced draft.
- Combined forced draft and tap-water cooling.

**Direct Cooling.**—This method of cooling is usually the simplest and cheapest. The water may be taken from a water main or

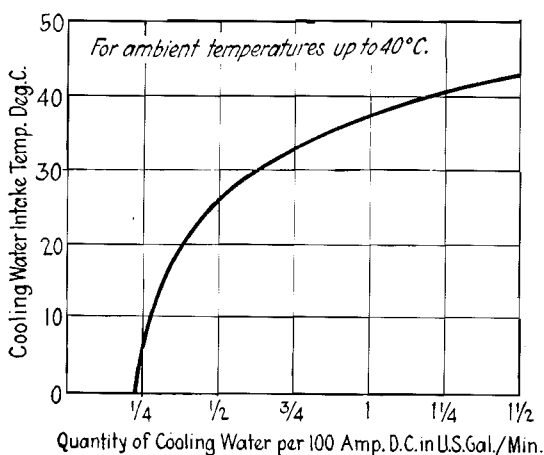

FIG. 138.—Curve showing cooling water requirements of a rectifier for different inlet temperatures.

well, circulated through the rectifier, and then discharged into a drain. The amount of water required for different inlet cooling water temperatures for an ambient temperature up to 40° C. is shown in Fig. 138. In order to reduce the water consumption during periods of light load the flow of water may be regulated by a thermostatically controlled water valve, set for the temperature at which it is desired to have the water discharge. In this way no more water will be used than is required to prevent the temperature of the rectifier from exceeding the desired operating



range. Such a cooling arrangement is shown schematically in Fig. 100*b*, and, with a somewhat different thermostatic regulating valve, in Fig. 139. Figure 100*a* shows an arrangement with a thermostatic electrical control. In Fig. 140 is shown a

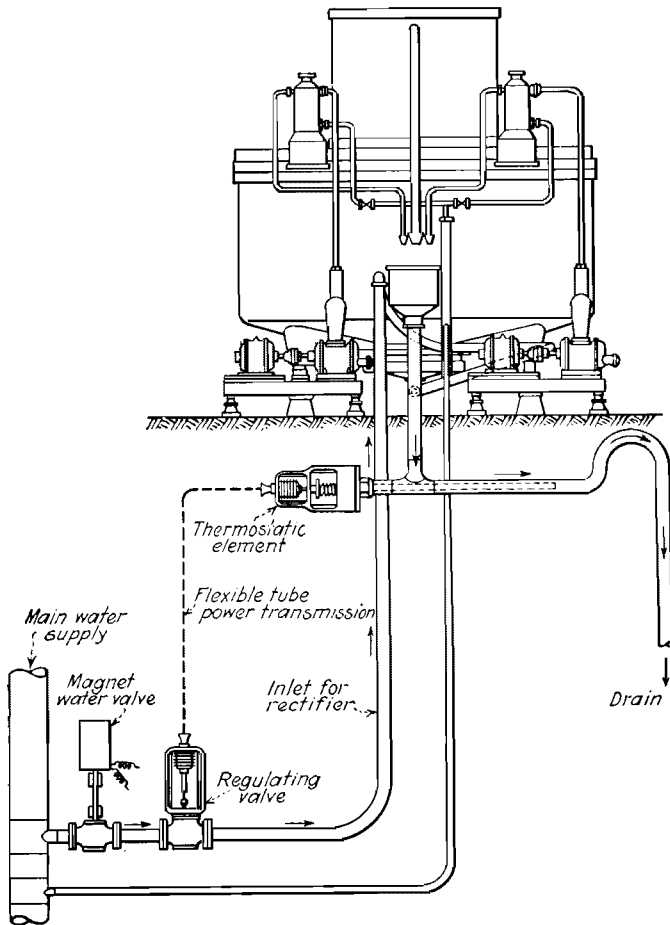

FIG. 139.—Direct (tap-water) cooling system of rectifier and vacuum pumps. The water flow is regulated by a thermostatically-controlled regulating valve. The magnet water valve is used for starting and stopping the flow of cooling water in automatic or remote-controlled stations.

thermostatic regulating valve. The hot water from the rectifier passes over the thermostatic element which is filled with a volatile liquid. The temperature variation causes this element to

expand and contract according to the temperature. The movements of this element regulate the opening of the valve in the water inlet pipe of the rectifier.

**Indirect Cooling.**—If the water contains acids or other impurities which may cause corrosion of the cylinder, or clogging of the water pipes, the water cannot be used directly for cooling the cylinder. In such a case the rectifier may be cooled by a closed water-cooling system, the water of which is cooled indirectly by the available water supply. The arrangement is usually such that the supply water flows through a special cooler, arranged on the counter-flow system, while the rectifier is indirectly cooled by water maintained in circulation through the rectifier and the cooler by means of a rotary pump. In this way the deposits are all collected in the cooler which can easily be cleaned without interrupting the operation of the rectifier.

**Recirculating Cooling.**—This system is used where there is no available continuous water supply or where the water contains impurities, in order to avoid electrolysis, particularly at higher direct-current voltages. Such a type of cooling system is comparatively expensive and consists of a water-cooling radiator, a motor-driven cooling fan and a motor-driven water-circulating pump, with the necessary control equipment and piping. The fact that the maximum temperature of the cooling air may rise above  $30^{\circ}\text{C}$ . in most localities limits the available temperature difference within which to operate the cooling system, and therefore necessitates the circulation of large quantities of both air and water in their respective paths to reduce the temperature rise and retain as great a temperature difference as possible for the transfer of heat in the radiator. Since the air temperature is usually taken as  $35^{\circ}\text{C}$ ., and since the permissible temperature of the rectifier is between  $50$  and  $60^{\circ}\text{C}$ ., the temperature gradient in the cooler itself is about  $15$  to  $25^{\circ}\text{C}$ ., which is relatively small and therefore necessitates a comparatively large equipment.

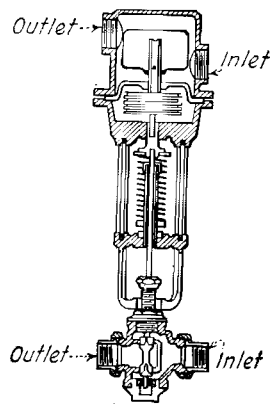

FIG. 140.—Direct-acting type of thermostatic regulating valve (see Fig. 100b).

The arrangement of such a system with a water cooler in connection with a cooling fan is illustrated in Fig. 141. The radiator unit and fan are shown located in the basement below the level of the rectifier. The cooler could also be located at the same or at a higher level than the rectifier. The radiator, water pump, and the entire piping system are insulated from the ground, in order to minimize corrosion caused by leakage current. The fan motor is insulated from the fan by an insulating coupling,

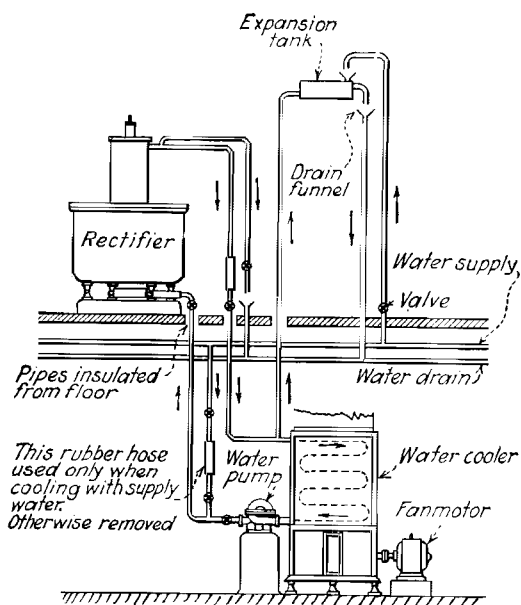

FIG. 141.—Forced-draft type recirculating water cooling system for rectifiers.

while the pump motor is insulated from the pump by a similar coupling. An expansion tank is provided to keep the water system primed and is located at a higher level than the rectifier. The rectifier cylinder itself is provided with an overflow pipe which is used so that the air can escape when the cooling system is being filled. This opening is closed during normal operation. The cooling system is refilled, to make up for evaporation, through the expansion tank. Provision is made for connecting the cooling system directly to the tap-water supply by means of a removable rubber hose, so that the rectifier can be cooled directly by fresh water if the recoler is out of service for inspection or repairs.

In Fig. 143 are given the details of a recoler. An installation with this type of cooler, of Brown Boveri manufacture, is shown in Fig. 144. Each cooler has a capacity of approximately 30,000 kg.-cal. per hour at a temperature difference of 20° C. The air outlets from the radiator units are provided with shutters, so that the hot air may be discharged to the inside of the building, for heating purposes in winter.

Another type of cooler used with rectifiers is shown in Fig. 145.

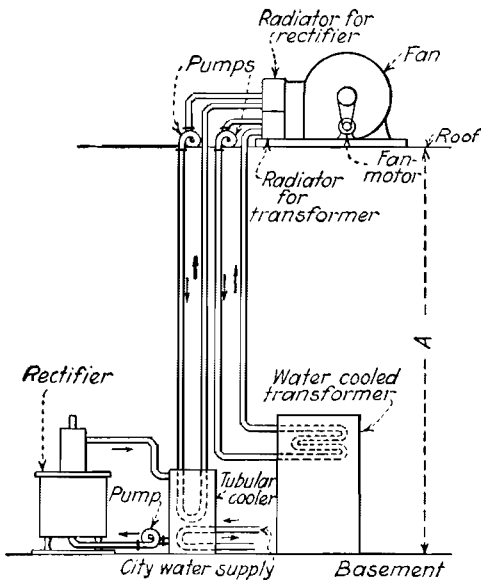

FIG. 142.—Forced-draft type water cooling system for rectifier and transformer located in the basement of a high building, with the recoler on the roof of the building.

**Combined Forced-draft and Tap-water Cooling.**—In order to reduce the size of the recoling unit, a combined forced-draft and tap-water cooling system may be used. With such a system, the recoler operates during periods of light load, while during periods of heavy load tap water is added. The arrangement of the apparatus and piping is similar to that shown in Fig. 141.

**Special Cooling System.**—The system shown in Fig. 142 is probably the one best suited for a rectifier installation in a large building, where space is limited and difficulties are encountered with the proper ventilation of the equipment. Since the heat

produced in the rectifier and transformer is dissipated by water, practically no ventilation of the substation is necessary, and all expensive air ducts are eliminated. The rectifier is located in the basement, while the cooling equipment, consisting of a radiator and fan, is on the roof of the building. The height  $A$  may be 300 ft. or more. A jacket water cooler, used for reducing the pressure on the rectifier cylinder, is located in the basement.

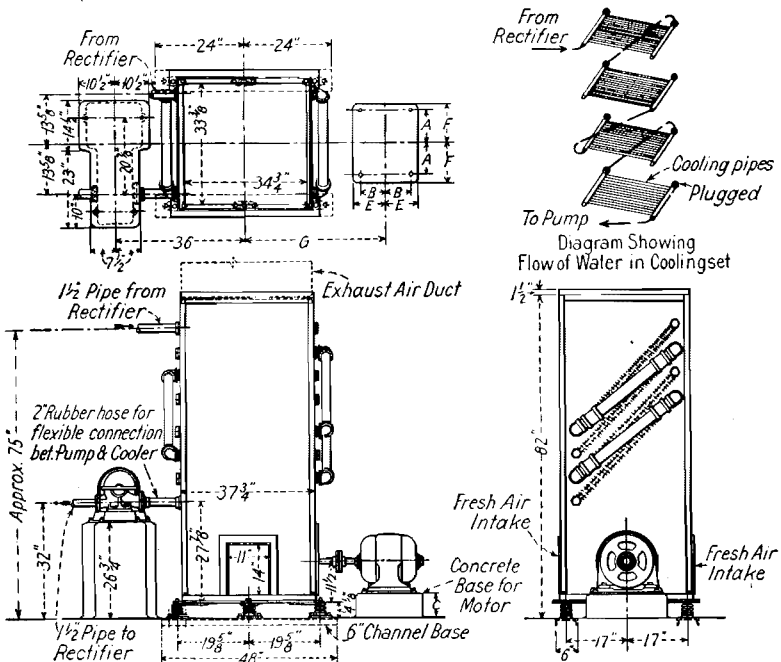

FIG. 143.—Forced-draft type water cooler for a 2000-amp. rectifier.

The transformer, located in the basement, is also water cooled, and the water used for cooling it is cooled also by the forced-draft unit on the roof.

**Cooling Water.**—If the rectifier is used on systems in which the negative pole is grounded, as in most of the railway systems of this country, the rectifier cylinder is at full direct-current potential to ground. Therefore, if the rectifier is cooled by a grounded cooling system, such as by city water, there is a leakage current from the rectifier to the ground through the connection formed by the cooling water from the tank to the ground. Even

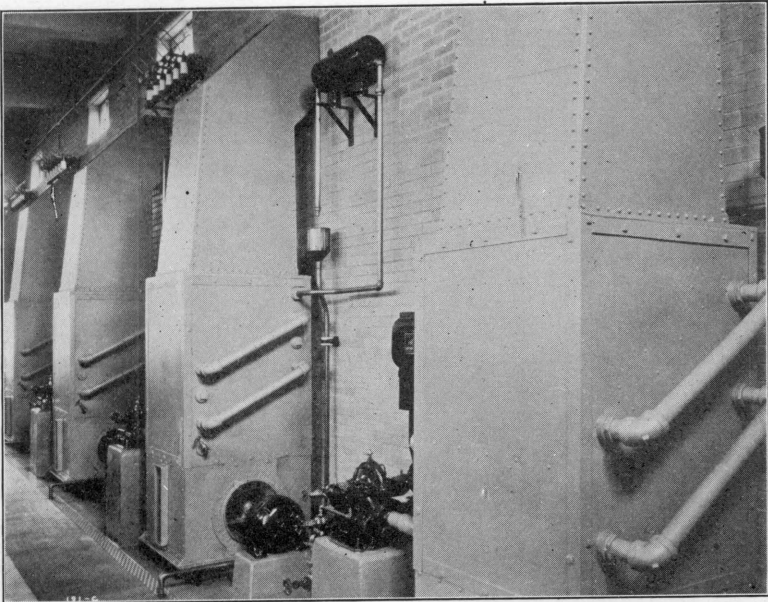

FIG. 144.—Forced-draft type water cooler used with Brown Boveri rectifiers in the Congress Street substation of The Connecticut Company.

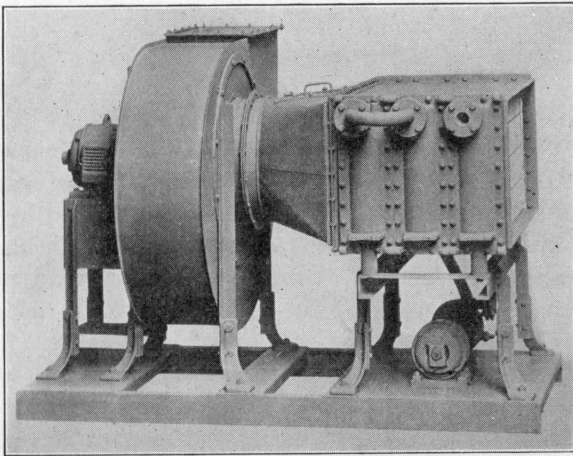

FIG. 145.—Brown Boveri forced-draft recooling unit for rectifiers.

if the rectifier is connected to the ground by a rubber hose, and if the water is relatively pure, there is always some leakage current. The magnitude of the leakage current is equal to the ratio of the direct-current voltage to the resistance of the water column from the rectifier to the ground. If the rectifier is cooled by city water and the drain water is discharged to a drain pipe which is also at ground potential, there are two paths for the leakage current to ground, one at the water intake of the rectifier and the other at the water outlet from the rectifier to the drain pipe.

The presence of the leakage current in the water dissociates the water molecules into hydrogen and oxygen ions. The oxygen ions carrying the negative charges are attracted to the intake or outlet of the cylinder which are at a high potential, and combine with the iron of the cylinder, forming iron oxide, which constitutes corrosion. If the water happens to contain free chlorine or chlorine compounds which may dissociate in water in the presence of an electric current, the chlorine will take on a negative charge and will also combine with the iron, forming iron chloride. Since the mercury vacuum pump is metallically connected to the rectifier cylinder, it is also at the same potential as the rectifier, and if cooled by a grounded cooling system corrosion will take place, similar to that at the rectifier cylinder, although to a lesser degree, due to the fact that the cross-section of the water is considerably smaller. The leakage current can be limited to a harmless value by using a sufficiently long rubber hose. The corrosion is less at the water outlet from the rectifier because there is a free discharge in open air into a funnel, while at the water inlet to the rectifier the rubber hose cannot act as a perfect insulator, because of slight conduction along its inner surface. Sediment deposited on the inner surface assists this conduction. Corrosion can of course also be entirely eliminated by using a recooling system, of the type shown in Fig. 141. Such a cooling system is advisable in any case for direct-current voltages of over 1,500 volts, because an excessively long hose would be necessary to reduce the leakage current to a proper value.

If the positive pole of the direct-current system is grounded corrosion of the rectifier cannot occur because the rectifier cylinder is then at ground potential and there can consequently be no leakage current to ground.

From tests and experience gained over a period of several years on several hundred installations, it has been found that

for minimum corrosion the cooling water should have the following characteristics:

Maximum total hardness (English degrees)..	17.5
Maximum total hardness (German degrees).	14.0
Maximum total hardness (French degrees)..	25.0
Maximum content of chlorides, sulphates, and nitrates, calculated as residue of chlor- ide, sulphate, and nitrate, by weight. . . . .	0.85 part in 100,000
Maximum residue of chloride alone. . . . .	0.65 part in 100,000
Minimum specific resistance. . . . .	2,000 to 2,500 ohms per cubic centimeter

To determine the suitability of the cooling water, it is desirable to know the following data:

- Evaporation deposit.
- Ash deposit.
- Total hardness.
- Temporary hardness (alkalinity).
- Constant hardness.
- Chlorine content.
- Sulphate content.
- Nitrate content.
- Sodium and potassium content.
- Specific resistance in ohms per cubic centimeter.

If the water has the characteristics specified above, it may be used directly, with no harmful results to be expected; otherwise an indirect or a forced-draft cooling system must be used.



## CHAPTER IX

### OPERATION OF MERCURY ARC RECTIFIERS

The operation of manual and automatic rectifier plants and their protective devices will be explained in a later chapter. The operation of the rectifier auxiliaries was described in the preceding chapter. In this chapter will be described the methods of preparing a rectifier for operation, the setting to work of a rectifier, its maintenance, and the parallel operation of rectifiers.

In order to put a rectifier cylinder into the proper condition for carrying load it has to undergo a certain forming process, in addition to being evacuated. A part of this process is usually carried out in the factory and the remainder on site, when the rectifier is being set up.

#### FORMING PROCESS AND SETTING TO WORK

As pointed out above, a vacuum must be established in the cylinder, and a so-called "forming" or "bake-out" process must be applied to the rectifier.<sup>1</sup> The purpose of this bake-out process is primarily to expel the gases occluded in the parts of the rectifier exposed to the rectifying arc and the vacuum, particularly the anodes. In the term "gases" are included actual gases, as well as moisture, grease, and any other impurities in the rectifier which would affect the vacuum. The bake-out, which is done partly in the factory, consists, in general, of heating the tank and the parts exposed to the vacuum to a temperature higher than that obtained during normal operation, and at the same time evacuating the tank by means of the vacuum pumps. During this process the materials of which the rectifier is made expand, and the gases, etc. are given off and carried away by the action of the pumps. Consequently, if, during regular operation thereafter, the rectifier is kept at a temperature lower than that used during forming, only a very small amount of gases will be liberated by the rectifier parts at normal loads, which will be taken care of by the vacuum pumps without affecting the regular

<sup>1</sup> The term "degassing" is also used to describe this process.

operation of the rectifier. The time required for this forming process depends on the design of the rectifier, the kind of materials used, as well as on the method by which the process is carried out.

In order to conduct this forming operation with any power supply that may be available, special devices are needed, such as variable heating resistances, bake-out transformers, some additional switching equipment, etc.

**Forming or Bake-out.**—The greater part of the forming process is done at the factory, where the rectifier is first thoroughly cleaned by scouring with alcohol, then dried, and finally baked out by means of electric current.

Various schemes were tried out to facilitate and hasten this forming process. This preparation is of the greatest importance, as without it the occluded gases, etc. can either not be expelled at all, or then only with the greatest difficulty and very slowly.

In order to shorten the forming process, it is important that first all moisture and gases be removed from within the tank. This is accomplished by heating the rectifier, either by hot water circulated through the water jacket or by an electric heater placed inside the cylinder. If a heater is used, the current is gradually increased, until the anode plate has a temperature of 70 to 80°C. This process is continued for about 24 hours while the vacuum pump is operating continuously throughout this period, removing the moisture and gases from the cylinder.

During the drying-out process, as well as during the subsequent forming with electric current, preferably both a hot-wire and a McLeod vacuum gage are used. In installations where the McLeod gage is not used for normal operation a portable gage is supplied which is connected to the vacuum piping during the forming and is later disconnected.

By using the two gages it is possible to determine the extent to which the moisture has been removed from the cylinder for the following reasons: The McLeod gage measures only the pressure of the non-condensable perfect gases, while the amount of water vapor is not measured because the water vapor which was trapped in the measuring tube of the gage is compressed and condensed when the mercury is admitted into the tube. The hot-wire gage, on the other hand, measures the pressure of both the vapors and the perfect gases, so that the difference in the readings of the two gages is more or less a measure of the water vapor in the cylinder.

When the water vapor has been sufficiently evacuated, so as to make it possible for the rectifier to carry current, the forming is begun by passing current through the rectifier.

The means used for this stage of the forming depend on the conditions prevailing in the substation. If direct current is available the rectifier may be formed by loading each anode

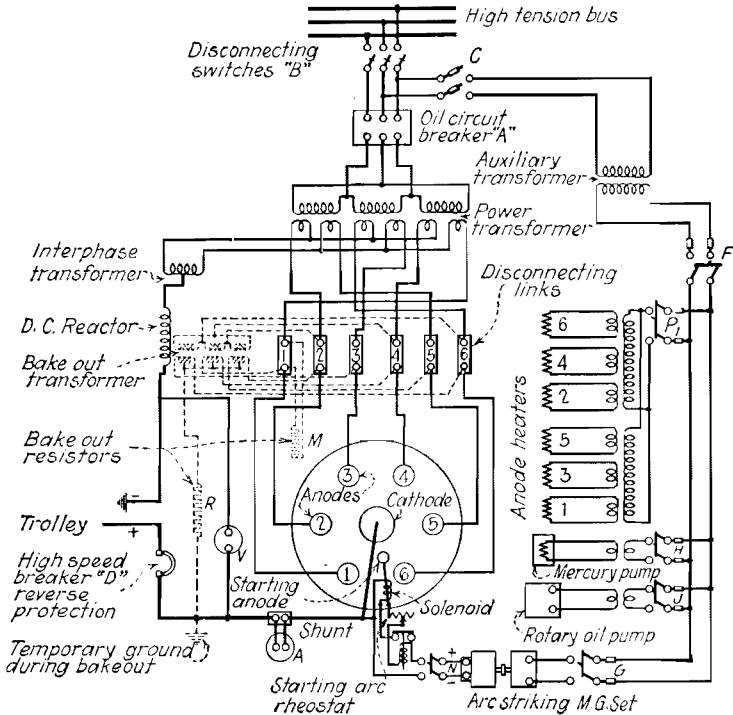

FIG. 146.—Diagram of connections of General Electric rectifier unit, showing connections of bake-out transformer and resistances (dotted lines).

individually with grid resistors or any other resistance available in the installation. An arc is started successively between each anode and the cathode, the current being started at a low value and gradually increased by any kind of a variable resistance. This process, however, requires considerable time, since each anode has to be treated in succession.

After all the anodes have thus been formed at light loads the rectifier is connected to the main transformer and the forming process is completed with 6 or 12 phases by connecting the recti-

fier to the direct-current system. In other words, this stage of the forming process consists of a regular operation of the rectifier under carefully controlled conditions and with a gradually increasing load.

**Forming Transformer.**—The best and quickest way to form a rectifier, however, is to use a special forming transformer, rated at about 150 to 200 kva. The purpose of this transformer is to control the input, reduce the voltage supplied to the anodes to about 50 to 90 volts or 50 to 300 volts, respectively, depending on the make of rectifier, and thus to control the load. As a load for this forming a water rheostat or any other resistance may be used. The forming transformer consists of a 3-phase primary and a 3-, 6-, or double 6-phase secondary. It is provided with means for changing the connections in order to vary the voltage. The primary of such a forming transformer is connected to three phases of the rectifier transformer secondary, as can be seen in Fig. 146. This figure shows the connections of a six-anode rectifier installation of the General Electric Company. The connections of the forming transformer are shown in dotted lines.

In Fig. 147 is shown a typical diagram of connections of a forming transformer which can be used for the forming of rectifiers of various direct-current voltages from 600 to 1,500 volts, and which can be connected for single-, 3-, 6-, and double 6-phase forming.

**Forming Transformer Connections.**—The primary of this transformer is connected to any three secondary phases of the rectifier transformer which form an equilateral 3-phase system. The primary is arranged for either series or parallel connection of the windings. For installations of 600 volts direct current or less the parallel connection is used. For higher voltages, up to

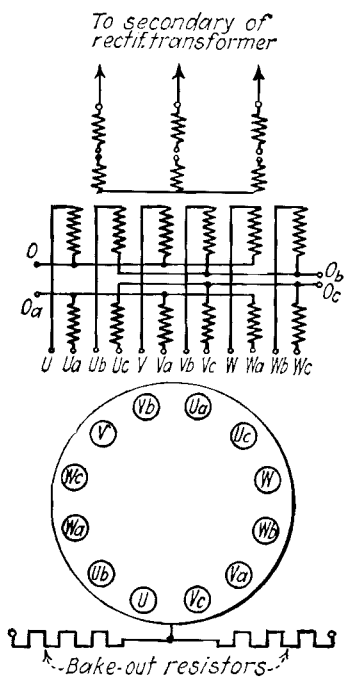

FIG. 147.—Connection diagram of Brown Boveri forming transformer for rectifiers.

1,500 volts direct current, the series connection is used. Both connections give a secondary phase voltage suitable for forming the rectifier.

*Single-phase Forming.*—During the preliminary steps of “current forming,” the anodes are successively subjected to single-phase, half-wave forming. For that purpose the anode to be treated is connected to any secondary terminal of the forming transformer, such as  $U$  (Fig. 147). The cathode is connected to the neutral  $O$ , through the bake-out resistors.

At first, considerable difficulties may be experienced in making the anode pick up the arc. In this case the voltage must be increased by connecting the resistor to another phase, say  $V$ , instead of to the neutral, thus giving  $\sqrt{3}$  times the phase voltage of the forming transformer.

When the forming process requires more current than can safely be carried by a single winding of the transformer, two parallel phases, such as  $V$  and  $V_b$  may be connected to one anode.

*Six-phase Forming.*—After the single-phase forming of each anode, the rectifier is ready for 6-phase forming. Alternate anodes are connected to a 6-phase system, say  $U$ ,  $U_a$ ,  $V$ ,  $V_a$ ,  $W$ , and  $W_a$ . The neutrals  $O$  and  $O_a$  are connected to the bake-out resistors. It is likely that not all six anodes will pick up at once, but if after a reasonable time they cannot maintain an arc it may be found necessary to repeat the single-phase forming.

If all the windings of the transformer are needed to carry the current in 6-phase forming of a 12-anode rectifier, the two sets of six anodes must each be formed alternately, each anode in operation having two parallel windings of the transformer connected to it.

*Double 6-phase Forming.*—When double 6-phase forming is possible, the secondary terminals of the forming transformer are connected to the correspondingly marked anodes, as in the regular rectifier transformer connection. The neutrals  $O$  and  $O_a$  are connected to one bake-out resistor, and  $O_b$  and  $O_c$  to the other resistor shown in the diagram (Fig. 147).

A separate resistance is necessary for each 6-phase system in order to make all the anodes carry current. If a single resistance were used there would be a possibility that six anodes, connected to one of the 6-phase systems, would either carry a higher current than the other six, or would take the entire current. This

would result in unequal forming of the anodes, and possible overloading of some of the anodes.

It is desirable to form a rectifier with a forming transformer of lowest possible voltage in order to reduce the size of the loading resistance and the power consumption used for forming. Before a rectifier is formed it is often difficult for the anodes to ignite and to operate stably at low voltages. To overcome this difficulty, six anodes may be connected to a source of higher voltage, such as the secondary of the rectifier transformer, and be operated at low currents, while the other six are connected to a forming transformer of low voltage and are operated at higher currents, as required for forming, on a separate loading resistance. The six anodes operating at the higher voltage act as excitation anodes, facilitating the ionization of the mercury vapor and thus making possible stable operation of the anodes being formed. To form the other six anodes the connections are interchanged.

It is, however, not necessary to use a forming transformer in an installation where it is possible to regulate the primary voltage by means of a step-down transformer or an auto-transformer, or by using some additional transformer that may be available in the installation.

**Forming after Inspection and Repair.**—Should the rectifier have to be opened on site for any reason after a period of operation, it will be necessary to repeat the forming process to some extent, depending on the length of time the rectifier was open. If the time was not very long, and the rectifier was in operation for a considerable period, the rectifier can usually be put back on the line after evacuating the cylinder, without any forming whatsoever. However, it will be necessary that a close check is kept on the vacuum, and that very little load is put on the rectifier at first. Since most installations usually run at light loads during the night such a procedure should be done preferably during the night. If the rectifier transformer is provided with taps this forming should be done by using the tap giving the lowest direct-current voltage.

If the system is such that the load on the rectifier can be regulated the rectifier may be formed directly on the system at full direct-current voltage. With this method of forming greater care must be taken regarding the vacuum to prevent internal short circuits, and the process should be carried out only by very experienced operators.

**Forming Phenomena.**—During forming, the following phenomena will usually occur, which have to be understood and carefully watched: At the beginning of the forming process the current fluctuates and the vacuum drops rapidly on account of the liberation of vapor and occluded gases, particularly from the anodes. The arc may even go out entirely and a higher voltage may be required before it can be established again. The vacuum should be carefully watched and if it drops to a low value, say 0.015 to 0.02 mm. mercury column, the forming process should be interrupted in order to allow the vacuum to rise again, so as to prevent internal short circuits. There may also be some difficulty in igniting the arc in the cylinder, and the ignition relay may have to operate an appreciable length of time, up to a minute, before the arc can be established. As the forming process is continued, these phenomena will gradually diminish and it will be necessary to stop the process less frequently, until after a few hours the rectifier can take current steadily. When forming with a polyphase transformer, only a few of the anodes may pick up current at first, so that the direct-current voltage may be lower than normal and the voltage will fluctuate within wide limits, as additional anodes pick up current. As the forming progresses, the load may gradually be increased, until about 50 to 100 per cent of rated current is carried by the anodes. The forming process with current usually requires about 12 to 15 hours, after which the rectifier may be connected to the line. This time depends a great deal on the factory forming, the equipment available for voltage regulation, the construction of the cylinder, the pump, etc.

A typical procedure of putting a rectifier into operation, as specified by one manufacturer of rectifiers, is given below:<sup>1</sup>

#### MANUFACTURER'S INSTRUCTIONS FOR FORMING

In order to obtain the proper circuit for bake-out a special transformer is used which steps down the voltage of the main transformer (see above), together with a resistance loading grid.

A regular bake-out is divided in three parts. The first part is termed "single-anode half-wave bake-out" because current is rectified through only one anode at a time and because current flows only during half the cycle or that in which the anode is positive. This anode has full-phase potential applied to one leg of the secondary with a resistor in series to limit the current (see resistor *M* in Fig. 146). The high voltage is

<sup>1</sup> Abstracted from General Electric instruction book GEH-474B.

applied because at the start of the bake-out the arc drop is so high that low voltage will not start the arc. Arc-back is very nearly impossible on half wave.

The second part of the bake-out involves rectifying with the low-voltage transformer and equipment, and controlling the water flow and level so that the rectifier exhaust chamber is heated to high temperature. In this part the current is gradually raised to approximately the full-current rating of the rectifier.

The third part includes rectifying current of overload capacity and raising the anode temperatures to a point higher than they go during normal operation. In this part the exhaust-chamber temperature is held within limits of safety.

**Single-anode Half-wave Bake-out.**—Before starting the bake-out be sure that the correct amount of mercury has been put into the anodes (see Figs. 90 and 108).

1. Make a temporary hose connection to the water jacket at the point where the water-regulator bulb is inserted. Then the water flow during the bake-out will be normal, except that it flows out at the temporary outlet, keeping the water off the cover of the vacuum chamber and allowing it to get hot. Fill the water jacket about half full of water and then shut the water off, as no water should flow through the water jacket during half-wave bake-out.

2. Start the pumps. Evacuate the tank to one micron. Start the arc-striking motor-generator set, and energize the anode heaters. Leave the heaters on for two hours before starting the bake-out. If the rectifier is equipped with jacket heaters, they should also be put on to heat the water in the water jacket up to 50° C. before putting on the bake-out current.

3. Ground the cathode with a temporary ground, as shown in dotted lines in Fig. 146. Open all anode disconnecting links. Connect grid *M* in circuit where No. 1 disconnecting link was removed as shown by the dotted lines in Fig. 146.

4. Close the oil switch completing the circuit for single-anode half-wave bake-out. The direct-current ammeter will record about 25 amp. and the direct-current voltage will be approximately one-half the anode-to-neutral voltage of the transformer. Both the voltage and current are unsteady at first, but become more steady as bake-out proceeds. Gas will develop and the vacuum will fall. If the vacuum falls below 50 microns, the current must be removed until the vacuum has improved.

5. At the end of a half hour remove the alternating-current power and disconnect the line of resistor *M* next to anode 1 and connect to anode 2. Put half-wave current on 2 for one-half hour.

6. In the same way, bake out the remaining anodes.

NOTE.—Warming up the tank with anode heaters and jacket heaters, and half-wave bake-out should not require over six hours, but this



time should be extended if the anodes gas excessively, to cause vacuum readings of lower than 25 microns, or if the current does not become steady after being held on an anode for half an hour.

7. Record the following readings every half hour: time, vacuum, cathode current, temperature of cathode, rectifier jacket, and cover.

After the single-anode half-wave bake-out is completed, the arc drop should be low enough for the low-voltage bake-out, either 6- or 3-phase, to be put on. If the bake-out transformer furnished with the equipment has a 6-phase secondary winding, 6-phase bake-out procedure must be followed.

**Six-phase Bake-out.**—1. The tank temperature during 6-phase bake-out is controlled entirely by adjusting the water flow. Special effort should be made to get the upper part of the tank hot as soon as possible. In doing this only a very small stream of water is necessary (only enough to keep the cathode insulator below 50° C.).

CAUTION.—If the cathode insulator is allowed to rise above 50° C. it is liable to crack.

2. Connect the primary of the bake-out transformer across one secondary *Y* of the power transformer, and the secondary of the bake-out transformer to the anodes, and grid resistor (*R*) in circuit as shown by dotted lines in wiring diagram, Fig. 146.

All anode disconnecting links must be open. Set resistance of the grid for 50 amp. as shown on its nameplate. The anode and jacket heaters should still be on from half-wave bake-out, and the pumps should be running all the time to pump out the gas as fast as possible. Before putting on 6-phase bake-out current, it is well to pump the tank out to at least 1 micron or higher, as the arc will pick up much more easily at high vacuum. Close the oil switch (*A*). About 50 amp. at approximately 35 to 40 volts direct current will be rectified.

Should the arc fail to pick up at any time, rectify with bake-out voltages on five anodes and with full-phase potential on the sixth, as follows: Remove bake-out line from anode 1 and connect bake-out resistor (*M*) across disconnecting link terminals of anode 1. The higher voltage on anode 1 then serves to maintain the arc until the arc drop decreases enough to allow the lower voltage to maintain, at which time the resistor (*M*) must be removed and the regular 6-phase bake-out resumed from the beginning.

3. When the vacuum holds better than 4 microns, or after 50 amp. has been held for at least 1 hour, take off anode and jacket heaters and increase current to 150 amp. Hold until the vacuum holds at 4 microns, or at least until 1 hour has elapsed.

4. In like manner, increase current to 200, 300, 400, 450, 600, 750, and 900 amp., by means of the various switches provided on the grid (*R*). Record the same readings as in half-wave bake-out.

## OPERATION OF MERCURY ARC RECTIFIERS 293

NOTE.—The lowest vacuum allowable at any of the above loads is 10 microns. If at any time the vacuum falls below this value, the current must be reduced temporarily, or removed to allow the vacuum to come back to 1 micron.

CAUTION.—The cover of the vacuum chamber must be dry up to this point. The height of the water is easily controlled by manipulation of the temporary outlet hose.

5. When the rectifier has been baked out at 900 amp., slowly raise the water over the cover of the vacuum chamber and bring the temperature down to 55° C. The water must be gradually flowed over the cover, taking care not to allow the temperature to go below 55° C. This temperature is then held for the remainder of the bake-out. Controlling the water flow to hold 55° C. on the cover automatically brings the cathode temperature lower than it has been up to this time.

Complete the bake-out at the following loads:

Amperes	Time
950.....	2 hours
300.....	15 min.
1,050.....	2 hours
300.....	15 min.
1,250.....	2 hours
300.....	15 min.
1,660.....	1 min.

NOTE.—The lowest vacuum allowable during the overload bake-out is 8 microns. Extreme care must be taken to avoid putting on any of the overloads with the vacuum below this value.

6. While the anodes are still very hot, remove the alternating-current power and seal the anode cooler plugs with orange shellac. If for any reason the coolers are opened up to air at any time, they must be again sealed off while hot.

7. As soon as possible after bake-out is finished, go over all the anode cooler bolts and tighten down the coolers more securely, as the heating up during bake-out has probably loosened the bolts somewhat. The only satisfactory way to do this is to drop the copper connection clamp and use the ½-in. rectifier socket wrench on the bolts of the coolers. The set screws in the anode clamping rings should also be gone over and retightened.

8. Remove the temporary hose connection and replace the bulb of the water regulator.

9. Flush out the rectifier jacket with cold water.

**Twelve-phase Bake-out.**—If the rectifier to be baked out has 12 anodes, the twelve anodes must be divided into two groups of six and baked out to the schedule.

Then put the overloads on each set of six anodes in succession.

The following schedule allows for the shifting of the power from one set of anodes to the other as current is increased in order to condition the whole twelve gradually and together. Aside from the schedule given, the bake-out for a 12-anode rectifier is the same as a 6-anode rectifier. The same precautions as to water flow, temperature, and vacuum must be observed in each case.

Anode number	Amperes	Time
1-3-5-7-9-11	$\left\{ \begin{array}{c} 50 \\ 150 \\ 200 \\ 300 \end{array} \right\}$	Until 4 microns constant, or at least 1 hour
2-4-6-8-10-12	$\left\{ \begin{array}{c} 50 \\ 150 \\ 200 \\ 300 \\ 400 \\ 450 \\ 500 \end{array} \right\}$	Until 4 microns constant, or at least 1 hour
1-3-5-7-9-11	300	15 min.
1-3-5-7-9-11	$\left\{ \begin{array}{c} 400 \\ 450 \\ 600 \\ 750 \\ 900 \end{array} \right\}$	Until 4 microns constant, or at least 1 hour
2-4-6-8-10-12	600	15 min.
2-4-6-8-10-12	$\left\{ \begin{array}{c} 750 \\ 900 \end{array} \right\}$	Until 4 microns constant, or at least 1 hour

**Special Precautions.**—Six-phase bake-out may be completed on a 6-anode rectifier in about 18 hours and on a 12-anode rectifier in about 36 hours, but this time must be extended if at any time during bake-out anything of an abnormal nature takes place. The following are the things to be watched closely.

1. *Temperature.*—As mentioned above it is absolutely necessary to get the upper part of the tank hot before putting on heavy bake-out current. To facilitate in doing this, the water should be kept off the cover until normal load current is reached; and furthermore, the rectifier should not be flooded with cold water at any time during bake-out.

2. On some equipments, the vacuum readings are not a positive guide to be followed in baking out, because the pumps are so fast that good vacuum is read all the time, even though the anodes are gassing exces-

sively. In this case, enough time should be given each step of current to be sure the anodes are baking out properly.

3. A direct-current voltmeter should be connected across the bake-out grid and watched closely during bake-out. It will be noticed that at each increase of current the voltage will drop somewhat and then come back again to a value a little lower than before. It is reasonable to expect a sudden drop in the direct-current voltage of 15 per cent on an increase of current of 100 amp. A sudden drop of 50 per cent in the direct-current voltage would indicate that the current is being increased too fast. Any fluctuations in the direct-current voltage are a positive indication that the anodes are gassing badly, causing a high arc drop. If this is observed at any time, the current must be reduced at once and then more time be allowed for the anodes to bake out before increasing the current again.

**Three-phase Bake-out.**—If the bake-out transformer furnished with the equipment has a 3-phase secondary with one neutral, 3-phase bake-out procedure must be followed. The single-anode half-wave bake-out being finished, proceed as follows:

1. The water connections are the same as for 6-phase bake-out. Observe all of the precautions explained under Six-phase Bake-out.

2. Connect bake-out transformer and grid resistor *R* in circuit as shown in Fig. 146 except that the secondary of the bake-out transformer is connected to lower studs of every other anode link; for example, anodes 1, 3, and 5. All anode links must be removed. Close the oil switch. Approximately 50 amp. at 50 volts direct current will be rectified. Should the arc fail to pick up, excite one of the idle anodes with full-phase potential as explained in paragraph 2 of Six-phase Bake-out. Observe the tabulated schedule below.

Anode number	Amperes	Time
1-3-5	$\left. \begin{array}{c} 50 \\ 150 \\ 200 \\ 300 \end{array} \right\}$	Until 4 microns constant, or at least 1 hour
2-4-6	$\left. \begin{array}{c} 50 \\ 150 \\ 200 \\ 300 \\ 350 \\ 450 \end{array} \right\}$	
1-3-5	300	15 min.
1-3-5	$\left. \begin{array}{c} 350 \\ 450 \end{array} \right\}$	Until 4 microns constant, or at least 1 hour

NOTE.—Take off jacket and anode heaters at the 150-amp. step.

3. When both sets have been baked out at 450 amp., raise the water over the cover of the vacuum chamber as explained in paragraph 5 of Six-phase Bake-out. Then complete the bake-out on each set of anodes in succession at the following loads:

Amperes	Time
150.....	15 min.
600.....	2 hours
150.....	15 min.
700.....	2 hours
900.....	1 min.

Follow the same procedure as explained for 6-phase bake-out, except that the anodes are to be warmed up between overloads with 150 amp.

NOTE.—The same vacuum limits as in 6-phase bake-out must be observed. Connect a direct-current voltmeter across the bake-out resistor and be guided by the direct-current voltage readings as explained in Special Precautions.

4. Seal anode coolers as explained in Six-phase Bake-out, paragraph 6.

5. Tighten down all bolts as explained in Six-phase Bake-out, paragraph 7.

6. Remove temporary hose connection and replace bulb of temperature regulator.

7. Flush rectifier jacket with cold water.

**Putting the Rectifier into Service.**—When the rectifier is installed and connected to the vacuum pump, the seals are examined and the gages filled to the proper level with mercury. If the level of the mercury does not drop after a short time the rectifier may be considered as sealed. This naturally applies only to rectifiers with mercury seals. With other types of seals a leaky seal will be indicated only by the dropping of the vacuum, as observed on the vacuum gage.

Before the air valve (denoted by *V* in Figs. 87, 94 and 96, Chap. VII) between the rectifier and the vacuum pump is opened, the vacuum piping is checked for leaks. This is done by running the vacuum pump and observing the vacuum gage. If the vacuum in the piping cannot be brought up to approximately 0.005 mm. mercury column in about 1 hour, the piping is probably not tight, and the joints should be tightened. After the vacuum in the piping has been brought to 3 to 5 microns (0.003 to 0.005 mm. mercury) the vacuum pump is stopped and the readings of the vacuum are taken at intervals. If the vacuum

does not drop appreciably the air valve to the cylinder is opened and the vacuum gage read again.

When the rectifier and vacuum piping have been checked for tightness and the vacuum is within the operating range, the rectifier may be put into service. In starting the rectifier, the following sequence of operations should be used:

1. Start cooling water to rectifier.
2. Close all disconnects.
3. Start the auxiliary arc in the rectifier.
4. Close alternating-current circuit breaker.
5. Close positive direct-current breaker.
6. Close overload and feeder breakers.

The various methods used for starting the arc in the rectifier were described in Chap. VIII. Detailed descriptions of the control systems for starting and operating manually and automatically operated rectifiers are given in Chap. XI.

During the first two months of operation of a new plant special care should be taken regarding checking the vacuum, unless an automatic vacuum gage is furnished with the rectifier. In case the vacuum pumps have been shut down for a considerable time, it is advisable when starting up the station, first to operate the mercury pump for about 15 min., so that its pumping action may start before the roughing pump is set in operation.

**Shutting Down the Rectifier.**—Disconnecting the rectifier from the line is accomplished by opening the automatic switch in the cathode lead and then opening the oil circuit breaker on the alternating-current side, which may also disconnect the excitation. After this, all switches of the auxiliary apparatus are opened, and the cooling water for the rectifier and for the vacuum pump is shut off.

**Maintenance.**—The service experience of many years shows that a mercury arc rectifier is not subject to wear. The electrodes as well as the mercury are in a vacuum, so that oxidation or decomposition cannot take place. As the rectifier is a perfectly stationary apparatus, the unavoidable replacing of brushes, and the consumption of lubricating and cleaning material, as required with rotating machinery, do not exist. The life of a rectifier has therefore no limit and the annual costs for upkeep are relatively low. Further, supervision is of the simplest, and consists chiefly of the checking of the vacuum in the rectifier. When cooling by fresh water is used, more or less cooling water

must be allowed to flow, according to the load. The mercury seals are to be inspected every week at the close of service, and while the rectifier is still warm. The preliminary vacuum pump requires a little care, as well as the circulating water pump in plants equipped with coolers. As in all electric installations, the whole switchgear must be inspected from time to time and overhauled if necessary.

In the case of fresh-water cooling and high-voltage cylinders, it is necessary that the outer surface of the rectifier cylinder is inspected and painted if the cylinder shows signs of corrosion and rust. Although the water which is used has to be very pure, it may nevertheless occur that deposits of sand will be found in the cooling jacket which will interfere with the cooling action of the water and must therefore be cleaned out.

In rectifiers which have been in service for a considerable period of time, the insulators inside the rectifier may in some cases become coated with a film of iron which is made up of iron evaporated from the metal parts exposed to the high temperatures and to the arc itself. This film might lead to flashovers over the insulators and should, therefore, be removed at intervals of several years.

As with all other apparatus, the maintenance cost depends a great deal on the regular and thorough inspection of the equipment. Below is given an inspection chart for rectifiers, used by the Milwaukee Electric Railway & Light Company.

#### INSPECTION REPORT FOR MERCURY ARC RECTIFIER STATIONS

Date.....

#### 26,400-volt equipment:

Insulators. Are any broken?..... Do any show leakage?.....

Lightning arresters. Condition.....

Disconnecting switches. Are there any signs of heating?.....

Do switches show mechanical defect?.....

Fuses. For auxiliary transformers.

(Inspect every 3 months).....

Date of last inspection..... Mechanical condition of fuse.....

#### Oil circuit breakers:

Date of inspection..... Was oil sample taken?.....

Date..... Oil sample to be taken every 3 months

Date oil was changed..... Were contacts inspected?.....

Condition.....

Operating mechanism. Oiled..... Do any parts show wear?.....

Which?.....

Main transformer and 50-kw. auxiliary transformers.

Oil level..... Insulators cleaned.....

## OPERATION OF MERCURY ARC RECTIFIERS 299

### INSPECTION REPORT FOR MERCURY ARC RECTIFIER STATIONS.—(Continued)

Is temperature normal?.....Connections.....  
 Rectifier. Insulators cleaned.....

**Mercury seal.**

Is level correct?.....What was rectifier temperature?.....  
 Was ignition mechanism checked?.....  
 Date water chamber was painted.....  
 Date water was added to circulating system.....  
 Date alcohol was added.....  
 Date alcohol was taken out.....  
 Condition of hose connection.....

**Vacuum pump.** Date oil was changed.....Packing.....  
 Motor.....Heating plate.....Bearings.....  
 Vacuum gage.....Contacts.....Resistance.....

Water circulating pump bearings. Packing.....  
 Thrust bearings.....Water connections.....Motor.....

**Fan.** Motor.....Bearings.....Bearing oil changed.....  
 Date fan started.....Date fan stopped.....

Alternating-current relays. No....No....No....No....No....  
 Resistance for relay.....

Contacts.....  
**Mechanical operation**.....

Time delay relay setting.....  
 Indicate if any relay settings have been changed.....  
 .....

**Excitation transformer and automatic equipment for it.**

Are there any signs of heating?.....  
 Were connections checked?.....  
 Date cleaned.....Was ignition coil checked?.....

**600-volt direct-current equipment:**

**Circuit breaker.** Mechanical operation.....  
 Main contacts.....Operating coils.....

Auxiliary contacts.....Resistance.....  
 Are lockout signals O.K.?.....Any lamps burned out?.....

Relay No. 13.....  
 Relay No. 12.....

**Wattmeter readings.** To be taken once each month.  
 Date.....Reading.....Constant.....

**Veeder counter readings.** To be taken weekly. Date taken.....  
 Direct-current breaker. Present reading... Previous reading... Diff...  
 Alternating-current breaker. Present reading... Previous reading...  
 Diff.....

**Condition of Building.** Report monthly.....

**Remarks.** Report any unusual conditions.....  
 .....

Inspector.....



**Effect of Sudden Overloads and Short Circuits.**—Operating experience has shown that a properly designed rectifier, if formed and kept at a vacuum within the working range, can withstand a large number of short circuits without any destructive effects or wear of any part. Over two hundred “dead” short circuits made on two Brown Boveri types of rectifiers, GRZ-56 and GRZ-1612, some at the Camden, N. J., factory, and others by the Commonwealth Edison Company, Chicago, Ill., demonstrate the reliability of this device. Some oscillograms taken during these tests are shown in Chap. XIV. Several series of these short-circuit tests were made at intervals of 10 sec., which is the time interval for which the automatically reclosing breakers are usually set.

#### PARALLEL OPERATION OF MERCURY ARC RECTIFIERS

**General.**—This section will deal with the parallel operation of mercury arc rectifiers with each other, with rotary converters, and with motor-generator sets.

The problems involved in the parallel operation of rectifiers with other rectifiers or with other sources of direct-current power are similar to those relating to the parallel operation of direct-current generators or synchronous converters.

The external characteristics of the sets working in parallel are the deciding factors in determining whether parallel operation will be possible, and also whether it will be satisfactory. Since parallel operation of two rectifiers with each other is possible if they are fed from two independent primary networks and even if these networks are of different frequencies, the characteristics of the sources are also a factor to be considered in such a case.

Two machines are considered as running satisfactorily in parallel when stability exists and if the variation of the percentage of load of each set is proportional to the variation in the total load.

**Fundamental Principles.**—In order to explain proper parallel operation two direct-current machines may be assumed to be feeding a load from the same busbars. In order to simplify the case it will be assumed that the machines have the same drooping voltage regulation characteristics and the same ratings. Let us assume that the load increases by a certain percentage. The increase of the load of each set will be the same percentage. This means that the currents furnished by the two sets will again be

equal, as there is no reason why one machine should carry a larger share of the load than the other. Should one machine tend to take more load, its voltage would drop, and the other machine with its higher voltage would automatically share this load. If two machines, A and B, having the voltage characteristics shown by solid lines in Fig. 149, are connected in parallel to a common load such as a traction system (Fig. 148a), and if the resistance of the line between the machines is negligible, the

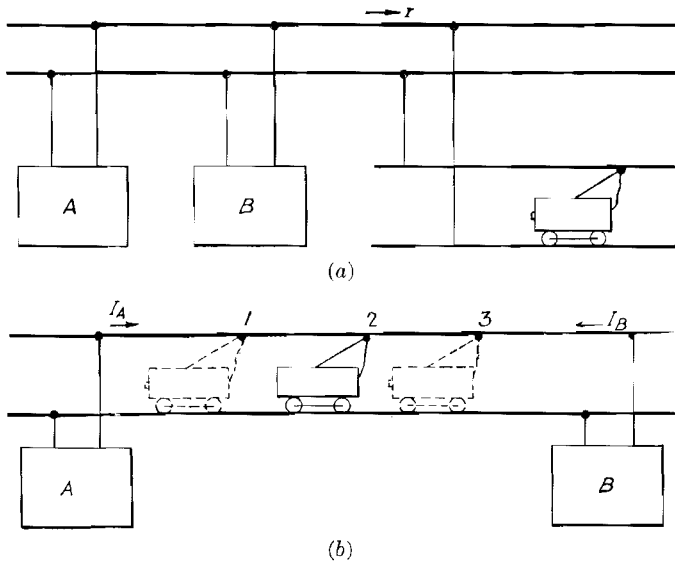

FIG. 148.—Railway load supplied by two machines operating in parallel: (a) in the same substation; (b) in separate substations, which are connected through feeders.

load will be divided between the two machines in accordance with their voltage characteristics. Thus, for example, if the total load current is equal to  $I$ , the voltage at the terminals of the machines will be  $E$  and the current delivered by the two machines will then be  $I_A$  and  $I_B$ , respectively. If the total load should now change to a value  $I'$  the magnitudes of the loads delivered by each machine will be  $I_A'$  and  $I_B'$ , respectively, corresponding to the terminal voltage  $E'$ . Thus, similarly, for any other load, the current taken by each machine can be determined from the voltage characteristics.

If the two machines are located in substations far apart (Fig. 148b) so that there is an appreciable resistance in the two feeder

lines, as for instance in a traction system, there is an additional voltage drop on account of the resistance in the line, and in order to determine the current taken by each machine feeding the common load it is necessary to modify the voltage characteristics to take into account the additional line drop.

In case of a uniform load moving along the line between the two stations the terminal voltage at any point is equal to the terminal voltage of the machine less the  $IR$  drop in the line

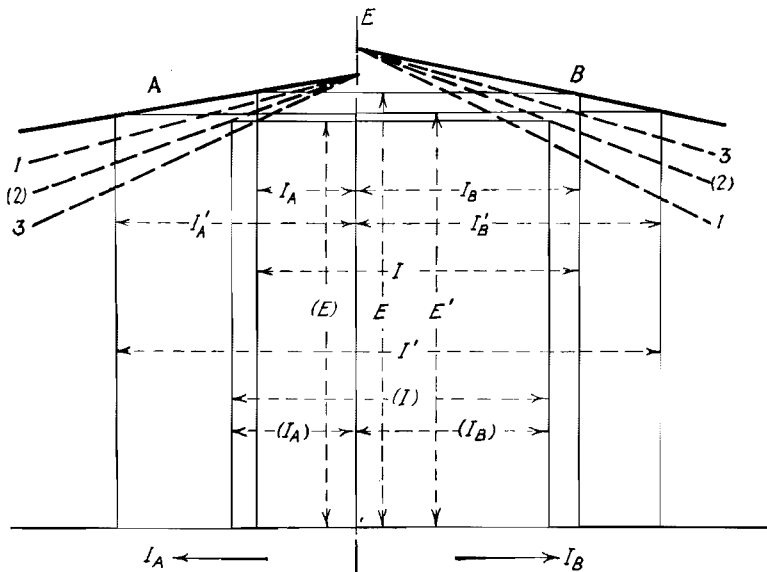

FIG. 149.—Voltage regulation characteristics of two machines operating in parallel, showing division of load under various conditions. Solid lines are regulation characteristics at terminals of machines. Broken lines are regulation characteristics at terminals of load, for different locations along the line (see Fig. 148b).

between the machine and that point. Thus, the voltage characteristics of the machines will vary for different points and are shown by dotted lines in Fig. 149 for points 1, 2, and 3 along the trolley line. For a given current taken by the load the distribution of the current between the machines at point 2, for example, can be determined by using the voltage characteristics for this particular point, similarly as was done for the machines shown in Fig. 148a.

From Fig. 149 it is evident that in the case illustrated in Fig. 148b it is impossible to have a proportionate division of

the load between the two machines at all times, even though their characteristics might be the same, since the load changes its position along the line, thereby introducing a variable line resistance, which in turn changes the voltage characteristic at the terminals of the load.

**Stability of Operation and Division of Load.**—From the previous discussion it may be possible to determine when satis-

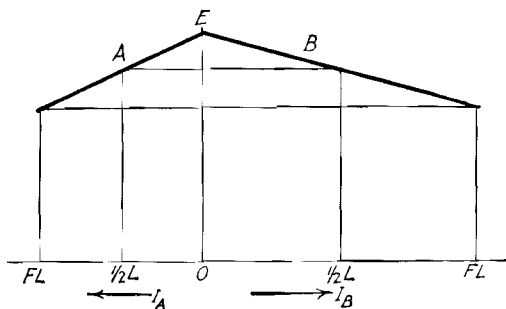

FIG. 150.—Voltage regulation curves illustrating parallel operation of two machines having different capacities, but the same per cent regulation between no load and full load.

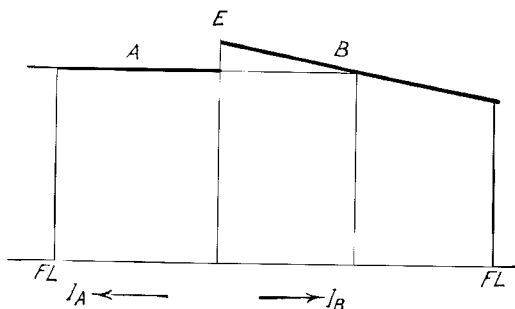

FIG. 151.—Voltage regulation curves illustrating parallel operation of two machines, one of which has a flat characteristic and the other a drooping (shunt) characteristic.

factory parallel operation can be obtained. Figure 150 shows the characteristics of two machines having different capacities but having equal voltages at no load and full load. In this case the two machines will take load in proportion to their ratings at all times, giving perfect parallel operation.

In Fig. 151 is shown the case where one machine A is flat-compounded while the other B has a drooping characteristic. In this case machine B will never take a load greater than about

50 per cent of its full load, while machine A will take all the load in excess of this. Such conditions are not satisfactory, since machine B is not fully utilized and machine A will be forced to take all the load swings.

If machine A were overcompounded, the conditions would be even worse, since the load would shift from one machine to the other and it would be impossible to maintain stable operation.

Sometimes it is very desirable to improve the all-day efficiency of an old converting station which has a very low load factor. In case the station is equipped with synchronous converters or motor generators a marked improvement can be obtained by having a rectifier working in parallel with the old machines.

The efficiencies of the two latter types of converters are lower at overloads and at partial loads than the efficiency of the rectifier. Therefore, in order to obtain a good average all-day efficiency for the plant, it is desirable to adjust these two types of converting devices for such load characteristics that in parallel operation the rotary converter or motor generator is always working at practically full load, while the fluctuating peaks are taken care of by the mercury arc rectifier. Assuming that the load characteristic of the motor generator is as shown on the right-hand side of Fig. 149, and the load characteristic of the mercury arc rectifier on the left-hand side, it is evident from the figure that the rectifier will take by far the larger share of a given increase in load. At normal load  $I$ , furnished by the rectifier and the motor-generator set in the ratio of 1 to 2, the voltage is  $E$ . Assuming that a heavy overload, drawing a current  $I'$ , is now imposed on the system, the voltage will drop to  $E'$ . The total current  $I'$  is nearly twice as great as  $I$ , but the current supplied by the motor generator is increased only about 30 per cent, while the current supplied by the rectifier is increased nearly 150 per cent. From this it is evident that a change in the load on such a system changes the load on the motor-generator set only slightly, and as a consequence it can run at practically constant load, *i.e.*, at its highest efficiency.

**Rectifiers Fed from Different Networks.**—As mentioned before, in accordance with the fundamental principles on which the operation of a mercury arc rectifier depends, energy cannot flow from the direct-current to the alternating-current network, since current can pass only from the anodes to the cathode. This, particularly, makes it possible successfully to parallel rectifiers

whose alternating-current supply is derived from two independent networks, whether of the same or of different frequencies. Should the frequency in one of the alternating-current networks vary, no troublesome or dangerous occurrences would have to be expected, such as motoring or flashovers on the commutators in the case of synchronous converters. It is also possible to operate a rectifier from different networks by feeding some of the anodes from one network and others by another network (see Chap. IV, Fig. 21).

**Special Cases.**—It is possible to feed two rectifier cylinders from one main transformer, and in such a case it is essential that

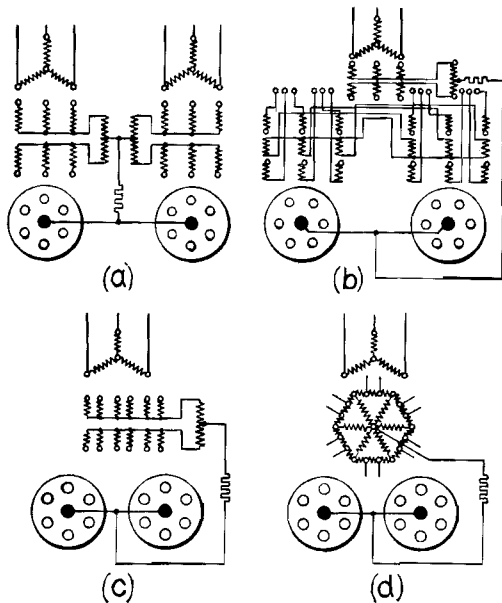

FIG. 152.—Parallel operation of two rectifiers (244): (a) connected to separate transformers; (b) connected to one transformer through anode choke coils; (c) connected to one transformer with a double 6-phase secondary; (d) connected to one transformer with a polygon-connected secondary.

each cylinder takes its proper share of the total load. The voltage drop curves of rectifier cylinders are given in Chap. II, Fig. 6a to c. In order to parallel successfully, a sufficiently large inductance has to be inserted in the anode circuits of each rectifier so as to obtain a suitable load characteristic which assures satisfactory parallel operation of each cylinder over a given range of load. For instance, a correctly dimensioned choke coil can be used to obtain such an inductance. The use of anode

choke coils for this purpose is illustrated in Fig. 152*b*. The coils are so interconnected that the flux and inductance are produced by the difference in the currents of two parallel anodes, and the magnitude of the inductance is therefore proportional to the degree of unbalance, which insures satisfactory parallel operation (244). See Chap. VI, Fig. 74.

The same effect can be obtained by utilizing that part of the main transformer inductance which corresponds to the stray field, by using either a separate transformer for each rectifier, or a double 6-phase arrangement, as given in Fig. 152*a* and *c*, respectively. However, the inductance produced in this way must be large enough to impress such a high voltage across the electrodes of a rectifier working in parallel with others but not taking a share of the load as will force it to pick up some of the load.

In Fig. 152*d* two rectifiers are made to operate in parallel on one transformer by using a polygon secondary connection with taps to provide a 12-phase system for the anodes.

## CHAPTER X

### APPLICATION OF MERCURY ARC RECTIFIERS

**General.**—The field of application of the steel-enclosed mercury arc rectifier is very broad, as can be seen from Table VI, which refers to rectifier plants in operation in 1929. Rectifiers are used in practically all fields where conversion from alternating current to direct current is involved, and are naturally used to great advantage where their peculiar qualities meet with the requirements of the service in question. To these classes of service belong installations where high direct-current voltages may be applied, and installations which are subject to large fluctuations in load and to heavy and short current peaks, such as main-line railways, street cars, subways, elevated railways, rolling mills, and the like. A comparison of the figures in the table brings out the above fact clearly, and further shows that the use of rectifiers for railway service is three times as great as for all other purposes combined.

Table VII shows the application, by voltages, of mercury arc rectifiers for street railways, subways, and interurban railways, for the years from 1910 to 1929.

TABLE VI.—FIELDS OF APPLICATION OF RECTIFIERS  
1910 to 1929

Application	Total number of plants	Total number of rectifiers	Installed capacity, kilowatts	Average rating per plant, kilowatts	Average rating per rectifier, kilowatts	Percentage of total installed capacity
Railways, (street railways, subways, interurban, and main-line roads) . . . . .	620	1,300	950,000	1,520	731	74.3
Light and power . . . . .	364	593	231,000	635	390	18.1
Conveyors for mines, hoists, etc. . . . .	30	45	17,900	600	400	1.3
Rolling mills . . . . .	18	50	27,000	1,500	540	2.0
Electrolytic and chemical plants . . . . .	14	30	44,500	3,180	148	3.4
Battery charging . . . . .	12	12	1,300	108	108	0.9
Totals . . . . .	1,058	2,030	1,271,700	1,212	632	100.0



TABLE VII.—APPLICATION OF RECTIFIERS TO STREET RAILWAYS, SUBWAYS,  
AND INTERURBAN RAILWAYS  
According to Voltages, 1910 to 1929

Rated voltage	Total number of plants	Total number of rectifiers	Total capacity, kilowatts	Average rating per plant, kilowatts	Average rating per rectifier, kilowatts	Percentage of total railway rectifiers
To 600	106	195	114,000	1,075	585	12.0
600 to 750	232	442	281,000	1,210	636	29.6
750 to 1,250	165	338	307,000	1,860	910	32.4
1,275 to 1,650	98	282	205,000	2,090	727	21.5
2,300 to 2,500	9	15	11,000	1,220	735	1.2
3,000	10	28	32,000	3,200	1,140	3.3
Totals.....	620	1,300	950,000	1,520	731	100.0

Next in order of importance is the application for power and light purposes; then follow motors for rolling mills, special drives, elevators, mining locomotives, etc., and, finally, rectifiers for electrochemical purposes. This last field has been opened to rectifiers only recently, with the development of units of high current capacities. Now, more and more attention is being devoted to the use of rectifiers for electrochemical purposes, and this may become one of the largest fields of application for mercury arc rectifiers in the near future. The reasons for this are the following: Disturbances on the primary side, such as voltage changes due to short circuits, etc., do not affect the operation of rectifiers as they do synchronous converters, for instance; maintenance is small, as no part of the rectifier is subject to wear as in the case of rotary machines, where the replacement of brushes, for example, adds a great deal to the maintenance expenses; and, finally, a rectifier cannot reverse its polarity, a fact of the utmost importance in some electro-chemical processes.

Probably the two factors which appealed most to those responsible for the early acceptance of the rectifier were that it is a stationary apparatus having a high efficiency at all loads and that it requires only very little attendance. These two factors are immediately reflected in the operating accounts and in some instances in so pronounced a manner as to establish large credits towards amortization of the replacement investment in cases where the rectifier was brought in to modernize a substation and supplant rotating machinery of early design. This was, and

is, so especially where machinery employed for conversion operates under conditions which impose a low annual load factor, as in the supply of direct-current power to rolling mill drives, elevators, dredge drives, mine, street railway, and heavy electric traction haulage, etc.

**Current and Voltage Ratings.**—While in 1910 it took 18 anodes for one rectifier cylinder to convert 150 amp., in 1924, ten times

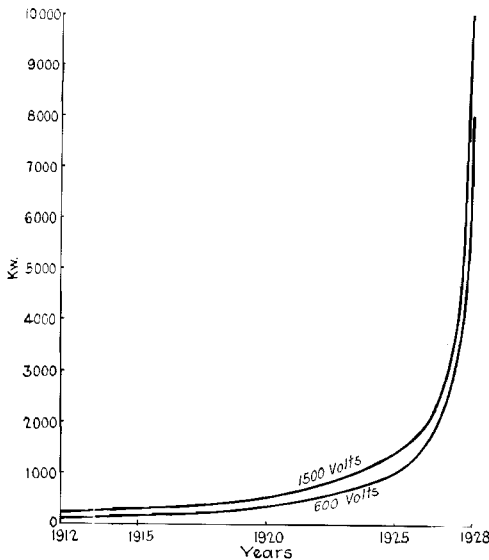

FIG. 153.—Curves showing the increase of kilowatt capacity of mercury arc rectifiers since 1912, for 600 and for 1,500 volts.

as much current, or 1,500 amp., could be rectified by 12 anodes, and in succeeding years even more: in 1925, 2,000 amp.; in 1926, 3,000 amp.; in 1927, 6,000 amp.

From Fig. 1 (Chap. I) can be seen the increase in voltage for which rectifiers were developed during the above period of time, while Fig. 153 illustrates the increase in capacity for which rectifiers have been built in the same period of time.

The mercury arc rectifier is inherently a machine with a continuous rating, due to the very small masses for storing the heat produced during its operation, and has high momentary overload capacity, principally due to the absence of rotating parts.

The rectifier proper can be built so that it can be used at different voltages; for instance, the same cylinder can be used

for all voltages up to 5,000 volts, and higher. In Fig. 154 are shown the rating curves of several types of Brown Boveri rectifiers. It can be seen from this figure that the current rating of the rectifier is constant up to 300 volts, and decreases somewhat at higher voltages. The kilowatt capacity increases with the voltage.

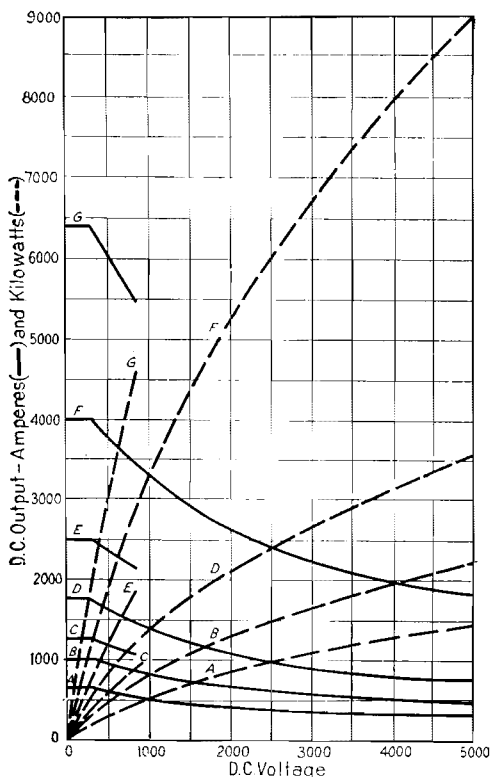

FIG. 154.—Rating curves of several types of Brown Boveri rectifiers.

**Decentralization.**—In order to reduce feeder losses, some recent applications of rectifiers to railway service make use of the idea of decentralization in locating the rectifier equipment. Rectifiers lend themselves to this scheme for the following reasons:

A rectifier plant can be made fully automatic with little expense.

No special foundations and very little headroom are required, with consequently cheaper building.

Very rapid starting.

Noiselessness.

High momentary overload capacity.

Furthermore, by using the scheme of decentralization, rectifiers may be employed with advantage even in present Edison systems for 250 volts direct current, although the efficiency of a rectifier for this voltage is low in comparison with other converters. Edison systems in large cities frequently have their conversion equipment located on leased floor space, usually below the street level, or in soundproof rooms or substations. These have to be quite spacious, comprising air intake and exhaust systems, air cleaning and blowing equipment, etc., part of which is fitted in and around the necessary massive foundations. Rectifiers, being noiseless, stationary, and requiring no air ventilation, are not difficult to locate, and are, therefore, less expensive from that point of view.

In view of the above, the larger conversion losses when rectifiers are used for low-voltage systems are compensated for by the smaller losses due to decentralization and by the interest from the smaller investment in buildings compared to that required for rotating converters.

### OPERATING CHARACTERISTICS

The outstanding characteristics of rectifiers are briefly enumerated below:

**Efficiency.**—Unlike rotating conversion apparatus, the electrical energy in a rectifier is not first changed into a mechanical form and then changed back again to the electrical form, but the conversion occurs directly, with no intermediate stages.

The losses and other disadvantages accompanying conversion by rotating machinery are either greatly reduced, or eliminated entirely. In a rectifier there are no iron, windage, friction, nor ventilation losses, and those losses which do occur (due to the voltage drop in the arc) do not vary as the square of the current, as in the usual electrical machines and apparatus, but only as a linear function, and independently of the voltage. Two important properties of the rectifier proper depend on this fact: the

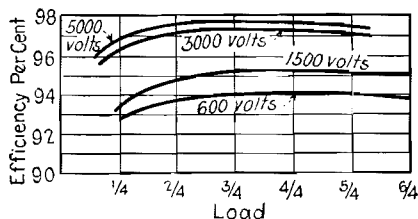

FIG. 155.—Overall efficiency curves of 600-, 1,500-, 3,000-, and 5,000-volt rectifier units, in function of the load.

efficiency remains practically constant at low loads, and changes only very slightly at higher loads; and, since the losses in the rectifier itself are practically constant at all operating voltages, the efficiency increases as the operating voltage is increased. In Fig. 156 are plotted the overall efficiencies of a 1,500-kw. rectifier unit, including the losses in the transformer and auxiliaries, for various direct-current voltages, up to 8,000 volts. The curves in Fig. 155 show the overall efficiencies of standard 600-, 1,500-, 3,000-, and 5,000-volt types. The characteristic high efficiency of rectifiers at partial loads is of particular importance in cases where the conversion apparatus has to be operated under

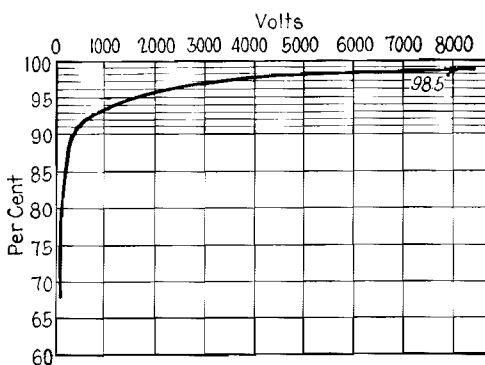

FIG. 156.—Overall efficiency of a 1,500-kw. rectifier unit, in function of the direct-current voltage.

conditions which impose a low annual load factor, as can be seen later. Figures 157 and 158 show comparative overall efficiencies of rectifiers and 60-cycle rotary converters.

It is unquestionable that the low losses of the rectifier at high voltages will gradually affect the selection of direct-current voltages for railroad electrification projects, and will also exert an influence on the question of direct-current *versus* alternating-current systems.

In support of this, the following figures, which show the advantages of a 2,000-kw. mercury arc rectifier as compared to a 2,000-kw. motor-generator set at 3,000 volts direct current, both at nominal rating, may be adduced. Assuming a load factor of 40 per cent, which is common in railway service (800 kw. for 24 hours), the daily energy demand is 19,200 kw.-hr.;

assuming a daily load cycle consisting of 2 hours at 150 per cent load, 8 hours at 50 per cent load, 8 hours at 30 per cent load, 4 hours at 5 per cent load, and 2 hours at no load, the table below

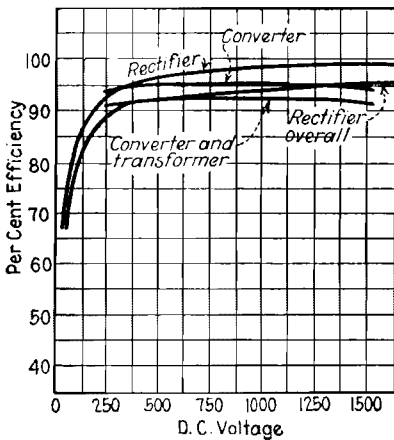

FIG. 157.—Comparative efficiencies of rectifiers and rotary converters, in function of the direct-current voltage.

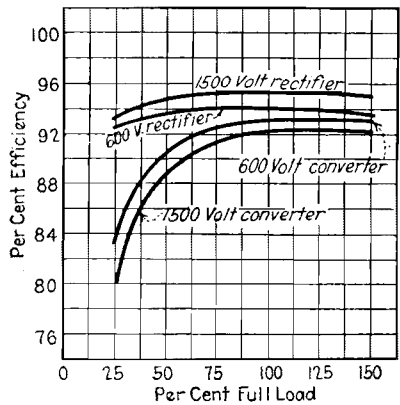

FIG. 158.—Comparative overall efficiencies of 600- and 1,500-volt rectifiers and rotary converters, in function of the load.

will illustrate the large saving which can be effected by employing a rectifier in place of a motor-generator set for this particular type of service.

Time, hours	Load, kilowatts	Efficiencies		Losses in kilowatt-hours	
		Rectifier	Motor generator	Rectifier	Motor generator
2	3,000	97.0	90.9	185	600
8	1,000	96.8	86.4	264	1,260
8	600	95.5	81.8	226	1,070
4	100	82.9	46	82	470
2	0	....	....	38	232
				795	3,632

Hence, the saving effected during 24 hours amounts to 2,837 kw.-hr., and per year to 1,035,000 kw.-hr. Assuming the cost of power to be 1 ct. per kilowatt-hour, an annual saving of about

\$10,000 would be obtained, which would pay for the substation in a few years.

Additional savings in the annual costs would result from the use of a rectifier of the above rating in place of a motor-generator set on account of the lower initial cost of the rectifier, which is about 55 per cent of the cost of the motor-generator set, and on account of the lower cost of the substation, since the building required by the rectifier would be smaller, and would not need special foundations nor cooling ducts.

As direct-current motors can be built to operate satisfactorily at voltages of 2,000 volts, there is no reason why direct-current line voltages of 4,000 volts and more may not become widely adopted for railway service. In fact, one railroad already is using a 4,700-volt operating voltage.

**Conversion Losses and Load Factor.**—In almost all electric railway systems the load factor is low and in consequence the converting units are working at low loads and even at no load most of the time. Since all rotating machines have relatively large no-load losses, due to friction, windage, etc., rectifiers, with their small losses at low loads and at no load are especially suitable for railway service. The use of rectifiers on railway systems, particularly when the load factor is low, as is usually the case on interurban lines, results in an appreciable economy of power.

Measurements made over long periods on systems fed simultaneously by rectifiers, synchronous converters, and motor-generator sets, confirm the above statement. Actual data on the all-day overall efficiency of these three classes of converting units are tabulated below:

TABLE VIII

Capacity, kilowatts	Direct-current voltage	Load factor, per cent	Efficiency		
			Rectifiers, per cent	Synchronous converters, per cent	Motor generators, per cent
1,000	1,500	65	95	.....	86
3,000	1,500	12	89	72.5	
500	600	40	92	88.6	

Additional data on the all-day overall efficiencies of 1,000- to 2,000-kw. rectifier installations for 600, 1,500, and 3,000 volts direct current, and at different load factors, are given below:

TABLE IX

600 volts		1,500 volts		3,000 volts	
Efficiency, percentage	Load factor, percentage	Efficiency, percentage	Load factor, percentage	Efficiency, percentage	Load factor, percentage
92.0	70				
92.3	60	95.5	65	95.3	40
91.8	55	90.3	16		
91.5	48	89.3	12.5		
90.2	25				

**Parallel Operation and Voltage Regulation.**—Since a rectifier with its transformer has a drooping voltage characteristic, it will work in parallel with another unit without any special equipment, and will divide the load as readily as two transformers working in parallel. It is not, however, possible to regulate the direct-current voltage of an ordinary rectifier, because the ratio of the alternating-current voltage to the direct-current voltage is a constant. The direct-current voltage can, therefore, be varied only by changing the alternating-current voltage correspondingly. This may be done either by tap switches on the transformer (changing either under load or at no load), or by induction regulators. The direct-current voltage characteristics can also be altered by means of an interphase transformer or anode reactors saturated with direct current. These methods are explained in more detail in Chap. XII. Means for adjusting the voltage are sometimes necessary to take care of variable service conditions, or to distribute the load advantageously when operating a rectifier unit in parallel with rotary machines. Usually a few taps on the transformer are sufficient.

**Power Factor.**—The power factor of a large polyphase rectifier is about 93 to 96 per cent, depending on the type of transformer connections used. It drops gradually at loads above three-fourths of full load, and more abruptly at loads below one-fourth, to about 80 per cent at one-tenth full load. The power factor is not adjustable as in the case of synchronous converters and motors. It is superior to that in the average industrial plant, however, and it is therefore not objectionable (see Chap. VI).

**Regeneration.**—Since a rectifier permits current to flow only in one direction, it is impossible to feed back from the direct-current to the alternating-current side. Regeneration as some-



times employed in electric railways to brake heavy trains is therefore possible only when rectifiers are used in parallel with rotating converting machines which will effect regeneration. The first system on which rectifiers were used, in connection with synchronous converters, in such a way that regenerative braking was possible was the Chemin de fer du Midi, in France. It may be mentioned here that regeneration has, in general, not gained the popularity expected of it when it was first introduced.

**Supply Frequencies and Primary Voltages.**—Rectifiers can be used for any frequency, and any primary voltage, and a single rectifier can even be fed from two different sources of supply (see Chap. IV, Fig. 21). Furthermore, there is no difficulty in paralleling rectifiers fed from different networks of different frequencies. See also Chap. IX in this connection.

**Freedom from Noise and Vibration.**—The rectifier itself is noiseless in its operation, while a rectifier transformer is as quiet as a transformer for any other purpose. There is no vibration in a rectifier cylinder, and no special foundations are required. The noise of the roughing pump and its motor is slight, and does not carry far, as there is very little power behind it. There is no other source of noise in a rectifier installation.

**Starting.**—Among the outstanding advantages of a mercury arc rectifier over a synchronous converter is the simplicity of the starting process. As was seen before, it takes only a few seconds to ignite the arc and put the rectifier into service. This makes it pre-eminently adapted to automatically controlled substations on railway systems.

**Ambient Temperature.**—Practically all the heat produced by the rectifier proper, except some of the heat generated at the anodes, is carried off by water. The room temperature therefore has no appreciable effect on the operation of a rectifier. This is another point of advantage possessed by the rectifier, as it can be located in buildings or rooms having only natural ventilation, or in places where the ambient temperature is high.

Other phases of the operation of rectifiers, which have to be considered in their application, are dealt with separately in other parts of this book.

#### RECTIFIER INSTALLATIONS

Below are described some of the most important and more typical rectifier installations, with the special features and

characteristics of each briefly mentioned. The application of rectifiers to various fields can best be illustrated by describing a few typical installations. Much space is given to rectifier installations for railway service, as this is their most important field of application. A few outstanding applications of rectifiers to railway service, characterized either by high direct-current voltage, large kilowatt capacity involved, or by the extent of the electrification program, will best exemplify the important rôle now being played by rectifiers in this field.

## RAILWAY SYSTEMS

### CITY AND INTERURBAN SYSTEMS

**Bridgeport, Conn.**—An outstanding installation of mercury arc rectifiers for city street-car lines was completed in 1927 by The Connecticut Company. The whole system depends on mercury arc rectifiers which are located in substations at Bridge-

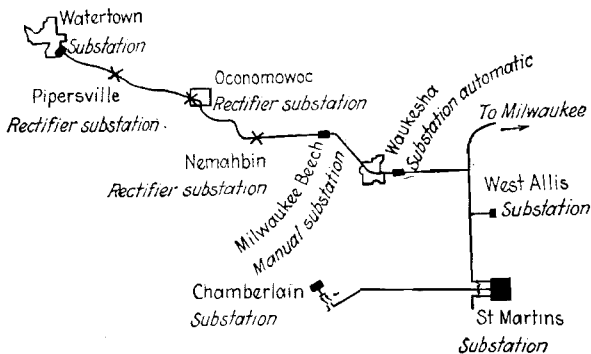

FIG. 159.—Road map of the Milwaukee-Watertown line, of the Milwaukee Electric Railway and Light Company, with the rectifier substations indicated by crosses.

port and Stratford. The Bridgeport substation contains five 1,200-kw., 600-volt, manually operated rectifiers, which are equipped with forced-draft water coolers and wave-filter equipment; the Stratford substation contains two 1,200-kw., 600-volt rectifiers and is fully automatic. The primary stepdown arrangement consists of transformers of the O.I.S.C. type, and auto-transformers. This arrangement was found to be the most suitable as provision had to be made for operation on either 25- or 60-cycle 3-phase current, at voltages of 6,600, 11,000, and 13,000 volts, with a number of taps. For further informa-

tion on this installation see Chap. XI and (369). After this installation was placed in service a complete filter equipment was added in order to eliminate interference with telephone lines (353). See also Figs. 144, 177, 178, and Chap. XIII.

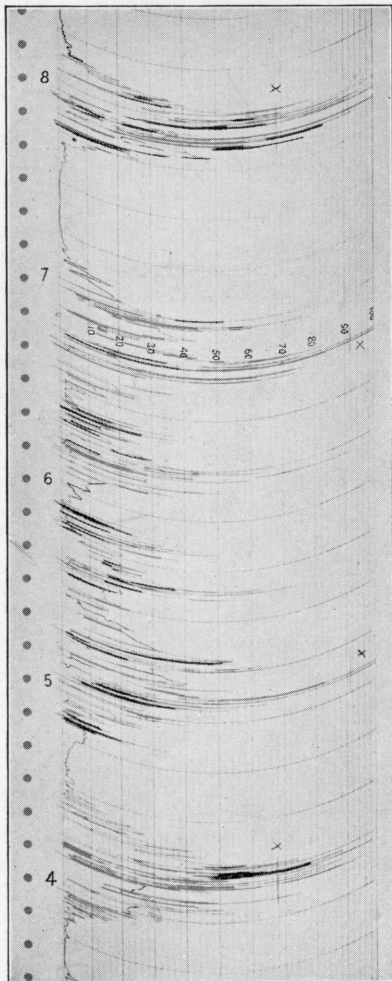

FIG. 160.—Load chart taken in the Oconomowoc rectifier substation of the Milwaukee Electric Railway and Light Company. The multiplying factor for the current scale is 20.

in Fig. 160 gives the load for a few hours in the Oconomowoc substation.

#### Watertown - Milwaukee.

A typical example of the use of mercury arc rectifiers for an interurban line is the installation of 550-kw., 600-volt rectifiers in three substations of the Watertown-Milwaukee line of the Milwaukee Electric Railway and Light Company in 1926. The substations are located about 6.5 miles apart, at Nemahbin, Oconomowoc, and Pipersville, and are indicated by crosses on the road map shown in Fig. 159.

They are interconnected through 600-volt trolley feeders of the interurban line, which is also fed by manually operated rotary-converter stations.

Due to the fact that when a three-car train starts near a substation the load demand may reach values as high as 3,500 amp., while the rectifiers are rated for only 1,840 amp. for 30 seconds, load-limiting or load-shifting resistors were installed. The load chart

The layout of one of these substations, with the very economically constructed building and installation possible with rectifiers, as well as its operation, are given in Chap. XI (see also 381).

#### ELEVATED AND SUBWAY LINES

**Chicago Elevated and Surface Lines.**—Two rectifiers of the then largest current capacity were installed by the Commonwealth Edison Company in 1928 for supplying power to the elevated and surface lines. These rectifiers are located at the Maypole and West Lawn substations and are of the type shown in Fig. 88. They are equipped with 12 anodes each, and are rated at 3,000 kw., 5,000 amp., 600 volts, with an overload capacity of 50 per cent for 2 hours and 100 per cent load for 1 min. Regarding the layout of the substations see Chap. XI and (380).

**Berlin Elevated Lines.**—The electric service on these lines was inaugurated in part in the middle of 1928, and is similar to other elevated or subway lines. The electrified system, with a total length of about 100 miles, consists of two loops serving the heart of the city and of several suburban lines branching out from the main loops. The schematic diagram of Fig. 161 shows the stops, the locations of the substations, the sectionalizing points of the third rails, and the 30-kv. feeder system. With the exception of the substations located at the three main junctions of the lines, which, due to their large load demand, have several rectifier units each, all the substations are equipped with two rectifier units each. Thirty-one substations, indicated by small solid blocks, are thus equipped with two rectifiers each; these stations are controlled from four points by a supervisory remote-control system. The rectifiers located in the three large substations at the main junctions, as well as the rectifiers for the branch lines, are controlled semi-automatically.

The substation equipment for the initial development of the loop, as is shown in Fig. 161, consists of 98 rectifiers with transformers, of a total capacity of 117,600 kw.; 92 of these are of the Brown Boveri type.

The branch lines are fed by several substations having several units. These substations are spaced farther apart than those in the loop, and the feeder sections are longer. In the loop the substations are spaced from  $\frac{1}{4}$  to 1 mile apart, and located close to the train stops. As can be seen from Figs. 161 and 190, the

third rails are cut at every other substation, the breaks in one track not being opposite those of the other.

This electrified system therefore has the most ideal decentralized power supply, since on the largest part of the lines the power conversion is split up into a number of small stations, and the substations themselves are rationally and efficiently located relative to the power demand centers; *i.e.*, they are placed so as to feed into the sections of the system at places where the current demand is greatest. This results in low direct-current losses,

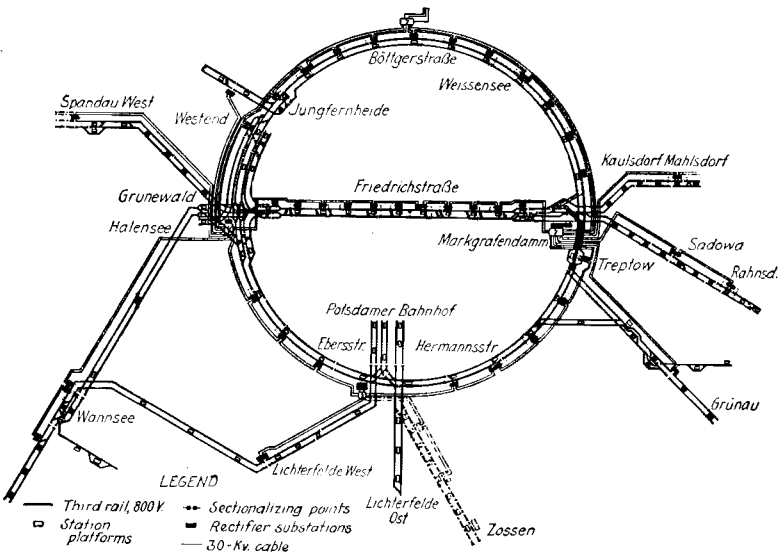

FIG. 161.—Schematic diagram of the Berlin elevated railway system.

reduces the number and length of direct-current feeders, and, in consequence, the cost. Furthermore, the use of such a system results in smaller stray currents and consequently there is less corrosion and the influence of the direct-current ripple on communication circuits is reduced.

Due to the short headway between trains, it is not feasible to start and stop the converting units in accordance with load demand. The units are therefore in service the greater part of the time, and since they are required to supply power for relatively short periods the load factor is low.

Such a system calls for converting equipment with as high an efficiency as possible at light loads, so as to obtain a high all-day

efficiency, and further, since many substations are needed, the building and maintenance costs must be as low as possible. It was found that the mercury arc rectifier was the most suitable converting device for such a system, as it has a high efficiency at all loads, permits the use of light foundations and simple and cheap housing, as there are no rotating parts, and the heat produced by a rectifier and its transformer can be carried off by water, thus necessitating no large ventilating arrangement, excessive overhead room, etc. The feature of grounding the positive pole of the system also helped to simplify the installation of the rectifiers considerably.

The use of rectifiers also made it possible to take advantage of the space under the arches supporting the tracks and station platforms and use it as the converting substation without expensive building alterations. For further details about these substations as well as about the control equipment and protective systems, see Chap. XI and references (354) and (375).

The rectifiers have been so designed that each of them is capable of supplying the load absorbed by a complete train. Each unit is rated at 1,200 kw., continuous, at 800 volts. However, the determining factor in selecting the rectifier type was not the continuous rating but the maximum required overloads. During the rush hours the trains follow each other at intervals of 90 sec., at which time the load cycle is 3,000 amp. for 40 sec., and 300 amp. for 50 sec. This unfavorable condition, however, takes place only when one rectifier unit fails and the two nearest units have to supply, in addition to their normal load, half the load dropped by the failing unit. The load therefore varies as indicated in Fig. 162; the second part of the diagram shows the same rush-hour conditions, but with no failure of adjacent substations.

The linear average value for the first part of the curve is 1,460 amp., and the effective average value 2,015 amp. Since the rectifier units are rated at 1,200 kw., 800 volts—that is, at 1,500 amp.—it follows from the above figures that they are overloaded 100 per cent for 40 sec. during every cycle of 90 sec. Overloads of such durations are no longer to be considered as overloads, but rather as continuous loads with temporary interruptions.

Practically all the transformers used in this system are of the double 6-phase type, with interphase transformers, and have a reactance of 9 to 9½ per cent. The regulation which was

obtained is shown in Fig. 163, namely,  $6\frac{1}{2}$  to 7 per cent at full load. In case of a diametrical 6-phase connection, the reactance would have had to be about  $4\frac{1}{2}$  for the same regulation;

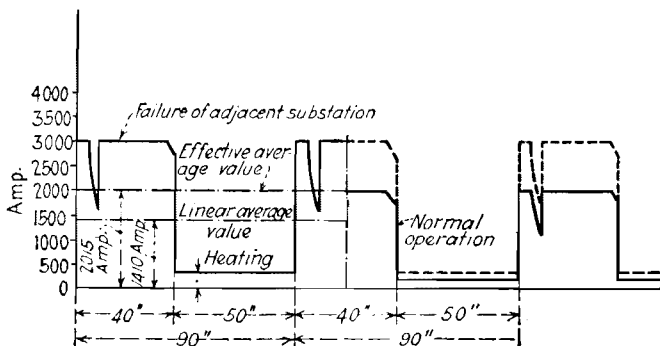

FIG. 162.—Rush-hour load-cycle diagram for rectifiers on the Berlin elevated lines, during normal operation and during failure of an adjacent substation.

that is, the short-circuit current would have increased to more than twice its present value. Tests at the factory of the Brown

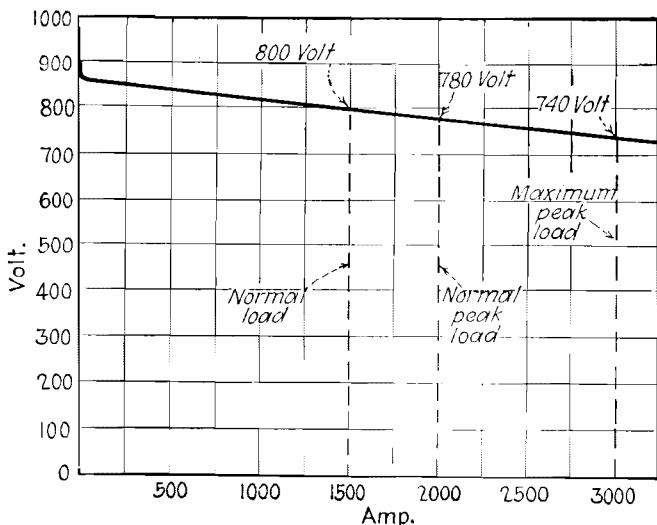

FIG. 163.—Voltage regulation curve of rectifiers on the Berlin elevated railways.

Boveri Company showed that with the absorption-reactance coils the short-circuit current on the direct-current side reached a maximum value of 18,000 amp. These values were measured by

means of oscillograms. Several large power plants were interconnected for these tests. At short circuit, the primary voltage on the transformers dropped about 18 per cent. On an infinite network the maximum value would have been around 21,000 amp., corresponding to a short-circuit rating of the transformers of about 15,000 kva. In addition to these short-circuit tests, extensive load tests were made, simulating the actual load conditions.

**Philadelphia and New York Subways.**—Two 2,500-kw., 630-volt, nominally-rated rectifier units were installed in Substation Number 7 of the new South Broad Street subway of Philadelphia, and were put in operation in April, 1930.

The new Eighth Avenue subway of New York City will have seven underground rectifier substations, each equipped with one 3,000-kw., 625-volt, nominally rated unit.

MAIN LINES

**Illinois Central Railroad.**—Mercury arc rectifiers are used as converters for the electrification of some parts of this road, electric operation having started on those parts in 1926. Figure 164 gives a road map and shows all the substations, those with rectifiers being marked with black circles. Their equipment is listed in the following table:

MAJOR SUBSTATION EQUIPMENT

Substation	Synchronous converters		Rectifiers		Total kilowatt capacity	1,500-volt feeders		Light and power transformer capacity
	Number	Rated kilowatt capacity	Number	Rated kilowatt capacity		Positive	Negative	
E. 16th St.....	3	3,000	1	3,000	12,000	7	6	1,500
Brookdale.....	2	3,000	1	3,000	9,000	10	9	1,500
Cheltenham.....	2	3,000	0	.....	6,000	4	2	150
Front.....	2	3,000	0	.....	6,000	7	6	300
Lafin.....	0	.....	1	1,500	1,500	2	1	75
Harvey.....	1	3,000	1	3,000	6,000	4	1	300
Vollmer Rd.....	1	3,000	1	1,500	4,500	4	1	300
Totals.....	11	33,000	5	12,000	45,000	38	26	4,125

The energy supply for the initial electrification is obtained through the above-mentioned seven substations located adjacent



to, or very near, the railroad right of way. Five of these are within the city and are fed from the generating stations at 12,000 volts, 60 cycles over the power company's cable system. The two substations in the suburban region are fed from the 33,000-volt, 60-cycle overhead transmission system of the Public Service

Company of Northern Illinois. The line arrangement throughout is such as to provide reasonable reserve so as to insure a high order of reliability.

The 1,500-volt direct-current energy for the traction service is derived in part through mercury arc rectifiers and in part through 3,000-kw. synchronous converter units. Each converter unit consists of two 750-volt machines in series, while the rectifiers furnish 1,500 volts at their terminals. Normally, the overhead system is all tied together through the substation and tie station buses. These stations are so located that in case a fault occurs the section affected will be automatically isolated.

There are five rectifier units on this system, their location being shown in the table. Three of them, of 3,000-kw. capacity, are of Brown Boveri manufacture, and the other two, rated at 1,500 kw. each, are of General Electric make.

Both of the 1,500-kw. units consist of two bowls each, operating in parallel. A single 3-phase transformer with 6-phase secondary windings and inter-phase transformer feeds the pair of bowls of the 1,500-kw. sets. The 3,000-kw. sets are in effect two 1,500-kw. sets operated from one high-voltage switch. Each bowl has its own 3-phase

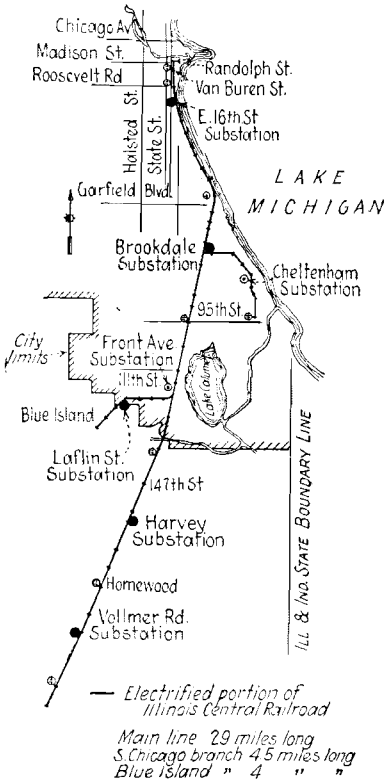

FIG. 164.—Map of the Chicago terminal electrification of the Illinois Central Railroad, showing the location of the substations. The substations in which rectifiers are installed are indicated by black circles.

transformer, having the secondary connected in double 6-phase for the twelve anodes of the bowl. These rectifiers are rated to carry 150 per cent load for 20 min. and 300 per cent momentarily.

Because of the higher efficiency of the rectifiers, they are naturally kept in service for the longer periods of lower load. The comparative data in Table VIII illustrate the savings effected on account of the higher efficiency of rectifiers over a wide load range.

These rectifiers are paralleled with synchronous converters in the same and in adjacent substations, and the parallel operation is very satisfactory.

The maximum demand of this road on the power supply system has thus far been approximately 24,000 kw. The total energy consumption in 1927 was slightly less than 59,000,000 kw.-hr. The annual load factor was thus about 28 per cent; the monthly load factor varied from 32½ per cent to more than 39 per cent (376).

**Ferrovie Nord Milano (Milano-Meda and Milano-Saronna).**—The Ferrovie Nord Milano, which had a number of important

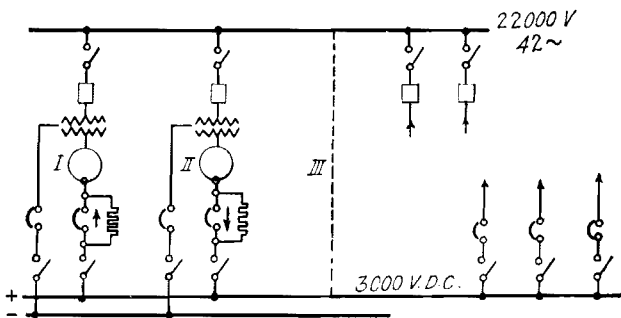

FIG. 165.—Elementary wiring diagram of Novate substation, Ferrovie Nord Milano.

steam-operated sections in northern Italy, decided, in 1927, to electrify its lines with 3,000 volts direct current, on account of the dense traffic on those sections. The contact wire on the Milano-Meda and the Milano-Saronna sections is fed from one substation, Novate, which contains three 2,000-kw., 3,000-volt rectifier units. More substations will be added when the electrification is extended.

An elementary diagram of the Novate substation is shown in Fig. 165. The rectifier units are supplied from a 22,000-volt,

3-phase, 42-cycle, alternating-current system. Each rectifier has 12 anodes and is supplied from a transformer having a double 6-phase fork-connected secondary. Each unit is provided with two direct-current circuit breakers, one in each pole. The positive breaker, of the high-speed type, is equipped with a reverse-current trip attachment and is bridged by a current-limiting resistance. The protective system is designed for selective tripping in case of back fire, so that only the faulty unit is disconnected, while the other units remain in operation. Thus,

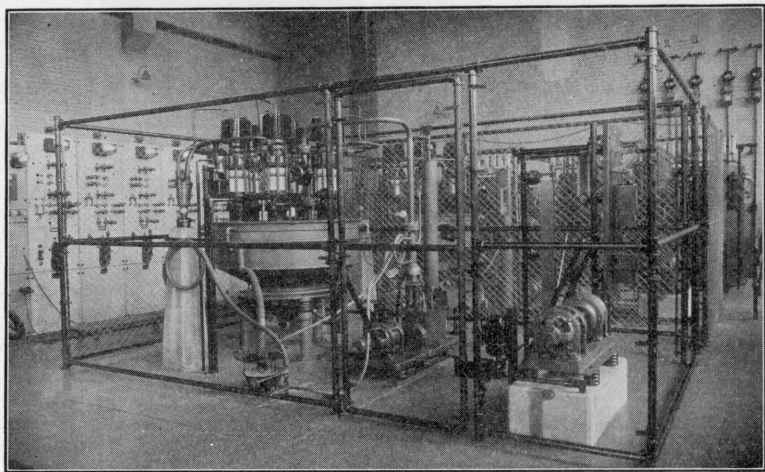

FIG. 166.—Jefferson substation of the Portland Electric Power Company, containing two 750-kw., 1,350-volt rectifiers, serving the Portland terminus of the Oregon Electric Railway.

if a back fire should occur in unit I, the current will flow as indicated in Fig. 165. The positive breaker of unit I will be tripped by the reverse current and will in turn trip the negative breaker through an interlock. The alternating-current circuit breaker of unit I will be tripped by instantaneous overload relays. The opening of the high-speed breaker of unit I will remove the overload from unit II before the alternating-current breaker of that unit can open. Unit II will therefore remain in operation.

**Oregon Electric Railway.**—The Portland Electric Power Company installed two 750-kw., 1,350-volt rectifiers in 1928, for furnishing power to the terminal of the Oregon Electric Railway, an interurban line of 125 miles. The regulation of the rectifiers is improved by compounding which is effected by means

of an interphase transformer saturated with direct current (see Chap. XII).

The transformers are of the indoor, water-cooled type. The two rectifiers are placed in a building which also contains synchronous converters and motor generators. The installation is shown in Fig. 166. The switchboard may be seen to the left of the rectifier enclosure (357).

**Delaware, Lackawanna & Western Railroad.**—The suburban electrification of the Delaware, Lackawanna & Western Railroad, between Hoboken and Dover, N. J., covers approximately 40 miles of heavy-traffic main line and 25 miles of branch lines. The 3,000-volt direct current for this electrification is supplied by five rectifier substations, with a total capacity of 37,000 kw. There are altogether 13 rectifier units, 11 of which are rated at 3,000 kw. nominal and 2 at 2,000 kw. nominal (428).

#### LIGHTING AND POWER LOADS

From the preceding discussion of the characteristics of the mercury arc rectifier it can readily be seen that the rectifier can be used to advantage for furnishing direct current for lighting, power, etc., either for individual large buildings, or for whole lighting networks, such as Edison three-wire systems. A number of rectifier installations furnish energy to the lighting networks of large cities. Among these may be mentioned Vienna, Austria where the rectifiers are used for both railway service and lighting.

#### INDUSTRIAL PLANTS

As already pointed out, rectifiers can be used in practically every field where alternating-current power is converted into direct current. Consequently, rectifiers are found in many industrial plants for operating hoist motors for coal and ore handling, in steel mills, etc. Among the considerable number of rolling mills employing rectifiers, three may be mentioned:

1. **Wendel & Company:** Seven rectifier units, totalling 3,130 kw. at 520 volts direct current. The mill is of the continuous type, and the rectifiers were installed in 1920.

2. **John Cockerill, Belgium:** Eight rectifier units, totalling 4,400 kw. at 550 volts direct current.

3. **Ougrée Marihay, Belgium:** Ten rectifier units, totalling 7,000 kw. at 540 volts direct current.

## ELECTROCHEMICAL PLANTS

Steel-enclosed mercury arc rectifiers are at present used successfully in the production of aluminum, zinc, hydrogen, chlorine, etc. The advantages gained by using rectifiers in such plants were already pointed out; therefore, brief mention will only be made of a few outstanding plants of this character:

1. I. G. Farbenindustrie A.-G., Germany: 500 kw., 1,800/3,500 volts direct current; 200 kw., 12,000 volts direct current.

2. Aluminum Industrie A.-G., Switzerland: 7,200 kw., 450 volts direct current. These rectifiers furnish power for the electrolytic production of aluminum in cells containing molten bauxite. The voltage can be regulated from 200 volts to 500 volts.

3. Consolidated Mining and Smelting Company, Trail, B.C., Canada: 16,800 kw., 500 volts direct current. This installation is used for the production of zinc electrolytically from a solution of zinc sulphate. Further details of this plant, including the layout of the equipment, are given in Chap. XI.

In regard to the effect, in general, of the undulations in the direct-current wave on the electrochemical efficiency of such cells, see Chap. V, p. 100.

## CHAPTER XI

### SUBSTATIONS

The present chapter will deal with the practical considerations entering into the location and design of rectifier substations, their control and protection. Descriptions are also given of several typical rectifier installations, pointing out their particular features.

#### THE LOCATION OF SUBSTATIONS

The location of substations is intimately tied up with the economics of power distribution, which is beyond the scope of this book. A comprehensive study of this subject was made by the American Electric Railway Association.<sup>1</sup>

The economics of power distribution on railway systems usually requires that a number of relatively small converting stations be located at different points along the system in order to save on feeder copper, to reduce feeder losses, to maintain a high trolley voltage over the entire system, and to minimize electrolysis which results when direct-current power is transmitted over long distances. Distributing the direct-current power from a number of smaller substations located in different parts of the system, instead of concentrating it in one or two large stations at the center of the system, also increases the reliability of the system and assures continuity of service during emergencies, such as fires, storms, and similar contingencies.

City railway systems are usually divided into load sections each fed by a converting station near its load center. As the system grows and additional power is required new stations are installed, probably in outlying districts, in order to improve the voltage conditions in those districts and to feed new railway sections.

On interurban railways and main-line railroads, substations are usually located at intervals along the right-of-way of the line, and at important junctions and switching points.

<sup>1</sup> The reader is referred to the 1922 and 1923 *Reports* of the Committee on Automatic Substations of the A.E.R.A. and to Appendix H of the A.E.R.A. *Proceedings*, 1926.

In order to reduce the operating costs as well as the costs of buildings and sites, and to operate the systems most economically, railway substations of the type mentioned are usually either automatically operated or remote controlled, either from a central point or from the nearest manual substation. Sometimes the automatic control is supplemented by remote control.

Automatically controlled railway substations are increasingly coming into use, on account of the high operating charges of manual stations and the confidence of operating engineers in automatic control gained as a result of operating experience.

The rectifier is particularly adaptable to such a system layout for the following reasons:

It is a stationary apparatus and being water cooled requires no ventilation, so that a substation building of light and simple construction may be used.

It is noiseless and can, therefore, always be located near the theoretical load center, whether in residential districts or office buildings.

It is readily adaptable to automatic and supervisory control and at relatively low cost, on account of the simplicity of the starting and stopping operations, and the small number of protective devices required.

#### SUBSTATION LAYOUT

In the design of rectifier substations the same general considerations apply as for any other substations. These are briefly as follows:

The floor space and size of the station should be as small as possible, consistent with safety and ease of operation. All apparatus should be easily accessible for inspection and repairs. Provision should be made to insure the safety of the personnel and equipment. All connections should be as short and simple as possible.

In manually operated substations, the safety and comfort of the operator and ease of control and supervision of the equipment are important considerations. The building must be well ventilated, lighted, and heated, and other provisions must be made as required for the existence of human beings. All the instruments, lamps, and control switches must be located on one switchboard, so that the operator may easily supervise and control the station from a central point. In the design of

automatic substations, the human element does not have to be considered, so that a smaller building of lighter construction without any heating system, etc. can be used. The indicating and control apparatus may be located close to the controlled equipment, thereby eliminating conduits and reducing the length of control wires.

A rectifier installation generally contains the following equipment: alternating-current disconnects, current transformers, oil circuit breaker, rectifier transformer, rectifier cylinder with vacuum pump and ignition and excitation devices, direct-current breaker, switchboard with protective and control apparatus and direct-current feeder equipment. In addition to the above equipment, the substation may contain alternating-current feeder equipment, alternating-current metering equipment, lightning arresters, and direct-current wave-smoothing equipment.

In addition to the main power supply to the rectifier transformer the substation should also have an auxiliary low-voltage alternating-current supply for operating the rectifier auxiliaries, as well as a direct-current supply for tripping the oil circuit breakers. The alternating-current auxiliary supply may be single- or 3-phase, depending on the type of motors employed for the vacuum pumps and recirculating cooler, when used, and is generally obtained from the main alternating-current bus through an auxiliary transformer. The direct-current supply is usually obtained from a battery.

**Alternating-current Equipment.**—The alternating-current switching equipment may be located either indoors or outdoors, depending on the alternating-current voltage, location of substation, etc., and is usually determined by economic considerations.

**Converting Equipment.**—The rectifier transformer may be placed indoors or outdoors. Rectifiers are at present constructed for indoor service only. The transformer should be so located with reference to the rectifier cylinder that the connections between the secondary terminals of the transformer and the rectifier anodes are as short as possible. If the transformer is placed indoors the secondary connections may be run directly to the rectifier. If the transformer is located outdoors, the secondary cables may be connected to the rectifier through wall bushings or conduits.

The rectifier cylinder is insulated from ground by means of insulating supports. If the positive pole of the direct-current



system is alive, as is the general practice on railway systems, the rectifier cylinder and the vacuum pump should be provided with a guard rail or screen. The cathode being located at the lower part of the rectifier, the connection from the cathode to the positive direct-current bus may be made by cable through conduits in the floor. If the direct-current bus is located on the floor below the rectifier, the connection from the cathode to the direct-current bus may also be made by copper bars passing through an opening in the floor.

For the making of inspection and repairs, facilities should be provided for raising the transformer core from the tank and for disassembling the rectifier. The minimum headroom of the substation building is usually determined by these requirements.

**Cooling.**—It is general practice to make the rectifier transformers oil immersed and self-cooled or water-cooled. If a self-cooled transformer is placed indoors, ventilating openings should be provided in the floor or the wall near the transformer to facilitate air circulation for cooling the transformer.

The rectifier cylinder and mercury vacuum pump are cooled by circulation of water. The cooling water may be obtained from the city water supply or from a well. In order to prevent electrolysis or clogging of the cooling system, the water should be free of impurities (see Chap. VIII). The rectifier may also be cooled by means of a closed recirculating system as was described in Chap. VIII. If the rectifier is cooled from a grounded water supply, a long rubber hose must be used for connecting the rectifier to the water supply in order to reduce the ground leakage current to such a small value as to prevent electrolytic corrosion of the rectifier cylinder. This leakage current should be limited to a few milliamperes. For rectifiers operating at high direct-current voltages a very long rubber hose would be required to limit the leakage current to a harmless value; for this reason, rectifiers operating at direct-current voltages above 1,500 volts with the negative grounded are generally cooled by means of a recirculating cooling system.

Such a cooling system is also used when there is no water supply available, when the cost of water is high, or when the water available contains impurities which may clog the water pipes or cause electrolysis.

If the rectifier is cooled by a forced draft recirculating cooling system, the radiator unit of the water recoler, the water pump,

and all the water piping to the rectifier should be insulated from ground to prevent electrolysis. Rubber hose connections should be inserted in the water piping between the rectifier and re cooler, so that in case the re cooler should accidentally become grounded no power current would flow to this ground.

The expansion tank used with a recirculating cooling system must also be insulated from ground and should be placed at an elevation above the top level of the cooling system to keep the system "primed."

The cooling air for the forced draft water re cooler may be taken from the outside or from the substation and may be discharged to the outside or into the substation. Provision may be made by means of shutters to discharge the air to the outside in the summer and into the substation in the winter for heating purposes.

In unheated stations where the temperature in winter may drop below the freezing point of water, an anti-freezing mixture should be used in the recirculating system to prevent freezing. A mixture of alcohol or glycerin with water or some other anti-freezing mixture may be used. In Table X are given data on the freezing temperatures for different mixtures of alcohol and water.

TABLE X.—FREEZING TEMPERATURES OF VARIOUS MIXTURES OF ALCOHOL AND WATER

Percentage of alcohol in mixture		Specific gravity of mixture	Freezing temperature of mixture	
By weight	By volume		Degrees, Centigrade	Degrees, Fahrenheit
0	0	1.000	0	+32
5	6.2	0.991	- 1.9	+28.5
10	12.4	0.984	- 4.2	+24.4
15	18.5	0.977	- 7.0	+19.4
20	24.5	0.971	-10.7	+12.7
25	30.4	0.965	-15.2	+ 4.7
30	36.2	0.958	-20.0	- 4.0
35	41.9	0.949	-25.3	-13.6
40	47.4	0.940	-30.8	-23.4
45	52.2	0.929	-36.2	-33.2
50	57.3	0.919	-41.9	-42.5

Since the rectifier usually operates at a higher temperature than the vacuum pump, the mercury vacuum pump generally cannot be cooled by the same recirculating system as the rectifier. If no tap water supply is available to supply the small amount of cooling water for cooling the pump, an independent recirculating system may be provided, which may be made a part of the cooler used for the rectifier.

**Switchboard.**—On the switchboard are mounted the control and protective equipment, instruments, direct-current switching equipment, and direct-current bus. In small converting stations containing small-capacity rectifiers, the general practice is to locate the circuit-breaker panels alongside the control panels. In larger converting stations the direct-current circuit breakers and direct-current bus are frequently located in the basement or in cells away from the control switchboard in order to insure safety of operation and to facilitate making connections to the machines and feeders.

**Cables and Wires.**—The control wires between the switchboard and the various apparatus are usually located in conduits which terminate in the back of the switchboard. The cables connecting the anodes to the secondary terminals of the rectifier transformer should have higher insulation than normally required for cables of the same operating voltage, on account of the surges which occur at the secondary terminals of the transformer during disturbances. For direct-current voltages up to 1,500 volts, anode cables insulated for 2,500 or 5,000 volts working pressure are generally used. The cables should be of a size capable of carrying the r.m.s values of anode currents. The relation of the anode currents to the direct-current output of the rectifier for different transformer connections may be obtained from the tables given in the chapter on transformers. The wires to the rectifier for the ignition and excitation circuits and for the anode and tank heaters, if used, should be insulated for the same working voltage as the anode cables, for protection against surges. Surge arresters of the horn-gap or condenser type are generally connected between the secondary terminals and neutral of the transformer to protect the transformer, rectifier, and cables against excessive surges.

If wave-smoothing equipment is used, special attention should be given to the connections between the resonant shunt filters and the direct-current buses. The connecting wires should be as

short as possible, should be finely stranded and should not be placed in a metallic conduit. These precautions are necessary in order to keep the voltage drop in these wires, due to the high frequency currents, at a low value since this voltage drop reduces the efficiency of the filter (see Chap. XIII).

#### MANUALLY OPERATED SUBSTATIONS

A diagram of connections of a rectifier unit with auxiliaries is shown in Fig. 86. In a manually operated substation all the starting and stopping operations are performed by an operator either by hand or from the switchboard. Before starting the rectifier the vacuum should be checked and the cooling water turned on. If the rectifier is provided with temperature control the temperatures should also be observed. To start the rectifier, the alternating-current breaker is closed thereby energizing the rectifier transformer. The rectifier arc is then ignited and an auxiliary excitation arc established, either automatically through auxiliary switches on the alternating-current breaker, as shown in Fig. 86, or by means of control switches on the switchboard. With the excitation arc established, the rectifier is ready to take load and may be connected to the bus by closing the direct-current breaker. The whole starting operation therefore consists of the closing of the alternating-current and direct-current breakers.

Since the rectifier is a static machine, has fixed polarities, and cannot feed back from the direct-current to the alternating-current side, synchronizing, polarity check, and voltage check are unnecessary. The rectifier can also be started by closing the direct-current breaker first.

When the rectifier is in operation the flow of cooling water and the temperature of the tank should be observed periodically in order to protect the rectifier against overheating.

The mercury vacuum pump is continuously in service. The rotary vacuum pump is started when the vacuum has dropped to a point requiring the service of the pump, and is stopped when the vacuum has been raised to the required point. The rotary pump should not be operated without the mercury pump, since this would cause the vacuum to drop too low (see Fig. 111). If for any reason the mercury pump has been shut down sufficiently long for the mercury to cool off, it is necessary, when starting the pump again, to operate the mercury pump for several

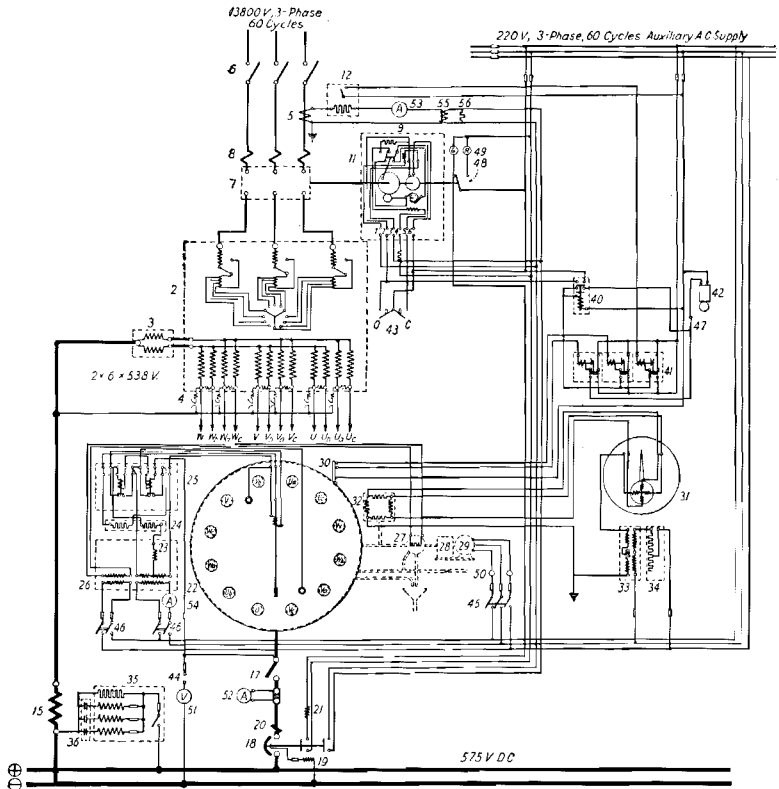

FIG. 167.—Diagram of connections of Brown Boveri manually operated rectifier unit.

- |  |   |   |
|--|---|---|
| 1. Rectifier                                   | 21. Shunt trip coil for 18              | 41. Drop annunciator                        |
| 2. Rectifier transformer                       | 22. Excitation and ignition transformer | 42. Signal bell                             |
| 3. Interphase transformer                      | 23. Excitation choke coil               | 43. Control switch for oil circuit breaker  |
| 4. Surge arresters                             | 24. Excitation and ignition resistances | 44. Potential receptacle                    |
| 5. Current transformer                         | 25. Ignition relays                     | 45. Knife switch for 29                     |
| 6. Alternating-current disconnects             | 26. Insulating transformer for 27       | 46. Knife switches for 22 and 26            |
| 7. Oil circuit breaker                         | 27. Mercury vacuum pump                 | 47. Knife switch for 42                     |
| 8. Series overload trips                       | 28. Rotary vacuum pump                  | 48. Auxiliary switch of oil circuit breaker |
| 9. Current transformer trip for 7              | 29. Rotary vacuum pump motor            | 49. Pilot lamps                             |
| 11. Motor mechanism of oil circuit breaker     | 30. Contact-making thermometer          | 50. Thermal cutouts                         |
| 12. Thermal overload relay                     | 31. Vacuum meter                        | 51. Direct-current voltmeter                |
| 15. Direct-current series reactor              | 32. Hot-wire element for vacuum gage    | 52. Direct-current ammeter                  |
| 17. Direct-current knife switch                | 33. Transformer for 32                  | 53. Alternating-current ammeter             |
| 18. Direct-current circuit breaker             | 34. Series resistance for 33            | 54. Alternating-current excitation ammeter  |
| 19. Reverse-current trip for 18 (voltage coil) | 35. Shunt reactors for filter           | 55. Current transformer for 9               |
| 20. Reverse-current trip for 18 (current coil) | 36. Shunt condensers for filter         | 56. Shunt resistance for 55                 |
|  | 40. Auxiliary tripping relay            |   |

minutes before starting the rotary pump, in order to allow the mercury time to heat up and produce sufficient vapor so that the pumping action produces enough back pressure for the rotary pump. When the mercury pump is in operation the flow of cooling water should be observed in order to insure efficient pumping action and to prevent mercury vapor from passing into the rotary pump due to insufficient cooling.

The rectifier may be stopped by opening the direct-current and alternating-current circuit breakers, and disconnecting the excitation. When the rectifier is shut down and left unattended for any length of time, the vacuum pump should be shut down and the valve between the mercury vacuum pump and the rectifier should be closed.

A wiring diagram of a manually operated Brown Boveri rectifier is shown in Fig. 167. The various items of the diagram are explained in the legend. The operation of the ignition and excitation device was explained in Chap. VIII. As can be seen in the diagram, the rectifier is protected against short circuits and overloads by means of overload and thermal relays. The direct-current breaker is provided with a reverse current trip attachment to trip it in case of back fire and disconnect it from the direct-current bus. The alternating-current breaker is provided with a current transformer trip coil which is normally short circuited by an auxiliary contact of the direct-current breaker and is connected into the circuit by the opening of the direct-current breaker to trip the alternating-current breaker on back fire. The rectifier is protected against excessive temperature by means of a contact-making thermometer which trips the alternating-current breaker when the temperature reaches 60° C.

#### AUTOMATICALLY OPERATED SUBSTATIONS

In an automatically operated substation the automatic devices must perform all the operations that would be performed by an operator in a manually operated substation. The station must also be fully self-protected against any operating contingencies that may arise in service.

Being a stationary machine, a rectifier is particularly well adapted to automatic control, and a manually operated rectifier unit may be made automatic by the addition of the necessary control equipment to start and stop the unit, to automatically control the vacuum pump, and to protect the equipment.

**Starting and Stopping.**—The impulses for starting and stopping the substation may be given by a control switch in the substation, by remote control, by a clock switch, or by load responsive devices, similar to those used for rotary converter stations. Any one of the above methods or several of them may be used for controlling the substation. Clock and load responsive controls are most commonly used.

When clock control is used, the substation may be started and stopped at certain times of the day to suit the load schedule. The clock switch may also be provided with a weekly attachment to shut the substation down on Saturday or Sunday.

The load responsive devices provide for the most complete full-automatic control of the substation. These devices consist of voltage, current, and time-delay relays. When the trolley voltage near the substation is low, indicating load requirement, the voltage relay functions to start the rectifier after a certain time delay. When the load demand has passed, the current relay disconnects the rectifier after a certain time delay. The time delay is necessary to prevent the station from being switched in and out too frequently, on short load swings. The relays have to be adjusted to suit the load conditions on the system.

If the substation has more than one unit, additional units may be started up when the load demand on the station exceeds the capacity of the units in operation, and may be disconnected when the load demand drops again.

This control function may be performed either by a thermal-type load relay or by a current relay with time delay. The sequence of leading and lagging units may be alternated at intervals by means of a selector switch in order that all the units may undergo the same number of service hours. If one of the units fails to complete its starting operation or is locked out, the next unit is automatically started in its place.

When the starting impulse is given by the master element, the alternating-current circuit breaker is closed, energizing the rectifier transformer. At the same time the ignition and excitation circuit and the water-circulating device, which may be a magnet water valve or the motors of a recirculating system, are energized through auxiliary switches of the alternating-current breaker, igniting the excitation arc in the rectifier, and starting the flow of cooling water through the rectifier. When the arc is established in the rectifier, the direct-current breaker

is closed by the voltage at the terminals of the rectifier or from another source.

When a stopping impulse is given by the controlling element, the alternating-current breaker is tripped, de-energizing the rectifier transformer, the ignition and excitation circuits and the water-circulating device; the direct-current breaker is tripped through an interlock of the alternating-current breaker.

**Reclosing and Lockout.**—If the alternating-current breaker is tripped by overload or short circuit, it may be reclosed automatically after a predetermined time interval by means of a reclosing relay. If the short circuit continues and the breaker is tripped successively after a predetermined number of reclosures, the breaker is locked out, and the unit cannot start again until the lockout is reset.

**Vacuum Pump Control.**—The vacuum pump is controlled so as to maintain a good vacuum in the rectifier at all times, and its control is independent of the operation of the rectifier. As already stated, the mercury vacuum pump is continually in operation, and is cooled by water. The rotary vacuum pump is started when the vacuum has dropped to a predetermined low value and is shut down when the vacuum has been raised to a predetermined high value. The starting and stopping operations are controlled through contacts on the indicating vacuum meter or through pressure responsive relays. In addition to these functions, the control equipment for the vacuum pump also protects the vacuum pump against failure of the cooling water supply and interruption of the heating plate circuit of the mercury pump, and provides the necessary time delay between the starting of the mercury and rotary pumps after the former has been shut down (see Manually Operated Substations).

**Temperature Control.**—Some types of rectifiers are provided with control equipment to maintain the temperatures of anodes and tank within certain operating limits which give the best operating conditions. Temperature control may be effected by regulating the temperature of the cooling water, and by using tank and anode heaters. If the rectifier is cooled by tap water the water temperature may be controlled by regulating the flow of cooling water by means of a thermostatic regulating valve as was shown in Fig. 100 (Chap. VII). If the rectifier is cooled by a forced-draft recirculating cooling system, the water temperature may be controlled by controlling the operation of the fan of the



forced-draft cooler by means of a thermal relay, stopping the fan when the water temperature has dropped to a predetermined low value, and starting it when the temperature has reached a predetermined high value. If tank heaters are used, they are also controlled by means of a thermal relay to maintain the tank temperature within certain limits. If anode heaters are used, they are connected to an auxiliary alternating-current supply through insulating transformers. The operation of the anode heaters is controlled by a current relay, which energizes the insulating transformers when the load current drops below a certain value.

**Protection.**—Automatic rectifier units are usually provided with protective features for protection against:

*Severe alternating-current overload* by means of overload relays connected to current transformers on the alternating-current side for tripping the alternating-current breaker.

*Sustained overload* by thermal overload relays connected to current transformers, which trip the alternating-current breaker and hold it open for a certain length of time to permit the rectifier and transformer to cool off.

*Reverse direct current* to disconnect the rectifier from the direct-current system in case of back fire.

*Overheating of the rectifier cylinder* by means of a contact thermometer which trips the alternating-current breaker and locks it out, or holds it out until the tank temperature has dropped to a sufficiently low value.

*Failure of cooling water supply to the rectifier* by means of a water flow relay which trips the direct-current breaker and holds it open until the water flows again.

*Operation with low vacuum* by means of a contact on the vacuum meter or a vacuum relay, which trips the alternating-current breaker and locks it out, or holds it out until good vacuum is restored.

*Incomplete start* by means of relays which trip and lock out the alternating-current breaker if the starting operation of the rectifier is not completed within a certain time limit.

Protection of the rectifier against alternating-current under-voltage, single-phase, and reverse-phase is not essential, as phase reversal has no effect on the operation of a rectifier, and, in case of low voltage or single-phase operation, the direct-current

voltage would drop, so that the load would be reduced or become zero and no serious harm could result to the rectifier.

Protection against undervoltage, single- and reverse-phase may be required, however, for the protection of alternating-current motors used with auxiliaries.

The protection of the vacuum pump has already been discussed under Vacuum Pump Control. Special circuit connections for selective protection of rectifiers will be described later.

**Diagrams of Connections.**—Below are described two automatic control systems for rectifiers and some of the control apparatus used.

In Fig. 168 is shown a schematic wiring diagram of a General Electric Company rectifier substation (406). The functions of the various apparatus are explained in the legend. The control equipment consists of temperature-control equipment, pressure-control equipment, starting- and stopping-control equipment, ignition and excitation equipment, alternating-current switching and protective equipment, and direct-current switching equipment.

The temperature-control equipment regulates the anode and tank temperatures within the limits giving best operation. The anode heaters are connected in parallel to two secondary windings of an insulating transformer, the primary of which is connected to the alternating-current control bus; they are controlled by current relay 37, which energizes them when the load drops to a low value. The tank heaters are controlled by a thermal relay 26, mounted on the rectifier (see Fig. 93), to maintain the desired tank temperature. This relay is provided with three contacts; one contact controls the tank heaters, and the two others, at high or low tank temperatures, respectively, open the master contactor circuit, or hold the rectifier out of service until the temperature of the tank is again within the proper limits, as the case may be. If the rectifier is cooled by a recirculating cooling system, the fan motor of the cooler may also be controlled by thermal relay 26, which starts the fan when the tank temperature has come up to a certain value. The water-circulating pump operates continuously. The temperature control of the tank operates independently of the rest of the substation to maintain the correct temperature all the time so that the rectifier may always be ready for service.

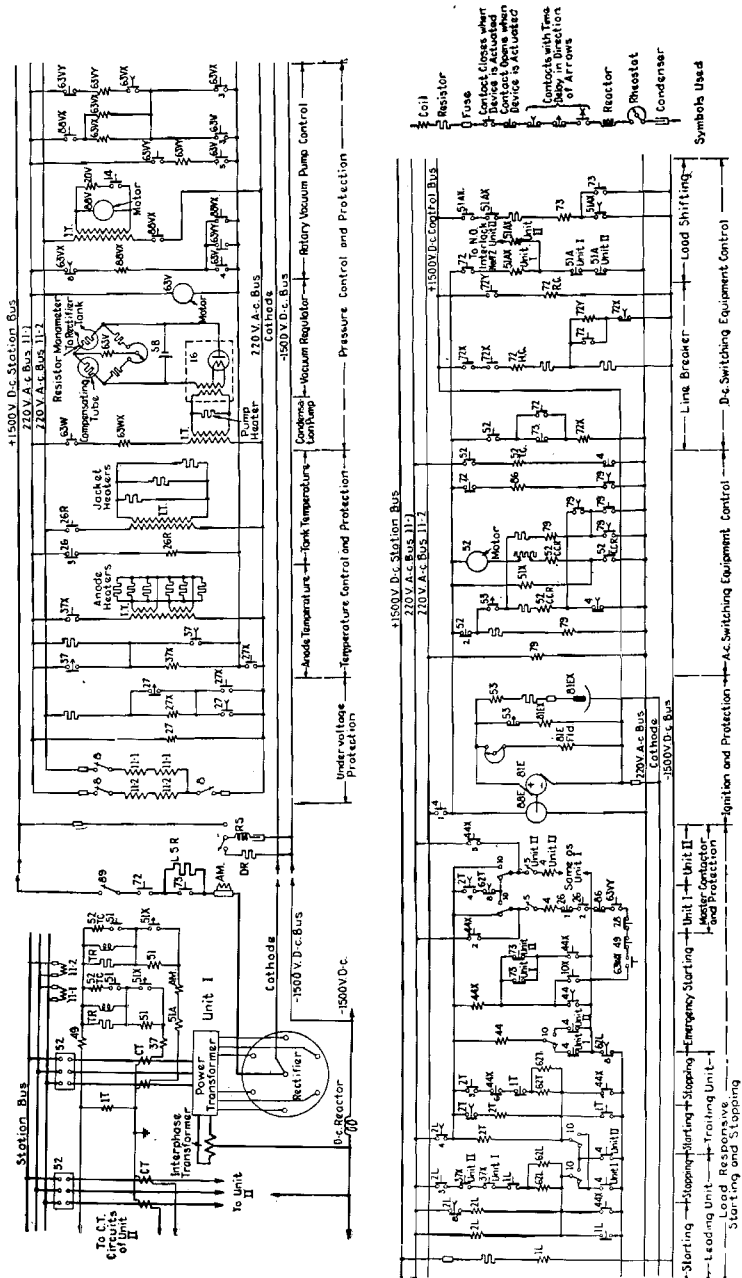

FIG. 16S.

The heater of the condensation (mercury) pump is always in operation, and is disconnected only by water flow relay 63W when the cooling water has failed. The rotary vacuum pump is controlled by air pressure relay 63V, which starts the vacuum pump motor 88V through an auxiliary contactor 88VX when the pressure in the rectifier has risen to a predetermined value. The regulating instrument with contactors is shown in Fig. 131, Chap. VIII. As the motor approaches normal speed, a speed switch 14 energizes a solenoid-operated valve 20V, which opens the passage from the interstage reservoir to the rotary vacuum pump. A second contact of 63V closes at a critically increased pressure within the rectifier, to energize auxiliary relay 63VY, which opens the master contactor 4 to prevent the operation of the rectifier and also to insure that the auxiliary contactor 88VX is energized to exhaust the tank. A third contact closes when the pressure becomes proper for operation, to energize auxiliary relay 63VX and reset relay 63VY, which allows contactor 4 to place the rectifier in operation once more. After a time delay to insure that a proper operating pressure is attained within the rectifier, relay 63VX opens contactor 88VX to stop the rotary pump.

The pressure control of the rectifier operates independently of the rest of the substation to maintain a high vacuum in the

FIG. 168.—Schematic diagram of connections for automatic switching control of General Electric rectifier. The lower part of the diagram is a continuation of the upper part.

1L, Master element for leading unit (voltage relay)	37, A-c. undercurrent relay	72X, Auxiliary contactor for 72
1T, Master element for trailing unit (current relay)	37X, Auxiliary contactor for 37	72Y, Auxiliary relay for 72
2L, Time-delay starting relay for leading unit	44, Emergency starting relay	73, Load-shifting-resistor shunting contactor
2T, Time-delay starting relay for trailing unit	44X, Auxiliary contactor for 44	79, A-c. reclosing relay
4, Master contactor	49, A-c. thermal relay	81E, Arc-striking generator
5, Manual stopping switch	51, A-c. overcurrent relay	81EX, Arc-striking anode
8, Control power switch	51X, Auxiliary contactor for 51	86, Locking-out relay
10, Manually-operated unit sequence switch	51A, A-c. overcurrent relay for load shifting resistor	88E, Auxiliary motor for arc-striking
10X, Manually-operated pull-button switch	51AX, Auxiliary contactor for 51A	88V, Auxiliary motor for vacuum pump
11-1, Control power transformer	52, Oil circuit breaker	88VX, Auxiliary contactor for 88V
11-2, Control power transformer	53, Ignition relay	89, D-c. line switch
14, Underspeed switch	62L, Time-delay stopping relay for leading unit	AM, Ammeter
16, Battery-charging device	62T, Time-delay stopping relay for trailing unit	CCR, Control contactor
20V, Vacuum valve	63V, Vacuum regulator	CT, Current transformer
26, Rectifier-tank thermostat	63VX, Auxiliary timing relay for 63V	DR, Discharge resistor
26R, Auxiliary contactor for 26	63VY, Auxiliary relay for 63V	FLD, Generator field (81E)
27, A-c. undervoltage relay	63W, Water-flow relay	HC, Holding coil
27X, Auxiliary contactor for 27	63WX, Auxiliary relay for 63W	IT, Insulating transformer
28, Load shifting resistor thermostat	72, D-c. high-speed circuit breaker	LSR, Load-shifting resistor
		RC, Reset coil
		RS, Resonant switch
		SB, Storage battery
		TC, Trip coil
		TR, Tripping relay

rectifier at all times, so that the rectifier may always be ready for service.

The starting of the leading unit is controlled by voltage relay  $1L$ , which closes its contact on low trolley voltage and energizes time delay relay  $2L$ . This relay gives the starting indication when the trolley voltage remains at a low value for a definite time.

The rectifier is started by master contactor 4, the circuit of which is controlled by the contact of relay  $2L$  and a series of other contacts which check the unit for safe tank temperature, safe internal pressure, cooling water for mercury pump, low or single-phase alternating-current voltage, safe temperature of load-shifting resistor, and freedom from previous repeated alternating-current overcurrents. If all these conditions are correct, master contactor 4 closes and the auxiliary generator  $81E$  energizes the exciting anode solenoid  $81EX$ . The exciting anode then touches the mercury cathode and current flows through the stabilizing resistor to energize exciter relay 53, which de-energizes exciting anode solenoid  $81EX$ . A spring then withdraws the exciting anode from the cathode, and an arc is drawn and maintained. Reclosing relay 79 closes oil circuit breaker 52 after a few seconds, if relay 53 indicates that the exciting arc is being maintained. Auxiliary contactor  $51X$  is energized in parallel with motor 52 and closes around the alternating-current overcurrent relays 51. Contactor  $51X$  opens after sufficient time has passed for the power transformer magnetizing transient to disappear.

When the exciting arc is maintained and the alternating-current breaker is closed, it energizes through an interlock auxiliary relay  $72X$ , which closes the direct-current line circuit breaker 72. In the absence of direct-current overcurrent, contactor 73 shunts out the load-shifting resistor. The whole starting sequence may be completed in less than 10 sec., if the first closure of the reclosing relay is adjusted for its shortest interval.

If breaker 72 fails to close, or if it opens and remains open for 3 min. while master contactor 4 is closed, relays 79 and 86 lock off the unit, thus giving the starting indication for the succeeding unit in a multiple-unit station.

If the direct-current load exceeds the capacity of the rectifier, relay 4 opens shunting contactor 73, to insert the load-shifting resistor. If the overload continues long enough to overheat the resistor and rectifier, the heated air from the resistor causes

thermal relay 28 to open contactor 4, shutting down the rectifier. It will restart when the equipment has become cool. After the load demand has passed, current relay 37 operates auxiliary contactor 37X to energize time-delay relay 62L, so that if the load demand remains below a set value for a predetermined time, the contact of relay 62L is opened, de-energizing contactor 4 and stopping the unit.

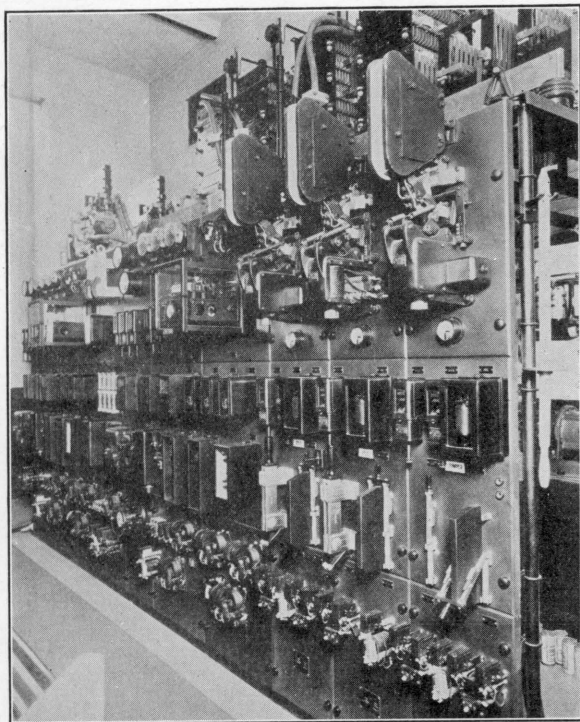
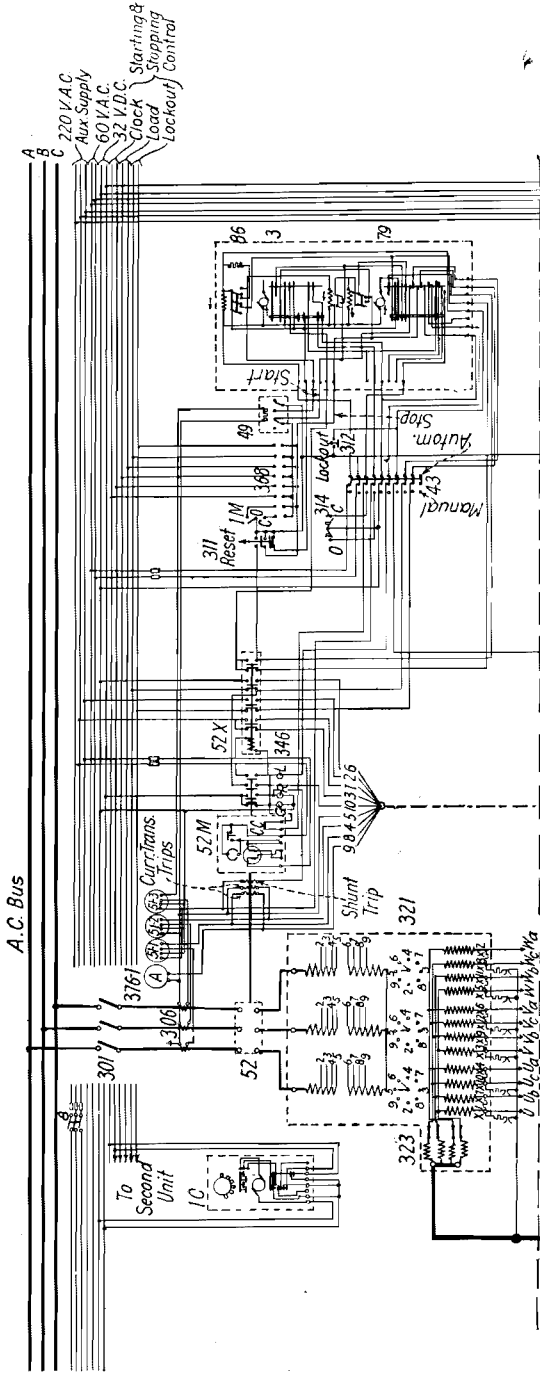

FIG. 169.—Switchboard for the automatic control of two 500-kw., 600-volt General Electric rectifier units and three direct-current feeders.

The starting and stopping of the trailing rectifier unit are controlled by current relay 17 through time-delay relays 2T and 62T. Either unit I or unit II may be made the leading or trailing unit by sequence switch 10.

In Fig. 169 is shown a switchboard for controlling two automatic 500-kw., 600-volt, General Electric type rectifier units and their direct-current feeders.

In Fig. 170 is shown the engineering wiring diagram of an American Brown Boveri 3,000-kw. rectifier unit. An explanation



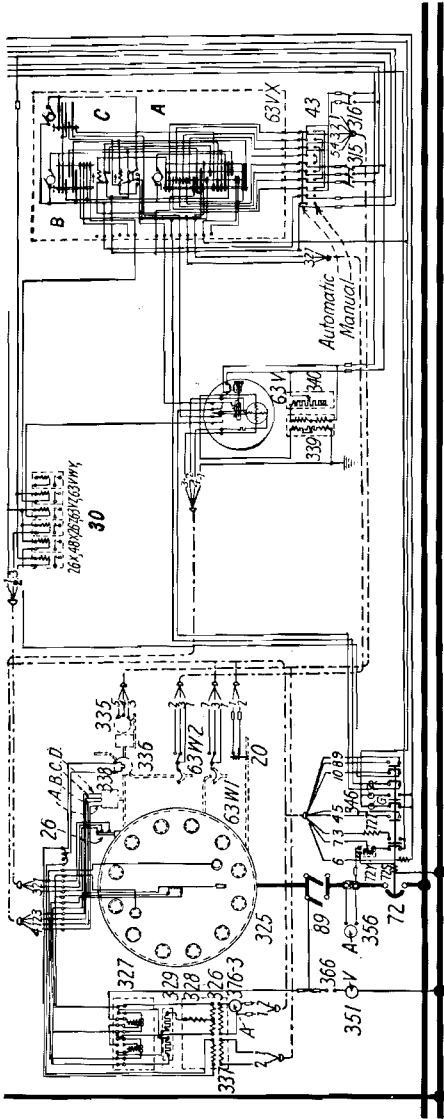

D.C. Bus

Fig. 170.—Engineering wiring diagram of a Brown Boveri automatic rectifier unit.

- 1C, Master element (clock)
- 1M, Master element (manual control)
- 3, Master relay
- 8, Auxiliary power switch
- 20, Magnet water valve
- 26, Contact-making thermometer
- 26X, Signal for 26-60° C.
- 26Z, Signal for 26-65° C. (lockout)
- 30, Drop annunciator
- 43, Changeover switch
- 48X, Signal for incomplete start (lockout)
- 49, Alternating-current thermal overload relay
- 51-1, 51-2, 51-3, Alternating-current overcurrent relays
- 52, Oil circuit breaker
- 52M, Motor mechanism for 52
- 52X, Auxiliary relay for 52
- 63V, Vacuum meter
- 63VX, Vacuum pump control relay
- 63VZ, Signal for low vacuum (lockout)
- 63VWY, Signal for vacuum pump and water failure
- 63W, Water flow relay for rectifier
- 63W2, Water flow relay for vacuum pump
- 72, Direct-current circuit breaker with reverse-current trip
- 72S, Closing coil for 72
- 72T, Shunt trip for 72
- 72Y, Closing contactor for 72
- 79, Alternating-current reclosing relay
- 86, Lockout relay
- 89, Direct-current knife switch
- 301, Alternating-current disconnects
- 306, Current transformers
- 311, Manual reset switch
- 312, Manual lockout switch
- 314, Control switch for direct manual control
- 327, Ignition relays
- 328, Excitation choke coil
- 329, Excitation and ignition resistances
- 335, Rotary vacuum pump
- 336, Static mercury vacuum pump
- 337, Insulating transformer for 336
- 338, Hot-wire element of vacuum gage
- 339, Transformer for vacuum gage
- 340, Resistance for 339
- 346, Pilot lamps (G-breaker open; R-breaker closed; L-lockout)
- 251, Direct-current voltmeter
- 356, Direct-current ammeter
- 366, Voltmeter receptacle
- 368, Selector receptacles
- 376-1, Alternating-current ammeter for rectifier
- 376-3, Alternating-current excitation ammeter
- 315, Knife switch for mercury vacuum pump
- 321, Rectifier transformer
- 323, Interphase transformers
- 325, Rectifier
- 326, Excitation and ignition transformer
- 327, Ignition relays
- 328, Excitation choke coil
- 329, Excitation and ignition resistances
- 335, Rotary vacuum pump
- 336, Static mercury vacuum pump
- 337, Insulating transformer for 336



of the equipment is given in the accompanying legend. The clock switch *1C* and the relays 3, 79, and 63*VX* are of the drum-contactor type, and are operated by vibrating alternating-current motors. The motor consists of a two-pole armature which is placed between the poles of a permanent magnet, and is coupled to a spring. When an alternating-current voltage is applied to the armature, it vibrates at the frequency of the alternating-current voltage, and these vibrations are converted into rotary motion of the contactor shaft through a ratchet and gear. A photo of this type of relay is shown in Fig. 171.

The unit may be started and stopped by clock switch *1C* or by control switch *1M*. If the unit is located in a multiple-unit substation, it may also be started and stopped by the load demand on the bus, or in place of another unit which is locked out. The type of control used is determined by the position of a 4-point plug in one of several "selector" receptacles.

When the starting indication is given, master relay 3 is energized and moves its contacts from the "stopping" to the "running" position. With relay 3 in the running position, closing and reclosing relay 79 is energized and its contacts begin to rotate. When the first point in the lowest contact of relay 79 is closed, the closing mechanism of the oil circuit breaker 52 is energized, closing the breaker. Should the breaker trip after the first closure, it is reclosed at definite time intervals by relay 79. If the breaker trips out after the last scheduled reclosure, relay 79 moves to the lockout position at the right, and then transmits the starting and stopping indications to the next unit. The same reclosing cycle takes place if the breaker is tripped out by overload during operation.

When the oil circuit breaker is closed, auxiliary control relay 52*X* is energized, closing the circuit from the control bus to the magnet water valve 20 and ignition and excitation transformer 326, thereby starting the flow of cooling water to the rectifier and igniting the arc in the rectifier. With the excitation arc established and the rectifier transformer under potential, a direct-current voltage is available at the direct-current terminals of the rectifier, which energizes the closing solenoid of the direct-current breaker 72, closing the breaker and connecting the rectifier to the direct-current bus.

When a stopping indication is given, relay 3 is moved to the stopping position, tripping the oil circuit breaker. When the

breaker is opened, relay 52X is de-energized, opening the circuits of the magnet valve and of the excitation transformer, and tripping the direct-current breaker through its shunt trip coil.

The rectifier unit is protected against severe alternating-current overloads by overload relays 51, which trip the oil circuit breaker. It is protected against overloads of long duration by thermal overload relay 49, which disconnects the rectifier unit by operating relay 3, and prevents the rectifier from restarting until it has cooled sufficiently. The rectifier cylinder is protected against overheating by contact thermometer 26, located on the anode plate, which locks out the rectifier unit by operating lock-out relay 86 if the rectifier temperature exceeds a safe operating value. The rectifier is protected against operation without cooling water by water-flow relay 63W1, which prevents the direct-current breaker from closing unless water is flowing, and trips out the direct-current breaker should the water supply fail during operation. The rectifier is protected against operation with low vacuum by a contact on the vacuum meter 63V, which operates the lockout relay 86 if the vacuum in the rectifier falls below a safe operating value.

The direct-current circuit breaker is provided with a reverse-current trip. If a back fire occurs in the rectifier, the direct-current breaker is tripped by reversal of the current, disconnecting the rectifier from the direct-current bus. When the direct-current breaker is opened, the short circuit is removed from the current transformer trip coils of the oil circuit breaker, causing the breaker to trip instantly and thereby interrupting the back fire. The oil circuit breaker is reclosed a few seconds later by relay 79, and puts the rectifier back into operation.

The vacuum pump is controlled automatically to maintain a good vacuum in the rectifier, independently of the operation of the rectifier unit. The control of the pump is effected by contact-making vacuum meter 63V and control relay 63VX. The mercury vacuum pump operates continually. The rotary vacuum pump is started by the contact-making vacuum meter and relay 63VX when the vacuum drops to a predetermined low value, and is stopped when good vacuum is established. Relay 63VX consists of three elements, A, B, C, each operated by a vibrating-type motor. Element A has four contact positions. In position 1 only the heating transformer of the mercury pump is energized. In position 2 the heating transformer and the

motor of the rotary pump are energized. In position 3 the motor is disconnected, and in position 4 the motor and heating plate transformer are disconnected. Positions 1 and 2 are the normal operating positions of the relay.

The mercury vacuum pump is protected against operation without cooling water by water-flow relay 63W2, which moves relay A to position 4, thus disconnecting the heating plate. If the current is interrupted in the circuit of the heating trans-

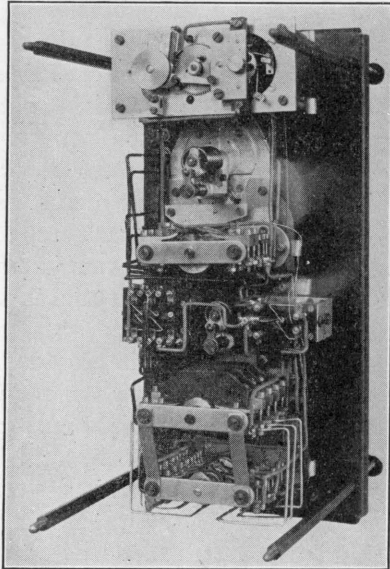

FIG. 171.—Brown Boveri automatic relay for controlling vacuum pump. The relay is denoted in Fig. 170 by device number 63VX.

former, relay A moves to position 3, disconnecting the vacuum pump motor and thus preventing the rotary pump from operating without the mercury pump. When normal conditions are re-established, the vacuum pumps automatically resume their operation. If the mercury pump is restarted after being out of service due to interruption of the cooling water supply or due to interruption of the heating current, the rotary pump is permitted to start after a definite time interval following the start of the mercury pump. The time delay between the starting of the two vacuum pumps is provided by relay C. Relay B provides a short time delay to prevent operation of time-delay relay C

in case of momentary failure of the water supply or heating current, or when relay A is going through a normal working cycle.

The multipole changeover switches 43 are used to change the control of the rectifier and vacuum pump from automatic to direct manual control, at the same time de-energizing the control relays. The drop annunciator 30 indicates the nature of any trouble occurring in the equipment.

In Fig. 172 is shown a switchboard for controlling two Brown Boveri 1,000-kw., 600-volt automatic rectifier units.

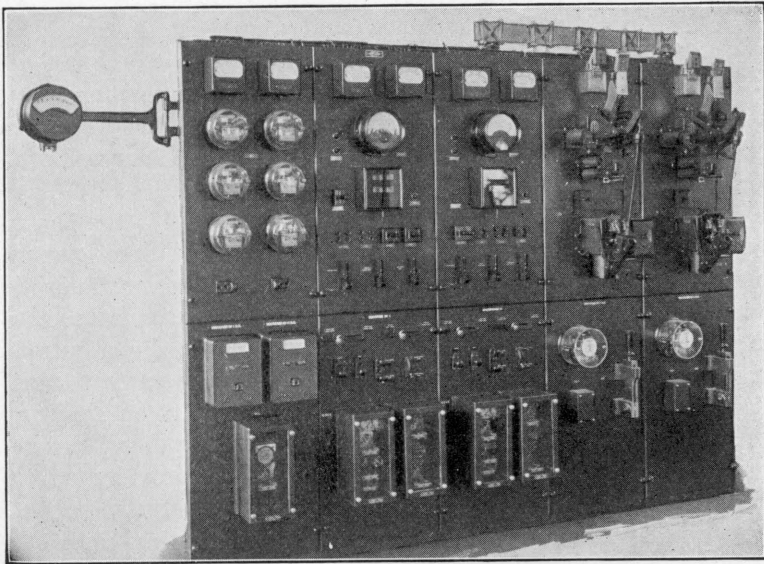

Fig. 172.—Switchboard for the automatic control of two 1,000-kw., 600-volt Brown Boveri rectifier units.

#### SELECTIVE PROTECTION OF RECTIFIERS

When a back fire occurs in a rectifier, current flows into the back-firing anode from the alternating-current system through the other anodes of the rectifier, and from the direct-current system through the cathode. The phenomena of back fires and the flow of current in a back-firing rectifier were considered in Chap. III. It is seen from Fig. 19 (Chap. III) that during a back fire a reverse current, which is supplied from parallel operating machines, flows on the direct-current side of the rectifier. A back fire is practically equivalent to a short circuit on the secondary of the transformer and on the direct-current bus, and it is necessary

to open both the direct-current and alternating-current circuit breakers to interrupt a back fire.

When a number of rectifiers operate in parallel in the same or adjacent substations, a back fire in one rectifier will impose a short circuit on the other rectifiers, and the protective system should be so designed that only the back-firing rectifier is tripped out as quickly as possible leaving the other rectifiers in service. Such selective tripping is essential for continuity of service. The back-firing rectifier can be put back into service immediately and the operation of the system is therefore not disturbed by the back fire, since the other machines could carry the load dropped by the faulty unit during the short interval.

Selective tripping is obtained by providing the rectifiers with tripping arrangements which are responsive to the abnormal circuit conditions occurring during a back fire. Several such arrangements are described below.

**Reverse Current Selective Tripping.**—In Fig. 173 are shown two rectifier units operating in parallel on the same direct-current bus. The alternating-current breakers are provided with normal overload protection consisting of overload relays connected to a direct-current trip coil *TC*. In addition to the direct-current trip coil each oil circuit breaker is provided with a current transformer trip coil *CTC*, which is short circuited by an auxiliary switch *a* on the direct-current breaker when the direct-current breaker is closed. The direct-current breaker is provided with a polarized reverse current trip which trips it on reversal of current but does not function when the current is in the normal direction.

When a back fire occurs in the rectifier of unit 1, reverse current flows into the rectifier from unit 2, as indicated by arrows, causing the direct-current breaker of unit 1 to trip out, thus disconnecting it from the direct-current bus. The opening of the direct-current breaker opens the auxiliary switch *a*, removing the short circuit from the current transformer trip coil. Since the back fire still continues in the rectifier, the high short-circuit current flowing from the current transformer secondary through the trip coil trips the alternating-current breaker, disconnecting the rectifier from the alternating-current bus and thus interrupting the back fire.

Since the opening time of the direct-current breaker is shorter than the operating time of the overload trip on the oil circuit breaker, the opening of the direct-current breaker of the back-



current breaker is open and there is no back fire, only the magnetizing current of the rectifier transformer flows through this trip coil, which is not sufficient to trip the breaker. The current transformer trip coil is so designed that it is not operated by the rush of magnetizing current when the alternating-current breaker is closed.

The reverse current trip of the direct-current breaker may be polarized by a permanent magnet or by a voltage coil connected to a battery or to the direct-current terminals of the rectifier. If the voltage coil is energized by the direct-current voltage of the rectifier the reverse current trip must be of such design that its

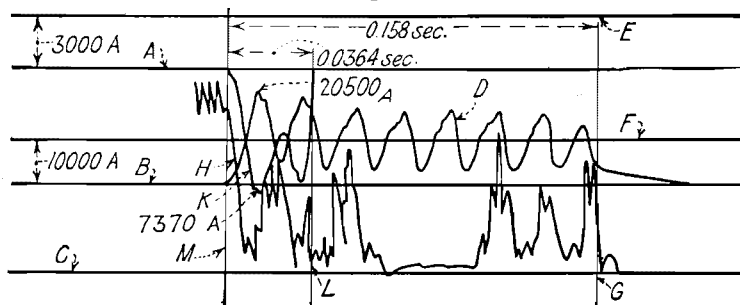

FIG. 174.—Oscillogram illustrating the operation of the selective tripping scheme of Fig. 173. *A*. Zero line of direct current. *B*. Zero line of current in back-firing anode. *C*. Zero line of direct-current voltage. *D*. Current in back-firing anode. *E*. Calibration line of direct current. *F*. Calibration line of current in back-firing anode. *G*. Alternating-current breaker opens. *H*. Direct-current voltage. *K*. Reverse current. *L*. Direct-current breaker opens. *M*. Start of back fire.

operation will not be affected by the low value of the direct-current voltage during a back fire.

Instead of using direct-current breakers with reverse current trip attachments, polarized reverse current relays may be used on the direct-current side of the rectifier units. When a back fire occurs in one of the units its *RC* relay operates and trips simultaneously the direct-current and alternating-current circuit breakers of that unit, either through current transformer trip coils or through shunt trip coils, while the other parallel operating units are left in operation.

In Fig. 175 is shown a selective protection scheme using two direct-current breakers for each rectifier unit. One of the breakers, shown connected in the positive pole, is a normal latched-in type breaker provided with an overload trip. The second breaker, shown connected in the negative pole, is a high-

speed breaker provided with a reverse current trip. The high-speed breaker is bridged by a load-limiting resistance. The alternating-current breakers are provided with normal overload protection. The high-speed breakers are normally closed whether or not the rectifiers are in operation. When a back fire occurs in unit 1, for example, the high-speed breaker of that unit trips on reverse current and cuts in the bridging resistance. This resistance limits the reverse current flowing from the direct-

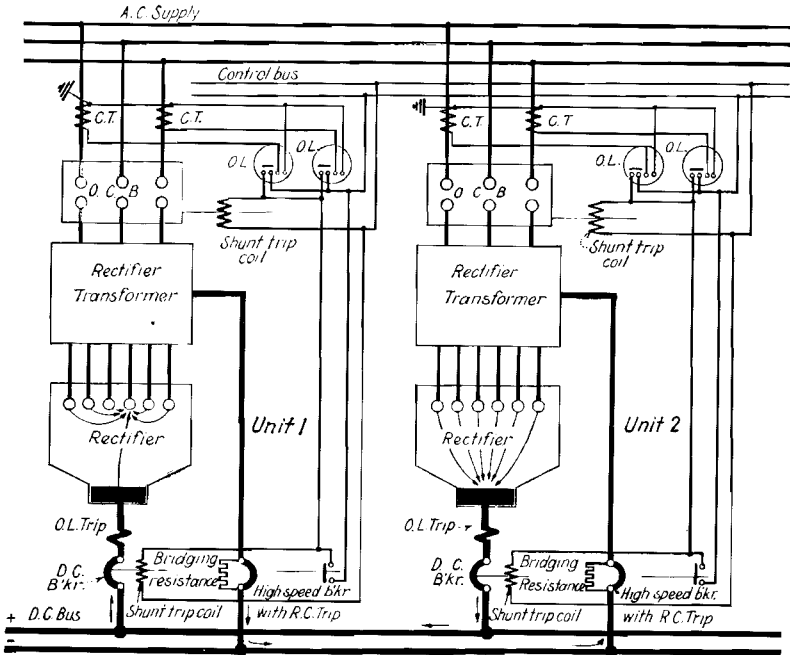

FIG. 175.—Connection diagram for the selective tripping of rectifiers during a back fire, using two direct-current breakers.

current bus into the back-firing rectifier to a value below the overload setting of the positive breakers, so that those breakers remain closed. The opening of the high-speed breaker of unit 1 trips out the alternating-current and direct-current breakers of that unit through an electrical interlock, and disconnects it from the alternating-current and direct-current buses. When the alternating-current and direct-current breakers of the back-firing unit have opened, the high-speed breaker may be reclosed automatically through electrical interlocks with those breakers.



The bridging resistances may be of low current-carrying capacity since they are required to carry current only for a fraction of a second. Both direct-current breakers of each rectifier may be connected in series in the same pole if desirable.

Current transformer trip coils, connected as in Fig. 173, may be used instead of the shunt trip coils shown in Fig. 175.

**Selective Tripping by Unbalance.**—When a rectifier is operated with a transformer connection using an interphase transformer,

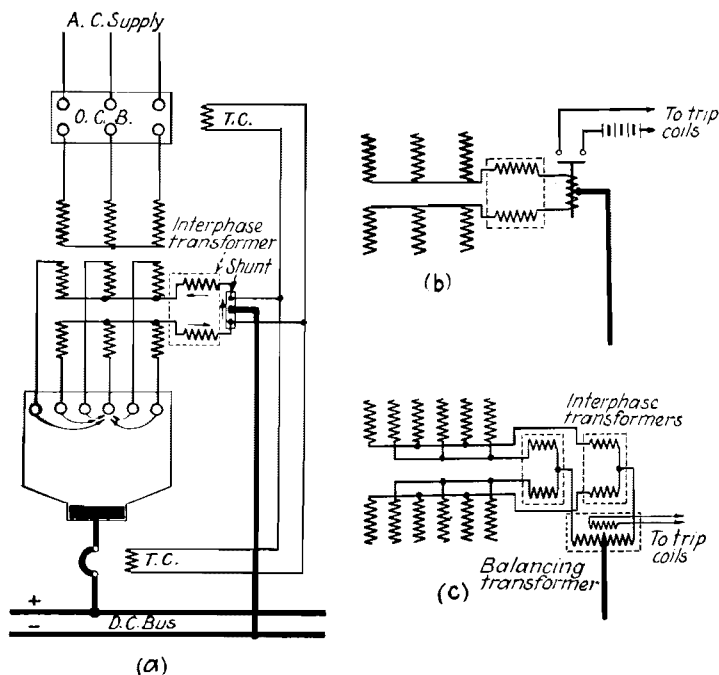

FIG. 176. Connection diagrams for the selective tripping of rectifiers during a back fire, making use of the unbalance of currents in the interphase transformers.

the unbalance in the interphase transformer during a back fire may be used for selective tripping of the rectifier unit. One such arrangement is shown in Fig. 176a. A shunt is connected between the two windings of the interphase transformer, with the negative lead connected to the middle point of the shunt. The trip coils of the alternating- and direct-current breakers are connected in parallel across the shunt. Under normal operating conditions, the currents in the two halves of the shunt are equal

and opposite, so that the voltage drop across the shunt is zero. When a back fire occurs in the rectifier, the current in one winding of the interphase transformer is reversed, as shown in the figure, producing a voltage drop across the shunt which causes the trip coils to operate and trip the breakers.

In Fig. 176*b* is shown another arrangement for selective tripping, utilizing the unbalance in the interphase transformer during a back fire. A two-winding relay is connected to the circuit in place of a shunt. Under normal operating conditions the currents in the two windings of the relay are equal and opposite, so that the flux in the relay core is zero. During a back fire the m.m.f.s in the two windings are additive causing the relay to operate and trip the breakers.

In Fig. 176*c* is shown a selective tripping scheme for a double 6-phase transformer connection with two interphase transformers. This transformer connection is sometimes used for a twelve-anode rectifier and consists of two parallel 6-phase systems, each provided with an interphase transformer. The neutrals of the two interphase transformers are connected to the negative bus through a balancing transformer, which is provided with a secondary winding connected to the trip coils of the circuit breakers. Under normal operating conditions, the currents in the two halves of the winding of the balancing transformer are equal and opposite, producing no flux in the core. When a back fire occurs in the rectifier, the currents in the two halves of the winding of the balancing transformer become unbalanced, producing a flux in the core, which induces a voltage in the secondary winding and trips the breakers.

The tripping arrangement shown in Fig. 176*c* is used in the rectifier substations of the Berlin elevated railway for instantaneous tripping of the alternating-current circuit breaker on a back fire. The selective protection scheme used in the substations of this railway is shown in Fig. 190 and is described in the latter part of this chapter (423).

### SUBSTATION LAYOUTS

On the following pages are explained and illustrated some typical layouts of rectifier substations. They are the following:

1. Bridgeport (Congress Street) Substation of The Connecticut Company.
2. Maypole Substation of The Commonwealth Edison Company, Chicago, Ill.

3. Nemahbin Substation of the Milwaukee Electric Railway and Light Company, Wisconsin.
4. Rockfield Substation of the Montreal Tramways Company.
5. Berlin Elevated Railway.
6. Wyoming Substation of the Philadelphia Rapid Transit Company.
7. Paris Metropolitan Railways (subway).
8. Portable Substation, City of Calgary.
9. Trail, B. C., plant of Consolidated Mining and Smelting Company, Canada.

**Congress Street, Bridgeport, Substation of The Connecticut Company.**—In Fig. 177 is shown the layout of a part of the above

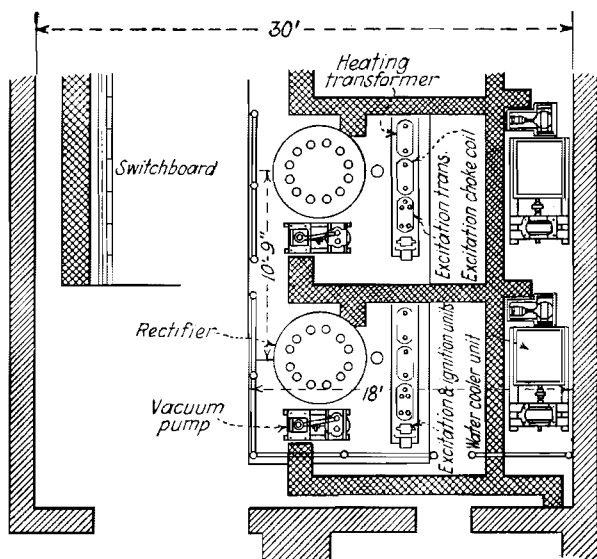

FIG. 177.—Layout of Congress Street rectifier substation of The Connecticut Company, showing two of the five 1,200-kw., 600-volt rectifier units.

substation, mentioned already in Chap. X. In this substation are installed five 12-anode rectifier cylinders, with the vacuum pumps and ignition-excitation equipment disposed around them. Next to the substation wall are located the recooling sets, consisting of tube radiators, circulation pumps, and motor-driven blowers. The arrangement of this type of cooler can be seen in Figs. 143 and 144. Cooling air is taken from the substation room and is discharged either out of doors or into the room again, depending on the season. Figure 178 shows the location of the rectifiers, cooling equipment, and the hoist rail for the rectifier tanks. The control switchboard is indicated in Fig. 177 and

consists of 20 panels, 14 of which control the out-going 600-volt direct-current feeders, 5 the rectifiers, and 1 the incoming lines. The building is of simple construction, and has a floor area of 0.29 sq. ft. per kilowatt of installed capacity. The transformers are located outdoors, together with the high-tension bus, the incoming line oil circuit breakers, and the breakers for the individual rectifiers.

A special feature of the bus layout is an auxiliary bus tapped from each of the incoming transmission lines ahead of their control breakers. These auxiliary buses occupy a position similar to the main bus over the aisle between the lightning

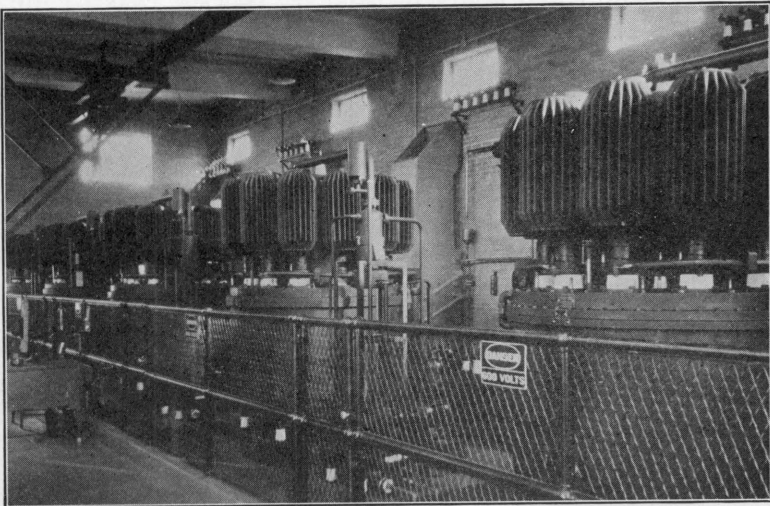

FIG. 178.—Interior view of Congress Street rectifier substation.

arresters and the transmission line control breakers. They are both normally energized and are connected through auxiliary transformers to the 220-volt auxiliary bus within the station. In the event of failure on either transmission line, the station auxiliary bus is automatically transferred from the line on which the failure occurs to the other by means of an automatic change-over switch. This arrangement was resorted to in order to insure a continuous supply of power to the auxiliary equipment, thus reducing the duration of outages to an absolute minimum in case of line trouble.

A third bus extends the entire length of the structure over the center line of the rectifier transformers. This is the station

negative bus to which the neutral points of the transformers and aerial negative track returns are connected. The negative sides of all instruments within the station are brought through a common lead to this bus, and with this exception the entire negative side of the system is out of doors.

For further information see (353) and (369).

**Maypole Substation of the Commonwealth Edison Company, Chicago, Ill.**—This substation is equipped with two rectifier units, the first of which was put in operation in 1928 and the second in 1929. The two rectifiers, which are of the largest ampere size installed to date in this country, are of Brown Boveri make. Each unit is rated for 3,000 kw., 5,000 amp., 600 volts, with 50 per cent overload capacity for 2 hours and 200 per cent load for 1 min. This capacity is obtained from a single cylinder arranged with 12 water-cooled anodes. The rectifiers, which receive their alternating-current energy from oil-insulated, self-cooled transformers, are operated from the 3-phase, 12,000-volt, 60-cycle grounded-neutral system of the Commonwealth Edison Company. The rectifier units together with the 600-volt feeders are fully automatic; the 12,000-volt switching equipment is remote controlled from the nearest attended substation in the territory. The layout of the equipment on the first floor and in the basement of this installation is shown in Fig. 179. A view of one rectifier and its transformer, as well as of the cables and auxiliaries, can be seen in Fig. 180. The control switchboard is shown in Fig. 181.

The starting of each unit is controlled by a time switch which can be set at any predetermined time to place in motion the customary control equipment, commencing with the master control relay, which functions in sequence to close the alternating-current breaker, strike the ignition and excitation arcs within the cylinder, start the cooling water, and close the direct-current breaker connecting the unit to the 600-volt bus. To shut down the unit the master relay trips the alternating-current breaker, which through auxiliary contacts cuts off the excitation and trips the direct-current breaker.

The pumping equipment, which is used to maintain vacuum within the cylinder, operates independently of any of the other automatic functions of the unit, and the control for this equipment is in operation at all times whether the rectifier is connected to the

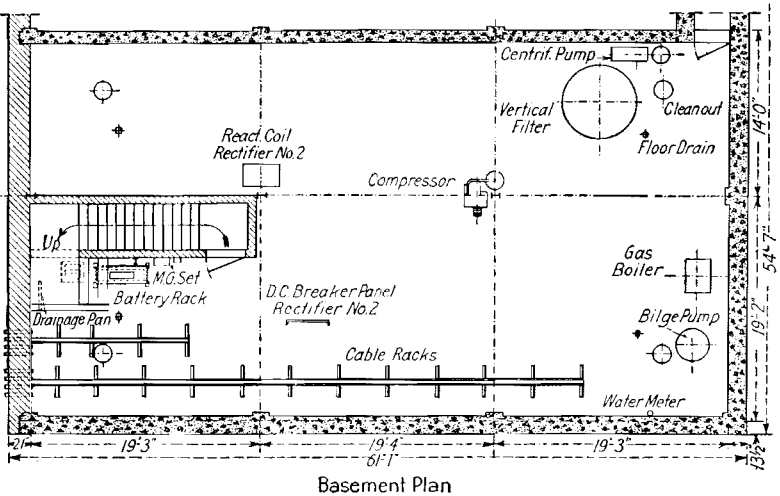
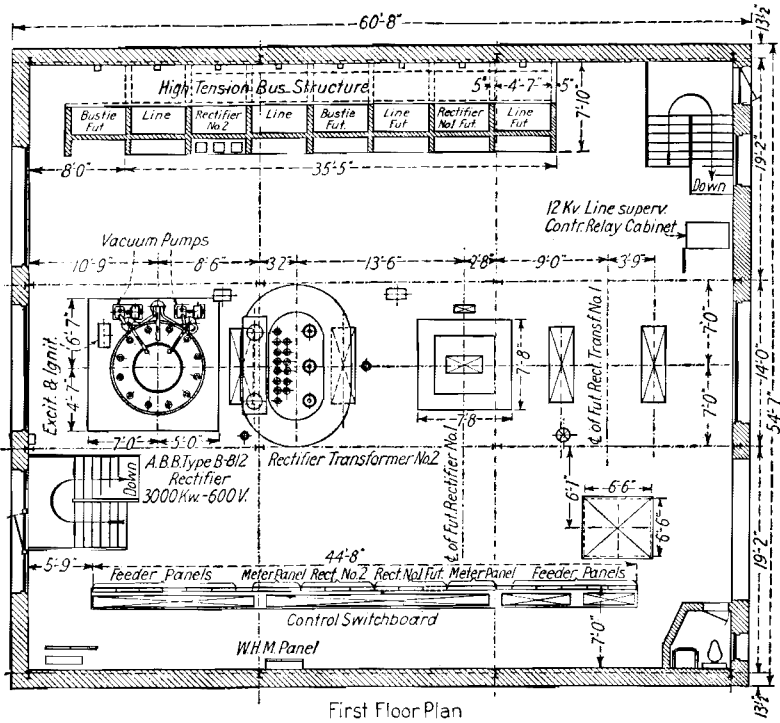

FIG. 179.—First floor and basement plans of Maypole rectifier substation, serving Chicago surface and elevated lines.

system or not, except at such times as the unit may be taken out of service for repairs or other reasons.

The amount of water supplied to the rectifier is regulated in accordance with the load demands through the registering of the temperature of the discharge water upon a thermostatic device which in turn controls a regulating valve in the water supply pipe.

Briefly, the entire installation is protected against overloads, short circuits, overheating of the rectifier cylinder, failure of

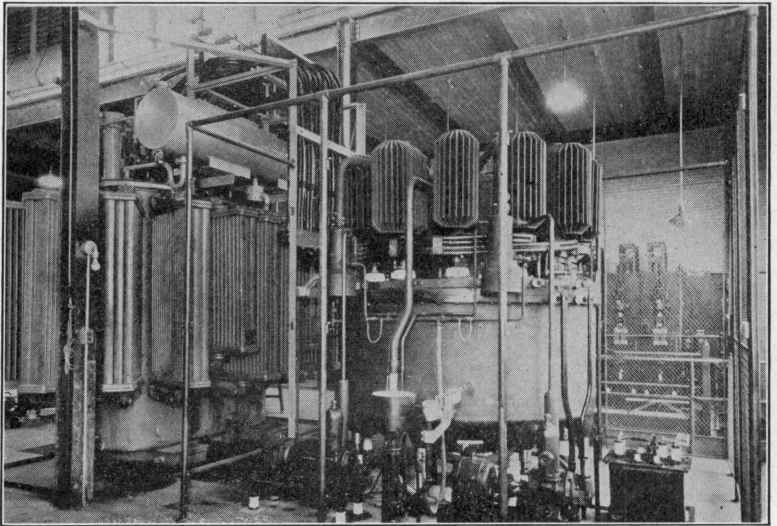

FIG. 180.—Interior view of Maypole substation.

the water supply, poor vacuum, failure of the auxiliary power supply, and high-voltage surges as follows:

Overload relays of the induction type located on the high-voltage side of the transformer protect against overload and short-circuit conditions. This action is selective with the direct-current breaker.

A series of continuous overloads which may occur below the setting of the overload relays and cause undue heating of the rectifier, if persisted in long enough, is guarded against by means of a thermal relay. The rectifier is further protected against overheating by a temperature relay which gives a visible warning when the temperature of the cylinder reaches  $60^{\circ}$  C. and at  $65^{\circ}$  C. locks out the substation. Protection is afforded to the

equipment in case the cooling water to the vacuum pumps fails, fuses in the supply circuit to the pumps blow, or the service of the supply circuit is interrupted or fails.

Protective resistances and spark gaps connected to the anode leads mitigate the effect of high-voltage surges.

To reduce the amount of scale-forming matter which may deposit in the water passages around the cylinder due to roiled or muddy water, the cooling water is first passed through sand filters.

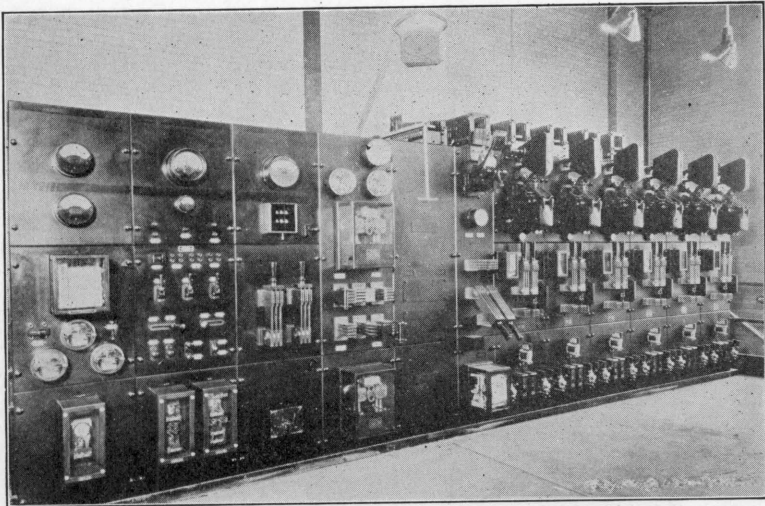

Fig. 181.—Control switchboard in Maypole substation.

The building is of simple construction, and has a floor space of 0.54 sq. ft. per kilowatt of installed capacity, taking into account the transformers.

For further information see (380).

**Nemahbin Substation of the Milwaukee Electric Railway and Light Company.**—One of the three substations serving the Milwaukee-Watertown line of the Milwaukee Electric Railway and Light Company is shown in Fig. 182. The ground plan and elevation of the station are given in Fig. 183. Some data pertaining to this railway from an application point of view are given in Chap. X and in (381).

Figure 183 shows the layout of the apparatus in this substation, the overhead structure, and the dimensions. The load-limiting devices, oil breaker, disconnects, etc., are mounted outside the



station, and can be seen in Fig. 182. Some features of this plant are given below:

Load-limiting resistors were installed in order to shift the load when it becomes excessive at one particular station. Without these resistors the higher current demands would put the stations off the line, resulting in a very poor trolley voltage in the vicinity of the station in question, with a corresponding reduction in possible train speeds. With the load-limiting

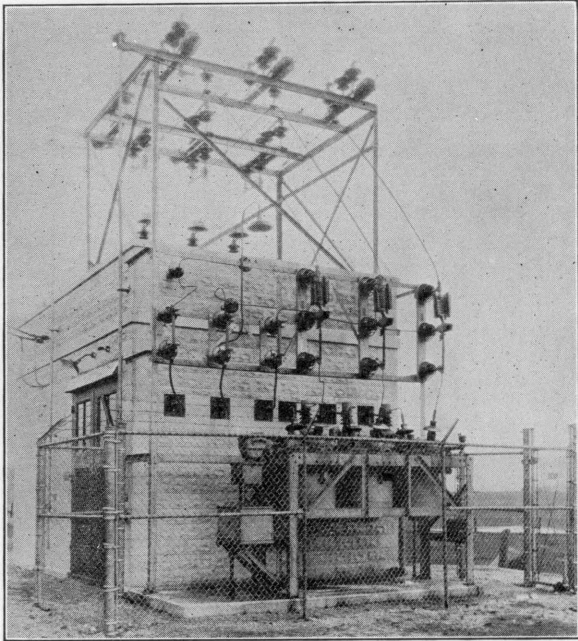

FIG. 182.—Nemahbin rectifier substation of Milwaukee Electric Railway and Light Company.

resistors inserted in the feeder circuit, a station is never disconnected from the line, and a fairly good trolley voltage can be maintained during high-demand periods.

The resistor-shunting breaker opens when the demand reaches 1,800 amp., and closes when the load decreases to approximately 1,000 amp. The resistors, located outside the substation building, are protected from the weather by sheet-steel coverings, open at the bottom. The equipment is readily accessible for inspection and repairs; trouble in the resistors cannot be transferred to the other station equipment, and the heat dissipated

by them does not affect the temperatures of the transformer and the rectifier.

The substation building is of simple construction, and has a floor area of 0.52 sq. ft. per kilowatt of installed capacity, including the transformer, or of about 0.31 sq. ft. per kilowatt for the rectifier and auxiliaries alone, without taking into account the space required by the transformer.

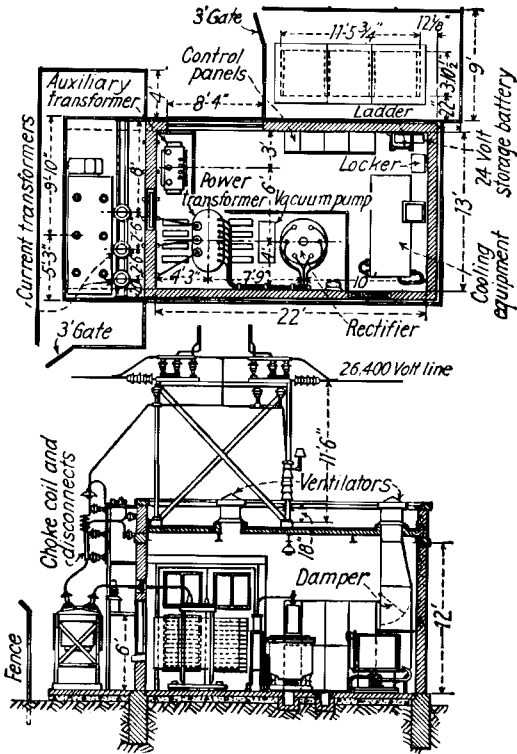

FIG. 183.—Plan and elevation of Nemahbin substation.

The rectifier substations have self-contained cooling systems, because no regular water supply is available. Water is circulated by a motor-driven pump through the water jacket surrounding the tank and through a radiator of the automotive type. The cooling system is at one end of the station. A motor-driven fan forces air drawn into the room at the opposite end past the step-down transformer and rectifier, through the radiator, and finally discharges it outside the building. A non-freeze solution of

water and high-grade alcohol is used in the cooling system during the winter, the fan being taken out of service. Fan, radiator, and pump are grounded, necessitating the use of distilled water with a non-conducting non-freeze solution, such as alcohol, to prevent electrolytic action. Some difficulty was encountered from corrosion in the water pipes and water jacket. It has been partially overcome by the use of distilled water with an alkaline tendency. Caustic soda is added to distilled water to give a concentration of about five parts of sodium hydrate per million. A hydrogen-ion indicator (being a measure of acidity or alkalinity) is used to measure the quality of the water. With the above solution a pH 9 is secured.

To prevent iron rust clogging the water pipes, a trap has been installed in the cooling system. This trap consists of a pipe tee connected in the water pipe. The tee is larger than the pipe line. To the third opening in the tee is connected a capped pipe that points downward. The velocity of the water in the tee is reduced and the suspended solids will settle into the trap. With a valve in the trap the dead-end pipe may be cleaned without disturbing the water in the cooling system.

**Rockfield Substation of the Montreal Tramways Company.**—A typical full automatic rectifier installation is shown in Figs. 184 to 189.

The building is a one-story brick structure with limestone trimmings, and has a floor area of 0.42 sq. ft. per kilowatt of installed capacity, taking into account the space occupied by the transformers. The substation is designed for an ultimate installation of four units.

The present equipment consists of two automatic, 1,200-kw., 600-volt rectifiers with their transformers, alternating-current switching equipment, recirculating forced-draft coolers, and wave-filter equipment. There are also installed two incoming alternating-current feeder breakers, six automatic direct-current feeder breakers, and station auxiliary transformers.

On the main floor of the building are located the rectifier cylinders and the alternating-current switching equipment. A 5-ton trolley is provided above the rectifiers to facilitate opening the rectifiers for inspection and repairs. The transformers are placed in separate compartments, the openings of which are covered by wire netting and rolling doors. In warm weather the doors are opened to provide adequate ventilation. Provi-

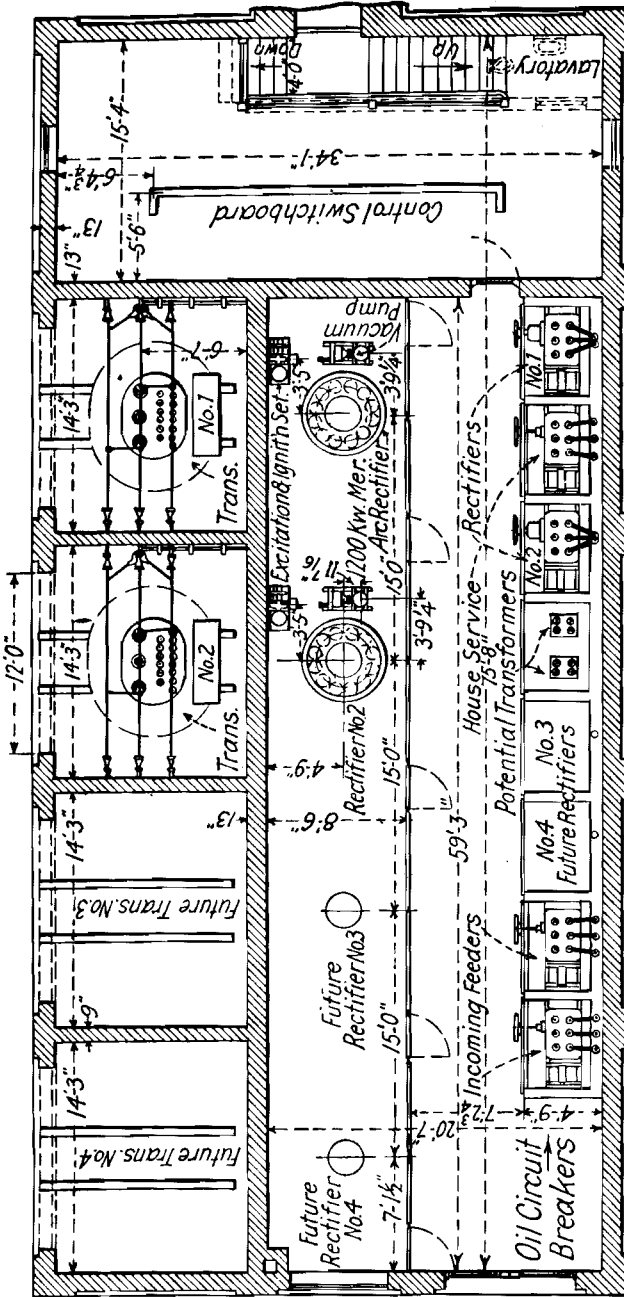

Plan

Fig. 184.—Plan view of Rockfield rectifier substation of Montreal Tramways Company.

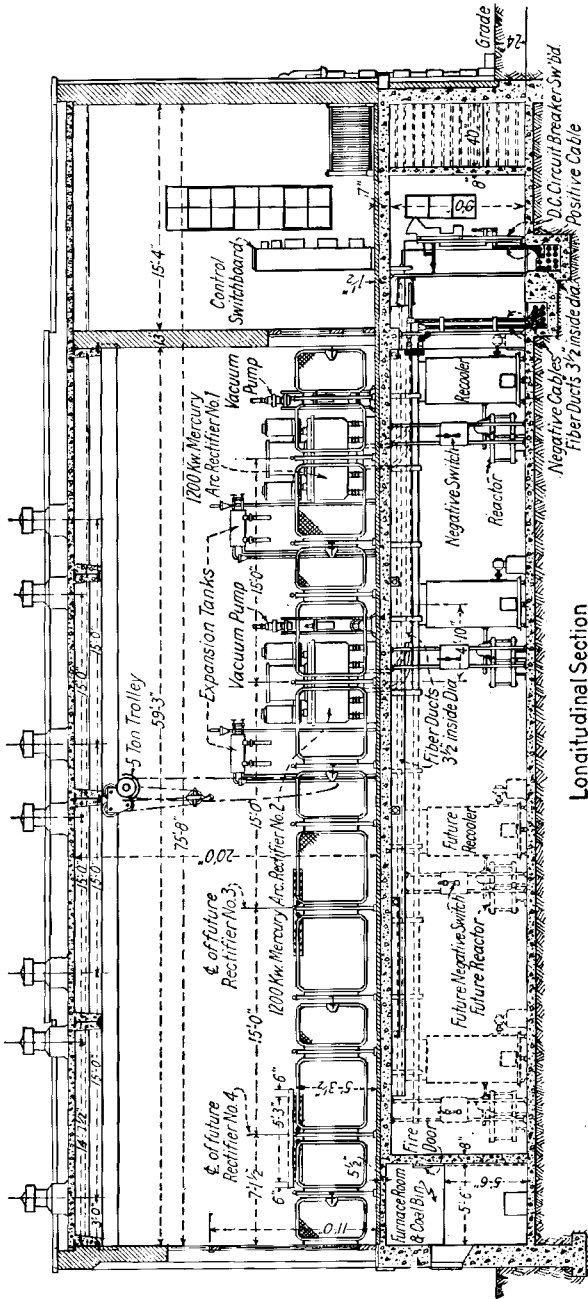

Longitudinal Section

Fig. 185.—Longitudinal section through Rockfield substation.

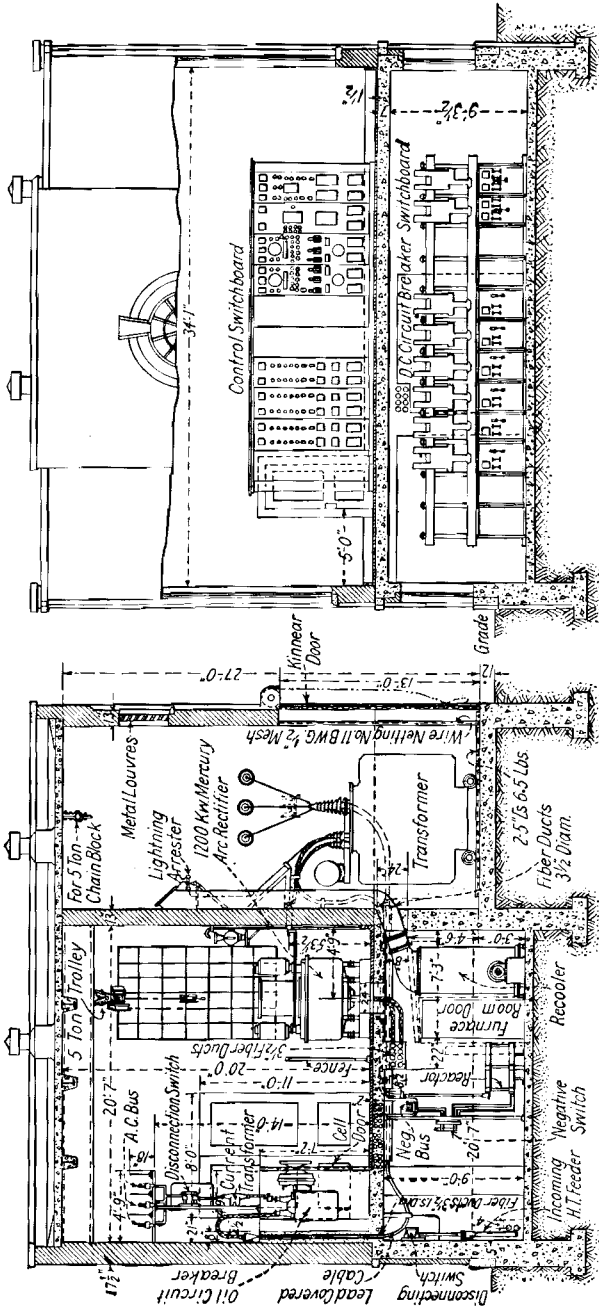

Cross-Section Through Switchboard Room

Cross-Section Through Rectifier Room

Fig. 186.—Cross-sections through rectifier and switchboard rooms, Rockfield substation.

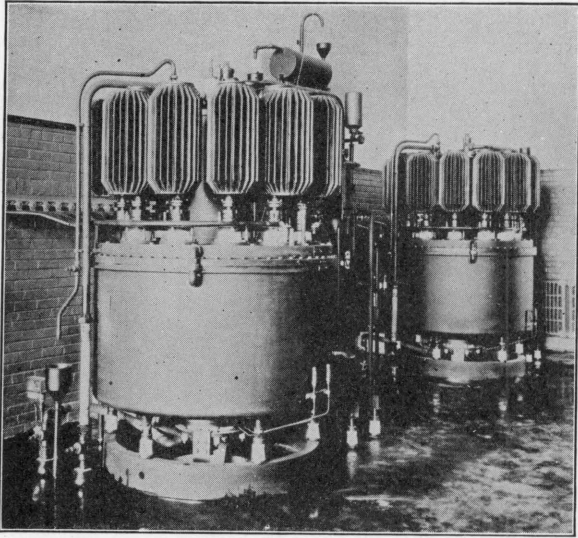

FIG. 187.—Interior view of Rockfield substation, showing 1,200-kw. Brown Boveri rectifiers.

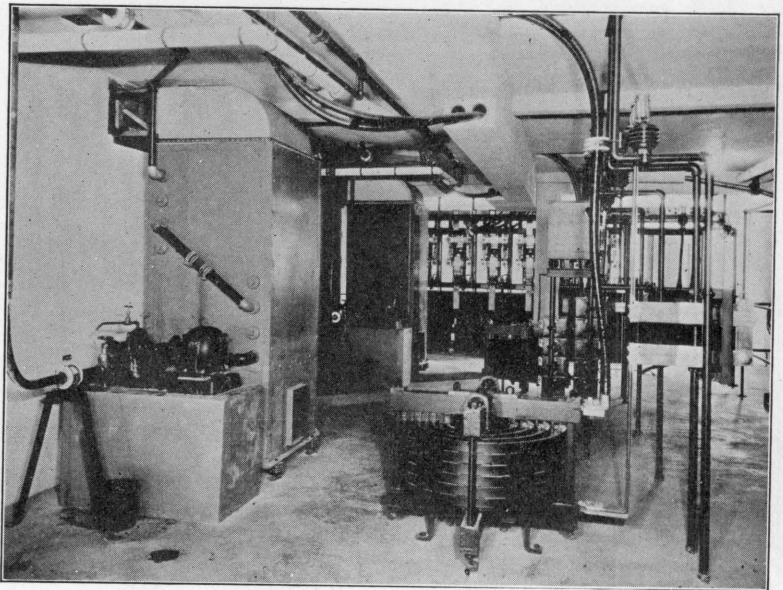

FIG. 188.—View of basement, Rockfield substation, showing recoolers, series reactors, wave filters, etc.

sion is made in the transformer compartments for supporting a 5-ton chain block, which may be used for removing the core from the tank. The transformer primaries are connected to the oil circuit breakers by 3-conductor lead-covered cables. The transformer secondaries are connected to the rectifier anodes through wall bushings.

In the basement of the building are located the forced-draft water coolers, the direct-current series reactors, the wave filters,

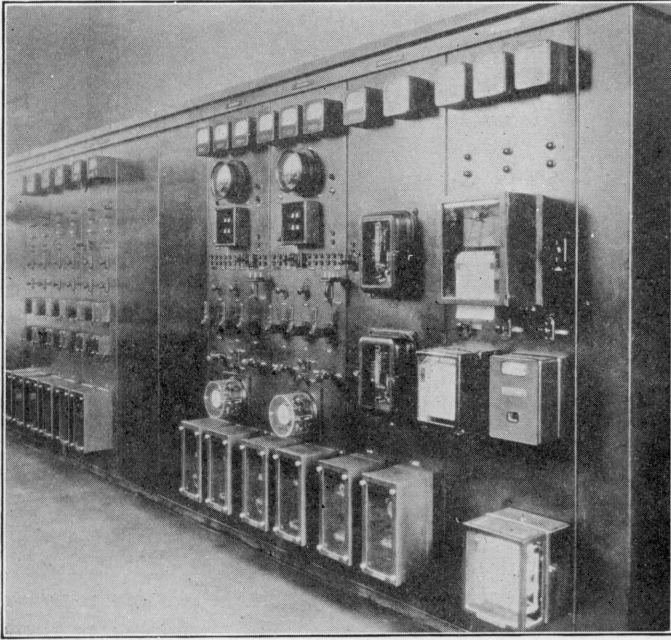

FIG. 189.—Automatic control switchboard, Rockfield substation. The panels from right to left are: alternating-current feeder and metering panel, station automatic-control panel, rectifier-control panels, and direct-current feeder-control panels.

and the direct-current switching equipment. The coolers are insulated from ground. The expansion tanks of the coolers are mounted in the rectifier room. The pipe connections to the rectifiers and expansion tanks are taken through insulators in the floor. The air for the coolers is taken from the basement and is discharged into the transformer compartments. The control switchboard is located in a separate room at the front of the building. The direct-current circuit breaker switchboard is in the basement, directly below the control switchboard.



The rectifiers are automatically operated, the substation being provided with clock and load-responsive controls. The control system of the rectifiers is similar to that shown in Fig. 170. On the control switchboard, shown in Fig. 189, are mounted the control equipment and meters for two rectifier units and six 2,000-amp. direct-current feeders. Blank panels are provided for two additional units and two additional feeders (397) (404).

**Berlin Elevated Railway.**—In Chap. X the layout of this railway system and the application of rectifiers to this system are described at length. Below are discussed the substation layout and some of the features of the control equipment as well as the arrangement for protecting the rectifiers against short circuits and back fires.

As mentioned in the preceding chapter, the third rail is connected to the negative terminals of the rectifiers, which is contrary to standard practice. Moreover, the larger part of the rectifiers are controlled by a supervisory and remote-control system. A diagram of connections, including the substation equipment and track connections, is shown in Fig. 190. Thirty-one of the substations, with a total of 62 rectifier units, are automatic and are controlled by a supervisory system from four different points. The two rectifiers in each substation work independently of each other, and the third rails of each track are fed independently and are sectionalized, as can be seen from Fig. 190. In normal operation the section breaks are bridged by the high-speed circuit breakers *DOL*, and in case of a serious fault on a rectifier unit they are closed by a special remote-controlled sectionalizing switch provided for such an emergency. This bridging method has the advantage of allowing parallel operation of the rectifiers feeding the same track, while giving operating selectivity in case a short circuit occurs on that track.

The alternating-current supply is 30,000-volt, 3-phase, 50-cycle current furnished by two steam plants, each supplying half the power required by the railway system. The railway load is supplied by separate generators, and carried by separate feeders; thus the oil breakers on the railway feeders can be set to trip at any suitable current value.

*Supervisory Control.*—The supervisory equipment is such that for each controlled station there is a sending apparatus at the dispatcher's station and a corresponding receiving apparatus at

the controlled substation. The equipment consists of special synchronous distributors provided with rotating segments similar to those commonly used in high-speed telegraphy. The individual distributor segments are constantly connected to the operating devices of the controlled apparatus.

The control covers closing and opening of the high-voltage feeder circuit breakers and disconnecting switches, and the closing and opening of the high-speed direct-current circuit breakers and sectionalizing switches. Every operation of these switches is signalled back to the controlling station as soon as it is completed. The indication of the substation load and the signalling of apparatus lockout are transmitted in a manner similar to the remote control.

*Protection against Overloads, Short Circuits, and Back Fires.*—The rectifiers are protected against overloads, short circuits, and back fires by means of high-speed breakers on the direct-current side, equipped with overload and reverse-current trips, while on the alternating-current side they are protected by oil circuit breakers equipped with overload trip and instantaneous trip in case of back fire. The arrangement of the oil circuit breakers, the high-speed breakers, the sectionalizing switches, as well as the division into sections, etc. are shown in Fig. 190. All the sections to which the rectifiers are connected are interconnected, during normal operation, by the high-speed breakers designated *DOL* in Fig. 190. The high-speed breakers *DOL* and *RC* are provided with directional overload and reverse-current tripping, respectively, so that the breakers *DOL*, provided with overload protection, will trip only on an overload in the forward direction, while the breakers *RC* will trip only on reverse current. The breakers designated by *OL* trip on overload in either direction. The breakers *DOL* and *OL* are set for high currents (4,000 to 5,000 amp.) and, therefore, trip only at peak loads, which means they actually trip only during section short circuits. This relatively high current setting can be used because the rectifiers are able to carry relatively high overload peaks for a few seconds. Overloads of less than 4,000 to 5,000 amp. and of longer duration are taken care of by the oil circuit breakers, which are set to trip after 2 to 3 sec. The relatively long setting of 2 to 3 sec. was used in order to have the breakers interrupt after the first rush of current has passed. This setting made it possible to use a breaker of smaller interrupting capacity for protection

against short circuits on the primary side of the transformer. In case of a back fire, these breakers open instantaneously,

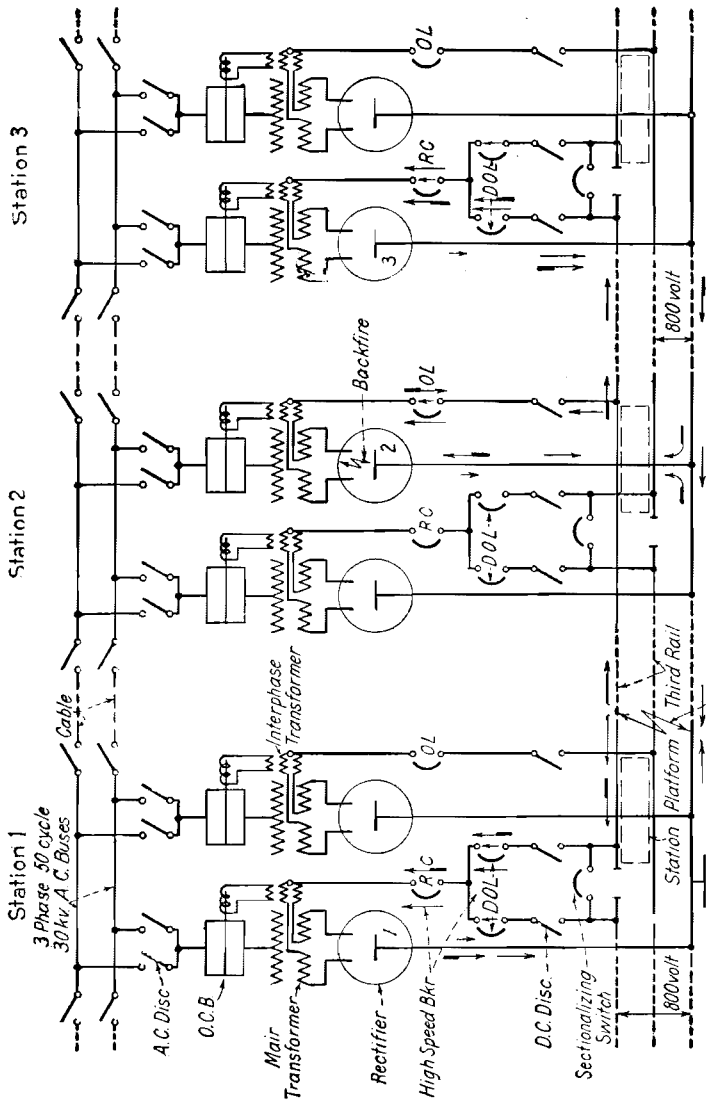

Fig. 190.—Simplified diagram of connections of substations on Berlin elevated railway, illustrating the functioning of the selective protective system during a short circuit and a back fire.

due to the special trip arrangement, the coil being energized directly from the circuit of the transformer neutral, as shown in Fig. 176c. In such a case the duty imposed on the oil circuit

breaker is only about 20,000 kva., due to the influence of the transformer reactance, thus making permissible instantaneous opening at the initial short-circuit current peak. In order to make the protective scheme outlined above readily comprehensible, the flow of the currents is indicated by means of arrows in Fig. 190. In case of a short circuit, the flow of current is as shown by plain arrows, while the current flow during a back fire is indicated by fan-tailed arrows. The normal direction of current is indicated by small arrows.

*Short Circuit.*—For example, let it be assumed that the short circuit occurs on the third rail fed by rectifiers 1, 2, 3, etc., between rectifiers 1 and 2, as indicated in Fig. 190. By following the plain arrows it can be seen that the breakers *DOL* and *OL* feeding the short will respond at once, and will disconnect the faulty section of the third rail, between stations 1 and 3, from the rectifiers. The faulty section is thus isolated by one breaker *OL* and two breakers *DOL*; however, only rectifier 2 is disconnected from the system, while the other rectifiers, 1 and 3, remain connected to the adjoining sections.

*Back Fire.*—Assuming that rectifier 2 back fires (Fig. 190), it can be seen by following the fan-tailed arrows that the back-firing rectifier is disconnected from the rails by breaker *OL*, which stops the other rectifier units from feeding into the faulty unit. The breakers *DOL* of units 1 and 3 do not trip, as the current rush towards the faulty unit is damped and limited by the reactance and resistance of the third rail. The back fire is cleared by the oil circuit breaker, which trips instantaneously, as explained above.

*Substation Layout.*—A typical substation layout, as used in a number of the stations located under the arches of the elevated structure, can be seen in Fig. 191 which is a photograph of a model. Pictures of two actual substations are shown in Figs. 192 and 193. The walls separating the high-tension switching equipment from the rest of the apparatus, as well as the tracks for moving the rectifier cylinders, can be seen in the photographs.

Every rectifier unit consists of high-tension switching equipment, rectifier power transformer with interphase transformer, mercury rectifier with vacuum pump, and direct-current switching equipment. The arrangement of the various pieces of apparatus is self-evident from Figs. 191 to 193.

At the points where lines branch off the main "ring," the substations are equipped with a number of rectifier tanks. Fig-

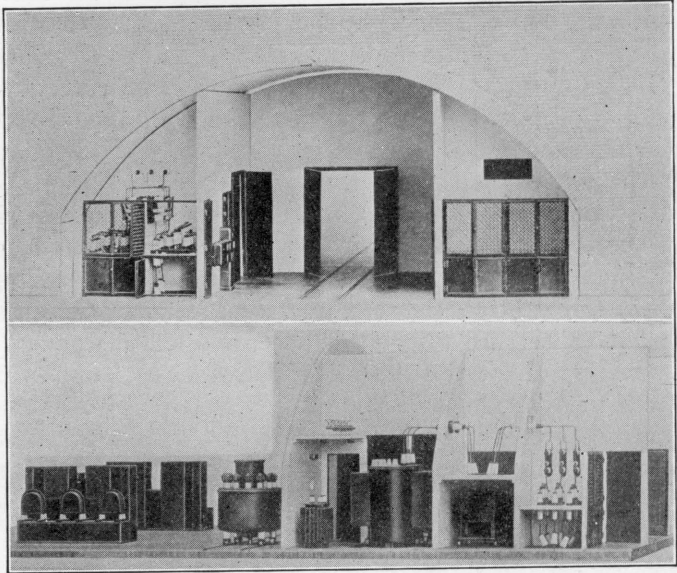

FIG. 191.—Model showing typical layout of Berlin elevated railway substation located under the arches of the elevated structure.

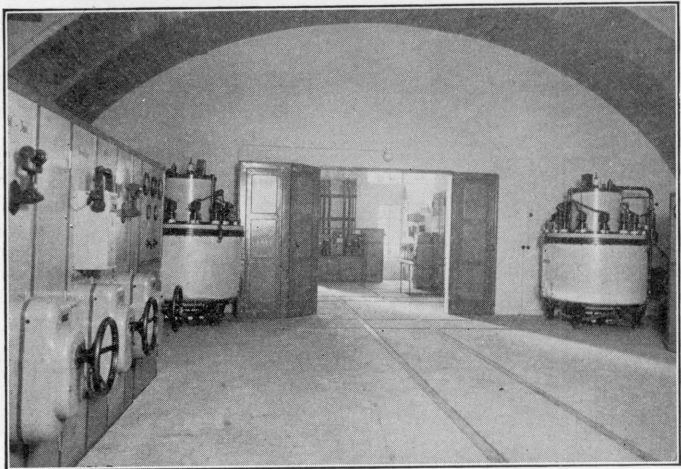

FIG. 192.—Jannowitzbruecke substation of Berlin elevated railway.

ure 194 is a picture of the rectifier room of the Halensee substation, containing nine units, each for 1,200 kw. at 800 volts.

The vacuum pumps are mounted directly on the tanks which makes it very easy to move the rectifiers from one place to another or to replace a faulty unit by a spare unit if necessary.

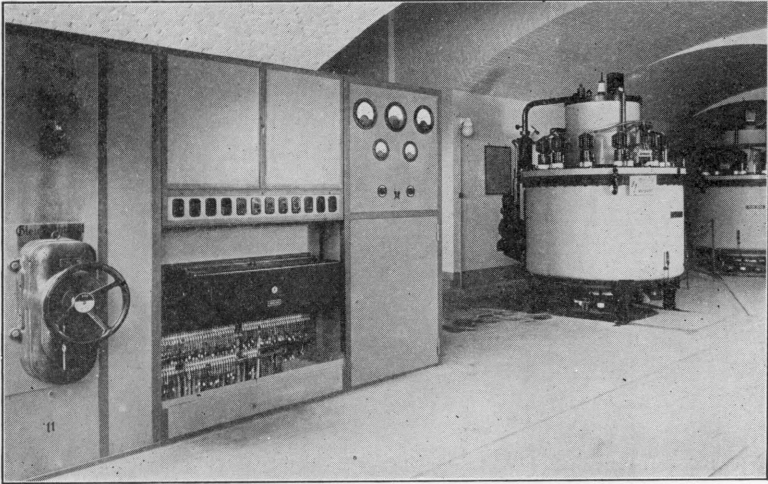

FIG. 193.—Tiergarten substation of Berlin elevated railway.

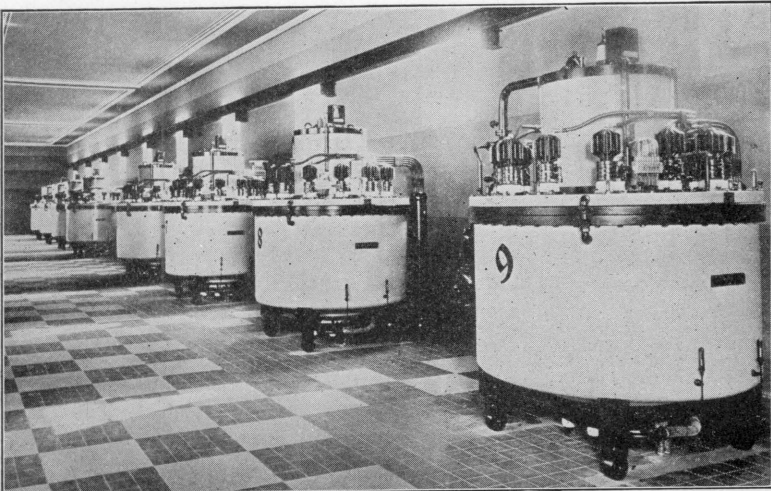

FIG. 194.—Halensee substation of Berlin elevated railway, containing nine 1,200-kw., 800-volt rectifier units.

Special precautions were taken against oil fires, and to this end all apparatus which contain oil are located in separate com-

partments which do not interconnect. On one side of the building are the 30-kv. cable terminals, the cable oil circuit breakers, the auxiliary transformers, and the ground reactors. Located in the center of the first floor are the 30-kv. buses. At one end of the building is a room fitted as a repair shop. Both the shop and the rectifier room are equipped with a 15-ton traveling crane, so that rectifiers and transformers can readily be moved and taken apart, if need be. On the other side of the building are located the transformers and their oil breakers. On the second floor are to be found the rectifiers, the 800-volt buses, the quick-acting breakers for the rectifiers and feeders, the switchboard, the auxiliary battery for control purposes, and some additional small rooms.

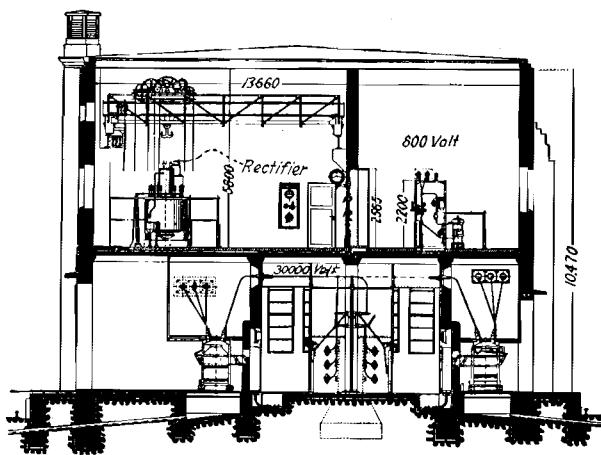

FIG. 195.—Tegel substation of the Berlin suburban lines (dimensions in millimeters).

All 30-kv. disconnects are so interlocked with their respective oil breakers that if their oil breaker is closed the disconnects cannot be operated, irrespective of whether they are open or closed at the time.

In one of these substations there is, in addition to the 800-volt bus, also a bake-out bus, to which each rectifier can be connected when it has to be formed, and which is connected to a water resistance.

To prevent leakage of the rail current to ground, with consequent danger of electrolysis of water and gas mains, etc., the cables connected to the track rails are insulated in the same way as those connected to the third rails.

In addition to the substations feeding the main city lines, there are a number of rectifier substations in the suburban areas, supplying power to the suburban lines. A cross-section through one of these substations (Tegel) is shown in Fig. 195. The layout, in general, is similar to that described above (423).

For more information on the Berlin rectifier installations, see references (354), (375), and (389).

**Wyoming Substation of the Philadelphia Rapid Transit Company.**—This substation contains three 1,000-kw., 600-volt automatic rectifier units, each consisting of a 12-anode rectifier

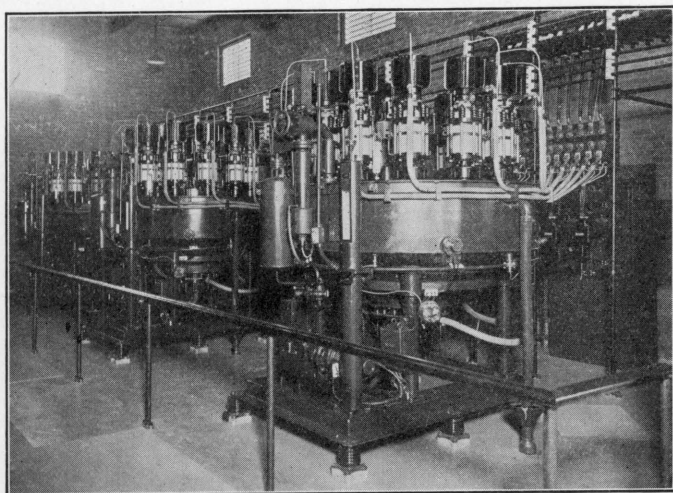

FIG. 196.—Wyoming substation of the Philadelphia Rapid Transit Company, containing three 1,000-kw., 600-volt automatic rectifier units.

connected to a 12-phase transformer. The alternating-current supply is 13,200 volts, 3-phase, 60-cycle. An interior view of the substation is shown in Fig. 196. Each rectifier, with its vacuum pump and McLeod gage, is mounted on a base which is supported by insulators. The anode leads are brought to terminal boards in the rear of the rectifiers. From the terminal boards, cable connections are led through wall insulators to the rectifier transformers, which are located outdoors. Above the terminal boards are located six cables from the bake-out transformer. These cables are run past all the rectifiers so that any rectifier may be connected to the bake-out transformer. This transformer and the rheostat are located in one corner of the substation.



Below the terminal boards are the insulating transformers for the anode heaters. The control switchboard (not shown) is

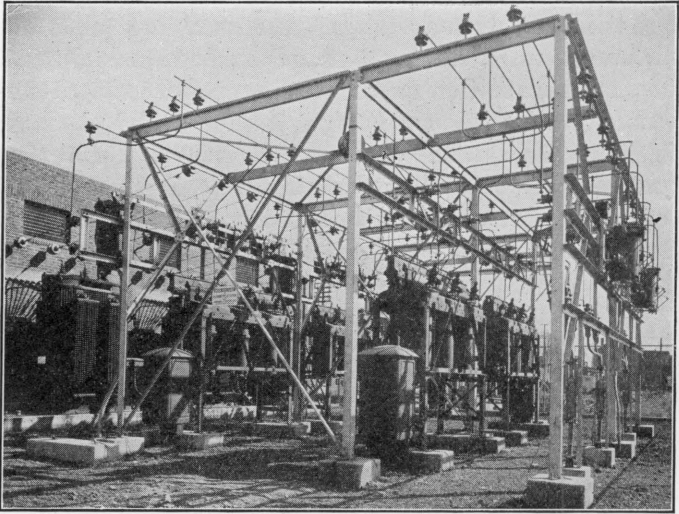

FIG. 197.—View of outdoor equipment, Wyoming rectifier substation.

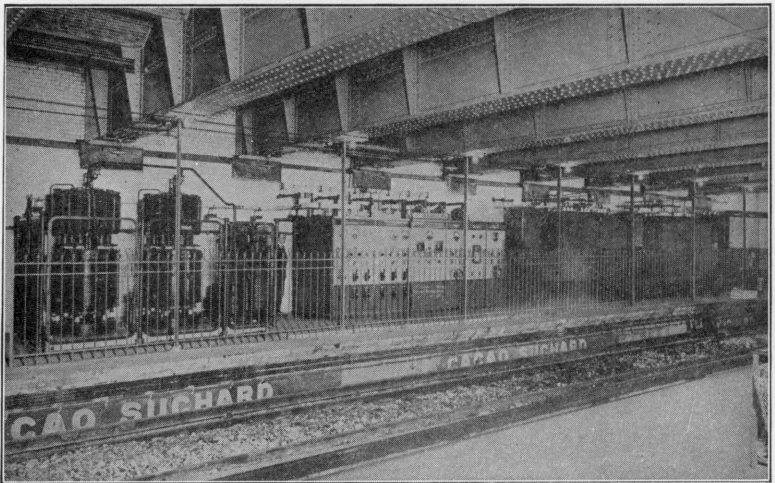
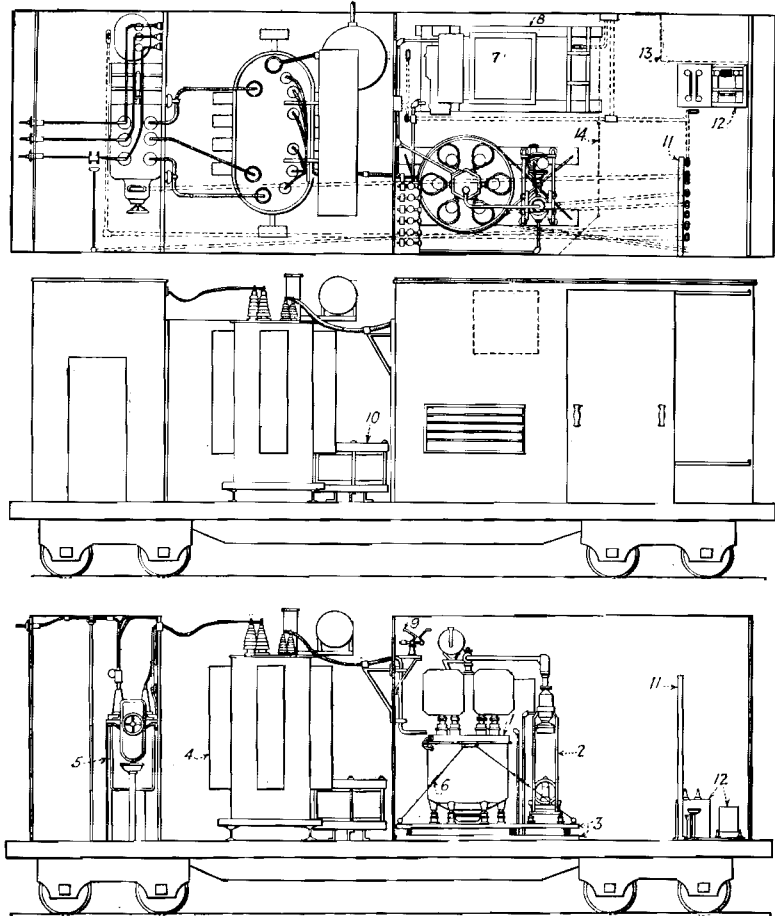

FIG. 198.—La Nation substation of the Paris Metropolitan Railways.

located to the left, facing the rectifiers. Behind the switchboard are located load-limiting resistors and the ignition motor-generator sets.

The operation of the rectifiers is controlled by load-responsive equipment, the leading unit starting on low trolley voltage and the additional units starting when the station load exceeds the



- |  |                                       |   |                     |
|--|---------------------------------------|---|---------------------|
| 1-Rectifier cylinder                     | 5-Oil circuit breaker                 | 9-Lighting arresters                        | 13-Filter equipment |
| 2-Vacuum pump                            | 6-Guy wires for<br>rectifier cylinder | 10-Air-core reactor for<br>filter equipment | 14-Protective rail  |
| 3-Frame for rectifier<br>and vacuum pump | 7-Cooling set                         | 11-Switchboard                              |                     |
| 4-Transformer                            | 8-Frame for cooling set               | 12-Ignition-excitation set                  |                     |

FIG. 199.—Plan view (top) and two elevation views of portable rectifier substation, City of Calgary.

capacity of the unit in operation. The sequence of the units may be varied by means of sequence switches.

In Fig. 197 is shown the outdoor equipment, consisting of the rectifier transformers with their interphase transformers, and the

oil circuit breakers for the rectifiers and alternating-current feeders.

**La Nation Substation of the Paris Metropolitan Railways.**—An installation which shows how readily rectifiers lend themselves to almost any location is the La Nation substation of the Paris Metropolitan Railways. The complete equipment was mounted on one of the platforms of the subway station, no structural changes having been necessary. The station is shown in Fig. 198. After several years of operation, the entire equipment of this substation has recently been transferred to a new substation erected in the vicinity.

**Portable Substations.**—Due to the fact that the mercury arc rectifier is a static type of converter it lends itself very readily for

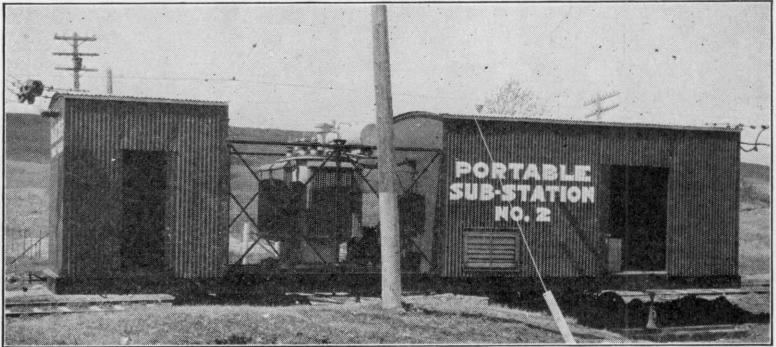

FIG. 200.—Exterior view of Calgary portable rectifier substation.

use in portable substations. Such substations are usually used for taking care of peak loads on overloaded sections, for which purpose the mercury arc rectifier is particularly well suited. In 1926, a 500-amp. portable substation with glass rectifier bulbs was placed in operation in Germany. The primary supply was 3-phase, 10,000-volt, and the load consisted of lighting and railway load. Four more similar units were subsequently built. The equipment was mounted on an automobile truck with trailer, the latter being divided into three compartments; the front one contained the high-tension equipment, the middle one the transformer, and the rear compartment the two glass bulbs together with the direct-current equipment.

The first full-automatic portable substation equipped with a 600-kw., 575-volt, steel-enclosed rectifier was put in operation,

in 1929, by the City of Calgary, Canada, and has proved very satisfactory in operation. The layout of the equipment on the car can be seen from the drawing shown in Fig. 199. The transformer 4 is of the outdoor type, while the alternating-current circuit breaker 5 is of the indoor type, and is located in a cab. The rectifier 1 with vacuum pump set 2, cooling set 7, switch-

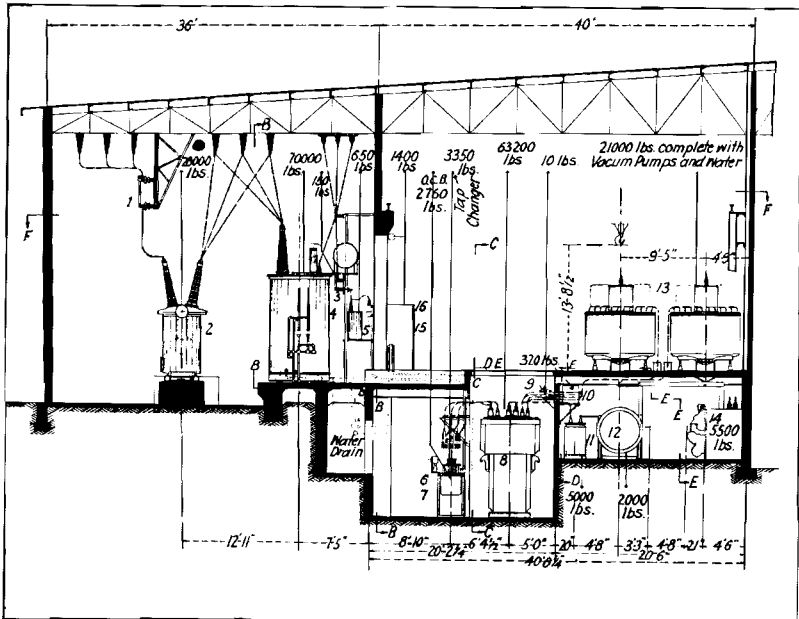

FIG. 201.—Cross-section through rectifier plant of Consolidated Mining and Smelting Company, Trail, B. C., containing three 10,000-amp., 460–560-volt rectifier units for the electrolytic production of zinc.

- |  |  |
|--|--|
| 1. 87-kv. disconnects  | 9. Surge arresters                             |
| 2. 87-kv. oil circuit breaker  | 10. Anode cables                               |
| 3. 13.2-kv. disconnects  | 11. Interphase transformer                     |
| 4. Step-down transformers, 60,000/13,200 volts   | 12. Direct-current reactor                     |
| 5. Current transformers  | 13. Rectifier cylinders (two per unit)         |
| 6. 13.2-kv. oil circuit breaker  | 14. Direct-current circuit-breaker switchboard |
| 7. 13.2-kv. tap changer operated under load, for regulating the direct-current voltage | 15. Rectifier switchboard                      |
| 8. Rectifier transformer, for 13,200-volt primary                                      | 16. 60-kv. control panel                       |

board 11, ignition-excitation equipment 12, and shunt filter 13, are located in a cab on the other side of the car. The rectifier and pump are mounted on a frame 3, and are fastened to it by means of steel cables which can be taken off after the car has been moved into the desired location. Figure 200 shows a photograph of the substation (419) (430).

**Electrochemical Zinc Plant of the Consolidated Mining & Smelting Company, Trail, B. C.**—One of the most outstanding

installations of this kind was recently completed by the Consolidated Mining & Smelting Company at Trail, B. C., Canada. It contains three single-phase, 8,500-kva., 60,000/13,200-volt, step-down transformers, and three rectifier transformers each connected to two rectifiers, furnishing 10,000 amp. at a voltage

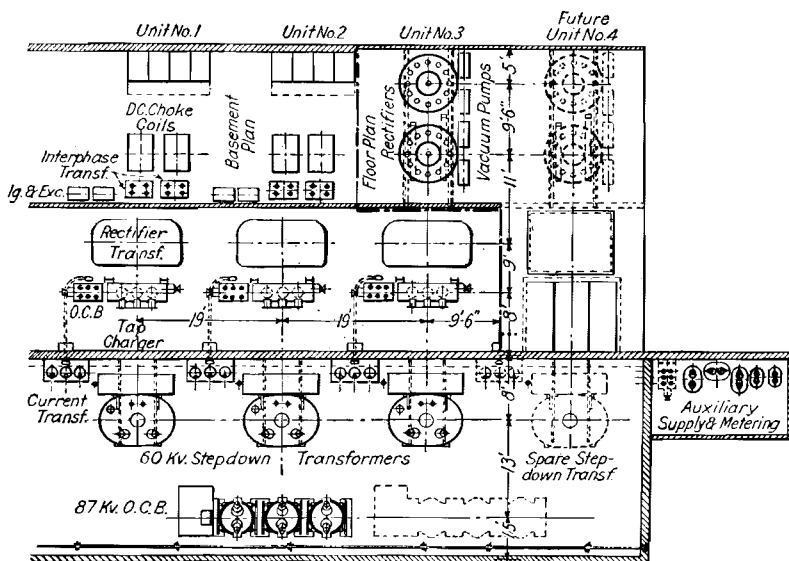

FIG. 202.—Plan view of Consolidated Mining and Smelting Company rectifier plant, showing layout of equipment in basement and on main floor.

adjustable under load between 460 and 560 volts. The layout is shown in Figs. 201 and 202 and embodies many interesting features. The rectifier oil circuit breakers and the transformers are located in pits, which allows of easier handling by the crane, and also gives more free floor space. Room is provided for an additional unit. Each unit furnishes 10,000 amp. for an independent group of zinc cells (415).

## CHAPTER XII

### VOLTAGE CONTROL AND REGULATION

It was shown in Chaps. IV and VI that the direct-current voltage of a rectifier has a definite relation to the alternating-current voltage of the transformer secondary. It was also shown that, due to the overlapping of the anode currents, produced by the reactance of the transformer, the rectifier has inherently a "shunt" load-voltage characteristic, the direct-current voltage decreasing as the load increases. The ratio of direct- to alternating-current voltage and the voltage regulation depend on the type of transformer connection used, and were derived in Chap. VI for different types of connections.

For some classes of service using rectifiers, it is necessary to regulate the direct-current voltage to accommodate variable load conditions, and to compensate for variations in the alternating-current voltage.

For some railway systems it is desirable to maintain a practically constant voltage over a large part of the load range for the purpose of maintaining the scheduled speed. It may also be necessary to parallel rectifiers with existing rotary converters having compounded voltage characteristics. Due to the fluctuating character of a railway load, the voltage regulation for this type of load should be automatic and rapid.

In electrolytic plants it is generally necessary to regulate the direct-current voltage to maintain a constant current in the cells under variable conditions of the electrolyte. It may also be necessary to use different voltages for different stages of the process. For such service rapid regulation is not essential, and the voltage may be regulated manually.

On Edison systems it is usually necessary to maintain a relatively constant voltage at the ends of feeders, and the converters must be regulated to compensate for feeder voltage drop. For this service the load fluctuations are slow and the voltage may be adjusted manually and gradually, to follow a certain load cycle.

The following methods may be used for regulating the direct-current voltage of rectifiers:

1. Methods using devices operating on the primary side of the transformer:
  - a. Voltage regulation by means of taps on the main transformer.
  - b. Voltage regulation by means of a separate regulating transformer.
  - c. Voltage regulation by means of an induction regulator.
2. Methods using devices operating on the secondary side:
  - a. Voltage regulation by means of anode reactors.
  - b. Voltage regulation by means of a saturated interphase transformer.
  - c. Voltage regulation by means of a secondary winding on the interphase transformer.
  - d. Voltage regulation by means of a booster motor-generator set.
3. Voltage regulation by controlling the electric fields in the rectifier.

**1. Methods Using Devices Operating on the Primary Side of the Transformer.** *a. Voltage Regulation by Means of Taps on the Main Transformer.*—Since the direct-current voltage has a definite relation to the secondary alternating-current voltage of the transformer, the direct-current voltage may be varied by changing the transformation ratio by means of taps on the transformer primary. Two types of tap changers may be used for changing transformer taps: tap changers operating with the transformer de-energized, and tap changers operating under load.

For applications where a relatively short interruption of the load on the rectifier is not objectionable, the first type of tap changer may be used, as it is simpler and less expensive than the second type. Since the rectifier can be stopped and started in a very short time, the load interruption for changing taps is very brief. This type of tap changer is located inside the transformer tank, and is operated by a handle from the outside.

The tap changer operated under load is used if the load cannot be interrupted for changing taps. Several types of tap changers for operation under load have been developed. The diagram of connections of one type of tap changer is shown in Fig. 203. Each pole of the tap changer is provided with two contact arms 2 and 3, which are connected together by resistance 5. The contact arms move over a set of stationary contacts arranged in a circle, which are connected to the transformer taps. When changing taps, from tap *a* to tap *b*, for instance, auxiliary contact arm 3 makes contact with point *b* before the main contact arm breaks contact with *a*, thus connecting resistance 5 across

the taps. After the contact between arm 2 and tap *a* is opened, the load current is carried momentarily through arm 3 and resistance 5, until arm 2 makes contact with *b*. Reversing switch 4 is operated after the contact arm 2 completes one revolution, and changes the tap windings from boosting to bucking connection, so that the range of taps may be doubled.

In Fig. 204 is shown a diagram of connections of another type of tap changer for changing taps without interrupting the

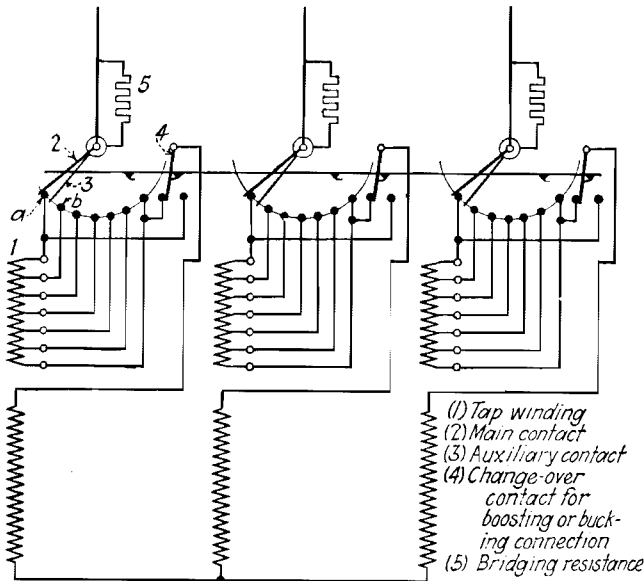

FIG. 203.—Three-pole transformer tap changer for operation under load, provided with main and auxiliary contact arms, bridging resistances, and reversing switches.

load circuit. The transformer is designed with multiple windings on the primary side, having the taps at the midpoints of the windings. Both transformer windings can be interrupted by circuit breakers  $B_1$  and  $B_2$ . The tap changing is effected by opening one of the breakers and changing the tap position of the winding which is open. This open winding is then closed, the other parallel winding interrupted, and the tap changer of that winding brought into a position corresponding to the position of the tap changer on the first winding. In this way the tap changing is done without having any load on the taps. The



reactance between the multiple paths is made small enough to prevent objectionable fluctuations in voltage during the switching process, and large enough to prevent excessive circulating current.

Tap changers may be manually operated, remote controlled, or automatically controlled by means of voltage, current, or time control. In Fig. 205 is shown a diagram of connections of an automatically controlled tap changer of the type shown

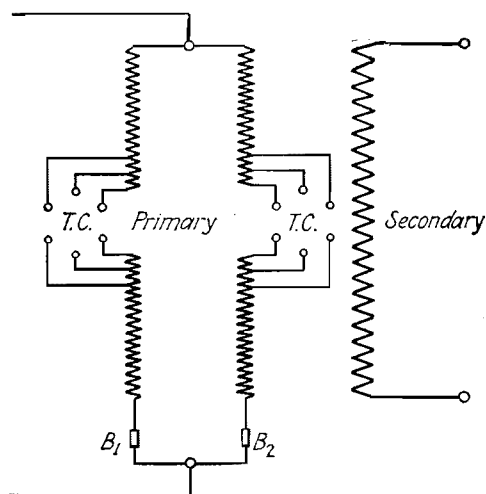

FIG. 204.—Diagram of connections of transformer (one phase) with tap changing under load equipment, consisting of no-load tap changers and circuit breakers in multiple primary windings.

in Fig. 203. The tap changer is motor-operated, and is controlled in function of the direct-current bus voltage and current, by means of relay 1. Contactors 5 *A* and *D* are energized by relays 1 and 4, and control the operation of the motor 6 for forward or reverse rotation. Time-lag relays 4 are used to prevent the tap changer from responding to momentary load swings. Brake magnet 7 is used to prevent overtravel of the motor. Interlocks 8, 9, and 10, and limit switch 11 are used to insure correct operation of the tap changer.

*b. Voltage Regulation by Means of Separate Regulating Transformer.*—When a large number, or a wide range, of taps is required, a separate regulating transformer with taps is sometimes used in series with the main transformer, in order to simplify the design of the main transformer. The regulating transformer

is connected to the tap changer in the same way as a tap winding of the main transformer.

*c. Voltage Regulation by Means of an Induction Regulator.*—The direct-current voltage of a rectifier may be regulated by regulating the alternating-current voltage applied to the transformer primary by means of an induction regulator. The connection of the induction regulator may be the same as that used for

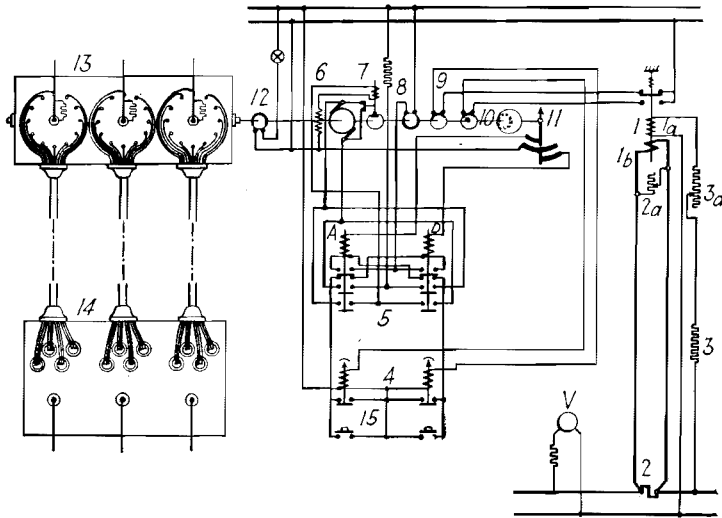

FIG. 205.—Connection diagram of motor-operated, automatically-controlled tap changer of the type shown in Fig. 203.

- |                                  |                                     |
|----------------------------------|-------------------------------------|
| 1. Control relay                 | D. For lowering voltage             |
| 1a. Voltage coil                 | 6. Motor                            |
| 1b. Current coil                 | 7. Brake magnet                     |
| 2. Shunt                         | 8, 9, 10. Interlocks                |
| 2a. Adjustable shunt resistance  | 11. Limit switch                    |
| 3. Fixed series resistance       | 12. Signal switch                   |
| 3a. Adjustable series resistance | 13. Tap changer                     |
| 4. Time-lag relays               | 14. Transformer                     |
| 5. Motor control relays          | 15. Push buttons for manual control |
| A. For raising voltage           | V. Voltmeter                        |

Switches 8, 9, 10, and 12 make one revolution for each tap.

the regulation of alternating-current feeders. The regulator may be controlled manually, by remote control, or by load and voltage control, similarly to a tap changer. When several rectifier units operate in parallel in the same station a separate induction regulator may be used for each unit, or a common regulator may be used for all the units. The former arrangement, while more expensive, provides greater flexibility of operation.

If it is desired to regulate the direct-current voltage between an upper limit  $E_{d1}$  and a lower limit  $E_{d2}$ , with the voltage of the

alternating-current supply varying between upper and lower limits  $E_{p1}$  and  $E_{p2}$ , respectively, the total regulating range required on the primary side of the transformer is equal to:

$$e = \frac{E_{d1}}{E_{d2}} E_{p1} - E_{p2}. \quad (193)$$

Since the regulator can be operated to buck or to boost the voltage, the voltage regulating range of the regulator should be equal to  $e/2$ .

The current rating of the regulator is equal to the current supplied from the alternating-current line at the minimum line voltage and rated kilovolt-amperes of the transformer primary. If the primary kilovolt-ampere rating of the transformer is  $P_p$ , the kilovolt-ampere rating of the regulator is

$$P_r = K \frac{1}{2} \frac{e P_p}{E_{p2}} \times \frac{E_{p1}}{E_{p2}} \quad (194)$$

in which  $K$  is a factor taking into account the efficiency of the regulator.

*Comparison of Voltage Regulation by Means of Tap Changers and by Means of Induction Regulators.*—When a tap changer, operated under load, is used, the voltage is regulated in steps, so that the voltage regulation is not smooth, especially if a wide range of regulation is necessary. Furthermore, the transformer must be provided with taps and bushings for connection to the tap changer, which complicate the design of the transformer and make it more expensive. When an induction regulator is used, the voltage regulation is smooth, and the voltage can be adjusted to the exact value desired. The transformer has no taps and is therefore simpler. On the other hand, the use of an induction regulator introduces additional power losses, while a tap changer has no losses. An induction regulator is generally more expensive than a tap changer, particularly at higher alternating-current line voltages, when a step-down transformer is required for exciting the regulator and a series transformer is necessary between the secondary of the induction regulator and the primary leads of the main transformer.

For any particular application the choice between a tap changer and an induction regulator is determined by the service conditions to be met, and by economic considerations.

**2. Methods Using Devices Operating on the Secondary Side of the Transformer.** *a. Voltage Regulation by Means of Anode*

*Reactors.*—As was pointed out at the beginning of this chapter, when the rectifier is carrying load the direct-current voltage is reduced, due to the transformer reactance, which produces overlapping of the anode currents. The voltage drop is directly proportional to the reactance, as shown by Eq. (22a) (Chap. IV). When reactors are connected in the anode circuits their reactance has the same effect on the voltage drop as the transformer reactance. This offers a means for regulating the direct-current

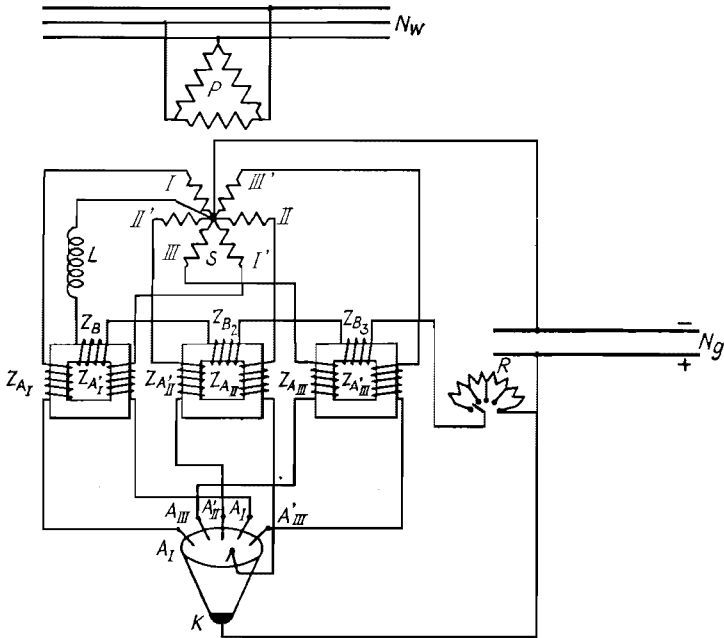

FIG. 206.—Connection diagram of rectifier provided with anode reactors magnetized by direct current, for regulating the direct-current voltage.

- |                                 |                                      |
|---------------------------------|--------------------------------------|
| A. Anodes                       | P. Transformer primary               |
| K. Cathode                      | R. Regulating rheostat               |
| L. Series reactor               | S. Transformer secondary             |
| $N_g$ . Direct-current bus      | ZA. Anode reactor coils              |
| $N_w$ . Alternating-current bus | ZB. Direct-current magnetizing coils |

voltage of a rectifier by using anode reactors and varying their reactance.

In Fig. 206 is shown an arrangement for regulating the direct-current voltage by this means. Three reactors are used, each provided with two windings, which are connected to phases 180 electrical degrees apart. Since the two phases connected to each reactor do not carry current at the same time, the windings have no influence on each other, and the core has to be dimen-

sioned for the flux produced by one winding only. Each core has an exciting winding which is energized by direct current supplied from the rectifier terminals. By varying the direct current excitation of the cores through the rheostat  $R$ , the reactance of the reactors changes, thereby varying the voltage drop due to the overlapping of the anode currents. The voltage regulation may be made automatic by replacing the rheostat  $R$  by a voltage

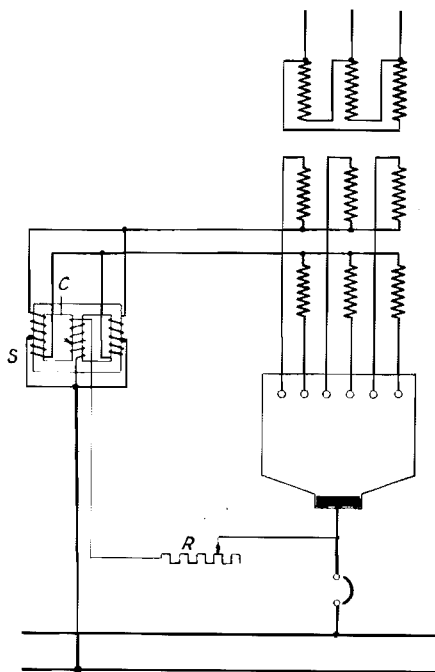

FIG. 207.—Connection diagram of 6-phase rectifier with interphase transformer, which is provided with a direct-current magnetizing winding for regulating the direct-current voltage.

regulator or by connecting the exciting windings in series with the load circuit.

*b. Voltage Regulation by Means of Saturated Interphase Transformer.*—The principle of operation of this method was explained in Chap. VI. In Fig. 207 is shown a diagram of connections for this method of voltage control. The core of the interphase transformer is excited by direct current through a winding  $C$  connected across the direct-current terminals of the rectifier, in series with a regulating rheostat  $R$ . The direct-current

voltage of the rectifier is raised by increasing the current in the exciting winding, and lowered by reducing this current. The voltage regulation may be made automatic by replacing the rheostat *R* by an automatic voltage regulator, or by connecting the exciting winding in series with the load circuit. With the latter arrangement, an increase of the load current increases the direct-current excitation, which automatically raises the voltage. A voltage regulation curve of a 6-phase rectifier obtained with series excitation of the interphase transformer is

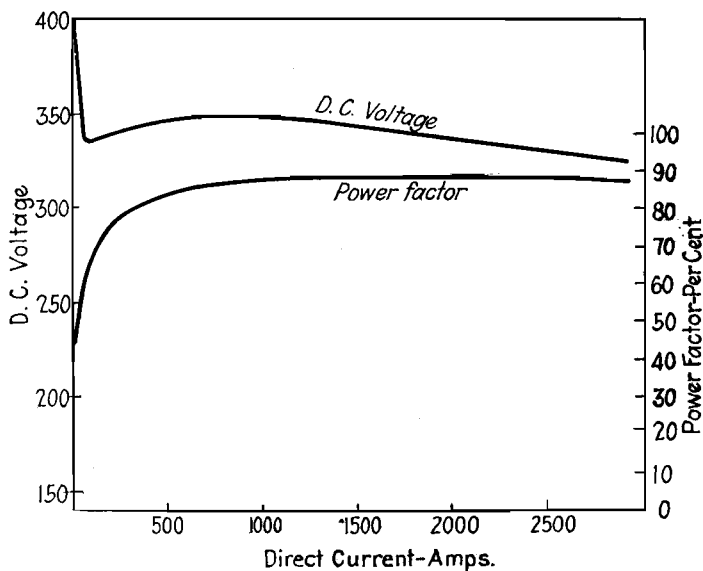

FIG. 208.—Voltage regulation and power-factor curves of a rectifier compounded by means of a saturated interphase transformer with series direct-current magnetization.

shown in Fig. 208. The shape of the curve may be adjusted by means of taps on the series exciting winding, within the limits shown in Fig. 64. A photograph of a General Electric interphase transformer with direct-current excitation, for a 12-phase transformer connection, is shown in Fig. 69.

As was pointed out in Chap. VI, when a rectifier is compounded by saturating the interphase transformer, the rectifier and main transformer operate as with the diametrical 6-phase connection without interphase transformer. For this connection, the kilovolt-ampere rating of the rectifier transformer is 23 per cent greater than for the 6-phase connection with interphase trans-

former. Furthermore, the power factor at the primary terminals of the rectifier transformer is lower, and the efficiency of the rectifier is reduced on account of the higher amplitude of the anode currents, as was brought out in Chap. II, Fig. 7. The power-factor curve for a 6-phase transformer connection with saturated interphase transformer is shown in Fig. 208.

*c. Voltage Regulation by Means of a Secondary Winding on the Interphase Transformer.*—This method of voltage regulation, shown in Fig. 209, is similar in principle to the preceding method with saturated interphase transformer. As shown in Fig. 209a, the interphase transformer is provided with a secondary winding  $S$ , which is connected to an external impedance  $Z$ . A third-har-

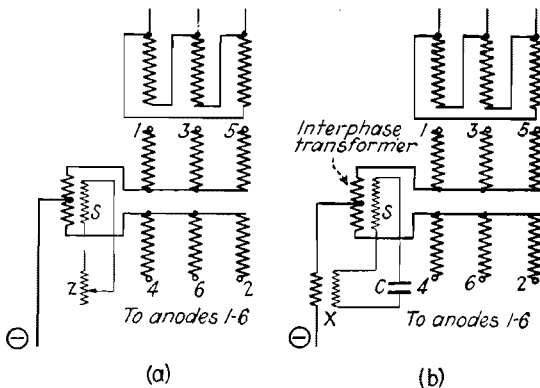

FIG. 209.—Connection diagrams for regulating the direct-current voltage of a rectifier by means of a secondary winding on the interphase transformer.

monic voltage is induced in this winding, causing a third-harmonic current to circulate through it. The demagnetizing effect of the ampere-turns resulting from this current requires a proportionate increase in the third-harmonic current component in the main winding of the interphase transformer in order to produce the necessary magnetization of the core required for inducing the third-harmonic voltage ( $e_3$ , Fig. 56) in the interphase transformer. This increase in the third-harmonic current causes the transition point of the voltage regulation curve (Figs. 61 and 64) to shift to the right. By varying the impedance  $Z$ , the third-harmonic magnetizing current, and consequently the position of the transition point of the voltage regulation curve, may be varied. The same result is thus obtained as with a direct-current magnetizing winding on the core of the interphase transformer, described

under *b* and shown in Fig. 207, and the direct-current voltage may therefore be regulated by varying the impedance *Z* in a similar way as accomplished by the rheostat *R* in Fig. 207.

In Fig. 209*b* is shown a circuit arrangement for automatic compounding of rectifiers by means of a secondary winding on the interphase transformer. The secondary winding *S* is connected to an iron-core reactor *X*, in series with a capacitance *C*. The core of the reactor is magnetized by a direct-current winding which is connected in series with the direct-current load circuit. The saturation of the iron core by direct current reduces the inductance of the reactor, thus causing the impedance of the circuit to vary in function of the direct-current load, and producing a "compound" voltage characteristic in a similar manner as with a series direct-current winding on the core of the interphase transformer described under *b* above, and shown in Figs. 64 and 208. The total impedance connected to the winding *S* is equal to the reactance of *X* minus the reactance of *C* at the triple frequency. The influence of *C* is to exaggerate the effect of the direct-current magnetization of the reactor *X* on the net impedance of the circuit.

*d. Voltage Regulation by Means of a Booster Motor-generator Set.*—The direct-current voltage may also be regulated by connecting in series with the rectifier a direct-current, motor-driven generator, the voltage of which is varied by regulating its field. The generator can be arranged to boost or buck the rectifier voltage, by reversing its field winding, so that the rated voltage of the generator has to be equal to one-half the total voltage range desired. The current rating of the generator is equal to the current rating of the rectifier. If the direct-current voltage is to be regulated between the limits of  $E_{d1}$  and  $E_{d2}$  and the current is *I*, the rated output of the generator is

$$P_g = \frac{E_{d1} - E_{d2}}{2} \cdot I. \quad (195)$$

In Fig. 210 is shown a diagram of connections of a rectifier with a booster motor-generator set controlled automatically by means of a voltage regulator. The generator has a direct-connected exciter, and is driven by a 3-phase induction motor provided with a starting resistance, controlled by a motor. The field of the exciter is controlled by the voltage regulator, the resistances of which are connected in the form of a bridge. With this type of connection it is possible to vary the exciter



field between two limits of opposite polarity, the voltage on the field being zero when the sectors of the regulator are in the middle position. The regulator is actuated by the alternating-current potential and load current, through potential and current transformers, so that the direct-current voltage is regulated to compensate for variations of the alternating-current voltage, and to produce compounding.

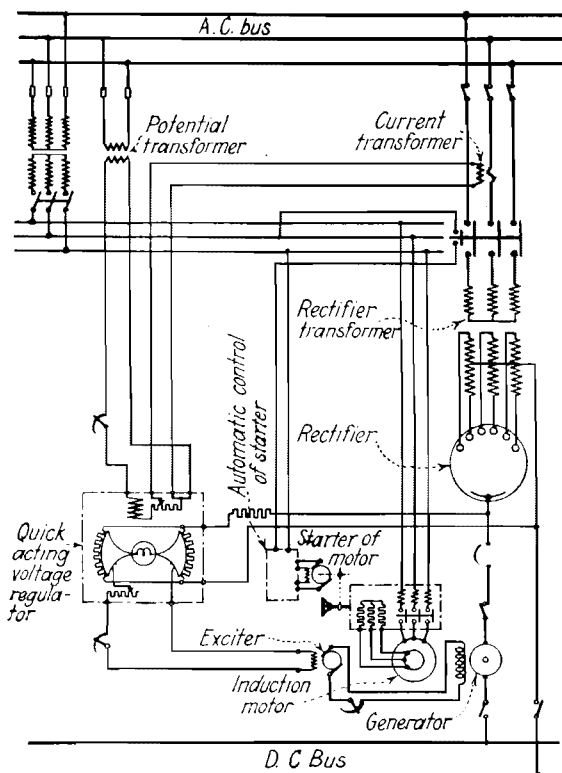

FIG. 210.—Connection diagram of a rectifier with automatically-controlled booster motor-generator set for regulating the direct-current voltage.

The booster set is started automatically through an auxiliary switch of the alternating-current circuit breaker, which energizes the motor starter when the breaker is closed.

A booster set is seldom used for regulating the direct-current voltage of a rectifier unit, as it introduces into the station a rotating machine which requires more attendance and reduces the overall efficiency of the plant. It is sometimes used when the

alternating-current voltage is high, which would require expensive apparatus for regulating the voltage on the alternating-current side.

**3. Voltage Regulation by Controlling the Electric Fields in Rectifiers.**—With this method of voltage regulation, the direct-current voltage of the rectifier is regulated by controlling the point of the cycle at which an anode picks up current.

As was brought out in preceding chapters, the flow of current in a rectifier is constituted of a movement of electrons from the cathode to the anode, and a movement of ions towards the cathode. This flow takes place along the electric field between the cathode and the anode, when the anode is positive with respect to the cathode. Current cannot flow when the field

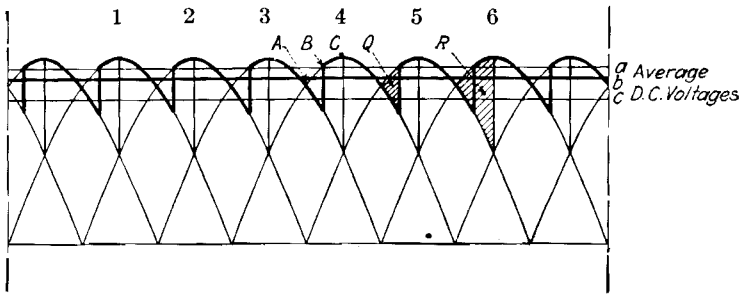

FIG. 211.—Anode and direct-current voltage waves of a polyphase rectifier, explaining the method of regulating the direct-current voltage by controlling the starting point of the anodes.

from anode to cathode is negative. The potential of the cathode is equal to the potential of the working anode minus the voltage drop in the arc. When a rectifier is supplied by a source of polyphase alternating current, an anode becomes positive to the cathode at the point where its voltage wave intersects the voltage wave of the working anode, and the current is then transferred from one anode to the other during a period of overlap, during which the potentials of the two anodes are equalized by the transformer reactance.

The shape of the direct-current voltage wave under load was shown in Fig. 25. Due to the overlapping, the average direct-current voltage wave is reduced by an amount equal to the shaded area shown in the figure.

By controlling the electric field between an anode and the cathode through grids, the point at which the anode starts work-



It is evident from Fig. 211 that by this means the direct-current voltage may be varied over wide limits without altering the value of the applied alternating-current voltage.

The starting point of the anodes may be controlled by interposing grids of the proper design in the arc paths of the anodes, and applying potentials to these grids, so that they have a negative potential to the cathode up to the point at which it is desired to start the anodes, when it is made positive. The potential of the grids to the cathode may be controlled with a battery by means of a synchronously rotating switch, or by some similar means.

One arrangement for regulating the direct-current voltage by controlling the potential of the grids is shown in Fig. 212. The anodes are connected to a polyphase transformer having phase voltages  $E_1$ ,  $E_2$ , etc., shown in Fig. 213. The grids of the anodes are connected to a polyphase auxiliary transformer producing the voltages  $G_1$ ,  $G_2$ , etc., and having the same number of phases and the same frequency as the rectifier transformer. The neutral point of the auxiliary transformer is connected to the cathode, in series with a source of direct-current potential which may be a battery, as shown in Fig. 212. The positive pole of the battery is connected to the cathode, and the negative pole to the neutral of the auxiliary transformer.

The arrangement shown in Fig. 212 operates as follows: The potential of a grid to the cathode at any instant is equal to the potential at that instant of that phase of the auxiliary alternating-current supply to which the grid is connected, minus the potential of the battery. At the instant when the grid has a positive alternating-current potential equal to the battery potential, its potential to the cathode is zero. Thus, referring to Fig. 213, if the battery potential has a value  $D_2$ , the potential to the cathode of grid 2, associated with anode 2, is equal to zero at point  $B$ . Before this point is reached, the grid has a negative potential to the cathode, and anode 2 is prevented from carrying current. When this point is passed, the grid potential to the cathode is positive, and anode 2 starts working. When the battery potential has a value  $D_1$ , the grid potential to the cathode is equal to zero at point  $A$ , so that anode 2 starts near  $A$ . When the battery potential is equal to  $D_3$ , the grid potential to the cathode is equal to zero at point  $C$ . It is thus seen that the starting points of the anodes, and, consequently, the direct-cur-

rent voltage, may be controlled by varying the potential of the battery.

Instead of using a battery, the direct-current supply may be obtained from the terminals of the rectifier by a potentiometer connection, by connecting the neutral of the auxiliary transformer to some point of a resistance connected across the rectifier terminals. The direct-current voltage may be regulated by varying the potential of this point with respect to the cathode, either manually, or by means of an automatic voltage regulator, or by some other automatic means.

With this method of voltage control it is possible to regulate the direct-current voltage of a rectifier similarly as the regula-

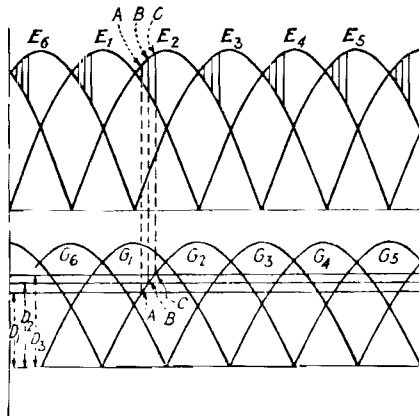

FIG. 213.—Anode and grid voltage waves explaining the operation of the voltage control system shown in Fig. 212.

tion of a direct-current generator voltage by field control, and within about the same relative limits. Since there is no time lag in changing the electric field of a rectifier, the regulation takes place instantaneously, the only time lag introduced being that of the regulating means used.

By the use of the regulating scheme described above it is possible to regulate the direct-current voltage in any way desired. Thus, the voltage characteristic of the rectifier can be compounded as well as compensated for fluctuations of the alternating-current voltage. The apparatus used for this purpose is practically independent of the rating of the rectifier or the primary voltage used, and, therefore, differs from the other regulating systems for rectifiers.

Since this regulation is accomplished by delaying the working periods of the anodes, the primary power factor is reduced. The reduction in power factor is approximately proportional to the reduction in direct-current voltage by the use of this regulation scheme.

**Methods for Suppressing the No-load Voltage Rise of Rectifiers Using Transformer Connections with Interphase Transformers.**—In Fig. 61 is given the regulation curve of a rectifier using a transformer connection with an interphase transformer. It shows a voltage rise at small loads. As stated in Chap. VI, the bend in the regulation curve occurs at load currents of 0.5 to 2.0 per cent of the full-load current. This voltage rise at small loads is sometimes found objectionable, as it may burn out lights or affect the insulation of car equipment. It may be eliminated by any one of the methods described below.

The first method is to connect across the terminals of the rectifier an artificial load which draws a current equal to the current at which the voltage starts to rise. The resistance may be left connected continually, or may be connected to the circuit automatically when the load current drops to a low value.

A second method for accomplishing this purpose is to disconnect one of the 3-phase groups of the transformer and operate the rectifier on 3 phases only at light loads.

With 3-phase operation the direct-current voltage at no-load is equal to the direct-current voltage at the bend of the regulation curve, Fig. 61. Since this operation on 3 phases takes place only at light loads, the rectifier and the rectifier transformer are not overloaded.

A third method for eliminating the voltage rise at light loads is to excite the interphase transformer with a third-harmonic current from an external source. As was stated in Chap. VI, the rise of the direct-current voltage is caused by a lack of sufficient load current to supply the necessary third-harmonic magnetizing current of the interphase transformer, so that by supplying this magnetizing current artificially the voltage rise may be eliminated.

In Fig. 214 is shown a diagram of connections for producing this effect. Three single-phase auxiliary transformers are used, with their primaries connected in 3-phase Y and their secondaries in open delta, connected to the interphase transformer. The transformer cores are over-saturated, thus producing third-harmonic

voltages in the secondaries, which send third-harmonic currents through the windings of the interphase transformer. With the delta connection of the secondaries, the fundamental voltages

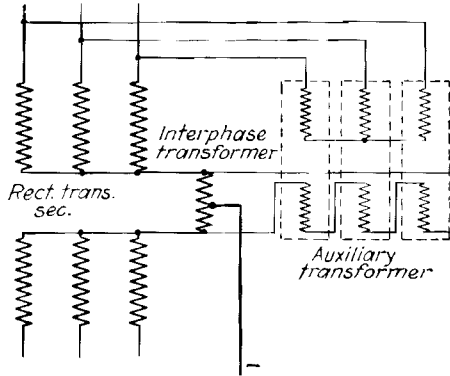

FIG. 214.—Connection diagram of auxiliary transformers used for suppressing the no-load voltage peak of a rectifier operating in connection with an interphase transformer.

are cancelled out at the terminals of the delta connection, while the third-harmonic voltages, being in phase, are added in all the three phases. The capacity of the auxiliary transformers is about 1/800th of the capacity of the main transformer.

## CHAPTER XIII

### INTERFERENCE WITH COMMUNICATION CIRCUITS

Interference in communication circuits is sometimes experienced due to their juxtaposition to power circuits. Such interference is frequently caused by power circuits, and particularly by railway circuits with ground return, in which an alternating current is flowing. Interference with communication circuits is sometimes also caused by direct-current railway systems supplied by rectifiers, due to the ripple in the direct-current voltage wave of a rectifier. The present chapter will deal with the influence of railway circuits supplied by rectifiers on communication circuits.

A railway circuit consisting of an overhead supply line and a ground return forms a loop in which the current flows from the substation, over the overhead line, through the traction motors, and back to the substation through the ground return. The current flowing in this loop produces a magnetic field as shown by dotted lines in Fig. 215. The potential difference between the overhead wire and ground also produces an electrostatic field between that wire and ground, as shown by solid lines in Fig. 215. If there is a two-wire communication circuit close to the railway circuit, it is linked with the electromagnetic and electrostatic fields of the railway circuit, and the following conditions may prevail:

1. Being in the electrostatic field of the trolley wire, the communication wires are at certain electrostatic potentials to ground. An electrostatic difference of potential may also exist between the two communication wires, if located in different equipotential planes.
2. The magnetic flux may traverse the space between the two conductors of the communication circuit.
3. The magnetic flux also traverses the space between the two communication wires and the ground.

**Electrostatic Induction.**—The electrostatic induction between the power conductor and ground is proportional to its capacitance to ground and to the voltage. The potential difference between the communication wires and ground depends on the



relative positions of the communication and power circuits (*i.e.*, on the position of the communication wires in the electrostatic field of the power circuit), but is independent of the length of parallelism between the two circuits. Any change of the voltage of the power circuit will produce a change in its electrostatic field, thereby causing a change of the electrostatic charge on the communication wires, resulting in the flow of a charging current in those wires. The magnitude of the charging current is proportional to the rate of change of the voltage and the

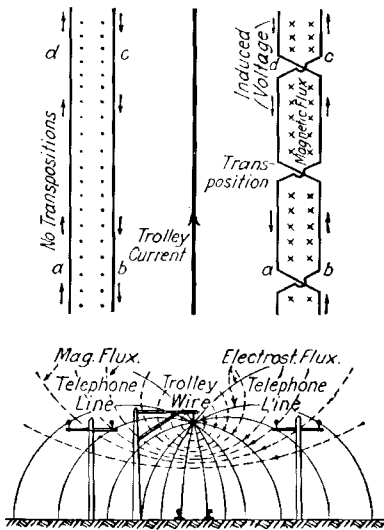

FIG. 215.—Diagram showing the influence of the magnetic and electrostatic fields of a trolley wire on adjacent communication lines and illustrating the effect of transposition on the voltages induced in the communication lines.

length of parallelism between the two circuits, but is not the same in all parts of the communication circuit. If the change in the voltage of the power circuit is due to the presence of alternating components in the voltage, the charging current flowing in the communication wires will have the same frequency as that voltage component and will be proportional to the frequency.

**Electromagnetic Induction.**—A change of the current in the power conductor will produce a change in its magnetic field and will induce a voltage between the two communication wires and between each wire and ground. The induced voltage is proportional to the mutual inductance between the communica-

tion circuit and the power circuit (*i.e.*, their relative positions and length of parallelism) and to the rate of change of the current, or its frequency. It is evident from Fig. 215 that, due to the greater spacing between the communication wires and ground, the voltage induced between the wires and the ground would be considerably higher than the voltage induced between the two wires. The current which is caused to flow in the communication wires by the induced voltage is the same in all parts of the wires.

**Interference.**—The currents which are caused to flow in a communication circuit by induction from adjacent power circuits, such as railway circuits, may interfere with the operation of the communication system; that is, these currents may interfere with the operation of signalling apparatus, or with the audibility of telephones if they happen to be of a frequency within the audible range. If a communication circuit is so located with respect to a power circuit that inductive interference may be expected, an “exposure” is said to exist. The length of the communication circuit paralleling a power circuit and subject to inductive interference from it is called the “length of exposure.”

As has been brought out before, the current induced in a communication circuit by electrostatic induction is proportional to the length of exposure. The voltage induced by electromagnetic induction is proportional to the length of exposure, and since the impedance of a given communication circuit is constant and independent of the exposure, the current flowing in the circuit as a result of electromagnetic induction is also proportional to the length of exposure.

Changes in the voltage and current of a railway circuit, which may produce interference in neighboring communication circuits, may be caused by changes in load, by short circuits, or by the presence of alternating current and voltage components in the railway circuit. The direct-current voltage of a rectifier, and consequently the current flowing in a circuit supplied by a rectifier, are not smooth, but have undulations consisting of harmonics of frequencies within the audible range, as has been shown in Chap. V. As a result of this, an interference problem may arise when a communication line is exposed to trolley wires or feeders of a direct-current railway system supplied by rectifiers.

The direct-current voltage wave of a rotary converter also has harmonic components, which have given rise to interference in a number of instances. These harmonics, however, are small and the telephone noises due to commutator ripples of car motors generally overshadow the noises due to the above harmonics. The inductive influence of the ripple in the voltage wave of a rectifier equipped only with a series reactor, and with no special auxiliary devices for correcting the wave shape, is three to five times that of a rotary converter and is therefore likely to be more disturbing.

When a rectifier operates in parallel with a rotary in the same substation, the ripple of the rectifier voltage wave produces a

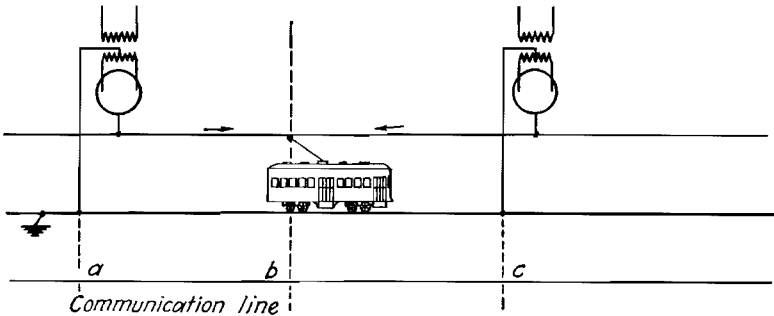

FIG. 216.—Diagram of a railway system and an exposed communication line, explaining the influence of the position of the moving car on interference effects.

circulating ripple current between the rectifier and rotary, which has a relatively low impedance to that current, and the direct-current bus voltage of the substation is considerably smoother than the rectifier voltage. When a rectifier and rotary operate in separate substations with a tie feeder between them, the circulating alternating current between the two machines flowing in the tie feeder may give rise to severe interference if a telephone line is exposed to the feeder. A similar case of interference may arise when two rectifiers located in different substations and connected by a tie feeder are supplied by alternating-current systems of different frequencies, or are so connected that there is a phase displacement between the harmonics in the direct-current voltage waves of the two rectifiers, thus causing a circulating current to flow in the tie feeder between them.

The inductive influence of a railway circuit on a communication circuit may also vary with the position of the load (car or loco-

motive). This is illustrated in Fig. 216, which shows a railway line supplied by rectifiers. Let it be assumed that a parallel communication line *abc* is exposed to the trolley wire over the distance *ac*. When the car has arrived at point *b*, which is halfway between the two substations, the voltages induced by the trolley current in the sections *ab* and *bc* of the communication circuit would be equal and opposite and there would therefore be no interference; but there would be interference for other locations of the car. If only the section *ab* of the communication line is exposed to the trolley line, the interference would be maximum at *b*. The above example was used merely to illustrate that the load distribution as well as the length of exposure has to be considered when studying interference conditions.

**Harmonic Voltages.**—The direct-current voltage wave of a rectifier consists of a direct-current component and of a superimposed alternating-current component made up of the upper portions of the sinusoidal waves of the secondary supply. The fundamental frequency of the ripple is equal to the product of the fundamental frequency of the alternating-current supply and the number of secondary phases. Thus, the direct-current voltage wave of a 6-phase rectifier supplied with current from a 60-cycle system has a 360-cycle ripple (see Chap. V). This ripple has harmonics of frequencies which are odd and even multiples of the 360-cycle fundamental frequency.

In Table XI are given the effective values of the harmonic components superimposed on the direct-current voltage wave of 6-phase, 60-cycle rectifiers. These values are the highest and the lowest measured in rectifier installations. It will be noted from Table XI that the magnitudes of these harmonics fall off rapidly with increasing frequency. For further informa-

TABLE XI

Frequency of Harmonic	Percentage Ratio of Effective Harmonic Voltage to Average Direct-current Voltage
360	4.5 to 5.95
720	1.26 to 1.37
1,080	0.53 to 0.90
1,440	0.61 to 0.72
1,800	0.40 to 0.80
2,160	0.43 to 0.62
2,520	0.41 to 0.44
2,880	0.35 to 0.36

tion on these harmonic components, see Chap. V, Figs. 35, 36, 38, 39, and 40, and Tables III and IV, page 94.

**Characteristics of the Load Circuit.**—Since no interference has so far been observed in balanced (Edison) systems, only railway systems with a grounded return circuit will be considered here. Figure 217 represents a railway system, the circuit of which has an impedance  $Z_2$  of the street-car or locomotive motors, and an impedance  $z_1$  per mile of trolley line. The impedance of each motor is a function of the terminal voltage, and the impedance of the street car or the locomotive depends on the connections of the motors (series or parallel).

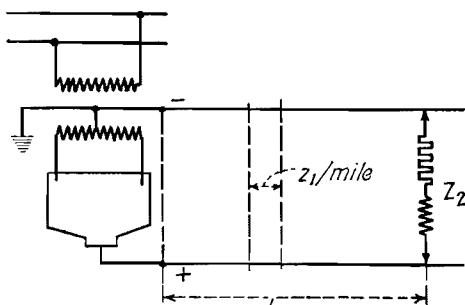

FIG. 217.—Diagram of a rectifier supplying a railway line with a moving load.

Below are given some approximate values of the inductance of railway circuits for various voltages. These values are sufficiently accurate for a preliminary study, for which purpose the ohmic resistance can also be neglected. The inductance of railway equipment built for 600 volts is 0.5 to 0.25 millihenry (two to four motors in parallel), for 1,500 volts 2 to 1 millihenrys (two motors in series, two motors in series-parallel), and for 3,000 volts 5 to 2.5 millihenrys, while the inductance of the trolley line is of the order of 3 millihenrys per mile. For a given trolley voltage and load characteristic, the spacing of the substations is more or less fixed by the permissible voltage drop. Assuming that these spacings for 600, 1,500, and 3,000 volts are 2.5, 5, and 10 miles, respectively, and also that there are no feeders or parallel circuits, the inductances of the load circuit can easily be computed. It will be found that the maximum and minimum inductances of the load circuit are:

For 600 volts, 0.5 millihenry to 8 millihenrys ( $0.5 + 2.5 \times 3.0$ )

For 1,500 volts, 2.0 millihenrys to 17 millihenrys ( $2 + 5 \times 3.0$ )

For 3,000 volts, 5.0 millihenrys to 35 millihenrys ( $5 + 10 \times 3.0$ )

The smaller values hold true when the locomotive is near the substation, and the larger when the locomotive or street car is farthest away. The average inductance of the load circuit as the locomotive is moving from the one point to the other on the 600-, 1,500-, and 3,000-volt systems is therefore  $8.5/2$ ,  $19/2$ , and  $40/2$  millihenrys, respectively.

The foregoing data apply only to systems comprising a single line fed from one point only. Usually railway systems comprise a network of lines and feeder circuits, either underground or along the trolley wires, suspended by the catenary; furthermore, there are usually several cars or locomotives running at the same time, so that the system impedances obtained in practice are much lower than the values given above. The measured inductance on actual networks of 600, 1,500, and 3,000 volts, given below, will therefore be of interest.

It was found that the average inductance of a

600-volt, ramified street-railway system was 0.6 to 1.5 millihenrys

1,500-volt, main-line railway system with unusually heavy traffic on several tracks, 2.5 to 5 millihenrys

3,000-volt, single-track, main-line railway system, 3 to 10 millihenrys

Comparing these figures with those given above, namely, 4.25, 9.5, and 20 millihenrys, respectively, it is seen that the actual figures average from one-half to one-fourth of the assumed ones. This is accounted for by the fact that all these railway systems were highly ramified, and that, in most of the systems, rotary converters or motor generators of low impedance were working in parallel with rectifiers in adjacent substations.

Moreover, these measurements revealed the fact that the internal inductance of the rectifier and transformer set was of the order of 0.1 millihenry, and of the synchronous converter, 0.1 to 0.15 millihenry. A simple calculation will show that in the case of a rectifier working in parallel with a synchronous converter in the same or in a near-by substation, the latter will, due to its low inductance, decrease the system impedance, and will also offer to the alternating-current harmonics an easy path, thus acting like a filter.

**Harmonic Currents.**—The harmonic currents produced in railway systems by the voltages given in Table XI can therefore be determined by dividing the harmonic voltages by the impedance  $Z = Z_2 + l \cdot z_1$ . The value of  $l \cdot z_1$  is equal to zero

when the locomotive or the street car passes the substation, and is a maximum when it reaches the end of the trolley line.

Assuming a 1,500-volt, 2,000-amp. railway system, fed by mercury arc rectifiers, with an average inductance of 8.5 millihenrys and an ohmic resistance of 0.75 ohm, and assuming a 360-cycle harmonic voltage of 5 per cent, the 360-cycle harmonic current component will have a value of

$$\frac{1,500 \cdot 0.05}{8.5 \cdot 2\pi \cdot 360 \cdot 10^{-3}} = 3.9 \text{ amp.}$$

which is only about 0.2 per cent of the load current of 2,000 amp.

Assuming another representative 600-volt, 2,000-amp. railway system, fed by rectifiers, with an inductance of 0.8 millihenry, and using the average values of the voltages given in Table XI, the various harmonic currents will have the values given in Table XII below. The effective value of the resultant is 17.6 amp., or 0.88 per cent of the direct current.

TABLE XII

Frequency of harmonic	Voltage	Impedance	Current, amperes	Current, percentage
360	31.4	1.8	15.60	0.870
720	7.9	3.6	2.20	0.110
1,080	4.3	5.4	0.80	0.040
1,440	3.9	7.2	0.55	0.028
1,800	3.2	9.0	0.35	0.018

Since the ohmic resistance of the rectifier with its transformer is negligible, and since their inductance is very small, they will contribute little to the limiting of the alternating-current harmonics. The computation of the harmonic currents illustrates clearly that by introducing a reactor into the trolley circuit the harmonic currents produced by the harmonic voltages given in Table XI will be reduced, and consequently, so will the interference factor. In Table XIII are given data obtained on a city railway system showing the favorable influence of a series reactor and of a synchronous converter connected in parallel with a rectifier. Since the trolley system under consideration has an inductance of about 0.6 millihenry, and the reactor an inductance of about 2.8 millihenrys, a reduction of the harmonic currents in the ratio of 3.4:0.6 is obtained—namely, in the ratio which the

total impedance of the load circuit and the series reactor bears to the impedance of the load circuit—which checks reasonably with the measured values given in Table XIII.

TABLE XIII

Frequency of harmonic	Percentage ratio of effective harmonic current to average direct current		
	Rectifier alone	With 2.8-milli-henry reactor in series	With reactor, and synchronous converter in parallel
360	1.47	0.4	0.162
720	0.21	0.048	0.0097
1,080	0.092	0.023	0.0082
1,440	0.08	0.0147	0.0031
1,800	0.046	0.0092	0.0031

**Effect of Harmonic Currents and Voltages—Magnetic Induction.**—Before going into a detailed explanation of the measures which can be taken and are used in practice for eliminating interference, it will be shown how the harmonic currents and voltages in the trolley wires and feeders of direct-current railways influence exposed communication circuits.

The voltages produced in a communication circuit by electric and magnetic fields may be separated into two effects: (1) the voltages induced between the two wires of a circuit because of differences in the exposure of the two wires to the disturbing circuit, which cause currents to circulate through the terminal apparatus, and (2) the voltages induced between the two wires of a circuit and ground, which will send currents through the terminal apparatus if there is a difference in the series impedances or admittances to ground of the two sides of the circuit.

Both the voltages between wires, and the voltages between wires and ground can be produced either by electrostatic or electromagnetic induction; however, electrostatic effects have been found to be practically negligible in all the railway systems investigated to date, and our study of this problem will therefore be limited to the interference caused by the harmonics of the current rather than the voltage.

The currents which flow in the power circuit produce a field which magnetically interlinks both circuits, and, therefore, if



the current is alternating, voltages will be induced in the adjacent communication circuits.

Figure 215 illustrates, in a simplified diagram, the effects of the magnetic fields from currents in a trolley system on a neighboring telephone circuit. The net induced voltage produced in the loop  $abcd$  is indicated by arrows. The benefits to be obtained (in the voltages induced between wires) by transposing the telephone wires are illustrated on the right-hand side of this figure. It can readily be seen that the voltages induced in the sections of the wire on the two sides of a transposition are equal and opposite, and therefore cancel each other. In the untransposed line, shown on the left-hand side of Fig. 215, however, the voltages

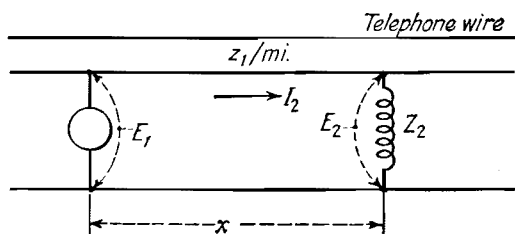

FIG. 218.—Schematic diagram of trolley line supplied by rectifier and paralleled by a telephone line.

induced in the wires are added. In practice, when the telephone lines are frequently transposed with due regard to the discontinuities in the exposure, the voltages and currents induced between wires are small as compared to those induced in a non-transposed circuit. Since the locomotive or car is in effect a traveling discontinuity, there is a practical limit to the effectiveness of transposition arrangements. Transpositions are not effective, of course, in reducing the voltages induced between wires and ground.

Figure 218 indicates, schematically, a trolley system fed from a rectifier, and a communication line exposed to the trolley system over the latter's entire length. Below are derived the expressions for the voltages induced in the telephone line, due to a harmonic component in the voltage wave of the rectifiers. The significance of the symbols used is as follows:

$f$  = frequency of any harmonic component in the direct-current output circuit of the rectifier

$$\omega = 2\pi f$$

$E_1$  = harmonic voltage of frequency  $f$  at rectifier terminals

$Z_2$  = impedance of load (locomotive or trolley car)

$z_1$  = impedance of trolley and track return per unit length

$Z_1$  = total impedance of trolley and track return between rectifier and load

$x$  = distance from rectifier to load

$m$  = mutual inductance between trolley-track circuit and telephone circuit per unit length

$e_t$  = voltage of frequency  $f$  induced (electromagnetic induction) in telephone circuit per unit length

$E_t$  = total voltage of frequency  $f$  induced in telephone circuit

The harmonic current of frequency  $f$  in the trolley circuit is

$$I_2 = \frac{E_1}{Z_1 + Z_2} \quad (196)$$

or

$$I_2 = \frac{E_1}{xz_1 + Z_2} \quad (197)$$

The voltage of frequency  $f$  induced in the telephone circuit per unit length is

$$e_t = \omega m I_2 \quad (198)$$

The total voltage of frequency  $f$  induced in the telephone circuit is

$$E_t = \omega m x I_2 \quad (199)$$

Substituting Eq. (197) in Eq. (199),

$$E_t = \frac{\omega m x E_1}{xz_1 + Z_2}$$

or

$$E_t = \frac{\omega m E_1}{z_1 + \frac{Z_2}{x}} \quad (200)$$

As the distance  $x$  becomes great, the term  $Z_2/x$  becomes small, and may be neglected as compared to  $z_1$ . For an infinitely long exposure, Eq. (200) becomes

$$E_t = \frac{\omega m E_1}{z_1} \quad (201)$$

The induced voltage for a long exposure may therefore be calculated from the harmonic voltage at the rectifier terminals,

the mutual reactance between the trolley-track system and the telephone circuit, and the self-impedance of the trolley-track system.

As pointed out above, both the voltages induced between wires of a telephone line and the voltages induced between wires and ground (the latter because of their effects on incidental unbalances in the telephone circuit) are of interest from the standpoint of inductive coordination. The following example indicates the order of magnitude of the 360-cycle voltages which might be expected between wires and between wires and ground of an untransposed 2-wire telephone circuit exposed to a single-trolley, 1,500-volt direct-current railway system supplied from a 6-phase, 60-cycle rectifier, without filter.

It will be assumed that both trolley and telephone wires are 20 ft. above the ground, the separation between the trolley and the nearest telephone conductor being 50 ft. The separation between telephone wires is assumed to be 12 in.

The mutual inductance  $m$  between the trolley-track circuit and the circuit between wires of the telephone line is approximately 0.007 millihenry per mile. The mutual inductance  $m$  between the trolley-track circuit and the circuit consisting of the two telephone wires in parallel and ground is approximately 0.5 millihenry per mile.

The 360-cycle voltage  $E_1$  will be assumed to be 75 volts.

The inductance of the load will be assumed to be 2 millihenrys. The self-inductance of the trolley and track circuit will be assumed to be 3.5 millihenrys per mile.

From Eq. (201), the 360-cycle voltage induced between the wires of the communication line, assuming the locomotive at an infinite distance from the substation, is

$$E_t = \frac{\omega m E_1}{z_1} = \frac{2262 \times 0.007 \times 10^{-3} \times 75}{2262 \times 3.5 \times 10^{-3}} = 0.15 \text{ volt}$$

Similarly, the voltage induced between the wires and ground would be

$$E_t = \frac{2262 \times 0.5 \times 10^{-3} \times 75}{2262 \times 3.5 \times 10^{-3}} = 10.7 \text{ volts}$$

In a similar manner, by means of Eq. (200), the induced voltages have been computed for several positions of the locomotive, as follows:

Miles from locomotive to substation	360-cycle voltage induced in communication line	
	Between wires	Between wires and ground
0	0	0
2	0.117	8.4
5	0.135	9.6
10	0.142	10.1
Infinity	0.150	10.7

The above table indicates that a section between locomotive and station of 5 miles is practically the equivalent (within 10 per cent) of an infinitely long section, from the standpoint of induced voltage.

**Telephone Interference Factor (Tif).**—To appreciate the effect of small currents in producing noise in telephone circuits, it should be borne in mind that a small fraction of a microwatt of power at voice frequencies will produce an audible sound in a telephone receiver. The frequencies of voice currents in a telephone circuit are found to lie between 100 and 4,000 cycles per second. Therefore, any stray currents in telephone circuits having frequencies within the limits mentioned will have some effect on the efficiency of the circuit. A number of special apparatus have been designed in the last few years for measuring such currents, as for instance: the telephone interference factor meter (tif-meter) for voltage and current, and the interference current and voltage meters (Siemens and Halske), for making measurements on the power circuit; the Western Electric noise-unit meter, the noise-voltage meter, and the unsymmetry meter, for making measurements on the communication lines. Harmonic analyzers have been developed for both power and communication lines (374).

The relative interfering effect of voltages induced in communication lines, and of the currents they produce, was measured, and was found by observation to be an empirical function of the frequency. Since, however, the voltages induced by the currents in interfering power lines are proportional to the magnitudes of those currents and to their frequency, the relative interfering effect of currents of various frequencies circulating in the power lines will also be proportional to the frequency. This effect is therefore no longer represented by the function considered above,

but by this function times the frequency, known as the "weighting factor," which is given in Fig. 219.<sup>1</sup> The ordinates of this curve are given in arbitrary units. By definition, the telephone interference factor of a harmonic in a direct- or alternating-current voltage or current is equal to the effective value of the harmonic times the weighting factor taken from Fig. 219, divided by the effective value of the voltage or current considered. If several harmonics are present, the tif is computed as being the

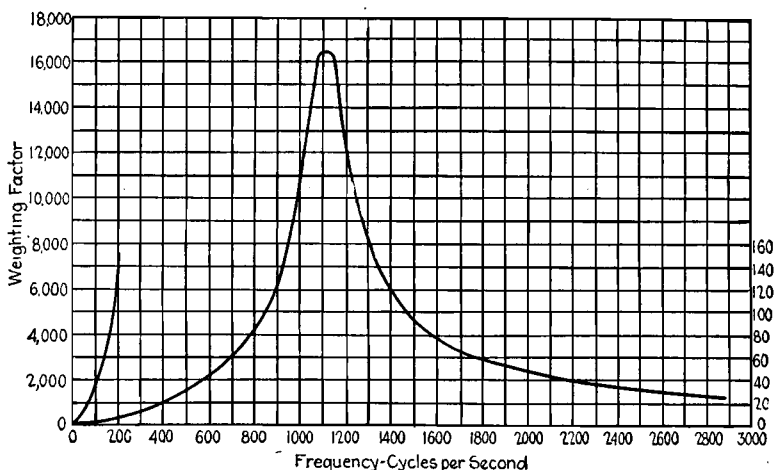

FIG. 219.—Curve of weighting factors, used for calculating the telephone interference factors of voltages and currents. (The curve on the left shows the lower part of the weighting-factor curve to an enlarged scale of the ordinates, shown on the right.)

r.m.s. of the tif's of the individual harmonics, which, for a direct-current voltage having ripple harmonics, reduces to

$$\text{Tif} = \frac{\sqrt{(H_1 W_1)^2 + (H_2 W_2)^2 + (H_3 W_3)^2 + \dots}}{E_d \text{ (r.m.s. value)}} \quad (202)$$

where  $H_1, H_2, \dots$  are the r.m.s. values of the harmonic voltages, and  $W_1, W_2, \dots$  their respective weighting factors.

Above was considered the effect on communication lines of harmonic currents circulating in power lines. Usually, however, the power and communication systems are too intricate to allow computing the magnitudes of the harmonic currents and the harmonic voltages induced in the telephone lines. Instead of figuring

<sup>1</sup> Taken from a paper by H. S. Osborne, *Trans. A.I.E.E.*, Vol. 38, Part I, p. 261, 1919.

interference on the basis of the current tif of a power circuit, it is, therefore, usually preferable to determine the voltage tif of the apparatus feeding the power system. If this system is comparatively simple, the harmonic currents and their tif may then also be computed.

It is interesting to consider the tif of 6- and 12-phase rectifiers supplied from a 60-cycle line, computed on the basis of the theoretical values of the harmonic voltages determined in Chap. V. In Table XIV are listed the theoretical tif values for several angles of overlap, corresponding to different magnitudes of the load. From the definition of the tif it appears that its value will be independent of the direct-current line voltage, although the interference in telephone lines will be proportional to the magnitude of the harmonic voltages, and, therefore, also proportional to the direct-current line voltage. This is to some extent compensated for by the greater spacing between power lines and telephone lines at higher voltages.

A number of measurements of tif on 6-phase rectifiers in service in the United States on 600- and 1,500-volt railway lines gave values ranging from 110 to 150 at loads from one-half to three-fourths of full load, which corresponds to an angle of overlap  $u$  of about  $15^\circ$ .

TABLE XIV.—THEORETICAL TIF VALUES OF RECTIFIERS

	Angle of overlap $u$			
	$0^\circ$	$10^\circ$	$20^\circ$	$30^\circ$
6-phase, 60-cycle.....	70	100	185	260
12-phase, 60-cycle.....	35	54	90	135

In a number of railway systems supplied by rectifiers it has been found that with the present practice of telephone systems interference was detected for values of the voltage tif of power systems as low as 50, whereas sometimes no interference was present in spite of a tif of 150 or over. This depends essentially on the exposure of the telephone lines to the induction of the power lines, and on the characteristics of the power circuit, such as the bonding of the track, presence of return feeders, etc. Various investigations have shown that in order to be certain of avoiding interference in the worst cases of exposure, it is necessary to reduce the rectifier tif to one-tenth of its original

value; in most cases, a reduction to one-fifth will be sufficient and will give satisfactory results. This is obtained by providing the rectifier with wave-smoothing devices, as considered below, so as to reduce each of the principal harmonic voltages in the desired ratio.

**Filter Equipment.**—A number of circuits and combinations of circuits have been proposed and used for smoothing out the ripple of the rectifier direct-current voltage. The simplest scheme is to insert a reactor into either of the rectifier lines; the ripple voltage impressed on the system fed by the rectifier will be reduced in the ratio of the system impedance to the total impedance of the circuit, including the reactor. Since, as was shown before, the impedance of a railway system may range from a frac-

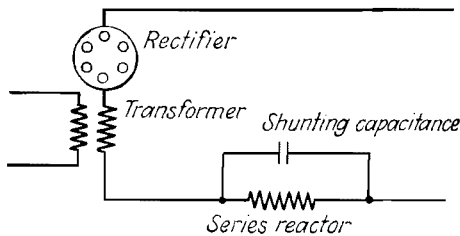

FIG. 220.—Anti-resonant filter consisting of a series reactor shunted by a condenser.

tion of a millihenry to several millihenrys, a large reactor will be necessary to reduce all harmonic voltages to only one-half or one-third of their value.

If only one harmonic voltage needs to be reduced further, this reduction can be accomplished by shunting the reactor by a condenser of capacitance  $C = 1/\omega^2L$ , where  $L$  is the inductance of the reactor, as shown in Fig. 220. The reactor and the condenser, in resonance at the frequency of the harmonic to be eliminated, constitute what is called an "anti-resonant filter," and absorb practically all of the particular harmonic voltage. This scheme has, however, the disadvantage of entering into resonance with the system. The reactance of the latter is varying constantly with the position of the cars, and is apt to take values which will bring the whole circuit into resonance for one of the higher harmonics of the rectifier voltage. This condition will usually be intermittent, but nevertheless is apt to cause serious interference.

Other types of filters have been proposed and used, three of which are shown in Fig. 221.

Another means for eliminating the ripple is to insert into the direct-current line the stator windings of alternating-current generators giving voltages equal and opposed to the voltages of the ripple components, the generators being driven by synchronous motors, supplied from the same source as the rectifier. An installation of this kind, besides being expensive, has the disadvantage of introducing rotating auxiliaries into the substation.

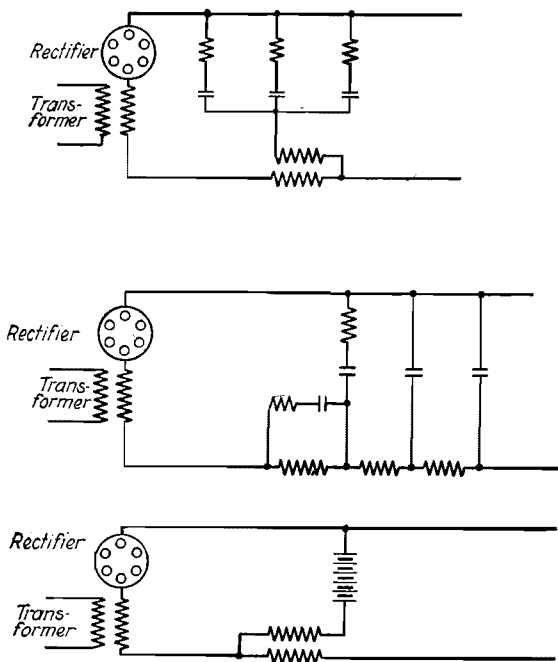

FIG. 221.—Connection diagrams of three filter circuits, which may be used for smoothing the voltage wave of a rectifier. (The connections of the rectifier and its transformer are shown schematically.)

Experience has shown that the most efficient and most economical solution consists in short-circuiting each harmonic voltage at the terminals of the rectifier by means of a resonant shunt composed of a reactor in series with a condenser. The reactor and the condenser are tuned for the particular harmonic by making their reactances, at the frequency of the harmonic, equal, in accordance with the relation

$$pn\omega L_n = \frac{1}{pn\omega C_n}$$

$$L_n = \frac{1}{(pn\omega)^2 C_n} \tag{203}$$



in which  $p$  is the number of phases,  $n$  the order of the harmonic,  $L_n$  the inductance of the shunt reactor in henrys,  $C_n$  the capacitance of the condensers in farads, and  $\omega = 2\pi f$ ,  $f$  being the frequency of the alternating-current supply (see Chap. V). A shunt of this nature will not take any direct current on account of the condenser. Since the shunt acts as a short circuit for its harmonic, its current can become very large and must be limited by a series reactor inserted in one of the leads of the rectifier (see Fig. 222).

In all except the most severe cases of interference, it is sufficient to eliminate the three most objectionable harmonics, and it was never found necessary to eliminate more than four. The same series reactor is used in conjunction with all shunts, and it also

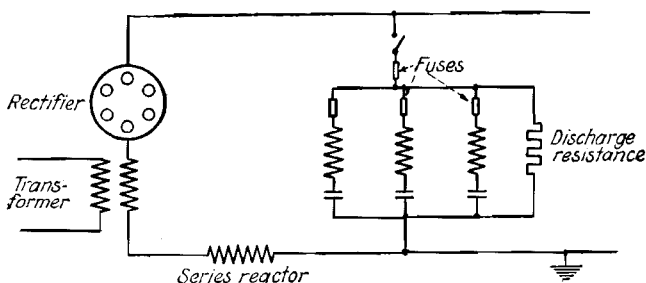

FIG. 222.—Connection diagram of filter consisting of series reactor and resonant shunts, which are tuned for the harmonic voltages to be eliminated.

reduces appreciably the harmonics for which no shunts are provided.

When making circuit calculations for any of the harmonics for which a resonant shunt is provided, the series reactor and the resonant shunt may be considered as forming a closed circuit to the harmonic voltage under consideration. The voltage drop in this circuit, produced by the harmonic current, is constituted of the reactive drop in the series reactor and the resistive drop due to the resistance of the series reactor and the resonant shunt. The resistive drop in the shunt is small compared with the reactive drop in the series reactor, and is in quadrature with it. It can therefore be assumed, when computing the harmonic current in the shunt circuit, that the whole harmonic voltage is absorbed by the series reactor. The resistive drop in the resonant shunt, due to the losses in the condensers and the resistance of the reactance coil and connecting wires, represents the residual

harmonic voltage at the terminals of the line. The ratio of the harmonic voltage at the terminals of the rectifier (or across the series reactor) to the residual harmonic voltage at the line terminals represents the reduction of the harmonic effected by the filter, and is therefore a measure of the effectiveness of the filter. Since the harmonic current of any frequency is the same in the series reactor and in the resonant shunt, and since the harmonic voltage across the series reactor was assumed to be equal to the harmonic voltage at the terminals of the rectifier, it can readily be seen that the reduction factor is equal to the ratio of the reactance of the series reactor to the effective resistance of the shunt at the frequency under consideration.

If  $L_0$  is the inductance of the series reactor and  $R_n$  the resistance of the resonant shunt for the  $n$ th harmonic, the reduction factor of this harmonic, as considered above, is

$$B_n = \frac{pn\omega L_0}{R_n} \quad (204)$$

The resistance of the resonant shunt circuit consists largely of the resistance of the shunt reactor; the effective resistance of this reactor is therefore the determining factor as to what reduction of the harmonic voltage will be effected by the filter. It is therefore desirable to have shunt reactors of low resistance. The shunt reactors should be made of finely stranded wire or, better yet, of "Litzendraht," in order to reduce the influence of skin-effect which increases the resistance of the wire at the high frequencies of the currents flowing in the shunt circuits. Stranded wires should also be used for connecting the shunt filter to the direct-current buses. These connections should be as short as possible and they should not be placed in metallic conduits. The alternating-current resistance of wire made of No. 36 B. & S. strands at 360 cycles is approximately twice their direct-current resistance.

The "quality"  $Q$  of a shunt reactor may be defined as the ratio of its reactance to its resistance, which will be assumed to be equal to the total resistance of the shunt circuit.

$$Q_n = \frac{pn\omega L_n}{R_n} \quad (205)$$

From Eqs. (204) and (205) the following expression is obtained for the inductance of the shunt reactor:

$$L_n = \frac{Q_n L_0}{B_n} \quad (206)$$

In case of severe interference, it will be required to reduce the three principal harmonics to one-tenth of their value. Past experience has shown that a reduction to one-fifth is sufficient in usual cases. To effect this, the alternating-current resistance of each shunt, including the leads to the busbars, must not exceed one-fifth of the reactance of the series reactor.

In designing a filter circuit of the type shown in Fig. 222, the following factors must be taken into consideration:

Although the alternating-current voltage across each shunt is approximately zero, each condenser has impressed on it a considerable voltage due to the passage of the harmonic current; this voltage is superposed on the direct-current voltage, and the peak value of the combined voltage determines the voltage rating of the condensers. The condensers also have a certain safe current rating per microfarad, which should not be exceeded. The current rating depends on the type of condenser used.

The shunt reactor should be designed to carry the current in the shunt circuit without overheating. Its resistance should not exceed the value necessary to give the desired reduction of the harmonic voltage, as determined by Eq. (204), taking into account also the additional resistance of the connecting wires and the losses in the condensers.

The series reactor must be designed to carry the rated direct current of the rectifier, and it must have sufficient inductance to limit the harmonic currents in the resonant shunts to the desired value.

It was shown in Chap. V that the magnitudes of the voltage harmonics are determined by the voltage and number of phases of the rectifier, and by the load carried by the rectifier. If the rectifier is provided with a series reactor and shunts, the current in each shunt is equal to the particular harmonic voltage divided by the reactance of the reactor for its frequency. This assumes that the direct-current system does not absorb any harmonic currents. Knowing the arithmetical sum of the currents taken by the shunts, the minimum amount of condensers is determined by their current-carrying capacity. Figure 223 gives the currents to be carried by the shunts for the four main harmonics of 6-phase rectifiers, as a function of the inductance of the series reactor. The curves were computed on the basis of the theoretical values of the harmonic voltages. Scales are given for 25- and

60-cycle alternating-current supply systems and for direct-current voltages of 600, 1,500, and 3,000 volts.

In designing filters it is possible to use a large number of combinations of circuit constants which would satisfy Eqs. (203)

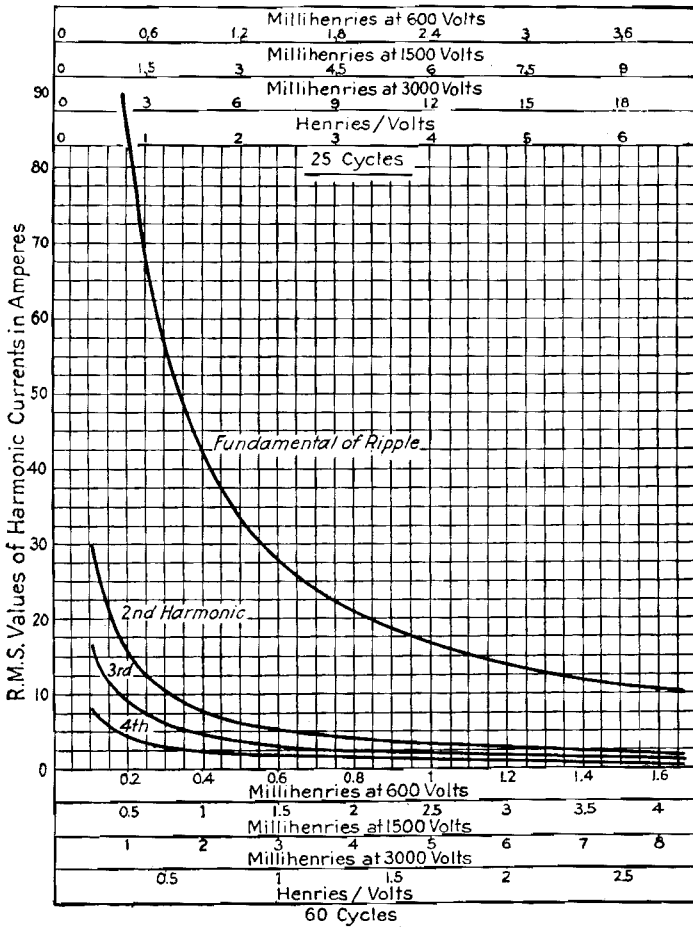

FIG. 223.—Curves showing relation between the inductance of the series reactor and the currents in the resonant shunts for the first four harmonics of a 6-phase rectifier.

and (204) and would fulfill the other conditions given above as well. The constants selected are determined by considerations of economy. As seen from Fig. 223, the smaller the inductance of the series reactor, the higher are the harmonic currents in the

resonant shunts, which would require a larger number of condensers. For some combination of series inductance and shunt capacitance the total cost of the filter is a minimum. In addition to the cost, the copper losses in the series reactor and the space requirements should also be considered. In general, the larger the rated capacity of the rectifier, for a given direct-current volt-

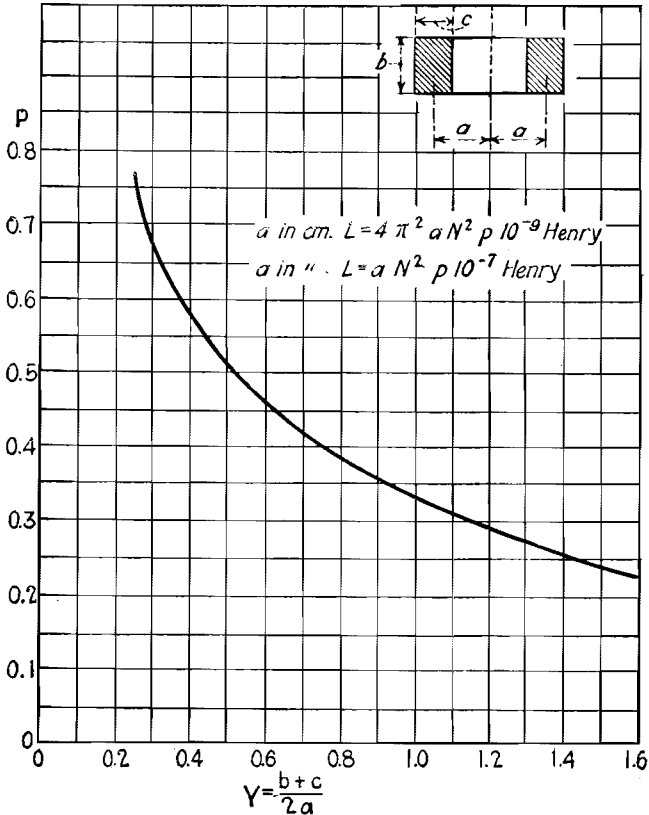

FIG. 224.—Curve used for calculating the inductance of air-core reactors.

age, the lower is the inductance of the series reactor for the most economical filter combination; the higher the direct-current voltage, for a given rated capacity, the higher is the inductance of the series reactor for the most economical filter.

Below are given the circuit constants of several filter circuits, for 6-phase, 60-cycle rectifier units, designed on the principles outlined above:

Direct-current voltage	Kilowatt rating	Series reactor, millihenrys	Frequency of harmonic, cycles	Shunt reactor, millihenrys	Shunt condensers, microfarads
600	500	0.6	360	3.26	60
			720	3.26	15
			1,080	1.45	15
600	1,000	0.4	360	2.17	90
			720	3.26	15
			1,080	1.45	15
600	3,000	0.28	360	1.30	150
			720	3.26	15
			1,080	1.45	15

The series and shunt reactors used for the filters listed in the above table are of the air-core type.

The inductance of air-core reactors may be computed by the formula  $L = aN^2p10^{-4}$  where  $L$  is the inductance in millihenrys,  $a$  the mean radius in inches,  $N$  the number of turns in the reactor;  $p$  is a function of  $\frac{b+c}{2a}$  where  $b$  is the length and  $c$  the thickness of the coil, as given in Fig. 224. For the most efficient use of the copper, different authorities give for the above ratio values ranging from 0.68 to 0.73, but there is quite a wide range of good utilization of the material outside these values. The formula is quite exact for reactors of stranded cable; for solid conductors, skin effect reduces  $L$  to a certain extent. The shunt reactors are computed by the same formula.

## CHAPTER XIV

### METHODS OF TESTING RECTIFIERS AND THEIR AUXILIARIES

When testing rectifiers, thought should be given to the selection of proper measuring instruments, and their connection in the circuits, on account of the irregular shapes of the current and voltage waves.

#### MEASURING INSTRUMENTS

The currents on the alternating-current side of the rectifier transformer are non-sinusoidal, and generally contain higher harmonic components of appreciable magnitude. The ammeters used should be of a type whose accuracy is not greatly affected by the frequency of the current. Hot-wire type instruments, or dynamometer-type instruments may be used for this purpose.

The direct-current voltage and current have undulations superimposed on the direct-current component. To measure their average values, *i.e.*, the direct-current components, permanent-magnet type instruments should be used. For measuring their r.m.s. values, dynamometer or hot-wire instruments should be used.

When making oscillographic records of currents and voltages in rectifier circuits, attention should be given to the adjustment of the damping of the oscillograph loop, on account of the steep wave shapes of some of the currents and voltages. Care should also be taken in analyzing oscillograms taken in rectifier circuits, as these oscillograms frequently show kicks or oscillations on steep parts of waves which may be due to improper damping of the loops. When making simultaneous oscillograms of currents or voltages in different parts of the rectifier circuit, care should be taken in arranging the connections so as not to impose excessive potentials between the loops of the oscillograph, in order to prevent flashovers. For example, when taking oscillograms of the currents in several anodes by using shunts, the shunts should be connected on the secondary side of the transformer, close to the neutral point, because the voltage

between opposite anodes, or between anode and cathode, is equal to approximately twice the direct-current voltage, which may cause insulation breakdown in the oscillograph if the shunts are connected to the rectifier side of the transformer secondary.

To obtain oscillograms of the anode currents, non-inductive shunts should be used. Current transformers of the ordinary type cannot be used for this purpose, on account of the error introduced by the saturation of the current transformer core by the direct-current component of the anode current. When the core is saturated, a large magnetizing current is required to induce the voltage of the secondary burden and the voltage drop in the reactance of the current transformer. The secondary current being equal to the primary current minus the magnetizing current, large ratio and phase-angle errors are introduced. These errors may be reduced if the current transformer is magnetized by direct current from the load circuit, through a tertiary winding, to compensate for the direct-current component of the anode current.

The above statements regarding the use of current transformers for taking oscillograms also apply to the use of current transformers in the anode circuits for ammeters and watt-hour meters (327 and 328).

#### PERFORMANCE TESTS

The performance characteristics of rectifier equipment may be determined by the following tests:

1. Measurement of arc voltage drop in the rectifier.
2. Tests of rectifier transformer.
3. Determination of efficiency from segregated losses.
4. Load tests on rectifier.
5. Dielectric tests on rectifier.
6. Tests on vacuum pumps and vacuum gages.

**1. Measurement of Arc Voltage Drop in Rectifier.**—The voltage drop in a static arc in a rectifier can easily be determined by passing direct current through an anode and the cathode, and measuring the voltage drop with a low-range voltmeter. The values of the arc drop obtained with this method do not, however, apply to a dynamic arc existing under actual working conditions in a rectifier, because in actual rectifying operation each anode operates only during part of a cycle and the arc moves



periodically from anode to anode, so that the drop at the anode as well as the drop in the arc itself differ from the drops in a stable arc, on account of the different conditions of ionization.

In measuring the arc drop under actual operating conditions, difficulties are encountered on account of the wide variation in the voltage between anode and cathode, this voltage being relatively low when the anode is carrying current, and high during the idling time. Thus, for example, for a 6-phase, 600-volt rectifier, the voltage between anode and cathode during the working period of the anode is approximately 25 volts, while during the idling time it reaches a value of 1,300 volts.

The following methods may be used to measure the arc voltage drop in a rectifier under operating conditions:

*Water-rate Method.*—The losses in a rectifier, when operating at a constant load, may be determined by measuring the heat absorbed by the cooling water, and dissipated by radiation. The losses absorbed by the cooling water may be determined by measuring the quantity of cooling water and the inlet and outlet temperatures. The losses dissipated by radiation may be computed from the areas and temperatures of the radiating surfaces and the ambient temperature. The voltage drop is computed by dividing the losses in watts by the load current.

This method is relatively simple and gives fairly accurate results.

*Wattmeter Method.*—The voltage drop in a rectifier may be determined by measuring the losses with a heavy-current type of Siemens dynamometer or Kelvin balance. The wattmeter is connected in one anode lead, and the voltage connections are from anode to cathode. The losses measured with the wattmeter, when divided by the average current in the anode, as measured with a direct-current ammeter, give the effective value of the arc drop. If the rectifier is symmetrical and well seasoned, the arc drop is practically identical for all the anodes. In order to obtain accurate results with this method, the measurements should be made with a low direct-current voltage, 100 volts or less, in order that the voltage drop in the arc may be appreciable compared to the voltage between anode and cathode during the idling time of the anode.

A modification of the above method has been developed for measuring accurately the arc drop at higher direct-current voltages, using a thermionic tube in connection with the wattmeter.

The voltage coil of the wattmeter is connected in series with an external resistance, and is shunted by the tube, the filament being connected to the anode terminal of the voltage coil. During the working period of the anode the filament is positive to the plate and the tube is open-circuited; during the idling period of the anode the plate is positive to the filament, allowing the greater part of the current from the external resistance of the voltage coil to pass through the tube. With this method a low-range voltage coil can be used without danger of burning out.

The use of wattmeters having their current coils connected in series with the anode leads is sometimes inconvenient, particularly when making measurements at high currents, as a special wattmeter for high currents must be used and care must be taken to shield the instrument against stray magnetic fields. A method has been developed for measuring the losses in a rectifier cylinder, employing current transformers in the anode circuits. With this method a standard wattmeter may be used. In order to avoid the errors due to the magnetization of the current transformer core by the direct-current component of the anode currents, the current transformers are provided with two primary windings, which are connected in the circuits of two phases of the rectifier transformer secondary with opposite polarities, so that the direct-current components of the two anode currents cancel each other and an alternating current is induced in the secondary of the current transformer which is connected to the current coil of the wattmeter. With this method the power input to the rectifier and the output from the rectifier may be measured and their difference taken as the losses in the rectifier. To obtain accurate results, the measurements should be made at low direct-current voltage, in order that the losses in the rectifier may be appreciable compared to the quantities measured.

*Oscillographic Method.*—The voltage drop in the rectifier may be determined by making an oscillographic record of the voltage between anode and cathode. It is of course desirable to obtain a trace of the voltage, during the operating period of the anode, to a large scale in order to be able to make accurate measurement of the voltage drop. One method for accomplishing this is to operate the rectifier at low voltage, so that the voltage drop is an appreciable portion of the total voltage from anode to cathode recorded by the oscillograph. Another method is to use a

synchronous switch for disconnecting the oscillograph during the non-working period of the anode, thus making it possible to use the full range of the deflection of the loop for recording the voltage during the operating period.

**2. Tests on Rectifier Transformers.**—Rectifier transformers are tested similarly as power transformers. The tests consist of ratio tests, dielectric tests, core-loss tests, short-circuit tests, and load tests.

The ratio tests are usually made with reduced voltage applied to the transformer. The dielectric test on the primary is made in accordance with established standards for power transformers. The secondary, however, should be tested at higher voltages than required for power transformers, on account of the surges which sometimes occur on the secondary side of a rectifier transformer. The core-loss tests are made, as for power transformers, by measuring the losses at rated voltage.

The reactance and copper losses are measured as for power transformers by short-circuiting part or all of the secondary and measuring the applied voltage and losses with rated current in the primary. Due to the fact that the copper losses occurring when the transformer operates with a rectifier can generally not be measured directly by means of a short-circuit test, these losses have to be calculated from the loss measurements made on short circuit as outlined in Chap. VI for various transformer connections.

The load test on a rectifier transformer cannot be made by the "pumping-back" or "opposition" method as used for testing power transformers, on account of the different kilovolt-ampere ratings of the primary and secondary windings of a rectifier transformer. Load tests can be made only in connection with a rectifier.

**3. Calculation of Overall Efficiency from Segregated Losses.**—The overall efficiency of a rectifier unit at various loads may be calculated from the segregated losses in the rectifier, transformer, and auxiliaries. The losses in the rectifier are computed from the measured arc voltage drop at various loads. The transformer core losses are assumed to be constant at all loads. The copper losses are assumed to be proportional to the square of the load. The losses in the auxiliaries should be included in accordance with the proportion of time during which they operate.

**4. Load Tests.**—The operating characteristics of a rectifier may be determined by making load tests under conditions which

approximate actual service conditions. The test schedule may consist of loads according to the guaranteed rating of the equipment, or according to a certain load cycle duplicating service conditions, and may include short-circuit tests at certain intervals.

The tests may be made by loading the rectifier on a rheostat or by the load-back method, using for this purpose a motor-generator set. With the latter arrangement only the losses in the rectifier set and the motor-generator set must be supplied from the alternating-current network.

During load tests it is desirable to make the following measurements and observations:

Readings of the alternating and direct currents.

Readings of the alternating- and direct-current voltages at various loads, to determine the voltage regulation of the unit.

Readings of the power input and output at various loads, by means of wattmeters on the primary side of the transformer and by means of an ammeter and a voltmeter on the direct-current side, to determine the efficiency curve. To determine the overall efficiency of the unit, the losses in the auxiliaries should be included. The overall efficiency determined in this way should be compared with the overall efficiency calculated by the segregated-loss method. When making load-cycle tests, the energy input and output should be measured with watt-hour meters to determine the average efficiency over a complete load cycle. The power factor may be computed from the alternating-current wattmeter, ammeter, and voltmeter readings.

Readings should be taken of the rectifier and transformer temperatures, and the inlet and outlet temperatures of the cooling water. If possible, the quantity of cooling water used should also be measured.

Readings should be taken of the vacuum by means of hot-wire and McLeod vacuum gages.

Records should be kept of the occurrence of back fires or any other abnormal occurrences, recording pertinent data on vacuum, current, temperature, etc., at the time of such occurrences. Particular note should be taken of the vacuum and the condition of the rectifier following short-circuit tests, and of its ability to resume service following short circuits or back fires.

If possible, oscillographic records should be made of the voltages and currents at normal loads and during short-circuit tests.

If the rectifier is equipped with seal gages, the condition of the seals should be checked periodically.

**5. Dielectric Tests on Rectifiers.**—The anodes and cathode of a rectifier are insulated from the tank and the tank is insulated from the ground. When a rectifier is in operation, the tank is at practically the same potential as the cathode; the cathode is insulated from the tank only for the purpose of preventing current conduction by the walls of the tank or the formation of cathode spots on them (see Chap. III). For this reason no dielectric test is necessary between cathode and tank. The highest operating voltage from an anode to the cathode and tank of a polyphase rectifier is equal to twice the voltage between anode and neutral. According to A.I.E.E. Standards for electrical machinery, the test voltage from anode to cathode and tank would then have to be equal to four times the voltage from anode to neutral, plus 1,000 volts. However, on account of the surges which sometimes occur in the anode circuits, and due to the fact that the breakdown voltage of mercury vapor decreases at higher temperatures, a higher test voltage is generally used. At the present writing there are no established standards for the testing of rectifiers.<sup>1</sup> The test voltage from the rectifier tank and cathode to ground, based on standards for electrical machines, should be equal to twice the highest direct-current operating voltage, plus 1,000 volts. The same test voltage should be used for rectifier auxiliaries which are subjected to the same potential as the rectifier.

**6. Tests on Vacuum Pumps and Vacuum Gages.**—It is evident that the larger the capacity of a vacuum pump, or its speed, as it is often called, the faster may a rectifier be exhausted and the higher the vacuum maintained. The capacity of a vacuum pump is therefore a criterion of its performance. The performance of a vacuum pump cannot be judged solely by the degree of rarefaction which it is able to produce in the rectifier to which it is connected, because in commercial rectifiers small leaks are always present, and the anodes and other materials used in the construction give off occluded gases when heated. The performance of a vacuum pump must therefore be judged by the quantity of gas per second which it can exhaust at a certain pressure.

The capacity of a vacuum pump can be measured in two ways:

<sup>1</sup> A.I.E.E. Standards for metal-tank rectifiers were prepared in 1930.

According to the first method, air is exhausted by the pump from a closed container of known volume, and the pressure in the container is measured at definite time intervals by means of a reliable gage which has no appreciable time lag. The average speed of the pump can then be calculated between each two points on the time-pressure curve.

According to the second method, a definite and adjustable amount of air is allowed to leak from the atmosphere into the suction side of the pump, and the vacuum which the pump is able to maintain at different air quantities is measured. This method is more practical than the first one, but it requires special valves which will allow extremely small quantities of air to pass from the outside atmosphere into the suction pipe of the pump. These valves, which consist of capillary tubes that may be varied in length, cross-section, or both, by a simple adjustment, must be very accurately made in order that reproducible results may be obtained. The valves are calibrated by connecting them to a closed recipient of known volume and measuring the amount of air which will leak into the recipient through the valve at different settings by observing the increase of the pressure in the recipient over a certain time.

The high vacuum required in mercury arc rectifiers makes it essential to have reliable gages for the accurate measurement of very low gas pressures. As a standard for calibration of the different gages the McLeod gage is used almost exclusively. In the McLeod gage, as described in Chap. VIII, a certain volume of the gas is separated from the remainder, compressed, and the volume reduction which is obtained, and which can be read directly on a scale, is a measure of the pressure of the gas before compression, according to Boyle's law. In gages to be used as standards, the volume of the measuring tube must be calibrated by filling it with liquid over its whole length, to avoid errors due to possible variations in the inner diameter. After this is done, the scale for the gas pressures can be calculated, and the gage will record the gas pressure accurately, if the necessary precautions for freezing out condensible vapors are observed. Absolute and exact values can be measured with this gage only if all vapors, such as water vapor, oil vapor, etc. are condensed or absorbed by traps before the measurements are taken. The calibrating outfit includes traps, *i.e.*, vessels cooled by liquid air, or by oxygen at  $-183^{\circ}\text{C}.$ , for condensing the vapors. Other glass

bulbs filled with phosphorus pentoxide absorb the moisture present. The remaining non-condensable gases follow the gas laws, so that the effective pressures are indicated by the McLeod vacuum gage during calibration.

#### EXPERIMENTAL STUDIES

The effect of various construction details, materials, and transformer connections on the performance characteristics of a rectifier, and the influence of various operating conditions on those characteristics, may be determined by making experimental studies on a rectifier. For such experimental work it is advantageous to have the rectifier provided with observation windows for observing the arc at the anodes and cathode, and to have a rectifier transformer suitable for making different connections. The phenomena in the arc may best be observed by viewing the arc through a stroboscopic disc which is rotated by a motor connected to the same alternating-current supply as the rectifier. The disc should have as many radial slots as the motor has pairs of poles, so that the arc may be viewed at a certain instant once every cycle, when the motor is running at synchronous speed. See Chap. III and (398).

A number of studies are suggested below:

**Voltage Drop in the Rectifier Arc.**—Effect on the voltage drop of the anode material, shape and size of anodes, diameter and shape of anode shields, arrangement of various vapor and arc guides, construction of cathode, distance between anodes and cathode. Effect on the voltage drop of the temperature and vacuum in the rectifier, temperature of the cathode cooling water. Effect of presence of air and other gases on the voltage drop. Effect of the amplitude and duration of the anode currents. Variation of the voltage drop with the load current. Comparison of the values of voltage drop measured with direct current and alternating currents of different frequencies.

Ignition of the arc in the rectifier with alternating and direct currents. Effect of temperature and pressure on the ignition. Minimum current required to maintain a stable arc to the excitation anodes and to the main anodes under various temperature and pressure conditions.

Rate of evaporation of mercury vapor for different constructions, different amounts of cooling of the cathode, and its effect on the arc drop.

**Transient Phenomena.**—Conditions affecting the occurrence of back fires. The effect on their occurrence of load current at various direct-current voltages; of pressure and temperature in the rectifier, and the temperature of the anodes; of the presence of impurities in the rectifier; of condensed mercury on the anodes. Effect of the anode material and of the arrangement of the arc guides.

The occurrence of surges when the rectifying arc is extinguished. Effect of the value of the current, rate of current change, pressure and temperature in the rectifier, and constants of anode and load circuits, on the magnitude of the surges.

**Inverse Current.**—A study of the inverse current flowing to an anode when it is not operating and is at a negative potential to the cathode; the effect of the load current, operating voltage,

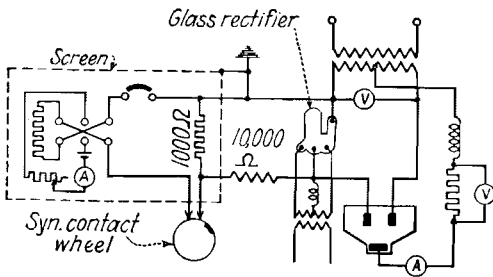

FIG. 225.—Connection diagram of circuit for measuring inverse current in rectifier, using an auxiliary rectifier in parallel with the measuring circuit.

pressure and temperature in the rectifier on the magnitude of the inverse current; the relation between the magnitude of the inverse current and the occurrence of back fires.

As was stated in Chap. III, the phenomenon of back fires is largely attributed to the inverse current flowing to an anode after its arc is extinguished. A study of the inverse current is therefore of particular interest in the investigation of back fires (410).

Since the inverse current is of the order of magnitude of milliamperes, and is therefore very small compared to the load current, special methods must be used in making the measurements.

Two circuits used for measuring the inverse current are shown in Figs. 225 and 226.

In Fig. 225 is shown a method for measuring directly the inverse current of a single-phase, two-anode rectifier under normal



operation. This is accomplished by using a second rectifier tube which allows the passage of the normal load current but intercepts the inverse current and makes it flow through the measuring circuit. A synchronous wheel is used to permit measuring the current at any point of the cycle (65 and 324).

With another method used to measure the inverse current an oscillograph is connected through a synchronous contact wheel to a shunt in an anode lead. Oscillograms of the inverse current may also be taken with the circuit of Fig. 225, by connecting the oscillograph loop in place of the measuring circuit.

In Fig. 226 is shown a circuit for measuring the inverse current under conditions which approximate operating conditions in

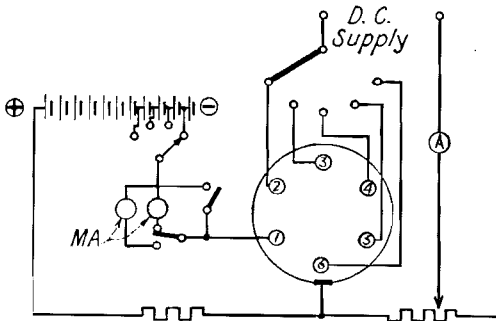

FIG. 226.—Circuit for measuring inverse current in idle anode of rectifier, to study influence of current carried by other anodes.

a rectifier, and which is particularly adaptable for investigating the factors affecting the inverse current. Anode 1 is connected to the negative pole of a variable direct-current source, which may be a battery or a direct-current generator. An arc is maintained in the rectifier, and any one of the remaining anodes may be connected to a direct-current supply in series with a resistance. The current flowing in anode 1 is measured by means of milliammeters. Two milliammeters are used, one with a high range and the other with a low range. A short-circuiting switch is provided in order to protect the instruments against a possible flashover from anode to cathode. This switch is opened only when a reading is taken.

With the circuit of Fig. 226, it is possible readily to determine the effect of the following factors on the inverse current: (1) the potential of anode 1; (2) current in the working anodes;

- (3) location of the working anode with reference to anode 1;
- (4) effect of anode shields, baffles, and screens.

**Rectifier Circuit Characteristics.**—A study of the wave shape of the currents and voltages and the relation between the voltages and currents in the various parts of the rectifier circuits, for different types of direct-current loads, different types of transformer connections, and with different amounts of reactance and resistance in the primary and secondary sides of the transformer. Relation of the currents and voltages at various loads, from no load to short circuit. Current and voltage conditions during a back fire.

Although natural back fires cannot be produced at will, the external circuit conditions during a back fire may be reproduced artificially when it is desired to obtain oscillographic records or to determine the effect of a back fire on the transformer, the protective devices, or other parts of the external circuit.

The circuit conditions during a back fire can be produced artificially by the following methods:

1. Surges may be applied to one of the anodes when the rectifier is carrying load. This method approaches very closely the conditions during a natural back fire, but the back fire may not occur at every attempt nor, if it does, at the instant desired.

2. Mercury may be sprayed on the surface of an anode. This method gives about the same results as method 1, but requires a more elaborate set-up inside the rectifier.

3. One anode may be connected externally to the cathode while there is an arc in the rectifier. With this method, the current from the other anodes will flow into the back-firing phase (the phase of the anode connected to the cathode) through the cathode and the external connections. This method is the simplest and the most dependable one for reproducing the external circuit conditions of a back fire; however, as can readily be seen, it does not reproduce the internal conditions of a natural back fire.

#### FIELD TESTS ON RECTIFIERS

On Sept. 30, 1928, the Commonwealth Edison Company made a series of short-circuit tests on the Brown Boveri rectifiers in the Lawndale substation. The diagram of connections of the rectifiers is given in Fig. 227. The unit consists of two rectifiers, Type

GRZ-56, connected to one transformer. The transformer primary is connected in Y and the secondary in double 6-phase with interphase transformer. The reactance of the transformer is 5.5 per cent.

Each rectifier is rated at 600 kw., 621 volts, 966 amp. direct current. The alternating-current supply is 12,000 volts, 3-phase, 60-cycle.

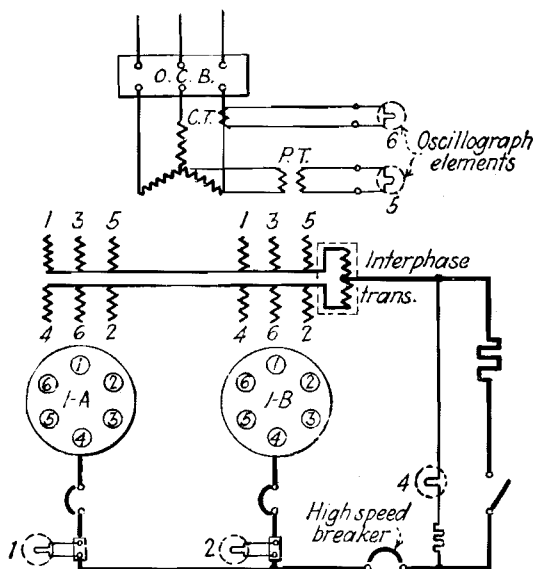

FIG. 227.—Diagram of connections of circuit employed for the short-circuit tests in the Lawndale substation of the Commonwealth Edison Company, Chicago.

Each rectifier was protected by means of a semi-high speed breaker provided with blowout coils and with a reverse-current trip attachment. The short circuits were interrupted by means of a high-speed circuit breaker with a tripping time of 0.5 cycle.

Oscillograms were taken of the primary current and voltage of phase C, the direct currents of the rectifiers, and the direct-current bus voltage.

These tests are of particular interest as the capacity of the alternating-current system was very high compared to the capacity of the rectifiers, the tests were made at short intervals,

and during some of the tests back fires occurred which were recorded by the oscillograph.

Nineteen tests were made in all, most of them at intervals of 1.5 to 3 min. The first five tests were made with resistances of 0.126 to 0.012 ohm. The remaining tests were "dead" short circuits across the direct-current buses, with about 50 ft. of 4/0 cable.

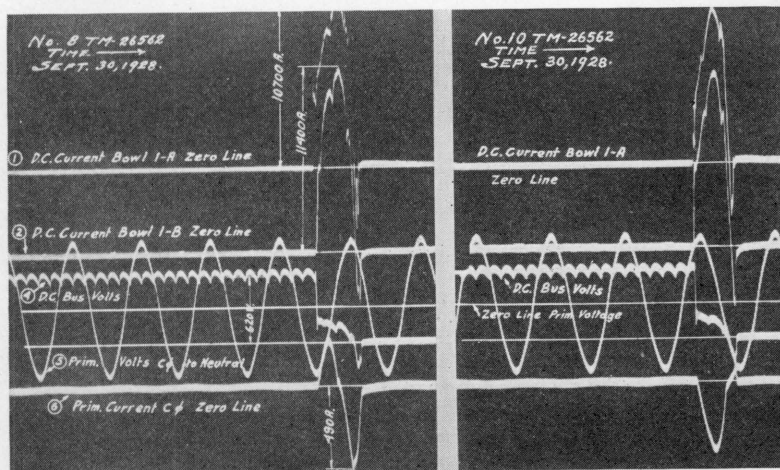

FIG. 228.—Oscillograms taken during short-circuit tests 8 and 10 on the rectifiers in the Lawndale substation.

The vacuum in the rectifiers at the start of the tests, measured by a McLeod gage, was 0.0013 mm. Hg; the vacuum at the conclusion of the tests was 0.0024 mm. Hg.

In Figs. 228, 229, and 230 are shown four of the oscillograms taken during the tests. The current and voltage values for these oscillograms are given in Table XV.

**Analysis of Oscillograms.**—In oscillograms 8 and 10, Fig. 228, as seen from curves 1 and 2, the short circuit was interrupted by the high-speed circuit breaker in about 0.5 cycle. The direct-current short-circuit current reached a maximum value in about 0.3 cycle (0.005 sec.). The average rate of current rise is approximately 2,000,000 amp. per second.

The direct-current bus voltage is shown by curve 4. At no load the voltage has an undulation of a frequency equal to the product of the alternating-current frequency and the number of phases. When the short circuit was applied the direct-current

voltage dropped. The residual voltage during the short circuit was due to the ohmic and inductive drop in the short-circuiting circuit; the voltage decreases as the rate of current rise is reduced, and becomes negative when the circuit is interrupted and the current drops to zero. No appreciable change is noticeable in the alternating-current voltage (curve 5) during the short circuit, on account of the relatively high capacity of the alternating-current supply.

TABLE XV

Oscillogram number	Direct-current short circuit, amperes (maximum)			Direct reverse current (maximum)	Average direct-current bus voltage		Primary current phase <i>C</i> (maximum)		Primary line voltage (r.m.s.)
	1A	1B	Total		No load	Short circuit	Short circuit	Back fire	
8	10,700	11,400	22,100	.....	620	180	500	.....	12,100
9	8,900	12,200	19,000 <sup>1</sup>	10,500	620	170	305	1,500	11,200
10	10,300	10,900	20,600 <sup>1</sup>	.....	620	160	442	.....	12,100
11	9,400	12,200	20,700 <sup>1</sup>	9,200	620	130	390	1,480	11,200

<sup>1</sup> The total maximum is less than the sum of the individual maxima, because the latter did not occur simultaneously.

The alternating current in phase *C* is shown by curve 6. The difference in the shapes of the current waves of oscillograms 8 and 10 is due to the fact that the short circuits were applied at different points of the voltage cycle.

In oscillograms 9 and 11, Figs. 229 and 230, the short circuit was followed by a back fire in rectifier 1A. The short circuit was interrupted by the high-speed circuit breaker, as in oscillograms 8 and 10. However, a back fire occurred at the instant of interruption. After the opening of the high-speed breaker, rectifier 1B fed current back into rectifier 1A. The reverse current in the back-firing rectifier is for this reason equal in magnitude to the forward current in the other rectifier, as seen from curves 1 and 2. The direct-current breaker of the back-firing rectifier 1A was tripped out on reverse current approximately 2.3 cycles after the back fire started, thus isolating the two rectifiers and stopping the backfeed from 1B to 1A. As seen from the primary current curve 6, the back fire in rectifier

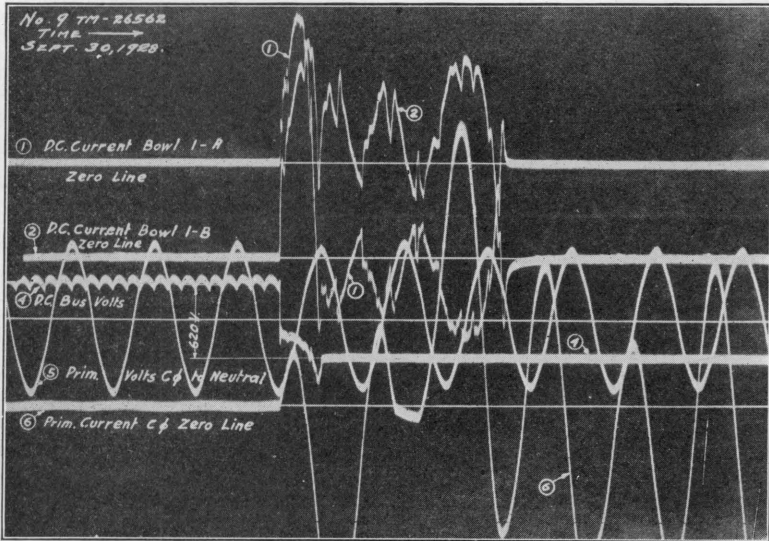

FIG. 229.—Oscillogram taken during test 9 in the Lawndale substation, in which the short circuit was followed by a back fire.

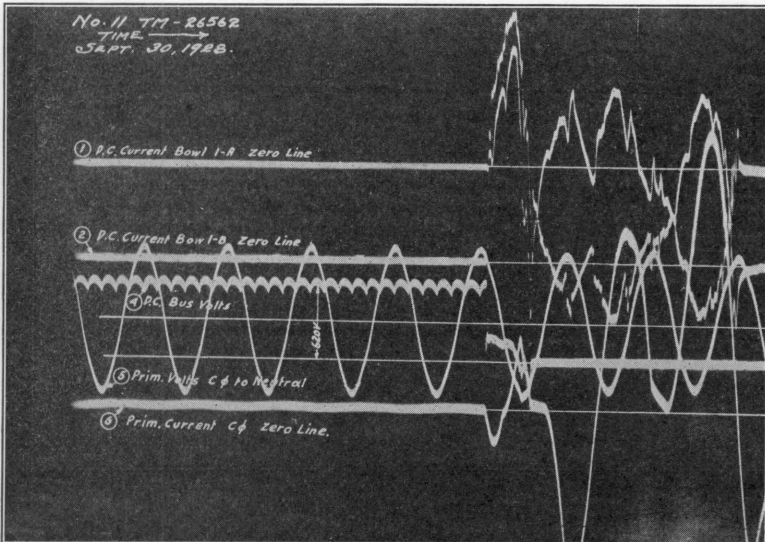

FIG. 230.—Oscillogram taken during test 11 in the Lawndale substation; short circuit followed by back fire.

1A continued until interrupted by the opening of the oil circuit breaker (not shown in oscillograms).

The alternating-current voltage dropped about 8 per cent during the back fire, as seen from curve 5.

The scales of the direct current waves in the oscillograms for rectifiers 1A and 1B are in the ratio of 188 to 175, respectively.

## BIBLIOGRAPHY

1. JEMIN and MENEUVRIER, "Arc between Mercury and Carbon," *Compt. Rend.*, Vol. 94, 1882.
- 1a. ARONS, "Ueber einen Quecksilberlichtbogen," *Ann. d. Physik*, Vol. 47, pp. 767-771, 1892.
2. EICHBERG and KALLIR, *Sitzungsbericht der Kaiserl. Akad. der Wissensch.*, Vienna, Vol. 103, 1894.
3. SAHULKA, M., *Sitzgsber. Akad. Wien.*, 1894.
4. ARONS, *Wied. Ann.*, Vol. 58, p. 73, 1896.
5. LANG, M. V., *ibid.*, Vol. 63, p. 191, 1897.
6. SCHUSTER and HEMSALECH, *Phil. Trans.*, Vol. 193, p. 189, 1899.
7. THOMSON, J. J., *Phil. Mag.*, Vol. 48, p. 547, 1899.
8. CHILD, *Phys. Rev.*, Vol. 10, p. 151, 1900.
9. KAUFMANN, *Ann. Physik*, Vol. 2, p. 158, 1900.
10. COOPER-HEWITT, *Elec. World and Eng.*, p. 641, 1901.
11. STARK, *Ann. Physik*, Vol. 4, p. 407, 1901.
12. DUDDELL, *Proc. Roy. Soc.*, Vol. 68, p. 512, 1901.
13. VON RECKLINGHAUSEN, M., *Elektrotech. Z.*, Vol. 83, 1902.
14. GRANQUIST, G., *Veroeffentlichungen der Gesellschaft der Wissensch. zu Upsala*, 1902.
15. STARK, *Ann. Physik*, Vol. 7, p. 438, 1902.
16. STARK, "Die Elektrizitaet in Gasen," pp. 152, 176, 205, Leipzig, 1902.
17. STARK and REICH, *Physik. Z.*, Vol. 4, p. 321, 1902.
18. STARK, "Der Kathodenfall des Glimmstromes als Funktion von Temperatur, Stromstaerke, und Gasdruck," *Ann. Physik*, Vierte Folge, Vol. 12, pp. 1-30, 1903.
19. STARK, "Zur Kenntniss des Lichtbogens," *Ann. Physik*, Vierte Folge, Vol. 12, pp. 673-713, 1903.
20. RICHARDSON, *Proc. Roy. Soc.*, Vol. 71, p. 415, 1903.
21. AYRTON, "The Electric Arc," London, p. 241, 1903.
22. GRANQUIST, *Veroeffentlichungen der Gesellschaft der Wissensch. zu Upsala*, 1903.
23. STARK, *Physik. Z.*, Vol. 4, p. 535, 1903.
24. WEINTRAUB, *Phys. Mag.* (London), p. 95, 1904.

1905

25. STEINMETZ, *Proc. A.I.E.E.*, p. 370, 1905.
26. STEINMETZ, *Proc. A.I.E.E.*, p. 743, 1905.
27. LODGE, OLIVER, "A Pertinacious Current," *Electrician* (London), Vol. 54, p. 953, 1905.
28. STEINMETZ, "Mercury-vapor Converter," *Western Electrician*, Vol. 36, pp. 345ff, 1905.



29. KRUH, O., "Mercury Rectifier Used as a Frequency Changer," *Elec. World and Eng.*, Vol. 45, p. 754, 1905.
30. WEINTRAUB, E., "The Mercury-arc Lamp and Rectifier," *Elec. World and Eng.*, Vol. 57, pp. 38-39, 1905.
31. THOMAS, P. H., "The Mercury-vapor Converter," *Elec. Jour.*, Vol. 2, pp. 397-403, 1905.
32. "Mercury Vapor Converters," *Page's Weekly*, Vol. 6, pp. 1285ff, 1905.
33. LEBLANC, M., "The Mercury-vapor Lamp and Rectifier," *Soc. Franc. Phys. Séances*, Vol. 1, pp. 63-77, 1905; *Soc. Int. Elec. Bull.* 5, pp. 401-427; *Rev. Elec.*, Vol. 3, pp. 271-281.
34. "Mercury-arc Rectifiers," *Elec. Rev.*, Vol. 57, pp. 864ff, 1905.

## 1906

35. FLEMING, R., "Mercury-vapor Rectifiers," *Western Electrician*, Vol. 39, p. 415, 1906.
36. ROSLING, P., "Rectification of Alternating Currents," *Inst. Elec. Eng. (British), Jour.*, Vol. 36, pp. 624-632, 1906; *Electrician*, Vol. 56, pp. 677-679; *Zentralblatt Akkumulatoren*, Vol. 7, pp. 61ff.; *Elec. Rev.*, Vol. 58, pp. 277-279, 1906.
37. LIBESNY, A., "The Rectification of Currents by the Mercury-vapor Apparatus," *Elektrotech. u. Maschinenbau*, Sept. 30 and Oct. 7, 1906.
38. FERRAND, A., "Auvert-Ferrant Rectifier Regulator and its Application to Main-line Traction," *Assoc. Ing. Elec. Liege, Bull.*, Vol. 6, pp. 130-169, 1906; also in *Elektrotech. u. Maschinenbau*, Vol. 24, pp. 829ff, 1906.

## 1907

39. HAGENBACH, "Handbuch der Radiologie," Vol. 4, 1907.
40. POLAK, *Elektrotech. Z.*, p. 599, 1907.
41. POLAK, "Untersuchungen eines Quecksilberdampf-Gleichrichters," *Elektrotech. u. Maschinenbau*, p. 415, 1907.
42. WEINTRAUB, E., "Changing Continuous-current Voltage by Means of Mercury-vapor Converter and Static Transformer," *Western Electrician*, Vol. 40, p. 146, 1907.
43. BEYER and LOPPIN, "Characteristics of Circuits Employing a Mercury-arc Rectifier," *Stevens Ind.*, Vol. 24, pp. 392-399, 1907.

## 1908

44. "Mercury-arc Rectifiers in Moving-picture Shows," *Elec. World and Eng.*, Vol. 51, p. 939, 1908.
45. "Mercury Rectifier Arc-lighting System," *Elec. World and Eng.*, Vol. 52, p. 152, 1908.
46. SAHULKA, *Elektrotech. u. Maschinenbau*, p. 1007, 1908.
47. HAHN, *Elektrotech. Z.*, p. 176, 1908.
48. HAHN, *Elektrotech. Z.*, Vol. 29, p. 198.
49. *Western Electrician*, Vol. 43, p. 432.
50. STEINMETZ, "Transient Electric Phenomena and Oscillations," p. 256, 1909.
51. SAHULKA, *Elektrotech. Z.*, Vol. 29, p. 1036.

52. HAHN, K., "Schott's Mercury Rectifier," *Elektrotech. Z.*, Vol. 29, pp. 178-180, 1908.

## 1909

53. LEBLANC, "Le Convertisseur Cooper-Hewitt à Vapeur de Mercure," *La Lum. Elec.*, 2d Ser., Vol. 8, pp. 168-173, 195-201, 1909.

54. SCHULZE, "Messung des Rueckstromes," *Elektrotech. u. Maschinenbau*, p. 524, 1909.

55. JACKSON, *Elektrotech. u. Maschinenbau*, p. 619, 1909.

56. SCHULZE, G., "Experiments on Mercury-vapor Rectifiers," *Elektrotech. Z.*, Vol. 30, pp. 295ff, and 373ff, 1909.

57. MEADE, N. G., "The Mercury Rectifier," *Power*, Nov. 2, 1909.

58. MUNDO, C. J., "The Constant-current Mercury-arc Rectifier," *Harvard Eng. Jour.*, June, 1909.

59. WAGONER, "Recent Applications of the Mercury-arc Rectifier," *Stevens Ind.*, Vol. 26, pp. 51-57, 1909.

## 1910

60. SIRCH, "Mercury-arc Rectifier Leakage Current," *Elec. World and Eng.*, Vol. 55, p. 567, 1910.

61. "Long Life of Rectifier Tubes at Detroit Lighting Plant," *Elec. World and Eng.*, Vol. 57, p. 374, 1910.

62. SCHULZE, "Betrag und Kurvenform des Rueckstromes," *Elektrotech. u. Maschinenbau*, p. 211, 1910; same in French, *La Lum. Elec.*, 2d Ser., Vol. 9, pp. 305-307, 1910.

63. JACKSON, *Elec. Jour.*, Vol. 9, p. 561.

64. NORDEN, "Wirtschaftlichkeit des Quecksilberdampf-Gleichrichters," *A.E.G. Mitteilungen*, February, 1910; also *Elektrotech. u. Maschinenbau*, Vol. 28, p. 186, 1910.

65. SCHULZE, G., "Investigations on Mercury Vapor Rectifiers," *Elektrotech. Z.*, Vol. 31, pp. 28-31, 1910.

66. SAKAI, Y., "F. Conrad's Self-sustaining Transformer Mercury Rectifier," *Elec. Jour.*, Vol. 7, pp. 216-224, 1910.

## 1911

67. SCHAEFER, "Ein neuer Quecksilberdampf-Gleichrichter fuer grosse Leistungen," *Elektrotech. Z.*, Vol. 32, pp. 2-5, 1911.

68. "Application of Mercury-arc Rectifiers to Street-lighting Systems," *Schweizerische Bauzeitung*, Aug. 19, 1911.

69. NIETHAMMER, "Quecksilberdampf-Gleichrichter als Perioden-Umwandler," *Elektr. Bahnen u. Kraftbetriehe*, p. 185, 1911.

70. ELLIOTT and PARSON, "Experiments on a Mercury-arc Converter," *Electrician* (London), Vol. 67, pp. 534-538, 1911.

71. "A.E.G. Gleichrichter mit Graphit Anoden," *Elektrotech. u. Maschinenbau*, p. 44, 1911.

72. *Elec. World*, Vol. 57, p. 1629.

73. WHITNEY, *Gen. Elec. Rev.*, December, 1911.

74. See (70).

75. GREEN, *Gen. Elec. Rev.*, pp. 623, 627, 1911.

76. "A Mercury-vapor Rectifier for Large Powers," *Elec. Rev.*, Vol. 68, pp. 208ff, Feb. 10, 1911.

77. "The Electrical Exhibit," *Engineer*, Vol. 112, p. 327, 1911.

78. ALVENSLEBEN, "Alternating-current Rectifiers," *Glueckauf*, Mar. 11, 1911.

## 1912

79. PAPALEXI, *Ann. Phys.*, Vol. 39, pp. 976ff, 1912.

80. TSCHUDI, "Experimentelle Untersuchungen am Quecksilberdampf-Gleichrichter fuer Wechselstrom," *S.E.V. Bull.* 3, pp. 85-115, 1912.

81. COOPER-HEWITT, P., *Elec. Ry. Jour.*, Vol. 39, p. 475, 1912.

82. TSCHUDI, *Arch. Elektrot.*, p. 415, 1912.

83. *Engineer* (London), Vol. 113, p. 378, 1912.

84. JACKSON, R. P., "Theory of the Operation of Mercury Rectifiers," *Elec. Jour.*, June, 1912.

85. BRACKETT, E. A., "Operation of Mercury-arc Rectifiers," *Elec. Jour.*, Vol. 9, pp. 138-149, 1912.

86. SCHAEFER, B., "Large-power Mercury-vapor Rectifiers with Steel Containing Vessels," *Elektrotech. Z.*, Vol. 33, pp. 1164-1168, 1912; *Elec. World*, Vol. 60, p. 1157; *Elec. Rev.*, Vol. 71, pp. 1030ff.

87. "Rectifiers for Tramway Work," *Elec. Rev.*, Vol. 71, p. 585, 1912.

88. HOEPEFNER, "The Mercury-vapor Rectifier in Practice," *Archiv Post. Tele.*, No. 18, pp. 525-527, 1912.

89. STEIN, P., "Three-phase Rectifier for Small Outputs," *Elektrotech. Z.* Vol. 33, pp. 56ff, 1912.

90. SCHULZE, G., "Energy Losses in Mercury-vapor Rectifiers," *Arch. Elektrot.*, No. 11, pp. 491-495, 1912.

## 1913

91. EPSTEIN, *Elektrotech. Z.*, pp. 1415-1420, 1913.

92. GUENTHER-SCHULZE, *Arch. Elektrot.*, pp. 491ff, 1913.

93. SCHULZE and TSCHUDI, Discussion of lecture by Hartmann Kempf on "Quecksilberdampf-Gleichrichter fuer Hohe Leistung," *Elektrotech. Z.*, pp. 253, 284, 1913.

94. TSCHUDI, "Entwicklungsmoeglichkeiten des Quecksilberdampf-Gleichrichters," *Elektr. Bahnen u. Kraftbetriebe*, Feb. 4, 1913.

95. BUSCH, *Physik. Z.*, Vol. 14, p. 524.

96. LEBLANC, "Mercury-vapor Converters, Their Capacity and Efficiency," *Electrician* (London), July 18, 1913.

97. *Engineer*, Vol. 117, p. 607.

98. NORDEN, K., "Development of Large Mercury Rectifiers," *Elektrotech. Z.*, Vol. 34, pp. 1479-1482, 1913.

99. PERKINS, H. F., "Mercury-arc Rectifier," *Met. Chem. Eng.*, Vol. 11, p. 491-494, 1913; *Elec. World*, Vol. 62, p. 548, 1913.

100. COFFIN, F. P., "Physical Phenomena of the Mercury-arc Rectifier," *Gen. Elec. Rev.*, Vol. 16, pp. 691-702, 1913.

101. RANDOLPH, J. A., "Current Rectifiers," *Power*, Vol. 38, p. 750, 1913.

102. LEBLANC, M., "The Mercury-vapor Rectifier," *Soc. Int. Elec. Bull.* 3, Ser. 3, pp. 11-31, 1913.

103. PERI, G., "Mercury-vapor Arc Rectifiers," *Industria*, Dec. 28, 1913.  
 104. MONGINI, G., "Measurements on a Mercury Converter," *Atti Dell' Assoc. Elett. Ital.*, Vol. 17, pp. 280-292, 1913.

## 1914

105. MEYER, A.E.G. *Mitteilungen*, Vol. 35, pp. 6, 29.  
 106. JAEGER, *Arch. Elektrot.*, p. 418, 1914.  
 107. SCHULZE and LINDEMANN, *Physik. Z.*, p. 254, 1914.  
 108. LEBLANC, "Les Progrès Récents du Convertisseur à Vapeur de Mercure," *La Rev. Elec.*, May 15, 1914, p. 469; *Electrician* (London), August, 1914.  
 109. "Mercury-vapor Rectifier Locomotive an Accomplished Fact," *Elec. Ry. Jour.*, Vol. 44, p. 1343, 1914.  
 110. "The Development of the Mercury Rectifier for Large Outputs," *Elec. Rev.*, Vol. 75, pp. 210-211, 1914.  
 111. KRÜH, O., "Mercury-arc Rectifiers," *Elektrotech. u. Maschinenbau*, Dec. 6, 1914.  
 112. MEYER, F. W., "Mercury Rectifiers and Speed Regulation," *Elektrotech. Z.*, Vol. 35, pp. 6-9, 1914.

## 1915

113. WHEELER and MURRAY, Discussion, *Jour. Franklin Inst.*, Vol. 174, No. 5, pp. 87ff, 1915.  
 114. Phys. Techn., Reichsamt, "Veröffentlichungen von Untersuchungen am Quecksilberdampf-Gleichrichter," *Z. Instrumentkunde*, Vol. 35, p. 108, 1915.  
 115. KRÜH, *Elektrotech. u. Maschinenbau*, Vol. 32, pp. 845, 860 and 874.  
 116. TSCHUDI, *Elec. World*, Vol. 67, p. 1409.  
 117. "Le Convertisseur à Vapeur de Mercure," *B.B.C. Revue*, Vol. 2, pp. 135-140, 1915.  
 118. "Mercury-arc Rectifiers for Charging Small Batteries" (Sheet-metal Covering), *Elec. World*, Vol. 66, p. 102, 1915.

## 1916

119. "Les Premières Applications du Convertisseur à Mercure dans les Centrales de Tramways," *B.B.C. Revue*, Vol. 3, pp. 147-151, 1916.  
 120. "B.B.C. Grossgleichrichter," *Helios*, Nov. 12, p. 46, 1916.  
 121. GEHRECKE, "Erscheinungen der Glimmentladungen an den Elektroden," "Handbuch der Radiologie," pp. 205-206, 1916.  
 122. TSCHUDI, W., "Analysis of Vapor Rectifier Losses," *Elec. World*, Vol. 67, pp. 1409-1412, 1916.

## 1917

123. SCHAEFER, *Elektrotech. Z.*, Vol. 38, pp. 89-91, 107-109, 1917.  
 124. "Mercury Rectifiers for Large Outputs," *Elec. Rev.*, Vol. 81, pp. 197, 199, 1917.  
 125. TSCHUDI, W., "Measurements on Mercury-vapor Rectifiers," *Elektrotech. Z.*, Vol. 38, pp. 6ff, 23ff, 1917.

126. "Mercury-arc Rectifiers; Patent," *Elec. World*, Vol. 69, p. 1252, 1917.

127. "Grossgleichrichter in Dreileiteranlagen," *B.B.C. Mitteilungen* (Mannheim), pp. 5-8, January, 1917.

## 1918

128. "Untersuchungen an einem Quecksilberdampf-Gleichrichter," *B.B.C. Mitteilungen*, Vol. 5, pp. 151-157, 1918.

129. "Battery Charging with Mercury-vapor Power Rectifiers," *ibid.*, pp. 222-226.

130. SCHAEFER, "Parallelhaltung und Spannungsregelung von Grossgleichrichtern," *Elektrotech. Z.*, Vol. 39, pp. 321-324, 1918.

131. *Rev. gén. élec.*, p. 656, 1918.

132. TSCHUDI, *Elec. World*, Vol. 71, pp. 403-405.

133. MUELLER, *Elektrotech. u. Maschinenbau*, Vol. 36, p. 558, 1918.

134. OBACH, J., "Large Mercury-vapor Rectifiers in Hirschberg Electric Plant," *Elektrotech. Z.*, Vol. 39, pp. 414ff, 423ff, 1918.

135. CORBINO, O. M., "A Converter of Three-phase into Direct Current," *Elettrotecnica*, Vol. 5, pp. 392-394, 1918.

136. See (130).

137. "Die Speisung von Gleichrichtern aus mehreren Netzen," *B.B.C. Mitteilungen* (Mannheim), Vol. 5, pp. 121-123, July, 1918.

## 1919

138. "Untersuchungen an einem Quecksilberdampf-Gleichrichter," *B.B.C. Mitteilungen* (Mannheim), pp. 3-9, January, 1919.

139. BOLLIGER, *Arch. Elektrot.*, Vol. 7, pp. 426-470, 1919.

140. "Gleichrichter-Anlage Monbijou des E. W. der Stadt Bern," *B.B.C. Mitteilungen*, Vol. 6, pp. 248-251, 1919.

141. "Mercury-vapor Power Rectifiers," *ibid.*, pp. 51-58, 123-126, 169-176, 192-195, 219-222.

142. "Der Wirkungsgrad von Unterstationen mit Rotierenden und Statischen Umformern zur Speisung von Gleichstrombahnen," *ibid.*, p. 102.

143. KELLER, G., Thesis, "Untersuchungen am Quecksilberdampf-Gleichrichter," published by the Eidgen. Techn. Hochschule, Zuerich, 1919.

144. "Connection in Parallel and Voltage Regulation of Mercury-arc Rectifiers," *Rev. gén. élec.*, Vol. 5, pp. 230-233, 1919.

145. CARLEVARO, E., "The Working of Mercury Rectifiers," *Elettrotecnica*, Vol. 6, pp. 362-371, 1919.

146. "Mercury-vapor Rectifiers," *Rev. gén. élec.*, Vol. 5, pp. 146-149, 1919.

147. "Rectifier for Alternating Currents," *Electricita*, Nos. 1924-1925, pp. 169-171, 1919.

148. "Parallel Connection and Voltage Regulation of Large Mercury Rectifiers," *Elec. Rev.*, Vol. 84, pp. 191ff, 1919.

149. NIELSEN, H., "Shape of Curve of Current and Voltage in Mercury-vapor Rectifiers for Single-phase Alternating Current," *Elektrotech. Z.*, Vol. 40, pp. 224-227, 1919.

1920

150. HEBB, *Phys. Rev.*, p. 375, 1920.
151. KLEEBERG, *Elektrotech. Z.*, pp. 145, 171, 193, 1920.
152. GIROZ, "Les Redresseurs à Vapeur de Mercure à Grand Débit," *Rev. gén. élec.*, Vol. 8, pp. 721-734, 1920.
153. STEINMETZ, "Transient Electric Phenomena," Sec. 2, Chap. 4, 1920.
154. SCHAEFER, "Elektrische Hochvakuummesser," *B.B.C. Mitteilungen*, Vol. 7, pp. 199-202, 1920.
155. CLAINFIELD, M., "Large Mercury-vapor Rectifiers," *Ztschr. des V.D.I.*, Vol. 64, pp. 403-406, 1920.
156. "Mercury-arc Rectifiers for Large Outputs," *Electrician*, Vol. 84, pp. 10-13, 1920.
157. MEYER, K., "Mercury Rectifiers for Large Capacities," *Eng. Progress*, Vol. 1, pp. 243-246, 1920.
158. "Self-exciting Mercury-arc Rectifiers," *Sci. Am.*, Vol. 123, p. 517, 1920.
159. "Mercury-vapor Rectifiers of High Capacity," *Soc. Franc. Elec. Bull.*, Vol. 10, pp. 375-386, 1920.

1921

160. "Quecksilberdampf-Hochvakuumpumpe," *B.B.C. Mitteilungen*, Vol. 8, p. 24, 1921.
161. WALTY, "Die Gleichrichteranlage der Selsa-Werke in Bodio," *ibid.*, pp. 219-222.
162. HIERTZELER, "Quecksilber-Grossgleichrichter fuer die Strassenbahn Bern-Muri-Worb," *ibid.*, p. 278.
163. *A.E.G. Mitteilungen*, Vol. 17, p. 91.
164. MILLIKEN, "Power Rectifiers," *Proc. Assoc. Iron and Steel Elec. Eng.*, pp. 645-657; Discussion, *ibid.*, pp. 657-677, 1921.
165. GIROZ, "High-power Mercury-arc Rectifiers," *Elec. World*, Vol. 77, p. 722, 1921.
166. MILLIKEN, J. H. "Steel-clad Rectifier Merits Attention," *ibid.*, Vol. 78, pp. 863, 865, 1921.
167. KLEEBERG, F., "Progress in the Construction of Mercury-vapor-arc Rectifiers," *Elektrot. Anzeiger*, Vol. 38, pp. 188-190, 1921.
168. "Large Mercury-arc Rectifiers," *Elec. Rev.*, Vol. 89, pp. 492ff, 1921.
169. HOEPP, W., "Progress in the Construction of Mercury-vapor-arc Rectifiers," *Elektrotech. Z.*, Vol. 42, pp. 1032-1036, 1921.
170. AYTON, F., "Steel-cylinder Mercury-vapor Rectifiers," *Elec. Times*, Vol. 59, pp. 554-556, 1921.
171. "Some Recent Arc-rectifier Installations," *Electrician*, Vol. 87, pp. 489ff, 1921.
172. KRIJGER, L. P., "The Power Factor in Mercury-vapor Rectifiers," *De Ingenieur*, p. 144, 1921.
173. NIELSON, H., "Recalculation of Three-phase Mercury-arc Rectifiers," *Elektrotech. Z.*, Vol. 42, pp. 1185-1190, 1921.
174. AUBERT, FRANÇOIS, "Mercury-vapor Rectifiers," *Technique Moderne*, Vol. 13, pp. 289-298, 1921.

175. SIMON, B., "Design and Operation of Mercury-vapor Rectifiers," *Glaser's Annalen*, Vol. 89, pp. 71-73, 1921.

176. MORRISON, R. L., "Brown Boveri Mercury-arc Rectifier for Large Outputs," *Elec. Rev.*, Vol. 88, pp. 217ff, 251ff, 1921.

177. LUDWIG, F., "Mercury-vapor Rectifiers," *Prometheus*, Vol. 32, pp. 293-298, 1921.

178. VAN NES, B., "Economy Diagrams for Street-railway Operation with Special Regard to Large Mercury-vapor-arc Rectifiers," *Elektrotech. Z.*, Vol. 42, pp. 878-883, 1921.

## 1922

179. See (169).

180. KRIJGER, *Elektrotech. Z.*, Vol. 42, p. 827.

181. *Elec. Jour.*, Vol. 6, p. 264.

182. "Mercury-arc Rectifiers at Monbijou Power Station of the Berne Municipal Electricity Supply," *Brown Boveri Rev.*, July, 1922.

183. ODERMATT, "Les Redresseurs à Vapeur de Mercure dans les Réseaux de Tramways," Published by *Secretariat Général de l'Union Internationale de Tramways, de Chemins de Fer d'Intérêt Local et de Transports Publics Automobiles*, October, 1922.

184. DUSHMAN, SAUL, "Production and Measurement of High Vacuum," Schenectady, 1922.

185. BOSSY, "Gleichrichteranlage Bruessel," *B.B.C. Mitteilungen*, Vol. 9, p. 59, 1922.

186. BALLY, "Gleichrichter, Bauart B.B.C.," *ibid.*, pp. 82-87.

187. EGG, "Grossgleichrichter fuer Gleichspannungen von 5,000 Volt," *ibid.*, p. 195.

188. KADE and KRAEMER, "The Conversion of Three-phase Current to Direct Current; Rotary Machines vs. Mercury Rectifiers," *Elektrotech. Z.*, Vol. 43, pp. 107-110, 1922.

189. "Rotary Converters vs. Mercury-arc Rectifiers," *B.E.A.M.A.*, Vol. 10, pp. 109-112, 1922.

190. MORRISON, R. L., "High-power Mercury-arc Rectifiers," *Elec. Rev.*, Vol. 90, pp. 353ff, 388ff, 424ff, 1922.

191. "High-pressure Rectifiers," *ibid.*, Vol. 91, p. 455, 1922.

192. "High-pressure Mercury-arc Rectifiers and Rotary Converters," *Electrician*, Vol. 89, p. 72, 1922.

193. HELLFORTH, R., "Converter Installations with Mercury-vapor Rectifiers," *Tech. Blaetter*, Vol. 12, pp. 129ff, 145ff, 1922.

194. JOTTE, CHARLES, "Mercury-vapor Rectifiers, with Special Reference to Inverse Current," *Rev. gén. élec.*, Vol. 11, pp. 322-325, 1922.

195. SYLVESTRE and ESCANDE, "Present State of Transforming Alternating Current to Direct Current," *Houille Blanche*, Vol. 21, pp. 123-130, 1922.

196. ROSS, B., "The Conversion of Alternating into Direct Current," *Ztschr. des Bayerischen Revisions Vereins*, Vol. 26, pp. 127ff, 1922.

197. TSCHUDI, W., "Regulating the Vacuum in Mercury-vapor Rectifiers," *S.E.V. Bull.*, 13, pp. 91-98, 1922.

198. HUND, A., "On the Rectification of Currents," *Elektrotech. u. Maschinenbau*, Vol. 40, pp. 37-40, 1922.

## 1923

199. PFLIEGER-HAERTEL, *Wissenschaft. Veroeffentlichung a. d. Siemensskzrn.*, Vol. 3, p. 61, 1923.

200. MORRISON, "Conversion from Alternating to Direct Current by Means of Mercury-arc Rectifiers," *Engineering*, Vol. 116, pp. 507-510, 543-546, 1923; SCHENKEL, Discussion, *Elektrotech. u. Maschinenbau*, Vol. 41, p. 535, 1923.

201. GUENTHER-SCHULZE, "Die Zuendspannung der Quecksilberdampf-Gleichrichter," *Arch. Elektrot.*, Vol. 12, pp. 121-124, 1923.

202. BALLY, "Brown Boveri Mercury-arc Rectifiers," *Brown Boveri Rev.*, September, 1923.

203. JUNGMICHL, "Primaere Stromkurvenform und Leistungsfactoren, bei Grossgleichrichtern," *Elektrotech. u. Maschinenbau*, Vol. 41, pp. 57-63, 1923.

204. ODERMATT, "Die Grossgleichrichter," *ibid.*, pp. 137-146; SAHULKA, Discussion, *ibid.*, p. 426.

205. ODERMATT, "Gleichrichter und Gleichrichteranlagen," *S.E.V. Bull.* 12, 1923.

206. See (210).

207. SCHENKEL, "Ueber die Beteiligung des metallenen Gehaueses an den Entladungsvorgaengen in Grossgleichrichtern," *ibid.*, pp. 923-926.

208. LANGMUIR, I., *Gen. Elec. Rev.*, Vol. 26, p. 731, 1923.

209. "High-power Mercury-arc Rectifiers," *Elec. Times.*, Vol. 63, pp. 471ff, 1923.

210. KRIJGER, L. P., "Effect of a Mercury-arc Rectifier on the Power Factor of Its Supply," *Elektrotech. Z.*, Vol. 44, pp. 286-288, 1923.

211. CONNELL, J. E., "Conversion of Electrical Power," *Power*, Vol. 57, pp. 88-90, 1923.

212. SCHMIDT, A., JR., "30-kw. 15,000-volt Rectifier for the U. S. Navy," *Gen. Elec. Rev.*, Vol. 26, pp. 276-278, 1923.

213. ODERMATT, A., "Mercury-vapor Rectifiers in Street-car Systems," *Industrie des Tramways*, Vol. 17, pp. 197-216, 1923.

214. "Automatic Mercury-vapor Rectifiers," *Elec. Rev. (London)*, Vol. 92, pp. 684-686, 1923.

215. MORRISON, R. L., "High-power Mercury-arc Rectifiers with Special Reference to Traction Service," *Engineer*, Vol. 135, pp. 258-260, 1923.

## 1924

216. LANGMUIR, I., *Gen. Elec. Rev.*, Vol. 27, pp. 449, 538, 616, 762, 810, 1924.

217. LASSEN, H., *Arch. Elektrot.*, Vol. 13, pp. 311-329, 1924.

218. PRINCE, D. C., "Rectifier Wave Forms," *Gen. Elec. Rev.*, Vol. 27, pp. 608-615, 1924.

219. GUENTHER-SCHULZE, "Elektrische Gleichrichter und Ventile," (Koesel and Pustet), 1924.

220. WALTY, "The Mercury-arc Rectifier Substations of the Midi Railway," *Brown Boveri Rev.*, Vol. 11, pp. 191-205, 1924.

221. GIROZ, "Les Redresseurs à Vapeur de Mercure," *Soc. Franc Elec. Bull.*, Vol. 4, pp. 463-513, 1924.



222. HENTSCHEL, M., "Neuere Quecksilberdampf-Gleichrichteranlagen," *Glaser's Annalen*, Vol. 95, No. 1, pp. 9-14, July 1, 1924.

223. MARCHANT, E. W., "Method of Getting Rid of Telephone Interference from a Mercury-arc Rectifier," *Inst. Elec. Eng. (British), Jour.*, Vol. 62, No. 334, October, 1924.

224. DAELLENBACH and GERECKE, "Die Strom und Spannungsverhaeltnisse der Grossgleichrichter," *Arch. Elektrot.*, Vol. 14, No. 2, 1924.

225. TAEGER, "Der Einfluss der Gleichstromdrosselspule auf den Leistungsfaktor des Wechselstromes beim Quecksilberdampf-Gleichrichter," *Elektrotech. Z.*, Vol. 45, p. 774, 1924.

226. DEMONTVIGNIER, *Rev. gén. élec.*, Vol. 15, pp. 493-499; Vol. 16, pp. 506-515, 1924.

227. KRUGER, *Arch. Elektrot.*, Vol. 13, pp. 441-459, 1924.

228. BAILEY, J. C., "High-power Mercury-arc Rectifiers," *Power*, Vol. 59, pp. 130-132, 1924.

229. ODERMATT, "Mercury-arc Rectifiers," *Elec. World*, Vol. 83, p. 393, 1924.

230. ROGERS, G., "Mercury-vapor Rectifier Substations," *Elec. Rev.*, Vol. 95, pp. 835-837, 1924.

231. GUENTHER-SCHULZE, A., "Overvoltages in Mercury-vapor Rectifiers and their Causes," *Z. tech. Physik*, Vol. 5, pp. 132-135, 1924.

232. KADEN, H., "Die Aenderung des Leistungsfaktors auf dem Wege vom Generator zum Gleichrichter," *Elektrotech. Z.*, Vol. 45, p. 248, 1924.

233. MUELLER, G. W., "Der Leistungsfaktor der Quecksilberdampf-Gleichrichter," *Elektrotech. Z.*, Vol. 45, pp. 624-626, 1924.

234. "Cost of Installing Rectifiers and Reactors," *Elec. World*, Vol. 83, p. 678, 1924.

235. COLLIN, F., "Industrial Development of Rectifying Current by Mercury Vapor," *Génie Civil*, Vol. 85, pp. 165-171, 1924.

236. BARTHELEMY, J., "Application of Mercury-vapor Rectifiers to Traction," *Rev. gén. élec.*, Vol. 16, pp. 455-463, 1924.

237. JACOBS, A. M., "Rectifiers," *S. African Inst. Elec. Engrs., Trans.*, Vol. 15, pp. 488-496, 1924.

238. "Mercury-vapor Rectifiers," *Soc. Franc. Elec. Bull.*, pp. 611-632, 1924.

239. SYIVESTRE, V., "Mercury-vapor Rectifiers," *Houille Blanche*, Vol. 23, pp. 52-57, 117-132, 1924.

## 1925

240. MORRISON, "The Brown Boveri Mercury-arc Rectifier, for Large Outputs," *Elec. Rev.*, Feb. 18 and 25, 1925.

241. BRYNHILDSEN, "High-voltage Rectifier Installations," *Brown Boveri Rev.*, Vol. 12, pp. 23-28, 1925.

242. ANNAY, F., "Les Redresseurs à Mercure," *Vie Technique et Industrielle*, Vol. 7, No. 65, pp. 743-748, February, 1925.

243. "Les Redresseurs à Vapeur de Mercure dans l'Industrie," *Industrie Electrique*, Vol. 34, No. 784, pp. 85-88, Feb. 25, 1925.

244. KERN, "The Parallel Operation of Mercury-arc Rectifiers with Each Other and with Rotary Converters," *Brown Boveri Rev.*, Vol. 12, p. 119, June, 1925.

245. FAYE-HANSEN, "Primary Current Wave Form and Power Factor in Mercury Rectifier Transformers," *Elektrotech. Z.*, Vol. 46, pp. 1104-1106, July 23, 1925.

246. ZIMMERMANN, W., "The Mercury Rectifier in Colliery Work," *Elektrotech. Z.*, Vol. 46, No. 32, pp. 1253-1260, Aug. 20, 1925.

247. "Rectifiers," *Engineer*, pp. 84, 107, 138, 161, 185, 220, 233, 264, 287, 318, 346, 368, 1925.

248. COHEN, "Mercury Rectifiers," *Elettrotecnica*, Vol. 12, pp. 673-683, 1925.

249. BRYNHILDSEN, "The Mercury-arc Rectifier Plant of the Zweiluctschinen Substation of the Bernese Oberland Railway," *Brown Boveri Rev.*, Vol. 12, p. 214, October, 1925.

250. NEWMAN, "The Production and Measurement of Low Pressures," London, 1925.

251. "Mercury-arc Rectifiers for Railway Work," *Elec. Ry. Jour.*, Vol. 66, p. 543, 1925.

252. WIDMER, "The Mercury-arc Rectifier Plant of the Forch Railway," *Brown Boveri Rev.*, Vol. 12, pp. 244-247, November, 1925.

253. NEWBURY, "Metal Tank Mercury-arc Rectifiers," *Elec. Jour.*, Vol. 22, p. 570, 1925.

254. GIROZ, "La Chute de Tension Inductive des Redresseurs à Vapeur de Mercure," *Rev. gén. élec.*, Vol. 17, pp. 253-261, 303-312, 1925.

255. BLANCHARD, A., *ibid.*, p. 395.

256. JOLLEY, L. B. W., *Inst. Elec. Eng. (British), Jour.*, Vol. 63, p. 588, 1925.

257. ROGERS, G., "Automatic and Semi-automatic Mercury-vapor Rectifier Substations," *ibid.*, pp. 157-172; Discussion, *ibid.*, pp. 173-189, 473-479.

258. MUELLER, K. E., "Der Quecksilberdampf-Gleichrichter," Vol. 1, (Springer), 1925.

259. JANITSKY, A., "Ueber die Bedeutung des Gasgehaltes von Metallen fuer einige elektrische Erscheinungen," *Z. Physik.*, Vol. 31, p. 277, 1925.

260. FLEMING, J. A., "Mercury-arc Rectifiers and Mercury-vapor Lamps," (Pitman), 1925.

261. SCHENKEL, "Der Blindleistungsverbrauch von Gleichrichteranlagen und seine Messung," *Elektrotech. Z.*, pp. 1369-1399, 1925; Discussion by KERN and SCHENKEL, *ibid.*, p. 1005, 1926.

262. "Important Questions in Mercury-vapor Rectifier Construction," *Elektrotech. Anzeiger*, Vol. 43, pp. 147ff, 165ff, 1925.

263. ROBINSON, "Mercury-arc Rectifier," Paper presented at Annual Meeting Association of Edison Illuminating Companies, Hot Springs, Ark., Oct. 19, 1925.

264. VAN VEEN, "Mercury-arc Rectifier Operates 12½ Years," *Elec. World*, Vol. 85, p. 1032, 1925.

265. "Mercury-arc Rectifier Station in Zuerich, Switzerland," *Aera*, Vol. 13, p. 1169, 1925.

266. "Mercury-arc Rectifier under Short Circuit," *Elec. World*, Feb. 7, 1925.

267. "High-power Mercury-arc Rectifiers, some recent experiences of their use for railway work," *Electrician*, Vol. 94, p. 124, 1925.

268. MORRISON, R. L., "High-power Mercury-arc Rectifiers, The Automatic Control of Substation Plants," *Elec. Rev.* (London), Vol. 97, pp. 484-487, 1925.
269. "New York Edison Company Installs Mercury-arc Converters," *Elec. World*, Vol. 85, p. 256, 1925.
270. KRIJGER, "Die Messung der Blindleistung beim Quecksilberdampf-Gleichrichter," *Elektrotech. Z.*, Vol. 46, pp. 48-50, 1925.
271. HELLMUTH, "Zur Berechnung von Transformatoren fuer Quecksilberdampf- und Argonal-Gleichrichter," *ibid.*, pp. 458-460.
272. SCHAEFER, "Quecksilberdampf-Grossgleichrichter in Unterwerken der Franzoesischen Hauptbahnen," *ibid.*, pp. 833-836.
273. ZASTROW and BENDA, "Einwirkungen von Gleichrichteranlagen auf Fernsprechleitungen," *ibid.*, pp. 1478-1481.
274. "Application of Cooling Apparatus to Mercury-arc Rectifiers," *Ingenieria*, Vol. 4, pp. 323-324, September, 1925.
275. DAELLENBACH, W., "Zur Phaenomenologie des Funkenpotentials und der Glimmentladung," *Physik Z.*, Vol. 26, pp. 483-495, 1925.
276. DAELLENBACH, GERECKE, and STOLL, "Vorgaenge an negativ geladenen Sonden und an Teilchen die in Gasentladungen suspendiert sind," *ibid.*, pp. 10-21.
277. KRIJGER, L. P., *Elektrotech. Z.*, Vol. 46, p. 48, 1925.
278. GUENTHER-SCHULZE, *Engineering Progress*, August, 1925.
279. GEBAUER, E., "Die Stromumformungsanlagen der Staedtischen Elektrizitaetswerke in Wien fuer den Betrieb der Wiener Elektrischen Stadtbahn," *Elektrotech. u. Maschinenbau*, Vol. 43, No. 39, pp. 769-780, Sept. 27, 1925.
280. BARTHELMY and SYLVESTRE, "L'application des Redresseurs à Vapeur de Mercure à la Traction sur les Voies Ferrées d'Intérêt Local," *Rev. gén. élec.*, Vol. 18, No. 24, pp. 981-987, Dec. 12, 1925.
281. L'EPPLATTENIER, O., "Improvements in Mercury-arc Rectifiers," *Elettrotecnica*, Vol. 12, pp. 854-859, 1925.
282. "Rectifier Substations for Victorian Government Railways," *Elec. Rev.*, Vol. 96, p. 548, 1925.

## 1926

283. BRYNHILDSEN, C., "The Rectifier Plant of the Turin-Lanzo-Ceres Railway (Italy)," *Brown Boveri Rev.*, Vol. 13, pp. 146-150, 1926.
284. BRYNHILDSEN, C., "A New Type of Mercury-arc Power Rectifier," *ibid.*, pp. 157-159.
285. SEITZ, O., "Vacuum Pump Sets for Mercury-arc Power Rectifiers," *ibid.*, pp. 175-180.
286. "Progress Made in Use of Mercury-arc Rectifiers," *Power*, Vol. 64, p. 33, 1926.
287. PRINCE, D. C., "Rectifier Voltage Control," *A.I.E.E. Jour.*, Vol. 45, pp. 630-636, 1920.
288. PRINCE, D. C., "Mercury-arc Rectifiers," *ibid.*, pp. 1087-1094; Discussion, *ibid.*, pp. 1176-1177.
289. "Another Type of Mercury-arc Rectifier," *Elec. Ry. Jour.*, Vol. 68 p. 814, 1926.

290. "Mercury-arc Rectifiers," *A.I.E.E. Rept., A.I.E.E. Jour.*, Vol. 45, pp. 951-952, 1926.

291. SCHENKEL, M., "Stoerungen des Fernsprechbetriebes durch Gleichrichter und ihre Beseitigung," *Elektrische Bahnen*, Vol. 2, No 7, pp. 217-227.

292. MARTI, O. K., "Rectification of Alternating Currents," *A.I.E.E. Jour.*, Vol. 45, pp. 832-846, 1926; Discussion, *ibid.*, pp. 1035-1038.

293. PARTZSCH, "Neuerungen an Grossgleichrichtern," *Elektrotech. Z.*, Vol. 47, pp. 1056-1060, 1926.

294. DANZ, "The St. Legier Automatic Rectifier and Rotary Converter Substation of the Chemins de Fer Electriques Veveysans," *Brown Boveri Rev.*, Vol. 13, pp. 193-200.

295. GAUDENZI, "Direct-reading Gage for Mercury-arc Power Rectifiers," *ibid.*, pp. 224-226.

296. WALTY, "Automatic Power Rectifier Installations," *ibid.*, pp. 241-249.

297. BLANDIN, J., "The Palais du Midi Automatic Rectifier Substation at Brussels," *ibid.*, pp. 259-267.

298. SEITZ, O., "Cooling Mercury-arc Power Rectifiers," *ibid.*, pp. 283-288.

299. "Ein neuer Quecksilberdampf-Grossgleichrichter," *Ztschr. V.D.I.*, Vol. 70, No. 39, p. 1277, 1926.

300. SCHUMACHER, R., "Zur Frage der Betriebsbrauchbarkeit von Grossgleichrichteranlagen," *Elektrotech. Z.*, Vol. 47, pp. 354ff, 388ff, 1926.

301. MUELLER, G. W., "Die Diagramme des Quecksilberdampf-Gleichrichters," *ibid.*, pp. 328-332.

302. "Der Induktive Spannungsabfall des Quecksilberdampf-Gleichrichters," *ibid.*, pp. 651-652.

303. See (390).

304. WAGNER, R., "Rotary Converters and Rectifiers," *Elek. Betrieb*, Vol. 24, pp. 77-80, 1926.

305. MUELLER, G. W., "Design of Autotransformers for Mercury Rectifiers," *Elektrotech. u. Maschinenbau*, Vol. 44, pp. 521-524, 1926.

306. MUELLER, K. E., "Elementary Equation for the Pulsating Direct Current of Mercury-arc Rectifiers," *Arch. Elektrot.*, Vol. 16, pp. 113-124, 1926.

1927

307. "Mercury-arc Power Rectifiers," *Gen. Elec. Rev.*, Vol. 30, p. 20, January, 1927.

308. BUTCHER, C. A., "Application of Mercury-arc Power Rectifiers," *A.I.E.E. Jour.*, Vol. 46, pp. 446-450, 1927.

309. SHAND, E. B., "Steel-tank Mercury-arc Rectifiers," *ibid.*, Vol. 46, pp. 597-602, 1927.

310. MARTI, O. K., and H. WINOGRAD, "Mercury-arc Power Rectifiers, Their Applications and Characteristics," *ibid.*, Vol. 46, pp. 818-826, 1926.

311. FLEISCHMANN, L., "Der Blindleistungsverbrauch von Gleichrichteranlagen und seine Messung," *Elektrotech. Z.*, Vol. 48, p. 12, 1927.

312. "First Canadian Automatic Rectifier Substation Installed by Montreal Tramways," *Elec. Ry. Jour.*, Vol. 69, pp. 766-772, 1927.

313. "Parallel Operation of Mercury-arc Power Rectifiers with Each Other and with Rotating Converters," *Elektrotech. Z.*, Vol. 48, p. 50, 1927.

314. WALTY, "A Power Rectifier for Direct Current at 5,000 Volts," *Brown Boveri Rev.*, Vol. 14, p. 66, 1927.

315. BOHRAUS, W., "Automatic Rectifier Plants for the Dutch State Railways," *ibid.*, p. 113.

316. BRYNHILDSSEN and KERN, "Mercury-arc Rectifiers as Converters for Local, Interurban, and Main-line Railways," *ibid.*, pp. 128-134, 154-159.

317. DANZ, A., "The Growth of the Field of Application of Rectifiers in Switzerland," *ibid.*, pp. 134-136.

318. BRYNHILDSSEN, C., "Rectifiers for Heavy Currents," *ibid.*, p. 161.

319. BLANDIN, "La Grand'Fontaine Automatic Substation for the Fri-bourg Tramways," *ibid.*, pp. 71-77; HELLFARTH, "Rectifier Installation of the Bonn Electricity Works," *Elektrotech. u. Maschinenbau*, Vol. 45, pp. 717-724, 1927.

320. BLANDIN, "The Mercury-arc Rectifier Substations of the Paris Underground Railways," *Brown Boveri Rev.*, Vol. 14, pp. 265-271.

321. WALTY, "Brown Boveri Rectifiers for Transformer Plants," *ibid.*, pp. 353-358.

322. PLIETZSCH, "The Power Supply of the Berlin Metropolitan and Suburban Railways by Means of Mercury-arc Power Rectifiers," *B.B.C. Nachrichten (Mannheim)*, Vol. 14, pp. 140-146, 1927.

323. PRINCE, D. C., and VOGDES, F. B., "Principles of Mercury-arc Rectifiers and Their Circuits," (McGraw-Hill Book Company, Inc.), 1927.

324. PRINCE, D. C., "Mercury-arc Rectifier Phenomena," *A.I.E.E. Jour.*, Vol. 46, pp. 667-674, 1927.

325. "Cooling of Mercury-arc Rectifiers," *Elektrotech. Z.*, Vol. 48, p. 731, May 26, 1927.

326. FARON, F. A., "Modern Power Mercury-arc Rectifiers," *Canadian Elec. News*, Vol. 36, pp. 37-38, May 1, 1927.

327. JUNGMICHEL, H., "Current Transformers in Anode Circuits of Rectifiers," *Elektrotech. u. Maschinenbau*, Vol. 45, pp. 423-425, May 22, 1927.

328. BEETZ, W., "Measurement of Energy in Anode Circuits of Mercury-arc Rectifiers," *Elektrotech. u. Maschinenbau*, pp. 921-923, Nov. 6, 1927.

329. AOKI, S., "Mercury-arc Rectifier," *Inst. Elec. Engrs., Japan, Jour.*, No. 472, pp. 1153-1168, November, 1927.

330. "Westinghouse Metal Rectifiers," *Elec. Times*, Vol. 72, pp. 667-668, Nov. 24, 1927.

331. DAELLENBACH, "Measuring the Reverse Current of Mercury-arc Rectifiers," *Elektrotech. Z.*, Vol. 48, p. 1032, July 21, 1927; GEYGER, W., "Measurement of the Alternating-current Component of Rectifier Currents by the Potentiometer Method," *Archiv Elektrot.*, Vol. 18, pp. 641-652, Sept. 21, 1927.

332. WEIDLICH, "The Rectifier Installation of the Blankenburg Electricity Supply," *Elektrotech. Z.*, Vol. 48, p. 825, June 16, 1927.

333. REAGAN, "Automatic Switching Control for Mercury-arc Rectifiers," *Elec. Jour.*, Vol. 24, pp. 496-499, October, 1927.

334. SHAND, "Mercury-arc Rectifier Characteristics," *ibid.*, pp. 486-493.

335. JONES, LANGMUIR, and MACKAY, *Phys. Rev.*, Vol. 30, p. 201, 1927.
- 335a. "Largest Mercury Arc Rectifier Installation Made at Bridgeport," *Elec. Rly. Jour.*, Vol. 70, pp. 1144-1147, 1927.
336. HOUGH, E. L., "Automatic-control Equipment for 1,500-volt Mercury-arc Rectifier Substations of the Chicago, South Shore and South Bend Railroad," *Gen. Elec. Rev.*, Vol. 30, pp. 345-348, 1927.
337. MCKEARIN, F. P., "Mercury-arc Rectifier Equipment," *Elec. Light and Power*, Vol. 5, pp. 100-102, June, 1927.
338. PLATZ, H., "Iron-type Mercury-arc Power Rectifiers," *A.E.G. Progress*, Vol. 3, pp. 273-278, 1927.
339. RICHER, M., "Transformation of Alternating Current into Direct Current by Means of Rectifiers," *Houille Blanche*, Vol. 26, pp. 109-118, 1927.
- 339a. "Grossgleichrichter fuer 10,000 Volt," *A.E.G. Mitt.*, Aug. 1927, pp. 341-342.

## 1928

340. ANTONIONO, C., "Operation and Performance of Mercury-arc Rectifier on the Chicago, North Shore and Milwaukee Railroad Co.," *A.I.E.E. Jour.*, Vol. 47, pp. 3-7, January, 1928; discussion, *ibid.*, pp. 68-69; *Elec. Ry. Jour.*, Jan. 7, 1928; *Elec. World*, Mar. 24, 1928.
341. "Brown Boveri Mercury-arc Power Rectifiers," *Brown Boveri Rev.*, Vol. 15, pp. 13-15, January, 1928.
342. ODERMATT, A., "Latest Improvements in the Design of Power Rectifiers," *ibid.*, pp. 121-123, March, 1928.
343. GERECKE, E., "Six-phase Rectifiers with Single-phase Transformers," *Arch. Elektrot.*, Vol. 19, pp. 449-462, Mar. 15, 1928.
344. SIEMENS, A., "Rubber Seal for Mercury-vapor Rectifiers," *Siemens Ztschr.*, Vol. 8, pp. 316-320, May, 1928.
345. SEELEY, H. T., "Automatic Control for Mercury-arc Rectifiers," *Gen. Elec. Rev.*, Vol. 31, pp. 537-541, October, 1928; WEISSBACH, "Bedienunglose Gleichrichter-Unterwerke," *Fachbericht der XXXIII. Jahresversammlung des V.D.E.*, pp. 32-34, 1928.
346. HUTTON, C. E., "Hamilton's New Automatic Mercury-arc Rectifier Substation," *Elec. News.*, pp. 29-32, Sept. 15, 1928.
347. MITSUDA and YOSHIKAWA, "On the Development of Mercury-arc Power Rectifiers and Their Performance," *Researches of Electrotechnical Lab.*, July 24, 1928.
348. GUENTHER-SCHULZE, "Electric Rectifiers and Valves," translated and revised by N. A. deBruyne (John Wiley & Sons, Inc.), 1928.
349. SMEDE, L., "High-voltage Mercury-arc Rectifiers," *Elec. Jour.*, pp. 403-406, August, 1928.
350. JUNGMICHEL, "Die Saugdrosselspule in Grossgleichrichteranlagen," *Wissensch. Veroeffentl. aus dem Siemens Konzern*, Vol. 6, No. 2, pp. 34-57, 1928.
351. JUNGMICHEL and EICHACKER, "Mehrphasiger Manteltransformator in Gleichrichteranlagen," *Siemens Zeitschr.*, pp. 381-391, July, 1928.
352. MEYER-DELIUS, "Achtzehn Jahre Grossgleichrichterbau," *Elektrizitaetswirtschaft, Mitteil. der V. D. E. W. (Verein, d. Elektr. Werke)*, pp. 309-315, June, 1928.

353. DALY, C. J., "Effect of Street-railway Mercury-arc Rectifiers on Communication Circuits," *A.I.E.E. Jour.*, Vol. 47, pp. 503-506, July, 1928.

354. REICHEL, W., "Gleichstromversorgung der Deutschen Reichsbahn, insbesondere durch Gleichrichteranlagen," *Elektrotech. Z.*, Vol. 49, pp. 903-917, June 14, 1928; GEBAUER, A., "Die Gleichrichterwerke der Vorortstrecke Berlin-Velten," *Elek. Bahnen*, Vol. 4, pp. 154-159, 186-191, 1928; NOWAG, "Der Brown Boveri Gleichrichter fuer die Berliner Stadt- und Ringbahn," *B.B.C. Nachrichten*, Vol. 15, pp. 79-89, 1928; WECHMANN, "Die Elektrisierung der . . . Berliner Stadt- und Vorortbahnen," *Elektrotech. Z.*, Vol. 49, pp. 887-902, June 14, 1928.

355. "Mercury-arc Rectifier Substations Used in European Railways," *Elec. Ry. Jour.*, Vol. 71, pp. 622-624, Apr. 14, 1928.

356. DEANGELIS, M. L., "Advantages of Mercury-arc Rectifiers," *Elec. Ry. Jour.*, Vol. 72, pp. 66-67, July 14, 1928.

357. HANSEN, V., "Performance of Mercury-arc Rectifiers," *Elec. World*, Vol. 92, pp. 457-458, Sept. 8, 1928.

358. POTTHOFF, K., "Theory of Mercury-arc Rectifiers," *Archiv f. Elektrot.* Vol. 19, pp. 301-312, Jan. 25, 1928.

359. DANZ, A., "The Automatic Rectifier Substations of the Dutch Railways," *Brown Boveri Rev.*, Vol. 15, pp. 335-352, 1928.

360. MEIER, J. A., "The Rectifier Substations of the Leningrad Street Railways," *Ztschr. des V.D.I.*, Vol. 72, pp. 1755-1759, 1928.

361. SCHENKEL, "Study of the Mercury Arc," Discussion of Ref. 354, *Elektrotech. Z.*, Vol. 49, pp. 1522-1524, Oct. 11, 1928.

362. SMEDE, L., "Automatic Vacuum Gages," *Elec. Jour.*, Vol. 25, pp. 437-440, September, 1928.

363. BLANDIN, J., "Pressure Regulation in Mercury-arc Rectifier Plants," *Brown Boveri Rev.*, Vol. 15, pp. 192-201, June, 1928.

364. KERN, E., "Selective Tripping of Mercury-arc Rectifiers on the Occurrence of Back Fires," *ibid.*, pp. 218-224, July, 1928.

365. KOTSCHUBEY, N., "Rectifier Plants for the New South Wales Government Railways and Tramways," *ibid.*, pp. 300-301, October, 1928.

366. BLANDIN, J., "Acceptance Tests at the St. Antoine Substation of the Chemin de fer Métropolitain de Paris," *ibid.*, p. 302.

367. DANZ, A., "Automatic Rectifier Substations of the Dutch Railways," *ibid.*, pp. 335-352, December, 1928.

368. TURLEY, L. J., "Automatic Mercury-arc Power Rectifier Substations on the Los Angeles Railway," *A.I.E.E. Jour.*, Vol. 47, pp. 715-718, October, 1928.

369. WOOD, G. E., "Mercury-arc Rectifier Substation at Bridgeport, Conn.," *A.I.E.E. Jour.*, Vol. 47, pp. 732-735, October, 1928.

370. "Mercury-arc Rectifier Substations Used on European Railways," *Elec. Ry. Jour.*, Vol. 71, pp. 622-624, Apr. 14, 1928.

371. FOSTER, W. C., "Steel-tank Mercury-arc Rectifiers Replace Rotary Converters," *Elec. West*, Vol. 61, p. 216, October, 1928.

372. LOOG, C., "Ignition of Mercury-arc Rectifiers," *Teleg. u. Fernsprech Techn.*, Vol. 17, pp. 199-203, July, 1928.

373. STIGANT and LACEY, "Interphase Reactor in Six-phase Transformer Rectifier Circuits," *Elec. Times*, Vol. 74, Sept. 6, 1928.

374. GEISE, "Erfahrungen mit Resonanzkreisen zur Oberwellenbeseitigung in Gleichrichteranlagen," *Fachberichte der XXXIII. Jahresversammlung des V.D.E.*, pp. 36-40, 1928. O. Brauns, "Gleichrichter-Bahnbetrieb und Reichspost," *Elektrische Bahnen, Ergaenzungsheft*, pp. 20-21, 1928; H. Klewe, "Bedeutung der Gleichrichter fuer die Deutsche Reichspost," *ibid.*, pp. 22-28; F. Weishaupt, "Die Fernsprechbetriebsschaltungen der Deutschen Reichspost unter der Einwirkung der Gleichrichteroberwellen elektrischer Bahnen," *ibid.*, pp. 29-38; L. Roehmann, "Messung der Fernsprechstoerwirkung von Gleichrichterbahnen," *ibid.*, pp. 38-44; Schlemmer and Schulze, "Bahnbetriebe mit Gleichrichtern in Frankreich," *ibid.*, pp. 45-48; E. Aubort, "Bahnbetrieb mit Gleichrichtern und Vermeidung von Fernsprechstoerungen," *ibid.*, pp. 49-56.

375. SCHLEICHER, "Die Speziellen Anordnungen der Fernsteuerung und Fernueberwachung bei der (Berliner) Stadt- und Ringbahn," *ibid.*, pp. 78-80.

376. SCHUCHARDT and VANDERSLUIS, "The Chicago Terminal Electrification of the Illinois Central Railroad," *A.I.E.E., Trans.*, Vol. 47, pp. 1081ff, October, 1928; "Mercury-vapor Rectifiers at Shoreditch," *Engineer*, Dec. 21, 1928; JORDAN, H., "Automatic Rectifier Substation of the Hagener Suburban Railway," *A.E.G. Mitteil.*, September, 1928.

## 1929

377. AUBORT, E., "Ueber die Beinflussung der Fernsprechanlagen durch die Tonfrequenzen der Starkstromanlagen," *Elektrizitaetswirtschaft*, January, 1929.

378. MICHELUZZI, "Die Hochstromgleichrichter und die bedienungslos betriebenen Gleichrichter der Staedtischen E. W. Wien," *Elektrotech. u. Maschinenbau*, Vol. 47, pp. 129-137, Feb. 17, 1929.

379. BLANDIN, J., "The Automatic Rectifier Substations of the Brno Tramway Company, Czechoslovakia," *Brown Boveri Rev.*, Vol. 16, pp. 79-92, February, 1929.

380. GARRETT, A. M., "Automatic Mercury Rectifier Substations in Chicago," *A.I.E.E. Jour.*, Vol. 48, pp. 301-303, April, 1929.

381. WARD, O. M., "Maintenance Problems with Mercury-arc Rectifiers," *Elec. Ry. Jour.*, Vol. 73, pp. 471-473, Mar. 23, 1929.

382. KRAEMER, "Eine Neue Zwoelfphasenschaltung von Transformatoren fuer Grossgleichrichter," *Elektrotech. Z.*, Vol. 50, pp. 303-305, Feb. 28, 1929.

383. HALL, W. B., "Wave Forms of Mercury-arc Rectifiers; Oscillographic Study of Bridgeport Traction Substation Units under Various Load Conditions," *Elec. World*, Vol. 93, pp. 673-675, Apr. 6, 1929.

384. FISCHER, K., "Die Verwendung von Elektrodynamischen Leistungsmessern Normaler Bauart fuer Messungen an Gleichrichtern," *Elektrotech. Z.*, Vol. 50, pp. 113-117, Jan. 24, 1929.

385. TOULON, P., "Convertisseur de Courant Electrique de Grande Puissance à Etincelle Pilote," *Rev. gén. élec.*, Vol. 25, pp. 477-482, 518-526, Mar. 30, 1929.

386. JUNGMICHEL and EICHACKER, "Smoothing the Direct-current Voltage of a Rectifier Installation," *Siemens Ztschr.*, Vol. 9, pp. 39-50, January, 1929.



387. GARRETT, A. M., "Direct-current Railway Substations for the Chicago Terminal Electrification, Illinois Central Railroad," *A.I.E.E. Jour.*, Vol. 48, pp. 678-681, Sept. 1929.
388. Report of Electrical Machinery Committee, *A.I.E.E. Jour.* p. 828.
389. NOWAG, "Die Schaltung der ferngesteuerten Brown Boveri Gleichrichter fuer die Berliner Stadt- und Ringbahn," *B.B.C. Nachrichten* (Mannheim), Vol. 16, No. 2, pp. 79-92, 1929.
390. JOLLEY, L. B. W., "Alternating-current Rectification," 3rd Ed., (John Wiley & Sons, Inc.), 1929.
391. VELLARD, L., "Substations of the Paris-Vierzon Railway," *Rev. gén. élec.*, May 11, 1929.
392. "Grossgleichrichter der Société Alsacienne," *Elektrotech. Z.*, Vol. 50, pp. 901ff, June 20, 1929.
393. "Mercury-arc Rectifiers," Report of Committee of American Railway Engineering Association, *Proc. A.R.E.A.*, Vol. 30, pp. 465ff, 1929.
394. GUENTHER-SCHULZE, A., "Elektrische Gleichrichter und Ventile" (Springer, Berlin), 1929.
395. NOWAG, "Die Verwendung von Grossgleichrichtern fuer Elektrolyse," Fachbericht-Sonderheft, *V.D.E.*, 1929.
396. "Investigations on Cathode-spot Temperature and Voltage Drop in Rectifiers," *Brown Boveri Rev.*, Vol. 16, pp. 61ff, January, 1929.
397. DE ANGELIS, M. L., "Montreal Tramways Extend Use of Mercury-arc Rectifiers," *Elec. Ry. Jour.*, Vol. 73, pp. 778-781, August, 1929.
- 397a. KRAEMER, C., "Modern A.E.G. Ironclad Power Rectifiers," *A.E.G. Mitt.*, No. 3, pp. 85f. Mar. 1929.
398. HAUFFE, G., "Instantaneous Photographs of a Mercury Arc Rectifier," *Ztschr. f. techn. Phys.*, Vol. 10, No. 1, pp. 23-25, 1929.
399. HERMANSPANN, P., "High-Frequency Rectifier Equipment with Automatic Regulation of the D-C Voltage," *Ztschr. f. Hochfrequenztechn.*, Vol. 33, pp. 121-127, April 1929; *Elektrotech. Z.*, p. 745, 1930.
400. SOULIER, A., "A-C Rectifiers," *Soc. Franc. Elect., Bull.*, Vol. 9, pp. 381-387, April 1929.
401. KOBEL, E., "Direct-Reading Vacuum Gage for Mercury Arc Rectifiers," *Brown Boveri Rev.*, Vol. 16, pp. 281-284, Oct. 1929.
402. GAUDENZI, A., "The Voltage Drop at the Cathode of a Mercury Arc," *ibid.*, pp. 303-305, Nov. 1929.
403. KOTSCHUBEY, N., "A-C Galvanometer Used as Pressure-Indicating Instrument for Mercury-Arc Power Rectifiers," *ibid.*, pp. 331f. Dec. 1929.
404. KOTSCHUBEY, N., "Rockfield Rectifier Substation of the Montreal Tramways," *ibid.*, pp. 337-340.
405. COCKS, H. C., "Application of Alternating Current to Electrodeposition," *Elec. Rev.*, Vol. 105, July 5, 1929, pp. 39ff.
406. HOFFMAN, D. C., "Automatic Switching Equipment for 1500-Volt Mercury Arc Rectifier," *General Electric Rev.*, Vol. 32, Sept. 1929, pp. 466-472.
407. ISSENDORFF, J. V., "Operation of Mercury Arc Rectifiers," *Elektrot. u. Maschinenbau*, Vol. 47, April 28, 1929, pp. 353-357.
408. JUNGMICHEL, H., "Stromteiler in Sechssphasen-Gleichrichteranlagen," *Elektrot. Ztschr.*, Vol. 50, pp. 1257-1262, Aug. 29, 1929.

409. KLEIST, "Stromteiler bei Gleichrichtern," *ibid.*, pp. 1879-1880, Dec. 26, 1929.
410. ISSENDORFF, J. V., "Neuere Untersuchungen ueber das Betriebsmaessige Verhalten von Quecksilberdampf-Gleichrichtern," *ibid.*, pp. 1079-1087; Discussion, *ibid.*, pp. 1099-1101, Jul. 25, 1929.
411. See (397).
412. HARVEY, R. M., "An Unattended Rectifier Substation," *Elec. Engr. of Australia & New Zealand*, pp. 93-98, June 15, 1929.
413. ZASTROW, A., "Ueber die Beeinflussung von Fernsprechanlagen durch Gleichrichter," *Elektrizitaetswirtschaft*, Vol. 28, p. 35.
414. GELBER and PLIETZSCH, "Elektrisierung des Abraumbetriebes der Grube Marie III der Anhaltischen Kohlenwerke," *BBB Nachrichten* (Mannheim), Vol. 16, pp. 280-283, Nov./Dec. 1929.
415. "New Mercury Rectifier for Zinc at Tadanac," *Can. Chem. & Met.*, Vol. 13, pp. 201ff, Jul. 1929.
416. SIEMENS, "Dichtung des SSW Quecksilberdampf-grossgleichrichters," *Elektrot. Ztschr.*, Vol. 50, pp. 60f, Jan. 10, 1929.
417. SCHLEUSENER, H., "Life of Rectifiers," *A.E.G. Mitt.*, No. 1, pp. 32-34, 1929.
418. MUELLER-LUEBECK, K. E., "Der Quecksilberdampf-Gleichrichter," Vol. 2, 1929 (Springer).

## 1930

419. "Portable Steel-Enclosed Mercury Arc Rectifier," *Elec. Wrld.*, p. 156, Jan. 18, 1930.
420. THURY, R., "Kraftuebertragung auf grosse Entfernungen durch hochgespannten Gleichstrom," *Elektrot. Ztschr.*, Vol. 51, pp. 114-122, 1930.
421. ORLICH, E., "Gleichrichtung grosser Wechselstromleistungen," *ibid.*, pp. 122-126.
422. MERTENS, F., "Hochspannungs-Quecksilberdampf-Gleichrichter zur Speisung von Roehrsendern," *ibid.*, pp. 305-307, Feb. 27.
423. NOWAG, W., "Die Brown Boveri Gleichrichter zur Stromversorgung der Berliner Strassenbahnen," *BBC Nachrichten* (Mannheim), Vol. 17, No. 1, pp. 12-23, 1930.
424. SACHS, K., "Mercury Arc Power Rectifiers," *Brown Boveri Rev.*, Vol. 17, No. 1, pp. 14-18, 52-53, Jan. 1930.
425. KOBEL, E., "Tests with a High A-c. Voltage on a Movable Mercury Probe in a Mercury Arc," *ibid.*, No. 2, pp. 84-88, Feb. 1930.
426. KOTSCHUBEY, N., "Mercury Arc Power Rectifiers in Direct-Current Lighting Plants," *ibid.*, pp. 155-157, April 1930.
427. BAUMGARTEN, A. W., "Modernization of the Chicago & Joliet Electric Railway," *General Electric Rev.*, Vol. 33, No. 4, pp. 226-229, April 1930.
428. MORELAND, E. L., "Lackawanna Electrification Relies Upon Mercury Arc Rectifiers," *Elec. World*, Vol. 95, No. 14, pp. 704-707, April 5, 1930.
429. NAEF, O., and GUTZWILLER, W. E., "1,000-kw. Automatic Rectifier of the Union Railway Company, New York," *Jour. A.I.E.E.*, p. 528 ff. 1930.

430. KOTSCHUBEV, N., "Eine fahrbare, bedienungslose Quecksilberdampf-Grossgleichrichter-Anlage," *Elektrot. Ztschr.*, Vol. 51, May 15, 1930, pp. 697-700.

431. BAKER, C. E., "Mercury Arc Rectifiers Meet Transportation Demands," *Elec. Rly. Jour.*, Vol. 74, June 1930, pp. 311-314.

432. Report on Power Rectifiers, No. 302-2, of Power Committee No 2, Amer. Elec. Rly. Engg. Assoc., 1930.

433. Report of Electrical Machinery Committee, *A.I.E.E. Jour.*, 1930.

434. GRECO, A., "Electrification of Main-line and Secondary Railways in Italy with High-tension Direct Current," *Brown Boveri Rev.*, Vol. 17, pp. 215-223, 1930.

435. BECK, H. C., "Mercury Arc Power Rectifiers for Wireless Transmission Plants," *ibid.*, pp. 233-235.

436. MARTI, O. K., "New Trends in Mercury Arc Rectifier Developments," *A.I.E.E. Jour.*, 1930.

## INDEX

### A

- Absorption-reactance coil (*see* Interphase transformer).
- Allgemeine Elektrizitaets-Gesellschaft, 222, 223, 226, 240, 247, 253, 268-269
- Alternating-current supply, multiple, 47
- Ambient temperature, 316
- Analysis of direct-current voltage wave, 88-94, 407
- Angle of overlap, 49, 57, 87, 92, 93, 116, 118, 140, 150, 158, 164-166, 171-173, 417
- Anode, auxiliary, 230-233, 241  
construction, 226-229  
cooling, 229  
current, construction of, 66-76  
density, 227  
general derivation, 66-69  
waves, 70-75  
with overlapping, 58  
without overlapping, 50  
excitation, 230-231  
function, 20  
graphite, 226, 237  
grids (*see* Anode screens).  
heaters, 218, 229-230, 237, 239, 286, 291, 340, 341-342  
ignition, 230-233  
insulators, 228-229  
paralleling of, 187-188, 201  
radiators, 229  
reactors, 187-188, 268, 305-306, 391-392  
screens, 42-43  
construction, 227-228, 232  
energized, 43, 397-401  
non-energized, 42  
shields, 4, 41, 221-223, 227
- Anode, steel, 226  
voltage drop, 20
- Anti-freeze mixture, 333, 365-366
- Anti-resonant filter, 418
- Application of rectifiers, 307-328  
electro-chemical service, 100-102, 308, 328  
fields of application, 307-308  
industrial plants, 327  
portable substations (*see* Substations).  
radio transmission, 7  
railway service, 308, 317-327
- Arc-back (*see* Back fires).
- Arc, characteristics, 14-16  
properties, 24-25
- Arc drop, 18-24  
curves, 22  
effect on direct-current voltage regulation, 168  
measurement, 427-430  
oscillographic method, 429-430  
water-rate method, 428  
wattmeter method, 428-429  
study of, 434
- Atom, 10
- Automatic control (*see* Automatic substations).
- Automatic substations, 337-351  
Brown Boveri automatic control, 345-351  
diagrams of connections, 341-351  
General Electric automatic control, 341-345  
protection, 340-341  
reclosing and lockout, 339, 344, 348  
starting and stopping, 338-339, 344-345, 348  
temperature control, 339-340, 341  
vacuum pump control, 339, 343, 349-351

## B

- Back fires, 35-43  
 causes, 38-42  
 currents and voltages, 80-82  
 effect on transformers, 188-191  
 explanation, 35  
 oscillograms, 82, 189, 354, 441  
 prevention, 42, 43  
 selective protection (*see* Selective protection of rectifiers).  
 tests, 82, 189, 437, 439-442
- Bake-out (*see* Forming).
- Bergmann rectifiers, 226, 230
- Berlin Elevated Railway, 319-323, 372-379  
 diagram of connections, 374  
 load cycle, 322  
 protection, 373-375  
 rectifier rating, 321  
 short-circuit tests, 322-323  
 substations, 372-379  
 supervisory control, 372  
 system layout, 319-321  
 voltage regulation, 322
- Bibliography, 443-462
- Booster motor-generator set, 395-397
- Breakdown of mercury vapor, 27-28, 38, 40
- Bridgeport, Conn., substation, 317-318, 358-360
- Brown Boveri, automatic control, 345-351  
 ignition set, 272  
 rectifiers, 212, 213, 215, 216, 238  
 vacuum gage, 258-263  
 vacuum pump, 245, 247, 249-250, 254  
 wiring diagram, automatic rectifier, 346-347  
 manually operated rectifier, 336
- C
- Cables and wires, 334
- Calgary portable substation, 381-383
- Cathode, 13, 16-18  
 construction, 16-17, 225-226  
 cooling, 214  
 insulation, 34-35, 214, 225-226
- Cathode, mercury, 225-226  
 potential, 32  
 spot, 17-18, 35  
 voltage drop, 19
- Characteristics of rectifiers, 311-316  
 efficiency, 311-315  
 power factor, 169-174, 315  
 regulation (*see* Voltage regulation).
- Checking vacuum piping, 296
- Chicago Elevated and Surface Lines, 319, 360-363, 437-442
- City railways, 317, 319-323, 329, 358-363, 366-382
- Commonwealth Edison Company, Chicago, Ill., 319, 324, 360-363, 437-442
- Communication interference (*see* Interference with communication).
- Compounding of rectifier, 145-147, 392-395
- Conduction, of current in gases, 10-13  
 by rectifier tank, 34-35
- Connecticut Company, The, 317-318, 358-360
- Connection diagram (*see* Diagram of connections).
- Conrad, Frank, 3
- Consolidated Mining and Smelting Company, Trail, B.C., 328, 383-384
- Control, automatic (*see* Automatic substations).  
 of direct-current voltage (*see* Voltage control).
- Controlling mercury vapor, 220-225
- Cooling, apparatus, 274-283, 333  
 control, 338, 340, 341, 348, 349, 350  
 of rectifier, 214-217, 231, 274-283, 332-334, 335, 340, 365-366  
 systems, 231, 275-280, 332-334  
 combined cooling, 279  
 direct cooling, 275-277, 332  
 forced-draft cooling, 277-281, 332-333, 365-366, 371  
 indirect cooling, 277

- Cooling systems, recirculating cooling, 277-279, 332, 365-366  
 water, analysis, 283  
   characteristics, 280-283, 336  
   requirements, 274-275
- Cooper-Hewitt, Peter, 2, 3
- Copper losses, tests, 191-197  
 effect on regulation, 167-168
- Corrosion, electrolytic, 215, 280-283, 332-333, 366
- Current density of anode, 227
- Current harmonics, 94-97, 409-411
- Current transformer, in anode circuit, 427, 429
- Current-transformer trips, 349, 352-354
- Current-voltage relations, 77-80
- Current wave, direct-current, 45, 94-99  
 effect of load on, 97-102, 408-411
- Cylinder, rectifier, 211-233
- D**
- Decentralization, 310-311, 320
- Degassing (*see* Forming).
- Degree of rectification, 95
- Delaware, Lackawanna and Western Railroad, 327
- Design and construction of rectifiers, 210-241
- Design of interphase transformer, 203-205  
 of rectifier transformer, 197-203  
 of wave filter, 418-425
- Diagram of connections, Brown Boveri automatic rectifier, 346-347  
 Brown Boveri manually operated rectifier, 336  
 General Electric automatic rectifier, 342  
 General Electric manually operated rectifier, 286
- Diametrical 6-phase transformer (*see* Transformer connections).
- Dielectric tests of rectifiers, 432
- Direct-current load circuits, 95-102, 408-409
- Direct-current power, with overlapping, 60  
 without overlapping, 51
- Direct-current power transmission, 7
- Direct-current voltage, construction of, 62-65, 68  
 equation of, 50, 60, 63, 78  
 general derivation, 62-66  
 regulation, 58-60, 79, 140-141, 145-147, 148, 150, 157-158, 163-169, 205-206, 322, 385-402  
 relation to alternating-current voltage, 50-51, 63, 78, 176-186  
 ripple, 83-87  
 waves, 45, 70-75, 83-94, 407
- Direct-current wave, 45, 94-99
- Displacement factor, 170
- Distortion factor, 170
- Double 6-phase connection, 187-188, 190-191, 197-203, 305, 356
- E**
- Edison systems, 311, 327, 385
- Efficiency, calculation, 205, 430  
 of rectifier, 105, 147, 311-315, 394  
 of rotary machines, 313-314
- Electric field control, 397-401
- Electro-chemical plants, 328, 383-384, 385
- Electrolytic cells, 100-102  
 corrosion, 215, 280-283, 332-333, 366
- Electromagnetic induction, 404-405, 411-415
- Electron, 10, 12, 24
- Electrostatic induction, 403-404, 411
- Excitation anodes, 230-231  
 apparatus (*see* Ignition and excitation).  
 arc, 16, 23
- Experimental tests, 434-437
- F**
- Ferrovie Nord Milano, Italy, 325-326
- Field control of direct-current voltage, 397-401

- Filters, 418-425  
 anti-resonant filter, 418  
 connecting wires, 334, 421  
 harmonic currents, 423  
 reduction factor, 421  
 resonant shunt filter, 419-425  
 series reactor, 410-411, 418, 420-425
- Five-leg transformer, 126, 182
- Forced-draft cooling, 277-281, 332-333, 365, 371
- Fork connection (*see* Transformer connections).
- Forming, manufacturer's instructions, 290-296  
 phenomena, 290  
 process, 284-296  
 connection diagram, 286, 287  
 double 6-phase forming, 288  
 heating out, 285  
 single-phase forming, 288, 291  
 6-phase forming, 288, 292-293  
 3-phase forming, 295-296  
 transformer, 287-289  
 voltage, 40, 287, 292
- Freezing temperature of water-alcohol, 333
- Fused seals, 236-238
- G
- Gaede diffusion pump, 248-249, 254
- Gages (*see* Vacuum gages).
- Gases, occluded, 5, 38, 42
- General Electric automatic control, 341-345  
 connection diagram, automatic rectifier, 342  
 manually operated rectifier, 286  
 rectifier, 213, 218-221, 226, 237 240  
 vacuum gage, 263-265  
 vacuum pumps, 246, 247, 251-252, 254
- Glow discharge, 14, 15, 37, 38, 39
- Graphite anode, 226, 237
- Grid control of direct-current voltage, 397-401
- Grids, anode, 42 43, 227-228, 232, 397-401
- Guenther-Schulze, 19
- H
- Harmonic currents in filter, 422-423
- Harmonics, in direct-current voltage wave, 88-94, 407  
 in direct-current wave, 94-97, 409-411
- Heaters, anode, 218, 229-230, 237, 239, 286, 291, 340, 341-342  
 tank, 218, 291, 340
- Heating out rectifier, 285
- High-vacuum pump (*see* Vacuum pump, mercury).
- High-voltage rectifiers, 7
- Hot-wire vacuum gage, 257-265, 285
- I
- Ignition angle, 63, 65-66  
 anode, 230-233  
 mechanism, 223, 227, 233
- Ignition and excitation, 16, 266-274  
 alternating-current ignition and excitation, 270-273  
 direct-current ignition and alternating-current excitation, 270  
 direct-current ignition and excitation, 266-270, 286  
 oscillogram of, 271
- Illinois Central Railroad, 323-325
- Induced voltages, 411-415
- Inductance of railway systems, 408-409  
 of reactors, 424, 425
- Induction, electromagnetic, 404-405, 411-415  
 electrostatic, 403-404, 411
- Induction regulator, 389-390
- Inductive interference (*see* Interference).
- Industrial plants, 327
- Inspection report, 298-299
- Installations, rectifier (*see* Rectifier installations).

- Instruments, measuring, 173, 415, 426-427, 428-430
- Insulation of cables and wires, 334
- Insulators, anode, 228-229  
cathode, 225-226
- Interference with communication, 403-425  
causes, 405-407  
electromagnetic induction, 404-405, 411-415  
electrostatic induction, 403-404, 411  
exposure, 405  
filter equipment, 418-425  
harmonic currents, 409-411  
harmonic voltages, 88-94, 407  
load characteristics, 408-409  
telephone interference factor, 415-418
- Interphase transformer, design, 203-205  
double 6-phase connection, 188, 190, 201, 203-205  
operation, 127-136  
selective protection, 356-357  
6-phase connection, 127-139, 141, 145-147, 176, 181  
12-phase connection, 152-156, 185  
voltage control, 145-147, 392-395  
winding arrangement, 204-205
- Interstage reservoir, 242, 248, 253, 343
- Interurban railway, 318, 329, 363-366
- Introduction, 1-9
- Inverse current, 37-38, 435-437
- Ion, 10-12
- Ionization, 10-13, 25
- Ionization vacuum gage, 264, 266
- Iron, rate of evaporation, 28
- K**
- Kelvin balance, 428
- Kelvin degrees, 28
- L**
- Langmuir, Irving, 18  
vacuum pump, 250-252, 254
- Layout of substations, 330-335, 357-384
- Leakage reactance, 106-108, 191, 202
- Lighting and heating load, 100
- Lighting and power load, 327  
"Litzendraht," 421
- Load circuit characteristics, 95-102, 408-409
- Load, effect of, on current wave, 97-102, 408-411
- Load factor, effect of, 314-315
- Load-shifting resistance, 344, 364
- Load tests, 430-432
- Location of substations, 329-330
- Losses, auxiliary, 203-205, 430  
rectifier, 18-24, 105, 205, 427-430  
transformer copper, 191-197, 202-205, 430  
transformer iron, 430
- M**
- Magnetizing current of transformer, 143, 173
- Main-line electrification, 323-327
- Maintenance, 297-299
- Manually operated substations, 335-337
- Manufacturer's forming instructions, 290-296
- Maypole substation, Chicago, Ill., 319, 360-363
- McLeod vacuum gage, 5, 255-257, 285, 433
- Measuring arc drop, 427-430
- Measuring instruments, 173, 426-427, 428-430
- Mercury arc, photograph, 18  
properties, 24-25  
rectifier (*see* Rectifier).  
stability, 15  
voltage characteristic, 14-16  
voltage drop, 18-24
- Mercury, cathode, 17  
evaporation, 221-225  
of cathode, 225-226  
properties, 24-26  
seals, 5, 235, 238, 239-241



- Mercury, vacuum pump (*see* Vacuum pump, mercury).  
 vapor, breakdown voltage, 27-28, 38, 40  
 controlling of, 220-225  
 properties, 24-28
- Micron, 255, 262
- Milwaukee Electric Railway, 318-319, 363-366
- Montreal Tramways Company, 366-372
- Mycalex seals, 220, 237-239
- N
- New York subway, 323
- No load to short circuit, 61-80
- No-load voltage rise, 140, 401-402
- O
- Occluded gases, 5, 38, 42
- Operation of rectifier, 13, 29-31, 296-297
- Oregon Electric Railway, 326-327
- "Oscillating" neutral, 121
- Oscillograms, back fire, 82, 354, 441  
 currents and voltages, 99  
 fork connection, 149  
 ignition-excitation, 271  
 primary current, 142  
 short-circuit tests, 439, 441  
 6-phase connection with inter-phase transformer, 133
- Oscillograph in rectifier tests, 426, 429, 436
- Overlap, angle of, 49, 57, 87, 92, 93, 116, 118, 140, 150, 158, 164-166, 171-173, 417
- Overlapping, 48, 54, 56
- P
- p*-phase rectifier, calculation of, 50, 54
- Parallel operation of rectifiers, 300-306, 315  
 on different alternating-current networks, 304-305  
 different substations, 301-303  
 fundamental principles, 300-303
- Parallel operation of rectifiers, on one transformer, 187-188, 305-306  
 with rotary machine, 304, 406, 409-411  
 same substation, 300-301  
 stability and load division, 303-304
- Paralleling anodes, 187-188, 201
- Paris Metropolitan Railways, 380, 382
- Performance tests, 427-434
- Philadelphia Rapid Transit Company, 379-382
- Philadelphia subway, 323
- Physical properties of mercury, 24-28
- Polygon transformer connection, 181, 305-306
- Polyphase rectification, 31-34
- Portable substations, 381-383
- Portland Electric Power Company, 326
- Potentials in rectifier circuit, 32
- Power, direct-current, equation of, 51, 60
- Power factor, 169-174, 315, 393
- Preliminary vacuum pump (*see* Vacuum pumps, rotary).
- Protection of rectifiers, 326, 337, 340, 349, 351-357, 373-375  
 back-fire, 326, 337, 340, 349, 351-357, 373-375  
 incomplete start, 340, 344  
 lockout, 339, 340, 344, 349  
 low vacuum, 340, 344, 349  
 overload, 337, 340, 349  
 over-temperature, 337, 340, 341, 344, 349  
 reverse current, 326, 337, 340, 349, 351-356, 373  
 selective protection, 326, 337, 349, 352-357, 373-375  
 water failure, 340, 344, 349, 350
- R
- Radiator-type coolers, 280-281
- Railway load, effect on current wave, 97-99, 409-411

- Railway rectifier installations, 317-327, 357-383
- Railway system inductance, 408-409
- Rating curves, 310
- Rating of rectifiers, 35, 40, 211, 309-310
- Reactance, effect of, 54-60, 164-167, 172  
leakage, 106-108, 191, 202
- Reactors, anode, 187-188, 268, 305-306, 391-392
- Recirculating cooling system, 277-280
- Reclosing, automatic, 339, 348
- Recoolers, forced-draft, 280-281
- Rectification, polyphase, 31-34  
principles, 10-16, 29-34  
single-phase, 29-31
- Rectifier, application of, 307-328  
automatically operated, 337-351  
auxiliaries, 210, 242-283  
cooling apparatus, 274-283  
ignition and excitation apparatus, 266-274  
vacuum gages, 255-266  
vacuum pumps, 242-254  
circuit potentials, 32  
cooling, 274-283, 332-334, 335, 338, 339-340, 348, 365-366  
cylinders, 211-233  
design and construction, 210-241  
development, 2-9  
elementary, 13  
high-voltage, 7  
installations, 317-328, 357-384  
Berlin Elevated Railway, 319-323, 372-379  
Bridgeport, Conn., 317-318, 358-360  
Calgary portable substation, 381-383  
Chicago Elevated and Surface Lines, 319, 360-363  
Consolidated Mining & Smelting Company, 328, 383-384  
Delaware, Lackawanna and Western Railroad Co., 327  
electrochemical plants, 328, 383-384
- Rectifier installations, Ferrovie Nord Milano, 325-326  
Illinois Central Railroad, 323-325  
industrial plants, 327  
Montreal Tramways Company, 366-372  
Oregon Electric Railway, 326-327  
Paris Metropolitan Railways, 380, 382  
Philadelphia and New York subways, 323  
Philadelphia Rapid Transit Company, 379-382  
railway rectifier installations, 317-327, 357-384  
Watertown-Milwaukee line, 318-319, 363-366  
interference (*see* Interference).  
manually operated, 335-337  
necessary elements, 16  
operating characteristics, 311-316  
parallel operation, 300-306  
principle of operation, 10-16, 29-34  
protection (*see* Protection of rectifiers).  
rating, 35, 40, 211, 309-310  
simplified connection, 210  
starting, 211, 297, 335, 338, 344, 348  
stopping, 297, 337, 339, 345, 348  
substations (*see* Substations).  
testing, 426-442  
transformers (*see* Transformers).  
types, Allgemeine Elektrizitäts-Gesellschaft, 222, 223, 226, 240  
Bergmann, 226, 230  
Brown Boveri, 212, 213, 215, 216, 238  
General Electric, 213, 218-221, 226, 237-240  
Siemens-Schuckert, 224, 227  
Westinghouse, 228, 236-237  
wave filter, 418-425
- Reduction factor of harmonic, 421
- Regeneration, 315-316

- Regulating transformer, 388-389  
 Regulation, curves, 79, 125, 141, 146, 322, 393  
   voltage, 58-60, 79, 140, 145-147, 150, 157, 163-169, 205-206, 322, 385-402  
 Residual m.m.f., 109-113, 121-124, 141, 159-160  
 Resonant shunt filter, 419-425  
 Reverse current, 36, 82, 352-356, *see also* Inverse current.  
 Reverse-current protection, 326, 337, 340, 349, 352-356, 373  
 Reversed rectifier connection, 33-34  
 Ripple loss in electrolytic cells, 100-102  
 Rockfield substation, Montreal, 366-372  
 Rotary vacuum pump (*see* Vacuum pumps, rotary).  
 Roughing vacuum pump (*see* Vacuum pumps, rotary).  
 Rubber seal, 234, 235, 240-241

## S

- Saturated interphase transformer, 145-147, 392-394  
 Schaefer, Bela, 3  
 Screens, anode, 42-43, 227-228, 232, 397-401  
 Seal gage, 238, 239  
 Seals, 5, 233-241  
   fused, 236-238  
   mercury, 5, 235, 238, 239-241  
   mycalex, 220, 237-239  
   rubber, 234, 235, 240-241  
   2-stage, 223, 240  
 Selective protection of rectifiers, 326, 351-357, 373-375  
   Berlin Elevated Railway, 373-375  
   current-transformer trip, 337, 349, 352-354, 356  
   Ferrovie Nord Milano, 326  
   reverse-current tripping, 326, 337, 349, 352-356, 373  
   tripping by unbalance, 356-357  
 Selective tripping (*see* Selective protection of rectifiers).  
 Series motors, 97-99  
 Series reactors, 410-411, 418, 420-425  
 Shell-type transformer, 126  
 Shields, anode, 4, 41, 221-223, 227  
 Short-circuit current, 76-77  
 Short-circuit tests, of rectifiers, 189, 437-442  
   of transformers, 189, 191-197, 430  
 Shunt filter, resonant, 419-425  
 Shunt motors, 99  
 Shunt reactor, 419-425  
 Siemens dynamometer, 428  
 Siemens-Schuckert rectifiers, 224, 227  
 Single-phase rectification, 29-31  
 Single-phase rectifier, 29, 51-52  
 Single-phase transformers, 127, 182  
 Six-phase connection (*see* Transformer connections).  
 Six-phase rectifier calculation, 52-54  
 Société Alsacienne, 237  
 Space charge, 11, 12  
 Stability of parallel operation, 303-304  
 Starting rectifier, 211, 297, 335, 338, 344, 348  
 Steel anode, 226  
 Steinmetz, Charles P., 2  
 Stopping rectifier, 297, 337, 339, 345, 348  
 Substations, 329-384  
   automatically operated, 337-351  
   equipment, 331  
   inspection report, 298-299  
   layout, 330-335, 357-384  
   location, 329-330  
   manually operated, 335-337  
   portable, 381-383  
   selective protection, 351-357  
 Surge arresters, 334  
 Switchboards, 330, 334, 345, 351, 363, 371

## T

- Tables of transformer connections, 175-186  
 Tank heaters, 218, 291, 340

- Tap changers, 386-389
- Telephone interference (*see* Interference with communication).
- Telephone interference factor (tif), 415-418
- Temperature, ambient, 316  
control, 339-340, 341
- Tertiary transformer winding, 113, 120-121
- Testing rectifiers and auxiliaries, 426-442  
arc-drop measurement, 427-430  
dielectric tests, 432  
experimental studies, 434-437  
field tests, 437-442  
inverse current measurement, 435-437  
load tests, 430-432  
measuring instruments, 426-427  
performance tests, 427-434  
short-circuit tests, 437-442  
transformer tests, 191-197, 430  
vacuum pumps and gages, 432-434
- Testing transformer, 191-197, 430
- Thermostatic regulating valve, 231, 275-277
- Transformer connections, delta-connected primary, 109-112  
diametrical 6-phase, delta primary, 117-119, 164, 166, 172, 179  
Y-primary, 112-113, 119-127  
magnetic shunt, 126-127, 182  
single-phase transformers, 127, 182  
with tertiary, 113, 120-121, 179  
without tertiary, 112-113, 121-126, 179  
double 6-phase, 187-188, 190, 197-203, 305, 356  
influence on arc drop, 21-23, 105, 147  
mesh-connected primary, 109-112  
primary connections, 108-113  
selection of, 104-106  
6-phase fork, 147-152, 165, 166, 172, 178, 188, 193-195, 209, 326
- Transformer connections, 6-phase fork, copper losses, 193-195  
current and voltage waves, 148, 149  
diagram of connections, 148  
direct-current voltage and regulation, 148-150, 165, 166  
power factor, 151, 171-172  
reactance, effective, 149-150  
transformer rating, 150-152
- 6-phase with interphase transformer, 127-147, 165, 166, 172, 181, 188, 192-193, 392-395  
advantages, 127  
copper losses, 192-193  
current and voltage waves, 132-133  
design example, 197-206  
diagram of connections, 128  
direct-current voltage and regulation, 139-141, 165, 166  
magnetizing current, 143  
no-load voltage rise, 140, 401-402  
power factor, 145, 171-172  
primary and line currents, 141-144  
principle of operation, 129  
transformer rating, 144-145  
transition current, 131, 138, 206  
transition period, 131-136  
voltage and current relations, 130-136  
voltage control, compounding, 145-147, 392-395
- star-connected primary, 112-113  
tables of, 174-186
- 12-phase with interphase transformer, 152-163, 165-166, 172, 185, 195-197  
copper losses, 195-197  
current and voltage waves, 155  
diagram of connections, 153  
direct-current voltage and regulation, 156-158, 165, 166  
interphase transformers, 154-156  
power factor, 163, 171-172

- Transformer connections, 12-phase with interphase transformer, primary currents, 159-162 residual m.m.f., 160 transformer rating, 162-163
- Transformer, forming, 287-289 interphase (*see* Interphase transformer). secondary rating, 51 tap changers, 386-389
- Transformers for rectifiers, backfires, effect of, 188-191, 202 comparison with power transformers, 103-104 construction, 206-209 copper losses, 191-197 design example, 197-206 general equations, 113-116 leakage reactance, 106-108, 191, 202 primary and line currents, 108-113 residual m.m.f., 109-113, 121-124, 141, 159-160 secondary currents, 108 testing, 191-197, 430 winding arrangement, 187-191, 200-202
- Transition current, 131, 138, 206
- Twelve-phase connection (*see* Transformer connections).
- Two-stage seal, 223, 240
- V
- Vacuum gages, 255-266 Brown Boveri type, 258-263 General Electric type, 263-265 hot-wire gage, 257-265, 285 ionization gage, 264-266 McLeod gage, 5, 255-257, 285 testing, 433, 434
- Vacuum meter, 262, 263, 265
- Vacuum piping, checking, 296
- Vacuum pumps, 242-254 automatic control, 339, 343, 349-351 characteristics, 244 connections, 233 mercury, 248-254
- Vacuum pumps, mercury, Brown Boveri type, 249-250, 254 characteristics, 254 cooling, 334 diffusion type, 248-249 Gaede diffusion pump, 248-249, 254 General Electric type, 251-252, 254 Langmuir condensation type, 250-252, 254 3-stage type, 252-254 2-stage type, 251-252 operation, 297, 335, 339 rotary, 243-248 Allgemeine Elektrizitaets-Gesellschaft type, 247 automatic vacuum valves, 247 Brown Boveri type, 245, 247 construction, 245-247 General Electric type, 246, 247 operating range, 243-244 testing, 432-433 system, 242
- Vacuum regulator, 262, 263, 265
- Vacuum valves, automatic, 247, 343
- Voltage control, 145-147, 385-402 anode reactors, 391-392 booster motor-generator set, 395-397 compounding, 145-147, 392-395 grid control, 397-401 induction regulator, 389-390 interphase transformer, 145-147, 392-395 methods, 386 suppressing no-load rise, 401-402 tap changer, 386-390
- Voltage drop, due to reactance, 59, 118, 125, 140, 150, 158, 164-167 in rectifier arc, 18-24
- Voltage harmonics, 88-94, 407
- Voltage induced in communication line, 411-415
- Voltage regulation, 58-60, 79, 163-169 calculation example, 205-206 copper loss effect, 167-168 fork connection, 148-150, 165, 166

- Voltage regulation, reactance effect, 164-167  
6-phase connection, 117-118, 139-141, 164-166, 322  
terminal direct-current voltage, 168  
12-phase connection, 157-158, 165, 166  
Voltage rise at no-load, 140, 401-402  
Voltage wave, direct current, 45, 70-75, 83-94, 407  
filters, 418-425
- W
- Water, analysis, 283  
characteristics, 280-283  
coolers, 280-281  
cooling systems, 275-280, 332-334, 365-366
- Water, regulating valves, 231, 275-277  
requirements (for rectifiers), 274-275  
Watertown-Milwaukee line, 318-319, 363-366  
Wattmeters, 428  
Wave-smoothing filters, 334, 418-425  
Weighting factor, 415-416  
Westinghouse rectifiers, 228, 236-237  
Windings of transformers, 188-191, 200  
Wires, 334  
Wiring diagrams (*see* Diagram of connections).  
Wyoming substation, Philadelphia, Pa., 379-382