

# 93/95/97 50 MHz SCOPEMETER®

## USERS MANUAL

For the benefit and convenience of its customers, Fluke Corporation (Fluke) has reproduced this copy of a manual which is no longer in production. This manual has not been edited or updated since the revision date shown on the *lower left hand corner of the first page*. Fluke will not be liable for any claims, losses or damages of any kind incurred by any user arising from use of this manual.

939514  
~~930901~~

© 1993 John Fluke Mfg. Co., Inc. All rights reserved. Printed in the Netherlands

**FLUKE®**

**50 MHz ScopeMeter®**

**CUSTOMER SUPPORT**

**FLUKE®**

**USU00511-2**

Revised 921001  
4822 872 08436

Related to: FLUKE 93/95/97      USERS MANUAL 916119/4822 872 00511

**Subject:**    1. New functions to ScopeMeter® with version 4 software  
                  2. Errata Sheet For ScopeMeter® Users Manual

*ScopeMeter is a trademark of Fluke and Philips. ScopeMeter is a registered U.S. trademark of Fluke.*

**1. NEW FUNCTIONS WITH  
VERSION 4 SOFTWARE**

Your ScopeMeter® now includes with the latest software release V4. You will find several new functions that are not described in the manual. The following list gives the most important changes:

**NEW**

**VERSION 4 SOFTWARE**

- Improved User Interface
- % Duty Cycle Measurements
- 30Ω Range, 0.01Ω Resolution
- Invert Waveform in Both Channels
- More Frequency Counter Resolution  
(ex. 60.00Hz, 400.0Hz, 9.999kHz)
- Record Mode Min Max Time Stamp
- Voltage Measurement at Cursor 1 ●<sup>85&97</sup> Only



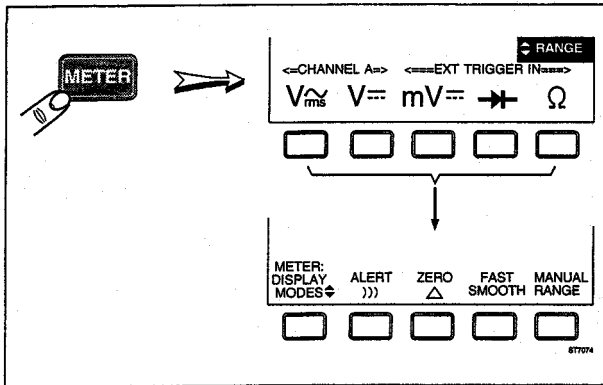

## 1.1 IMPROVED USER INTERFACE

**ALERT**  Improved accessibility of the alert function (see page 5-4).

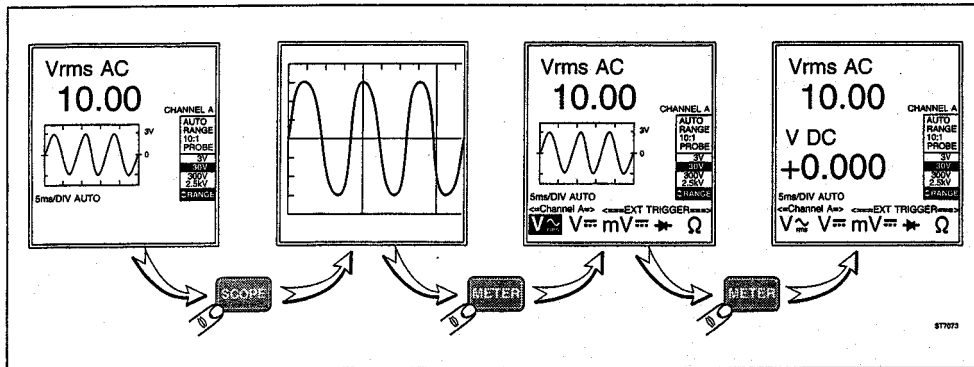

Switching between **METER** mode and **SCOPE** mode no longer influences the original display. Pressing the **METER** key a second time results in the main meter display.

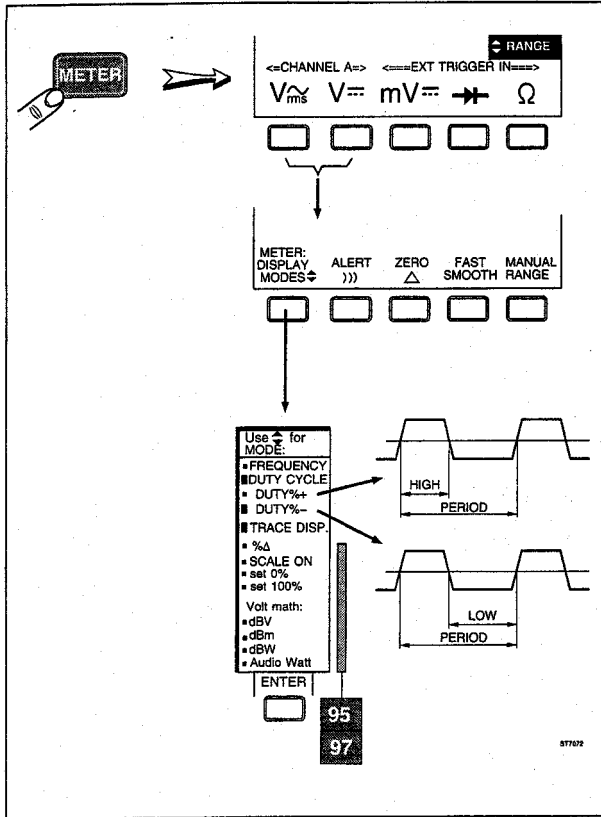

## 1.2 % DUTY CYCLE MEASUREMENTS

New duty cycle measurement function in meter mode.

**RANGE** From <2.0% to >98.0% for signal amplitudes >10% of the input voltage range.

**RESOLUTION** 0.1%

**ACCURACY** Within  $\pm 0.5\%$  for logic or pulse waveforms.

$$\text{Within } \pm 1\% + \left( \frac{\text{VOLTAGE RANGE}}{\text{RMS INPUT VOLTAGE}} \times 1\% \right)$$

for sine or triangle waveforms.

**DUTY CYCLE** When duty cycle is selected, the meter voltage display is replaced by the duty cycle display. Measurement of duty cycle is possible in Vrms AC, Vrms AC+DC, and V DC functions.

**DUTY%+** The displayed value is calculated using the following formula:

$$\text{duty cycle} = \frac{\text{high time}}{\text{period time}} \times 100\%$$

**DUTY%-** The displayed value is calculated using the following formula:

$$\text{duty cycle} = \frac{\text{low time}}{\text{period time}} \times 100\%$$

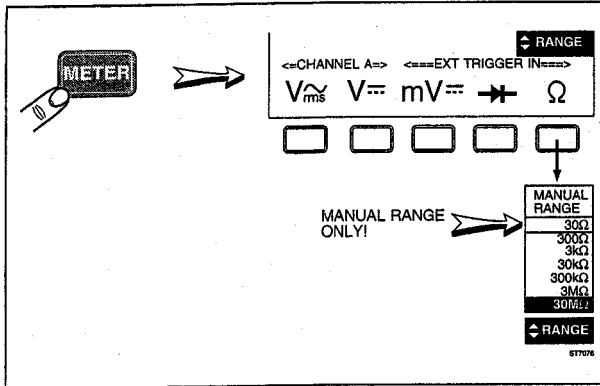

### 1.3 30Ω RANGE, 0.01Ω RESOLUTION

The 30-Ω range is accessible only in Manual Range mode. Maximum reading: 99.99Ω, Accuracy:  $\pm 2.5\% \pm 25$  counts.

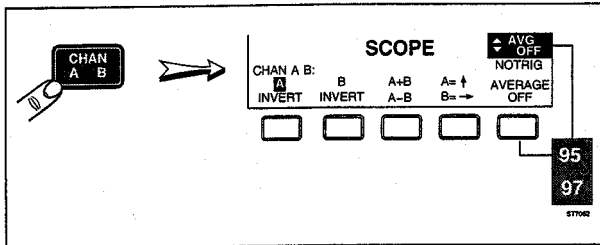

### 1.4 INVERT WAVEFORM IN BOTH CHANNELS

Channel A can now be inverted just like channel B.

### 1.5 MORE FREQUENCY COUNTER RESOLUTION

Increased frequency counter resolution to four full digits.

Examples: 50.00Hz, 60.00Hz, or 9.999kHz

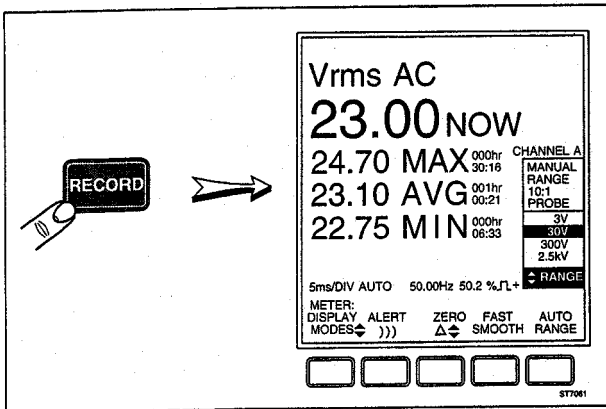

## 1.6 RECORD MODE MIN MAX TIME STAMP (Models 95 and 97)

**RECORD** Recording of MINIMUM, MAXIMUM and AVERAGE values (see page 3-6 and 5-7) are displayed with the time they occurred. This time stamp is related to the start of the recording and is displayed (in hours, minutes and seconds) beside the actual measurement value.

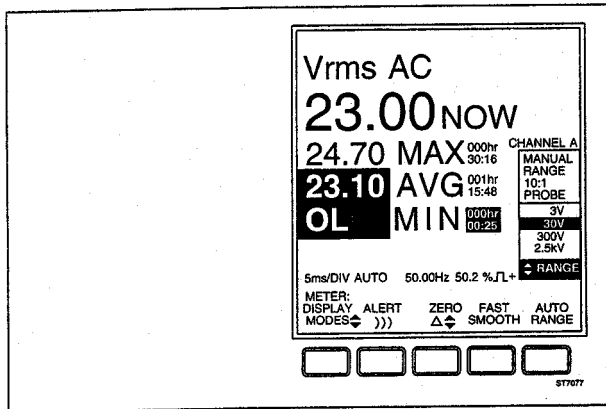

**ATTENTION:** An overload of MIN or MAX will stop the Record mode. The overloaded value (MIN or MAX) and the AVG are then displayed inverse and their timer is stopped.

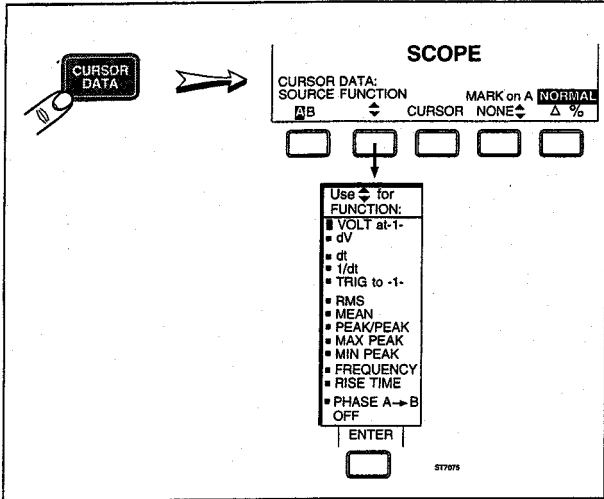

## 1.7 VOLTAGE MEASUREMENT AT CURSOR 1 (Models 95 and 97)

SCOPE mode CURSOR DATA, FUNCTION menu:

**Volt at -1-** : voltage of signal at cursor 1 relative to ground.

## 2. ERRATUM

- **Add to page 1-1, Section 1.3 (SAFETY PRECAUTIONS) the following text:**

The terms ISOLATED or ELECTRICALLY FLOATING are used in this manual to indicate a measurement in which the ScopeMeter® COM ⚡ (common, also called ground) is connected to a voltage different from earth ground. The term GROUNDED is used in this manual to indicate a measurement in which the ScopeMeter® COM ⚡ (common) is connected to an earth ground potential.

### WARNING

The ScopeMeter® COM ⚡ (common) inputs (Channel A red BNC shield, Channel B grey BNC shield, and black banana jack) are connected internally via self-recovering fault protection. Similar to a safety-designed multimeter, but unlike a conventional oscilloscope, the input connectors have no exposed metal and are fully insulated to protect against electrical shock. The black banana jack COM ⚡ (common) can be connected to a voltage above earth ground for isolated (electrically floating) measurements and is rated up to 600V rms above earth ground.

### WARNING

**TO AVOID ELECTRICAL SHOCK IF A SCOPEMETER® COM ⚡ (common) INPUT IS CONNECTED TO >42V PEAK (30V rms):**

1. **Use only the PM9266 Test Lead Set and the PM8918 ScopeMeter® Probe Set or test leads and probes that are designed for making isolated (electrically floating) measurements and are designated for use on the ScopeMeter®.**
2. **Do not use conventional exposed metal BNC or banana plug connectors if the COM ⚡ (common) is >42V peak (30V rms).**
3. **Use only one COM ⚡ (common) connection, the black banana jack.**
4. **Remove all unused probes and test leads.**
5. **Use 600V rated probe tip adapters.**

The ScopeMeter® uses a three lead connection system for dual channel, isolated (electrically floating) measurements. The connections for isolated and grounded measurements are shown in the figures on pages 12-6 to 12-8 (at the rear of the manual).



- Add to page 3-17, (USEFUL TIPS) the following text:

**SMALL SIGNAL GROUNDED ELECTRONIC MEASUREMENTS**

Grounded electronic measurements at 5 mV/div (50 mV/div with a 10:1 probe) have the lowest noise when the ScopeMeter® is operating on battery power. If the PM8907 (or equivalent) line voltage adapter is used, connect a test lead from the ScopeMeter® banana jack COM  $\nabla$  (common) to the measurement common (ground) of the system under test. This will reduce or eliminate any power line related noise. If a scope probe ground lead is also used, make sure it and the banana jack ground (common) test lead are both connected to the same ground circuit on the system under test.

- Change the WARNING on page 4-3 to the following:

**WARNING**

**RISK OF ELECTRIC SHOCK OR FIRE**  
**USE ONLY INSULATED PROBES, TEST LEADS AND CONNECTORS SPECIFIED IN THIS MANUAL WHEN MAKING MEASUREMENTS >42V PEAK (30V RMS) ABOVE EARTH GROUND OR ON CIRCUITS >4800 VA. SEE PAGE 1-2.**  
**USE PROBES AND TEST LEADS WITHIN RATINGS AND INSPECT BEFORE USE.**  
**REMOVE UNUSED PROBES AND TEST LEADS.**  
**REMOVE PROBES AND TEST LEADS, BEFORE OPENING CASE OR BATTERY COVER.**

- Add to index:

Floating . . . . . 1-2, 12-8  
 Grounded . . . . . 1-2, 12-6, 12-7  
 Isolated. . . . . 1-2, 12-6, 12-7

# Manual Supplement

Manual Title: Fluke 93/95/97  
Part Number: 4822 872 00522-00526  
4822 872 00563-00564  
4822 872 00579-00581

Print Date: 1 June 1991  
Revision/Date: 1 Sept. 1993

Supplement Issue: 1  
Part Number: 4822 872 08492

Issue Date: 15 Okt. 1995  
Page Count 4

---

This supplement contains information necessary to  
ensure the accuracy of the above manual.

© 1995 Fluke Corporation. All rights reserved. Printed in the Netherlands

**FLUKE**®

MSU 200522.0-1



1 3 6 9

## DECLARATION OF CONFORMITY

for

Fluke 93/95/97  
ScopeMeter®

**Manufacturer**  
Fluke Industrial B.V.  
Lelyweg 1  
7602 EA Almelo  
The Netherlands

### Statement of Conformity

Based on test results using appropriate standards,  
the product is in conformity with  
Electromagnetic Compatibility Directive 89/336/EEC  
Low Voltage Directive 73/23/EEC

**Sample tests**  
Standards used:

IEC 348 (1978)  
Safety Requirements for Electronic Measuring Apparatus

EN 50081-1 (1992)  
Electromagnetic Compatibility.  
Generic Emission Standard:  
EN55022 and EN60555-2

EN 50082-1 (1992)  
Electromagnetic Compatibility.  
Generic Immunity Standard:  
IEC801 -2, -3, -4, -5

The tests have been performed in a  
typical configuration.

This Conformity is indicated by the symbol **CE**,  
i.e. "Conformité européenne".

The Fluke 93, 95, and 97, including standard accessories, conforms with the EEC Directive 89/336 for EMI immunity, as defined by IEC 801-3, with the addition of the following tables.

**Scope mode (excluding probe factor):**

Table 1.

	<b>Susceptibility: no visible disturbance</b>		
Frequency range: 10 kHz - 25 MHz	$E = < 0.1 \text{ V/m}$	$E = 1 \text{ V/m}$	$E = 3 \text{ V/m}$
Stand alone	1 mV/div - 100 V/div	1 mV/div - 100 V/div	1 mV/div - 100 V/div
With PM8918	1 mV/div - 100 V/div	1 mV/div - 100 V/div	5 mV/div - 100 V/div

Table 2.

	<b>Susceptibility: no visible disturbance</b>		
Frequency range: 25 MHz - 1 GHz	$E = < 0.1 \text{ V/m}$	$E = 1 \text{ V/m}$	$E = 3 \text{ V/m}$
Stand alone	1 mV/div - 100 V/div	1 mV/div - 100 V/div	1 mV/div - 100 V/div
With PM8918	1 mV/div - 100 V/div	100 mV/div - 100 V/div	500 mV/div - 100 V/div

Table 3.

	<b>Susceptibility: disturbance less than 10 % of full scale</b>		
Frequency range: 10 kHz - 25 MHz	E = < 0.1V/m	E = 1 V/m	E = 3 V/m
Stand alone	N/A	N/A	N/A
With PM8918	N/A	N/A	1 mV/div - 2 mV/div

Table 4.

	<b>Susceptibility: disturbance less than 10 % of full scale</b>		
Frequency range: 25 MHz - 1 GHz	E = < 0.1V/m	E = 1 V/m	E = 3 V/m
Stand alone	N/A	N/A	N/A
With PM8918	N/A	20 mV/div - 50 mV/div	100 mV/div - 200 mV/div

For conditions not specified in tables 1 - 4, a susceptibility effect of more than 10 % is possible

**Multimeter mode (V dc, excluding probe factor):**

Table 1.

	<b>Susceptibility: no visible disturbance</b>		
Frequency range: 10 kHz - 25 MHz	E = < 0.1V/m	E = 1 V/m	E = 3 V/m
Stand alone / with PM8918	300 mV - 300V	300 mV - 300V	300 mV - 300V

Table 2.

	<b>Susceptibility: no visible disturbance</b>		
Frequency range: 25 MHz - 1 GHz	E = < 0.1V/m	E = 1 V/m	E = 3 V/m
Stand alone	300 mV - 300V	300 mV - 300V	300 mV - 300V
With PM8918	300 mV - 300V	300 mV - 300V	3V - 300V

Table 3.

	<b>Susceptibility: disturbance less than 10 % of full scale</b>		
Frequency range: 25 MHz - 1 GHz	E = < 0.1V/m	E = 1 V/m	E = 3 V/m
Stand alone	N/A	N/A	N/A
With PM8918	N/A	N/A	300 mV



# Table of Contents

SECTION NAME	SECTION NUMBER
Introducing Your ScopeMeter.....	1
Using the Meter.....	2
Using the Scope.....	3
More Advanced features.....	4
Measuring Examples .....	5
ScopeMeter Tutorial.....	6
User Maintenance.....	7
Appendices .....	8



## ABOUT THIS MANUAL

### Section 1 Introducing Your ScopeMeter®

This section introduces ScopeMeter features and capabilities. In about 10 minutes you will become familiar with your ScopeMeter.

### Section 2 Using the Meter

This section addresses specific ScopeMeter uses as a digital multimeter. You will learn how to set up ScopeMeter for ac and dc voltage measurement, diode tests, and resistance measurement.

### Section 3 Using the Scope

This section explores the use of ScopeMeter as a dual trace, digital storage oscilloscope. You will learn how to make, store, and compare measurements.

### Section 4 Additional Capabilities

This section covers the more advanced features available with ScopeMeter.

### Section 5 Measuring Examples

This section examines some typical measurements with your ScopeMeter. The examples given here can help make many tests.

### Section 6 ScopeMeter Tutorials

This section looks at the more advanced capabilities of your ScopeMeter. You will become familiar with all aspects of your ScopeMeter by using the demonstration unit delivered with your ScopeMeter.

### Section 7 User Maintenance

This section describes the cleaning and replacement of your ScopeMeter battery. Periodic probe calibration and performance verification are also covered here.

### Section 8 Appendices

- A. Specifications: ScopeMeter's operating characteristics
- B. Parts and Accessories
- C. PM8907 information: Different Power Adapter/Battery Charger types.
- D. Warranty and Service Centers: Warranty terms and Service Center addresses.
- E. Terminology
- F. Menu Trees: Consult for a graphic view of the various softkey menus and popup menus and their relationship to each other.

## UNPACKING

The following items should be included in your ScopeMeter® kit:

- 1 ScopeMeter
- 1 PM9083/001 Yellow Holster
- 1 PM9086/001 NiCad Battery Pack (installed)
- 1 PM8907/00x Power Adapter/Battery Charger
- 1 PM8918/002 Set of two Probes (inside C75 Accessory case)
- 1 PM9084/001 Set of two Industrial Alligator clips (for scope probes)
- 1 C75 Accessory Case
- 1 Probe Accessory Set
- 1 Multimeter Test Lead Set
- 1 Demonstration board with 9V battery
- 1 Users Manual
- 1 Quick Operating Guide (inside holster)

Check the contents of the shipment for completeness. If something in the kit is damaged or missing, contact your distributor or the nearest FLUKE sales or service office immediately.



**NOTE**

*When new, the rechargeable NiCad battery pack, PM9086/001 is not fully charged. See Section 1-4.*

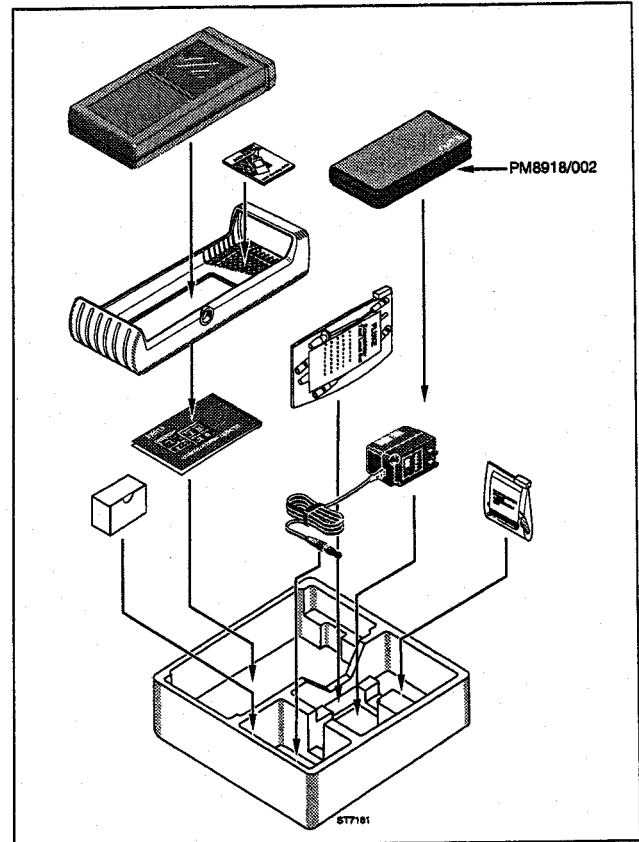

**Figure 1 ScopeMeter kit**

## WARNING

**READ "SAFETY" CAREFULLY BEFORE USING YOUR SCOPEMETER.**

## SAFETY

The instrument described in this manual is designed to be used only by qualified personnel.

## SAFETY PRECAUTIONS

To use this instrument safely, it is essential that operating and servicing personnel follow both generally accepted safety procedures and the safety precautions specified in this manual.









Specific warning and caution statements, where they apply, will be found throughout the manual.

Where necessary, the warning and caution statements and/or symbols are marked on the instrument.

**A CAUTION identifies conditions and actions that may damage the ScopeMeter.**

**A WARNING IDENTIFIES CONDITIONS AND ACTIONS THAT POSE HAZARD(S) TO THE USER.**

International electrical symbols used are explained below.

	Caution (see explanation in manual)		DOUBLE INSULATION (Protection Class).
	Common (Lo) input symbol, equipotentiality		Recycling symbol
	High BNC input symbol		DC-Direct Current
	Earth		AC-Alternating Current

The terms "Isolated" or "Electrically floating" are used in this manual to indicate a measurement in which the ScopeMeter COM (common, also called ground) is connected to a voltage different from earth ground. The term "Grounded" is used in this manual to indicate a measurement in which the ScopeMeter COM (common) is connected to an earth ground potential.

The ScopeMeter COM (common) inputs (Channel A red BNC shield, Channel B grey BNC shield, and black banana jack) are connected internally via self-recovering fault protection. The input connectors have no exposed metal and are fully insulated to protect against electrical shock. The black banana jack COM (common) can be connected to a voltage above earth ground for isolated (electrically floating) measurements and is rated up to 600V rms above earth ground.

The ScopeMeter uses a three lead connection system for dual channel, isolated (electrically floating) measurements. The connections for isolated and grounded measurements are shown in the following illustration.

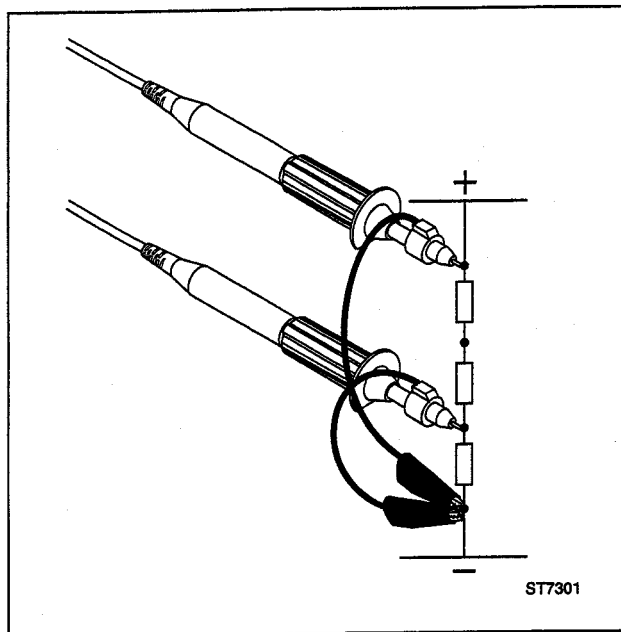

Figure 2 Common (Ground) connections

## **⚠ WARNING**

**TO AVOID ELECTRICAL SHOCK IF A SCOPEMETER COM (COMMON) INPUT IS CONNECTED TO >42V PEAK (30V RMS):**

1. **USE ONLY THE TEST LEAD SET AND THE SCOPEMETER PROBE SET OR TEST LEADS AND PROBES THAT ARE DESIGNED FOR MAKING ISOLATED (ELECTRICALLY FLOATING) MEASUREMENTS AND ARE DESIGNED FOR USE ON THE SCOPEMETER.**
2. **DO NOT USE CONVENTIONAL EXPOSED METAL BNC OR BANANA PLUG CONNECTORS IF THE COM ⚠ (COMMON) IS >42V PEAK (30V RMS).**
3. **USE ONLY ONE COM (COMMON) CONNECTION (THE BLACK BANANA JACK).**
4. **REMOVE ALL PROBES AND TEST LEADS THAT ARE NOT IN USE.**
5. **USE 600V RATED PROBE TIP ADAPTERS. "600V" IS PRINTED ON EQUIPMENT SO RATED.**

## IMPAIRED SAFETY-PROTECTION

**Use of equipment in a manner not specified may impair the protection provided by the equipment. Before use, inspect probes for mechanical damage and replace damaged probes!**

Whenever it is likely that safety has been impaired, the instrument must be turned off and disconnected from line power. The matter should then be referred to qualified personnel. Safety is likely to be impaired if, for example, the instrument fails to perform the intended measurements or shows visible damage.

## ISOLATED MEASUREMENTS

### Isolation from Earth Ground

ScopeMeter uses a three lead connection system for dual channel, isolated (electrically floating) measurements. Use a Test Lead connected to the black safety banana jack as common ground.

There are only three wires to connect for dual channel isolated ground operation, useful for three phase industrial voltage measurements. You can connect the three leads

on ScopeMeter (channel A, channel B, and common) to a three-phase electrical power line in any order. Use the **A-B** (A minus B) mode to display all three phases of electrical power at the same time.

For three-phase electrical or other isolated ground industrial measurements, we strongly recommend the AC 20 Industrial Alligator Clips and PM9084/001 Industrial Probe Clips (see Figure 4) be used. These parts are included with original purchase ScopeMeters and are also available as accessories from your FLUKE representative.

### Isolation from Channel to Channel

ScopeMeter is not isolated between channels, but uses the black safety banana jack for measurements isolated from earth ground.

Complete isolation between channel A and channel B is useful for some floating measurement applications such as measuring different isolated transformer windings at the same time.

For those applications requiring true isolated grounds (commons) between channels, we recommend that you make two separate measurements or use two ScopeMeters.

## USING THE DEMONSTRATION (DEMO) BOARD

A Demo Board is included in your ScopeMeter kit. It generates different types of waveforms that can be measured at the testpoints TP1 to TP5. All descriptions and measurement examples are referred to a waveform that can be measured on this Demo Board.

Before making any measurement on the Demo Board, take care of the following:

- Place the Demo Board on a non-conductive surface.
- Connect the 9 volt battery, and make sure that polarity is correct.
- Connect the black banana to the COM black banana jack and to the GND testpoint of the Demo Board.
- Connect the red scope probe to the CHANNEL A BNC input and to the testpoint that is indicated in the Users Manual.

- Connect the grey scope probe to the CHANNEL B BNC input and to the testpoint that is indicated in the Users Manual.

The displays and measurements shown in this manual are typical. They will vary dependent on the condition of the Demo Board battery.



**NOTE**

### **ENVIRONMENTAL CARE**

*Your ScopeMeter contains a Nickel-Cadmium battery. Do not dispose of this battery with other solid waste. Used batteries should be disposed of by a qualified recycler or hazardous materials handler. Contact your authorized FLUKE Service Center for recycling information.*

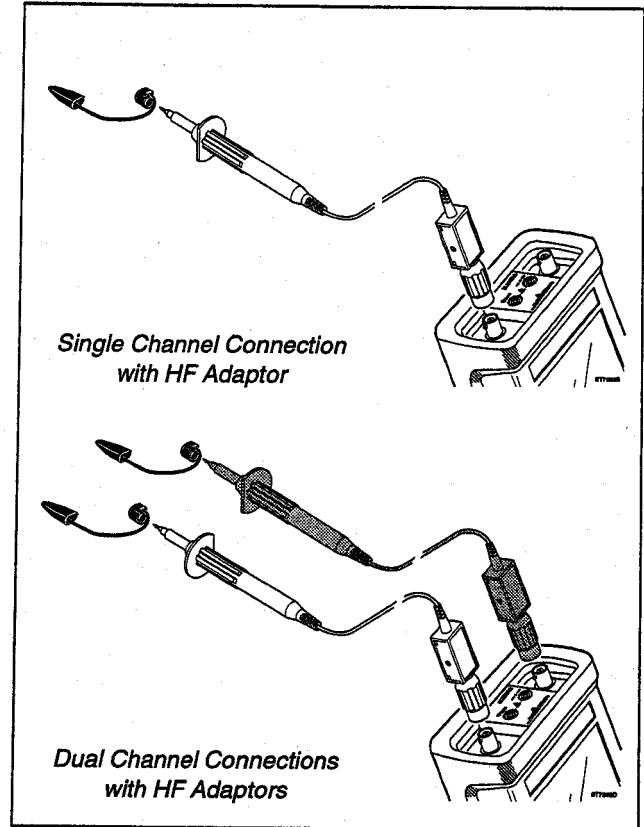
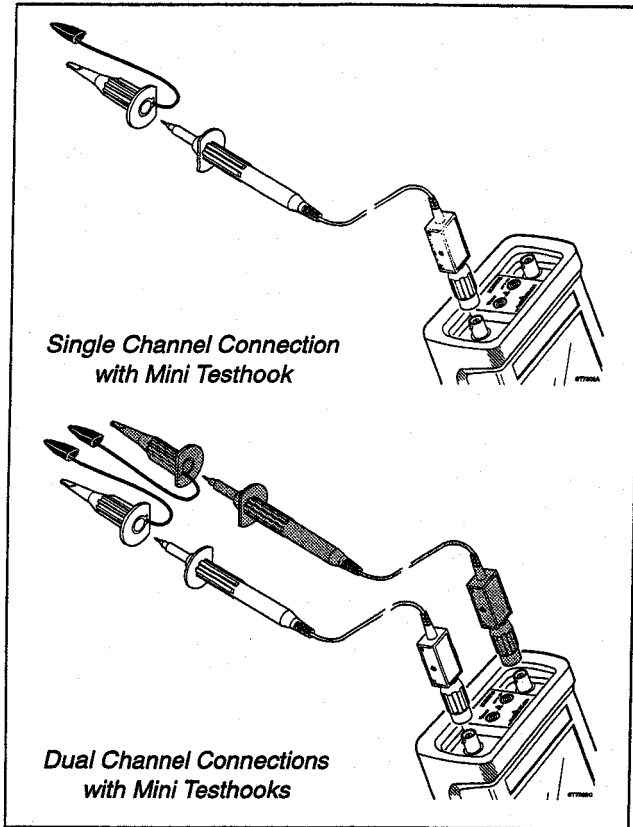

**Figure 3** ScopeMeter connections for High Frequency Electronic Measurement

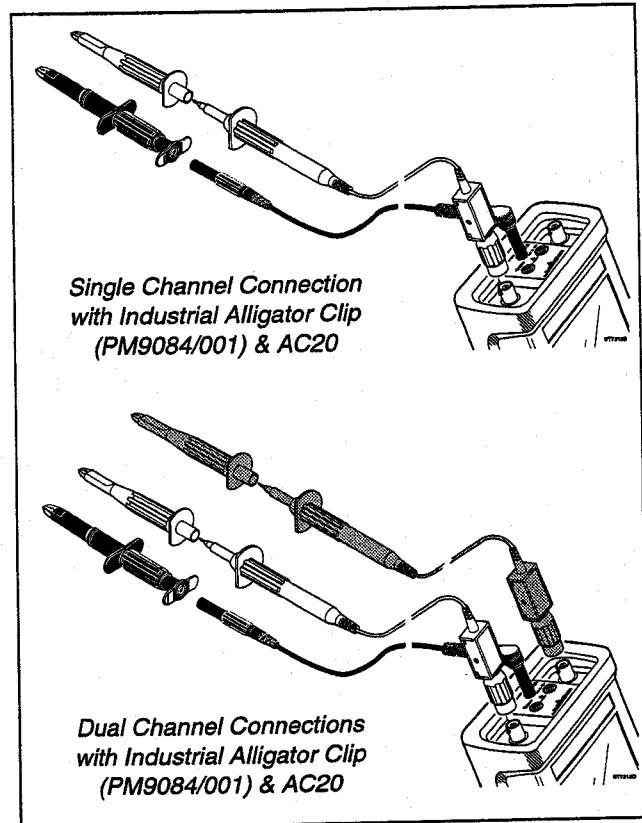
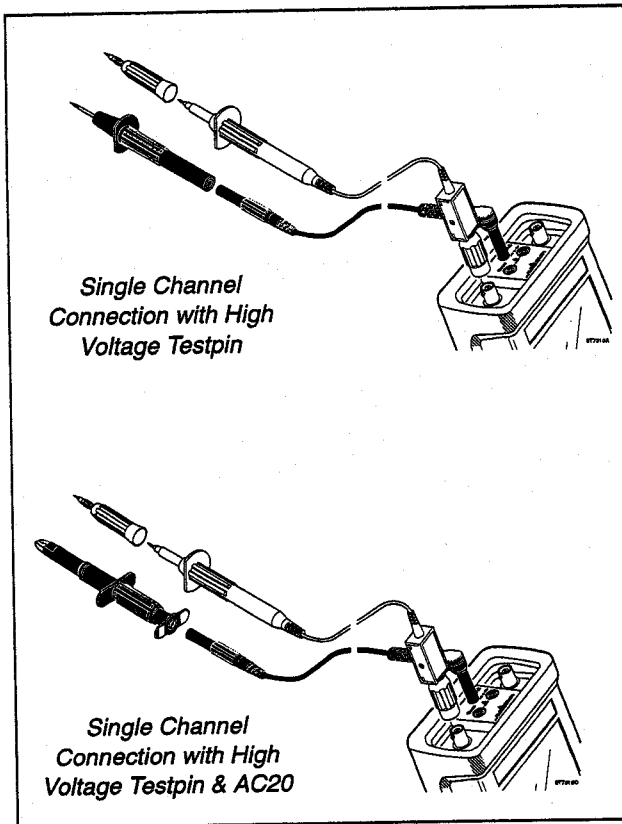

**Figure 4** Input connections for Isolated Ground Heavy Duty Industrial Measurements





# Section 1

## Introducing Your ScopeMeter

### Contents

---

<b>SCOPEMETER FEATURES</b> .....	1-2	Bottom Display .....	1-7
<b>HOLSTER</b> .....	1-2	Message Bars .....	1-7
<b>TILT STAND</b> .....	1-3	<b>USING THE KEYS</b> .....	1-8
<b>POWERING SCOPEMETER</b> .....	1-4	<b>GETTING STARTED</b> .....	1-8
<b>BATTERY CHARGING</b> .....	1-5	<b>ADJUSTING THE DISPLAY</b> .....	1-9
Battery Save feature .....	1-5	Contrast .....	1-9
<b>MEASUREMENT CONNECTIONS</b> .....	1-6	Backlight .....	1-9
Meter Inputs .....	1-6	Picture .....	1-9
Scope Inputs .....	1-6	Grid .....	1-10
Common Ground, Channels A B .....	1-6	<b>SELECT YOUR PROBE TYPE</b> .....	1-10
Input/Output Terminal Ratings .....	1-6	<b>DEFAULT STARTUP PROBE TYPE</b> .....	1-10
RS-232-C Optical Interface Connection .....	1-6	Default Startup 10:1 (Master Reset) .....	1-10
<b>READING THE DISPLAY</b> .....	1-7	Default Startup 1:1 .....	1-11
Top Display (Scope Mode Only) .....	1-7	<b>AUTO SET</b> .....	1-11
Main Display .....	1-7	<b>UNDO</b> .....	1-11
Right Display (including Pop-Up Menu) .....	1-7	<b>USING THE DEMONSTRATION (DEMO) BOARD</b> .	1-12

## SCOPEMETER FEATURES

Your ScopeMeter combines the capabilities of a dual-trace, digital storage oscilloscope with the versatility of a digital multimeter. This combination allows you to analyze and compare complex waveforms, read voltage levels, or simply measure resistances.

ScopeMeter features include:

- Dual Trace, 50 MHz Bandwidth Scope.
- 25 million samples-per-second, 40 ns glitch capture capability.
- 3  $\frac{2}{3}$  digit, 3000-Count Digital Multimeter (DMM).
- Menu-Driven Operator Interface for easy operation.
- Storage of 10 front panel setups (Meter and Scope Modes) allows for semi-automated operation.
- Digital storage for eight waveforms.
- Simultaneous display of four waveforms (any combination of live and stored) allows for useful comparisons.
- Auto set configures ScopeMeter to select the best voltage and time base setting for a meaningful display.
- Undo feature allows you to step back through the 10 most recent key presses.
- True portability and three power source choices allow for testing in real-life environments.
- A Quick Operating Guide, found in the ScopeMeter holster, serves as a useful reference.

## HOLSTER

The ScopeMeter is cradled in a custom yellow holster that provides shock protection during rough handling. All keys and connections are accessible with the holster in place. You will need to remove the holster only when replacing the batteries or accessing the Quick Operating Guide (See Section 7 for battery replacement instructions).

## TILT STAND

The ScopeMeter is equipped with a multipurpose tilt stand, allowing viewing from different angles. The stand can also be used to hang the ScopeMeter at a convenient viewing position. Simply push up on the quick release and tilt the stand. The tilt stand/bracket is fully usable with the yellow holster fitted on ScopeMeter. Typical uses are shown in Figure 1.1.

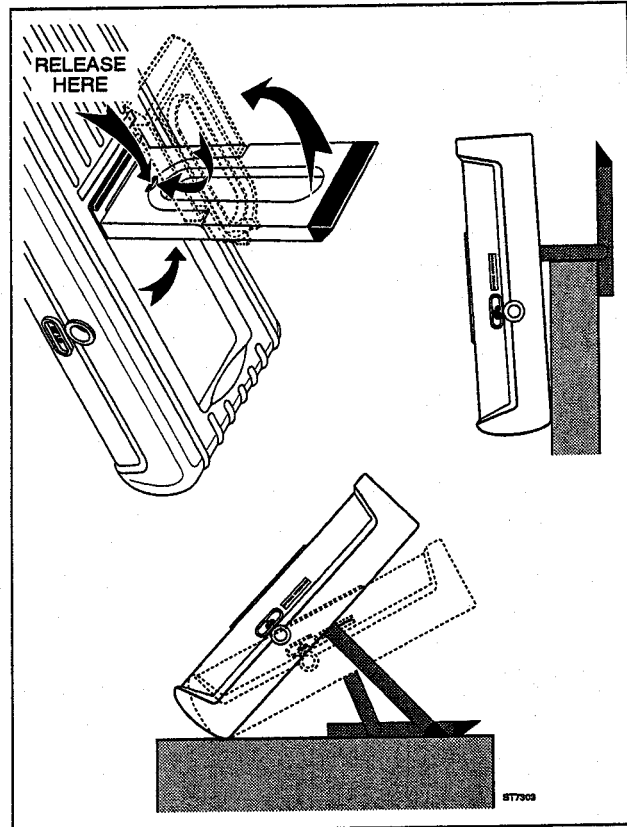

Figure 1.1 Multi-Position Stand

## POWERING SCOPEMETER

ScopeMeter can be powered from any of the following sources. Refer to Figure 1.2

- **Internal Battery Pack**  
A PM9086/001 Rechargeable NiCad Battery Pack comes installed in every ScopeMeter.
- **C Cell Batteries**  
You can use four alkaline batteries in place of the NiCad Battery Pack. (The charger is defeated when standard C cells are installed).
- **AC Adapter**  
The PM8907 Power Adapter/Battery Charger powers ScopeMeter from a standard ac outlet. ScopeMeter can be used during battery charging. Verify that your local line voltage is appropriate before using the Power Adapter/Battery Charger to power ScopeMeter and/or charge the battery pack.  
  
See Appendix 8C for more information.
- **Automotive Adapter (optional)**  
The PM9087/002 powers and/or charges ScopeMeter from a standard 12V dc automotive accessory (lighter) outlet.

Refer to Section 7 for battery replacement instructions.

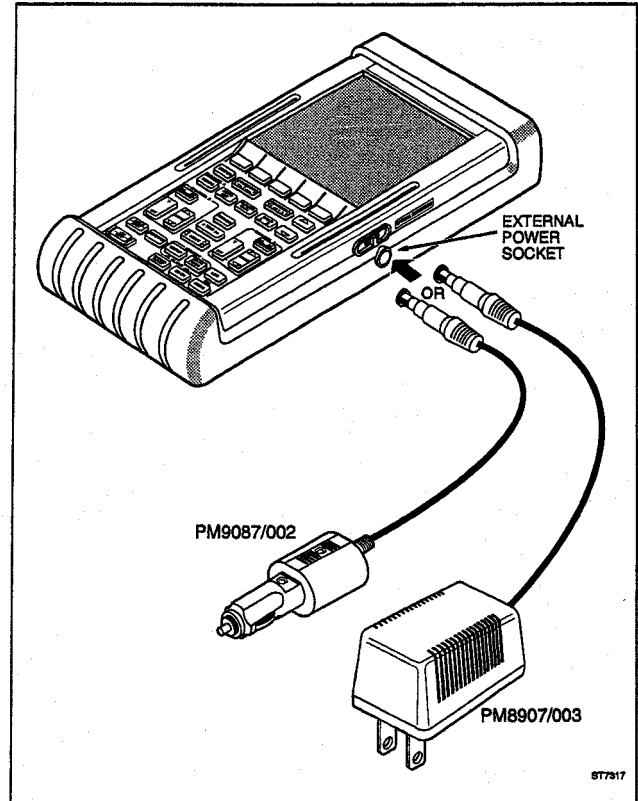

Figure 1.2 Power connections

## BATTERY CHARGING



### WARNING

**TO AVOID ELECTRICAL SHOCK, USE ONLY A BATTERY CHARGER THAT IS AUTHORIZED FOR USE WITH SCOPEMETER.**

Use the following procedure to charge the battery pack and power the instrument:

1. Insert the PM8907 Power Adapter/Battery Charger low voltage plug into ScopeMeter's POWER ADAPTER connector.
2. Connect the PM8907 Power Adapter/Battery Charger to line voltage. ScopeMeter can now be used while the NiCad Battery Pack charges slowly. If ScopeMeter is off, the Battery Pack charges more quickly.

At power on,  **POWER** or **ADAPTER POWER** is displayed to indicate the power source.

During operation, when the batteries are low, a blinking battery symbol  appears in the lower left corner of the display. When this occurs there is typically more than 30 minutes operating time left.

3. The PM8907 trickle charges the batteries, so no damage can occur if you leave ScopeMeter charging for long periods e.g., through the weekend. Typically 16 hours recharge provides 4 hours of use.

### Battery Save feature

When operated only on batteries, ScopeMeter conserves power by beginning to shut itself down if no new key entries are made for five minutes or if the battery level is too low. ScopeMeter beeps and momentarily displays the following message bar:

**ScopeMeter auto shutdown in 5 minutes!!**

If no key is pressed during the next five minutes, ScopeMeter turns itself off automatically. When  is pressed ON, the display configuration in effect before the automatic shutdown is restored.

If Meter Record or Scope Record mode is on, ScopeMeter continues recording even if no key entries are made. Although recording will continue if the batteries are low, retention of waveform and setup memories is not jeopardized.

If the POWER ADAPTER is connected, there is no automatic power shutdown.

## MEASUREMENT CONNECTIONS

ScopeMeter provides four signal connection points: two BNC safety inputs (CHANNEL A and CHANNEL B) and two safety banana jack inputs (COM and  $mV \Omega$   $\leftrightarrow$ ). This arrangement is shown in Figure 1.3. All four connections are positioned within a protective recess at the top of the instrument.

The banana jacks are also used as Signal Generator Output.

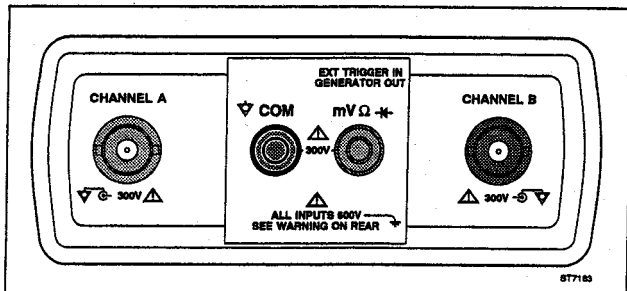

Figure 1.3 Measurement Connections

### Meter Inputs

In Meter Mode, ScopeMeter inputs are the red safety CHANNEL A BNC jack for  $V_{\approx}$  and  $V_{\infty}$  measurement functions. The red safety banana jack is used for  $\leftrightarrow$ , and  $\Omega$  measurement functions, and for accessory measurements  $mV_{\infty}$ . For low frequency measurements (up to about 2 MHz), ground can be connected to the black safety banana jack.

### Scope Inputs

In Scope Mode, ScopeMeter inputs are the red safety CHANNEL A BNC jack and at the grey safety CHANNEL B BNC jack. For low frequency measurements (up to about 2 MHz), ground can be connected to the black safety banana jack.

The red safety banana jack also serves as an input connection for an external trigger in Scope mode or as an output connection for the signal generator. This signal generator can provide voltage or current output.

### Common Ground, Channels A B

The ScopeMeter uses a three-lead connection system for dual channel, isolated (electrically floating) measurements.

### Input/Output Terminal Ratings

Maximum voltage ratings are defined on ScopeMeter near the related terminal. Refer to the Specifications in Appendix 8A for complete terminal rating information.

### RS-232-C Optical Interface Connection ~~98~~ ~~95~~

The PM9080/001 optically isolated RS-232-C interface adapter can be connected to ScopeMeter for printer output and computer interface. This adapter is optional.

## READING THE DISPLAY

The ScopeMeter display presents you with a great deal of information. The major part of the display is always devoted to the meter reading or scope waveform. The top, bottom, and right-side display area describes the reading or waveform much more precisely. Refer to Figure 1.4 during the following discussions.

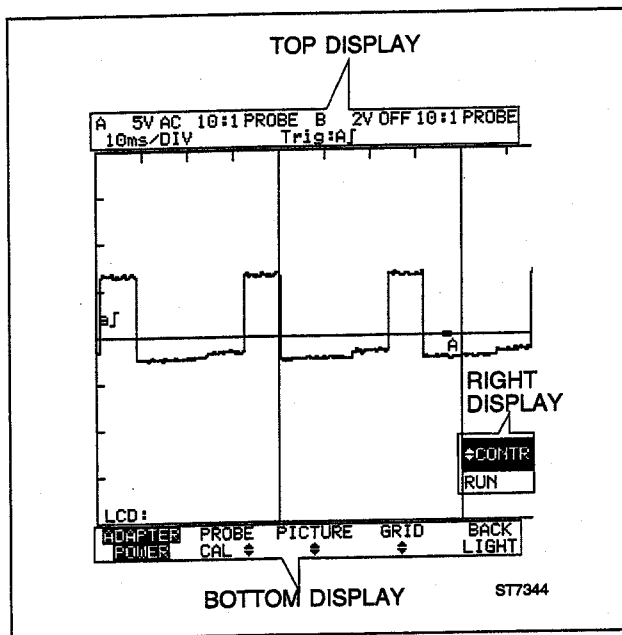

Figure 1.4 ScopeMeter display

### Top Display (Scope Mode Only)

Identifies the voltage amplitude, type of signal coupling, selected probe type for channels A and B, time scale, trigger source, and trigger slope.

### Main Display

Displays the numeric measurement (Meter Mode), actual or stored waveforms (Scope Mode), or a combination (Scope Trace display in Meter Mode).

### Right Display (including Pop-Up Menu)

Used to display choices accessed with the related softkey from which you make a selection by pressing the blue  $\triangle$   $\nabla$  keys. Once you make a selection from a pop-up menu (visible in reverse video), press  $\text{SOFT KEY}$  (ENTER) to activate the function. A selected function is indicated by a large square to the left of the selected item. In some pop-up menus more than one function can be selected before the pop-up menu disappears. Press the same softkey to switch the pop-up menu off again.

### Bottom Display

Provides choices available through the softkeys and shows which are active.

### NOTE

*If no selection is made, the pop-up menu closes automatically after about 30 seconds.*

### Message Bars

Provide information about the present condition or explain procedures taking place.



## USING THE KEYS

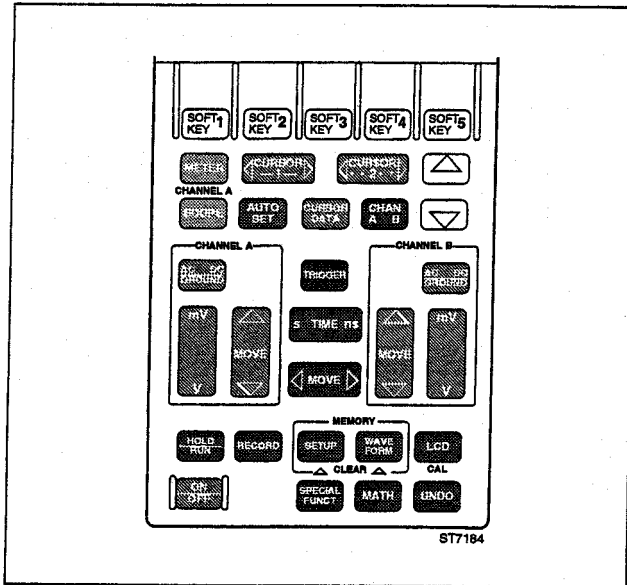



Figure 1.5 The Keypad

Hardkeys have a predefined function, regardless of ScopeMeter's mode. Mostly they give access to a menu, where items can be selected using pop-up menus and softkeys. The five unmarked blue keys are called softkeys. These keys change function based on the current mode or settings. Actual softkey definitions appear on the bottom

display. Softkeys and pop-up menus work together to provide a complete menu-driven user interface. The  softkeys are used to choose an item in the pop-up menu and are indicated by two blue arrows.

### NOTE:

*Although not so marked, the five blue softkeys along the top of the keypad are referred to as*

    .

*This approach simplifies references in this manual.*

 is often the 'ENTER' key, which activates the choice you highlighted.

## GETTING STARTED

This section provides a 10-minute demonstration intended for those who are not familiar with ScopeMeter. It gives some hands-on experience, with an emphasis on learning by seeing and doing. Those who are familiar with ScopeMeter can skip the following pages and continue to Section 2.

Press  ON, to turn on the ScopeMeter. Operation begins in the last-known configuration and the LCD Softkey Menu appears. Factory default settings are used at the first power up. Subsequent power ups maintain configuration changes made with keystrokes or through recall of a setup memory during the previous session. Master Reset is explained in detail later in this section.

## ADJUSTING THE DISPLAY

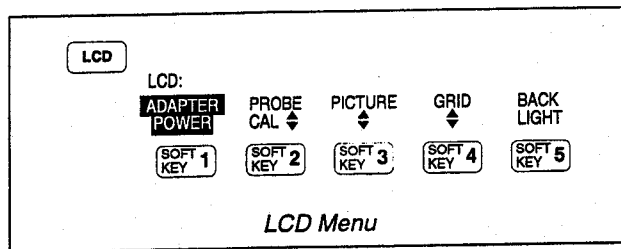

- At power on, **ON** **POWER** or **ADAPTER POWER** is displayed in the Bottom Display to indicate the power source.

### Contrast

- Press **▲** **▼** to adjust the contrast of the LCD to your preference. Note that contrast adjustment of the LCD is stored in the ScopeMeter memory until a new adjustment is made.

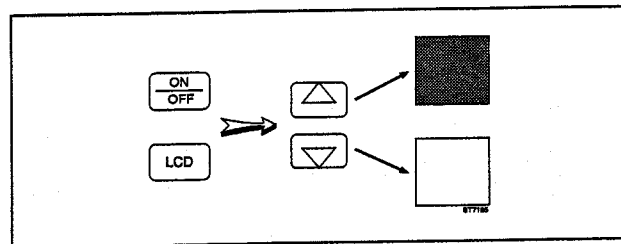

Figure 1.6 Contrast adjustment

Contrast adjustment is also available after **LCD** is pressed.

### Backlight ~~98~~ ~~95~~

- Press **SOFT KEY 5** to activate or deactivate the backlight. Note that using the backlight shortens battery power operation time by about 1/2 hour.

### Picture

- Press **SCOPE** to activate Scope Mode.
- Press **LCD**.
- Press **SOFT KEY 3** to enter the PICTURE Pop-Up Menu.
- Use **▼** to highlight DOTSIZ 3
- Press **SOFT KEY 5** to activate.

You have now changed the trace width to be three dots wide. In the same way you can select DOTSIZ 1 or 2 for a single or double dot trace width. In the PICTURE Pop-up menu you can also choose the DOT JOIN function which either shows the individual measurement samples or joins them together to give a continuous trace. REVERSE allows you to select positive or negative video of the LCD.

## Grid

- Press **SOFT KEY 4** to enter the GRID Pop-Up menu. Choose FULL, QUADRANT, or BORDER. BORDER provides only a perimeter line with time and amplitude division marks. QUADRANT adds horizontal and vertical center-lines as additional reference points to the border display. FULL adds a crosshatch pattern based on the horizontal time and vertical amplitude divisions on the display.

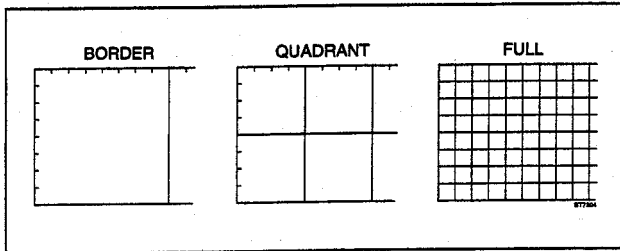

Figure 1.7 Grid selection

## SELECT YOUR PROBE TYPE

To prevent measurement errors, at power up ensure that your ScopeMeter is adapted to your probe.

- Press **SOFT KEY 2** to enter the PROBE CAL Pop-Up menu. Select the probe type for channel A and channel B (1:1, 10:1, 100:1, or 1000:1). Note that the PM8918

probes, delivered with the ScopeMeter, have an attenuation of 10:1.

For accurate measurement periodic probe dc calibration and ac adjustment are necessary. This is explained in Section 7, "User Maintenance".

## DEFAULT STARTUP PROBE TYPE

### Default Startup 10:1 (Master Reset)



1. Turn ScopeMeter off.
2. Press and hold **LCD**.
3. Press and release **ON/OFF**.  
ScopeMeter turns on, and you should hear a double beep, indicating the master reset was successful. The pop-up menu should display 10:1 probe.

Perform a Master Reset to make sure that your ScopeMeter is in the default starting condition. Master Reset sets ScopeMeter for using 10:1 probes. Refer to Section 4 for a further discussion of the Master Reset procedure.

### CAUTION

**A Master Reset erases everything stored in setup and waveform memory. Never perform a Master Reset unless you are prepared to lose everything you stored in memory.**

**Default Startup 1:1**

1. Turn ScopeMeter off.
2. Press and hold .
3. Press and release .

ScopeMeter turns on, and you should hear a single beep. The pop-up menu should display 1:1 probe. This feature is very useful when using the direct test leads or 1:1 probes.

**AUTO SET**

For quick operation, ScopeMeter is equipped with an AUTO SET function. This function optimizes the range in Meter mode or sets the parameters (timebase and amplitude) in SCOPE mode. Often, you will only need to press  to obtain a meaningful display. You can redefine "Auto set" configuration to your own preference. Refer to Section 4 for a further discussion of redefinition of Auto set.

**UNDO**  

Press  to step back through preceding key/display configurations; you can take 10 steps back in this fashion. Use it when you made a mistake in operation.

## USING THE DEMONSTRATION (DEMO) BOARD

During the Quick Meter and Quick Scope Operation you will use the Demo Board that is included with your ScopeMeter kit. Before making any measurement, take care of the safety precautions that are given on page V. The setup for this demonstration is given in Figure 1.8.

- Connect the red scope probe to TP2.

For the Meter and Scope Demonstration, continue with Quick Meter Operation.

### NOTE

*This signal does not produce perfectly stable meter readings. The displays and measurements are typical. They will vary dependent on the condition of the Demo Board battery.*

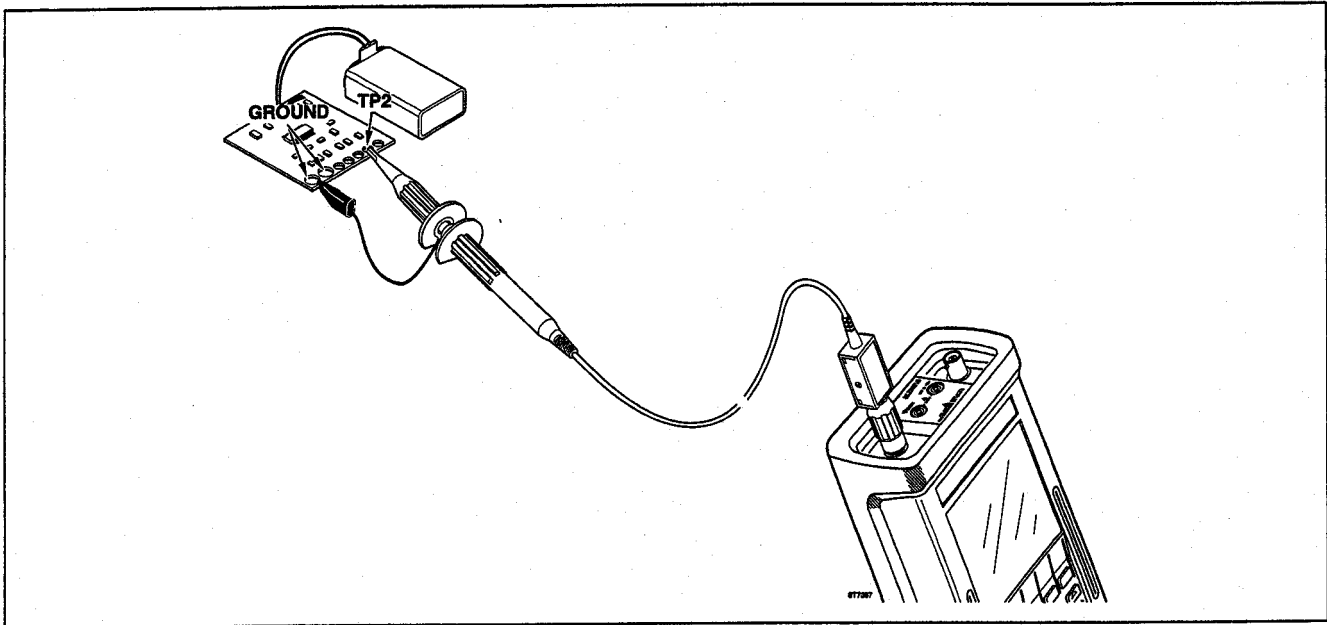
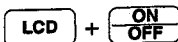

Figure 1.8 ScopeMeter Demonstration Connections

①



Perform a Master Reset to turn ScopeMeter on.

②



Activates Meter Mode. All five softkey definitions in the bottom display now change to meter function identifiers. The ScopeMeter has a Digital Multimeter Mode (DMM) to display the measured result in a numerical value. (Ensure the probe range is 10:1, as indicated in the pop-up menu. If necessary, select the 10:1 probe type). ScopeMeter displays about Vrms AC "3.400" and V DC "2.140".

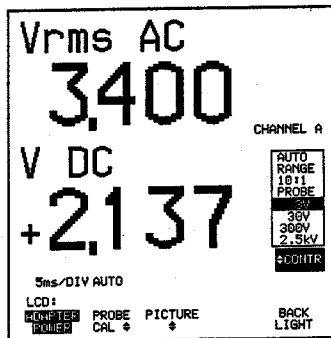

③



Pop-up menu changes to 30V manual range; screen displays Vrms AC "03.40" and V DC "02.14"

④





Press this key once to freeze the displayed measurement. HLD appears on the display.

⑤



Press this key once again to resume new measurements.

Continued to next page

- ⑥ **AUTO SET** ScopeMeter automatically assumes a new setup that is optimized for measuring the actual input signal.
- ⑦ **SOFT KEY 1** Activates  $V_{\text{RMS}}$  Mode. ScopeMeter displays the  $V_{\text{RMS}}$  result in a numerical value, but an additional scope trace now gives a graphical representation of the waveform.
- ⑧ **CHAN A B** **Key not possible in this ScopeMeter mode** Some keys can be used only in the Scope Mode. ScopeMeter operation continues uninterrupted. After a few seconds, this message clears itself from the display.
- ⑨ **SOFT KEY 1** Activates the MODE Pop-Up Menu. Press   to highlight FREQUENCY.
- ⑩ **SOFT KEY 5** Press the fifth softkey (ENTER) to activate FREQUENCY. ScopeMeter now displays the frequency in a numerical value of about Hz "32.00".

This completes the Quick Meter Operation demo, continue with Quick Scope Operation.

### **Quick Meter Operation**

If you have not done so already perform step 1 of the Quick Meter Operaton.

①

**SCOPE**

Activates Scope Mode.

②

**AUTO SET**

This always gives you a readable display. An image of the signal appears on the display. The top display shows the attenuator, probe, timebase and trigger information.

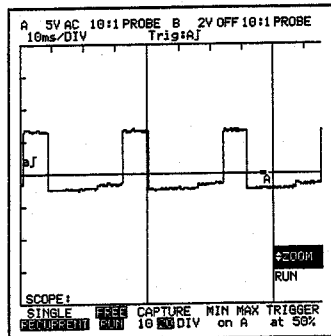

③

**V** chA

The waveform amplitude decreases. The attenuator scale in the top display changes to a less sensitive range.

④

**S TIME**

The number of periods of the waveform increases. The timebase scale in the top display changes to a slower time /DIV.

⑤

**MOVE** chA

The waveform shifts upwards.

⑥









**MOVE**

The waveform shifts to the right on the display.

Continued to next page

**Quick Scope Operation**



- ⑦  Take a look at the Trigger Softkey Menu now.
- ⑧  Choose a trigger source. For now, select A and continue on. If B is selected, the waveform wanders; there is no input on channel B. If EXT is selected, ScopeMeter's External Trigger input supplies the trigger.
- ⑨  Begin display as the waveform rises above the trigger level (+SLOPE) or falls below the trigger level (-SLOPE). Watch the display; the pattern starts at a different place as trigger + or - is selected. Continue with +SLOPE.
- ⑩  This enables the Trigger LEVEL function. The level value is displayed below LEVEL in the Right Display, and is visualized by the a ] icon on the left edge of the display. Ensure also that RUN is displayed underneath the level value as an indication that your ScopeMeter is triggered.
- ⑪  Adjust the trigger level: the a ] icon moves upwards as you change the trigger level. When the level is more than the signal value, RUN changes into NOTRIG, and the display becomes unstable: your ScopeMeter is no longer triggered.
- ⑫  Return to Scope Mode menu.
- ⑬  This sets the trigger level automatically to 50% of the waveform amplitude, so that ScopeMeter is always triggered on a signal.
- ⑭  Turn ScopeMeter off again.

You are now able to operate ScopeMeter's basic functions in routine applications. Continue with Sections 2 and 3 for a more detailed discussion of the Meter Mode and Scope Mode.

### ***Quick Scope Operation***

# Section 2

## Using the Meter

### Contents

---

<b>METER MODE CONNECTIONS</b> .....	2-2	<b>ZERO <math>\Delta</math></b> .....	2-11
<b>METER AUTO-MEASUREMENT FUNCTION</b> .....	2-3	<b>FAST/SMOOTH</b> .....	2-11
<b>METER FUNCTIONS AND METER RANGES</b> .....	2-4	<b>DISPLAY MODES (cont.)</b> .....	2-11
Manual/Auto Range .....	2-5	<b>%<math>\Delta</math></b> .....	2-11
<b>DISPLAY MODES</b> .....	2-6	Scaling .....	2-12
<b>TOUCH HOLD</b> .....	2-8	Volt math .....	2-13
Display hold .....	2-8	Using Meter Record Mode to Set Scale Values .	2-13
<b>METER RECORD</b> .....	2-9	Using Meter Record Mode to Set Zero Value ..	2-15
<b>ALERT</b> .....	2-11		

## METER MODE CONNECTIONS

In Meter Mode, use the red safety CHANNEL A BNC-jack for  $V_{\approx}$  and  $V_{\approx}$  measurement functions. When you use the PM8918 probe, select the 10:1 probe type for correct decimal readout (see Section 1). The red safety banana jack is used for  $mV_{\approx}$ ,  $\rightarrow$ , and  $\Omega$  measurement functions. Use the black safety banana jack as common ground for signals upto about 2 MHz. Measurement connections for the Meter Mode functions are shown in Figure 2.1

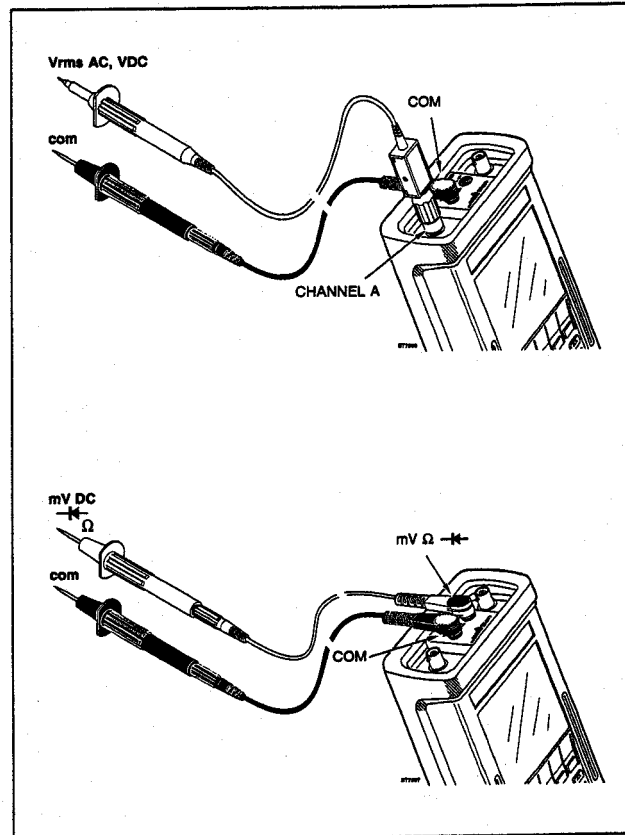

Figure 2.1 Meter Mode Connections

## METER AUTO-MEASUREMENT FUNCTION

At power-on, the ScopeMeter starts with the settings that were active at power-off. If the ScopeMeter is in a lower Meter Mode menu, or in Scope Mode, press the **METER** key twice to access ac plus dc Voltmeter display mode. Both the ac and dc part of the input signal supplied to the red input BNC of channel A are separately displayed.

The Meter Mode has an auto-measurement function. This function automatically ranges the signal supplied to channel A without making any additional meter settings.

Choose a meter function with any of the five softkeys:

$V_{\sim}$  ,  $V_{=}$  ,  $mV_{=}$  ,  $\ast$ , or  $\Omega$

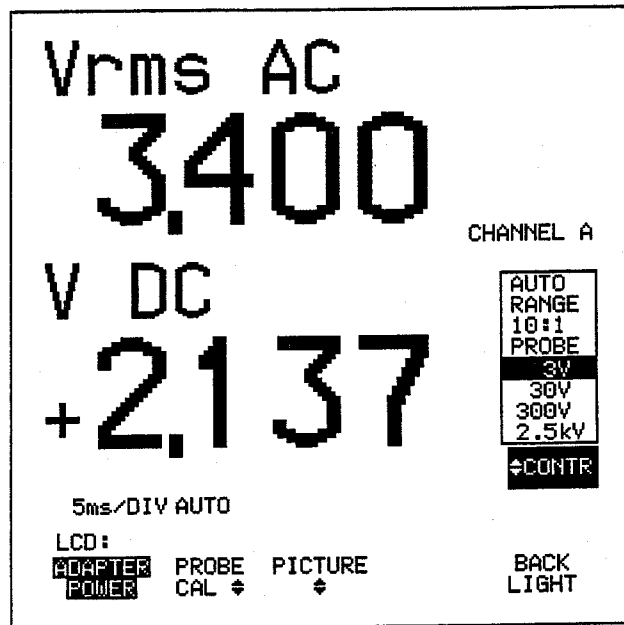

## METER FUNCTIONS AND METER RANGES

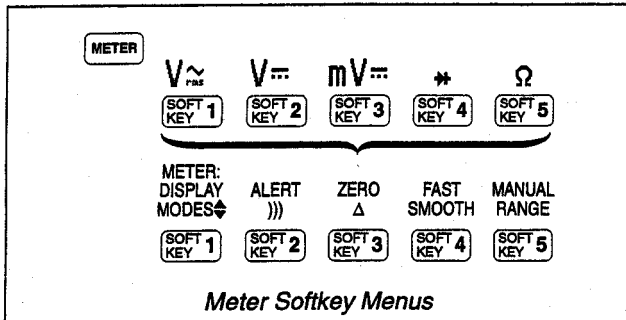

When a meter function is selected, the softkey menu gives the corresponding specific function control menu. The display changes into a combined meter display and scope trace display. In addition to the numerical representation the ScopeMeter automatically shows a "5 division scope trace". In manual ranging, the ranges are selected with the  $\Delta$  and  $\nabla$  keys or with CHANNEL A  $\overline{mV}$   $\downarrow$ . Available ranges and the highlighted selected range are shown on the right side of the display.

Press  $\text{TIME}$  to select the desired time base. In  $V_{\sim}$  and  $V_{=}$ , you can select time bases from 1  $\mu$ s to 100 ms/div. In  $mV_{=}$ ,  $\ast$ , and  $\Omega$ , the time base is fixed at 5 ms/div.

$\text{SOFT KEY 1}$   $V_{\sim}$  Channel A is used for the input to measure Vrms AC (Alternating Voltage Root-Mean-Square) signals, resulting in a 3000-count meter display or a combined dis-

play with meter digits and a scope trace. You can also select ac or dc input coupling, time base speed, and the range of both the scope trace and meter display.

Input Coupling: When Vrms AC is selected, press  $\text{GROUND}$  to select the type of input coupling for channel A. when the display shows "Vrms AC", an ac-coupled input is selected. When the display shows "Vrms AC+DC", dc-coupled input is selected.

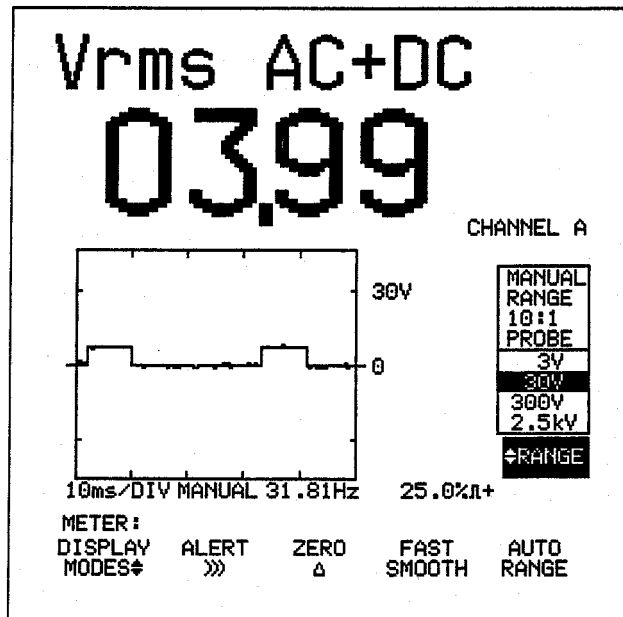

**SOFT KEY 2**  $V_{\text{DC}}$  Direct Voltage function. Signals supplied to channel A are measured. The measurement result is displayed in a  $3\frac{2}{3}$ -digit display and a scope trace. For the 10:1 scope probe the actual ranges are 3V, 30V, 300V, and 3 kV.

**SOFT KEY 3**  $mV_{\Omega}$  Direct milliVolt function. Signals supplied to the  $mV_{\Omega}$  and COMmon banana jack inputs are measured. The measurement result is displayed as a  $3\frac{2}{3}$ -digit display and a scope trace. The ranges are 300 mV and 3V. *The time base is fixed at 5 ms/DIV.*

**SOFT KEY 4**  $\rightarrow$  Diode test function. Using the function, a diode connected to the  $mV_{\Omega}$  and COMmon banana jack inputs can be tested. The measurement current through the diode is 0.5 mA. The RED banana jack is the high input while the BLACK one is the low. The result is displayed as the forward or reverse voltage of a diode. *The time base is fixed at 5 ms/DIV and the attenuator at 3V.*

#### NOTE

*In the diode and resistance test function the black COMmon banana jack is not connected internally to the common of the scope BNC inputs of channel A and B.*

**SOFT KEY 5**  $\Omega$  Resistance function. A resistor connected to the  $mV_{\Omega}$  and COMmon banana jack inputs is measured.

The RED banana socket is the high input while the BLACK one is the low. *The time base is fixed at 5 ms/DIV.*

#### NOTE

*In the diode and resistance test function the black COMmon banana jack is not connected internally to the common of the scope BNC inputs of channel A and B.*

The measurement result is displayed as a  $3\frac{2}{3}$ -digit display. The ranges are 30 $\Omega$  (manual only), 300 $\Omega$ , 3 k $\Omega$ , 30 k $\Omega$ , 300 k $\Omega$ , 3 M $\Omega$ , and 30 M $\Omega$ . A beeper warning is generated at <5% of a selected range in Manual Range Mode. The beeper warning is turned on with ALERT))).

#### Manual/Auto Range

From each Meter function, you can toggle between manual and auto ranging by pressing **SOFT KEY 5** (except diode test function).

In manual range, the ScopeMeter input attenuator range can now be changed by pressing  $\triangle$   $\nabla$  or the CHANNEL A  $mV$   $v$  key. If in auto range, this switches automatically to manual range. An overview of the ranges and the highlighted selected range is shown on the display.

Select the desired time base range by pressing **TIME**.

Ranges available for each function are shown in Figure 2.2.

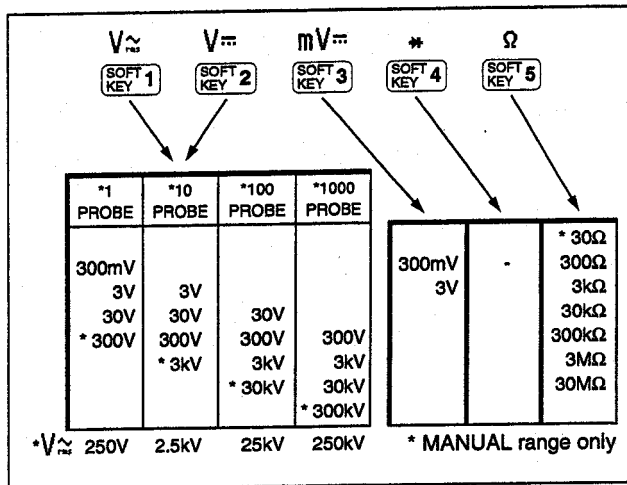

Figure 2.2 Meter Ranges

Auto ranging (automatic setting of the attenuator and time base) is selected when you do any of the following actions:

- Press **AUTO SET**.
- Press **SOFT KEY 6** from each Meter function.
- Select a new Meter function.

#### NOTE

In the  $\Omega$  function, the 30 $\Omega$  range can be selected only in manual ranging.

## DISPLAY MODES

Once you have selected a specific Meter function, you can access the Display Modes Pop-Up Menu by pressing **SOFT KEY 1**.

**FREQUENCY** Select frequency to display the frequency of the input signal in a numerical value. Measures the frequency of the input signal in V<sub>rms</sub> AC, V<sub>rms</sub> AC + DC, and V DC functions. Frequency counter resolution is four full digits, for example: 31.97 Hz.

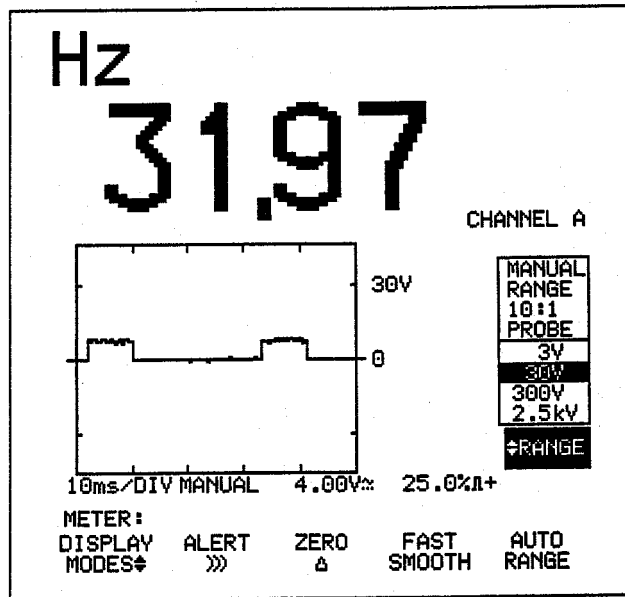

**DUTY CYCLE** Select duty cycle to display the relative on-to-off time of a varying input signal. It is shown as a percentage figure. You must select DUTY%+ or DUTY%- to display the duty cycle of the input above or below the reference level.

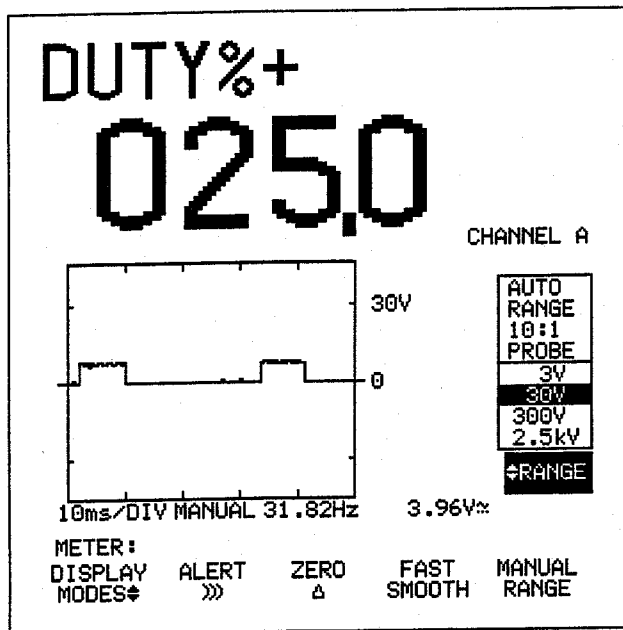

**TRACE DISP** Trace display turns the scope trace off and on. In Vrms and VDC functions, the frequency and duty cycle values are also displayed if the trace is turned off. Trace display is on by default when a meter function is selected.

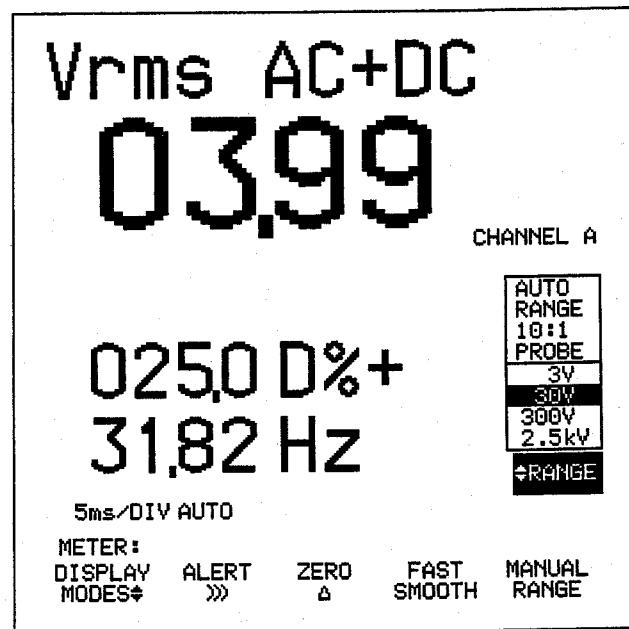



Refer to the end of this section for a detailed description of all other functions in this pop-up menu (%Δ, Scaling, and Volt Math).



## TOUCH HOLD®

Touch Hold captures the next stable measurement and a beep indicates that a measurement has been made. When first switched on, the numeric display is frozen (held) until a stable measurement is detected. Stable measurements are defined as within  $\pm 100$  display counts for 1s; and above 200 display counts in VDC and mVDC, 300 display counts in VAC, and below overload (OL) in  $\Omega$  and diode test. **HLD** is displayed in large non-reverse characters when Touch Hold is active.

The following procedure can be used for Touch Hold:

1. Press  and measure the signal.
2. Wait until the ScopeMeter produces a beeper signal to indicate a stable signal.
3. Remove the measuring leads and read the result from the display.
4. Measure a new signal, wait for the beeper, remove the leads, and read again.
5. Press  to return to normal measurement mode.

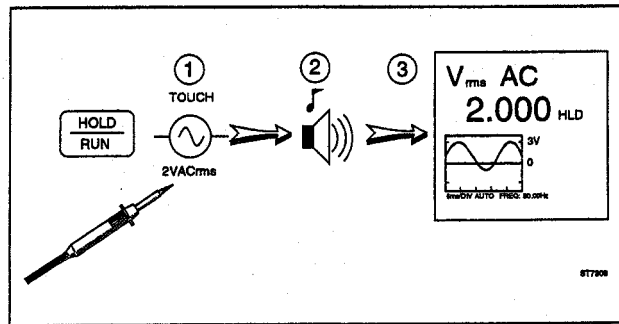



Figure 2.3 Touch Hold

### NOTE

*Touch Hold is not available with the FREQUENCY or DUTY CYCLE display modes, FAST SMOOTH, and the Meter Record mode. HLD is displayed in reverse characters for these functions.*

### Display hold

You can press  at any time to freeze the displayed reading. **HLD** appears in the display (reversed or non-reversed). Press  a second time to resume the display updates.

**METER RECORD** 

Press **RECORD** to record the maximum (**MAX**), average (**AVG**), and minimum (**MIN**) readings. ScopeMeter continues also to display the present readings (**NOW**). Time stamps appear next to the MAX, AVG, and MIN readings to show the elapsed time in hours, minutes, and seconds since Meter Record start to the most recent change in the respective reading. The AVG time stamp updates continuously. The MAX and MIN time stamps update only when new high or low readings are encountered.

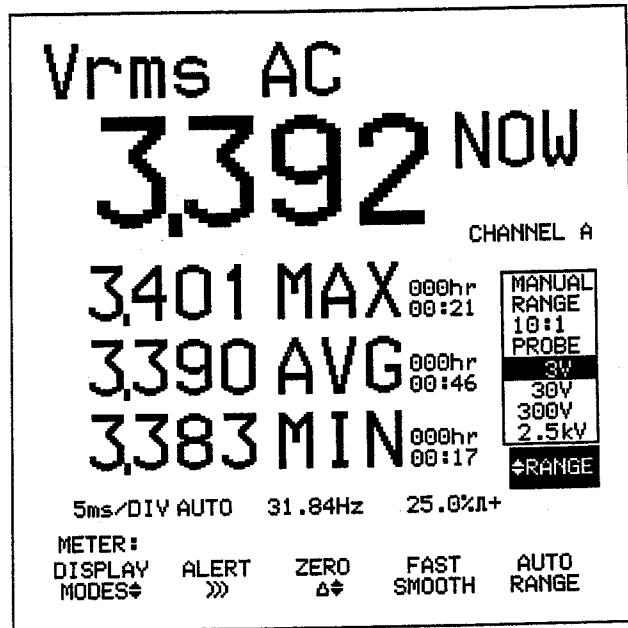

Turn Meter Record off again with one of the following actions:

- Press **RECORD** a second time.
- Select a new Meter Function.
- Press **AUTO SET**.

#### NOTE

*A beep occurs when a new MAX or MIN value is detected. New MIN, MAX, and AVG readings are then updated on the display.*

#### ATTENTION

*An overload of MAX or MIN will stop the Meter Record mode. The overloaded value (MAX or MIN) and the AVG are then displayed in reverse video and the time stamp of the overloaded value is stopped.*

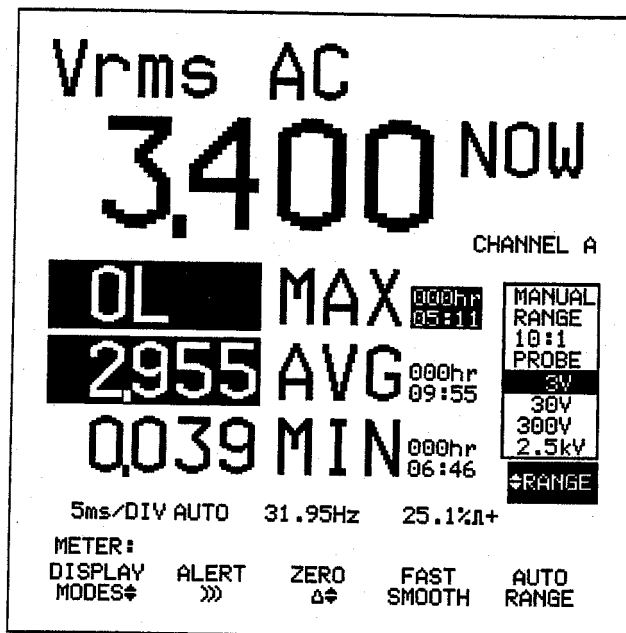

## ALERT

From any Meter function menu, press **SOFT KEY 2** to activate an audible alert signal. ScopeMeter will warn you with a beep when the measurement changes more than 100 digits. In resistance ( $\Omega$ ) function ALERT also warns you when the measurement falls to less than 5% of the measurement range.

## ZERO $\Delta$

Press **SOFT KEY 3** to set the current reading as the zero reference point. Subsequent readings are displayed as units of variation from this point. This feature is useful when you need to monitor input activity in relation to a known good value. The zero function can also be used with dBV, dBm, dBW or Audio Watts.

## FAST/SMOOTH

Select **SOFT KEY 4** (**FAST**) to speed up the refresh rate in the measurement result display. A fast refresh rate is useful when you are making adjustments and must see the resulting reading as quickly as possible.

Select **SOFT KEY 4** (**SMOOTH**) to average readings over the last six seconds. It reduces the influence of noise or unstable input signals.

## DISPLAY MODES (cont.)

Meter Display Modes Pop-up Menu also offers advanced measurements such as  $\% \Delta$ , Scaling, and Volt math. To use these functions, select a specific meter function, and press **SOFT KEY 1** to access the Display Modes Pop-Up Menu.

$\% \Delta$  ~~98~~

Percentage change (delta) uses the present reading as a relative reference. The display then shows a percentage, representing the difference between each new reading and the relative reference.

$\% \Delta$  appears in the **SOFT KEY 3** definition and next to the function description.

A new reading is calculated with the following formula:

$$\% \Delta \text{reading} = \left( \frac{\text{new reading} - \text{ref. reading}}{\text{ref. reading}} \right) \times 100\%$$

The figure below shows percentage change (tolerance) when measuring a resistor:

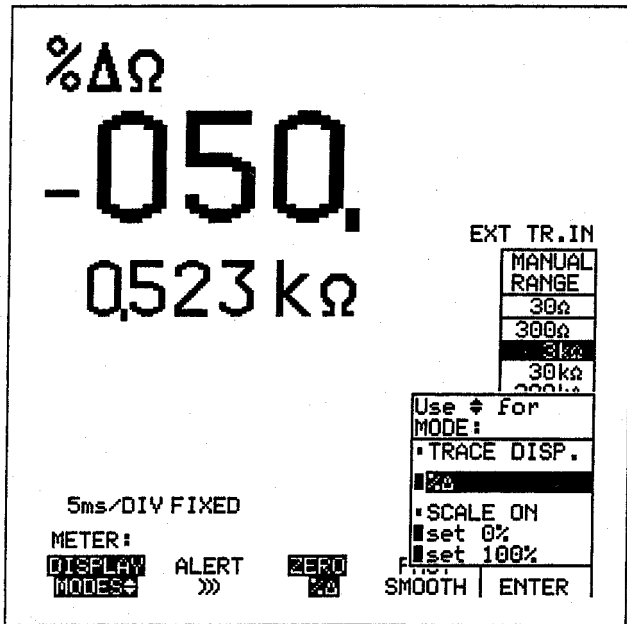

## Scaling ~~93~~

Scaling displays the present measurement result with respect to a defined range with a 0% and 100% value. Entering the 0% and 100% values automatically selects SCALE ON.

The scaled display value is calculated using the following formula:

$$\% \text{ reading} = \left( \frac{\text{new reading} - 0\% \text{ value}}{100\% \text{ value} - 0\% \text{ value}} \right) \times 100$$

Scaling starts automatically when both 0% and 100% values have been entered.

Use the following procedure:

1. Press one of the five Meter Mode softkeys.
2. Measure the value that will represent 0%.
3. Press **SOFT KEY 1** (DISPLAY MODES).
4. Press **▼** to highlight **set 0%**.
5. Press **SOFT KEY 5** to store the displayed value as 0%.
6. Repeat actions 2 to 5 for the 100% value.

The display now gives a scaled % readout. To stop scaling do one of the following:

- Select another function.
- Press **SOFT KEY 1** (DISPLAY MODES), highlight **SCALE ON** in the Scaling section of the menu, and press **SOFT KEY 5**.

As long as 0% and 100% remain defined, you can toggle Scaling on and off as needed.

A typical scaling display is shown in the figure below:

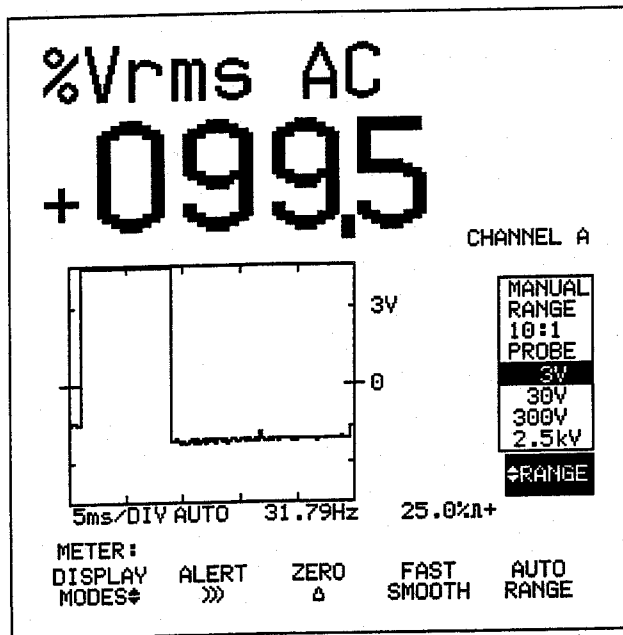

## Volt math $\times$

Use one of the Volt math selections to display the measurement in **dBV** (decibel Volts), **dBm** (decibel milliwatt), **dBW** (decibel Watt), or **Audio Watt**. For **dBm**, **dBW**, and **Audio Watt**, a range of reference impedances can be selected next by pressing  $\Delta$  or  $\nabla$ , for example **Rload**.

For **dBm**, the following reference impedances can be selected: 50, 60, 75, 93, 110, 125, 135, 150, 250, 300, 500, 600, 800, 900, 1000, and 1200 $\Omega$ .

For **dBW** and **Audio Watt**, the following reference impedances can be selected: 1, 2, 4, 8, 16 and 50 $\Omega$ .

## Using Meter Record Mode to Set Scale Values $\times$

The Meter Mode Softkey Menu also offers you access to a scaling function when ScopeMeter is in Meter RECORD Mode. Press  $\text{SOFT KEY 1}$  **DISPLAY MODES**; and the Meter Record Display Modes Pop-Up Menu appears.

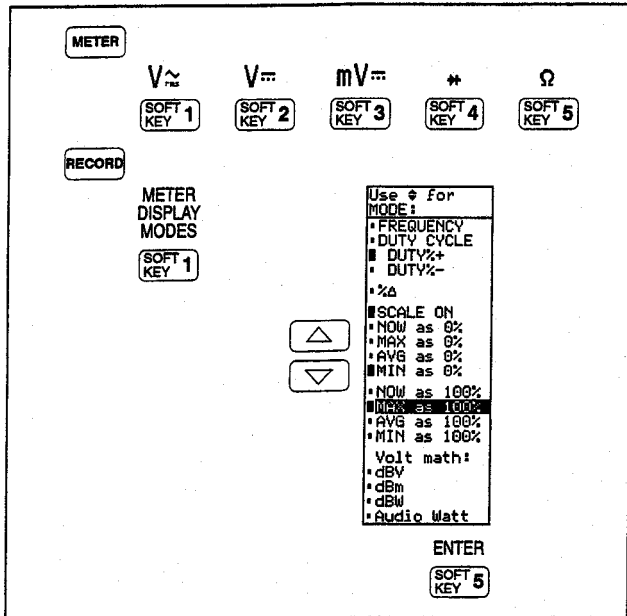
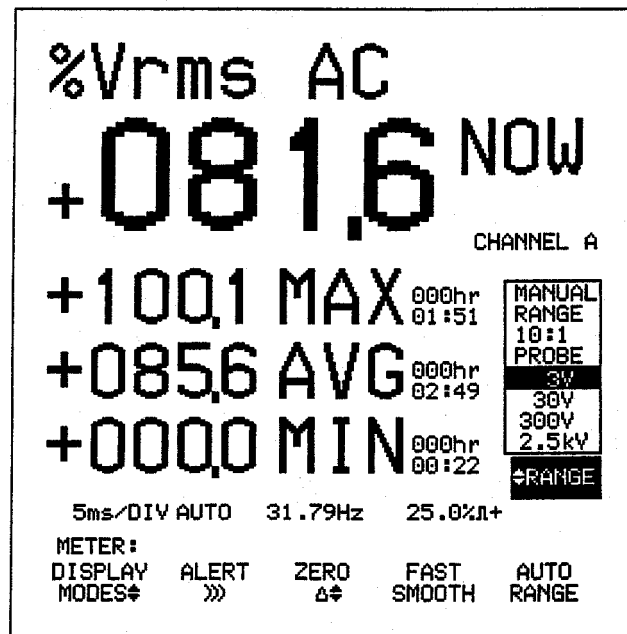

Figure 2.4 Meter Record Display Modes Pop-Up Menu

Record Scaling views the readings as relative percentage values. For example, you can determine how the existing reading (**NOW**) relates as a percentage of a range defined by two of the following settings: **MIN**, **MAX**, and **AVG**. You would accomplish this from the Meter Record Display Modes Pop-Up Menu as follows:

1. Press to highlight **MIN as 0%**.

2. Press to activate this selection.
3. Press , then highlight **MAX as 100%**.
4. Press again.
5. Since these entries set up a valid range, ScopeMeter begins scaling with a display similar to the one in next figure which was created by disconnecting the probe:



Certain combinations of 0% and 100% points are invalid, resulting in the following message bar:

**Invalid Reference: 0L or divide by 0 err**

#### NOTE

*Scaling and zero selections are mutually exclusive; selecting one deactivates the other.*

### Using Meter Record Mode to Set Zero Value

~~98~~

Meter Record Zero views the relative readings in units appropriate for the function and range selected. When in Meter RECORD Mode, press **SOFT KEY 3** **ZERO**  $\Delta$ , and the Meter Record Zero Pop-Up Menu appears. You can now select **NOW**, **MAX**, **AVG**, or **MIN** as a zero reference value.

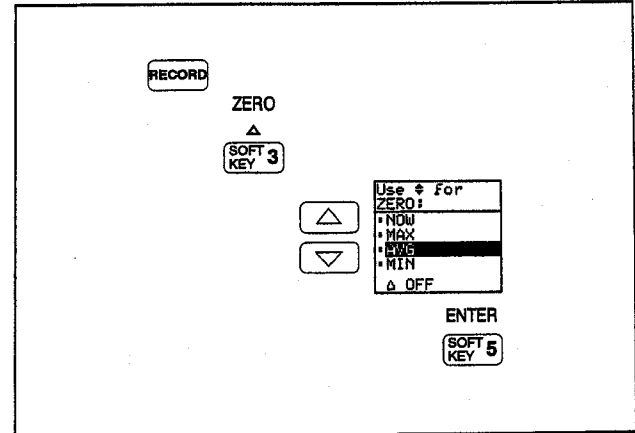
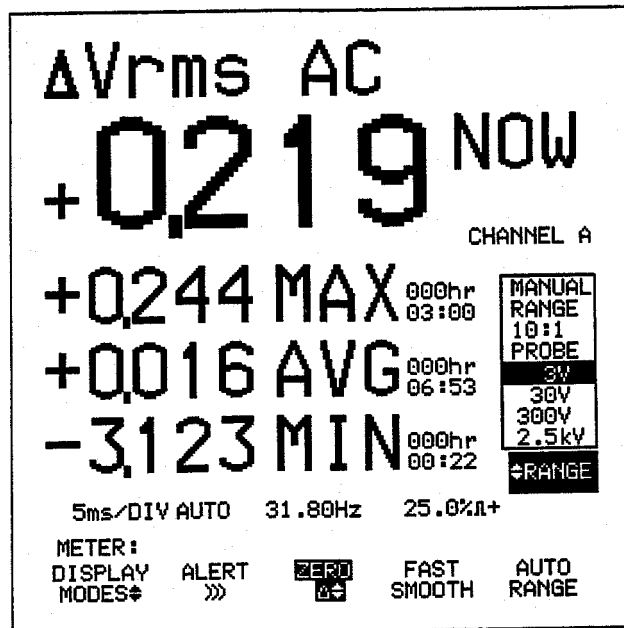

Figure 2.5 Meter Record Zero Pop-Up Menu



Press **SOFT 3** to access the menu. Then press **▲** **▼** to highlight your choice, followed by **SOFT 5** to activate the selection.



# Section 3

## Using the Scope

### Contents

---

<b>SCOPE MODE CONNECTIONS</b> .....	3-2	Trigger Level .....	3-6
<b>AUTO SET</b> .....	3-3	Trigger Delay .....	3-7
<b>WAVEFORM ACQUISITION</b> .....	3-3	TRIGGER at 50% .....	3-8
Recurrent .....	3-3	<b>INPUT COUPLING</b> .....	3-8
Single .....	3-4	<b>ADJUSTING THE AMPLITUDE</b> .....	3-9
Capture 10 20 divisions .....	3-4	<b>ADJUSTING THE TIME BASE</b> .....	3-9
MIN MAX on A .....	3-5	<b>POSITIONING THE WAVEFORM ON</b>	
Roll Mode .....	3-5	<b>THE DISPLAY</b> .....	3-10
Zoom .....	3-5	<b>CHANNEL SELECTION</b> .....	3-11
<b>SELECTING THE TRIGGER</b> .....	3-6	<b>AVERAGING</b> .....	3-12
Trigger Basics .....	3-6	<b>SCOPE RECORD</b> .....	3-13
Trigger Source .....	3-6	<b>DISPLAYING MULTIPLE WAVEFORMS</b> .....	3-14
Trigger Slope .....	3-6	<b>MORE INFORMATION</b> .....	3-14

## SCOPE MODE CONNECTIONS

Scope Mode connections are illustrated in Figure 3.1.



Maximum scope inputs on either channel are as follows:

- Maximum input signal voltage: 300V rms direct
- Maximum input signal voltage: 600V rms when using 10:1 probe
- Voltage to ground: 600V rms

Input impedance is 10 M $\Omega$ /15 pF with the 1:10 probe or 1 M $\Omega$ /25 pF with the 1:1 probe.

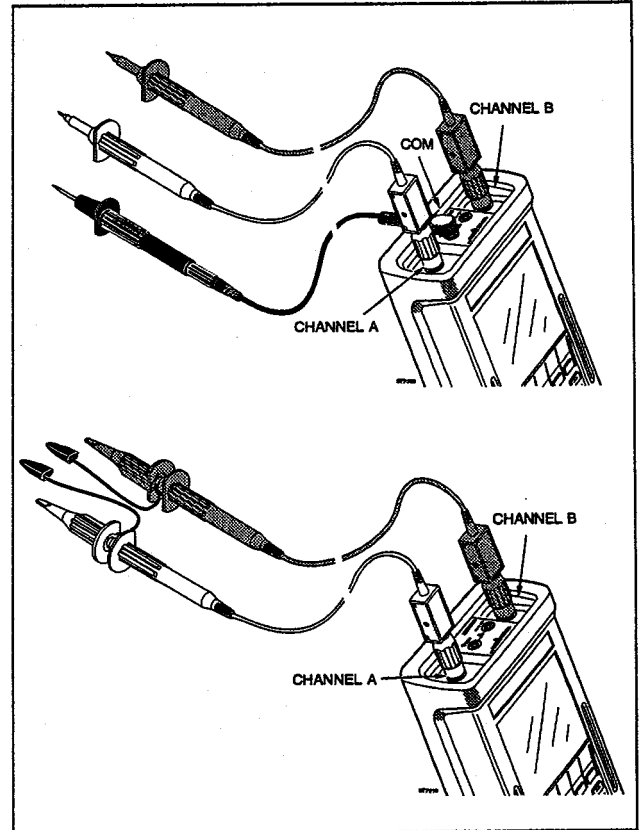

Figure 3.1 Scope Mode Connections

## AUTO SET

AUTO SET automatically selects the optimum settings for connected input signals. Start AUTO SET by pressing **SCOPE** **AUTO SET**. For most signals, ScopeMeter will automatically set channels, amplitudes, time base setting, and triggering for an optimum display.

AUTO SET sets the following:

- Channel A and/or channel B is switched on depending on signal input. All other waveform displays are switched off.
- Between 2 and 8 periods of the signal with the lowest frequency are displayed.
- The attenuation per channel is set so that the signal occupies about four vertical divisions.
- The trigger source is chosen as the input signal with the lowest frequency.

AUTO SET can be configured through the **SETUP** Auto Set Pop-Up Menu. Refer to Section 4 for a complete description.

If no triggerable signal is found when you press **AUTO SET**, approximate settings are used. If the input signal subsequently changes, AUTO SET does not readjust by itself; you must press **AUTO SET** again.

## WAVEFORM ACQUISITION

Press **SCOPE** to access the Scope Function Softkey menu.

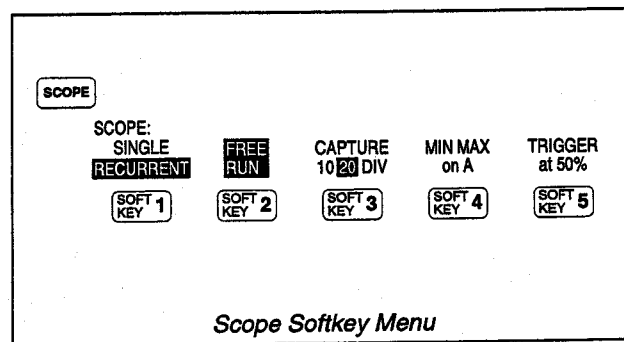

You can instruct ScopeMeter to continuously update its display, giving you a dynamic look at waveform activity as it occurs (**RECURRENT**). You can also tell ScopeMeter to update its display only once, yielding a snapshot record of waveform activity (**SINGLE**), termed "Single Shot" elsewhere in this manual.

### Recurrent

Press **SOFT 1** to highlight this selection for continuous display updates as triggers are detected. Pressing **HOLD RUN** stops and starts acquisitions. A flashing **HOLD** on the display indicates that acquisition is stopped. The time base range is from 5s/DIV to 10ns/DIV.

## Single

Set up ScopeMeter for "Single Shot" acquisitions with the following procedure:

1. Press **SOFT 2** to turn off **FREE RUN** (not highlighted).
2. Press **SOFT 1** to highlight **SINGLE**.  
**HOLD** begins flashing in the lower Right Display.
3. Press **HOLD RUN**.  
**NO TRIG** begins flashing in the lower Right Display. ScopeMeter is waiting for a trigger.
4. **RUN** appears on the screen when the single acquisition is triggered. **HOLD** then reappears when acquisition is completed.
5. Now press **HOLD RUN** again and wait for another single acquisition trigger.

The time base range is from 5s/DIV to 100ns/DIV.

Waveform acquisition relies on a valid trigger source being available. Triggering is fully discussed later in this section. The Scope Softkey Menu normally shows **FREE RUN** on (highlighted); if no trigger is detected for 100 ms, ScopeMeter generates its own trigger. You can deactivate **FREE RUN** by pressing **SOFT 2**.

### NOTE

***NOTRIG** flashing in the Right Display indicates that ScopeMeter is ready and waiting for a trigger signal.*

## Roll Mode

Roll Mode supplies a visual log of waveform activity and is especially useful when measuring lower frequency signals. To enter Roll Mode, press **SOFT 1** from the Scope Mode Softkey Menu to select **RECURRENT**, then press **TIME** to select 10s/DIV ROLL, 20s/DIV ROLL, or 60s/DIV ROLL.

The waveform is now slowly traced on the display from left to right. The waveform is now slowly traced on the display from left to right until the screen is written. Thereafter the trace slowly shifts from right to left like on a penrecorder. The Roll Mode is automatically turned off if a time base of 5s/DIV or faster is selected.

Roll is an untriggered mode. The **CAPTURE 10 20 DIV, TRIGGER at 50%**, and **FREE RUN** softkey selections are not available. However, the waveform can be frozen on the display by pressing **HOLD RUN**.

### Capture 10 20 divisions

This enables either 10 divisions or 20 divisions of signal detail to be captured. Selecting 10 divisions, or one full screen, is sufficient for most applications. For fast single shots, selecting 20 divisions enables more information to be captured, but on slow signals, it lowers the screen update speed by a factor of 2. Use  to select 10 or 20 divisions capture.

You can use  to move the acquired waveform right and left across the display. Display width is either 9.6 time divisions (cursors off) or 8 time divisions (cursors on, occupying 1.6 time divisions in the Right Display area).

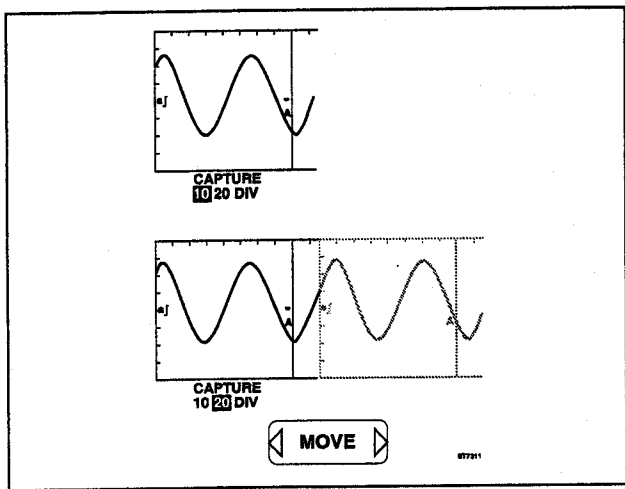

Figure 3.2 Waveform Capture

### MIN MAX on A

Min Max on A stores and displays the events that occur between two samples on channel A. Channel B is automatically turned off. The events can be glitches or other asynchronous signals that are 40 ns (nanoseconds) or wider.



The glitches between the samples can be stored and displayed using **MIN MAX on A**. Results are displayed as spikes (new maximums or minimums) on the previously displayed signal.

This function works on all time base ranges up to 1  $\mu$ s/DIV including the roll mode.

### NOTE

*MIN MAX on A and Average are mutually exclusive.*

### Zoom

Zoom displays a waveform with increased time resolution, giving up to 1000x magnification. Look for  **ZOOM** in the Right Display area. Then press  to enlarge the waveform (speed up the time base) or  to shrink the waveform (slow down the time base). ScopeMeter zooms in and out one step at the time and, if necessary, the trigger delay is recalculated. The focal point for this activity is waveform activity at the fourth time division (midpoint of display). The zoom feature is useful as a quick examination of a live waveform. Zoom cannot be used on stored waveforms recalled from memory or when the waveform is frozen (HOLD).

## SELECTING THE TRIGGER

### Trigger Basics

Triggering tells ScopeMeter when to begin displaying the waveform. You can select which input signal should be used as the source, on which edge this should occur, and at what signal level it should occur. Finally, you can tell ScopeMeter to delay what it displays until after a specified time delay, number of cycles, or number of events has occurred.

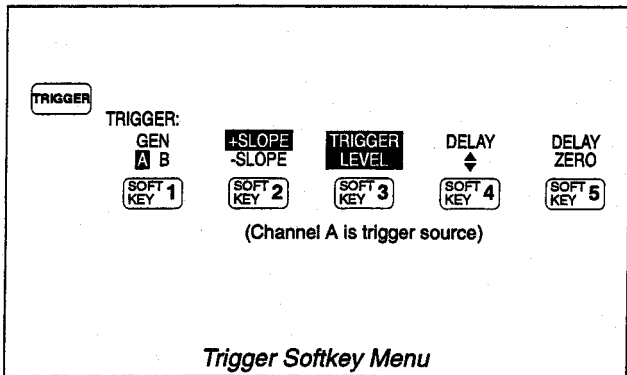

*Trigger Softkey Menu*

### Trigger Source

Press **SOFT KEY 1** to select trigger source **A** (via channel A), **B** (via channel B), **GEN** (via internal signal generator) or **EXT** (via external trigger input).

- **GEN** ~~98~~ ~~95~~ appears only if the generator has been turned on. To turn the generator on, press **SPECIAL FUNCT** **SOFT KEY 1** to access the Generator Pop-Up Menu. Then press **△** **▽** (to highlight 1.95kHz, 976Hz, 400Hz, or SINE WAVE), followed by **SOFT KEY 6** (ENTER) to activate the selection.
- **EXT** is available as a trigger source selection when the generator is off. Press **SOFT KEY 3** to highlight the appropriate TTL-compatible (Transistor to Transistor Logic) trigger level (0.2V or 2V). An external trigger can be connected at the RED Banana jack or by using the PM9081 Banana-to-BNC adapter supplied.

### Trigger Slope

Press **SOFT KEY 2** to select triggering on either the +SLOPE or -SLOPE of the chosen channel.

### Trigger Level

Press **TRIGGER** to access trigger level adjustment. If channel A or B is selected as the trigger source, **LEVEL** appears in the Right Display area, and you can use **△** and **▽** to adjust the trigger level. Observe the level changes in the Right Display, just below **LEVEL**. For example, if the 1V range is selected, press **△** and **▽** to change the level in 40 mV steps. At the same time the trigger level icon "a" **┘** moves to identify the level on the display.

### Trigger Delay

You can also tell ScopeMeter to begin displaying the waveform at some time before or after the trigger point is detected. From the Trigger Softkey Menu, press **SOFT KEY 4** to enter the Trigger Delay Pop-Up Menu. You can now select the trigger delay.

#### NOTE

*The (TIME) DELAY function is directly accessible in the Model 93 ScopeMeter.*

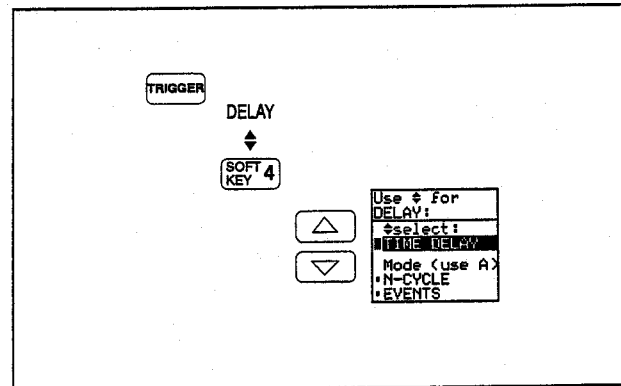

Figure 3.3 Trigger Delay Pop-Up Menu ~~98~~



Types of trigger delays are discussed below. In many instances, you can select more than one type of delay.

- **TIME DELAY**  $\updownarrow$  **DELAY** appears in the Right Display area. You can now press  $\triangle$  or  $\nabla$  to set the trigger time delay in increments of the existing time base divisions. The range of divisions is -20 to +640. For example, if the time base is set to 2ms/DIV, +16 defines a delay of 16 time divisions (32 milliseconds). This results in data acquisition and display starting 32 milliseconds after the trigger is detected.
- **N-CYCLE**  $\times$   $\leftarrow$  The trigger signal is divided by N to create a stable picture for signals with a cyclic character. (N-CYCLE can be used only on Channel A.) Select the **N-CYCLE** number by pressing  $\triangle$  and  $\nabla$ . A total of +2 to +255 cycles can be selected.
- **EVENTS**  $\times$   $\leftarrow$  Triggering via the external input is delayed by a number of events that occur on channel A. Select the number of events (+1 to +1023) by pressing  $\triangle$  and  $\nabla$ . External trigger starts the delay, and after the number of events on channel A is equal to the selected number, ScopeMeter acquires the channel A signal.
- **DELAY ZERO** Press  $\text{SOFT B}$   $\text{KEY B}$ . All the selected trigger delays are reset to their initial values (TIME DELAY = 0, N-CYCLE = 2, EVENTS = 1).

### TRIGGER at 50%

From the Scope Softkey Menu, press  $\text{SOFT B}$   $\text{KEY B}$  to set the trigger level at 50% of the trigger source signal voltage.

### INPUT COUPLING

Press  $\text{AC}$   $\text{DC}$   $\text{GROUND}$  on the appropriate channel to select the input signal coupling. The selection is shown in the upper line of the Top Display. AC coupling allows for reading ac voltages above 40 Hz. DC coupling allows for reading ac and dc voltages.

The **GROUND** selection disconnects the input signal and displays the ground or zero level as a horizontal line. **GROUND** provides a useful tool for setting up the display to show a high dc level or voltage spike. For example, if you anticipate a high positive dc level, select **GROUND** and press  $\text{MOVE}$  to move the ground level lower on the display. A small marker box on the right side of the display identifies the ground level.

## ADJUSTING THE AMPLITUDE

You can use  $\langle \text{mV} \rangle \langle \text{V} \rangle$  for channel A or B to adjust input signal attenuation. Sixteen ranges are available. A 1:1 probe can accommodate 1 mV (5 mV for model 93) to a maximum of 100V per division, while a 10:1 probe can accommodate 10 mV (50 mV for model 93) to a maximum of 1 kV per division. The amplitude can be changed in increments of 1, 2, and 5 (e.g., 100 mV, 200 mV, 500 mV). The upper row of the Top Display shows the range and the type of probe for each channel.

When a 10:1 probe is used with the 10 mV or 20 mV range, averaging is turned on automatically (**AVG 4** appears on the display)  $\langle \text{AVG} \rangle$ .

## ADJUSTING THE TIME BASE

Press  $\langle \text{TIME} \text{ ns} \rangle$  to increase or decrease the number of periods. Time base readout is on the Upper Row of the Top Display. Refer to Figure 3.4. Available settings depend on the acquisition mode in effect, and are as follows:

- Recurrent 10ns/DIV - 5s/DIV
- Single 100 ns/DIV - 5s/DIV
- Roll 10s/DIV - 60s/DIV

The time base can be changed in increments of 1, 2, and 5 (e.g., 10 ns, 20 ns, 50 ns).

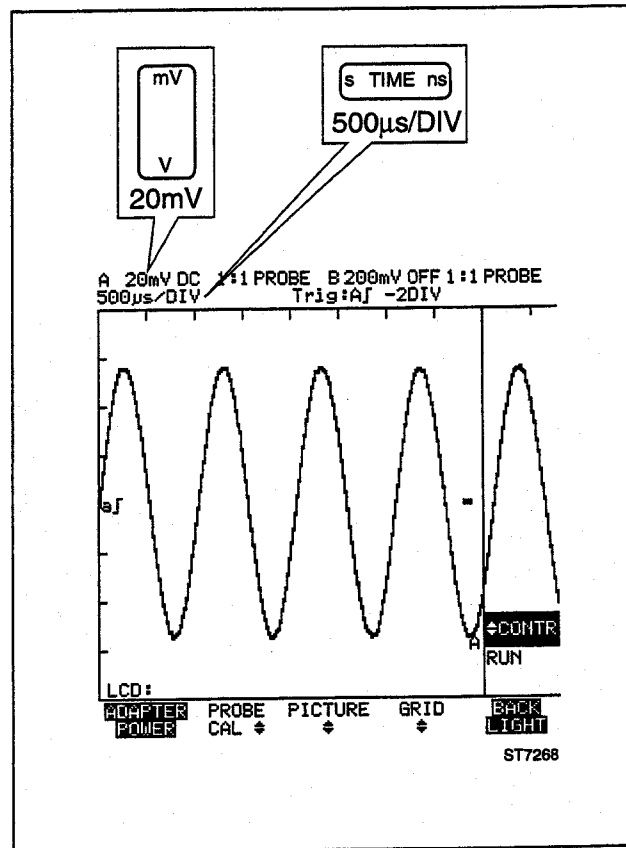





Figure 3.4 Time Base and Amplitude Adjustment

## POSITIONING THE WAVEFORM ON THE DISPLAY

Considerable flexibility is offered in moving the trace(s) around the display.  and  reposition the trace up or down 4 divisions. This operation can be done separately for each channel. The  key simultaneously repositions all traces left or right from -4 to +16.5 divisions. Waveform positioning is demonstrated in Figure 3.5.

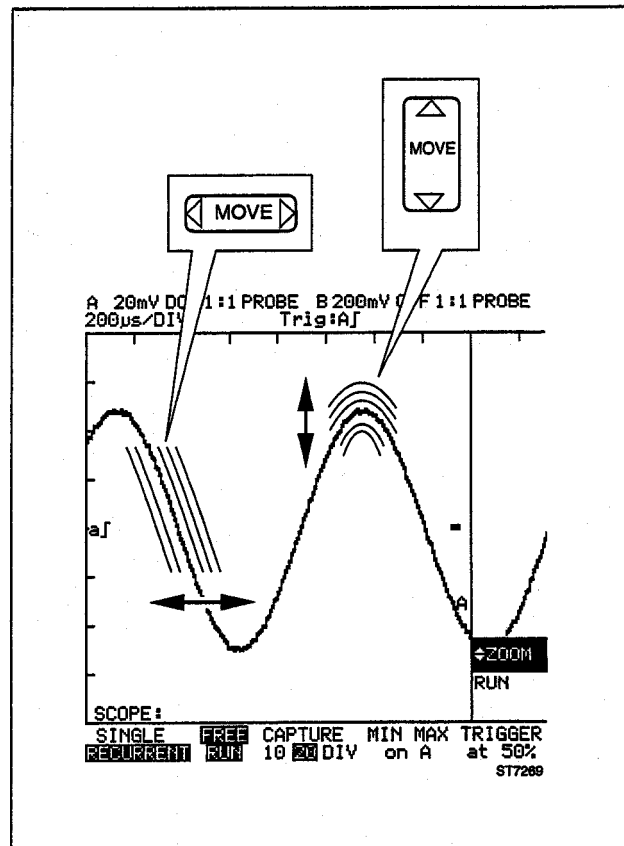
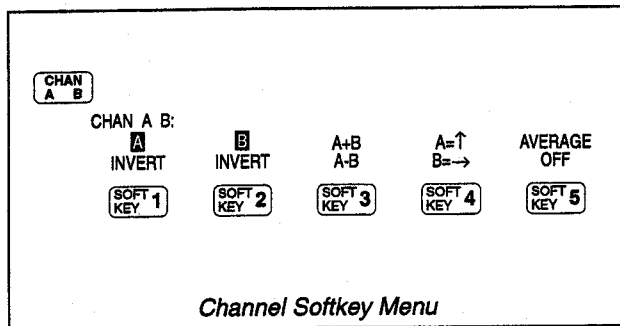

Figure 3.5 Positioning the Waveform

## CHANNEL SELECTION

Press **CHAN A B** to access the Channel Selection Softkey Menu. You can now use **SOFT KEY 1** **SOFT KEY 2** to select if and how channels A and B are displayed. This can be normal display, inverted display, or neither.



**INVERT** reverses the polarity of displayed waveform. This is identified with a reverse video waveform identifier and trigger icon on the display. For example, a negative-going signal would be displayed as positive-going, providing a more meaningful viewing perspective in some cases.

Press **SOFT KEY 3** to select A+B to show channels A and B added together or to select A-B to show channel B subtracted from channel A.

Press **SOFT KEY 4** (A=↑ B=→) to provide a display with channel A on the vertical axis and channel B on the horizontal axis.





### NOTE

*At least one signal display must be active at all times. Highlighting any selection accessed with **SOFT KEY 1**, **SOFT KEY 2**, **SOFT KEY 3**, or **SOFT KEY 4** satisfies this requirement. A signal recalled from memory can also satisfy this requirement.*

If **MIN MAX on A** is selected from the Scope Mode Softkey Menu, only **SOFT KEY 1** can be used in the Channel Selection Softkey Menu.

## AVERAGING

ScopeMeter can average multiple samples of a waveform, allowing for noise suppression without loss of bandwidth. To select averaging in the Scope Mode do the following:

1. Press .  
 ◆ **AVG** now appears in the Right Display.
2. Press   to select the number of waveforms to average for each display update. The maximum number is 256.
3. Press  to turn off averaging.

### NOTE

**AVERAGE OFF** changes to **AVERAGE MIN** in the 10 mV and 20 mV attenuator ranges when a 10:1 probe is used. The minimum factor is then set to 4 when  is pressed. Averaging and MIN MAX on A are mutually exclusive.

Additional information about averaging appears in Section 4. Waveform samples with and without averaging are shown in Figure 3.6.

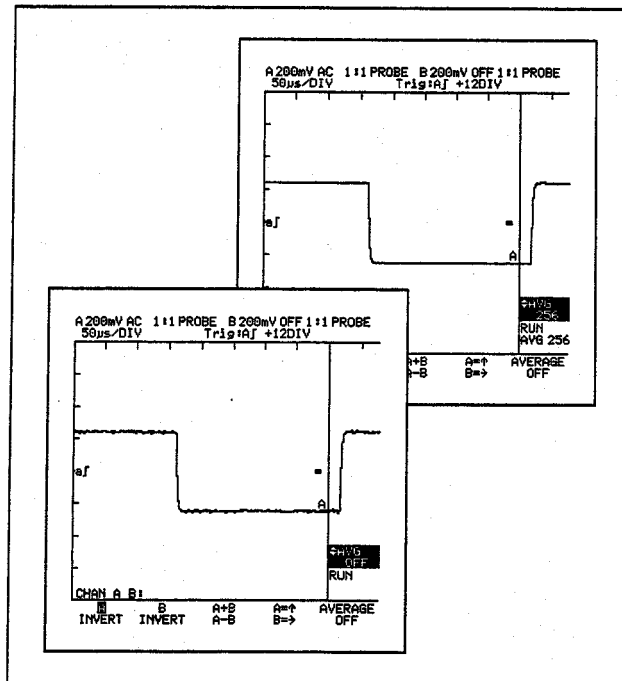

Figure 3.6 Averaging

## SCOPE RECORD

ScopeMeter records the envelopes (minimum and maximum) of the acquisition signals A and B, and the A±B.

Press **RECORD** to activate the mode. A flashing **RECORD** now appears in the Right Display

The envelopes are automatically saved in the temporary memories 1, 2, and 3. The display shows the resultant envelope waveform(s) together with the actual signal. The time to build up the Record display is selectable between infinite and 2 seconds. The Record time can be configured through the **SETUP** Initial Setup Pop-up Menu. Refer to Section 4 for a complete description. You can use this mode to observe variations in time or amplitude of input signals over a longer period of time

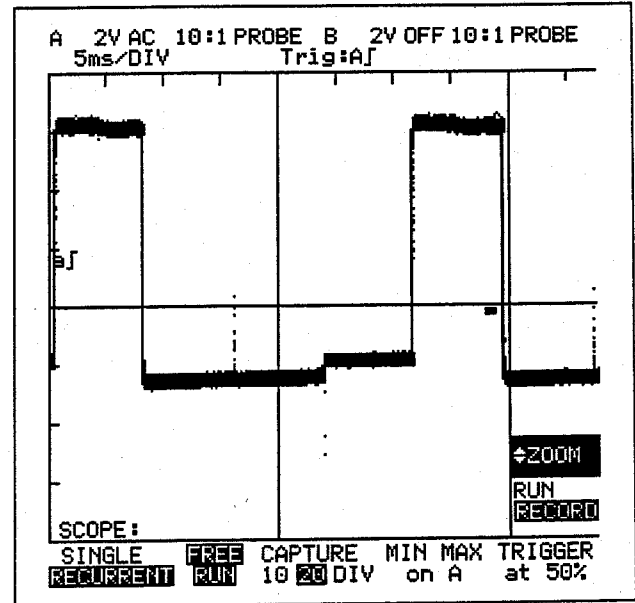

## DISPLAYING MULTIPLE WAVEFORMS

By displaying a combination of measurement channels and stored waveforms, a maximum of four traces can be displayed simultaneously. For example, channels A, B, A+B, and/or waveforms recalled from memory could be displayed. You can display any combination of four waveforms. At least one waveform trace must be turned on (A, B, A±B, or a memory) any time ScopeMeter is in Scope Mode.

### NOTE

*The A versus B (A↑ B→) display is not counted in the four-trace maximum.*

If you attempt to display a fifth waveform, the following message is displayed:

**Not executed: already max. traces on LCD**

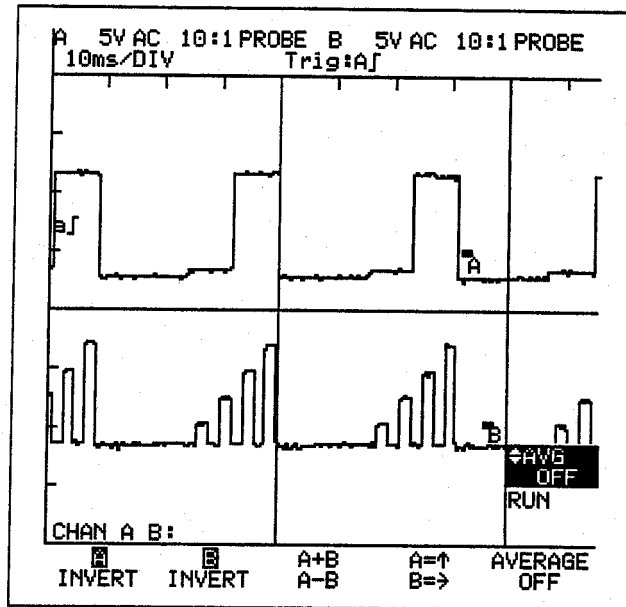

## MORE INFORMATION

Sections 6 (ScopeMeter Tutorial) presents Scope Mode applications that use many of the features discussed here in Section 3. Refer to Section 4 for a discussion of additional capabilities.

# Section 4

## More Advanced Features

### Contents

---

<b>INTRODUCTION</b> .....	4-2	<b>WAVEFORM MATHEMATICS</b> .....	4-10
<b>USING THE CURSORS</b> .....	4-2	<b>PRINTING</b> .....	4-14
Cursor Source .....	4-3	Print Format .....	4-14
Cursor Function .....	4-3	Printer Setup .....	4-15
Markers .....	4-4	Start Print .....	4-15
<b>CLEARING MEMORY</b> .....	4-5	<b>MASTER RESET CONFIGURATION</b> .....	4-16
<b>SAVING AND RECALLING SETUPS</b> .....	4-6	Performing a Master Reset .....	4-17
Saving a Setup: .....	4-6	<b>AUTO SET CONFIGURATION</b> .....	4-17
Recall a Setup: .....	4-7	<b>MEASURING COMPONENTS</b> .....	4-19
Delete a Setup: .....	4-7	<b>USING THE SIGNAL GENERATOR</b> .....	4-20
<b>STORING AND RETRIEVING WAVEFORMS</b> .....	4-7	<b>MINIMIZING SIGNAL NOISE</b> .....	4-20
Quick Waveform Storage .....	4-8		
Saving and Copying Waveforms .....	4-8		
Displaying Stored Waveforms .....	4-9		



## INTRODUCTION

This section describes some advanced, less frequently used ScopeMeter features. All screen examples are made by using Testpoint TP2 on the Demo Board for your ScopeMeter.



## USING THE CURSORS

Cursors allow you to make precise digital measurements of waveform activity.

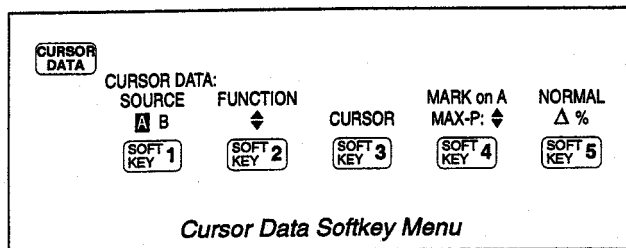
Press  to access the Cursor Data Softkey Menu.



Cursors can now be switched on and off by pressing . Active cursors appear on the screen as two vertical and two horizontal dashed lines.

- The vertical cursor on the left is a series of long dashes and can be moved left or right by pressing .
- The vertical cursor on the right is a series of shorter dashes and can be moved left or right by pressing .

- Horizontally, a long dash line and a short dash line automatically track the cross points of CURSOR1 and CURSOR2 with the chosen waveform.

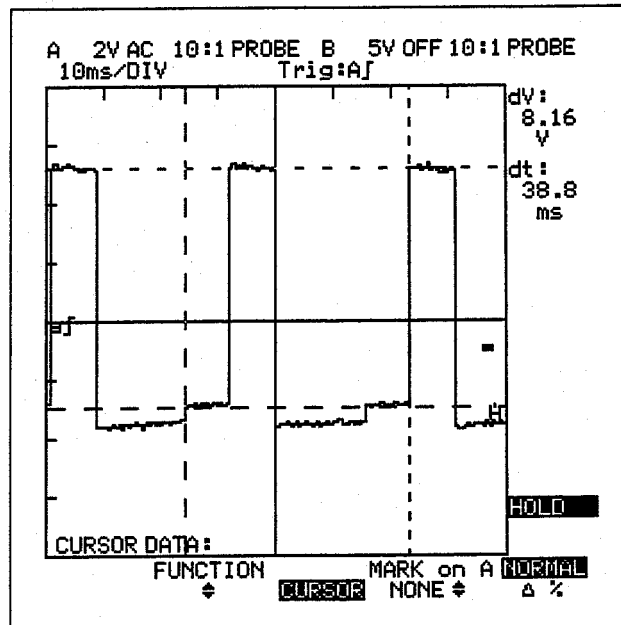

Figure 4.1 ScopeMeter display with active cursors

### Cursor Source

Press **SOFT KEY 1** to select the waveform for cursor measurements. The cursor source selection is determined by active display traces. The traces can be obtained from the active display (A, B, A±B) or from memory (1 through 8).

### Cursor Function

Press **SOFT KEY 2** to select the cursor **FUNCTION**. The Cursor Function Pop-Up Menu opens, allowing you to select the cursor measurement types to display. ScopeMeter uses waveform activity between vertical cursors in making cursor function calculations.

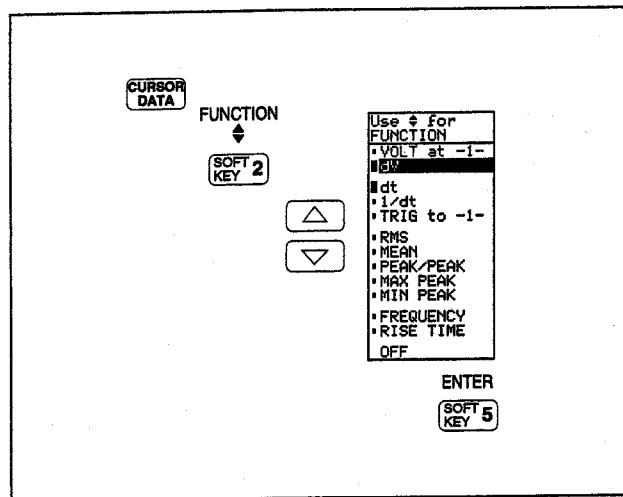
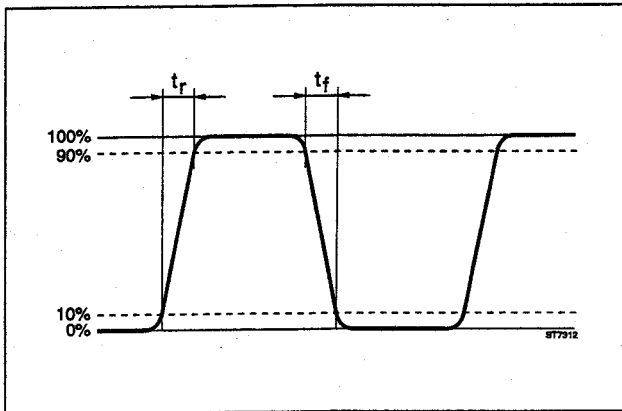

Figure 4.2 Cursor Function Pop-Up Menu

The measurement results are displayed in the Right Display area. A maximum of five measuring functions can be turned on at the same time. A list of the functions is defined in the Cursor Function Pop-Up Menu in the Right Display:

- **VOLT at -1- (CUR-1-)** Measure the voltage amplitude where cursor 1 crosses the waveform, relative to the GND indicator level.
- **dV** (for delta Volts) Measure the voltage difference between the (horizontal) cursors.
- **dt** (for delta time) Measure the time difference between the (vertical) cursors.
- **1/dt** (for relative frequency) Show the reciprocal value of dt.
- **TRIG to -1- (┌ to-1-)** Measure the time difference between the trigger occurrence and cursor 1.
- **RMS** (for Root Mean Square) Measure the RMS voltage between the (vertical) cursors.
- **MEAN** Measure the MEAN (average of readings) value of signal between the cursors.
- **PEAK/PEAK (P/P:)** Measure the PEAK to PEAK value of signal between the cursors.
- **MAX PEAK (MAX-P:)** Measure the maximum peak value of the signal between the cursors.

- **MIN PEAK (MIN-P:)** Measure the minimum peak value of the signal between the cursors.
- **FREQUENCY (FREQ:)** Measure the frequency of the signal between the cursors. At least  $1\frac{1}{2}$  cycles of this signal must occur between the cursors. A varying frequency waveform be can read easily with ScopeMeter. You can scroll a waveform through the cursors by pressing **MOVE**. Read the frequency change in the Right Display.
- **RISE TIME (RISE:)** Measure the rise time between 10% and 90% points of the signal. The 0% and 100% points are determined by the intersection of the signal and the cursors.



- **PHASE** Measure the phase shift between two traces. A maximum of three phase shift measurements are possible.

### Markers

Use the marker to identify the point on the waveform that a measurement has occurred or is expected to occur. The marker appears on the waveform as an "X".

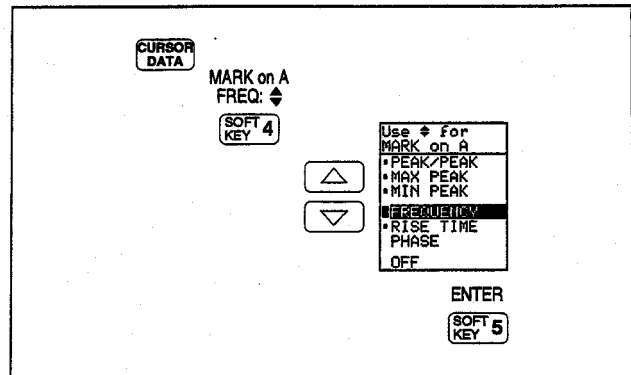
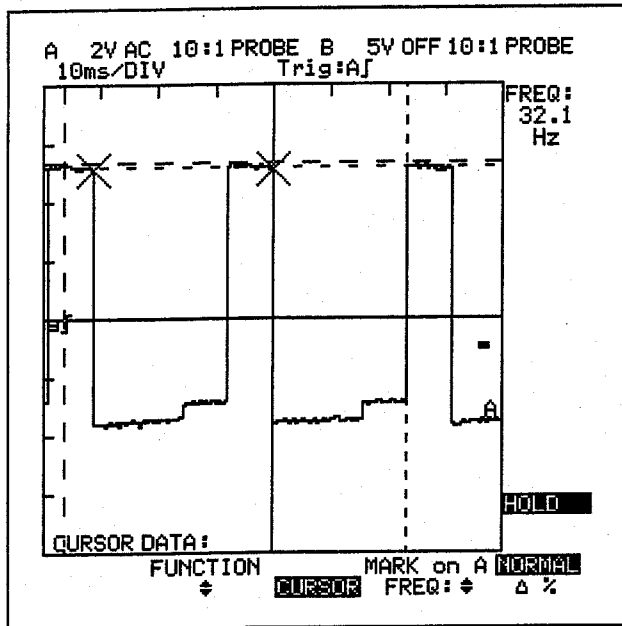

Figure 4.3 Cursor Marker Pop-up Menu

From the Cursor Data Softkey Menu, press **SOFT KEY 4**. The Marker Pop-Up Menu now opens. Use **▲** **▼** to highlight the marker use, then press **SOFT KEY 5**. The selected use (P/P:, MAX-P:, MIN-P:, FREQ:, RISE:, PHASE:, NONE) is then abbreviated under the MARK on X indication in the Cursor Data Softkey Menu.



The markers are defining sample points for measuring frequency.

**NOTE**

Markers may be easier to see when you press **HOLD RUN**.

**CLEARING MEMORY** ~~98~~ ~~95~~

Access the Memory Clear Softkey Menu at any time by pressing **SETUP** and **WAVE FORM** simultaneously. The model 95 ScopeMeter Memory Clear is selected from the Waveform softkey menu.

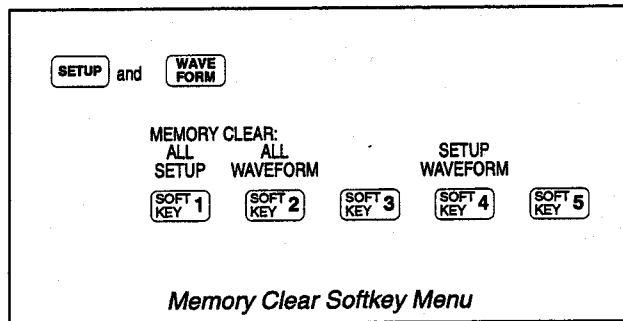

You can now press **SOFT KEY 1** **SOFT KEY 2** or **SOFT KEY 4** to clear ALL SETUP (setup memories 1 through 10), ALL WAVEFORM (temporary memories 1 through 3 and regular memories 4 through 8), or SETUP WAVEFORM (clear everything).

## SAVING AND RECALLING SETUPS ~~98~~ ~~95~~

You can avoid repeating your keystrokes by storing the ScopeMeter setup in memory. (A setup is simply the current operating configuration). You can save a maximum of 10 ScopeMeter setups in this fashion.

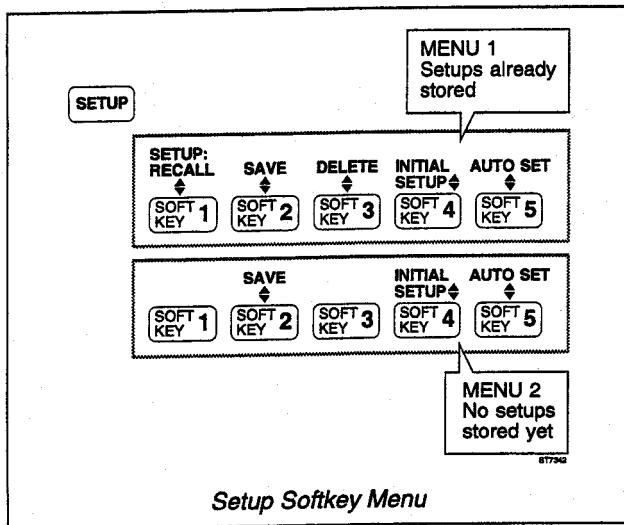

### Saving a Setup:

Once you have configured ScopeMeter to make the required measurement you can save this configuration in a Setup using the following procedure:

1. Press **SETUP**.  
The Setup Softkey Menu appears. If a setup has already been stored, the first menu shown is displayed. If no setup has been stored, the second menu is displayed.
2. Press **SOFT KEY 2** (SAVE) to save a setup into setup memory (Setup 1 through Setup 10).
3. Use **▲** and **▼** to highlight the Setup memory where you want to save this configuration. A small dot in front of an item indicates a used setup memory.
4. Press **SOFT KEY 5** to save it.

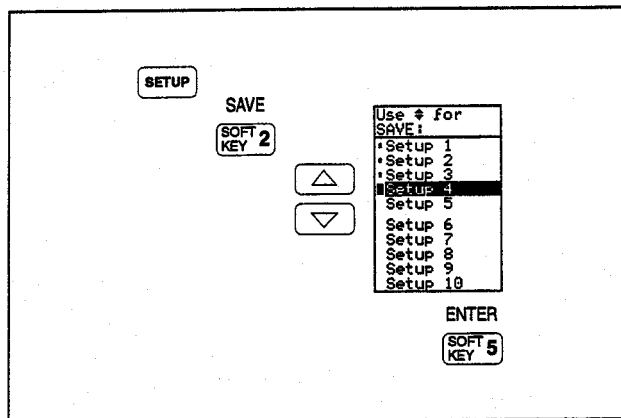

Figure 4.4 Setup Save Pop-Up Menu

**Recall a Setup:**

- Press **SOFT KEY 1** (RECALL) to recall a saved setup from setup memory (Setup 1 through Setup 10). The Right Display keeps track of the recalled setup by memory number (just below **RECALL**). While **RECALL** is displayed, you can also quickly rotate through the setups using **UP** and **DOWN**.

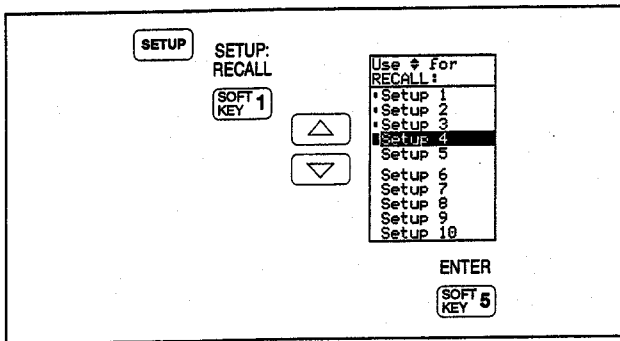

Figure 4.5 Setup Recall Pop-Up Menu

**Delete a Setup:**

- Press **SOFT KEY 3** (DELETE) to delete a saved setup from setup memory (Setup 1 through Setup 10).

**NOTE:**

*A Master Reset destroys these selected items and leaves initial setup with its default settings. Refer to "Master Reset configuration" further on in this section for a complete discussion of Initial Setup.*

**STORING AND RETRIEVING WAVEFORMS**

You can save waveforms to memory, copy waveforms between memories, and recall waveforms from memory. Three volatile acquisition memories, three nonvolatile temporary memories, and five nonvolatile memories are available.

The temporary memories are used to save the contents of the acquisition memories A, B, and A±B in one action.

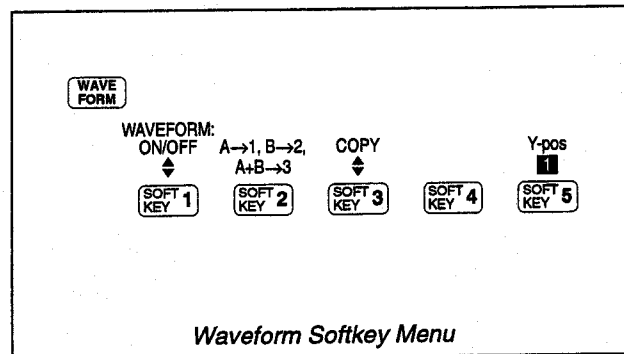

Waveform Softkey Menu

Press **SOFT KEY 2** to perform a simultaneous copy of acquisition memories A, B, and A±B to waveform temporary registers 1, 2, and 3, respectively.

Press **SOFT KEY 3** to copy a waveform to another memory. Waveforms from acquisition memories A, B, or A±B, temporary memories 1, 2, and 3, or regular memories 4 through 8 can be selected for copying to memories 1 through 8.

### Quick Waveform Storage

Acquired waveforms on channel A, channel B, and A±B can be stored automatically by pressing **WAVE FORM** **SOFT KEY 2**. The waveforms are stored in temporary memories 1, 2, and 3, respectively. The display continues to show the actual input signal and the cursor functions.

### Saving and Copying Waveforms

To save or copy a waveform from one memory to another, you need to press **WAVE FORM** **SOFT KEY 3** and highlight from which memory you want to copy. On pressing **SOFT KEY 5** (ENTER) you must then highlight the memory to which you want to copy. A small dot in front of a memory indicates it already contains a waveform. On pressing **SOFT KEY 5** once more this copy action takes place.

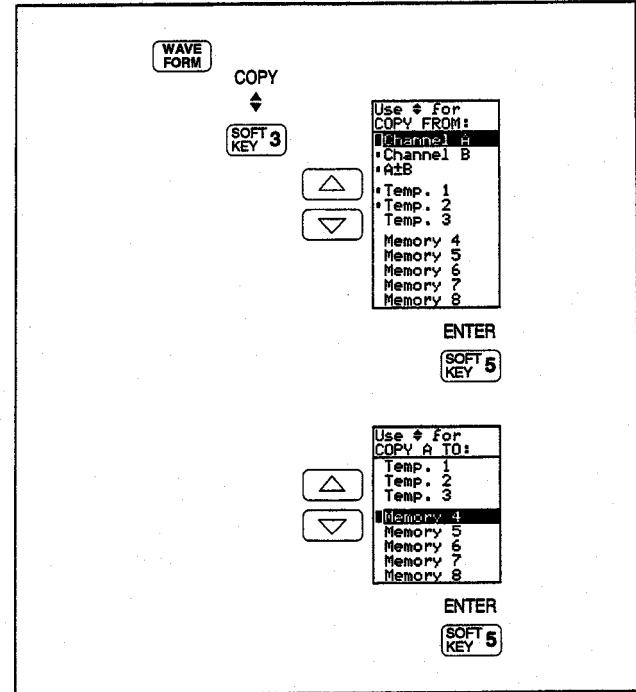

Figure 4.6 Waveform Copy From/To Pop-Up Menus

### Displaying Stored Waveforms

In the Waveform ON/OFF Pop-Up Menu, the saved waveforms and the corresponding setup can be recalled. A small dot in front of the item indicates that the memory location is filled with a waveform. A large dot in front of an item indicates that the waveform is displayed. A displayed waveform has a figure indication that corresponds with the waveform memory number.

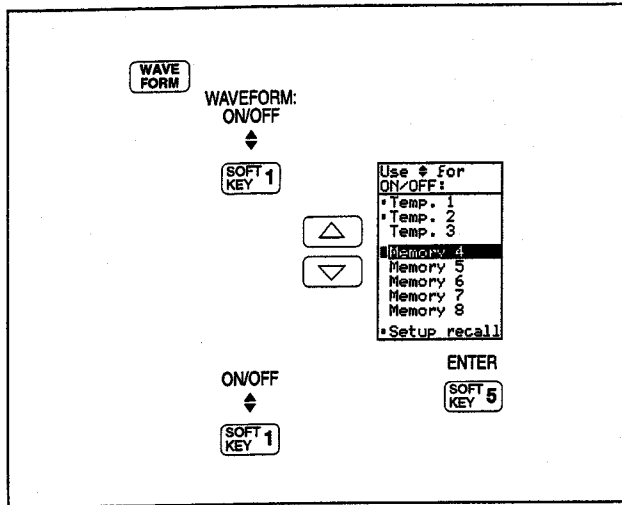

Figure 4.7 Waveform ON/OFF Pop-Up Menu

You can display the stored waveforms with the following procedure:

1. Press **WAVE FORM**.
2. Press **SOFT KEY 1** to access the Waveform ON/OFF Pop-Up menu. A list of eight memory locations now appears. A small square appears next to a memory if a waveform is stored in that memory.
3. Press **▲** **▼** to highlight the required waveform memory to be displayed.
4. Press **SOFT KEY 5** to display the waveforms in these memory locations.  
A large dot appears next to each memory selected. A maximum of four waveforms can be displayed at one time.
5. Press **SOFT KEY 1** to leave this Pop-Up menu.

A maximum of four waveforms can be displayed at one time. If you attempt to display a fifth waveform, the following message is displayed:

**Not executed: already max. traces on LCD**

When **Y-pos** is displayed in the Right Display, press **▲** **▼** to reposition any of the displayed waveforms from memory. Select the waveforms separately by pressing **SOFT KEY 5**.

To recall a waveform setup you must highlight the required memory and then select **Setup recall**.



## WAVEFORM MATHEMATICS ~~98~~ ~~95~~

Press **MATH** to access the Math Softkey Menu. You can now perform several math functions on the various memories. Press **SOFT KEY 1** for a list of the math functions available.

- **ADD, SUBTRACT, and MULTIPLY** require two operands (SOURCE1 and SOURCE2). The operands can be selected from acquisition memories, temporary waveform memories, or waveform memories.
- **INVERT, INTEGRATE, and FILTER** functions require one operand (SOURCE1) from acquisition memories, temporary waveform memories, or waveform memories.
- All functions require a **DESTIN** (destination) memory selection.

Start or stop the selected math function by pressing **SOFT KEY 5**. You can view the math result by accessing the waveform memory that you used for the destination. Press **SOFT KEY 1**, then **SOFT KEY 1**. Highlight the desired waveform memory by pressing **SOFT KEY 1**, then press **SOFT KEY 5**.

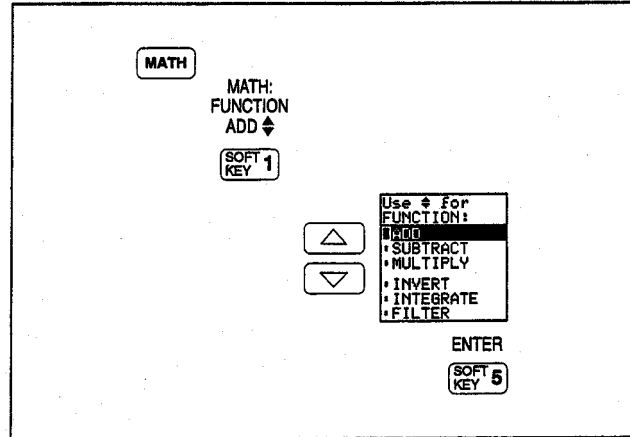



Figure 4.8 Math Function Pop-Up Menu

While the Math Softkey Menu is displayed, **SCALE** appears in the right display. The Scale factor allows you to adjust the display to accommodate the math result. You can now press  and  to select none, /5, /25, or /125.

**ADD** Adds two traces (each sourced from an active channel or a memory location) and stores the result in a chosen memory location. For example, waveforms from channel A (SOURCE1) and memory 1 (SOURCE2) can be added, resulting in a waveform stored in memory 4 (DESTIN).

**SUBTRACT** Subtracts the SOURCE2 trace from the SOURCE1 trace and stores the result in the chosen memory location. As with ADD, active channels or memory locations can be used in any combination for the sources.

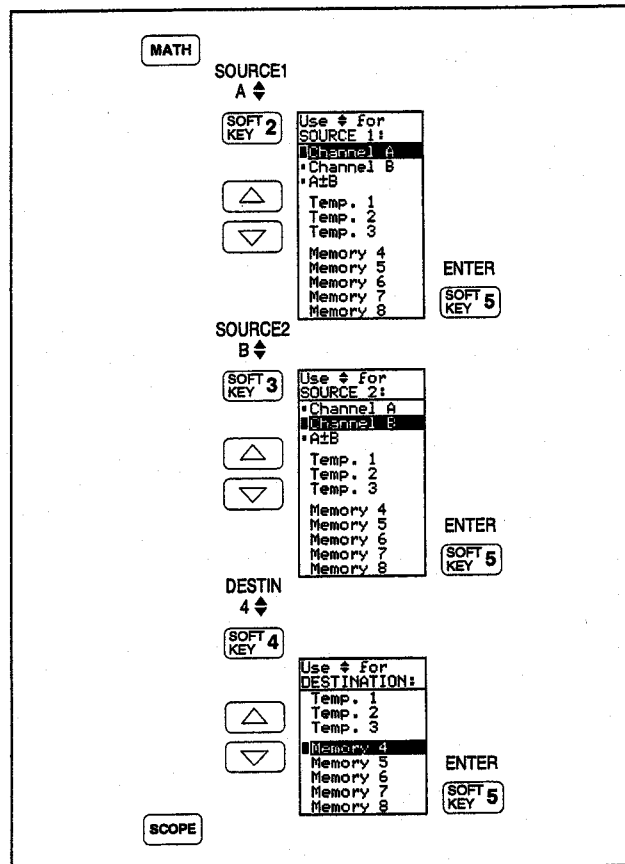
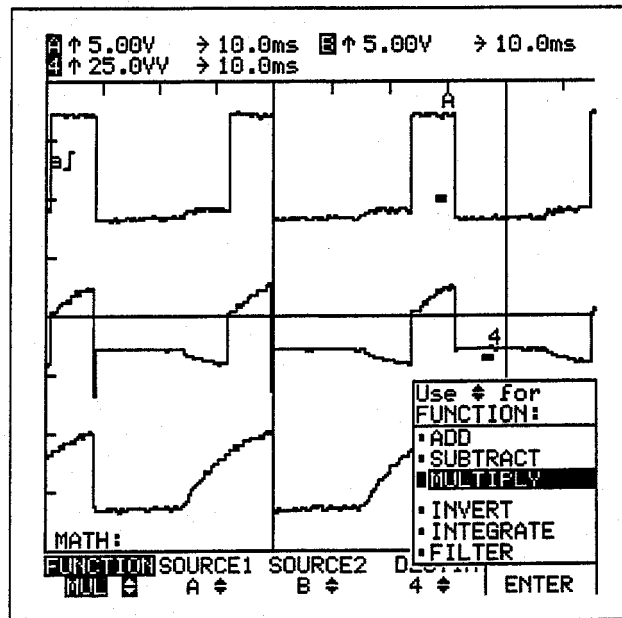

Figure 4.9 Math Source1/Source2/Destin Pop-Up Menus

**MULTIPLY** Multiplies two traces (each sourced from an active channel or a memory location) and stores the result in a chosen memory location. For example, power can be calculated with MULTIPLY if SOURCE1 represents the voltage drop across a device, and SOURCE2 represents current through that device. In the next Figure, waveforms from channel A (upper) and memory 4 (middle) are multiplied, resulting in the waveform stored in memory 5 (lower).

**INVERT** INVERT allows you to reverse the polarity on an active channel or memory signal and store the new waveform in another memory location.

**INTEGRATE** This function performs a numerical integration on the selected waveform.



**FILTER** Any waveform (active channel or memory) can be filtered, with the resulting waveform stored in a new memory location. Noise suppression or simply waveform smoothing is thereby possible. Filtering is especially useful with single-shot waveforms, where averaging of multiple waveform samples is not otherwise available. In the next Figure, the upper waveform represents the channel A signal as measured, and the lower waveform represents the filtered version recalled from memory 4.

**NOTE**

*In FILTER function, the -3 dB frequency is  $0.8/\text{time-per-division}$ .*

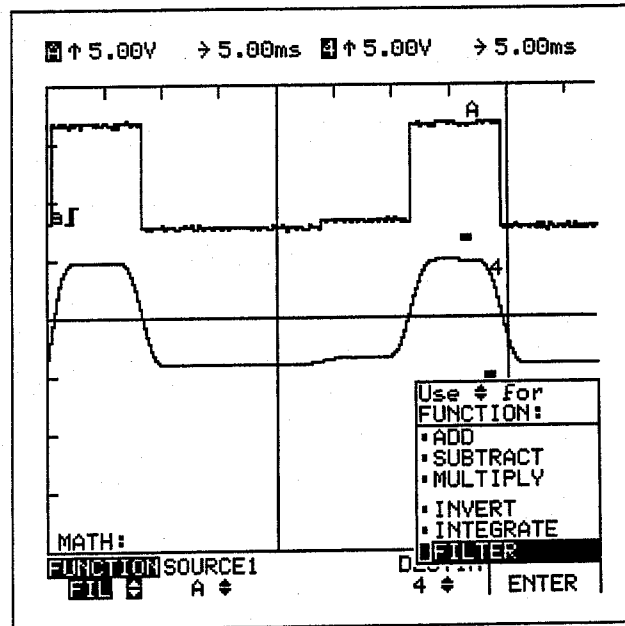

## PRINTING ~~93~~ ~~95~~

Refer to the Users Manual provided with the Optically Isolated RS-232-C Interface Adapter for complete printer connection and operation instructions. This adapter is an option available by ordering the PM9080/001 from your Fluke representative.

The following instructions relate to actions you must take at the ScopeMeter side of this operation.

### Print Format

Press **SPECIAL FUNCT** to access the Special Functions Softkey Menu. Then press **SOFT KEY 3** to enter the Print Format Pop-Up Menu. You can now choose the type of information to print.

This menu is organized into the following three groups:

- **SCREEN** (default setting) Print a graphic copy of the actual ScopeMeter display (Meter, Scope, or Component Testing mode).
- **LOG readings** Set the print interval time for Meter measurements, or Scope cursor data.
- **WAVEFORM** Print out the selected waveform. The waveform is printed in a numerical format that represents sample data points (Scope mode only).

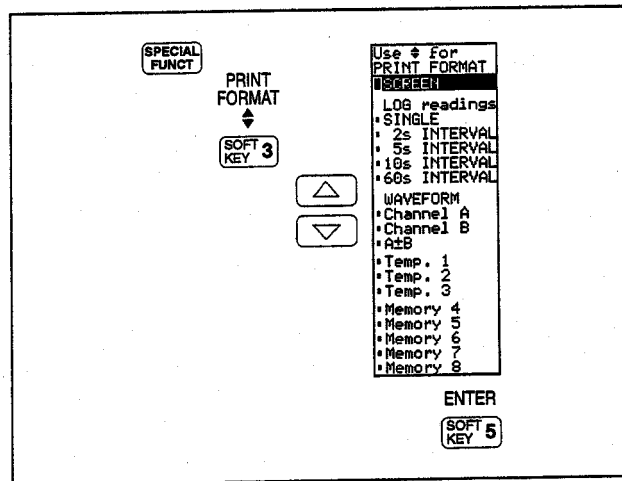

Figure 4.10 Print Format Pop-Up Menu

### Printer Setup

ScopeMeter can print directly to an FX/LQ (Epson) type or HP ThinkJet type printer at 1200 or 9600 baud. From the Special Function Softkey Menu, press **SOFT KEY 4** to make these selections.

### Start Print

Press **SOFT KEY 5** from the Special Function Softkey Menu to start printing via the ScopeMeter serial RS-232-C port. The settings you made in the Print Format and the Printer Setup Pop-Up Menu will be used.

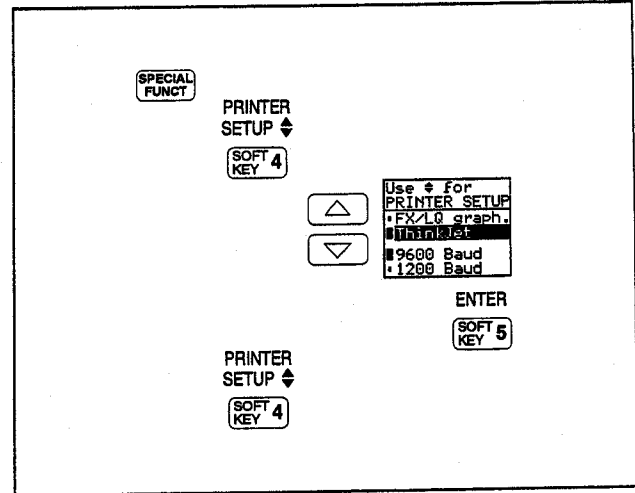

Figure 4.11 Printer Setup Pop-Up Menu

## MASTER RESET CONFIGURATION

When  ON  OFF is pressed ON, ScopeMeter begins operation in the last-known configuration and the LCD Softkey Menu appears. Factory default settings are used at the first power up. Subsequent power ups maintain configuration changes made with keystrokes or through recall of a setup memory during the previous session.

A master reset includes the following settings:

- Meter Mode
- Vrms AC + V DC
- LCD Screen, Backlight Off
- Probe Cal 10:1, Channels A and B
- Dot Join
- Dotsize 1
- Setup Memory cleared
- Waveform Memory cleared
- Generator Off
- Print Format Screen
- Printer Setup FX/LQ graph, 1200 Baud
- Autoranging

Some of the configuration settings can be preset to become active at every power up. Press , then access these selections from the Setup Softkey Menu by pressing . The Initial Setup Pop-Up Menu appears.

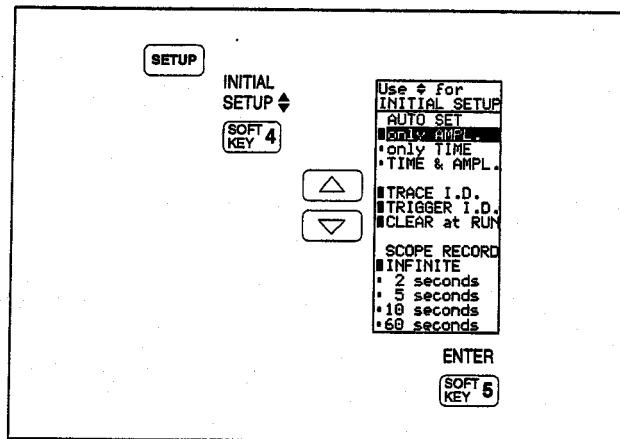

Figure 4.12 Initial Setup Pop-Up Menu

The first part of these selections defines some basic actions taken at Auto Set. Here, you can specify whether Auto Set will attempt to optimize the attenuator (**only AMPL.**), the time base (**only TIME**), or both (**TIME & AMPL.**). Note that you must also choose as **INIT.SET.** in the Auto Set Pop-Up Menu to use your attenuator/time base optimization selection. The factory default optimization is **only AMPL.**

The next part of the Initial Setup Pop-Up Menu selects some Scope Mode setups. You can specify whether to identify the waveform (trace) source (**TRACE I.D.**), whether to identify the trigger source and slope (**TRIGGER I.D.**), and whether to **CLEAR at RUN**. Factory defaults place all three of these items on.

A final part of the Initial Setup Pop-Up Menu specifies the period for Scope Record updates. The factory default is **INFINITE**. Other selections are 2, 5, 10, or 60 seconds (or acquisitions.)

### Performing a Master Reset

A Master Reset clears all setups and memories, restoring factory default settings and sets ScopeMeter to the Meter Mode.

### CAUTION

**A Master Reset also clears both WAVEFORM and SETUP memories.**

1. Press **ON/OFF** to turn ScopeMeter off.
2. Press and hold **LCD**; while holding **LCD** pressed, momentarily press **ON/OFF**.

After you hear the double beep, release **LCD**.

3. ScopeMeter turns on.

## AUTO SET CONFIGURATION

When **AUTO SET** is pressed, ScopeMeter assumes the auto set configuration. To change this configuration, press **SETUP** to access the Setup Softkey Menu, then press **SOFT KEY 5**. The Auto set Pop-Up Menu appears.

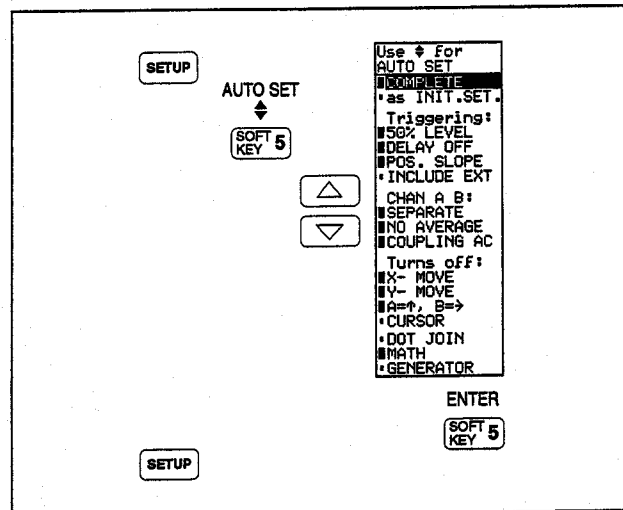

Figure 4.13 Auto Set Pop-Up Menu



The items shown in this menu are divided into the following four groups:

1. **AUTO SET** source

- a. **COMPLETE** (Default is ON)
- b. **as INIT.SET.** (Default is OFF)

**NOTE**

*Choose **COMPLETE** for best predictability. If you choose **as INIT.SET.**, the time base assumed may not be predictable, depending on your optimization selection in the Initial Setup Pop-Up Menu.*

2. **Triggering:** selections

- a. **50% LEVEL** (Default is ON - previously set trigger level will be switched off).
- b. **DELAY OFF** (Default is ON - any delay set will be switched off).
- c. **POS. SLOPE** (Default is ON - triggers on positive slope).
- d. **INCLUDE EXT.** (Default is OFF - excludes external triggering).

3. **CHAN A B:** setup

- a. **SEPARATE** (Default is ON - both channels are displayed, seperated for four divisions).
- b. **NO AVERAGE** (Default is ON - average turned off).
- c. **COUPLING AC** (Default is ON - both channels AC coupled).

4. **Turns off:** Items that are turned off when  **AUTO SET** is pressed. An item marked with a large black square here is turned off; items marked with a small square are left unchanged.

- a. **X- MOVE** (Default is OFF - trace in screen center).
- b. **Y- MOVE** (Default is OFF - trace in screen center).
- c. **A = ↑, B = →** (Default is OFF - mode is turned off).
- d. **CURSOR** (Default is ON - Cursors not switched off).
- e. **DOT JOIN** (Default is ON - Dot Join remains active).
- f. **MATH** (Default is OFF - Math function is turned off).
- g. **GENERATOR** (Default is ON - Generator is not switched off).

Items not listed here are not impacted by Auto Set.

## MEASURING COMPONENTS ~~98~~ ~~95~~

From the Special Functions Softkey Menu, press **SOFT KEY 2** to use ScopeMeter as a predefined measuring tool for components.

Depending on the menu selection, ScopeMeter outputs a slow voltage (-2V to +2V) or current ramp (0 to +2mA). Connect the component to be tested, between the GENERATOR OUT and COM (common). Measure the component on CHANNEL A, it's characteristics are shown on the special measure display.

Auto Set cannot be used with the Component Measurement Mode.

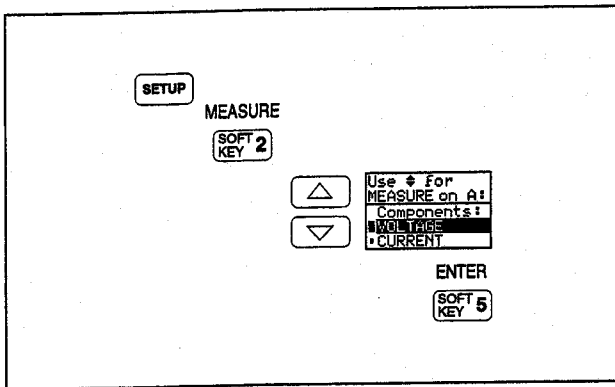
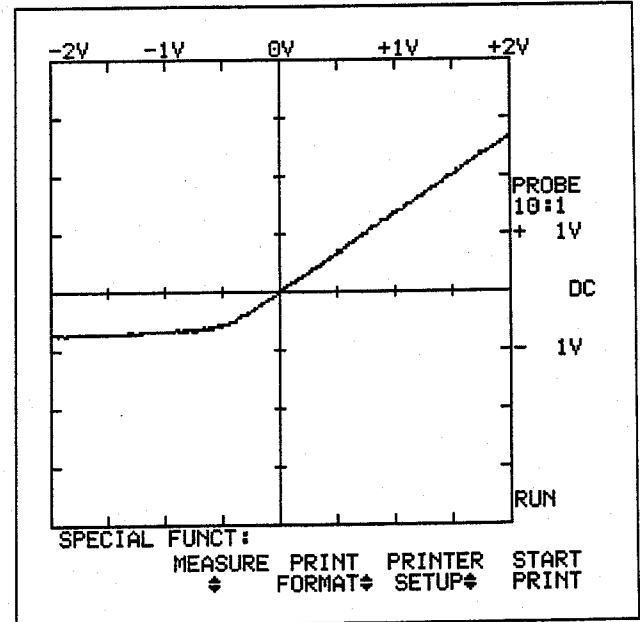

Figure 4.14 Component Measurement Pop-Up Menu



## USING THE SIGNAL GENERATOR ~~98~~ ~~95~~

Press **SPECIAL FUNCT** to select the Special Functions Softkey Menu. Then press **SOFT KEY 1** to select the Generator Pop-Up Menu. You can now select a signal output at GENERATOR OUT and COM (common).

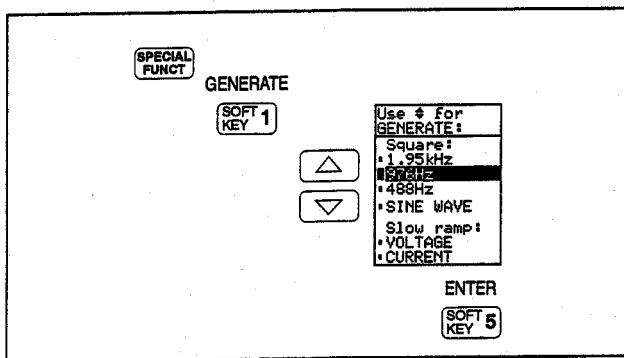

Figure 4.15 Generator Pop-Up Menu

The output choices are:

- Square: 1.95kHz, 976Hz, 488Hz (all at 5V p-p)
- SINE WAVE (1V p-p, 976 Hz)
- Slow ramp:
  - VOLTAGE (-2V to +2V, 1 mA maximum)
  - CURRENT (0 to 3 mA, 2V maximum)

The generator is automatically disabled if the mV DC,  $\Omega$ , or  $\leftarrow$  function is active in Meter mode.

The generator output also can be selected as trigger source; when turned on, it replaces the EXT (external) trigger source in the TRIGGER menu.

## MINIMIZING SIGNAL NOISE

In general, using your ScopeMeter on battery power only will minimize noise pickup. Using the 10:1 probe will help in noise rejection.

If you are using the line voltage adapter (PM8907 or equivalent), connect a test lead from the ScopeMeter banana jack COM (common) to the measurement common (ground) of the system under test. This technique reduces or eliminates any power line related noise.

# Section 5

## Measuring Examples

### Contents

---

<b>SINGLE MEASUREMENT</b> .....	5-2	<b>DUAL CHANNEL THREE PHASE</b>	
<b>CURRENT MEASUREMENTS</b> .....	5-3	<b>MEASUREMENT</b> .....	5-10
<b>MEASURING POWER WITH MATH FUNCTION</b> ....	5-6	<b>PHASE MEASUREMENT USING THE CURSORS</b> .	5-12

This section examines some typical measurements which can be made with your ScopeMeter. The examples given can be used as an aid in many applications.

## SINGLE MEASUREMENT

Making a single (single shot) measurement is one of the more difficult acquisitions a scope user has to do. The single shot mode is used to capture a waveform or event which may only occur once. When used in combination with trigger delay, you can observe the event, along with the information that occurred just before the trigger point. For a more detailed Single Shot exercise refer to Section 6, ScopeMeter Tutorial.

- ① Connect ScopeMeter to the measurement point, using the a scope probe.

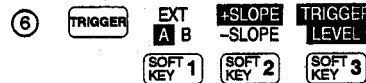
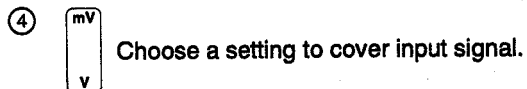

set slope to appropriate edge (rising or falling).

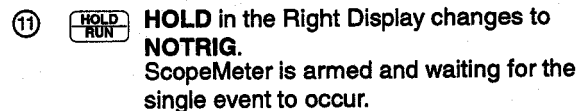
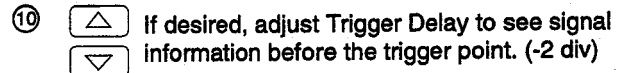
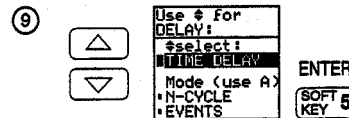
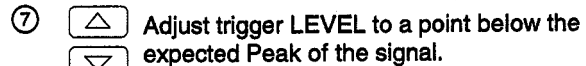

When the single acquisition triggers the scope **NOTRIG** changes to **RUN**, indicating that ScopeMeter has captured the signal. Acquisitions can fill two full screens (20 divisions). When complete **RUN** changes to **HOLD** again.

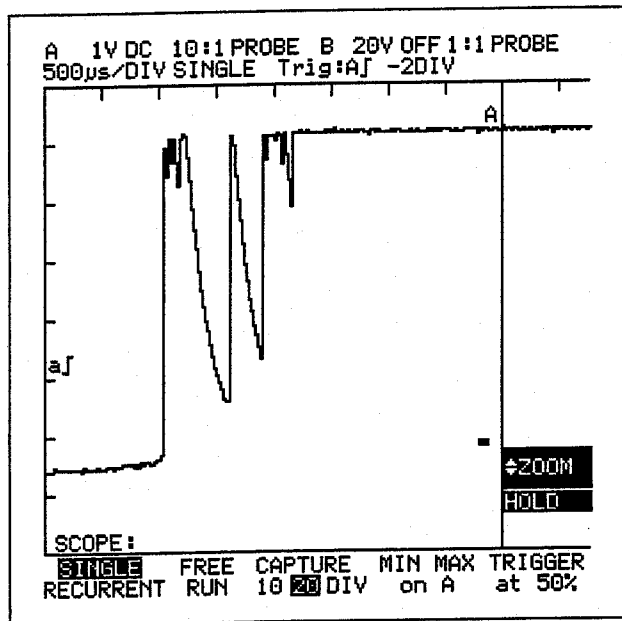

Figure 5.1 Single shot measurement with two divisions trigger delay

For another single shot, simply press **HOLD RUN** again and wait for the next acquisition.

## CURRENT MEASUREMENTS

The 80i-1000S Current Probe is an optional accessory designed for use with ScopeMeter to measure current flow in electrical circuits. The millivolt reading in the Meter Mode or Scope Mode with cursors is directly proportional to current (Amps) sensed by the Current Probe. For example, when the 80i-1000S range switch is set to 1 mV/A, a 22.5 mV reading would equal 22.5A. Refer to the instruction sheet provided with 80i-1000S for complete information about Current Probe operation.

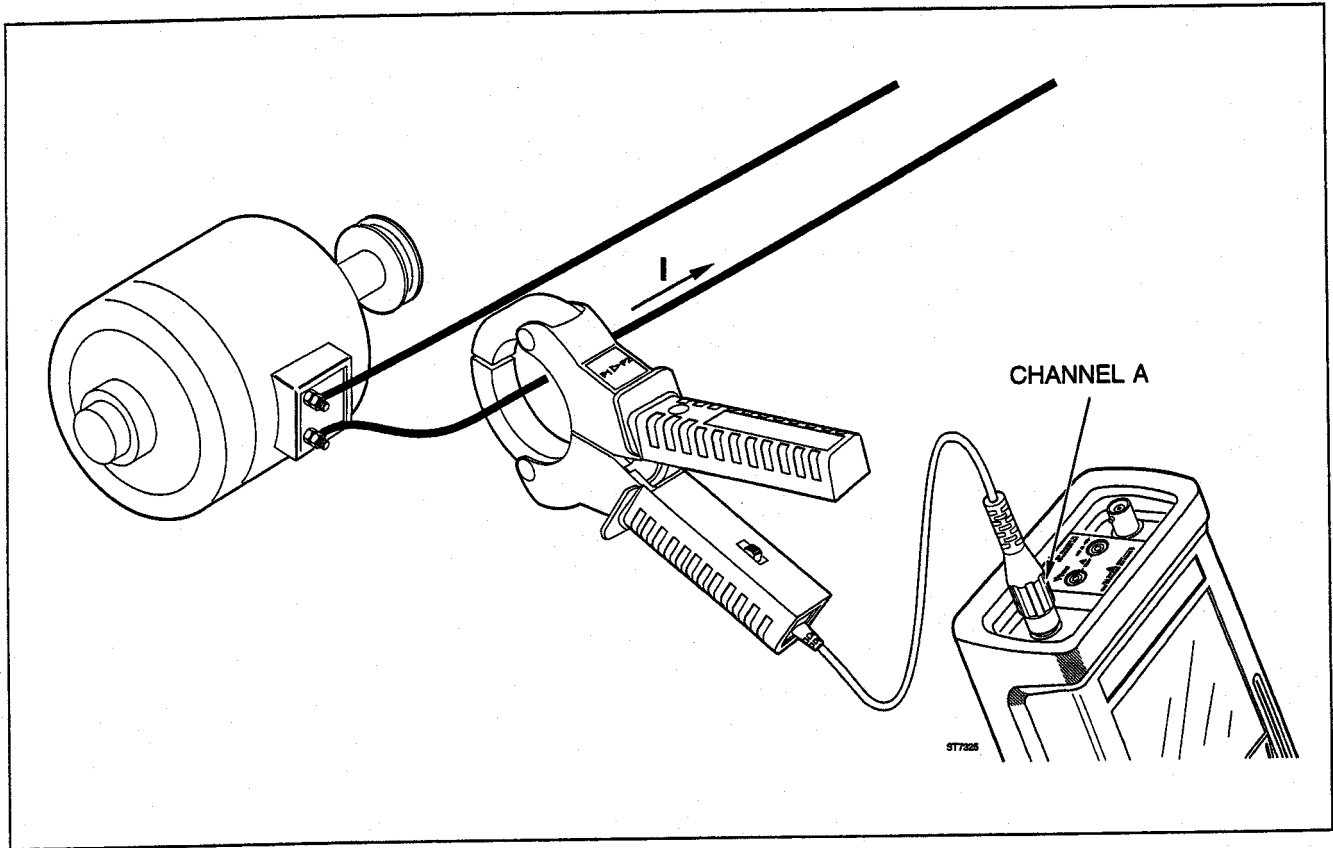







Figure 5.2 Current measurement setup

**⚠ WARNING**

**TO AVOID ELECTRICAL SHOCK, USE ONLY CURRENT PROBE ACCESSORIES SPECIFICALLY DESIGNED AND APPROVED FOR USE WITH SCOPEMETER. OTHER PROBES MAY EXPOSE THE OPERATOR TO AN ELECTRIC SHOCK HAZARD IF ANY OF THE THREE COMMON INPUT CONNECTIONS ARE CONNECTED TO A POTENTIAL GREATER THAN 30 VRMS OR 42V DC.**

- ① Disconnect all test leads from ScopeMeter inputs, and connect the 80i-1000S to the CHANNEL A BNC input.
- ② Set Current Probe range switch to 1 mV/A.
- ③  +  ScopeMeter turns on, probe factor is 1:1.
- ④    

- ⑤ Clamp the Current probe jaws around the conductor to be measured.
- ⑥ ScopeMeter displays the actual current. In this example 238.6 mVrms equals 238.6A.

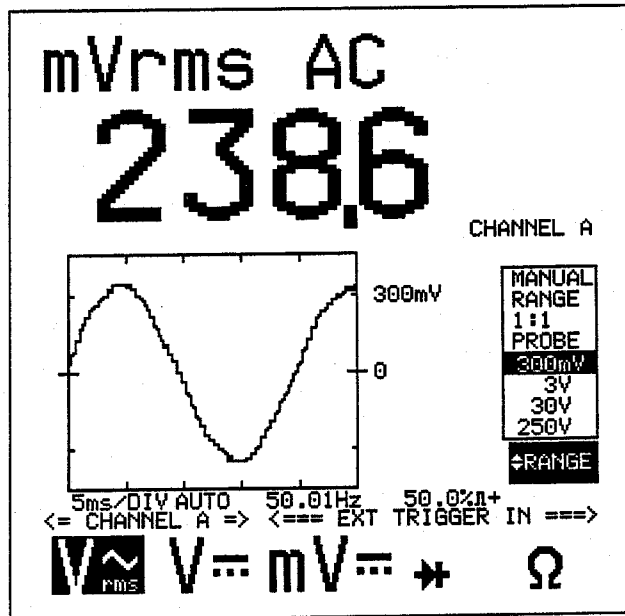

Figure 5.3 Current measurement in Meter mode



To see the current as a waveform, set ScopeMeter as follows:

⑦ **SCOPE**

⑧ **AUTO SET**

⑨ ScopeMeter displays the current as a waveform, which can be analyzed using all other functions of ScopeMeter.

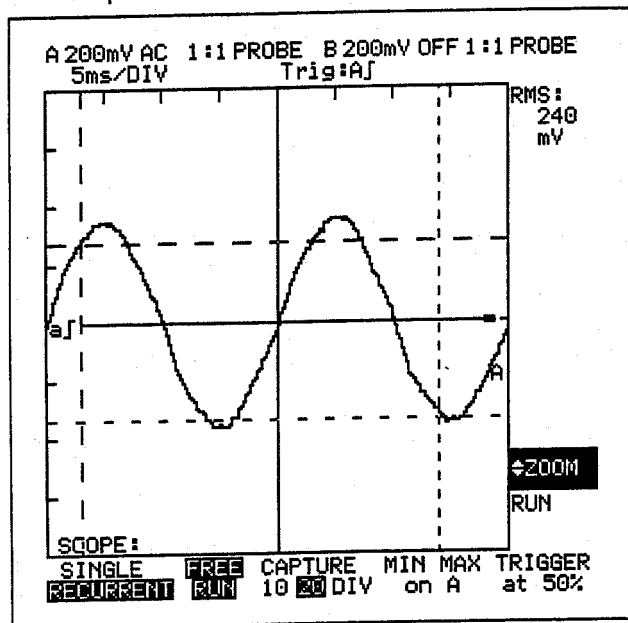

Figure 5.4 Current measurement in Scope mode

## MEASURING POWER WITH MATH FUNCTION

When using the optional Current Probe 80i-1000S ScopeMeter is able to measure voltage and current at the same time. This may be used to measure average power consumption of an electrical load on a single phase circuit. This measurement is reliable over a wide range of frequencies, irrespective of the wave shapes of voltage or current.

In this example you make use of the previous measurement set-up, measuring current with the 80i-1000S on channel A, and will add the voltage measurement using the grey scope probe on channel B. Be sure that channel B is set for a 10:1 probe.

On the following pages you see the connection method and MATH function operation to realize this.

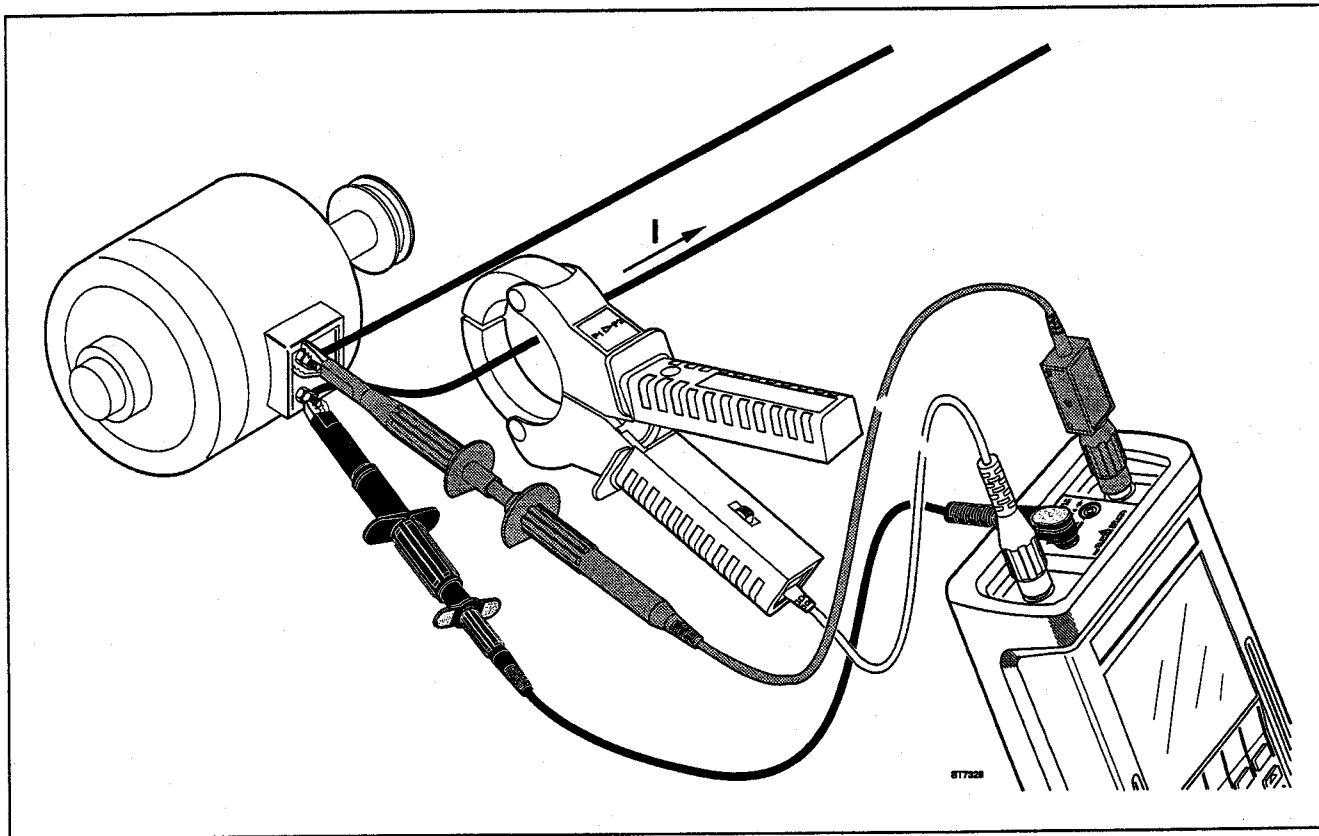

Figure 5.5 Power measurement setup

① **MATH**

FUNCTION

**SOFT KEY 1**

Use # for FUNCTION!
*ADD
*SUBTRACT
*MULTIPLY
*INVERT
*INTEGRATE
*FILTER

ENTER

**SOFT KEY 5**

② SOURCE1

**SOFT KEY 2**

Use # for SOURCE 1:
*Channel A
*Channel B
*A+B
Temp. 1
Temp. 2
Temp. 3
Memory 4
Memory 5
Memory 6
Memory 7
Memory 8

ENTER

**SOFT KEY 5**

③ SOURCE2

**SOFT KEY 3**

Use # for SOURCE 2:
*Channel A
*Channel B
*A+B
Temp. 1
Temp. 2
Temp. 3
Memory 4
Memory 5
Memory 6
Memory 7
Memory 8

ENTER

**SOFT KEY 5**

④ Store the resulting waveform in memory 4.

DESTIN

**SOFT KEY 4**

Use # for DESTINATION:
Temp. 1
Temp. 2
Temp. 3
Memory 4
Memory 5
Memory 6
Memory 7
Memory 8

ENTER

**SOFT KEY 5**

⑤ START MULTIPLY

**SOFT KEY 5**

⑥ **WAVE FORM**

**ON/OFF**

**SOFT KEY 1**

Use # for ON/OFF:
Temp. 1
Temp. 2
Temp. 3
Memory 4
Memory 5
Memory 6
Memory 7
Memory 8
*Setup recall

ENTER

**SOFT KEY 5**

⑦ **ON/OFF**

**SOFT KEY 1**

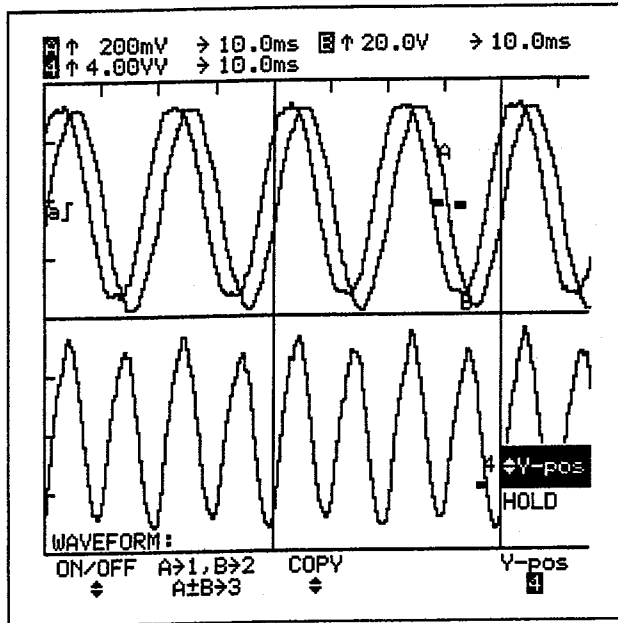

Figure 5.6 Power measurement

In Figure 5.6 Channel A represents the current measurement, Channel B the voltage measurement, and Memory 4 the product (equals power).

In this example the following scales are used:

Channel A: 200 mV/DIV equals 2 A/DIV

Channel B: 20.0 V/DIV

Memory 4: 4.00 VV/DIV equals 40 W/DIV

- ⓑ  If necessary you can shift the resulting waveform over the display.
-

## DUAL CHANNEL THREE PHASE MEASUREMENT

Dual channel measurements can be used for many applications. This example shows how to use it to determine phase rotation of a "Y" connected three phase system at a load center. Use alligator clips to connect ScopeMeter to the three phase system connections.

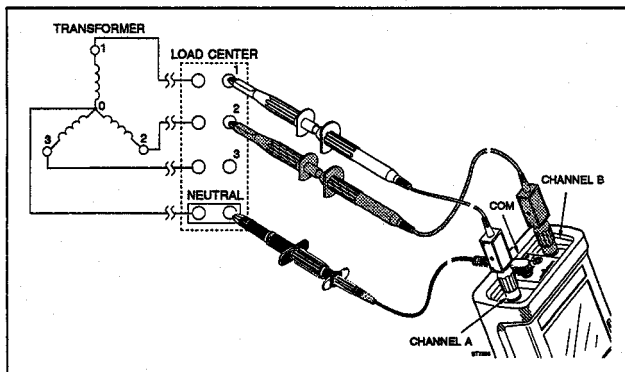

Figure 5.7 Testing a three phase system

### WARNING

THE SETUP REQUIRES CONNECTING TEST LEADS TO LIVE COMPONENTS OF A HIGH ENERGY CIRCUIT. TO AVOID ELECTRICAL SHOCK AND/OR EQUIPMENT DAMAGE, USE CAUTION WHEN CONNECTING THE SLIP-ON ALLIGATOR CLIPS TO LIVE COMPONENTS.

IN FULLY OPEN POSITION, THE EXPOSED METAL JAWS OF THE ALLIGATOR CLIPS CAN CREATE A SHORT CIRCUIT BETWEEN CLOSELY SPACED LIVE PARTS. AVOID MAKING CONNECTIONS TO FEEDER CONDUCTORS OR BUSS BARS AT ELEVATED POTENTIALS. WHENEVER POSSIBLE MAKE CONNECTIONS TO THE OUTPUT SIDE OF A CIRCUIT BREAKER WHICH CAN PROVIDE BETTER SHORT CIRCUIT PROTECTION.

MAKE CONNECTIONS TO CIRCUIT BREAKERS BY FIRST TURNING THE CIRCUIT BREAKER OFF. THEN CONNECT THE ALLIGATOR CLIP TO THE BREAKER OUTPUT TERMINAL VIA A SHORT PIECE OF INSULATED WIRE AS SHOWN IN FIGURE 5.8.

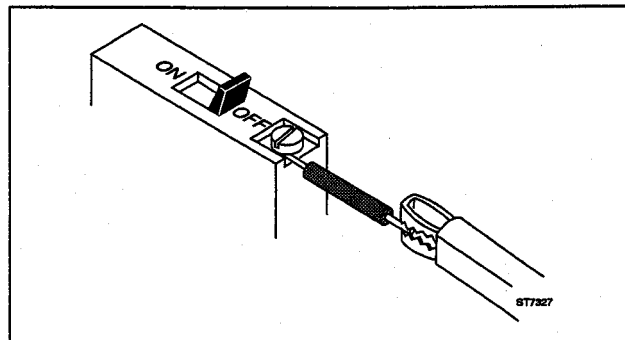

Figure 5.8 Connecting the wires

① Make sure the circuit breaker is turned off. Connect the ScopeMeter to two circuit breakers and the neutral buss bar as shown in Figure 5.8. Use the alligator clips for the red and grey scope probes and black multimeter test lead.

② **LCD** + **ON/OFF**

ScopeMeter turns on, probe scaling factor is 10:1.

③ **SCOPE**

④ **AUTO SET**

⑤ **mV** Channel A and Channel B as necessary  
**V**

⑥ Turn circuit breaker on.

⑦ Measure connection 1 and connection 2 (see Figure 5.9).

The upper waveform is Figure 5.9 shows that line 2 (channel B) follows line 1 (channel A). The lower waveform shows line 3 follows line 1.

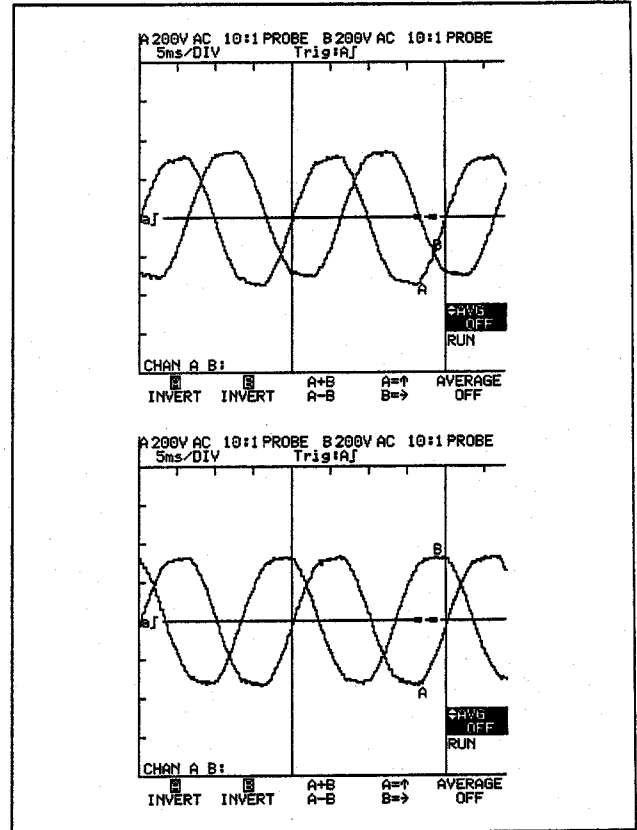







Figure 5.9 Rotation measurements

## PHASE MEASUREMENT USING THE CURSORS

In this example you will use the cursors to measure the phase difference between the waveforms on channel A and channel B. Use the two waveforms from the dual channel three phase measurement in the previous exercise. Cursors allow you to make accurate digital measurements. It is advised first to press  to freeze the signals to be measured.

① Measure the two sine wave signals as explained in previous example.

②  **HOLD** begins flashing in lower right display.

③  **SOURCE** **A B**   
 

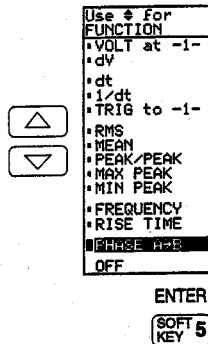

④ **FUNCTION**



This removes the pop-up menu again.

⑤  

Position the two cursors on the waveform, see Figure 5.10.

⑥ ScopeMeters display shows the phase between the waveforms on channel A and channel B: "PHASE A→B -119°" (see Figure 5.10).

To identify the point on the waveforms where the measurement has occurred, you can use the markers:

⑦  **MARK on A**  



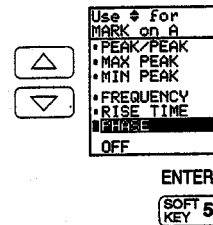
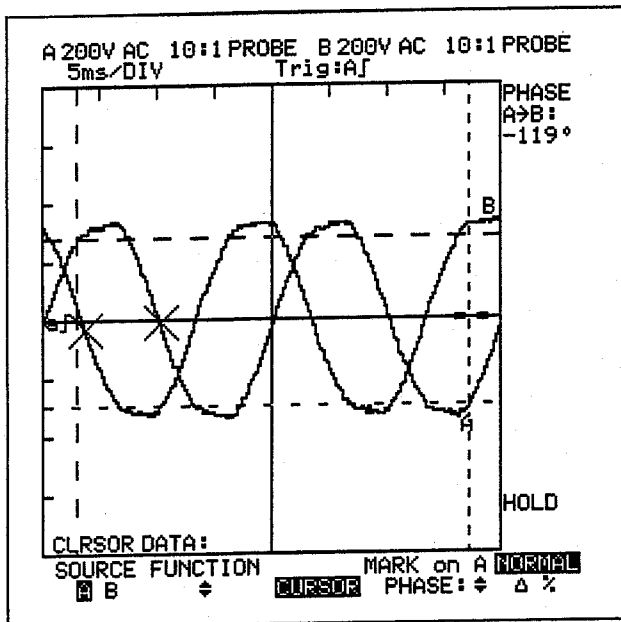

Figure 5.10 Phase measurement with markers





# Section 6

## ScopeMeter Tutorial

### Contents

---

<b>MAKING LOW FREQUENCY VOLTAGE MEASUREMENTS WITH THE METER</b> .....	6-4	<b>MAKING SINGLE SHOT MEASUREMENTS WITH THE SCOPE</b> .....	6-18
<b>TESTING POTENTIOMETERS</b> .....	6-8	<b>FINDING HIDDEN SIGNAL DETAILS WITH THE SCOPE</b> .....	6-20
<b>USING AND ASSISTING SCOPE AUTO SET</b> .....	6-9	<b>MAKING SCOPE CURSOR MEASUREMENTS</b> ...	6-24
<b>MAKING LOW FREQUENCY MEASUREMENTS WITH THE SCOPE</b> .....	6-15	<b>USING THE MATH FUNCTIONS</b> .....	6-29

This section demonstrates how to use several of the advanced features in your ScopeMeter. To become familiar with these features you must use the Demo Board delivered with your ScopeMeter. All the following tutorials (except "Testing Potentiometers"), require that ScopeMeter be connected to the relevant test point (TP1 through TP5) on the "Demo Board". In "Testing potentiometers" you must supply your own potentiometer. Before making any measurement, be aware of the safety precautions, found on page IV. The Demo Board connections are shown in figure 6-1.

#### NOTE

*All displays shown in the example figures are typical values. Actual measured values may vary because the Demo Board signal levels are dependent on the battery voltage.*

Before starting each application, Reset the ScopeMeter (Press and hold **LCD**, then press **ON/OFF**), to ensure that your ScopeMeter is set to the factory default configuration, with 10:1 probe attenuation.



#### WARNING

##### TO AVOID ELECTRIC SHOCK OR FIRE:

1. USE ONLY THE TEST LEAD/PROBE SET SUPPLIED WITH SCOPEMETER (OR SAFETY-DESIGNED EQUIVALENTS) WITHOUT EXPOSED METAL CONNECTORS.
2. USE ONLY ONE COM (COMMON) CONNECTION (THE BLACK BANANA JACK).
3. REMOVE ALL PROBES AND TEST LEADS THAT ARE NOT IN USE.

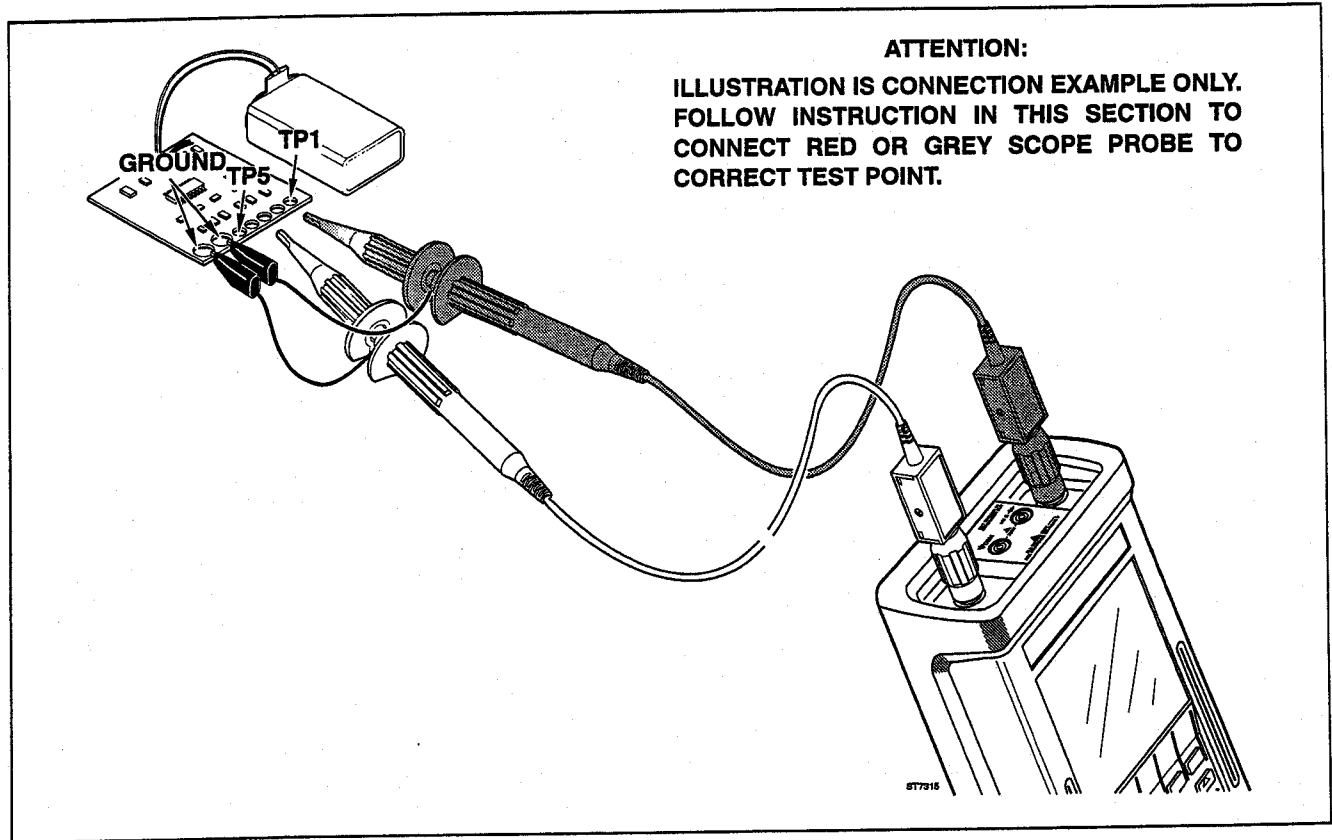

Figure 6.1 ScopeMeter Tutorial setup

## MAKING LOW FREQUENCY VOLTAGE MEASUREMENTS WITH THE METER

ScopeMeter can make rms voltage measurements on signals as low as 1 Hz. In this example, you will practice making such a measurement.

### Connection

Connect the red scope probe from Channel A (meter high) to TP1 (the test signal) on the Demo Board. Connect the meter low to ground of the Demo Board using either the COM banana input of ScopeMeter with a test lead or the ground lead of the probe hook clip. Disconnect the probe for channel B

### Making the Measurement

- Reset the ScopeMeter.

To select the dual AC and DC volts display:

- Press **METER**.

You should now see two unstable readings on the display and occasionally hear the ranging relays click. The auto ranging is the result of a low frequency signal being produced at TP1, which can be examined in the following ways:

#### A. Finding the Minimum and Maximum.

The Minimum and Maximum levels in this example are DC.

To select DC Volts:

- Press **SOFT KEY 2**.

You should now see the combined display showing V DC and the small Scope trace display. Notice the numerical readout is unstable and the trace display shows a changing level, sometimes high, or low, or with a vertical edge, and the ranging relays are still slowly clicking (See Figure 6-2).

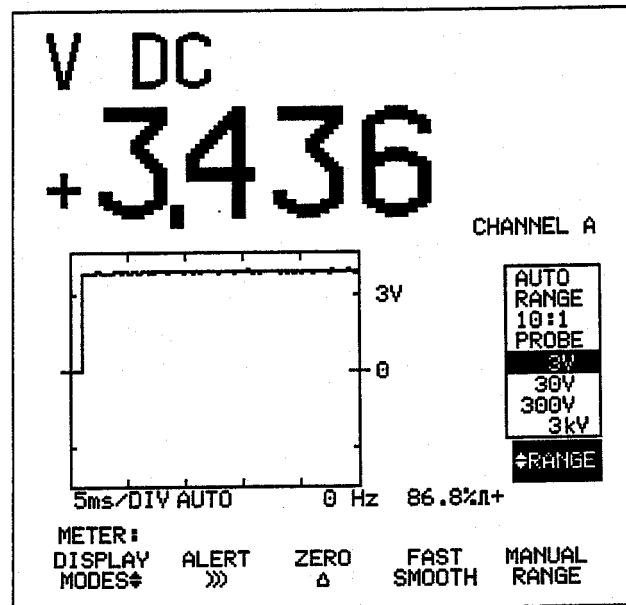

Figure 6.2

Selecting a manual range will stop the relay clicking:

- Press  to highlight 30V.

The display should now show a DC reading between 0 and about 4 volts and the trace display shows changing levels and sometimes an edge. Now select the min/max RECORD mode:

- Press  .  
(model 93 users go to B).

ScopeMeter beeps each time a new minimum or maximum is measured. After a couple of minutes you should see a readout similar to Figure 6-3. Note the time stamp which indicates the elapsed time before the displayed minimum or maximum occurred. The Average value time stamp shows the total elapsed time since RECORD was pressed.

To turn off the RECORD mode:

- Press .

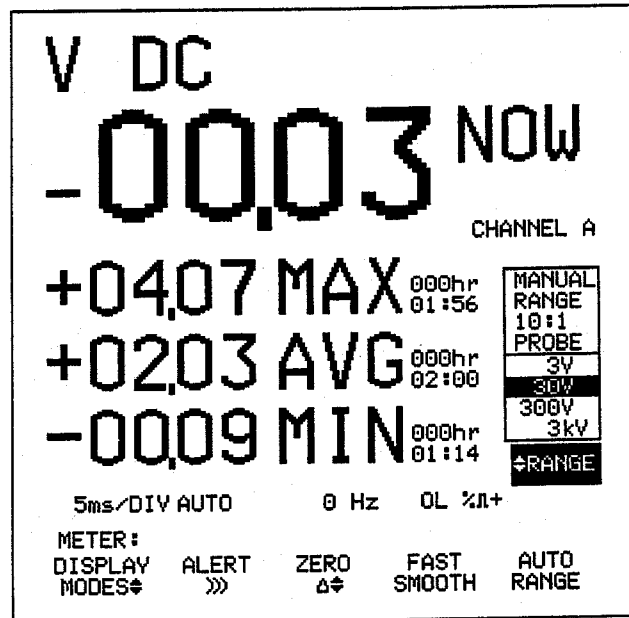

Figure 6.3

## B. Stabilizing the trace display

Under the trace display you see a readout of 5 ms/DIV AUTO, which is the horizontal time base of the trace. The 5 ms/DIV is the slowest time base used in the AUTO mode and gives measurements down to 15 Hz. To manually select a slower time base:

- Press **TIME**.

Continue pressing the **TIME** key until the time base readout is 100 ms/DIV MANUAL. The digital display should now be stable and show a reading of about 2 volts. The trace display is also stable and under the trace there is now a stable frequency readout of about 4 Hz, and a % duty cycle of about 50%. To increase the trace amplitude select the 3V range:

- Press **△** to highlight the 3V range.

ScopeMeter has a DC over range capability to 4500 counts, which is 4.5V for the 3V range; therefore you will see the 4V high level of this signal even though the 3V range has been selected as shown in Figure 6-4.

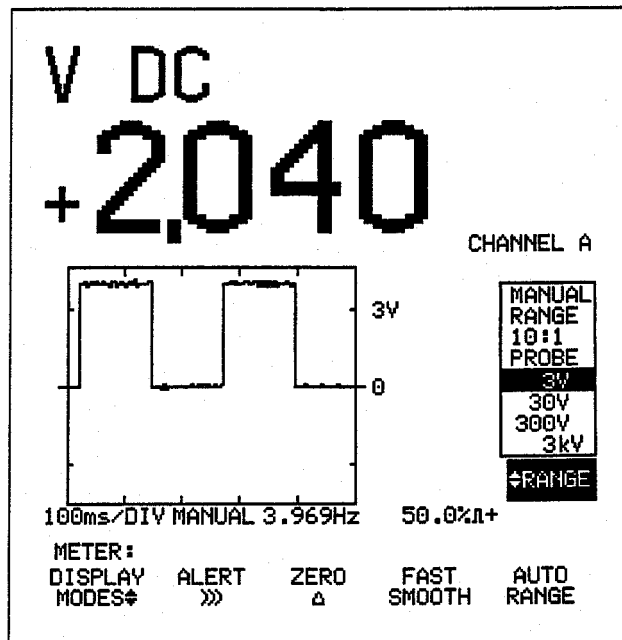

Figure 6.4

### C. Making an AC measurement

To Select VAC:

- Press **METER** to select the Meter menu.
- Press **SOFT KEY 1** to select  $V_{rms}$ .

Slow the time base to 100ms/DIV:

- Press **TIME** four times.

Comparing the AC trace of Figure 6-5 with the DC trace of Figure 6-4, the signal is now centered vertically about the middle of the screen and slopes between the switching edges. The slopes appear because the signal is AC coupled where higher frequency signals (>50Hz without probe or >5Hz with probe) can be measured accurately. To make an accurate measurement on this low frequency signal use DC coupling and measure AC+DC rms.

- Press Channel A **AC+DC** for DC coupling.

The trace now looks like the DC measurement and a 3 Volt AC+DC rms measurement is made.

#### A Tip

When making low frequency AC measurements with the meter, be sure to select AC+DC coupling and ensure the trace and the frequency displays are stable. If they are not, manually reduce the sweep speed. Then you can be sure of making reliable measurements.

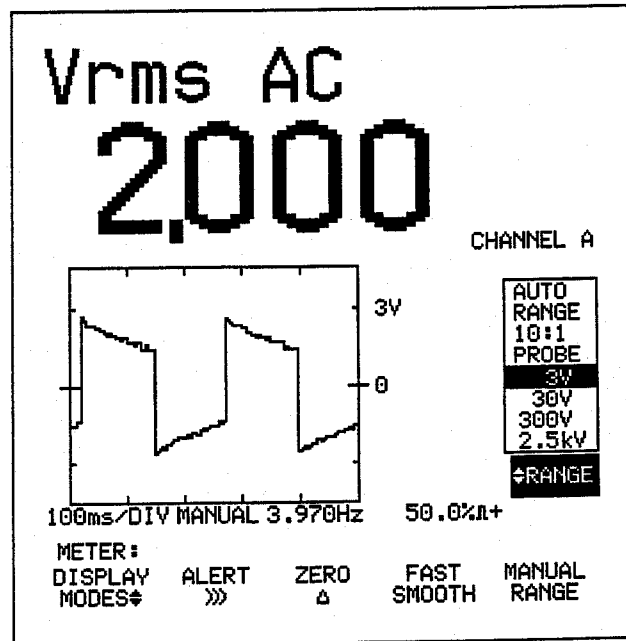

Figure 6.5



## TESTING POTENTIOMETERS

ScopeMeter can provide a numeric readout and a trace display of resistance. Using the COM (black) and  $\Omega$  (red) banana inputs connect ScopeMeter to the wiper and one end of the variable resistance to be tested. This signal is not available on the DEMO board.

To select the dual display ohms mode:

- Reset the ScopeMeter.
- Press **METER** to select Meter menu.
- Press **SOFT KEY 5** for  $\Omega$ .

Display should be similar to Figure 6-6, but the value will depend on the potentiometer used.

Once the reading is stable, vary the resistance (adjust the potentiometer) and observe the trace display movement. Spikes on the display indicate discontinuities in the potentiometer. The resistance trace display enables quick testing of potentiometers and shows discontinuities immediately.

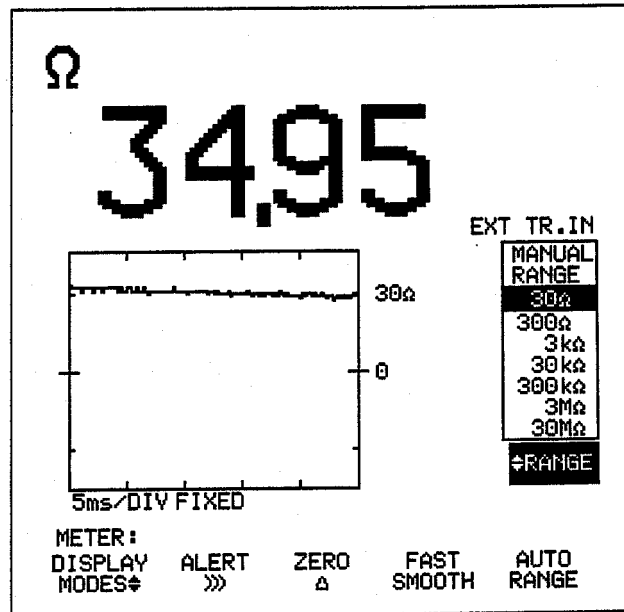

Figure 6.6

## USING AND ASSISTING SCOPE AUTO SET

In the Scope mode, AUTO SET samples the inputs to see which have signals connected, scales the signal(s) to fit on the screen, scales the sweep speed to show a number of cycles of the signal, and sets the trigger point to the mid point of the signal. AUTO SET gives a stable display of most repetitive signals, with some exceptions which can be split into three types.

- Complex Signals like video or modulated signals.
- Slow repetitive signals under 40 Hz (see "Making Low Frequency Measurements With The Scope").
- Single shot signals (see "Making Single Shot Measurements With The Scope").

The following example covers the first of these unusual signal areas.

### Connection

Connect the red scope probe from channel A to TP3 on the Demo Board.

### Making the Measurement

- Reset the ScopeMeter.
- Press **SCOPE** to select the Scope mode.
- Press **AUTO SET**.

Auto Set occurs but gives a display which is not completely stable. The signal appears to have a number of levels and is unstable. Adjust the time base and amplitude to give a display as shown in Figure 6-7:

- Press **mv** to increase amplitude if required.
- Press **TIME** to slow the time base.

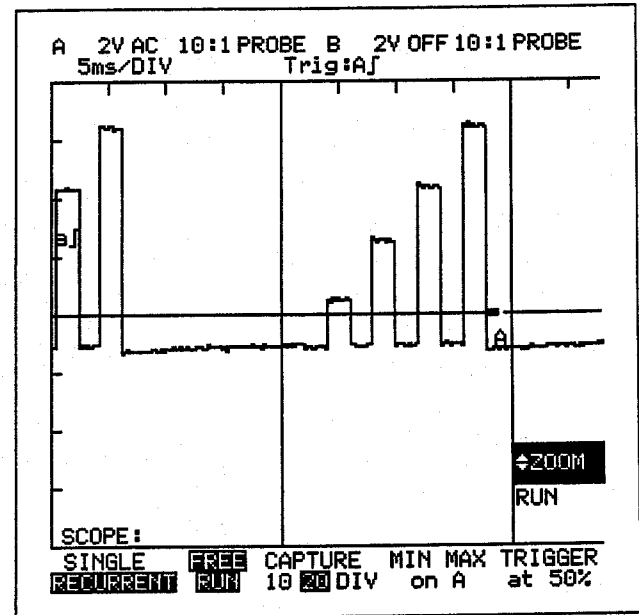

Figure 6.7

The signal in Figure 6-7 has five distinct levels. The trigger level chosen by Auto Set is about mid level of the signal. Because this signal has two pulses which exceed the mid level, triggering can occur on either of the two pulses. This results in an unstable display after Auto Set. To obtain stable triggering adjust the trigger level to a point between the upper two pulses so that triggering only occurs on the largest pulse.

- Press **TRIGGER**.
- Use **▲** to increase trigger level to close to the maximum pulse height.

The signal can now be clearly seen as a repetitive block of four pulses. Each block consists of the first pulse at 25% of the largest pulse, then 50%, then 75% and finally the largest pulse, where triggering occurs. To have a stable trigger and see just this block of four pulses in detail increase the sweep speed and use pre-trigger delay:

- Press **TIME 20** to increase the sweep speed to 2 ms/DIV.
- Press **SOFT 4** to select DELAY.
- Use **▲ ▼** if required to select TIME DELAY (Time delay is default for the model 93).
- Press **SOFT 5** to ENTER this choice.
- Use **▼** to adjust the DELAY to -7 (refer to Figure 6-8).

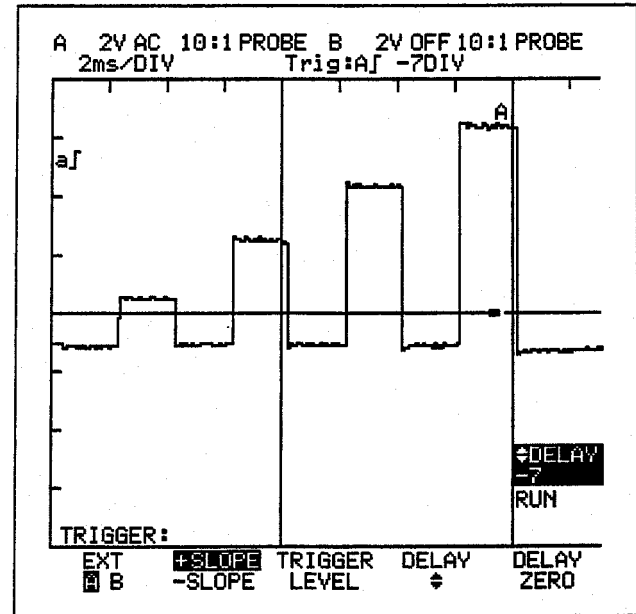

Figure 6.8

Adjusting the time delay to -7 DIV has moved the trigger point to the seventh division on the screen and you now see seven divisions of information that occur before the trigger. (see Figure 6-8.). To look in more detail at the 50% pulse you can use ZOOM (The ZOOM Function not available on the 93). The ZOOM function expands the trace referenced to the fourth display division, and automatically adjusts the delay.

- Press **SCOPE**.
- Use **△** to ZOOM in.

### Tips and Techniques for a stable display

- Find a stable trigger source that can be connected to the other channel.

In many applications it is possible to find another signal that can serve as a trigger source, then Auto Set does all the work for you. To try this connect the red scope probe from channel A to TB3 and connect the grey scope probe from channel B to TP2.

- Reset the ScopeMeter.
- Press **SCOPE** to select the Scope mode
- Press **AUTO SET**.

- Press **mV** **v** to adjust channel amplitudes if required.
- Use **MOVE** **MOVE** to position the channels on screen (see Figure 6-9).

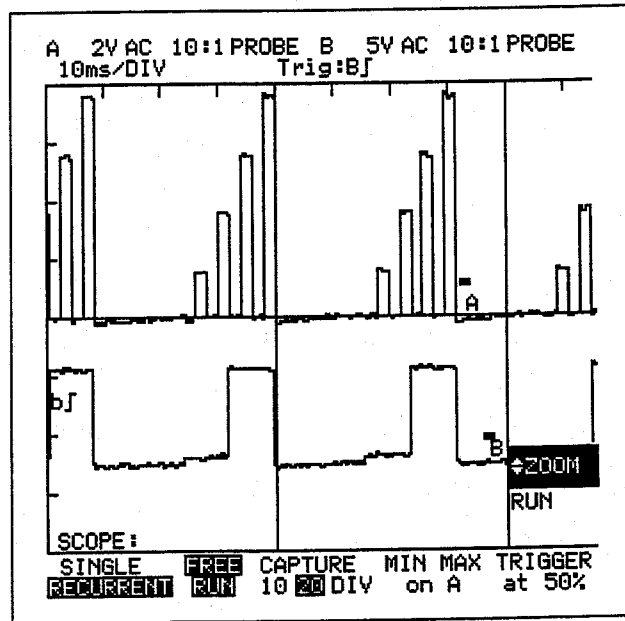

Figure 6.9

Channel B is automatically detected during Auto Set and since it has a lower frequency than Channel A, it is chosen as the trigger signal.

Other examples where this technique can be used for Video signals where a frame sync pulse is available, or PWM (Pulse Width Modulated) motor drives where the chopped square wave signal can be used (see Figure 6-10). The top signal is the motor signal, and triggering occurs on the lower square wave.

### WARNING

MEASURING ON PWM MOTOR DRIVES CAN CREATE A POTENTIAL SHOCK HAZARD. ENSURE THAT THE MOTOR IS OFF BEFORE YOU CONNECT OR DISCONNECT PROBES OR TEST LEADS. USE ONLY INSULATED PROBES, TEST LEADS, AND CONNECTORS SPECIFIED IN THIS MANUAL WHEN MAKING MEASUREMENTS >42V PEAK (30V RMS) ABOVE EARTH GROUND OR IN CIRCUITS >4800 VA. USE PROBES AND TEST LEADS WITHIN RATINGS AND INSPECT BEFORE USE.

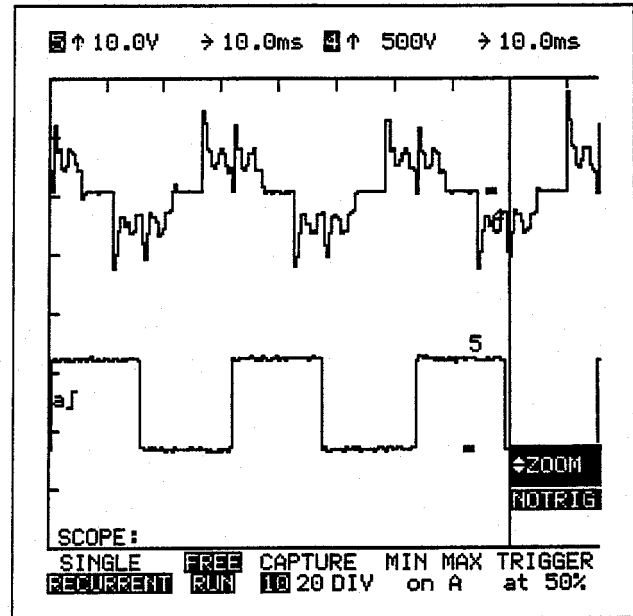

Figure 6.10

**II) Adjust trigger level to the maximum or minimum of the signal.**

This adjustment was made in the first Auto Set example. Another common example is line triggering on a video signal where a minimum level should be used, which corresponds with the line sync pulse signal (See Figure 6-11). The trigger icon "a┘" identifies the trigger level.

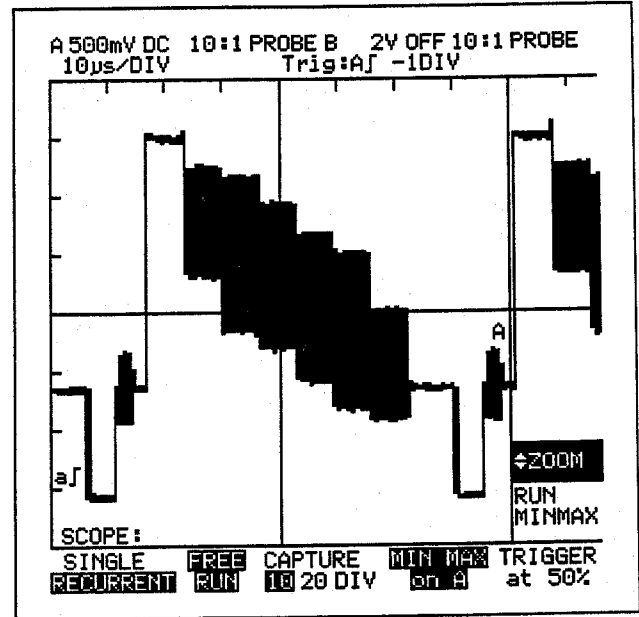

Figure 6.11

### III) Using N-CYCLE delay for signals having a repetitive pattern ~~88~~.

Many signals are built from a repetitive pattern or sequence of events. For example a four cylinder car has four steps to its sequence, or a variable frequency motor drive has a fixed number of pulses but varies the frequency and repetition rate. The signal on TP3 has four pulses in its sequence of varying amplitude. To use the N-Cycle mode first disconnect the Channel B probe from ScopeMeter and then:

- Press **AUTO SET**.
- Press **TIME** to slow the sweep speed to 5 ms/DIV.
- Press **TRIGGER**.
- Use **▽** to adjust the trigger LEVEL just above the base level, which gives a very unstable picture (see Figure 6-12).
- Press **SOFT KEY 4** to select DELAY.
- Use **▽** to select N-CYCLE.
- Press **SOFT KEY 5** to ENTER.
- Use **△** to set N-CYCLE to +4.

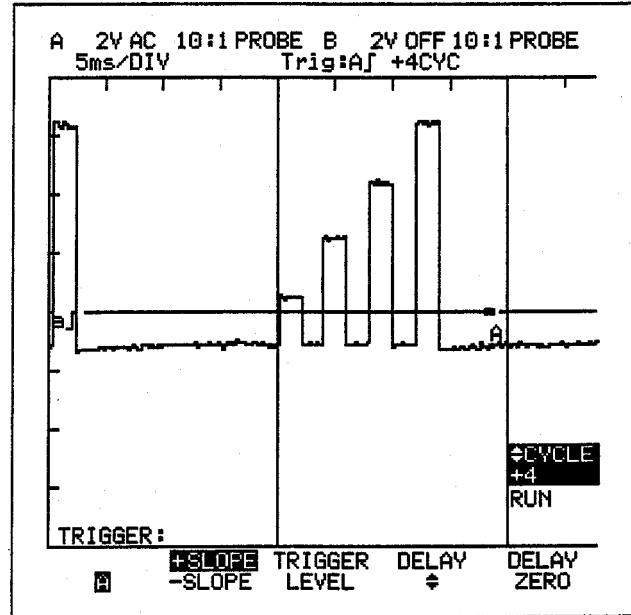

Figure 6.12

The N-CYCLE sequence has a random starting position within the sequence of events. As it counts trigger pulses it always provides a trigger output after the nth occurrence (4th in this example). In this way it remains synchronized so the signal triggering always occurs on the same nth pulse in the sequence. In the N-CYCLE mode, triggering is possible only on Channel A.

## MAKING LOW FREQUENCY MEASUREMENTS WITH THE SCOPE

### A. Choose the best Trigger Edge

#### Connection

Connect the red scope probe from channel A to TP5 on the Demo Board.

#### Making the Measurement

- Reset the ScopeMeter.
- Press **SCOPE**.
- Press **AUTO SET** (**AUTO SET** may need to be pressed a second time to give a good signal).

You should have a signal display with a slow rising edge and a fast falling edge. The default for Auto Set is to choose a rising edge for its trigger. In this case the result is a trace which seems to jump backwards and forwards (jitter) the whole time. If you increase the sweep speed and adjust the trigger level to the top of the signal where the slope is slowest the jitter becomes even worse.

- Press **TIME** to adjust the sweep speed to 5ms/DIV.
- Press **TRIGGER** to select the trigger menu.
- Use **▲** **▼** to adjust trigger level to almost the top of the signal.

Because the chosen trigger signal slope is not very fast, there is a time uncertainty in the trigger period, and causes the jitter. If the sharp negative slope is selected as the trigger edge, the display becomes stable. To stabilize the display:

- Press **SOFT KEY 2** to select -SLOPE (see Figure 6-13).

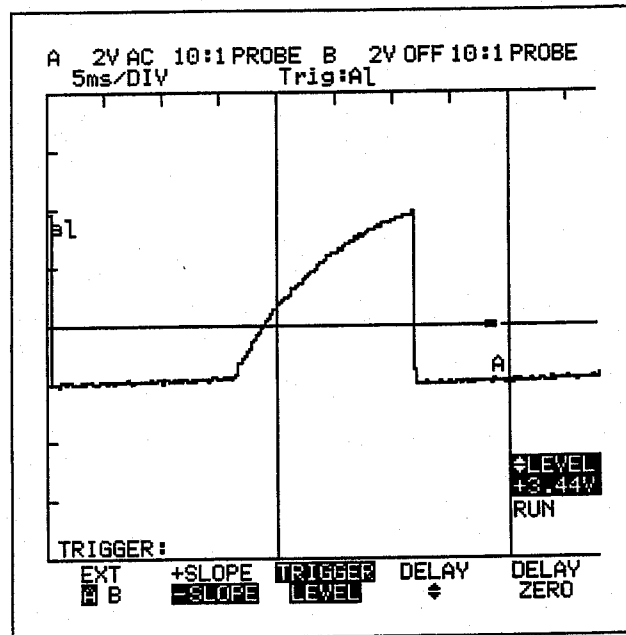

Figure 6.13



## B. Trigger Mode and Display

### Connection

Connect the red scope probe from channel A to TP4 on the Demo Board.

### Making the Measurement

- Reset the ScopeMeter.
- Press **SCOPE**.
- Press **AUTO SET**.

Auto Set has selected its lowest sweep speed of 5 ms/DIV but the signal at TP4 is a lot slower. Look at the display and notice that the signal occasionally makes large changes in level. ScopeMeter is in the FREE RUN mode, which updates the display if a trigger is not found within 100 ms of starting the acquisition. For slow signals FREE RUN must be off to prevent false triggering.

- Press **SOFT KEY 2** to turn FREE RUN off.

Most of the time the displayed waveform remains still and the status "NO TRIG" appears in the bottom Right Display. This status message changes to "RUN" when the large level occurs and indicates that triggering has taken place. Slow the sweep speed to see more of the signal, and adjust the trigger level to occur at a higher level in the signal.

- Press **TIME** six times to reduce the sweep speed to 500 ms/DIV.
- Press **TRIGGER** to select the Trigger Menu.
- Press **△** to adjust the trigger level to a mid point on the positive edge.

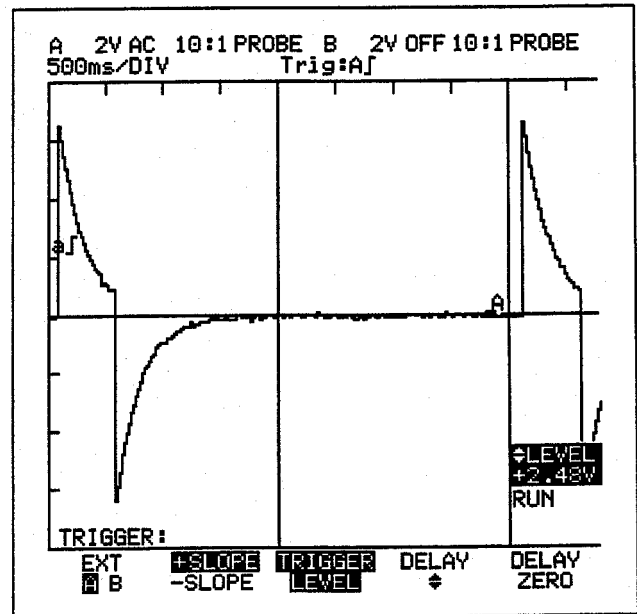

Figure 6.14

The slope of the signal between the switching edges indicates ScopeMeter is probably set for AC coupling. To make accurate low frequency measurements DC coupling must be used.

- Press **AC/DC** on Channel A to select DC coupling (indicated on the left in the TopDisplay).

There should be two correctly formed pulses on the display. Reduce the time base further to see the complete signal.

- Press **TIME** twice to reduce the time base to 2 sec/DIV. (Figure 6-15).

The signal is a 0.5s pulse, which occurs every 4 seconds. Note that in Figure 6-15 you see the RUN in the lower Right Display followed by ">", indicating that ScopeMeter is running and storing the data in the memory area to the right of the displayed screen. This can give the impression of a slow update rate. To increase the update rate:

- Press **SCOPE** to select the Scope menu.
- Press **SOFT KEY 3** to change the CAPTURE length to 10 divisions (= 1 full screen) or 20 divisions (= 2 full screens).

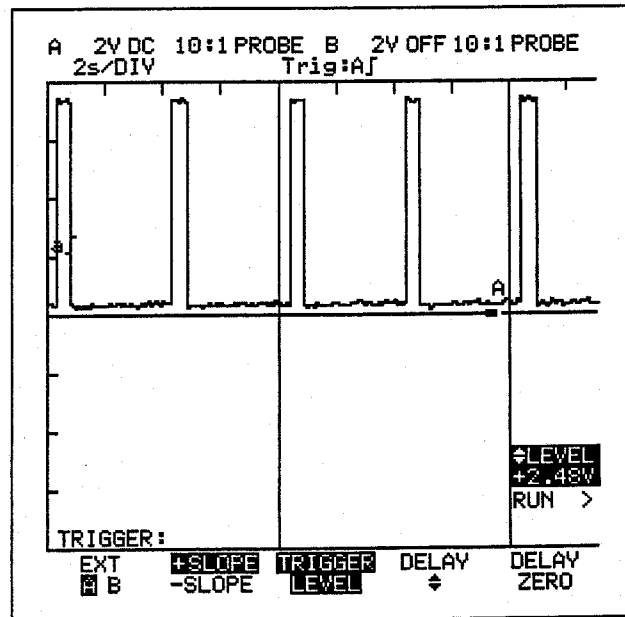

Figure 6.15

### Tips for low frequency measurements

- I) **Always select DC coupling for low frequency measurements.**
- II) **Make sure you select the best trigger edge. It should be the fastest edge available.**
- III) **Make sure FREE RUN is off, or the display will possibly be unstable.**
- IV) **If you are in doubt about the nature of a signal, then use the following "quick indication" method.**

Connect channel A only.

- Press **SCOPE** to select the scope mode.
- Press **AUTO SET** to automatically set up the scope.
- Press **AC DC GROUND** to select DC coupling on channel A.
- Press **SOFT KEY 4** MIN/MAX to turn on the MIN/MAX glitch capture mode. ~~98~~
- Press **TIME** to reduce sweep speed.

Continue to slowly reduce the sweep speed until you can see enough detail of the signal to make the best amplitude, timebase, and trigger settings. When you select a time base of 10 sec/DIV or slower the Roll Mode is activated. The Roll Mode functions like a pen recorder. Try this on TP4.

## MAKING SINGLE SHOT MEASUREMENTS WITH THE SCOPE

A Single shot measurement captures and freezes a one time signal occurrence. Although the Demo Board does not provide a single shot output it is possible to practice this technique on a low repetition rate signal.

### Connection

Connect the red scope probe from channel A to TP4 on the Demo Board.

### Making the Measurement

Repeat application "Trigger Mode and Display" on page 6-16 until you have the same display as in Figure 6-15. You will make single shot measurements to examine the leading and trailing edges of a pulse. To make a Single shot measurement you must ensure the correct trigger level is set, and to see more detail you will need to increase the sweep speed.

- Press **SCOPE** to select the Scope Menu.
- Press **SOFT KEY 1** to activate the Single mode.
- Press **SOFT KEY 2** to turn FREE RUN off.
- Press **TRIGGER** to select the Trigger Menu.
- Use **▲ ▼** and adjust the trigger level to the mid level of the signal.

- Press **TIME 10** a number of times to increase speed to 10  $\mu\text{s}/\text{DIV}$ .
- Press **SOFT KEY 4** to select the DELAY Pop-up menu.
- Use **▲ ▼** to highlight TIME DELAY.
- Press **SOFT KEY 5** to enter this choice.
- Use **▼** to adjust the delay to -4 DIV.

Note that as the settings were changed the trace did not update. We have now prepared everything for a single shot, including positioning the trigger point at the center of the display.

To start the single shot measurement:

- Press **HOLD RUN**.

The display is first cleared and the leading edge of the pulse is now captured and the ScopeMeter has returned to the HOLD mode (Figure 6-16). To capture the falling edge of the pulse in the single shot mode:

- Press **TRIGGER** to activate the Trigger Menu.
- Press **SOFT KEY 2** to select the - Slope.
- Press **HOLD RUN** to start the Single shot.

You can now see the difference in the speed of the rising and falling edges of this signal. Note that in the Initial Set-Up Menu it is possible to configure ScopeMeter to clear the display each time a new single shot is started.

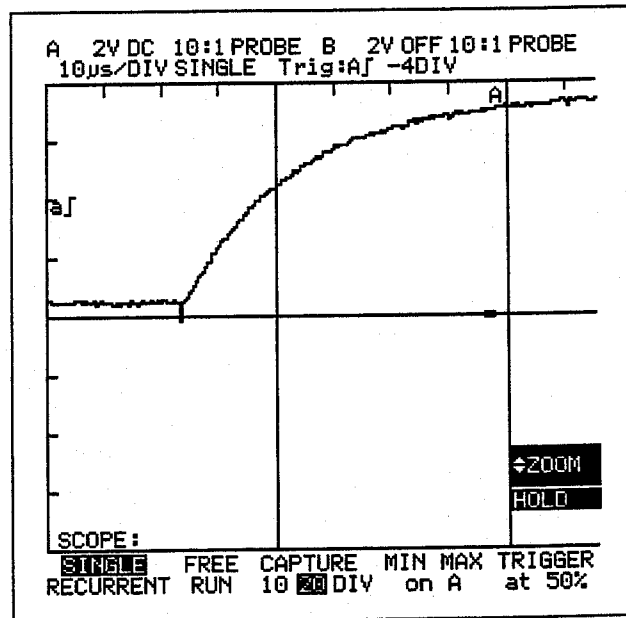

Figure 6.16

### Tips for Single Shot Measurements

- I) Always select DC coupling for the input channel being used.
- II Set a trigger level that is above the base line noise but below the expected signal amplitude.
- III) Use Pre-Trigger delay to ensure that you catch the start of the event, for example -4 divisions.
- IV) Select a time base that is fast enough to catch the signal yet slow enough to capture a sufficient length of signal. Often the use of the MIN/MAX glitch capture mode (see the following example), and the 20 DIV capture mode can help.
- V) To ensure correct triggering make sure the FREE RUN mode is off.



## FINDING HIDDEN SIGNAL DETAILS WITH THE SCOPE

### A. Glitches

#### Connection

Connect the red scope probe from channel A to TP2 on the Demo Board.

#### Making the Measurement

- Reset the ScopeMeter.
- Press .
- Press .

It appears as if the signal is a simple pulse with about a 25% duty cycle. Very occasionally small spikes may be seen. To check exactly what's happening turn on the MIN/MAX glitch capture mode to capture any fast transients that may occur.

- Press  to turn on MIN MAX on A. ~~98~~

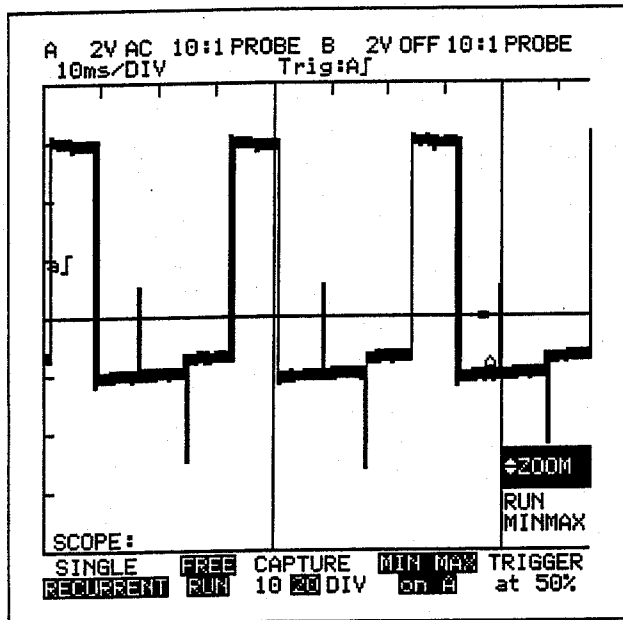

Figure 6.17

The glitches on this signal are clearly visible on the trace, but what if the glitches are only intermittent and occur once a day? To watch the screen the whole day is not realistic, for this purpose the RECORD mode can be turned on. RECORD mode retains all the samples made by the ScopeMeter on the screen for a defined period of time as set in the INITIAL SETUP menu.

The default setting is infinity which means from the time you activate this function to the time you deactivate it. To turn on the RECORD mode, and only catch triggered data.

- Press **RECORD**.
- Press **SOFT KEY 2** to turn FREE RUN off.

You will then see the sample points build up on the screen. These points stay on the screen, even if the signal disappears, for example you remove the scope probe from ScopeMeter.

### B. Noise

Often signals have a lots of noise superimposed upon them. Sometimes you need to measure the noise and sometimes you need to see the signal through the noise.

### Connection

Connect the red scope probe from channel A to TP5 on the Demo Board.

### Making the Measurement

- Reset the ScopeMeter.
- Press **SCOPE**.
- Press **AUTO SET**.
- Press **mV** on channel A to increase the amplitude to almost full screen.

- Press **MOVE** to position the trace on screen.
- Press **TRIGGER** to activate the trigger menu.
- Use **▲** to adjust the trigger level close to the top of the signal.
- Press **TIME IN** to increase the timebase speed to 5 ms/DIV.
- Press **SCOPE** to activate the Scope menu.
- Use **MOVE** to position the middle of the leading (slow) edge on center of the screen.
- Press **▲** to Zoom in on the leading edge.

You should now see a slow rising edge across the screen that is rather noisy. Activate Record for a couple of minutes to see the amplitude of the noise (see Figure 6-18).

- Press **RECORD** to activate the RECORD mode. ~~ⓧ~~

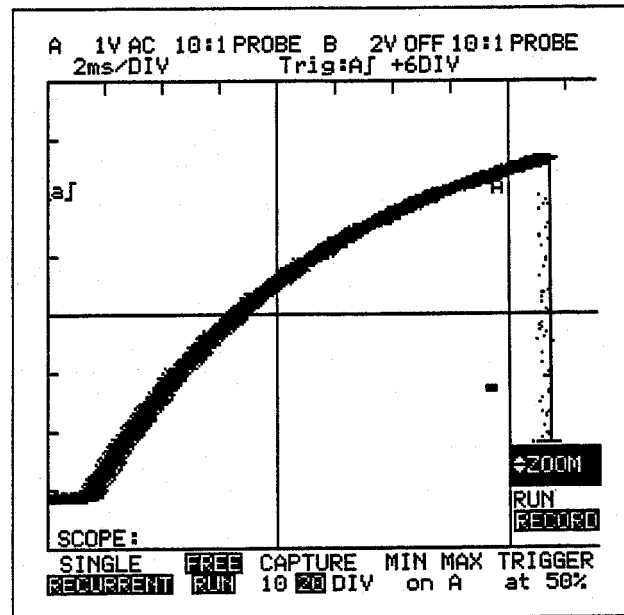

Figure 6.18

Averaging can be used to remove this random noise from the signal. The Average function will average a number of acquisitions and smooth out the random noise. To use the Average function:

- Press **RECORD** to disable Record.
- Press **CHAN A/B** to select the Channels Menu.
- Press **△** five times to achieve an average factor of 32. ~~98~~

You should now have a noise free trace on the display as shown in Figure 6-19.

Note that Averaging slows down the signal response. Don't forget to deactivate averaging when it is not required; otherwise, ScopeMeter will appear sluggish.

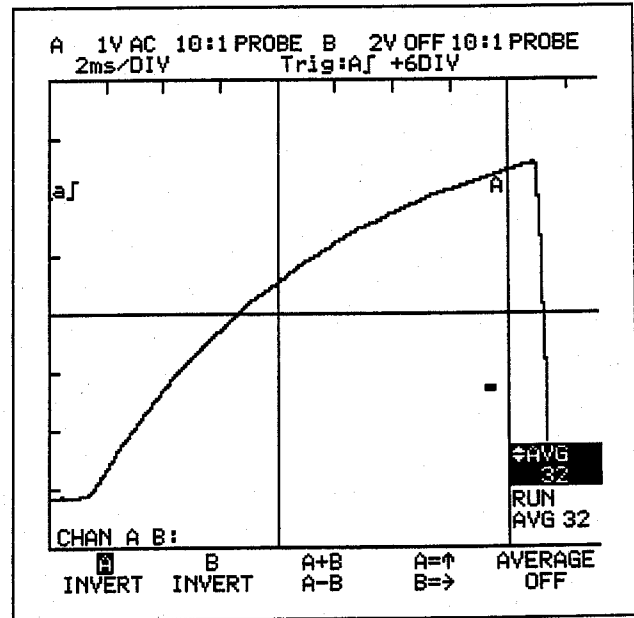

Figure 6.19



## MAKING SCOPE CURSOR MEASUREMENTS

98

Scope cursors can make measurements on 13 different signal parameters, of which any 5 can be presented in the Right Display. The definitions for each of these cursor measurements can be found in Section 4. Cursor measurements are made on the signal contained between the two cursors, so it is possible to measure just part of the signal, such as the frequency of a burst rather than the main signal frequency.

### Connection

Connect the red scope probe from channel A to TP5 on the Demo Board.

### Making the Measurement

- Press **SCOPE** to make sure you are in the scope mode.
- Press **AUTO SET**.
- Press **TRIGGER** to activate the Trigger menu.
- Press **SOFT KEY 2** to select the negative or falling edge for stable triggering.
- Press **TIME** to reduce the sweep speed if required to show 3 cycles on screen.
- Press **HOLD RUN** to HOLD the display.

Holding the display is not necessary when making cursor measurements, but for this example, it gives stable values that are easier to examine.

### Making Cursor Amplitude (Voltage) measurements

To select which Cursor measurements are to be made you need to:

- Press **CURSOR DATA** to activate the cursor menu.
- Press **SOFT KEY 2** to access the menu of cursor functions.
- Use **▲** OR **▼** to select VOLT at -1-.
- Press **SOFT KEY 5** to activate (indicated by larger square).
- Use **▼** to select dV.
- Press **SOFT KEY 5** to activate (indicated by larger square).
- Press **SOFT KEY 2** to remove the Pop-up menu.
- Use **CURSOR 1** and **CURSOR 2** to horizontally position cursors exactly as shown in Figure 6-20.

As you move the cursors left and right, their intersection with the trace is indicated by a horizontal line having the same line type as the vertical cursor line. Make sure that Cursor 1 is at the bottom of the signal and Cursor 2 at the top.

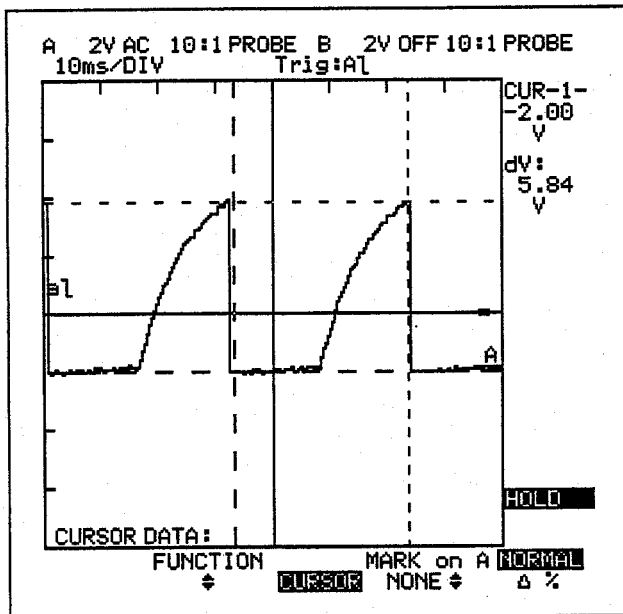

Figure 6.20

The voltage at Cursor 1 is about -2V. Remember that this signal is AC coupled, so you are not measuring the absolute DC value, but the offset relative to the middle of the signal, as marked by the "1" indicator. To make absolute DC measurements like RMS, MEAN, MAX PEAK, MIN PEAK or VOLT at -1- DC coupling must be selected.

The dV measurement is the voltage between the intersection of the trace and the two cursors. This measurement is the same for both AC or DC coupled signals. To make measurements referenced to certain signal levels, first locate the cursors on the two levels (use the current positions):

- Press **(SOFT KEY 5)** and you will see the "Δ" function is activated.

The two cursor readouts now change to 0 "Δ" V. Move Cursor 1 to the right:

- Press **(CURSOR)** until it is about half way up the slope.

You should have the same value for both cursor readouts, because the absolute voltage change is the same for both functions. To see this as a % change :

- Press **(SOFT KEY 5)** and the "%" function is activated.

The dV readout is about 50% because Cursor 1 halfway up the slope. Its reference points were the top and bottom of the slope.

The CUR -1- readout is -50% because its 100% reference point was about -2V, and its 0% reference is always 0V. Because Cursor 1 is above the signal zero line at almost +1V its "Δ%" value is now -50%.

Move Cursor 1 up and down the signal slope. At the start (bottom) of the edge both readings are 100%. When Cursor 1 crosses the zero line, the CUR -1- readout is 0%, and when it touches Cursor 2, the dV readout is 0%.

## Making Cursor Time measurements

In addition to amplitude measurements you can also make time measurements.

- Press **SOFT KEY 5** to return to normal measurements.
- Press **SOFT KEY 2** (FUNCTION) to activate the cursor menu.
- Use **▲ ▼** and locate VOLT at -1-.
- Press **SOFT KEY 5** to deactivate this function.
- Use **▼** to locate dV.
- Press **SOFT KEY 5** to deactivate this function.
- Use **▼** to locate dt.
- Press **SOFT KEY 5** to activate this function.
- Use **▼** to locate 1/dt.
- Press **SOFT KEY 5** to activate this function.
- Use **▼** to locate FREQUENCY.
- Press **SOFT KEY 5** to activate this function.
- Use **▼** to locate RISE TIME.
- Press **SOFT KEY 5** to activate this function.

- Press **SOFT KEY 2** to remove the cursor menu.
- Use **← CURSOR** and **CURSOR →** to locate the cursors as shown in Figure 6-21.

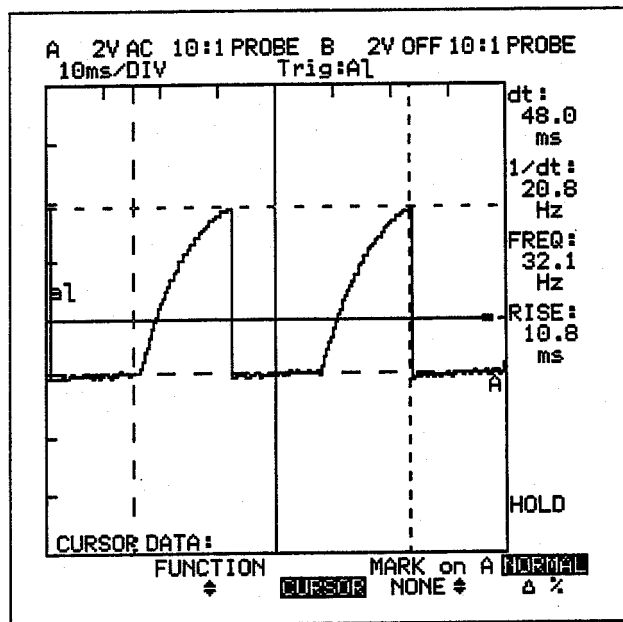

Figure 6.21

The dt value is the time between the two cursors. The 1/dt value gives a Hz readout. You can use this function to measure the repetition frequency of a burst.

The real frequency measurement is an automatic measurement that occurs on the first full period contained between the cursors. If the cursors are too close together for a full period to be recognized, ScopeMeter is unable to make a measurement and you see an answer of "????". To correct this situation move Cursor 2 to the right. This Frequency function makes simple measurements of sub-frequencies possible. Just move Cursor 1 to the start of the signal detail you want to measure and read the frequency. The Rise Time measurement also occurs on the first edge following Cursor 1. You must set Cursor 1 at the signal low level and Cursor 2 at the signal high level. These two levels are used as the 0% and 100% references. Rise Time is defined as the time taken for the signal to go from 10% to 90% of these two reference levels. To see the markers:

- Press **SOFT KEY 4** to activate the MARKER Pop-up menu.
- Use **▲ ▼** to select RISE TIME.
- Press **SOFT KEY 5** to activate.

You now have two 'X' markers on the leading edge of the signal, which indicate where the 10% and 90% levels are. If you move Cursor 1 to the right, you see these markers move too.

To make a Fall Time measurement, you must set Cursor 1 at the high level and Cursor 2 at the low level.

## Making Cursor Phase Measurements

In addition to the previous connection, also connect the grey scope probe from channel B to TP2.

- Press **AUTO SET** to see both traces on the screen.
- Press **TRIGGER** to select the Trigger menu.
- Press **SOFT KEY 2** to select negative slope.
- Press **CURSOR DATA** to select Cursor menu.
- Press **SOFT KEY 2** to activate the FUNCTION Pop-up menu.
- Use **▲ ▼** to locate OFF at the bottom of the Pop-up menu.
- Press **SOFT KEY 5** to deactivate and notice that all the functions have been disabled.
- Use **▲ ▼** to select PHASE A→B.
- Press **SOFT KEY 5** to activate.
- Press **SOFT KEY 2** to remove the FUNCTION Pop-up menu.
- Press **HOLD RUN** to HOLD the display.

*(If the display shows glitches on Channel B, press **HOLD RUN** twice more until they disappear otherwise incorrect measurements will be made).*

You have now selected a phase measurement but to see where it will actually occur it is best to activate the markers.

- Press **SOFT KEY 4** to activate the MARKER Pop-up menu.
- Use **▲ ▼** to locate Phase.
- Press **SOFT KEY 5** to activate.

You should now have a display that looks like Figure 6-22.

The phase measurement occurs at the mid level of the two signals rising edges, beginning on the first edge after Cursor 1. The Source signal (Channel A) period is used as the 360 degree reference. For Channel A the mid-level is clearly identified, but for channel B there was no sample made at the mid point because of its sharp edge, so the marker is located on the closest sample point. Move Cursor 1 and Cursor 2 to the right and see how the markers position themselves to give either a phase leading (+) or a phase lagging (-) result.

If you want to make Channel B the reference:

- Press **SOFT KEY 1** to change the source to B

Note that when you have a number of signals on the screen you can simply change all the cursor measurements from one signal to the next using **SOFT KEY 1**.

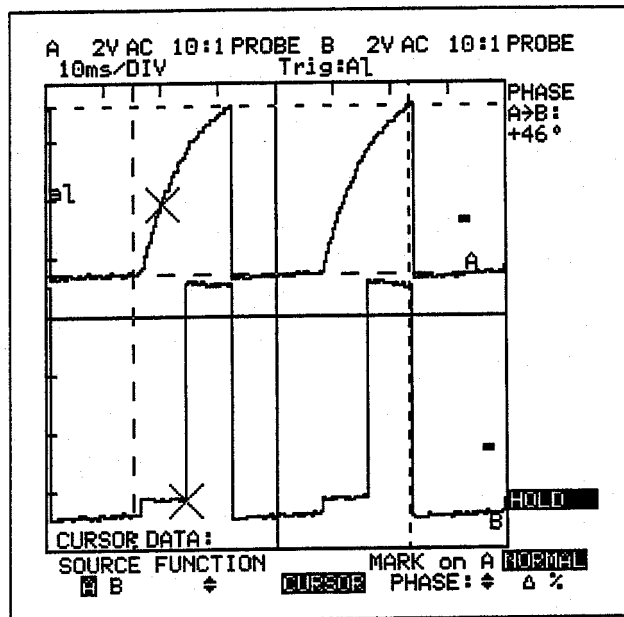

Figure 6.22

## USING THE MATH FUNCTIONS ~~98~~ ~~95~~

ScopeMeter has a variety of Math functions which enable you to extract more information from the signals than by just looking at them.

### Connection

Connect the red scope probe from channel A to TP3, and the grey scope probe from channel B to TP2 on the Demo Board.

### Making the Measurement

- Reset the ScopeMeter.
- Press **SCOPE** to select Scope mode.
- Press **AUTO SET** to scale and trigger the display.
- Press **DC DC GROUND** to set both channels to DC coupling.
- Use **TIME** and **mV** and **INVERT** until you have a display as shown in Figure 6-23.
- Press **CHAN A B** to select the Channel A B menu.
- Use **▲** **▼** to select an average factor of 32.

This will average the noise to give cleaner signals. When the screen is stable:

- Press **HOLD RUN** to freeze the display.

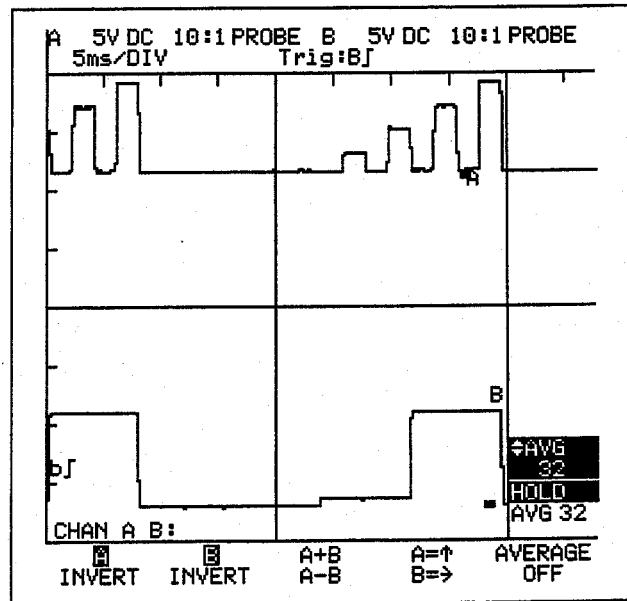

Figure 6.23

- Press **MATH** to access the Math menu.
- Press **SOFT 1** to see the pop-up of the various Math functions.
- Use **▲** **▼** to select ADD.
- Press **SOFT 6** to activate this function.

The Add, Subtract, and Multiply functions, process information from two waveforms (or sources) and the result is placed in another waveform memory (or destination). To add channels A and B together and show the resulting waveform on the display.

- Press **SOFT KEY 2** to select Source 1.
- Use **▲ ▼** to locate Channel A.
- Press **SOFT KEY 5** to select Channel A.
- Press **SOFT KEY 3** to select source 2.
- Use **▲ ▼** to locate Channel B.
- Press **SOFT KEY 5** to select Channel B.
- Press **SOFT KEY 4** to select the destination.
- Use **▲ ▼** to locate MEMORY 4.
- Press **SOFT KEY 5** to select MEMORY 4.
- Press **SOFT KEY 5** to start the add function.

The results is being stored in MEMORY # 4, to display its contents on the display.

- Press **WAVE FORM** to select the waveform softkey menu.
- Press **SOFT KEY 1** for the ON/OFF Pop-up menu.
- Use **▲ ▼** to locate MEMORY 4.
- Press **SOFT KEY 5** to select MEMORY 4.
- Press **SOFT KEY 1** to remove the Pop-up menu.
- Use **▲ ▼** to move MEMORY 4 up and down the display.

If the Memory 4 signal amplitude needs adjustment.

- Press **MATH** to select the MATH menu.
- Use **▲ ▼** for the appropriate scaling factor.

You should now have a display as shown in Figure 6-24 where the sum of channel A and B is clearly visible.

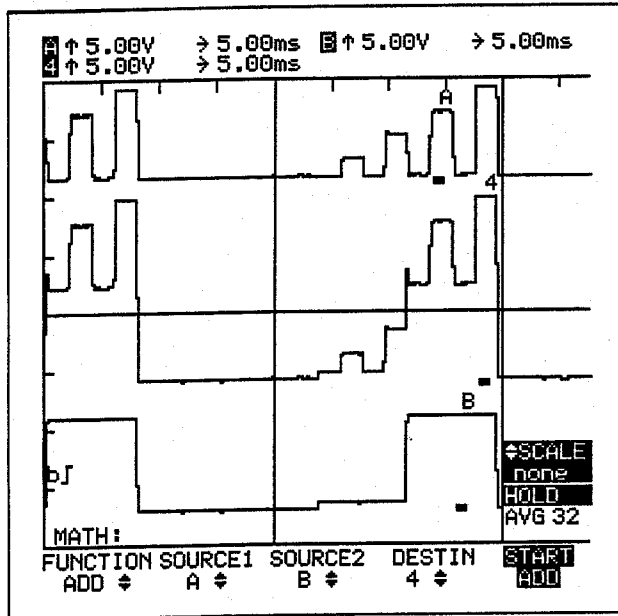

Figure 6.24

Using the same procedure you can perform subtraction or multiplication of two waveforms

The Invert, Integrate and Filter functions process information from just one waveform (or source) and place the result in another waveform memory (or destination). Invert is almost the same as the Channel invert function found under the **CHAN A/B** menu. Integration allows you to totalize the signal over a period of time, showing the real power dissipation when signal changes levels.

To use the integrate function:

- Press **MATH** for the MATH menu.
- Press **SOFT KEY 1** to select the FUNCTION Pop-up menu.
- Use **▲ ▼** to locate INTEGRATE.
- Use **SOFT KEY 5** to select this function.



Notice that only Source 1 is now available on the softkeys. Channel A has a good signal to demonstrate integration and Memory 4 is already displayed therefore you only need to:

- Press **SOFT KEY 5** to start the integrate function.
- Use **▲ ▼** to scale the result in Memory 4.

To position Memory 4 on the display.

- Press **WAVE FORM** to select the waveform menu.
- Use **▲ ▼** to position Memory 4.

With Channel A set for DC coupling and the signal varying from about 0 to +4V the result of the Integrate function is a positive increasing line. When pulses occur on Channel A the integral result increases accordingly. You can also use the cursors to make measurements on the Math results, as shown in Figure 6.25.

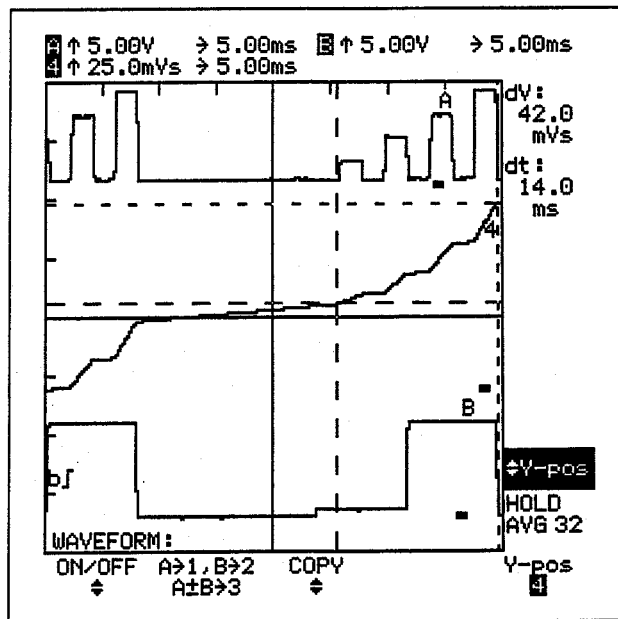

Figure 6.25

The Math Filter function averages the last five and the next five samples and removes high frequency noise from low frequency signals. Filtering is most useful to "clean up" single shot acquisitions.

To see the effect of the filter function:

- Press **MATH** to select the math menu.
- Press **SOFT KEY 1** to select the MATH FUNCTION Pop-up menu.
- Use **▲ ▼** to locate FILTER.
- Press **SOFT KEY 5** to select this function.
- Press **SOFT KEY 2** to select the SOURCE Pop-up menu.
- Use **▲ ▼** to select Channel B.
- Press **SOFT KEY 5** to start the filter function.
- Use **▲ ▼** to scale the filtered waveform.
- Press **WAVEFORM** to select the Waveform menu.
- Use **▲ ▼** to position Memory 4.

You now have a display as shown in Figure 6-26.

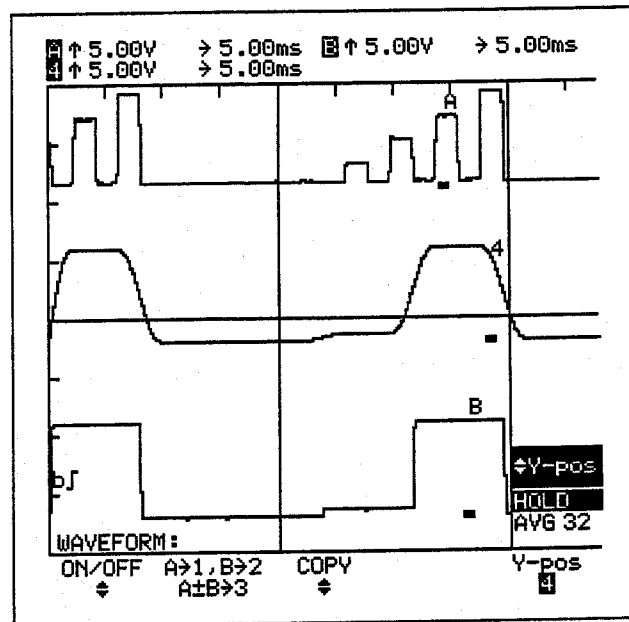

Figure 6.26

This completes the ScopeMeter Tutorial.

At completion be sure to disconnect the 9 volt battery on the Demo Board again.



# Section 7

## User Maintenance

### Contents

---

<b>CLEANING</b> .....	7-2	<b>PERFORMANCE TEST</b> .....	7-5
<b>REPLACING THE BATTERIES</b> .....	7-2	Preparation (Scope and Meter) .....	7-5
<b>FUSE REPLACEMENT</b> .....	7-4	Scope Verification .....	7-6
<b>PROBE CALIBRATION</b> .....	7-4	Meter Verification .....	7-7
DC Calibration .....	7-4		
AC Adjustment .....	7-4		

 **WARNING****RISK OF ELECTRIC SHOCK:**

**USE ONLY INSULATED PROBES, TEST LEADS AND CONNECTORS SPECIFIED IN THIS MANUAL WHEN MAKING MEASUREMENTS >42V PEAK (30V RMS) ABOVE EARTH GROUND OR ON CIRCUITS >4800 VA.**

**USE PROBES AND TEST LEADS WITHIN RATINGS AND INSPECT BEFORE USE. REMOVE UNUSED PROBES AND TEST LEADS. REMOVE PROBES AND TEST LEADS, BEFORE OPENING CASE OR BATTERY COVER.**

**WHEN SCOPEMETER IS CONNECTED TO ITS POWER ADAPTER/BATTERY CHARGER, TERMINALS MAY BE LIVE, AND THE OPENING OF COVERS OR REMOVAL OF PARTS (EXCEPT THOSE THAT CAN BE ACCESSED BY HAND) IS LIKELY TO EXPOSE LIVE PARTS.**

**SCOPEMETER MUST BE DISCONNECTED FROM ALL VOLTAGE SOURCES BEFORE IT IS OPENED FOR ANY ADJUSTMENT, REPLACEMENT, MAINTENANCE, OR REPAIR.**

**CAPACITORS INSIDE SCOPEMETER MAY STILL BE CHARGED EVEN IF SCOPEMETER HAS BEEN DISCONNECTED FROM ALL VOLTAGE SOURCES.**

**CLEANING**

Clean ScopeMeter with a damp cloth and a mild detergent. Do not use abrasives, solvents, or alcohol.

**REPLACING THE BATTERIES** **WARNING**

**TO AVOID ELECTRICAL SHOCK, REMOVE THE TEST LEADS, PROBES, AND BATTERY CHARGER BEFORE REPLACING THE BATTERIES.**

1. Disconnect the test leads, probes, and battery charger both at the source and at ScopeMeter.
2. Separate ScopeMeter from its holster.
3. Locate the battery cover on the bottom rear of ScopeMeter. Loosen the two screws with a flat-blade screwdriver.
4. Lift the battery cover away from ScopeMeter.

**NOTE**

*At this point, be sure that you have new batteries ready for installation into ScopeMeter. When the batteries are removed, ScopeMeter retains memory for approximately 30 seconds. If the batteries are not replaced within this time limit, ScopeMeter loses setup and waveform memory, returning to the Master Reset configuration.*

5. Lift the NiCad battery pack (or loose alkaline batteries, type KR27/50 or R14) out of the battery compartment.

**NOTE**

*This instrument contains a Nickel-Cadmium battery. Do not dispose of this battery with other solid waste. Used batteries should be disposed of by a qualified recycler or hazardous materials handler. Contact your authorized Fluke Service Center for recycling information.*

6. Install a new NiCad battery pack (PM9086/001) or new alkaline (C Cell) batteries (type KR27/50 or R14) as shown in Figure 7.1.

**NOTE**

*Ensure that the NiCad battery pack charging contact is aligned in the battery compartment as shown in Figure 7.1. Use only the PM9086/001 NiCad battery pack.*

7. Reinstall the battery cover and secure the two screws.

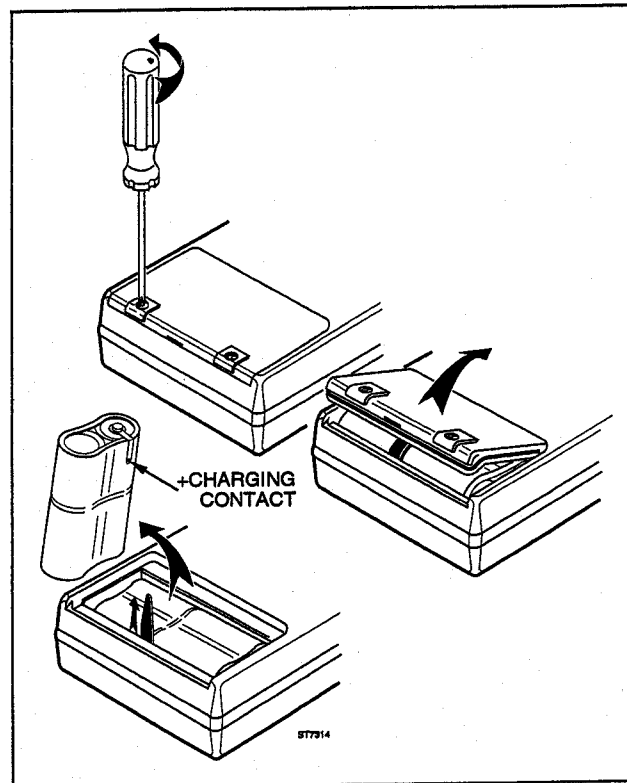

**Figure 7.1 Battery Replacement**

## FUSE REPLACEMENT

Since ScopeMeter uses electronically protected inputs, no fuses are required.

## PROBE CALIBRATION

The following procedures describe dc calibration and ac adjustment for the 10:1 probe used on CHANNEL A (red scope probe) and CHANNEL B (grey scope probe).

### NOTE

*To meet full user specifications, use the 10:1 probes only with the inputs on which they have been calibrated.*

### DC Calibration

- Connect the red scope probe to the CHANNEL A BNC input and, using the 4 mm banana adapter, connect to the GENERATOR OUT red banana jack.
- Turn the ScopeMeter on.
- Press **LCD**.
- Press **SOFT KEY 2** (PROBE CAL) to select the Probe Calibration Pop-up Menu.
- Press **▽** to select **10:1** for channel A, and press **SOFT KEY 5** (ENTER).

- Press **SOFT KEY 2** (PROBE CAL) to select the Probe Calibration Pop-up Menu.
- Press **▽** to select **DC CAL** for channel A, and press **SOFT KEY 5** (ENTER).

ScopeMeter outputs a voltage on the GENERATOR OUT banana jack to the connected probe, and the ScopeMeter automatically calibrates itself to the probe.

**PROBE successfully calibrated** is displayed when DC CAL is completed.

### AC Adjustment

- Press **SOFT KEY 2** (PROBE CAL) to select the Probe Calibration Pop-up Menu again.
- Press **△** to select **AC ADJUST**, and press **SOFT KEY 5** (ENTER).

ScopeMeter now sets itself automatically to the correct attenuation and time base and begins outputting a square wave from the GENERATOR OUTPUT banana jack to the connected probe.

- The probe adjustment can now be made. Adjust the trimmer screw in the probe housing of channel A to give an optimum square wave within the equal markers on the display (see Figure 7.2).

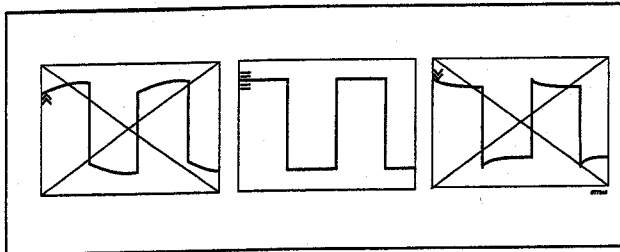

Figure 7.2 Adjusting the probe

To adjust the grey scope probe on channel B, proceed in the same order as for Channel A; except, use the grey channel B BNC input and the grey probe.

## PERFORMANCE TEST

This procedure uses a minimum of test steps and actions to verify basic ScopeMeter operation and measurement accuracy.

### NOTE

*The procedure does not check all ScopeMeter specifications; refer to the Service Manual for a complete ScopeMeter Performance Verification Procedure.*

The ScopeMeter's internally-generated 1.95-kHz, 5V p-p square wave signal can be measured as a performance verification procedure. This signal can be measured in both the Scope and Meter modes.

### Preparation (Scope and Meter)

Complete the following setup steps:

- Connect the red scope probe to the CHANNEL A BNC input and, using the 4 mm banana adapter, to the GENERATOR OUT red banana jack (see Figure 7.3).

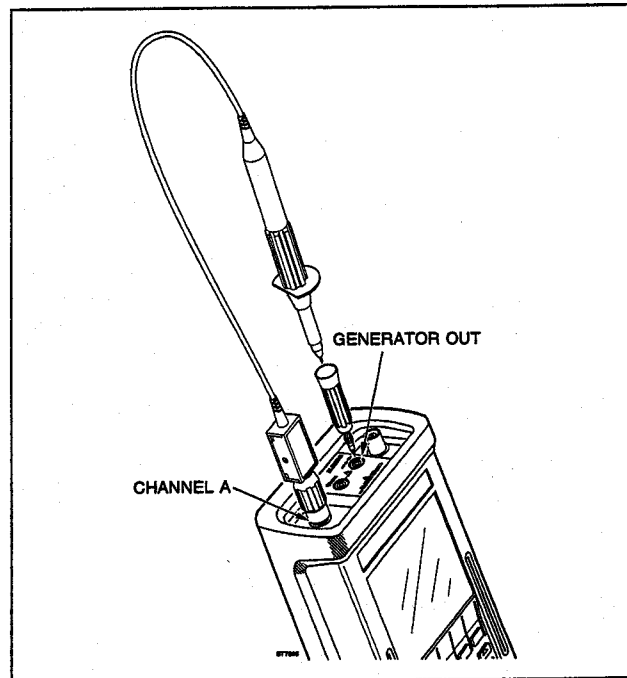

Figure 7.3 Performance Test Setup



- Perform a MASTER RESET (Press and hold **LCD**), then press **ON/OFF**).

### CAUTION

Master Reset erases all waveform and setup memory.

- Press **LCD** **SOFT KEY 2** to turn the PROBE CAL Pop-up Menu on. Highlight **AC ADJUST** and press **SOFT KEY 5** (ENTER) to activate this selection.

### Scope Verification

Use the following procedure to verify scope operation:

- Perform all steps in "Preparation (Scope and Meter)" if not already done.

- Check the Scope display for waveform and the following settings:

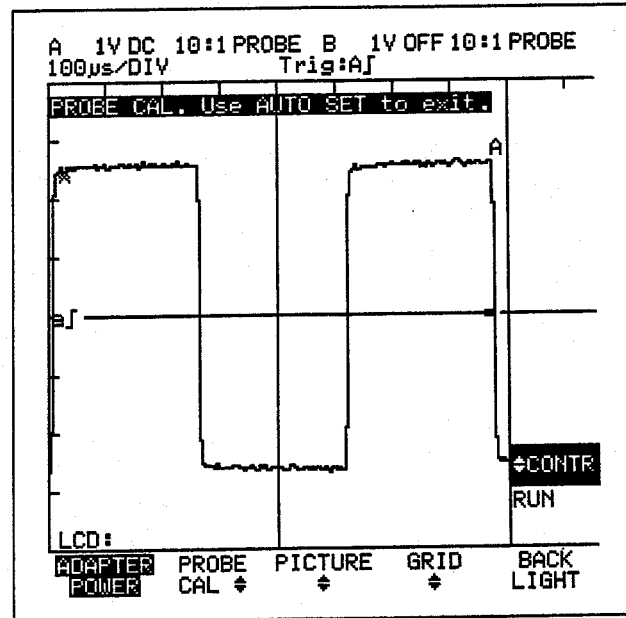

To verify the scope operation of channel B, proceed in the same order as for Channel A; however, use the grey channel B BNC socket and the grey scope probe.

**Meter Verification**

Use the following procedure to verify meter operation:

- Perform all steps in the "Preparation (Scope and Meter)" if not already done
- Press **METER**. ScopeMeter sets itself to the Meter Mode.

**NOTE**

*Meter operation is verified on channel A only.  
Channel B cannot be used in Meter Mode.*

- Check the Meter display for measuring results and the following settings:

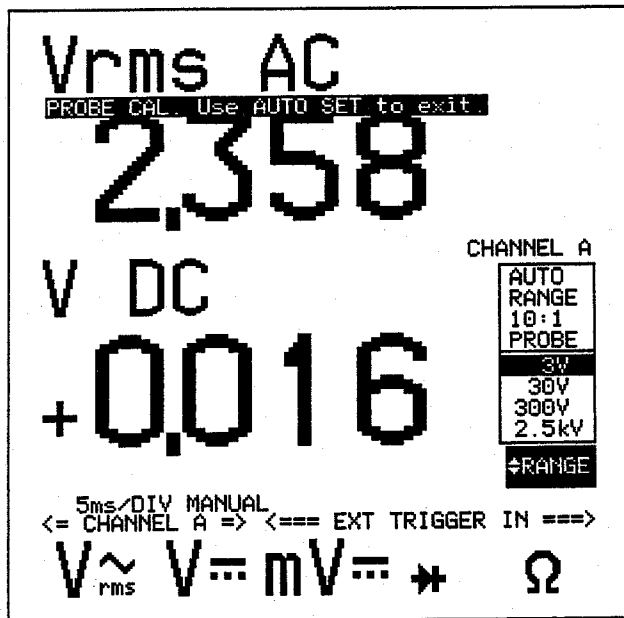

- To end the operation verification procedure, press **AUTO SET**.
- Press **ON/OFF** to turn off ScopeMeter.



# Section 8 Appendices

## Contents

---

8A Specifications .....	8-3	8D Warranty and Service Centres .....	8-17
8B Parts and Accessories .....	8-13	8E Terminology .....	8-23
8C PM8907 Information .....	8-15	8F Menu Trees .....	8-29



# Appendix 8A Specifications

---

## INTRODUCTION

### Performance Characteristics

FLUKE guarantees the properties expressed in numerical values with the stated tolerance. Specified non-tolerance numerical values indicate those that could be nominally expected from the mean of a range of identical ScopeMeters.

For definitions of terms, refer to IEC Publication 351-1.

### Safety Characteristics

ScopeMeter has been designed and tested in accordance with IEC Publication 348, Safety Requirements for Electronic Measuring Apparatus. This manual contains information and warnings that must be followed by the user to ensure safe operation and to keep ScopeMeter in a safe condition. Use of this equipment in a manner not specified by the manufacturer may impair protection provided by the equipment.

### Environmental Data

The environmental data mentioned in this manual are based on the results of the manufacturer's verification procedures.

## MULTIMETER

### DC Volt

Ranges: 300 mV, 3V, 30V and 300V

Accuracy:  $\pm 0.5\% \pm 5$  counts

### AC Volt

Ranges: 300 mV, 3V, 30V and 250V

Accuracy:  $\pm 1\% \pm 10$  counts, 50 Hz to 60 Hz

$\pm 2\% \pm 15$  counts, 20 Hz to 20 kHz



$\pm 3\% \pm 20$  counts, 5 Hz to 1 MHz

Additional error  $\pm 1\% \geq 1$  kHz

Accuracy valid from 5% to 100% of range

For <10 Hz with 10:1 probe or <100 Hz direct (1:1 probe), use function **Vrms AC + V DC**.

The 10:1 accessory probe increases the ranges by a factor of 10.

To create more accurate measurements on ac, or on dc with a large ac component, the time base often can be optimized by pressing  or by changing the setting accessed by pressing .

### mV DC

Ranges: 300 mV and 3V

Accuracy:  $\pm 0.5\% \pm 5$  counts

This range has a low-pass filter with a bandwidth of 5 kHz.

### $\Omega$

Ranges: 300 $\Omega$ , 3 k $\Omega$ , 30 k $\Omega$ , 300 k $\Omega$ , 3 M $\Omega$  and 30 M $\Omega$ .

Accuracy:  $\pm 0.5\% \pm 5$  counts

Range: 30 $\Omega$

Accuracy:  $\pm 2.5\% \pm 25$  counts

### Diode

Measuring Current: 0.5 mA

Maximum Voltage: 4V

If Output Voltage is higher than 2.8V, **OL** (OverLoad) is displayed.

## Display Modes

### FREQUENCY

The frequency can be displayed within the following parameters:

Range: 1 Hz ... 5 MHz

Accuracy:  $\pm 0.5\%$

Resolution: 4 digits

### TRACE DISP

The display trace can be switched off.

### DUTY%+, DUTY%-

Relative on-to-off time of a varying input can be displayed as a percentage.

- Range: from  $<2.0\%$  to  $>98.0\%$  for signal amplitudes  $>10\%$  of the input voltage range.
- Resolution: 0.1%
- Accuracy (logic or pulse waveforms): within  $\pm 0.5\%$
- Accuracy (sine or triangle waveforms): within  $\pm 1\% + ((\text{Voltage Range}/\text{RMS Input Voltage}) \times 1\%)$

### %/DELTA

Displays the difference after 0% or  $\% \Delta$  is pressed.

### SCALING ~~98~~

0% and 100% can be set as scale reference, and x is the measured value referred to 0%.

### VOLT MATH ~~98~~

Results can be displayed in dBV, dBm, dBW, or Audio Watt. The assumed load resistance can be chosen from: 1, 2, 4, 8, 16, 50, 60, 75, 93, 110, 125, 135, 150, 200, 250, 300, 500, 600, 800, 900, 1000 or  $1200\Omega$ , depending on the display mode.

### Record ~~98~~

In Meter Mode, the actual value is displayed simultaneously with the maximum, average, and minimum values.

### Touch Hold® Feature

Can be activated by pressing .



## OSCILLOSCOPE

### Vertical System

#### DEFLECTION FACTOR

1 mV to 100V per division (5 mV to 100V per division for model 93) in 1-2-5 sequence, for time base 60s/division to 1ms/division. This can be expanded by a factor of 10 with the 10:1 probe.

#### VERTICAL RESOLUTION

8 bits, 25 levels per division.

#### DC ACCURACY

$\pm (2\% \pm 1 \text{ digit})$

#### RISE TIME

Vertical amplifier response limits the rise time to 7 ns. For time base settings slower than 200 ns the rise time is smaller than the sample distance, so the measured rise time is unreliable if it is smaller than  $(2 \times s/\text{div})/25$

#### BANDWIDTH

With 10:1 probe only:  $> 50 \text{ MHz} (-3 \text{ dB})$

#### NONLINEARITY

Including Analog to Digital Converter, which will have no missing codes and is monotonic:  $\pm(2\% \pm 1 \text{ digit})$

#### MOVE CONTROL RANGE

From +4 divisions to -4 divisions

#### DC BALANCE

Base line is automatically readjusted after switching the attenuator or ac/dc/ground.

#### MIN/MAX ~~98~~

Acquisition mode at 1  $\mu\text{s}$  per division or slower on Channel A only. Pulse width for 100% probability of detection is 40 ns.

#### AVERAGE ~~98~~

The running average can be set to 256 maximum. In Roll Mode, the average is fixed at 10.

#### ZOOM ~~98~~

Expand or contract view centered around the 4th division, within the limits of the time base and the maximum delay.

### Horizontal System

#### RANGE

5s to 10 ns per division with triggered start.

The Roll Mode is active from 60s to 10s per division.

Single shots are possible from 5s to 100 ns per division. For time base settings faster than 1 ms, an automatic interpolation takes place. The useful bandwidth is about 6 MHz.

For time base settings of 50  $\mu\text{s}$  or slower, the channels are chopped.

For time base settings of 20  $\mu$ s or faster, the channels are alternated. Channel A is displayed first and, after a second trigger pulse, Channel B is displayed second.

#### ACCURACY

Accuracy is  $\pm 0.1\% \pm 1$  LSB

#### SAMPLE FREQUENCY

Dependent on time base:

$\frac{25}{\text{sec/div}}$  Hz (maximum 25 MHz)

In Min/Max: 25 MHz ~~98~~

#### RECORD LENGTH

512 samples calibrated for 25 samples per division.

CAPTURE allows selection of a record length of 10 or 20 divisions.

#### MOVE CONTROL

From +4 divisions to -16.5 divisions.

#### A VERSUS B

Channel A is displayed along the vertical axis, and Channel B along the horizontal axis. The time base is set manually.

## Trigger

#### INTERNAL SENSITIVITY

For frequencies lower than 10 MHz: <0.8 div

Extra amplification in the vertical system allows for 2 mV and 1 mV per division for the input signal, but not for the trigger. Therefore, sensitivity at 2 mV and 1 mV decreases by a factor of 5. ~~98~~

#### LEVEL RANGE

From +4 divisions to -4 divisions.

#### EXTERNAL

TTL compatible. Selectable for 0.2V or 2V.  
Trigger level is indicated on the screen.

#### DELAY RANGE

TIME DELAY: -20 to +640 divisions

EVENTS: 1 to 1023 ~~98~~

N\_CYCLE: trigger frequency divided by N (2 to 255.) ~~98~~

## Autoset

Autoset automatically sets the vertical deflection, the horizontal time base, and the trigger selection. Trigger selection can be left unaffected by selecting **ONLY AMPLITUDE**, **ONLY TIME**, or **TIME & AMPLITUDE**.

In model 97, Autoset can also be fully configured via a Pop-Up Menu selections are as follows (default in parentheses):

**VERTICAL**

MOVE: (zero), or not affected

Input Coupling: (ac), or not affected

A versus B: (off), or not affected

Average: (off), or not affected

Separate, 1 channel: (Center of screen)

Separate, dual channel: (Channel A+1 div, Channel B-1 div)

**HORIZONTAL**

MOVE: (zero), or not affected

**TRIGGERING**

Delay (>0): (off), or not affected

Delay (<0): (not affected)

Include External: include external or (A or B)

Level: (50% of signal), or not affected

Slope: (positive), or not affected

**MISCELLANEOUS**

Cursors: (not affected), or off

Mathematics: (off), or not affected

Generator: (not affected), or off

Dot Join: (not affected), or off

**Record** ~~98~~

In Scope Mode, all the measured values are displayed.

A reset is possible every 2, 5, 10, or 60 seconds. ~~98~~

**Cursors** ~~98~~

The following measurements can be made on the waveform selected between the cursors:

- dV, dt, 1/dt, RMS, mean, maximum, minimum, peak to peak, rise or fall time, frequency, and phase.
- The time between trigger and cursor.
- Ratio
- The voltage at the cursor relative to ground.

A maximum of any five of these measurements can be displayed at the right hand side of the display.

**Mathematics** ~~98~~ ~~95~~

The following math functions can be carried out on the waveforms: multiplication, addition, subtraction, filtering, inversion, and integration. The result is stored in a selected memory.

**Waveform Memories** ~~98~~

For waveform storage, eight extra memories are available. In model 97, the memories can be cleared all together.

Each memory contains 512 words for waveform and the setup belonging to this waveform.

## SETUP MEMORIES ~~98~~ ~~95~~

A maximum of 10 setups (meter and/or scope) can be stored. You can recall, save, or delete each setup. Separate Initial Setup and Auto Set memories are also maintained.

## UNDO ~~98~~ ~~95~~

The front panel setup is stepped backward once per press of **UNDO**. After 10 steps backward, continued **UNDO** presses step the setup forward.

## GENERATOR

The generator can be used for probe calibration. The output impedance is typically 400 $\Omega$ . Following generator specifications are valid for Model 97 only:

- Square Wave
  - Amplitude: 5V p-p typical
  - Frequency: 488 Hz, 976 Hz or 1.95 kHz (selectable)
- Sinewave
  - Amplitude: 1V p-p typical
  - Frequency: 976 Hz
- Slow Ramp Current
  - Range: 0 to 3 mA
  - Maximum Voltage: 2V
- Slow Ramp Voltage
  - Range: -2V to 2V
  - Maximum Current: 1 mA

## GENERAL



### Input Terminals (Channels A, B and External Trigger)

Impedance: 1 M $\Omega$  // 25 pF

Maximum Voltage: 300V up to 1 MHz (maximum allowed voltage decreases 6 dB per octave at higher frequencies)

The maximum input voltage between any terminal and earth ground is 600V.

Input Protection: The inputs are protected for line voltages of 600V and surge voltages of 4 kV.

Channels A and B have insulated BNC connectors. Two 4-mm banana sockets are used for external triggering, mV DC measurement, resistor measurement, diode testing, and generator output.

Commons of all inputs are connected together.

## Display

LCD Type: Super Twisted Nematic

Active Area: 240x240 pixels, diagonal of 4.7 inches (12 cm).

Trace Area: 200x240 pixels

A graticule with 25 pixels per division can be chosen via softkey.

An electro-luminescent backlight can be activated via softkey. ~~98~~ ~~95~~

The CONTRAST ratio is adjustable in the LCD Softkey Menu.



### External Power Requirements

Input Voltage Range: 8V to 20V dc.



### WARNING

**THE MINUS VOLTAGE IS CONNECTED TO COMMON. WHEN USING A POWER SUPPLY THAT IS NOT DOUBLE INSULATED, CONNECT COMMON TO PROTECTIVE GROUNDING.**

Power Consumption: 5W (typical)

### Internal Battery Power

Operating Time

Ni-Cd Pack: 4 hours (typical)

Alkaline C-Cell: 4 hours (KR27/50 or R-14 size can be used.)

Charging Time: 16 hours (typical) while not operating

Charging Current:

100 mA with ScopeMeter ON

200 mA with ScopeMeter OFF

Maximum Temperature During Charging: 45 °C

## Temperature and Humidity

Operating Temperature: 0 °C to 50 °C

Storage Temperature: -20 °C to 70 °C

Relative Humidity:

90% from 20 °C to 30 °C

70% from 30 °C to 50 °C

## Shock and Vibration

Per MIL-T-28800 for a Class 3 instrument.

Meets requirements of MIL-T-28800D Type III Class 3, Style C, except for temperature range and power switch.

## Size (HxWxL)

ScopeMeter only

60 mm x 129 mm x 262 mm  
(2.4 inch x 5.1 inch x 10.3 inch)

With holster

62 mm x 140 mm x 281 mm  
(2.5 inch x 5.5 inch x 11.1 inch)

## Weight

ScopeMeter only: 1.5 kg (3.3 lbs)

With holster: 1.8 kg (4.0 lbs)

## Safety



Designed to protection Class II per IEC 348 and UL1244 for 600V.

## Sealing

Dust and splash proof

## ACCESSORY INFORMATION

### PM8918/202 10:1 Passive Probe

Attenuation	x10
Useful Bandwidth	50 MHz
Input resistance	10 MΩ
Input capacitance	15 pF
Cable length	2.5m
Max. signal Voltage	600V rms
Max. surge Voltage	6 kV
Max. Voltage to Ground	600V rms

Double insulated per IEC1010-1 for 600V.





# Appendix 8B Parts and Accessories

## SERVICE MANUAL

Ordering Number:

4822 872 05352 or FLUKE part number 931605

## STANDARD KIT CONTENTS

DESCRIPTION	MODEL	ORDERING NUMBER	REMARK
Yellow Holster	PM9083/001	---	
NiCad Battery Pack (installed)	PM9086/001	---	
Power Adapter/Battery Charger (four models available:)			
● Universal Europe 220V, 50 Hz	PM8907/001	---	
● North America 110V, 60 Hz	PM8907/003	---	
● United Kingdom 240V, 50 Hz	PM8907/004	---	
● Universal 115V/230V	PM8907/008	---	
Accessory Case, Soft	C 75	---	



DESCRIPTION	MODEL	ORDERING NUMBER	REMARK
Probe Set 10:1	PM8918/002	---	set of two
● HF Adapter (2 x Black)		5322 263 50193	set of two
● High Voltage Testpin (Red)		5322 264 20087	
● High Voltage Testpin (Grey)		5322 264 20088	
● Mini Test Hook (Red)		5322 210 70131	
● Mini Test Hook (Grey)		5322 210 70129	
● Trim Screwdriver (Red)		5322 395 50417	
● Trim Screwdriver (Grey)		5322 395 50416	
Industrial Alligator Clips (Red and Grey)	PM9084/001		set of two
Multimeter Test Lead Set:		5322 310 32086	
● Test Leads (Red and Black)	TL24	---	set of two
● Industrial Test Probes (Red and Black)	TP20	---	set of two
● Industrial Alligator Clip (Black)	AC20	---	
● Banana Adapter (Red)		5322 264 20051	
● Banana Adapter (Black)		5322 264 20052	
Adapter Dual Banana Plug to BNC	PM9081/001	---	
Adapter Probe Tip to Banana (RED)		5322 264 20096	
Adapter Probe Tip to Banana (GREY)		5322 264 20097	
Demo Board		5322 216 51279	
Users Manual (English)		4822 872 00522	
Users Manual (German)		4822 872 00563	
Users Manual (French)		4822 872 00564	
Users Manual (Italian)		4822 872 00579	
Users Manual (Dutch)		4822 872 00581	
Users Manual (Spanish)		4822 872 00526	
Quick Operating Guide		4822 872 00519	

## Appendix 8C PM8907 Information

---

Your ScopeMeter is powered by a PM8907 Power Adapter/Battery Charger. The version you use depends on the ordered ScopeMeter configuration.

Four versions are use with ScopeMeter:

- PM8907/001 Universal European mains (line) plug  
230V  $\pm 10\%$
- PM8907/003 North American mains (line) plug  
110V  $\pm 15\%$
- PM8907/004 United Kingdom mains (line) plug  
240V  $\pm 10\%$
- PM8907/008 North American mains (line) plug and  
switchable mains (line) voltage  
115V  $\pm 15\%$  or 230V  $\pm 15\%$

The mains (line) frequency range for all units is 50 to 400Hz  $\pm 10$

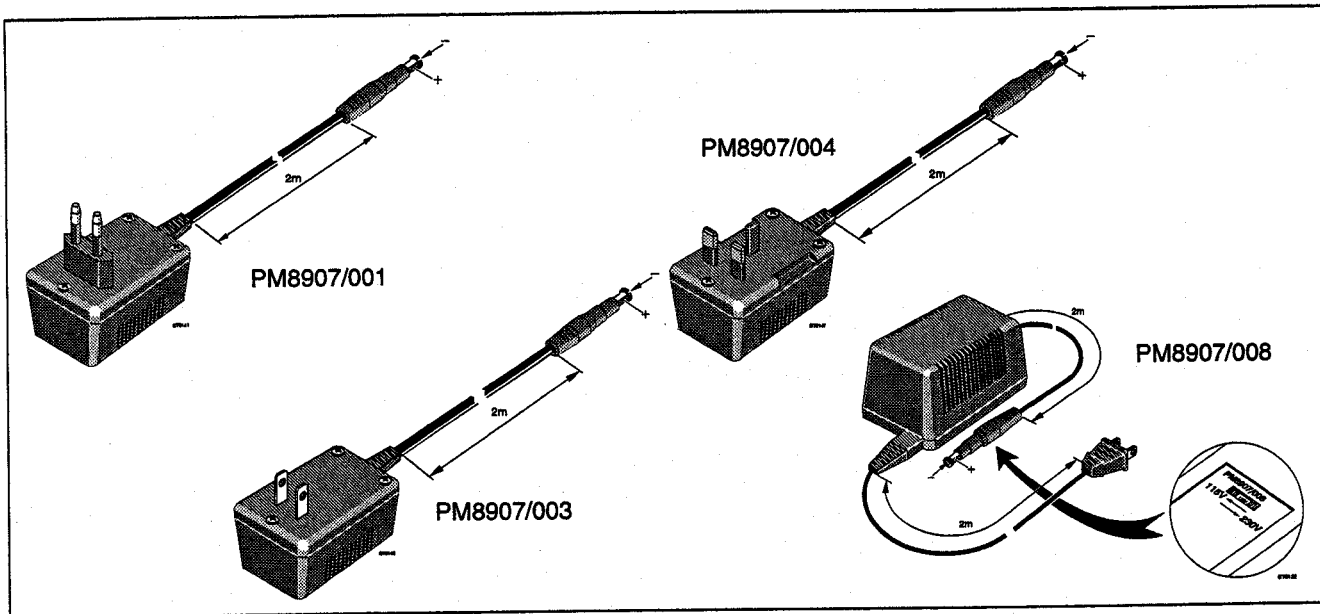

Figure 8C.1 Four versions of PM8907

At delivery, the PM8907/008 is set to 230V, and is provided with Power Supply Cord and Attachment Plug that is for use at 115V setting only. When operating the unit at 230V setting, you require a North American-to-European mains (line) plug adapter.

## CAUTION

Before you connect the PM8907/008 to the local mains (line), first check the preselected voltage setting on this unit. You can find the voltage selector switch on bottom of the PM8907/008. If necessary, select the corresponding mains (line) voltage with the slide switch and ensure that the proper voltage is visible in the window of the slide selector (see Figure 8C.1).

# Appendix 8D Warranty and Service Centers

---

## Warranty Information

Congratulations on your purchase of a Fluke ScopeMeter<sup>®</sup>, which is designed to give you years of troublefree service. The following LIMITED WARRANTY covers your ScopeMeter for a period of three years and accessories provided with your ScopeMeter for a period of one year.

Please record date of purchase and your instrument serial number from the back of your ScopeMeter. Keep this information and your purchase invoice in a safe place separate from your ScopeMeter.

Date of purchase \_\_\_\_\_ Serial number \_\_\_\_\_

## Statement of Calibration Practice

This ScopeMeter<sup>®</sup> has been calibrated using standards and instruments the accuracy of which is traceable to the National Standard (Dutch Institute of Standards, NMI) or to nationally accepted measuring systems. The standards and instruments used in calibration are supported by a calibration system which meets or exceeds the requirements of MIL-STD-45662.

A serialized and dated Certificate of Calibration for any individual instrument can be obtained from any Fluke Technical Service Centre listed in the Users Manual. A nominal calibration fee will be charged.

*Corporate Quality Assurance*

## LIMITED WARRANTY

Fluke warrants to the original product purchaser that each product it manufactures will be free from defects in material and workmanship under normal use and service. The warranty period is controlled by the warranty document furnished with each product and begins on the date of shipment. Fluke's warranty does not apply to fuses, batteries, or any product which, in Fluke's opinion, has been misused, altered, neglected, or damaged by accident or abnormal conditions of operation or handling.

To obtain warranty service, contact your nearest Fluke Service Center or send the product, with a description of the difficulty, postage and insurance prepaid, to the nearest Fluke Service Center. Fluke assumes no risk for damage in transit. Fluke will, at its option, repair or replace the defective product free of charge or refund your purchase price. However, if Fluke determines that the failure was caused by misuse, alteration, accident or abnormal condition of operation or handling, you will be billed for the repair and the repaired product will be returned to you transportation prepaid.

THIS WARRANTY IS EXCLUSIVE AND IS IN LIEU OF ALL OTHER WARRANTIES, EXPRESS OR IMPLIED, INCLUDING BUT NOT LIMITED TO ANY IMPLIED WARRANTY OR MERCHANTABILITY OR FITNESS FOR A PARTICULAR PURPOSE OR USE. FLUKE WILL NOT BE LIABLE FOR ANY SPECIAL, INDIRECT, INCIDENTAL, OR CONSEQUENTIAL DAMAGES OR LOSS OF DATA, WHETHER IN CONTRACT, TORT, OR OTHERWISE.

In USA, some states do not allow the exclusion or limitation of incidental or consequential damages, or implied warranty periods, so the above limitations may not apply to you. Other rights may vary from state to state.

For application or operation assistance or information on Fluke products in USA, call:

800-426-0361 in most of U.S.A.  
206-356-5400 from AK and WA

**USA**

California  
Fluke Technical Center  
46610 Landing Parkway  
Fremont, CA 94538  
TEL: (415)651-5112

Fluke Technical Center  
16715 Von Karman Avenue  
Suite 110  
Irvine, CA 92714  
TEL: (714)863-9031

Florida  
Fluke Technical Center  
550 S. North Lake Blvd.  
Altamonte Springs, FL 32701-5227  
TEL: (407)331-2929

Illinois  
Fluke Technical Center  
1150 W. Euclid Avenue  
Palatine, IL 60067  
TEL: (708)705-0500

New Jersey  
Fluke Technical Center  
East 66 Midland Avenue  
Paramus, NJ 07652-0930  
TEL: (201)599-9500

Texas  
Fluke Technical Center  
2104 Hutton Drive  
Suite 112  
Carrollton, TX 75006  
TEL: (214)406-1000

Washington  
Fluke Technical Center  
John Fluke Mfg. Co., Inc.  
M/S 6-30  
Everett WA 98203  
TEL: (206)356-5560

**INTERNATIONAL**

Argentina  
Coasin S.A.  
Virrey del Pino 4071 DPTO E-65  
1430 CAP FED  
Buenos Aires  
TEL: 54 1 522-5248

Australia  
Philips Customer Support  
Scientific and Industrial  
23 Lakeside Drive  
Tall Ho Technology Park  
East Burwood  
Victoria 3151

Philips Customer Support  
Scientific and Industrial  
25-27 Paul St. North  
North Ryde, N.S.W. 2113  
TEL: 61 2 888-8222

Austria  
Fluke Österreich G.m.b.H.  
Guthell-Schoder-Gasse 10  
A-1102 Wien  
TEL: 43 1 60101/1772  
FAX: 43 1 6032165

Belgium  
N.V. Fluke Belgium S.A.  
Langeveldpark - Unit 5 & 7  
P. Basteleusstraat 2-4-6  
1600 Sint-Pieters-Leeuw  
B-1070 Brussels  
TEL: 32 2 33 12 777  
FAX: 32 2 33 11 489

Brazil  
Hi-Tek Electronica Ltda.  
Al. Amazonas 422, Alphaville  
CEP 06400 Barueri  
Sao Paulo  
TEL: 55 011 421-5477

Canada  
Fluke Electronics Canada Inc.  
400 Britannia Road East, Unit #1  
Mississauga, Ontario  
L4Z 1X9  
TEL: 416 890-7600

Chile  
Intronsa Inc.  
Casilla 16228  
Santiago 9  
TEL: 56 2 232-1886/ 232 4308

China  
Fluke Service Center  
Room 2111 Scite Tower  
Jianguomenwai Dajie  
Beijing 100004, PRC  
TEL: 86 1 512-3436 or -6351

Colombia  
Sistemas E Instrumentacion, Ltda.  
Carrera 21, NO. 39A-21, OF. 101  
Ap. Aereo 29583  
Bogota  
TEL: 57 287-5424

Costa Rica  
Electronic Engineering, S.A.  
Carretera de Circunvalacion  
Sabanilla Av. Novena  
San Jose  
TEL: 506-53-3759

Denmark  
Fluke Danmark A/S  
Ejby Industrivej 40  
2600 Glostrup  
TEL: 45 43 44 1900  
FAX: 45 43 43 9192

Ecuador  
Proteco Coasin Cia., Ltda.  
P.O. Box 17-03-228-A  
Ave. 12 de Octubre  
2449 y Orellana  
Quito  
TEL: 593 2 230283 or 520005

Egypt  
Phillips Egypt  
10, Abdel Rahman el Rafei st.  
el. Mohandessin  
P.O. Box 242  
Dokki Cairo  
TEL: 20 2 490922

Federal Republic of Germany  
 Fluke Deutschland G.m.b.H.  
 Miramstrasse 87  
 34123 Kassel  
 TEL: 49 561 501 1495  
 FAX: 49 561 501 1690

Finland  
 Fluke Finland Oy  
 P.L. 75  
 02631 Espoo  
 TEL: 358 0 5026 600  
 FAX: 358 0 5026 414

France  
 Fluke France S.A.  
 105 Rue de Paris BP 187  
 93003 Bobigny, Cedex  
 TEL: 33 1 49 42 8080  
 FAX: 33 1 49 42 8100

Greece  
 Philips S.A. Hellenique  
 15,25th March Street  
 177 78 Tavros  
 10210 Athens  
 TEL: 30 1 4894911

Hong Kong  
 Schmidt & Co (H.K.) Ltd.  
 18/FL., Great Eagle Centre  
 23 Harbour Road  
 Wanchai  
 TEL: 852 507-0222

India  
 Hinditron Services Pvt. Inc.  
 33/44A Raj Mahal Vilas Extension  
 8th Main Road  
 Bangalore 560 080  
 TEL: 91 812 346-266 or 340-068

Hinditron Services Pvt. Inc.  
 1st Floor, 17-B,  
 Mahal Industrial Estate  
 Mahakali Road, Andheri East  
 Bombay 400093  
 TEL: 91 2 6300043

Hinditron Services Pvt. Ltd.  
 15 Community Centre  
 Panchshila Park  
 New Delhi 110 017  
 TEL: 91 011 643-3675

Hinditron Services Pvt. Ltd.  
 Field Service Center  
 Emerald Complex 1-7-264  
 5th Floor  
 114 Sarojini Devi Road  
 Secunderabad 500 003  
 TEL: 91 842-844033

Indonesia  
 P. T. Daeng Brothers  
 Phillips House  
 J1. Rasuna Said Kav. 3-4  
 Jakarta 12950  
 TEL: 62 21 520 1122

Israel  
 R.D.T. Electronics Engineering, Ltd.  
 P.O. Box 58013  
 Tel Aviv 61580  
 TEL: 972-3-5483737

Italy  
 Fluke Italia s.r.l.  
 Viale Casati 23  
 20052 Monza (MI)  
 TEL: 39 39 203 6519  
 FAX: 39 39 203 6619

Japan  
 Fluke Corporation  
 Sumitomo Higashi Shinbashi Bldg.  
 1-1-11 Hamamatsucho  
 Minato-ku  
 Tokyo 105  
 TEL: 81 3 3434-0181

Korea  
 Myoung Corporation  
 Yeo Eui Do P.O. Box 14  
 Seoul 150  
 TEL: 82 2 784-9942

Malaysia  
 Mecomb Malaysia Sdn. Bhd.  
 P.O. Box 24  
 46700 Petaling Jaya  
 Selangor  
 TEL: 60 3 774-3422

Mexico  
 Mexel Mexicana De Electronica  
 Industrial, S.A. De C.V.  
 Calle Diagonal #27 3er.  
 Col. Del Valle  
 C.P. 03100, Mexico D.F.  
 TEL: 52-5-682-9-8040

Netherlands  
 Fluke Nederland B.V.  
 Postbus 1337  
 5802 BH Eindhoven  
 TEL: 31 40 644100  
 FAX: 31 40 644111

New Zealand  
 Phillips Customer Support  
 Scientific & Industrial  
 2 Wagener Place Mt. Albert  
 Private Bag, St. Lukes  
 Auckland 3  
 TEL: 64 9 894-160

Norway  
 Fluke Norge A/S  
 Ole Deviks vei 2  
 N 0666 Oslo  
 TEL: 47 22 653400  
 FAX: 47 22 653407

Peru  
 Importaciones & Representaciones  
 Electronicas S.A.  
 Avad Franklin D. Roosevelt 105  
 Lima 1  
 TEL: 51 14 288650

Philippines  
 Spark Electronics Corp.  
 P.O. Box 610, Greenhills  
 Metro Manila 1502  
 TEL: 63 2 700-621

Portugal  
 Fluke Ibérica, S.L.  
 Rua Dr. A. Loureiro Borges 5  
 Arquiparque - Miraflores  
 P.O. Box 300  
 2795 LINDA-A-VELHA  
 TEL: 351 1 4101000  
 FAX: 351 1 4107986

Republic of South Africa  
South African Philips (Pty) Ltd.  
P.O. Box 7703  
Johannesburg 2000  
TEL: 27 11 889-3911

Singapore  
Rank O'Connor's Singapore Pte Ltd  
98 Pasir Panjang Road  
Singapore 0511  
TEL: 65 4737944

Spain  
Fluke Ibérica, S.L.  
C/Martinéz Villergas, 2  
28027 Madrid  
TEL: 34 1 326 7146  
FAX: 43 1 326 0668

Sweden  
Fluke Sverige AB  
Box 61  
164 94 Kista  
TEL: 46 8 751 0230  
FAX: 46 8 751 0480

Switzerland  
Fluke (Switzerland) AG  
Riedstrasse 12  
Postfach 360  
CH-8953 Dietikon  
TEL: 41 1 745 2244  
FAX: 41 1 745 2240

Taiwan, R.O.C.  
Schmidt Electronics Corp.  
5th Floor, Cathay Min Sheng  
Commercial Building,  
344 Min Sheng East Road  
Taipei  
TEL: 886 2 501-3468

Thailand  
Measuretronix Ltd.  
2102/31 Ramkhamhaeng Road  
Bangkok 10240  
TEL: 66 2 375-2733.375-2734

Turkey  
Turk Philips Ticaret A.S.  
Inonu Caddesi 78/80  
Posta Kutusu 504-Beyoglu  
Istanbul  
TEL: 90 1 1435891

United Kingdom  
Fluke (UK) Ltd  
Colonial Way  
Watford  
HERTS WD2 4TT  
TEL: 44 923 240511  
FAX: 44 923 225067

Uruguay  
Coasin Uruguay S.A.  
Casilla de Correo 1400  
Libertad 2525  
Montevideo  
TEL: 598-2-789015

Venezuela  
Coasin C.A.  
Calle 9 Con Calle 4, Edif. Edinurbi  
Apartado de Correos Nr-70-136  
Los Ruices  
Caracas 1070-A  
TEL: 58 2 241-0309, 241-1248





## Appendix 8E Terminology

---

Following list defines special terms used in this manual. The terms are listed in alphabetical order. Words shown in italics can be found elsewhere in the list.

**AC** See "Alternating Current."

**AC Coupling** A mode of signal transmission that passes the dynamic AC signal component to channel A and channel B but blocks the DC component. Useful to observe an AC signal that is normally riding on a DC signal.

**Activate** The steps necessary to turn on a feature or function.

**Alternating Current** An electrical signal in which current and voltage vary in a repeating pattern over time.

**Amplitude** The difference between the highest and lowest level of a *waveform*.

**Attenuation** The decrease in *amplitude* of a signal.

**Average** A processing technique to obtain the average value of a *repetitive* signal, useful to eliminate *noise*.

**Auto Set** A feature of ScopeMeter that automatically produces a stable *waveform* of usable size. Auto Set adjusts Voltage Scale and Time Base based on the characteristic of the active waveform.

**Backlight** A light that brightens 97 ScopeMeter's *display*.

**Bandwidth** The range of *frequencies* that ScopeMeter can display accurately with no more than -3 dB (.7x) *attenuation* of the original signal.

**BNC** Coaxial type input connector used for channel A and channel B.

**Bottom Display** The lower part of ScopeMeter's *display*, where the *Softkey* functions are listed.

**Capture 20 Divisions** A feature that allows ScopeMeter to record and *display* 20 time divisions, although the display only shows 10 at a time. "Move" allows you to view the additional 10 divisions.

**Compensation** Probe adjustment for 10:1 *probes* that balances the capacitance of the probe with the input capacitance of your ScopeMeter.

**Cursors** Movable display markers that allow you to make measurements between two locations on a *waveform*.

**Cycle** One complete set of changes in a recurring signal.

**DC** See "Direct Current."

**DC Coupling** A mode of signal transmission that passes both AC and DC signal components to the channel A and channel B circuit (see also *AC Coupling*).

**Deactivate** A series of steps necessary to turn off a feature or function.

**Delay Time** The time between the trigger event and the real acquisition of the waveform.

**Delta Time** The change in time. When chosen from the Cursor menu, ScopeMeter displays the amount of time displayed between the *Cursors*.

**Digital Storage Capability** Because of the design of digital oscilloscopes, signals are not displayed at the moment they are acquired. Instead, signals are first stored in memory, and then send to the *display*. This enables ScopeMeter to present several options when displaying information, including "negative delay."

**Direct Current** A signal with a constant voltage and current.

**Division** A part of a *waveform*, as defined alongside the lines of the grid on ScopeMeter's *display*.

**Dual Trace** A feature that allows ScopeMeter to display two separate live *waveforms* at the same time.

**Duty Cycle** Relative on-time to total on/off-time, as measured in Percentage of Pulse Width.

**Earth Ground** Reference point which is directly connected to the ground via a conductor.

**Envelope** The display of a *waveform* that shows the variation extremes of several acquisitions (see also *Record*).

**Falling Slope** The part of a *waveform* that shows the voltage decreasing.

**Filter** Function that reduces or removes certain electrical components from a signal.

**Free Run** Feature that allows ScopeMeter to display a *waveform* without a trigger.

**Freeze** To *hold* a *waveform* acquisition: freezes the display for closer examination (see also Hold).

**Frequency** The number of times a *waveform* repeats in one second, measured in *Hertz* (Hz) where one Hz is one cycle per second.

**Glitch** A momentary spike in a *waveform*.

**GND** See "Ground".

**Ground** The voltage reference point in a circuit.

**Hardcopy** A copy on paper of ScopeMeter's *display* (Model 97), made by a printer.

**Hardkeys** ScopeMeter keys that have always the same function, regardless of ScopeMeter's mode.

**Hertz** Unit of measure for counting the number of times that an electrical cycle repeats every second. One Hertz is one cycle per second.

**Hold** A feature of ScopeMeter that allows you to *freeze* the *display* for closer examination.

**Intermittent** A condition that happens with no apparent or predictable pattern.

**LCD** See "Liquid Crystal Display."

**Liquid Crystal Display** A *display* that uses liquid crystals to display *waveforms* and text on its screen.

**Main Display** The center *display* area that shows measurement results or displays the waveform(s).

**Master Reset** Procedure to restore ScopeMeter to a set of standard settings.

**Maximum Peak** The highest voltage recorded over a specific time period.

**Menu** A list of choices on the *display* to select functions via the five *softkeys*.

**Message Bar** A way for ScopeMeter to display information for the user.

**Meter Mode** In this setting, ScopeMeter works like a digital multimeter, presenting information in a digital readout, and sometimes also a reduced Scope display.

**MIN-MAX on A** Feature of ScopeMeter that increases its sampling rate to maximum so that *glitches* can be detected.

**Minimum Peak** The lowest voltage recorded over a specific time period.

**Negative Duty Cycle** Timing measurement that represents the ratio of the negative pulse width to the signal period, expressed as a percentage.

**Noise** Extraneous electrical signal, mostly unwanted.

**Non-Repetitive Pulse** A random electrical signal, with no specific pattern or frequency.

**Oscillations** The up-and-down peaks of a *waveform*. One oscillation consists of one complete up-peak and one complete down-peak.

**Oscilloscope** A device for viewing and diagnosing electrical signals such as *waveforms*.

**Peak-to-Peak** A feature of ScopeMeter for measuring the highest and lowest voltage measured over a specific time period.

**Percentage of Pulse Width** The ratio of signal on-time to its total cycle time, as measured in percent.

**Pop-up Menu** A list of choices displayed along ScopeMeter's *Right Display* for configuring a *Setup* or choosing a feature.

**Positive Duty Cycle** Timing measurement that represents the ratio of the positive pulse width to the signal period, expressed as a percentage.

**Probe Calibration** A procedure to allow ScopeMeter to adjust internally to compensate for resistance variations between probes.

**Probes** Measuring conductor that connects ScopeMeter to a circuit; specifically for use in the *BNC* jacks.

**Pulse** A *waveform* that increases from a constant value, then decreases to its original value.

**Pulse Trains** A repetitive series of pulses.

**Pulse Width** The duration from the beginning to the end of a signal's on-time or off-time.

**Range** The quantity between two points or levels.

**Recall** The function of loading a stored *Setup* or *Waveform* back into ScopeMeter.

**Record** A feature that allows ScopeMeter to draw a new *trace* without erasing earlier traces (*envelope*). This allows you to capture momentary *glitches* without having to visually monitor the signal.

**Repetitive Pulse** A signal with a regular pattern or *frequency*.

**Right Display** A display area listing existing conditions about ScopeMeter, and a location for *Pop-up menus*.

**Rising Slope** The part of a *waveform* displaying a rise in voltage.

**RMS** See "Root Mean Square."

**Root Mean Square** Conversion of AC voltages to the effective DC value.

**Sample** A momentary reading taken from an input signal. ScopeMeter takes a series of samples to display a *waveform*.

**Sampling Rate** The number of readings taken from a signal every second. ScopeMeter can take up to 25,000,000 samples per second.

**Scope Mode** In this setting, ScopeMeter works like a digital *oscilloscope*.

**Setup** Series of adjustments necessary for ScopeMeter to display a *waveform* or reading.

**Setup Memories** A feature that allows ScopeMeter to save an existing *setup* for later use.

**Sine Wave** A common curved *waveform* that is mathematically defined.

**Single Shot** Feature that allows ScopeMeter to capture a single event.

**Softkey Menu** See "Bottom Display".

**Softkeys** ScopeMeter keys that change function based on the current mode or settings. Softkey definitions appear in the *Bottom Display*.

**Square Wave** A common *waveform* that consists of repeating square pulses.

**Sweep Speed** see "Time Base"

**Time Base** The time defined per horizontal division on ScopeMeter's *display*, expressed in seconds per division.

**Top Display** The upper edge of the *display*, where ScopeMeter lists probe calibration, Voltage scale, *time Base*, voltage Coupling, and *trigger* information.

**Trace** The displayed *waveform* that shows the voltage variations of the input signal as a function of time.

**Trigger** Determines the beginning point of a *waveform*.

**Trigger at 50%** A feature that automatically sets ScopeMeter's *Trigger Level* half-way between the highest and lowest voltage recorded.

**Trigger Delay** The time after the voltage crosses the *Trigger Level*.

**Trigger Level** The voltage level that an input signal must reach before ScopeMeter will read in.

**Trigger Slope** The voltage direction necessary for ScopeMeter to begin its trace. A positive Slope requires the voltage to rise as it crosses the *Trigger Level*. A negative Slope requires the voltage to be fall.

**Trigger Source** The signal that triggers ScopeMeter. This can be the signal being viewed, or it can come from another signal.

**Voltage at One** A feature that allows ScopeMeter to display the signal voltage directly under Cursor 1.

**Voltage Spike** A momentary increase or decrease in voltage (see also *Glitch*).

**Waveform** The pattern defined by an electrical signal.

## Appendix 8F Menu Trees

---

This appendix presents a series of charts showing the interrelationships of the softkey and pop-up menus. The charts are organized as follows:

- Figure 8F.1 presents menu sequences you will encounter only in Meter Mode.
- Figure 8F.2 presents menus only used with Scope Mode.
- Figure 8F.3 shows the set of menus used with both Meter and Scope Modes.

### *Note*

*The charts show trees for Model 97. However, Models 93 and 95 have fewer softkey choices. Where not applicable, it is indicated in the charts.*



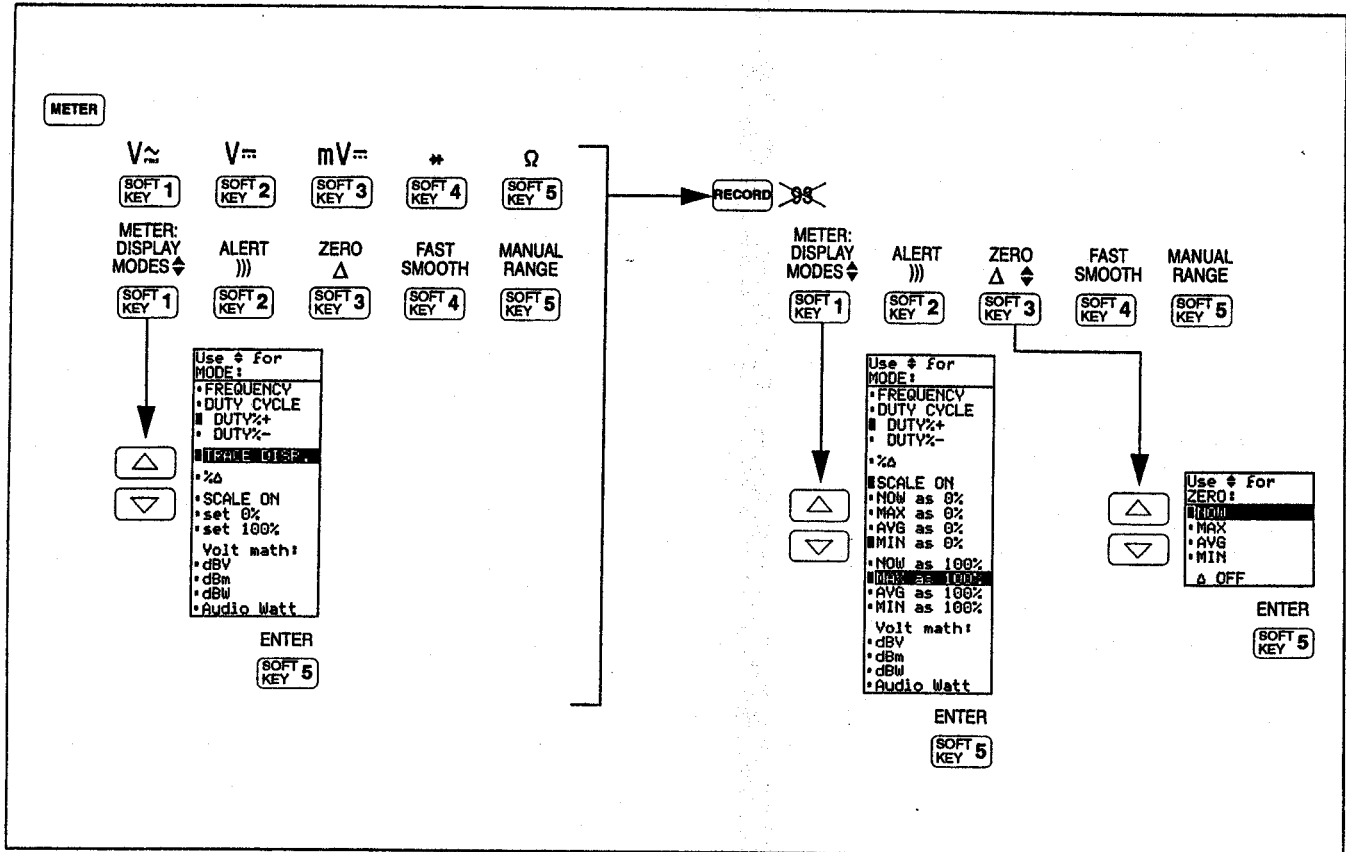

Figure 8F.1 Meter Mode Menus

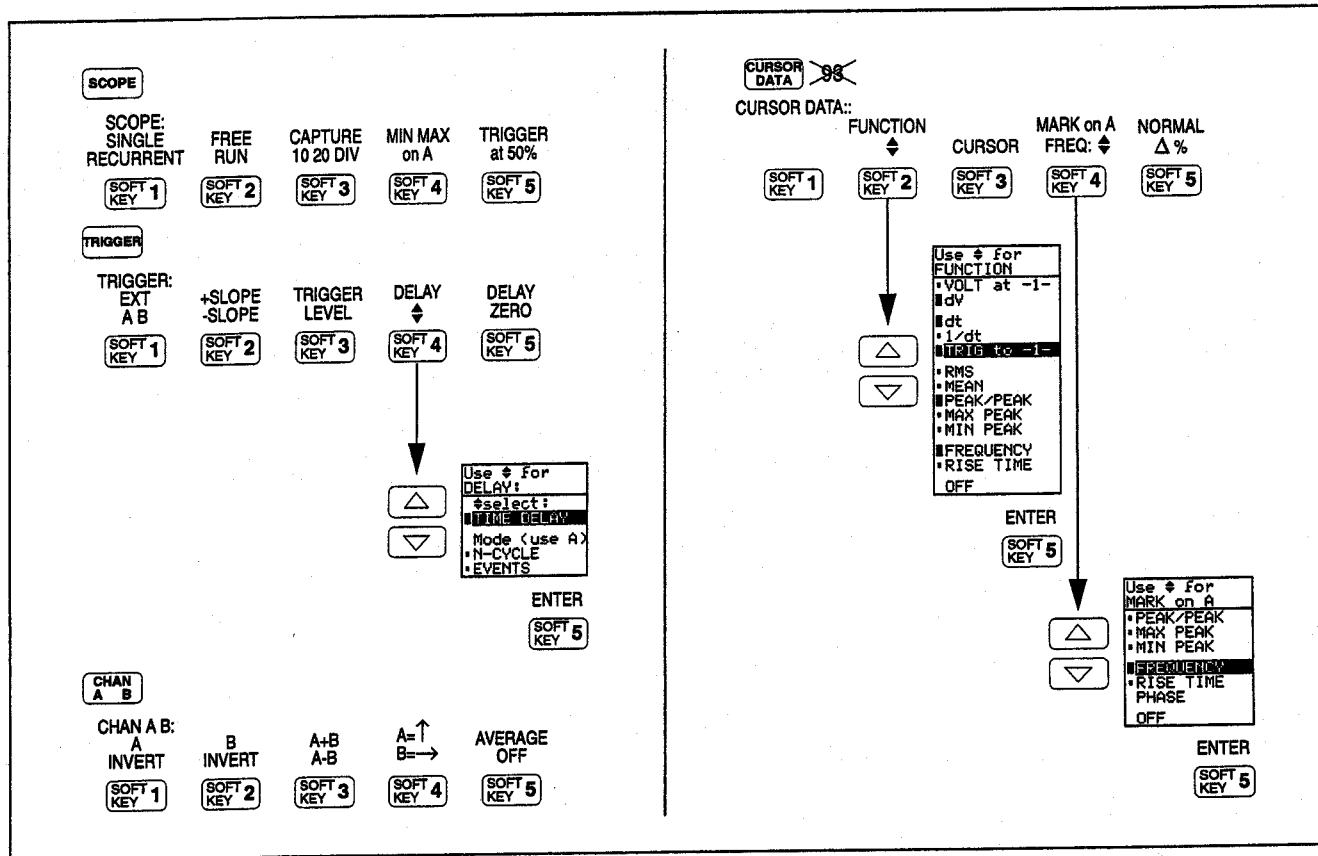

Figure 8F.2a Scope Mode Menus

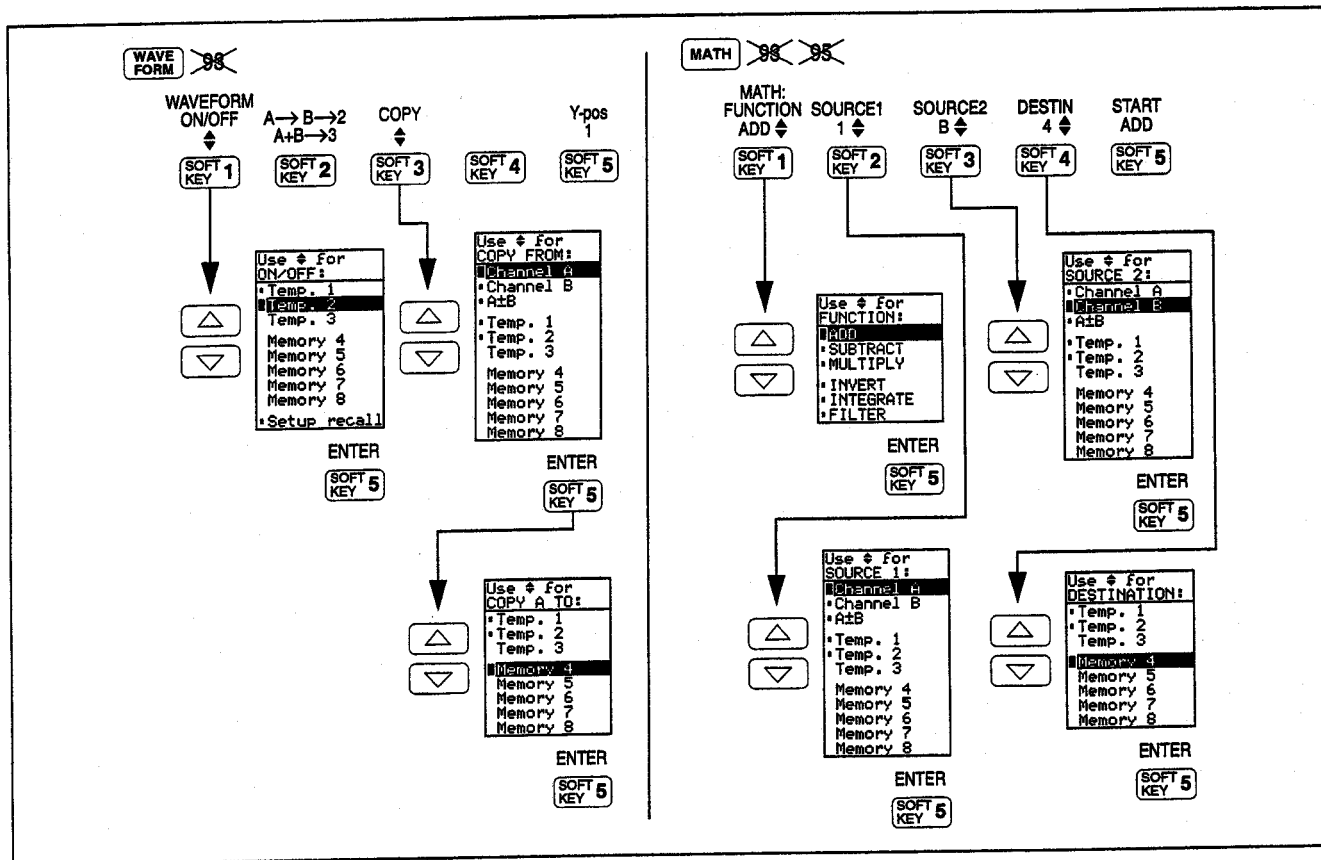

Figure 8F.2b Scope Mode Menus

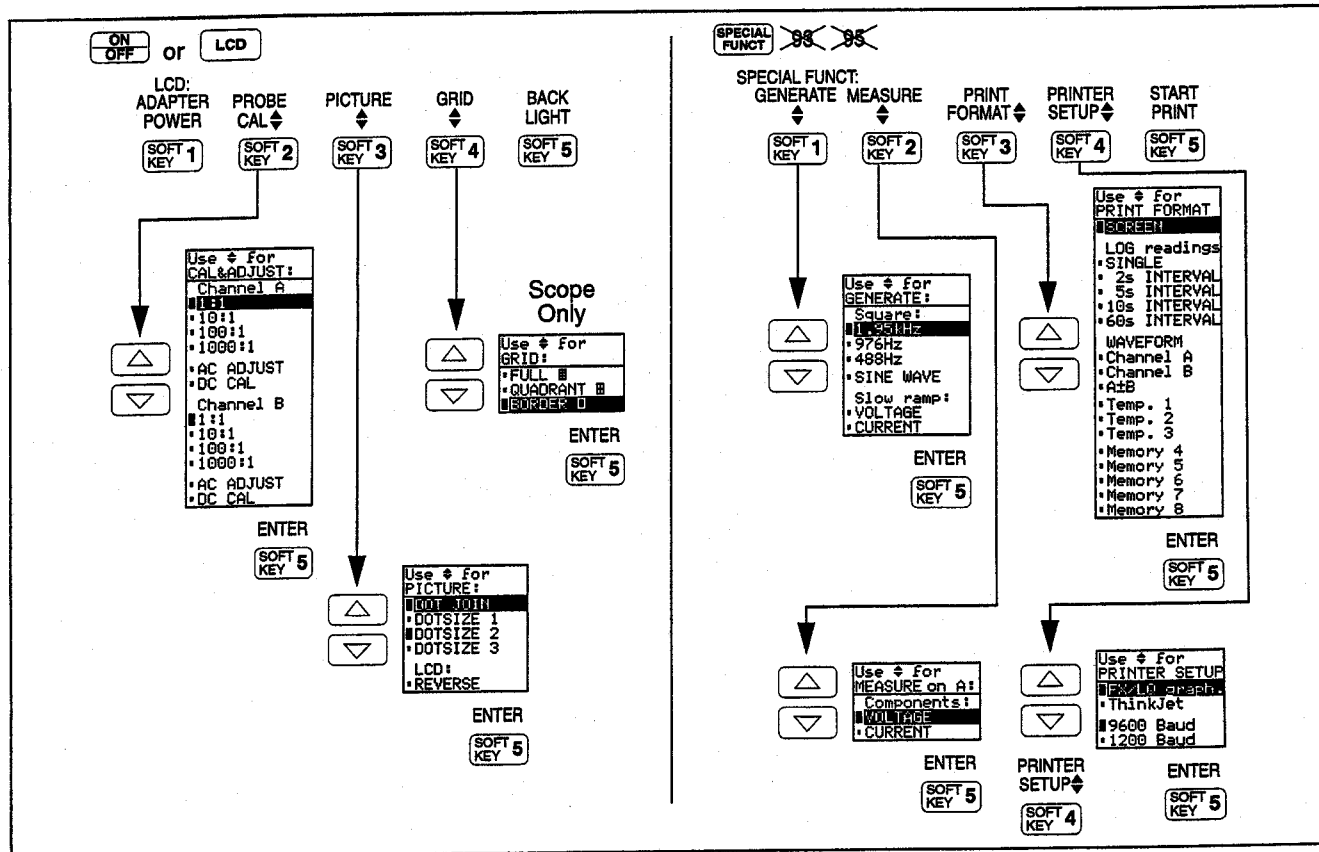

Figure 8F.3a General Usage Menus

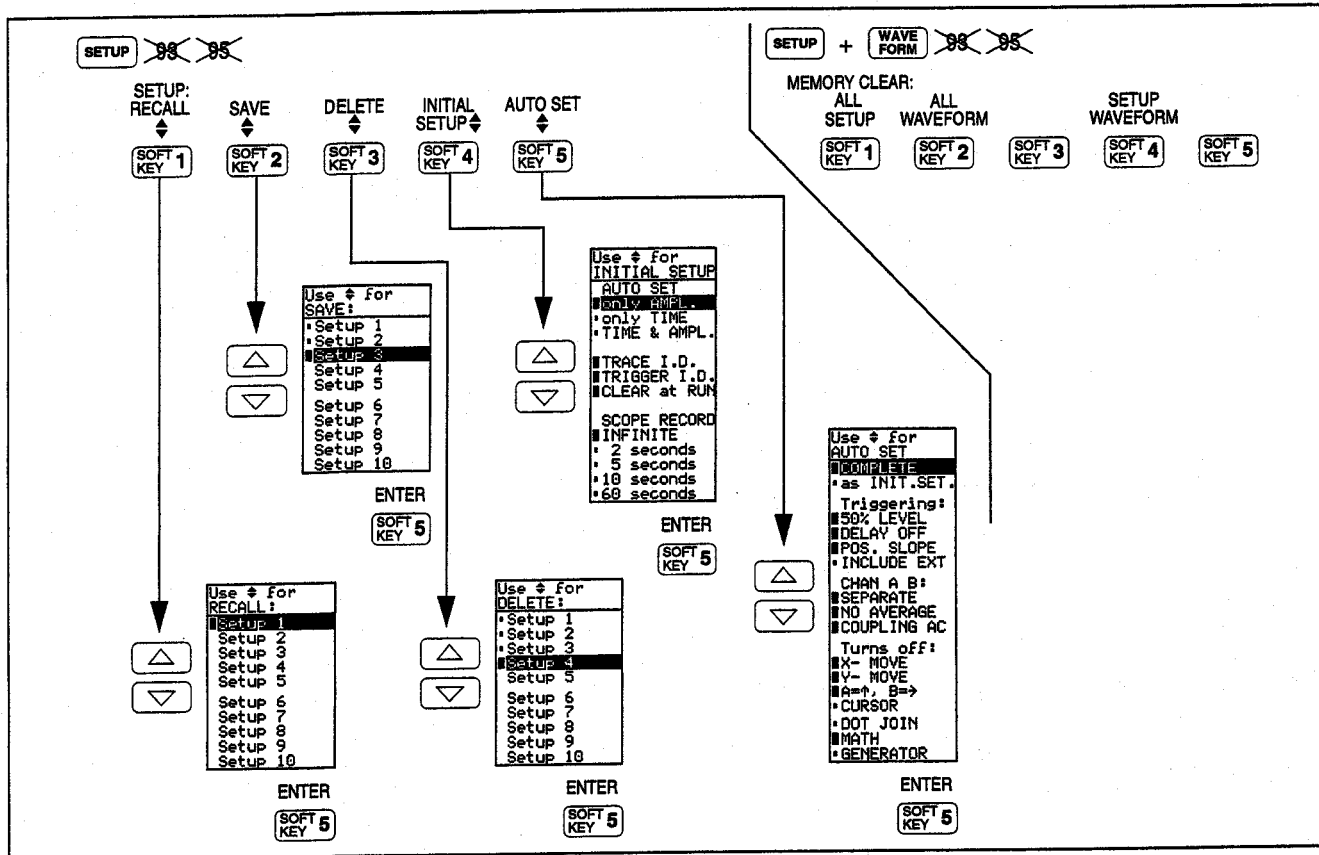

Figure 8F.3b General Usage Menus

# INDEX

---

## ***Symbols***

---

$\% \Delta$  ..... 2-11

## ***Numerics***

---

1/dt ..... 4-3  
10-minute demonstration ..... 1-8

## ***A***

---

A and B Added ..... 3-11  
A+B ..... 3-11  
A= $\uparrow$  B= $\rightarrow$  ..... 3-11  
A-B ..... 3-11  
AC Adapter ..... 1-4  
AC Measurement ..... 6-7  
Accessory Information ..... 8-11  
Ac-coupled input ..... 2-4

Add ..... 4-11  
Adjusting the Amplitude ..... 3-9  
Adjusting the Display ..... 1-9  
Adjusting the Probe ..... 7-5  
Adjusting the Time Base ..... 3-9  
Advanced ..... 4-2  
Advanced Features ..... 6-2  
Alert ..... 2-11  
Amplitude ..... 3-9  
Auto Range ..... 2-5  
Auto Set ..... 1-11, 3-3, 6-9  
Auto Set Configuration ..... 4-17  
Auto Set Pop-Up Menu ..... 4-17  
Automatic Power Shutdown ..... 1-5  
Auto-measurement Function ..... 2-3  
Automotive Adapter ..... 1-4  
Average ..... 2-9  
Averaging ..... 3-12

**B**

Backlight	1-9
Banana Jack Inputs	1-6
Battery Charging	1-4, 1-5
Battery Pack	1-4
Battery Replacement	7-3
Battery Save Feature	1-5
Best Trigger Edge	6-15
BNC Safety Inputs	1-6
BORDER	1-10
Bottom Display	1-7

**C**

Calibration	7-4
Capture 10 20 Divisions	3-5
Channel Selection	3-11
Channel Softkey Menu	3-11
Characteristics	8-3
Cleaning	7-2
Clearing Memory	4-5
Common Ground	1-6
Component Measurement Pop-Up Menu	4-19
Computer Interface	1-6
Configuration	4-17
Configuration Settings	4-16
Connections	3-2
Contrast	1-9
Copy Waveforms	4-7

Current Measurement Setup	5-4
Current Measurements	5-3
Current Probe	5-3
Cursor Amplitude (Voltage) Measurements	6-24
Cursor Data Softkey Menu	4-2
Cursor Function	4-3
Cursor Function Pop-Up Menu	4-3
Cursor Marker Pop-Up Menu	4-4
Cursor Measurements	6-24
Cursor Phase Measurements	6-27
Cursor Source	4-3
Cursor Time Measurements	6-26
Cursors	4-2, 5-12

**D**

dc-coupled input	2-4
Default Startup Probe Type	1-10
Delay Menu	5-2
Delay Zero	3-8
Delete	4-7
Demo Board	4-2, 6-2
Demonstration (DEMO) Board	VII, 1-12
Diode Test Function	2-5
Direct Voltage Function	2-5
Display Hold	2-8
Display Modes	2-6, 2-11
Displaying Stored Waveforms	4-9
Dot Join	1-9
Dotsize	1-9

dt .....	4-3
Dual Channel Connections .....	VIII
Dual Channel Three Phase Measurements .....	5-10
Duty Cycle .....	2-7
dV .....	4-3

## ***E***

---

Earth Ground .....	IV
Electrically Floating .....	IV
Envelopes .....	3-13
Environmental Care .....	VII
Events .....	3-8
External Trigger .....	3-6

## ***F***

---

Fast/Smooth .....	2-11
Features .....	4-2
Filter .....	4-13
Frequency .....	2-6, 4-4
Full .....	1-10
Fuse Replacement .....	7-4

## ***G***

---

Generator .....	3-6
Getting Started .....	1-8
Glitches .....	6-20
Grid Selection .....	1-10

## ***H***

---

Hardkeys .....	1-8
Hidden Signal Details .....	6-20
Holster .....	1-2

## ***I***

---

Initial Setup Pop-Up Menu .....	4-16
Input coupling .....	2-4
Input Impedance .....	3-2
Input/Output Terminal Ratings .....	1-6
Integrate .....	4-12
Invert .....	3-11, 4-12
Isolated .....	IV

## ***K***

---

Keypad .....	1-8
--------------	-----

## ***L***

---

LCD Menu .....	1-9
Low Frequency Measurements .....	1-6, 6-15
Low Frequency Voltage Measurements .....	6-4

## ***M***

---

Main Display .....	1-7
Manual Ranging .....	2-4, 2-5



Markers .....	4-4
Master Reset .....	1-10, 4-17
Master Reset Configuration .....	4-16
Math Function Pop-Up Menu .....	4-10
Math Functions .....	6-29
Math Source1/Source2/Destin Pop-Up Menus .....	4-11
Mathematics .....	4-10
Max Peak .....	4-3
Maximum (MAX) .....	2-9, 6-4
Mean .....	4-3
Measurements Connections .....	1-6
Measuring Components .....	4-19
Measuring Power .....	5-6
Memory .....	4-5
Memory Clear Softkey Menu .....	4-5
Menu Trees .....	8-29
Message Bars .....	1-7
Meter Auto-measurement Function .....	2-3
Meter Functions .....	2-4
Meter Inputs .....	1-6
METER MODE CONNECTIONS .....	2-2
Meter Mode Connections .....	2-2
Meter Ranges .....	2-4, 2-6
Meter Record .....	2-9
Meter Record Display Modes Pop-Up Menu .....	2-14
Meter Record Mode .....	2-13, 2-15
Meter Record Zero Pop-Up Menu .....	2-15
Meter Softkey Menus .....	2-4
MIN MAX on A .....	3-5, 3-11
Min Peak .....	4-4

Minimum (MIN) .....	2-9, 6-4
Multiple Waveforms .....	3-14
Multiply .....	4-12

## N

N-cycle .....	3-8, 6-14
Nickel-Cadmium Battery .....	7-3
Noise .....	6-21
Noise Suppression .....	4-13

## O

Overload .....	2-10
----------------	------

## P

Peak/Peak .....	4-3
PerformanceTest .....	7-5
Phase .....	4-4
Phase Measurement .....	5-12
Picture .....	1-9
Positioning the Waveform .....	3-10
Power Consumption .....	5-6
Power Measurement Setup .....	5-7
Powering ScopeMeter .....	1-4
Print Format .....	4-14
Print Format Pop-Up Menu .....	4-14
Printer Output .....	1-6
Printer Setup .....	4-15

Printer Setup Pop-Up Menu .....	4-15
Printing .....	4-14
Probe Calibration .....	7-4
Probe Type .....	1-10

## **Q**

---

Quadrant .....	1-10
Quick Meter Operation .....	1-13
Quick Operating Guide .....	1-2
Quick Scope Operation .....	1-15
Quick Waveform Storage .....	4-8

## **R**

---

Ranges .....	2-4, 2-6
Reading the Display .....	1-7
Recall .....	4-7
Recall Waveforms .....	4-7
Record .....	3-13
Recurrent .....	3-3, 3-9
Replacing the Batteries .....	7-2
Resistance Function .....	2-5
Right Display (including Pop-Up Menu) .....	1-7
Rise Time .....	4-4
Roll .....	3-9
Roll Mode .....	3-4
Root Mean Square (RMS) .....	4-3
Root-Mean-Square Signals .....	2-4

Rotation Measurements .....	5-11
RS-232-C Optical Interface .....	1-6

## **S**

---

Save .....	4-6
Save Waveforms .....	4-7
Saving and Copying Waveforms .....	4-8
Scaling .....	2-12
Scope Inputs .....	1-6
Scope Mode Connections .....	3-2
Scope Record .....	3-13
Scope Softkey Menu .....	3-3
ScopeMeter Tutorial Setup .....	6-3
Selecting the Trigger .....	3-6
Service Centers .....	8-17
Service Manual .....	8-13
Set Scale Values .....	2-13
Setup Recall .....	4-9
Setup Recall Pop-Up Menu .....	4-7
Setup Save Pop-Up Menu .....	4-6
Setup Softkey Menu .....	4-6
Setups .....	4-6
Signal Generator Output .....	1-6
Single .....	3-4, 3-9
Single Channel Connections .....	VIII, IX
Single Measurements .....	5-2
Single Shot Measurement .....	5-3
Single Shot Measurements .....	6-18

Smooth .....	2-11
Smoothing .....	4-13
Softkeys .....	1-8
Specifications .....	8-3
Stabilizing the Trace Display .....	6-6
Stable Trigger Source .....	6-11
Standard Kit Contents .....	8-13
Start Print .....	4-15
Stored Waveforms .....	4-9
Subtract .....	4-11

## ***T***

---

Terminology .....	8-23
Testing Potentiometers .....	6-8
Three Phase System .....	5-10
Tilt Stand .....	1-3
Time Base .....	3-9
Time Base and Amplitude Adjustment .....	3-9
Time Delay .....	3-8
Top Display .....	1-7
Touch Hold .....	2-8
Trace Display .....	2-7
Trig to -1- .....	4-3
Trigger at 50% .....	3-8
Trigger Basics .....	3-6
Trigger Delay .....	3-7
Trigger Delay Pop-Up Menu .....	3-7
Trigger Level .....	3-6
Trigger Mode and Display .....	6-16

Trigger Slope .....	3-6
Trigger Softkey Menu .....	3-6
Trigger Source .....	3-6
Triggering .....	4-18
Tutorial .....	6-2

## ***U***

---

Undo .....	1-11
Using the Keys .....	1-8

## ***V***

---

Verification .....	7-6
Volt at -1- .....	4-3
Volt Math .....	2-13

## ***W***

---

Warranty .....	8-17
Waveform Acquisition .....	3-3
Waveform Copy From/To Pop-Up Menus .....	4-8
Waveform ON/OFF Pop-Up Menu .....	4-9
Waveform Positioning .....	3-10
Waveform Softkey Menu .....	4-7
Waveforms .....	4-7

## ***X***

---

X-Y mode .....	3-11
----------------	------

**Z**

---

Zero $\Delta$ .....	2-11
Zero Value .....	2-15
Zoom .....	3-5